

# **Genetic resources of native tree species and their deployment under climate change**

**Richard R Whittet**

A thesis submitted in fulfilment of the requirements for the degree of Doctor of  
Philosophy in the School of Biological Sciences

The University of Edinburgh

**2016**



## **Declaration of Authorship**

I, Richard Whittet, declare that this thesis, titled, “Genetic resources in native tree species and their deployment under climate change” and the work presented in it are my own. I confirm that:

1. This work was done wholly or mainly while in candidature for a research degree at this University.
2. Where any part of this thesis has previously been submitted for a degree or any other qualification at this University or at any other institution, this has been clearly stated.
3. Where I have consulted the published work of others, this is always clearly attributed
4. Where I have quoted from the work of others, the source is always given. With the exception of such quotations, this thesis is entirely my own work.
5. I have acknowledged all main sources of help.
6. Where the thesis is based on work done by myself jointly with others, I have made clear exactly what was done by others and what I have contributed myself.

Signed:

Date:

*“Every heritor, Life-Renter, and Wodsetter... within this ancient Kingdom of Scotland, worth one thousand pounds of yearly values Rent shall inclose four Aikers of Land Yearly at least, and enclose the same about with Trees of Oak, Elm, Ash, Plain, Sauch, or other Timber at three yards distance”*

*~ Act of the Parliament of Scotland, 1661*

## Lay summary

Planting trees provides society with many benefits. Trees provide timber, wood and other products, they provide habitat for wildlife, they provide us with beautiful places to visit, they provide employment, shelter, and they reduce flooding and store carbon from the atmosphere in exchange for the air that we breathe. For these reasons, Governments in the United Kingdom and elsewhere are committed to planting trees to increase the area of woodland.

Different members of the same species can vary substantially. In trees, it may not be quite as obvious as it is with dogs or humans but over many generations of natural selection in specific environments, trees often become adapted to aspects of their home environment, a phenomenon known as local adaptation. One consequence of local adaptation is that it means that locally collected seed should have an advantage, in some way, over non-locally collected seed if they are grown together. For this reason, when planting woodland, seed for planting has traditionally been collected from a local forest under the assumption that it will be best suited for the planting site and that it will help to conserve natural patterns of genetic variation. Under rapid climate change, the environments to which trees are adapted are changing at rates much faster than populations of trees can move and so it has been suggested that we should collect seed from further south, as trees will be better adapted to the warmer conditions expected in the future. However, there is little evidence yet to suggest that this strategy will work – and, at least in Britain, information on variation within and between populations of trees is very much limited.

This thesis begins by investigating the specific case of ancient semi-natural ‘Caledonian’ Scots pine forests in Scotland. Seed zones for Scots pine were defined by describing geographical regions in which the trees contain different frequencies of biochemical markers. However, the biochemical variation is not thought to influence tree survival, and the regions, which are all in the uplands, contain much environmental variation within them. By looking at the other plants that grow in these forests, and analysing long term average climatic variables, a more biologically meaningful way to match seed sources to planting sites is recognised and described.

Adaptation to climate change will depend on exchange of genes (via pollen and/or seed) between different populations of trees, to ensure that there will be high levels of genetic variation upon which natural selection can act. This can only be successful if trees in different places can reproduce at the same time. To discover whether this is the case, a

sample of twenty trees at each of three (2014) to five (2015, 2016) native pinewood sites was visited in three consecutive springs. The results show that pollen is released by male flowers earliest in the warmer west of Scotland, and they can be separated from the trees in the colder east by up to fifteen days but that populations which are closer to one another will be more synchronised.

Computer simulations were used to test different methods of sourcing seed (collecting seed locally, collecting seed from further south, collecting mixtures of local and southern seed, collecting seed from anywhere). The simulations suggest that planting trees grown from seed collected further south means that more adaptive change can be achieved but that this can come at the cost of very high levels of mortality.

Members of the domestic forest nursery sector in Great Britain were consulted to identify problems they face when supplying native trees. The major issues, mentioned unanimously were related to the way forest planting schemes are funded and the limited notice nurseries get from their customers. It takes a long time to grow a tree from seed but it is almost impossible for these businesses to accurately predict demand which means that trees are either wasted when there is overproduction, or imported when there is a shortage. Reducing uncertainty and volatility in grant systems would help the nursery sector supply the trees that are needed for future forests.

UNIVERSITY OF EDINBURGH

**Abstract**

College of Science and Engineering

School of Biological Sciences

Doctor of Philosophy

**Genetic resources of native tree species and their deployment under climate change**

Richard Robert Whittet

Current and emerging threats to trees and forest ecosystems require a re-evaluation of the way forest genetic resources are managed. Governments in the United Kingdom and elsewhere are committed to the restoration, expansion and creation of new woodlands. Tree populations are often adaptively differentiated from one another, so a key question underpinning the success of planting schemes is the choice of seed origin. A long held understanding is that locally sourced seeds will have the best opportunity to tolerate conditions of the planting site (local provenancing). However, the rate at which the environment is changing introduces a great deal of uncertainty into decision making and there is concern that climate change is proceeding at rates faster than those with which locally adapted trees would be able to cope. As such, there are suggestions that seed collected from areas already experiencing the anticipated future conditions will improve the adaptability of forests (predictive provenancing). This thesis investigated outstanding questions relating to the merits of the local provenancing and predictive provenancing approaches, and the practical implementation of seed sourcing policy in British forestry.

The validity of existing seed zone boundaries used under local provenancing was analysed for ancient semi-natural Scots pine *Pinus sylvestris* L. forests of Scotland. Vegetation

description and analyses of climatic covariates revealed that the existing series of seed zones used to guide selection of planting stock for restoration do not necessarily environmentally match seed sources to planting sites under current conditions. Additional disparity is introduced when edaphic variation (or proxies for this) is considered.

To determine whether future adaptation under local provenancing may be restricted by limited pollen flow among populations of native Scots pine in Scotland, the timing of pollen production in five populations was estimated by repeatedly measuring strobilus development on a series of twenty trees over three consecutive springs. Differences in the mean predicted date of pollen production were found, with populations in the warmer west shedding pollen earliest each year, although the timing and differences in timing among populations varied from year to year, with shedding taking place earliest in the warmest of the three years and latest in the coolest year.

A theoretical multi-patch, ecological genetic individual-based model (IBM) was developed to investigate the utility of different seed sourcing strategies (local versus non local provenance) and their capacity to help populations adapt to directional climate change. As well as being adapted to climate, which varied in a clinal pattern, individuals also had to be well adapted to the habitat conditions of the planting site in order to survive hard selection at the seedling stage. The model showed that population size of a new planting was reduced when planting stock adapted to the future conditions but not to current conditions was deployed. The differences were most severe when selection acted simultaneously on both the climate-related and the habitat-related phenotype.

Finally, a series of in-depth qualitative surveys conducted with members of the domestic forest nursery and seed supply sector in Great Britain found that there are many difficulties associated with seed sourcing and the supply of trees. These problems arise due to a very limited ability to predict demand at the time of seed sowing, and lead to waste when demand is overestimated and importation of planting stock when demand is underestimated. Confidence and competitiveness in the domestic sector could be greatly improved by updating seed sourcing guidelines and by simplifying certain aspects of the process by which forest planting projects are funded.



## Acknowledgements

Firstly, I am very grateful to Forestry Commission Scotland and Forestry Commission GB for funding my project and to Climate XChange for generously providing me with a research expenses grant, which greatly enriched the project by enabling me to travel to collect data and attend conferences. Financial support was also received from EVOLTREE, which kindly provided me with a conference grant to present research at a conference in Iceland and from LabExCOTE for supporting my attendance at an excellent summer school in Aquitaine.

Secondly, I wish to signify gratitude and admiration for my supervisors; Richard Ennos, Stephen Cavers and Joan Cottrell who have provided me with much encouragement, invaluable advice and mentoring throughout the period of my PhD.

Dan Chapman wrote the lion's share of the code for the individual based model described in chapter four. This chapter would not exist without his R virtuosity and patient guidance.

Colin Edwards (Forestry Commission Scotland) has been especially supportive of the project, an excellent source of information and knowledge about all things operational within FCS, particularly at an early stage of the project. Thanks also to Amanda Campbell, and Sam Samuel who were very generous with their time whilst preparing the nursery surveys.

I was lucky to receive cooperation, information and interest from the many landholders and/or estate/reserves staff I contacted or met during my field visits and I was extremely lucky to have assistance, or at least company, from many people during my short but frequent field trips around Scotland and found that occupancy of the passenger seat in the Hilux was hotly contested. Many thanks are due to Zak Jeffcoat (3 trips); Anne Whittet, Nikola Petkovic; Vladimir Krivtsov and Andy Scobie.

I was delighted to discover that Britain has a seed supply and forest nursery sector full of very bright, engaged people. Their insights provided the basis for chapter five and it was a great pleasure to channel these into a piece of written communication which will hopefully be useful for everybody. The advice of Mireia Pecurul was very helpful in achieving this.

Assorted help or chat with many friends and colleagues at Ashworth labs, CEH and elsewhere has been fruitful. Honourable mention to Darren Obbard for being the nearest responsible adult throughout much of my PhD and to Luiz Fagundes de Carvalho, who has

provided expert statistical advice on several occasions, especially with the resampling method applied to seed zones vs climatic clusters in chapter two.

All of my family have been and continue to be incredibly supportive of me and for that I feel especially fortunate and grateful. Special credit is due to my loving parents, Alan and Anne Whittet, who have enabled me to arrive at this pleasant stage in my life.

Finally, much love to my chief field assistant, collaborator, editor, co-commiserator and all of the other more important things in between, Cristina Rosique Esplugas, to whom this thesis is dedicated.

## Table of contents

<b>Declaration of authorship</b>	<b>i.</b>
<b>Lay summary</b>	<b>iii.</b>
<b>Abstract</b>	<b>v.</b>
<b>Acknowledgements</b>	<b>vii.</b>
<b>Table of contents</b>	<b>ix.</b>
<b>List of figures</b>	<b>xii.</b>
<b>List of tables</b>	<b>xv.</b>
<b><i>1. Introduction and background.</i></b>	<b>1.</b>
<b>1.1. Introduction</b>	<b>1.</b>
<b>1.2. The forest resource of Great Britain</b>	<b>3.</b>
<b>1.3. Genetic resources of forest trees and their deployment</b>	<b>6.</b>
1.3.1. Genetic characteristics of temperate trees	<b>6.</b>
1.3.2. Measuring adaptive genetic variation in trees	<b>7.</b>
1.3.3. Adaptive genetic resources of native trees in Great Britain	<b>11.</b>
1.3.4. The current system for sourcing seed and planting stock for native woodlands	<b>15.</b>
<b>1.4. Climate change</b>	<b>17.</b>
1.4.1. Climate of Great Britain	<b>17.</b>
1.4.2. Climate change in Great Britain	<b>19.</b>
1.4.3. Potential direct impacts of climate change on GB forests	<b>21.</b>
1.4.4. Interactions with pests and diseases	<b>22.</b>
1.4.5. Can evolution help forests cope with climate change	<b>24.</b>
<b>1.5. Should climate change influence the way genetic resources are deployed?</b>	<b>26.</b>
1.5.1. Predictive provenancing	<b>26.</b>
1.5.2. Species change	<b>28.</b>
1.5.3. Currently adapted planting stock	<b>28.</b>
<b>1.6. Purpose of this thesis</b>	<b>29.</b>
<b><i>2. Defining climatic and ecological groupings amongst the native pinewoods of Scotland.</i></b>	<b>33.</b>
<b>2.1. Introduction</b>	<b>33.</b>
<b>2.2. Materials and methods</b>	<b>37.</b>
2.2.1. Site selection	<b>37.</b>
2.2.2. Obtaining environmental data	<b>37.</b>
2.2.3. Vegetation sampling	<b>37.</b>
2.2.4. Mean Ellenberg indicator values	<b>38.</b>
2.2.5. Statistical analyses	<b>39.</b>
2.2.5.1 Climatic site clustering	<b>39.</b>
2.2.5.2 Vegetation description and analyses	<b>40.</b>
<b>2.3. Results</b>	<b>41.</b>
2.3.1. Climatic site clustering	<b>41.</b>

2.3.2.	Vegetation description and analyses	46.
2.3.2.1.	Identifying sub-communities	46.
2.3.2.2.	Environmental interpretation	48.
<b>2.4.</b>	<b>Discussion</b>	<b>51.</b>
 <b>3. Substantial variation in the timing of pollen production indicates limited reproductive synchrony between distant native populations of <i>Pinus sylvestris</i> in Scotland.</b>		 <b>55.</b>
<b>3.1.</b>	<b>Introduction</b>	<b>56.</b>
<b>3.2.</b>	<b>Materials and methods</b>	<b>58.</b>
3.2.1.	Reproductive biology of <i>Pinus sylvestris</i>	58.
3.2.2.	Selection of sites and individuals	58.
3.2.3.	Phenological scoring	60.
3.2.4.	Climatic data	61.
3.2.5.	Statistical analyses	62.
<b>3.3.</b>	<b>Results</b>	<b>64.</b>
3.3.1.	Variation in the timing of strobilus development among sites	64.
3.3.2.	Predicting timing of pollen production	65.
3.3.3.	Variation in the timing of strobilus development among years	67.
3.3.4.	Response of strobilus development to thermal time	68.
3.3.5.	Variation within sites	70.
<b>3.4.</b>	<b>Discussion</b>	<b>72.</b>
 <b>4. Testing options for adaptive forest seed sourcing: insights from an individual based model.</b>		 <b>75.</b>
<b>4.1.</b>	<b>Introduction</b>	<b>75.</b>
<b>4.2.</b>	<b>Materials and methods</b>	<b>78.</b>
4.2.1.	Purpose	78.
4.2.2.	Simulation procedure	78.
4.2.2.1.	Initiation of the landscape and tree populations	78.
4.2.2.2.	Process overview and scheduling	81.
4.3.2.	Simulations	84.
4.2.3.1.	Equilibration	84.
4.2.3.2.	Seed sourcing and restoration planting	85.
4.2.3.3.	Climate change	86.
4.2.3.4.	Juvenile mortality sub-model	86.
4.2.4.	Simulation experiments	88.
4.2.5.	Statistical analyses	88.
<b>4.3.</b>	<b>Results</b>	<b>89.</b>
4.3.1.	Equilibration and generation of locally adapted populations	89.
4.3.2.	Responses to climate change	89.
4.3.2.1.	Phenotypic change following replanting	89.
4.3.2.2.	Population size following replanting	92.
4.3.3.	Responses to habitat selection and climate change	93.
4.3.3.1.	Phenotypic change following replanting	93.
4.3.3.2.	Population size following replanting	94.
4.3.4.	Sensitivity of responses to other parameter variation	95.
<b>4.4.</b>	<b>Discussion</b>	<b>97.</b>
4.4.1.	What do results indicate?	97.
4.4.2.	Adaptation and demography	98.
4.4.3.	Choosing a seed source in a changing climate	101.
 <b>5. Supplying trees in an era of environmental uncertainty: An analysis</b>		

<i>of the options for the forest nursery sector in Great Britain.</i>	103.
<b>5.1. Introduction</b>	103.
<b>5.2. Materials and methods</b>	105.
5.2.1. Background and context	105.
5.2.2. Selection of informants	106.
5.2.3. Interviews	107.
5.2.4. Selection of quotations	108.
5.2.5. Generating nursery typologies	108.
5.2.6. Trade records	109.
<b>5.3. Results</b>	109.
5.3.1. Characteristics of the survey respondents	109.
5.3.2. Seed sourcing	110.
5.3.2.1. Seed collection	110.
5.3.2.2. The current system of seed zoning	112.
5.3.2.3. Seed sourcing and climate change	114.
5.3.3. Plant supply	116.
5.3.3.1. Grant schemes	116.
5.3.3.2. Trading in live plants	117.
5.3.3.3. Advance purchase of plants – contract growing	122.
<b>5.4. Discussion</b>	123.
5.4.1. Tree seed sourcing	123.
5.4.2. Plant supply	125.
<b>5.5. Conclusions</b>	127.
<b>6. Conclusions</b>	129.
<b>6.1. Summary of key findings</b>	129.
<b>6.2. Possibilities for further research</b>	130.
<b>6.3. Practical implications for forest management</b>	132.
<b>6.4. Concluding remarks</b>	136.
<b>References</b>	139.

## List of figures

### Chapter one

- Figure 1.1.** The annual area of new planting and restocking in Great Britain (1971-2015). 'Conifers' is virtually analogous to timber production and 'Broadleaves' is virtually analogous to native woodlands. Data source: Forestry Commission. 5.
- Figure 1.2.** a). The 24 seed zones of Great Britain, coloured according to the 'Regions of provenance' (Herbert et al., 1999). b). The seven biochemical regions used as seed zones for Scots pine within the native range in Scotland (native range shaded). 15.
- Figure 1.3.** Location of the weather stations summarised in Table 1.2 within Great Britain. 19.
- Figure 1.4.** Mean projected change in seasonal mean temperature (+/- 95% confidence intervals) for eight regions of Europe for the period 2071-2100, based on seventeen different simulations. Data from Christensen and Christensen (2007). 21.

### Chapter two

- Figure 2.1.** Hierarchical cluster dendrogram of the 84 pinewood sites listed on the Caledonian pinewood inventory, based on climatic dissimilarity. Branch colours represent membership of each of the seven climatic clusters. Leaf colour represents membership of existing biochemical seed zones. 42.
- Figure 2.2.** Classification tree of the 'climatic cluster' groups fitted with 13 environmental variables, converging on a solution involving only two variables (AP = annual precipitation (mm); GSL = growing season length (days)). When threshold conditions at each node are met, the branching proceeds to the left. There are 2/84 misclassifications. Tree redrawn based on a topology produced in the R package 'tree' (Ripley, 2016). The labels ("Cairngorms", "Central-Atlantic" and "Hyper-oceanic") are optional subjective classifications. 42.
- Figure 2.3.** Map of Scotland with the locations of the 84 native pinewoods, indicating a) biochemical seed zone membership and b) membership of the 'climatic clusters' defined here. 43.
- Figure 2.4.** Plot of the first two principal components of variation amongst a set of 13 climatic variables, accounting for 64.6 and 24.6% of the total variation respectively indicating a) biochemical seed zone membership and b) climatic cluster membership. The variables used and their correlation coefficients with each of the first two components are shown in table 2.1. The key to the abbreviations used for the biochemical seed zones is as follows: EC = east central, N = north, NC = north central, NE = north east, NW = north west, SC = south central, SW = south west. 45.
- Figure 2.5.** Hierarchical cluster dendrogram demonstrating group membership (branch colours), and biochemical seed zone membership (leaf colours). Figure customised using functions from the 'dendextend' package (Galili, 2015). 46.
- Figure 2.6.** Map of Scotland with the locations of the 21 native pinewoods in which vegetation sampling was conducted, indicating a) biochemical seed zone membership and b) membership of the vegetation sub-communities. 47.
- Figure 2.7.** NMDS ordination biplot for the 21 pinewood sites surveyed for their vegetation composition, demonstrating sub-community membership and their geometric centroids. The solution is rotated so that the first axis is oriented with longitude. Fitted environmental vectors are those in which  $p < 0.01$ . Unabbreviated vector names are provided in Table 2.3. 49.
- Figure 2.8.** Classification tree derived from environmental variables associated with populations in each of the four sub-communities, manually redrawn by the author based on a topology produced in the R package 'tree' (Ripley, 2016). 50.
- Figure 2.9.** Values for each of the external environmental variables used to discriminate between sub-communities, in order of placement on the tree. Vertical lines on the plots indicate the threshold value for discrimination and horizontal lines on the lower two plots indicate where a sub-community has already been classified at an earlier node. Diamond shaped plotting characters indicate misclassified sites. 51.

## Chapter three

<b>Figure 3.1.</b>	Map of mainland Scotland indicating the location of field sites.	<b>60.</b>
<b>Figure 3.2.</b>	Line illustrations indicating strobilus morphology at each of the modal states (1-7). Illustrations by Cristina Rosique.	<b>61.</b>
<b>Figure 3.3.</b>	Mean strobilus scores and 95% confidence intervals on the observation dates. The dashed horizontal line is plotted at stage 5, which is when trees are at peak pollen production. Site abbreviations are AC: Allt Cul, BE: Beinn Eighe, BL: Bunloyne, LD: Lochindorb, RM: Rothiemurchus. NB: RM and BE overlap one another on the final date of observation in 2016.	<b>65.</b>
<b>Figure 3.4.</b>	Modelled timing of pollen shedding indicating for each score level, exceeding those which come before pollen is shed (5-7), the probability that strobili of trees at each of the sites have reached a given score.	<b>66.</b>
<b>Figure 3.5.</b>	Comparison of estimated developmental time difference in days between sites in 2014, 2015 and 2016. Square symbols represent 'significance', which is defined as differences between sites which exceed three days plus the confidence interval of the site estimate.	<b>67.</b>
<b>Figure 3.6.</b>	Modelled timing of pollen shedding, indicating the cumulative probability that strobili have minimally reached stage 5 (peak pollen shedding) from the first of May (inclusive) at each site in each of the three observation years for the three sites visited in each sampling year.	<b>68.</b>
<b>Figure 3.7.</b>	Modelled accumulated GDD at the time of pollen shedding, indicating the cumulative probability that strobili have minimally reached stage 5 (peak pollen shedding).	<b>69.</b>
<b>Figure 3.8.</b>	Differences from long term average GDD based on temperature data from the nearest weather stations 1960-2011.	<b>69.</b>
<b>Figure 3.9.</b>	Estimated time lags/leads (number of days) between the different years, based on pooled estimates for AC, BE and RM, as shown in Figure 3.6 and Table 3.5.	<b>70.</b>
<b>Figure 3.10.</b>	Summed strobilus scores for each tree across the first three sets of observations in each year, ranked in descending order according to a reference year. The reference year for BE, AC and RM is 2014. The reference year for BL and LD is 2015.	
<b>Figure 3.11.</b>	Distribution of ancient semi-natural ('Caledonian') pinewoods and planted pinewoods in the native pinewood zone.	<b>73.</b>

## Chapter four

<b>Figure 4.1.</b>	Spatial arrangement of the patches within the simulation landscape and their values for climatic and habitat phenotypic optima. Note that the habitat optima are reshuffled for each model replicate and that the three configurations shown here are only examples to demonstrate possible arrangements.	<b>80.</b>
<b>Figure 4.2.</b>	Graphical representation of the dispersal weighting functions applied in the model indicating a). Inverse distance weighted pollen dispersal kernel and b). Proportion of mating events involving extra-patch pollen weighted by home patch.	<b>82.</b>
<b>Figure 4.3.</b>	Flow diagram illustrating the scheduling of processes in the simulations. The annual schedule takes place each year that the model is running.	<b>84.</b>
<b>Figure 4.4.</b>	Graphical representation of bivariate Gaussian selection function, with a default standard deviation set to 0.225 (solid line). Dashed lines represent other values tested in sensitivity analyses.	<b>87.</b>
<b>Figure 4.5.</b>	Typical model run indicating three populations' progress throughout equilibration and 500 years of directional selection indicating a) adaptive evolution in the climate phenotype and b) adaptive evolution in the habitat phenotype. The vertical dashed line indicates the change from the equilibration phase to the directional selection phase. In the simulated populations shown, no planting took place.	<b>89.</b>
<b>Figure 4.6.</b>	Change in the mean climate phenotype during the period of simulation, when parameter settings are held at default values under the fixed and selective juvenile mortality sub-models. The dashed black line represents the mean value for the changing climatic optimum. Regeneration refers to phenotypic change occurring in populations which have not undergone felling and replacement. Error bars represent 95% confidence intervals. The positions of the points and error bars are artificially offset to avoid overlap.	<b>90.</b>
<b>Figure 4.7.</b>	Size of the planted population in year 5 following implementation of juvenile mortality functions. In this case, adaptation is to climate only. Habitat is not considered selectively important.	<b>93.</b>
<b>Figure 4.8.</b>	Mean habitat mismatch and 95% confidence intervals recorded in years 5,	

	25, 50 and 100 under fixed mortality (upper panel) and selective juvenile mortality (lower panel) when parameter settings are held at default ( $hS = 1$ , i.e. selection on climate and habitat phenotypes are equally strong). The dashed horizontal line represents a mismatch of 0, i.e. fitness to the optimum. Years are plotted on different facets to avoid overlapping confidence intervals.	94.
<b>Figure 4.9.</b>	Size of the planted population following implementation of juvenile mortality functions and under different values of $hS$ .	95.
<b>Figure 4.10.</b>	The effect sizes of permuting key state variables, pooled across seed sourcing strategies under the selective juvenile mortality sub-model.	96.
<b>Figure 4.11.</b>	Phenotypic change achieved by the end of the simulation period plotted against population size in year 5, for all replicates when state variables are held at default levels.	98.
<b>Figure 4.12.</b>	Mean population size throughout the simulation period when juvenile mortality of planted trees is selective and when other state variables are held at default values. Population recovery following decline is rapid.	99.

## **Chapter five**

<b>Figure 5.1.</b>	Annual quantity (kg.) of seed collected for the two native <i>Quercus</i> spp. in GB. Data obtained from the Forestry Commission FRM database.	111.
<b>Figure 5.2.</b>	Location of seed collected for the two native <i>Quercus</i> spp. in GB, in the years 2012 and 2013, summarised by seed zone. Breaks for colour coding indicate seed quantity for each species and were generated using the 'sd' style within the R package "classInt" (Bivand et al., 2013). The numerical scales are based on values for the year in which seed was more abundant – in both cases, 2013.	111.
<b>Figure 5.3.</b>	Idealised timeline diagram of events involved in plant production and grant application and approval.	116.
<b>Figure 5.4.</b>	The number of plants (thousands) recorded as being imported to GB 2003-2013 for species in which the total number of trees imported exceeded one million, according to the FC FRM database.	119.
<b>Figure 5.5.</b>	The supplying country of imported planting stock presented in Figure 4. This is broken down by country of provenance (GB/non-GB), to demonstrate the proportion of imported planting stock which is of GB provenance.	120.
<b>Figure 5.6.</b>	Annual sales volume for softwoods and hardwoods at a private sector nursery 2007-2013.	121.
<b>Figure 5.7.</b>	Annual sales volume for <i>Betula</i> spp. and <i>Crataegus monogyna</i> at the same nursery between 2007 and 2013.	121.
<b>Figure 5.8.</b>	The total number of plants (thousands) recorded as being imported to GB 2003-2013 for all species, according to the FC FRM database.	122.



## List of tables

### Chapter one

<b>Table 1.1.</b>	A summary of published knowledge gained from GB-based experiments involving three or more different seed origins grown under common conditions, indicating the focal species, the number of GB provenances (although trials may also contain non-GB provenance), the traits under investigation and reference.	12.
<b>Table 1.2.</b>	Average climatic values for selected meteorological stations in GB (1981-2010). Data source: MET Office <a href="http://www.metoffice.gov.uk/public/weather/climate-network/#?tab=climateNetwork">http://www.metoffice.gov.uk/public/weather/climate-network/#?tab=climateNetwork</a>	18.

### Chapter two

<b>Table 2.1.</b>	List of climatic variables used in the principal component analysis and their correlation coefficients with the first two axes of variation.	45.
<b>Table 2.2.</b>	Significant indicator species of each sub-community.	48.
<b>Table 2.3.</b>	List of environmental variables used in vector fitting and their correlation coefficients with the NMDS axes. Those in bold and italics are significant to $p < 0.01$ .	50.

### Chapter three

<b>Table 3.1.</b>	Location details of each of the five field sites and their nearest weather stations for which daily temperature values were available.	62.
<b>Table 3.2.</b>	Estimated beta coefficients for parameters in the separate phenological models fitted for each year. Rothiemurchus, which is the intermediate site in most cases is the reference to which other sites are compared ( <i>estimated parameter for Rothiemurchus = 0</i> ).	66.
<b>Table 3.3.</b>	Estimated beta coefficients and interaction terms in the phenological model fitted to investigate the timing of phenological development in different years. 2014 is the reference year to which other years are compared and Allt Cul is the reference site ( <i>estimated parameter for AC in 2014 = 0</i> ).	67.
<b>Table 3.4.</b>	Estimated beta coefficients and interaction terms in the phenological model fitted to investigate the effect of temperature accumulation (GDD) on phenological development. 2014 is the reference year to which other years are compared and Allt Cul is the reference site ( <i>estimated parameter for AC in 2014 = 0</i> ).	68.
<b>Table 3.5.</b>	Proportion of strobili to have minimally reached a score of five on each of the visits in each year.	71.
<b>Table 3.6.</b>	Spearman rank correlation coefficients for the pooled sum of phenological scores for each tree in each year. Strong correlations suggest that trees within a site develop in the same order in different years.	71.

### Chapter four

<b>Table 4.1.</b>	Description of the different seed sourcing strategies applied in the IBM.	86.
<b>Table 4.2.</b>	Description and values of key state variables which were permuted within the model. Default values are in bold and underlined.	88.
<b>Table 4.3.</b>	Analysis of covariance table for rates of phenotypic change between years 100 and 200. Local provenancing is the reference and therefore the parameter estimate for Local provenancing is 0. Only the interaction terms are considered informative.	91.
<b>Table 4.4.</b>	Number of extinction events under all model replicates, arranged by planting strategy,	99.

### Chapter five

<b>Table 5.1.</b>	Characteristics and codes of the survey respondents.	110.
-------------------	--	------



## **Chapter one**

### ***Introduction and background***

#### **1.1. Introduction**

Initiatives are in place to restore and extend the distribution of forests around the world (Thomas et al., 2014). The success of these initiatives depends, amongst other considerations, on the availability and selection of planting stock which is of good quality and is sufficiently adapted to conditions at the planting site in order to survive, compete and reproduce. This situation is exemplified by the case of native woodland establishment in Great Britain (GB) where high demand for planting stock is driven by ambitious policies aimed at increasing the area of forest cover (Scottish Executive, 2006; Forestry Commission, 2007a; Welsh Assembly Government, 2009). If the policy objectives of increasing forest area are to be met, it is essential that there is a general understanding of the ecological and evolutionary processes underpinning appropriate seed source selection in a changing climate and how policy can encourage such practice.

Until recently, policies relating to seed sourcing in GB and elsewhere have been based on the understanding that climatic conditions are stable over the long term. Increasing recognition of rapid environmental change undermines this assumption (Rehfeldt et al., 2002; Parmesan, 2006). Not only is environmental change expected to be rapid, it is also difficult to predict. Whilst we might expect directional change in mean values of some climatic variables, increasing variability and increases in the frequency and severity of some extreme events are probable (IPCC, 2013). The prevalence of some endemic pests and diseases is also likely to increase, as a result of climatic shifts (Battisti et al., 2005; Sturrock et al., 2011). Finally, increased pressure from novel, exotic pests and pathogens is anticipated, caused in part by greater long distance movement of plants by humans (Brasier, 2008; Liebhold et al., 2012; Banks et al., 2015, Jung et al., 2015). These considerations indicate the need for a thorough re-evaluation of existing seed sourcing guidelines (Alberto et al., 2013, Lefèvre et al., 2014). One option which has gained considerable attention in recent years is the possibility of sourcing seed from areas which already experience conditions anticipated for planting sites in the future (Aitken and Whitlock, 2013; Breed et al., 2013), a practice which is described by Breed et al. (2013), as ‘predictive provenancing’, which is the name which will be used in this thesis.

## Introduction

Before deciding whether such strategies ought to be adopted, it is necessary to ask a series of questions to fill gaps in our knowledge. Parts of the thesis (chapters two and three) will focus on the specific case of Scots pine *Pinus sylvestris* L. within its native range in Highland Scotland, for which there is already some evidence of adaptive differentiation among populations in response to environmental variation (Salmela et al., 2011; 2013; Donnelly, 2016; Perry et al., 2016a,b). Chapters four and five consider general principles and challenges to updating seed sourcing policy but do not focus on any particular study system. The questions of the thesis and the means by which they will be addressed are:

i. At what scale do climatic selective regimes in GB vary? How can this be described and does this preclude the use of space-for-time substitutions in adaptive seed sourcing? Do other environmental characteristics vary at more idiosyncratic scales than climate among tree populations? Is there evidence that these non-climatic factors are selectively important? Description and classification of variation in plant community composition is conducted to describe groups of sites which are expected to experience similar selective regimes.

ii. Are fragmented populations sufficiently well connected by gene flow to maintain the high levels of genetic variation required for adaptation to climate change? A possible barrier to gene flow is reproductive asynchrony and so the timing of pollen production in a series of native pinewoods is estimated.

iii. What factors influence the suitability of different seed sourcing strategies? A theoretical model is developed which compares the current practice of local provenancing with alternatives such as introducing pre-adapted genotypes in various proportions and spatially unbiased seed sourcing.

iv. If alternative seed sourcing strategies are adopted, what practical changes in the supply of seed and plants would be necessary to enable this? Do pre-existing problems preclude changes to policy and how can these problems be remedied? Evidence gained from in-depth, qualitative interviews within members of the plant and seed supply industry in GB is used to provide an overview of the challenges faced by the industry.

Before beginning the thesis proper, it is necessary to provide some background against which the original investigations of the thesis rest. This introductory chapter will begin by briefly describing the native woodland resource in GB, with a historical account of planting efforts and current policy priorities. The introduction will then discuss genetic resources in forest trees and the current state of the knowledge base pertaining specifically to genetic variation in trees within GB as well as a description of current domestic seed sourcing

guidance. This is followed by a brief summary of climate change in GB, the impacts that climate change may have on forests and an analysis of the options for changing seed sourcing policy to account for rapid climate change. The introduction concludes by setting out the main purposes of the thesis and provides a rationale for each of the chapters.

## **1.2. The forest resource of Great Britain**

The character of native woodlands in Great Britain (GB) differs regionally. The native woodlands of lowland Britain are composed of temperate mixed broadleaved forest in which the dominant canopy species tend to be *Quercus robur* L., *Fraxinus excelsior* L. and *Fagus sylvatica* L. Towards the north of the country, particularly in the uplands of Scotland, there is a gradient towards boreal forest communities characterised by *Pinus sylvestris* and *Betula* L. spp. This coenocline represents not only a relatively steep environmental gradient from south-east to north-west but also the migration history of trees in the British landscape during the Holocene (Birks, 1988).

There has been much speculation about the ‘past natural’ *sensu* Peterken (1993) status of the GB landscape and how much of it was maximally covered in woodland. A view which prevailed throughout much of the 20<sup>th</sup> Century was that the vast majority of GB would have been covered in more or less continuous forest (Tansley, 1911). More recently, it has been pointed out that this vision is unrealistic, even without human intervention (Breeze, 1992; Vera, 2000).

Regardless of the previous maximum extent, it can be generalised that woodland cover has, at some time in the current inter-glacial period been much higher than it is currently (Roberts et al., 1992). A combination of climatic changes and human deforestation during the Holocene has caused the coverage of native woodland to decline substantially. By the early 20<sup>th</sup> century, it is estimated that woodland cover was around 5% (Smout, 2005). Some large-scale tree planting had taken place between the 17<sup>th</sup> and 20<sup>th</sup> century on private estates, typically in close proximity to the big estate houses (House and Dingwall, 2003) although there was no national policy in place to protect, expand or manage woodlands in perpetuity (Foot, 2003).

It was not until the establishment of the Forestry Commission in 1919 following the First World War that a deliberate public initiative to create woodlands as a strategic reserve of timber for military efforts that broadscale planting of trees took place (Smout, 2005). This was made possible by public purchase of relatively cheap land unsuitable for agriculture and

## Introduction

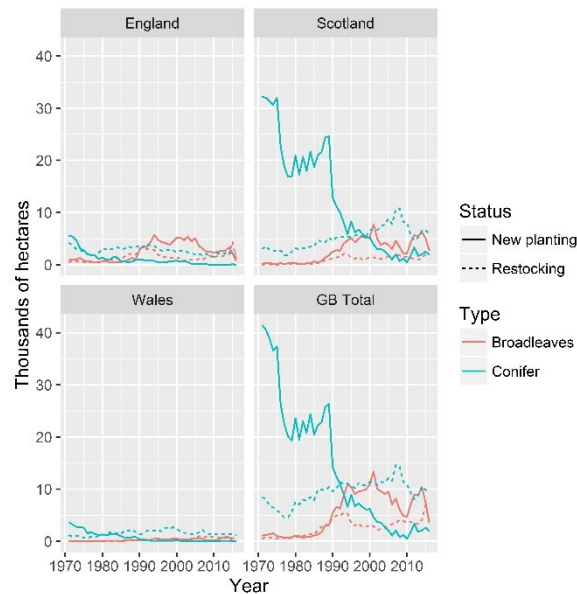
the initiation of ‘dedication’ and tax incentive schemes for private landholders and investors in forestry (Warren, 2000; Foot, 2003).

By the time of the Second World War, newly established plantations were still too young to be exploited and as such, private forests and native woodlands were felled to support military efforts. The net effect of this was that by the early 1960’s woodland cover had increased by only 1% in Scotland, despite public planting initiatives (Foot, 2003). From the 1960’s onwards, afforestation expanded rapidly due to renewed demand, the emergence of private forestry companies, technological advancements and favourable tax regimes for woodland creation (Foot, 2003).

Intensive silvicultural planting of Sitka spruce *Picea sitchensis* (Bong.) Carr., a coniferous species from the northern Pacific seaboard of North America became particularly prevalent in the landscape due to its ability to grow well on very wet soils of the uplands (Samuel et al., 2007). This planting took place not only on previously unwooded land but also replaced semi-natural woodland, which declined in extent by 20% during the century (Hampson and Peterken, 1998). Conifer plantations now account for 51% of the forest area in GB, of which Sitka spruce represents 50% (Forestry Commission, 2011a). This species continues to account for the sale of 30 million tree seedlings annually to Scotland, much of which is used for restocking felled plantations (Forestry Commission, 2016).

Large scale conifer plantations had been unpopular for a long time due to their perceived detrimental landscapes. Ultimately, controversy was caused by some high profile schemes (Warren, 2000; Foot 2003). An example of such a high profile scheme, or series of schemes can be found in the rapid proliferation of tree planting that took place on the ecologically important deep peats of the ‘Flow Country’ in Caithness during the late 1970’s and 1980’s which was enabled by private investment in forestry by absentee landholders (Mather and Murray, 1987). At the time, willingness to pay analyses discovered that the general public claimed that they would pay personally to prevent further afforestation (Hanley and Craig, 1991). An increasingly poor public perception of forestry, and greater recognition of the multiple possible benefits of sustainable forest management led to policy changes to encourage multi-functional forest planning (Slee, 2005; Quine et al., 2013; Thomas et al., 2015; Nijnik et al., 2016). The tax incentive system was removed in the chancellor’s budget of 1988 (Hansard, 1988) and replaced with a series of ‘woodland grant schemes’, which would ensure that woodland creation could continue with publicly invested funds (Urquhart et al., 2010). Such woodland grant schemes would eventually provide funding not only for

initial planting but also for assisting the expansion of native woodland by natural regeneration and other management activities (McIntosh, 2006).



**Figure 1.1.** The annual area of new planting and restocking in Great Britain (1971–2015). ‘Conifers’ is virtually analogous to timber production and ‘Broadleaves’ is virtually analogous to native woodlands. Data source: Forestry Commission.

By the end of the 20<sup>th</sup> century, woodland cover had nearly tripled across GB with current estimates suggesting that c. 12% of the land area occupied by woodland (Forestry Commission, 2011a). There was a steep decline in new planting of conifers towards the end of the 1980’s and a corresponding increase in new planting of broadleaves at around this time (Figure 1.1). Nonetheless, total rates of afforestation are at a much lower level generally than they were during the 1970’s and 1980’s (Figure 1.1).

There is now currently high motivation to continue expanding the area of native woodlands in GB for a range of purposes including the provision of habitat for native biodiversity, access to green space for public health and recreation purposes (e.g. Ward-Thompson et al., 2005); provision of ecosystem services such as uptake of carbon (Feliciano et al., 2013; Nijnik et al., 2013) and for flood attenuation (Nisbet and Thomas, 2006), as well as a sustainable source of timber and wood (Lee et al., 2015). Forest policy in the United Kingdom is devolved to each of the four constituent countries: England, Northern Ireland, Scotland and Wales. Governments in each of the countries have expressed commitments to expanding the area of woodland cover to deliver the public benefits that woodland expansion can achieve (Scottish Government, 2006; Forest Service, 2006; Forestry Commission 2007a; Welsh Assembly Government, 2009). Scotland, which has the highest proportion of

## Introduction

woodland cover in the UK and underwent by far the greatest expansion in the 20<sup>th</sup> Century has set ambitious targets, stating in 2006, that the area of land under woodland cover would increase from 17% to 50% by the year 2025 (Scottish Government, 2006). Targets are continually being missed for several reasons (Thomas et al., 2015). Delays to planting due to difficulties with bureaucracy are frequently cited amongst the main barriers to woodland expansion (WEAG, 2012; Thomas et al., 2015). In Northern Ireland, a target was set to double the area of woodland cover from 8% to 16% in the fifty years following 2006 (Forest Service, 2006). However, as in Scotland, targets are being missed for similar reasons (Northern Ireland Land Matters Taskforce, 2015). England and Wales set no specific targets although state aspirations to expand or improve woodlands within their national strategy.

If such planting ambitions are to be realised, it will take continued and concentrated effort to rapidly increase the rate of tree planting, meaning that demand for planting stock is set to increase. Recognition of contemporary challenges such as rapid environmental change and the increasing prevalence of exotic pests and pathogens call for an appraisal of the way such planting stock is currently sourced, produced and deployed. It is therefore necessary to take the opportunity to ask a series of questions about the origins and supply of planting stock and the management of genetic resources in native trees; essential prerequisites for woodland creation in an era of environmental uncertainty.

## **1.3. Genetic resources of forest trees and their deployment**

### **1.3.1. Genetic characteristics of temperate trees**

Trees are characterised by a unique combination of life history characteristics which enable efficient adaptation to environmental change (Kremer et al., 2012). Trees typically very large, immobile organisms with long generation times (seed-to-seed), long life spans and delayed but prolific reproductive output (Petit and Hampe, 2006).

Most of the ecologically and silviculturally important tree species which are native to Britain have very large ranges spanning across much of Eurasia. Such species are often dominant within their ecosystems and thereby typically have very large population sizes (Petit and Hampe, 2006; Cavers and Cottrell, 2015). Large population sizes of long-lived organisms with overlapping generations are capable of containing within them high levels of genetic diversity because polymorphisms can be retained within the standing population for long periods of time (Hamrick and Godt, 1996; Petit and Hampe, 2006).



Trees are often highly fecund and predominantly outcrossing (Hamrick and Godt, 1996) and so pools of seedlings produced via natural regeneration can be both very large and highly genetically variable. Natural selection acts at an early stage upon such pools of seedlings, removing individuals unable to cope with the environmental conditions prevailing at that time thereby increasing the likelihood that well fitted individuals will survive until maturity and contribute to subsequent generations. Space tends to be limited for naturally regenerated seedlings and so natural selection is very strong and efficient (Petit and Hampe, 2006). Different environmental conditions throughout the species' range impose variable selection pressures on the offspring of standing trees in different places, a process which leads to adaptive differentiation or local adaptation (Kawecki and Ebert, 2004; Savolainen et al., 2007).

The large stature of trees 'makes the world smaller for them' (Petit and Hampe, 2006), which assists in the dispersal of pollen and seed over long distances. This is particularly prevalent in northern temperate species in which pollen dispersal by wind is common. Estimated pollen dispersal distances are often 20-200 times that of seed dispersal (Ennos, 1994), and rare events can transport viable pollen for hundreds of kilometres (Varis et al., 2009).

Gene flow reduces differentiation between populations although it increases the variation within a single population. Variation in adaptive traits is typically quantitative, meaning that it arises as a product of many loci of small effect, rather than few large effect loci (Mackay and Latta, 2002; Savolainen et al., 2013). This acts in favour of adaptive differentiation because it means that, despite low genetic differentiation between populations at neutral markers brought about by extensive gene flow, many combinations of phenotypic trait variation are possible and strong natural selection will act upon this variation, removing individuals which cannot cope (Petit and Hampe, 2006). Quantitative trait variation in trees typically shows moderate to high heritability values (Alberto et al., 2013a), which means that that there is considerable potential evolutionary change from one generation to the next (Cavers and Cottrell, 2015).

### **1.3.2. Measuring adaptive genetic variation in trees**

Adaptive genetic variation can be assessed in various types of common garden tests, which involve growing plants raised from seed together in a common environment. Under such conditions, each seed source experiences similar environmental conditions such that observed differences between phenotypes can be inferred to be due to genetic differences

## Introduction

between them. There are many possible variations of common garden tests used in tree genecology and the types of inferences that can be made will depend very much on the quality of the experimental configuration (White et al., 2007; Aitken et al., 2008; Gibson et al., 2016), the traits assessed, the methods for assessing trait variation and the spatial and temporal scale of the experimental trials (Gibson et al., 2016). Tests which maintain a family structure, i.e. retain the identity of parent trees of progeny throughout the investigation, have the added value of enabling estimates of trait heritability and the most meaningful approximations of genetic variation within populations because variance components for families within populations can be determined (White et al., 2007).

Two broad categories of common garden tests are described by White et al. (2007) as ‘short term seedling studies’ and ‘long-term provenance trials in field experiments’ and provide an excellent description of the advantages, disadvantages and motivations of each approach (White et al., 2007, pages 198-204). These will be summarised here.

Short term seedling studies tend to be single-site tests carried out in artificial (e.g. glasshouse or laboratory) conditions, which have the intention of determining whether there are adaptive differences between populations. Results from such trials can be used to investigate correlations between expressed trait variation and aspects of the genotypes’ home environment (Aitken et al., 2008; White et al., 2007). Larger numbers of provenances within a test will enable the most robust correlations with environmental characteristics (if present) and indoor studies may be particularly useful for this purpose due to the capability of controlling the environment which minimises experimental noise. In some cases, local adaptation may only become apparent when genotypes are exposed to stress, and so indoor studies are also useful for conducting experimental manipulations, such as measuring phenotypic responses to deliberately imposed stress such as extremes of temperature (Bower and Aitken, 2006); drought (Anekonda et al., 2002; Arend et al., 2011); waterlogging (Donnelly, 2015) or pathogen pressure (Perry et al., 2016a,b). However, results are unlikely to apply to field conditions and do not provide information about long-term survival (White et al., 2007). There is also the possibility that, by chance, some individuals will be better adapted to the conditions of the glasshouse or laboratory which may generate false positive results, meaning that these studies are not ideal for choosing provenances for deployment at particular planting sites (Kawecki and Ebert, 2004; Gibson et al., 2016).

Replicated, long-term trials in realistic field conditions enable for stronger inferences to be made and are desirable if the intention is to identify suitable seed sources for planting because the responses of genotypes in different environments can be observed. The presence

of strong genotype by environment (G x E) interactions (White et al., 2007) indicates that the most suitable seed source will vary from site to site. Ideally, long-term trials should be replicated involving seed sources and trial locations representative of as large a range of the environmental variation in the area of interest as possible and involve assessments of survival and growth related traits at longer time scales than are possible in short term tests (White et al., 2007). With high levels of replication, it may be possible to use results to predict responses in many environments, using population transfer functions, (e.g. Rehfeldt et al., 1999) or population response functions to specific sets of environmental variables (e.g. Rehfeldt et al., 2002; Wang et al., 2006, Saenz-Romero et al., 2016). To determine whether local genotypes have a home site advantage, i.e. whether true local adaptation exists, fully reciprocal transplant experiments are required in which each genotype from each population in the experiment are reciprocally transplanted in each of the natural home environments (Kawecki and Ebert, 2004; Blanquart et al., 2013). However, for most applied forest science purposes, an indication that populations are adaptively differentiated and robust correlations with environmental variables may be sufficient for sourcing suitable planting stock, without going to the effort of establishing resource intensive reciprocal transplant experiments with many provenances. In this case, it may be more desirable to have reasonably well replicated trials of many provenances rather than fully reciprocal transplants of few provenances, unless the aim is to establish that there is a home site advantage *sensu stricto*.

In many biological systems, fitness is measured as a function of reproductive output, or the genetic composition of subsequent generations, i.e. ‘Darwinian’ fitness (Orr, 2009). Trees are long lived, take up large amounts of space and resources and typically have late maturity and so measuring fitness in this manner is not typically feasible (Aitken and Bemmels, 2016). Instead, proxies for fitness are measured among a range of ‘performance’ or growth related traits; phenological traits such as bud burst and bud set; physiological traits such as those related to water use (e.g. stomatal characters, carbon isotope discrimination) or photosynthesis (e.g. chlorophyll fluorescence) and traits related to tolerance of stress such as survival and responses to experimental treatments which deliberately impose stress such as drought (Salmela, 2011) or waterlogging (Donnelly, 2015). Disease resistance can be assessed in trials in which trees can be deliberately inoculated with a pathogen (e.g. Perry et al., 2016a), or allowed to be colonised naturally (e.g. Pliura et al., 2011; Perry et al., 2016b), revealing geographical patterns in susceptibility or assessing the extent of genetic variation in resistance within populations. Two traits which are very commonly assessed in common garden tests are height growth (e.g. Rehfeldt, 1989; Rehfeldt et al., 2002; Reich and Oleksyn, 2008; Lee et al., 2015) and the timing of initiation (bud flush) and cessation (bud set) of

## Introduction

annual growth (e.g. Campbell, 1974; St Clair et al., 2005; Vitasse et al., 2009; Alberto et al., 2013b; Vander Mijnsbrugge et al., 2015; 2016; Delpierre et al., 2016).

Height growth tends to show moderate to high levels of quantitative genetic differentiation ( $Q_{ST}$ ) amongst populations (Alberto et al., 2013a) and it is a useful phenotypic trait to investigate in experiments because it indicates that a genotype has been healthy enough to grow to a large stature (Aitken and Bemmels, 2016). In addition to ‘performance’, height may also reflect the ability for a tree to compete with others trees for light and better opportunities for dispersal of pollen and seed (Ying and Yanchuk, 2006; Savolainen et al., 2007). However, the interpretation of results regarding genetic differences in height growth should consider the age of trees measured. For instance, in a Scottish trial of *Betula pendula*, involving a mixture of Scottish and non-local (Scandinavian) provenances, Worrell *et al.*, (2000) found that Scandinavian origins which had shown good initial growth subsequently proved to be susceptible to damage by late spring frosts after mild winters as long as ten years after planting and therefore eventually experienced substantially higher mortality than native origin material. This suggests that assessments of height alone, particularly when measured at a juvenile stage, are insufficient to gain meaningful predictions of suitability of planting stock at different sites.

The timing of bud flush and bud set show similar levels of  $Q_{ST}$  to height growth (Alberto et al., 2013a). These traits are informative because these events should be reasonably synchronised with the local growing season to maximise growth during summer but minimise the risk of frost damage during active growth in spring or autumn (Howe et al., 2004; Aitken and Bemmels, 2016).

An important component of local adaptation is that it may be associated with conservative growth as a result of evolved tolerance of local conditions (Ledig, 1998). Temperate trees are likely to simultaneously experience hard stabilising selection on timing of growth and dormancy (cold hardiness) and soft directional selection on growth due to the need to compete with neighbouring trees of the same species and other species (Aitken et al., 2008). Locally adapted individuals may also be conservatively adapted to historical extreme climatic episodes which occur periodically at the home site (Montalvo et al., 1997; Gutschick and BassiriRad, 2003). These factors combine to suggest that a locally adapted individual may not necessarily show the greatest growth in any particular duration of time compared to individuals sourced from other populations, but may be best able to cope with the full range of environmental conditions at its home site experienced during its life time.

### 1.3.3. Adaptive genetic resources of native trees in Great Britain

Throughout the last century, efforts at provenance testing and selection in Britain have tended to focus on economically desirable traits (e.g. height, wood density) for exotic conifer species. Improvement programmes were established by the Forestry Commission for several species. These are *Picea sitchensis* (Fletcher and Faulkner, 1972; Samuel et al., 2007; Lee and Connolly, 2010), *Pseudotsuga menziesii* (Mirb.) Franco (Fletcher and Samuel, 2010), *Pinus sylvestris* (Lee, 2002), *Pinus nigra* subsp. *laricio* Maire (Lee, 2002), *Pinus contorta* Douglas ex Loudon (Shelbourne, 1974; Lee and Connolly, 2004) and *Larix X eurolepis* (Lee, 2003). Currently, only the improvement programme for *Picea sitchensis* remains active, although clonal archives remain for other species and improved material is widely deployed. *Pinus sylvestris* grown for commercial forestry purposes continues to be sourced from a seed orchard containing select ‘plus’ trees of mixed origin. Genetically improved Scots pine has accounted for approximately 50% (19.8 million) of all Scots pine sales to Scottish planting schemes by British nurseries between 2005 and 2015 (Forestry Commission, 2016). By comparison, genetically improved Sitka spruce accounted for >90% (240 million) of the nursery stock sold to Scotland for this species in the same period, of which 55 million of were produced via clonal propagation (Forestry Commission, 2016). It should be noted that the purposes of these programmes was for selection of superior phenotypes, and the work has sought to identify sources to contribute to seed mixtures which perform similarly well under many conditions in GB. For Sitka spruce, this has tended to be based on initial collections from parent trees in the Queen Charlotte Islands (Samuel et al., 2007).

Improvement of broadleaved species such as *Betula pendula*, *Quercus* spp., *Prunus avium* (L.) L., *Juglans regia* L., *Fagus sylvatica* and *Acer pseudoplatanus* L. are underway although programmes are at earlier stages than conifer improvement programmes and are not organised within the public sector (Hubert et al., 2010). Relatively little effort has been placed in measuring adaptive genetic variation in native species for purposes other than selection for economically desirable traits (Boshier and Stewart, 2005; Cavers and Cottrell, 2015). There have been a number of experiments established in the past thirty years involving genotypes from multiple native populations (Table 1.1), from which two rather general statements can be made.

Firstly, strong adaptive differentiation between populations can occur at relatively narrow spatial scales. The differences between populations are often related to continentality of climate, which in GB is determined by longitude. For instance, populations of downy birch

## Introduction

*Betula pubescens* from the north west of Scotland have evolved smaller leaves than populations in the south east and this is thought to be an adaptation to windy conditions (Pelham et al., 1988).

Secondly, despite the differentiation between populations, there is typically very high variation within single populations. For instance, under common garden conditions individuals within Scottish populations of Scots pine show substantial differences in their susceptibility to *Dothistroma* needle blight (Perry et al., 2016b). There is greater variation within a single population than between populations for this trait. This reflects the effect of high gene flow rates, but shows that if pathogen pressure increased, the population could potentially evolve by natural selection as more resistant genotypes were favoured. In this case, despite the fact that most of the variation was found within rather than between populations, the total variation showed a similar longitudinal pattern (Perry et al., 2016b).

Despite these efforts, the number of individual studies and the number of species studied is low and most of the trials either have no or limited replication (Table 1.1) or do not include a series of either provenances or trial sites that reflect the full range of environmental variation that British populations experience (e.g. Cundall et al., 2003; Boshier and Stewart, 2005; Hubert, 2005).

Therefore, whilst the existing evidence base goes some way towards understanding broadscale patterns of adaptive variation in some native species, the ability to predict survival and adaptedness at planting sites in the highly heterogeneous landscape of GB is currently limited.

**Table 1.1.** A summary of published knowledge gained from GB-based experiments involving three or more different seed origins grown under common conditions, indicating the focal species, the number of GB provenances (although trials may also contain non-GB provenances), the traits under investigation and reference.

Species	Number GB provenances	Type of experiment	Traits investigated	Reference
<i>Betula pendula</i>	7	Single site provenance trial	Height (3 <sup>rd</sup> Year) Basal diameter Stem form Cold hardiness	Blackburn and Brown, 1988
	3	Laboratory experiment	Germination time	Midmore et al., 2015
	36	Multiple but non-identical provenance trials	Height Survival Flushing Senescence	Worrell et al., 2002

	58	Multi-site provenance trials	Height	Lee et al., 2015
	3	Single site provenance trial	Bud burst	Billington and Pelham, 1991
	42	Multi-site provenance trials (4 trials)	Survival Height Chlorophyll fluorescence Stomatal density Leaf morphology	C. Rosique et al., <i>unpublished data</i>
<i>Betula pubescens</i>	26	Single site provenance trial	Leaf morphology Height Survival Diameter Fungi	Pelham et al., 1988
	7	Single site provenance trial	Bud burst	Billington and Pelham, 1991
<i>Crataegus monogyna</i> Jacq.	5	Multi-site provenance trial (2 trials)	Height Bud burst Basal diameter Branching Infection (Powdery mildew) 'Thorniness'	Jones et al., 2001
<i>Fraxinus excelsior</i>	12	Multi-site provenance trials	Survival Height	Cundall et al., 2003
	8	Reciprocal transplant experiment	Volume Basal diameter Height	Boshier and Stewart, 2005
	42	Multi-site provenance trials (2 trials)	Survival Height Diameter Chlorophyll fluorescence Stomatal density Leaf morphology	C. Rosique et al., <i>unpublished data</i>
	6	Reciprocal transplant experiment	Survival Height Basal diameter (3 yrs)	Clark, 2013
<i>Pinus sylvestris</i>	4	Single site common garden	Stem dimensions Root condition Root frost hardiness Bud dry matter	Perks and McKay 1997
	4	Single site common	Diameter	Perks and Ennos

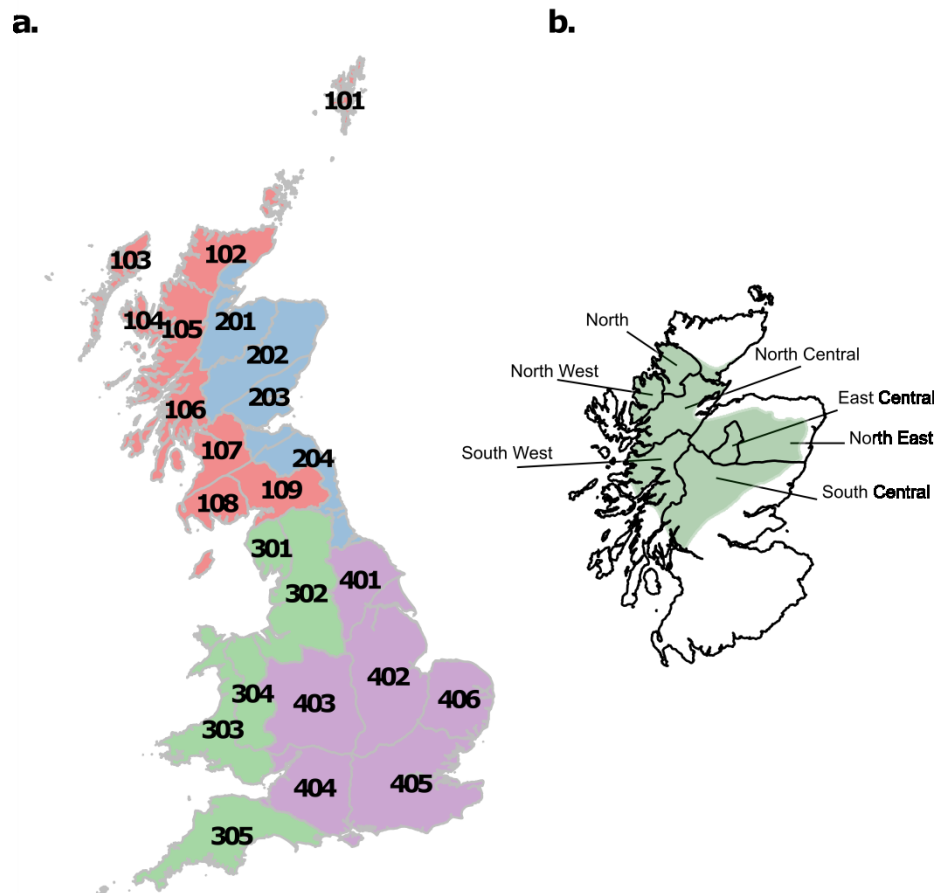
Introduction

		garden	Height	1999
	8	Single site common garden	Bud burst Chlorophyll fluorescence following low temperatures	Salmela et al., 2011
	21	Replicated indoor common garden (2 trials)	Bud burst	Salmela et al., 2013
	8	Single site indoor common garden	Leaf morphology	Donnelly et al., 2016
			Waterlogging tolerance Carbon isotope ratio	K. Donnelly et al., <i>unpublished data</i>
	6	Single site indoor common garden	Susceptibility to <i>Dothistroma</i> (indoor)	Perry et al., 2016a
	6	Single site outdoor common garden	Susceptibility to <i>Dothistroma</i> (outdoor)	Perry et al., 2016b
	21	Multi-site provenance trial (3 trials)	Height Phenology Disease resistance Endophytes	S. Cavers, J. Cottrell, G. Iason, <i>unpublished data</i>
<i>Populus tremula</i> L.	Maximum 89 genotypes	5 clonal trials (not strictly a provenance test)	Survival Height Diameter	Mason et al., 2002
<i>Quercus petraea</i>	4 in one series 8 in another series	8 non-identical provenance trials	Survival Height	Hubert, 2005
<i>Quercus robur</i>	6 in one series 5 in another series	8 non-identical provenance trials	Survival Height	Hubert, 2005
<i>Sorbus aucuparia</i>	Seed from 15 individuals on an altitudinal gradient	Laboratory experiment	Germination	Barclay and Crawford, 1984
	42	Multi-site provenance trials (4 trials).	Survival Height Chlorophyll fluorescence Stomatal density Leaf morphology	C. Rosique et al., <i>unpublished data</i>



### 1.3.4. The current system for sourcing seed and planting stock for native woodlands

For new planting of native trees and shrubs in GB, seed sourcing guidelines currently involve adherence to a series of ‘seed zones’ (Figure 1.2). Seed zones are fixed geographical regions with distinct boundaries. The purpose of seed zoning is to define regions in which seed can be transferred with minimal risk of maladaptation (Herbert et al., 1999; Ying and Yanchuk, 2006).



**Figure 1.2.** a). The 24 seed zones of Great Britain, coloured according to the ‘Regions of provenance’ (Herbert et al., 1999). b). The seven biochemical regions used as seed zones for Scots pine within the native range in Scotland (native range shaded).

Delimitation of the common seed zones is based not on known patterns of adaptive variation of trees but on proxies for these which include geomorphology and major watersheds together with an additional altitudinal discriminant factor whereby seedlots are described as having been collected either above or below 300 m. The map (Figure 1.2) was created by Herbert et al., (1999) to encourage the use of local stock at planting sites as an extension to

## Introduction

earlier administrative systems for identification and certification of seedlots under the Organisation for Economic Co-operation and Development (OECD) (Gordon et al., 1992).

Following adoption of this system in 1999, adherence to local provenance became a stipulation for receipt of government grant support for native woodland creation, at least when seed can be obtained without excessive difficulty (Buckley and Blakesley, 2008). A major achievement of the current system of seed zoning is that it has generally discouraged grant support being provided for use of stock of non-GB provenance, much of which has been shown to survive for shorter periods or grow less well than GB provenances in Britain, including silver birch *Betula pendula* Roth (Worrell, 1992; Worrell et al., 2000); Scots pine *Pinus sylvestris*, alder *Alnus glutinosa* (L.) Gaertn. and sessile oak *Quercus petraea* (Matt.) Liebl. (Worrell, 1992); hawthorn *Crataegus monogyna* (Jones et al., 2001); ash *Fraxinus excelsior* (Cundall et al., 2003) and for sessile and pedunculate oak *Quercus robur* (Hubert, 2005). It was estimated that 70% of the native broadleaved trees supplied to British planting schemes in 1993 were grown in other countries (Gordon, 1998). Since that time, the proportion of imported trees has reduced to around 12.5% (Anon, 2012), with 59% of these imported trees certified as having been raised from seed collected from trees in GB (Whittet et al., 2016a).

It was recognised from its inception that the seed zone system for encouraging currently adapted seed sources in GB was no more than a first attempt which would require refinement as more knowledge became available (Herbert et al., 1999). In the course of the last fifteen years a number of shortcomings in the system have been recognised, the first of which is that the regions of provenance and seed zones specified do not accurately reflect geographic areas with uniform environmental conditions for tree survival and growth in GB (Salmela et al., 2010).

In upland regions, such as the Highlands of Scotland, the current seed zones contain within them a high degree of climatic variation (Salmela et al., 2010). Where climatic conditions are not uniform within seed zones, fine scale patterns of adaptive variation may be overlooked, such that the seed zones do not consist of populations which are adapted to similar environmental conditions (Salmela et al., 2011; 2013). Therefore, adhering to local seed zones in a heterogeneous landscape does not necessarily guarantee a local fitness advantage as plants from a geographically proximal location may be adapted to very different temperature, moisture and exposure regimes (Bischoff et al., 2006).

On the other hand, in more topographically homogenous lowland regions such as central and eastern England, seed zones could justifiably be enlarged. Seed zones which are smaller than

necessary may make seed collection and stock management more laborious and complicated than necessary without any clear fitness advantage to planted stock (Hubert and Cottrell, 2007; Buckley and Blakesley, 2008; O'Neill et al., 2014). An example of excessively conservative seed zoning has been found for alder *Alnus glutinosa* in Belgium, a relatively flat country, where assessment of patterns of molecular and adaptive variation demonstrated that material from each of the five seed zones could be exchanged with little risk of maladaptation (De Kort et al., 2014).

The second shortcoming of the seed zone system in GB is that (with the exception of Scots pine *Pinus sylvestris*) it is applied uniformly to all native species on the assumption that they show equivalent patterns of adaptive variation across the landscape, which is unlikely to be the case (Rehfeldt, 1994; Johnson et al., 2004; Boshier and Stewart, 2005; Cavers and Cottrell, 2015; Loranger et al., 2016). There is good evidence that this assumption is unlikely to be warranted. For instance, Vitasse et al., (2009) observed opposing adaptive clines in the phenological response of beech *Fagus sylvatica* to those of ash *Fraxinus excelsior* and sessile oak *Quercus petraea* in the Pyrenees. In multiple common garden experiments established along an altitudinal cline, beech populations from a higher altitude were found to be the earliest to flush, whereas the opposite trend was recorded in ash and oak. Moreover in the same trial it was shown that for three other species, sycamore *Acer pseudoplatanus*, holly *Ilex aquifolium* L. and European silver fir *Abies alba* Mill., there was no evidence of adaptive differences in phenology in response to altitude (Vitasse et al., 2009).

There are therefore a series of shortcomings associated with the current approach to seed sourcing in GB related not only to aspects of tree biology, but also in their practical implementation, which will be discussed in chapter five.

## **1.4. Climate change**

### **1.4.1. Climate of Great Britain**

Great Britain has a maritime climate which is typically classified in its entirety within the temperate-oceanic within the Köppen-Geiger classification (Peel et al., 2007). The island (and surrounding islands) is situated between 49 and 61°N but experiences a warmer climate than elsewhere on this latitude due to the effect of mid-latitude westerly air flows and the North Atlantic Drift (the 'Gulf stream') which introduce warm air and seawater of tropical origin (Barrow and Hulme, 1997). The high thermal inertia of the ocean reduces temperature variation within a year because relatively warm sea surface temperatures, compared to air temperatures keep coastal areas mild in temperature in autumn and winter and relatively cool

## Introduction

sea surface temperatures in spring and summer compared to air temperatures keep coastal areas relatively cool in spring and summer (Barrow and Hulme, 1997). While the whole country is strongly influenced by the Atlantic ocean to the west and the North Sea to the east and has a generally oceanic climate; inland areas have a more continental climate and experience a larger extreme temperature range with higher summer maximum temperatures and lower winter maximum temperatures than coastal areas and thus may be more exposed to extremes of temperature and its consequences such as frost and drought (Barrow and Hulme, 1997). The highest levels of precipitation are usually produced by cyclonic, southerly or westerly air circulations which bring maritime air masses from the Atlantic Ocean. When moist Atlantic air masses reach the GB, they are forced to rise due to the presence of mountains, or meeting continental easterlies in fronts, producing very large quantities of precipitation and cloud, especially in the west of the country. For instance the west coast of Scotland can receive up to five times as much precipitation as the east coast (Barrow and Hulme, 1997). Autumn and winter often contribute the greatest amount of precipitation to the annual total due to more frequent depressions, especially in the north and west of the country. In more continental areas of the south and east, the seasonal variation in precipitation is less clear (Barrow and Hulme, 1997). The location of GB, on the Oceanic margin of a large continental land mass gives rise to an extreme wind climate (Cook and Prior, 1987). Prevailing winds are south-westerly in origin; the highest wind speeds are produced in coastal and upland areas, both of which are prone to frequent gale force conditions (Palutikof et al., 1997). Average temperature and precipitation regimes for a selection of Met Office weather stations are summarised in Table 1.2. The stations were deliberately chosen to represent a geographical distribution which would demonstrate variation in temperature and rainfall in GB (Figure 1.3) where February is typically the coldest month and July is typically the warmest month.

**Table 1.2** Average climatic values for selected meteorological stations in GB (1981-2010). Data source: MET Office <http://www.metoffice.gov.uk/public/weather/climate-network/#?tab=climateNetwork>

<b>Station name</b>	<b>Altitude (m)</b>	<b>Maximum July temperature (°C)</b>	<b>Minimum February temperature (°C)</b>	<b>Annual precipitation (mm)</b>
Stornoway	15	16.1	2.1	1248.5
Braemar	339	18.1	-1.4	932
Eskdalemuir	242	18.2	-0.5	1742.1
Llanfairfechan	40	19.5	3	1099.7
Church Fenton	8	21.2	0.9	603.2
St Austell	79	20.4	3.7	1206.1
Kew Gardens	6	23.5	1.7	622.5



**Figure 1.3.** Location of the weather stations summarised in Table 1.2 within Great Britain.

### 1.4.2. Climate change in Great Britain

Recent trends in meteorological variables indicate that the surface temperature of GB is increasing. Central England Temperature, which is the longest known series of monthly temperature observations (Jones and Hulme, 1997), has increased by 1°C since the 1970's. Due to the longevity of this time series, it has been possible to relate the long term temperature increase directly to human activity (Jenkins et al., 2008). Annual precipitation sums have increased in Scotland in the last 45 years and, although these have not changed appreciably in England and Wales; all parts of the UK have experienced an increased contribution towards annual precipitation sums from heavy precipitation events in winter. Most regions (except north east England and northern Scotland) have experienced drier summers in the last 45 years (Jenkins et al., 2008). The North Atlantic Oscillation (NAO),

## Introduction

which can greatly influence winter weather conditions (Stenseth et al., 2002), has been particularly variable since 1990 and there has been an increase in stormy weather although these have not of greater frequency or magnitude than in the 1920's, another period in which the NAO exhibited great variability (Jenkins et al., 2008).

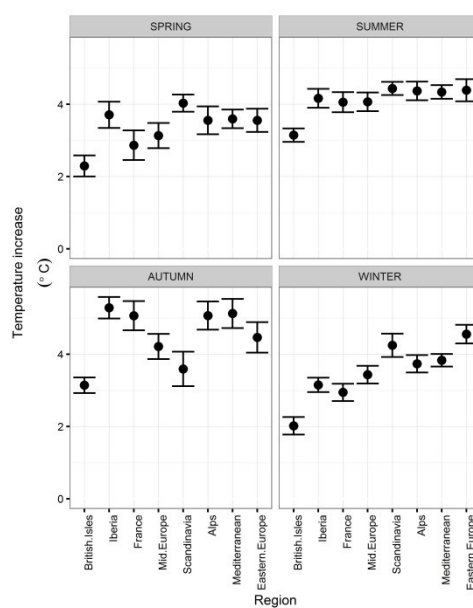
The most recent comprehensive set of climate change projections for the whole of the UK are the UKCP09 projections which provide probabilistic projections of change in a series of climatic variables (Jenkins et al., 2008; 2010; Murphy et al., 2009). These probabilistic projections are calculated for seven future, overlapping time periods and are modelled against a baseline climate of average values from 1961-1990 (Murphy et al., 2009). These are given for three distinct emissions scenarios (IPCC, 2013), and are available at a spatial resolution of 25 km.

There is a cascade of confidence in the probabilistic projections and there is much uncertainty, particularly regarding local scale changes (Murphy et al., 2009). However, it is possible to make some general statements about expected climate change in GB.

Increasingly high temperatures are expected throughout the year in most places. These will be accompanied by drier summers and continued, and possibly larger contribution to annual precipitation sums from heavy precipitation events in winter (Jenkins et al., 2010).

It has been suggested that extreme wind events will increase in frequency (Ray, 2008) although there is a particularly high degree of uncertainty in projections of changing wind regimes (Jenkins et al., 2010). Nonetheless, a trend towards weather which is generally more variable and difficult to predict (IPCC, 2013), especially if it includes intense rainfall events, is likely to be accompanied by more frequent stormy conditions (Ray, 2008).

Europe and the Mediterranean are expected to experience a higher level of warming than the global average (Christensen et al., 2007). However, it is worth noting that the magnitude of temperature increase expected is lowest in the north west of the region. An analysis of seventeen different climate change simulations identified the British Isles as the region in Europe which would undergo the least warming in all seasons by the period between 2071-2100 (Figure 1.4) (Christensen and Christensen, 2007). Therefore, in the design of adaptive strategies is important to consider that the idiosyncrasies of the oceanic British climate, notably the variability that can be produced at short time scales



**Figure 1.4.** Mean projected change in seasonal mean temperature ( $\pm$  95% confidence intervals) for eight regions of Europe for the period 2071-2100, based on seventeen different simulations. Data from Christensen and Christensen (2007).

### 1.4.3. Potential direct impacts of climate change on GB forests

Higher temperatures and levels of CO<sub>2</sub> are expected to increase forest growth and productivity in areas not limited by water (Saxe et al., 2001; Boisvenue and Running, 2006; Lindner et al., 2012). Challenges for GB forests due to climate change are more likely to arise from altered disturbance regimes and interactions with pests and diseases (Dale et al., 2001; Lindner et al., 2012).

Warmer and drier summers are likely to increase the risk of drought in some places, most notably in the south-east of England, where confidence in projections of reduced water availability are highest (Jenkins et al., 2010). Instances of drought induced mortality of trees are becoming more frequent globally and there are many documented examples of drought induced mortality events in European forests, albeit mostly in the lower latitudinal parts of species ranges (Allen et al., 2010). Extreme drought causes stress and may lead to mortality in trees in multiple interacting ways. Firstly, extreme simultaneous drought and heat stress may kill trees through hydraulic failure through xylem cavitation, whereby pockets of air in the xylem prevent movement of water in the stem (McDowell et al., 2008). Secondly, prolonged exposure to drought conditions may lead to carbon starvation, whereby closure of stomata to prevent desiccation compromises metabolic processes (McDowell et al., 2008). For either of these two hypothesised mechanisms of drought induced mortality to directly kill trees in GB, drought would have to be very severe. As with other reports of drought

## Introduction

induced mortality in Europe (Allen et al., 2010); a more likely mechanism of drought induced mortality is via altered biotic interactions with antagonists or latent antagonists, which will be discussed in section 1.4.4.

Intense precipitation events in winter are expected to increase in frequency, which enhances the possibility of flooding. While trees can play an active role in the interception of flood water (Calder et al., 2003), this is less efficient during winter when trees are not in active growth. The mechanical load and anaerobic conditions caused by waterlogging can lead to fine root death which results in poorer stability (Ray and Nicoll, 1998).

The British Isles are already prone to very high winds (Cook and Prior, 1987; Palutikof et al., 1997), and there is very limited confidence in projections of wind related variables into the future (Jenkins et al., 2010). The magnitude of increases in wind speeds and extremes are likely to be less than those which occur due to interannual variability in the already extreme wind conditions of the British Isles (Quine and Gardiner, 2002). Nonetheless, diversifying the structure of commercial plantations could assist in delivering resilience to change. The uniform and even-aged stands typical of clear-fell silviculture of upland Britain may be more vulnerable to storms than structurally complex, continuous cover systems (Mason, 2002; Hanewinkel et al., 2014).

### **1.4.4. Interactions with pests and diseases**

Climate change may interact with tree pests and diseases in many ways. Generalisations of impacts are difficult to make because effects will vary widely depending on the ecology and evolutionary history of the pathosystem (Sturrock et al., 2011; Ennos et al., 2015; Desprez-Loustau et al., 2016). The most important climate-related impacts on pest and pathogen outbreaks in GB are likely to arise from stress and mechanical problems caused by drought and waterlogging; increased levels of injury caused by storm conditions and higher minimum temperatures in winter changing the activity of pests and pathogens.

Desprez-Loustau et al (2006), describe two main processes by which fungal pathogens may be positively influenced by drought. Firstly, drought may assist pathogen attack via altered community interactions, for instance changes to the behaviour of insect vectors (Gibbs and Greig, 1977; Wainhouse and Inward, 2016), or when competitive interactions between pathogens with different drought sensitivities result in a reduction of antagonism on one species which becomes aggressive (Cook, 1973; Redfern and Stenlid, 1998). Secondly, pathogens may be positively influenced by changes in host physiology caused by water stress (Schoeneweiss, 1975; Dale et al., 2001; Desprez-Loustau et al., 2006; Jactel et al.,



2012; Telford et al., 2015). Trees may be predisposed to attack by facultative or non-aggressive pathogens, e.g. endophytes of the Botryosphaeriaceae (Slippers and Wingfield, 2007), although exhibit resistance when not in conditions of physiological stress (Schoeneweiss, 1975). The presence of water-stressed tissues, considered better substrate for some pathogens, may trigger a switch in behaviour from latency to aggression (Desprez-Loustau et al., 2006). It is worth noting that the climate of much of GB is highly oceanic and that severe droughts, such as those experienced in 1976 (Peterken and Mountford, 1996; Cavin et al., 2013) and in 1995 (Redfern et al., 1996; Subak et al., 2000) are much more likely to occur in the south-east of England than elsewhere (Broadmeadow et al., 2005).

On the other hand, many fungal, bacterial and fungus-like pathogens require moist conditions for dispersal, such as the flagellate zoospores of *Phytophthora* spp. which may be hindered in drought conditions (Desprez-Loustau et al., 2006; Sturrock et al., 2011). A greater frequency of flooding events which lead to anaerobic, waterlogged soil conditions which kill or prevent formation of fine roots (Ray and Nicoll, 1998) coupled with root invasions of *Phytophthora* could be particularly devastating for susceptible trees (Brasier, 1996). Extended periods of high air humidity, a circumstance not uncommon in GB plantation forests which are often planted at very high density (Ennos, 2015), may also facilitate fungal pathogen dispersal. Outbreaks of *Dothistroma* needle blights on pines in GB and in North America have been associated with particularly wet spring and summer conditions (Woods et al., 2005; Brown and Webber, 2008).

If tree injury becomes more common under windier conditions, opportunities for infection of trees via wounds may increase. More windthrow in forest stands would expose breeding habitat for secondary pests, such as pine shoot beetles *Tomicus piniperda* L. (Wainhouse and Inward, 2016). However, there is a high degree of uncertainty surrounding changes to wind regimes (Jenkins et al., 2010).

Damage from some relatively weak ‘dormant-season’ pathogens (*sensu* Lonsdale and Gibbs, 2002) may become more prevalent in milder winters. These are pathogens which are unable to overcome host resistance during the growing season but able to establish and become pathogenic in temperatures slightly lower than those in which hosts are active (Lonsdale and Gibbs, 2002). An example of such a ‘dormant-season’ pathogen can be found in *Phacidium coniferarum* (G.G. Hahn) DiCosmo, Nag Raj & W.B. Kendr. By making monthly annual artificial inoculations of this fungus in wounds of Japanese larch *Larix kaempferi* (Lamb.) Carrière in the Netherlands during the relatively mild winters of 1949-50 and 1950-51; van Vloten (1952) found that the number and size of stem lesions were highest during Autumn

## Introduction

and early winter at which time trees were in dormancy but temperatures were sufficiently high to enable microbial activity. Higher minimum temperatures in winter may extend the asynchronous dormancy period, such that there are greater opportunities in early winter for dormant-season pathogens to become aggressive in dormant trees (Lonsdale and Gibbs, 2002).

Finally, under milder winter conditions with fewer frost events, the winter survival of some pests and pathogens will be higher, possibly facilitating poleward or up-slope range expansion of some species, e.g. the pine processionary moth *Thaumetopoea pityocampa* Denis & Schiffermüller (Battisti et al., 2005), *Phytophthora cinnamomi* Rands (Bergot et al., 2004). Climate-induced range expansion will occur simultaneously with ongoing human-mediated dispersal of live plants and forest products as a result of international trade (Brasier, 2008; Leibhold et al., 2012; Banks et al., 2015; Jung et al., 2015), meaning that forests will not only have to cope with possibly higher levels of virulence of indigenous pests and pathogens, but also with exotic pest and pathogen species to which they are not currently adapted due to an absence of contact in recent evolutionary history (Ennos, 2015).

### **1.4.5. Can evolution help forests cope with climate change?**

As discussed in section 1.3.1., trees and forests possess a suite of evolutionary characteristics which can enable efficient adaptation to environmental change despite their very long generation times. Ongoing rapid climate change in the next century will require both plastic acclimation responses and adaptive evolution by natural selection.

The immediate response of forest trees to rapid environmental change will be a plastic one involving a change in their physiology or morphology but no change in their genetic composition (Nicotra et al., 2010; Reich et al., 2016). Where this change improves the chances of individual tree survival and reproduction during the period of extreme environmental conditions the change is known as acclimation. As long lived organisms that survive naturally through environmental conditions that can be highly variable in time and space, acclimation, or plastic responses to environmental change can be highly developed in trees (Rehfeldt et al., 2001; Aitken et al., 2008; Chevin et al., 2013). However, such plastic responses are often associated with metabolic costs, or trade-offs amongst traits meaning that there may be losses in the efficiency of evolutionary genetic adaptation (DeWitt et al., 1998; Valladares et al., 2007; Aitken et al., 2008; Richter et al., 2012). Furthermore, there are limits to acclimation responses and trees may die either directly or as a consequence of stress which compromises their herbivore and pathogen defences (Telford et al., 2015).

Within a tree population there are very high levels of genetic variation among individuals for adaptive characters such as timing of growth, cold, drought and flooding tolerance, and resistance to herbivores and pathogens (Petit and Hampe, 2006). Even where population sizes of trees are very small, there can still be substantial genetic and phenotypic variation amongst standing trees and offspring, in situations where genetic variation is delivered by long distance gene flow (Bacles et al., 2004; Hampe et al., 2013). Over a long period of relatively constant environment at any one site, a range of genotypes will have been selected that are adapted to the combination of abiotic and biotic conditions at that site, known as local adaptation (Ennos et al., 1998; Savolainen et al., 2007). Local adaptation does not necessarily mean that the local genotypes in a site will show greater growth over any particular duration than genotypes from other sites. This is because local populations can possess a conservative legacy of adaptation to extreme events in which acclimation responses were exceeded, leading to lower height growth but a greater tolerance of extremes (Montalvo et al., 1997; Gutschick and BassiriRad, 2003). Conservatism may not be recognisable as intrinsically advantageous within a single generation if extreme events do not occur (Ledig, 1998). However, it does mean that the local population is likely to be the most successful if one of these extreme climatic events does occur during a generation.

If a novel environment is imposed on a genetically variable, locally adapted population, individual trees will respond differently, and the most successful will make the greatest contribution of offspring to the next generation. If the offspring of these fitter individuals are able to establish, the population will evolve genetically, producing a subsequent generation that is better adapted to the novel environmental conditions, i.e. natural selection occurs. The rapidity of this evolution will be proportional to the amount of adaptive variation present in the original population (Davis and Shaw, 2001; Alberto et al., 2013a). However, adaptive evolution comes at a cost. Trees that respond poorly to the change in environment may either die or grow very slowly, leading to a reduction in size of the reproducing population. The magnitude of this cost of adaptation will increase with the rapidity of the environmental change imposed. If the environmental change is too rapid, populations may go extinct before they adapt (St Clair and Howe, 2007). In any event, there will always be some degree of lag in adaptation to the new environmental conditions (Aitken et al., 2008; Kuparinen et al., 2010). Importantly, for adaptive evolution to operate, it is essential that forests are able to regenerate.

A proxy for the limits of adaptation of the species can be found by analysing the limits of the environmental envelope naturally occupied by the species, with the caveat that recognized

## Introduction

natural distributions may not reflect the total fundamental niche of that species. If the predicted environmental conditions lie far outside that envelope, it will be unrealistic to expect future adaptation to those conditions. If it is generally considered that climate change is more likely to cause extirpation at the lower latitudinal edges of species distributions, the most probable mechanism for such extirpation is via drought or heat stress leading to pathogen attack and the death of existing trees (McDowell et al., 2008; Allen et al., 2010; Fady et al., 2016), or enhanced competition from other taxa which are also shifting their ranges poleward or upslope (Aitken et al., 2008). It is worth noting that the majority of native British trees are not at their lower latitudinal edge of their distributions and as such, climate change in GB is unlikely to cause extinction of species or even local extirpation but rather potential changes in suitability of planting some species in some places for particular purposes (Broadmeadow et al., 2005).

## **1.5. Should climate change influence the way genetic resources are deployed?**

Amid concerns about the rate at which climate change is taking place, there is current interest in proposals to change the way planting stock is sourced for woodland establishment, which are summarised here as ‘predictive provenancing’, ‘species change’ and ‘currently adapted’.

### **1.5.1. Predictive provenancing**

The ‘predictive provenancing’ strategy holds that seed sources should be planted that are adapted to a predicted future climate. Predictive provenancing recommends use of material from parts of the species range in which the current climate matches predicted future conditions at the planting site. A variation on this theme is composite provenancing, where a mixture of local and non-local material, the latter of which is, sourced from areas matching predicted future climates, is used (Broadhurst et al., 2008; Breed et al., 2013). This has also been called assisted gene flow (Aitken and Whitlock, 2013) and seed portfolio (Crowe and Parker, 2008) and is described within the context of ecosystem centred assisted migration (Sansilvestri et al., 2015). In a GB context, this would involve sourcing seed from currently warmer climates further south, most plausibly from France.

Predictive provenancing uses planting stock raised from seed collected in an area that currently experiences a climate similar to that predicted for the planting site in the future. A pure predictive provenancing approach would involve selection of a single seed source

population which offered the closest match to anticipated climate at some time in the future (i.e., a space-for-time substitution), in place of local origin material.

An intermediate option between continuing to source locally and sourcing all planting stock from further south is composite provenancing (Broadhurst et al., 2008; Breed et al., 2013). Under composite provenancing, proportions of the seed would be collected from multiple populations located in areas at increasing geographical distances from the planting site. The seed would be collected from populations in locations experiencing currently warmer conditions than the planting site and would be mixed with a proportion of local seed. For instance, under composite provenancing, a planting scheme in southern Scotland would be designed to include perhaps one third of locally sourced seed, one third southern English origin seed and one third French origin seed. The inclusion of varying proportions of southerly provenances alongside local provenance material in new plantings has been recommended as an adaptation strategy in England by Forestry Commission England (Broadmeadow et al., 2005; Forestry Commission England, 2010; Ray et al., 2010; Weir, 2015), as well as by Natural England and the RSPB (2014). A recommendation is to use a mixture of planting material derived from seed from multiple provenances located 2-5° further south than the planting site, provided that distance from the Atlantic Ocean of seed sources is similar to that of the planting site. Recommendations suggest that these should be used in addition to at least one third local provenance material (Forestry Commission England, 2010).

Despite considerable debate in the literature and the existence of many review and opinion papers on the topic (McLachlan et al., 2007; Broadhurst et al., 2008; Crowe and Parker, 2008; Kreyling et al., 2011; Sgrò et al., 2011; Weeks et al., 2011; Pedlar et al., 2012; Aitken and Whitlock, 2013; Breed et al., 2013; Jones, 2013; Williams and Dumroese, 2013; Havens et al., 2015; Kelly and Phillips, 2015; Sansilvestri et al., 2015; Aitken and Bemmels, 2016; Whittet et al., 2016a,b), there is currently very little evidence to suggest that this strategy is necessary, or that it will be effective (Bucharova, 2016). Due to the very long generation times of trees, gaining empirical support for the efficacy of the strategy to help newly established populations adapt in the long term is implausible. The focus of chapter four of this thesis is to formalise some theory regarding the relative strengths and weaknesses of the strategy of sourcing seed from currently warmer climates with the use of individual based models.

## Introduction

### **1.5.2. Species change**

A more radical suggestion than the deployment of southerly seed origins is the introduction of further exotic species into GB for use in planting schemes. This is driven not only by climate change but also by concern that GB lacks sufficient genetic and species diversity for resilience to novel pathogens (Ray et al., 2010; Forest Policy Group, 2012). This is arguably most relevant to silvicultural management, but is also considered in the context of native woodland creation as a means to find *alternative* species to take on the ecological role of vulnerable native species (Mitchell et al., 2014). For instance, the recent outbreak of ash dieback *Hymenoschyphus fraxinea* (T. Kowalski) Baral, Queloz, Hosoya. on susceptible British ash trees has triggered a search for resistant ash trees from Asia (Boshier and Buggs, 2015; Harper et al., 2016).

Some bioclimatic envelope models predict that the climatic niches of many species will shift at faster rates under climate change than the species are capable of migrating (Parmesan, 2006; Cheaib et al., 2012). Assisted migration, or assisted colonisation is a species conservation strategy in which poleward species translocation is conducted to conserve dispersal limited species which are threatened by climate change in their range but which may have the opportunity to establish in areas which have a predicted future climate matching the current, or recent climatic envelope of the species (Hoegh-Guldberg et al., 2008; Kreyling et al., 2011; McLane and Aitken, 2012). Assisted migration is not a major focus of the thesis and no effort will be made to discuss this or test theory, but it is worth mentioning since much of the current debate regarding predictive provenancing has emerged from theory surrounding conservation-oriented species translocations.

### **1.5.3. Currently adapted planting stock**

A final option is to continue to plant trees within their native range using seed which is putatively adapted to current conditions but to sophisticate the way in which seed is sourced and woodlands are managed (Cavers and Cottrell, 2015; Whittet et al., 2016b). A major advantage of this strategy is that it will minimise the risk of translocation failure due to maladaptation to climate during early development, for instance due to unseasonal frost damage (Worrell et al., 2000; Benito-Garzon et al., 2013b). Using local, or regional planting stock also reduces the likelihood that translocated genotypes will be maladapted to aspects of the biotic environment (Frascaria-Lacoste and Fernández-Manjarrés, 2012; Bucharova, 2016; Whittet et al., 2016b). If survival rates of the new planting are high due to adaptation to current conditions, then the initial goal of restoration can be considered to have been

achieved. With as large a population size as possible, the newly established population will then have the greatest chance of tolerating stochastic events during the first generation (Lande, 1993; Lacy, 2000), and will also contain high genetic variation required for continued adaptation to changing conditions, with the greatest contribution coming from well adapted individuals and additional genetic variation delivered by gene flow from existing populations (Cavers and Cottrell, 2015). This success of this strategy is strongly couched in the assumption that natural regeneration will take place. To ensure that natural regeneration occurs, control of herbivore populations and periodical human-mediated disturbances within the forest will encourage generational turnover and increase the rate of genetic adaptation (Kramer et al., 2008; Kuparinen et al., 2010). Woodland management planning on a landscape scale which aims to connect populations either physically, or within dispersal range of one another will encourage gene flow among populations, thereby increasing effective population sizes. However, for this to be done effectively requires evidence regarding spatial and temporal patterns of gene flow, which is the subject of chapter three of this thesis.

Problems with continuing to source local origin seed are that over the first generation of the new woodland, the planted trees may become maladapted to aspects of the environment which change rapidly (Jump and Peñuelas, 2005; St Clair and Howe, 2007), or that adaptation lag will be so great that there will be failure of the focal species to compete with other species (Kellomäki et al., 2001; Aitken et al., 2008; Gómez-Aparicio et al., 2011). A further problem (already discussed in section 1.2.4) arises in the actual selection of local or regional planting stock, as geographic proximity does not necessarily imply adaptation to the planting site (Bischoff et al., 2006; Salmela et al., 2010); the fact that scales and patterns of adaptive variation are not always repeatable across species (Rehfeldt, 1994; Vitasse et al., 2009) and the current lack of knowledge of the adaptive genetic resources of trees within GB required to set limits to seed transfer (Boshier and Stewart, 2005; Cavers and Cottrell, 2015; Whittet et al., 2016b). In the absence of data regarding patterns of adaptive genetic variation, a plausible first step may be to make use of climatic and ecological information to better characterise seed zones, based on the classical assumption that currently adapted material is best, which is the subject of chapter two.

## **1.6. Purpose of the thesis**

The purpose of this thesis is to address several important knowledge gaps pertaining to the choice of seed origins for woodland creation under climate change, using methods from a

## Introduction

range of fields. Chapters two and three are empirical, focussing on the specific case of *Pinus sylvestris* in Scotland as a study organism. However, it is hoped that the methods and reasoning applied to this particular study system will be useful for other tree species. Chapter four is theoretical, and uses simulated data to generalise adaptive responses of trees although with no strong focus on any particular tree species. Chapter five is inductive, using qualitative methods from social sciences to identify the socio-economic challenges and consequences of seed sourcing policies for all native trees and shrubs. The following key questions will be addressed:

### **i. Does the current system of seed zones for native Scots pine reflect realistic patterns of climatic and/or ecological variation?**

#### Chapter two. Defining climatic and ecological groupings among the native pinewoods of Scotland.

The second chapter of the thesis investigates the specific situation for seed sourcing for Scots pine in its native range in the Scottish uplands. Concerns expressed about the relevance of the current system of seed zones (Ennos et al., 1998; Salmela et al., 2010; Whittet et al., 2016b) will be addressed using multivariate analyses of interpolated climatic covariates for each of the 84 ‘Caledonian’ pinewoods to identify natural climatically similar clusters of pinewoods, assessing whether the amount of climatic variation existing within the current seed zones can be minimised with an alternative grouping system. Reducing the climatic variation within groups but maximising variation between groups would provide a basis for delineation of ‘floating’ seed zones (*sensu* Rehfeldt, 1983) based on environmental distances rather than geographical proximity of seed source and planting site. Considerations often missing from seed transfer guidelines are aspects of the edaphic and biotic environment, although there is clear evidence from some tree species that local adaptation to these selective pressures does take place (Linhart and Grant, 1996; Viherä-Aarnio and Heikkilä, 2006; Smith et al., 2012; Pickles et al., 2015), and that community composition of associated species can be associated with tree genotype (Wimp et al., 2005; Davies et al., 2014; Sinclair et al., 2015; Bucharova et al., 2016a). To provide a broad description of ecological dissimilarity among sites, vegetation survey and analyses were conducted, based on a subset of the ‘Caledonian’ pinewoods (n = 21), treating plant community dissimilarities as a surrogate for measured variation in non-climatic aspects of the environment. The chapter concludes with recommendations for further research required to refine and improve the biological relevance of seed sourcing guidelines.

### **ii. Do different native populations of Scots pine release pollen at the same time?**



Chapter three - Variation in the timing of pollen production indicates limited reproductive synchrony between distant native populations of *Pinus sylvestris* in Scotland.

In the third chapter, the potential for temporal variation in pollen production amongst populations to limit inter-population gene flow is assessed. This was achieved by making repeated sets of observations of the morphology of male strobili on trees growing *in situ* in three native populations in 2014, adding a further two populations to the assay for 2015 and 2016. In the absence of data regarding the timing of female strobilus receptivity, the time and space over which viable pollen can be transported between populations in the Scottish landscape and the direction and strength of winds at any given time; it is difficult to make predictions of the probabilities of gene flow amongst specific stands. However, the results are a useful step towards developing an understanding of patterns and possible barriers to pollen flow in the complex Scottish uplands (Whittet et al., 2017).

**iii. What factors influence the suitability of implementing predictive provenancing?**

Chapter four - Testing options for adaptive forest seed sourcing. Insights from individual based model simulations.

In chapter four, simulations from an individual based model (IBM) are used to investigate factors influencing the suitability of adopting alternative strategies for seed sourcing, aimed specifically at helping newly established plantations to adapt to unidirectional environmental change. A custom multi-patch ( $n = 11$ ), bi-allelic IBM is developed and is used to generalise adaptive evolutionary responses to environmental change in a newly established population. The IBM considers adaptedness to more than one aspect of the environment, namely climate, which varies clinally and changes over time and ‘habitat’, which is considered to be a proxy for any non-climatic aspects of the environment. Contrasting with climate, ‘habitat’ variation amongst patches is randomly spatially arranged and remains constant over time.

Adaptedness to either of these selection pressures is determined by individuals’ genotypes. The individuals in the model therefore undergo simultaneous directional and stabilising natural selection on two genetically uncorrelated traits.

The main experimental treatment applied in the IBM is to establish a new population under different seed sourcing strategies. These are to continue the established practice of sourcing currently adapted, locally sourced seed; to source seed from a population which experiences conditions most similar to a correctly predicted future climate (i.e. nearer the equator); to source mixtures of currently adapted, local seed and from more equatorial populations and finally, to source seed randomly from the entire species range. The main outputs from the

## Introduction

model are the amount of change to the mean phenotype of the population the number of trees surviving strong selective mortality in the first years after planting.

### **iv. What is the current status of the plant and seed supply chain in GB? Which practical considerations will limit implementation of science-based policies for seed sourcing?**

#### Chapter five - Supplying trees in an era of environmental uncertainty: An analysis of the options for the forest nursery sector in Great Britain.

In applied forest science, it is important to understand the practical boundaries within which science-based policy can be implemented. Regarding seed sourcing for woodland creation and expansion, a clear practical and economic constraint upon the uptake of science based policy is that imposed by the commercial trade in forest plants and seed (Hubert and Cottrell, 2007; Buckley and Blakesley, 2008; O' Neill et al., 2014; Broadhurst et al., 2016).

In this chapter, inductive methods from qualitative social sciences are used to provide an overview of the current status of the domestic forest nursery and seed supply sector in GB. To build this overview, semi-structured interviews were conducted in person with members of the domestic forest nursery and seed supply industry. Respondents included 14 private sector forest nurseries, one representative of the public sector organisation involved in plant and seed supply and the only major specialist tree and shrub seed merchant in the UK. The interview guideline included a mixture of quantitative (descriptive) and qualitative (discursive) questions on seed procurement, plant production, sales and customer demand; grant schemes; attitudes to climate change and open questions regarding any other bottlenecks in the plant and seed supply chain.

### **v. Chapter six - Discussion and conclusions**

Chapter six will summarise the results from each of the main chapters of the thesis and discuss implications for forest management planning to encourage adaptation to climate change.

## **Chapter two**

### ***Defining climatic and ecological groupings amongst the native pinewoods of Scotland.***

#### **Abstract**

The eighty-four native populations of *Pinus sylvestris* L. in Scotland, often known as the ‘Caledonian pinewoods’ are grouped into a series of seven regions which are used to define seed transfer limits for the creation of new native woodland. The biochemical variation found among populations reflects the species’ postglacial history in Scotland but is not known to be selectively important, whereby it does not influence adaptedness of seed sources to planting sites. The landscapes contained within the biochemical regions are topographically heterogeneous, meaning that the populations within them do not form climatically uniform clusters. Using hierarchical cluster analysis of a distance matrix of 13 environmental variables, we provide an alternative classification of the native pinewoods by specifying a number of ‘climatic clusters’ equivalent to the number of seed zones to find groups of sites which experience a similar climatic selection regime. As a means to test climatic congruence of seed zones, comparison of site classifications was conducted which found that site membership of existing seed zones agrees with site membership of the climatically defined site clusters at a rate of 0.74 ( $p < 0.0001$ ), a pattern most likely derived by spatial auto-correlation in climatic variables at relatively broad geographical scales. Nonetheless, analyses of variance of the first two axes of climatic variation identified in a principal components analysis demonstrated that the classification produced by climatic clustering was more effective in explaining variation between groups. The ecological relevance of the seed zones is assessed with description and analyses of plant communities at a subset of these sites ( $n = 21$ ) which finds four ‘sub-communities’ within the native pinewoods. The differences between sub-communities can be explained firstly by a longitudinal axis of continentality and secondly by soil nutrient status. However, the extent to which this lithological variation, or variation in community composition contributes to adaptive genetic variation in pine trees remains untested.

#### **2.1. Introduction**

Seed sourcing guidelines for native tree and shrub species tend to involve designating geographical regions in which use of seed for new planting is considered to entail a low risk of maladaptation to local conditions. In Great Britain, geographically divisive seed zones are

### Climatic and ecological groupings within native pinewoods

applied to all native tree species. All but one species share an identical series of seed zones which, in the absence of comprehensive data regarding phenotypic variation and correlations with environmental variables, were defined arbitrarily, based on major geomorphological landforms and watersheds (Herbert et al., 1999). The exception is *Pinus sylvestris* L. in its native range in Scotland. The seed zones applied to *Pinus sylvestris* are also geographically divisive but the delineation was based on variation among populations in the frequency of biochemicals, e.g. monoterpenes (Forrest, 1980; 1982) and allozyme alleles (Kinloch et al. 1986). These are molecular markers which are thought to be selectively neutral, i.e. have little or no effect on fitness (Ennos et al., 1998; McKay and Latta, 2002). The rationale for delineating seed zones in this way was that restricting the choice of seed for new planting to local origins should firstly mean that planting stock should be well adapted to the planting site and secondly, should preserve the ‘genetic integrity’ of populations (Forestry Commission, 1998; Herbert et al., 1999). The definition of ‘genetic integrity’ is slightly unclear (Salmela et al., 2010), but presumably refers to maintenance of distinct genetic variation, including possible co-adapted gene complexes, and a naturally developed genetic structure. However, it is worth noting that levels of molecular genetic diversity in Scottish populations of Scots pine are similar to those found in continuous parts of the species range and the majority of genetic variation is held within, rather than between populations. The genetic differences between populations are typically due to small variations in allele frequencies, rather than the existence of unique alleles in different populations, suggesting that levels of gene flow are sufficient to have minimised divergence among populations (Provan et al., 1998; Wachowiak et al., 2011; 2013). The area covered by timber plantations of Scots pine in Scotland, which have historically been based on unknown origin material or planting stock based on mixtures of Scottish and non-Scottish seed origins in seed orchards (Lee, 2002), is estimated as 100,000 ha, which is over five times the 18,000 ha covered by the native pinewoods (Mason et al., 2004). The possibility or extent of pollen contamination from non-indigenous stands into indigenous stands remains to be tested, but is not implausible (Forrest and Fletcher, 1994; Salmela et al., 2010). This lack of natural selectively neutral genetic structure and extensive gene flow which most likely involves gene flow between plantations and native woodlands suggests that ‘genetic integrity’ is of much lower relevance than adaptively significant variation when selecting seed sources for new planting.

Variation in adaptively significant traits evolves in response to natural selection, which acts on phenotypic variation generated by the product of many loci of small effect, rather than variation at single genetic marker loci (Le Corre and Kremer, 2012; Alberto et al., 2013a;

Savolainen et al., 2013). Adaptively significant genetic variation can be assessed in common garden experiments or provenance trials in which trees, raised from seed collected from populations in many locations, are grown together in common conditions. In this scenario, environmental conditions are held constant and so differences in the phenotypes of individuals in the experiment can be inferred to reflect differences in the genotypes (White et al., 2007). Where there are geographic differences in phenotypes between populations, it is possible to form hypotheses about the selective forces that have shaped the variation, by relating phenotypic to environmental variation (White et al., 2007).

Optimally, seed transfer guidelines would be informed by evidence from well replicated long-term field tests or fully reciprocal transplant experiments in which the survival and ability for genotypes to compete in multiple environments could be assessed (Rehfeldt et al., 2002; Reich and Oleksyn, 2008; Wang et al., 2006). Although reciprocal transplant data do not yet exist for Scottish populations, data from single-site provenance tests demonstrate adaptive differences within and between native populations. Experiments indicate significant adaptive variation among families within populations for physiological characteristics such as growth characteristics such as height and diameter increment, phenology and cold tolerance (Perks and McKay, 1997; Perks and Ennos, 1999; Salmela et al. 2011; 2013), variation in susceptibility to infection by *Dothistroma septosporum* (Dorog) Morelet (Perry et al., 2016a, b) and variation in needle anatomy (Donnelly et al., 2016). Where significant adaptive differences have been found between populations, variation in phenotypic traits tends to be most closely related to longitude. For instance, when grown in a common environment in trials based in either Edinburgh or Aberdeen, the progeny of populations from colder, drier eastern environments initiated their annual growth earlier than those from warmer, wetter western sites (Salmela et al., 2013). Similarly, in an outdoor trial in the south west of Scotland, the progeny of populations from western sites showed lower susceptibility to infection by *Dothistroma septosporum* than those from the east, perhaps due to co-evolved resistance in the plants from humid environments with higher pathogen pressure (Perry et al., 2016a). Even when the majority of variation has been found within rather than between populations, phenotypic variation tends to show the same regionality, for instance for photochemical responses to cold temperatures (Salmela et al., 2011) and variation in needle morphology (Donnelly et al., 2016). These results reflect the relatively steep environmental gradient that exists between the oceanic west and more continental east of Scotland. For example, the driest of the native pinewoods, Carn na Loine, which is in the Cairngorm mountains in the east central Highlands receives 739 mm of annual precipitation whereas Glen Barisdale on the Knoydart peninsula in the west receives 3730 mm of annual

### Climatic and ecological groupings within native pinewoods

precipitation despite geographic separation of only 115 km. Geographic proximity does not always mean that sites experience similar conditions. For example, the warmest and coldest of all of the native pinewoods, based on long term average annual growing degree days (GDD; accumulated number of degrees per day on days in which the mean temperature exceeds 5.5° C) are in the same seed zone. Loch Maree Islands, which is 12 m above sea level has an average GDD of 1423.6 whilst Coir a' Ghamhna, which is 249 m above sea level has an average GDD of 436.6, despite geographical separation of 18 km.

Selectively neutral molecular markers provide relatively little useful information on the extent to which plants are adapted to local conditions (Ennos et al., 1998; McKay and Latta, 2002; Holderegger et al., 2006; Jørgensen et al., 2016). This is exemplified in topographically complex landscapes, such as those which the native pinewoods occupy in Scotland. In this case, populations which are geographically proximal may not experience similar selection regimes due to the confounding effects of altitude and aspect, and a closer climatic match may be found at pinewood sites which are located further away (i.e., in another seed zone). The lack of environmental coherence in existing seed zones was demonstrated for the native Scots pine by investigating the principal components of variation among a series of climatic covariates by Salmela et al. (2010). This analysis showed that the most climatically similar sites were often not within the same seed zone.

In this chapter, we begin by applying similar multivariate techniques to identify natural groupings of pinewoods which do experience similar climatic regimes, thus forming an initial basis for delineation of custom 'floating' (unfixed seed zones which aim to match sites rather than draw boundaries) seed transfer guidelines (Rehfeldt, 1983) for native *Pinus sylvestris* in Scotland. However, organisms must also be able to cope with, or adapt to aspects of the biotic and edaphic environment (Bucharova et al., 2016a), conditions which are likely to vary more dynamically and at different, more mosaic-like patterns than climatic covariates (Linhart and Grant, 1996) but which may be overlooked when climatic covariates are considered alone. A proxy for selectively different environments incorporating these multiple aspects of the environment might be found by investigating plant communities at a range of sites, as these are the product of these combined selective pressures. To characterise sites ecologically, we conducted a survey and analysis of plant communities at a series of 21 native pinewood sites. Plant communities are useful in this context because they are relatively easy to describe using well-established methods (Rodwell et al., 1991). The use of plant species as bioindicators, suitable for detecting ecological variation between sites is well established in British forest management (Pyatt et al., 2001).

This combined approach enables us to quantitatively test the suitability of the existing seed zones for identifying populations which undergo similar climatic selective regimes and use floristic data to determine whether there is additional, idiosyncratic environmental variation potentially producing responses which would go un-noticed if climate was considered as a proxy for selection alone. Together, these approaches provide a basis for improving upon the current system of seed zoning for native woodland creation in Scotland.

## **2.2. Materials and methods**

### **2.2.1. Site selection**

The native or ‘Caledonian’ pinewoods in Scotland consist of 84 ancient-semi natural Scots pine *Pinus sylvestris* populations which are considered to have persisted through natural regeneration since their initial colonisation and establishment. These 84 populations are listed as such on the ‘Caledonian pinewood inventory’ (Forestry Commission, 1998) and here, these will be subjected to climatic clustering.

### **2.2.2. Obtaining environmental data**

Long term average values for a series of 13 climatic variables were extracted from the UK Meteorological Office’s datasets for each of the 84 sites on the Caledonian pinewood inventory, for the years 1970-2000. Values for the meteorological variables are interpolated onto 5 x 5 km grids in order to estimate values for the entire country (Perry and Hollis, 2005). Monthly values for count variables (e.g. sunshine hours, days of snow lying, precipitation) were summed and mean monthly variables were averaged (e.g. mean wind speed, mean monthly temperatures) to generate annual values for each of the covariates, using a custom script in R version 3.2.3 (R Core Team, 2015).

### **2.2.3. Vegetation sampling**

Selection of sites for inclusion within the vegetation surveys was based on a sub-set of 21 populations (Figure 2.1) from which seed had been collected in 2007 for inclusion within provenance-progeny trials raised at Centre for Ecology and Hydrology in Edinburgh and the James Hutton Institute near Aberdeen. Details of these trials can be found in Salmela et al. (2013). These 21 populations represent one quarter of the ‘Caledonian’ pinewoods and include three sites from each of the seven biochemical regions which are used as seed zones. The site names used here match those used in the Caledonian pinewood inventory.

### Climatic and ecological groupings within native pinewoods

All the vegetation surveys were conducted in the summer of 2014. Sampling followed a similar approach to that of the National Vegetation Classification (Rodwell, 1991). Ground layer species were identified within 1 \* 1 m quadrats and the shrub layer within 5 \* 5 m, inclusive of the ground layer quadrat. Abundance was estimated using the ten category DOMIN scale. Where plants were growing interspersed amongst others, or in slightly different layers, total abundance values were permitted to exceed a cumulative score of 10 – or 100% of the quadrat. Tree cover was estimated within a 15 x 15 m plot. The surveying based on 1, 5 and 15 m square quadrats was repeated at five locations at each site. Selection of sampling plots within populations was on a stratified-random basis, to enable rapid sampling. Five plots were selected from within blank site polygons within ArcMap v.10.1 (ESRI, Redlands, California) and subsequently located and sampled once on site. Some of the woodlands are very large and so sampling was targeted in a limited area. When this was the case, the area chosen was in close proximity to the locations of the parent trees from which seed had been collected for common garden experiments. In situations where the GPS waypoint lay in a location which was not representative of pine woodland, the quadrat was cast into the nearest representative area. No attempts to quantify grazing intensity, canopy height or openness, slope, aspect or any soil properties were made. Furthermore, no deliberate effort was made to capture total variation or conduct exhaustive surveys throughout the forests. Instead, our intention was to produce a rapid characterisation of the vegetation type at each site.

#### **2.2.4. Mean Ellenberg indicator values**

Ellenberg indicator values (EIVs) are bioindicator values assigned to plant species for a series of six habitat traits on a nine point ordinal scale (Ellenberg, 1992). These values were initially assigned based on measured variation of habitat characteristics in Central European sites, but have since been adjusted for use in the British Isles for vascular plants (Hill et al., 2004) and bryophytes (Hill et al., 2007).

The purpose of using EIVs in this study is as a surrogate for measured variation in soil variables, notably soil reaction and nitrogen content which can be difficult to measure and which can exhibit considerable variation at narrow spatial and temporal scales (Diekmann, 2003). We will use only the mean site EIVs for N (nitrogen) and R (reaction), as measured long-term climatic observations are available to describe other phenomena. To gain frequency-weighted mean EIVs for each of the pinewood sites, we followed the protocol of Pyatt et al. (2001). Under this protocol, species weightings are calculated by multiplying the species' frequency score (the number of quadrats within each site in which the species



occurred) with the EIV of that species. The weighting value for species occurring in only one quadrat at a site is dropped from 1 to 0.5 to reduce the strength of the effects of rare species in the dataset. The calculations were made using the full dataset, including site-singletons.

However, constant species in the dataset, which were *Pinus sylvestris*, *Hylocomium splendens*, *Vaccinium myrtillus* and *Calluna vulgaris* were not considered in the calculations.

Mean EIVs for each site are calculated as the sum of the species weighted values divided by the sum of all of the species weights at that site, giving the mean taxon EIV for the site.

This therefore gives the mean EIV of the taxa at that site. N and R indicator values have a recognised tendency to be positively correlated (Hawkes et al., 1997; Dzwonko, 2001; Pyatt et al., 2001) and were indeed strongly positively correlated in our dataset ( $r = 0.8$ ,  $df = 19$ ,  $p = <0.01$ ). Due to this strong correlation, values for each of these were combined by calculating the mean of both values to give a combined 'soil nutrient regime' (SNR) score.

### **2.2.5. Statistical analyses**

All the statistical analyses described here were performed in R version 3.2.3. (R Core Team, 2015), with particular reliance on the 'vegan' package for vegetation analyses (Oksanen et al., 2016).

#### **2.2.5.1. Climatic site clustering**

Heirarchical cluster analysis, with complete linkage was applied to a Euclidean distance matrix of the full set of environmental covariates for the 84 pinewood sites on the Caledonian pinewood inventory which aimed to produce seven distinct groups of sites and to explore whether their composition matched that of the seven seed zones that already exist for Scots pine. This number was deliberately chosen so that it would be possible to assess how well membership of the existing seed zones matches a classification based on actual climatic variation. Classification tree analysis was then conducted, treating cluster group as a factor response variable. This method uses recursive binary partitioning to choose splits based on the predictor terms in the formula (in this case, all 13 variables). The tree, built using the 'tree' package within R (Ripley, 2016) searches iteratively for splits amongst the response terms which maximise the reduction in Gini impurity (a measure of misclassification) until the number of terminal nodes is equivalent to the number of factor levels (Ripley, 2016).

The two classifications (seed zones, climatic clusters) were then compared to determine whether group membership is more similar than would be expected by chance, using simulated data. Since the actual number of clusters is arbitrary and the groupings made by

### *Climatic and ecological groupings within native pinewoods*

either classification cannot be compared directly, we produced  $n \times n$  binary ‘membership’ matrices for each of the classifications in which pairwise comparisons of sites within the same cluster would be scored as successes (1) and sites which were in different groups would be scored as failures (0). Agreement between membership matrices was calculated as the sum of the paired successes between classifications. The number of possible agreements between matrices therefore ranges from  $n = 84$  to  $n^2 = 7056$ . After correcting for different frequencies of the pre-defined seed zone classifier, 10000 simulated binary datasets were generated and compared to the reference classification to give a probability of achieving a higher number of agreements between the classifications by chance.

Principal components analysis (PCA) was then applied to a correlation matrix of the same set of environmental covariates to identify important axes of climatic variation in the dataset. Analysis of variance in the first two principal components was then applied; treating the classification levels (seed zones, climatic clusters) as grouping factors in order to evaluate variance explained between and within groups under each system of classification.

#### **2.2.5.2. Vegetation description and analyses**

Prior to conducting statistical analyses, the vegetation dataset was summarised to use frequency values for each site (the number of relevés from each site in which species occurred, regardless of their abundance). This was conducted because the aims are to interpret variation in community composition between sites, rather than within sites. Singletons, which are taxa occurring at only one site were removed from the dataset to avoid the presence of rare taxa exaggerating dissimilarities between sites. Additionally, Wisconsin standardisation of these frequency scores was applied to down weigh infrequent but not unique taxa. Hierarchical clustering, using a Ward minimal variance algorithm (Ward, 1963), was applied to a Bray-Curtis dissimilarity matrix of pairwise site combinations to produce a dendrogram. The subjective criteria for pruning the dendrogram into clusters were to find the greatest number of clusters possible, provided that each cluster could be represented by no fewer than three sites and that each cluster could be represented by at least one significant indicator species. Dufrière-Legendre indicator species analysis (Dufrière and Legendre, 1997) was implemented using the ‘indval’ function of the ‘labdsv’ package (Roberts, 2016). This function calculates the fidelity and relative abundance of species within each of the predefined clusters to identify taxa which can be significantly associated with each of the communities or sub-communities.

To visually interpret dissimilarities and to test associations with environmental variables, ordination of vegetation data onto two axes of variation by nonmetric multidimensional

scaling (NMDS) based on a Bray-Curtis dissimilarity matrix was applied, using the function 'metaMDS'. In NMDS, a random starting configuration of points (sites) in ordination space is assigned. On each iteration, the distance between points in the ordination is calculated and 'stress', a measure of goodness of fit between the dissimilarity matrix and the ordination solution is calculated. The algorithm proceeded with a maximum 20 random starts and ran until it found a solution with the lowest stress and highest goodness of fit. Multiple runs were performed to ensure that the function did not converge on a local optimum and were found not to appreciably change the results, thereby the solution was considered appropriate. An advantage of NMDS over other ordination procedures is that it does not make assumptions about the distribution of the data and can accommodate the use of different dissimilarity metrics.

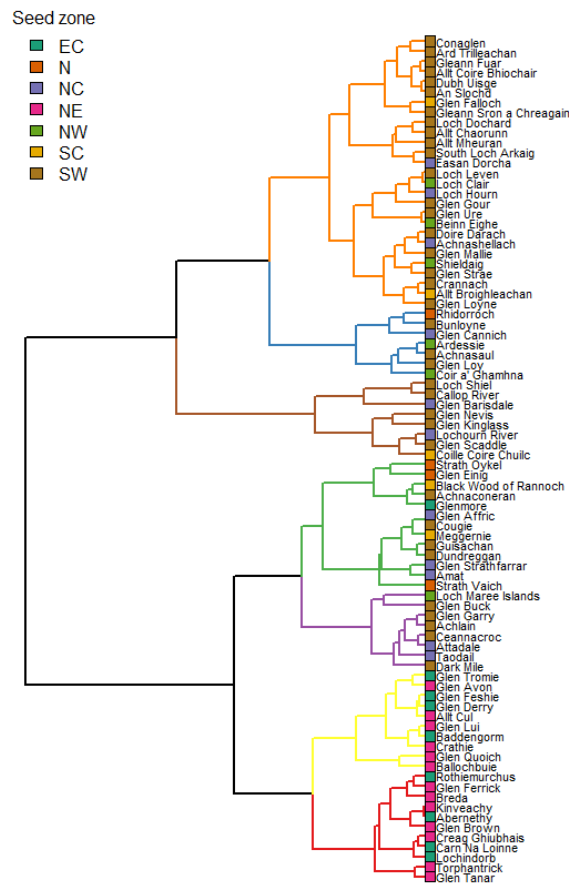
Vector fitting, using the full set of environmental variables described in section 2.2.2 was applied to the ordination solution using the 'envfit' function within vegan to test for associations between axes of variation in community composition (NMDS axes) and environmental variables. Significance of vectors was tested using 999 permutations. Finally, a classification tree was built using the same methods as were applied to produce the classification tree of climatic clusters to identify environmental factors which can be used to discriminate between the different sub communities, again using the 'tree' package (Ripley, 2016).

## **2.3. Results**

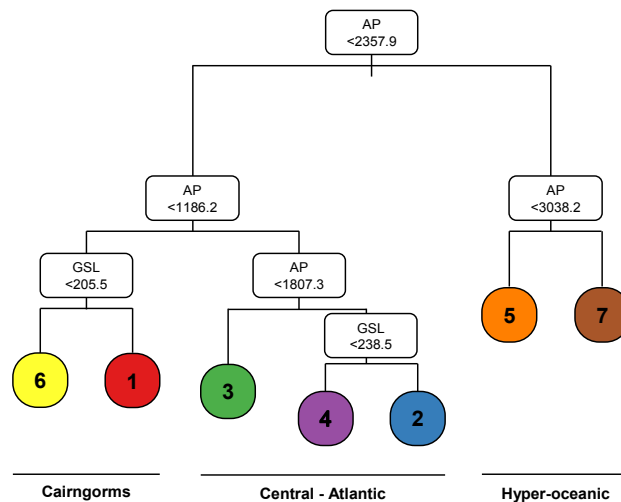
### **2.3.1. Climatic site clustering**

The dendrogram solution produced by hierarchical cluster analysis was deliberately cut to produce seven climatic clusters of sites in order to have the same number of classes as the current system of seed zones (Figure 2.1). The first division separates sites in the eastern, central and northern Highlands from those in the west. The classification tree which treated cluster membership as a factor variable found that membership of climatic clusters could be determined using just two climatic variables, AP (annual precipitation) and GSL (growing season length) (Figure 2.2).

Climatic and ecological groupings within native pinewoods

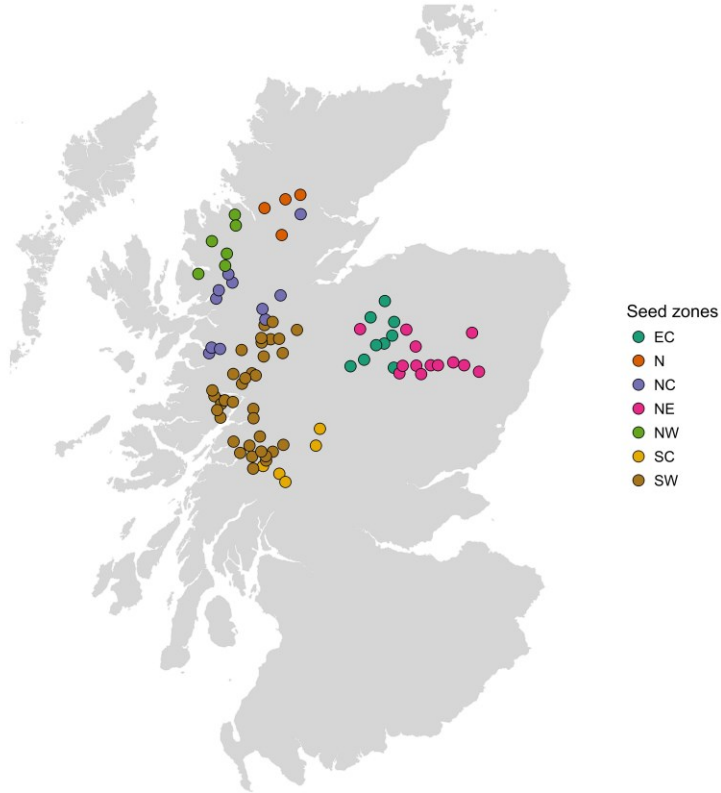


**Figure 2.1.** Hierarchical cluster dendrogram of the 84 pinewoods on the Caledonian pinewood inventory, based on climatic dissimilarity. Branch colours represent membership of each of the seven climatic clusters. Leaf colour represents membership of existing seed zones.

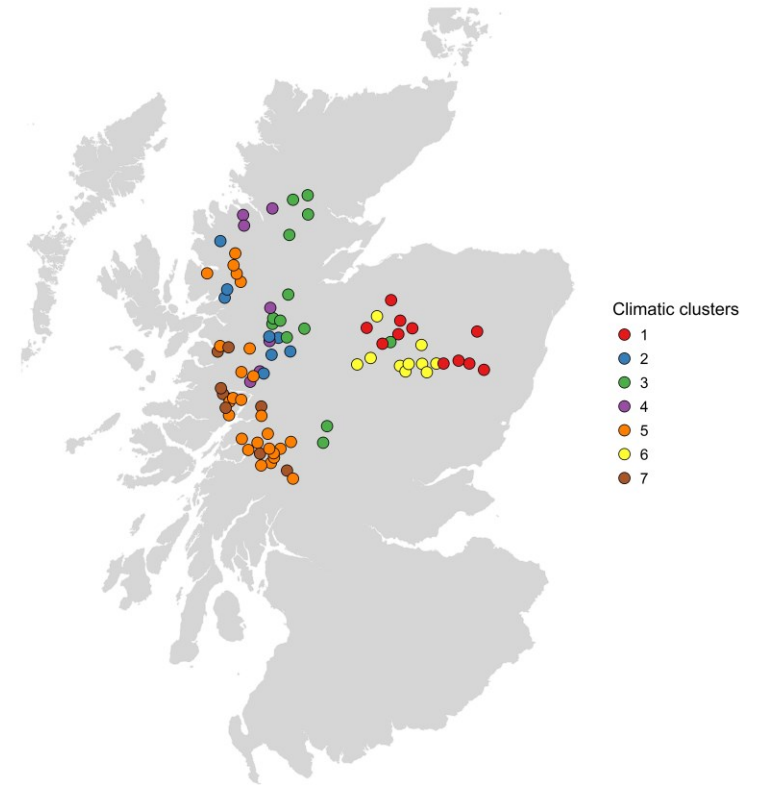


**Figure 2.2.** Classification tree of the 'climatic cluster' groups fitted with 13 environmental variables, converging on a solution involving only two variables (AP = annual precipitation (mm); GSL = growing season length (days)). When threshold conditions at each node are met, the branching proceeds to the left. There are 2/84 misclassifications. Tree redrawn based on a topology produced in the R package 'tree' (Ripley, 2016). The labels ("Cairngorms", "Central-Atlantic" and "Hyper-oceanic") are optional subjective classifications

a.



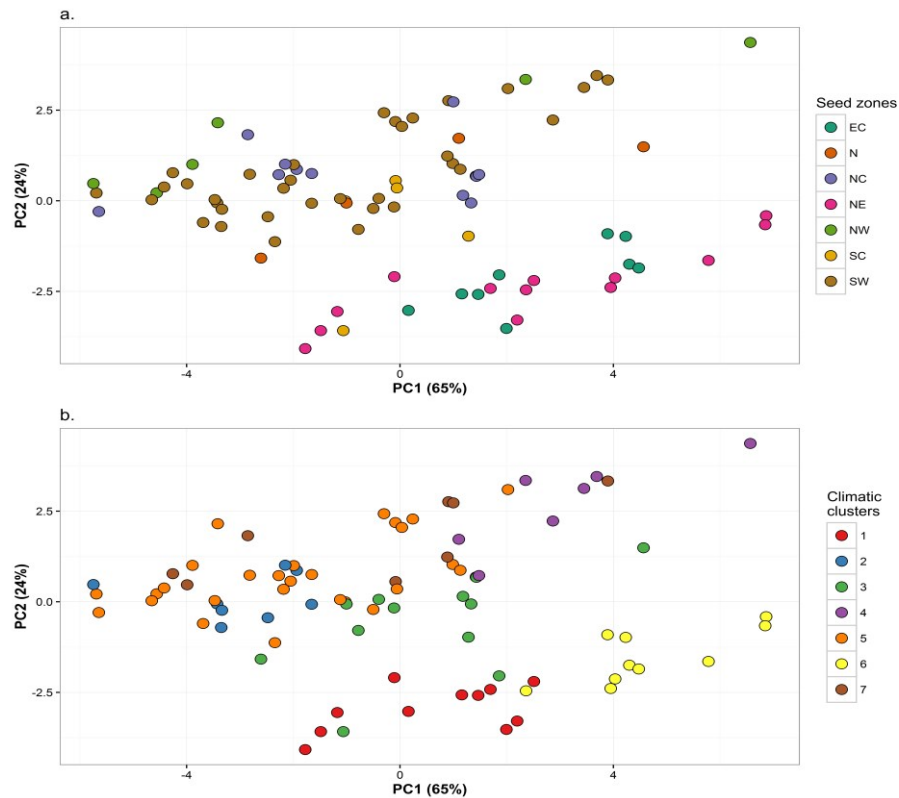
b.



**Figure 2.3.** Map of Scotland with the locations of the 84 native pinewoods, indicating a) seed zone membership and b) membership of the 'climatic clusters' defined here.

We found 5244/7056 agreements between the seed zones classifier and the climatic clusters, representing an agreement rate of 0.74. For instance, the majority of sites from the ‘east-central’ and ‘north-east’ seed zones, in the east of Scotland cluster together climatically. The agreement rate was higher than in any of the 10000 simulated datasets therefore the probability of producing a classification which matched the climatic clusters as well as the existing seed zones by chance is  $p = <0.0001$ .

The first two principal components of variation in climatic variables explained 64.6% and 24.6% of the total variation respectively (Figure 2.4). PC1 represents a gradient in temperature related variables, having a strong negative correlation with values of variables such as GDD (growing degree days); MFT and MJT (mean monthly temperatures for February and July). PC2 represents a gradient in precipitation and continentality, having a strong positive correlation with AP (annual precipitation), and a strong negative correlation with SH (mean annual sunshine hours), and ETR (extreme temperature range). Visually, the principal component biplot suggests that different pinewood sites within seed zones do not form environmentally uniform clusters (Salmela et al., 2010), and that the defined ‘climatic clusters’ provide a more discrete solution to minimising variation within groups but maximising variation between groups (Figure 2.4). This is confirmed by analysis of variance, which demonstrates that this is indeed the case (Table 2.1). While climatic differences between levels of both classifications (climatic clusters and seed zones) are highly significant; the variance explained by the climatic clusters is greater. The climatic clusters explain 0.62 of the variance in PC1 ( $ANOVA F_{(6,77)} = 24.831$ ) and 0.73 of the variance in PC2 ( $ANOVA F_{(6,77)} = 27.778$ ) whereas the seed zones explain 0.26 of the variance in PC1 ( $ANOVA F_{(6,77)} = 6.3942$ ) and 0.6 of the variance in PC2 ( $ANOVA F_{(6,77)} = 14.648$ ). All significance values are well below 0.001.



**Figure 2.4.** Plot of the first two principal components of variation amongst a set of 13 climatic variables, accounting for 64.6 and 24.6% of the total variation respectively indicating a) seed zone membership and b) climatic cluster membership. The variables used and their correlation coefficients with each of the first two components are shown in table 2.1. The key to the abbreviations used for the seed zones is as follows: EC = east central, N = north, NC = north central, NE = north east, NW = north west, SC = south central, SW = south west.

**Table 2.1.** List of climatic variables used in the principal component analysis and their correlation coefficients with the first two axes of variation.

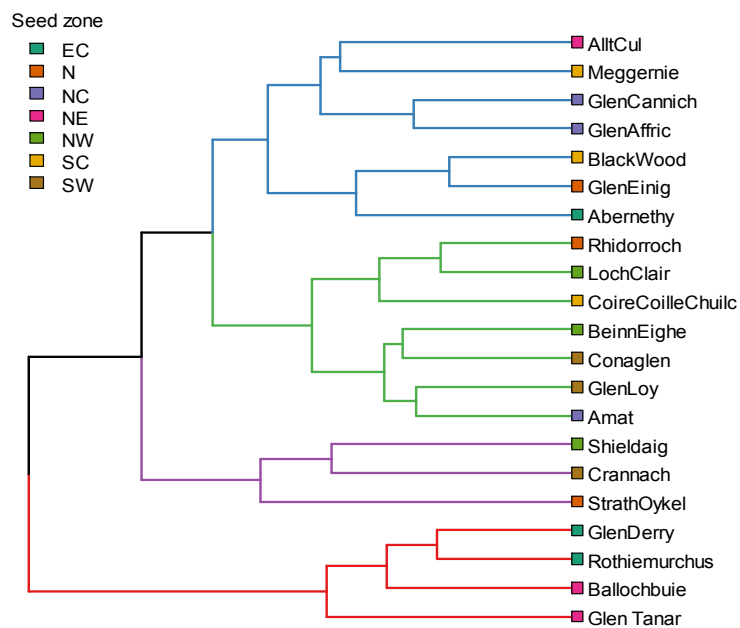
<u>Variable</u>	<u>Abbreviation</u>	<u>PC1</u>	<u>PC2</u>
Mean February temperature	MFT	-0.341	0.289
Mean July temperature	MJT	-0.303	-0.255
Consecutive dry days	CDD	-0.265	-0.312
Mean wind speed	MWS	0.28	0.262
Sunshine hours	SH	-0.518	0.18
Growing degree days	GDD	-0.328	-0.134
Days of snow lying	DSL	0.317	-0.133
Vapour pressure	VAP	-0.341	0.123
Annual precipitation	AP	-0.178	0.38
Growing season length	GSL	-0.336	0.205
Extreme temperature range	ETR	0.142	-0.468
Ground frost days	GFD	0.309	-0.204
Altitude	ALT	0.244	-0.237

### 2.3.2. Vegetation description and analyses

A total of 89 plant species were found amongst the pinewood sites, of which 21 were singletons, i.e. taxa which occurred at only one site and were thus omitted from multivariate analyses. Strath Oykel and Shildaig had a relatively high number of singletons with eight and six respectively. Eleven of the 21 sites contained no singletons.

#### 2.3.2.1. Identifying sub-communities

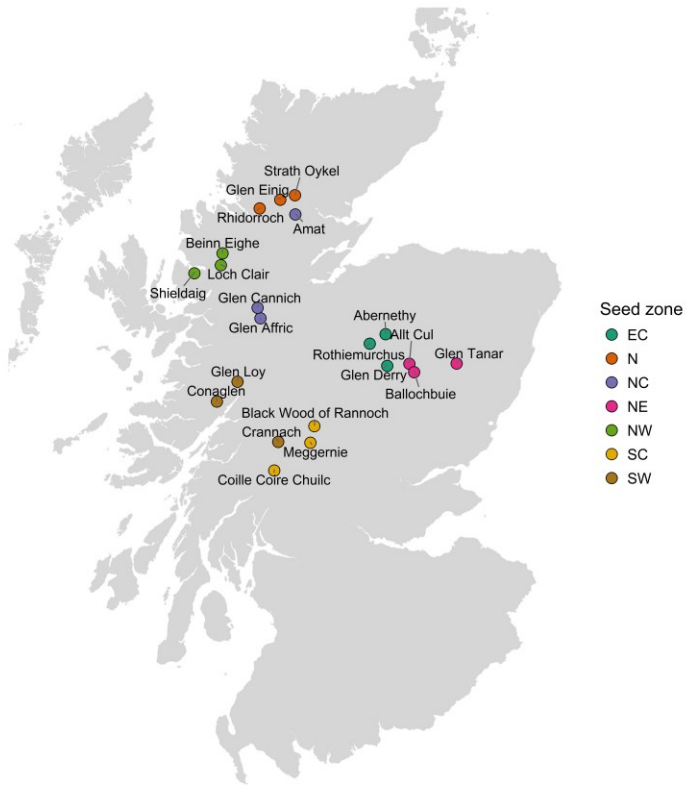
Hierarchical clustering, based on Bray-Curtis dissimilarities were produced a dendrogram from the vegetation data (Figure 2.5) which found four discrete groups of sites (henceforth described as sub-communities). The 21 sites that were included in the vegetation survey consisted of three sites from each of the seven Scots pine seed zones yet the three sites from the same seed zone never clustered together in the same plant sub-community (Figure 2.5), despite the smaller number of sub-communities ( $n = 4$ ) than seed zones ( $n = 7$ ). Each of the four sub-communities could be associated with at least one significant indicator species (Table 2.2).



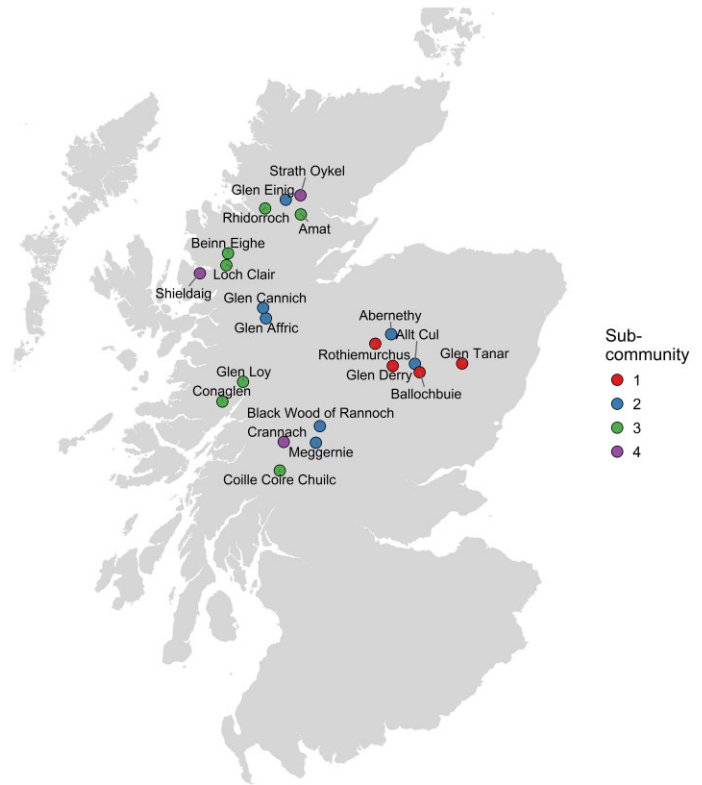
**Figure 2.5.** Hierarchical cluster dendrogram demonstrating group membership (branch colours), and seed zone membership (leaf colours). Figure customised using functions from the 'dendextend' package (Galili, 2015).



a.



b.



**Figure 2.6.** Map of Scotland with the locations of the 21 native pinewoods in which vegetation sampling was conducted, indicating a) seed zone membership and b) membership of the vegetation sub-communities.

**Table 2.2.** Significant indicator species of each sub-community

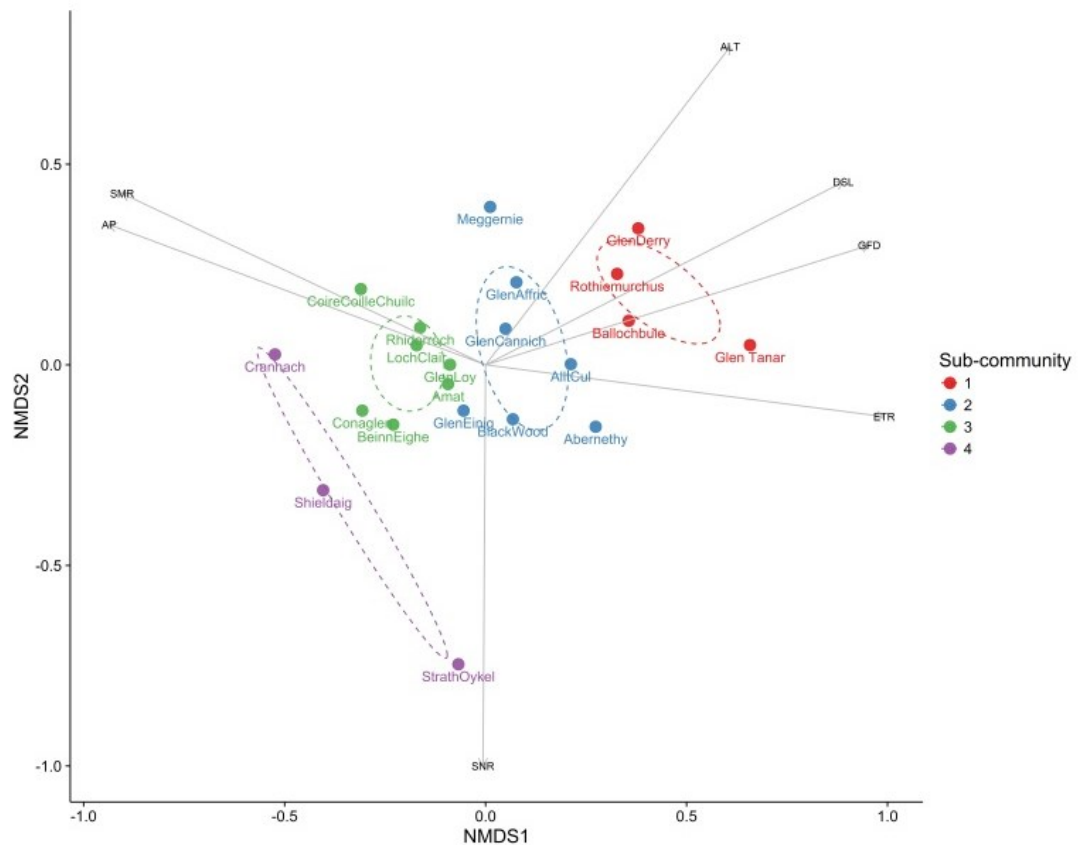
Sub-community	Taxon	Indicator value	P value
1.	<i>Pleurozium schreberi</i> (Willd. Ex Brid.) Mitt.	0.4818	0.001
	<i>Vaccinium myrtillus</i> L.	0.3731	0.001
	<i>Vaccinium vitis-idaea</i> L.	0.4639	0.001
	<i>Calluna vulgaris</i> (L.) Hull	0.3874	0.001
	<i>Hylocomium splendens</i> (Hedw.) Schimp.	0.3189	0.019
	<i>Rhytidiadelphus triquetrus</i> (Hedw.) Warnst.	0.4912	0.036
2.	<i>Plagiothecium undulatum</i> (Hedw.) Schimp.	0.3818	0.031
3.	<i>Sphagnum</i> (L.) spp.	0.4921	0.011
	<i>Sorbus aucuparia</i> L.	0.5558	0.019
	<i>Dicranum majus</i> Turner	0.3901	0.032
4.	<i>Pteridium aquilinum</i> (L.) Kuhn	0.4422	0.022
	<i>Potentilla erecta</i> (L.) Raeusch.	0.6418	0.003
	<i>Viola riviniana</i> Rchb.	0.6039	0.016
	<i>Mnium hornum</i> Hedw.	0.6667	0.016
	<i>Pseudoscleropodium purum</i> (Hedw.) M.	0.4871	0.038
	Fleisch.		

### 2.3.2.2. Environmental interpretation

Nonmetric multidimensional scaling produced a solution with a minimum stress of 0.146 and a non-metric fit of  $R^2 = 0.979$  (Figure 2.7). The first axis of community composition was related to continentality and positively correlated with extreme temperature range ( $p = 0.006$ ) and negatively correlated with annual precipitation ( $p = 0.001$ ) (Table 2.3). The second axis was strongly negatively correlated with soil nutrient regime ( $p = 0.001$ ). The strength of these environmental correlations meant that a classification tree could be produced to indicate the environmental criteria under which each sub-community develops. On the first run, the classification tree found one fewer terminal node than those which had been described by clustering, i.e. the first tree did not discriminate between two of the clusters. To build a fully resolved tree, the analysis was repeated by implementing a separate model considering only the two unclassified sub-communities (2 and 3). The resulting classification tree (Figure 2.8) contains four terminal nodes, with misclassification error rates of 1/21 at the first node, which is split by SNR; 3/18 at the second node, split by AP and 1/14 at the final node to separate sub-communities 2 and 3 by altitude (Figure 2.9). Because SNR is used for the first division, and these values are derived from plant composition as a surrogate for measured variation in soil nutrient status, it should be strongly emphasised that this is not an external variable and as such, the tree should be considered a tool by which to classify

existing data, rather than to predict based on environmental variables (Zelený and Schaffers, 2012).

The classification tree and the ordination solution are sufficient to provide a verbal description of each of the sub-communities as follows: 1 = dry, base-poor pinewoods; 2 = central pinewoods; 3 = oceanic bryophyte rich pinewoods; 4 = relatively base rich pinewoods. These categories are approximately similar to those determined from the climatic clustering, with the main novelty being that of the ‘base-rich’ pinewood sub-community, which is not explained by climatic variation. Sub-communities 1, 2 and 3 are clearly arranged along a geographical and ecological gradient on the ordination biplot (Figure 2.7) and this shows strong spatial auto-correlation (Mantel test statistic based on Pearson’s  $r = 0.3624$ ,  $p < 0.001$ ).

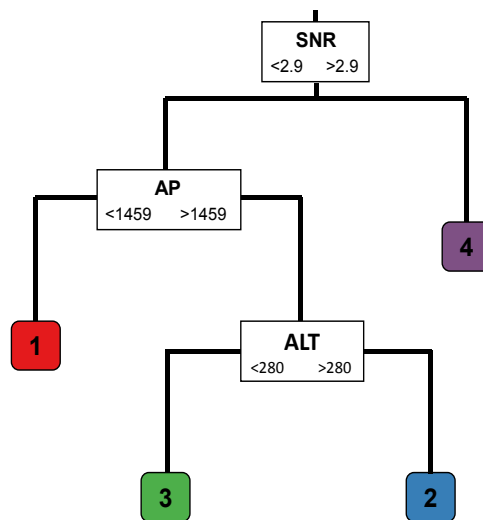


**Figure 2.7.** NMDS ordination biplot for the 21 pinewood sites, demonstrating sub-community membership and their geometric centroids. The solution is rotated so that the first axis is oriented with longitude. Fitted environmental vectors are those in which  $p < 0.01$ . Unabbreviated vector names are provided in Table 2.3.

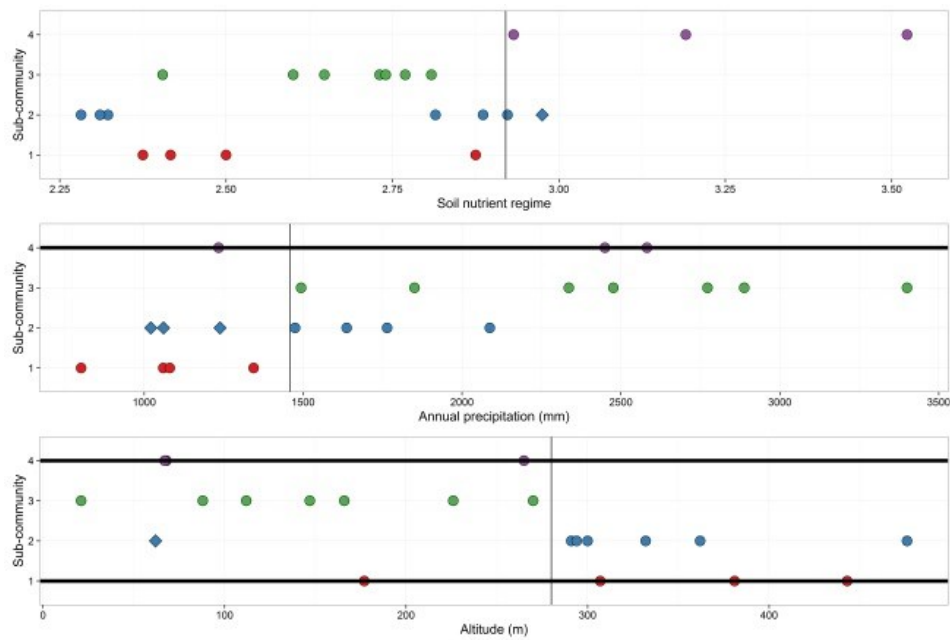
Climatic and ecological groupings within native pinewoods

**Table 2.3.** List of environmental variables used in vector fitting and their correlation coefficients with the NMDS axes. Those in bold and italics are significant to  $p < 0.01$ .

<u>Variable</u>	<u>Abbreviation</u>	<u>NMDS1</u>	<u>NMDS2</u>	<u>R<sup>2</sup></u>	<u>P value</u>
Mean February temperature	MFT	-0.71881	-0.6952	0.4011	0.014
Mean July temperature	MJT	-0.08012	-0.99679	0.1814	0.172
<b><i>Soil moisture regime</i></b>	<b><i>SMR</i></b>	<b><i>-0.90419</i></b>	<b><i>0.42712</i></b>	<b><i>0.4972</i></b>	<b><i>0.005</i></b>
<b><i>Soil nutrient regime</i></b>	<b><i>SNR</i></b>	<b><i>-0.00658</i></b>	<b><i>-0.99998</i></b>	<b><i>0.7428</i></b>	<b><i>0.001</i></b>
Consecutive dry days	CDD	0.24385	-0.96981	0.03	0.768
Mean wind speed	MWS	0.25135	0.9679	0.0776	0.485
Sunshine hours	SH	0.96242	-0.27156	0.4022	0.018
Growing degree days	GDD	-0.27995	-0.96001	0.2724	0.055
<b><i>Days of snow lying</i></b>	<b><i>DSL</i></b>	<b><i>0.88995</i></b>	<b><i>0.45606</i></b>	<b><i>0.4706</i></b>	<b><i>0.008</i></b>
Vapour pressure	VAP	-0.65313	-0.75724	0.3551	0.026
<b><i>Annual precipitation</i></b>	<b><i>AP</i></b>	<b><i>-0.93689</i></b>	<b><i>0.34963</i></b>	<b><i>0.7383</i></b>	<b><i>0.001</i></b>
Growing season length	GSL	-0.56106	-0.82777	0.3718	0.019
<b><i>Extreme temperature range</i></b>	<b><i>ETR</i></b>	<b><i>0.99163</i></b>	<b><i>-0.12908</i></b>	<b><i>0.4295</i></b>	<b><i>0.006</i></b>
<b><i>Ground frost days</i></b>	<b><i>GFD</i></b>	<b><i>0.95452</i></b>	<b><i>0.29813</i></b>	<b><i>0.4844</i></b>	<b><i>0.006</i></b>
<b><i>Altitude</i></b>	<b><i>ALT</i></b>	<b><i>0.60847</i></b>	<b><i>0.79358</i></b>	<b><i>0.4683</i></b>	<b><i>0.004</i></b>



**Figure 2.8.** Classification tree derived from environmental variables associated with populations in each of the four sub-communities, manually redrawn by the author based on a topology produced in the R package 'tree' (Ripley, 2016).



**Figure 2.9.** Values for each of the external environmental variables used to discriminate between sub-communities, in order of placement on the tree. Vertical lines on the plots indicate the threshold value for discrimination and horizontal lines on the lower two plots indicate where a sub-community has already been classified at an earlier node. Diamond shaped plotting characters indicate mis-classified sites.

## **2.4. Discussion**

Geographically defined seed zones offer a convenient way for forest reproductive material to be described and certified by producers (Ying and Yanchuk, 2006). Fixed geographical boundaries provide the most intuitive and simple solution to this, as they can be represented with lines on a two dimensional map. However, in heterogeneous environments such as upland Scotland, geographically defined seed zones do not necessarily contain similarly adapted populations, as microclimate, topography and lithology can vary at narrow spatial scales (Linhart and Grant, 1996; Bischoff et al., 2006; Salmela et al., 2010). Our analyses have shown that the current seed zones for Scots pine in Scotland do not account for fine-scale climatic variation in 26% of sites and that alternative groups can be defined in which differences between groups can be increased whilst minimising the climatic differences between sites within a single group.

Survey and analysis of vegetation at a subset of the native pinewood sites found four different sub-communities. The variation in plant community composition was strongly spatially auto-correlated and the associations with climatic variables, particularly those related to continentality support the climatic clusters defined when considering climatic variation alone. The novel information emerging from vegetation description and analysis

### Climatic and ecological groupings within native pinewoods

was the second axis of variation which is attributed to proxy values for soil nutrient status (SNR). The magnitude of differences in SNR observed here are relative only to the native pinewoods in which the vegetation sampling was conducted, a habitat which in Scotland is notable for its association with strongly leached, acidic podzol soils (Steven and Carlisle, 1959; Carlisle and Brown, 1968; Rodwell et al., 1991), meaning that the ecological importance of the edaphic variation within the sample is difficult to interpret.

Furthermore, the measure of soil nutrient status applied here was gained from mean EIVs, which are not independent of community composition, provoking a circularity of reasoning whereby dissimilarities in EIVs can be inherited by dissimilarities in community composition (Zelený and Schaffers, 2012). Whilst the strength of the correlation between SNR and community composition reported here may be somewhat inflated by the use of EIVs, the gradient in SNR found in the vegetation data is nevertheless qualitatively realistic. Significant indicators of the 'base rich' sub-community include the herbs *Viola riviniana* and *Potentilla erecta* and bracken *Pteridium aquilinum*, which was constant whilst *Vaccinium vitis-idaea* was almost entirely absent and *V. myrtillus* and *Calluna vulgaris* were much less abundant than elsewhere. The sites in this sub-community contained a high number of singletons, including species more commonly associated with deciduous woodlands on brown-earth soils. Examples of singletons from sites within this group are *Lonicera periclymenum* L., *Hyacinthoides non-scripta* (L.) Chouard ex Rothm., *Lysimachia nemorum* L. and *Brachypodium sylvaticum* (Huds.) P.Beauv.

Ecological information inferred from the use of bioindicators is already used to inform species choice in GB woodlands, as part of the 'Ecological site classification' (ESC) decision support system (Pyatt et al., 2001). The site classification models in ESC are applied at higher taxonomic scales and imply lower precision in the estimated variable than would be implied by selecting components of genetic variation *within* species based on high precision measurements or estimates of environmental variation at narrow spatial scales. Therefore, there are a number of important shortcomings in applying this type of ecological site matching to the selection of seed origins for new planting. Firstly, matching characteristics of currently unwooded planting sites to woodlands based on community assembly alone is inherently problematic because it relies on the use of bioindicator values. Composition and physiognomy of vegetation between wooded and non-wooded sites will necessarily be different, perhaps inflating differences in indicator values, due to dissimilarities inherited from compositional dissimilarity (Zelený and Schaffers, 2012). Secondly, a comprehensive ecological site matching tool based on plant community

composition would require vegetation classification at a greater number of sites and ideally, would require higher sampling intensity than was carried out in this study. This would be time consuming and expensive. A further problem with this is that pragmatic decisions taken during vegetation sampling often render results subjective (Podani, 2006), and for this reason it would be difficult to ensure that ecological profiles created by different recorders were comparable. Finally, without conducting the research necessary to determine whether edaphic variation gives rise to selectively important phenotypic variation and the scales at which this operates, it will be difficult to determine whether it is necessary to incorporate this information into seed sourcing guidelines.

An experiment in which seed collected from five open pollinated maternal genotypes of *Populus angustifolia* E. James in Utah, with a total separation distance of 65 km were grown reciprocally in soil collected from beneath the parent trees demonstrated that seedling survival in local soils was 2.5 times higher than in non-local soils, and plant size (based on a multivariate size-related trait) was between 15-20% larger in local soils (Smith et al., 2012). In replicated trials of *Pseudotsuga menziesii* (Mirb.) Franco in southwestern British Columbia, provenances demonstrated heritable specificity to ectomycorrhizal fungi, with the consequence that productivity of non-local tree genotypes planted in the trials reduced with increasing divergence of ectomycorrhizal communities between the sites of origin (Kranabetter et al., 2015). There is evidence of variation amongst ectomycorrhizal communities in the native pinewoods in Scotland linked both to interpolated predicted values of nitrogen deposition (Dore et al., 2012) as well as regional scale variation in climate (Jarvis et al., 2013). The possibility that local adaptation of pine trees as hosts to ectomycorrhizae, or vice versa, or local adaptation of either to the soil environment has not been tested in this system.

Ideally, seed sourcing would be informed by a deeper understanding of patterns of adaptive genetic variation in tree species than we currently have. Existing data strongly suggest that adaptive variation in *Pinus sylvestris* is largely partitioned longitudinally in Scotland (Salmela et al., 2011; 2013; Donnelly et al., 2016; Perry et al., 2016a, b) and the results of ongoing replicated provenance trials will yield a higher level of information required to understand how genotypes respond to multiple different environments (S. Cavers, J. Cottrell, G. Iason et al., *unpublished data*). An additional component of future research work may attempt to quantify the extent to which edaphic variation (and associated microbiota) is of selective importance to *Pinus sylvestris* populations in Scotland. However, designing experiments to address the question comprehensively would be challenging as it would

### Climatic and ecological groupings within native pinewoods

likely require a very large combination of factors and replication at a large scale. Relatively little phenotypic variation in North American populations of *Pseudotsuga menziesii* is explained by edaphic variables (Monserud and Rehfeldt, 1990; Campbell, 1991) despite fine scale adaptation to climate in early geneecological studies (Campbell, 1979; Rehfeldt, 1994). On these criteria, Ying and Yanchuk (2006), conclude that whilst edaphic variation is not unimportant, the scale at which it varies render them ‘unnecessary details’ (*sensu* Levin, 1992), likely to complicate predictions of tree genotypes’ adaptedness to planting site conditions beyond a level which is operationally practicable.

As more information regarding patterns of adaptive variation in *Pinus sylvestris* is generated, this can be used in conjunction with the results presented here to determine the number of seed transfer zones required in Scotland. For instance, multivariate regression trees, parameterised with values for traits such as survival, growth, phenology and disease resistance as response variables could be fitted to the environmental parameters to identify environmental distances over which seed can be deployed safely (Hamann et al., 2011; Oubida et al., 2015). Such an approach would extend and increase the sophistication of the classification trees applied here (Figures 2.2 and 2.8), by using actual measured observations of phenotypic variation in trees to define biologically relevant groupings of sites.

It may be the case that the number of climatic clusters defined here are greater, or indeed even fewer, than strictly necessary. We can speculate that the three regions subjectively described in Figure 2.2 as ‘Cairngorms’, ‘Central-Atlantic’ and ‘Hyper-Oceanic’ may be sufficient as this reflects the longitudinal pattern of phenotypic variation identified thus far (Salmela et al., 2011; 2013; Donnelly et al., 2016; Perry et al., 2016a, b).

Alternatively, these results could provide the basis for development of a climatic site-matching tool, such as those which exist in Canada (McKenney et al., 1999) and the United States (Howe et al., 2009). A climatic site-matching tool would enable bespoke seed origin choice provided that planters were able to provide nursery producers with sufficient time to source seeds to be sown and raised to the stature required for planting in the field, a situation which is currently very uncommon in Great Britain (Whittet et al., 2016a). As long as the reliance on speculative production of planting stock in GB continues, categorical seed zones will offer the best solution to enable nursery producers to make decisions about where to source seed for speculative sowing, with the caveat that further investigation is required to determine the number of seed zones actually warranted by native Scots pine in Scotland.



## **Chapter three**

### ***Substantial variation in the timing of pollen production suggests limited reproductive synchrony between distant native populations of *Pinus sylvestris* L. in Scotland***

This chapter is published as:

Whittet, R., Cavers, S., Cottrell, J., Rosique-Esplugas, C. and Ennos, R. 2017. Substantial variation in the timing of pollen production reduces reproductive synchrony between distant populations of *Pinus sylvestris* L. in Scotland. *Ecology and Evolution*. DOI: 10.1002/ece3.3154.

#### **Abstract**

Gene flow among populations of temperate trees is an essential prerequisite for maintenance of high levels of genetic diversity within populations and so is required to enable adaptive responses to environmental change. Fragmented ancient semi-natural populations of *Pinus sylvestris* in Highland Scotland show a pattern of adaptive differentiation for a range of phenotypic traits despite the fact that most of the selectively neutral variation is maintained within, rather than between populations. This pattern, which is common in widespread, wind dispersed trees, is indicative of strong, spatially variable natural selection acting against the possibly homogenising effect of extensive contemporary or historic gene flow. However the mechanisms of gene flow among these fragmented populations remain understudied. To begin to develop an understanding of whether populations are currently as well connected as molecular data would suggest it is essential to make field observations of trees to determine whether there are barriers to effective pollen dispersal. To assess synchrony in pollen production among populations, a sample of twenty trees at each of these sites was repeatedly visited roughly every ten days during the springs of 2014, 2015 and 2016. Male strobili on these trees were assigned a value based on a developmental ordinal morphological scale. Ordinal regression models were applied which identified clear differences in predicted mean date of maximum pollen shedding among populations with the westernmost site developing the earliest in each year and the most easterly site developing latest in each year. Predicted dates and the differences in predicted date between sites varied by year, indicating that there may be some variation in plasticity for the timing of pollen production. Each of the three

### Temporal variation in pollen production

sampling years was warmer than the local long term average temperature and asynchrony was greatest in the warmest of the three years (2014) and smallest in the coolest year (2015).

## **3.1. Introduction**

A characteristic of many boreal and northern temperate tree species is the capacity for long distance pollen dispersal by wind and high levels of gene flow between populations are thought to be widespread (Savolainen et al., 2007; Kremer et al., 2012). Gene flow amongst tree populations is essential for maintenance of the naturally high levels of genetic variation within populations and provides the raw material upon which natural selection can act to enable populations to continually adapt to environmental changes (Davis and Shaw, 2001).

*Pinus sylvestris* is one such species which is capable of extensive pollen dispersal over long distances (Robledo-Arnuncio and Gil, 2005; Varis et al., 2009). In Scotland, the 84 semi-natural populations of *Pinus sylvestris*, also known as the ‘Caledonian pinewoods’ persist in a fragmented distribution, thought now to represent only 1 % of its former maximum distribution (McVean and Ratcliffe, 1962). Despite severe fragmentation, levels of neutral genetic variation remain similar to those observed in more continuous parts of the species range in Eurasia, with the majority of the genetic variation held within rather than between populations (Forrest, 1980; Kinloch et al., 1986; Provan et al., 1998; Wachowiak et al., 2011; 2013). A possible explanation for this distribution of genetic differentiation among populations is that they are, or have in recent history, been connected by levels of gene flow which are sufficiently high to prevent genetic differentiation between populations.

Despite the lack of major differentiation at neutral genetic markers, there is evidence from common garden experiments that these Scottish populations are differentiated for a range of adaptive traits (Salmela et al. 2011; 2013; Donnelly et al., 2016; Perry et al., 2016a, b), indicating that spatially variable selection is sufficiently strong to counteract some of the homogenising effect of gene flow. An adaptive trait which has been shown to vary amongst populations is spring vegetative phenology (timing of bud burst). When grown together under common conditions in a glasshouse in the south of Scotland, trees raised from seed collected from mother trees growing in colder environments initiated their annual growth earlier than those from warmer environments (Salmela et al., 2013). Differentiation for spring phenology is common in trees, typically showing moderate to high  $Q_{ST}$  in response to clines in temperature (Vitasse et al., 2011; Alberto et al., 2013a; Aitken and Bemmels, 2016). The phasing of initiation and cessation of annual growth evolves as a mechanism by which to maximise annual growth whilst minimising the risk of frost damage in spring and autumn

(Howe et al., 2004; Aitken et al., 2008; Vander Mijnsbrugge et al., 2015; Lenz et al., 2016). Due to high genetic differentiation, strong selective importance and relative ease of assessment from a young age, spring phenology is frequently assessed in provenance tests.

Reproductive phenology (i.e. timing of flowering in angiosperms, or timing of strobilus development in gymnosperms) is more difficult to investigate in provenance tests because many tree species have delayed maturity (Petit and Hampe, 2006). As there theoretically can be many reproductive events in the lifetime of an individual, selection on reproductive phenology is likely to be softer than selection on timing of bud burst and show high levels of phenotypic plasticity (Koski and Sievanen, 1985; Vander Mijnsbrugge et al., 2015).

However, reproductive phenology is almost certainly serially autocorrelated with the timing of bud burst, thus showing a similar pattern of variation (Soularue and Kremer, 2012; 2014) and is highly relevant for population and landscape genetic studies which aim to understand patterns of gene flow, local adaptation and genetic structure (Manel et al., 2003; Ramstad et al., 2004; Kremer et al., 2012; Thomasset et al., 2014).

In *Pinus sylvestris*, there is already an evidence base for variation in reproductive phenology among populations. The majority of this evidence has been generated from research in seed orchards in the Nordic countries (especially Finland), (Jonsson et al., 1976; Chung, 1981; Parantainen and Pulkkinen, 2003), and from forest stands *in situ* (Luomajoki, 1993; Pulkkinen and Rantio-Lehtimäki, 1995; Parantainen and Pulkkinen, 2002; Varis et al., 2009). A common finding from these studies is that pollen tends to be produced in the warmer south of Finland earlier than it is produced in the colder north but that there can be considerable interannual variation in timing.

Although there is some information on the timing of spring vegetative phenology from a glasshouse experiment (Salmela et al., 2013), no information on the timing of pollen production in Scottish pinewoods *in situ* yet exists. The aims of this study are to investigate whether there are differences in the timing of pollen production between native populations of *Pinus sylvestris* in Scotland *in situ* across three consecutive years (2014; 2015; 2016). With this information, it will then be possible to begin to investigate whether populations experiencing different environmental conditions are as connected by gene flow as is suggested by observed low divergence at neutral marker loci (Forrest, 1980; Kinloch et al., 1986; Provan et al., 1998; Wachowiak et al., 2011; 2013).

## **3.2. Materials and methods**

### **3.2.1. Reproductive biology of *Pinus sylvestris***

*Pinus sylvestris* is a monoecious gymnosperm which bears male and female reproductive structures (strobili) separately on the same individual. The pollen grains, which have lateral air sacs to assist dispersal by wind, are borne on strobili which are highly variable in size, but are often c. 30-60 mm in length, shedding pollen minimally from the age of 10-15 years (Carlisle and Brown, 1968). The pollen can retain high germinability rates after several days' exposure to air (Lindgren and Lindgren, 1996). Although the dispersal kernel is strongly leptokurtic (Robledo-Arnuncio and Gil, 2005), with the majority of pollen falling proximally, infrequent long distance mating events do occur. Robledo-Arnuncio (2011) reports that 4.4% of seedlings sampled from an isolated Scots pine remnant stand in Iberia were sired by individuals in a stand which was c. 100 km away, suggesting that significant long distance dispersal of pollen was not rare in the sparsely forested landscape studied.

Female strobili are roughly 5-7 mm long and tend to be borne on the tips of well-illuminated branches and can set seed in trees that are six years old or over (Carlisle and Brown, 1968). Female strobili are pollinated during summer. Pollen comes into contact with a liquid secretion from the female strobilus ('pollination drop') and is drawn into the pollen chamber. The pollen chamber of *Pinus sylvestris* has room for around six pollen grains (Sarvas 1962), and because grains are often clustered together so that more than one pollen grain may enter simultaneously, it has been suggested that early arriving pollen has a greater chance of occupying a position closest to the nucellus, increasing its probability of fertilising the ovum (Sarvas, 1962). Varis et al (2008) point out that the reality may be more complex than this, involving competitive interactions amongst pollen grains, for instance via genetic differences in the temperature requirements of pollen germination and the rate of pollen tube growth. Whilst self-pollination can occur, little selfed seed is produced because it tends to abort due to presence of lethal homozygous recessives (Hedrick et al., 1999).

### **3.2.2. Selection of sites and individuals**

Selection of sites was based on an inventory of ancient, semi-natural pinewoods in Scotland, which are considered to have persisted through natural regeneration since their initial colonisation and establishment and are known collectively as the 'Caledonian pinewoods' (Forestry Commission, 1998). The site names applied here are those from the Caledonian pinewood inventory. In the first year of observations, three sites (Beinn Eighe, Rothiemurchus and Allt Cul) were selected for phenological recording on the basis of their

location along a longitudinal gradient (Figure 3.1), which in upland Scotland represents the most important axis of environmental variation and one which has been shown to exhibit correlations with variation in phenotypic traits among Scots pine populations in common garden studies (Salmela et al., 2011, 2013; Donnelly et al., 2016; Perry et al., 2016a, b). These sites were deliberately chosen because they were geographically far apart yet were readily accessible by road such that they could all be visited in a single round trip lasting two or three days and so the short time difference between when phenological measurements were taken across all sites meant that results between sites would be comparable (Figure 3.1). For 2015 and 2016, a further two sites (Lochindorb and Bunloyne) were added to the sample. The maximum distance between these five populations is 137 km, a distance which can likely be occasionally achieved by wind dispersed pollen in certain conditions (Varis et al., 2009).

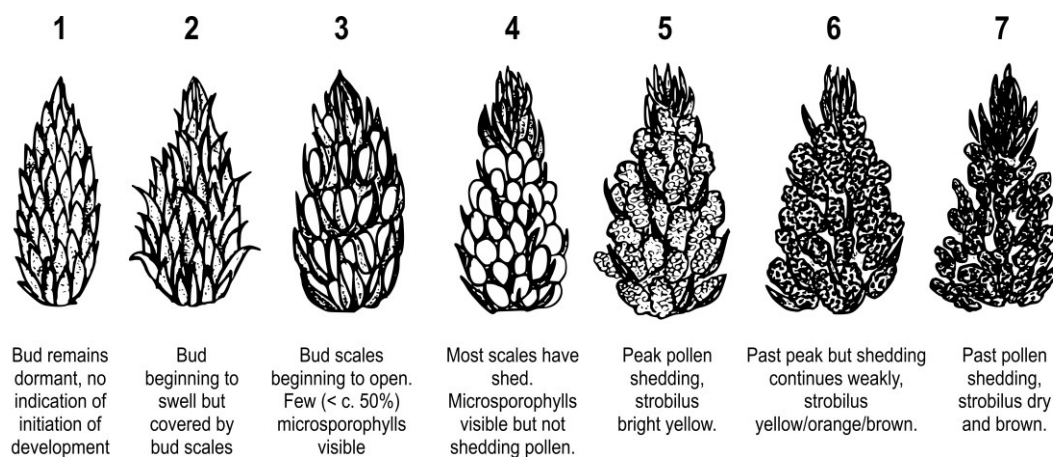
Twenty trees within each site were selected along circuitous walking routes. To minimise bias, a patch of trees would be identified from a distance and then the first one arrived at that was; accessible, seemingly of a reproductively mature age, amenable for visual inspection and likely to survive the three sampling years was marked non-permanently for inclusion within the sample. No measurements of tree size or age were made of the sampled trees. Where possible, the recorded trees were separated by at least 100 metres. However, at Bunloyne, Allt Cul and Lochindorb, which are small sites containing fewer than 100 mature pine trees, some of the recorded trees were unavoidably less than 100 metres apart. At these three small sites, most of the pine trees were very old and there were few young trees and almost no natural regeneration. Population sizes at the two larger sites of Rothiemurchus and Beinn Eighe were (orders of magnitude) larger and age and size structure were more variable.



**Figure 3.1.** Map of mainland Scotland indicating the location of field sites

### **3.2.3. Phenological scoring**

At each site, the preselected sample of 20 trees was visited repetitively during the months of May and June in 2014, 2015 and 2016, in order to make phenological recordings during the period of male strobilus development. Strobili were assigned an ordinal developmental score, based on their morphology, which is an extension of a scale used by Gömöry *et al.* (2000) (Figure 3.2.).



**Figure 3.2.** Line illustrations indicating strobilus morphology at each of the modal states (1-7). Illustrations by Cristina Rosique.

Male strobili in pine trees are highly abundant, and so a pragmatic decision to score the five most developed strobili on each tree was made. These were scored based on a one minute visual search of the entire crown either unaided or with binoculars. Tree branches were agitated to confirm whether pollen shedding was taking place. In almost all cases, the five most developed strobili were all at the same stage of development, although there can be considerable variation throughout the crown of a tree, particularly between north and south facing sides of the crown (Pérez et al., 2002).

### 3.2.4. Climatic data

Daily maximum and minimum air temperatures for the nearest Met Office weather station to each recorded population were obtained from the first of January 2013 until the 30<sup>th</sup> of June 2016. Average daily temperature was calculated as the median of the maximum and minimum temperature. Daily average temperatures were then used to calculate indices of thermal time for the periods preceding anthesis. To do this, we calculated *growing degree days* (GDD), which is the cumulative daily sum of the number of degrees Celsius on days in which the average air temperature exceeds 5.5°C, beginning on the first of January in each year. This is a standard index of thermal time which has been found to be informative for understanding climatic cues of spring phenological activity in temperate trees (Murray et al., 1986; Vitasse et al., 2013), including *P. sylvestris* (Chung, 1981; Luomajoki, 1993).

It should be noted that there is wide variation in the distance between weather stations and sampling sites (Table 3.1), and in some cases, the temperatures observed at weather stations may not be particularly representative of those of the sampling site. This may be due not only to geographical distance but also to the effects of altitude and aspect, which vary at

### Temporal variation in pollen production

narrow spatial scales in the Scottish Highlands (Salmela et al., 2010). The nearest weather stations to Bunloyne and Lochindorb are particularly geographically distant and situated in different topographical contexts. Variation in temperature within sites has not been considered.

**Table 3.1.** Location details of each of the five field sites and their nearest weather stations for which daily temperature values were available. Distance, difference in altitude and the likely sign of difference in air temperature between site and weather station are also listed.

<u>Site name</u>	<u>Location (OSGB36)</u>	<u>Mean tree altitude (m)</u>	<u>Weather station name</u>	<u>Location (OSGB36)</u>	<u>Weather station altitude (m)</u>	<u>Distance (km)</u>	<u>Altitude difference (m)</u>	<u>Temperature at site likely to be:</u>
Beinn Eighe	NG995654	90	Kinlochewe	NH626629	19	4	71	Slightly cooler
Rothiemurchus	NH930080	307	Aviemore	NH896143	229	7.2	78	Slightly cooler
Allt Cul	NO180953	475	Braemar No. 2	NO152919	341	4.5	134	Cooler
Bunloyne	NH217097	150	Cluanie Inn No. 3	NH076117	218	14	-68	Warmer
Lochindorb	NH984355	372	Cromdale	NJ072284	193	11.2	179	Cooler

### **3.2.5. Statistical analyses**

All of the statistical analyses were performed in R version 3.2.3. (R Core Team, 2015). Data management, analysis and visualisation relied upon the ‘dplyr’ (Wickham and Francois, 2015) and ‘ggplot2’ (Wickham, 2009) packages.

Due to the intervals between site visits, it was not always possible to be at each of the sites at precisely the time at which the majority of pollen is shed, a period which, in Finland, lasts only around three days per tree (Parantainen and Pulkkinen, 2003). To overcome this, estimates of the differences in timing of development between sites were made using cumulative link models, a type of ordinal logistic regression implemented using the ‘ordinal’ package within R (Christensen, 2015). A major advantage of ordinal logistic regression models in this context is that they recognise that an ordinal response is bounded at both ends and make no assumption about the spacing between values of the response variable, as would be implied by a linear regression model with a continuous response (Harrell, 2015).

#### *i. Between site variation*

In the cumulative link models, different intercepts for each factor level  $j$  (e.g. sites) are set as a function of a constant  $\theta$ , meaning that a common slope is applied to each  $j$ . This means that the slopes for different sites do not vary and as such, differences between sites will be the same at any of the response levels (1-7).



Optimally, the phenological scores would be modelled thus:

$$P_{[\text{STROBILUS} = x]} = \text{Day} + \text{Site*Year}$$

In which  $P_{[\text{STROBILUS} = x]}$  is the phenological observation and  $x$  is any one of the phenological modal states (1-7). Day is the day of observation counting from May 1. Site and Year are factor variables.

As each of the sites was not visited every year, the full dataset is rank deficient. For this reason, the Site\*Year interaction term was dropped and, to investigate interactions between site and year, separate models were fitted for each year and to a restricted dataset containing only the sites visited in a given year.

To estimate the time lag between sites, we followed the method of Vander Mijnsbrugge et al. (2015), by using beta coefficients returned by the fitted models. The time lag is defined as the difference in number of days in which half of the strobili at one site has reached the same phenological stage as at another site and is calculated thus:

$$\text{Day}_{[\text{Site } i]} - \text{Day}_{[\text{Site } j]} = (\beta_{[\text{Site } j]} - \beta_{[\text{Site } i]}) / \beta_{\text{Day}}$$

In which  $\beta_{[\text{Site } i, j]}$  are the estimated beta coefficients for sites in the fitted model and  $\beta_{\text{Day}}$  is the estimated coefficient for time. Confidence intervals of these estimates were calculated using nonparametric bootstrapping but were considered to be insufficiently stringent to account for the variation within sites and the time period over which pollen is shed. To account for this variability, an additional three days were added to the confidence intervals for ‘significance’ testing. If these penalised confidence intervals for any pairwise comparison among sites overlapped zero, the difference between sites was considered insignificant.

#### *ii. Between year variation*

To investigate the differences in timing of phenological events amongst years, a similar model was fitted and was based on a restricted dataset including only the three sites which were visited in all three sampling years.

$$P_{[\text{STROBILUS} = x]} = \text{Day}_{[\text{from May 1(inclusive)}]} + \text{Site*Year}$$

#### *iii. Thermal time response*

To investigate male pollen phenological responses to indices of thermal time, models were fitted to indices of thermal time (growing degree days, GDD), rather than calendar dates. The temperature data for the nearest weather stations to Bunloyne and Lochindorb were considered likely to be unrepresentative of conditions at the two pinewood sites and these

### Temporal variation in pollen production

were therefore excluded from the analysis to concentrate on the extreme sites and an intermediate temperature site which had data from a weather station that was much nearer to it (Rothiemurchus). This model was specified thus:

$$P_{[\text{STROBILUS} = x]} = \text{GDD} + \text{Site} * \text{Year}$$

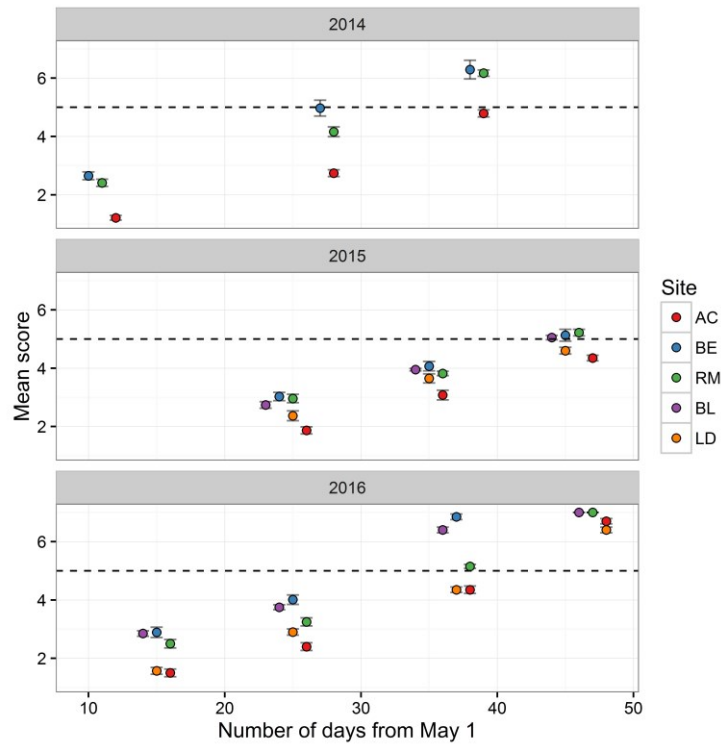
#### *iv. Variation within sites*

To investigate the consistency across observation years in the rank order of trees' male strobilus development at each site, the sum of strobilus scores were taken for each tree across all of the site visits. The tree with the highest summed scores is taken as being the earliest to develop at each of the site. Correlation among years was tested with Spearman rank correlation.

## **3.3. Results**

### **3.3.1. Variation in timing of strobilus development among sites**

At the site level, there were clear differences in the timing of strobilus development between populations, with the most westerly site (Beinn Eighe) consistently developing earliest, and the most easterly site (Allt Cul), typically developing latest (Figure 3.3). The intermediate sites typically followed the same order with Bunloyne second, Rothiemurchus third and Lochindorb fourth.



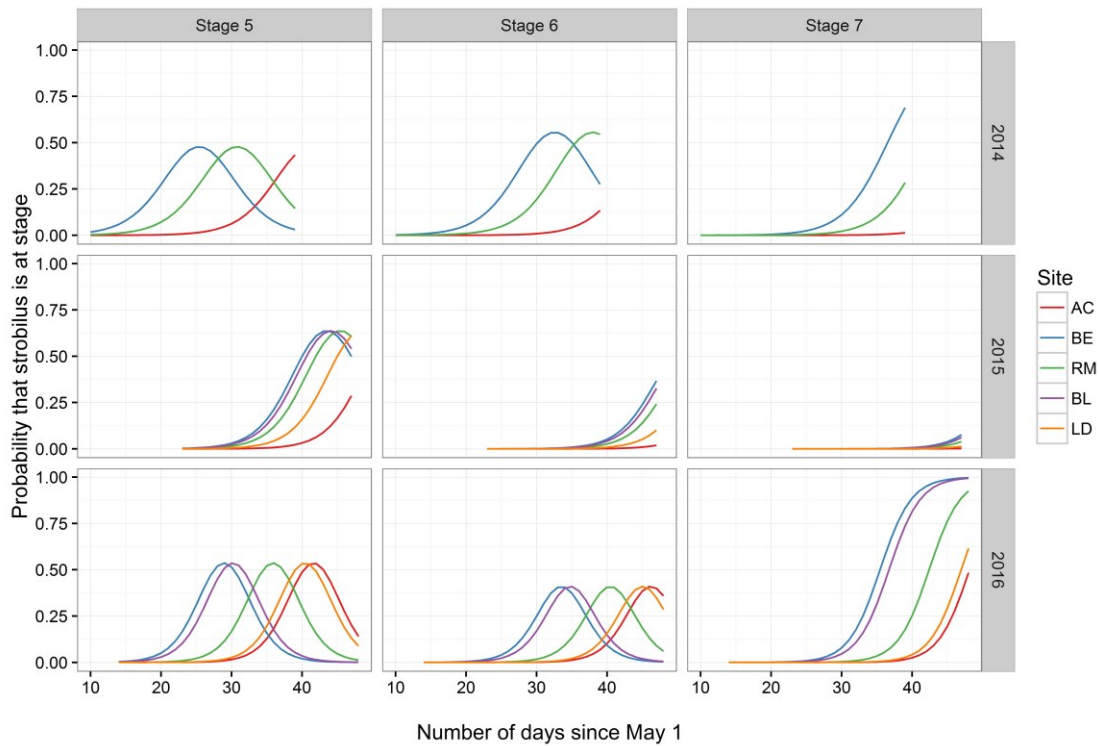
**Figure 3.3.** Mean strobilus scores and 95% confidence intervals on the observation dates. The dashed horizontal line is plotted at stage 5, which is when trees are at peak pollen production. Site abbreviations are AC: Allt Cul, BE: Beinn Eighe, BL: Bunloyne, LD: Lochindorb, RM: Rothiemurchus. NB: RM and BE overlap one another on the final date of observation in 2016 as each observed strobilus had reached stage 7.

### 3.3.2. Predicting timing of pollen production

The cumulative link models found significant differences amongst sites (Figure 3.4, Table 3.2) and were used to generate parameter estimates to predict the time lag between sites (Figure 3.5). In each year, the greatest time lags were between Beinn Eighe (BE) and Allt Cul (AC), ranging from 9.85 days in 2015 to 15.8 days in 2014. Allt Cul and Lochindorb (LD) were separated from the other sites by more than three days in the years sampled, although the difference between Allt Cul and Lochindorb was less than 2 days in 2016 (Figure 3.5.).

Despite tendencies for these timing differences between sites, the model predicts overlap between the tails of the distributions for even the most distant sites (BE, AC) (Figure 3.4). For instance, in 2014, at the time when the latest 10-15% of strobili were expected to be at stage 5 at Beinn Eighe, the earliest 10-15% were predicted to be at stage five in Allt Cul (intersection of the blue and red curves on Figure 3.4). This means that, all else being equal, there is a possibility of pollen from Beinn Eighe arriving at Allt Cul at a time when some female strobili are receptive.

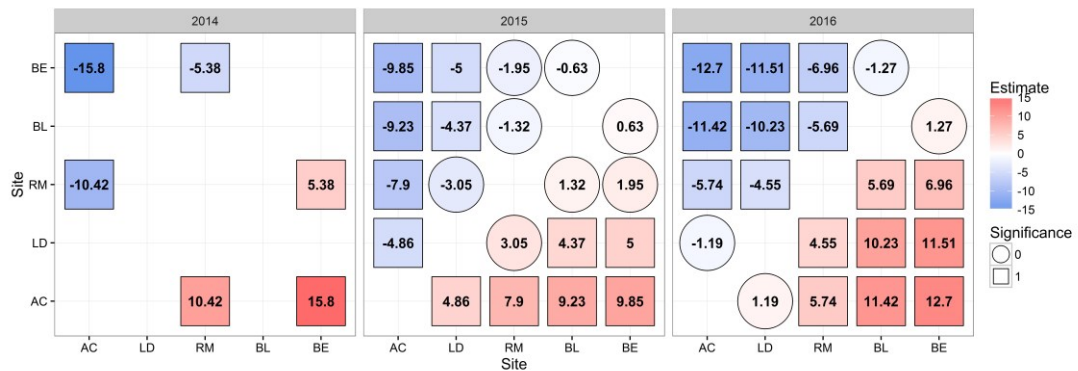
Temporal variation in pollen production



**Figure 3.4.** Modelled timing of pollen shedding indicating for each score level, exceeding those which come before pollen is shed (5-7), the probability that strobili of trees at each of the sites have reached a given score.

**Table 3.2.** Estimated beta coefficients for parameters in the separate phenological models fitted for each year. Rothiemurchus, which is the intermediate site in most cases is the reference to which other sites are compared (estimated parameter for Rothiemurchus = 0).

Year = 2014				
	Estimate	Standard error	z value	p value
Day	0.31994	0.01265	25.29	<2e <sup>-16</sup> ***
Allt Cul	-3.33438	0.19124	-17.44	<2e <sup>-16</sup> ***
Beinn Eighe	1.72096	0.16500	10.43	<2e <sup>-16</sup> ***
Year = 2015				
	Estimate	Standard error	z value	p value
Day	0.36521	0.01229	29.72	<2e <sup>-16</sup> ***
Allt Cul	-2.88661	0.18078	-15.968	<2e <sup>-16</sup> ***
Beinn Eighe	0.71232	0.17425	4.088	4.35e <sup>-5</sup> ***
Bunloyne	0.48288	0.16753	2.882	0.00395 **
Lochindorb	-1.11316	0.17213	-6.461	9.99e <sup>-11</sup> ***
Year = 2016				
	Estimate	Standard error	z value	p value
Day	0.45109	0.01221	36.93	<2e <sup>-16</sup> ***
Allt Cul	-2.58712	0.16300	-15.87	<2e <sup>-16</sup> ***
Beinn Eighe	3.14027	0.18427	17.04	<2e <sup>-16</sup> ***
Bunloyne	2.56554	0.16592	15.46	<2e <sup>-16</sup> ***
Lochindorb	-2.05079	0.15645	-13.11	<2e <sup>-16</sup> ***



**Figure 3.5.** Comparison of estimated developmental time difference in days between sites in 2014, 2015 and 2016. Square symbols represent 'significance', which is defined as differences between mean site scores which exceed three days plus the confidence interval of the site estimate.

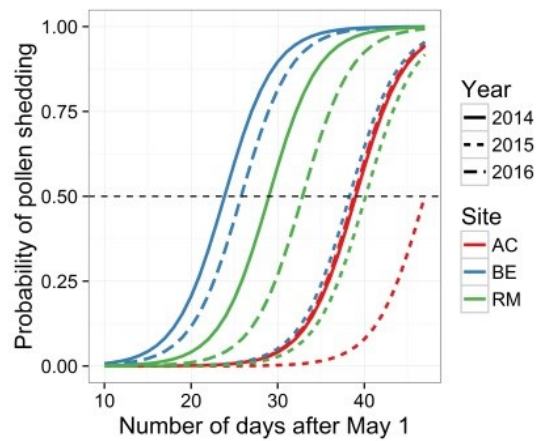
### 3.3.3. Variation in timing of strobilus development among years.

Although the rank order of sites in terms of male strobilus development was consistent across years, the actual timing and the differences in timing between sites were variable between years in most cases. An exception is for Allt Cul, where the timing was the same in 2014 and 2016 (Figure 3.6, Table 3.3).

**Table 3.3.** Estimated beta coefficients and interaction terms in the phenological model fitted to investigate the timing of phenological development in different years. 2014 is the reference year to which other years are compared and Allt Cul is the reference site (*estimated parameter for AC in 2014 = 0*).

	Estimate	Standard error	z score	p value
Time	0.351073	0.007372	47.624	<2e <sup>-16</sup> ***
SiteBE	5.320636	0.193581	27.485	<2e <sup>-16</sup> ***
SiteRM	3.522285	0.171889	20.492	<2e <sup>-16</sup> ***
Year2015	-2.79851	0.17338	-16.141	<2e <sup>-16</sup> ***
Year2016	0.07263	0.156045	0.465	0.64162
SiteBE:Year2015	-2.2717	0.234546	-9.686	<2e <sup>-16</sup> ***
SiteRM:Year2015	-1.12068	0.222555	-5.036	4.77e <sup>-07</sup> ***
SiteBE:Year2016	-0.74973	0.228456	-3.282	0.00103 **
SiteRM:Year2016	-1.43396	0.214075	-6.698	2.11e <sup>-11</sup> ***

### Temporal variation in pollen production



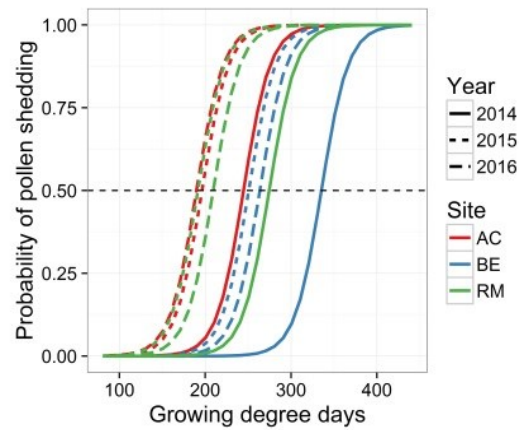
**Figure 3.6.** Modelled timing of pollen shedding, indicating the cumulative probability that strobili have minimally reached stage 5 (peak pollen shedding) from the first of May (inclusive) at each site in each of the three observation years for the three sites visited in each sampling year.

### 3.3.4. Response of strobilus development to thermal time.

When thermal time (GDD) is considered in place of calendar time, we found that the pattern was reversed whereby a lower heat sum has been accumulated at Allt Cul by the time trees are predicted to be shedding pollen than at Beinn Eighe (Figure 3.7). However, as with calendar time, the degree day sum at the predicted time of pollen shedding varied by year (Table 3.4), suggesting that there is plasticity in the response and that anthesis is not driven solely by temperature regimes

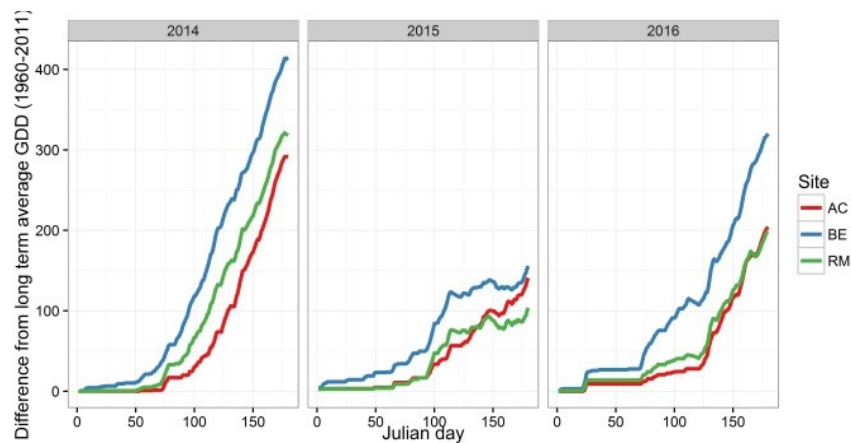
**Table 3.4.** Estimated beta coefficients and interaction terms in the phenological model fitted to investigate the effect of temperature accumulation (GDD) on phenological development. 2014 is the reference year to which other years are compared and Allt Cul is the reference site (*estimated parameter for AC in 2014 = 0*).

	Estimate	Standard error	z score	p value
GDD	0.064047	0.001345	47.635	<2e <sup>-16</sup> ***
SiteBE	-5.80744	0.222883	-26.056	<2e <sup>-16</sup> ***
SiteRM	-1.91364	0.171499	-11.158	<2e <sup>-16</sup> ***
Year2015	3.094563	0.17209	17.982	<2e <sup>-16</sup> ***
Year2016	3.505477	0.167658	20.908	<2e <sup>-16</sup> ***
SiteBE:Year2015	2.320135	0.242268	9.577	<2e <sup>-16</sup> ***
SiteRM:Year2015	2.217429	0.229563	9.659	<2e <sup>-16</sup> ***
SiteBE:Year2016	1.087952	0.235684	4.616	3.91e <sup>-06</sup> ***
SiteRM:Year2016	0.666183	0.21529	3.094	0.00197 ***



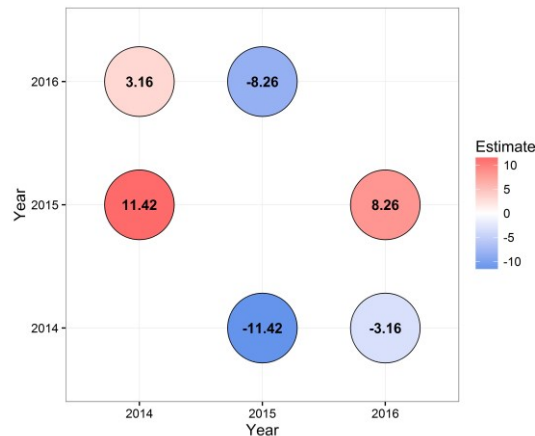
**Figure 3.7.** Modelled accumulated GDD at the time of pollen shedding, indicating the cumulative probability that strobili have minimally reached stage 5 (peak pollen shedding).

Of the three sampling years, 2014 experienced the warmest temperatures in the period leading up to and including strobilus development (Figure 3.8). Correspondingly, development was earliest in this year, showing a tendency to take place 3.2 days earlier than in 2016 and 11.4 days earlier than 2015 (Figure 3.9). In each of the three sampling years, the greatest high temperature anomalies were observed at Beinn Eighe (Figure 3.8.), suggesting that differences in asynchrony may be due to local anomalies rather than an effect of uniformly warmer conditions.



**Figure 3.8.** Differences from long term average GDD based on temperature data from the nearest weather stations 1960-2011.

### Temporal variation in pollen production



**Figure 3.9.** Estimated time lags/leads (number of days) between the different years, based on pooled estimates for AC, BE and RM, as shown in Figure 3.6 and Table 3.3.

Interannual climatic variation also seems to influence the range of variation between populations. The range of variation between sites was greatest in the warmest year (15.8 days in 2014) and lowest in the coolest year (9.85 days in 2015) (Figure 3.9). Notably, the degree by which temperatures sums exceed annual averages was greatest for Beinn Eighe in each of the three years (Figure 3.9), suggesting that greater differences possibly arise due to particularly high temperature anomalies in the west in the three years of sampling.

#### **3.3.5. Variation within sites**

Despite tendencies for earlier development in sites in the warmer west, there was considerable variation within sites. For instance, in 2014 and 2015, some of the trees at Beinn Eighe were reluctant to flower at all, containing very few or no male strobili. Trees were randomly chosen in early May 2014, before anthesis had begun. At that time, it was impossible to determine whether all of the trees were reproductively mature or active. It may be the case that the trees which did not reach advanced stages of development were sterile or immature at that time, despite deliberate attempts to choose trees which looked old enough to produce male strobili (c. 20 years in *Pinus sylvestris* (Carlisle and Brown, 1968)). Another example of a surprising result when within site variation is considered is that a single tree was shedding pollen at Lochindorb in 2015 before any of those at Bunloyne and Rothiemurchus (Table 3.5), despite the general tendency for slower development at Lochindorb (Figure 3.3). This individual tree was again amongst the first at Lochindorb to shed pollen in 2016. The order of development of individual trees tends to be correlated in different years generally (Table 3.6, Figure 3.10), which has previously been recognised in



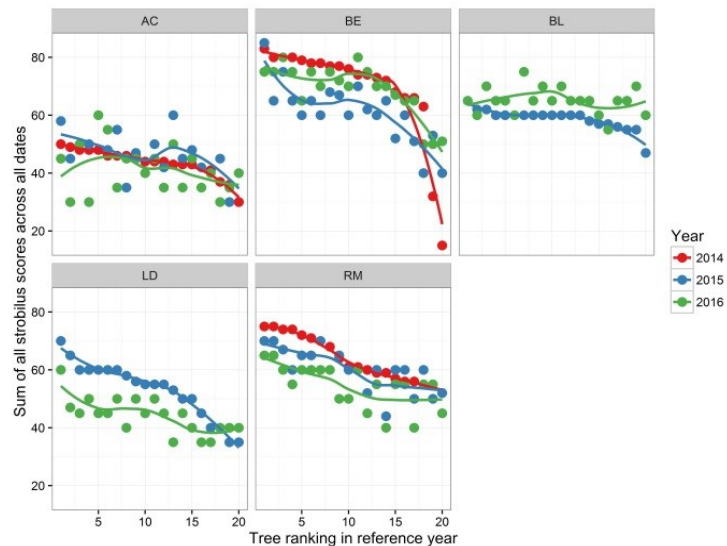
*P. sylvestris* (Burczyk and Chalupka, 1997), and in several broadleaved tree species (Hinks et al., 2015; Delpierre et al., 2016).

**Table 3.5.** Proportion of strobili to have minimally reached a score of five on each of the visits in each year.

	Visit 1	Visit 2	Visit 3
<u>2014</u>	<u>10-12 May</u>	<u>27-28 May</u>	<u>7-8 June</u>
AC			.59
BE		.78	.92
RM		.45	1
<u>2015</u>	<u>23-26 May</u>	<u>3-5 June</u>	<u>13-16 June</u>
AC			.35
BE		.21	.81
BL			.95
LD		.05	.55
RM			.92
<u>2016</u>	<u>14-16 May</u>	<u>24-26 May</u>	<u>5-7 June</u>
AC			.45
BE		.25	1
BL			1
LD			.35
RM			1

**Table 3.6.** Spearman rank correlation coefficients for the pooled sum of phenological scores for each tree in each year. Strong correlations suggest that trees within a site develop in the same order in different years. Significance codes,  $p > 0.05$ , \*  $p < 0.05$ , \*\*\*  $p < 0.001$

Site	2014/2015	2014/2016	2015/2016
AC	0.56 *	0.25 <i>n.s.</i>	0.42 <i>n.s.</i>
BE	0.73 ***	0.72 ***	0.89 ***
BL			0.27 <i>n.s.</i>
LD			0.71 ***
RM	0.78 ***	0.7 ***	0.8 ***



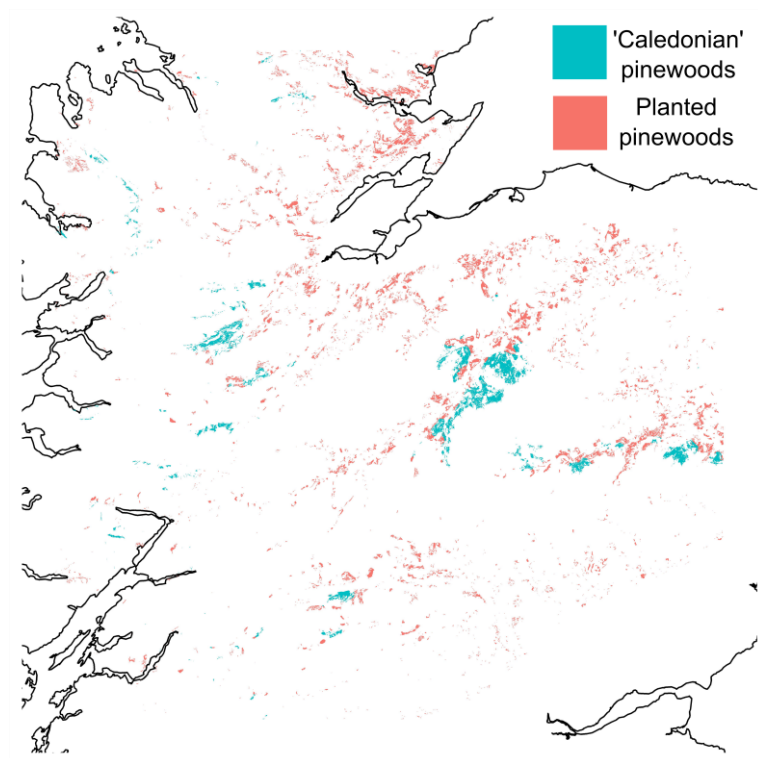
**Figure 3.10.** Summed strobilus scores for each tree across the first three sets of observations in each year, ranked in descending order according to a reference year. The reference year for BE, AC and RM is 2014. The reference year for BL and LD is 2015.

### **3.4. Discussion**

There were large differences in the predicted timing of pollen production between the sites sampled in each year and between years. The largest of these differences were observed between the pair of sites that were separated by the greatest geographical distance (Beinn Eighe and Allt Cul). Populations in the warmer west showed a strong tendency to shed pollen earlier than those in the colder east, but the populations in the east were capable of producing pollen at much lower temperature sums. These results show the opposite pattern from common garden experiments in which populations from the colder east commence spring phenological activity earliest (Salmela et al., 2013). The apparent negative correlation between experimental and field observations follows a pattern of counter-gradient phenotypic variation (Levins, 1969; Conover and Schultz, 1995; Soularue and Kremer, 2012; 2014).

The size of these observed differences in the predicted timing of pollen shedding (9.85 – 16.8 days) suggest that direct pollen transfer between the extreme populations, which would already be infrequent due to the large distance between them would be further limited by a degree of reproductive asynchrony. Nonetheless, the cumulative link models predicted a small overlap between the tails of the distributions of the reproductive period between the extreme populations and the ranking of individuals within sites tended to be correlated between years (particularly in the larger populations of BE and RM). This means that, if a effective dispersal among distant populations would only partially connect populations and likely involve the same overlapping individuals each year, a situation of assortative mating. The likely pattern of assortative mating among the populations studied would involve immigrant alleles from the latest individuals to produce pollen in a warmer environment (BE), into a receiving environment which selects for early growth initiation (AC). The late warm-adapted alleles may be maladaptive in the cold environment and therefore never recruited into the standing population (Soularue and Kremer, 2012; 2014). The largest differences in timing of pollen production between sites were observed in 2014, which was the warmest sampling year. The smallest differences were observed in 2015, which was the coldest year. Notably, in each of these three years, temperatures in the western site (Beinn Eighe) were particularly high compared to long term averages, suggesting that spatially variable climatic warming (i.e. greater levels of warming in the west) may lead to increasing reproductive asynchrony among populations.

It is important to note that there are many other populations of Scots pine between those sampled here, which will presumably exhibit intermediate timing. Although synchrony between the extreme sites (BE and AC), which are separated geographically by 137 km is limited, the differences in timing of strobilus development between more proximal populations is smaller and, all else being equal, unlikely to impose a barrier to reproduction between populations. Furthermore, the area of timber plantations of Scots pine in Scotland exceeds the area of semi-natural woodlands by over five times (Mason et al., 2004). The genetic base of such plantations is mixed, including material of unknown origin and material derived from seed orchards based on seed collected from phenotypically superior trees growing in Scotland and elsewhere (Lee, 2002). Gene flow, resulting in fertilisation between exotic-origin plantations and native populations of *Pinus sylvestris* has been reported in southern Iberia (Unger et al., 2014; Ramírez-Valiente and Robledo-Arnuncio, 2015). The occurrence of gene flow between these exotic and mixed origin plantations and semi-natural populations in Scotland has not been tested but seems probable (Forrest and Fletcher, 1994; Ennos et al., 1998; Salmela et al., 2010).



**Figure 3.11.** Distribution of ancient semi-natural ('Caledonian') pinewoods and planted pinewoods in the native pinewood zone.

Only male strobili were considered in the sampling regime, as they are much more conspicuous than females, being larger, abundant throughout the crown and with

### Temporal variation in pollen production

morphologies which are relatively easy to describe. Female strobili are much smaller than the males and tend to be higher up in the tree crown, in exposed, illuminated positions at the ends of branches (Carlisle and Brown, 1968). *Pinus sylvestris* is thought to be protogynous, whereby female strobili are often receptive before male strobili shed pollen (Sarvas, 1962; Jonnson et al, 1976; Chung, 1980; Lindgren et al., 1995; Parantainen and Pulkkinen 2003). However, there can be considerable temporal variation across a single tree crown. Pérez et al (2002) report a delay of up to one week between the shaded and sunny sides of *Pinus pinaster* Aiton and *P. sylvestris* seems qualitatively similar. Nonetheless, the temporal difference between development of male and female strobili within a single tree crown is likely to exceed the differences within a branch and the variation within a population means that synchronous receptivity and pollen shedding within a large population will not be restricted due to protogyny.

However, if it is the case that some female strobili will be receptive before any local pollen is available, and there is an advantage to early pollination (Sarvas, 1962), it is more likely that non-local pollen contribution to any population will be from warmer than from colder environments. The prevailing winds in Scotland in May and June proceed from the south west (Cook and Prior, 1987); meaning that there is a greater likelihood that pollen will be transported from the (warmer) west to the (colder) east. This directional bias in gene flow from warmer sites to colder sites may be beneficial in delivering alleles which would confer an advantage to seedlings produced under warmer temperatures predicted for the future (Davis and Shaw, 2001; Aitken and Whitlock, 2013), provided that the adaptive differences are not so great that selection for early development acts against these warm-adapted alleles (Soularue and Kremer, 2012; 2014). Another consequence of this geographical variation is that the western populations are less likely to receive large volumes of non-local pollen than populations elsewhere. Collectively, native Scottish populations of *Pinus sylvestris* represent the westerly oceanic margin of the species' natural range (Carlisle and Brown, 1968). Within Scotland, the western populations represent the upper temperature margin of Scottish populations, ostensibly the 'rear-edge' of the Scottish meta-population in terms of gene flow. The marginal status of these western populations and their potential capacity for contributing warm-adapted alleles to other populations under climate change mean that they are important candidates for dynamic gene conservation (Hampe and Petit, 2005; Lefèvre et al., 2013; Fady et al., 2016).

## **Chapter four**

### ***Testing options for adaptive forest seed sourcing: insights from an individual based model***

#### **Abstract**

As climate change accelerates, the traditional practice of using locally collected seed to plant forests is increasingly being questioned. It is now widely proposed that seed collected from populations which already experience climatic conditions expected for the planting site in the future should be used to help 'pre-adapt' newly established populations to future conditions, a form of within-species assisted migration. Here, we use a multi-patch, multi-trait individual-based additive genetic model (IBM) to simulate early survival and adaptive responses of tree populations established using different seed sourcing strategies. These strategies include deploying currently adapted local seed, seed adapted to warmer future climates and mixed seedlots involving proportions of seed adapted to the current and to the future climate. The fitness of individuals in the model depends on variation in two genetically uncorrelated quantitative traits and the degree of mismatch to local conditions. . One trait was climate-associated, varied clinally in the landscape and changed through time. The second trait was habitat-associated, varied randomly in space but remained temporally stable. The interplay between these two selection pressures was investigated by modifying their relative selective importance. Sourcing seed from currently warmer locations caused greater phenotypic change in response to climate change. However, this was accompanied by very high juvenile mortality rates because the plants were not adapted to contemporary conditions. Levels of mortality were highest when the habitat-associated trait was selectively important. These findings emphasise that adaptive management should pay attention to local non-climatic site factors and population size in the short term as well as genetic composition at the time of establishment.

#### **4.1. Introduction**

For long lived species such as forest trees, there is concern that the rate at which the environment is changing will exceed the rate at which trees can adapt or migrate, such that local populations will become increasingly maladapted, or fail to survive *in situ* (Jump and Peñuelas, 2005; St Clair and Howe, 2007; Aitken et al., 2008). Reforestation is one activity which, alongside many other benefits, may help to mitigate against climate change and to be achieved successfully requires effective decision making surrounding sourcing of

### Options for adaptive forest seed sourcing

appropriate planting material (Thomas et al., 2014; Broadhurst et al., 2016). A long-held view is that the most appropriate strategy when establishing new populations of plants for ecological restoration is to source seed collected locally, on the basis that it ought to be best suited to tolerate local site conditions (i.e. is locally adapted) (McKay et al., 2005; Vander Mijnsbrugge et al., 2010; Bucharova et al., 2016b).

However, the motivation to source currently adapted seed is partly based on the understanding that climatic conditions are relatively stable in the long term, an assumption that is no longer valid (Parmesan, 2006; Aitken and Bemmels, 2016). A possible practical solution to account for climate change predictions in seed sourcing is to identify populations within the range of the focal species which already experience conditions expected for the planting site into the future and to collect seeds for planting from those populations (Ledig and Kitzmiller, 1992; Broadhurst et al., 2008; Aitken and Whitlock, 2013; Breed et al., 2013; Jones, 2013; Havens et al., 2015). Incorporating proportions of genetic material from currently warmer or drier regions into new plantings is expected to provide components of ‘pre-adapted’ genetic variation which would help the newly established planting adapt to climate change, and possibly help other local populations adapt, via migration of alleles beneficial in a future environment (Aitken and Whitlock, 2013). Following Breed et al. (2013), we describe the sourcing of seed from currently warmer environments as ‘predictive provenancing’, sourcing of mixtures of locally adapted seed with non-local seed from currently warmer environments as ‘composite provenancing’.

However, there are several biological and practical difficulties associated with a predictive approach (Whittet et al., 2016a, b). For instance, it is important to note that climatic predictions are far from certain, not least because an increase in the frequency and severity of extreme events is likely to occur simultaneously with directional change in some variables (IPCC, 2013). Variability will mean that it is particularly difficult to downscale broad climatic trends to local areas, especially in heterogeneous environments (Jenkins et al., 2008). This presents the first major obstacle to successful predictive provenancing, i.e., if we are to use climatic predictions to make space-for-time substitutions, at which time or times into the future do we wish our newly established population to be adapted to? Does the contemporary climate in the putative seed source accurately reflect the expected for the future, or will the future consist of no-analogue climates (Williams et al., 2007)? If a point in the future is selected, will translocated genotypes possess the evolved conservatism required to tolerate harsh conditions during extreme events in the intervening period (Gutschick and

BassiRad, 2003)? What will be the consequences for the population as a whole if one such extreme event does occur?

A further difficulty in selecting suitable non-local source populations is the possibility that tree populations are differentially adapted to other, non-climatic aspects of the environment which may vary at more idiosyncratic spatial scales than climate and remain approximately the same over time (Aitken and Whitlock, 2013; Bucharova et al., 2016a). Such aspects might include biotic interactions with pathogens, herbivores and mutualists (Linhart and Grant, 1996; Ennos, 2015; Pickles et al., 2015), or lithological features, such as soils and geology (Worrell, 1992; Smith et al., 2012). Adaptation to environmental change is likely to be a complex process and one which may be constrained by correlations, or the decoupling of correlations between multiple traits (Jump and Peñuelas, 2005; Cotto and Ronce, 2014; Lefèvre et al., 2014). Nonetheless there remains a tendency to model adaptive responses in terms of individual genetic traits within a single population in a homogeneous environment (Hoffman and Sgrò, 2011).

Empirical studies investigating the processes of adaptation to environmental change tend, for obvious reasons, to focus on model species with short generation times, e.g. *Drosophila* (Willi and Hoffmann, 2009); *Chlamydomonas* (Bell and Collins, 2004; Lachapelle et al., 2015) and *Sacharromyces* (e.g. Bell and Gonzalez, 2009; 2011). A consequence of the very long generation times of trees is that it is impossible to rapidly gain any empirical support for either, the long term efficacy of alternative seed sourcing strategies, or the possibility of an adaptive response enabling evolutionary rescue under rapid climate change.

In the immediate absence of such information, theoretical models provide a useful opportunity to formalise arguments surrounding the limitations of the different approaches for seed sourcing under directional climate change. To investigate the advantages and disadvantages of different seed sourcing strategies, such a model must have the capability to describe the responses both in terms of the degree to which populations adapt genetically in response to directional selection, and the absolute size of the population following afforestation. Models must also take into account the possibility that populations are differentially adapted to non-climatic aspects of the environment (for convenience, ‘habitat’), and examine the outcome of interactions between adaptive or demographic responses and habitat heterogeneity (Schiffers et al., 2013; Bourne et al., 2014).

Here, a fully customised multi-patch, multi-locus, bi-allelic individual based evolutionary model is introduced and is used to explore the adaptive and demographic responses of tree populations established under four different seed sourcing strategies. Individuals within the

model vary in two genetically uncorrelated quantitative traits which evolve in response to spatial habitat and climate variability.

## **4.2. Materials and methods**

### **4.2.1. Purpose**

The purpose of this model is to investigate factors influencing the application of different seed sourcing strategies for woodland creation, in particular the potential for different strategies to assist populations as a whole to adapt genetically to environmental change.

The model is designed to represent a low-intensity forest created in perpetuity for restoration, biological conservation or landscape/amenity purposes rather than a high-intensity setting in which cyclical harvesting and restocking occurs. The geographical context is a relatively harsh selective landscape, reflecting the type of marginal upland site in which this type of land use is applied in place of more intensive forms of land use such as arable farming which are likely to take priority in a productive lowland setting.

### **4.2.2. Simulation procedure**

#### **4.2.2.1. Initiation of the landscape and tree populations**

Eleven patches, each consisting of 1024 cells arranged as 32 x 32 cell grids are established, whereby one living tree can occupy one grid cell at a time (patch carrying capacity = 1024). Each patch is characterised by different local phenotypic optimum values for two environmental variables: 'climate' and 'habitat'. To represent a latitudinal species range, the patches are arranged in a single column such that peripheral patches have a single neighbour and interior patches have two neighbours (Figure 4.1).

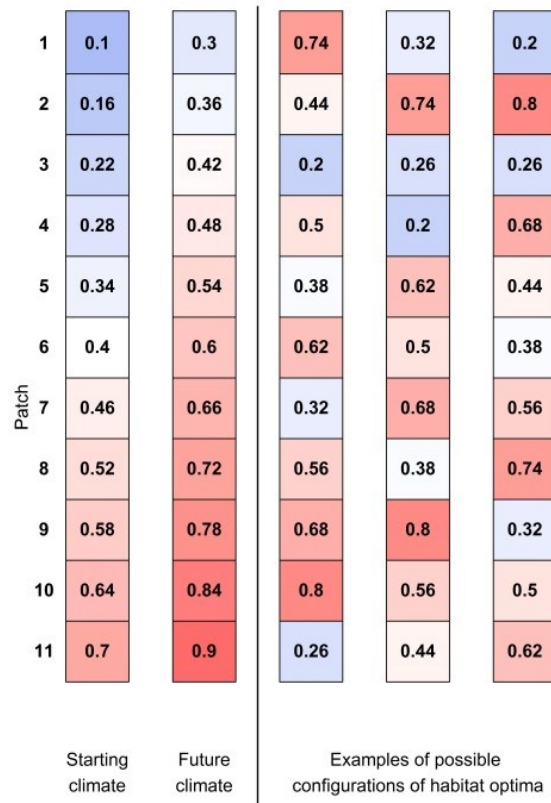
The climate of the patches in the landscape was represented by a single, arbitrarily-scaled temperature variable with interannual fluctuations. During simulations, the initial long term mean phenotypic optima for climate at each patch is taken from an equal-interval sequence of 0.1:0.7. These values are arranged clinally with the largest number (0.7) representing the lower latitudinal patch and the smallest number (0.1) representing the upper latitudinal patch (Figure 4.1). To simulate climate change, the mean climatic optima for each patch are increased by 0.2 gradually over a period of 100 years. The annual climatic optimum in each patch was generated as the local climatic optimum plus a single random number drawn from a normal distribution with mean of 0 and standard deviation set by **climSD**. Although temperature was scaled arbitrarily, there was a realistic ratio between interannual variability



and the warming trend calculated by examining historical records of Central England Temperature (CET) (Parker et al., 1992). From 1700-1940, temperatures were stationary (regression slope  $P = 0.454$ ) and approximately normally distributed with a standard deviation of  $0.6^{\circ}\text{C}$  and little correlation between consecutive years (Pearson's  $r = 0.124$ ,  $P = 0.054$ ). If an increase of  $2^{\circ}\text{C}$  per century above this baseline is to be realised, which is consistent with the CET warming trend from 1970-2015 (regression slope =  $0.021^{\circ}\text{C yr}^{-1}$ ,  $P < 0.001$ ), then the inter-annual standard deviation in temperatures is approximately 30% of the warming per century. In the model, mean annual temperature values rose linearly by 0.2 over a period of 100 years following the equilibration phase and temperature standard deviation (**climSD**) was set to 0.05 by default (25% of the total warming). Conditions within a patch are uniform.

The phenotypic optimum for habitat in each patch is drawn randomly from an equal-interval sequence of 0.2:0.8. The values are reshuffled at the beginning of each model replicate although the actual numerical values themselves remain the same (Fig 4.1). The phenotypic optimum for habitat in any patch remains constant throughout the equilibration and selection phases of the simulations. Conditions within a patch are uniform.

Options for adaptive forest seed sourcing



**Figure 4.1.** Spatial arrangement of the patches within the simulation landscape and their values for climatic and habitat phenotypic optima. Note that the habitat optima are reshuffled for each model replicate and that the three configurations shown here are only examples to demonstrate possible arrangements.

The model organism is a monoecious tree species based very loosely on *Pinus sylvestris* L. Within each patch, individuals are assigned attributes for age, alive/dead status and a genotype, which is used to determine phenotypic values which describe their optimal climate and habitat values.

To begin the simulation, living individuals are placed in each grid cell. These are of a mixed age-structure, with ages randomly drawn from the exponential distribution with a scale parameter equivalent to the annual mortality rate (1/150, see section 4.2.2.2.iii.). Ages are rounded to the nearest integer. We assume a minimum reproductive age of five years whereby younger trees have zero fecundity and older trees have equivalent fecundity each year. The minimum reproductive age of 5 is based on the minimal age of female reproduction in *Pinus sylvestris* (Carlisle and Brown, 1968).

The genotype for each of the two traits (climate phenotype, habitat phenotype) is a vector of 10 unlinked diploid bi-allelic loci, in which the two possible alleles are represented as binary integers (1 or 0). An individual's phenotypic value pertaining to either climate or habitat is the arithmetic mean value of its allelic value at the ten loci and therefore can vary from zero

to one. Ten loci were considered appropriate following trials with larger numbers of loci, which did not appreciably change the results. The climate and habitat traits are genetically independent of each other. In the starting population, the allelic state at each locus is randomly drawn from the Bernoulli distribution. The distribution probability for each individual is randomly drawn from a uniform distribution, to ensure a wide diversity of genotypes and phenotypes in the initial population. The inheritance model thus considered only additive genetic variation with no epistasis.

#### 4.2.2.2. Process overview and scheduling

The model proceeds with overlapping generations running with discrete annual time steps. Within each time step, the following processes take place in order (Figure 4.3.).

##### *i. Annual climatic optimum generation*

The annual climatic optimum in each patch is generated as the local mean climatic optimum plus a single random number drawn from a normal distribution with mean of 0 and a standard deviation set by **climSD**, which has a default value of 0.05.

##### *ii. Reproduction, recombination, dispersal and selection*

Recruitment of new trees is only permitted in gaps, i.e. grid cells not currently occupied by a living tree. Following Savolainen et al. (2004), we generate a pool of up to ten seedlings in each gap. Each of these seedlings has an opportunity to become established.

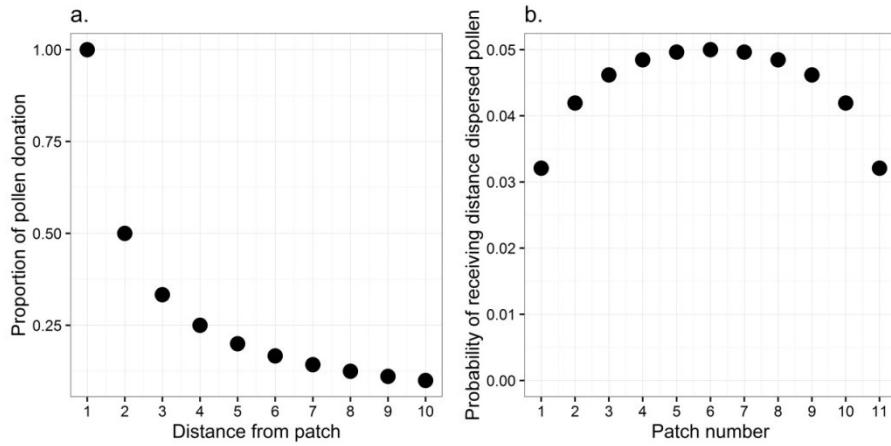
We assume spatially localised seed dispersal, so that seedling mothers are randomly selected from living individuals of reproductive age in the eight (Moore neighbour) cells immediately surrounding the gap, if such a candidate can be found. We assume the trees are entirely self-incompatible but that their pollen is highly dispersive, so that these mothers have been pollinated by any other living tree of reproductive age which is in the same patch as the mother, or by long-distance dispersed pollen from reproductive-age trees in other patches.

The frequency of long distance dispersal events varies for each patch, because of loss of pollen dispersing out of the species' range. We assume that long-distance-dispersed pollen is more likely to come from a neighbouring patch than from further afield and that peripheral patches receive less pollen from other patches than the interior patches (Figure 4.2). To model this we calculate an index for the relative 'connectivity' of a patch  $i$  to all the other patches  $s(i) = \sum_{j \neq i} |i - j|^{-1}$ , where  $i$  and  $j$  are integers coding the patches position in the cline. The central interior patch has the highest connectivity, so the proportion of mating events involving the contribution of pollen from other patches is expressed as

Options for adaptive forest seed sourcing

**maxPropPollenLDD**  $s(i)/s(6)$ , where **maxPropPollenLDD** is the maximum proportion of matings from long-distance pollen and has a default value of 0.05.

As with local pollen dispersal, the location of the individual contributing long-distance dispersed pollen within its local patch is not considered.



**Figure 4.2.** Graphical representation of the dispersal weighting functions applied in the model indicating a). Inverse distance weighted pollen dispersal kernel and b). Proportion of mating events involving extra-patch pollen weighted by home patch.

The genotype of each seedling is determined by randomly combining the maternal and paternal alleles. There is no linkage among loci and so inheritance is independent. Mutation occurs at a rate **prMutation**, with a default setting of  $10^{-7}$  per allele per generation, which, following Schiffers et al (2012), represents average published mutation rates for *Arabidopsis thaliana* (Schultz et al., 1999; Hoffman et al., 2004; Ossowski et al., 2010). Only point mutations are considered and these have the effect of substituting a 1 with a 0 and vice versa. After fertilisation and mutation have been accounted for, the genotype of the seedlings is generated and thus the phenotype score can be calculated.

We assume strong density-dependent selection on recruitment of seedlings to the adult tree population, based on the combined degrees of mismatch between their phenotypes and the local values of climate and habitat in that patch and year. Of the ten candidate seedlings, individuals with higher fitness values have a greater probability of becoming established (Savolainen et al. 2004). A seedlings' fitness  $W_{c,h}(z)$  relative to the environment is calculated by a bivariate Gaussian fitness function:

$$W_{c,h}(z) = \exp \left[ -\frac{(z_c - \theta_c)^2}{0.01} - \frac{hS \times (z_h - \theta_h)^2}{0.01} \right]$$

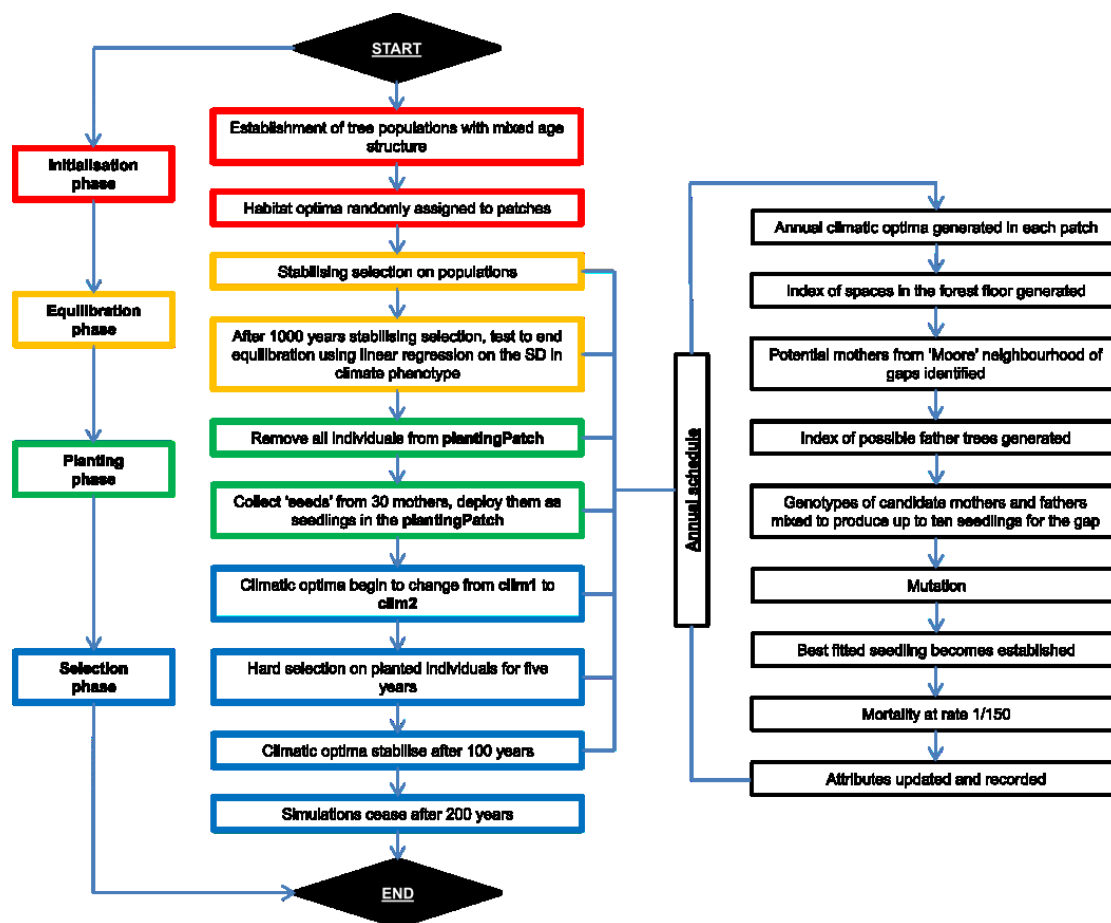
In which  $z$  is the observed phenotype of the individual for  $c$  climate and  $h$  habitat,  $\theta$  is the local phenotypic optimum at the time and 0.01 is a parameter that scales the relative strength of selection. Parameter  $hS$  ('habitat strength') allows the selective importance of habitat relative to climate to be varied. The pool of seedlings is then sampled stochastically with the probability of establishment related to the fitness condition of each individual.

### *iii. Mortality*

To create canopy gaps, mortality of the standing population occurs randomly with Bernoulli trials at an annual rate **prMort**, with the default setting of 1/150 (following Savolainen et al., 2004). Therefore, the median lifespan is 104 years.

### *iv. Updating attributes*

Live status of individuals (alive/dead) is updated, individuals are aged by one year and output summaries of each patch are generated. These summaries include the mean and standard deviation of the phenotype values for all individuals in each patch; the number of live individuals in each patch and the median age of live individuals in each patch. When the full experiments were conducted, these summary values were recorded and saved during the selection phase for the years 0 (prior to felling the locally adapted **plantingPatch**), 5, 25, 50, 75, 100, 125, 150, 175 and 200. Results presented will be based on the summary values for these years.



**Figure 4.3.** Flow diagram illustrating the scheduling of processes in the simulations. The annual schedule takes place each year that the model is running.

### 4.2.3. Simulations

#### 4.2.3.1. Equilibration

An equilibration or ‘burn-in’ phase, in which climate does not change over the long term is simulated to allow populations to adapt to the starting environment. From the initially diverse population, stabilising selection causes asymptotic decline in the standard deviation of the mean phenotype. The equilibration phase of the model is ended once the phenotypic standard deviation has reached the asymptote and the simulation has been running for at least 1000 years. To test for this each year, linear regression is used to estimate the temporal trend in phenotypic standard deviation over the previous 500 years. The populations are considered to have reached equilibrium on the first occasion when the regression slope in phenotypic standard deviation is  $>0$ . At this point, the asymptote has been reached but stochasticity in the simulations means a very slightly positive slope is estimated.

#### 4.2.3.2. Seed sourcing and restoration planting

To make space for simulated restoration planting, immediately after the equilibration phase of the model, all of the individuals within a single focal patch (set by **plantingPatch**, Table 4.2) are removed, rendering the patch available for replanting 1024 new individuals.

Although the aim is to represent a previously unwooded site, felling and replanting takes place for two reasons. Firstly, it removes the necessity to fully spatialize the model and sophisticate the dispersal modules. Patches can be described simply by their identity number on the gradient and dispersal probabilities can be based on this number alone, meaning that actual distances are arbitrary and can be modified. Secondly, the mean phenotype of the planted patch can be compared to expected phenotypes at equilibrium stage, enabling calculation of the mean phenotypic change. This is therefore a matter of methodological convenience, rather than a suggestion that existing woodlands be replaced.

To collect 1024 seeds for deployment at the planting site, thirty open-pollinated mother trees are randomly sampled with replacement. We assume the mothers have been pollinated following the same algorithms described above. Because the carrying capacity ( $K$ ) of the planting patch is relatively low and of a much smaller number of genotypes than would normally be deployed to a planting site ( $n = 1024$ ), we make the philosophical assumption that these seeds would be germinated and raised to transplantable stature in a nursery and transplanted to the newly available patch rather than sown directly. Individuals sampled within a patch are determined randomly, without any spatial stratification *sensu* Hoban and Strand (2015).

Four different provenancing strategies are applied, following the typology set out by Breed et al (2013). The specification of the model to follow any strategy determines the identity of the patch or patches from which the seeds are collected (Table 4.1).

## Options for adaptive forest seed sourcing

**Table 4.1.** Description of the different seed sourcing strategies applied in the IBM

<b>Seed sourcing strategy</b>	<b>Model implementation</b>
Local provenancing	All seed is sampled from the local patch prior to felling, i.e. maternal genotype is generated from individuals that were in the felled patch and are deployed the following year.
Predictive provenancing	All seed is sampled from mothers in the patch for which the current mean climatic optimum ( <b>clim1</b> ) has the minimum mismatch from the future mean climatic optimum one hundred years hence ( <b>clim2</b> ) of the focal patch.
Composite provenancing	This strategy is specified by a binary operator whereby at each trial, mothers are selected either from the local patch ( <i>sensu Local provenancing</i> ) OR from any other source patch up to and including that which minimises the mismatch between current source optimum ( <b>clim1</b> ) and future local optimum ( <b>clim2</b> ) <i>sensu</i> Predictive provenancing. This strategy is therefore an intermediate of local and predictive provenancing.
Admixture provenancing	Seed is sampled randomly from any individual in the entire species distribution, including the felled patch.
<b>Other strategy</b>	<b>Model implementation</b>
Natural regeneration	Natural regeneration is modelled implicitly and measured as the mean response in all of the populations in which felling and replanting does not take place but tree cover is maintained throughout the entire simulation period.

### 4.2.3.3. Climate change

In the first year after the equilibration phase has ended, the mean phenotypic optima for climate in all eleven patches begin to change directionally (from **clim1** to **clim2**, Figure 4.1.) for a period of 100 years, after which it stabilises and remains constant for a further 100 years of simulation. The phenotypic optima for ‘habitat’ remain stable throughout the duration of the simulation. After 200 years of directional selection, the simulation stops. During this period, there is no change in the ‘habitat’ optima.

### 4.2.3.4. Juvenile mortality sub-model

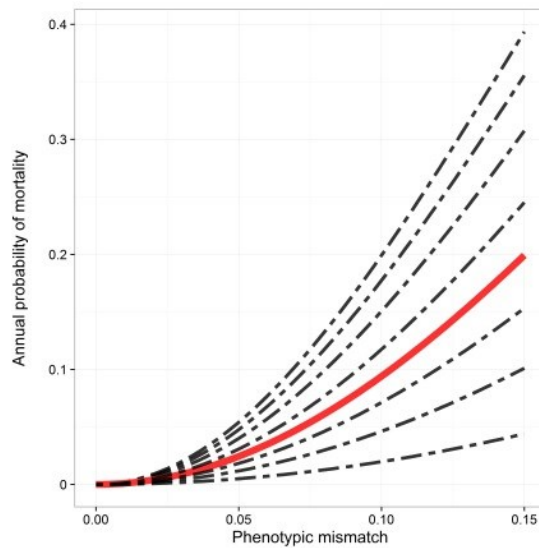
In forest planting schemes, as well as in our gap recruitment model, juvenile mortality is typically very high (Persson and Stahl, 1990; Petit and Hampe, 2006). Two different sub models for juvenile mortality during the first five years immediately after planting were applied. Importantly, this additional selection only operates on the planted trees and not on natural recruits at any other stage in the simulations.

Firstly, there is a Gaussian selective mortality function (Figure 4.4.), implying that the probability of surviving to establishment  $W$  at age 5 is determined by the individual’s phenotypic value for both ‘climate’  $W_c$  and ‘habitat’  $W_h$  in each of the first five years after planting (Schiffers et al., 2012). Mortality is then determined by Bernoulli trials, using the annual probability gained from the function. Fitness is determined by:



$$W_{cl,h}(z) = \exp \left[ -\frac{(z_{cl,h} - \theta_{cl,h})^2}{2\sigma_{\omega}^2} \right]$$

In which  $z$  is the observed phenotype of the individual for  $c$  climate and  $h$  habitat,  $\theta$  is the phenotypic optimum at the time.  $\sigma_{\omega}^2$  is the standard deviation of the Gaussian function (default = 0.225), which represents the selection intensity, or niche breadth of the individual (Lynch and Lande, 1992; Pease et al., 1989; Schiffers et al., 2013). Simulations were run with different settings of  $\sigma_{\omega}^2$  (Figure 4.3) but the intermediate value of 0.225 was selected as the default value as the effect of modifying  $\sigma_{\omega}^2$  was found to have no more than an additive effect. The probability of mortality used in Bernoulli trials is therefore  $1 - W_{c,h}(z)$ .



**Figure 4.4.** Graphical representation of bivariate Gaussian selection function, with a default standard deviation set to 0.225 (solid line). Dashed lines represent other values tested in sensitivity analyses.

Secondly, the model was implemented with a **fixed** mortality function. This implies that the probability of early mortality does not depend on the phenotype but that a fixed number of individuals would fail to survive the first five years of selection, regardless of any parameters in the model. The mortality strength was determined by calculating the annual mortality experienced by all planted trees under the **selective** model – regardless of the planting strategy applied or any other parameter setting. The annual mortality  $aM$  rate applied in the fixed mortality model was calculated thus:

$$aM = 1 - \frac{\mu SIZE}{K^{1/5}}$$

In which  $K$  represents the carrying capacity (1024) and  $\mu SIZE$  is the mean population size after five years of initial selection under the selective mortality model.

#### 4.2.4. Simulation experiments

Fully factorial experiments were established, in which each of the parameters in tables 4.1 and 4.2 varied, as well as the two juvenile mortality models (fixed and selective). Each unique parameter combination was replicated 50 times, giving a total of 150,000 replicates. Code for the simulation model was written and processed in R version 3.1.1. (R Core Team, 2015) and was implemented on a high performance computer cluster at CEH Edinburgh.

**Table 4.2.** Description and values of key state variables which were permuted within the model. Default values are in bold and underlined.

Parameter	Description	Settings
plantingPatch	The patch in which felling and replanting takes place	2 (upper latitudinal), <b><u>5 (mid-range)</u></b> , 8 (lower latitudinal)
habitatStrength ( <i>hS</i> )	The relative importance of 'habitat' selection versus climatic selection	0, 0.5, <b><u>1</u></b> , 1.5, 2
climSD	The inter-annual variability of the phenotypic optimum for climate (standard deviation around long term mean optimum)	0.005, 0.01, <b><u>0.05</u></b> , 0.1, 0.2
maxPropPollenLDD	The maximum proportion of mating events involving pollen contribution from trees out with the local patch	0.005, 0.01, <b><u>0.05</u></b> , 0.1, 0.2

#### 4.2.5. Statistical analyses

Differential rates of adaptation in the mean climate phenotype to the changing optimum were tested by investigating the significance of interaction terms in analyses of covariance ANCOVA, with the formula:

$$\text{Rate} = \mu_{z_{cl}} \sim \text{year}_{[100,200]} \times \text{Seed sourcing strategy}$$

These were conducted separately for the 'fixed' and 'selective' mortality sub-models and were based on simulations in which parameters were held at default values. Only the years following the period in which climate was changing directionally were considered.

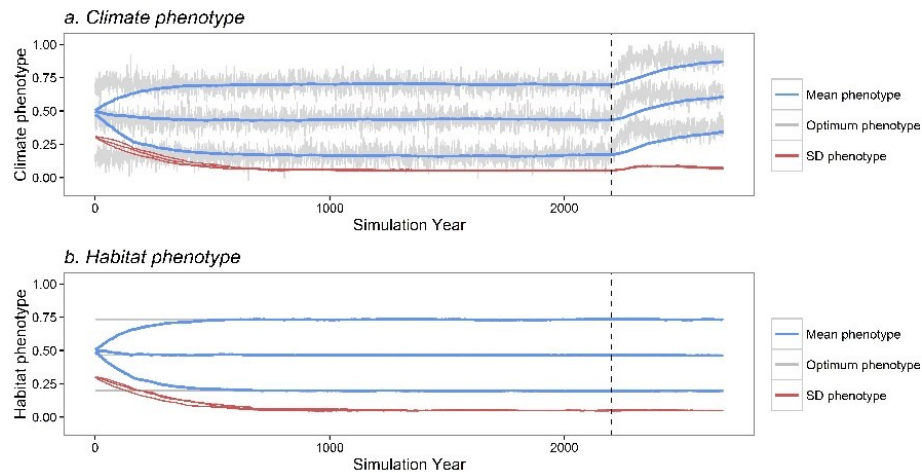
The effect sizes of independently permuting key state variables (Table 4.2) on simulated results were calculated using Hedges' *g* with 95% confidence intervals, using the 'effsize' package within R (Torchiano, 2016). Effect size calculation was based on comparisons between the maximum and minimum values for each of the variables permuted and included only simulations in which all other state variables were held at default values.

Data management and visualisation were conducted with particular reliance on the 'dplyr' (Wickham and Francois, 2015) and 'ggplot2' (Wickham, 2009) libraries within R.

## 4.3. Results

### 4.3.1. Equilibration and generation of locally adapted populations

Locally adapted populations are generated after a minimum of 1000 annual time steps and when the temporal trend in the standard deviation of the patches' mean phenotype has reached an asymptote for 500 years. By the time equilibrium is achieved, each of the eleven populations has a mean phenotypic value matching the local optima for both climate and habitat (Fig. 4.5).



**Figure 4.5.** Typical model run indicating the progress of three populations throughout equilibration and 500 years of directional selection indicating a) adaptive evolution in the climate phenotype and b) adaptive evolution in the habitat phenotype. The vertical dashed line indicates the change from the equilibration phase to the directional selection phase. In the simulated populations shown, no planting took place.

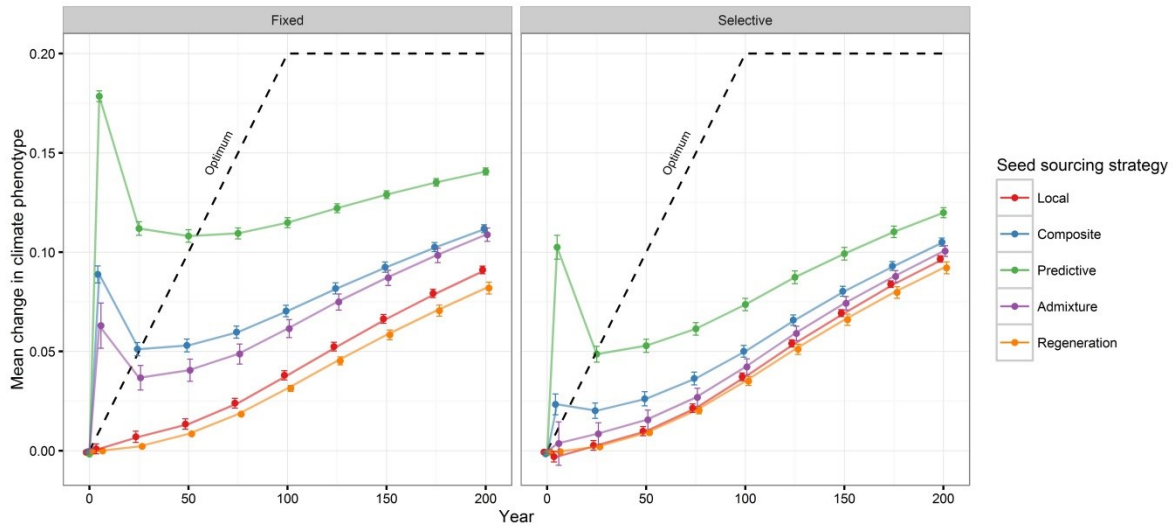
### 4.3.2. Responses to climate change

#### 4.3.2.1. Phenotypic change following replanting

By the end of the period of directional selection, predictive provenancing emerged as the seed sourcing strategy which enabled the greatest total change in the mean climatic phenotype of the planted population (Figure 4.6). The populations established under local provenancing achieved less change in climate phenotype and the other two strategies which involved some non-local genotypes (composite, admixture), were intermediate. Unassisted natural regeneration, which was measured as the mean phenotypic change recorded in all patches in which no felling and replanting took place (i.e., a ‘do-nothing’ approach), achieved the least change to the climate phenotype. This is presumably due to the absence of a pulse of mortality followed by a major recruitment event involving recent selection on planted trees (Kramer et al., 2008; Kuparinen et al., 2010). For this reason, even when locally sourced genotypes are planted, which are the offspring of the felled local parents, a

### Options for adaptive forest seed sourcing

greater shift in the distribution of phenotypes towards the new climatic optimum is achieved than when the population regenerates without intervention.



**Figure 4.6.** Change in the mean climate phenotype during the period of simulation, when parameter settings are held at default values under the fixed and selective juvenile mortality sub-models. The dashed black line represents the mean value for the changing climatic optimum. Regeneration refers to phenotypic change occurring in patches which have not undergone felling and replacement. Error bars represent 95% confidence intervals. The positions of the points and error bars are artificially offset to avoid overlap.

Differences in the rate of adaptation between years 100 and 200 (i.e. once the climate had stabilised) were calculated by analyses of covariance (interaction terms in Table 4.3). Under selective early mortality, the rate of adaptive change is slowest when predictive provenancing is applied, but there are no differences between any of the other strategies. When the early mortality rate is fixed, the rate of adaptation (i.e. amount of change per time step) is greatest under local provenancing and natural regeneration and is slower when any strategy involving non-local genotypes is used.

**Table 4.3.** Analysis of covariance table for rates of phenotypic change between years 100 and 200. Local provenancing is the reference and therefore the parameter estimate for Local provenancing is 0. Only the interaction terms are considered informative.

<b>Establishment model = Fixed</b>					
	Estimate	Standard error	<i>t</i> value	<i>p</i> value	
(Intercept)	-1.43e-02	1.72e-03	-8.316	5.32e-07	***
Year	5.32e-04	1.12e-05	47.563	2.00e-16	***
Composite	4.39e-02	2.44e-03	18.027	1.41e-11	***
Predictive	1.04e-01	2.44e-03	42.659	2.00e-16	***
Admixture	2.96e-02	2.44e-03	12.148	3.65e-09	***
Regeneration	-3.99e-03	2.44e-03	-1.637	0.12253	
<b>Year: Composite</b>	<b>-1.17e-04</b>	<b>1.58e-05</b>	<b>-7.399</b>	<b>2.22e-06</b>	<b>***</b>
<b>Year: Predictive</b>	<b>-2.74e-04</b>	<b>1.58e-05</b>	<b>-17.296</b>	<b>2.56e-11</b>	<b>***</b>
<b>Year: Admixture</b>	<b>-5.93e-05</b>	<b>1.58e-05</b>	<b>-3.753</b>	<b>0.00192</b>	<b>**</b>
Year: Regeneration	-2.64e-05	1.58e-05	-1.67	0.1157	
<b>Establishment model = Selective</b>					
	Estimate	Standard error	<i>t</i> value	<i>p</i> value	
(Intercept)	-2.09e-02	2.74e-03	-7.642	1.51e-06	***
Year	5.95e-04	1.78e-05	33.432	1.68e-15	***
Composite	1.75e-02	3.88e-03	4.521	0.000406	***
Predictive	4.98e-02	3.88e-03	12.842	1.70e-09	***
Admixture	6.49e-03	3.88e-03	1.676	0.114535	
Regeneration	1.65e-04	3.88e-03	0.043	0.966525	
Year: Composite	-4.58e-05	2.52e-05	-1.823	0.088308	.
<b>Year: Predictive</b>	<b>-1.33e-04</b>	<b>2.52e-05</b>	<b>-5.281</b>	<b>9.24e-05</b>	<b>***</b>
Year: Admixture	-1.30e-05	2.52e-05	-0.518	0.611677	
Year: Regeneration	-2.40e-05	2.52e-05	-0.953	0.355477	

There is an initial spike in mean population climatic phenotype under predictive and composite provenancing at year 5 (Figure 4.6). This represents the initial step change in mean phenotype of the planting patch compared to that of the felled patch at the end of equilibration. Under both selective and fixed mortality models, a rapid decline occurs by year 25. Under the selective mortality model, this is due to both heavy losses during the five initial years of hard selection on planted trees and, to a lesser extent, subsequent density dependent selection on recruits towards the contemporary optimum.

Under the fixed mortality model, any change in the mean phenotype during the first five years is caused by random genetic drift. This is then followed by natural selection acting upon recruits after the end of the juvenile sensitivity period, causing the mean phenotype of the population to migrate rapidly towards the current optimum. Rapid adaptation can take place at an early stage in the simulation years because, following juvenile mortality, there are

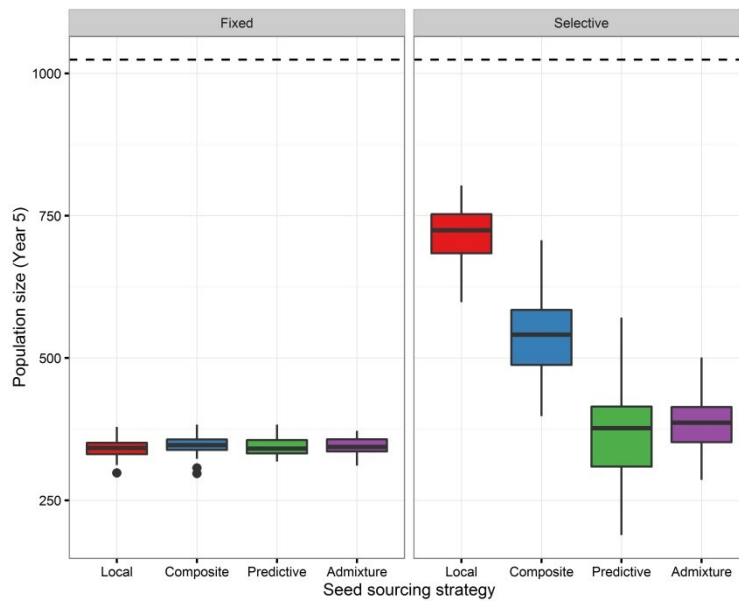
### Options for adaptive forest seed sourcing

many gaps on the forest floor and thus many opportunities for recruitment, in which the best fitted individuals in any year become established. Once these gaps have been filled, a process which takes place rapidly; there are fewer annual opportunities for selection to act upon recruits, thereby slowing the rate of ongoing adaptation (Kuparinen et al., 2010).

The reduction in the extent of change which occurs under composite and predictive provenancing in the first 25 years occurs because the climate is changing gradually. The planted genotypes were initially 'overfitted', i.e. they are adapted to conditions correctly predicted for one hundred years hence but not to the conditions prevailing at the time. Counter-gradient selection causes the population to adapt to a contemporary optimum (when the solid lines intersect the dashed lines on Figure 4.6). However, by this time, the rate of change experienced during the first 25 years can no longer be achieved. Ongoing adaptation is not as fast as it had been initially because there are fewer opportunities for recruitment because the population size approaches carrying capacity and is therefore limited to regeneration following mortality which occurs at a rate of 1/150.

#### **4.3.2.2. Population size following replanting**

The initial phenotypic change achieved in the planting patch is concurrent with high levels of juvenile mortality occurring during the phase of hard selection on planted trees. Juvenile mortality was highest when the planted trees are not adapted to contemporary conditions (Figure 4.7) and thus, local origin genotypes have the highest survival rates. The lowest and most variable survival rates were observed when predictive provenancing was applied.



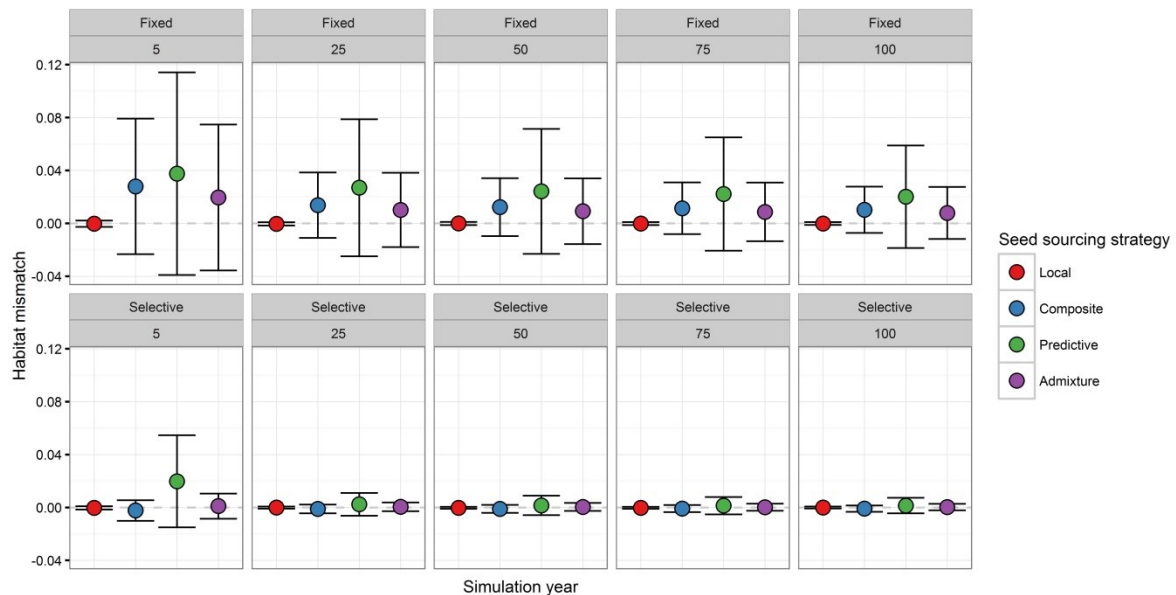
**Figure 4.7.** Size of the planted patch in year 5 following implementation of juvenile mortality functions. In this case, adaptation is to climate only. Habitat is not considered selectively important.

### 4.3.3. Responses to habitat selection and climate change

#### 4.3.3.1. Phenotypic change following replanting

Understanding the effects of selection acting upon the habitat phenotype is somewhat different to the effects of selection acting on the climate phenotype for two reasons. Firstly, the phenotypic optimum pertaining to habitat does not change throughout the period of selection for climate and so the pattern of selection acting upon habitat phenotypes is stabilising, rather than directional, meaning that the results are best visualised as mismatches. Secondly, the values for habitat optima are assigned randomly to patches at the beginning of each iteration of the model, which means that variation associated with these mean mismatches was necessarily large, increasing with the mean (Figure 4.8).

## Options for adaptive forest seed sourcing



**Figure 4.8.** Mean habitat mismatch and 95% confidence intervals recorded in years 5, 25, 50 and 100 under fixed mortality (upper panel) and selective juvenile mortality (lower panel) when parameter settings are held at default ( $hS = 1$ , i.e. selection on climate and habitat phenotypes are equally strong). The dashed horizontal line represents a mismatch of 0, i.e. fitness to the optimum. Years are plotted on different facets to avoid overlapping confidence intervals.

Predictive provenancing leads to the most variable response and the greatest mismatch at an early stage. Under predictive provenancing, seeds are sampled from a single patch whereas under admixture provenancing and composite provenancing, seed is sampled from multiple patches, thereby implying a greater probability of finding proportions of the seedlot which are better adapted to the habitat optimum at the planting site than is the case when choosing from a single non-local patch. Local provenancing results in a consistently small phenotypic mismatch for habitat (Figure 4.8). Stabilising selection operates faster when the selective juvenile mortality sub-model is applied. Under fixed juvenile mortality, adaptation to habitat takes longer (Figure 4.8), as it is due only to selection upon naturally regenerated seedlings.

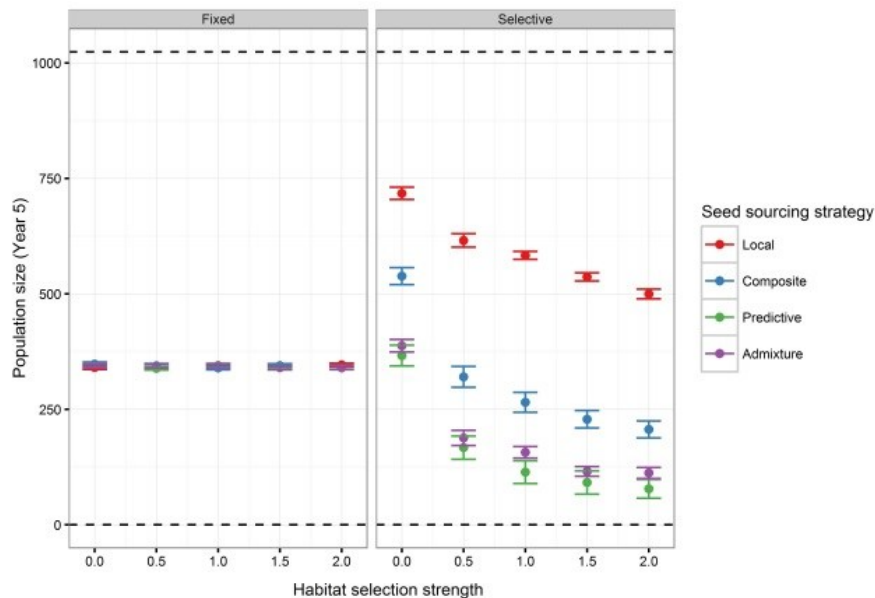
### 4.3.3.2. Population size following replanting

Increasing the strength of selection on the habitat phenotype ( $hS$ ) causes the number of surviving trees to decrease because the total selection strength is greater; individuals must be simultaneously well adapted to the prevailing climate and local habitat.

The difference in population size when  $hS$  was increased was largest when non-local genotypes were deployed. The greatest of these differences was observed between settings of 0 (habitat not selectively important at all) and 0.5 (habitat half as selectively important as climate). This suggests that if selection does not operate on the habitat phenotype at all, chances of non-local genotypes' surviving the first five years are much higher than they



would be otherwise. However, when habitat was at all selectively important, including when it was less important than climate, there was a large reduction in population size (Figure 4.9). At increasing levels of  $hS$ , the population size decreases, but the size of the differences resulting between settings for  $hS$  decreases with increasing selection strength, becoming insignificant for composite, admixture and predictive strategies when  $hS$  was one or greater, due to very low but highly variable population sizes in different model replicates (Figure 4.8).



**Figure 4.9.** Size of the planted population following implementation of juvenile mortality functions and under different values of  $hS$ .

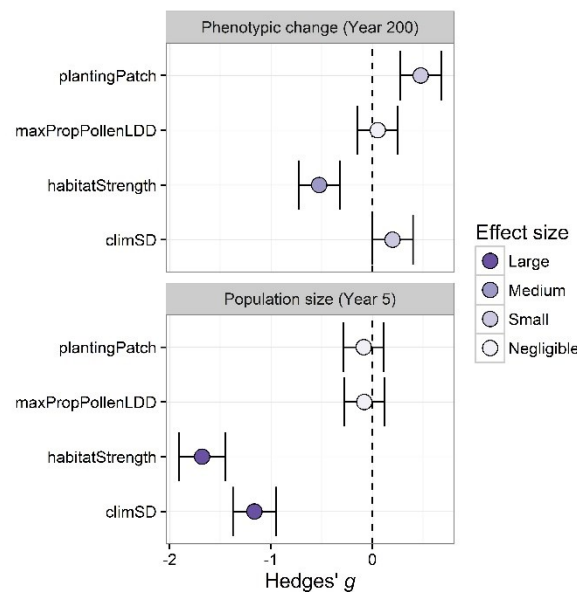
#### 4.3.4. Sensitivity of responses to other parameter variation

The parameters other than  $hS$  varied in sensitivity analyses (Table 4.2) were found to have small, or spurious effects on the simulation results and so have not been presented within the main results.

Varying the proportion of mating events involving extra-patch pollen dispersal (**maxPropPollenLDD**) had a negligible effect on both population size and phenotypic change (Figure 4.10). Phenotypic change was lower when planting was conducted in patch 2 than in patch 8, although the effect size is small (**plantingPatch**, Figure 4.10). However, this is likely related to different allele frequencies in different parts of the cline at equilibrium. In patch 2, the optimum climatic phenotype at equilibrium (**clim1**) is 0.16, whereas in patch 8, **clim1** is 0.52. Following planting, selection is directional, increasing the optima by a value of 0.2, meaning that ‘1’ alleles will be favoured over ‘0’ alleles. Parent trees in patch 8 are

### Options for adaptive forest seed sourcing

52/16 (3.25) times more likely to produce seedlings with '1' alleles than they are in patch 2, meaning that there is an adaptive advantage towards a higher phenotype score. If fitness was determined by a single locus, at which allele frequencies varied clinally, this phenomenon may not be unrealistic. However, variation in adaptive traits is typically governed by many loci, each of small effect, rather than variation at a single locus (Le Corre and Kremer, 2012; Savolainen et al., 2013), and so this result should be considered an artefact of the model. Increasing the interannual climatic variability (**climSD**) had a large effect on the population size at year 5 because very high variability implicitly increases the range of phenotypes which will have a very low fitness condition in at least one of the five years (Figure 4.10). The size of the effect of increasing **climSD** was smaller under predictive provenancing, because high interannual variability may also, by chance, increase the range of phenotypes with a high fitness condition in particularly 'warm' years. Predictive provenancing therefore, might be more successful in replicates in which each of the five years of hard selection were comparatively 'warm', although overall, the effect of increasing **climSD** was negative and led to highly variable population sizes under predictive provenancing. The outputs printed from simulations did not include the climatic optimum in every year and so this cannot be confirmed or refuted.



**Figure 4.10.** The effect sizes of permuting key state variables, pooled across seed sourcing strategies under the selective juvenile mortality sub-model.

## **4.4. Discussion**

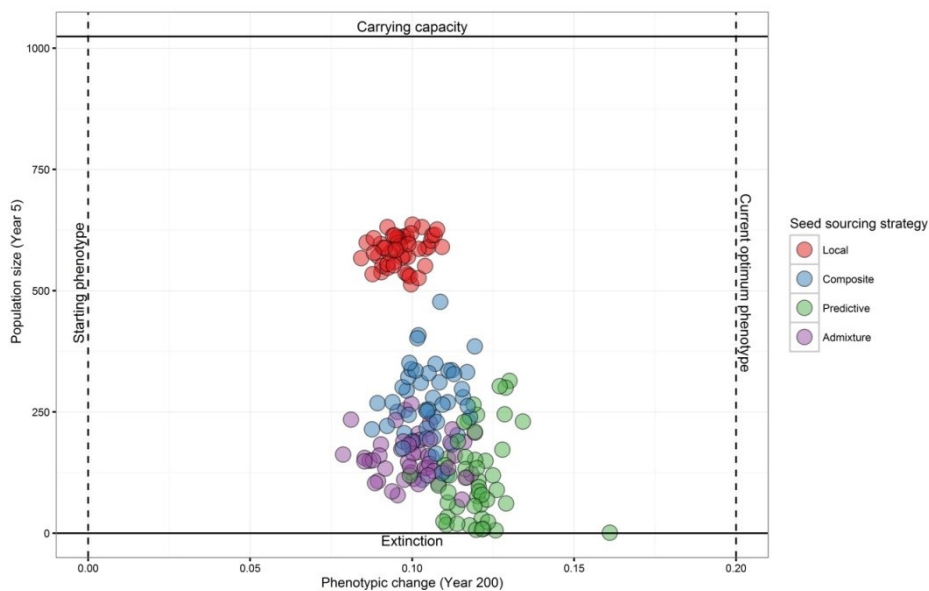
### **4.4.1. What do the results indicate?**

From the model outputs, we can see that adaptation to climate change happened in all cases, and at approximately similar rates. In all cases, adaptation lagged behind the arbitrary moving optimum but the total lag by the end of the simulation period was smaller when predictive provenancing was applied. However, this is not due to differences in adaptive potential or the rate of adaptation, as the rate of adaptation from years 100-200 was actually slightly lower than that of local provenancing (Table 4.3). Rather, it is due to a step change in the mean phenotype of the population at the time of planting with genotypes adapted to conditions 100 years hence. Hard natural selection at an early stage resulted in very high levels of mortality, leading to a population collapse, with only those individuals remaining which were not too maladapted to survive in the first five years. The existence of many spaces on the forest floor meant that recruits, which underwent softer density-dependent selection were able to adapt rapidly to contemporary conditions. However, the direction of selection at this point was opposed to the direction in which the phenotypic optimum was changing in the longer term because adaptation to current conditions was occurring. Such an initial high rate of adaptation could no longer be sustained once the population size approached carrying capacity because there were fewer opportunities for recruitment. Local provenancing, on the other hand experienced lower mortality rates and thus maintained a high effective population size throughout the simulations. However, the mean phenotype at the end of the simulation period had undergone less change than either of the other two seed sourcing strategies. The influence of using mixtures of local and non-local genotypes was found to have no more than an additive effect and composite and admixture provenancing were conspicuously intermediate in terms of their effect upon the two main response variables investigated here. Higher order interactions between more sophisticated response variables and other parameter values (Table 4.2) may emerge under further investigation, although the proportion of variation in phenotypic change and population size explained by seed sourcing strategy was sufficiently high to concentrate on these basic qualitative results. Relaxing the assumption that populations are strongly adaptively differentiated by the end of the equilibrium, for instance by stipulating a time-limit for the ‘burn in’ phase equilibration rather than requiring low phenotypic variation would be useful to investigate effectiveness of the strategies among different landscape configurations. Different sets of circumstances and landscape configurations which could be investigated are connectedness (modelled by varying **maxPropPollenLDD**), habitat heterogeneity (**varying hS**) and short term temporal environmental variability (**climSD**).

### Options for adaptive forest seed sourcing

The most influential of the parameters varied within the simulations (Table 4.2) was the selective importance of non-climatic factors ( $hS$ ). Increasing  $hS$  led to lower population sizes, although the reduction was less severe when local seed was deployed (Figure 4.9).

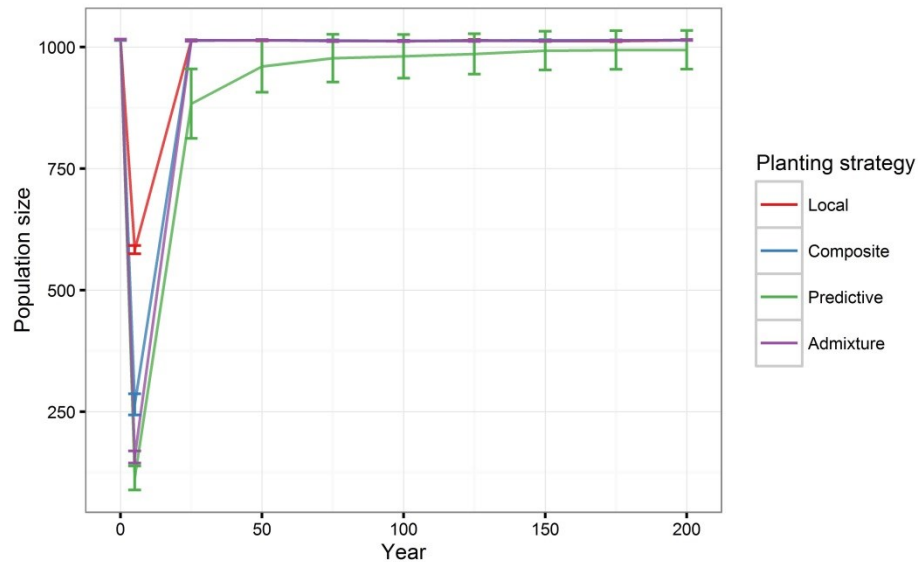
The simplest summary of the results is that varying the seed sourcing strategy involved a trade-off between maintenance of a large population size and total phenotypic change (Figure 4.11). Less change was achieved under local provenancing although the population size remained higher. Predictive provenancing achieved the greatest change, although the population size was lowest and extinction events occurred. Composite provenancing was intermediate and was most effective when selection only acted on the climate phenotype. Admixture provenancing led to the most variable results and was poorer than composite provenancing both in terms of phenotypic change and population size, suggesting that directed composite provenancing is both more effective and less risky than admixture provenancing (Figure 4.11).



**Figure 4.11.** Phenotypic change achieved by the end of the simulation period plotted against population size in year 5, for all replicates when state variables are held at default levels.

#### **4.4.2. Adaptation and demography**

Results from the IBM indicate that in situations where local adaptation exists and early survival depends on the phenotype; there is a greater probability of mortality in the early stages after planting takes place. In this IBM, it is possible for the planted populations to recover rather quickly from these intense mortality events (Figure 4.12).



**Figure 4.12.** Mean population size throughout the simulation period when juvenile mortality of planted trees is selective and when other state variables are held at default values. Population recovery following decline is rapid.

In reality, recovery would be constrained by exposure of very small populations to stochastic processes (Shaffer, 1981; Lacy, 2000; Willi and Hoffman, 2009). Stochastic processes may be natural catastrophes or high temporal environmental variability (Dale et al., 2001; Nabel et al., 2013; Botero et al., 2015), outbreaks of indigenous or exotic pathogens or herbivores (Woods et al., 2005; Ennos, 2015; Desprez-Loustau et al., 2016) or intense competition from other plant species (Kellomäki et al., 2001; Gómez-Aparicio et al., 2011) ecological interactions not included in the IBM.

Furthermore, in the IBM, unless population size declines to zero during the first five years (Table 4.4), the chance that at least one seedling establishes is 1 because annual mating events are implicit in the model. Even if only a single tree survives, pollen contribution from another population will ensure that a pool of seedlings will be established. From the pool of seedlings produced, seedlings with a smaller phenotypic mismatch from the current optimum have the greatest chance of survival. The effect of this is that there are no selective limits in the density-dependent natural recruitment phase. Furthermore, both male and female reproductive output is not related to fitness, does not vary from year to year and commences from an early age (5 years).

**Table 4.4.** Number of extinction events under all model replicates, arranged by planting strategy (max = 37500).

Seed sourcing strategy	Number of model replicates in which population size after 5 years is 0	Number of model replicates in which population size after 5 years is <5
Admixture	32	199
Composite	16	84
Local	12	43
Predictive	1202	2763

The IBM assumes a situation of random mating and even sexual allocation in individuals. Departures from either of these situations in a very small population in reality could lead to demographic stochasticity, reducing reproductive output and success, for example due to reproductive asynchrony caused by phenological differences (Ennos, 2003). The fact that reproduction and reproductive success is guaranteed provided there is at least one gap on the forest floor and at least one individual capable of dispersing seed into a gap likely combine to over-estimate the rate and ease by which natural regeneration can take place in reality. Recovery of the population from a very small initial size is possible within the IBM largely due to these two reasons, as well as the absence of stochastic events.

The IBM considers only additive genetic variation, with no genetic architecture and our inheritance model assumes free recombination. Similar allelic models which consider linkage show that strong linkage will constrain the efficiency of natural selection upon genetic variation and thus reduce likely rates of adaptation (Schiffers et al., 2013; Bourne et al., 2013).

Another consequence of the lack of genetic architecture is that there are no opportunities for genetic Allee effects (e.g. inbreeding depression) to emerge. Nonetheless, in a real-world setting with trees, genetic stochasticity is less likely to present a major problem than environmental or demographic stochasticity for two main reasons. Firstly, small populations of highly fecund and predominantly outcrossing species which have the capacity for long distance dispersal of seed and/or pollen are unlikely to suffer from sustained inbreeding depression. Even very small, fragmented populations of fewer than ten trees are capable of producing highly genetically variable seed crops. Negative fitness consequences of inbreeding are erased by selective purging of inbred individuals and genetic variation can be restored efficiently by distance migration of pollen and seed (Bacles et al., 2005; 2006; Hampe et al., 2013).

Secondly, forest tree planting schemes tend to be involve tens or hundreds of thousands of individuals, rather than the maximum of 1024 planted in the IBM. Genetic and demographic stochasticity in tree populations is likely to be much more sensitive to population size than environmental stochasticity or natural catastrophes, as the latter can similarly impact larger populations (Lande, 1993).

### 4.4.3. Choosing a seed source in a changing climate

The purpose of this highly abstracted modelling exercise was to identify factors which may influence the suitability of different seed sourcing strategies, rather than to provide evidence for decision making in forest management. Results in realistic scenarios will be highly dependent on species biology, management objectives, landscape configuration and the magnitude and type of climate change, all of which will be highly context dependent, varying by region (Breed et al., 2013; Whittet et al., 2016b).

Nonetheless, several results are qualitatively useful. Firstly, adaptation is rapid when there are many spaces available for recruitment (Figure 4.6), although slows down considerably when population size approaches carrying capacity. In a simulation of this type, mortality will necessarily hasten adaptation (Kramer et al., 2008; Kuparinen et al., 2010) because it generates more opportunities for contemporary natural selection to act upon recruits. This supports the concept of utilising disturbance based management in forest ecosystems (Harvey et al., 2002; Brang et al., 2014; Lefèvre et al., 2014; Cavers and Cottrell, 2015; Fady et al., 2016), although sensible and context dependent limits to the magnitude of artificial disturbances imposed on forests are required. These limits should take into account population size, the ease by which natural regeneration occurs, resilience to environmental stochasticity at the population level and the delivery of other management objectives than adaptation to climate change. Additionally, increasing climatic variability caused by climate change may increase the frequency of such disturbance events without management intervention (Dale et al., 2001).

The amount of adaptive change achieved, and the rate of juvenile mortality were both negatively influenced when the habitat phenotype was considered selectively important. If there is evidence that past adaptation to temperature regimes is much more important than to any other (temporally stable) aspect of the environment, demographic risks of using proportions of non-local planting stock are lower than they would be otherwise (Aitken and Whitlock, 2013). For instance, when the habitat phenotype was not selectively important ( $hS = 0$ ), the difference in survival rate between composite and local provenancing was much smaller than when habitat was considered selectively important ( $hS > 0$ ) (Figure 4.9). If knowledge of adaptive variation is limited, habitat is heterogeneous and it is unclear whether non-climatic factors are of adaptive significance, predictive provenancing from a *single* population should be avoided. It will be safer, in this case, to assume that local adaptation does exist than to assume that it does not (Aitken and Bemmels, 2016).

### Options for adaptive forest seed sourcing

The dramatic population size reductions following hard early selection is couched in the assumption that populations show strong adaptive differentiation and a somewhat narrow climatic niche. This narrow local adaptation operates such that novel environments impose severe selective pressures on planted trees. The extent to which this reflects reality will very much depend on the geographical context and aspects of species biology. Local adaptation is common in plants, and perhaps especially in tree species with large ranges (Savolainen et al., 2007), but it is not ubiquitous (Leimu and Fischer, 2004). It will remain very difficult to empirically validate the extent to which composite or predictive provenancing would actually help forests adapt to climate change. A more plausible approach would be to reparametrize models with survival results from long term field provenance tests, as such data may be informative after 15-30 years (White et al., 2007), which is shorter than the generation time of most trees. If demographic risks can be quantified with empirical data, new models could then be applied to better understand whether predictive and composite provenancing strategies provide resilience to climate change whilst minimising risk of population collapse.



## **Chapter five**

### ***Supplying trees in an era of environmental uncertainty: identifying challenges faced by the forest nursery sector in Great Britain.***

This chapter is published as:

Whittet, R., Cottrell, J., Cavers, S., Pecurul, M. and Ennos, R. 2016a. Supplying trees in an era of environmental uncertainty: Identifying challenges faced by the forest nursery sector in Great Britain. *Land Use Policy* **58**, 415-226.

#### **Abstract**

In recent years, numerous articles have addressed management strategies aimed at assisting forests to adapt to climate change. However, these seldom take into account the practical and economic implications of implementing these strategies, notably, supply of forest plants and seed. Using semi-structured interviews with practitioners involved in the plant and seed supply chain in Great Britain, we highlight a series of practical and economic bottlenecks commonly encountered in the supply of locally sourced seed and domestically produced planting stock for native woodland and hedging markets. We find that adoption of alternative seed sourcing strategies, designed specifically to account for directional climate warming, is likely to exacerbate existing problems by adding further complexity to decisions nurseries make about tree species and seed origins to produce. The lack of long-term market predictability brought about by the current configuration of forestry grants and regulations and, in particular, the administrative systems for processing grant applications is identified as a major impediment to having a sustainable and competitive supply of home-grown and currently adapted planting stock. Finally, the time and effort it takes to supply healthy plants for native woodland creation projects deserves much wider recognition throughout the industry and will be crucial if planting objectives are to be met sustainably.

#### **5.1. Introduction**

A sustainable supply of germplasm or planting material is crucial for any plant based ecological restoration project (Broadhurst et al., 2016). An abundance of research emphasises that the planting material supplied for native woodland creation and restoration should come from a seed source that is ecologically and genetically appropriate for the

### Supplying trees in an era of uncertainty

planting site (McKay et al., 2005; Leimu and Fischer, 2008; Vander Mijnsbrugge et al., 2010; Sgrò et al., 2011; Breed et al., 2013; Bucharova et al., 2016b).

A long held view, especially in conservation science has been that the use of locally sourced seed for planting or sowing is the optimal strategy. However, with increasing recognition of global climate change, it has been proposed that in future, seed should be sourced from areas which currently experience climatic conditions expected for the planting site at some point into the future (Aitken and Whitlock, 2013; Breed et al., 2013; Prober et al., 2015).

Absent from much of this ongoing debate regarding the biological considerations affecting seed sourcing is any assessment of the practical implications of seed-sourcing strategies and the impact that seed origin specification has upon forest nursery enterprise. In this chapter we explore how private businesses involved in the supply of seed and planting stock of trees and shrubs for the forestry and hedging markets are affected by policies that govern seed origin choice – using Great Britain (GB), as our study region. The situation in GB, the archipelago composed of the countries of England, Scotland and Wales, is particularly pertinent because there is currently high motivation to expand and restore native woodland in many parts of the country (Scottish Executive, 2006; Forestry Commission, 2007a; Welsh Assembly Government, 2009), and due to problems with fragmentation of woodland and unreliability of natural regeneration, this is best conducted by planting of nursery-raised tree seedlings, rather the use of less resource intensive direct seeding approaches (Willoughby et al., 2004).

To achieve our objectives we have canvassed and attempted to portray opinion on these issues from members of the domestic forest nursery sector in GB. This provides us with a sound basis of critical qualitative data which is frequently communicated verbally and via various informal online platforms, but rarely discussed in the scientific literature. This information, combined with summary data from publicly held trade records (see section 5.2.6), has been synthesized to provide an account of the seed supply and forest nursery sector as it exists in practice in GB, and to explore its strengths and weaknesses.

A key practical aim of the chapter is to highlight bottlenecks in the forest seed and plant supply chain, i.e. identify where various practicalities or bureaucratic protocols impose constraints on the ability for the nursery sector, and their customers to follow biologically based guidance related to seed sourcing for forest trees. We look at these issues under guidelines that were designed under the assumption of a stable climate, but also explore whether changes to existing guidance which aim to account specifically for directional climate warming (e.g. Morison et al., 2010; Forestry Commission England, 2010; Forestry

Commission, 2011b; Weir, 2015), will complicate or ease the current status of the supply chain.

## **5.2. Materials and methods**

### **5.2.1. Background and context**

For native species, seed sourcing and certification in GB involves a geographical system of seed zones comprising four regions of provenance which are subdivided into 24 seed zones of roughly similar size (Herbert et al., 1999). Apart from the special case of Scots pine (*Pinus sylvestris* L.), which has customised seed zones based on patterns of selectively neutral genetic variation (Forrest, 1980; Kinloch et al., 1986), the delineation of seed zones is identical for all native species and thus fails to take into account the possibility that patterns of adaptive variation may vary amongst different species (Rehfeldt, 1994; Vitasse et al., 2009). The purpose of the seed zones is to encourage the use of locally adapted planting stock for woodland creation, i.e. a planting scheme should use planting stock which has been raised from seed collected from within the confines of the local seed zone. The requirement to use locally sourced seed is based on the premise that generations of natural selection in similar environments will have produced phenotypes best able to cope with biotic and abiotic conditions of the planting site. Using locally sourced seeds is often a requirement to obtain subsidy support for a planting scheme. However, it is worth noting that delineation of the seed zones, in their current form was somewhat arbitrary, based on major geographical boundaries and watersheds but not based on evidence of phenotypic or genetic variation in tree populations (reviewed in Whittet et al., 2016b).

Seed collections from native trees are typically organised by nurseries and seed merchants and conducted by contractors from wild tree populations (Herbert et al., 1998). British tree seed collection guidelines for native species suggest that collections should be made from at least 20-30, well-spaced, open-pollinated individuals which are isolated from non-indigenous stands of the same or closely related species, and should avoid selecting trees based on any particular morphological characteristics (Herbert et al., 1998). However, it is worth noting that following these guidelines is typically at the discretion of the seed collector. Problems with a lack of sufficient genetic variation may arise if, for instance, seed demand is very low or if seed crops are very small. One system of control over this is that commercial seed suppliers tend only to purchase seed from contractors when volumes are large enough to preclude collections from few individuals. In addition to seed collection, seed for most species tend to require cleaning and stratification (breaking dormancy) before they are sown,

### Supplying trees in an era of uncertainty

which, along with seed storage, is considered by most nurseries to be a specialist activity and therefore often tends to be conducted by specialist seed merchants rather than by nurseries.

Most tree planting schemes are eligible for subsidy support via contributions from the United Kingdom's allowance of funding from the Common Agricultural Policy of the European Union (EU). As part of the grant application process, applicants must demonstrate that the proposed planting scheme complies with regional priorities. Usually, stating the intended seed origin of planting stock is required and often the authority overseeing the proposal stipulates that seed from the local seed zone is used. However, the extent to which seed origin choice influences approval of a planting scheme can vary depending on the region and the objectives of planting. The applicant must also state the year in which they will claim for grant money following completion of work, meaning that funding is recouped once work has been successfully completed. Stating the claim year takes place before they know whether the proposed scheme will be approved, a process which involves many other protocols and assurances (e.g. Environmental Impact Assessment) and as such may take some time.

To meet demand, nurseries can trade amongst themselves, provided that EU regulations pertaining to the marketing of seeds, plants and parts of plants, collectively known as 'forest reproductive material' (FRM) are followed (Forestry Commission, 2007). This may involve purchasing FRM from large scale enterprises on the European mainland which speculatively buy and raise GB provenance seed to be raised into plants for the GB marketplace (Russell and Evans, 2003). Imported plant material has been strongly implicated as a major pathway for transfer of plant pests and pathogens into the UK (Brasier, 2008) and elsewhere (Liebhold et al., 2012; Jung et al., 2015).

#### **5.2.2. Selection of informants**

Selection of informants was based on a list of 149 registered suppliers of FRM, maintained by Forestry Commission GB; the national forestry authority in GB. With expert opinion from key informants (representatives of the Forestry Commission who are in regular correspondence with the nursery sector), 34 businesses were contacted by email and invited to participate. This sample was subjectively considered to be a representative cross-section of the industry at the time as it contained nurseries of varying size, product specialities and with representation throughout all parts of GB. Of these 34, 19 responded positively. Ultimately, 14 private sector nurseries, 1 public sector nursery and 1 seed merchant were visited, based on the relevance of their business models to our questions. As a matter of convenience, we will henceforth describe all of the businesses as nurseries. Collectively,

these nurseries estimated that they were responsible for the sale of approximately 83 million trees annually, although this number may include some double counting as many nurseries trade amongst each other. Nonetheless, this is likely to represent a very high proportion of the trees sold annually in GB.

### **5.2.3. Interviews**

Interviews were conducted in person in semi-formal office settings and were held with senior staff, which always included owner/operators for sole traders and managing directors for limited companies. On three occasions, more than one interviewee was able to participate and when this was the case, the interview panel included other managerial staff.

Interviews were conducted towards the end of the lifting season (when plants are harvested for sale) in 2014, between February and April, with one interview conducted in April 2015. Interview duration ranged from 30 minutes to 2 hours and followed a semi-structured format with a pre-defined interview guideline containing a mixture of quantitative (descriptive) and qualitative (discursive) questions – although in some cases, answers were not provided, for example, most respondents were unwilling or unable to provide detailed summaries of annual sales volume by species. The interview guideline included questions on seed procurement, plant production and sales, grant schemes, attitude to climate change and open questions regarding any other bottlenecks in the supply chain and policy recommendations. All meetings were recorded digitally using a hand held voice recorder and transcribed manually.

Transcripts were analysed using a ‘grounded theory’ approach (Glaser and Strauss, 2009), which is a widely used inductive technique for qualitative research and seeks to address questions without *a priori* hypotheses or assumptions. Transcripts are coded manually to identify particularly informative chunks of text within the responses, meaning that data collection and analysis to be performed simultaneously. Codes which are repeated across the different responses are grouped into concepts. Concepts are grouped into categories, which then form theories or hypotheses. Hypotheses are formed from the patterns which emerge in the early stages of analysis and are continually tested by re-reading and coding transcripts until a point of diminishing returns is reached, when no novel information emerges (Ní Dhubháin et al., 2009; Górriz-Mifsud et al., 2015). The theories emerging from grounded theory analysis provide the structure for communication of the results.

#### **5.2.4. Selection of quotations**

Quotations reported here are used to demonstrate themes that were derived from qualitative data coded during data collection and analysis. We have aimed to provide a limited series of anonymous quotes to demonstrate the range of views held by the industry. Initially, all quotations relevant to each theme were collated and reviewed by the authors. The selection was narrowed down iteratively by the authors to maintain only those quotations which were either most pertinent to the matter at hand, or those which added important information which otherwise would be absent from the manuscript.

#### **5.2.5. Generating nursery typologies**

In order to contextualise the respondent's views, quantitative summary data gathered from respondents were used to generate typologies of the different nurseries. Such criteria included details of size (*sales volume; number of employees*) and position in market place (*proportion of turnover generated by native species; dominant growth system (containerised production or bare root production); proportion of sales generated by own-produced versus traded stock; proportion of customers which were end users*). An attempt was made to apply a hierarchical cluster analysis to objectively classify the respondents into groups. However, results were difficult to interpret and not all businesses could be categorised according to these criteria (e.g. seed merchants), which would restrict the possibility of anonymising responses.

Instead, a less objective but more easily interpretable approach has been applied which is used to categorise nurseries based on three attributes. These three attributes are relative size, determined by ranking the nurseries by sales volume, as well as the number of employees and contractors; trading status, determined by self-sourced/grown versus purchased product and whether the nursery was involved predominantly in the market for exotic or native trees and seed. The latter two attributes were distinguished by using a 50% (i.e. majority) discriminator, i.e., if > 50% of the nursery's turnover was having been derived from trade in seed or plants for native species, it has been scored as an 'N' for native. Otherwise, it has been scored as an 'E' for exotic. If the proportion is between 40 and 60% for native and exotic species, then the nursery was scored as 'NE'. Importantly, 'exotic' species does not necessarily imply that the exotic planting stock is used for forestry purposes. It also includes exotic species supplied for amenity or horticultural purposes.

### 5.2.6. Trade records

To complement the qualitative aspect of this research, we also interrogated the Forestry Commission's FRM databases which contain records of import and export transactions for forest reproductive material and for registration of seed collections. This national database is maintained in accordance with EU directives on trade in FRM.

## 5.3. Results

Grounded theory emerged as a satisfactory method of data collection and analysis for the interview transcripts, as common concepts emerged across responses and could be formed into logical categories rapidly. An interesting attribute of the forest nursery sector in GB is that private sector nurseries tend to be organised into professional membership groups, for example, the CONFOR nursery producer's group ([www.confor.org.uk/AboutUs/Default.aspx?pid=137](http://www.confor.org.uk/AboutUs/Default.aspx?pid=137)) and the Horticulture Trades Association tree and hedging group ([www.the-hta.org.uk/page.php?pageid=58](http://www.the-hta.org.uk/page.php?pageid=58)). Members of these groups are in frequent communication and competition with one another and experience virtually identical market conditions. For this reason, common themes emerged in most interviews and hypotheses could be generated rapidly forming the basis of our results. We firstly discuss issues related to seed sourcing (section 5.3.2.), most notably those pertaining to procuring seed of particular seed origins for sowing in nurseries. We then discuss issues related to the next stage of the supply chain, i.e., actually supplying the planting stock to customers for planting schemes (section 5.3.3). In this second section, we focus on factors identified as complicating prediction of demand (forest grant schemes and regulations) and measures taken by nurseries to counteract these difficulties (trading in live plants, contract growing).

### 5.3.1. Characteristics of the survey respondents

The sample was indeed found to represent a reasonably diverse set of nurseries, supporting the subjective criteria we had adopted whilst selecting informants (Table 5.1). Quotations used in the following sections will be accompanied with a code (Table 5.1) to demonstrate the category of respondent the quotation can be attributed to. These classifications are provided only to set context to the quotes and ought to be interpreted qualitatively, as there are too few respondents to make any statistical inference or comparative analysis of views held by different types of nurseries.

## Supplying trees in an era of uncertainty

**Table 5.1.** Characteristics and codes of the survey respondents

Attribute	<u>Nursery size</u>			<u>Trading status</u>		<u>Majority market (species)</u>		
	<u>Large</u>	<u>Medium</u>	<u>Small</u>	<u>Producer</u>	<u>Trader</u>	<u>Natives</u>	<u>Exotics</u>	<u>Equal</u>
Number	4	7	5	12	4	7	6	3
Code	L	M	S	P	T	N	Ex	NEx

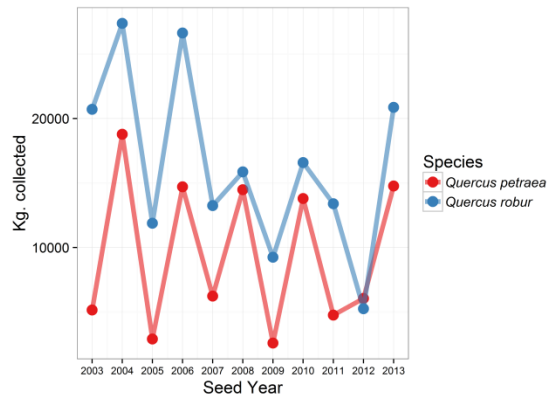
### **5.3.2. Seed sourcing**

#### **5.3.2.1. Seed collection**

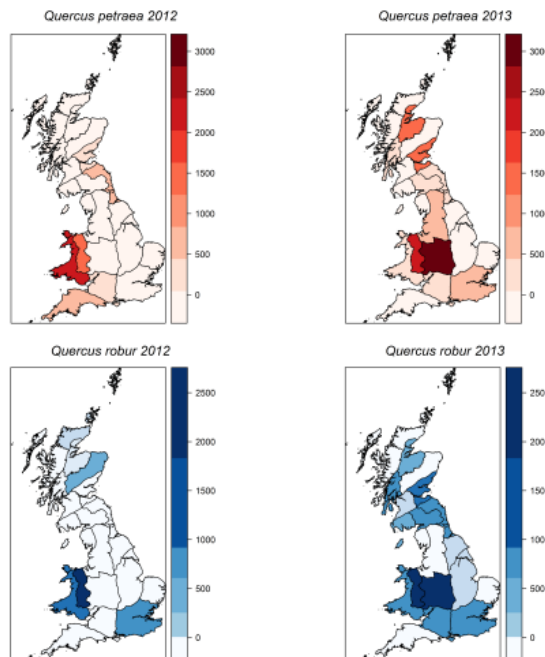
Two of the nurseries surveyed, which were small producers of native species, collected seed for all of the stock they grew with only occasional exceptions. Four nurseries organised their own seed collections and typically employed contractors to do so. It is unclear what proportion of total stock produced was derived from their own collections, although collections were made for a broad suite of tree species. Other producers either did not collect at all (n=6) or collected fairly haphazardly, when it was economically viable to do so, such as during a mast year when large quantities of seed are locally available. Other nurseries were content to rely on seed merchants as they considered that seed collection, treatment and storage to be a highly skilled activity which some nurseries have no interest in incorporating as part of their regular business practice.

There can be considerable variation in availability of seed from year to year for some species. For example, oak trees (*Quercus* spp.), exhibit masting behaviour, with highly variable interannual seed crops (Figure 5.1). In the case of oaks, this is further complicated by the seed being recalcitrant (desiccation-intolerant) and cannot be viably stored for long periods (Gosling, 2007). In addition to temporal variability, most northern hemisphere trees exhibit spatially variable synchrony in seed production, meaning that, in some years, seed is produced in greater quantity in some places than in other places (Silvertown, 1980; Koenig and Knops, 2000). Spatial patterns of oak seed availability in GB differ between years (Figure 5.2).





**Figure 5.1.** Annual quantity (kg.) of seed collected for the two native *Quercus* spp. in GB. Data obtained from the Forestry Commission FRM database.



**Figure 5.2.** Location of seed collected for the two native *Quercus* spp. in GB, in the years 2012 and 2013, summarised by seed zone. Breaks for colour coding indicate seed quantity for each species and were generated using the ‘sd’ style within the R package “classInt” (Bivand et al., 2013). The numerical scales are based on values for the year in which seed was more abundant – in both cases, 2013.

Variability in seed production is not always considered in woodland creation plans.

*“There hasn’t been a good acorn year in the last five years. It was good in the east last year [2013] but not here and we haven’t taken any orders yet the Forestry Commission are still approving schemes that are 60% planted oak, the customers are coming back and saying “what am I going to do?” I can’t magic acorns out of nowhere.” [S|P|N]*

### Supplying trees in an era of uncertainty

*“If nurseries don’t sell any oak then that means that they don’t sell any companion species either and all the schemes involving oak will be put off for a year.” [M|P|N]*

#### **5.3.2.2. The current system of seed zoning**

Respondents were asked for their views of the existing system of seed zones (mapped in Figure 5.2). Discussion tended to focus on two themes. Firstly, the biological relevance of the seed zones, i.e. whether adhering to local origin encourages the use of adapted material and secondly, the practical application of the seed zones for suppliers, i.e. whether seed zone stipulation helps or hinders their business operations.

One respondent, who had described difficulties with the seed zones, found it hard to envisage a viable alternative solution.

*“The lines on the map have to be there anyway to maintain bureaucracy. Creating separate zones for more species would create an even more convoluted system than is already present and it would become impossible to get what you want.” [M|P|NEx]*

Some were sceptical of the seed zone maps, calling into question their biological relevance.

*“I understand why we want seed zones and the reason for having them – climate et cetera but that does not adhere to how they are split at the moment. If you can split up the country using motorways and stuff like that then there isn’t much science behind it.” [M|P|NEx]*

*“I do feel that southern Britain is one outbreeding mass... I really have difficulty seeing much difference between 405,403,404 [three seed zones in the south of England].” [M|P|N]*

*“I think that you could get away with three zones in England– the semi-arid zone, the wet zone and the dry zone. Once you get north of the border [Scotland], it’s a different story because topography plays a major role and I don’t think the current seed zone map allows for that” [M|P|N]*

Despite these doubts, there was some support for the seed zones, at least conceptually, as they add assurances to products, which gives the domestic sector a competitive advantage over producers elsewhere.

*“I’ve always thought that basically, if it hadn’t been for the seed zones, during the time of recession, there would be a whole lot less nurseries out there” [M|P|N]*

Almost all respondents commented that they experienced difficulties in supplying specific seed origins for a planting scheme at some time. The problems were linked to demand at short notice.

*“What I said at the time [the seed zones were initiated] is this is going to make our sales a complete lottery and if you’ve happened to grow the provenances that suddenly there’s a big planting scheme for then you’ve won the lottery but if you haven’t then there’s a load of stock which isn’t going to go anywhere.” [M|P|Ex]*

Respondents indicated that forest authorities in different parts of GB had differing opinions about the necessity to source local origin material. Several respondents mentioned that certain forest conservancies [administrative regions in which grants and guidance are issued] in Scotland and Wales were far stricter about seed origin and that at times this had hindered or even prevented initiation of planting schemes. English authorities were perceived as being more lenient regarding seed origin choice and were often content to accept non-local GB or non-GB material.

*“It depends which conservancy they are in. In Wales they like Wales, England is broader. Scotland is much stricter, especially in the Highlands.” [M|P|N]*

*“The Welsh office is always asking for Welsh provenance. Why is that? It’s not particularly botanical survival I think. It’s a political wheeze. What happens is you get all the landscape contractors going around all the nurseries asking for the right provenance spec. They might find five or six nurseries with a bucketful each of Welsh provenance, and where do they go? To some extent, the nurseries with the most flexible paperwork get the deal. I don’t know.” [M|P|N]*

Regional differences in provenance specification are due to differences in species behaviour in different environments. Local adaptation is likely to be much more frequent in heterogeneous landscapes with strong selective gradients (Kawecki and Ebert, 2004), such as upland regions in Scotland and Wales and so, arguably, it is logical to apply a more conservative approach in these areas.

Occasionally, using planting stock raised from seed collected in seed zones adjacent to a planting site is considered acceptable by the forestry authority (Forestry Commission Scotland, 2006). The influence that this flexibility has had upon the system was clearly recognised by one respondent, who had noticed that demand for seed of one region, 102 (northernmost Scotland) had reduced.

*“The situation is now that if you haven’t got the right zone, you’ve got to have the one next door to it. There’s nothing [few other seed zones] next to 102 so it’s not a very popular zone. If you go into 105 or 106, you’ve actually got 104, 102, 201 and 106. We haven’t got a clue what people want next year. We haven’t got a clue what people want tomorrow. So what*

### Supplying trees in an era of uncertainty

*you've now got is that the demand is coming from those provenances in which you can have the least amount of provenances but the most of the country covered.” [L|P|N]*

#### **5.3.2.3. Seed sourcing and climate change**

Respondents were asked for their opinion of the practice of predictive provenancing, i.e. sourcing seed from areas which currently experience climatic conditions expected for planting sites into the future (Aitken and Whitlock, 2013; Breed et al., 2013; Prober et al., 2015). In a GB context, this would involve sourcing seed from locations 2 – 5 degrees south of the planting site (Broadmeadow et al., 2005; Forestry Commission England, 2010; Morison et al., 2010; Weir, 2015).

Some felt that this would put the domestic trade at risk and have the unintended consequence of moving the market away from GB-grown material. Although most respondents were to some extent ambivalent, 12/16 of the respondents were either mostly sceptical or claimed that they did not understand the science but would not do it anyway. Two were very supportive of the concept and two felt that it did not matter. A common perspective was that indiscriminate sourcing of seed from currently warmer climates was not viable but that there was merit in the ideology of the approach as part of a general drive to diversify the base of material used.

Generally, respondents felt that climate change was more complicated than patterns of directional warming, and therefore sourcing seed from more southerly origins was not suitable as a single strategy.

*“Climate and weather are two different things. I believe in climate change but if we adapt to climate change, we also have to take account of the present weather conditions we are having. I think the ideology of thinking long term is correct but whatever we are thinking long term has got to be able to tackle the short term too.” [L|P|N]*

*“There's only one thing I can guarantee you about the [climate change predictions] forecast, and that is that it is wrong, because all forecasts are wrong. We want to build in resilience for the unknown. If you've got known unknowns, don't try and turn it into a known known because you never will.” [M|P|N]*

Some respondents gave very pragmatic answers.

*“We generally don't go south because of the risk of frost damage.” [S|T|Ex].*

*“No [sourcing seed from further south is not a sensible adaptation strategy], because the local climate effects are huge” [S|P|N].*

Others were not convinced that it was necessary and that it may be best to spend more time considering the options.

*“I think that a foresters’ job is to manage his clients’ woodland. If there is a risk on the horizon, you consider it and have a think about how to mitigate or deal with it. Doing nothing can be all right though, as long as you have thought about it. It shouldn’t be chosen blindly. Trees do adapt, they can cope with a level of change.” [M|P|NEx]*

*“There has been too much action and not enough thinking. The issue with forestry is that foresters tend to be very proactive “do-stuff” people but in this case it might be best to do absolutely nothing. People feel the need to do something although it’s not always necessary. There’s too much of “I want this to happen in my career”, but that shouldn’t be the case.” [M|P|N]*

Another response was that it would make little difference, due to widespread historical imports of plant material.

*“I would think that there is such a vast amount coming in from Holland, Belgium and France that the mix of crop already in the UK always has been coming from those areas and that it wouldn’t make much difference.” [L|T|Ex].*

Supplying alternative products was recognised as a niche marketing opportunity.

*“[There are] some people who are living off the back of these recommendations and making money from it. I’m not sure they necessarily agree with it but it is a marketing opportunity” [M|P|N]*

One respondent was very supportive of the move for southerly origins.

*“Yes. In the right territories, within reason, assuming it’s all ok and disease free and not bringing in anything different up into the UK. Yes, definitely, yes. That’s what we’re doing, that’s what we’re getting customers asking us for. I think the people who are looking for climate change tolerance or testing out these species are people who are more serious productive people. Growing people. Thinking people.” [M|P|NEx]*

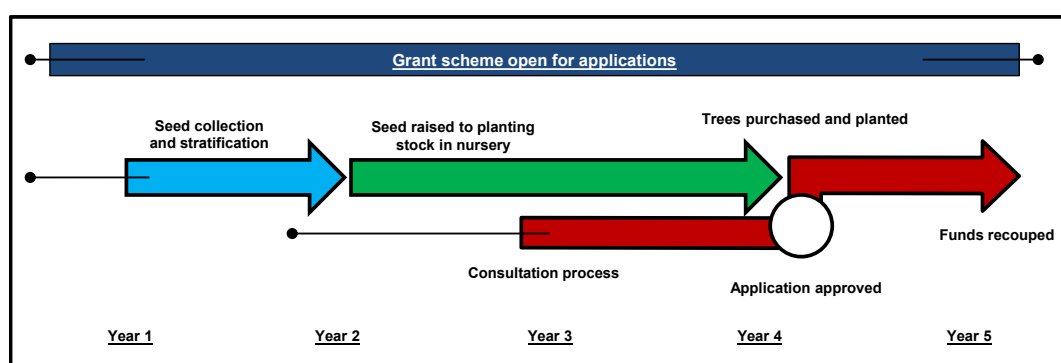
### 5.3.3. Plant supply

#### 5.3.3.1. Grant schemes

Forest planting schemes in GB tend to rely on subsidy support from grant schemes funded by the UK's share of EU Common Agricultural Policy funds. Beginning in 1988 with the Woodland Grant Scheme, there have been six grant schemes in Scotland and five grant schemes in both England and Wales, with an average duration of 4.8 years. Additionally, subsidy rates for different activities and policies vary both between and within grant schemes at times – and the administrative systems required for their implementation are revised, which can create delays (Macaskill, 2016). Respondents to the survey were asked to comment on problems they have experienced with grant schemes and for their opinions regarding possible changes to grant schemes which might improve the efficiency of the plant and seed supply chain.

*“We should have a system reflecting that the industry is long term and not moving the goal posts every five years. If you remove the politics of it, you get an overarching strategy in place for twenty years that is the best thing for the sector” [L|P|Ex]*

Due to grant stipulations, and the long period of time it can take to secure funding, forest managers usually provide nurseries with specifications with little notice – despite nurseries requiring up to three years to produce a tree seedling which is ready to be deployed to the planting site, and longer if targeted seed collection is required. If grant application took place before plant specification, the entire process would be likely take longer than the period in which a single grant scheme is open for (Figure 5.3).



**Figure 5.3.** Idealised timeline diagram of events involved in plant production and grant application and approval. *NB there is likely to be much variation in the time and one of these activities may take. This variation is likely to be particularly strong for seed collection and stratification, grant approval and grant scheme duration. This is indicated by the additional narrow tails.*

*“Most of our clients are coming to us and saying, I would like to buy one million plants. When do they need them? Two weeks. They are all purchasing plants for the season we are already in or the season we are about to enter. That’s to do with the amount of time it takes for grant approvals to go through.” [M|P|NEx]*

*“You take a forester who is specifying to his or her nursery two weeks before they want it delivered. They want a certain species, of a given size, of the correct provenance. They’re also now specifying where it is grown, of a given altitude and want it in two weeks’ time. How is the nursery trade supposed to produce this product?” [L|P|N]* This view was extended by some respondents, who suggested that subsidy schemes were not conducive to long term management.

*“If you want the really big answer, you would remove all of the agricultural and forestry grants. The blackface sheep would come off the hillsides and the price of land would come down and after a few years people would really be thinking about what they want to achieve by doing x, y or z on that hill. There is no room for people to sit down with the client and say – ‘what do you want for your estate? What is it going to look like in 30 years? What do you want to achieve?’” [S|P|N]*

*“I personally, would like to see the industry move away from direct support. I think it would come out stronger” [L|P|N]*

*“We shouldn’t have taken away the tax concessions [of the 1980’s]. The people who were getting them weren’t taking money; it just meant that the tax was deferred. It was a good system. A company I used to work for were sending out lorry loads of trees and when that ended it just stopped” [S|T|Ex]*

### **5.3.3.2. Trading in live plants**

Due to the prevalence of speculative production in GB nurseries, trading among nurseries to fulfil stock requests is common. In addition to trading amongst GB nurseries, planting stock is also sourced from large scale nursery enterprises in other countries, especially in Western Europe (Russell and Evans, 2003). In our survey four out of the sixteen respondents did not import any planting stock from other countries. Those that did import planting stock indicated that they generally did so because they could rely on the quality of products and services and trusted their trading partners.

### Supplying trees in an era of uncertainty

*“The producers in Europe grow excellent stock. It is a safety net for us. We produce what we know we can sell. If for any reason, there is an increase in demand, we can meet that by importing”* [M|P|NEx]

*“When the ash dieback thing [outbreak of *Hymenoscyphus fraxineus* infection of ash trees] happened, people were saying, why were you and the nursery trade importing such vast amounts of ash from abroad? I suppose it was spontaneous demand and unusual specifications late in the season. This spontaneity doesn't help stability in British production.”* [M|P|N]

One trading nursery that relies entirely on hedging or forestry-purposes stock grown outside of GB had tried but failed to commit to exclusively supplying GB-grown planting stock.

*“We decided last year that what we would try to do was buy British. And so we started buying more in this country but they weren't able to do what we wanted them to do. We managed it for about two months, completely hit and miss deliveries and they were delivering the wrong size. It was complete chaos and so we went back to what we were doing before, sadly, buying from the continent.”* [S|T|Ex]

*“Often the choice is between having continental seed grown here or British seed grown on the continent. So you can have an imported plant of the right provenance or the wrong provenance that is grown in the UK.”* [M|P|NEx]

Purchasing and selling trees grown elsewhere can be profitable, and negates some of the risk associated with speculative production.

*“We work pretty closely with two other [GB] nurseries and these are people I know I can trust. I can make money from selling other people's trees. If we just sold our own trees, we'd be pretty poor.”* [S|P|N]

Two respondents suggested that there are ways to bypass the marketing certification system and that, at times, European suppliers have taken advantage of weak policing of the FRM system by supplying false documentation.

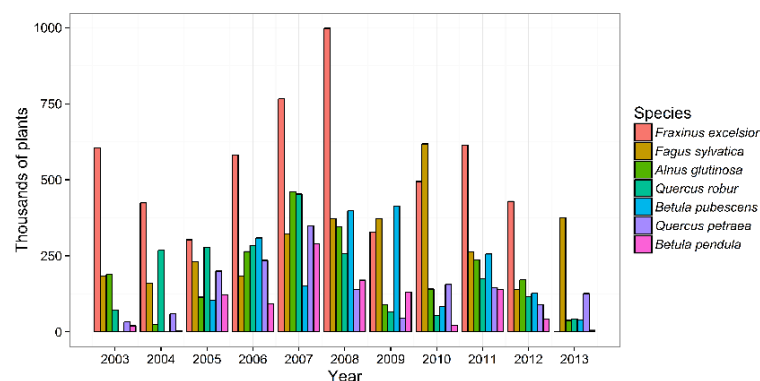
*“I work widely in the European market and some of the things I am asked to do are blatant fraud. They're looking for someone to produce the paperwork – that goes on widely.”*

[L|P|N]



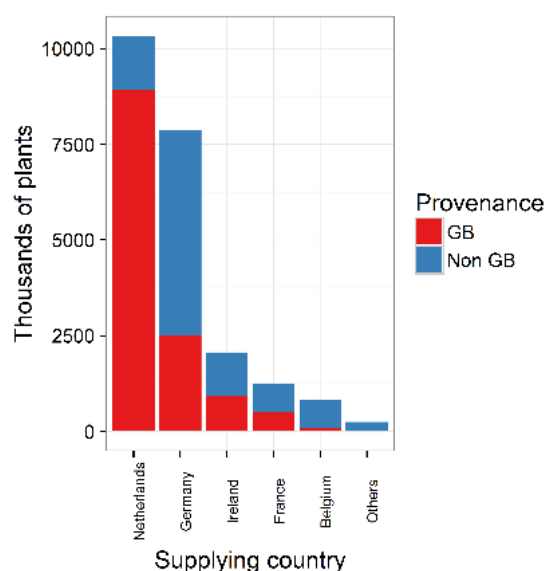
*“They [overseas suppliers] will say – you don’t need the certificate, just tell your customer lies. I think by and large we do get it right in this country but I think we need to be slightly more aware that not everybody is honest and truthful.” [M|P|N]*

The Forestry Commission FRM database records the number of plants imported for regulated species for which they have been notified. These can be broken down by year and by species (Figure 5.4). In total, approximately 59% of plants recorded as imported for 2003-2013 were certified as being of GB provenance (i.e. raised from seed collected in GB), but supplied by other countries (Figure 5.5). The CONFOR nursery producer’s group which, at the time comprised seven of the largest forest nurseries in GB, estimated that their members imported at least 10 million plants in 2012 (Anon, 2012). Fewer than half of this number (36.5%) appears in the FC FRM database for that year, suggesting that the estimates we derived from the national databases are likely to be lower than the actual number of imported plants. In any case, the proportion of imported versus non-imported trees, which is estimated as 12.5% in Anon (2012) is much lower than the 70% estimated for native broadleaves in 1993 (Gordon, 1998). This is in line with recent trends in customer preference for GB-grown material. A recent survey identified that 69% of woodland owners stated a preference for GB-grown trees for the future (Hemery et al., 2015). Interestingly, the intention to specify particular provenances is predicted to decline. A small majority of 54% of survey respondents claiming that they have tended to specify provenance in the past but only 44% claim that they will continue to do so into the future (Hemery et al., 2015). This suggests that less value will be placed on provenance than the location of supplier by forest owners into the future, contrasting with trends in the past decade in which importation of GB provenance material has been widespread (Figure 5.5).



**Figure 5.4.** The number of plants (thousands) recorded as being imported to GB 2003-2013 for species in which the total number of trees imported exceeded one million, according to the FC FRM database.

## Supplying trees in an era of uncertainty



**Figure 5.5.** The supplying country of imported planting stock presented in Figure 5.4. This is broken down by country of provenance (GB/non-GB), to demonstrate the proportion of imported planting stock which is of GB provenance.

### **Box 1. Uncertainty begets importation**

Using quantitative data offered by one respondent, we aim to present an example of problems which can be caused by rapid shifts in policy and subsidy support.

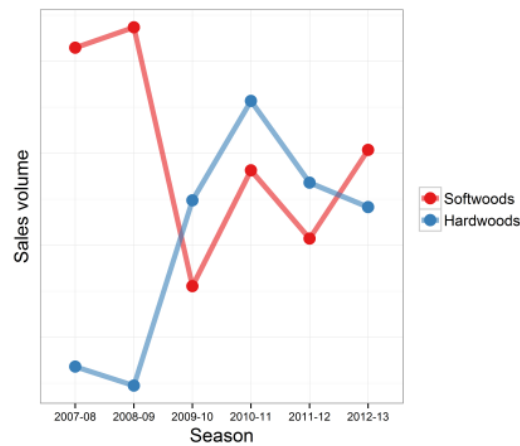
*“Overnight the demand shifted because the grant rate was more attractive for hardwoods in the new scheme [Figure 5.6]. We can’t magic plants out of thin air, so when the demand for softwoods dropped – the proportion we still have on the nursery gets burnt because we can’t sell it”*

In this scenario, there was a rapid shift from one subsidy scheme to another in 2007. In the latter scheme, more attractive rates of subsidy were available for broadleaved species (especially agricultural hedging) than before. This influenced demand at very short notice to the nurseries – and as such, conifer crops which were already being grown at this nursery were destroyed as subsidy rates were less competitive. The nursery was able to diversify quickly by importing planting stock.

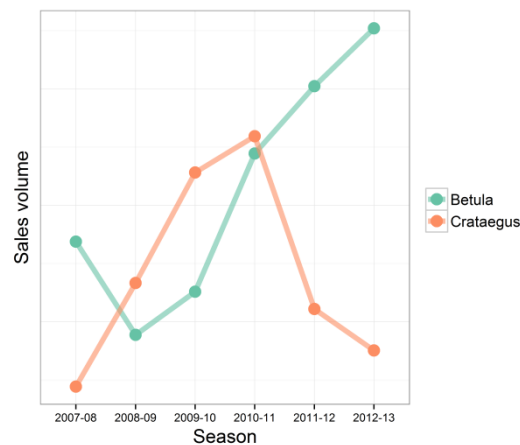
*“There was a hedging grant. That allowed us to survive the transition because of that hedging. We were able to import those plants because provenance wasn’t important – the farmers didn’t care about the provenance of their hedges. That increase buffered that decrease [in conifer sales] which is why we are still here”*

However, in 2010 the subsidy rate for hedging was removed, again, at short notice, and without prior consultation with the nursery sector (Figure 5.7). In this case, reduced *Crataegus* sales were buffered increased in *Betula* sales.

*“If I had decided here [3 years prior] – the market looks good for this [hedging] so I will sow loads of them, I would have been burning them at this point. So that ability to import is in my opinion necessary until the market is stable enough to allow advance purchase of plants.”*



**Figure 5.6.** Annual sales volume for softwoods and hardwoods at a private sector nursery 2007-2013.

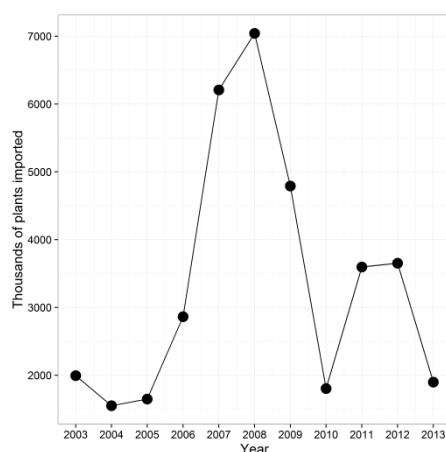


**Figure 5.7.** Annual sales volume for *Betula* spp. and *Crataegus monogyna* at the same nursery between 2007 and 2013. Note – There are no values on the Y axes, as these data are confidential. Additionally, the scale of the Y axes of the figures 5.6 and 5.7 is not equivalent – these data are used to indicate magnitude and thus should be interpreted qualitatively.

Looking more widely, there seems to be a relationship between the volume of imports and transitions between grant schemes. The change from the Scottish Forestry Grant Scheme to

### Supplying trees in an era of uncertainty

the Scottish Rural Development Programme occurred between September 2006 and January 2007. There were major revisions to the English Woodland Grant Scheme between 2007 and 2009 and a new grant scheme in Wales, “Better Woodlands for Wales”, opened in September 2006. The period between 2006 and 2009 is when the highest number of plants was reported as having been imported (Figure 5.8). It seems likely that these two factors are related and supports the claims made by the nursery used in our example of grant scheme transitions.



**Figure 5.8.** The total number of plants (thousands) recorded as being imported to GB 2003-2013 for all species, according to the FC FRM database.

#### **5.3.3.3. Advance purchase of plants – contract growing**

Contract grows, whereby a customer specifies a particular seed origin, either by providing the seed or contracting a collection in addition to growing the plants are one option which may add assurance to crop production. The advantage of contract growing is that the stock can be grown in addition to normal production, with an agreement on the sale in place at the time of sowing. This is common practice in some countries, e.g. Finland (Rikala, 2000) and the United States (Haase, D. *personal communication*), especially for large planting schemes.

Few examples of contract growing were found within the domestic sector in GB. One nursery reported that 60% of their stock was grown under contract and another reported 40%. For all of the other respondents, the proportion was lower than 5% and several said that it had happened once or twice or never at all.

Generally, nurseries were amenable to the idea of advance purchase of plants, although several respondents made it clear that contract growing is not a *panacea* and it does present its own difficulties:

*“Yes, it has its difficulties but if people want a particular seed origin and if it’s seed from ancient woodland or something special then it is definitely a good idea.” [S|T|Ex]*

One respondent noted that contract growing is a partial solution, but could not replace speculative production.

*“On spec, we don’t know who is going to take it [planting stock] but we know that somebody will. Even if half of that were on contract, it wouldn’t make the slightest bit of difference to the other half. That would still be speculative. Contract grows are a bit of a red herring.” [M|P|N]*

For smaller producers, entering into a contract to supply plants is often more of a risk than speculative production.

*“No contract grows, it is too much risk. Too much risk for ourselves, contract prices are low prices and if we have a disaster it’s a big disaster, then you have to go out and re-buy the stock.” [S|P|N]*

## **5.4. Discussion**

### **5.4.1. Tree seed sourcing**

The availability of tree seed is the first limiting factor in any seed sourcing process and is subject to the vagaries of nature, especially when harvested in field conditions (Broadhurst et al., 2015). Strategies to improve availability could either involve increasing collection effort *in situ*, increasing seed production *ex situ* (Broadhurst et al., 2016) or investigating technology to increase the period of time for which germplasm can be stored without losing the ability to germinate (Gosling, 2007). In the immediate absence of these capabilities, organisations responsible for overseeing grant applications should make better recognition of these natural fluctuations in availability of seed. Whilst this may entail delays in planting, it is preferable to deploying planting stock of an inappropriate seed origin or species for the planting site and preferable to importing the planting stock (Hubert and Cundall, 2006). Grant schemes do not currently offer enough flexibility to allow for this, as they place a time limit on completion of works following approval.

The current system of seed origin choice (seed zones), clearly creates problems for suppliers, as they increase the number of product lines a supplier is expected to manage beyond those which would enable a nursery to produce any specific seed origin in volume. This is a problem because tree seedlings are perishable and must be sown long before they are available for sale, a process which typically takes 1-3 years. Without prior knowledge of

### Supplying trees in an era of uncertainty

demand, nurseries must be judicious when sourcing seed and decide whether to grow large quantities of trees from few seed origins (high risk, high reward), or smaller quantities of trees from many seed origins (lower risk, lower reward). Of course, this risk is a reality for any commercial enterprise but it can lead to negative consequences for genetic resource management (inappropriate material planted), biosecurity (excessive reliance on imports) and leads to unnecessary waste. It is important to remember that much of the capital supporting this industry is indirectly derived from taxpayers on the understanding that woodland expansion delivers public benefits.

A survey in British Columbia and Alberta discovered that support for reforestation with non-local seed for climate change adaptation amongst the general public was around 60%, and that increasing levels of knowledge of reforestation technology increased the likelihood of acceptance of the strategy (Hajjar and Kozak, 2015). Our sample was comprised of highly knowledgeable individuals and although it is smaller than necessary to make statistical inference, the GB nursery sector seems to be more sceptical about predictive provenancing. This may be due to the much smaller scale, and perhaps inherently more commercially conservative status of the forest industry in GB than in Canada. Nonetheless, most of the criticisms of predictive provenancing (sourcing seed from more currently warmer locations) were related to the biological considerations (section 5.3.2.3).

In addition to biological considerations, some practical and economic problems with predictive provenancing emerged from the survey. Landholders of seed stands typically receive a proportion of profit achieved on the sale of seed collected from their woodlands. A shift to non-local seed origins could remove the incentive for landholders to manage or allow access to seed stands or increase costs of obtaining seed if collectors are required to source seed from further afield. This would increase the wholesale cost of seed and the costs of woodland establishment. If nurseries are required to speculatively produce planting stock from additional seed origins to those already grown, this will add further risk to their own investments than already exists. Finally, if the suggested practice of mixing the seed origins of planting stock at a single planting site is adopted (Forestry Commission, 2011), a likely scenario, given the existing difficulties associated with predicting demand, is that managers will either have to accept whichever seed origins a nursery sows or accept that trading will be required to provide planting stock of multiple seed origins simultaneously.

More research is required to identify major patterns of adaptive variation in GB tree species, and this should inform policies related to seed sourcing (Boshier and Stewart, 2005; Cavers and Cottrell, 2014; Whittet et al., 2016b). For instance, several respondents perceived that

there are currently more seed zones than is necessary in the relatively homogeneous south of England, as has been demonstrated for Black alder *Alnus glutinosa* L. Gaertn. in Belgium (De Kort et al., 2014). In this case, small seed zones may make seed collection and stock control more complicated than necessary, with no obvious fitness advantage of using local material (Hubert and Cottrell, 2007; O'Neill et al., 2014). A more bespoke, biologically relevant system for sourcing currently adapted seed would not necessarily be more restrictive or complicated than that the current system of seed zones. Such a bespoke system, based on scientific evidence, would also have the advantage of better predicting tree survival at planting sites. This coupled with a greater capacity to access documented and stored seed would add security to the supply chain.

#### **5.4.2. Plant supply**

Demand or at least a preference for GB-grown planting stock is increasing, partly brought about by awareness of plant health problems (Hemery et al., 2015). This greater emphasis on home-grown planting stock should theoretically improve the competitiveness of the domestic nursery sector. However, whilst uncertainty created by the configuration of GB grant schemes remains, there is little indication that imports are likely to cease in the foreseeable future. Large nurseries in mainland Europe have the volume, infrastructure and climate to produce a greater number of product lines, including those grown from GB provenance seed or traded in from elsewhere in Europe. These efficiencies of scale provide continental producers with the confidence to grow trees from a range of GB seed origins speculatively and still make sustainable profit margins by selling back into GB or elsewhere.

Contract growing, in the strict sense, is not an ideal solution to the problem of unpredictable demand, since it requires the supplier and customer to enter into a legally binding agreement, which itself is not free from risk. Contract grows are useful when stock specifications are very tight or when the product being sought is not typically carried by a supplier, especially if targeted seed collection is required. However, in some instances they are unattractive because the sale price may be lower. If nurseries are tied completely into contracts, they will lose the ability to innovate, or gain higher rewards associated with speculative production. In any case, contract growing relies on consumer confidence, which is currently lacking and is a major bottleneck in sustainable seed and plant supply.

Transitioning from a subsidised to a free-market status was mentioned by some of the respondents as a way of increasing consumer autonomy and confidence. Decoupling from agricultural subsidies took place in New Zealand in the 1970's. This was initially followed

### Supplying trees in an era of uncertainty

by a steep decline in the country's agricultural human population and subsequently led to intensification of the agriculture sector (Macleod and Moller, 2006). Effects of liberalising the market in GB would be complex and would constitute very radical reform (Potter, 1996). A possible scenario is that it would lead to reluctance to deliberately create non-profit making native woodlands by private landholders. On the other hand, reducing the rates of subsidy, or adopting a more moderate cost-sharing incentive scheme rather than direct support might entail a shift away from native woodland creation by *materialistic/profit-seeking* landholders to *recreational* landholders (*sensu* Serbruyns and Luysaert, 2006), meaning that deliberate woodland creation for non-financial purposes would be conducted only by those who are genuinely interested in and motivated by positive environmental outcomes. Another indirect consequence of removing agricultural subsidy might be natural colonisation of formerly agricultural land by trees in instances where currently subsidised activities become economically inviable without financial support, particularly in remote areas less favoured by intensive agriculture (Potter and Goodwin, 1998).

Although in-depth analysis of alternative modes of incentivising native woodland creation and expansion is beyond the scope of this chapter; the most obvious consensus from respondents is that more stable grant schemes would allow nurseries to operate efficiently and plan over much longer time-scales than they are currently able to do. Greater flexibility and tolerance of changes to individual planting schemes where there are legitimate reasons for doing so (e.g. inability to procure GB-grown plants of appropriate origin) are also a priority.

To achieve this, it is necessary to develop simpler and more reliable administrative systems for processing grant proposals. Decentralisation of some aspects of the approval process may also enable more efficient delivery of woodland creation and expansion projects whilst taking advantage of local knowledge. Of course, over time, it may be necessary to modify some guidance and policies as our understanding of environmental change develops and to reflect naturally changing requirements of the industry. However, any such changes must be coupled with extensive consultation between the public and private sectors and notice should be provided long in advance of changes, especially to nursery producers in the private sector. Nursery producers are arguably exposed to the highest level of the risk in the supply chain (Broadhurst et al., 2016), despite the fact that their ability to produce and compete with suppliers elsewhere to supply plants for native woodland expansion is clearly in the public interest.



## **5.5. Conclusions**

The ability to create resilient and healthy woodlands from nursery raised planting stock depends on the existence of a resilient domestic seed and plant supply chain to support these efforts. Identifying challenges faced by the forest nursery sector in Great Britain has revealed that bottlenecks in the supply chain are principally natural (seed availability at a given time) and bureaucratic (grants and regulations). Little can be done to mitigate the former bottleneck in the short term. However; greater tolerance at an administrative level may go some way towards easing the constraints it poses. Across the sector currently, productivity and competitiveness are hindered, not by an intrinsic lack of capacity in the GB domestic forest nursery sector, but by a lack of long term market predictability which leads to overproduction and waste on one hand and underproduction and consequent reliance on imports on the other. This analysis suggests that better scientific information – and the tools to use it efficiently – is required to guide seed sourcing policies under uncertain future conditions. Sourcing appropriate planting stock is an inherently long term process and so for such information to be adopted operationally, much more stable and efficient administrative systems for financing and regulating native woodland creation than currently exist are required. In the absence of consistent policy, it may be necessary to revisit stated planting targets and ask whether these are achievable, and at what costs? Finally, an important conclusion from this chapter is that it is crucial for scientists and policy makers to consult with industry to determine the practicability and economic viability of any change to forest policy.



## **Chapter six**

### ***Conclusions***

#### **6.1. Summary of key findings**

Chapter two showed that the seed zones for native Scots pine do not always ensure that a seed source within the seed zone is a closer match to the planting site than another source may be. There are opportunities to improve upon the existing system in order to identify sources of seed which have evolved in similar conditions. Incorporating site-scale ecological information is likely to be very complex. Experiments would have to be conducted to determine whether it is necessary to incorporate ecological information into seed zoning.

Chapter three showed that pine populations in different areas show a tendency to release pollen at different times. In the three study years, male pine strobilus development was earliest in the warmest site in the west of Scotland and proceeded up to 15 days earlier than at the coldest site at the highest altitude in the east of Scotland. However, in every case, models predicted that there is some overlap between all of the sites sampled. This suggests that gene flow is more likely to proceed from west to east than from east to west.

Chapter four used simulations which suggested that using seed sourced from further south enabled a newly planted population to change its mean phenotype to a greater degree when local seed was used. However, this was only due to a step change in the genetic composition, rather than differences in the intrinsic adaptive capacity, of the population. Furthermore, using seed not adapted to the current climate meant that there were high levels of juvenile mortality, especially when aspects other than climate were selectively important. In all cases, adaptation was fastest when there were many opportunities for recruitment.

Chapter five demonstrated that the British forest nursery sector experiences significant difficulties in the provision of domestically grown, locally sourced planting stock. These are caused by spatio-temporal variation in the availability of seed and excessive difficulties in predicting demand due to the current configuration of forestry grants and regulations. Importing of live plants continues to be widespread and is a threat to domestic biosecurity. Longer term, stable systems for funding woodland establishment are required if planted targets are to be met sustainably.

## **6.2. Possibilities for further research**

Improving seed sourcing guidelines requires more information on patterns of adaptive genetic variation than currently exists within GB (Boshier and Stewart, 2005; Cavers and Cottrell, 2014). The approach applied in chapter two using climatic and ecological information forms a basis for improving the ability to match seed sources to planting sites although remains couched in the assumption that local adaptation exists. To define transfer limits, well replicated provenance tests for a range of species, representing a large a range of source and trial environments are possible. Work is underway with trial series' of *Betula pendula*, *Fraxinus excelsior* and *Sorbus aucuparia* which will contribute greatly towards our understanding of adaptive variation in these species (C. Rosique et al., *unpublished data*).

Given the highly resource intensive nature of such experiments and the influence that early decisions can have on results, it will be necessary to set priorities in terms of species choice and to make very clear the purpose of conducting such experiments. If they are to identify seed sources which will be most productive in certain environments the goal may be to sample from high quality trees in the field and to focus on measuring and reporting variation in economically important traits so that these can contribute to improvement programmes in the long term. However, if the aim is to establish more generally whether genotype by environment interactions exist then initial planning may be less selective (White et al., 2007). Collaboration with the forest industry would be very helpful in this regard, for instance by gaining semi-quantitative data on establishment mortality rates of different species in different environments by means of a survey of forest managers. The survey could also target the forest nursery sector and attempt to gain information on relative volumes of stock for different species sold as 'beat-up' (planting stock resold to replace failed trees in the first year), as well as canvassing opinion on seed sourcing throughout the sector as a whole.

Future research could endeavour to determine the influence of edaphic or biotic variation on phenotypic variation among populations of Scots pine and other species. This would help to understand whether it is necessary to consider such variation within seed sourcing guidelines. A plausible experiment would be to reciprocally grow genotypes from different environments in soils collected from their home sites in short term seedling tests under common conditions, with a controlled replicate growing in sterilised soil. Although it would difficult to fully replicate the edaphic environment of any given site in artificial conditions; it would be impossible to control for the effect of climate in field conditions and so sowing

seed in pots in controlled conditions would be desirable. Such an experiment would help indicate whether populations are differentially adapted to their edaphic environments. However, caution would be required in choice of fitness measures, as traditional ‘performance’ indicators such as height growth may reflect enemy release, rather than local adaptation (Dostál et al., 2013; Gundale et al., 2014). A sample of the biotic component of the different soils could be described using molecular approaches prior to sowing seed and at the end of the experiment to determine whether the different tree genotypes influence recruitment or turnover of different species (e.g. ectomycorrhizae).

The aim of chapter three was to investigate and demonstrate, using a simple methodology, whether timing of pollen production is synchronous amongst populations. Differences among distant sites were found to be as many as 15 days, with anthesis taking place earliest in the warmer west of the country. Due to protogyny and prevailing westerly or south-westerly winds, a hypothesis emerging from the study was that the directional bias in pollen transfer among populations is from the west to the east. However, there is a large conceptual difference between the presence of pollen in one location and the effective dispersal of pollen among locations (i.e. successful dispersal, fertilisation, germination and establishment). There may be several other pre-zygotic barriers to gene flow among populations which may be temporal, spatial, or spatio-temporal. Future studies could aim to investigate the timing of female strobilus receptivity among sites and more clearly test hypotheses surrounding the cues of spring reproductive phenology in pines. A relationship with temperature seems highly plausible, but would require higher resolution temperature data than were available in this study for confirmation. Continuing to visit the same trees into the future would generate valuable data, and the mechanisms underpinning variation in reproductive phenology become clearer under further investigation.

The next steps in developing a clear picture of patterns of pollen dispersal in Scottish pine populations would be to parameterise pollen dispersal kernel using molecular markers, accepting that it will be very difficult to capture long-distance events (Kremer et al., 2012). Pollen dispersal kernels could be made spatially explicit/coherent with modelling studies of wind patterns at the time of predicted pollen shedding, as well as elucidating whether certain landscape features (e.g. mountain ranges, conifer plantations) would act against pollen dispersal. Future studies may also endeavour to investigate whether interannual variation in reproductive phenology has consequences for seed production (Koenig et al., 2015).

## Conclusions

The model presented in chapter four was highly abstracted and necessarily made a series of simplifying assumptions to generalise adaptive responses. Future efforts to use simulations to investigate seed sourcing strategies could endeavour to incorporate more realistic processes, for instance by considering clinal phenotypic variation in a trait linked closely to fitness, e.g. timing of bud burst (Aitken and Bemmels, 2016), alongside a more spatially explicit landscape and a more sophisticated basis for genetic adaptation to a realistic climate. A further improvement would be to explicitly incorporate heritable variation in phenotypic plasticity into the model (Chevin et al., 2010; Oddou Muratorio and Davi, 2014), to assess the relative contribution of plasticity to the adaptive responses of populations established under the different seed sourcing strategies and identify whether there are evolutionary tipping points in plastic responses (Botero et al., 2015).

An obvious flaw in the model is that there were no implicit consequences for low population size and evolutionary rescue was not constrained by any ecological interactions or Allee effects. This was simply a matter of interpretation, as the population size at year 5 was considered to be the main response variable but it is conceivable that, had a competing species with a faster life cycle been included in the model, evolutionary rescue from a very small population size would have been limited.

However, gaining experimental data would be more informative and more valuable than more modelling (Bucharova, 2016). Experiments could help to fill two of the major knowledge gaps the model identified. Gaining information on the extent to which populations are adaptively differentiated in terms of non-climatic aspects of the environment, as discussed in short term seedling tests would help to inform how likely phenotypic mismatch leading to early mortality could be among provenances. Longer term provenance tests in realistic field settings will be more useful to determine whether genotypes translocated from currently more benign climates can survive in the field. Confirming whether there are any differences in the extent to which any of the seed sourcing strategies will help populations adapt to climate change will remain very difficult with long-lived trees. Virtually all aspects of the simulation experiments could realistically be replicated in a microbial system (e.g. *Chlamydomonas reinhardtii* P.A. Dang.). Although such an experiment would be biologically interesting, it would not contribute very useful information for forest management and would be little more biologically realistic, and much more difficult than using simulated data.

### **6.3. Practical implications for forest management**

Until it is possible to determine whether biotic or edaphic variation explains sufficient quantities of phenotypic variation in trees at a fine geographical scale (i.e. within the rather limited range of the native pinewoods), it will be difficult to determine whether seed sourcing guidelines ought to be modified to take these details into account (Ying and Yanchuk, 2006). At broader scales, however, for instance when considering introducing new species or translocations over larger differences, biotic or edaphic variation may be of greater effect and certainly warrants further investigation (Bucharova, 2016). Nonetheless, the analysis of climatic covariates clearly showed that improvements can be made upon geographical boundaries with a climatic site matching tool, and one could be designed with relative simplicity, such as those in the USA (Howe et al., 2009) and Canada (McKenney et al., 1999). The main problem with a site matching tool, or ‘floating’ seed transfer zones (*sensu* Rehfeldt, 1983) would be that, in order to obtain the closest match between seed source and planting site, it would be necessary for seed to be available already in storage, or to arrange bespoke seed collection and sowing in time for plants to be raised and deployed at the planting site, something which is rarely possible in GB (Whittet et al., 2016a). The entire process would be more effective if results from trials found quantitative limits in environmental distance over which seed can be transferred without risk of maladaptation. The general geographical pattern of variation in climatic and community compositional was a longitudinal one, matching with empirical results from provenance tests and short term seedling studies with *Pinus sylvestris* in Scotland (Salmela et al., 2011; 2013; Donnelly et al., 2016; Perry et al., 2016a,b). Although no fully comparative data are yet available to determine transfer limits, it seemed subjectively possible that the number of seed zones for Scots pine could be reduced to three. These three seed zones would include a hyper-oceanic group in the far west of Scotland, a central group of populations at higher altitudes in the central and northern Highlands and a third group containing populations in and around the Cairngorms national park.

The potential that temporal reproduction isolation between distant pine populations exists in some years seems plausible. Further research is required to elucidate the mechanisms of these phenological differences in reproduction, but it is worth noting that temporal isolation is just one of many possible barriers to gene flow. Parameterising more complex models of pollen flow with empirical data can only reduce expectations of effective dispersal. A further

## Conclusions

hypothesis is that warming temperatures, if not synchronised across the landscape could act to increase asynchrony in reproduction. Exchange of genetic variation among populations maintains high levels of diversity among populations, which is a crucial prerequisite for genetic adaptation (Savolainen et al., 2007; Kremer et al., 2012). Therefore, forest management planning at landscape scales ought to endeavour to identify realistic pollen and seed dispersal routes and incorporate them into the design of connected forest habitat networks.

Use of the individual based models did not support or refute the use of predictive provenancing. It was, however, an effective means by which to formalise several arguments regarding the approach. Firstly, that adaptation to characteristics other than climate, e.g. soils or biota will impose additional selection on translocated genotypes meaning that establishment mortality could be more severe, especially if variation in two selectively important traits is genetically uncorrelated and arranged in different spatial patterns. Secondly, that the effect of varying proportions of provenances within a seed lot has no more than an additive effect, influencing the genetic composition at the time of planting, but having no emergent effect on the rate of adaptation. Finally, in all sets of circumstances, adaptation change under directional selection does happen and this is necessarily fastest when there are opportunities for recruitment (Kramer et al., 2008; Kuparinen et al., 2010), supporting the idea of utilising disturbance based management by imposing periodic disturbances in new and existing stands (Harvey et al., 2002; Brang et al., 2014; Cavers and Cottrell, 2015). This could be achieved by conducting thinning, as part of a continuous cover approach, or under shelterwood systems (Whittet et al., 2016c). Predictive provenancing from a single population is discouraged as it was found to result in very low population sizes and often extinction. Composite provenancing (i.e. deliberate mixtures of seed from further south with local seed) were found to be more useful than admixture (random) provenancing in all cases and therefore, admixture provenancing is also discouraged. One conceptual problem with the approach is that, outwith a long term experimental context, it would be impossible to determine whether predictive provenancing is effective. As such, implementing predictive provenancing is an act of faith, rather than evidence based decision making.

The nursery surveys identified that there are two main problems in the supply chain for native tree seed and plants. These were related firstly to availability of seed and secondly, to minimal consumer confidence caused by difficulties in the approval of grant schemes. The availability of seed for some native species can be problematic, especially where lead-in



times are lacking (Russell and Evans, 2003). There are currently few long term seed stores in Great Britain and therefore much of the stored seed is held in few locations. Additional seed stores in multiple locations could reduce the vulnerability of this key stage in the plant supply chain. For species with recalcitrant seeds, long term seed storage is not at present a viable option and so establishment of regional seed orchards, designed to conserve genetic diversity and improve seed availability may be a more appropriate strategy for improving seed availability in the long term. For recalcitrant-seeded species with late maturity such as oaks, public investment or involvement in assisting organisations with existing expertise in seed collection and stratification could increase productivity in the short term. Oak seed may be especially difficult to obtain due to strong interannual variability in seed production (mast seeding) (Silvertown, 1980; Koenig and Knops, 2000). Planning for woodland creation schemes involving oaks must recognise that it will not always be possible to obtain seed or plants at short notice and so raised awareness and clearer communication is required when planting schemes involving oak are being conceived and reviewed. Establishment of a national forum on seed availability would be helpful in this regard and could perhaps provide anecdotal predictions of forthcoming seed crops.

A clear practical recommendation emerging from the nursery surveys was that longer lead-in times for planting schemes are required so that nurseries have the ability to better predict demand, thereby reducing waste and reliance on imported planting stock. A review of grant approvals with recommendations for streamlining the process has recently been produced at the request of the Scottish Government (MacKinnon, 2016), and this seems to have bolstered ambitions in Scotland (Anon, 2016). However, the future of subsidy schemes elsewhere is deeply uncertain. The United Kingdom voted to leave the European Union shortly after chapter five (Whittet et al., 2016a), which discussed subsidy schemes and plant imports was accepted for publication. Implications for the subsidisation of woodland planting schemes, implementation of plant health directives as well as environmental policy in general have generated uncertainty within the sector and will be complex (Glynn, 2016; Winkel and Derks, 2016). Certain aspects of deregulation, if it proceeds, may represent opportunities for increased levels of planting (Glynn, 2016). However, deregulation, if it proceeds, is also likely to lead to reduced levels of protection for existing forests (Glynn, 2016) and will perhaps favour production of timber over less profitable native woodland management.

## **6.4. Concluding remarks**

Climate change is just one of many challenges to the maintenance and expansion of woodland cover in Great Britain. Other factors include high herbivore density, patterns of land use and ownership, infrastructure development, pests and diseases. The threat posed by these multiple pressures and the interactions between them highlight the need to recognise that there is no “quick fix” for adaptation to climate change and no single seed sourcing strategy can be seen as a surrogate for sound, continued woodland management which aims to encourage natural regeneration and colonisation. Several potential problems have been identified with predictive provenancing. However, maintaining the status quo by continuing to adhere to the current system of seed zones may also be problematic. A moderate approach might involve updating or extending the status quo in order to improve knowledge and make better use of existing genetic resources and evolutionary processes, thereby ensuring that native tree seed sourcing is better grounded in biological principles. In the short term, this would involve using environmental information to better match seed sources with planting sites, rather than focusing strictly on the current system of seed zones whilst continually monitoring populations further south which are likely to experience climate change related problems before they occur in Britain. However, in the longer term, this ought to be informed by a more detailed understanding of the responses of tree species and the populations within them to different environments. To achieve this, we firstly need information from a range of populations on their ability to acclimate to novel environmental conditions. Secondly, we need information on the pattern of adaptation of trees across the landscape in response to environmental factors, so that presently adapted seed sources can be identified for any particular planting site. Thirdly, we need a better assessment of the extent of genetic variability in standing tree populations. Although adaptation will depend on a whole range of factors, for some traits a measure of the extent of heritable genetic variation in populations can be obtained from progeny trials. This will allow an indication of likely rates at which populations might adapt to a novel environment if natural regeneration occurs. Finally, we need to know the limits of adaptation or tolerance of the species as a whole. This will determine whether a population of the species can realistically be expected to adapt to and survive in changed conditions. In the immediate absence of this information, it is necessary to pay close attention to a series of potential risks of deploying non-local planting stock. Firstly, it may not be possible to find contemporary analogues of future climates (Williams et al., 2007). Secondly, confidence in climate change projections, especially for covariates other than temperature change is strongly limited at local scale, especially in

heterogeneous upland settings such as the north of Scotland (Jenkins et al., 2010). Site scale decision making should recognise that there is great potential for error in projections, and high interannual variability and increased and wider extremes are likely to occur alongside directional change (IPCC, 2013). Thirdly, if population size is greatly reduced due to extreme events happening at an early stage after establishment, the remaining trees will be more exposed to Allee effects and more vulnerable to further environmental stochasticity (Lande, 1993; Dale et al., 2001). Finally, there may be other aspects of the environment to which trees are differentially adapted which vary at different spatial scales and in patterns which contrast with climatic variation (Linhart and Grant, 1996; Bucharova et al., 2016b). Managers ought to consider these risks before exposing newly established woodlands to the many uncertainties in the implications of predictive provenancing. Any such efforts must initially be conducted conservatively and treated as long-term experiments until sufficient evidence can be found which suggests that these strategies are necessary, effective and can be implemented practically.



**References**

- Aitken, S.N. and Bemmels, J.B. 2016. Time to get moving: assisted gene flow of forest trees. *Evolutionary Applications* **9**, 271-290.
- Aitken, S.N. and Whitlock, M.C. 2013. Assisted gene flow to facilitate local adaptation to climate change. *Annal Review of Ecology, Evolution and Systematics* **44**, 367-388.
- Aitken S.N., Yeaman S., Holliday J.A., Wang T. and Curtis-McLane S. 2008. Adaptation, migration or extirpation: climate change outcomes for tree populations. *Evolutionary Applications* **1**, 95-111.
- Alberto, F.J., Aitken, S.N., Alía, R., González-Martínez, S.C., Hänninen, H., Kremer, A., Lefèvre, F., Lenormand, T., Yeaman, S., Whetten, R. and Savolainen, O. 2013a. Potential for evolutionary responses to climate change – evidence from tree populations. *Global Change Biology* **19**, 1645-1661.
- Alberto, F.J., Derory, J., Boury, C., Frigerio, J.M., Zimmermann, N.E. and Kremer, A. 2013b. Imprints of natural selection along environmental gradients in phenology-related genes of *Quercus petraea*. *Genetics* **195**, 495-512.
- Alía R., García del Barrio J., Iglesias S., Mancha J., De Miguel J., Nicolás J., Pérez F. and Sánchez de Ron D. 2009. *Regiones de Procedencia de especies forestales en España*. MARM, Área de Medio Ambiente. Madrid.
- Allen, C.D., Macalady, A.K., Chenchouni, H., Bachelet, D., McDowell, N., Vennetier, M., Kitzberger, T., Rigling, A., Breshears, D.D., Hogg, E.T. and Gonzalez, P., 2010. A global overview of drought and heat-induced tree mortality reveals emerging climate change risks for forests. *Forest Ecology and Management* **259**, 660-684.
- Anekonda, T.S., Lomas, M.C., Adams, W.T., Kavanagh, K.L. and Aitken, S.N. 2002. Genetic variation in drought hardiness of coastal Douglas-fir seedlings from British Columbia. *Canadian Journal of Forest Research*, **32**, 1701-1716.
- Anon. 2012. Confor welcomes Government proposal to boost plant health resources. <http://www.confor.org.uk/NewsAndEvents/News.aspx?pid=23&id=1327> (accessed on 11 August 2015).
- Anon. 2016. Extra funding for tree planting in Scotland welcomed. <http://www.confor.org.uk/news/latest-news/forestry-sector-welcomes-final-piece-in-planting-jigsaw/> (accessed on 20 December 2016).
- Arend, M., Kuster, T., Günthardt-Goerg, M.S. and Dobbertin, M. 2011. Provenance-specific growth responses to drought and air warming in three European oak species (*Quercus robur*, *Q. petraea* and *Q. pubescens*). *Tree Physiology*, **31**, 287-297.

## References

- Bacles, C. F., Lowe, A.J. and Ennos, R.A. 2004. Genetic effects of chronic habitat fragmentation on tree species: the case of *Sorbus aucuparia* in a deforested Scottish landscape. *Molecular Ecology* **13**, 573-584.
- Bacles, C.F., Lowe, A.J. and Ennos, R.A. 2006. Effective seed dispersal across a fragmented landscape. *Science* **311**, 628-628.
- Banks, N.C., Paini, D.R., Bayliss, K.L. and Hodda, M. 2015. The role of global trade and transport network topology in the human-mediated dispersal of alien species. *Ecology Letters* **18**, 188-199.
- Barclay, A.M. and Crawford, R.M.M. 1984. Seedling emergence in the rowan (*Sorbus aucuparia*) from an altitudinal gradient. *Journal of Ecology* **72**, 627-636
- Bell, G. and Gonzalez, A. 2009. Evolutionary rescue can prevent extinction following environmental change. *Ecology letters* **12**, 942-948.
- Bell, G. and Gonzalez, A. 2011. Adaptation and evolutionary rescue in metapopulations experiencing environmental deterioration. *Science* **332**, 1327-1330.
- Benito-Garzón, M., Ha-Duong, M., Frascaria-Lacoste, N. and Fernández-Maniarrés, J.F. 2013a. Extreme climate variability should be considered in forestry assisted migration. *BioScience* **63**, 317.
- Benito-Garzón, M., Ha-Duong, M., Frascaria-Lacoste, N. and Fernández-Manjarrés, J. 2013b. Habitat Restoration and Climate Change: Dealing with Climate Variability, Incomplete Data, and Management Decisions with Tree Translocations. *Restoration Ecology* **21**, 530-536.
- Bergot, M., Cloppet, E., Pérarnaud, V., Déqué, M., Marçais, B. and Desprez-Loustau, M.L. 2004. Simulation of potential range expansion of oak disease caused by *Phytophthora cinnamomi* under climate change. *Global Change Biology*, **10**, 1539-1552.
- Billington, H.L. and Pelham, J. 1991. Genetic variation in the date of budburst in Scottish birch populations: implications for climate change. *Functional Ecology* **5**, 403-409.
- Birks, H.J. 1989. Holocene isochrone maps and patterns of tree-spreading in the British Isles. *Journal of Biogeography* **16**, 503-540.
- Bischoff, A., Vonlanthen, B., Steinger, T. and Müller-Schärer, H. 2006. Seed provenance matters—effects on germination of four plant species used for ecological restoration. *Basic and Applied Ecology* **7**, 347-359.
- Bivand, R., Ono, H., Dunlap, R. and Stigler, M. 2013. classInt: Choose univariate class intervals. URL <http://CRAN.R-project.org/package=classInt>. R package version 0.1–21.

- Blackburn, P. and Brown, I.R. 1988. Some effects of exposure and frost on selected birch progenies. *Forestry* **61**, 219-234
- Blanquart, F., Kaltz, O., Nuismer, S.L. and Gandon, S. 2013. A practical guide to measuring local adaptation. *Ecology Letters* **16**, 1195-1205
- Boisvenue, C. and Running, S.W. 2006. Impacts of climate change on natural forest productivity—evidence since the middle of the 20th century. *Global Change Biology* **12**, 862-882.
- Boshier, D. and Stewart, J. 2005. How local is local? Identifying the scale of adaptive variation in ash (*Fraxinus excelsior* L.): results from the nursery. *Forestry* **78**, 135-143.
- Botero, C.A., Weissing, F.J., Wright, J. and Rubenstein, D.R. 2015. Evolutionary tipping points in the capacity to adapt to environmental change. *Proceedings of the National Academy of Sciences* **112**, 184-189.
- Bourne, E.C., Bocedi, G., Travis, J.M., Pakeman, R.J., Brooker, R.W. and Schiffers, K. 2014. Between migration load and evolutionary rescue: dispersal, adaptation and the response of spatially structured populations to environmental change. *Proceedings of the Royal Society of London B: Biological Sciences* **281**, p.20132795.
- Bower, A.D. and Aitken, S.N. 2006. Geographic and seasonal variation in cold hardiness of whitebark pine. *Canadian Journal of Forest Research* **36**, 1842-1850.
- Brang, P., Spathelf, P., Larsen, J.B., Bauhus, J., Boncčina, A., Chauvin, C., Drössler, L., García-Güemes, C., Heiri, C., Kerr, G. and Lexer, M.J. 2014. Suitability of close-to-nature silviculture for adapting temperate European forests to climate change. *Forestry* **87**, 492-503.
- Brasier, C.M. 1996. Phytophthora cinnamomi and oak decline in southern Europe. Environmental constraints including climate change. *Annals of Forest Science* **53**, 347-358.
- Brasier, C.M. 2008. The biosecurity threat to the UK and global environment from international trade in plants. *Plant Pathology* **57**, 792-808.
- Breed, M.F., Stead, M.G., Ottewell, K.M., Gardner, M.G. and Lowe, A.J. 2013. Which provenance and where? Seed sourcing strategies for revegetation in a changing environment. *Conservation Genetics*, **14**, 1-10.
- Breeze, D.J. 1997. The Great Myth of Caledon. *Scottish Forestry* **46**, 331-335.
- Broadhurst, L., Driver, M., Guja, L., North, T., Vanzella, B., Fifield, G., Bruce, S., Taylor, D. and Bush, D. 2015. Seeding the future—the issues of supply and demand in restoration in Australia. *Ecological Management and Restoration* **16**, 29-32.

## References

- Broadhurst, L.M., Jones, T.A., Smith, F.S., North, T. and Guja, L. 2016. Maximizing Seed Resources for Restoration in an Uncertain Future. *BioScience* **66**, 73-79.
- Broadmeadow, M., Ray, D. and Samuel, C. 2005. Climate change and the future for broadleaved tree species in Britain. *Forestry* **78**, 145-161.
- Brown, A.V. and Webber, J. 2008. *Red Band Needle Blight of Conifers in Britain*. Forestry Commission Research Note 2. Forestry Commission, Edinburgh.
- Bucharova, A. 2016. Assisted migration within species range ignores biotic interactions and lacks evidence. *Restoration Ecology*. DOI: 10.1111/rec.12457
- Bucharova, A., Frenzel, M., Mody, K., Parepa, M., Durka, W. and Bossdorf, O. 2016a. Plant ecotype affects interacting organisms across multiple trophic levels. *Basic and Applied Ecology* **17**, 688-695.
- Bucharova, A., Michalski, S., Hermann, J.-M., Heveling, K., Durka, W., Hölzel, N., Kollmann, J. and Bossdorf, O. 2016b. Genetic differentiation and regional adaptation among seed origins used for grassland restoration: lessons from a multi-species transplant experiment. *Journal of Applied Ecology* DOI: 10.1111/1365-2664.12645
- Buckley, P. and Blakesley, D. 2008. *Sourcing local native plants for nursery production: guidance for seed suppliers and growers*. Forestry Commission England.
- Burczyk, J. and Chalupka, W. 1997. Flowering and cone production variability and its effect on parental balance in a Scots pine clonal seed orchard. *Annals of Forest Science* **54**, 129-144.
- Calder, I.R., Reid, I., Nisbet, T. and Green, J.C. 2003. Impact of lowland forests in England on water resources – applications of the HYLUC model. *Water Resources Research* **39**, 1319-1328.
- Campbell, R.K. 1974. Use of phenology for examining provenance transfers in reforestation of Douglas-fir. *Journal of Applied Ecology*, pp.1069-1080.
- Campbell, R.K. 1979. Genecology of Douglas-Fir in a Watershed in the Oregon Cascades. *Ecology* **60**, 1036-1050.
- Campbell, R.K. 1991. Soils, seed-zone maps, and physiography: guidelines for seed transfer of Douglas-fir in southwestern Oregon. *Forest Science*, **37**, 973-986.
- Carlisle, A. and Brown, A.H.F. 1968. *Pinus sylvestris* L. *Journal of Ecology* **56**, 269-307.
- Cavers, S. and Cottrell, J. 2015. The basis of resilience in forest tree species and its use in adaptive forest management in Britain. *Forestry* **88**, 13-26.



- Cavin, L., Mountford, E.P., Peterken, G.F. and Jump, A.S. 2013. Extreme drought alters competitive dominance within and between tree species in a mixed forest stand. *Functional Ecology* **27**, 1424-1435.
- Chebib, A., Badeau, V., Boe, J., Chuine, I., Delire, C., Dufrene, E., Francois, C., Gritti, E.S., Legay, M., Pagé, C. and Thuiller, W. 2012. Climate change impacts on tree ranges: model intercomparison facilitates understanding and quantification of uncertainty. *Ecology Letters* **15**, 533-544.
- Chevin, L.-M., Collins, S. and Lefèvre, F. 2013. Phenotypic plasticity and evolutionary demographic responses to climate change: taking theory out to the field. *Functional Ecology* **27**, 966-979.
- Chevin, L.M., Lande, R. and Mace, G.M. 2010. Adaptation, plasticity, and extinction in a changing environment: towards a predictive theory. *PLoS Biol* **8**, e1000357.
- Christensen, J.H. and Christensen, O.B. 2007. A summary of the PRUDENCE model projections of changes in European climate by the end of this century. *Climatic change* **81**, 7-30.
- Christensen, R. H. B. (2015). ordinal - Regression Models for Ordinal Data. R package version 2015.6-28. <http://www.cran.r-project.org/package=ordinal/>.
- Chung, M.S. 1981. Flowering characteristics of *Pinus sylvestris* L. with special emphasis on the reproductive adaptation to local temperature factor. *Acta Forestalia Fennica* **169**, 1-69.
- Clark, J.R., 2013. PhD Thesis: *Adaptation of ash (Fraxinus excelsior L.) to climate change*. Bangor University, UK.
- Collins, S. and Bell, G. 2004. Phenotypic consequences of 1,000 generations of selection at elevated CO<sub>2</sub> in a green alga. *Nature* **431** 566-569.
- Conover, D.O. and Schultz, E.T. 1995. Phenotypic similarity and the evolutionary significance of countergradient variation. *Trends in Ecology & Evolution* **10**, 248-252.
- Cook, N.J. and Prior, M.J. 1987. Extreme wind climate of the United Kingdom. *Journal of Wind Engineering and Industrial Aerodynamics*, **26**, 371-389.
- Cook, R.J. 1973. Influence of low plant and soil water potentials on diseases caused by soilborne fungi. *Phytopathology* **63**, 451:458
- Cotto, O. and Ronce, O. 2014. Maladaptation as a source of senescence in habitats variable in space and time. *Evolution* **68**, 2481-2493.
- Crowe, K.A. and Parker, W.H. 2008. Using portfolio theory to guide reforestation and restoration under climate change scenarios. *Climatic Change* **89**, 355-370.

## References

- Cundall, E.P., Cahalan, C.M. and Connolly, T. 2003. Early results of ash (*Fraxinus excelsior* L.) provenance trials at sites in England and Wales. *Forestry* **76**, 385-400.
- Dale, V.H., Joyce, L.A., McNulty, S., Neilson, R.P., Ayres, M.P., Flannigan, M.D., Hanson, P.J., Irland, L.C., Lugo, A.E., Peterson, C.J. and Simberloff, D. 2001. Climate change and forest disturbances: climate change can affect forests by altering the frequency, intensity, duration, and timing of fire, drought, introduced species, insect and pathogen outbreaks, hurricanes, windstorms, ice storms, or landslides. *BioScience*, **51**, 723-734.
- Davies, C., Ellis, C.J., Iason, G.R. and Ennos, R.A. 2014. Genotypic variation in a foundation tree (*Populus tremula* L.) explains community structure of associated epiphytes. *Biology Letters* **10**, p.20140190
- Davis, M.B. and Shaw, R.G. 2001. Range shifts and adaptive responses to Quaternary climate change. *Science* **292**, 673-679
- De Kort, H., Mergeay, J., Vander Mijnsbrugge, K., Decocq, G., Maccherini, S., Bruun, H., Honnay, O. and Vandepitte, K. 2014. An evaluation of seed zone delineation using phenotypic and population genomic data on black alder *Alnus glutinosa*. *Journal of Applied Ecology* **51**, 1218-1227.
- Delpierre, N., Guillemot, J., Dufrière, E., Cecchini, S. and Nicolas, M. 2016. Tree phenological ranks repeat from year to year and correlate with growth in temperate deciduous forests. *Agricultural and Forest Meteorology*. DOI: 10.1016/j.agroformet.2016.12.008
- Desprez-Loustau, M.L., Marçais, B., Nageleisen, L.M., Piou, D. and Vannini, A. 2006. Interactive effects of drought and pathogens in forest trees. *Annals of Forest Science* **63**, 597-612.
- Desprez-Loustau, M.L., Aguayo, J., Dutech, C., Hayden, K.J., Husson, C., Jakushkin, B., Marçais, B., Piou, D., Robin, C. and Vacher, C. 2016. An evolutionary ecology perspective to address forest pathology challenges of today and tomorrow. *Annals of Forest Science* **73**, 45-67.
- DeWitt, T.J., Sih, A. and Wilson, D.S. 1998. Costs and limits of phenotypic plasticity. *Trends in Ecology and Evolution* **13**, 77-81.
- Diekmann, M. 2003. Species indicator values as an important tool in applied plant ecology—a review. *Basic and Applied Ecology*, **4**, 493-506.
- Donnelly, K. 2015. PhD Thesis: *Molecular and adaptive variation in the Caledonian Pine, Pinus sylvestris* L. University of Edinburgh, UK.

- Donnelly, K., Cavers, S., Cottrell, J.E. and Ennos, R.A. 2016. Genetic variation for needle traits in Scots pine (*Pinus sylvestris* L.). *Tree Genetics & Genomes* **12**, 1-10.
- Dore, A.J., Kryza, M., Hall, J.R., Hallsworth, S., Keller, V.J.D., Vieno, M. and Sutton, M.A. 2012. The influence of model grid resolution on estimation of national scale nitrogen deposition and exceedance of critical loads. *Biogeosciences* **9**, 1597-1609.
- Dostál, P., Müllerová, J., Pyšek, P., Pergl, J. and Klinerová, T. 2013. The impact of an invasive plant changes over time. *Ecology letters* **16**, 1277-1284.
- Dufrêne, M. and Legendre, P. 1997. Species assemblages and indicator species: the need for a flexible asymmetrical approach. *Ecological Monographs* **67**, 345-366.
- Dzwonko, Z. 2001. Assessment of light and soil conditions in ancient and recent woodlands by Ellenberg indicator values. *Journal of Applied Ecology*, **38**, 942-951.
- Ellenberg, H., Weber, H.E., Düll, R., Wirth, V., Werner, W. and Paulißen, D. 1992. Zeigerwerte von pflanzen in Mitteleuropa. *Scripta Geobotanica* **18**, 1-248.
- Ennos, R. 1994. Estimating the relative rates of pollen and seed migration among plant populations. *Heredity* **72**, 250-259.
- Ennos, R., Worrell, R. and Malcolm, D. 1998. The genetic management of native species in Scotland. *Forestry* **71**, 1-23.
- Ennos, R. A. 2003. The contribution of population genetics studies to plant conservation studies. *Botanical Journal of Scotland* **55**, 89-100.
- Ennos, R.A. 2015. Resilience of forests to pathogens: an evolutionary ecology perspective. *Forestry* **88**, 41-52.
- Fady, B., Aravanopoulos, F.A., Alizoti, P., Mátyás, C., Von Wühlisch, G., Westergren, M., Belletti, P., Cvjetkovic, B., Ducci, F., Huber, G.; Kelleher, C.T; Khaldi, A., Dagher Kharrat, M.B., Kraigher, H., Kramer, K., Muhlethaler, U., Peris, S., Perry, A., Roussi, M., Sbay, H., Stojnic, S., Tijardovic, M., Tsvetkov, I., Varela, M.C., Vendramin, G.G., Zlatanov, T. 2016. Evolution-based approach needed for the conservation and silviculture of peripheral forest tree populations. *Forest Ecology and Management* **375**, 66-75.
- Feliciano, D., Hunter, C., Slee, B. and Smith, P. 2013. Selecting land-based mitigation practices to reduce GHG emissions from the rural land use sector: A case study of North East Scotland. *Journal of environmental management* **120**, 93-104.
- Fletcher, A.M. and Samuel, C.J.A. 2010. Selecting Douglas Fir seed sources for use in Britain. *Forestry Commission Bulletin No. 129*. Forestry Commission, Edinburgh

## References

- Fletcher, A.M.F. and Faulkner, R. 1972. A plan for the improvement of Sitka spruce by breeding and selection. Forestry Commission Research and Development Paper Number 85, HMSO, London.
- Foot, D. 2003. The Twentieth Century: Forestry Takes Off. In: *People and Woods in Scotland, A History*. Smout, T.C., ed. Edinburgh University Press, Edinburgh.
- Forestry Commission, 1999. *Caledonian Pinewood Inventory 1998*. Edinburgh: Forestry Commission.
- Forestry Commission. 2007a. *England Forestry Strategy. A new focus for England's woodlands*. Forestry Commission, Cambridge.
- Forestry Commission. 2007b. *Forest reproductive material: regulations controlling seed, cuttings and planting stock for forestry in Great Britain*. Forestry Commission, Edinburgh.
- Forestry Commission, 2011a. *NFI 2011 woodland map GB. National Forest Inventory Report*.  
[http://www.forestry.gov.uk/pdf/NFI\\_GB\\_REPORT\\_010813.pdf/\\$FILE/NFI\\_GB\\_REPORT\\_010813.pdf](http://www.forestry.gov.uk/pdf/NFI_GB_REPORT_010813.pdf/$FILE/NFI_GB_REPORT_010813.pdf) (accessed 8 September 2016).
- Forestry Commission. 2011b. *Forests and Climate Change. UK Forestry Standard Guidelines*. Forestry Commission, Edinburgh.
- Forestry Commission, 2016. Nursery survey: 2016 edition.  
<http://www.forestry.gov.uk/forestry/inf-d8fme72>. (accessed 8 September 2016).
- Forestry Commission England. 2010. *Managing ancient and native woodland in England*. Forestry Commission England Practice Guide. Forestry Commission England, Bristol.
- Forestry Commission Scotland. 2006. *Seed sources for planting native trees and shrubs in Scotland*. Forestry Commission Scotland, Edinburgh.  
<http://www.forestry.gov.uk/forestry/inf-d8fme72> (Accessed on 4 September 2016).
- Forest Service. 2006. *Northern Ireland forestry – a strategy for sustainability and growth*. Forest Service, Belfast.
- Forrest, G.I. 1980. Genotypic variation among native Scots pine populations in Scotland based on monoterpene analysis. *Forestry* **53**, 101-128.
- Forrest, G.I. 1982. Relationship of some European Scots pine populations to native Scottish woodlands based on monoterpene analysis. *Forestry* **55**, 19-37.
- Frascaria-Lacoste, N. and Fernández-Manjarrés, J. 2012. Assisted colonization of foundation species: lack of consideration of the extended phenotype concept—response to Kreyling et al. (2011). *Restoration Ecology* **20**, 296-298.

- Galili, T. 2015. Dendextend: an R package for visualising, adjusting and comparing trees of hierarchical clustering. *Bioinformatics* **31**, 3718-3720.
- Gibbs, J.N. and Greig, B.J.W. 1977. Some consequences of the 1975–1976 drought for Dutch elm disease in Southern England. *Forestry* **50**, 145-154.
- Gibson, A.L., Espeland, E.K., Wagner, V. and Nelson, C.R. 2016. Can local adaptation research in plants inform selection of native plant materials? An analysis of experimental methodologies. *Evolutionary Applications*. DOI: 10.1111/eva.12379
- Glaser, B.G. and Strauss, A.L. 2009. *The discovery of grounded theory: Strategies for qualitative research*. Transaction Publishers, Piscataway, NJ.
- Glynn, M. 2016. *The impact of leaving the European Union on the UK Forestry Sector*. <http://www.confor.org.uk/media/246192/the-impact-of-leaving-the-eu-on-the-uk-forestry-sector.pdf> (accessed on 17 December 2016).
- Gómez-Aparicio, L., García-Valdés, R., Ruíz-Benito, P. and Zavala, M.A. 2011. Disentangling the relative importance of climate, size and competition on tree growth in Iberian forests: implications for forest management under global change. *Global Change Biology* **17**, 2400-2414.
- Gömöry, D., Bruchanik, R. and Paule, L. 2000. Effective population number estimation of three Scots pine (*Pinus sylvestris* L.) seed orchards based on an integrated assessment of flowering, floral phenology, and seed orchard design. *Forest Genetics* **7**, 65-75.
- Gordon, A. 1998. Whence British Trees? *Tree News*. Autumn 1998, 15
- Gordon, A., Faulkner, R., Lines, R., Samuel, C., Aldhous, J. and Fletcher, A. 1992. Seed manual for forest trees. *Forestry Commission Bulletin No. 63*. HMSO, London.
- Górriz-Mifsud, E., Domínguez-Torres, G. and Prokofieva, I. 2015. Understanding forest owners' preferences for policy interventions addressing mushroom picking in Catalonia (north-east Spain). *European Journal of Forest Research* **134**, 585-598.
- Gosling, P. 2007. Raising trees and shrubs from seed. Forestry Commission Practice Guide. Forestry Commission, Edinburgh.
- Grimm, V., Berger, U., Bastiansen, F., Eliassen, S., Ginot, V., Giske, J., Goss-Custard, J., Grand, T., Heinz, S.K., Huse, G. and Huth, A. 2006. A standard protocol for describing individual-based and agent-based models. *Ecological Modelling* **198**, 115-126.
- Gundale, M.J., Kardol, P., Nilsson, M.C., Nilsson, U., Lucas, R.W. and Wardle, D.A. 2014. Interactions with soil biota shift from negative to positive when a tree species is moved outside its native range. *New phytologist* **202**, 415-421.

## References

- Gutschick, V.P. and BassiriRad, H. 2003. Extreme events as shaping physiology, ecology, and evolution of plants: toward a unified definition and evaluation of their consequences. *New Phytologist* **160**, 21-42.
- Hajjar, R. and Kozak, R.A. 2015. Exploring public perceptions of forest adaptation strategies in Western Canada: Implications for policy-makers. *Forest Policy and Economics* **61**, 59-69.
- Hamann, A., Gylander, T. and Chen, P.Y. 2011. Developing seed zones and transfer guidelines with multivariate regression trees. *Tree Genetics & Genomes* **7**, 399-408.
- Hampe, A. and Petit, R.J. 2005. Conserving biodiversity under climate change: the rear edge matters. *Ecology letters* **8**, 461-467.
- Hampe, A., Pemonge, M.H. and Petit, R.J. 2013. Efficient mitigation of founder effects during the establishment of a leading-edge oak population. *Proceedings of the Royal Society of London B: Biological Sciences* **280**, 1-7.
- Hampson, A.M. and Peterken, G.F. 1998. Enhancing the biodiversity of Scotland's forest resource through the development of a network of forest habitats. *Biodiversity & Conservation* **7**, 179-192.
- Hamrick, J.L. and Godt, M.J.W. 1996. Effects of life history traits on genetic diversity in plant species. *Philosophical Transactions of the Royal Society B: Biological Sciences* **351**, 1291-1298.
- Hanewinkel M., Kuhn T., Bugmann H., Lanz A. and Brang P. 2014. Vulnerability of uneven-aged forests to storm damage. *Forestry* **87**, 525-534.
- Hanley, N. and Craig, S. 1991. Wilderness development decisions and the Krutilla-Fisher model: the case of Scotland's 'flow country'. *Ecological Economics* **4**, 145-164.
- Hansard. 1988. House of Commons Debate 15 March 1988 vol. 129 cc. 1006-13 [Electronic version].
- Harrell, F. 2015. *Regression modeling strategies: with applications to linear models, logistic and ordinal regression, and survival analysis. Second Edition.* Springer, New York.
- Harvey, B.D., Leduc, A., Gauthier, S. and Bergeron, Y. 2002. Stand-landscape integration in natural disturbance-based management of the southern boreal forest. *Forest Ecology and Management* **155**, 369-385.
- Havens, K., Vitt, P., Still, S., Kramer, A.T., Fant, J.B. and Schatz, K. 2015. Seed sourcing for restoration in an era of climate change. *Natural Areas Journal* **35**, 122-133.
- Hawkes J.C., Pyatt D.G. and White I.M.S. 1997. Using Ellenberg Indicator Values to Assess Soil Quality in British Forests from Ground Vegetation: A Pilot Study. *Journal of Applied Ecology* **34**, 375-387.

- Hedrick, P.W., Savolainen, O. and Kärkkäinen, K. 1999. Factors influencing the extent of inbreeding depression: an example from Scots pine. *Heredity* **82**, 441-450.
- Hemery, G., Petrokofsky, G., Ambrose-Oji, B., Atkinson, G., Broadmeadow, M., Edwards, D., Harrison, C., Lloyd, S., Mumford, J., O'Brien, L., Reid, C., Seville, M., Townsend, M., Weir, J. and Yeomans, A. 2015. Awareness, action and aspiration among Britain's forestry community relating to environmental change: Report of the British Woodlands Survey 2015. <http://www.sylva.org.uk/forestryhorizons/bws2015> (accessed on 28 March 2016).
- Herbert, R., Samuel, S. and Patterson, G. 1999. *Using Local Stock for Planting Native Trees and Shrubs*. Forestry Commission Practice Note 8. Forestry Commission, Edinburgh.
- Hill, M.O., Preston, C., Bosanquet, S. and Roy, D. 2007. *BRYOATT: attributes of British and Irish mosses, liverworts and hornworts*. Centre for Ecology and Hydrology, Wallingford.
- Hill, M.O., Preston, C.D. and Roy, D. 2004. *PLANTATT-attributes of British and Irish plants: status, size, life history, geography and habitats*. Centre for Ecology & Hydrology, Wallingford.
- Hinks, A.E., Cole, E.F., Daniels, K.J., Wilkin, T.A., Nakagawa, S. and Sheldon, B.C. 2015. Scale-dependent phenological synchrony between songbirds and their caterpillar food source. *The American Naturalist* **186**, 84-97.
- Hoban, S. and Strand, A. 2015. Ex situ seed collections will benefit from considering spatial sampling design and species' reproductive biology. *Biological Conservation* **187**, 182-191.
- Hoegh-Guldberg, O., Hughes, L., McIntyre, S., Lindenmayer, D.B., Parmesan, C., Possingham, H.P. and Thomas, C.D. 2008. Assisted colonization and rapid climate change. *Science* **321**, 345-346
- Hoffman, P.D., Leonard, J.M., Lindberg, G.E., Bollmann, S.R. and Hays, J.B. 2004. Rapid accumulation of mutations during seed-to-seed propagation of mismatch-repair-defective *Arabidopsis*. *Genes & development* **18**, 2676-2685.
- Hoffmann, A.A. and Sgro, C.M. 2011. Climate change and evolutionary adaptation. *Nature* **470**, 479-485.
- Holderegger, R., Kamm, U. and Gugerli, F. 2006. Adaptive vs. neutral genetic diversity: implications for landscape genetics. *Landscape Ecology* **21**, 797-807.

## References

- House, S. and Dingwall, C. 2003. 'A Nation of Planters': Introducing the New Trees, 1650-1900. In: *People and Woods in Scotland, A History*. Smout, T.C., ed. Edinburgh University Press, Edinburgh.
- Howe, G. T., Aitken, S.N., Neale, D.B., Jermstad, K. D., Wheeler, N.C. and Chen, T.T.H. 2003. From genotype to phenotype: unraveling the complexities of cold adaptation in forest trees. *Canadian Journal of Botany* **81**, 1247–1266.
- Howe, G.T., St. Clair, J.B., Beloin, R. 2009. Seedlot selection tool. <http://sst.forestry.oregonstate.edu/index.html>. (accessed on 15 July, 2015).
- Hubert, J. 2005. *Selecting the right provenance of oak for planting in Britain*. Forestry Commission Information Note 76. Forestry Commission, Edinburgh.
- Hubert, J. and Cundall, E. 2006. Choosing provenance in broadleaved trees. Forestry Commission Information Note 82. Forestry Commission, Edinburgh.
- Hubert, J. and Cottrell, J. 2007. *The role of forest genetic resources in helping British forests respond to climate change*. Forestry Commission Information Note 86. Forestry Commission, Edinburgh.
- Hubert, J., Worrell, R., Wilson, S., Clark, J., Taylor, H., Malcolm, D. 2010. Broadleaved tree breeding in Scotland. *Scottish Forestry* **64**, 6-11.
- IPCC. 2013. Climate change 2013: the physical science basis. In: *Contribution of Working Group I to the fifth assessment report of the Intergovernmental Panel on Climate Change*. Stocker, T.F., Qin, D., Plattner, G-K., Tignor, M., Allen, S.K., Boschung, J., Nauels, A., Xia, Y., Bex, V., Midgley, P.M., eds. Cambridge, UK/New York, NY, USA: Cambridge University Press.
- Jones, A.T., Hayes, M.J. and Sackville Hamilton, N.R. 2001. The effect of provenance on the performance of *Crataegus monogyna* in hedges. *Journal of Applied Ecology* **38**, 952-962.
- Jones, T.A. 2013. When local isn't best. *Evolutionary applications* **6**, 1109-1118.
- Jactel, H., Petit, J., Desprez-Loustau, M.L., Delzon, S., Piou, D., Battisti, A. and Koricheva, J. 2012. Drought effects on damage by forest insects and pathogens: a meta-analysis. *Global Change Biology* **18**, 267-276
- Jarvis, S., Woodward, S., Alexander, I.J. and Taylor, A.F.S. 2013. Regional scale gradients of climate and nitrogen deposition drive variation in ectomycorrhizal fungal communities associated with native Scots pine. *Global Change Biology* **19**, 1688-1696.
- Jenkins, G.J., Perry, M.C. and Prior, M.J. 2008. *The climate of the United Kingdom and recent trends*. Met Office Hadley Centre, Exeter, UK.



- Jenkins, G.J., Murphy, J.M., Sexton, D.M.H., Lowe, J.A., Jones, P. and Kilsby, C.G. 2010. *UK Climate Projections: Briefing report. Version 2*. Met Office Hadley Centre, Exeter, UK.
- Johnson, G.R., Sorensen, F.C., St Clair, J.B. and Cronn, R.C. 2004. Pacific Northwest Forest Tree Seed Zones A template for native plants? *Native Plants Journal* **5**, 131-140.
- Jones, T.A. 2013. When local isn't best. *Evolutionary applications* **6**, 1109-1118.
- Jonsson, A., Ekberg, I. and Eriksson, G. 1976. Flowering in a seed orchard of *Pinus sylvestris* L. *Studia Forestalia Suecia* **135**, 1-38.
- Jørgensen, M. H., Elameen, A., Hofman, N., Klemsdal, S., Malaval, S. and Fjellheim, S. 2016. What's the meaning of local? Using molecular markers to define seed transfer zones for ecological restoration in Norway. *Evolutionary Applications* **9**, 673–684.
- Jump, A.S. and Penuelas, J. 2005. Running to stand still: adaptation and the response of plants to rapid climate change. *Ecology Letters* **8**, 1010-1020.
- Jump, A.S., Hunt, J.M. and Peñuelas, J. 2006. Rapid climate change-related growth decline at the southern range edge of *Fagus sylvatica*. *Global Change Biology* **12**, 2163-2174.
- Jung, T., Orlikowski, L., Henricot, B., Abad-Campos, P., Aday, A.G., Aguín Casal, O., Bakonyi, J., Cacciola, S.O., Cech, T., Chavarriaga, D., Corcobado, T., Cravador, A., Decourcelle, T., Denton, G., Diamandis, S., Doğmuş-Lehtijärvi, H.T., Franceschini, A., Ginetti, B., Green, S., Glavendekić, M., Hantula, J., Hartmann, G., Herrero, M., Ivic, D., Horta Jung, M., Lilja, A., Keca, N., Kramarets, V., Lyubenova, A., Machado, H., Magnano di San Lio, G., Mansilla Vázquez, P.J., Marçais, B., Matsiakh, I., Milenkovic, I., Moricca, S., Nagy, Z.Á., Nechwatal, J., Olsson, C., Oszako, T., Pane, A., Paplomatas, E.J., Pintos Varela, C., Prospero, S., Rial Martínez, C., Rigling, D., Robin, C., Rytönen, A., Sánchez, M.E., Sanz Ros, A.V., Scanu, B., Schlenzig, A., Schumacher, J., Slavov, S., Solla, A., Sousa, E., Stenlid, J., Talgø, V., Tomic, Z., Tsopelas, P., Vannini, A., Vettraino, A.M., Wenneker, M., Woodward, S. and Pérez-Sierra, A. 2015. Widespread Phytophthora infestations in European nurseries put forest, semi-natural and horticultural ecosystems at high risk of Phytophthora diseases. *Forest Pathology* **46**, 134-163.
- Kawecki, T.J. and Ebert, D. 2004. Conceptual issues in local adaptation. *Ecology Letters* **7**, 1225-1241.
- Kellomäki, S., Rouvinen, I., Peltola, H., Strandman, H. and Steinbrecher, R. 2001. Impact of global warming on the tree species composition of boreal forests in Finland and effects on emissions of isoprenoids. *Global Change Biology* **7**, 531-544.

## References

- Kelly, E. and Phillips, B.L. 2015. Targeted gene flow for conservation. *Conservation Biology* **30**, 259-267.
- Kinloch, B.B., Westfall, R.D. and Forrest, G.I. 1986. Caledonian Scots pine: origins and genetic structure. *New Phytologist* **104**, 703-729.
- Koenig, W.D. and Knops, J.M. 2000. Patterns of annual seed production by northern hemisphere trees: a global perspective. *American Naturalist* **155**, 59-69.
- Koenig, W.D., Knops, J.M., Carmen, W.J. and Pearse, I.S. 2015. What drives masting? The phenological synchrony hypothesis. *Ecology* **96**, 184-192.
- Koski, V and Sievänen, R. 1985. *Timing of growth cessation in relation to the variations in the growing season*. In: Crop physiology of forest trees--Tigerstedt P, Puttonen MA, Koski V, eds. Helsinki University Press, Helsinki.
- Kramer, K., Degen, B., Buschbom, J., Hickler, T., Thuiller, W., Sykes, M.T. and de Winter, W. 2010. Modelling exploration of the future of European beech (*Fagus sylvatica* L.) under climate change—Range, abundance, genetic diversity and adaptive response. *Forest Ecology and Management*. **259**, 2213-2222.
- Kranabetter, J.M., Stoehr, M. and O'Neill, G.A. 2015. Ectomycorrhizal fungal maladaptation and growth reductions associated with assisted migration of Douglas-fir. *New Phytologist* **206**, 1135-1144.
- Kremer, A., Ronce, O., Robledo-Arnuncio, J. J., Guillaume, F., Bohrer, G., Nathan, R., Bridle, J. R., Gomulkiewicz, R., Klein, E. K., Ritland, K., Kuparinen, A., Gerber, S. and Schueler, S. 2012. Long-distance gene flow and adaptation of forest trees to rapid climate change. *Ecology Letters* **15**, 378–392.
- Kreyling, J., Bittner, T., Jaeschke, A., Jentsch, A., Jonas Steinbauer, M., Thiel, D. and Beierkuhnlein, C. 2011. Assisted colonization: a question of focal units and recipient localities. *Restoration Ecology* **19**, 433-440.
- Kuparinen, A., Savolainen, O. and Schurr, F.M. 2010. Increased mortality can promote evolutionary adaptation of forest trees to climate change. *Forest Ecology and Management* **259**, 1003-1008.
- Lachapelle, J., Bell, G. and Colegrave, N. 2015. Experimental adaptation to marine conditions by a freshwater alga. *Evolution* **69**, 2662-2675.
- Lacy, R.C. 2000. Considering threats to the viability of small populations using individual-based models. *Ecological Bulletins* **48**, 39-51.
- Lande, R. 1993. Risks of population extinction from demographic and environmental stochasticity and random catastrophes. *American Naturalist* **142**, 911-927.

- Le Corre, V. and Kremer, A. 2012. The genetic differentiation at quantitative trait loci under local adaptation. *Molecular Ecology* **21**, 1548-1566.
- Ledig, T. 1998. Genetic variation in Pines. In: *Ecology and Biogeography of Pinus*. Richardson, D.M., ed. Cambridge University Press, Cambridge.
- Ledig, F.T. and Kitzmiller, J.H. 1992. Genetic strategies for reforestation in the face of global climate change. *Forest Ecology and Management* **50**, 153-169.
- Lee, S. 2002. Selection of parents for the Scots pine breeding population in Britain. *Forestry* **75**, 293-303.
- Lee, S. 2003. *Breeding Hybrid Larch in Britain*. Forestry Commission Information Note 52. Forestry Commission, Edinburgh.
- Lee, S. and Connolly, T. 2004. Selection of parents for the Corsican pine breeding population in Britain. *Forestry* **77**, 205-212.
- Lee S.J. and Connolly T. 2010. Finalizing the selection of parents for the Sitka spruce (*Picea sitchensis* (Bong.) Carr) breeding population in Britain using Mixed Model Analysis. *Forestry* **83**, 423-431.
- Lee, S.J., Connolly, T., Wilson, S.M., Malcolm, D.C., Fonweban, J., Worrell, R., Hubert, J. and Sykes, R.J. 2015. Early height growth of silver birch (*Betula pendula* Roth) provenances and implications for choice of planting stock in Britain. *Forestry* **88**, 484-499.
- Lefèvre, F., Koskela, J., Hubert, J., Kraigher, H., Longauer, R., Olrik, D.C., Schüller, S., Bozzano, M., Alizoti, P., Bakys, R. and Baldwin, C. 2013. Dynamic conservation of forest genetic resources in 33 European countries. *Conservation biology* **27**, 373-384.
- Lefèvre, F., Boivin, T., Bontemps, A., Courbet, F., Davi, H., Durand-Gillmann, M., Fady, B., Gauzere, J., Gidoïn, C., Karam, M.-J., Lalagüe, H., Oddou-Muratorio, S. and Pichot, C. 2014. Considering evolutionary processes in adaptive forestry. *Annals of Forest Science* **71**, 723-739.
- Leimu, R. and Fischer, M. 2008. A meta-analysis of local adaptation in plants. *PLoS One* **3**, e4010
- Lenz, A., Hoch, G., Körner, C. and Vitasse, Y. 2016. Convergence of leaf-out towards minimum risk of freezing damage in temperate trees. *Functional Ecology* **30**, 1480-1490.
- Levin, S.A. 1992. The problem of patterns and scale in ecology. *Ecology* **73**, 1943-1967.
- Levins, R. 1969. Thermal acclimation and heat resistance in *Drosophila* species. *American Naturalist* **103**, 483-499.

## References

- Liebhold, A. M., Brockerhoff, E. G., Garrett, L. J., Parke, J. L and Britton, K. O. 2012. Live plant imports: the major pathway for forest insect and pathogen invasions of the US. *Frontiers in Ecology and the Environment* **10**, 135-143.
- Lindgren, K. and Lindgren, D. 1996. Germinability of Norway spruce and Scots pine pollen exposed to open air. *Silva Fennica* **30**, 3-9.
- Lindgren, D., Paule, L., Xihuan, S., Yazdani, R., Segerström, U., Wallin, J.E. and Lejdebros, M.L. 1995. Can viable pollen carry Scots pine genes over long distances? *Grana* **34**, 64-69.
- Lindner, M., Maroschek, M., Netherer, S., Kremer, A., Barbati, A., Garcia-Gonzalo, J., Seidl, R., Delzon, S., Corona, P., Kolström, M. and Lexer, M.J. 2010. Climate change impacts, adaptive capacity, and vulnerability of European forest ecosystems. *Forest Ecology and Management* **259**, 698-709.
- Linhart, Y.B. and Grant, M.C. 1996. Evolutionary significance of local genetic differentiation in plants. *Annual Review of Ecology and Systematics* **27**, 237-277.
- Lonsdale, D. and Gibbs, J. 2002. Effects of climate change on fungal diseases of trees. In: *Climate Change: Impacts on UK Forests*, Broadmeadow, M., ed. Forestry Commission, Edinburgh.
- Luomajoki, A. 1993. Climatic adaptation of Scots pine (*Pinus sylvestris* L.) in Finland based on male flowering phenology. *Acta Forestalia Fennica* **237**, 1-27.
- Lynch, M. and Lande, R. 1993. Evolution and extinction in response to environmental change. In: *Biotic interactions and global change*. Kareiva, P., Kingsolver, J., Huey, R., eds. Sinauer, Sunderland, MA.
- Macaskill, M. 2016. Can't see the wood for the burnt trees.  
<http://www.thesundaytimes.co.uk/sto/news/article1680501.ece> (accessed on 28 March 2016).
- MacLeod, C.J. and Moller, H. 2006. Intensification and diversification of New Zealand agriculture since 1960: An evaluation of current indicators of land use change. *Agriculture, Ecosystems & Environment*. **115**, 201-218.
- Mackinnon, J. 2016. Analysis of Current Arrangements for the Consideration and Approval of Forestry Planting Proposals. <http://www.gov.scot/Resource/0051/00511591.pdf> (accessed on 17 December 2016).
- Manel, S., Schwartz, M.K., Luikart, G. and Taberlet, P. 2003. Landscape genetics: combining landscape ecology and population genetics. *Trends in ecology & evolution* **18**,189-197.

- Mason, B., Easton, E. and Ennos, R. 2002. Variation in Aspen in Scotland: genetics and silviculture. *The biodiversity and management of aspen woodlands*, pp.45-55.
- Mason W.L. 2002. Are irregular stands more windfirm? *Forestry* **75**, 347-355.
- Mason, W.L., Hampson, A. and Edwards, C. 2004. *Managing the pinewoods of Scotland*. Forestry Commission, Edinburgh.
- Mather, A.S. and Murray, N.C. 1987. Employment and private-sector afforestation in Scotland. *Journal of Rural Studies* **3**, 207-218.
- McDowell, N., Pockman, W.T., Allen, C.D., Breshears, D.D., Cobb, N., Kolb, T., Plaut, J., Sperry, J., West, A., Williams, D.G. and Yezpez, E.A. 2008. Mechanisms of plant survival and mortality during drought: why do some plants survive while others succumb to drought? *New phytologist* **178**, 719-739.
- McKenney, D.W., Mackey B.G. and Joyce D. 1999. Seedwhere: a computer tool to support seed transfer and ecological restoration decisions. *Environmental Modelling and Software* **14**, 589-595.
- McKay, J.K. and Latta, R.G. 2002. Adaptive population divergence: markers, QTL and traits. *Trends in Ecology & Evolution* **17**, 285-291.
- McKay, J.K., Christian, C.E., Harrison, S. and Rice, K.J. 2005. "How local is local?" - a review of practical and conceptual issues in the genetics of restoration. *Restoration Ecology* **13**, 432-440.
- McIntosh, B. 2006. Native pinewoods in Scotland: perspectives on policy and management. *Forestry* **79**, 303-307.
- McLachlan, J.S., Hellmann, J.J. and Schwartz, M.W. 2007. A framework for debate of assisted migration in an era of climate change. *Conservation Biology* **21**, 297-302.
- McLane, S.C. and Aitken, S.N. 2012. Whitebark pine (*Pinus albicaulis*) assisted migration potential: testing establishment north of the species range. *Ecological Applications* **22**, 142-153.
- McVean, D. N. and Ratcliffe, D. A. 1962. Plant communities of the Scottish Highlands. A study of Scottish mountain, moorland and forest vegetation. Monographs of the Nature Conservancy, No. 1.
- Midmore, E.K., McCartan, S.A., Jinks, R.L. and Cahalan, C.M. 2015. Using thermal time models to predict germination of five provenances of silver birch (*Betula pendula* Roth) in southern England. *Silva Fennica* **49**, 1266.
- Monserud, R.A. and Rehfeldt, G.E. 1990. Genetic and environmental components of variation of site index in inland Douglas-fir. *Forest Science* **36**, 1-9.

## References

- Montalvo, A.M., Williams, S.L., Rice, K.J., Buchmann, S.L., Cory, C., Handel, S.N., Nabhan, G.P., Primack, R. and Robichaux, R.H. 1997. Restoration biology: a population biology perspective. *Restoration Ecology* **5**, 277-290.
- Murphy, J.M., Sexton, D.M.H., Jenkins, G.J., Boorman, P.M., Booth, B.B.B., Brown, C.C., Clark, R.T., Collins, M., Harris, G.R., Kendon, E.J., Betts, R.A., Brown, S.J., Howard, T. P., Humphrey, K. A., McCarthy, M. P., McDonald, R. E., Stephens, A., Wallace, C., Warren, R., Wilby, R., Wood, R. A. 2009. *UK Climate Projections Science Report: Climate change projections*. Met Office Hadley Centre, Exeter.
- Murray, M.B., Cannell, M.G.R. and Smith, R.I. 1989. Date of budburst of fifteen tree species in Britain following climatic warming. *Journal of Applied Ecology* **26**, 693-700.
- Nabel, J.E., Zurbriggen, N. and Lischke, H. 2013. Interannual climate variability and population density thresholds can have a substantial impact on simulated tree species' migration. *Ecological Modelling* **257**, 88-100.
- Nagamitsu, T., Shimada, K.-i. and Kanazashi, A. 2014. A reciprocal transplant trial suggests a disadvantage of northward seed transfer in survival and growth of Japanese red pine (*Pinus densiflora*) trees. *Tree Genetics and Genomes* **11**, 1-10.
- Natural England and RSPB. 2014. *Climate Change Adaptation Manual*. Natural England, York.
- Ní Dhubháin, Á., Fléchar, M.-C., Moloney, R. and O'Connor, D. 2009. Stakeholders' perceptions of forestry in rural areas—Two case studies in Ireland. *Land Use Policy* **26**, 695-703.
- Nicotra, A.B., Atkin, O.K., Bonser, S.P., Davidson, A.M., Finnegan, E.J., Mathesius, U., Poot, P., Purugganan, M.D., Richards, C.L., Valladares, F. and van Kleunen, M. 2010. Plant phenotypic plasticity in a changing climate. *Trends in Plant Science* **15**, 684–692.
- Nijnik, M., Nijnik, A. and Brown, I. 2016. Exploring the linkages between multifunctional forestry goals and the legacy of spruce plantations in Scotland. *Canadian Journal of Forest Research* **46**,1-8.
- Nijnik, M., Pajot, G., Moffat, A.J. and Slee, B. 2013. An economic analysis of the establishment of forest plantations in the United Kingdom to mitigate climatic change. *Forest Policy and Economics* **26**, 34-42.
- Nisbet, T.R. and Thomas, H. 2006. The role of woodland in flood control: a landscape perspective. In: *Proceedings of the 14th annual IALE(UK) 2006 conference on Water and the Landscape*, Davies, B. and Thompson, S. eds. IALE (UK), Oxford.

- Northern Ireland Land Matters Taskforce. 2015. Towards a land strategy for Northern Ireland. [http://www.nienvironmentlink.org/cmsfiles/Towards-a-Land-Strategy-for-NI\\_2015-Main-Report.pdf](http://www.nienvironmentlink.org/cmsfiles/Towards-a-Land-Strategy-for-NI_2015-Main-Report.pdf) (accessed 4 September 2016).
- O'Neill, G.A., Stoehr, M. and Jaquish, B. 2014. Quantifying safe seed transfer distance and impacts of tree breeding on adaptation. *Forest Ecology and Management* **328**, 122-130.
- Oddou-Muratorio, S. and Davi, H. 2014. Simulating local adaptation to climate of forest trees with a Physio-Demo-Genetics model. *Evolutionary applications* **7**, 453-467.
- Oksanen, J., Guillaume Blanchet, F., Friendly, M., Kindt, R., Legendre, P., McGlinn, D., Minchin, P.R., O'Hara, R.B., Simpson, G.L., Solymos, P., Stevens, M.H.H., Szoecs, E., Wagner, H. 2016. Vegan: Community Ecology Package. R package version 2.3-3. <https://CRAN.R-project.org/package=vegan>
- Orr, H.A. 2009. Fitness and its role in evolutionary genetics. *Nature Reviews Genetics* **10**, 531-539
- Ossowski, S., Schneeberger, K., Lucas-Lledó, J.I., Warthmann, N., Clark, R.M., Shaw, R.G., Weigel, D. and Lynch, M. 2010. The rate and molecular spectrum of spontaneous mutations in *Arabidopsis thaliana*. *Science* **327**, 92-94.
- Oubida, R.W., Gantulga, D., Zhang, M., Zhou, L., Bawa, R. and Holliday, J.A. 2015. Partitioning of multivariate phenotypes using regression trees reveals complex patterns of adaptation to climate across the range of black cottonwood (*Populus trichocarpa*). *Frontiers in plant science* **6** DOI:10.3389/fpls.2015.00181
- Parantainen, A. and Pulkkinen, P. 2002. Pollen viability of Scots pine (*Pinus sylvestris*) in different temperature conditions: high levels of variation among and within latitudes. *Forest Ecology and Management* **167**, 149-160.
- Parantainen, A. and Pulkkinen, P. 2003. Flowering and airborne pollen occurrence in a *Pinus sylvestris* seed orchard consisting of northern clones. *Scandinavian journal of forest research* **18**, 111-117.
- Parker, D.E., Legg, T.P. and Folland, C.K. 1992. A new daily central England temperature series, 1772-1991. *International Journal of Climatology* **12**, 317-342.
- Parnesan, C. 2006. Ecological and evolutionary responses to recent climate change. *Annual Review of Ecology, Evolution and Systematics* **37**, 637-669.
- Parnesan, C. and Yohe, G. 2003. A globally coherent fingerprint of climate change impacts across natural systems. *Nature* **421**, 37-42.
- Pease, C.M., Lande, R. and Bull, J.J. 1989. A model of population growth, dispersal and evolution in a changing environment. *Ecology* **70**, 1657-1664.

## References

- Pedlar, J.H., McKenney, D.W., Aubin, I., Beardmore, T., Beaulieu, J., Iverson, L., O'Neill, G.A., Winder R.S. and Ste-Marie, C. 2012. Placing forestry in the assisted migration debate. *BioScience* **62**, 835-842.
- Peel, M.C., Finlayson, B.L. and McMahon, T.A. 2007. Updated world map of the Köppen-Geiger climate classification. *Hydrology and earth system sciences discussions* **4**, 439-473.
- Pelham, J., Gardiner, A.S., Smith, R.I. and Last, F.T. 1988. Variation in *Betula pubescens* Ehrh. (Betulaceae) in Scotland: its nature and association with environmental factors. *Botanical Journal of the Linnean Society*. **96**, 217-234.
- Pérez, I.M., Martínez, S.G., Miranda, R.A. and Sánchez, L.G. 2002. Growth phenology and mating system of maritime pine (*Pinus pinaster* Aiton) in central Spain. *Forest Systems* **11**, 193-204.
- Perks, M.P. and Ennos, R.A. 1999. Analysis of genetic variation for quantitative characters between and within four native populations of Scots pine (*Pinus sylvestris*). *Botanical Journal of Scotland*, **51**, 103-110.
- Perks, M.P. and McKay, H.M. 1997. Morphological and physiological differences in Scots pine seedlings of six seed origins. *Forestry* **70**, 223-232.
- Perry, A., Wachowiak, W., Brown, A.V., Ennos, R.A., Cottrell, J.E. and Cavers, S. 2016 a. Substantial heritable variation for susceptibility to *Dothistroma septosporum* within populations of native British Scots pine (*Pinus sylvestris*). *Plant Pathology* **65**, 987-996.
- Perry, A., Brown, A., Cavers, S., Cottrell, J.E. and Ennos, R.A. 2016 b. Has Scots pine (*Pinus sylvestris*) co-evolved with *Dothistroma septosporum* in Scotland? Evidence for spatial heterogeneity in the susceptibility of native provenances. *Evolutionary Applications* **9**, 982-993.
- Perry, M. and Hollis, D. 2005. The generation of monthly gridded datasets for a range of climatic variables over the UK. *International Journal of Climatology* **25**, 1041-1054.
- Persson, B. and Ståhl, E.G. 1990. Survival and yield of *Pinus sylvestris* L. as related to provenance transfer and spacing at high altitudes in northern Sweden. *Scandinavian Journal of Forest Research* **5**, 381-395.
- Peterken, G.F. 1993. *Woodland Conservation and Management (2nd edition)*. Chapman and Hall, London
- Peterken, G.F. and Mountford, E.P. 1996. Effects of drought on beech in Lady Park Wood, an unmanaged mixed deciduous woodland. *Forestry* **69**, 125-136.



- Petit, R.J. and Hampe, A. 2006. Some Evolutionary Consequences of Being a Tree. *Annual Review of Ecology, Evolution and Systematics* **37**, 187-214.
- Pickles, B.J., Twieg, B.D., O'Neill, G.A., Mohn, W.W. and Simard, S.W. 2015. Local adaptation in migrated interior Douglas-fir seedlings is mediated by ectomycorrhizas and other soil factors. *New Phytologist* **207**, 858-871.
- Pliura, A., Lygis, V., Suchockas, V. and Bartkevicius, E. 2011. Performance of twenty four European *Fraxinus excelsior* populations in three Lithuanian progeny trials with a special emphasis on resistance to *Chalara fraxinea*. *Baltic Forestry* **17**, 17-34.
- Podani, J. 2006. Braun-Blanquet's legacy and data analysis in vegetation science. *Journal of Vegetation Science* **17**, 113-117.
- Potter, C. 1996. *Decoupling by Degrees? Agricultural Liberalisation and its Implications for Nature Conservation in Britain*. English Nature Research Reports No. 196. English Nature, Peterborough.
- Potter, C. and Goodwin, P. 1998. Agricultural liberalization in the European union: an analysis of the implications for nature conservation. *Journal of Rural Studies* **14**, 287-298.
- Prober, S.M., Byrne, M., McLean, E.H., Steane, D.A., Potts, B.M., Vaillancourt, R.E. and Stock, W.D. 2015. Climate-adjusted provenancing: a strategy for climate-resilient ecological restoration. *Front. Ecol. Evol.* **3**, 65.
- Provan, J., Soranzo, N., Wilson, N.J., McNicol, J.W., Forrest, G.I., Cottrell, J. and Powell, W. 1998. Gene-pool variation in Caledonian and European Scots pine (*Pinus sylvestris* L.) revealed by chloroplast simple-sequence repeats. *Proceedings of the Royal Society of London B: Biological Sciences* **265**, 1697-1705.
- Pulkkinen, P. and Rantio-Lehtimäki, A. 1995. Viability and seasonal distribution patterns of Scots pine pollen in Finland. *Tree Physiology* **15**, 515-518.
- Pyatt, D.G., Ray, D. and Fletcher, J. 2001. *An ecological site classification for forestry in Great Britain*. Forestry Commission, Edinburgh.
- Quine, C. and Gardiner, B. 2002. Climate change impacts: storms. In: *Climate Change: Impacts on UK Forests*, Broadmeadow, M., ed. Forestry Commission, Edinburgh.
- Quine, C.P., Bailey, S.A. and Watts, K. 2013. Sustainable forest management in a time of ecosystem services frameworks: common ground and consequences. *Journal of Applied Ecology* **50**, 863-867.
- R Core Team. 2015. R: A language and environment for statistical computing. R Foundation for Statistical Computing, Vienna, Austria. URL <https://www.R-project.org/>.

## References

- Ramírez-Valiente, J.A. and Robledo-Arnuncio, J.J. 2015. Exotic gene flow affects fitness trait values but not levels of heritable trait variation in the southernmost population of Scots pine (*Pinus sylvestris* L. var. *nevadensis*). *Biological Conservation* **192**, 331-342.
- Ramstad, K.M., Woody, C.A., Sage, G.K. and Allendorf, F.W. 2004. Founding events influence genetic population structure of sockeye salmon (*Oncorhynchus nerka*) in Lake Clark, Alaska. *Molecular Ecology* **13**, 277-290.
- Ray, D. and Nicoll, B.C. 1998. The effect of soil water-table depth on root-plate development and stability of Sitka spruce. *Forestry* **71**, 169-182
- Ray, D., Morison, J. and Broadmeadow, M. 2010. *Climate change: impacts and adaption in England's woodlands*. Forestry Commission, Edinburgh.
- Read, D.J., Freer-Smith, P.H., Morison, J.I.L., Hanley, N., West, C.C. and Snowdon, P. (eds). 2009. *Combating climate change – a role for UK forests. An assessment of the potential of the UK's trees and woodlands to mitigate and adapt to climate change*. The Stationery Office, Edinburgh.
- Redfern D.B. and Stenlid J. 1998. Spore dispersal and infection. In: *Heterobasidion annosum. Biology, Ecology, Impact and Control*. Woodward, S., Stenlid, J., Karjalainen, R., Hüttermann, A., eds., CABI Int., Oxon, UK.
- Rehfeldt, G.E. 1983. Adaptation of *Pinus contorta* populations to heterogeneous environments in northern Idaho. *Canadian Journal of Forest Research* **13**, 405-411.
- Rehfeldt, G.E. 1989. Ecological adaptations in Douglas-fir (*Pseudotsuga menziesii* var. *glauca*): a synthesis. *Forest Ecology and Management* **28**, 203-215.
- Rehfeldt, G.E. 1994. Evolutionary genetics, the biological species, and the ecology of the interior cedar-hemlock forests. Proceedings of the Conference: Interior Cedar-Hemlock-White Pine Forests: Ecology and Management, Spokane, WA, March 2–4, Department of Natural Resource Sciences, Washington State University, Pullman, WA.
- Rehfeldt, G.E., Tchebakova, N.M., Parfenova, Y.I., Wykoff, W.R., Kuzmina, N.A. and Milyutin, L.I. 2002. Intraspecific responses to climate in *Pinus sylvestris*. *Global Change Biology* **8**, 912-929.
- Rehfeldt, G.E., Wykoff, W.R. and Ying, C.C. 2001. Physiologic plasticity, evolution, and impacts of a changing climate on *Pinus contorta*. *Climatic Change*, **50**, 355-376.
- Rehfeldt, G.E., Ying, C.C., Spittlehouse, D.L. and Hamilton, D.A. 1999. Genetic responses to climate in *Pinus contorta*: niche breadth, climate change, and reforestation. *Ecological Monographs* **69**, 375-407.

- Reich, P.B. and Oleksyn, J. 2008. Climate warming will reduce growth and survival of Scots pine except in the far north. *Ecology letters* **11**, 588-597.
- Richter, S., Kipfer, T., Wohlgemuth, T., Guerrero, C.C., Ghazoul, J. and Moser, B. 2012. Phenotypic plasticity facilitates resistance to climate change in a highly variable environment. *Oecologia* **169**, 269-279.
- Rikala, R. 2000. Production and quality requirements of forest tree seedlings in Finland. *Tree Planters' Notes* **49**, 56-60.
- Ripley, B. 2016. tree: Classification and Regression Trees. R package version 1.0-37. <https://CRAN.R-project.org/package=tree>
- Roberts, A.J., Russell, C., Walker, G.J. and Kirby, K.J. 1992. Regional variation in the origin, extent and composition of Scottish woodland. *Botanical Journal of Scotland* **46**, 167-189.
- Roberts, D.W. 2016. labdsv: Ordination and Multivariate Analysis for Ecology. R package version 1.8-0. <https://CRAN.R-project.org/package=labdsv>
- Robledo-Arnuncio, J.J. 2011. Wind pollination over mesoscale distances: an investigation with Scots pine. *New Phytologist* **190**, 222-233.
- Robledo-Arnuncio, J.J. and Gil, L. 2005. Patterns of pollen dispersal in a small population of *Pinus sylvestris* L. revealed by total-exclusion paternity analysis. *Heredity* **94**, 13-22.
- Rodwell, J.S. 1991. British Plant Communities: Volume 1, Woodlands and scrub. Cambridge University Press, Cambridge.
- Russell, K. and Evans, K. 2003. Nursery Survey Report: to identify the problems experienced by the nursery industry in sourcing and providing local stock of native trees and shrubs. In Horticulture Research International and Forest Research
- Sáenz-Romero, C., Lamy, J.B., Ducousso, A., Musch, B., Ehrenmann, F., Delzon, S., Cavers, S., Chałupka, W., Dağdaş, S., Hansen, J.K., Lee, S.J., Liesebach, M., Rau, H.-M., Psomas, A., Schneck, V., Steiner, W., Zimmermann, N.E. and Kremer, A. 2016. Adaptive and plastic responses of *Quercus petraea* populations to climate across Europe. *Global Change Biology*. DOI: 10.1111/gcb.13576.
- Salmela, M.J. 2011. PhD Thesis: *Adaptive genetic variation in Scots pine (Pinus sylvestris L.) in Scotland*. University of Edinburgh, UK.
- Salmela, M.J., Cavers, S., Wachowiak, W., Cottrell, J.E., Iason, G.R. and Ennos, R.A. 2010. Understanding the evolution of native pinewoods in Scotland will benefit their future management and conservation. *Forestry* **83**, 535-545.
- Salmela, M. J., Cavers, S., Cottrell, J. E., Iason, G. R. and Ennos, R. A. 2011. Seasonal patterns of photochemical capacity and spring phenology reveal genetic

## References

- differentiation among native Scots pine (*Pinus sylvestris* L.) populations in Scotland. *Forest Ecology and Management* **262**, 1020-1029.
- Salmela, M.J., Cavers, S., Cottrell, J.E., Iason, G.R., and Ennos, R.A. 2013. Spring phenology shows genetic variation among and within populations in seedlings of Scots pine (*Pinus sylvestris* L.) in the Scottish Highlands. *Plant Ecology and Diversity* **6**, 523-536.
- Samuel C. 1996. *The influence of seed origin on the growth of grand fir in Britain*. Research Information Note 280. Forestry Commission, Edinburgh
- Samuel C., Fletcher A.M. and Lines R. 2007. Choice of Sitka spruce seed origins for use in British forests. *Forestry Commission Bulletin No. 127*. Forestry Commission, Edinburgh
- Sansilvestri, R., Frascaria-Lacoste, N. and Fernández-Manjarrés, J.F. 2015. Reconstructing a deconstructed concept: Policy tools for implementing assisted migration for species and ecosystem management. *Environmental Science and Policy* **51**, 192-201.
- Sarvas, R. 1962. Investigations on the flowering and seed crop of *Pinus sylvestris*. *Communicationes Instituti Forestales Fenniae* **53**, 1–198
- Savolainen, O., Bokma, F., García-Gil, R., Komulainen, P. and Repo, T. 2004. Genetic variation in cessation of growth and frost hardiness and consequences for adaptation of *Pinus sylvestris* to climatic changes. *Forest Ecology and Management* **197**, 79-89.
- Savolainen, O., Pyhäjärvi, T. and Knürr, T. 2007. Gene flow and local adaptation in trees. *Annal Review of Ecology, Evolution and Systematics* **38**, 595-619.
- Savolainen, O., Lascoux, M. and Merilä, J. 2013. Ecological genomics of local adaptation. *Nature Reviews Genetics* **14**, 807-820.
- Saxe H., Cannell, M.G., Johnsen, Ø., Ryan, M.G. and Vourlitis, G. 2001. Tree and forest functioning in response to global warming. *New phytologist* **149**, 369-399.
- Schiffers, K., Bourne, E.C., Lavergne, S., Thuiller, W. and Travis, J.M. 2013. Limited evolutionary rescue of locally adapted populations facing climate change. *Philosophical transactions of the Royal Society of London B: Biological sciences* **368**, p.20120083
- Schoeneweiss, D.F. 1975. Predisposition, stress, and plant disease. *Annual review of phytopathology*, **13**,193-211.
- Schultz, S.T., Lynch, M. and Willis, J.H. 1999. Spontaneous deleterious mutation in *Arabidopsis thaliana*. *Proceedings of the National Academy of Sciences* **96**, 11393-11398.

- Scottish Executive. 2006. *The Scottish Forestry Strategy*. Forestry Commission Scotland, Edinburgh.
- Serbruyns, I. and Luysaert, S. 2006. Acceptance of sticks, carrots and sermons as policy instruments for directing private forest management. *Forest Policy and Economics*. **9**, 285-296.
- Sgrò, C.M., Lowe, A.J. and Hoffmann, A.A. 2011. Building evolutionary resilience for conserving biodiversity under climate change. *Evolutionary Applications* **4**, 326-337.
- Shelbourne, C.J.A. 1974. *The genetic improvement of Lodgepole pine (Pinus contorta Dougl.) in Great Britain. Internal Genetics Branch Document*. Forestry Commission, Edinburgh.
- Shaffer, M.L. 1981. Minimum population sizes for species conservation. *BioScience* **31**, 131-134.
- Silvertown, J.W. 1980. The evolutionary ecology of mast seeding in trees. *Biological Journal of the Linnean Society* **14**, 235-250.
- Sinclair, F.H., Stone, G.N., Nicholls, J.A., Cavers, S., Gibbs, M., Butterill, P., Wagner, S., Ducouso, A., Gerber, S., Petit, R.J. and Kremer, A. 2015. Impacts of local adaptation of forest trees on associations with herbivorous insects: implications for adaptive forest management. *Evolutionary applications* **8**, 972-987.
- Slee, R.W. 2005. From countrysides of production to countrysides of consumption? *The Journal of Agricultural Science* **143**, 255-265.
- Smith, D.S., Schweitzer, J.A., Turk, P., Bailey, J.K., Hart, S.C., Shuster, S.M. and Whitham, T.G. 2012. Soil-mediated local adaptation alters seedling survival and performance. *Plant and Soil* **352**, 243-251.
- Smout, T.C., MacDonald, A.R. and Watson, F. 2005. *A history of the native woodlands of Scotland, 1500-1920*. Edinburgh University Press, Edinburgh.
- Soularue, J.P. and Kremer, A. 2012. Assortative mating and gene flow generate clinal phenological variation in trees. *BMC evolutionary biology* **12**, 1-14
- Soularue, J.P. and Kremer, A. 2014. Evolutionary responses of tree phenology to the combined effects of assortative mating, gene flow and divergent selection. *Heredity* **113**, 485-494.
- St Clair, J.B. and Howe, G.T. 2007. Genetic maladaptation of coastal Douglas-fir seedlings to future climates. *Global Change Biology* **13**, 1441-1454.
- St Clair, J.B., Mandel, N.L. and Vance-Borland, K.W. 2005. Genecology of Douglas fir in western Oregon and Washington. *Annals of Botany* **96**, 1199-1214.

## References

- Stenseth, N.C., Mysterud, A., Ottersen, G., Hurrell, J.W., Chan, K.-S. and Lima, M. 2002. Ecological effects of climate fluctuations. *Science* **297**, 1292-1296.
- Steven, H. and Carlisle, A. 1959. *The Native Pinewoods of Scotland*. Oliver and Boyd, Edinburgh.
- Sturrock, R.N., Frankel, S.J., Brown, A.V., Hennon, P.E., Kliejunas, J.T., Lewis, K.J., Worrall, J.J. and Woods, A.J. 2011. Climate change and forest diseases. *Plant Pathology* **60**, 133-149.
- Subak, S., Palutikof, J.P., Agnew, M.D., Watson, S.J., Bentham, C.G., Cannell, M.G.R., Hulme, M., McNally, S., Thornes, J.E., Waughray, D. and Woods, J.C. 2000. The impact of the anomalous weather of 1995 on the UK economy. *Climatic Change* **44**, 1-26.
- Tansley, A.G. 1911. *Types of British Vegetation*. Cambridge University Press, Cambridge.
- Telford, A., Cavers, S., Ennos, R.A. and Cottrell, J.E. 2015. Can we protect forests by harnessing variation in resistance to pests and pathogens? *Forestry* **88**, 3-12.
- Thomas, E., Jalonen, R., Loo, J., Boshier, D., Gallo, L., Cavers, S., Bordács, S., Smith, P. and Bozzano, M. 2014. Genetic considerations in ecosystem restoration using native tree species. *Forest Ecology and Management* **333**, 66-75.
- Thomas, H.J., Paterson, J.S., Metzger, M.J. and Sing, L. 2015. Towards a research agenda for woodland expansion in Scotland. *Forest Ecology and Management* **349**, 149-161.
- Thomasset, M., Hodkinson, T.R., Restoux, G., Frascaria-Lacoste, N., Douglas, G.C. and Fernández-Manjarrés, J.F. 2014. Thank you for not flowering: conservation genetics and gene flow analysis of native and non-native populations of *Fraxinus* (Oleaceae) in Ireland. *Heredity* **112**, 596-606.
- Torchiano, M. 2016. Effsize: Efficient Effect Size Computation. R package version 0.6.4. <https://CRAN.R-project.org/package=effsize>
- Unger, G.M., Vendramin, G.G. and Robledo-Arnuncio, J.J. 2014. Estimating exotic gene flow into native pine stands: zygotic vs. gametic components. *Molecular Ecology* **23**, 5435-5447.
- Urquhart, J., Courtney, P. and Slee, B. 2010. Private ownership and public good provision in English woodlands. *Small-scale Forestry* **9**, 1-20
- Valladares, F., Gianoli, E. and Gómez, J.M. 2007. Ecological limits to plant phenotypic plasticity. *New Phytologist* **176**, 749-763.
- Van Vloten, H. 1952. Evidence of host-parasite relations by experiments with *Phomopsis pseudotsugae* Wilson. *Scottish Forestry* **6**, 38-46

- Vander Mijnsbrugge, K., Bischoff, A. and Smith, B. 2010. A question of origin: where and how to collect seed for ecological restoration. *Basic and Applied Ecology* **11**, 300-311.
- Vander Mijnsbrugge, K., Onkelinx, T. and De Cuyper, B. 2015. Variation in bud burst and flower opening responses of local versus non-local provenances of hawthorn (*Crataegus monogyna* Jacq.) in Belgium. *Plant Systematics and Evolution* **301**, 1171-1179.
- Vander Mijnsbrugge, K., Turcsán, A. and Michiels, B. 2016. Population differentiation and phenotypic plasticity in temperature response of bud burst in *Frangula alnus* provenances of different latitude. *Plant Systematics and Evolution* **302**, 257-264.
- Varis, S., Santanen, A., Pakkanen, A. and Pulkkinen, P. 2008. The importance of being the first pollen in the strobili of Scots pine. *Canadian journal of forest research* **38**, 2976-2980.
- Varis, S., Pakkanen, A., Galofré, A. and Pulkkinen, P. 2009. The extent of south-north pollen transfer in Finnish Scots pine. *Silva Fennica* **43**, 717-726.
- Vera, F.V.M. 2000. *Grazing ecology and forest history*. CABI, Wallingford.
- Viherä-Aarnio, A. and Heikkilä, R. 2006. Effect of the latitude of seed origin on moose (*Alces alces*) browsing on silver birch (*Betula pendula*). *Forest Ecology and Management*, **229**, 325-332.
- Vitasse, Y. and Basler, D. 2013. What role for photoperiod in the bud burst phenology of European beech. *European Journal of Forest Research* **132**, 1-8.
- Vitasse, Y., Delzon, S., Bresson, C.C., Michalet, R. and Kremer, A. 2009. Altitudinal differentiation in growth and phenology among populations of temperate-zone tree species growing in a common garden. *Canadian Journal of Forest Research* **39**, 1259-1269.
- Vitasse, Y., François, C., Delpierre, N., Dufrêne, E., Kremer, A., Chuine, I. and Delzon, S. 2011. Assessing the effects of climate change on the phenology of European temperate trees. *Agricultural and Forest Meteorology* **151**, 969-980.
- Wachowiak, W., Salmela, M.J., Ennos, R.A., Iason, G. and Cavers, S. 2011. High genetic diversity at the extreme range edge: nucleotide variation at nuclear loci in Scots pine (*Pinus sylvestris* L.) in Scotland. *Heredity* **106**, 775-787.
- Wachowiak, W., Iason, G.R. and Cavers, S. 2013. Among population differentiation at nuclear genes in native Scots pine (*Pinus sylvestris* L.) in Scotland. *Flora-Morphology, Distribution, Functional Ecology of Plants* **208**, 79-86.

## References

- Wang, T., Hamann, A., Yanchuk, A., O' Neill, G.A. and Aitken, S.N. 2006. Use of response functions in selecting lodgepole pine populations for future climates. *Global Change Biology* **12**, 2404-2416.
- Ward, J.H. 1963. Hierarchical grouping to optimize an objective function. *Journal of the American Statistical Association* **58**, 236-244.
- Ward Thompson, C., Aspinal, P., Bell, S. and Findlay, C. 2005. "It Gets You Away From Everyday Life": Local Woodlands and Community Use—What Makes a Difference? *Landscape Research* **30**, 109-146.
- Warren, C. 2000. 'Birds, bogs and forestry' revisited: The significance of the flow country controversy. *The Scottish Geographical Magazine* **116**, 315-337.
- WEAG. 2012. Report of the Woodland Expansion Advisory Group to the Cabinet Secretary for Rural Affairs and Environment, Richard Lochhead MSP.  
[http://www.forestry.gov.uk/pdf/WEAGFinalReport.pdf/\\$FILE/WEAGFinalReport.pdf](http://www.forestry.gov.uk/pdf/WEAGFinalReport.pdf/$FILE/WEAGFinalReport.pdf) (accessed on 15 December 2016).
- Weeks, A.R., Sgro, C.M., Young, A.G., Frankham, R., Mitchell, N.J., Miller, K.A., Byrne, M., Coates, D.J., Eldridge, M.D. and Sunnucks, P. 2011. Assessing the benefits and risks of translocations in changing environments: a genetic perspective. *Evolutionary Applications* **4**, 709-725.
- Weir, J. 2015. Foresters: are you thinking about tomorrow when choosing trees for today? *Forestry Journal*, **2/15**, 16-19.
- Welsh Assembly Government. 2009. *Woodlands for Wales. The Welsh Assembly Government's strategy for woodlands and trees*. Forestry Commission Wales, Cardiff.
- White, T.L., Adams, W.T. and Neale, D.B. 2007. *Forest Genetics*. CABI Publishing, Wallingford.
- Whittet, R., Cottrell, J., Cavers, S., Pecurul, M. and Ennos, R. 2016a. Supplying trees in an era of environmental uncertainty: Identifying challenges faced by the forest nursery sector in Great Britain. *Land Use Policy* **58**, 415-226.
- Whittet, R., Cavers, S., Cottrell, J. and Ennos, R. 2016b. Seed sourcing for woodland creation in an era of uncertainty: An analysis of the options for Great Britain. *Forestry*. DOI: 10.1093/forestry/cp037
- Whittet, R., Ennos, R., Cavers, S. and Cottrell, J. 2016c. Adapt and survive. The origins of genetic variation in native trees and implications for practical management. *Woodwise, Woodland Conservation News, Autumn 2016*. Woodland Trust, Grantham.



- Whittet, R., Cavers, S., Cottrell, J., Rosique-Esplugas, C. and Ennos, R. 2017. Substantial variation in the timing of pollen production reduces reproductive synchrony between distant populations of *Pinus sylvestris* L. in Scotland. *Ecology and Evolution*. DOI: 10.1002/ece3.3154.
- Wickham, H. 2009. ggplot2: Elegant Graphics for Data Analysis. Springer-Verlag, New York
- Wickham, H. and Francois, R. 2015. dplyr: A Grammar of Data Manipulation. R package version 0.4.3. <http://CRAN.R-project.org/package=dplyr>
- Willi, Y. and Hoffmann, A.A. 2009. Demographic factors and genetic variation influence population persistence under environmental change. *Journal of evolutionary biology* **22**, 124-133.
- Williams, M.I. and Dumroese, R.K. 2013. Preparing for climate change: Forestry and assisted migration. *Journal of Forestry* **111**, 287-297.
- Williams, J.W., Jackson, S.T. and Kutzbach, J.E. 2007. Projected distributions of novel and disappearing climates by 2100 AD. *Proceedings of the National Academy of Sciences* **104**, 5738-5742.
- Willoughby, I., Jinks, R., Gosling, P. and Kerr, G. 2004. *Creating new broadleaved woodland by direct seeding*. Forestry Commission practice guide. Forestry Commission, Edinburgh.
- Wimp, G.M., Martinsen, G.D., Floate, K.D., Bangert, R.K. and Whitham, T.G. 2005. Plant genetic determinants of arthropod community structure and diversity. *Evolution* **59**, 61-69.
- Winkel, G. and Derks, J. 2016. The nature of Brexit. How the UK exiting the European Union could affect European forest and (forest related) environmental policy. *Forest Policy and Economics* **70**, 124-127.
- Woods, A., Coates, K.D. and Hamann, A. 2005. Is an unprecedented Dothistroma needle blight epidemic related to climate change? *BioScience* **55**, 761-769.
- Worrell, R. 1992. A comparison between European continental and British provenances of some British native trees: growth, survival and stem form. *Forestry* **65**, 253-280.
- Worrell, R., Cundall, E.P., Malcolm, D.C. and Ennos, R.A. 2000. Variation among seed sources of silver birch in Scotland. *Forestry* **73**, 419-435.
- Ying, C. C. and Yanchuk, A.D. 2006. The development of British Columbia's tree seed transfer guidelines: Purpose, concept, methodology, and implementation. *Forest Ecology and Management*. **227**, 1-13.

## References

Zelený, D. and Schaffers, A.P. 2012. Too good to be true: pitfalls of using mean Ellenberg indicator values in vegetation analyses. *Journal of Vegetation Science* **23**, 419-431.