

Expression of monocyte Heat Shock Protein 70 (HSP70) during malaria fever in the presence of antimalarial, anti-inflammatory drugs and β -haematin

by

Kajal Fowdar

MSc (Biomedical Engineering) (University of Surrey)

Submitted in fulfilment of the academic requirements of
Doctor of Philosophy

in the Discipline of Biochemistry
School of Biochemistry, Genetics and Microbiology
College of Agriculture, Engineering and Science
University of KwaZulu-Natal
Pietermaritzburg
South Africa

January 2017

PREFACE

The research contained in this thesis was completed based in the Discipline of Biochemistry, School of Biochemistry, Genetics and Microbiology of the College of Agriculture, Engineering and Science, University of KwaZulu-Natal, Pietermaritzburg, South Africa, from February 2014 to December 2016, under the supervision of Professor J.P.D Goldring.

The contents of this work have not been submitted in any form to another university and, except where the work of others is acknowledged in the text, the results reported are due to investigations by the candidate.

Signed: Professor J.P.D Goldring

Date: January 2017

Kajal Fowdar

DECLARATION: PLAGIARISM

I, Kajal Fowdar, declare that:

(i) the research reported in this dissertation, except where otherwise indicated or acknowledged, is my original work;

(ii) this dissertation has not been submitted in full or in part for any degree or examination to any other university;

(iii) this dissertation does not contain other persons' data, pictures, graphs or other information, unless specifically acknowledged as being sourced from other persons;

(iv) this dissertation does not contain other persons' writing, unless specifically acknowledged as being sourced from other researchers. Where other written sources have been quoted, then:

a) their words have been re-written but the general information attributed to them has been referenced;

b) where their exact words have been used, their writing has been placed inside quotation marks, and referenced;

(v) where I have used material for which publications followed, I have indicated in detail my role in the work;

(vi) this dissertation is primarily a collection of material, prepared by myself, published as journal articles or presented as a poster and oral presentations at conferences. In some cases, additional material has been included;

(vii) this dissertation does not contain text, graphics or tables copied and pasted from the Internet, unless specifically acknowledged, and the source being detailed in the dissertation and in the References sections.

Signed: Kajal Fowdar

ABSTRACT

Malaria is an infectious disease caused by one of the parasitic *Plasmodium* species (*Plasmodium falciparum*, *P. vivax*, *P. knowlesi*, *P. malariae*, *P. ovale*). During the host response to malaria infection, periods of fever are experienced. Fever has been reported to decrease parasite growth but could be pathogenic as it has been found to increase cytoadherence between parasites and endothelial cells. During fever, host cells express a family of protective heat shock proteins that act as chaperones to prevent protein aggregation, and help renature denatured protein, and hence maintain cellular homeostasis. One of the main heat shock proteins expressed is heat shock protein 70 (HSP70). Increased expression of HSP70 has been reported to decrease cell cytotoxicity and apoptosis mediated by TNF- α and oxidative stress.

During a malaria infection, monocytes act as the first line of defence and phagocytose infected red blood cells, free parasites and parasite products including the malaria pigment, haemozoin. Monocytes also express and secrete a wide range of cytokines, nitric oxide, reactive oxygen species and phospholipase A2 to combat the infection. A dysregulated expression of cytokines could lead to severe and cerebral malaria. As malaria treatment, antimalarial and anti-inflammatory drugs are given to malaria-infected patients. They seem to affect the expression of cytokines including TNF- α and prevent severe/cerebral malaria but the mechanism by which they act is still under debate. It was of interest to study the effects of antimalarial, anti-inflammatory drugs and β -haematin on monocyte HSP70 protein expression during febrile conditions, to see whether they could affect monocyte responses through monocyte HSP70 protein expression.

Human HSP70 was recombinantly expressed, affinity-purified and used to raise antibodies against rHSP70 in chickens. Monoclonal antibodies against rHSP70 were made and expressed as single chain variable fragment (scFv), using phage display technology. J774A.1 and U937 monocytes were treated with nine antimalarial drugs, namely artemisinin, artemether, artesunate, chloroquine, quinine, quinacrine, quinidine, primaquine and pyrimethamine and with four anti-inflammatory drugs, including danazol, probucol, ambroxol and curcumin at the therapeutic concentration of each drug, then heat shocked. J774A.1 monocytes were fed with β -haematin and latex beads, under feverish conditions. Recombinant antibodies against HSP70 were then used to detect HSP70 protein expression in monocyte lysates.

It was found that chloroquine and artemether increased HSP70 protein expression in monocytes, with artemether being the most effective. Artemisinin, quinine, quinidine, quinacrine and primaquine decreased monocyte HSP70 protein expression with quinine and quinacrine being

most effective. Pyrimethamine had no effect on monocyte HSP70 protein expression, and artesunate seemed to increase HSP70 expression in J774A.1 cells, but not significantly. Danazol decreased monocyte HSP70 expression, ambroxol and probucol decreased HSP70 expression in U937 cells, while ambroxol increased HSP70 expression in J774A.1 cells. Curcumin decreased HSP70 expression in J774A.1 cells and increased HSP70 expression in U937 cells. Haemozoin laden monocytes have been reported to lead to a dysregulated production of cytokines, and to suppress the functions of monocytes. Monocytes were incubated with β -haematin, hemin and latex beads to study their effects on HSP70 protein expression during fever conditions and it was found that they all decreased monocyte HSP70 protein expression. The decreased monocyte HSP70 protein expression could not be attributed to the presence of β -haematin only, and it could have been the result of phagocytosis but this finding needs to be explored further to be confirmed.

There seemed to be an inverse relationship with TNF- α expression and monocyte HSP70 expression, and a correlation between neopterin secretion and monocyte HSP70 expression with the antimalarial drugs. Antimalarial drugs which increased reactive oxygen species were found to increase monocyte HSP70 expression, suggesting a possible link between them. With the anti-inflammatory drugs, there seemed to be a correlation between TNF- α expression and monocyte HSP70 expression. This study has therefore shown that antimalarial and anti-inflammatory drugs could potentially affect monocyte responses through monocyte HSP70 expression. However, more investigations are required to understand how these drugs can be used in the treatment and management of malaria. Drugs can be chosen depending on whether an upregulation or downregulation of monocyte HSP70 is more beneficial. Future studies might measure the levels of cytokines expressed together with monocyte HSP70 expression to determine whether they are related.

The results of this study may be extended to cancer studies. Most cancer cell lines overexpress HSP70, which render them resistant to chemotherapy drugs and to apoptosis. Drugs that inhibit HSP70 expression have been found to render the cancer cells susceptible to chemotherapy drugs and prevent the cancer cells from being malignant. In this study, most of the antimalarial and anti-inflammatory drugs inhibited HSP70 protein expression at therapeutic concentrations. Their use could be explored in cancer cells.

GRAPHICAL SUMMARY

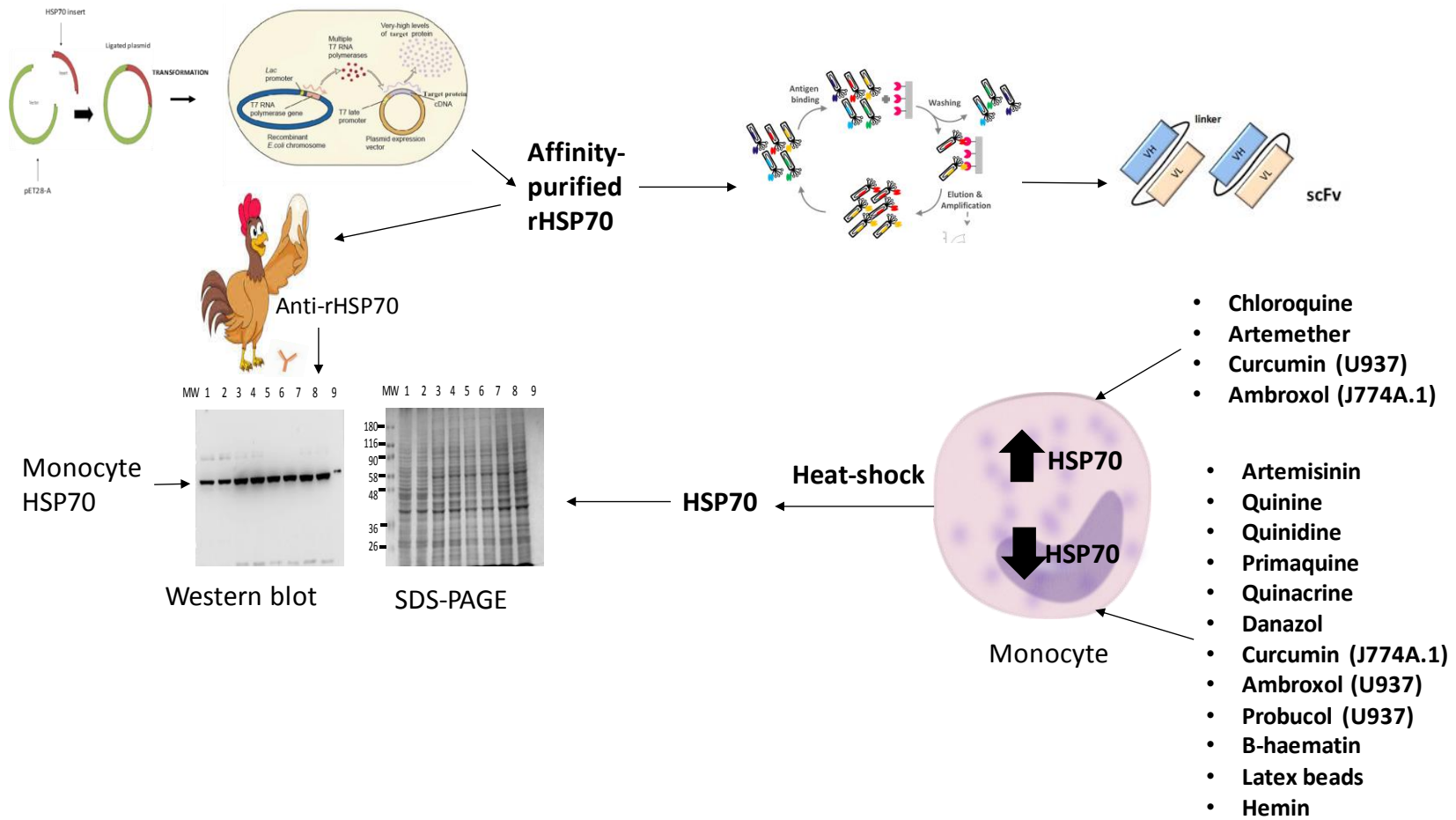

("Monocyte Cell Clip Art At Clker.Com - Vector Clip Art Online, Royalty Free & Public Domain"), ("Cloning Of Scfv Fragments | Antibody Design Labs"), (<https://www.id-interactive.fr/>), ("Project 4A Manual: Experimental Procedures"), ("Protein Expression Service - Creative Biostructure"), ("Free Chicken Clipart - Clip Art Pictures - Graphics - Illustrations")

AKNOWLEDGEMENTS

I would like to express my deepest gratitude to the following people:

Professor J.P.D Goldring for his encouragement, support, patience and advice throughout this study.

Professor T.H.T Coetzer for her encouragement and Professor C.U Nieslar for her help and advice on tissue culture and constant encouragement.

My laboratory colleagues: Zainab, Mloni, Mark, Eugene, Sheldon, Mark C, Sno, Abdul for all their support, encouragement and positive attitude.

A special thanks to Rob Krause for all his help, his support, expert advice and patience.

Laboratory colleagues from Lab 39 and 44: Colin, Lauren, Alex, Maxine and Melanie for all your help and support

Patricia Joubert with all the help with orders and Charmaine Ahrens, Tanya Karalic for all administrative help.

Jessica Moodley and Yegan for all their help throughout.

My parents for their constant support, advice, unconditional love and unrelenting faith in me.

My husband for seeing only the good in me, pushing me to move forward always and his unconditional love.

TABLE OF CONTENTS

PREFACE.....	ii
DECLARATION: PLAGIARISM.....	iii
ABSTRACT	iv
GRAPHICAL SUMMARY	vi
ACKNOWLEDGEMENTS.....	vii
TABLE OF CONTENTS	viii
LIST OF FIGURES.....	xiii
LIST OF TABLES.....	xvi
ABBREVIATIONS	xvii
CHAPTER 1: LITERATURE REVIEW	1
1.1 Introduction to malaria	1
1.2 Biology of malaria	2
1.3.....	3
Malaria pathology.....	3
1.3.1 Symptoms of malaria	3
1.3.2 Cytoadherence	4
1.4 Monocyte/macrophage	4
1.4.1 Monocyte/macrophage in malaria.....	6
1.4.1.1 Cytokine responses	6
1.4.1.1.1 Pro-inflammatory cytokines.....	6
1.4.1.1.2 Anti-inflammatory cytokines	8
1.4.1.2 Neopterin secretion by monocytes.....	9
1.4.1.3 Phospholipase A2 secretion by monocytes.....	10
1.4.1.4 Nitric oxide (NO) and reactive oxygen species (ROS) production	10
1.4.1.5 Phagocytosis	11
1.4.1.6 Influence of haemozoin (malaria pigment) on the immune responses.....	11
1.5 Antimalarial drugs.....	14
1.5.1 Chloroquine	15
1.5.2 Quinine.....	16
1.5.3 Quinidine.....	17

1.5.4 Quinacrine	17
1.5.5 Pyrimethamine	18
1.5.6 Primaquine	18
1.5.7 Artemisinin derivatives (Artemisinin, artesunate, artemether).....	19
1.6 Anti-inflammatory drugs.....	21
1.6.1 Danazol.....	21
1.6.2 Ambroxol.....	22
1.6.3 Probucol.....	22
1.6.4 Curcumin	23
1.7 Heat shock proteins.....	25
1.7.1 Heat Shock Protein 70 (HSP70) Family	26
1.7.2 Intracellular HSP70 and monocyte/macrophage.....	28
1.7.3 Extracellular HSP70 and immune responses	29
1.7.4 Heat shock and HSP70 expression during malaria	30
1.7.5 Effects of antimalarial, anti-inflammatory drugs, and β -haematin on HSP70 expression	31
1.8 Aims of the study	32
CHAPTER 2: MATERIALS AND METHODS.....	34
2.1 Introduction.....	34
2.2 Materials and reagents	34
2.3 Sub-cloning of human HSP70	34
2.4 Expression, purification of rHSP70 and assay for ATPase activity	34
2.5 Gel-filtration chromatography	35
2.6 Electrophoresis, western blotting and determination of protein concentration	35
2.7 Antibody production in chickens.....	36
2.7.1 Chicken immunization and IgY isolation.....	36
2.7.2 Direct ELISA.....	36
2.8 Selection of scFv against rHSP70	36
2.8.1 Nkuku [®] library	36
2.8.2 Selection of specific clones.....	37
2.8.2.1 Panning.....	37
2.8.2.2 Polyclonal phage ELISA	37
2.8.2.3 Monoclonal ELISA, colony PCR, nested PCR	37

2.9 Cell culture.....	38
2.9.1 Antimalarial, anti-inflammatory drug treatment.....	38
2.9.2 β -haematin, latex beads, hemin treatment.....	39
2.10 Statistical analysis.....	39
CHAPTER 3: CLONING, RECOMBINANT EXPRESSION AND PURIFICATION OF RECOMBINANT HUMAN HEAT SHOCK PROTEIN 70 (rHSP70)	40
3.1 Introduction.....	40
3.1.1 Heat Shock Protein 70 (HSP70)	40
3.1.2 Recombinant expression of human HSP70	40
3.1.3 Affinity-purification of rHSP70	41
3.2 Results	42
3.2.1 Sub-cloning of human HSP70 from pcDNA5/FRT/TO/HIS HSPA1A to pET-28a plasmid	42
3.2.2 Expression of recombinant HSP70.....	43
3.2.2.1 Colony selection for recombinant expression of rHSP70	43
3.2.2.2 Recombinant expression of rHSP70 in different media: TEB, 2xYT and LB media	44
3.2.2.3 Cell lysis	47
3.2.3 Purification of rHSP70	48
3.2.4 ATPase activity of rHSP70.....	51
3.3 Discussion.....	52
3.3.1 Cloning and expression of rHSP70	52
3.3.2 Purification of rHSP70	53
3.3.3 ATPase activity of rHSP70.....	54
3.4 Conclusion.....	56
CHAPTER 4: ANTIBODY PRODUCTION AGAINST rHSP70.....	57
4.1 Introduction.....	57
4.2 RESULTS	59
4.2.1 Polyclonal antibody production in chickens.....	59
4.2.2 Selection of single chain variable fragment (scFv) clones against rHSP70.....	61
4.2.2.1 Polyclonal phage ELISAs	63
4.2.2.1.1 Column/Eluted phages	63
4.2.2.1.2 Blocking agent.....	63
4.2.2.2 Monoclonal phage ELISAs	65
4.2.2.3 Monoclonal soluble scFv ELISA.....	69

4.2.2.4 Characterization of selected scFv clones.....	71
4.2.2.5 Comparing eluted phages and column phages.....	74
4.3 Discussion.....	75
4.3.1 Polyclonal antibodies against rHSP70 in chickens	75
4.3.2 Selection of scFv clones against rHSP70	76
4.3.2.1 On column infection/ Off column infection (eluted phages).....	76
4.3.2.2 Blocking agents.....	77
4.3.2.3 Expression of soluble scFv.....	78
4.3.2.4 Characterisation of clones	78
4.4 Conclusion	79
CHAPTER 5: EFFECTS OF ANTIMALARIAL, ANTI-INFLAMMATORY DRUGS AND β - HAEMATIN ON MONOCYTE HSP70 PROTEIN EXPRESSION	80
5.1 Introduction.....	80
5.1.1 Malaria, fever and HSP70.....	80
5.1.2 Characterisation of cell lines.....	81
5.1.3 Antimalarial drugs.....	81
5.1.4 Anti-inflammatory drugs	82
5.1.5 Influence of haemozoin on monocyte responses.....	83
5.2 Results	83
5.2.1 Characterisation of the two monocyte cell lines	83
5.2.2 Statistical analysis.....	83
5.2.3 Effects of antimalarial drugs on monocyte HSP70 protein expression.....	86
5.2.4 Effects of anti-inflammatory drugs on monocyte HSP70 protein expression.....	94
5.2.5 Effects of β -haematin, latex beads and hemin on monocyte HSP70 protein expression.....	98
5.3 Discussion.....	100
5.3.1 Characterisation of cell lines.....	100
5.3.2 Antimalarial drugs and HSP70 expression.....	101
5.3.2.1 Antimalarial drugs, monocyte HSP70 and monocyte responses	103
5.3.2.1.1 Antimalarial drugs, monocyte HSP70 and TNF- α expression	104
5.3.2.1.2 Antimalarial drugs, monocyte HSP70 and reactive oxygen species secretion	104
5.3.2.1.3 Antimalarial drugs, monocyte HSP70 and phagocytosis.....	104
5.3.2.1.4 Antimalarial drugs, monocyte HSP70 and neopterin secretion	105
5.3.2.2 Monocyte HSP70 and the anti-inflammatory responses of antimalarial drugs.....	105

5.3.3 Anti-inflammatory drugs and monocyte HSP70 expression	106
5.3.3.1 Anti-inflammatory drugs, monocyte HSP70 and monocyte responses	107
5.3.3.1.1 Anti-inflammatory drugs, monocyte HSP70 expression and TNF- α and IL-1 expressions	107
5.3.3.1.2 Anti-inflammatory drugs, monocyte HSP70 expression and ROS secretion	108
5.3.3.2 Effects of β -haematin (haemozoin) on monocyte HSP70 protein expression.....	108
5.4 Conclusion	109
CHAPTER 6: GENERAL DISCUSSION.....	110
6.1 Overview of study	110
6.2 Aims of the study	112
6.3 Cloning, expression and purification of recombinant HSP70 (rHSP70).....	112
6.4 Antibody production.....	112
6.5 Effects of antimalarial, anti-inflammatory and β -haematin on monocyte HSP70 expression	113
6.6 Contribution of the study to current knowledge and its potential impact on the management and treatment of malaria.....	116
6.7 Contribution of the study on cancer	117
APPENDIX I: Densitometry results when total protein was used as the loading control.....	118
APPENDIX II: Wilcoxon rank sum test (Mann Whitney U test).....	122
REFERENCES	123

LIST OF FIGURES

Figure 1.1: Malaria cases (millions) by regions as estimated by WHO, 2016.....	2
Figure 1.2: Malaria deaths (thousands) by regions as estimated by WHO, 2016.....	2
Figure 1.3: Life cycle of <i>P. falciparum</i> malaria.....	3
Figure 1.4: Monocyte/macrophage ultrastructure.....	5
Figure 1.5: Phagocytosis by monocytes in malaria.....	11
Figure 1.6: Immune responses to malaria infection.....	13
Figure 1.7: Chemical structures of antimalarial drugs.....	14
Figure 1.8: Schematic diagram of HSP70/HSC70 structure.....	27
Figure 1.9: Induction of inducible HSP70.....	28
Figure 1.10: Summary of monocyte responses due to increased monocyte HSP70 expression.....	29
Figure 3.1: Digestion of plasmids with <i>Bam</i> HI and <i>Not</i> I.....	42
Figure 3.2: Digestion of ligated pET-28a-HSP70 plasmids with <i>Bam</i> HI and <i>Not</i> I.....	43
Figure 3.3: Expression of rHSP70 from ten colonies, induced with IPTG.....	44
Figure 3.4: Expression of rHSP70 induced with IPTG in TEB.....	45
Figure 3.5: Expression of rHSP70 induced by auto-induction in TEB.....	45
Figure 3.6: Expression of rHSP70 by auto-induction in TEB, at 20°C and 37°C.....	46
Figure 3.7: Expression of rHSP70 induced with IPTG in 2xYT and LB media.....	46
Figure 3.8: Expression of rHSP70 in LB media induced at OD ₆₀₀ 0.4 or 0.6.....	47
Figure 3.9: Effects of lysis on the yield of rHSP70.....	48
Figure 3.10: Gradient elution of rHSP70 grown in LB media, affinity-purified using TALON® resin.....	49
Figure 3.11: Gradient elution of rHSP70 grown in TEB, affinity-purified using TALON® resin.....	49
Figure 3.12: Large scale purification of rHSP70, expressed by IPTG induction in LB media.....	50
Figure 3.13: Sephacryl S200 gel filtration of rHSP70.....	50
Figure 3.14: rHSP70 ATPase activity.....	51
Figure 3.15: Kinetics of rHSP70 activity.....	51
Figure 3.16: ATPase activity of rHSP70 at pH 5.0, 7.4 and 8.0.....	52
Figure 4.1: Clustal alignment of humanHSP70 and chicken HSP70.....	58
Figure 4.2: ELISA of anti-rHSP70 antibodies from crude IgY and elution profile of affinity-purified anti-rHSP70 antibodies.....	60
Figure 4.3: Specificity of affinity-purified anti-rHSP70 antibodies.....	60
Figure 4.4: Comparison of affinity-purified anti-rHSP70, anti-HIS tag and commercial available anti-HSP70 antibodies.....	61
Figure 4.5: Detection of monocyte HSP70 with affinity-purified anti-rHSP70 antibodies.....	61
Figure 4.6: Flow-chart of scFv isolation.....	62

Figure 4.7: Polyclonal phage ELISA of scFv against rHSP70 comparing column phages with eluted phages.....	64
Figure 4.8: Polyclonal phage ELISA of scFv against rHSP70 comparing milk powder and BSA as blocking agents.....	64
Figure 4.9: Polyclonal phage ELISA of scFv against rHSP70, using alternate blocking agents.....	65
Figure 4.10: Monoclonal phage ELISA and colony PCR from the third round of panning, using column phages, when milk powder was used as blocking agent.....	66
Figure 4.11: Monoclonal phage ELISA from the fourth round of panning against rHSP70, using column phages, when milk powder was used as blocking agent.....	67
Figure 4.12: Monoclonal phage ELISA and colony PCR of scFv clones from third round of panning, using eluted phages, when milk powder was used as blocking agent.....	68
Figure 4.13: Monoclonal phage ELISA and colony PCR of scFv clones from fourth round of panning, using eluted phages, and milk powder as blocking agent.....	68
Figure 4.14: Monoclonal phage ELISA and colony PCR of scFv clones from third round of panning, using eluted phages, and BSA as blocking agent.....	68
Figure 4.15: Monoclonal phage ELISA and colony PCR of scFv clones from fourth round of panning, using eluted phages, when BSA was used as blocking agent.....	69
Figure 4.16: Monoclonal soluble scFv ELISAs induced by auto-induction in TEB.....	70
Figure 4.17: Monoclonal soluble scFv ELISAs induced by IPTG.....	70
Figure 4.18: Nested PCR and <i>AluI</i> digests of positive clones.....	71
Figure 4.19: Dot blots using different scFv clones.....	72
Figure 4.20: Anti-rHSP70 scFv phage amino acid sequences aligned with the chicken germline immunoglobulin sequence, and with an anti-PMT scFv clone.....	73
Figure 4.21: Evaluation of the elution methods using colony PCR.....	74
Figure 5.1: Staining of J774A.1 and U937 cells.....	85
Figure 5.2: HSP70 expression in J774A.1 cells incubated with artemisinin.....	87
Figure 5.3: HSP70 expression in J774A.1 cells incubated with artemisinin and heat shocked...	87
Figure 5.4: HSP70 expression in U937 cells incubated with artemisinin and heat shocked.....	87
Figure 5.5: HSP70 expression in J774A.1 cells incubated with artesunate and heat shocked....	88
Figure 5.6: HSP70 expression in U937 cells incubated with artesunate and heat shocked.....	88
Figure 5.7: HSP70 expression in J774A.1 cells incubated with artemether and heat shocked...	88
Figure 5.8: HSP70 expression in U937 cells incubated with artemether and heat shocked.....	89
Figure 5.9: HSP70 expression in J774A.1 cells incubated with chloroquine and heat shocked..	89
Figure 5.10: HSP70 expression in U937 cells incubated with chloroquine and heat shocked.....	89
Figure 5.11: HSP70 expression in J774A.1 cells incubated with pyrimethamine and heat shocked.....	90
Figure 5.12: HSP70 expression in U937 cells incubated with pyrimethamine and heat shocked...	90
Figure 5.13: HSP70 expression in J774A.1 cells incubated with primaquine and heat shocked...	90

Figure 5.14: HSP70 expression in U937 cells incubated with primaquine and heat shocked.....	91
Figure 5.15: HSP70 expression in J774A.1 cells incubated with quinine and heat shocked.....	91
Figure 5.16: HSP70 expression in U937 cells incubated with quinine and heat shocked.....	91
Figure 5.17: HSP70 expression in U937 cells incubated with quinine (15 µg/ml) and heat shocked.....	92
Figure 5.18: HSP70 expression in J774A.1 cells incubated with quinidine and heat shocked.....	92
Figure 5.19: HSP70 expression in U937 cells incubated with quinidine and heat shocked.....	92
Figure 5.20: HSP70 expression in J774A.1 cells incubated with quinacrine and heat shocked.....	93
Figure 5.21: HSP70 expression in U937 cells incubated with quinacrine and heat shocked.....	93
Figure 5.22: Summary of antimalarial drugs' effects on monocyte HSP70 protein expression, after heat shock.....	94
Figure 5.23: HSP70 expression in J774A.1 cells incubated with ambroxol at 37°C.....	95
Figure 5.24: HSP70 expression in J774A.1 cells incubated with ambroxol and heat shocked.....	95
Figure 5.25: HSP70 expression in U937 cells incubated with ambroxol and heat shocked.....	95
Figure 5.26: HSP70 expression in J774A.1 cells incubated with probucol and heat shocked.....	96
Figure 5.27: HSP70 expression in U937 cells incubated with probucol and heat shocked.....	96
Figure 5.28: HSP70 expression in J774A.1 cells incubated with danazol and heat shocked.....	96
Figure 5.29: HSP70 expression in U937 cells incubated with danazol and heat shocked.....	97
Figure 5.30: HSP70 expression in J774A.1 cells incubated with curcumin and heat shocked.....	97
Figure 5.31: HSP70 expression in U937 cells incubated with curcumin and heat shocked.....	97
Figure 5.32: Summary of anti-inflammatory drugs on monocyte HSP70 protein expression, after heat shock.....	98
Figure 5.33: HSP70 expression in monocytes incubated with β-haematin.....	99
Figure 5.34: HSP70 expression in monocytes incubated with β-haematin and heat shocked.....	99
Figure 5.35: HSP70 expression in J774A.1 cells incubated with latex beads, hemin and β-haematin, and heat shocked.....	100
Figure 5.36: Artemisinin metabolism in the liver	102
Figure 5.37: Effects of antimalarial drugs on monocyte responses.....	103
Figure 5.38: Effects of increased expression of monocyte HSP70 in monocyte responses	105
Figure 5.39: Effects of anti-inflammatory drugs on monocyte responses	107
Figure 5.40: Effects of β-haematin on monocyte responses	108

LIST OF TABLES

Table 1.1:	Summary table showing the effects of the antimalarial/anti-inflammatory drugs on immune responses and on HSP70.....	32
Table 3.1:	Purification table of rHSP70 from one round of purification.....	50
Table 3.2:	Comparison of HSP70 enzyme kinetics in different species.....	55
Table 4.1:	Summary of colony PCR results of selected clones.....	68
Table 4.2:	Summary of monoclonal soluble ELISA auto-induced in TEB.....	70
Table 4.3:	<i>AluI</i> digest sites for individual clones.....	71
Table 4.4:	Comparison of elution and on column methods.....	73
Table 5.1:	Summary of the findings of the effect of antimalarial drugs on monocyte HSP70 expression.....	92
Table 5.2:	Summary of the findings of the effect of anti-inflammatory drugs on monocyte HSP70 expression.....	97
Table 5.3:	Summary of the findings of the effect of β -haematin, latex beads and hemin on monocyte HSP70 expression, after heat shock.....	99

ABBREVIATIONS

ABTS	2,2'-azino-di-(3-ethylbenzthiozoline-6-sulfonic acid)
BCIP	5-bromo-4-chloro-3-indolylphosphate
BSA	bovine serum albumin
Bp	base pairs
CD	Cluster of differentiation
CRT	Chloroquine resistance transporter
CSA	Chondroitin Sulfate A
DAB	3,3'-diaminobenzidine
DHFR	dihydrofolate reductase
DHPS	dihydropteroate synthase
DMEM	Dulbecco's Modified Eagle's Medium
DMSO	dimethyl sulphoxide
DNA	deoxyribonucleic acid
dNTP	deoxynucleotide triphosphate
<i>E. coli</i>	<i>Escherichia coli</i>
EDTA	ethylenediaminetetraacetic acid, disodium salt
ELISA	enzyme-linked immunosorbent assay
FBS	foetal bovine serum
<i>g</i>	relative centrifugal force
GAPDH	glyceraldehyde-3-phosphate dehydrogenase
GTP	guanosine triphosphate
h	hour(s)
HA	Hyaluronic acid
HSP	Heat Shock Protein
HSP70	Heat Shock Protein 70
HSP90	Heat Shock Protein 90
HRPO	horse radish peroxidase
ICAM	intercellular adhesion molecule
IFN- γ	interferon- γ
IgG	immunoglobulin G
IgY	immunoglobulin Y
IL	interleukin
IMAC	Immobilised Metal Affinity Chromatography
LB	Luria Broth
LDH	Lactate dehydrogenase
LPS	lipopolysaccharide(s)
MDR	Multidrug resistance
MHC	major histocompatibility complex
min	minute(s)
MIF	migration inhibitory factor
MIP	macrophage inflammatory protein
mRNA	messenger ribonucleic acid
MRP	Multidrug resistance
NBT 4	nitro blue tetrazolium chloride
NF- κ B	Nuclear factor kappa-light-chain enhancer of activated B cells
NHE	Na ⁺ /H ⁺ exchanger
NK	cells natural killer cells

NO	nitric oxide
ODN	Oligodeoxynucleotides
PBMC	peripheral blood mononuclear cells
PBS	phosphate buffered saline
PEG	polyethylene glycol
ROS	reactive oxygen species
RPMI-1640	Roswell Park Memorial Institute-1640 medium
RT	room temperature
s	second(s)
SDS	sodium dodecyl sulphate
TEB	Terrific broth
TGF- β	transforming growth factor- β
Th 1	T-helper cell subtype 1
Th 2	T-helper cell subtype 2
TNF- α	tumour necrosis factor- α
U	unit of enzyme activity
VCAM	Vascular cell adhesion molecule

CHAPTER 1: LITERATURE REVIEW

1.1 Introduction to malaria

Malaria is caused by *Plasmodium* parasites from the Apicomplexa phylum (Schofield and Grau, 2005). The parasite requires two hosts to complete its life cycle; a mosquito vector (female *Anopheles*) and a vertebrate host such as human or monkey, amongst others (Marti *et al.*, 2004). There are five main species of *Plasmodium* which cause malaria infections in humans, namely, *Plasmodium falciparum*, *P. malariae*, *P. ovale*, *P. knowlesi*, and *P. vivax* (WHO, 2015b). *P. falciparum* causes the most virulent form of the disease resulting in the highest mortality and morbidity. Description of malaria symptoms has been reported as early as 2000 BC in many ancient manuscripts (Cox, 2010) and in Egyptian mummy remains (Nerlich *et al.*, 2008). It is thought that malaria might have played a role in the selection of the human genome, by selecting in favour of mild blood disorders such as thalassemia, glucose-6-phosphate dehydrogenase (GP6D) deficiency and haemoglobin C as these protect against severe malaria infection (Kwiatkowski, 2005).

According to the 2016 World Health Organization (WHO) report, there were an estimated 212 million cases of malaria (Figure 1.1), and 429000 deaths in 2016 (Figure 1.2) worldwide. Even though the incidence of malaria has decreased in the last 15 years, 80% of malaria cases and 90% of deaths still occur in Sub-Saharan Africa (Figures 1.1, 1.2) (WHO, 2016). The incidence of malaria has decreased about 52% around the world, except for Africa where the decrease was only about 17% (WHO, 2015b). Children under 5 years old are more susceptible to malaria and 70% of malaria deaths occur in children. Despite the decreased incidence of malaria, the risk of getting malaria remains very high and it was estimated some 3.2 million people were at risk of malaria infection (WHO, 2015b). It is predicted that regions currently devoid of malaria, could be exposed to malaria soon due to environmental conditions changing (climate change), and suit mosquitoes breeding in those areas (Eckhoff, 2011).

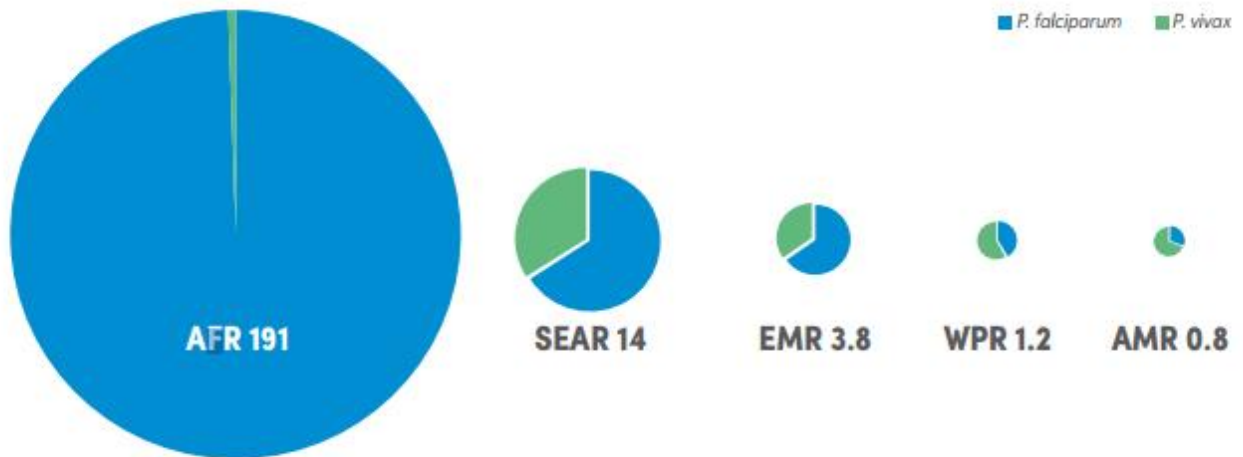

AFR, WHO African Region; AMR, WHO Region of the Americas; EMR, WHO Eastern Mediterranean Region; SEAR, WHO South-East Asia Region; WPR, WHO Western Pacific Region

Figure 1.1: Malaria cases (millions) by regions as estimated by WHO, 2016

Malaria cases according to WHO region and to species are depicted.

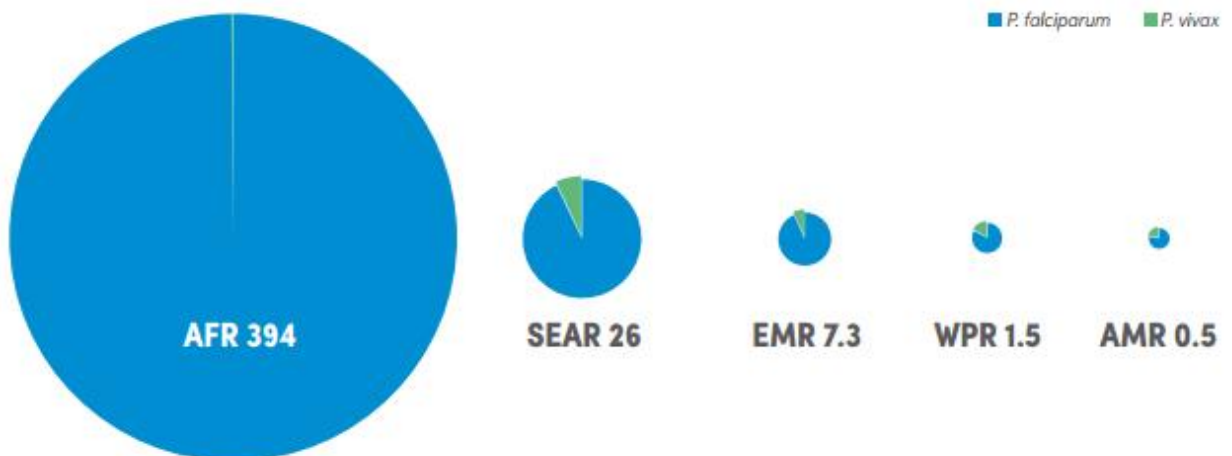

AFR, WHO African Region; AMR, WHO Region of the Americas; EMR, WHO Eastern Mediterranean Region; SEAR, WHO South-East Asia Region; WPR, WHO Western Pacific Region

Figure 1.2: Malaria deaths (thousands) by regions as estimated by WHO, 2016

Malaria deaths according to WHO region, and to species are depicted.

1.2 Biology of malaria

The infective stage of malaria occurs during mosquito feeds, whereby the female *Anopheles* mosquito deposits sporozoites in skin cells (Greenwood *et al.*, 2008). The mobile sporozoites move across dermal cells into the bloodstream and reach the liver where they infect hepatocytes (Amino *et al.*, 2005). Here, they multiply and develop into merozoites which after schizony, are released into the blood where they infect red blood cells, marking the beginning of the erythrocytic

stage of malaria (Silvie *et al.*, 2008). Once in the red blood cells, the parasites produce proteins which participate in the remodelling of the red blood cell (Cowman and Crabb, 2006). The parasites replicate and develop through the ring, trophozoite and into schizont erythrocytic stages (Figure 1.3). The red blood cells eventually rupture releasing merozoites which can infect other red blood cells. Some of the parasites also develop into gametocytes, the sexual stages of the parasite, allowing parasite transmission to a mosquito, hence completing the cycle (Figure 1.3) (Tilley and Hanssen, 2008, Cowman and Crabb, 2006).

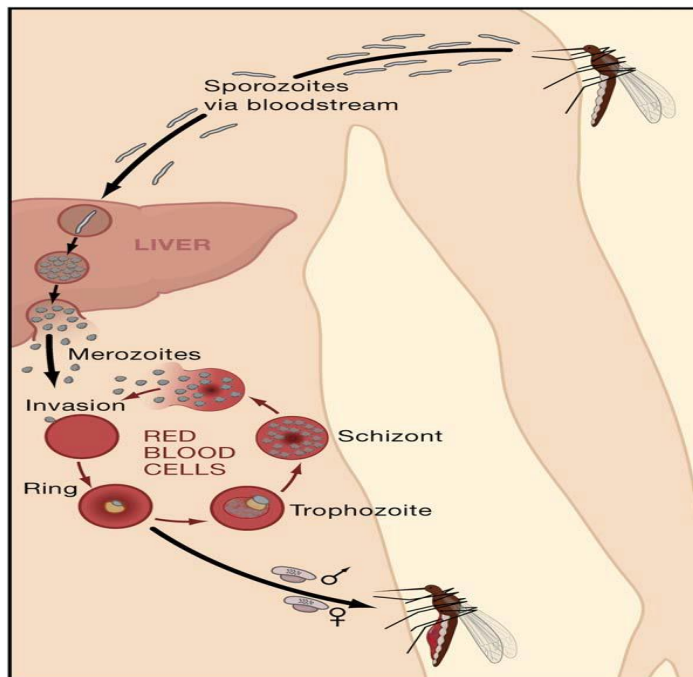

Figure 1.3: Life cycle of *P. falciparum* malaria

The infected female *Anopheles* mosquito injects the sporozoites into the skin, where they reach the bloodstream, and travel to the liver. The sporozoites infect hepatocytes, differentiate into merozoites which are released into the bloodstream to infect red blood cells. They develop through ring, trophozoite and schizont erythrocytic stages. Some of the parasites reproduce sexually to form gametocytes which are taken up by female *Anopheles* mosquitoes during feeds, completing the cycle (Cowman and Crabb, 2006).

1.3 Malaria pathology

1.3.1 Symptoms of malaria

Clinical symptoms of malaria usually appear during the erythrocytic stage of the disease and one of the main symptoms is periods of fever. Fevers and chills occur every 48 hours in *P. falciparum* and *P. vivax* and every 72 hours in *P. malariae* infected patients (Oakley *et al.*, 2007, Garcia *et al.*, 2001). In non-immune individuals, symptoms can vary depending if one or multiple organs are affected. Some of the complications arising from malaria may include cerebral malaria and severe malarial anaemia (Schofield and Grau, 2005). Cerebral malaria is usually accompanied

by coma with convulsions (Malaguarnera and Musumeci, 2002). Uncontrolled growth of parasites and dysregulation of cytokines may lead to severe malaria (Chua *et al.*, 2013, Malaguarnera and Musumeci, 2002). Severe malaria is attributed to an interplay of factors reducing oxygen supply to tissues (Malaguarnera and Musumeci, 2002).

1.3.2 Cytoadherence

When malaria parasites invade mammalian red blood cells, they remodel the red blood cell shape and contents (Silvie *et al.*, 2008). The parasite expresses proteins on the surface of red blood cells which protrude, causing characteristic knob-like structures (Cooke *et al.*, 2000). These make the red blood cells “sticky”, and cause them to adhere to other red blood cells (rosetting), or to endothelial cells of blood vessels (Newbold *et al.*, 1999, Goldring *et al.*, 1999). This process is called cytoadherence and blocks blood flow to tissues (Serghides *et al.*, 2003, Carvalho *et al.*, 2013). The red blood cell count also decreases due to lysis of the infected red blood cells, leading to anaemia. Together these effects result in reduced oxygen delivery to tissues (Malaguarnera and Musumeci, 2002). Cytoadherence is considered to protect the parasites against clearance from the spleen (Weatherall *et al.*, 2002, Heddini, 2002). Rosetting may allow parasites evade immune cells by surrounding the infected red blood cells with non-infected red blood cells and hide behind the non-infected red blood cells (Beeson and Brown, 2002).

The parasite adhesion molecule *Plasmodium falciparum* erythrocyte membrane protein 1 (*PFEMP1*) is usually expressed on the red blood cell surface and has the ability to bind to some host receptors including cluster of differentiation 36 (CD36), intercellular adhesion molecule 1 (ICAM-1), hyaluronic acid (HA) and chondroitin sulphate A (CSA), which allow them to sequester (cytoadhere) and disappear from peripheral circulation (Beeson and Brown, 2002, Serghides *et al.*, 2003, Rudin *et al.*, 1997, Kwiatkowski *et al.*, 1993, Carvalho *et al.*, 2013). CD36 receptors are expressed in the lungs, kidney and liver, while ICAM-1 receptors are expressed in the brain, blood vessels, lungs, and kidney (Beeson and Brown, 2002, Serghides *et al.*, 2003). CSA and HA are expressed in the placenta, and are associated with sequestration of infected red blood cells in the placenta (Beeson and Brown, 2002).

1.4 Monocyte/macrophage

Monocytes/macrophages are immune cells that act as the primary defence against pathogens (Gordon and Mantovani, 2011, Hirako *et al.*, 2016). They show high diversity and plasticity as they are present in different tissues, with different morphologies to allow for their respective functions (Gordon and Mantovani, 2011). A common myeloid progenitor for monocytes and

neutrophils originates in the bone marrow, and with specialisation, neutrophils and monocytes are differentiated. They are released into the bloodstream, where they circulate for some days before entering tissues and augment the tissue macrophage population (Gordon and Taylor, 2005, Van Furth, 1982, Shi and Pamer, 2011).

Monocytes/macrophages are usually spherical in shape, with an oval or kidney-like nucleus and a large cytoplasm containing a lot of granules (Figure 1.4) (Rees, 2010). Their main functions include antigen presentation (Figure 1.6), phagocytosis and regulation of the immune response (Dale *et al.*, 2008). They take part in the remodelling and repair of damaged tissues (Gordon and Taylor, 2005, Hume, 2006). Monocytes are non-homogeneous, forming two populations which differ with respect to the receptors they express, either CD14 or CD16 or both. They differ in the types of cytokines and chemokines they secrete (Gordon and Taylor, 2005, Hume, 2006, Shi and Pamer, 2011).

A (monocyte)

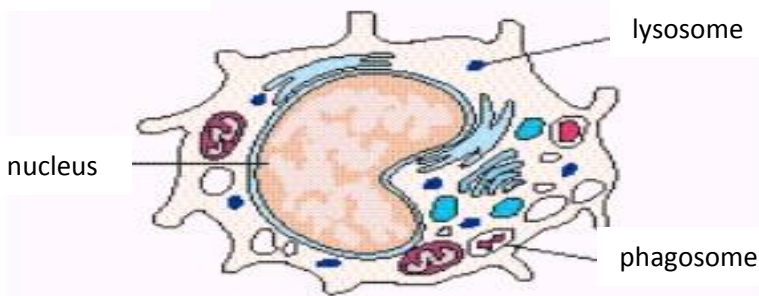

B (macrophage)

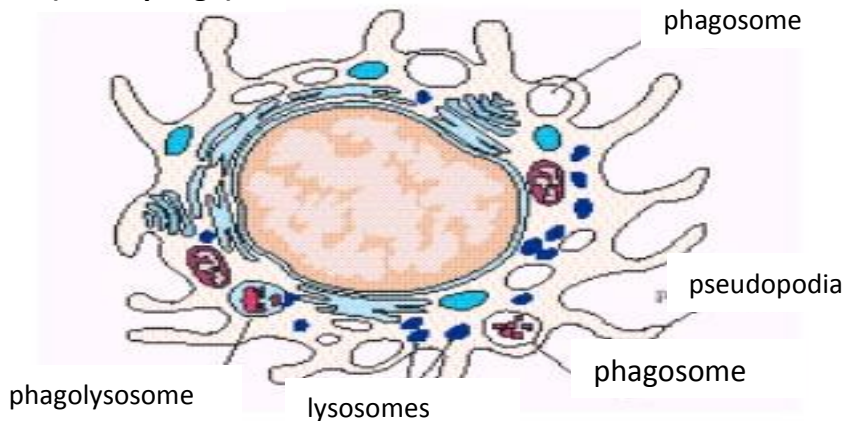

Figure 1.4: Monocyte/macrophage ultrastructure

The ultrastructures for monocyte (A) and macrophage (B) are depicted. ([Http://Www.Clker.Com/Cliparts/B/0/F/1/1206569457439600428Keikannui_Monocyte.Svg.Hi.Png](http://www.Clker.Com/Cliparts/B/0/F/1/1206569457439600428Keikannui_Monocyte.Svg.Hi.Png))

1.4.1 Monocyte/macrophage in malaria

Monocytes/macrophages respond to malaria using different mechanisms:

- Cytokine responses (Chua *et al.*, 2013)
- The secretions of nitric oxide (NO), reactive oxygen species (ROS) (Chua *et al.*, 2013), and phospholipase A2 (PLA2) (Vadas *et al.*, 1993)
- Phagocytosis of infected red blood cells, free parasites (Kumaratilake and Ferrante, 2000), parasite products including glycosylphosphatidylinositol (GPI) and haemozoin (Malaguarnera and Musumeci, 2002).

1.4.1.1 Cytokine responses

When immune cells such as monocytes are exposed to foreign antigens including glycosylphosphatidylinositol (GPI), malaria pigment (haemozoin), infected red blood cells, parasitic proteins (Malaguarnera and Musumeci, 2002), immune-complexes containing parasite DNA (Hirako *et al.*, 2015) and cell debris; the immune cells mount a cytokine response to help the body fight the parasitic infection (Malaguarnera and Musumeci, 2002, Bate *et al.*, 1988, Clark *et al.*, 1981). The response appears to have two aspects to it, a pro-inflammatory and an anti-inflammatory response (Jason *et al.*, 2001).

1.4.1.1.1 Pro-inflammatory cytokines

Tumour necrosis factor-alpha (TNF- α), also known as cachectin, (Chu, 2013) is a pro-inflammatory cytokine produced by monocytes/macrophages (Figure 1.6) (Bate *et al.*, 1988, Chu, 2013). While having homeostatic functions in healthy cells, it can be pathogenic when expressed at high levels (Kallioliias and Ivashkiv, 2016). The TNF- α promoter region has DNA binding sites for NF- κ B (nuclear factor kappa-light-chain-enhancer of B activated cells) suggesting that transcription of TNF- α could activate the NF- κ B pathway, which is responsible for the activation of the pro-inflammatory pathway (Chu, 2013). TNF- α has been suggested to be a mediator for malarial fever, as serum levels correlate with malaria fever (Karunaweera *et al.*, 1992). TNF- α expression may inhibit parasite growth at low concentrations (Taverne *et al.*, 1987), but high levels of TNF- α are associated with placental, severe and cerebral malaria (Odeh, 2001, Richards, 1997, Kwiatkowski *et al.*, 1989, Rudin *et al.*, 1997, Shaffer *et al.*, 1991, Korner *et al.*, 2010). It was suggested that measuring TNF- α levels could indicate the severity of malaria (Kinra and Dutta, 2013). High levels of TNF- α increased ICAM-1 adhesion receptor expression in the brain leading to an increased sequestration of *P. falciparum* infected red blood cells, promoting development of cerebral malaria (Korner *et al.*, 2010, Udomsangpetch *et al.*, 2002). It was reported that high

levels of TNF- α increase the attraction of monocytes, lymphocytes and neutrophils to sites of infection, and enhance their adhesion to endothelial cells, promoting sequestration of cells in the brain microvasculature (Gimenez *et al.*, 2003, Korner *et al.*, 2010). TNF- α secretions were suggested to disrupt the blood-brain barrier which could lead to cerebral malaria (Korner *et al.*, 2010). However, when an anti-TNF therapy was given to children with cerebral malaria, it did not treat the children of cerebral malaria, but only inhibited fever in them (Kwiatkowski *et al.*, 1993). This showed that TNF- α might contribute to cerebral malaria, but is not solely responsible for cerebral malaria (Kwiatkowski *et al.*, 1993). High levels of TNF- α have been associated with severe malaria anaemia (Boeuf *et al.*, 2012, Pathak and Ghosh, 2016, Sarangi *et al.*, 2012) as TNF- α enhances apoptosis in bone marrow derived cells, including red blood cells progenitors (Odeh, 2001). TNF- α secretions are reported to enhance erythrophagocytosis and to suppress erythropoiesis (Odeh, 2001). TNF- α levels differ among individuals based on their genetics, suggesting that other factors can be responsible for determining whether a person will develop uncomplicated or severe malaria (Richards, 1997, Nasr *et al.*, 2014). TNF- α induces the expression of pro-inflammatory cytokines including interleukin 1 (IL-1), interleukin 6 (IL-6) (Kalliolias and Ivashkiv, 2016) and interferon-gamma (IFN- γ) (Richards, 1997).

IL-1 β is produced by monocytes/macrophages, natural killer cells, B cells and dendritic cells (Richards, 1997, Sims and Smith, 2010), and causes fibrosis, degrades tissue matrix and attracts inflammatory cells to sites of infection (Dinarello, 1991, Garlanda *et al.*, 2013). High serum levels of IL-1 β were observed in malaria patients when compared to healthy controls (Mshana *et al.*, 1991, Al-Fadhli *et al.*, 2014, Lyke *et al.*, 2004). IL-1 β expression enhances inflammatory functions of neutrophils and macrophages (Mantovani *et al.*, 2011). Together with TNF- α , IL-1 β expression may have an immunosuppressive reaction on haematopoiesis, which can be associated with severe malarial anaemia (Dinarello, 1991, Richards, 1997, Sarangi *et al.*, 2012). Both TNF- α and IL-1 β induce fever in the host, stimulate the production of reactive oxygen intermediates (ROI), and increase ICAM-1 receptor expression, promoting cytoadherence in malaria (Richards, 1997, Sims and Smith, 2010, Garlanda *et al.*, 2013). IL-1 β stimulates the production of pro-inflammatory cytokines, interleukin-2 (IL-2) and interleukin-6 (IL-6) (Riley *et al.*, 1993, Hunter and Jones, 2015).

Interleukin-6 (IL-6) is another potent pro-inflammatory cytokine secreted by monocytes/macrophages and helper T-cells (Figure 1.6) (Sortica *et al.*, 2014, Riley and Stewart, 2013). IL-6 has been reported to induce B-cell maturation and to promote T-cell survival (Jang *et al.*, 2006, Rincon, 2012). IL-6 has been reported to be expressed at high levels during a stress event such as UV exposure and presence of pathogens (Rincon, 2012). IL-6 suppresses the

production of IFN- γ from T-cells (Rincon, 2012). High levels of IL-6 have been associated with severe malaria (Richards, 1997, Lyke *et al.*, 2004, Keswani *et al.*, 2016, Kern *et al.*, 1989). Together with TNF- α , high levels of serum IL-6 can be used as markers for complicated malaria (Kern *et al.*, 1989). Decreasing IL-6 production was found to decrease parasitaemia in a mouse model, but reducing IL-6 production did not decrease cerebral malaria symptoms in mice infected with *P. berghei* ANKA (Keswani *et al.*, 2016).

Interferon-gamma (IFN- γ), also known as type II interferon (Gray and Goeddel, 1982) is produced by CD8+, CD4+ T-cells and natural killer cells (Figure 1.6) (King and Lamb, 2015, Riley and Stewart, 2013). Interleukin-12 (IL-12) and interleukin-18 (IL-18) stimulate the production of IFN- γ by antigen presenting cells (Figure 1.6) (McCall and Sauerwein, 2010, Riley and Stewart, 2013). IFN- γ activates monocytes/macrophages, stimulating TNF- α , IL-1, and IL-6 production (Malaguarnera and Musumeci, 2002, Richards, 1997). IFN- γ is important in controlling *Plasmodium* infection both in the liver and in erythrocytic stages (King and Lamb, 2015). IFN- γ stimulates the phagocytic activity of macrophages which help with the clearing of malaria parasites (King and Lamb, 2015). While low levels of IFN- γ during early infection are associated with severe malaria, high levels of IFN- γ during late infection are also associated with severe malaria (Hunt and Grau, 2003, Agudelo *et al.*, 2012). It has been reported that high IFN- γ levels may lead to cerebral malaria, but this is not the sole factor leading to cerebral malaria (Hunt and Grau, 2003, Richards, 1997, Malaguarnera and Musumeci, 2002, King and Lamb, 2015, Bakmiwewa *et al.*, 2016).

1.4.1.1.2 Anti-inflammatory cytokines

Anti-inflammatory cytokines such as interleukin-10 (IL-10) and interleukin-4 (IL-4) are associated with malarial infections (Lyke *et al.*, 2004, Richards, 1997). IL-10 is produced by monocytes, type 2 helper T-cells (Th2), and B cells (Riley and Stewart, 2013) (Figure 1.6) and seems to suppress the production of TNF- α , IL-1 and IL-6 by monocytes (Niikura *et al.*, 2011). IL-10 inhibits cytokine production by type 1 T-helper cells (Th1) and CD8+ cells, and aids in the development and maturation of antibodies during malarial infection (Malaguarnera and Musumeci, 2002). High levels of IL-10 decrease the major histocompatibility complex (MHC) class II receptors on macrophages, leading to fewer antigen presentations, which could inhibit parasite killing, and hence aggravate malaria (Niikura *et al.*, 2011). IL-10 inhibits the formation of reactive oxygen intermediates (ROI); T-cell priming and maturation and the production of IFN- γ by T-cells (Malaguarnera and Musumeci, 2002, Couper *et al.*, 2008, Foey *et al.*, 1998, do Rosario and Langhorne, 2012). Hence, it acts as a potent anti-inflammatory cytokine by regulating expression

of pro-inflammatory cytokines (Niikura *et al.*, 2011). High levels of IL-10 have been reported with severe malaria, suggesting that inhibition of pro-inflammatory cytokines may inhibit parasite clearance by immune cells (Lyke *et al.*, 2004, Couper *et al.*, 2008, Wenisch *et al.*, 1995, do Rosario and Langhorne, 2012). Hepcidin is reported to inhibit iron absorption in macrophages (Huang *et al.*, 2014). High levels of IL-10 induces hepcidin production by macrophages, during malaria, which may partly contribute to the development of severe malarial anaemia (Huang *et al.*, 2014).

Interleukin-4 (IL-4) is produced by Th2 cells and inhibits IFN- γ production (Richards, 1997, Eisenhut, 2010). The levels of IL-4 are higher during severe malaria, compared to uncomplicated malaria, which may be related to disease pathogenesis (Cabantous *et al.*, 2009), as too much IL-4 might inhibit phagocytosis of infected red blood cells by macrophages (Perkmann *et al.*, 2005, Richards, 1997, Eisenhut, 2010). However, another study reported that IL-4 levels were associated with parasitaemia level, rather than with the degree of malaria severity (Elhoussein *et al.*, 2015). It was reported that IL-4 increases vascular cell-adhesion factor molecule 1 (VCAM-1) expression on endothelial cells, together with TNF- α . This might promote cerebral malaria by enhancing sequestration of infected red blood cells in the brain (Eisenhut, 2010).

1.4.1.2 Neopterin secretion by monocytes

Neopterin is secreted by IFN-stimulated macrophages (Facer, 1995), and is an important marker of immune activation and inflammation (Awandare *et al.*, 2006, Wachter *et al.*, 1989). Neopterin is synthesized from guanosine triphosphate (GTP), whereby GTP cyclohydrolase-1 breaks down GTP to 7,8-dihydroneopterin 3' tri-phosphate, which is then further metabolized to neopterin (Werner *et al.*, 1990). High levels of neopterin were reported to be present in patients' sera infected with malaria (Ringwald *et al.*, 1991, te Witt *et al.*, 2010) and the neopterin levels correlated with degree of anaemia experienced during malaria (Biemba *et al.*, 1998, Awandare *et al.*, 2006). Cumming *et al.* (2011) measured the expression of the enzyme GTP cyclohydrolase-1, required to synthesize neopterin, during the phagocytosis of β -haematin by IFN- γ stimulated monocytes, and found an increase in GTP cyclohydrolase-1 mRNA expression, suggesting an increase in neopterin secretion. The study, however found a decrease in GTP cyclohydrolase-1 mRNA expression when the monocytes phagocytosed *P. falciparum* infected red blood cells, suggesting a decrease in neopterin production.

1.4.1.3 Phospholipase A2 secretion by monocytes

Phospholipase A2 (PLA2) is an enzyme that participates in the arachidonic pathway. PLA2 acts by cleaving the ester bond at the *sn*-2 position of phospholipids and the products are used to synthesize leukotrienes and prostanoids (Yu *et al.*, 1998, Murakami *et al.*, 2011). PLA2 is expressed and secreted by macrophages (Channon and Leslie, 1990). High plasma levels of circulating PLA2 were found in sera of *P. falciparum* infected children (Vadas *et al.*, 1993). PLA2 levels correlated with parasitaemia (Vadas *et al.*, 1993). Mice deficient of cytosolic PLA2 were infected with *P. berghei* and contrary to expectation, all mice died suggesting that secreted PLA2 and not cytosolic PLA2 cause malaria severity (Ishikawa *et al.*, 2004).

1.4.1.4 Nitric oxide (NO) and reactive oxygen species (ROS) production

TNF- α , IL-1, IL-2 and IFN- γ stimulate nitric oxide (NO) secretion by a wide range of cells, including macrophages (Figure 1.6), endothelial cells, neutrophils and neurons (Newton and Krishna, 1998, Sobolewski *et al.*, 2005, Stuehr and Marletta, 1987, Kim *et al.*, 1999, James, 1995, Riley and Stewart, 2013). NO is made from L-Arginine by the NO synthase enzyme and is reported to have anti-parasitic, anti-tumour activity (Wink *et al.*, 2011, Cartwright *et al.*, 1997, Rockett *et al.*, 1992, Legorreta-Herrera *et al.*, 2011, Riley and Stewart, 2013, James, 1995) and anti-inflammatory properties (Clark *et al.*, 2003). It was thought that high levels of NO were associated with severe malaria by leading to a dysfunction of neurons, contributing to cerebral malaria (Rockett *et al.*, 1992); but it was recently found that low bioavailability of NO led to cerebral malaria in mice (Gramaglia *et al.*, 2006, Yeo *et al.*, 2014, Barber *et al.*, 2016). The mechanisms which lead to low levels of NO are still being debated on. It was found that there were fewer NO producing monocytes in children infected with *P. falciparum*, leading to lower levels of NO (Weinberg *et al.*, 2016). It was also suggested that nitric oxide is removed from the blood circulation by free haemoglobin and by superoxide (Sobolewski *et al.*, 2005).

Monocytes secrete reactive oxygen species (ROS) during an immune response, and the ROS have been shown to kill parasites during malaria (Figure 1.6) (Brinkmann *et al.*, 1984, Percário *et al.*, 2012, Riley and Stewart, 2013). IFN- γ and TNF- α increase the production of superoxide anion radicals, which are converted to ROS by the nicotinamide adenine dinucleotide phosphate-oxidase (NADPH) enzyme (Sanni *et al.*, 1999, Percário *et al.*, 2012). ROS are important for the antimicrobial activity of phagocytes, but excessive amounts of ROS may cause tissue injury. It was thought that ROS might contribute to cerebral malaria, but no relationship between ROS and cerebral malaria in murine models have been found (Sanni *et al.*, 1999). ROS can cause lipid peroxidation of erythrocytes membranes leading to cell lysis (Percário *et al.*, 2012). Even non-

infected erythrocytes which were in contact with activated monocytes that released ROS, underwent cell lysis, leading to anaemia (Mohan *et al.*, 1995, Aguilar *et al.*, 2014).

1.4.1.5 Phagocytosis

Monocytes phagocytose *Plasmodium* infected red blood cells, merozoites and parasite products including haemozoin during malaria (Kumaratilake and Ferrante, 2000, Chua *et al.*, 2013). It was reported that monocytes phagocytose infected red blood cells via CD36 receptors (Figure 1.5) (McGilvray *et al.*, 2000, Ayi *et al.*, 2005). Antibodies against merozoite proteins and parasitic surface proteins on infected red blood cells, bind to monocyte and mediate phagocytosis of infected red blood cells (Figure 1.5) (Chua *et al.*, 2013, Hill *et al.*, 2012, Osier *et al.*, 2014). Antibody-mediated phagocytosis has been associated with protection and immunity to malaria (Osier *et al.*, 2014).

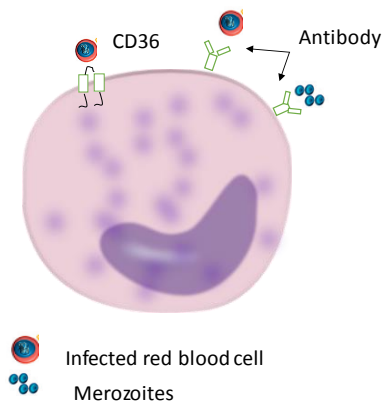

Figure 1.5: Phagocytosis by monocytes in malaria

Monocytes clear parasites by antibody-mediated phagocytosis of infected red blood cell and free merozoites. They also phagocytose infected red blood cell via the CD36 receptor (Chua *et al.*, 2013) (http://www.Clker.Com/Cliparts/B/0/F/1/1206569457439600428Keikannui_Monocyte.Svg.Hi.Png).

1.4.1.6 Influence of haemozoin (malaria pigment) on the immune responses

Mammalian red blood cells (erythrocytes) are highly specialized cells which do not have a nucleus. They comprise primarily of haemoglobin for oxygen and carbon dioxide transport (Gilson *et al.*, 2016). While in the red blood cell, the trophozoite stage of the malaria parasite ingests and degrades host erythrocyte haemoglobin avidly, releasing free haem in the cell (Goldberg *et al.*, 1990, Tilley *et al.*, 2011). This can be harmful as free haem can cause oxidative damage to the parasites (Percário *et al.*, 2012). The parasite has therefore developed mechanisms to rapidly convert the degradation products of haemoglobin into a non-toxic crystalline form, called haemozoin or malaria pigment which is stored in its digestive vacuole (Ihekwereme *et al.*, 2014,

Parroche *et al.*, 2007, Tilley *et al.*, 2011). Haemozoin is a ferriprotoporphyrin IX crystal and is a dark brown insoluble pigment. It was thought that haemoglobin degradation provides the parasites with essential amino acids (Goldberg *et al.*, 1990, Ihekwereme *et al.*, 2014, Parroche *et al.*, 2007, Giribaldi *et al.*, 2011), but other studies contradicting this hypothesis (Coronado *et al.*, 2014), have reinforced the notion that haemoglobin is degraded to create a proper functional environment for the parasites to develop (Boura *et al.*, 2013).

During schizont rupture, parasitic haemozoin is released into the blood circulation and is rapidly phagocytosed by monocytes (Skorokhod *et al.*, 2014). However, haemozoin is not completely digested leading to an accumulation of haemozoin in phagocytic cells and in various organs such as the spleen, liver and brain (Skorokhod *et al.*, 2014, Malaguarnera and Musumeci, 2002). Haemozoin seems to modulate monocyte responses (Sun *et al.*, 2016, Skorokhod *et al.*, 2014). Incomplete breakdown of haemozoin leads to uncontrolled monocyte functions, such as inhibition of repeated phagocytosis, impaired antigen presentation, inhibition of the oxidative burst releasing ROS, dysregulation of chemotactic motility and impaired erythropoiesis (Giribaldi *et al.*, 2010, Skorokhod *et al.*, 2014, Schwarzer *et al.*, 1992, Schwarzer and Arese, 1996, Malaguarnera and Musumeci, 2002).

Monocytes incubated with either purified *Plasmodium* haemozoin or synthetic haemozoin expressed high levels of cytokine production, including TNF- α , IL-12, and chemokines such as macrophage inflammatory protein-1 α (MIP-1 α) and MIP-1 β (Jaramillo *et al.*, 2009, Giribaldi *et al.*, 2010). IFN- γ activation of NO has also been reported to increase in the presence of haemozoin (Jaramillo *et al.*, 2009, Olivier *et al.*, 2014, Ranjan *et al.*, 2016). It was reported that macrophages treated with haemozoin only did not stimulate the production of NO, but pre-treated macrophages with haemozoin and stimulated by IFN- γ , produced NO (Ranjan *et al.*, 2016). Other studies have however, reported a decrease in IL-2, IL-12 and IFN- γ cytokines following monocytes/macrophages phagocytosis of haemozoin, but an increase in IL-10, TNF- α and IL-1 β expressions, suggesting a role of haemozoin in immunosuppression (Deshpande and Shastry, 2004, Scorza *et al.*, 1999). Mandala *et al.* (2016) reported a decrease in TNF- α and IL-6 producing monocytes in children with cerebral malaria and severe malaria anaemia. They attributed this immunosuppression to the presence of haemozoin (Mandala *et al.*, 2016). Monocytes are less likely to undergo apoptosis when laden with haemozoin. This can increase the burden of unregulated immune responses, as dysfunctional monocytes may produce uncontrolled amounts of cytokines, leading to disease pathogenesis (Giribaldi *et al.*, 2010, Skorokhod *et al.*, 2014, Schwarzer *et al.*, 1992).

The accumulation of haemozoin in the spleen may contribute to the development of anaemia, as it was found that spleen enlargement occurs during malaria, and that the red blood cell and white blood cell counts decrease when β -haematin (synthetic haemozoin) was given to healthy mice (Sun *et al.*, 2016). Recently, it was found that children with severe malaria anaemia had higher amounts of haemozoin laden monocytes when compared to children with cerebral malaria (Mandala *et al.*, 2016). Haemozoin laden monocytes/macrophages, have increased production of pro-inflammatory mediator macrophage migration inhibitory factor (MIF), which has been associated with malarial anaemia as it suppresses production of red blood cells (Awandare *et al.*, 2007).

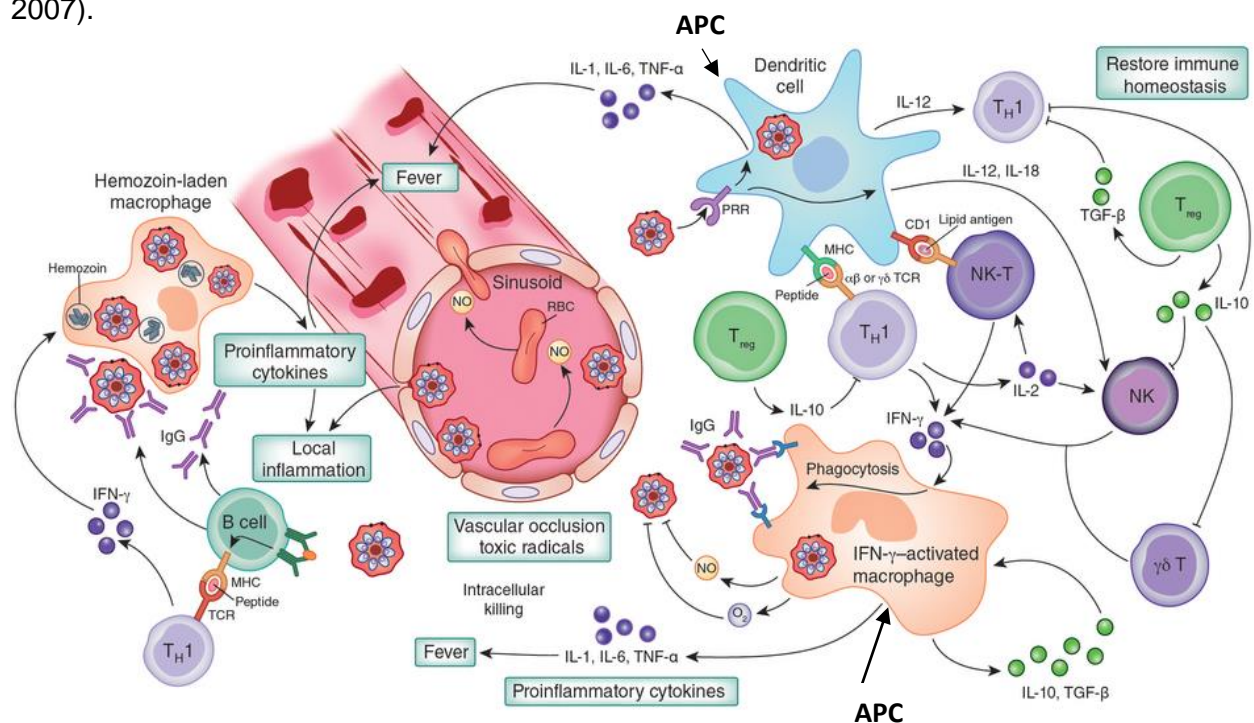

Figure 1.6: Immune responses to malaria infection

Antigen presenting cells (APC) including dendritic cells and macrophages bind to parasitic protein exposed on the surface of infected red blood cells, ingest, process them and present antigenic peptides on their surface. T-cells including T_H1 bind to the antigenic peptides, and mount an immune response. T_H1 cells produce $IFN-\gamma$, which activate macrophages. The activated macrophages express $IL-1$, $TNF-\alpha$ and $IL-6$ inducing fever. Activated monocytes enhance phagocytosis of infected red blood cells. $IL-2$ expressed by T_H1 cells activates natural killer cells which also produce $IFN-\gamma$. The dendritic cells produce $IL-12$ and $IL-18$ which activate natural killer cells. $IL-10$ and $TGF-\beta$ are produced by monocytes. Nitric oxide and reactive oxygen species are produced by activated macrophages which help in killing malaria parasites. T regulatory cells also secrete $IL-10$ to modulate the immune response. Haemozoin-laden macrophages secrete pro-inflammatory cytokines. B cells bind to T_H1 cells and make antibodies against the parasites and infected red blood cells (Riley and Stewart, 2013).

1.5 Antimalarial drugs

Antimalarial drugs are compounds that kill malaria parasites (Blanchard, 1947, Cunha-Rodrigues *et al.*, 2006). There are different families of drugs namely 4-Aminoquinolines (chloroquine, amodiaquine, piperazine); Amino-alcohols (quinine, quinidine, mefloquine, halofantrine, lumefantrine); Sulfonamides and sulfones (sulfadoxine, sulfalene, dapsone); Biguanides (proguanil, chloroproguanil); Diaminopyrimidine (pyrimethamine); 8-Aminoquinoline (primaquine); Sesquiterpene lactones (artemisinin, arte-ether, artemether, artesunate, dihydroartemisinin); naphthoquinone (atovaquone) and antibiotics (azythromycin, clindamycin, doxycycline, tetracycline) (WHO, 2010). Understanding how antimalarial drugs influence monocyte HSP70 expression may give an insight on how they affect monocyte responses. This study focused on nine antimalarial drugs and their effects on monocyte HSP70 expression, during fever conditions to see whether the antimalarial drugs can affect monocyte responses by influencing monocyte HSP70 expression. The antimalarial drugs used were chloroquine, quinine, quinidine, quinacrine, pyrimethamine, primaquine, artemisinin, artemether and artesunate.

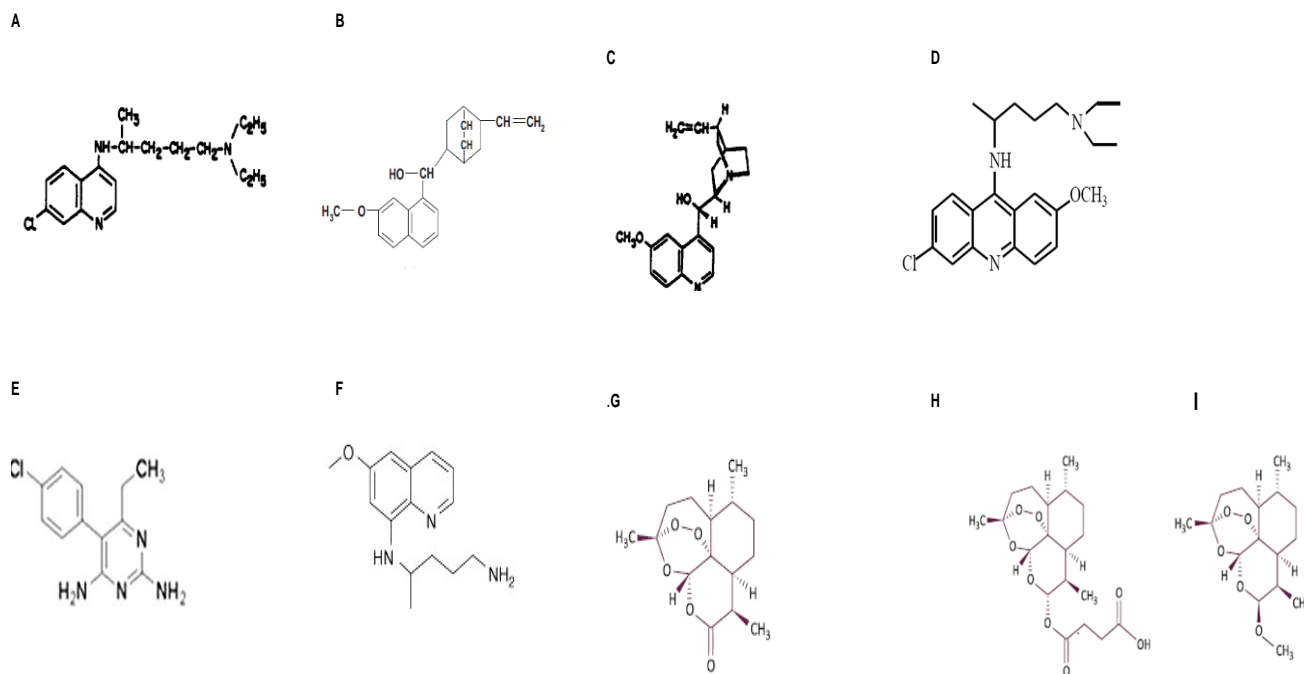

Figure 1.7: Chemical structures of antimalarial drugs

The chemical structures of each antimalarial drug used is shown. (A) Chloroquine (Slater, 1993); (B) Quinine (Okombo *et al.*, 2011); (C) Quinidine (Slater, 1993); (D) Quinacrine (Ehsanian *et al.*, 2011); (E) Pyrimethamine (Aboge *et al.*, 2008); (F) Primaquine (Miller *et al.*, 2013); (G) Artemisinin (Tilley *et al.*, 2016); (H) Artesunate (Tilley *et al.*, 2016); (I) Artemether (Tilley *et al.*, 2016).

1.5.1 Chloroquine

Chloroquine (7-chloro-4(4-diethylamino-1-methylbutylamino) quinolone) (Figure 1.7) has been extensively used for the treatment of malaria (Slater, 1993) for decades but with the advent of chloroquine resistant strains of parasites, its use is now limited (Thomé *et al.*, 2013). Chloroquine is used together with primaquine to treat *P. vivax* malaria (Thomé *et al.*, 2013). As parasites invade red blood cells, they actively digest haemoglobin and convert it to haemozoin which is deposited in the digestive vacuole (Thomé *et al.*, 2013). Chloroquine is thought to interfere with the formation of haemozoin from haemoglobin digestion (Thomé *et al.*, 2013, Schlitzer, 2008, Bray *et al.*, 1999). Chloroquine was reported to inhibit *P. falciparum* phospholipase A2 in infected red blood cells which could contribute to the antimalarial activity of the drug (Zidovetzki *et al.*, 1993). Chloroquine inhibited *P. falciparum* pyridoxal kinase, suggesting that it could affect the parasite metabolism (Kimura *et al.*, 2014).

Parasites have developed resistance to chloroquine which has reduced its use in malaria (Thomé *et al.*, 2013, Schlitzer, 2008, Slater, 1993). In non-resistant parasite strains, it is speculated that chloroquine enters and gets accumulated in the parasite digestive vacuole (Thomé *et al.*, 2013). The mechanism by which chloroquine gets accumulated is still debated on. One hypothesis is that unprotonated chloroquine travels into the infected red blood cell, and into the parasite vacuole. Once in the vacuole, chloroquine becomes protonated and cannot leave the parasite vacuole, hence becoming trapped (Krogstad and Schlesinger, 1986, Thomé *et al.*, 2013). In resistant parasite strains, the *P. falciparum* chloroquine resistance transporter (*PfCRT*), which is a trans-membrane protein located in the parasite's digestive vacuole (Thomé *et al.*, 2013, Fidock *et al.*, 2000), is mutated (Chinappi *et al.*, 2010). One amino acid at position 73 on the trans-membrane protein is mutated from lysine to threonine (Fidock *et al.*, 2000, Thomé *et al.*, 2013). It allows chloroquine to leave the digestive vacuole as fast as it enters, hence preventing accumulation of chloroquine (Thomé *et al.*, 2013).

Chloroquine has been used to treat rheumatoid arthritis and systemic lupus erythematosus due to its anti-inflammatory properties (Macfarlane and Manzel, 1998, Thomé *et al.*, 2013). Chloroquine inhibits phospholipase A2 activation by causing acidification of lysosomes in platelets (Nujic *et al.*, 2012, Nosál *et al.*, 1995, Jančinová and Danihelová, 2000) and in macrophages (Bondeson and Sundler, 1998). Chloroquine inhibits the expressions of TNF- α , IL-6 and IL-1 β in monocytes (López Suárez *et al.*, 2014, Jang *et al.*, 2006, Bondeson and Sundler, 1998) and in splenocytes (Gumede *et al.*, 2009). Chloroquine inhibited IFN- γ expression from concavalin A-treated splenocytes (Gumede *et al.*, 2009). Infected mice with *P. berghei* were given

chloroquine, and an increase in reactive oxygen species expressed by the spleen cells was reported (Prada *et al.*, 1996). The drug was reported to inhibit nitric oxide expression in IFN- γ stimulated macrophages (Hrabák *et al.*, 1998, Park *et al.*, 1999). Chloroquine inhibited phagocytosis of infected red blood cells (Shalmiev *et al.*, 1996), β -haematin and latex beads (Cumming, 2009) by monocytes.

1.5.2 Quinine

Quinine was isolated from the bark of the cinchona (quina-quina) tree, and has been used to treat malaria since 1600s (Okombo *et al.*, 2011). The drug is still used as the second line of treatment for malaria (Achan *et al.*, 2011, Ménard *et al.*, 2013). Quinine (6-methoxy-(5-vinyl-2-quinuclidinyl)-4-quinolinemethanol) (Slater, 1993), is a cinchona alkaloid and forms part of the amino-alcohol group of antimalarial drugs (Figure 1.7) (Achan *et al.*, 2011, Hellgren *et al.*, 1995). Quinine is a monoprotic base (Silamut *et al.*, 1991) and is reported to be very basic (Achan *et al.*, 2011, Hellgren *et al.*, 1995). Quinine is thought to accumulate within the parasite digestive vacuole and interfere with haemozoin formation, causing the parasites to die from haem induced toxicity (Ménard *et al.*, 2013, Schlitzer, 2008, Egan *et al.*, 1994). Quinine exerts its effects on the schizont erythrocytic stage of parasites. Quinine inhibits gametocyte growth in *P. vivax* and *P. malariae* but not in *P. falciparum* (Achan *et al.*, 2011). The drug has been found to inhibit plasmodial phospholipase A2 in infected red blood cells (Zidovetzki *et al.*, 1993). Quinine disrupts rosettes between *P. falciparum* infected red blood cells and non-infected red blood cells (Goldring *et al.*, 1999) and it was found to decrease cytoadherence between infected red blood cells and monocytes (Goldring and Nemaorani, 1999). Quinine was found to be more potent at inhibiting rosetting compared to cytoadherence (Udomsangpetch *et al.*, 1996).

Quinine resistance has been rarely found and has not progressed over the years (Ménard *et al.*, 2013). Resistance has been associated with mutations in the *P. falciparum multidrug resistance-1 (pfmdr-1)* (Zalis *et al.*, 1998) and *pfcr1* genes (Ménard *et al.*, 2013, Okombo *et al.*, 2011). Both *pfmdr-1* and *pfcr1* genes encode for transporter proteins, suggesting that accumulation of quinine is not sustained in the parasite vacuole (Okombo *et al.*, 2011). Another mutation on *P. falciparum Na⁺/H⁺ exchanger-1* gene (*pfneh-1*) was identified to cause quinine resistance, but it was found present in only endemic areas (Ménard *et al.*, 2013). The Na⁺/H⁺ exchanger was reported to be involved in regulating the pH within the parasite's digestive vacuole (Bennett *et al.*, 2007). An increased *PNHE* activity was reported in quinine resistant strains, suggesting that the pH within the digestive vacuole is increased (Bennett *et al.*, 2007, Ménard *et al.*, 2013). This could interfere

with the accumulation of quinine within the digestive vacuole (Ménard *et al.*, 2013). However, the mechanism for quinine resistance is still hypothetical and requires more research (Okombo *et al.*, 2011).

Quinine was reported to inhibit TNF- α mRNA expression in alveolar macrophages at a concentration of 200 μ M (Maruyama *et al.*, 1994). However, another study reported that quinine did not affect TNF- α production from macrophages isolated from human volunteers at concentration below 100 μ M (Picot *et al.*, 1993). Quinine decreased nitric oxide production by LPS-activated macrophages (Lowry *et al.*, 1998) and inhibited phagocytosis of infected red blood cells by monocytes (Kwiatkowski and Bate, 1995, Shalmiev *et al.*, 1996). Phagocytosis of β -haematin by monocytes was enhanced in the presence of quinine, but phagocytosis of latex beads was inhibited by quinine (Cumming, 2009). GTP cyclohydrolase-1 mRNA expression was inhibited by 1.63 fold by quinine in IFN- γ stimulated U937 monocytes, implying that quinine inhibits neopterin secretion (Cumming *et al.*, 2011).

1.5.3 Quinidine

Quinidine was also isolated from the bark of cinchona tree (Achan *et al.*, 2011). Quinidine is the *d*-enantiomer of quinine (White *et al.*, 1981, Achan *et al.*, 2011) and was found to be more active than quinine due to its stereochemistry (Slater, 1993). Like quinine, quinidine is a cinchona alkaloid, which belongs to the amino alcohol group (Figure 1.7) (Achan *et al.*, 2011). It inhibits the formation of haemozoin and β -haematin (synthetic form of haemozoin) (Egan *et al.*, 1999, Silva *et al.*, 1997, Sullivan *et al.*, 1998). Quinidine was found to be more effective than quinine when treating uncomplicated malaria (Phillips *et al.*, 1985, White *et al.*, 1981), and has also been used for treating cardiac arrhythmias (Aviado and Salem, 1975).

Quinidine inhibited the phagocytosis of latex beads (Das and Misra, 1994), apoptotic and necrotic cells by mouse macrophages (Ablin *et al.*, 2005). Quinidine stimulated the production of TNF- α in peripheral blood mononuclear cells (Matsumori *et al.*, 1997).

1.5.4 Quinacrine

Quinacrine, also known as mepacrine and atabrine, is a heterocyclic three ring compound that is used for the treatment of malaria (Figure 1.7) (Chumanovich *et al.*, 2016), giardiasis, tapeworm infection, lupus, and arthritis (Ehsanian *et al.*, 2011). Quinacrine damages DNA by disrupting the structure of the DNA. Quinacrine stacks between DNA base pairs and causes them to intercalate (Ehsanian *et al.*, 2011).

Quinacrine inhibited phospholipase A2 (PLA₂) activity by binding to the membrane phospholipid, and intercalating into the membrane which disrupts PLA₂ activity in rat liver (Löffler *et al.*, 1985), endometrial cells (Ahmed *et al.*, 1992, Ehsanian *et al.*, 2011) and macrophages (Bondeson and Sundler, 1998). Quinacrine inhibited IL-1 β expression in mouse peritoneal macrophages (Bondeson and Sundler, 1998). It was reported that quinacrine decreased inducible NO protein expression in murine macrophages (Chumanevich *et al.*, 2016).

1.5.5 Pyrimethamine

Pyrimethamine forms part of the anti-folate category of antimalarial drugs (Figure 1.7) (Cowman and Lew, 1989). It targets the parasite dihydrofolate reductase (DHFR) and dihydropteroate synthase (DHPS) enzymes, therefore impairing the parasite synthesis of dihydrofolate (Cui *et al.*, 2015). However, parasites quickly developed resistance against pyrimethamine and the drug is now used in combination with sulfadoxine (Watkins *et al.*, 1997, Schlitzer, 2008). Mutations in the *dhfr* gene account for drug resistance, which decrease the uptake of pyrimethamine by the parasites (Cowman and Lew, 1989, Müller and Hyde, 2013). Mutations in parasite transporters have also been linked to pyrimethamine resistance, such as in *P. falciparum* multi-drug resistance associated protein-1 (*PfMRP1*), *P. falciparum* multi-drug resistance-2 (*PfMDR2*).

Pyrimethamine was reported to increase IFN- γ and transforming growth beta (TGF- β) secretions in mice infected with *P. yoelli* (Ramos-Avila *et al.*, 2007). Another study found that pyrimethamine increased NO secretion in the serum and spleen of infected mice with *P. yoelli*, hence suggesting that pyrimethamine causes oxidative stress which may aid in parasite clearance (Legorreta-Herrera *et al.*, 2010). Pyrimethamine has been shown to disrupt rosettes between *P. falciparum* infected red blood cells and non-infected red blood cells (Goldring *et al.*, 1999) and it was found that it enhanced phagocytosis of β -haematin by monocytes/macrophages (Cumming, 2009).

1.5.6 Primaquine

Primaquine is widely used to treat *P. vivax* infections as it prevents relapse of the disease resulting from liver dormant stages (Baird and Hoffman, 2004, Fernando *et al.*, 2011). Primaquine decreases the number of circulating gametocytes (Delves *et al.*, 2012, Baird and Hoffman, 2004). The mechanism by which primaquine kills parasites is still poorly understood (Thomas *et al.*, 2016). Some studies suggest it could bind to parasite DNA and alter it (López-Antuñano, 1999) while others have suggested that primaquine could affect parasite mitochondrial activity or cause oxidative stress (Lalève *et al.*, 2016, Ganesan *et al.*, 2012). Lalève *et al.* (2016) suggested that primaquine could act on Fe-S containing clusters, and cause oxidative stress to the parasite.

Primaquine was found to inhibit pyridoxal kinase, important for the synthesis of vitamin B6, in both human HeLa cells and *P. falciparum* parasites (Kimura *et al.*, 2014), suggesting that primaquine could exert its antimalarial activity by affecting parasite vitamin B6 synthesis. While primaquine resistance has been reported, its mechanism still needs to be explored (Thomas *et al.*, 2016).

Primaquine was shown to disrupt rosettes between *P. falciparum* infected red blood cells and non-infected red blood cells (Goldring *et al.*, 1999). Primaquine increased IL-10 and TGF- β expressions, but decreased TNF- α , IFN- γ and IL-17 expressions in mice which were given autoimmune encephalomyelitis (Zanucoli *et al.*, 2014). Primaquine decreased GTP cyclohydrolase-1 mRNA expression in IFN- γ stimulated U937 monocytes by 1.29 fold, hence decreasing neopterin secretion (Cumming *et al.*, 2011). Primaquine inhibited PLA2 activity *in vitro* (Authi and Traynor, 1979). The drug enhanced phagocytosis of β -haematin in murine macrophages (J774A.1) and human monocytes (U937), but inhibited latex bead phagocytosis in those cells (Cumming, 2009).

1.5.7 Artemisinin derivatives (Artemisinin, artesunate, artemether)

Artemisinin is a natural product extracted from the Chinese herb *Artemisia annua* and has long been used for the treatment of malaria (Hou and Huang, 2016, Saeed *et al.*, 2016, Balint, 2001). Artemisinin is a sesquiterpene trioxane lactone comprising of a peroxidase bridge (Figure 1.7) (Hou and Huang, 2016, Balint, 2001). The peroxidase bridge was reported to be necessary for the anti-malarial activity of artemisinin (Balint, 2001). Artemisinin and its derivatives including artesunate, arte-ether and artemether are used as the first line of treatment for malaria, as advised by WHO (Van Agtmael *et al.*, 1999, WHO, 2015a). Artemisinin derivatives are potent antimalarial drugs as they act rapidly and clear parasites from the blood within 48 hours (Van Agtmael *et al.*, 1999). Artesunate, artemether and dihydroartemisinin (DHA) have better bioavailability and efficacy than artemisinin (Shakir *et al.*, 2011, Hou and Huang, 2016). Artemether and artesunate are also known as pro-drugs as they are both metabolized to dihydroartemisinin (DHA), the active compound (Shakir *et al.*, 2011). Although very effective, artemisinin derivatives have short half-lives, typically 1 hour and are used in combination with other anti-malarial drugs to increase their bioavailability. The mechanism by which artemisinin derivatives works is thought to involve the breakdown of the endoperoxide bond, catalysed by iron (Hou and Huang, 2016, Shakir *et al.*, 2011). This produces carbon-centred radicals which react with parasite proteins and cause oxidative stress (Antoine *et al.*, 2014, Crespo-Ortiz and Wei, 2011). Artemisinin was also reported to inhibit endocytosis in *P. falciparum*, preventing the parasites from acquiring their nutrients from digesting the host cytoplasm (Hoppe *et al.*, 2004). Artemether decreased cytoadherence between infected red blood cells and monocytes very effectively (Goldring and Nemaorani, 1999).

Artemisinin derivatives act against all stages of malaria, but are most effective against the trophozoite erythrocytic stage (Shakir *et al.*, 2011). At the trophozoite stage, the parasite is actively degrading high amounts of haemoglobin in the erythrocyte, which releases iron that activates artemisinin derivatives (Shakir *et al.*, 2011).

While artemisinin derivatives are very effective, resistance against them has appeared (Tilley *et al.*, 2016). Artemisinin resistance is characterised by slow clearance of parasites (Ariey *et al.*, 2014, Ashley *et al.*, 2014). Mutations which were found within a *kelch* repeat of the C-terminal K-13 propeller gene, present in *PF3D7* parasite strain, were linked to artemisinin-based resistance parasites (Tilley *et al.*, 2016, Ashley *et al.*, 2014, Ariey *et al.*, 2014).

Artemisinin was reported to decrease TNF- α and IL-6 expressions in RAW264.7 murine macrophage-like cell line induced by CpG oligodeoxynucleotides (ODN), LPS and heat-killed *E. coli* (Wang *et al.*, 2006). The inhibition of TNF- α expression was attributed to the inhibition of the NF- κ B pathway (Wang *et al.*, 2006). In splenocytes, artemisinin decreased IL-2, IFN- γ and IL-6 expressions (Gumede *et al.*, 2009). Artemisinin inhibited NO secretion in RAW246.7 murine macrophage like cells by inhibiting IFN- β expression in the cells (Park *et al.*, 2012). Konkimalla *et al.* (2008) reported a decrease in NO expression in monocytes in the presence of artemisinin, during malarial infection. Artemisinin disrupted rosettes between *P. falciparum* infected and non-infected red blood cells (Goldring *et al.*, 1999) and decreased the expression of monocyte receptors by about 40% (Goldring and Nemaorani, 1999). Cumming *et al.* (2011) found that artemisinin decreased GTP cyclohydrolase-1 mRNA expression from IFN- γ stimulated U937 cells. Artemisinin enhanced β -haematin phagocytosis but decreased latex beads phagocytosis by murine and human derived monocytes (Cumming, 2009). Wensch *et al.* (1997) reported an inhibition of neutrophil phagocytosis, but an increase in reactive oxygen species expressed by neutrophils, in the presence of artemisinin.

Artesunate decreased TNF- α and IL-6 expressions in mouse peritoneal macrophages, stimulated by heat-killed *Escherichia coli* (*E. coli*), LPS, CpG Oligodeoxynucleotide (CpG ODN) (Li *et al.*, 2008) and heat-killed *Staphylococcus aureus* (Li *et al.*, 2010). Artesunate also decreased TLR9 and TLR4 mRNA expressions in a murine macrophage like cell line; RAW264.7 which suggested that artesunate inhibited the NF- κ B pathway (Li *et al.*, 2008). Li *et al.* (2010) reported that artesunate inhibited TNF- α expression by inhibiting the toll-like receptor 2 (TLR 2) mRNA expression and nucleotide-binding oligomerization domain containing 2 (Nod2) expression, which led to a NF- κ B inhibition. Artesunate decreased NO mRNA expression in murine macrophages (Konkimalla *et al.*, 2008). Artesunate decreased neutrophil phagocytosis but increased the

secretion of reactive oxygen species in neutrophils (Wenisch *et al.*, 1997). Artesunate inhibited IL-10 and IFN- γ expressions in splenocytes at high concentration (90 μ M), but no effect was observed at low concentration (3 μ M) (Gumede *et al.*, 2009). However, another study using an artemisinin synthetic derivative SM934, reported an increase in IL-10 production in mouse macrophages (Hou *et al.*, 2012).

Artemether decreased IFN- γ and IL-2 expressions from mice splenocytes, suggesting that artemether modulates T cell responses (Wang *et al.*, 2007). Artemether decreased nitric oxide expression in collagen induced arthritic mice (Cuzzocrea *et al.*, 2005). Mice infected with *P. berghei*, after treatment with artemether produced more reactive nitrogen intermediates and reactive oxygen intermediates when compared to untreated mice (Prada *et al.*, 1996). Phagocytosis by neutrophils was inhibited by artemether (Wenisch *et al.*, 1997). There was an increased IL-4 production in splenocytes isolated from mice who had tumors, when treated with artemether (Farsam *et al.*, 2011).

1.6 Anti-inflammatory drugs

During a malaria infection, reactive oxygen species, reactive nitrogen intermediates and pro-inflammatory cytokines are expressed in large quantities to combat the infection (Percário *et al.*, 2012, Lourembam *et al.*, 2013). Anti-inflammatory drugs that decrease pro-inflammatory cytokine expression and decrease oxidative stress are thought to help reduce inflammation during malaria (Percário *et al.*, 2012). Four anti-inflammatory drugs were chosen in this study, namely danazol (Liu *et al.*, 2000), ambroxol (Gillissen and Nowak, 1998), probucol (Fu *et al.*, 2015) and curcumin (Reddy *et al.*, 2005) as they decrease oxidative stress, inflammatory cytokines and have antimalarial properties (Goldring and Ramoshebi, 1999, Jain *et al.*, 2013, Herbas *et al.*, 2015). They could be used as an adjunct therapy to antimalarial drugs during malaria. Their effects on monocyte HSP70, during fever conditions might give an insight on their effects on monocyte responses.

1.6.1 Danazol

Danzol is a heterocyclic weak androgen (Letchumanan and Thumboo, 2011) which can inhibit Luteinizing hormone (LH) and follicle stimulating hormone (FSH). It has been used to mainly treat endometriosis (Surrey and Halme, 1992), benign breast lesion and angioneurotic edema (Letchumanan and Thumboo, 2011) but its use in malaria treatment has been poorly documented. Danazol was reported to decrease cytoadherence between monocytes and infected

red blood cells *in vitro*, suggesting that it could decrease monocyte receptors, and reduce sequestration during malaria (Goldring and Ramoshebi, 1999).

Danazol inhibited TNF- α and IL-6 protein expressions in peritoneal macrophages, by potentially decreasing the calcium concentration in the macrophages (Liu *et al.*, 2000). Danazol inhibited IL-1 β and TNF- α protein expressions from streptococcal activated monocytes (Mori *et al.*, 1990) and decreased estrogen receptor gene expression in monocytes (Fujimoto *et al.*, 1995). Danazol suppressed estrogen binding sites on monocytes by competing with estrogen *in vitro* (Wada *et al.*, 1992). The drug inhibited endometrial cell proliferation by peripheral monocytes, suggesting that danazol could affect monocyte growth factors (Braun *et al.*, 1994). Danazol was reported to affect peripheral blood monocyte phagocytosis minimally (Magri *et al.*, 1997).

1.6.2 Ambroxol

Ambroxol has been widely used to treat chronic lung diseases due to its mucolytic and surfactant enhancing properties (Utsugi *et al.*, 2002, Lee *et al.*, 1999). Ambroxol also has anti-oxidant and anti-inflammatory properties due to its ability to scavenge reactive oxygen species (Gillissen and Nowak, 1998) but its use in malaria has not been well explored. Except for Goldring and Ramoshebi (1999) who reported a decrease in cytoadherence between monocytes and *P. falciparum* infected red blood cells, no other studies relating ambroxol to malaria were found.

Ambroxol has a wide range of effects on monocyte responses (Beeh *et al.*, 2008). The drug inhibited platelet-derived growth factor (PDGF) mRNA expression in LPS-stimulated THP-1 monocytes (Utsugi *et al.*, 2002), inhibited NO, reactive oxygen species secretions and calcium concentration in LPS-activated alveolar macrophages (Lee *et al.*, 1999). Ambroxol was found to inhibit histamine production from Con-A stimulated monocytes (Gibbs *et al.*, 1999). Ambroxol inhibited IL-2, TNF- α and IFN- γ production from broncho-alveolar macrophages and peripheral blood mononuclear cells (Pfeifer *et al.*, 1997, Bianchi *et al.*, 1990). Ambroxol inhibited IL-12 secretion in LPS-activated alveolar macrophages (Aihara *et al.*, 2000) and inhibited IL-1 β mRNA expression in LPS-activated monocytes (Bianchi *et al.*, 1990, Beeh *et al.*, 2008). In another study, ambroxol was reported to decrease TNF- α , IL-6, hydrogen peroxide, and nitric oxide secretions from LPS-activated alveolar macrophages (Jang *et al.*, 2003, Cho *et al.*, 1999). Ambroxol did not have any effect on the phagocytic ability of monocytes (Capsoni *et al.*, 1984).

1.6.3 Probucol

Probucol is an anti-oxidant, and an anti-hyperlipidaemia drug that has been used to treat cardiovascular diseases (Kume *et al.*, 2016, Fu *et al.*, 2015). It has been reported to decrease α -

tocopherol transfer protein present in the liver responsible for modulating vitamin E concentration, in sera of hypercholesterolemic patients (Elinder *et al.*, 1995, Levander *et al.*, 1995). α -tocopherol deficient mice were infected with *P. berghei* and it was found that the mice did not develop cerebral malaria (Herbas *et al.*, 2010). Probucol was also found to decrease parasitaemia in infected mice with *P. yoelli* and *P. berghei* (Herbas *et al.*, 2015, Kume *et al.*, 2016). The infected mice were protected against malaria and survived the infection, as compared to non-treated mice (Herbas *et al.*, 2015, Kume *et al.*, 2016). Another study reported that probucol decreased the effective dose of dihydroartemisinin (DHA) to clear parasites (Kume *et al.*, 2016) and suggested that probucol could be used together with DHA to clear malaria parasites. Probucol, by decreasing α -tocopherol, decreased the level of vitamin E (Herbas *et al.*, 2015). Free radicals could not be scavenged, which might have caused DNA damage in the parasites (Kume *et al.*, 2016). Probucol decreased cytoadherence between monocytes and *P. falciparum* infected red blood cells, which might also decrease cerebral malaria (Goldring and Ramoshebi, 1999).

Probucol has anti-inflammatory properties (Guo *et al.*, 2015). In diabetes mellitus induced-rabbits, probucol decreased TGF- β , NF- κ B and TNF- α expressions in the atrial tissue (Fu *et al.*, 2015). Probucol decreased vascular cell adhesion molecule (V-CAM) receptor expression in human vascular endothelial cells (Zapolska-Downar *et al.*, 2001). The drug decreased hydrogen peroxide production from macrophages in pancreatic islet cells, decreasing oxidative stress (Fukuda *et al.*, 1995). IL-1 β production was inhibited by probucol in differentiated macrophages (Akeson *et al.*, 1991).

1.6.4 Curcumin

Curcumin (diferuloylmethane) also known as turmeric, haldi and ukon, has been used in Asian medicine for a long time (Sharma *et al.*, 2005). Curcumin, isolated from the roots of the *Curcuma longa* plant has anti-tumorigenic, anti-oxidant, anti-inflammatory, anti-microbial and anti-protozoal activity (Reddy *et al.*, 2005, Zhang *et al.*, 2016, Sharma *et al.*, 2005). Curcumin was found to decrease *P. falciparum* parasitaemia in both chloroquine-susceptible (Cui *et al.*, 2007) and chloroquine-resistant strains (Reddy *et al.*, 2005, Cui *et al.*, 2007), by increasing the levels of reactive oxygen species in the parasites and inhibiting parasite histone acetylation transferase (HAT) (Cui *et al.*, 2007). HAT is responsible for post-translational modifications on histone, and hence responsible for gene expression. Inhibiting parasite HAT could lead to a dysregulation of gene expression and impair parasite growth (Cui *et al.*, 2007). Curcumin was found to damage parasite tubulin which could partially account for the anti-malarial activity of curcumin (Chakrabarti *et al.*, 2013). Curcumin used in combination with primaquine increased survival of *P. berghei*

infected mice and decreased the effective amount of primaquine required to exert its antimalarial activity (Aditya *et al.*, 2009). Curcumin decreased malaria parasitaemia in mice, and resulted in 100% survival of mice infected with *P. berghei* malaria when used in combination with arte-ether (Reddy *et al.*, 2005, Nandakumar *et al.*, 2006, Memvanga *et al.*, 2013). Curcumin was reported to prevent the breakdown of blood brain barrier and prevent sequestration of infected red blood cells in infected *P. berghei* mice (Dende *et al.*, 2015). The mice did not develop cerebral malaria, but they all died with anaemia since curcumin did not effectively inhibit parasite growth (Dende *et al.*, 2015). Curcumin inhibited brain endothelial cell apoptosis induced by infected red blood cells, PBMC and platelets, similar to artesunate (Kunwittaya *et al.*, 2014). Curcumin is being favoured as an adjunct therapy in the treatment of malaria due to its immunomodulatory properties and its effects in preventing cerebral malaria (Jain *et al.*, 2013, Mimche *et al.*, 2012).

Curcumin decreased IL-8, IL-1 β and TNF- α secretions in LPS-stimulated alveolar macrophages (Literat *et al.*, 2001). Curcumin decreased IL-1, IL-6, IL-18, TNF- α , TGF- β mRNA expressions in subcutaneous tissue from mice who were exposed to radiation (Okunieff *et al.*, 2006, Julie and Jurenka, 2009). In the presence of high level of glucose, THP-1 monocytes expressed high levels of cytokines including IL-6 and TNF- α , which were inhibited by curcumin (Yun *et al.*, 2011, Julie and Jurenka, 2009). Curcumin inhibited human HAT p300 mRNA expression, which is a coactivator of NF- κ B, and therefore, inhibited cytokine expression by inhibiting the NF- κ B pathway (Yun *et al.*, 2011). Curcumin was reported to inhibit the NF- κ B pathway by inhibiting phosphorylation of I κ B α (Kanitkar *et al.*, 2008, Soetikno *et al.*, 2011, Jobin *et al.*, 1999, Reyes-Gordillo *et al.*, 2007). Curcumin decreased NO mRNA expression from cytokine-stimulated pancreatic islet cells (Kanitkar *et al.*, 2008). Curcumin inhibited the pro-inflammatory cytokines IL-1, IL-8, TNF- α production in LPS-activated monocytes and alveolar macrophages (Abe *et al.*, 1999, Bisht *et al.*, 2009) and inhibited IL-12 expression in thioglycolate-stimulated peritoneal mouse macrophages (Gao *et al.*, 2004). Inhibition of IL-12 led to the decrease of IFN- γ and increase in IL-4 expressions in LPS-activated macrophages by curcumin (Reyes-Gordillo *et al.*, 2007). Curcumin was reported to induce apoptosis in tumor cell lines including breast carcinoma cells, ovarian carcinoma cells but not in non-transformed cells including rat lymphocytes and rat skin fibroblasts (Varalakshmi *et al.*, 2008). The drug enhanced T-cell proliferation in mice which were challenged with ConA, and contrary to other studies, curcumin was reported to not affect NO expression from macrophages isolated from LPS-challenged mice (Varalakshmi *et al.*, 2008). Bisht *et al.* (2009) reported an increase in phagocytosis in mouse macrophages, in the presence of curcumin. Curcumin was reported to increase CD36 receptor expression on human monocytes

and increased ROS production in monocytes (Mimche *et al.*, 2012). Because of its wide range of actions, curcumin has been proposed to be a promiscuous agent, but there is not much data supporting this idea (Silver, 2011).

A summary of the effects on the antimalarial and anti-inflammatory effects on the immune responses are described in table 1.1.

1.7 Heat shock proteins

Heat shock proteins (HSPs) are highly conserved proteins, present in abundance in a large variety of species, including prokaryotes and eukaryotes (Kregel, 2002, Kiang and Tsokos, 1998). HSPs were first discovered in 1962 in *Drosophila melanogaster*, when they were accidentally heat shocked (Srivastava *et al.*, 1998, Kiang and Tsokos, 1998, Lindquist, 1980). HSPs are expressed when cells are exposed to stress, including heat shock, glucose deprivation, pH changes, presence of heavy metals, strong oxidants and UV irradiation to name a few (Figure 1.9). HSPs are important in cell homeostasis as they are involved in the proper folding of newly translated proteins and assist with protein translocation across membranes (Nollen and Morimoto, 2002). HSPs protect cells against cytotoxicity arising from stress (Jäättelä and Wissing, 1993). They do so by binding to proteins and helping them to regain/retain their proper conformation, and to prevent them from aggregating (Nollen and Morimoto, 2002). They also take part in cell signalling pathways, and inhibit apoptosis (Nollen and Morimoto, 2002, Samali and Cotter, 1996, Gabai *et al.*, 1997, Mosser *et al.*, 1997).

HSPs are distinguished by their molecular weights, and are distributed in different cellular compartments including the cytosol, nucleus, mitochondria and endoplasmic reticulum (Kregel, 2002, Kiang and Tsokos, 1998, Murphy, 2013). High molecular weight HSPs include HSP60, HSP70, HSP90 and HSP110 (Kiang and Tsokos, 1998) and low molecular weight HSPs include HSP10, HSP27 and HSP40 (Kim *et al.*, 2006). HSP40 acts as a co-chaperone to HSP70 and helps in regulating the functions of HSP70 by controlling its association with other polypeptides (Fan *et al.*, 2003). HSP60 is found within the mitochondrial matrix and is important for the proper folding of mitochondrial proteins (Bukau and Horwich, 1998). HSP110 acts as a co-chaperone to HSP60 and regulates its function by regulating the ATPase and substrate-binding activity of HSP60 (Bukau and Horwich, 1998, Parcellier *et al.*, 2003). HSP90 is also a major heat shock protein present in abundance in cells (Parcellier *et al.*, 2003, Nathan and Lindquist, 1995), and is involved in maintaining cell stability by preventing denaturing of proteins (Parcellier *et al.*, 2003), as with HSP70. However, HSP90 seems to be more selective towards its substrate polypeptide

(Picard, 2002, Young *et al.*, 2001). HSP110 acts as a chaperone by binding to denatured proteins and uses ATP to help them regain their proper conformation. It also helps HSP70 to renature misfolded proteins (Mattoo *et al.*, 2013). HSP27 forms part of the small heat shock protein family and has been extensively studied (De *et al.*, 2000). HSP27 is expressed constitutively in cells and is overexpressed during stress conditions. It has been associated with acquired thermotolerance (Landry *et al.*, 1992). In this study, more focus has been put on HSP70.

1.7.1 Heat Shock Protein 70 (HSP70) Family

HSP70 proteins are the most conserved of all HSPs (Kregel, 2002). Thirteen proteins which are similar in sequences from the HSP70 family have been reported (Brocchieri *et al.*, 2008, Boswell-Casteel *et al.*, 2015). Grp78 and Bip form part of HSPA5; HSPA8 consists of HSC70 and HSP73; HSPA9 consists of mortalin and mtHSP70 (Kampinga *et al.*, 2009, Brocchieri *et al.*, 2008, Boswell-Casteel *et al.*, 2015). These proteins are constitutively expressed and have important roles in maintaining cell homeostasis (Kampinga *et al.*, 2009). HSPA5 proteins are found in the endoplasmic reticulum and are involved in the proper folding of secretory proteins (Boswell-Casteel *et al.*, 2015, Gidalevitz *et al.*, 2013). HSPA8 proteins are found both in the nucleus and in the cytosol. They maintain cell homeostasis by regulating protein translocation and degrade proteins which could be harmful (Ziemienowicz *et al.*, 1995, Boswell-Casteel *et al.*, 2015). HSPA9 proteins are found mainly in the mitochondria and are responsible for protein translocation in the mitochondrial matrix (Kaul *et al.*, 2007, Boswell-Casteel *et al.*, 2015). The stress inducible form of HSP70 is called HSPA1A (Smith *et al.*, 2007) and is the main focus of this study. HSPA1A is referred to as HSP70 in this study.

HSP70 consists of a 44 kDa fragment, an 18 kDa protein binding domain and a 10 kDa fragment (Figure 1.8) (Kiang and Tsokos, 1998, Kumar *et al.*, 2016). The 44 kDa fragment, after X-ray crystallography, has been shown to comprise of four domains forming two lobes, with a deep cleft in between them (Kiang and Tsokos, 1998). It contains the ATPase domain (Kregel, 2002). The 18 kDa protein binding domain/substrate binding domain consists of two four-stranded antiparallel β -sheets and a single α -helix, as modelled by nuclear magnetic resonance. The 10 kDa fragment forms an α -helix which is followed by a glycine/proline rich segment, close to the conserved EEVD sequence (Kiang and Tsokos, 1998). EEVD residues are important in mediating translation of HSP70 during heat shock and are important for substrate binding and refolding. The EEVD domain interacts with the co-chaperone Hop (HSP70-HSP90 organising protein) during protein folding (Matambo *et al.*, 2004, Brinker *et al.*, 2002).

Constitutive HSP70 (HSC70) is about 73 kDa and is always expressed in cells (Kregel, 2002). Inducible HSP70 (HSPA1A) is about 72 kDa and is expressed when cells undergo stress. The HSP70 gene is about 2440 bp in size with a 212 bp leader sequence and a 242 bp 3' untranslated region (Kregel, 2002, Smith *et al.*, 2007). Induction of HSP70 during a stress event involves heat shock transcription factors (HSFs) binding to heat shock element (HSEs) in the DNA (Figure 1.9). After HSP70 is expressed in sufficient amounts, it binds to HSF preventing it from binding to HSE, therefore, acting as a negative regulator of HSP70 expression (Figure 1.9) (Kiang and Tsokos, 1998, Abravaya *et al.*, 1992). Following a stressful condition, such as heat shock for a transient amount of time, inducible HSP70 expression (HSPA1A) increases tolerance in cells to the stress (Kregel, 2002).

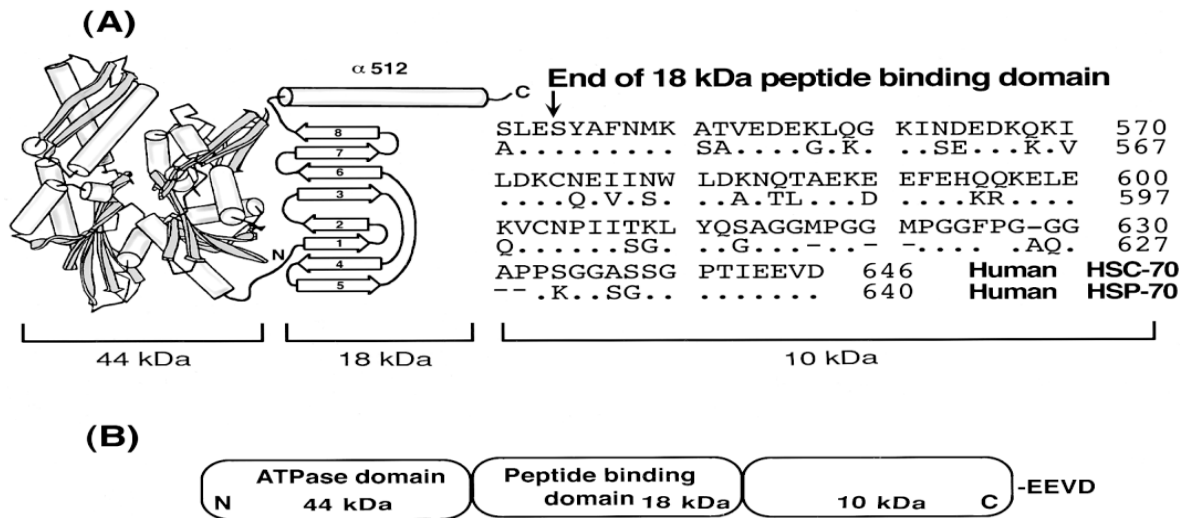

Figure 1.8: Schematic diagram of HSP70/HSC70 structure

The 3-D structure of HSP70/HSC70 is shown in (A), where the differences between HSP70 and HSC70 are shown, based on the amino acid sequence of 10 kDa domain. (B) shows the domains of HSP70, containing the ATPase domain, and a peptide binding domain. The 10 kDa C-terminal domain with the highly conserved EEVD sequence is shown (Kiang and Tsokos, 1998).

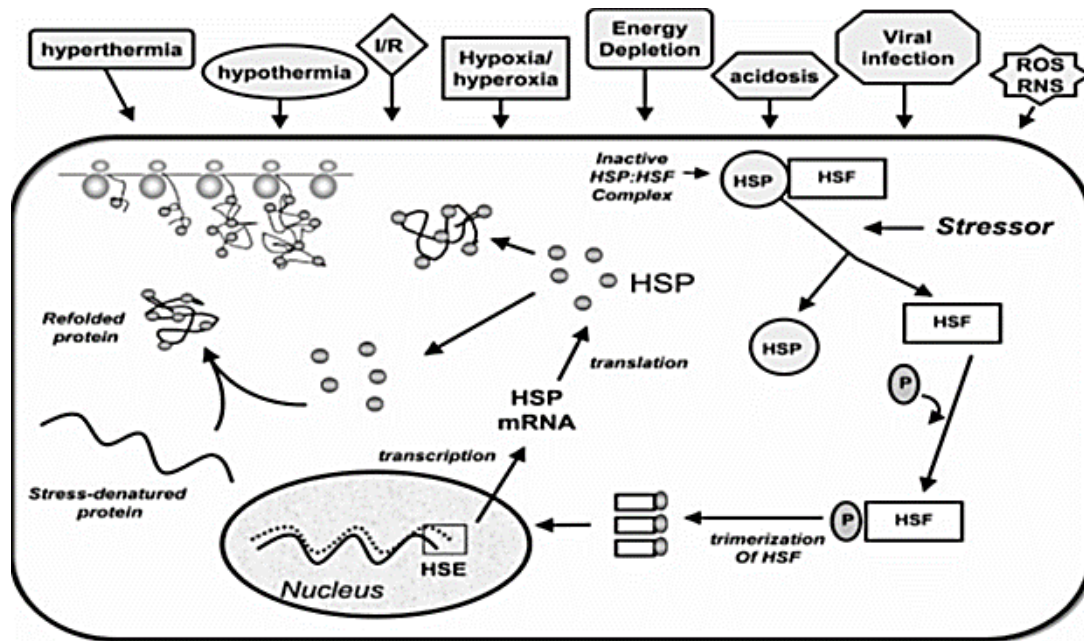

Figure 1.9: Induction of inducible HSP70

Different stimuli activate the expression of HSP70, causing the inactive HSP/HSF complex to dissociate, allowing the HSF to bind to HSE in the nucleus and initiate HSP70 production. HSP70 then binds to denatured protein and renatures them (Kregel, 2002).

1.7.2 Intracellular HSP70 and monocyte/macrophage

Intracellular HSP70 has been reported to be anti-inflammatory due to its inhibitory effects on pro-inflammatory cytokines (Borges *et al.*, 2012). Monocytes/macrophages have the highest expression of inducible HSP70 when compared to other leukocytes including neutrophils (Oehler *et al.*, 2001). HSP70 inhibited NO secretion from IFN- γ stimulated murine peritoneal macrophages (Kim *et al.*, 1999). It was reported that increased HSP70 expression decreased the level of mRNA expressions of TNF- α , IL-1 β , IL-10 and IL-12 in LPS-activated human peripheral blood monocyte-derived macrophages (Ding *et al.*, 2001). Another study reported that HSP70 increased IL-10 protein expression in macrophage rich peritoneal exudate cells (Yang *et al.*, 2013). Increased production of heat shock factor-1 (HSF-1) in RAW264.7 macrophages increased the mRNA expression of IL-10, suggesting that increased HSP70 stimulates IL-10 production (Zhang *et al.*, 2012). Post heat shock, increased HSP70 expression was found to inhibit IL-12 mRNA expression in both LPS-activated murine peritoneal macrophages and in LPS-activated murine macrophage like cells (RAW264.7) (Li *et al.*, 2001). Li *et al.* (2001) suggested that HSP70 could inhibit these pro-inflammatory cytokines by inhibiting the NF- κ B pathway since the latter is responsible for the expression of TNF- α , IL-1, IL-8 and IL-12. NF- κ B is activated when its inhibitor I- κ B is degraded and it was suggested that HSP70 prevents degradation of the I- κ B inhibitor (Li *et al.*, 2001). *In vivo* inhibition of TNF- α and IL-6 expressions by HSP70 were reported

in mice sera, who were challenged with high doses of TNF- α (Van Molle *et al.*, 2002). Increased expression of HSP70 was reported to inhibit PLA2 secretion in TNF-induced WEHI cells, supporting the notion that intracellular HSP70 is anti-inflammatory (Jäättelä and Wissing, 1993), however another study reported that HSP70 activated PLA2 *in vitro* (Mahalka *et al.*, 2011). Monocyte responses to increased HSP70 expression in monocytes/macrophage are summarised in Figure 1.10.

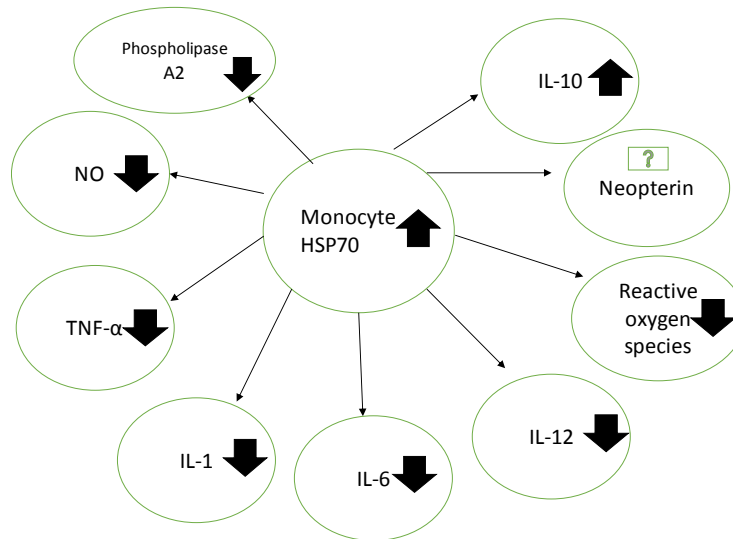

Figure 1.10: Summary of monocyte responses due to increased intracellular monocyte HSP70 expression

HSP70 inhibits expressions of pro-inflammatory cytokines including TNF- α , IL-1, IL-6, IL-12 and reduces oxidative stress by decreasing reactive oxygen species and nitric oxide expression. The anti-inflammatory cytokine IL-10 expression is enhanced by HSP70. The effect of HSP70 expression on neopterin secretion is unknown. \blacktriangleup Represents an increased expression; \blacktriangledown represents a decreased expression.

1.7.3 Extracellular HSP70 and immune responses

While HSP70 is considered an intracellular protein, it was also found to be secreted by monocytes (Asea *et al.*, 2000). Extracellular HSP70 was thought to act as a cytokine, affecting other cells and stimulating the production of pro-inflammatory cytokines such as TNF- α , IL-6 and IL-1 β and NO secretion in monocytes (Asea *et al.*, 2000, Panjwani *et al.*, 2002). Contradictory studies have, however reported that the cytokine functions of HSP70 could have been a result of the use of endotoxin contaminated HSP70 (Tsan and Gao, 2004). There is still a debate on whether extracellular HSP70 is anti-inflammatory or pro-inflammatory.

Endotoxin free HSP70 was expressed in insect cells, which was used to study whether extracellular HSP70 exerted pro-inflammatory effects (Zheng *et al.*, 2010). Mouse splenocytes were incubated with the endotoxin free HSP70, and it was found to increase the protein

expression of pro-inflammatory cytokines including TNF- α , IL-12 and IFN- γ . It was also observed that the anti-inflammatory cytokine IL-4 protein expression increased with the addition of extracellular HSP70, but more focus was put on the pro-inflammatory cytokines (Zheng *et al.*, 2010). U937 monocytes transfected with HSP70 cDNA, overexpressed HSP70 and secreted HSP70 in the cell medium (Lee *et al.*, 2006). Non-transfected U937 cells were incubated with the cell medium containing the extracellular HSP70, and it was found that they had an increased expression of matrix metalloproteinase-9 (MMP), showing that extracellular HSP70 has pro-inflammatory properties (Lee *et al.*, 2006). Campisi *et al.* (2003) found that when rat macrophages and splenocytes were incubated with extracellular HSP70, higher protein expressions of TNF- α , IL-6, IL-1 β and NO were observed. These studies suggest that extracellular HSP70 acts as a danger signal to other cells and activate the immune responses (Campisi *et al.*, 2003).

There is a continuous debate on whether extracellular HSP70 is pro-inflammatory or anti-inflammatory. Ferat-Osorio *et al.* (2014) found that extracellular HSP70 inhibited TNF- α and IL-6 expression in TLR-activated monocytes, hence, acted as anti-inflammatory. Endotoxin free HSP70 was used in the assay. Luo *et al.* (2008) reported an increased level of the anti-inflammatory cytokine IL-10 protein expression in fibroblast-like synoviocytes when incubated with extracellular HSP70. Another study reported a decrease in pro-inflammatory cytokines including TNF- α and IFN- γ in bone marrow derived murine dendritic cells incubated with extracellular HSP70 (Borges *et al.*, 2013).

1.7.4 Heat shock and HSP70 expression during malaria

Periods of fever (>37°C) are experienced during malaria and have been reported to kill parasites (Kwiatkowski, 1989, Long *et al.*, 2001). Fever is a defence mechanism induced by the body in response to infection and damage (Singh and Hasday, 2013). Fever causes heat shock in both the malaria parasites and the host (Oakley *et al.*, 2007, Polla, 1991). In the human host, during a malaria infection, host HSP70 has been reported to be expressed on the cell surface of infected red blood cells (Banumathy *et al.*, 2002). Natural killer cells recognise the exposed HSP70 and secrete granulocyte B which is cytotoxic for the parasites (Bottger *et al.*, 2012). Febrile episodes which are associated with periods of fever have been reported to aid malaria parasites advance from ring to trophozoite erythrocytic stage (Pavithra *et al.*, 2004, Gravenor and Kwiatkowski, 1998). Febrile episodes stimulated the expression of *Plasmodium falciparum* HSP90 (*PfHSP90*), which was found to be important in allowing the parasites to progress in the infection cycle. Inhibition of *PfHSP90* led to a decrease in the number of parasites transiting from the ring stage to trophozoite stage (Pavithra *et al.*, 2004). It was reported that fever increased the production of

genes responsible for causing cytoadherence and rosetting including *Var* genes (Oakley *et al.*, 2007) and *PfEMP1* (Udomsangpetch *et al.*, 2002) in *Plasmodium* parasites that were heat shocked (Oakley *et al.*, 2007, Udomsangpetch *et al.*, 2002). Udomsangpetch *et al.* (2002) reported increased cytoadherence of infected red blood cells to purified CD36 and ICAM-1 receptors with heat shock, when compared to red blood cells that were not heat shocked. Increased adherence of infected red blood cells to mouse fibroblasts transfected with CD36 or ICAM-1 was shown with heat shock, when compared to non-heat shock conditions (Udomsangpetch *et al.*, 2002). It was reported that infected red blood cells were less deformable than healthy red blood cells with heat shock (Marinkovic *et al.*, 2009). Fever was associated with increased phosphatidylserine expression on *P. falciparum* infected red blood cell membrane, which could be associated with increased cytoadherence during malaria (Pattanapanyasat *et al.*, 2010). These findings suggested that fever could contribute to the pathogenesis to malaria. The expression of *P. falciparum* HSP70 (*PfHSP70*) was enhanced in heat shocked *P. falciparum* parasites (Oakley *et al.*, 2007) and was present in all stages of parasite development, suggesting that *PfHSP70* could play a role in parasite survival during heat shock (Matambo *et al.*, 2004). *PfHSP70* maintains parasite homeostasis by preventing protein aggregation during heat shock, and to maintain parasite proteins in their native forms (Przyborski *et al.*, 2015).

1.7.5 Effects of antimalarial, anti-inflammatory drugs, and β -haematin on HSP70 expression

Quinacrine was reported to inhibit HSP70 protein expression in HeLa cells (Neznanov *et al.*, 2009). The study showed that quinacrine inhibited heat shock factor (HSF) from initiating transcription of HSP70 (Neznanov *et al.*, 2009, de Billy *et al.*, 2009). Danazol decreased HSP70 expression in endometrial cells, as measured by immunostaining (Ota *et al.*, 1997) and probucol decreased HSP70 protein expression in the left atrial tissue of alloxan-diabetic induced rabbits (Fu *et al.*, 2015). Curcumin induced expression of HSP70 in leukemia cells via the translocation of HSF to the nucleus, allowing it to bind HSE and induce transcription of HSP70 (Teiten *et al.*, 2009) and increased HSP70 expression in rat cortical cells (Xia *et al.*, 2015). Haemozoin, the natural form of β -haematin, increased HSP27 in monocytes but not HSP70 (Prato *et al.*, 2010), while a recent study reported that haemozoin reduced the expression of HSP70 in human leukemia cells (Kempaiah *et al.*, 2016). The effects of the listed antimalarial and antimalarial drugs on monocyte HSP70, during malaria fever are unknown. The effects they have on other cell lines' HSP70 could be used as a reference to determine whether similar results are being

obtained in this study. Table 1.1 shows a summary of the effects of the antimalarial and anti-inflammatory effects on HSP70.

Table 1.1: Summary table showing the effects of the antimalarial/anti-inflammatory drugs on immune responses and on HSP70.

Antimalarial/anti-inflammatory drugs	Effects on immune responses	Effects on HSP70
Chloroquine	<p>↓ TNF-α, IL-6, IL-1β</p> <p>↑ ROS</p>	No info
Quinine	↓ TNF- α , NO	↑
Quinidine	↑ TNF- α	No info
Quinacrine	↓ TNF- α , IL-1 β , NO	↓
Pyrimethamine	↑ IFN- γ , TGF- β , NO	No info
Primaquine	<p>↑ IL-10, TGF-β</p> <p>↓ TNF-α, IFN-γ, IL-17</p>	No info
Artemisinin	<p>↓ TNF-α, IL-6, IL-2, IFN-γ, IL-6, NO</p> <p>↓ ROS</p>	No info
Artesunate	↓ TNF- α , IL-6, NO, IL-10, IFN- γ	No info
Artemether	<p>↓ IFN-γ, IL-2, NO</p> <p>↑ ROS, IL-4</p>	No info
Danazol	↓ TNF- α , IL-6, IL-1 β	↓
Ambroxol	↓ NO, ROS, IL-2, TNF- α , IFN- γ , IL-12, IL-1 β , IL-6, NO	No info
Probucol	↓ TGF- β , TNF- α , hydrogen peroxide, IL-1 β	↓
Curcumin	<p>↓ IL-8, IL-1β, TNF-α, IL-10, IL-6, IL-18, TGF-β, NO, IL-12</p> <p>↑ IL-4</p>	↑

1.8 Aims of the study

Antimalarial, anti-inflammatory drugs and β -haematin all have immunomodulatory functions in malaria, but their effects on monocyte inducible HSP70 (HSPA1A) expression, during fever have not been well documented. It was hypothesized that monocyte HSP70 expression will give an overview of how the drugs and β -haematin might affect monocyte responses. This study aims to recombinantly express HSP70 and to raise antibodies against human HSP70 so that they can be used to study the effects of antimalarial and anti-inflammatory drugs, at therapeutic concentrations, on monocyte HSP70 protein expression under fever-like conditions. The effect of β -haematin (malaria pigment) on monocyte HSP70 expression will also be studied to see if it affects monocyte responses through HSP70 protein expression.

Intracellular HSPA1A, the inducible form of HSP70 was studied as it is expressed during stress conditions such as fever and its upregulation or downregulation could give an insight on how the drugs and β -haematin affect the monocytes.

CHAPTER 2: MATERIALS AND METHODS

2.1 Introduction

This chapter describes the biochemical, immunochemical methods, molecular biology techniques, phage display and cell culture methods used in this study.

2.2 Materials and reagents

All reagents were from Sigma-Aldrich (Missouri, USA), unless specified otherwise. They were of analytical grade. *Taq* polymerase was obtained from Takara Bio Inc (Japan, Kusatsu). Restriction endonucleases were obtained from Thermo Scientific Fisher (Massachusetts, USA). Secondary antibodies were bought from Jackson ImmunoResearch Laboratories Inc (Pennsylvania, USA)

2.3 Sub-cloning of human HSP70

The plasmid pcDNA5/FRT/TO HIS HSPA1A was a gift from Harm Kampinga (Addgene plasmid # 19537) (Cambridge, Massachusetts) and pET-28a plasmid was obtained from Novagen (Damstadt, Germany). The plasmids were isolated using ThermoScientific GeneJET plasmid mini-prep kit (www.thermofisher.com). They were digested with *Bam*HI and *Not*I restriction endonucleases, gel purified using the ThermoScientific GeneJET gel extraction kit (www.thermofisher.com) and these were ligated using T4 ligase, following the manufacturer's instructions (www.thermofisher.com). Competent JM109 and BL21-(DE3) *E. coli* cells were transformed with the ligation mix, and successful transformations were screened using restriction digests using the same set of restriction endonucleases (Sambrook *et al.*, 1989). All digestions were viewed on 1% (w/v) agarose gels (Sambrook *et al.*, 1989).

2.4 Expression, purification of rHSP70 and assay for ATPase activity

Recombinant expression of HSP70 from the pET-28a-HSP70 plasmid was carried out in BL21-(DE3) *E. coli* cells. The cultures were grown in Luria-bertani (LB) media [10 g/L Bactotryptone, 5 g/L Yeast extract, 10 g/L NaCl, 2 g/L glucose, pH 7.2], terrific-broth (TEB) [1.2% (w/v) Bactotryptone, 2.4% (w/v) yeast extract, 0.4% (v/v) glycerol, 1% (v/v) potassium-phosphate buffer, pH 7.2], or 2xYT media [5 g/L NaCl, 16 g/L tryptone, 10 g/L yeast extract, pH 7.2], containing 50 µg/ml kanamycin. The cultures were grown at 37°C or 20°C and induced with 0.3 mM isopropyl thioglucopyranoside (IPTG), when they reached an OD₆₀₀ 0.4-0.6. Terrific broth (TEB) was also used for auto-induction of rHSP70 as described by Studier (2005). The cells were collected by

centrifugation at 4000 xg for 10 min. Cells were lysed either by freeze-thaw (4 cycles), lysozyme lysis (1 mg/ml, 1 h, 30°C) or sonication using a Virsonic 60 sonicator (8 W, 3x30 s) on ice. The lysate was centrifuged at 12000 xg for 20 min at 4°C. The his-tagged recombinant HSP70 was affinity-purified from soluble cell extract using a TALON[®] resin according to manufacturer's instructions (www.clontech.com). Care was taken to make sure that only pure HSP70 was isolated, by running SDS-PAGE gels and doing corresponding western blots. Since the recombinant HSP70 was not used in cell assays, the level of endotoxin was not measured. Endotoxin level could be measured using the LAL assay to ensure its purity. The malachite green assay was used to measure the ATPase activity of rHSP70. The hydrolysis of ATP releases a free inorganic phosphate that forms a phospho-molybdate complex, which reacts with malachite green to give a colour change, that can be detected using the spectrophotometer at 650 nm (Rowlands *et al.*, 2004). The procedure was adapted from Rowlands *et al.* (2010). Kinetic analysis was carried out using a non-linear regression fit of the data values to the Michaelis-Menten equation.

2.5 Gel-filtration chromatography

The purity and oligomeric state of rHSP70 were analysed using gel-filtration chromatography on a Sephacryl S200 column (~309 ml volume). The column was pre-equilibrated with two column volumes of the buffer [50 mM NaH₂PO₄ 150 mM NaCl, pH 8.0]. 5 mg of rHSP70 in 4 ml of buffer was applied to the column and 2 ml fractions were collected. The flow-rate was 1 ml/min. The column was calibrated using appropriate molecular weight markers (6 mg blue dextran (2000 kDa), and 15 mg each of sheep IgG (150 kDa), bovine serum albumin (68 kDa), ovalbumin (45 kDa), and myoglobin (18.8 kDa)).

2.6 Electrophoresis, western blotting and determination of protein concentration

Proteins were resolved on reducing SDS-PAGE gels (7.5%, 10%, 12.5%) (Laemmli, 1970), and stained with Coomassie Brilliant Blue R-250 (Sigma-Aldrich) staining solution. After running SDS-PAGE, the proteins were electrophoretically transferred overnight at constant 40 mA to a nitrocellulose membrane (Goldring, 2015a). The membrane was blocked with 5% (w/v) non-fat milk in phosphate-buffered saline (PBS) [NaCl (8 g/L), KCl (0.2 g/L), NaH₂PO₄ (1.02 g/L), KH₂PO₄ (0.2 g/L), pH 7.2], containing 0.05% (v/v) Tween-20. The blots were probed with mouse anti-His tag IgG antibody, Merck BioSciences (Damstadt, Germany) (1:4000), and goat anti-mouse HRPO IgG as secondary antibody (1:1000). The western blots were viewed using the VersaDoc[™] gel

documentation system, purchased from BioRad (California, USA). Protein concentrations were measured using the Bradford assay, adapted from Bradford (1976) (Goldring, 2015b).

2.7 Antibody production in chickens

2.7.1 Chicken immunization and IgY isolation

Standard protocols were followed to raise chicken polyclonal serum against rHSP70 (Goldring *et al.*, 2005, Krause *et al.*, 2015). Briefly, 50 µg of rHSP70 was administered intramuscularly to two chickens. The rHSP70 was mixed 1:1 in Freund's adjuvant. The first immunisation was done in Freund's complete adjuvant, while incomplete Freund's adjuvant was used for booster immunisations. Ethical approval for this study was granted by the Animal Research Ethics Committee of the University of KwaZulu-Natal (004/15/Animal). Eggs were collected daily and stored at 4°C, until used. IgY isolation was done according to Goldring and Coetzer (2003), based on a modification of the method described by Polson *et al.* (1980).

2.7.2 Direct ELISA

For the IgY titre of eggs post immunisation, Nunc Maxisorp ELISA plates were coated with 1 µg/ml of rHSP70 in coating buffer [0.1 M NaHCO₃ pH 9.6], overnight at 4°C. Un-bound rHSP70 was removed by washing, and the wells were blocked with 0.5% (w/v) BSA-PBS for 1 h, then washed thrice with 0.01% (v/v) PBS-T. 25 µg/ml of IgY was added to each well, and incubated (2 h, 37°C), then washed as above. Rabbit anti-chicken IgY HRPO antibodies were added to each well (1:10000), and allowed to bind (1 h, 37°C). The plate was washed again, and the substrate [0.05% (w/v) ABTS; 0.0015% (v/v) H₂O₂; 0.15-M citrate phosphate buffer, pH 5.0] was added and left to develop in the dark for 30 min. The plates were read in a FLUOstar OPTIMA ELISA-plate reader (BMG, LabTECH, Ortenberg, Germany) at 405 nm. Specific antibodies from the IgY pool were isolated and purified from AminoLink™ resin, as per the manufacturer's instructions (www.thermofisher.com) (Krause *et al.*, 2015). The affinity-purified anti-rHSP70 antibodies were compared to a mouse monoclonal anti-HSP70 antibody, clone number C92F3A-5 (StressMarq Biosciences, Victoria, Canada).

2.8 Selection of scFv against rHSP70

2.8.1 *Nkuku*® library

The *Nkuku*® library, derived from chicken bursa, was developed by Van Wyngaardt *et al.* (2004). The naïve library consisting of about 2x10⁷ clones was merged with a sub-library consisting of amino acids that code for the third H chain complementarity region 3 (CDR3) so that the number of clones was increased to about 2x10⁹. Phagemids were used as the vector for display since

they have high transformation efficiencies. They are packaged within phage particles that require helper phages, M13K07 to provide the structural proteins (Hoogenboom *et al.*, 1998).

2.8.2 Selection of specific clones

2.8.2.1 Panning

Panning methodology was adapted from Van Wyngaardt *et al.* (2004), with some modifications. Briefly, four consecutive rounds of panning were carried out in immuno-tubes (Nunc Polysorp) coated with affinity-purified rHSP70 (100-12.5 µg/ml) in coating buffer, overnight at 4°C. The immuno-tubes were blocked with either 2% (w/v) skimmed milk-PBS, or 3% (w/v) BSA-PBS or used alternatively in subsequent rounds of panning. After blocking, the immuno-tubes were washed with 0.1% (v/v) PBS-T. 10¹² phage particles were pre-incubated in the blocking buffer for 30 min at room temperature (RT), then added to the tubes and incubated for 2 h at RT. After incubation, the tubes were washed with PBS-T and PBS (20x each). Logarithmic phase TG1 *Escherichia coli* (*E. coli*) cells were either infected by on column-bound phages (on column infection) or by eluted phages (off column infection). The infected cells were grown on TYE-Ampicillin agar plates [15 g/L agar; 8 g/L NaCl; 10 g/L Tryptone; 5 g/L yeast extract; 100 µg/ml Ampicillin] overnight at 30°C, and phages were rescued by PEG precipitation as described by Van Wyngaardt *et al.* (2004).

2.8.2.2 Polyclonal phage ELISA

Phages were isolated from every round of panning, and used in polyclonal phage ELISA. The ELISA protocol was adapted from Van Wyngaardt *et al.* (2004), with some modifications. Briefly, the wells of an ELISA plate were coated with 1 µg/ml of rHSP70, in coating buffer, overnight at 4°C. The un-bound rHSP70 was discarded, and the plate was blocked with 1% (w/v) BSA-PBS (1 h, 37°C). Washing steps consisted of three washes with 0.01% (v/v) PBS-T. The plate was washed and incubated with (1:10) dilution of phages in PBS-T (2 h, 37°C). After washing, the wells were incubated with mouse anti-M13 antibodies (1:4000) (1 h, 37°C). The plate was washed, and incubated with goat anti-mouse HRPO IgG (1:1000) (1 h, 37°C). The plate was washed and the ELISA was developed as mentioned in section 2.7.2.

2.8.2.3 Monoclonal ELISA, colony PCR, nested PCR

Monoclonal phage and monoclonal soluble ELISAs were then done using individual colonies from selected rounds as described by Van Wyngaardt *et al.* (2004), with some modifications. Phage ELISA was done as above. Expression of soluble phages was done with either 3 mM IPTG or

auto-induction in TEB (Ukkonen *et al.*, 2013). For monoclonal soluble ELISA, the ELISA plate was blocked with 0.5% (w/v) BSA-PBS and it was washed with PBS only. The bound soluble phages were probed with chicken anti-c-myc IgY antibodies (1 µg/ml), and rabbit-anti-chicken IgY HRPO IgG was used as the secondary antibody (1:10000).

Colony PCR (<http://www.csun.edu/~mls42367/Protocols/Colony%20PCR.pdf>) and nested PCR were done on selected high affinity clones as described elsewhere (Sambrook *et al.*, 1989). The forward primer was: OP52 5'-CCC TCA TAG TTA GCG TAA CG-3' and the reverse primer for colony PCR was M13 5'-CAGGAAACAGCTATGAC-3' and the nested reverse primer was 5'- TCA GGT GGA GGT GGC TCT GG-3' (Van Wyngaardt *et al.*, 2004). *AluI* digests were carried out on the selected scFv clones, according to the manufacturer's manual ([www.thermofisher](http://www.thermofisher.com)) to obtain a DNA fingerprint of each scFv clone.

Selected clones were tested on a dot blot and western blot formats. The clones were sent for sequencing at the Central Analytical Facilities at Stellenbosch University.

2.9 Cell culture

The J774A.1 cell line (ECACC, UK), a mouse monocyte/macrophage cell line and U937 cell line (ECACC, UK), a human monocyte cell line were cultured at 37°C in a humidified atmosphere with 5% CO₂ in their respective media; DMEM and RPMI-1640, supplemented with 1x antibiotic-antimycotic solution, and 10% Fetal bovine serum (FBS) (Biowest) (Nuaille, France). The cell lines were cultured according to ECACC recommendations.

2.9.1 Antimalarial, anti-inflammatory drug treatment

The cells were incubated for 18 h with either 400 ng/ml chloroquine, 200 ng/ml artemisinin, 153 ng/ml primaquine, 234 ng/ml pyrimethamine, 10 µg/ml quinine (Cumming *et al.*, 2011), 200 ng/ml artesunate (Khanh *et al.*, 1999), 200 ng/ml artemether (Teja-Isavadharm *et al.*, 1996), 5 µg/ml quinidine (White *et al.*, 1981), 10 µg/ml quinacrine (Neznanov *et al.*, 2009), 70 µg/ml probucol, 44 µg/ml ambroxol (Goldring and Ramoshebi, 1999), 1 µg/ml danazol (Hill *et al.*, 1987), 10 µM curcumin (Reddy *et al.*, 2005). After incubation, the cells were heat shocked (40°C, 2 h), then allowed to rest (37°C, 2 h) (Wang *et al.*, 2003) to mimic febrile episodes experienced during malaria. The cells were collected and lysed and subjected to 10% SDS-PAGE reducing gels (Laemmli, 1970). Protein quantification was done using Bradford assay and equal amounts of monocyte lysates were loaded on two gels; one for western blot and the other one served as a reference gel (Welinder and Ekblad, 2011). The western blots were probed with anti-rHSP70 IgY

as the primary antibody (1 µg/ml), and rabbit anti-chicken IgY HRPO IgG (1:10000) as the secondary antibody. The western blot was viewed by enhanced chemiluminescence (ECL) [(40 mg/ml luminol in 1 % (v/v) DMSO), (0.1 M p-iodophenol in 1 ml DMSO), 0.1 M Tris-HCl pH 8.5 buffer] (Bradd and Dunn, 1993). The level of expression of monocyte HSP70 was quantified using ImageJ (Rasband, 1997-2016) (www.imagej.net). The level of monocyte HSP70 expressed was normalized to one single protein band of 42 kDa on the SDS-PAGE gel (Welinder and Ekblad, 2011). The 42 kDa band is thought to correspond to beta actin, which is normally used as a loading control in experiments (Greer *et al.*, 2010). Controls consisted of concentrations of solvents used to solubilize the antimalarial drugs.

2.9.2 β-haematin, latex beads, hemin treatment

The cells were incubated with 25 µg/ml of β-haematin or 25 µg/ml of hemin or 0.1% (w/v) latex beads for 2 h at 37°C (Cumming, 2009). The cells were then heat shocked (2 h, 40°C), and allowed to rest for 2 h at 37°C. The cells were lysed and monocyte HSP70 protein expression was measured as described above.

2.10 Statistical analysis

All experiments were repeated at least three times, and loaded in duplicate on SDS-PAGE gels. The statistical significance between two groups by the unpaired t-test was analysed. $P < 0.05$ was considered significant. A single protein on the SDS-PAGE was used as the loading control. Total protein was also used as the loading control to compare the results we got, and minimal differences were observed (Data attached to Appendix I). Wilcoxon rank sum test, also known as the Mann-Whitney U test was also carried out to verify the results obtained by the unpaired t-test to see whether skewed data affected the results obtained (Data attached to Appendix II).

CHAPTER 3: CLONING, RECOMBINANT EXPRESSION AND PURIFICATION OF RECOMBINANT HUMAN HEAT SHOCK PROTEIN 70 (rHSP70)

3.1 Introduction

3.1.1 Heat Shock Protein 70 (HSP70)

Human heat shock protein 70 (HSP70) is a highly conserved protein that serves as a housekeeping protein. It binds to misfolded proteins and refolds them into their native conformations so that they are active (Mayer and Bukau, 2005). Human HSP70 is encoded by an intron-less gene, found within the major histocompatibility (MHC) class III, on the locus NM_005345 (https://www.ncbi.nlm.nih.gov/nuccore/NM_005345) on the 6p21.3 chromosome (Daugaard *et al.*, 2007). The gene is 2.4 kb in length and is expressed as a 641 amino acid protein, with a molecular weight of 70.052 kDa (Kiang and Tsokos, 1998). The protein has two main domains, a 25 kDa C-terminal substrate binding domain (SBD) and a 44 kDa N-terminal nucleotide binding domain (NBD) which has low intrinsic ATPase activity (Chang *et al.*, 2008). The protein uses energy from ATP hydrolysis for binding and releasing substrates and its activity is vital for its chaperone function (Liu and Hendrickson, 2007). While HSP70 is mostly monomeric, it has been found that in the absence of ATP and/or other nucleotides, HSP70 can form reversible oligomers both *in vitro* and *in vivo* (Aprile *et al.*, 2013, Kim *et al.*, 1992).

3.1.2 Recombinant expression of human HSP70

Recombinant expression is widely used in biotechnology whereby a recombinant protein is expressed from an engineered plasmid (Overton, 2014). Currently, there are different hosts for recombinant protein expression; mammalian, yeast, and bacterial, where, *Escherichia coli* (*E. coli*) is often favoured. The *E. coli* expression system has several advantages including being cheap to obtain, host cells are easy to transform, require inexpensive media, and grow quickly to a high cell density (Rosano and Ceccarelli, 2014, Choi *et al.*, 2006).

Human HSP70 was sub-cloned from a mammalian expression plasmid pcDNA/FRT/TO/HIS HSPA1A to a bacterial expression plasmid pET-28a since the laboratory did not have the reagents and expertise for a mammalian expression system. The pET-28a plasmid contains a strong T7 promoter and a *lacUV5* promoter which is inducible by isopropyl β -D-1-thiogalactopyranoside (IPTG). It has a hexa-histidine (His₆) tag at the N-terminus which allows for easy purification of the expressed protein and the lac repressor which prevents leaky expression. The JM109 and BL21-(DE3) *E. coli* host cells were used. JM109 cells were used for propagation of the

recombinant plasmid as JM109 cells are *recA*⁻ and lack the *E. coli* K restriction system which prevents the DNA from recombining with host DNA. JM109 cells also have an endonuclease A⁻ mutation which enables production of high purity plasmids in large quantities (Casali, 2003). The BL21-(DE3) *E. coli* strain was used for recombinant expression of HSP70, since it has a T7 polymerase gene, and is protease deficient, which avoids bacterial protease degradation of the recombinant protein (Shiloach *et al.*, 1996). Upon addition of IPTG, the T7 polymerase binds to the T7 promoter and initiates protein expression. This allows for controlled recombinant protein expression (Studier, 2005). Expression conditions including different media, temperature and lysis methods were optimised for greatest yields of soluble recombinant human HSP70 (rHSP70).

3.1.3 Affinity-purification of rHSP70

The rHSP70 was isolated and affinity-purified to remove any contaminating *E. coli* proteins. This was an important source of protein, both for immunizations and preparing affinity resins to purify the anti-rHSP70 antibodies. Immobilized metal-ion affinity chromatography (IMAC) is widely used for the purification of His-tagged recombinant proteins as it is efficient and user-friendly. It usually consists of a metal ion (Nickel, Zinc, Cobalt or Copper) coupled to a resin where the His-Tag of a recombinant protein binds to the resin and is therefore separated from untagged proteins (Bornhorst and Falke, 2000). In this study, a TALON[®] resin which contains bound cobalt ions (Co²⁺) was used. Imidazole has a similar side chain to histidine, hence it also binds to the IMAC resin. This simplifies elution of the bound recombinant protein off the resin as imidazole competes with the histidine tag to bind to the resin. Other *E. coli* proteins that have affinity for the Co²⁺ resin might also bind to the resin. To remove these, low concentrations of imidazole are used to wash off *E. coli* contaminants from the resin (Westra *et al.*, 2001). For elution of the bound recombinant protein, a higher concentration of imidazole can be used.

Recombinant HSP70 was cloned, expressed and affinity-purified using a TALON[®] resin in this study. The rHSP70 was analysed using gel filtration to see whether it formed oligomers, and the ATPase activity of rHSP70 was measured. Gel filtration and ATPase analysis were done to ensure that the native protein was expressed and isolated, as native proteins were found to elicit a higher immune response than the denatured form of the protein (Koch *et al.*, 1996).

3.2 Results

3.2.1 Sub-cloning of human HSP70 from pcDNA5/FRT/TO/HIS HSPA1A to pET-28a plasmid

The pcDNA5/FRT/TO/HIS HSPA1A plasmid contained the human HSP70 (HSPA1A) gene insert, having a 5' *Bam*HI, and a 3' *Not*I cloning sites. The full plasmid, including the 1955 bp HSP70 insert, was 7041 bp in length. After *Bam*HI and *Not*I digestion of the plasmid, the HSP70 insert was isolated (Figure 3.1 A) with a size of 1936 bp. To obtain an empty host vector with sticky ends, a pET-28a plasmid containing a *Plasmodium yoelli* lactate dehydrogenase (*Py*LDH) insert was digested with *Bam*HI and *Not*I to excise the *Py*LDH insert. Two bands were obtained at 6000 bp and 950 bp, showing the empty pET-28a and *Py*LDH insert respectively (Figure 3.1 B). The HSP70 insert and the empty pET-28a vector were gel purified, and ligated using T4 ligase. The ligated product was used to transform JM109 and BL21-(DE3) *E. coli* cells. Restriction digests using *Bam*HI and *Not*I on selected plasmid clones were performed to confirm successful ligation and transformation. All colonies harboured the recombinant plasmid in JM109 and BL21-(DE3) *E. coli* cells, as shown by the presence of the 1936 bp band, corresponding to the HSP70 insert (Figure 3.2).

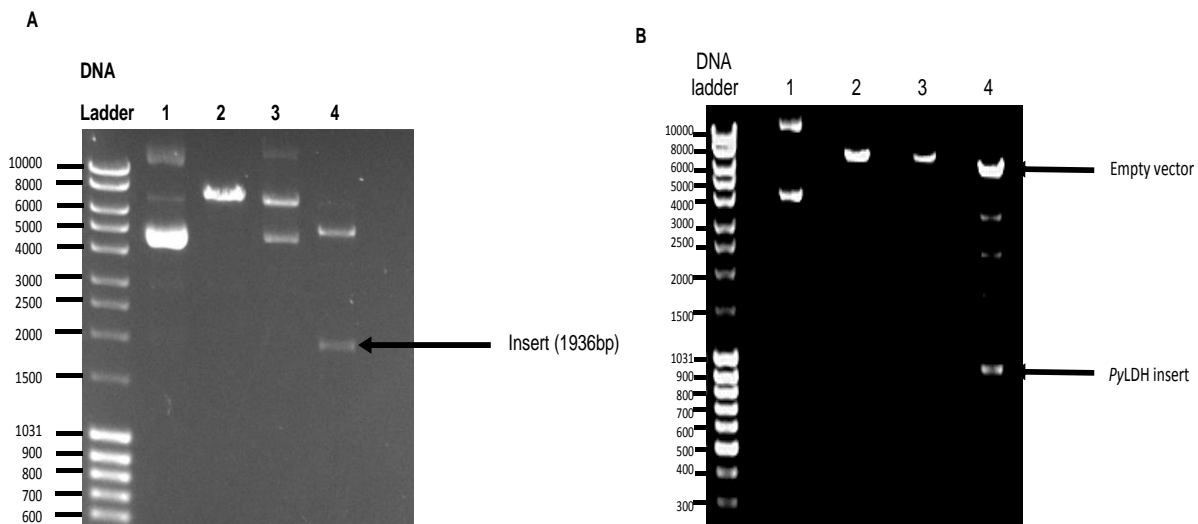

Figure 3.1: Digestion of plasmids with *Bam*HI and *Not*I

The pcDNA5/FRT/TO HIS HSPA1A (A) and pET-28a *Py*LDH (B) plasmids were digested with *Bam*HI and *Not*I for 16 h at 37°C. The products were resolved on 1% (w/v) agarose gel and viewed under UV light. Lane 1, undigested plasmid; Lane 2 & 3, *Bam*HI and *Not*I linearized plasmids; Lane 4, plasmid digested with *Bam*HI and *Not*I.

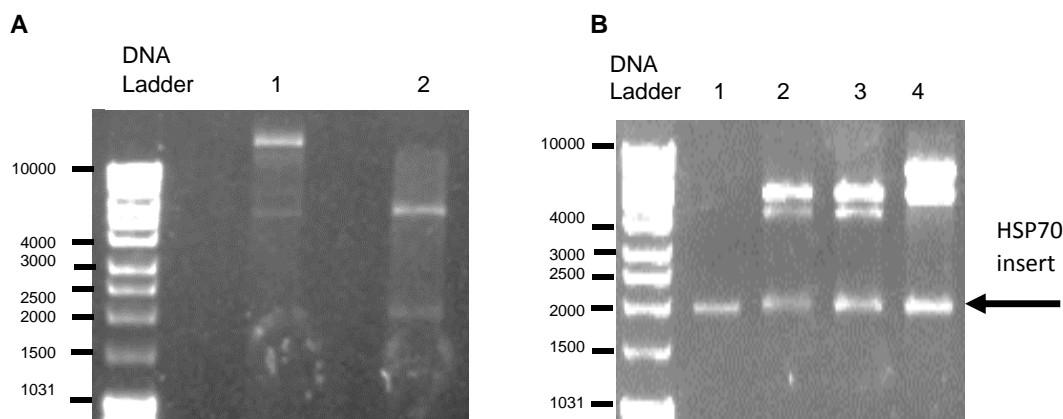

Figure 3.2: Digestion of ligated pET-28a-HSP70 plasmids with *Bam*HI and *Not*I

The plasmids ligated with HSP70 insert and isolated from JM109 *E. coli* cells (A) Lane 1; plasmid linearized with *Bam*HI; Lane 2, plasmid digested with *Bam*HI and *Not*I. Plasmids isolated from BL21-(DE3) cells are shown in (B). Lanes 1-4; plasmids digested with *Bam*HI and *Not*I. The products were resolved on 1% (w/v) agarose gel and viewed under UV light.

3.2.2 Expression of recombinant HSP70

Expression of recombinant human HSP70 (rHSP70) was optimised by expressing transformed BL21-(DE3) in LB, TEB and 2xYT media. Expression was induced by either the addition of 0.3 mM IPTG or induced by auto-induction in TEB. Expression was optimised under different temperatures, and induced at different OD₆₀₀ (0.4/0.6). The lysis conditions were optimised to obtain the best yield of rHSP70. The calculated size of rHSP70 is ~73kDa, obtained from the sequence data from Addgene (Hageman and Kampinga, 2009), using the program *Expasy* (<http://web.expasy.org/translate/>) (Artimo *et al.*, 2012). The calculated size (73 kDa) and the reported size of HSP70 in the literature (70 kDa) are different since the recombinantly expressed HSP70 in this study, had additional amino acids such as the HIS tag and additional plasmid derived sequence amino acids.

3.2.2.1 Colony selection for recombinant expression of rHSP70

Ten single colonies from a LB-Kanamycin (50 µg/ml) plate were randomly picked and cultured in LB media, to investigate whether all colonies expressed rHSP70 equally. Expression was induced with 0.3 mM IPTG for 4 h at 37°C and bacterial lysates were resolved on 7.5% reducing SDS-PAGE (Figure 3.3). A non-induced culture served as the negative control. Different colonies grew and expressed rHSP70 at different levels. Eight colonies expressed rHSP70 at high levels, while two colonies expressed very little rHSP70. Glycerol stocks of the colonies in lanes 3, 6-10 expressing high amounts of rHSP70 were prepared and stored.

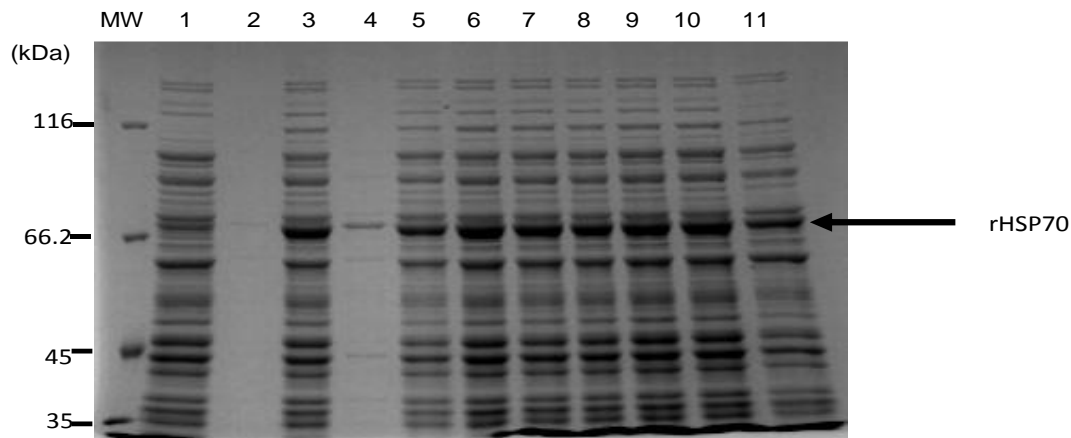

Figure 3.3: Expression of rHSP70 from ten colonies, induced with IPTG

Expression of rHSP70 from ten different colonies in LB was compared to a non-induced control. Expression was induced with 0.3 mM IPTG for 4 h at 37°C. The bacterial lysates were resolved on a 7.5% reducing SDS-PAGE gel. MW: Molecular weight marker; Lane 1, non-induced culture; Lanes 2-11, ten individual induced cultures.

3.2.2.2 Recombinant expression of rHSP70 in different media: TEB, 2xYT and LB media

The effect of IPTG induction on bacterial cultures grown in TEB showed minimal difference between expression of rHSP70 in non-induced and induced cultures (Figure 3.4). The effect of auto-induction was studied on rHSP70 expression in TEB. With auto-induction, there was more rHSP70 expression compared to the LB non-induced control (Figure 3.5). Two temperatures of 20°C or 37°C were compared (Figure 3.6) and it was found that there was little difference in the amount of rHSP70 expressed, therefore, 37°C was chosen for auto-induction. When bacterial cultures grown in 2xYT and LB media were induced, they over-expressed rHSP70 compared to the non-induced culture (Figure 3.7). Bacterial cultures are usually induced when an OD_{600} of 0.4 to 0.6 was reached. This is when the bacterial cultures are growing at the exponential phase. The effect of inducing cultures at either OD_{600} 0.4 or 0.6 was compared. With LB, much higher rHSP70 expression was obtained when induced at OD_{600} 0.6 than at 0.4 (Figure 3.8 A). With TEB, there was higher rHSP70 expression when induced at OD_{600} 0.6 but the expression was not as prominent as in LB media (Figure 3.8 A). Plotting the growth curve for bacteria in LB media, showed that at OD_{600} 0.4, the bacteria are at an early exponential phase whereas at OD_{600} 0.6, the bacteria are at the late exponential phase (Figure 3.8 B). This suggests that there may have been more bacteria expressing rHSP70 at OD_{600} 0.6 than at OD_{600} 0.4. Hence, all inductions were done at an OD_{600} 0.6.

Recombinant HSP70 was expressed in LB and TEB, for purification purposes. 2xYT seemed to express rHSP70 but was not used, since, it required more reagents, making it more expensive to use, for large scale expression.

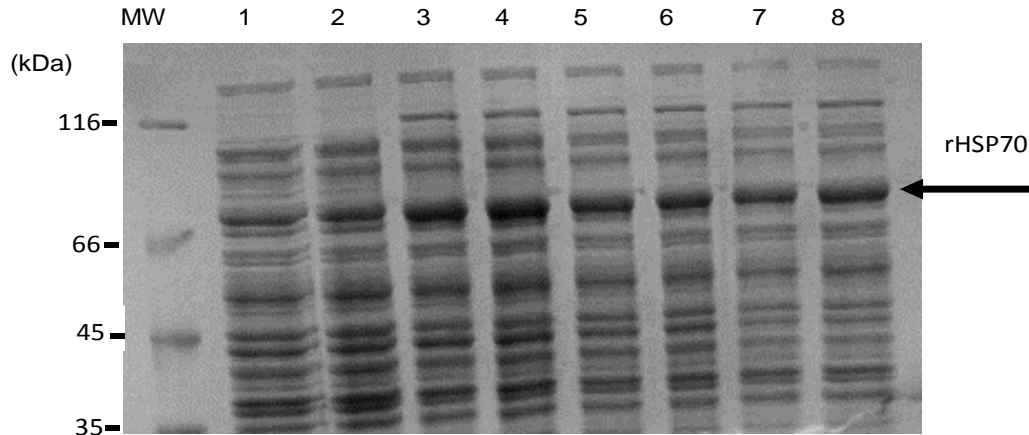

Figure 3.4: Expression of rHSP70 induced with IPTG in TEB

The rHSP70 was expressed in TEB and induced with 0.3 mM IPTG for 4 h at 37°C. The bacterial lysates were resolved on 10% reducing SDS-PAGE gel. MW: Molecular weight marker; Lanes 1-2, non-induced culture loaded in duplicate; Lanes 3-8, triplicate induced cultures, loaded in duplicate.

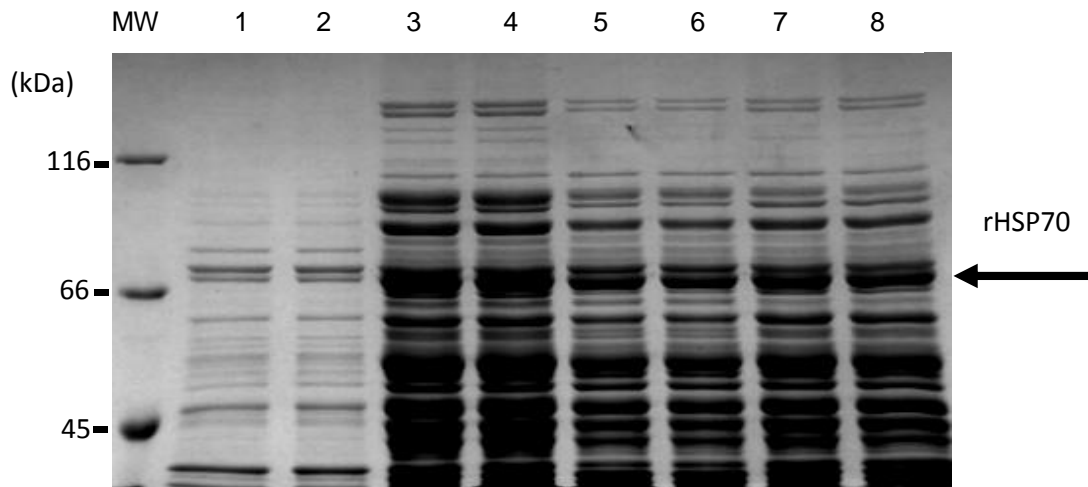

Figure 3.5: Expression of rHSP70 induced by auto-induction in TEB

The rHSP70 was expressed by auto-induction in TEB overnight for 16 h at 37°C. The lysates were resolved on 7.5% reducing SDS-PAGE gel. MW: Molecular weight marker; Lanes 1-2, LB non-induced culture; Lanes 3-8, triplicate induced cultures loaded in duplicate.

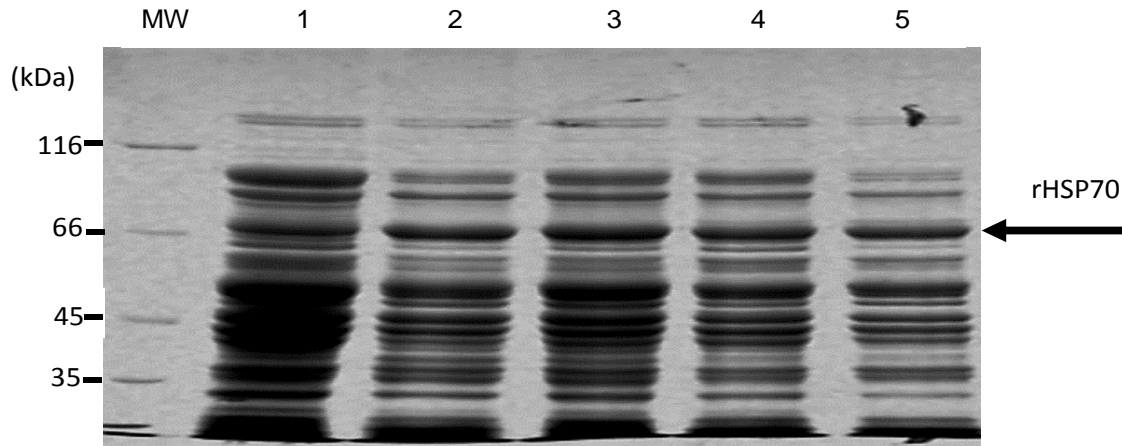

Figure 3.6: Expression of rHSP70 by auto-induction in TEB, at 20°C and 37°C.

The rHSP70 was expressed in auto-inducing in TEB at 20°C and 37°C for 16 h. The bacterial lysates were resolved on 7.5% reducing SDS-PAGE gel. MW: Molecular weight marker; Lane 1, untransformed BL21-(DE3) *E. coli* control, Lanes 2-3, 20°C auto-induced culture loaded in duplicate; Lanes 4-5, 37°C auto-induced culture loaded in duplicate.

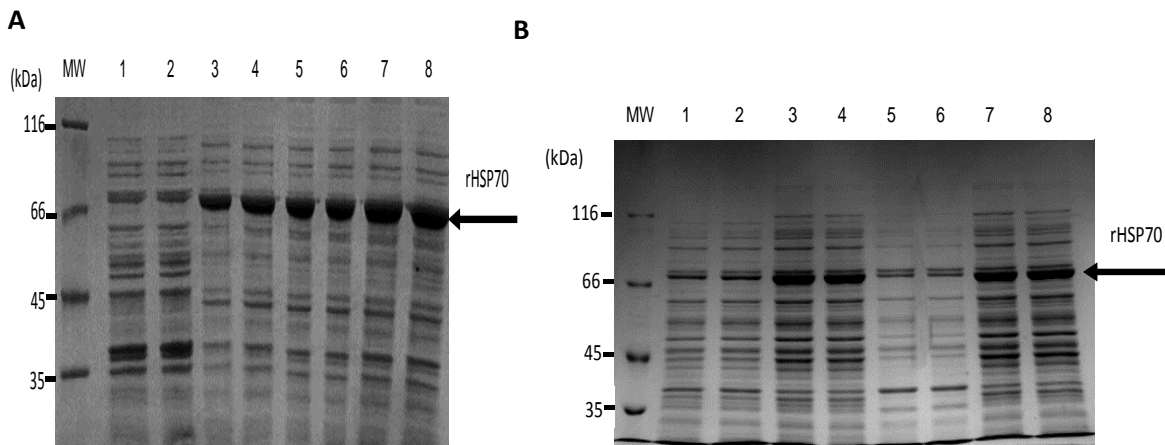

Figure 3.7: Expression of rHSP70 induced with IPTG in 2xYT and LB media

The rHSP70 was expressed in 2xYT media (A) and LB media (B) by inducing three cultures with 0.3 mM IPTG for 4 h at 37°C. The bacterial lysates were resolved on a 10% reducing SDS-PAGE gel. MW: Molecular weight marker; Lanes 1-2, non-induced culture loaded in duplicate; Lanes 3-8, triplicate induced cultures loaded in duplicate.

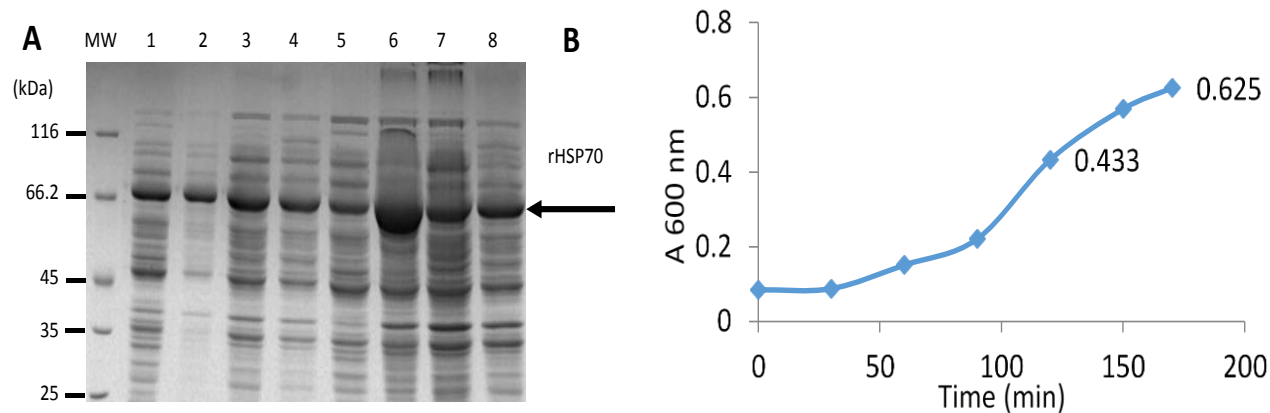

Figure 3.8: Expression of rHSP70 in LB media induced at OD₆₀₀ 0.4 or 0.6

The rHSP70 was expressed in either LB media or TEB and induced at OD₆₀₀ 0.4 or 0.6 with 0.3 mM IPTG for 4 h at 37°C. The bacterial lysates were resolved on 7.5% reducing SDS-PAGE gel (A). MW: Molecular weight marker; Lane 1; non-induced LB culture; Lane 2, induced LB culture at OD₆₀₀ 0.4; Lane 3, non-induced TEB culture; Lane 4, induced TEB culture at OD₆₀₀ 0.4; Lane 5, non-induced LB culture; Lane 6, induced LB culture at OD₆₀₀ 0.6; Lane 7, non-induced TEB culture; Lane 8, induced TEB culture at OD₆₀₀ 0.6. The growth curve of *E. coli* harbouring the recombinant plasmid is shown in (B). Fresh LB media was inoculated with 5% (v/v) of an overnight culture and the OD₆₀₀ was recorded every 30 min for 3 h to monitor the growth of the bacteria harbouring the recombinant plasmid.

3.2.2.3 Cell lysis

After recombinant expression, the cells are lysed to release the recombinant protein. There are different lysis methods including mechanical, enzymatic, freeze-thaw and chemical disruption of cells (Brown and Audet, 2008). Each method may affect the quality and yield of the final protein. In this study, sonication, freeze-thaw and lysozyme lysis methods were compared. Sound waves are used in sonication, whereby localised cavitations disrupt cells (Brown and Audet, 2008). Repeated freeze-thawing disrupts the cells based on the formation and melting of ice in the cells (Cao *et al.*, 2003). Lysozyme breaks down the cell wall of *E. coli* cells and releases the cytoplasmic contents, containing the recombinant protein (Repaske, 1958, Voss, 1964). Sonication gave the best yield of protein when compared to freeze thaw and lysozyme lysis (Figure 3.9).

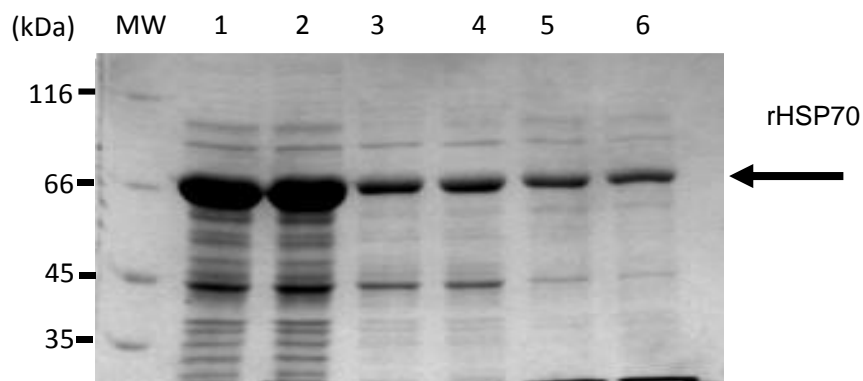

Figure 3.9: Effects of lysis on the yield of rHSP70

Bacterial cultures harbouring the recombinant rHSP70 plasmid were induced with 0.3 mM IPTG and harvested after 4 h. Different methods were used to lyse the cells. The bacterial lysates were resolved on 7.5% reducing SDS-PAGE gel. MW: Molecular weight marker; Lanes 1-2, Sonicated supernatants; Lanes 3-4, freeze-thawed supernatants; Lanes 5-6, lysozyme lysis.

3.2.3 Purification of rHSP70

An imidazole gradient was used to determine the optimal imidazole concentration to elute rHSP70 from a TALON[®] affinity column. Most of the rHSP70 eluted between 140 to 155 mM imidazole (Figure 3.10) for cultures expressed in LB media. For TEB, most of the rHSP70 eluted between 50 to 90 mM imidazole (Figure 3.11). 250 mM imidazole was used for large scale purification to ensure that all protein was eluted off the column. For large scale expression and purification, cultures were grown in LB media since high yields of rHSP70 was obtained (Figure 3.12). Recombinant expression in TEB also gave high yield of rHSP70, but other *E. coli* host proteins were also overexpressed, which could make purification of rHSP70 more difficult.

Figure 3.12 shows the 7.5% reducing SDS-PAGE gel (A), and the corresponding western blot (B) for the purification of a 250 mL culture of rHSP70. While a prominent band of rHSP70 is seen on the gel, other bands of lower molecular weight are also present. The anti-His tag antibody detected these small bands, suggesting that these bands are not contaminating *E. coli* proteins, but arise from the eluted protein itself. The proteins could be degraded or truncated proteins. Since a large amount of the rHSP70 was not bound to the matrix, the bands eluted in the unbound fraction were recycled through the column twice to allow maximum recovery of rHSP70 from a single culture. It was found that for each cycle of purification, 3.6 mg of protein was recovered (Table 3.1). The final yield of rHSP70 was 6 mg from an initial 250 ml culture.

To confirm the purity of the rHSP70, gel filtration using Sephacryl S200 was done (Figure 3.13). The fractions containing the peaks were run on a 12.5% reducing SDS-PAGE gel. There was a prominent peak co-eluting with blue dextran which could be due to the oligomerisation of the

protein. There was also a small peak corresponding to 70 kDa. The protein fractions were run on 12.5% reducing SDS-PAGE gel, and the large protein co-eluting with blue dextran, was resolved as a 70 kDa protein on the SDS-PAGE,

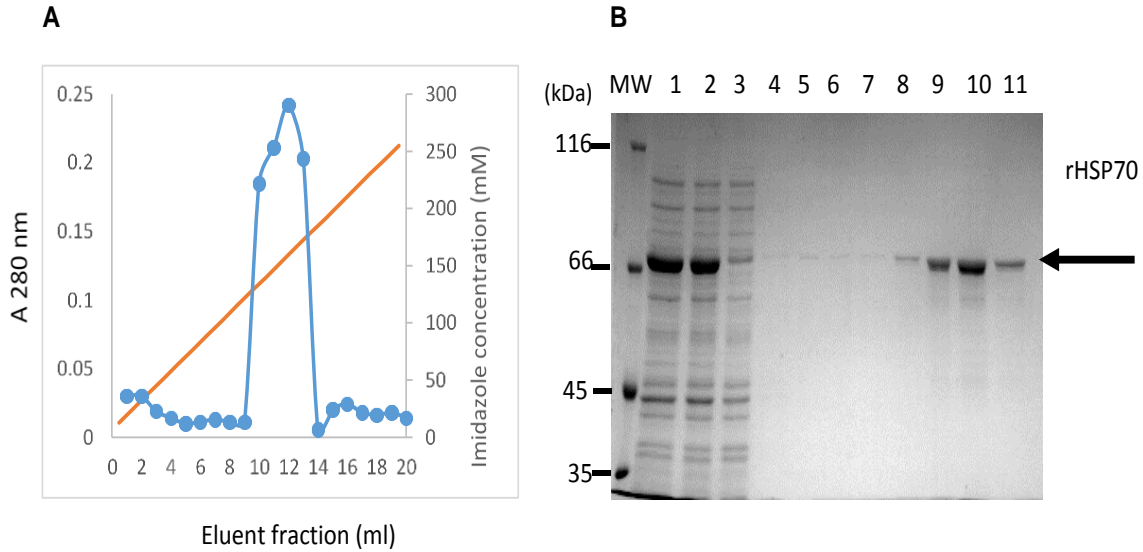

Figure 3.10: Gradient elution of rHSP70 grown in LB media affinity-purified using TALON® resin
 The rHSP70 was eluted from a TALON® resin, using an imidazole gradient from 0-250 mM (A). The eluents were resolved on a 7.5% reducing SDS-PAGE gel shown in (B). MW: Molecular weight marker; Lane 1; crude lysate; Lane 2, filtered lysate; Lane 3, unbound fraction; Lanes 4-5, washes; Lanes 6-11, eluent fractions at (102 mM, 115 mM, 128 mM, 140 mM, 153 mM and 166 mM) imidazole, pertaining to eluent fractions 8-13 respectively.

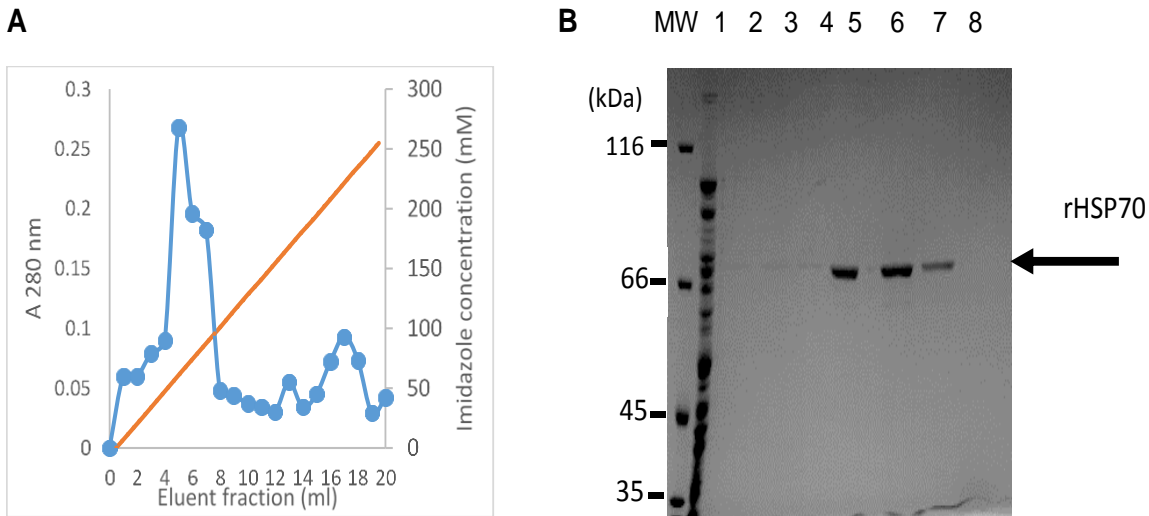

Figure 3.11: Gradient elution of rHSP70 grown in TEB, affinity-purified using TALON® resin
 The rHSP70 was eluted from a TALON® resin, using an imidazole gradient from 0-250 mM (A). The eluents were resolved on a 7.5% reducing SDS-PAGE gel shown in (B). MW: Molecular weight marker; Lane 1, crude lysate; Lanes 2-8, eluent fractions at (13 mM, 26 mM, 38 mM, 51 mM, 64 mM, 77 mM and 90 mM) imidazole corresponding to eluent fractions 2-7.

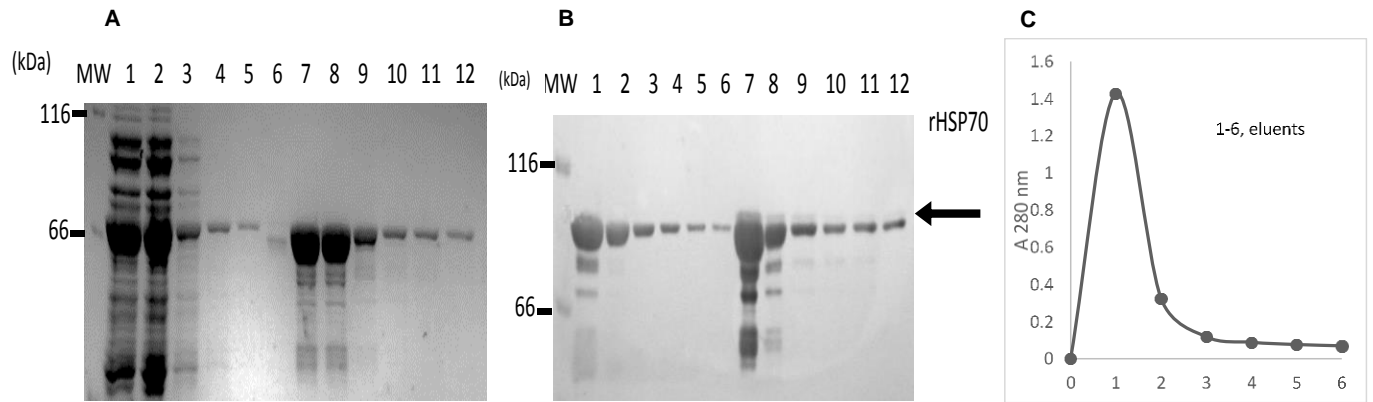

Figure 3.12: Large scale purification of rHSP70, expressed by IPTG induction in LB media

The rHSP70 was expressed in LB media and affinity-purified using 250 mM imidazole on a TALON® resin. The fractions were resolved on 7.5% reducing SDS-PAGE gel (A). The corresponding western blot (B) was probed with anti-his tag antibody as the primary antibody (1:5000) and goat-anti mouse HRPO as the secondary antibody (1:1000). MW: Molecular weight marker; Lane 1, crude lysate; Lane 2, unbound fraction; Lanes 3-6, washes with 10 mM imidazole; Lane 7-12, eluent fractions. (C) shows the elution profile of rHSP70 from the affinity-matrix.

Table 3.1: Purification table of rHSP70 from one round of purification.

Step	Total protein (mg)	Total activity (units)	Specific activity (units/mg)	Yield (%)	Fold
Crude lysate	11	1.6	0.15	100	1
Affinity purified protein	3.6	1.3	0.37	81	2.5

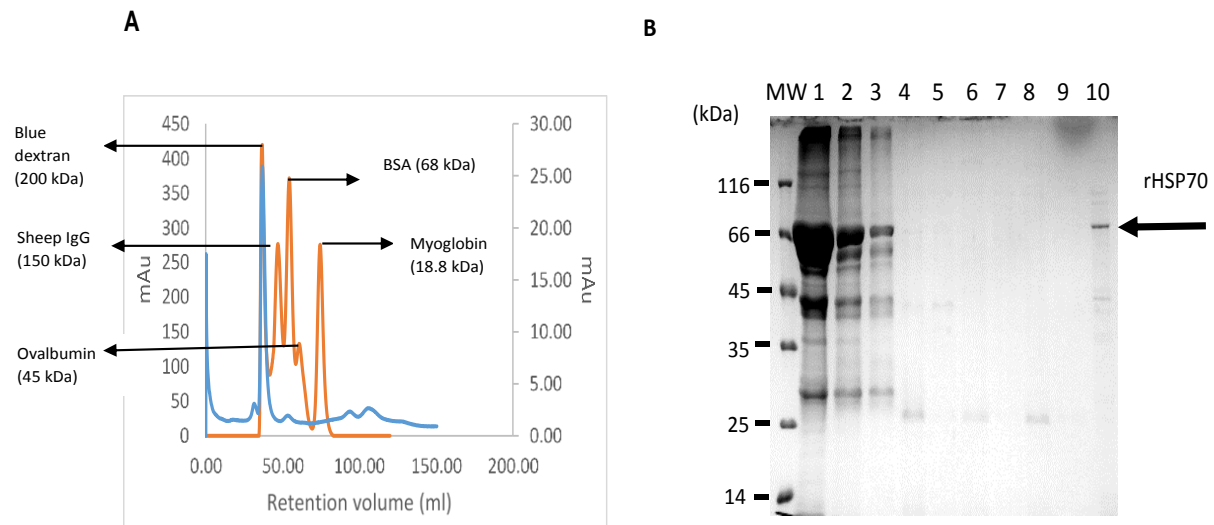

Figure 3.13: Sephacryl S200 gel filtration of rHSP70

The protein elution profile (blue line) for rHSP70 is shown in (A) where the calibration profile is shown on the primary y-axis (orange line). The fractions containing the peaks were concentrated and resolved on reducing 12.5% reducing SDS-PAGE gel (B). MW: Molecular weight marker; Lanes 1-8, fractions 18-25; Lane 9, fraction 27; Lane 10, pure rHSP70.

3.2.4 ATPase activity of rHSP70

The malachite green assay was used to measure the ATPase activity of rHSP70. The ATPase activity of rHSP70 increased with time (Figure 3.14 A). For further analyses, triplicate readings of the assay were taken at 3 h end-point. When the concentration of rHSP70 was increased from 0 to 0.6 mg/ml, the ATPase activity also increased (Figure 3.14 B). With increasing ATP concentrations ranging from 200 to 1000 μM , the ATPase activity of rHSP70 increased (Figure 3.14 C). The Hanes Woolf plot for rHSP70 enzyme activity of rHSP70 was plotted (Figure 3.15). Values of K_m and V_{max} were 523 μM and 0.29 $\mu\text{M}/\text{min}$ respectively. It was found that pH affected the ATPase activity of rHSP70. Acidic and basic buffers increased the ATPase activity of rHSP70, when compared to physiological pH at 7.4 (Figure 3.16). 'Goods buffers' were used to ensure that the ionic strength remained constant.

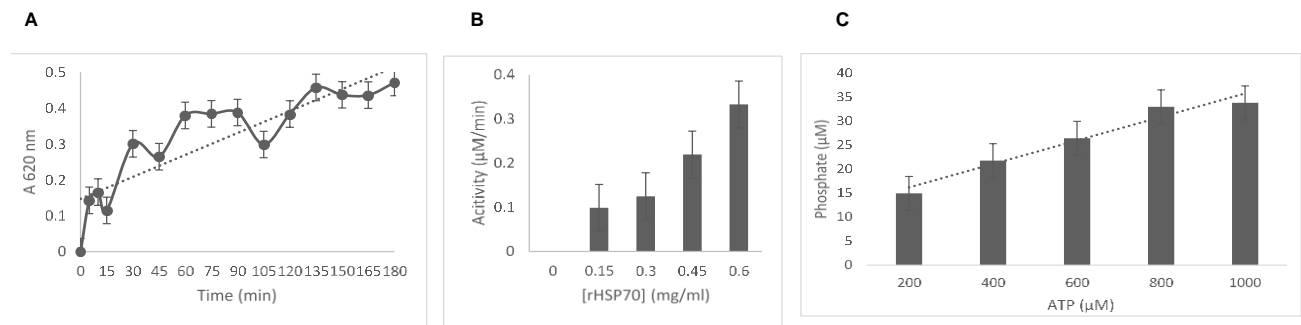

Figure 3.14: rHSP70 ATPase activity

The ATPase activity of affinity-purified rHSP70 was measured using the malachite green assay. The ATPase activity was measured using 0.3 mg/ml of rHSP70 for 180 min in (A); the ATPase activity with increasing rHSP70 concentrations was measured in (B); the ATPase activity was measured with increasing ATP concentrations (200 to 1000 μM) at a fixed rHSP70 concentration of 0.3 mg/ml in (C).

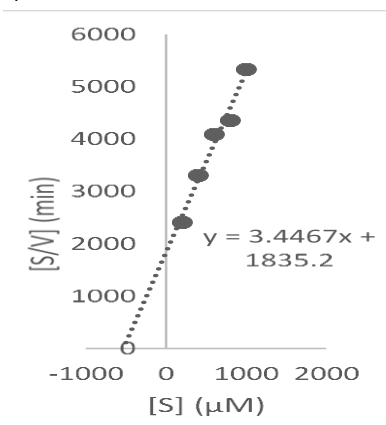

Figure 3.15: Kinetics of rHSP70 activity

The ATPase activity of rHSP70 was investigated using the malachite green assay. The Hanes' woolf plot is shown.

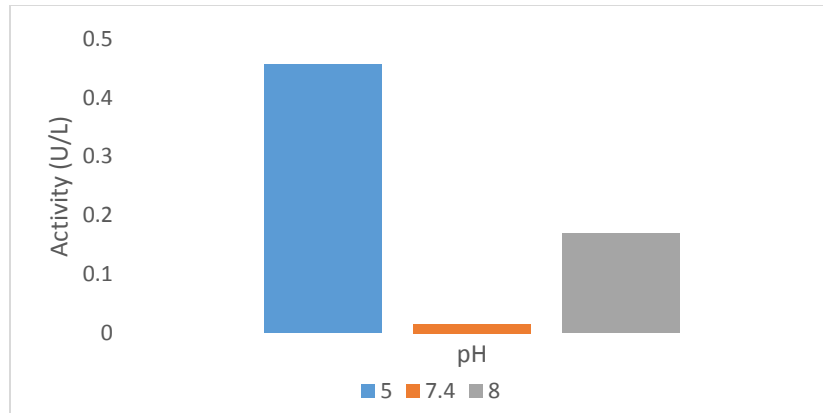

Figure 3.16: ATPase activity of rHSP70 at pH 5.0, 7.4 and 8.0.

ATPase activity of rHSP70 was measured in acidic (pH 5.0), neutral (pH 7.4) and alkaline pH (pH 8.0) using 'Good buffers' done in triplicate.

3.3 Discussion

3.3.1 Cloning and expression of rHSP70

The plasmid pcDNA5/FRT/TO/HIS HSPA1A was designed for the expression of a recombinant protein in a mammalian expression system. The latter requires expensive cell lines and media for recombinant protein expression. A mammalian expression system has the advantage of expressing proteins with post-translational modifications and the expressed proteins are free of bacterial endotoxins (Khan, 2013). However, it is cheaper to grow bacterial cultures where high yields of rHSP70 can be obtained relatively quickly (Khan, 2013). The pcDNA5/FRT/TO/HIS HSPA1A plasmid had the appropriate restriction endonucleases sites for sub-cloning HSP70 into a pET-28a plasmid. All restriction endonuclease digests were visualised on 1% (w/v) agarose gels containing ethidium bromide using UV light (Sigmon and Larcom, 1996). The agarose gels were exposed to UV light for minimal periods, to avoid DNA damage and mutations from exposure to the UV light (Yilmaz *et al.*, 2012). Ethidium bromide is a known mutagen, and safer reagents are now available to view DNA. Crystal violet is a safe alternative to ethidium bromide but has a lower sensitivity (Rand, 1996). Other alternatives include SYBR Green and SYBR Safe which are more sensitive and less toxic than ethidium bromide, but are more expensive (Yilmaz *et al.*, 2012).

Human HSP70 has been cloned and expressed in an *E. coli* expression system (Macejak *et al.*, 1990, Jindal *et al.*, 1995). Most of the expressed protein was found in inclusion bodies and required solubilisation (Macejak *et al.*, 1990, Jindal *et al.*, 1995). In this study, most of the recombinant protein expressed was soluble and the yield was 6 mg per 250 mL of *E. coli* culture, while only 1 to 3 µg of recombinant HSP70 was obtained per litre of *E. coli* culture by Macejak *et*

al. (1990). Recombinant expression of HSP70 has been done in a baculovirus expression system where high yields and endotoxin-free HSP70 was obtained (Zheng *et al.*, 2010). The insect cells and media are, however expensive. The system is time consuming as it takes around 96 h to obtain the recombinant protein, while it takes around 24 h to obtain the recombinant protein in an *E. coli* expression system (Zheng *et al.*, 2010).

The conditions for optimal expression of rHSP70 were investigated. Terrific broth, 2xYT and LB media were compared for the recombinant expression of rHSP70. Terrific broth is an enriched media and has glycerol as an extra nutrient source for the bacteria. This allows the bacteria to grow fast and to higher cell density than LB media (Letterer and Schagat, 2007). During growth, when the bacterial culture has used up the available glucose, it switches to using lactose and glycerol to make allolactose. The latter then acts as the recombinant expression inducer (Blommel *et al.*, 2007). The 2xYT media is a modification of LB media which contains double the concentration of yeast extract. Bacterial cultures grown in 2xYT reach higher cell density in comparison to those grown in LB media (Rosano and Ceccarelli, 2014). LB is a rich media and has the advantage of being easily prepared, and bacteria at log phase grow at a fairly constant rate. This increases the reproducibility of the experiments (Sezonov *et al.*, 2007, Rosano and Ceccarelli, 2014). Expression induced at an OD₆₀₀ 0.6 at 37°C, gave the best yields of rHSP70. Sonication was chosen as the method of lysis since most of the protein was liberated from the cytosol of *E. coli* cells. However, with freeze thaw and lysozyme lysis, the recombinant protein was released most compared to host *E. coli* proteins. This could aid purification of the recombinant protein. With TEB, the yield of rHSP70 was better than other media used, but all proteins were overexpressed, including host proteins. With LB media, IPTG was required to induce the recombinant expression. The advantage of this method is that only rHSP70 was overexpressed in comparison to host proteins. The disadvantage of using IPTG as an inducer, is leaky expression. When expressed in large amounts, the recombinant protein can be toxic to the host cell (Studier, 2005). However, toxicity was not observed for IPTG induced cultures in LB media in this study. At high cell density, LB media can turn acidic as there is no pH buffering agent, compared to TEB as the latter contains a phosphate buffer (Studier, 2005).

3.3.2 Purification of rHSP70

The rHSP70 was affinity-purified using an IMAC TALON[®] resin, similar to other studies (Rowlands *et al.*, 2010). The ATP/ADP affinity columns or a mixture of ATP affinity column and freeze-thaw have also been used to isolate and purify recombinant HSP70 (Jindal *et al.*, 1995, Ménoret, 2004,

Peng *et al.*, 1997, Macejak *et al.*, 1990). With ATP/ADP agarose column chromatography, DnaK, the bacterial HSP70 homologue, is usually co-eluted with recombinant HSP70 since they are closely related and it also has ATPase activity (Ménoret, 2004). Using a fusion protein such as a His₆ tag, eliminates the risk of getting DnaK contaminant as DnaK will not bind to the column. The His₆ tag has high affinity with metal ions, and it is small enough to not affect the solubility and shape of the protein. It also does not interfere with any enzyme activity the protein might have (Bornhorst and Falke, 2000). Other affinity tags such as Poly-Arginine tag, c-myc tag and Strep tag are short peptides that are usually non-immunogenic, and rarely have to be cleaved off (Terpe, 2003). Large fusion peptides such as glutathione S-transferase-tag (GST) and maltose-binding protein (MBP) are also widely used. The GST tag is reported to stabilise the recombinant protein and makes it less prone to protease degradation, while MBP is reported to increase the solubility of a recombinant protein (Terpe, 2003). The fusion partner however, may alter the three-dimensional structure of the native protein and alter its activity (Terpe, 2003).

For elution of rHSP70 off the column, 250 mM of imidazole in the elution buffer was used. Other elution methods include a change in pH (Bornhorst and Falke, 2000), EDTA (Hengen, 1995), or a salt gradient (Fouchaq *et al.*, 1999). The EDTA can, however, chelate and leach the metal ions off the resin and reduce efficiency of the column (Westra *et al.*, 2001).

3.3.3 ATPase activity of rHSP70

The ATPase activity of rHSP70 was measured using the malachite green assay. The assay has been used for the measurement of the ATPase activity of HSP90 and HSP70 (Rowlands *et al.*, 2004, Miyata *et al.*, 2010). The assay requires all buffers and equipment to be phosphate free, otherwise it becomes insensitive and gives a high background signal (Bartolini *et al.*, 2013). Sodium citrate buffer was added after adding the malachite green reagent to minimize ATP hydrolysis caused by the presence of the acidic medium (Rowlands *et al.*, 2004). The preparation of the reagent takes 2 h (Bartolini *et al.*, 2013). It nevertheless is still a good option when compared to the other methods.

Other methods used include the use of radioactive ATP and measuring the radioactivity when phosphate is released (Geladopoulos *et al.*, 1991, Raynes and Guerriero, 1998), ion exchange chromatography to measure the production of ADP (Bartolini *et al.*, 2013), the use of anti-ADP antibodies in a kit format (Rowlands *et al.*, 2010) and fluorescence method, whereby the excitation

and emission was measured using a plate reader (Miyata *et al.*, 2010). These methods require expensive reagents, equipment and are time consuming.

Table 3.2: Comparison of HSP70 enzyme kinetics in different species

Study	HSP70	Species	Km	Specific activity	Turnover (min ⁻¹)
Palleros <i>et al.</i> (1993)	00DnaK	<i>E. coli</i>	NA	NA	0.42 (before HPLC) 0.087 (after HPLC)
Chang <i>et al.</i> (2008)	DnaK	<i>E. coli</i>	NA	NA	0.12
Chamberlain and Burgoyne (1997)	HSC70	Human	NA	1.08 nM/min/mg	NA
	HSP70	Human	NA	0.5 nM/min/mg	
Dores-Silva <i>et al.</i> (2015)	HSPA1A	Human	270 μ M	0.62 pmol/min/ μ g	NA
Lopez-Buesa <i>et al.</i> (1998)	Ssa (HSP70)	Yeast	0.11 μ M	NA	NA
Matambo <i>et al.</i> (2004)	PfHSP70-1	<i>Plasmodium falciparum</i>	616.5 μ M	NA	1.03
This study	rHSP70	Human	532 μ M	0.9 μ M/min/mg	0.16

NA- Not available

It has been observed that the ATPase activity of HSP70 reported varies across different species, even if it is a fairly conserved protein (Table 3.2). The differences in the ATPase activity can be due to the techniques used to measure the ATPase activity. The turnover measured by Chang *et al.* (2008) was closely related to the turnover rate obtained for rHSP70, and this might be because the malachite green assay was used in both cases to measure the ATPase activity. The Km value obtained for rHSP70 in this study was much higher than reported in the literature (Table 3.2), but closer to what Dores-Silva *et al.* (2015) found. They used a commercial kit to measure the ATPase activity. The exact Km and Vmax values have not been established as different papers have published different results (Table 3.2). The difficulty in obtaining a fixed value is due to the nature of the HSP70 protein. It has a low ATPase activity, and can in some cases form oligomers (Aprile *et al.*, 2013). The oligomers can increase the ATPase activity and hence give different Km values (Araujo *et al.*, 2014).

The effect of pH on the ATPase activity of rHSP70 was studied, and it was found that in acidic conditions, the ATPase activity was higher than when in neutral or basic conditions. A similar result was obtained by McCarty and Walker (1991) which investigated the ATPase activity of DnaK in acidic and basic medium. In our study, the ATPase activity of rHSP70 was higher at pH

8.0 and pH 5.0 than at pH 7.4, which is around physiological pH. This could be explained by the function of HSP70, which should become more active during stress conditions. Because acidic and basic conditions cause stress, the ATPase activity of HSP70 increases to maximise binding to substrates and renaturing them to their proper conformation (Kregel, 2002).

Gel filtration was used to identify the formation of oligomers of rHSP70 and to see if the protein was pure. The presence of rHSP70 in the void volume, indicated that rHSP70 aggregated and formed high molecular weight oligomers. There have been reports that HSP70 forms oligomers both in the presence and absence of ATP (Sarheng *et al.*, 2015). The percentage of oligomers formed increases with the concentration of protein present (Kim *et al.*, 1992). Oligomerisation of HSP70 has been reported to help its chaperone function (Kim *et al.*, 1992, Sarheng *et al.*, 2015). In this study, a high concentration of rHSP70 was used, in a buffer devoid of ATP, which might have promoted the oligomerisation of rHSP70.

3.4 Conclusion

Human HSP70 was sub-cloned from a mammalian plasmid to a pET-28a plasmid, and used to transform BL21-(DE3) and JM109 *E. coli* cells. Recombinant expression of rHSP70 was optimised in LB media at 37°C, and sonication was used as the mode of lysis. Purification of rHSP70 was achieved using IMAC, and enzyme kinetics were done on the ATPase activity of the recombinant rHSP70.

CHAPTER 4: ANTIBODY PRODUCTION AGAINST rHSP70

4.1 Introduction

Antibodies play an essential part in the biotechnology sector. They are used in ELISAs, western blots, diagnostic tests and as therapeutic agents (Chadd and Chamow, 2001, Hau and Hendriksen, 2005, Shen *et al.*, 2012). Mammals are usually chosen as the experimental animal because they make the same type of antibodies as humans including IgG, IgM, and IgE but problems arise when antibodies against conserved mammalian proteins are needed (Lipman *et al.*, 2005). Chicken are evolutionarily distant to mammals, hence are likely to elicit a strong immune response against conserved mammalian proteins such as the human heat shock protein 70 (HSP70) (Krief *et al.*, 2002, Gassmann *et al.*, 1990). Sequence alignment analysis of rHSP70 (Hageman and Kampinga, 2009) with chicken HSP70 (NCBI reference sequence: NP001006686.1) revealed 85.76% identity between the two orthologues (Figure 4.1). In this study, polyclonal antibodies against rHSP70 were raised in chicken using affinity-purified recombinant HSP70 (rHSP70).

Monoclonal antibodies are important when specificity for an antigen is required (Lipman *et al.*, 2005). Hybridoma technology has been widely used to make monoclonal antibodies, whereby a single B cell is used to produce hybridoma clones which are identical and recognise a single epitope. It takes a long time to obtain pure monoclonal antibodies and is technically challenging (Leenaars *et al.*, 1999, Griffiths and Duncan, 1998). Recombinant antibody technology is becoming widely used to make monoclonal antibodies, as an alternative to hybridoma technology (Griffiths and Duncan, 1998). It is based on the synthesis of large naïve antibody gene libraries combined with phage display, usually cloned in phage or phagemid vectors (Hoogenboom *et al.*, 1998, Ohara *et al.*, 2006, Konthur and Walter, 2002). Immunisation is not required and antibodies can be made *in vitro* (Konthur and Walter, 2002). The advantage of this technology is that any animal can be chosen to make the antibody gene library, including human, mice, goat, donkey and chicken (Hoogenboom *et al.*, 1998).

To construct an antibody library from mice or human DNA, a number of primers are required which makes it laborious (Davies *et al.*, 1995). It is easier to make chicken antibody libraries as a single set of primers allows amplification of the naïve antibody repertoire (Andris-Widhopf *et al.*, 2000, Van Wyngaardt *et al.*, 2004). Van Wyngaardt *et al.* (2004) designed a chicken library, known as the *Nkuku*[®] library, which included a synthetic sub-library of complementarity determining region (CDR3) to increase the number of clones contained within the library. Antibodies were expressed

as single chain variable fragment (scFv) whereby the heavy and light variable chains are fused by a peptide linker (Griffiths and Duncan, 1998).

```

Human      -MAKAAAIGIDLGTTYSCVGVFQHGKVEIIANDQGNRTTPSYVAFTDTERLIGDAAKNQV
Chicken    MSGKGPAAIGIDLGTTYSCVGVFQHGKVEIIANDQGNRTTPSYVAFTDTERLIGDAAKNQV
           .*. *****

Human      ALNPQNTVFDKRLIGRKFGDPVVQSDMKHWPFPVINDGDKPKVQVSYKGETKAFYPEEI
Chicken    AMNPTNTIFDAKRLIGRKYDDPTVQSDMKHWPFRVNVNEGKPKVQVEYKEMKTFPPEEI
           *:* **:******:.*.*****:*.:.*****.***** *:*:*

Human      SSMVLTKMKEIAEAYLGYPTNAVITVPAYFNDSQRQATKDAGVIAGLNVLRINEPTAA
Chicken    SSMVLTKMKEIAEAYLGKQVNAVITVPAYFNDSQRQATKDAGTITGLNVMRINEPTAA
           ***** * *****.*:*****:*****

Human      AIAYGLDRTG--KGERNVLIFDLGGGTFDVSILTIDDGIFEVKATAGDTHLGGEDFDNRL
Chicken    AIAYGLDKKGTRAGEKNVLIIFDLGGGTFDVSILTIEDGIFEVKSTAGDTHLGGEDFDNRM
           *****:.* **:******:*****:*****:

Human      VNHFVEEFKRKHKKDISQNKRAVRLRTACERAKRTLSSSTQASLEIDSLFEGIDFYTSI
Chicken    VNHFVEEFKRKHKKRDIAGNKRAVRLRTACERAKRTLSSSTQASIEIDSLFEGIDFYTSI
           *****:*. **:******:*****:*****

Human      TRARFEELCSDLFRSTLEPVEKALRDAKLDKAQIHDLVLVGGSTRIPKVQKLLQDFFNDR
Chicken    TRARFEELNADLFRGTLEPVEKALRDAKLDKGQIQEIVLVGGSTRIPKIQKLLQDFFNDR
           ***** :****.*****.***:.*:*****:*****:

Human      DLNKSINPDEAVAYGAAVQAAIILMGDKSENVQDLLLLDVAPLSLGLLETAGGVMTALIKRN
Chicken    ELNKSINPDEAVAYGAAVQAAIILMGDKSENVQDLLLLDVTPLSLGIETAGGVMTALIKRN
           :*****:*****:*****:*****:*****:*****

Human      STIPTKQTQIFTTYSDNQPGVLIQVYEGERAMTKDNNLLGRFELSGLIPPAPRGVQPQIEVT
Chicken    TTIPTKQTQFTTTYSDNQSSVLVQVYEGERAMTKDNNLLGKFDLTGIPPAPRGVQPQIEVT
           :***** ***** .**:******:*.:.*****

Human      FDIDANGILNVTATDKSTGKANKITITNDKGRLSKEEIERMVQEAKEYKAEDEVRERVS
Chicken    FDIDANGILNVSADVSTGKANKITITNDKGRLSKDDIDRMVQEAKEYKAEDEANRDRVG
           *****:.*.***** *****:*.:.*****:*.:.

Human      AKNALESYAFNMKSAVEDEGLKGI SEADKKKVLDKCQEVI SWLDANTLAEKDEFEHKRK
Chicken    AKNSLESYTYNMKQTVDEKLGKISDQDKQKVLDKCQEVI SWLDRNQMAEKEEYEHKQK
           ***:***:.*.***:**** *****: **:****** * :***:*.***:

Human      ELEQVCNPIISGLYQGAGGPGGGFQAQGPKGGSGSGPTIEEVD
Chicken    ELEKLCNPIVTKLYQGAGGAGAGGSG-----GPTIEEVD
           ***:.*:***:.* ***** * * * *****

```

Figure 4.1: Clustal alignment of human HSP70 and chicken HSP70

Clustal Omega program from EMBL-EBL (www.ebi.ac.uk/Tools/msa/clustalo/) (Larkin *et al.*, 2007) was used to analyse and compare human HSP70 sequence with chicken HSP70 sequence (NCBI reference sequence NP_001006686.1) (<https://www.ncbi.nlm.nih.gov/protein/55742654>). “*” shows conserved residues, “:” shows non-conserved residues, “.” Shows similar residues, “-” shows absent residues. (<https://www.ncbi.nlm.nih.gov/>) Accessed 10th October 2016.

In this study, both polyclonal and monoclonal antibodies against rHSP70 were made. Polyclonal antibodies were made by immunising chickens with affinity-purified rHSP70, and monoclonal antibodies were made by screening a phage library for scFv clones against rHSP70. The bio-panning process was optimised to obtain high affinity scFv clones against rHSP70 from the *Nkuku*[®] library. The scFv clones were characterised using colony, nested PCR, *AluI* digests, dot blots, western blots and sequencing.

4.2 RESULTS

4.2.1 Polyclonal antibody production in chickens

The chickens were immunised with affinity-purified rHSP70 and eggs were collected each week over a period of 12 weeks. IgY isolated from single eggs corresponding to each week was used in an ELISA against rHSP70 to show the antibody titre developed by each chicken to rHSP70. It was found that Chicken 1 (KMF1) had a better response against rHSP70, than chicken 2 (KMF2) as seen with the high absorbance values with chicken 1 (Figure 4.2 A). Chicken 1 however, stopped laying eggs from week 7. Antibody production against rHSP70 antibodies in both chickens peaked from week two onwards (Figure 4.2 A).

IgY antibodies were isolated from the egg yolk using a modified methodology developed by Polson *et al.* (1980) (Goldring and Coetzer, 2003). Specific antibodies against rHSP70 were isolated from the IgY pools and affinity-purified using an AminoLink™ resin coupled with affinity-purified rHSP70 (Figure 4.2 B). The affinity-purified anti-rHSP70 antibodies were shown to be specific for rHSP70 (Figure 4.3). A BL21-(DE3) recombinant *Plasmodium yoelli* lactate dehydrogenase (*rPflDH*) *Escherichia coli* (*E. coli*) lysate were used as the negative controls and the anti-rHSP70 antibodies did not detect any *E. coli* proteins (Figure 4.3). The affinity-purified anti-rHSP70 antibodies were comparable to a commercial anti-HSP70 antibody (StressMarq) (Figure 4.4) as both detected the rHSP70 as a 73 kDa band on the western blots. Additional protein bands were detected by the affinity-purified anti-rHSP70 antibodies and the anti-HIS tag antibody confirming that the bands originated from the rHSP70 protein (Figure 4.4). IgY polyclonal rHSP70 antibodies detected degradation products of the recombinant protein. These were not detected by the more specific commercial monoclonal antibody as it recognises only one epitope on the protein. The anti-rHSP70 antibodies were specific for inducible HSP70 as they detected HSP70 in heat-shocked monocytes only (Figure 4.5). This also meant that the polyclonal antibodies did not detect HSC70, which is the constitutive form of HSP70, as no bands were detected at 37°C (Figure 4.5). The polyclonal antibodies are unique as they have been made in chickens, and detect only inducible HSP70.

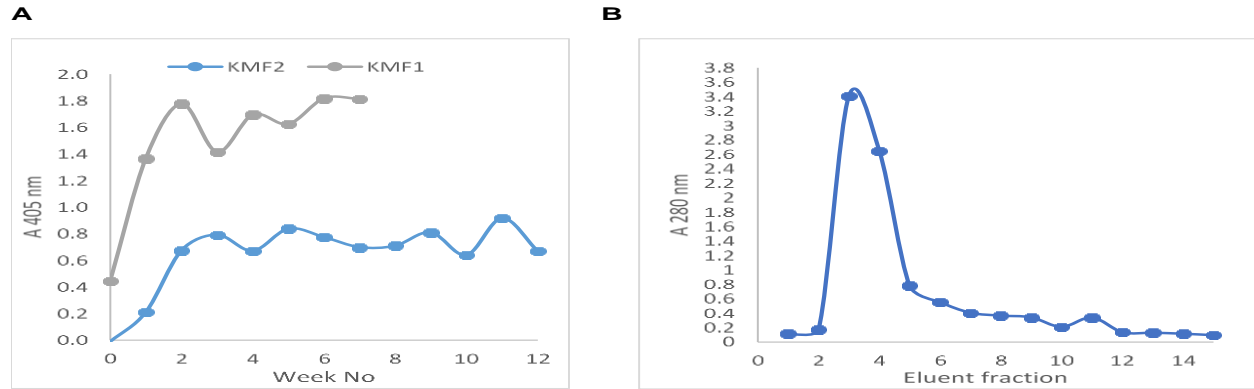

Figure 4.2: ELISA of anti-rHSP70 antibodies from crude IgY and elution profile of affinity-purified anti-rHSP70 antibodies

Eggs were collected weekly for twelve weeks and IgY was isolated from single eggs corresponding to the last day of each week. The ELISA (A) was probed with 25 µg/ml of IgY as the primary antibody. Rabbit anti-chicken HRPO (1:10000) was used as the secondary antibody. An AminoLink™ resin was coupled with rHSP70 to bind anti-rHSP70 antibodies. The elution profile from the affinity matrix is shown in (B).

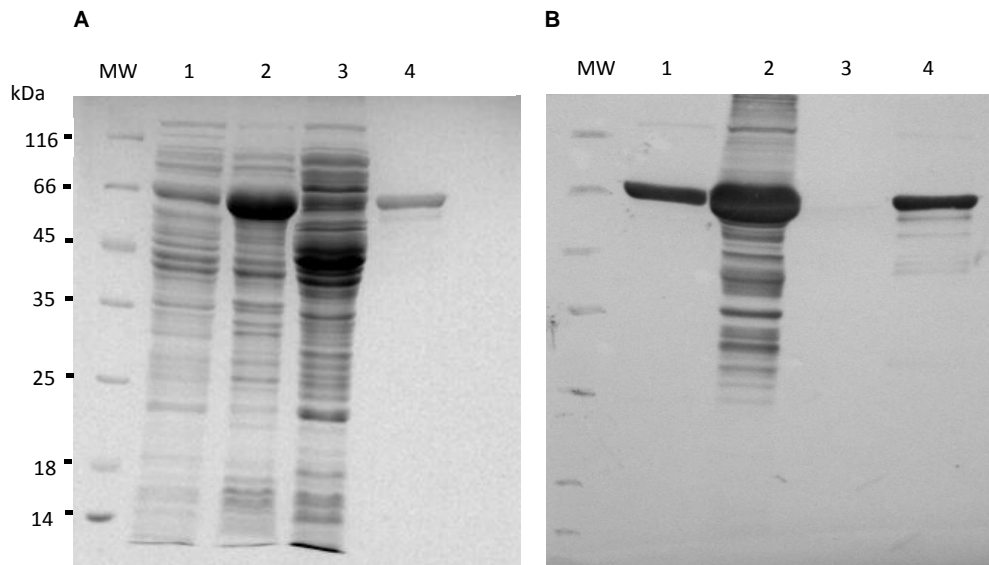

Figure 4.3: Specificity of affinity-purified anti-rHSP70 antibodies

A 12.5% reducing SDS-PAGE containing BL21-(DE3) *E. coli* lysates and pure rHSP70 were run (A). The corresponding western blot was probed with affinity-purified anti-rHSP70 antibodies at 1 µg/ml. Rabbit anti-chicken HRPO (1:10000) was used as the secondary antibody (B). MW: Molecular weight marker; Lane 1; non-induced rHSP70 lysate; Lane 2, induced rHSP70 lysate; Lane 3, induced rP₁LDH lysate; Lane 4, affinity-purified rHSP70.

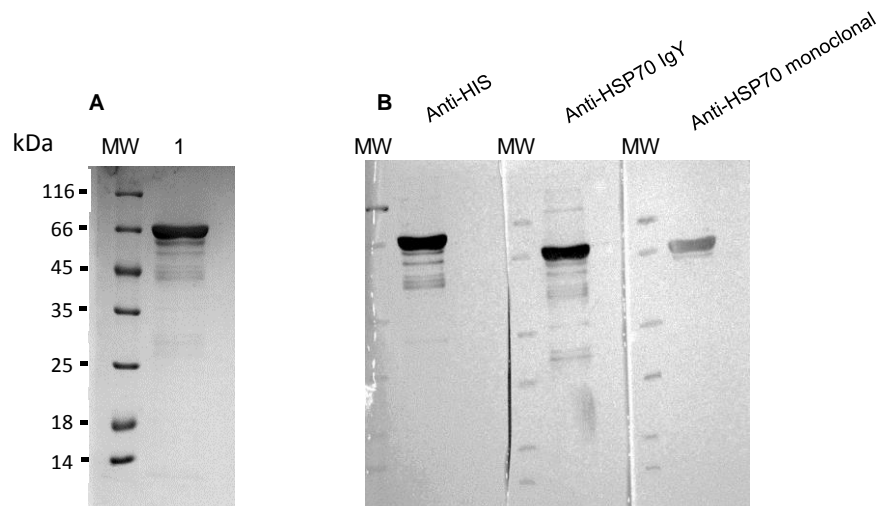

Figure 4.4: Comparison of affinity-purified anti-rHSP70, anti-His tag and commercial anti-HSP70 antibodies

Affinity-purified rHSP70 was run on 12.5% reducing SDS-PAGE gel (A). The corresponding western blots (B) were probed with either mouse monoclonal anti-His tag antibody (1:5000); chicken affinity-purified anti-rHSP70 antibody (1 μ g/ml) or commercial mouse monoclonal anti-HSP70 antibody (1:1000). Where mouse monoclonal antibodies were used, goat anti-mouse HRPO secondary antibody was used at 1:1000. For the chicken antibodies, rabbit anti-chicken HRPO secondary antibody was used at 1:10000. MW: Molecular weight marker; Lane 1, affinity-purified rHSP70.

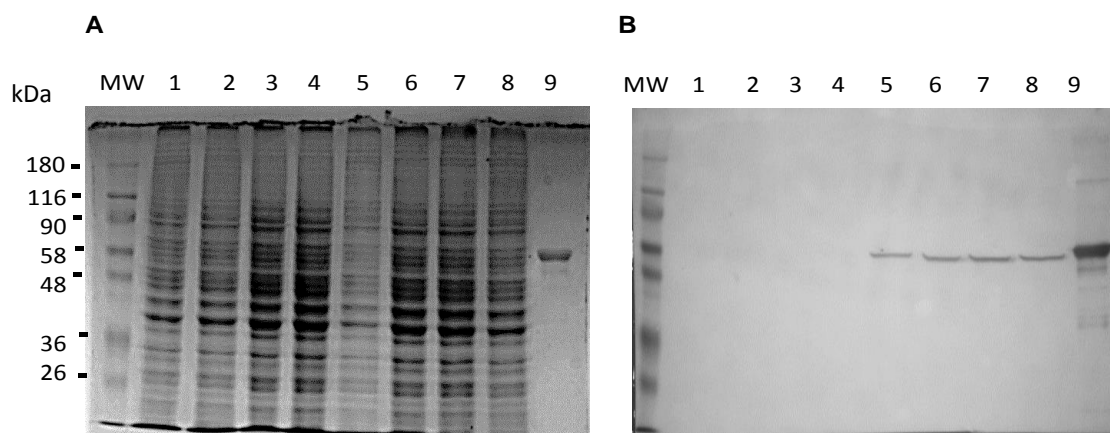

Figure 4.5: Detection of monocyte HSP70 with affinity-purified anti-rHSP70 antibodies

Normal and heat shocked J774A.1 cell lysates were run on a 10% reducing SDS-PAGE gel (A). The corresponding western blot (B) was probed with affinity-purified anti-rHSP70 antibodies at 1 μ g/ml, and rabbit anti-chicken HRPO as the secondary antibody at 1:10000. The western blot was visualised using enhanced chemiluminescence (ECL). MW: Molecular weight marker; Lanes 1-4, non-heat shocked monocyte lysates; Lanes 5-8, heat shocked lysates; Lane 9, affinity-purified rHSP70.

4.2.2 Selection of single chain variable fragment (scFv) clones against rHSP70

The optimisation and characterisation steps of panning are shown below in Figure 4.6. The different infection modes and different blocking agents were compared. Polyclonal phage ELISAs were performed to see which round of panning produced more specific clones to HSP70.

Monoclonal phage ELISAs were then carried out on colonies picked from that round of panning. Clones that seemed specific for HSP70 were analysed by colony PCR to verify whether they were of complete length. Full length clones were then chosen for monoclonal soluble ELISA to find which clones secreted scFv against HSP70. The clones were then further characterised by nested PCR, dot blots and western blots.

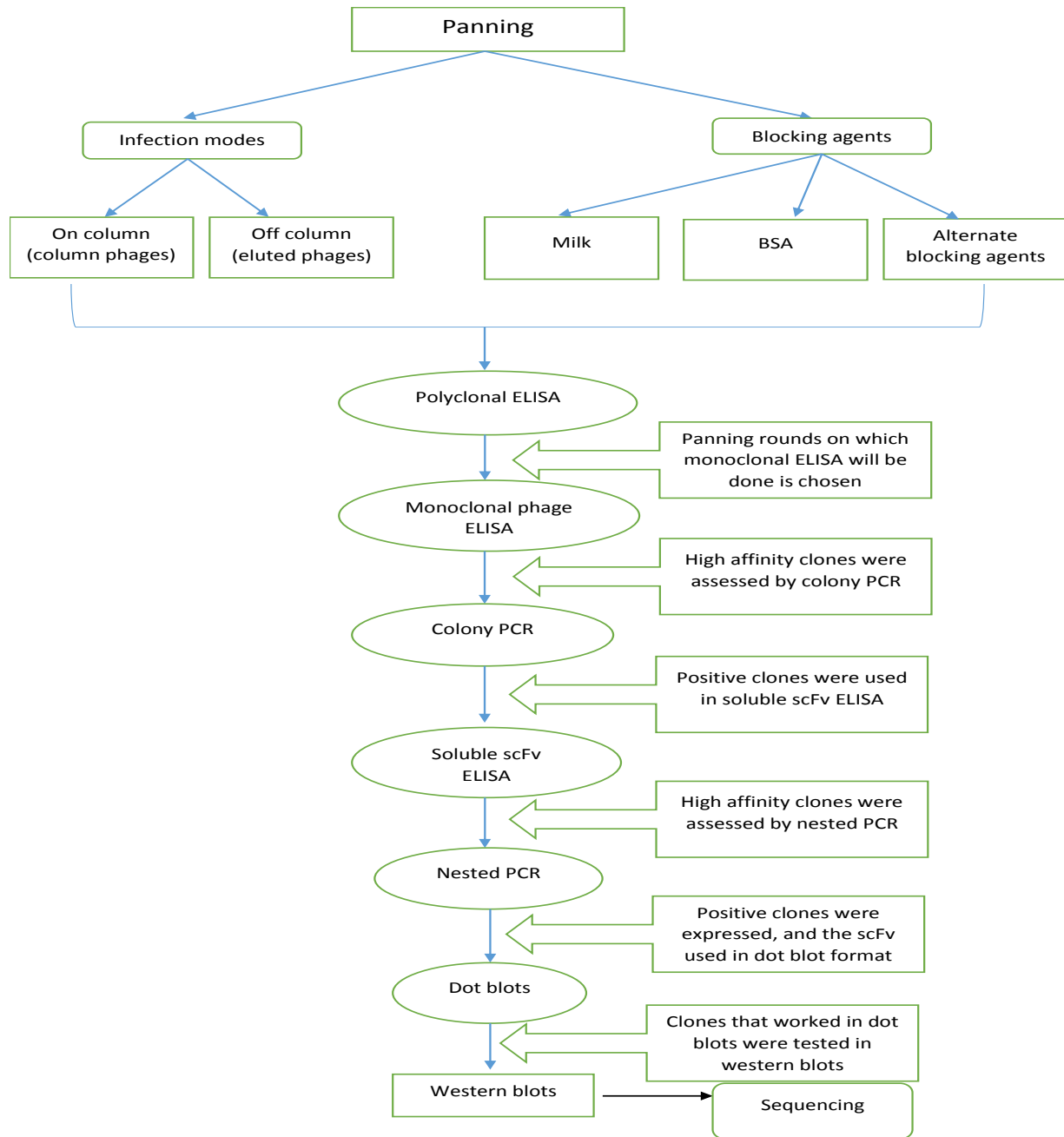

Figure 4.6: Flow-chart of scFv isolation

The steps leading to the isolation of specific scFv clones against rHSP70 are shown in the flow-chart.

4.2.2.1 Polyclonal phage ELISAs

4.2.2.1.1 Column/Eluted phages

After each round of panning, rescued pools of phages were used in an ELISA to determine if there was enrichment of scFvs specific for rHSP70 with each round of panning (Figure 4.6). On column infection of TG1 *E. coli* cells with phages (column phages) and infection of TG1 *E. coli* cells with eluted phages were compared (Figure 4.7). Higher affinity scFv clones to rHSP70 were obtained with eluted phages than with column phages, as observed with the higher absorbance values with eluted phages compared to column phages (Figure 4.7). The enrichment of scFvs was weak for both column and eluted phages with every round of panning. From the polyclonal ELISA, it was found that scFv clones against rHSP70 clones were enriched using both eluted and column phages.

4.2.2.1.2 Blocking agent

The impact of blocking agents (Figure 4.6) on enrichment of scFvs against rHSP70 was investigated with skimmed milk powder, BSA, and the use of alternate blocking agents (BSA in first round of panning, milk in second round of panning, BSA in third round of panning, milk in the fourth round of panning) during bio-panning (Figures 4.8, 4.9). There were more phages binding to rHSP70 than to milk or to BSA (Figure 4.8). However, with increasing rounds of panning, phages binding to BSA also increased (Figure 4.8). When alternate blocking agents were used, it was found that there were more phages that bound to BSA than rHSP70 when eluted phages were used (Figure 4.9 A). For column phages, there was no enrichment of scFvs against rHSP70, when alternate blocking agents were used (Figure 4.9 B). The use of alternate blocking agents did not seem favourable in our study. Colonies were not picked from those rounds of panning for monoclonal ELISAs. Milk powder seemed to be a better blocking agent compared to BSA since the phages binding to milk did not increase with each round of panning.

A**B**

Figure 4.7 Polyclonal phage ELISA of scFv against rHSP70 comparing column phages with eluted phages

Rescued column phages (A) and eluted phages (B) from each round of panning were used in the polyclonal phage ELISA, and the anti-M13 antibody was used as the primary antibody at 1:4000. Goat anti-mouse HRPO was used as the secondary antibody at 1:1000. The absorbance at 405 nm was measured. Un-panned phages and milk powder were used as negative controls.

A**B**

Figure 4.8: Polyclonal phage ELISA of scFv against rHSP70 comparing milk powder and BSA as blocking agents

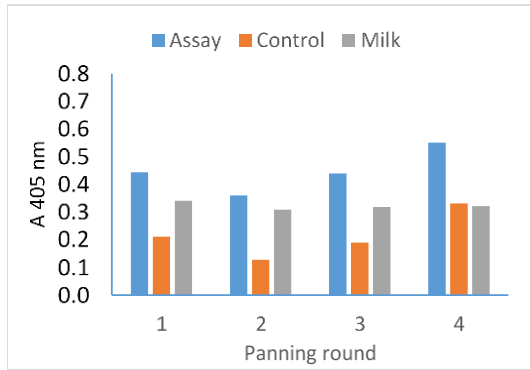
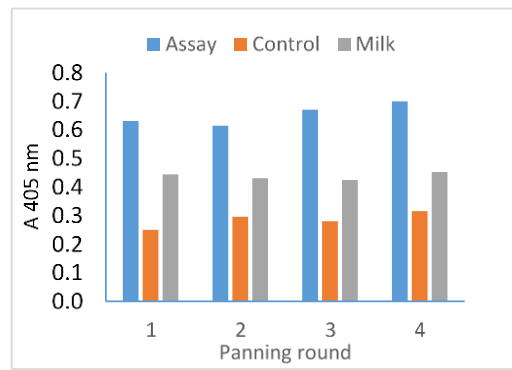
Rescued eluted phages from each round of panning were used in the polyclonal phage ELISA, blocked by milk powder (A) and BSA (B). Anti-M13 antibody was used as the primary antibody at 1:4000 and goat anti-mouse HRPO was used as the secondary antibody at 1:1000. The absorbance at 405 nm was measured. Un-panned phages, BSA (A) and milk powder (B) were used as controls.

A**B**

Figure 4.9: Polyclonal phage ELISA of scFv against rHSP70, using alternate blocking agents.

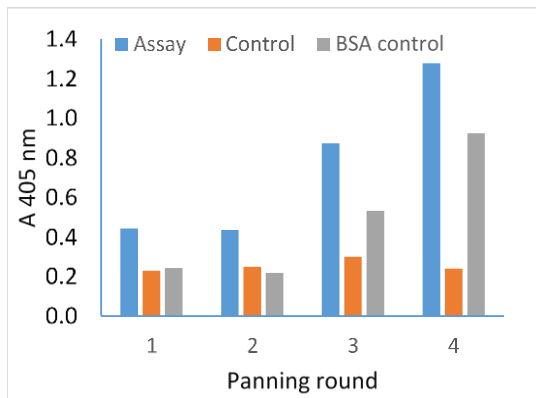
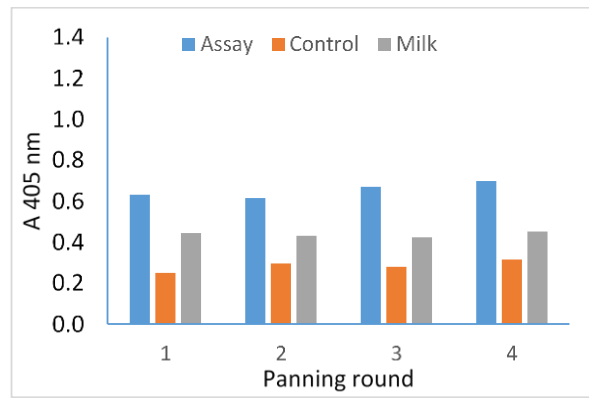
Rescued eluted phages (A) and column phages (B) from each round of panning were used in the polyclonal ELISA, and the anti-M13 antibody was used as the primary antibody at 1:4000. Goat anti-mouse HRPO was used as the secondary antibody at 1:1000. The absorbance at 405 nm was measured. Milk powder, BSA and un-panned phages were used as controls.

4.2.2.2 Monoclonal phage ELISAs

Based on the polyclonal phage ELISAs, single colonies were picked from third and fourth rounds of panning for eluted phages, blocked by milk powder; third and fourth round of panning for eluted phages, blocked by BSA; third and fourth round of panning for column phages, blocked by milk powder (Figures 4.10-4.15). A blocking control was included, depending on whether milk powder or BSA was used. For colonies that were picked from rounds of panning blocked with milk, an additional control was done. BSA was coated to wells of an ELISA plate to investigate whether the selected scFv clones bound to BSA (data not shown) since BSA was used as the blocking agent in ELISAs. The absorbance values were very low, and showed that non-specific interaction with BSA was low (data not shown). Rescued phages from individual colonies that had high affinity for rHSP70 and low affinity for BSA/milk were selected for colony PCR (Figure 4.6). Colony PCR was done to confirm if the phage was of complete size (1000 bp), confirming that it had the complementarity determining regions (CDR) of the heavy and light chains, and the linker region. When BSA was used as the blocking agent, all of the scFv clones had higher affinity to rHSP70 than to BSA. The scFvs were then tested against affinity-purified *rPflDH* and BL21-(DE3) *E. coli* lysate to select for more specific scFvs against rHSP70 (data not shown).

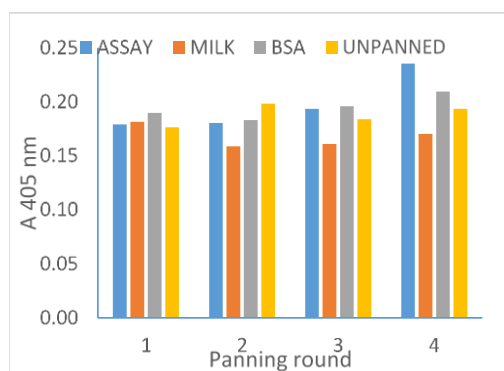
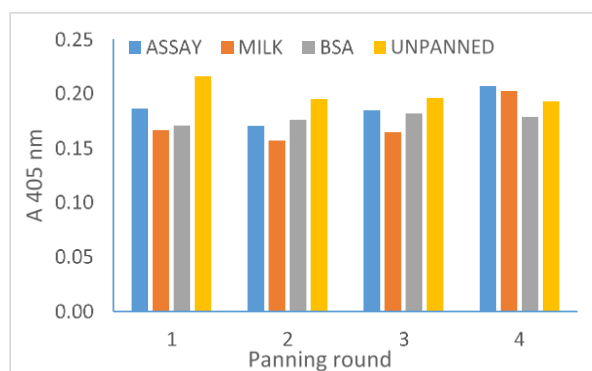
Colony PCR was then done on clones that had high affinity for rHSP70, and low affinity for their respective blocking controls. A colony PCR product of about 1000 bp confirmed the presence of a full length scFv clone coding sequence, referred to as a positive clone. Incomplete clones were usually represented by DNA bands of about 500 bp and 300 bp which represented the V_H chain

and the V_L chain respectively (Chiliza, 2008). Table 4.1 shows the results for colony PCR. In total, there were twenty-five positive clones (Table 4.1). Monoclonal soluble scFv ELISAs (Figure 4.6) were then performed to determine which clones expressed soluble scFvs that detected rHSP70.

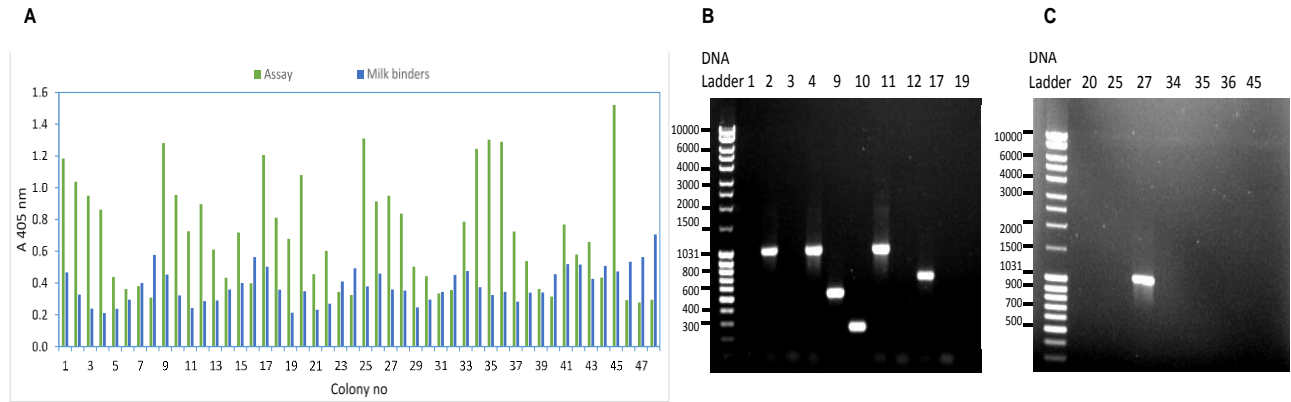

Figure 4.10: Monoclonal phage ELISA and colony PCR from the third round of panning, using column phages, when milk powder was used as blocking agent

Forty-eight colonies were picked from the third round of panning and monoclonal phage ELISA was done (A). Anti-M13 antibody was used as the primary antibody at 1:4000, and goat-anti mouse HRPO was used as the secondary antibody at 1:1000. Milk powder was used as the control. Ten high affinity clones from the monoclonal phage ELISA were then used for colony PCR (B). The forward primer used was OP52 and reverse primer used was M13. The products were resolved on a 1% (w/v) agarose gel. The lane number corresponds to the colony number.

For the third round of panning, when column phages were rescued from individual colonies, most rescued phages had higher affinity for the rHSP70 antigen than for the blocking agent (milk powder) (Figure 4.10 A). Clones that had the highest affinity for rHSP70 (1-4, 9-12, 17, 19, 20, 25, 27, 34, 35, 36, 45) were chosen for colony PCR (Figure 4.10 B). Only clones 2, 4, 11 and 27 were of the expected size (1000 bp). Clones 9, 10, and 17 were incomplete clones. The remaining clones did not amplify; hence, the lanes were empty.

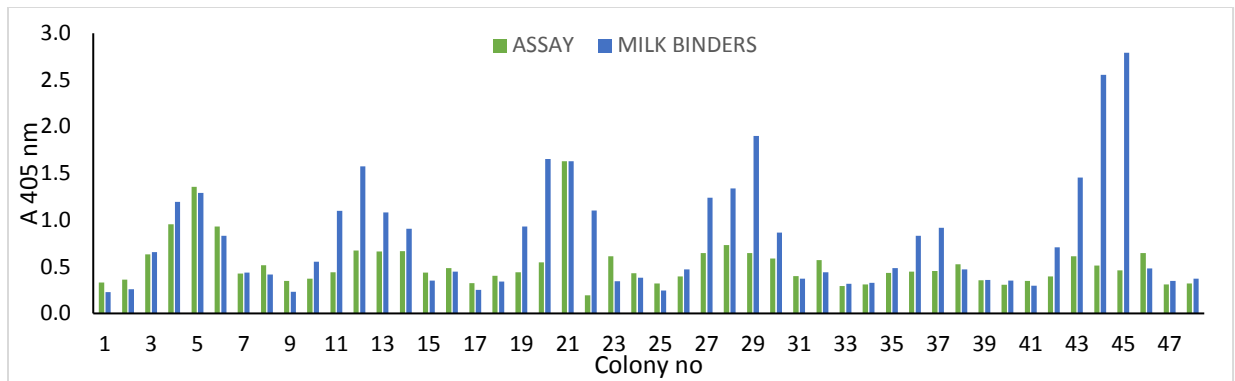

Figure 4.11: Monoclonal phage ELISA from the fourth round of panning against rHSP70, using column phages, when milk powder was used as blocking agent

Forty-eight colonies were picked from fourth round of panning round and monoclonal phage ELISA was done. Anti-M13 antibody was used as the primary antibody at 1:4000, and goat-anti mouse HRPO was used as the secondary antibody at 1:1000. Milk powder was used as the blocking control.

For the fourth round of panning, when column phages were used, all scFv clones had higher affinity for the blocking control (milk powder) than the rHSP70 antigen (Figure 4.11). This showed that there were no scFv clones against rHSP70. Colony PCR was not done for this round.

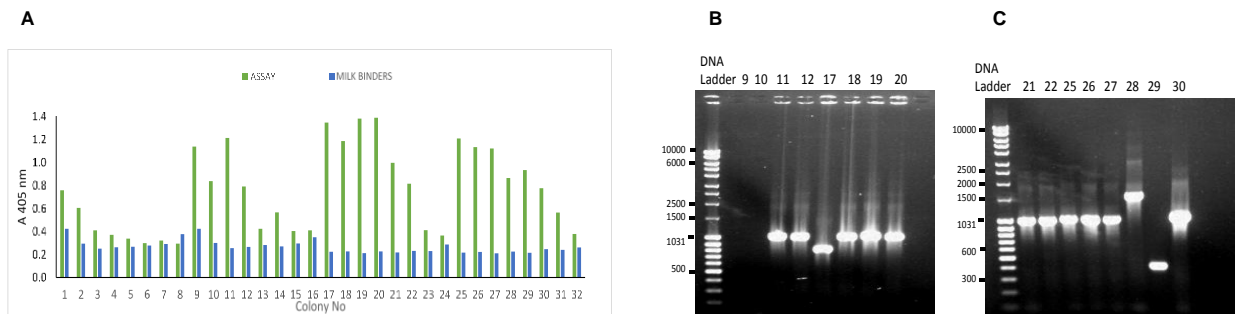

Figure 4.12: Monoclonal phage ELISA and colony PCR of scFv clones from third round of panning, using eluted phages, when milk powder was used as blocking agent

Thirty-two colonies were selected from third round of panning and monoclonal phage ELISA was done (A). Anti-M13 antibody was used as the primary antibody at 1:4000, and goat-anti mouse HRPO was used as the secondary antibody at 1:1000. Milk powder was used as the control. Sixteen high affinity clones from the monoclonal phage ELISA were then used for colony PCR (B). The forward and reverse primers used were OP52 and M13 respectively. The products were resolved on a 1% (w/v) agarose gel. The lane number corresponds to the colony number.

For the third round of panning, when eluted phages were rescued from individual colonies, most scFv clones had higher affinity for the rHSP70 antigen than for the blocking agent (milk powder) (Figure 4.12A). Clones (9-12, 17-22, 25-30) which had the highest affinity to rHSP70 were chosen for colony PCR (Figure 4.12B). Clones 11, 12, 18-22, 25-30 were full-length scFv clones. Clones 17 and 29 were of incomplete clones since they had a lower size than the expected 1000 bp. It was interesting to note that clone 28 was of a larger size than 1000 bp. This could have been a result of duplication. Only full-length clones were further analysed.

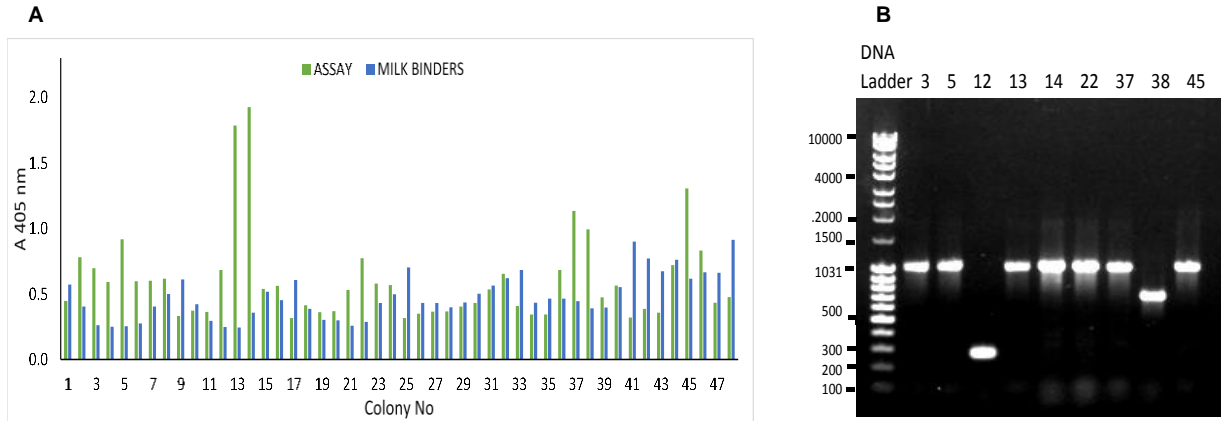

Figure 4.13: Monoclonal phage ELISA and colony PCR of scFv clones from fourth round of panning, using eluted phages, and milk powder as blocking agent

Forty-eight colonies were picked from fourth round of panning and used in monoclonal phage ELISA (A). Anti-M13 antibody was used as the primary antibody at 1:4000, and goat-anti mouse HRPO was used as the secondary antibody at 1:1000. Absorbance was read at 405 nm. Nine clones from the monoclonal phage ELISA were then used for colony PCR (B). The forward and reverse primers used were OP52 and M13 respectively. The products were resolved on a 1% (w/v) agarose gel. The lane number corresponds to the colony number.

For the fourth round of panning, when eluted phages were rescued from individual colonies, most phages had higher affinity for rHSP70 antigen than for the blocking agent (milk powder) (Figure 4.13). Clones (3, 5, 12-14, 22, 37, 38, 45) which had the highest affinity to rHSP70 were chosen for colony PCR. Clones 3, 5, 13, 14, 22, 37, and 45 were of full-length clones (1000 bp). Clones 12 and 38 were of incomplete clones since they had a lower size than the expected 1000 bp.

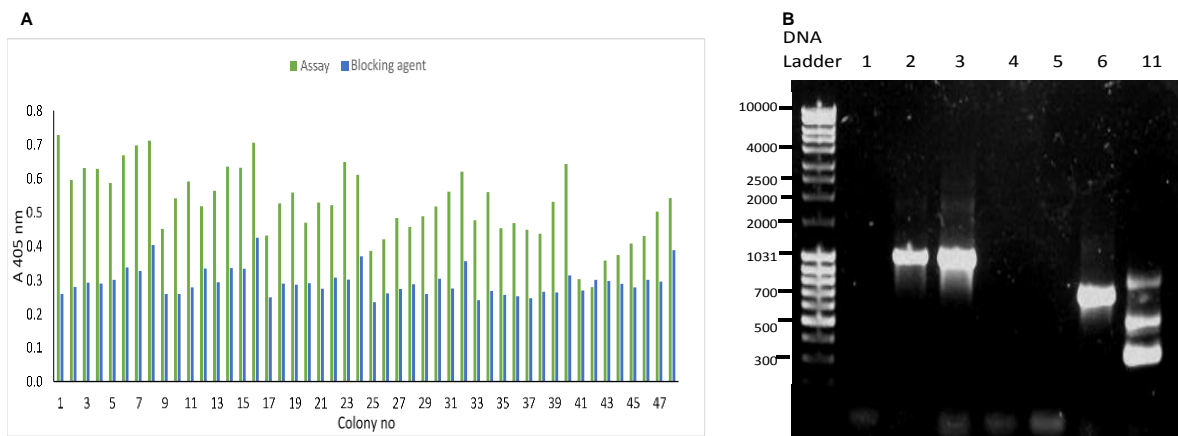

Figure 4.14: Monoclonal phage ELISA and colony PCR of scFv clones from third round of panning, using eluted phages, and BSA as blocking agent

Forty-eight colonies were picked from third round of panning, and used in monoclonal phage ELISA (A). Anti-M13 antibody was used as the primary antibody at 1:4000, and goat-anti mouse HRPO was used as the secondary antibody at 1:1000. Seven clones that had high affinity for rHSP70 were used for colony PCR (B). The forward and reverse primers used were OP52 and M13 respectively. The products were resolved on a 1% (w/v) agarose gel. The lane number corresponds to the colony number.

For the third round of panning, when eluted phages were rescued from individual colonies, most phages had higher affinity for rHSP70 antigen than for the blocking agent (BSA) (Figure 4.14). Clones (1-6, 11) that had highest affinity to rHSP70 were chosen for colony PCR. Only clones 2 and 3 were full-length clones (1000 bp). Clones 6 and 11 were of incomplete clones since they had a lower size than the expected 1000 bp.

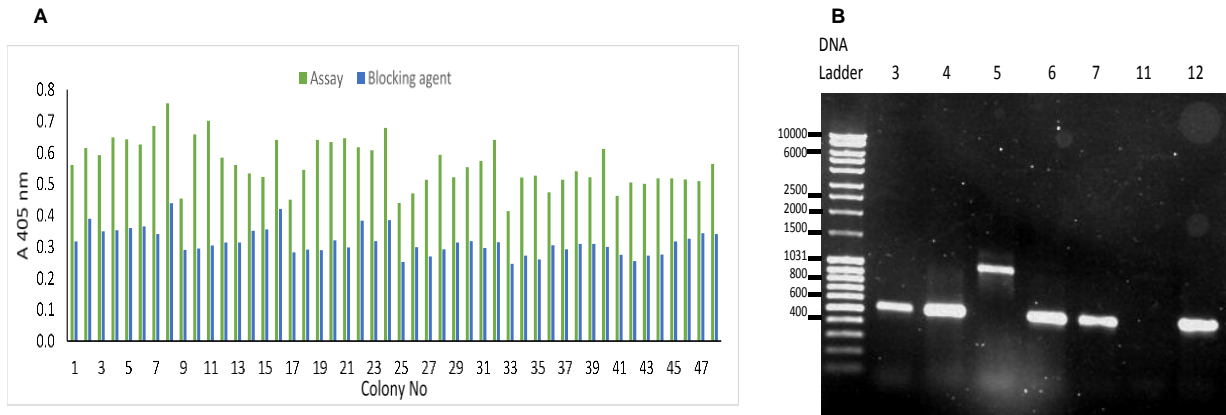

Figure 4.15: Monoclonal phage ELISA and colony PCR of scFv clones from fourth round of panning, using eluted phages, when BSA was used as blocking agent

Forty-eight colonies were picked from fourth round of panning, and used in monoclonal phage ELISA (A). Anti-M13 antibody was used as the primary antibody at 1:4000, and goat-anti mouse HRPO was used as the secondary antibody at 1:1000. Seven clones that had high affinity for rHSP70 were used for colony PCR. The forward primer used was OP52 and reverse primer used was M13. The products were resolved on a 1% (w/v) agarose gel (B). The lane number corresponds to the colony number.

For the fourth round of panning, when eluted phages were rescued from individual colonies, most phages had higher affinity for rHSP70 antigen than for the blocking agent (BSA) (Figure 4.15). Clones (3-7, 11, 12) which had high affinity for rHSP70 were chosen for colony PCR. Only clone 5 was a full-length clone (1000 bp). The rest were incomplete clones.

A summary of the results for colony PCR of all selected clones are shown in table 4.1.

Table 4.1: Summary of colony PCR results of selected clones

Eluted/Column	Panning round	Blocking agent	Total No of colonies	Positive (~1000 bp)
Column	3	Milk	10	4
Eluted	3	Milk	16	11
Eluted	4	Milk	9	7
Eluted	3	BSA	9	2
Eluted	4	BSA	7	1

4.2.2.3 Monoclonal soluble scFv ELISA

All twenty-five positive clones were tested to see if they express soluble scFv clones. Expression of soluble scFv was compared between auto-induction in TEB (Figure 4.16) and IPTG induction

in 2xYT media (Figure 4.17). Affinity-purified rP₁LDH was used as the negative control. BL21-(DE3) *E. coli* lysate was also included to see if there were any soluble scFv clones that bound to *E. coli* proteins. Auto-induction in TEB gave better expression of soluble scFvs than IPTG induced expression. Table 4.2 shows the results for the expression of soluble scFv against rHSP70 in TEB. scFv clones from the third round of panning, using eluted phages, when milk was used as blocking agent seemed to have higher affinity to rHSP70 when compared to other scFv clones. The ten high affinity clones from this round of panning were chosen for further characterisation.

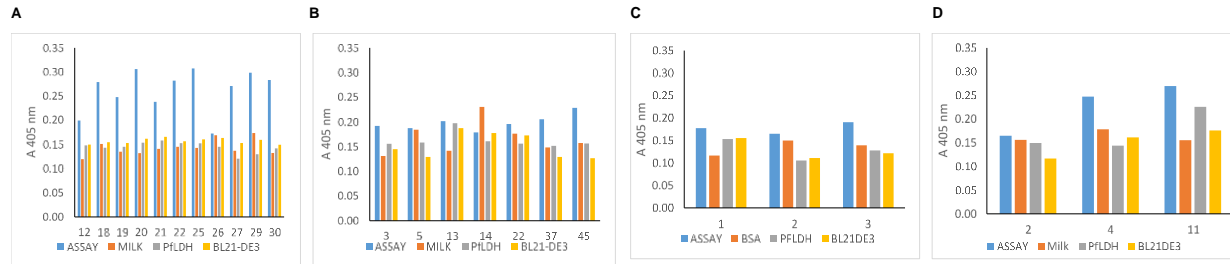

Figure 4.16: Monoclonal soluble scFv ELISAs induced by auto-induction in TEB

The results for the eleven positive clones from the third round of panning, using eluted phages when milk was used as the blocking agent is shown in (A). The results for the seven positive clones from fourth round of panning, using eluted phages when milk powder is used as the blocking agent is shown in (B). (C) shows the results for the three positive clones, using eluted phages when BSA was used in third and fourth rounds of panning. (D) shows the results for the three positive clones, using column phages, when milk was used as the blocking agent. Affinity-purified rP₁LDH, un-transformed BL21-(DE3) *E. coli* lysate and either milk powder or BSA were used as the controls. Anti-c-myc antibodies were used as the primary antibody at 1 µg/ml, and rabbit anti-chicken HRPO was used at 1:10000 as the secondary antibodies.

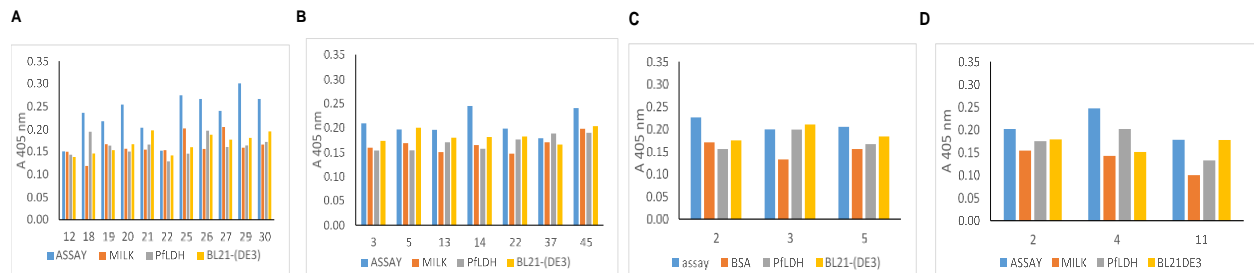

Figure 4.17: Monoclonal soluble scFv ELISAs induced by IPTG

The results for the eleven positive clones from the third round of panning, using eluted phages when milk was used as the blocking agent is shown in (A). The results for the seven positive clones from fourth round of panning, using eluted phages when milk is used as the blocking agent is shown in (B). (C) shows the results for the three positive clones, using eluted phages when BSA was used in the third and fourth rounds of panning. (D) shows the results for the three positive clones, using column phages, when milk was used as the blocking agent. Affinity-purified rP₁LDH, un-transformed BL21-(DE3) *E. coli* and either milk powder or BSA were used as the controls. Anti-c-myc antibodies were used as the primary antibody at 1 µg/ml, and rabbit anti-chicken HRPO was used at 1:10000 as the secondary antibodies.

Table 4.2: Summary of monoclonal soluble ELISA auto-induced in TEB

Eluted/Column	Panning round	Blocking agent	Total number of clones	High affinity	Low affinity
Eluted	3	Milk	11	10	1
Eluted	4	Milk	7	2	5
Eluted	3 & 4	BSA	3	1	2
Column	3	Milk	3	1	2

High affinity: $A_{405} > 0.2$

4.2.2.4 Characterization of selected scFv clones

Nested PCR was done on all eleven soluble scFv clones from the third round of panning, using eluted phages, and milk powder as the blocking agent, to confirm whether the scFv clones contained the linker region (Figure 4.18 A). The nested PCR reaction amplified a PCR product of 500 bp, which confirmed the presence of the linker region in all the selected clones. Other bands were also present, because the nested PCR was done on impure colony PCR products.

DNA repeats of AGTC are present in abundance in the genome and are called the Alu DNA repeat sequence (Abdurashitov *et al.*, 2008). *AluI* restriction enzyme cuts DNA sequence at Alu sites, creating a unique profile for different DNA sequences (Abdurashitov *et al.*, 2008). *AluI* digests were done on the colony PCR products of the selected clones to determine if they were different clones (Figure 4.18 B). After *AluI* digests of the colony PCR products, it was found that there were six unique clones (12, 18, 22, 25, 27, 29), since they gave unique restriction digest profiles (Figure 4.18 B).

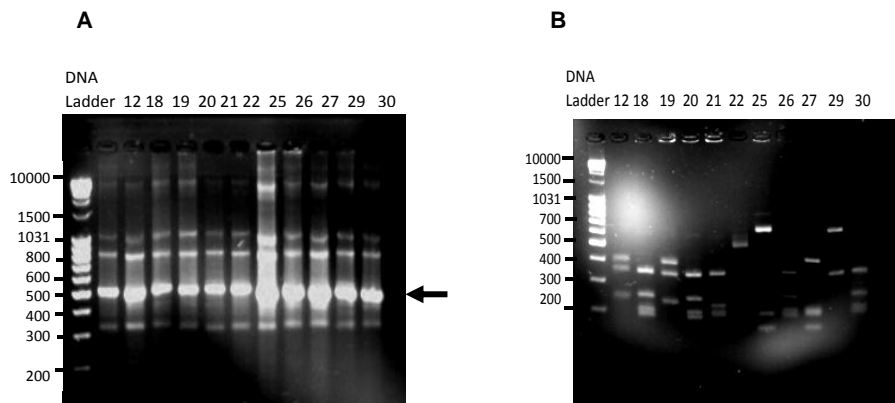

Figure 4.18: Nested PCR and *AluI* digests of positive clones

Nested PCR was carried out on the eleven positive clones from the third round of panning, using eluted phages, when milk was used as the blocking agent (A). Specifically designed forward nested primers and M13 reverse primers were used to detect the presence of the linker peptide. The colony PCR products were also digested with *AluI* restriction enzyme for 16 h at 37°C, to identify unique clones (B). All products were run on 3% (w/v) agarose gel, and viewed under UV light. The lane number corresponds to the colony number.

Nine clones which had high affinity to rHSP70 were chosen to determine if they detected rHSP70 on a dot blot format and they all did (Figure 4.19). Five clones (clones 12, 18, 19, 22 and 27), which detected rHSP70 on the dot blot and had high affinity to rHSP70 were chosen to detect rHSP70 on a western blot, but were unsuccessful (data not shown). No protein bands were detected on the western blot.

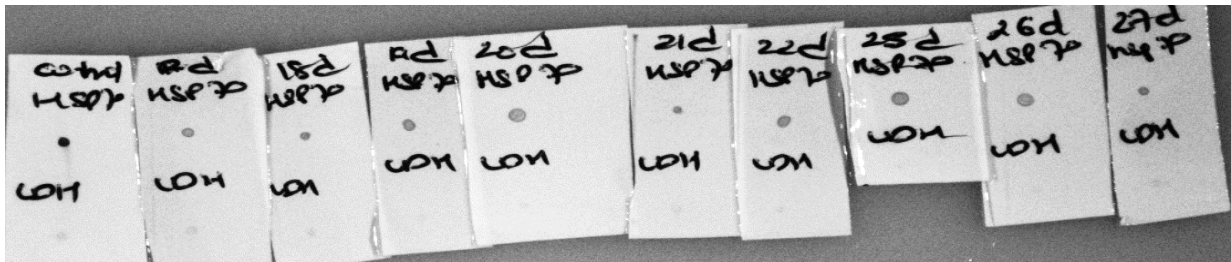

Figure 4.19: Dot blots using different scFv clones

Nine clones were used to detect rHSP70 dotted on a nitrocellulose membrane. The nitrocellulose membrane was probed with soluble scFv supernatants from each clone, followed by anti-c-myc antibody at 1 µg/ml. Rabbit anti-chicken HRPO was used as the secondary antibody (1:15000). rPLDH lysate was used as the negative control. A control blot was included, which was probed with affinity-purified anti-rHSP70 antibody at 1 µg/ml and rabbit-anti chicken HRPO was used as the secondary antibody at 1:15000. Clones 12, 18-22, 25-27 from third round of panning using eluted phages, when milk powder was used as the blocking agent, were used.

From the *AluI* digest profile (Figure 4.18 B), clones 12 and 19 seemed similar, hence they were sent for sequencing to confirm whether they were identical clones or different clones. Clones 18, 22, and 27 were also sent for sequencing because they looked different clones on the *AluI* digest profiles (Figure 4.18 B). They were also shown to have high affinity to rHSP70 in ELISA and in the dot blot. Those five clones were sent for sequencing (Figure 4.20).

Table 4.3: *AluI* digest sites for individual clones

Clone	<i>AluI</i> sites	Sizes (bp)
12	6	188, 247, 346
18	7	376, 232, 342
19	8	188, 247, 345
22	7	595, 149, 191
27	6	602, 347

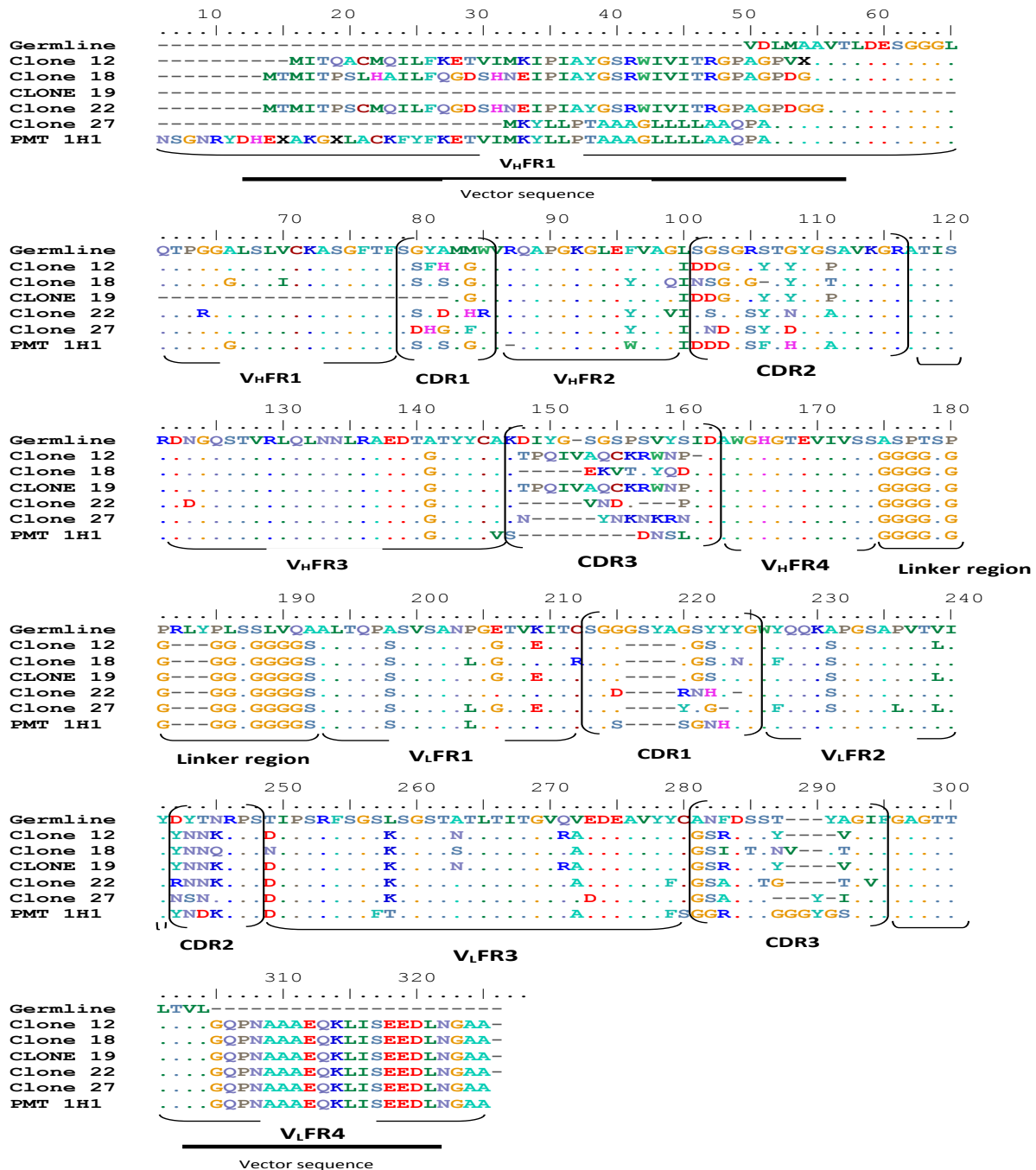

Figure 4.20: Anti-rHSP70 scFv phage amino acid sequences aligned with the chicken germline immunoglobulin sequence, and with an anti-PMT scFv clone.

The protein sequences for five scFv clones (clones 12, 18, 19, 22, 27) against rHSP70 were aligned with the chicken germline and with anti-PMT scFv clone. The linker sequence is shown as (G₄S₃)₃ and the different regions are labelled as V_H for sequences coding for the heavy chain, and V_L for sequences coding for the light chain. V_HFR- V_H framework region (constant/conserved regions); V_LFR- V_L framework region (constant/conserved regions). Complementarity determining regions (CDR) are represented by open boxes. Sequences pertaining to the vector (phagemid) are underlined. "." represent identical residues to the germline sequence, letters represent an amino acid substitution, "-" represent gaps in the alignment.

From the *A**l**u**I* digests, clones 12 and 19 looked similar and we used the sequencing data to confirm the results of the *A**l**u**I* digests (Table 4.3). The CDR2 and CDR3 in the heavy chains for clones 12 and 19 were identical, confirming that they are the same phage clone (Figure 4.20). The rest of the clones differed in the heavy chain CDR sequences, suggesting that they are different clones which might bind to different epitopes of rHSP70. From the sequences obtained, the potential *A**l**u**I* sites were determined, and the approximate sizes of the DNA digests were estimated and correlated with the restriction digests (Table 4.3). The DNA digest sizes correlated with the sequencing data.

4.2.2.5 Comparing eluted phages and column phages

Table 4.4 shows the difference between column phages and eluted phages with each round of panning. With increasing rounds of panning, on column phages tend to produce incomplete scFvs (Figure 4.21).

Table 4.4: Comparison of elution and on column methods

ELUTED				COLUMN			
Panning round	Number of clones	Positive	% Positives	Panning round	Number of clones	Positive	% Positives
1	6	5	83	1	4	3	75
2	5	5	100	2	5	3	60
3	5	3	60	3	5	2	40
4	5	4	80	4	5	0	0

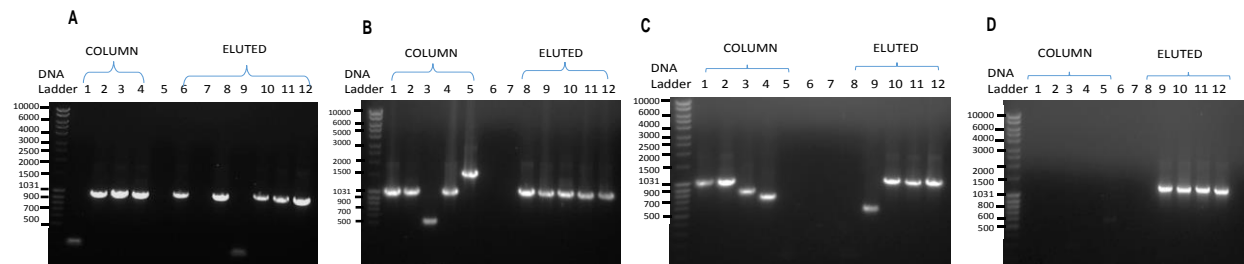

Figure 4.21: Evaluation of the elution methods using colony PCR

Clones that gave high readings in monoclonal ELISAs were selected from each round of panning and colony PCR was done on those clones. The OP52 and M13 were used as the forward and reverse primers respectively. The products were resolved on 1% (m/v) agarose gel and viewed under UV light. (A) shows the colony PCR for first round of panning. Lanes 1-4, clones when column phages were used; Lanes 5,7 empty lanes; Lanes 6, 8-12, six clones when eluted phages were used. (B) shows the colony PCR for panning round two. Lanes 1-5, 5 clones when column phages were used; Lanes 6-7, empty lanes; Lanes 8-12, 5 clones when eluted phages were used. (C) shows the colony PCR for panning round three. Lanes 1-5, 5 clones when column phages were used; Lanes 6-7, empty lanes; Lanes 8-12, 5 clones when eluted phages were used. (D) shows the colony PCR for panning round four. Lanes 1-5, 5 clones when column phages were used; Lanes 6-7, empty lanes; Lanes 8-12, clones when eluted phages were used.

4.3 Discussion

4.3.1 Polyclonal antibodies against rHSP70 in chickens

Antibodies were raised against affinity-purified rHSP70 in chickens in this study. Other animals such as horses and donkeys were not used for antibody production, as they require larger spaces and are difficult to maintain (Polson *et al.*, 1980). Eggs are collected for antibody isolation when using chickens, while other animals need to be bled to obtain the antibodies. The yield of specific antibodies obtained from IgY is greater than IgG (Tini *et al.*, 2002). IgY is stable at room temperature and at 4°C for long periods of time, while IgG degrades more rapidly (Michael *et al.*, 2010). Antibodies have been made against β -ketoalcohol, *Pf*LDH, *Pf*GAPDH, primaquine, pyrimethamine, dapson, tetracycline, doxycycline and bovine HSP70 in chickens, and they were comparable to the antibodies made in mice (Krief *et al.*, 2002, Goldring *et al.*, 2005, Krause *et al.*, 2015, Gutierrez and Guerriero, 1991).

In this study, Freund's adjuvant was used for immunisation. There are other adjuvants available such as Aluminium based adjuvants. Aluminium based adjuvants have been found to elicit a weak immune response and usually induce inflammation (Petrovsky and Aguilar, 2004). Aluminium salts can also accumulate and cause neurotoxicity. Saponin-derived adjuvant such as Quil-A has also been widely used in animal immunisation, as it is considered to be too harsh on humans. Quil-A elicits a high immune response but also causes harm to the animal. Other adjuvants include LPS, cytokines, pheroid and adjuvant emulsions (Petrovsky and Aguilar, 2004, Krause *et al.*, 2015). Freund's complete adjuvant is a mixture of inactivated *Mycobacteria* and mineral oil. Krause *et al.* (2015) found that Freund's adjuvant elicited a higher immune response in chickens than pheroids. The choice of adjuvants has to be a compromise between eliciting a high immune response and the safety of the animal.

A modified version of Polson *et al.* (1980) for IgY isolation was used in this study (Goldring *et al.*, 2005). Sequential PEG precipitation was used to isolate IgY from the lipidic and other protein fractions. Other methods for IgY isolation comprise the use of dextran sulphate, alginate, caprylic acid, chloroform and ammonium sulphate (Michael *et al.*, 2010). Other studies have used repeated freeze-thawing, pH changes and salting out with either sodium chloride, or ammonium sulphate to isolate and purify IgY (Hodek *et al.*, 2013, Tong *et al.*, 2014). Sequential use of PEG precipitation is more efficient, and the yield obtained using this technique is greater than other techniques, such as ammonium sulphate precipitation and dextran sulphate (Goldring and Coetzer, 2003).

4.3.2 Selection of scFv clones against rHSP70

Monoclonal antibodies are highly specific as they recognise one single epitope. They have been used to study conformational changes, interactions between proteins, phosphorylation activation/inactivation states, and in the identification of specific proteins (Lipman *et al.*, 2005). Antibody phage display is becoming more popular than hybridoma technology for monoclonal antibody production, as antibody repertoires are becoming more easily available, and repertoires are being made in different animals, such as mouse, humans and chicken (Winter *et al.*, 1994, Van Wyngaardt *et al.*, 2004).

Immuno-tubes were coated with rHSP70 overnight, and for the first round of panning, the *Nkuku*[®] library was used to select for phages with high affinity to rHSP70. Unbound phages were washed off, and the bound phages were either eluted using tri-ethylamine to infect TG1 *E. coli* cells, or the infection was done on column. The rescued phage pool was used for the next round, for a total of four rounds of panning, increasing the stringency with each round of panning. This allowed for enrichment of specific phages against rHSP70 (Hoogenboom *et al.*, 1998). Rescued phage pool after each round of panning was used in polyclonal phage ELISA, to determine at which round of panning were the most specific single chain variable fragment (scFv) clones expressed. Monoclonal phage ELISA and monoclonal soluble ELISA were done on single colonies picked from different rounds of panning.

4.3.2.1 On column infection/ Off column infection (eluted phages)

In this study, bio-panning was optimised. Tri-ethylamine, an alkaline agent, was used to release the bound phages from the immuno-tubes for elution (Smith and Petrenko, 1997). When on column infection was compared to off column (eluted phages), using milk powder as the blocking agent, it was found that most of the high affinity clones were incomplete scFv clones, since colony PCR showed clones of lower sizes than the expected 1000 bp. To further explore how these two methods differ, colony PCR was done after each round of panning. As the selection process became more stringent, full length scFv clones were lost, and incomplete scFv clones were selected for. Most studies on producing antibodies using phage library have used eluted phages to infect *E. coli* cells (Marks *et al.*, 1991, Van Wyngaardt *et al.*, 2004, Nukarinen, 2016, Hawkins *et al.*, 1992). Smith and Petrenko (1997) reported the use of on column phages, but suggested that the yield of phages obtained was lower compared to eluted phages. They also reported that this method of infection was used for peptides displayed on pVIII, and not much information has been obtained when this method has been used for peptides/antibodies displayed on pIII. A study screening for peptides, using a phage display system, infected *E. coli* cells by using on column

phages (Noppe *et al.*, 2009). They, however did not test the effectiveness of the phages, and did not verify if the phages were of full length. Another study which used on column infection for antibody screening found that the diversity of clones decreased with increasing rounds of panning (Lou *et al.*, 2001). Our study suggests that if on column infection is to be used with the *Nkuku*[®] library, rounds of panning should be limited so as to select for full length scFv clones.

While tri-ethylamine has been widely used for phage elution, other non-specific elution buffers such as 6 M urea, glycine, sodium chloride, and HCl have been used to elute phages off columns (Van Wyngaardt and Du Plessis, 1998, Watters *et al.*, 1997, Kuba and Furukawa, 2009). Those buffers denature the phages, hence causing them to detach from the immune-tube (Smith and Petrenko, 1997).

4.3.2.2 Blocking agents

Two different blocking agents (milk powder and BSA) were compared based on the yield and quality of clones obtained against rHSP70. Milk powder was a better blocking agent than BSA in these experiments, as fewer phages bound to milk, when compared to BSA. It was also found that when BSA was used as the blocking agent in this study, incomplete scFv clones were being selected for. Non-fat milk has been widely used as a blocking agent in various applications such as western blots, southern blots, and ELISAs (Shen *et al.*, 2012). Many studies have used milk powder as the blocking agent during bio-panning and obtained good yields and full length scFv clones for their selected antigens (Van Wyngaardt and Du Plessis, 1998, Davies *et al.*, 1995, Marks *et al.*, 1991). BSA is a large protein, that is stable and does not affect many reactions, therefore used as a blocking agent (Shen *et al.*, 2012). Studies using BSA as a blocking agent and which obtained functional scFvs include Hawkins *et al.* (1992), Merz *et al.* (1995) and Watters *et al.* (1997).

A study was conducted to compare milk powder and BSA as blocking agents, for selecting high affinity phages, on a phage-based magnetoelastic biosensor (Shen *et al.*, 2012). They used different concentrations of milk and BSA, and found that at high concentrations of BSA (5 mg/ml), there were more phages binding to BSA than to the antigen. But when the concentration was reduced to 1 mg/ml, there were fewer phages binding to BSA than to antigen. For milk powder, at a low concentration (0.1 mg/ml), there were more phages binding to antigen than to milk. They suggest that the use of blocking agent should be optimised (Shen *et al.*, 2012). The use of BSA might have favoured the selection and enrichment of incomplete scFvs, since most of the phages

were incomplete in length in this study. It is also possible that because the concentration of BSA used in this study was high, [3% (w/v)], there were more phages binding to BSA than the antigen.

Alternate blocking agents (BSA in the first round of panning, milk powder in the second round of panning, BSA in the third round of panning, milk powder in the fourth round of panning) were used in successive rounds of panning to eliminate any phages binding to the blocking, and to enrich for phages binding to rHSP70 only. That proved to be unsuccessful since phages binding to rHSP70 were not enriched. This parallels the findings of the study conducted by Saggy *et al.* (2012) which found the use of alternate blocking agent to be a failure, and attributed this to the de-enrichment of phages. Other blocking agents that have been commonly used include casein and gelatine (Shen *et al.*, 2012, Bradbury and Marks, 2004, Saggy *et al.*, 2012).

4.3.2.3 Expression of soluble scFv

Expression of soluble scFv using auto-induction and IPTG induction were compared. Auto-induction in TEB was better at expressing soluble scFv compared to IPTG induction in 2xYT media. This simplifies expression of soluble scFvs and makes it more cost effective. This study reflects the data obtained by another study which found that auto-induction expressed high levels of antibodies compared to IPTG induction (Nadkarni *et al.*, 2007, Ukkonen *et al.*, 2013). Lactose induction was also compared and was found to be less efficient than IPTG since the bacteria did not grow to high cell densities (Nadkarni *et al.*, 2007).

4.3.2.4 Characterisation of clones

Selected scFv clones detected rHSP70 in ELISA and dot blot formats, but not in a western blot. This might be because the phages recognise conformational epitopes (Smith and Petrenko, 1997, Liu and Marks, 2000). In western blot, proteins are heat denatured and transferred to nitrocellulose membrane for detection. This might have denatured conformational epitopes and hence, the scFvs could not detect the antigen (Liu and Marks, 2000). Another study was successful in making scFv clones against recombinant human HSP70, and successfully used them to detect the protein on a western blot (Baek *et al.*, 2004). They however, could not detect HSP70 from U937 cell lysates, and suggested that the clones selected for, did not bind to the native form of HSP70 since HSP70 might form different conformations in a mammalian cell, when compared with an *E. coli* cell (Baek *et al.*, 2004).

4.4 Conclusion

Polyclonal antibodies were made against rHSP70 in chickens, and used to detect native HSP70 from both human and mouse monocytes throughout this study. A *Nkuku*[®] phage library was used to screen for scFvs against rHSP70. The panning process was optimised and it was found that eluted phages work best, and that milk was the best blocking agent. Expression of soluble scFvs was found to give the best yields of soluble scFvs. Selected clones detected rHSP70 in a dot-blot format but did not detect the recombinant protein or native HSP70 in a western blot, as the rHSP70 was denatured, hence lost its conformational epitopes. This study showed that monoclonal antibodies can be made *in vitro*, and in a relatively short period of time. Immunisation of animals was not required. The specific scFv phages against rHSP70 could be used in ELISA formats as they could detect native forms of HSP70. They could also be used in immunoprecipitation and immuno-florescence assays.

CHAPTER 5: EFFECTS OF ANTIMALARIAL, ANTI-INFLAMMATORY DRUGS AND β -HAEMATIN ON MONOCYTE HSP70 PROTEIN EXPRESSION

5.1 Introduction

5.1.1 Malaria, fever and HSP70

Malaria is caused by parasites of the *Plasmodium* genus and most malaria morbidity and mortality is caused by *P. falciparum* infections (Urban and Roberts, 2002). One of the main features of malaria is periodical fever (Pavithra *et al.*, 2004). Schizont rupture is usually accompanied by fever (Garcia *et al.*, 2001) and a rise in tumour necrosis factor- α (TNF- α) serum levels (Polla, 1991, Clark and Cowden, 2003). During fever, both the host and the parasites experience heat shock conditions (Polla, 1991). While fever has been reported to inhibit parasite growth (Kwiatkowski, 1989), it has mostly been associated to increase the disease burden (Carvalho *et al.*, 2013, Oakley *et al.*, 2007). Fever increases cytoadherence and rosetting of infected red blood cells (Oakley *et al.*, 2007) and fever can synchronise parasite growth *in vitro* (Pavithra *et al.*, 2004).

Heat shock protein 70 (HSP70) is a highly conserved protein which is expressed by cells, when exposed to stress including heat shock (Robert, 2003, Borges *et al.*, 2012). HSP70 has been reported to be anti-inflammatory (Borges *et al.*, 2012) and anti-apoptotic (Jäättelä, 1999). HSP70 protects cells against TNF- α , nitric oxide and oxidative stress mediated cytotoxicity (Jäättelä and Wissing, 1993). During stress, HSP70 is expressed at higher levels in monocytes when compared to other leucocytes (Bachelet *et al.*, 1998).

Monocytes act as the first line of defence against parasites (Gordon and Mantovani, 2011). They phagocytose infected red blood cells, free parasites, parasite products and haemozoin during malaria (Malaguarnera and Musumeci, 2002), mounting a response by releasing pro-inflammatory cytokines such as TNF- α , IL-6 and anti-inflammatory cytokines such as IL-10 (Gordon and Taylor, 2005, Schofield and Grau, 2005). Monocytes secrete neopterin (Facer, 1995) and phospholipase A2 (PLA2) (Vadas *et al.*, 1993) during malaria. It was however, reported that monocyte functions during malaria are compromised when they phagocytose haemozoin (Schwarzer *et al.*, 1992). The haemozoin laden monocytes produce uncontrolled amounts of cytokines, lose their ability to undergo repeated phagocytosis and have suppressed NADPH oxidative activity (Giribaldi *et al.*, 2010, Schwarzer *et al.*, 1992, Schwarzer and Arese, 1996).

5.1.2 Characterisation of cell lines

Two cell lines were used in this study, namely J774A.1 and U937 cells. The J774A.1 cells are derived from a histiocytic lymphoma from a female BALB/c/ NIH mouse (Ralph *et al.*, 1975). They are adherent and phagocytic cells (Ralph *et al.*, 1975). The U937 cell line is a pro-monocytic cell line, isolated from a histiocytic lymphoma from a 37-year-old male (Sundström and Nilsson, 1976). The cells are non-adherent, and lack IgG receptors (Chanput *et al.*, 2015, Sundström and Nilsson, 1976) and are non-phagocytic (Ralph *et al.*, 1976). The body consists of both monocytes and macrophages, which is why two different cell lines representing both populations were used. A mouse cell line was used to see what would happen *in vivo* when mice would be used to test the effects of the antimalarial, anti-inflammatory drugs on monocyte HSP70. *In vivo* studies were not done in this study, but the *in vitro* results could be used as a reference for when animal studies are done. Histochemical techniques were used to characterise two different monocyte/macrophage cell lines, J774A.1 and U937. Giemsa and methyl green stains were used for morphological studies. Peroxidase and alkaline phosphatase activity of monocytes were used to assess cell viability and to show that the cells were healthy and active.

5.1.3 Antimalarial drugs

Antimalarial drugs have been primarily used to treat malaria (Wolf *et al.*, 2000, Blanchard, 1947), but they can influence the host immune response as well (Thomé *et al.*, 2013, Wolf *et al.*, 2000). Understanding how antimalarial drugs influence monocyte HSP70 expression may give an insight on how they affect monocyte responses. Nine antimalarial drugs namely artemisinin, artesunate, artemether, chloroquine, pyrimethamine, primaquine, quinine, quinidine and quinacrine were used at therapeutic concentration of each drug in this study. Artemisinin and its derivatives, artesunate and artemether have been reported to be anti-inflammatory, as they inhibit expression of pro-inflammatory cytokines from monocytes (Hou and Huang, 2016). Artemisinin and artesunate decreased TNF- α and IL-6 expressions from mouse peritoneal macrophages (Wang *et al.*, 2006, Li *et al.*, 2008), while artemether inhibited IL-2 and IFN- γ productions by mice splenocytes (Wang *et al.*, 2007). Chloroquine inhibited TNF- α and IL-6 expressions from monocytes (López Suárez *et al.*, 2014, Jang *et al.*, 2006), and it has been used for the treatment of rheumatoid arthritis and lupus due to its anti-inflammatory properties (Thomé *et al.*, 2013). Pyrimethamine has been found to increase nitric oxide secretion in infected mice sera (Legorreta-Herrera *et al.*, 2010). Primaquine decreased TNF- α and IFN- γ secretions in mice sera which were given autoimmune encephalomyelitis (Zanucoli *et al.*, 2014). Quinine decreased TNF- α and nitric oxide expressions in macrophages (Maruyama *et al.*, 1994, Lowry *et al.*, 1998). Quinidine

increased TNF- α expression in peripheral blood mononuclear cells (Matsumori *et al.*, 1997). Quinacrine decreased TNF- α , IL- β and nitric oxide expressions from macrophages (Bondeson and Sundler, 1998, Jani *et al.*, 2010, Chumanevich *et al.*, 2016). Quinine, primaquine and artemisinin decreased the neopterin secretion from IFN-stimulated macrophages, by inhibiting the GTP cyclohydrolase-1 enzyme, which is required to convert break down GTP to intermediates required for neopterin synthesis (Cumming *et al.*, 2011). Artemisinin and quinine were reported to be most effective in reducing rosette formation between trophozoite infected red blood cells and non-infected red blood cells (Goldring *et al.*, 1999). Another study reported that quinine and pyrimethamine were more effective in reducing cytoadherence between monocytes and infected red blood cells (Goldring and Nemaorani, 1999).

5.1.4 Anti-inflammatory drugs

Four anti-inflammatory drugs, ambroxol, danazol, probucol and curcumin were used in this study. They have antimalarial properties, which suggest that they can be used as adjunct therapy with antimalarial drugs in the treatment of malaria. Ambroxol, danazol and probucol were reported to inhibit cytoadherence between infected red blood cells and monocytes (Goldring and Ramoshebi, 1999). ProbucoL was also found to decrease α -tocopherol in the blood, therefore increasing oxidative stress, which has been attributed to the killing of parasites (Herbas *et al.*, 2015). ProbucoL also decreased the effective concentration of dihydroartemisinin (DHA) for use in malaria (Kume *et al.*, 2016). Curcumin was reported to prevent the breakdown of the blood-brain barrier, and to prevent brain endothelial cell apoptosis during a malaria infection, hence preventing cerebral malaria (Kunwittaya *et al.*, 2014, Dende *et al.*, 2015). It was thought that the anti-inflammatory drugs could affect monocyte responses, and monocyte HSP70 expression was measured to determine whether they have an effect on monocytes.

Ambroxol was reported to decrease TNF- α , IL-6, IL-1 β , NO expressions in macrophages (Beeh *et al.*, 2008), while probucol decreased IL-1 β and hydrogen peroxide production in monocytes (Akeson *et al.*, 1991, Fukuda *et al.*, 1995). Danazol decreased IL6, IL-1 β and TNF- α expressions in macrophages (Mori *et al.*, 1990, Liu *et al.*, 2000). Curcumin decreased TNF- α , IL-6, IL-1 β expressions in monocytes (Literat *et al.*, 2001, Julie and Jurenka, 2009). Curcumin increased reactive oxygen species secretion by monocytes (Mimche *et al.*, 2012). Ambroxol, probucol and danazol decreased cytoadherence between infected red blood cells and monocytes, suggesting that monocyte receptors were downregulated in the presence of those anti-inflammatory drugs (Goldring and Ramoshebi, 1999). Danazol has been reported to decrease estrogen receptors on

monocytes (Fujimoto *et al.*, 1995), while curcumin increased CD36 receptors on monocytes (Mimche *et al.*, 2012).

The effects of antimalarial and anti-inflammatory drugs on monocyte HSP70 protein expression were not reported elsewhere.

5.1.5 Influence of haemozoin on monocyte responses

Monocytes avidly phagocytose malaria haemozoin, but their functions have been reported to be affected by the incomplete digestion of haemozoin (Skorokhod *et al.*, 2014). Monocytes laden with haemozoin produce dysregulated amounts of cytokines, have inhibited phagocytosis, cannot process antigen for antigen presentation, and have produce low levels of reactive oxygen intermediates, due to inhibition of the NADPH enzyme (Giribaldi *et al.*, 2010, Schwarzer *et al.*, 1992, Schwarzer and Arese, 1996). Monocytes with haemozoin have been reported to express high levels of TNF- α , IL-12, NO (Jaramillo *et al.*, 2009, Ranjan *et al.*, 2016).

5.2 Results

5.2.1 Characterisation of the two monocyte cell lines

Giemsa stains the cell nuclei bright blue, and the cytoplasm light blue (Figure 5.1 A, B), and cell nuclei stained bright green and the cytoplasm stained light green with methyl green (Figure 5.1 C, D). Granules were observed as they stained more brightly than the cytoplasm. The kidney shaped nucleus could be seen for both J774A.1 and U937, from the Giemsa and methyl stains (Figure 5.1 A, B). The Giemsa and methyl stains confirmed that the cells had monocyte morphology. Cells with peroxidase activity stained brown (Figure 5.1 E, F) and those with alkaline phosphatase activity stained blue (Figure 5.1 G, H). U937 cells stained pale blue compared to J774A.1 cells, which might suggest that they had lower alkaline phosphatase activity than J774A.1 cells (Figure 5.1). Both J774A.1 and U937 cells had peroxidase and alkaline phosphate activity (Figure 5.1). Trypan blue assay was also used to see if the cells were viable (data not shown). These show that the cells expressed peroxidase and alkaline phosphatase activity and were active, therefore were healthy.

5.2.2 Statistical analysis

Three different (triplicate) cultures of J774A.1 and U937 cells were incubated with each drug at their therapeutic concentrations. Samples from each of the three treated cultures were loaded in duplicate on a reducing SDS-PAGE gel. Monocyte HSP70 protein expression was analysed from the SDS-PAGE gel and its corresponding western blot. The experiments were repeated at different times and the effects obtained were identical. This ensured that the effects obtained were repeatable. Monocytes untreated and monocytes treated with DMSO were heat shocked

for 2 h at 40°C, and allowed to rest for 2 h at 37°C. The monocyte lysates were analysed on a SDS-PAGE gel there was no difference in the expression level of monocyte HSP70 (data not shown). Monocyte HSP70 protein expression was quantified using densitometry where monocyte HSP70 expression was compared to either the total protein in each lane or a single protein band from the same lane from the reference SDS-PAGE gel (Welinder and Ekblad, 2011). A prominent protein band at about 42 kDa which was present in all lanes from monocyte cell lysates in the SDS-PAGE gel, was used as the protein band for loading and expression control. As referred in chapter two, the 42 kDa band is thought to be beta-actin. The use of a single protein band for normalising data was preferred in this study since it was thought that the increase in HSP70 expression induced by the experiments may alter the total protein in a particular lane. HSP70 protein expression when, both total protein (data attached to Appendix) or a single protein band were used as loading control, was compared and minimal differences were found. Results obtained when a single protein band was used as the loading control are reported.

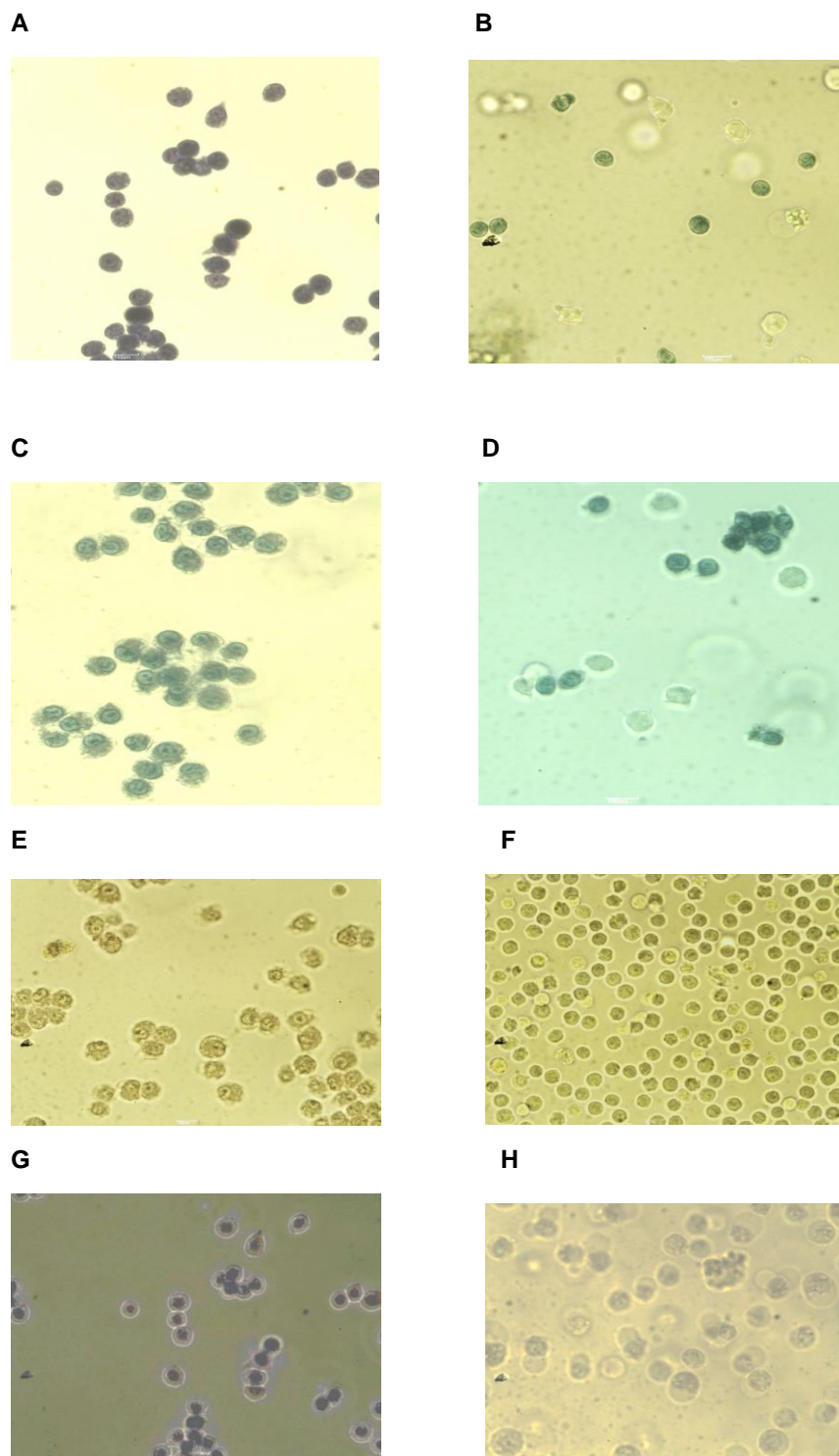

Figure 5.1: Staining of J774A.1 and U937 cells

The J774A.1 (A) and U937 (B) cells were stained with Giemsa; J774A.1 (C) and U937 (D) cells were stained with methyl green; peroxidase activity of J774A.1 (E) and U937 (F) cells were visualised with DAB stain; alkaline phosphatase activity of J774A.1 (G) and U937 (H) cells were visualised using BCIP/NBT stain. The cells were viewed under a phase contrast microscope at 400X magnification.

5.2.3 Effects of antimalarial drugs on monocyte HSP70 protein expression

The effects of artemisinin, artesunate, artemether, chloroquine, quinine, quinidine, quinacrine, pyrimethamine and primaquine on monocyte HSP70 protein expression were investigated. A summary of the data is presented in a table and a figure, at the end of the section (Table 5.1, Figure 5.21). None of the antimalarial drugs had an effect on the inducible HSP70 protein expression at 37°C in monocytes. A representative gel and western blot for artemisinin are shown in Figure 5.2. The western blots of all the anti-malarial drugs were blank, as with artemisinin. This served as a negative control. Because the interplay of fever and presence of antimalarial drugs on monocyte HSP70 protein expression were investigated, monocytes pre-treated with each drug at therapeutic concentration for 18 h, were heat shocked for 2 h at 40°C, and allowed to rest for 2 h at 37°C (Aunpad *et al.*, 2009), so as to mimic febrile episodes experienced during malaria.

Artemisinin had an apparent decrease in J774A.1 HSP70 protein expression, which was not significant ($p=0.54$) and a significant decrease in HSP70 expression in U937 cells ($p=0.0014$) (Figures 5.3, 5.4). With Artesunate, both J774A.1 ($p=0.10$) and U937 ($p=0.36$) cells showed no significant change in the HSP70 protein expression, though an apparent increase was observed in J774A.1 cells (Figures 5.5, 5.6). When treated with artemether, there was a significant increase in HSP70 protein expression in J774A.1 ($p=0.0068$) but not in U937 ($p=0.22$) cells (Figures 5.7, 5.8). There was a significant increase ($p=0.016$) in HSP70 expression when J774A.1 cells were treated with chloroquine (Figure 5.9) and an apparent increase in HSP70 in U937 cells ($p=0.17$) (Figure 5.10). No significant change in the HSP70 protein expression was observed when J774A.1 ($p=0.32$) and U937 ($p=0.54$) cells were treated with pyrimethamine (Figures 5.11, 5.12). There was a significant decrease in HSP70 expression in both J774A.1 ($p=0.0034$) and U937 cells ($p=0.014$) with primaquine (Figures 5.13, 5.14). It can be seen that quinine decreased HSP70 protein expression in both J774A.1 (0.00002) and U937 (0.00003) cells (Figures 5.15, 5.16). When the concentration of quinine was increased to 15 µg/ml, it was found that the HSP70 protein expression decreased even more (Figure 5.17). With Quinidine, a decrease in both cells ($p=0.024$) and ($p=0.054$) (Figures 5.18, 5.19). With Quinacrine, both J774A.1 ($p=0.0000019$) and U937 ($p=0.0000072$) cells showed a significant decrease in HSP70 protein expression (Figures 5.20, 5.21). There was barely any HSP70 protein expressed with quinacrine.

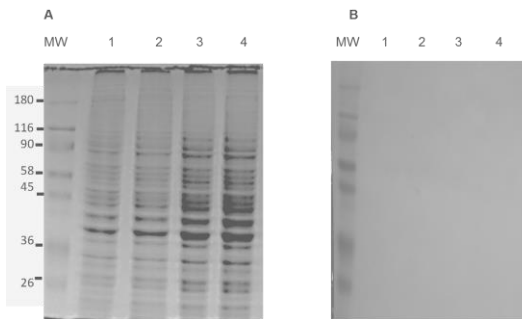

Figure 5.2: HSP70 protein expression in J774A.1 cells incubated with artemisinin

The cells were treated with 400 ng/ml of artemisinin for 18 h at 37°C, and then lysed. The cell lysates were run on a reducing 10% SDS-PAGE gel (A). The corresponding western blot (B) was probed with affinity purified anti-rHSP70 antibody at 1 µg/ml. Rabbit anti-chicken HRPO was used as the secondary antibody at (1:10000). The western blot was viewed using ECL. MW: Molecular weight marker; Lane 1, DMSO control; Lanes 2-4, triplicate cultures treated with Artemisinin.

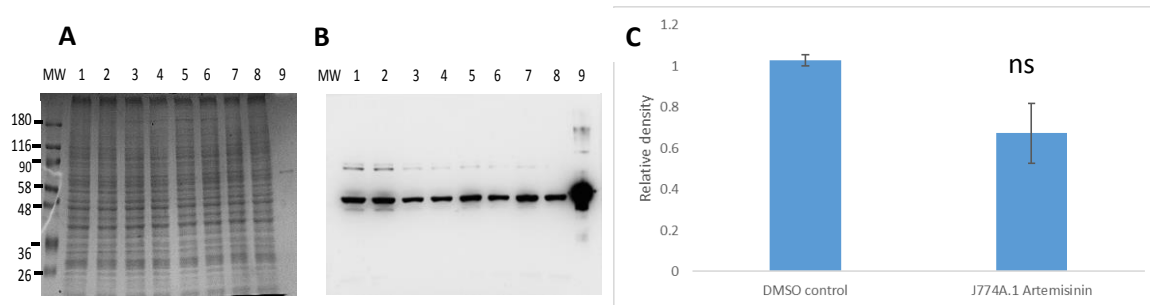

Figure 5.3: HSP70 expression in J774A.1 cells incubated with artemisinin and heat shocked

The cells were treated with 400 ng/ml of artemisinin for 18 h at 37°C, then heat shocked for 2 h at 40°C, and allowed to rest for 2 h at 37°C. The cell lysates were run on a reducing 10% SDS-PAGE gel (A). The corresponding western blot (B) was probed with affinity-purified anti-rHSP70 antibody at 1 µg/ml. Rabbit anti-chicken HRPO was used as the secondary antibody at (1:10000). The western blot was viewed using ECL. MW: Molecular weight marker; Lanes 1-2, DMSO control; Lanes 3-8, triplicate cultures treated with Artemisinin, loaded in duplicate; Lane 9, pure rHSP70. (C) shows the densitometry analysis of the western blot, using ImageJ. Values are means \pm SE; ns:(non-significant); $p>0.05$.

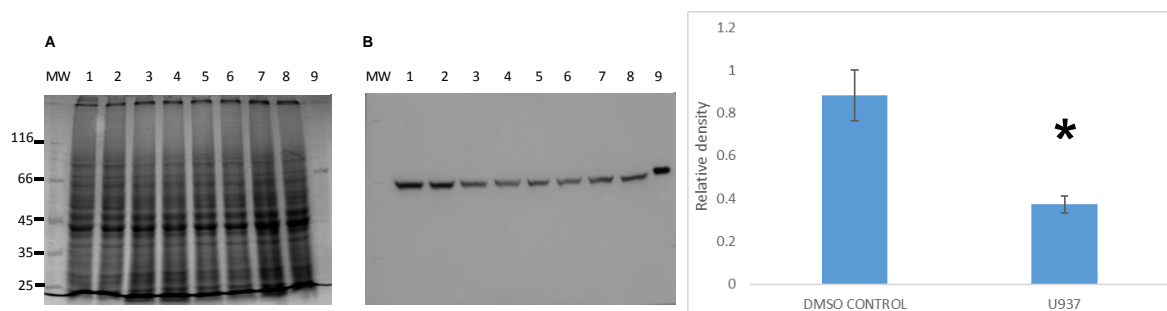

Figure 5.4: HSP70 expression in U937 cells incubated with artemisinin and heat shocked

The cells were treated with 400 ng/ml artemisinin for 18 h at 37°C, then heat shocked for 2 h at 40°C, and allowed to rest for 2 h at 37°C. The cells lysates were run on a reducing 10% SDS-PAGE gel (A). The corresponding western blot (B) was probed with and affinity-purified anti-rHSP70 antibodies at 1 µg/ml. Rabbit anti-chicken HRPO was used as the secondary antibody at (1:10000). The western blot was viewed using ECL. MW: Molecular weight marker; Lanes 1-2, DMSO control; Lanes 3-8, triplicate cultures treated with artemisinin, loaded in duplicate; Lane 9, pure rHSP70. (C) shows the densitometry analysis of the western blot, using ImageJ. Values are means \pm SE; * $p<0.05$, ($p=0.0014$).

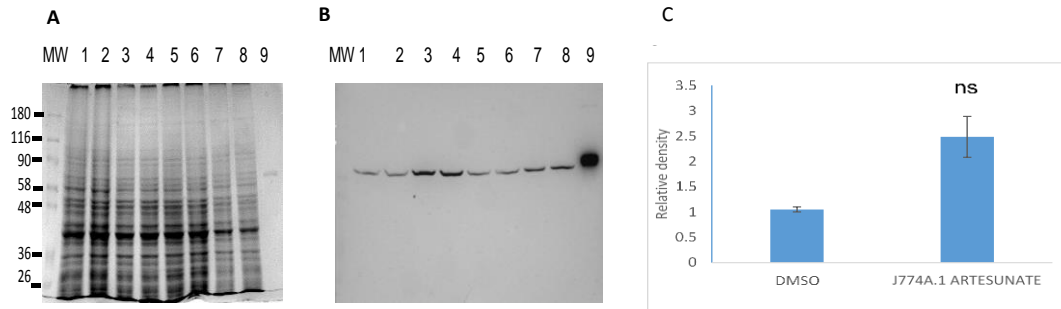

Figure 5.5: HSP70 expression in J774A.1 cells incubated with artesunate and heat shocked

The cells were treated with 200 ng/ml artesunate for 18 h at 37°C, then heat shocked for 2 h at 40°C, and allowed to rest for 2 h at 37°C. The cell lysates were run on a reducing 10% SDS-PAGE gel (A). The corresponding western blot (B) was probed with affinity-purified anti-rHSP70 antibody at 1 µg/ml. Rabbit anti-chicken HRPO was used as the secondary antibody at (1:10000). The western blot was viewed using ECL. MW: Molecular weight marker; Lanes 1-2, DMSO control; Lanes 3-8, triplicate cultures treated with artesunate, loaded in duplicate; Lane 9, pure rHSP70. (C) shows the densitometry analysis of the western blot, using ImageJ. Values are means ± SE; ns:(non-significant); $p > 0.05$.

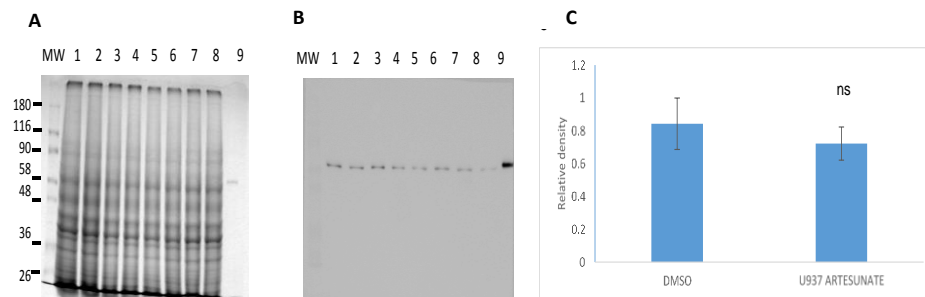

Figure 5.6: HSP70 expression in U937 cells incubated with artesunate and heat shocked

The cells were treated with 200 ng/ml artesunate for 18 h at 37°C, then heat shocked for 2 h at 40°C, and allowed to rest for 2 h at 37°C. The cell lysates were run on a reducing 10% SDS-PAGE gel (A). The corresponding western blot (B) was probed with affinity-purified anti-rHSP70 antibodies at 1 µg/ml. Rabbit anti-chicken HRPO was used as the secondary antibody at (1:10000). The western blot was viewed using ECL. MW: Molecular weight marker; Lanes 1-2, DMSO control; Lanes 3-8, triplicate cultures treated with artesunate, loaded in duplicate; Lane 9, pure rHSP70. (C) shows the densitometry analysis of the western blot, using ImageJ. Values are means ± SE; ns:(non-significant); $p > 0.05$.

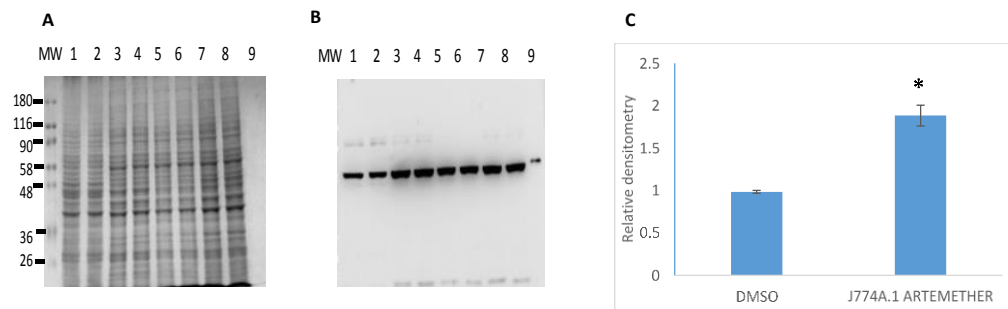

Figure 5.7: HSP70 expression in J774A.1 cells incubated with artemether and heat shocked

The cells were treated with 200 ng/ml of artemether for 18 h at 37°C, then heat shocked for 2 h at 40°C, and allowed to rest for 2 h at 37°C. The cell lysates were run on a reducing 10% SDS-PAGE gel (A). The corresponding western blot (B) was probed with affinity-purified anti-rHSP70 antibody at 1 µg/ml. Rabbit anti-chicken HRPO was used as the secondary antibody at (1:10000). The western blot was viewed using ECL. MW: Molecular weight marker; Lanes 1-2, DMSO control; Lanes 3-8, triplicate cultures treated with artemether, loaded in duplicate; Lane 9, pure rHSP70. (C) shows the densitometry analysis of the western blot, using ImageJ. Values are means ± SE; * $p < 0.05$; ($p = 0.0068$).

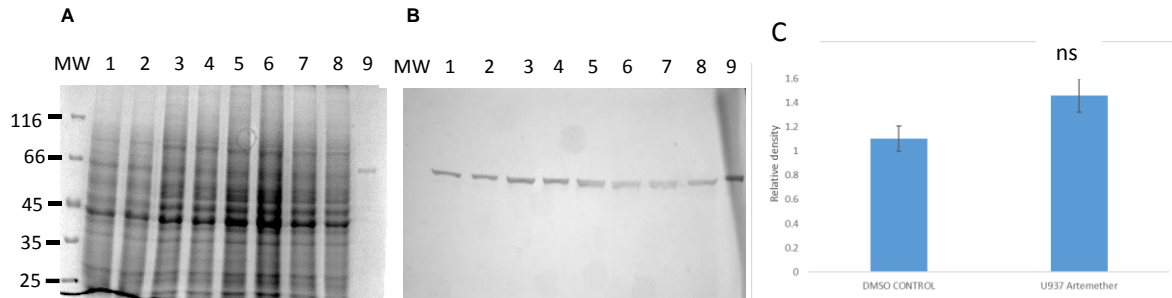

Figure 5.8: HSP70 expression in U937 cells incubated with artemether and heat shocked

The cells were treated with 200 ng/ml of artemether for 18 h at 37°C, then heat shocked for 2 h at 40°C, and allowed to rest for 2 h at 37°C. The cell lysates were run on a reducing 10% SDS-PAGE gel (A). The corresponding western blot (B) was probed with affinity-purified anti-rHSP70 antibodies at 1 µg/ml. Rabbit anti-chicken HRPO was used as the secondary antibody at (1:10000). The western blot was viewed using ECL. MW: Molecular weight marker; Lanes 1-2, DMSO control; Lanes 3-8, triplicate cultures treated with artemether, loaded in duplicate; Lane 9, pure rHSP70. (C) shows the densitometry analysis of the western blot, using ImageJ. Values are means ± SE; ns:(non-significant); $p > 0.05$.

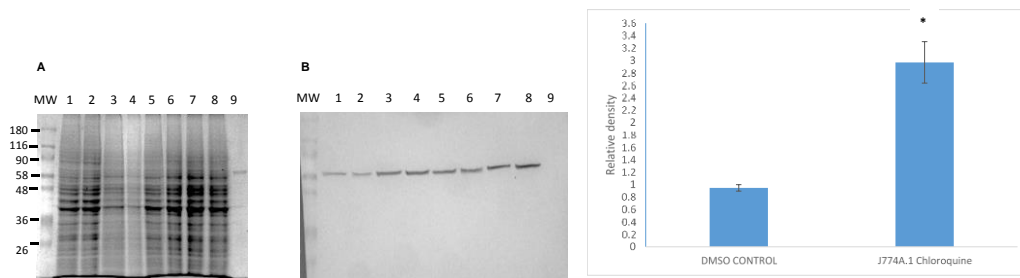

Figure 5.9: HSP70 expression in J774A.1 cells incubated with chloroquine and heat shocked

The cells were treated with 200 ng/ml of chloroquine for 18 h at 37°C, then heat shocked for 2 h at 40°C, and allowed to rest for 2 h at 37°C. The cells were lysed and run on a reducing 10% SDS-PAGE gel (A). The western corresponding blot (B) was probed with affinity-purified anti-rHSP70 antibodies at 1 µg/ml. Rabbit anti-chicken HRPO was used as the secondary antibody at (1:10000). The western blot was viewed using ECL. MW: Molecular weight marker; Lanes 1-2, DMSO control; Lanes 3-8, triplicate cultures treated with chloroquine, loaded in duplicate; Lane 9, pure rHSP70. (C) shows the densitometry analysis of the western blot, using ImageJ. Values are means ± SE; * $p < 0.05$; ($p = 0.0016$).

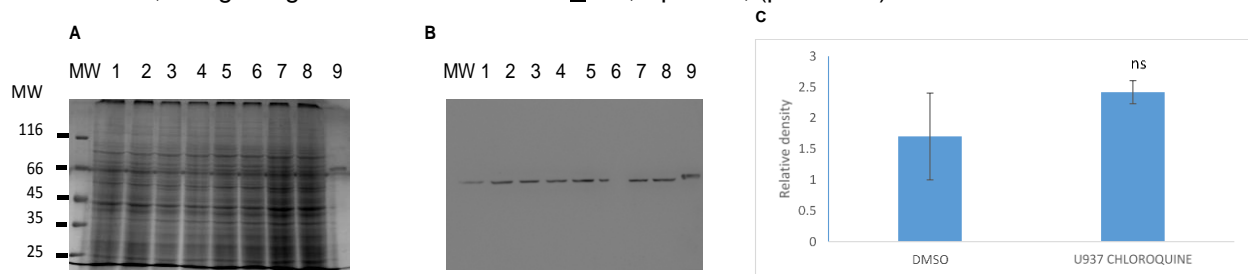

Figure 5.10: HSP70 expression in U937 cells incubated with chloroquine and heat shocked

The cells were treated with 200 ng/ml of chloroquine for 18 h at 37°C, then heat shocked for 2 h at 40°C, and allowed to rest for 2 h at 37°C. The cell lysates were run on a reducing 10% SDS-PAGE gel (A). The corresponding western blot (B) was probed with affinity-purified anti-rHSP70 antibody at 1 µg/ml as the primary antibody. Rabbit anti-chicken HRPO was used as the secondary antibody at (1:10000). The western blot was viewed using ECL. MW: Molecular weight marker; Lanes 1-2, DMSO control; Lanes 3-8, triplicate cultures treated with chloroquine, loaded in duplicate; Lane 9, pure rHSP70. (C) shows the densitometry analysis of the western blot, using ImageJ. Values are means ± SE; ns:(non-significant); $p > 0.05$.

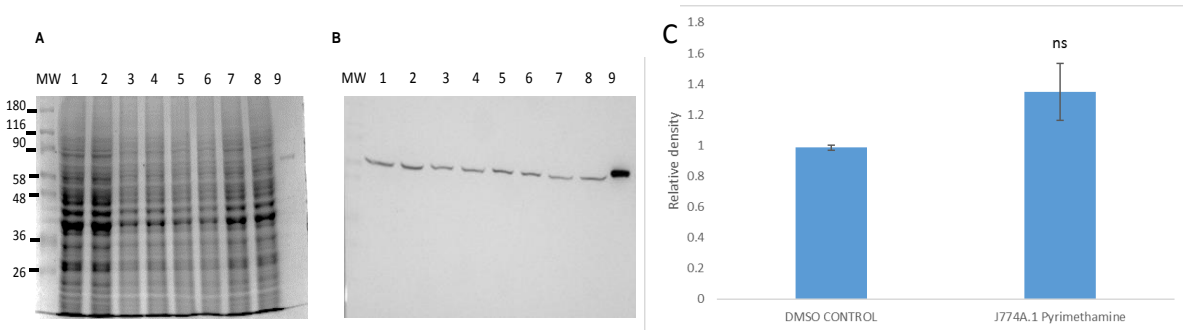

Figure 5.11: HSP70 expression in J774A.1 cells incubated with pyrimethamine and heat shocked
 The cells were treated with 153 ng/ml of pyrimethamine for 18 h at 37°C, then heat shocked for 2 h at 40°C, and allowed to rest for 2 h at 37°C. The cell lysates were run on a reducing 10% SDS-PAGE gel (A). The corresponding western blot (B) was probed with affinity-purified anti-rHSP70 antibodies at 1 µg/ml. Rabbit anti-chicken HRPO was used as the secondary antibody at (1:10000). The blot was viewed using ECL. MW: Molecular weight marker; Lanes 1-2, DMSO control; Lanes 3-8, triplicate cultures treated with pyrimethamine, loaded in duplicate; Lane 9, pure rHSP70. (C) shows the densitometry analysis of the western blot, using ImageJ. Values are means ± SE; ns:(non-significant); p>0.05.

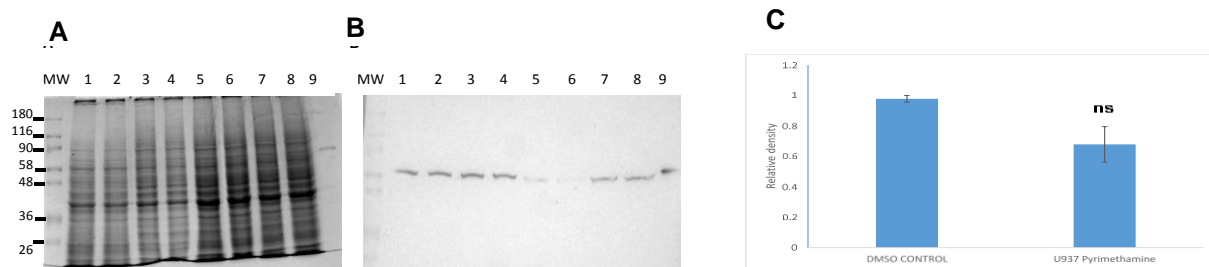

Figure 5.12: HSP70 expression in U937 cells incubated with pyrimethamine and heat shocked
 The cells were treated with 153 ng/ml of pyrimethamine for 18 h at 37°C, then heat shocked for 2 h at 40°C, and allowed to rest for 2 h at 37°C. The cell lysates were run on a reducing 10% SDS-PAGE gel (A). The corresponding western blot (B) was probed with affinity-purified anti-rHSP70 antibodies at 1 µg/ml. Rabbit anti-chicken HRPO was used as the secondary antibody at (1:10000). The western blot was viewed using ECL. MW: Molecular weight marker; Lanes 1-2, DMSO control; Lanes 3-8, triplicate cultures treated with pyrimethamine, loaded in duplicate; Lane 9, pure rHSP70. (C) shows the densitometry analysis of the western blot, using ImageJ. Values are means ± SE; ns:(non-significant); p>0.05.

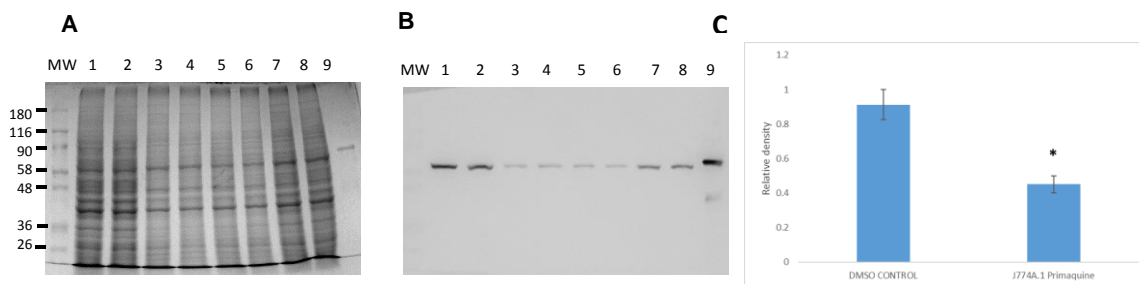

Figure 5.13: HSP70 expression in J774A.1 cells incubated with primaquine and heat shocked
 The cells were treated with 234 ng/ml of primaquine for 18 h at 37°C, then heat shocked for 2 h at 40°C, and allowed to rest for 2 h at 37°C. The cell lysates were run on a reducing 10% SDS-PAGE gel (A). The corresponding western blot (B) was probed with affinity-purified anti-rHSP70 antibodies at 1 µg/ml. Rabbit anti-chicken HRPO was used as the secondary antibody at (1:10000). The western blot was viewed using ECL. MW: Molecular weight marker; Lanes 1-2, DMSO control; Lanes 3-8, triplicate cultures treated with primaquine, loaded in duplicate; Lane 9, pure rHSP70. (C) shows the densitometry analysis of the western blot, using ImageJ. Values are means ± SE; * p<0.05; (p=0.0034).

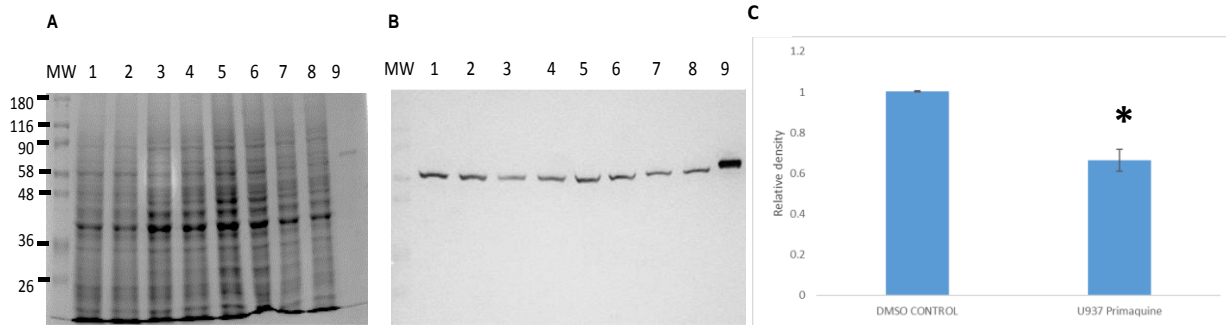

Figure 5.14: HSP70 expression in U937 cells incubated with primaquine and heat shocked

The cells were treated with 234 ng/ml of primaquine for 18 h at 37°C, then heat shocked for 2 h at 40°C, and allowed to rest for 2 h at 37°C. The cell lysates were run on a reducing 10% SDS-PAGE gel (A). The corresponding western blot (B) was probed with affinity-purified anti-rHSP70 antibodies at 1 µg/ml. Rabbit anti-chicken HRPO was used as the secondary antibody at (1:10000). The western blot was viewed using ECL. MW: Molecular weight marker; Lanes 1-2, DMSO control; Lanes 3-8, triplicate cultures treated with primaquine, loaded in duplicate; Lane 9, pure rHSP70. (C) shows the densitometry analysis of the western blot, using ImageJ. Values are means ± SE; * p<0.05; (p=0.014).

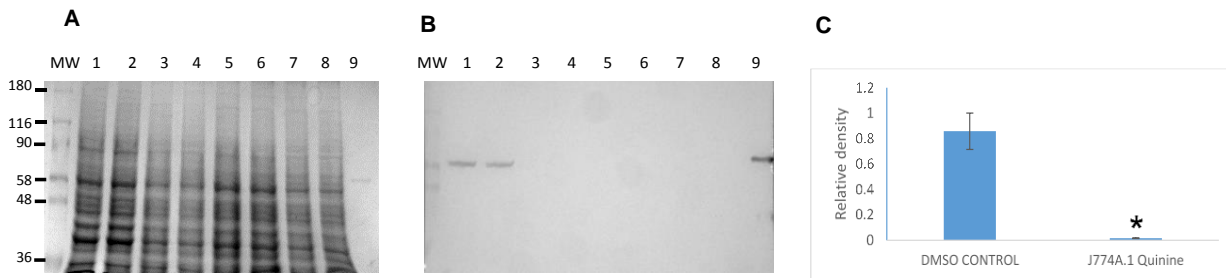

Figure 5.15: HSP70 expression in J774A.1 cells incubated with quinine and heat shocked.

The cells were treated with 10 µg/ml of quinine for 18 h at 37°C, then heat shocked for 2 h at 40°C, and allowed to rest for 2 h at 37°C. The cells were lysed and run on a reducing 10% SDS-PAGE gel (A). The corresponding western blot (B) was probed with affinity-purified anti-rHSP70 antibodies at 1 µg/ml. Rabbit anti-chicken HRPO was used as the secondary antibody at (1:10000). The western blot was viewed using ECL. MW: Molecular weight marker; Lanes 1-2, DMSO control; Lanes 3-8, triplicate cultures treated with quinine, loaded in duplicate; Lane 9, pure rHSP70. (C) shows the densitometry analysis of the western blot, using ImageJ. Values are means ± SE; * p<0.05; (p=0.000017).

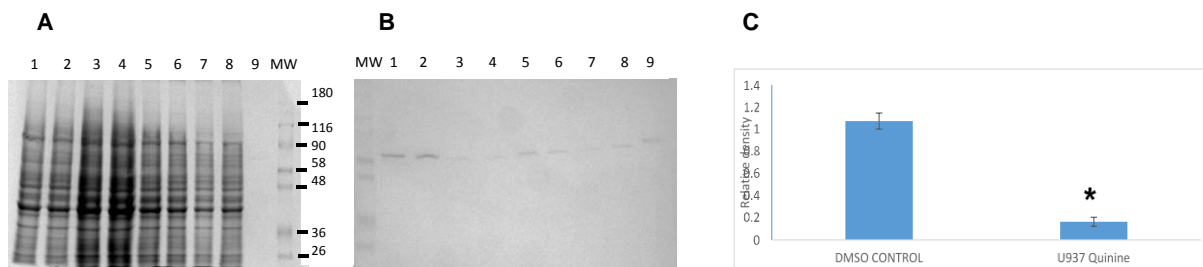

Figure 5.16: HSP70 expression in U937 cells incubated with quinine and heat shocked.

The cells were treated with 10 µg/ml of quinine for 18 h at 37°C, then heat shocked for 2 h at 40°C, and allowed to rest for 2 h at 37°C. The cell lysates were run on a reducing 10% SDS-PAGE gel (A). The corresponding western blot (B) was probed with affinity-purified anti-rHSP70 antibodies at 1 µg/ml. Rabbit anti-chicken HRPO was used as the secondary antibody at (1:10000). The western blot was viewed using ECL. MW: Molecular weight marker; Lanes 1-2, DMSO control; Lanes 3-8, triplicate cultures treated with quinine, loaded in duplicate; Lane 9, pure rHSP70. (C) shows the densitometry analysis of the western blot, using ImageJ. Values are means ± SE; * p<0.05; (p=0.000032).

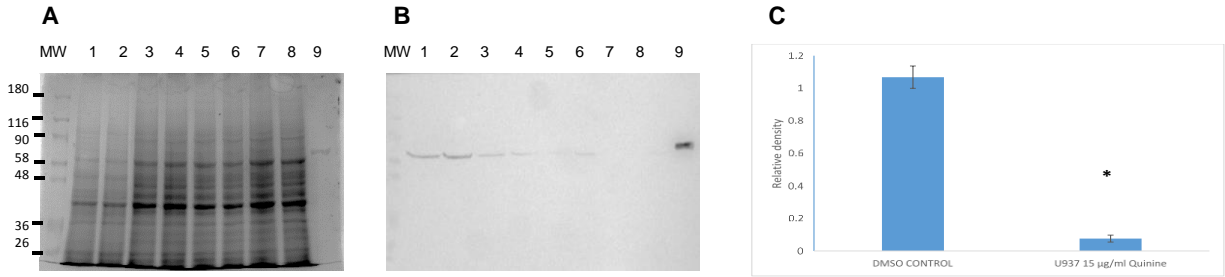

Figure 5.17: HSP70 expression in U937 cells incubated with quinine (15µg/ml) and heat shocked.

The cells were treated with 15 µg/ml of quinine for 18 h at 37°C, then heat shocked for 2 h at 40°C, and allowed to rest for 2 h at 37°C. The cells were lysed and run on a reducing 10% SDS-PAGE gel (A). The corresponding western blot (B) was probed with affinity-purified anti-rHSP70 antibodies at 1 µg/ml. Rabbit anti-chicken HRPO was used as the secondary antibody at (1:10000). The western blot was viewed using ECL. MW: Molecular weight marker; Lanes 1-2, DMSO control; Lanes 3-8, triplicate cultures treated with quinine, loaded in duplicate; Lane 9, pure rHSP70. (C) shows the densitometry analysis of the western blot, using ImageJ. Values are means \pm SE; * $p < 0.05$; ($p = 0.000032$).

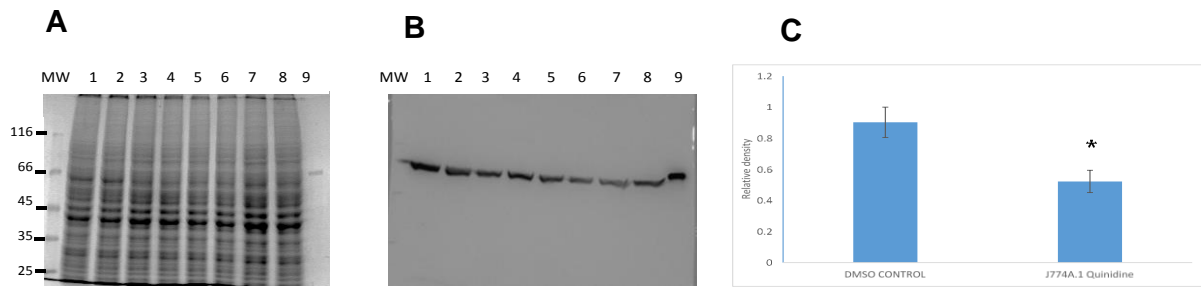

Figure 5.18: HSP70 expression in J774A.1 cells incubated with quinidine and heat shocked

The cells were treated with 5 µg/ml of quinidine for 18 h at 37°C, then heat shocked for 2 h at 40°C, and allowed to rest for 2 h at 37°C. The cell lysates were run on a reducing 10% SDS-PAGE gel (A). The corresponding western blot (B) was probed with affinity-purified anti-rHSP70 antibodies at 1 µg/ml. Rabbit anti-chicken HRPO was used as the secondary antibody at (1:10000). The western blot was viewed using ECL. MW: Molecular weight marker; Lanes 1-2, DMSO control; Lanes 3-8, triplicate cultures treated with quinidine, loaded in duplicate; Lane 9, pure rHSP70. (C) shows the densitometry analysis of the western blot, using ImageJ. Values are means \pm SE; * $p < 0.05$; ($p = 0.024$).

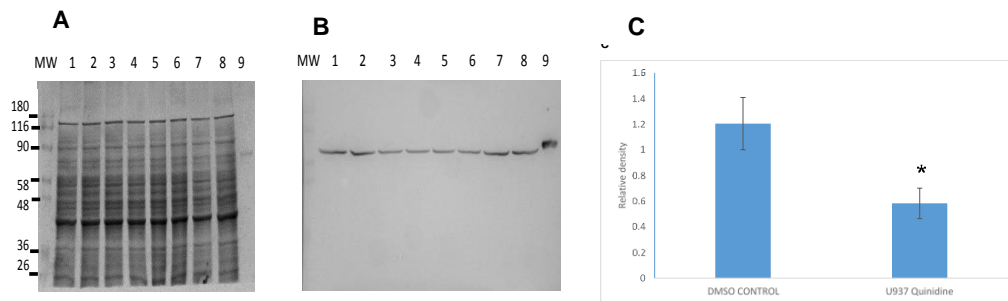

Figure 5.19: HSP70 expression in U937 cells incubated with quinidine and heat shocked.

The cells were treated with 5 µg/ml of quinidine for 18 h at 37°C, then heat shocked for 2 h at 40°C, and allowed to rest for 2 h at 37°C. The cells were lysed and run on a reducing 10% SDS-PAGE gel (A). The corresponding western blot (B) was probed with affinity-purified anti-rHSP70 antibodies at 1 µg/ml. Rabbit anti-chicken HRPO was used as the secondary antibody at (1:10000). The western blot was viewed using ECL. MW: Molecular weight marker; Lanes 1-2, DMSO control; Lanes 3-8, triplicate cultures treated with quinidine, loaded in duplicate; Lane 9, pure rHSP70. (C) shows the densitometry analysis of the western blot, using ImageJ. Values are means \pm SE; * $p < 0.05$; ($p = 0.05$).

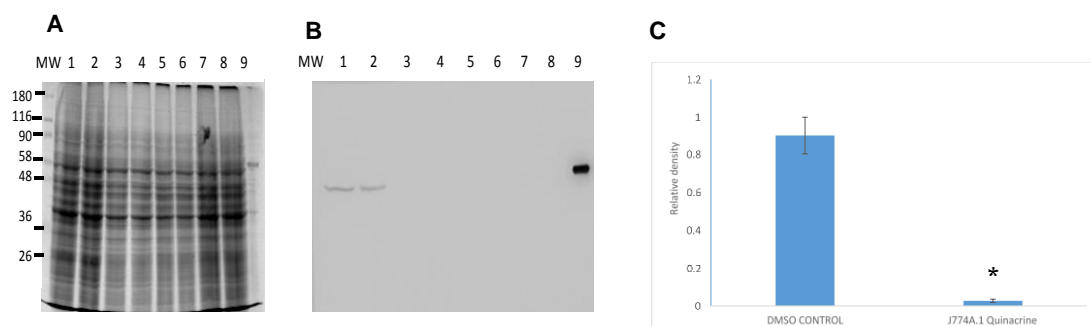

Figure 5.20: HSP70 expression in J774A.1 cells incubated with quinacrine and heat shocked

The cells were treated with 10 µg/ml of quinacrine for 18 h at 37°C, then heat shocked for 2 h at 40°C, and allowed to rest for 2 h at 37°C. The cell lysates were run on a reducing 10% SDS-PAGE gel (A). The corresponding blot (B) was probed with affinity-purified anti-rHSP70 antibodies at 1 µg/ml as the primary antibody. Rabbit anti-chicken HRPO was used as the secondary antibody at 1:10000. The blot was viewed using ECL. MW: Molecular weight marker; Lanes 1-2, DMSO control; Lanes 3-8, triplicate cultures treated with quinacrine, loaded in duplicate; Lane 9, pure rHSP70. (C) shows the densitometry analysis of the western blot, using ImageJ. Values are means ± SE; * p<0.05; (p=0.0000019).

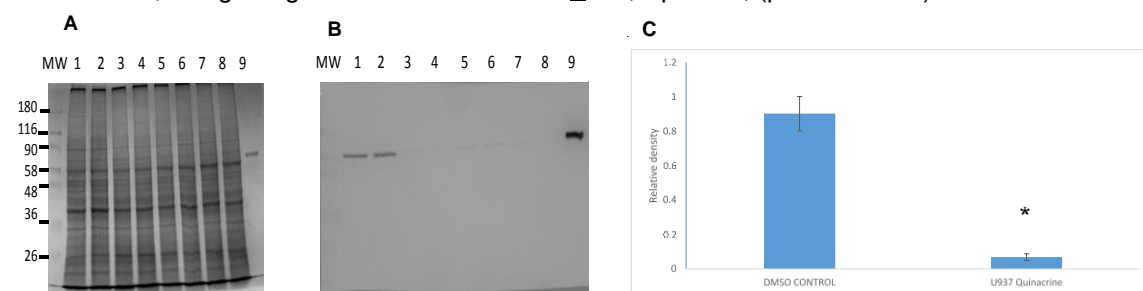

Figure 5.21: HSP70 expression in U937 cells incubated with quinacrine and heat shocked

The cells were treated with 10 µg/ml of quinacrine for 18 h at 37°C, then heat shocked for 2 h at 40°C, and allowed to rest for 2 h at 37°C. The cell lysates were run on a reducing 10% SDS-PAGE gel (A). The corresponding western blot (B) was probed with affinity-purified anti-rHSP70 antibodies at 1 µg/ml. Rabbit anti-chicken HRPO was used as the secondary antibody at (1:10000). The western blot was viewed using ECL. MW: Molecular weight marker; Lanes 1-2, DMSO control; Lanes 3-8, triplicate cultures treated with quinacrine, loaded in duplicate; Lane 9, pure rHSP70. (C) shows the densitometry analysis of the western blot, using ImageJ. Values are means ± SE; * p<0.05; (p=0.0000078).

Table 5.1: Summary of the findings of the effect of antimalarial drugs on monocyte HSP70 expression

Antimalarial drugs	Concentration (µg/ml)	J774A.1	P value	U937	P value
Artemisinin	0.4	NS	0.54	↓	0.0014
Artesunate	0.2	NS	0.10	NS	0.36
Artemether	0.2	↑	0.0068	NS	0.22
Chloroquine	0.2	↑	0.0016	NS	0.17
Pyrimethamine	0.234	NS	0.32	NS	0.54
Primaquine	0.153	↓	0.003	↓	0.014
Quinacrine	10	↓	0.0000019	↓	0.0000078
Quinidine	5	↓	0.024	↓	0.05
Quinine	10, 15	↓	0.000017	↓	0.000032

NS: Not significant, p>0.05; ↑: increase; ↓: decrease

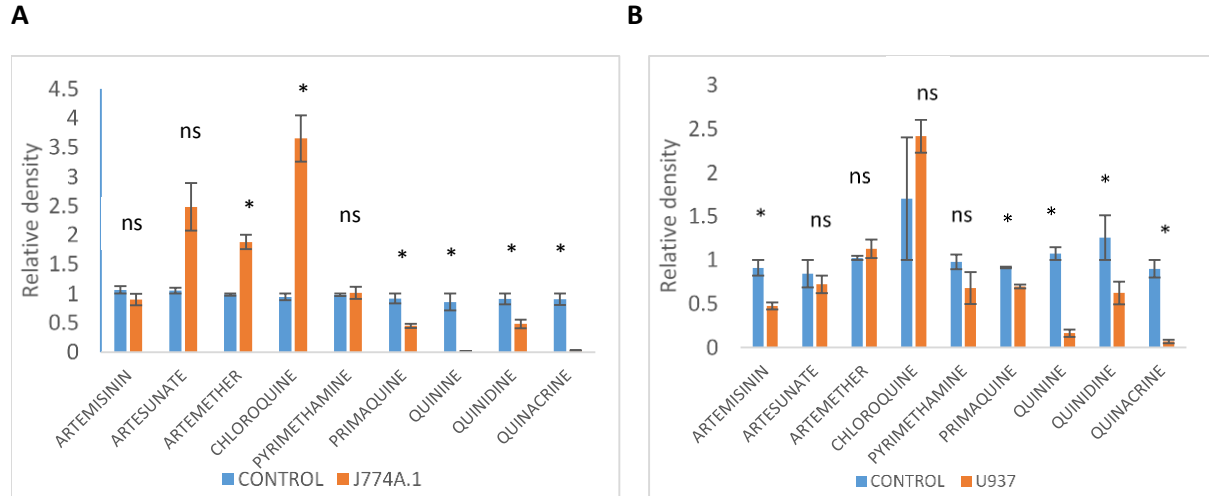

Figure 5.22: Summary of antimalarial drugs' effects on monocyte HSP70 protein expression, after heat shock

The effects of different antimalarial drugs on J774A.1 monocytes (A) and U937 monocytes (B) on monocyte HSP70 protein expression are shown. Densitometry analysis was done using ImageJ. Values are means \pm SE; * $p < 0.05$ versus control; ns: non-significant, $p > 0.05$ versus control.

Three antimalarial drugs chloroquine, artemether and artesunate increased HSP70 protein expression in monocytes, with chloroquine and artemether being most effective at increasing monocyte HSP70 protein expression. Five antimalarial drugs, quinacrine, quinine, primaquine, artemisinin and quinidine decreased HSP70 protein expression in monocytes, with quinacrine, quinine and primaquine being the most effective, and artemisinin and quinidine being the least effective.

5.2.4 Effects of anti-inflammatory drugs on monocyte HSP70 protein expression

Ambroxol, probucol, danazol and curcumin did not induce HSP70 protein expression in J774A.1 and U937 cells at physiological temperature, 37°C. A representative gel and its corresponding western blot for ambroxol at 37°C is shown (Figure 5.23). The western blots for the remaining anti-inflammatory drugs are all blank (data not shown). The interplay of fever and anti-inflammatory drugs on HSP70 protein expression was investigated. The monocytes were pre-treated with each anti-inflammatory drug at therapeutic concentration, and heat shocked for 2 h at 40°C, and allowed to rest for 2 h at 37°C. A summary of the findings is represented later (Table 5.2, Figure 5.32).

Ambroxol increased HSP70 protein expression in J774A.1 cells ($p = 0.017$) (Figure 5.24) and decreased HSP70 protein expression in U937 cells ($p = 0.00053$) (Figure 5.25). When J774A.1 cells were treated with probucol, there was an apparent increase in HSP70 expression ($p = 0.19$)

(Figure 5.26) and a decreased ($p=0.000037$) HSP70 protein expression in U937 cells (Figure 5.27). Danazol decreased HSP70 protein expression in both J774A.1 ($p=0.0045$) and U937 ($p=0.0000019$) cells (Figures 5.28, 5.29). Curcumin decreased the HSP70 protein expression in J774A.1 cells ($p=0.00038$) (Figure 5.30) and increased HSP70 expression in U937 monocytes, ($p=0.011$) (Figure 5.31).

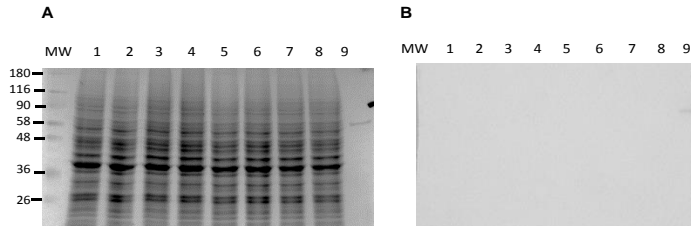

Figure 5.23: HSP70 expression in J774A.1 cells incubated with ambroxol at 37°C

The cells were treated with 44 $\mu\text{g/ml}$ of ambroxol for 18 h at 37°C and the cell lysates were run on a reducing 10% SDS-PAGE gel (A). The corresponding western blot (B) was probed with affinity-purified anti-rHSP70 antibodies at 1 $\mu\text{g/ml}$. Rabbit anti-chicken HRPO was used as the secondary antibody at (1:10000). The western blot was viewed using ECL. MW: Molecular weight marker; Lanes 1-2, DMSO control; Lanes 3-8, triplicate cultures treated with ambroxol, loaded in duplicate; Lane 9, pure rHSP70.

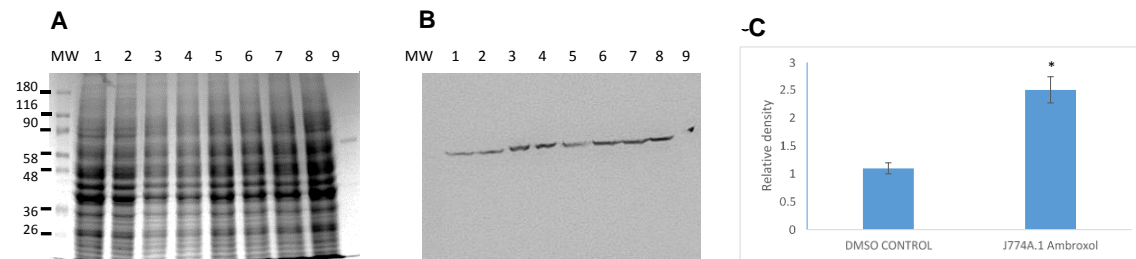

Figure 5.24: HSP70 expression in J774A.1 cells incubated with ambroxol and heat shocked

The cells were treated with 44 $\mu\text{g/ml}$ of ambroxol for 18 h at 37°C, then heat shocked for 2 h at 40°C, and allowed to rest for 2 h at 37°C. The cell lysates were run on a reducing 10% SDS-PAGE gel (A). The corresponding western blot (B) was probed with affinity-purified anti-rHSP70 antibodies at 1 $\mu\text{g/ml}$. Rabbit anti-chicken HRPO was used as the secondary antibody at (1:10000). The western blot was viewed using ECL. MW: Molecular weight marker; Lanes 1-2, DMSO control; Lanes 3-8, triplicate cultures treated with ambroxol, loaded in duplicate; Lane 9, pure rHSP70. (C) shows the densitometry analysis of the western blot, using ImageJ. Values are means \pm SE; * $p<0.05$; ($p=0.017$).

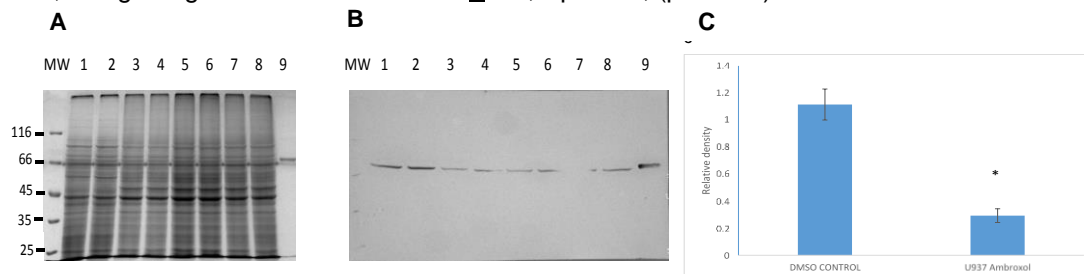

Figure 5.25: HSP70 expression in U937 cells incubated with ambroxol and heat shocked

The cells were treated with 44 $\mu\text{g/ml}$ of ambroxol for 18 h at 37°C, then heat shocked for 2 h at 40°C, and allowed to rest for 2 h at 37°C. The cell lysates were run on a reducing 10% SDS-PAGE gel (A). The corresponding western blot (B) was probed with affinity-purified anti-rHSP70 antibodies at 1 $\mu\text{g/ml}$. Rabbit anti-chicken HRPO was used as the secondary antibody at (1:10000). The western blot was viewed using ECL. MW: Molecular weight marker; Lanes 1-2, DMSO control; Lanes 3-8, triplicate cultures treated with ambroxol, loaded in duplicate; Lane 9, pure rHSP70. (C) shows the densitometry analysis of the western blot, using ImageJ. Values are means \pm SE; * $p<0.05$; ($p=0.00053$).

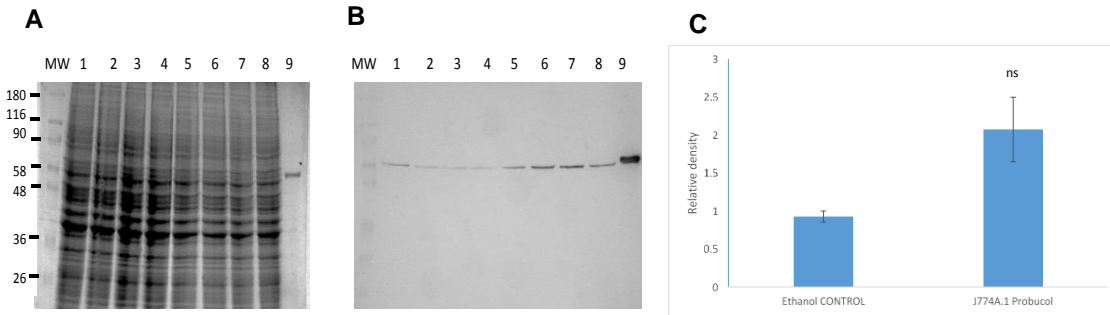

Figure 5.26: HSP70 expression in J774A.1 cells incubated with probucol and heat shocked

The cells were treated with 70 $\mu\text{g/ml}$ of probucol for 18 h at 37°C, then heat shocked for 2 h at 40°C, and allowed to rest for 2 h at 37°C. The cell lysates were run on a reducing 10% SDS-PAGE gel (A). The corresponding western blot (B) was probed with affinity-purified anti-rHSP70 antibodies at 1 $\mu\text{g/ml}$. Rabbit anti-chicken HRPO was used as the secondary antibody at (1:10000). The western blot was viewed using ECL. MW: Molecular weight marker; Lanes 1-2, Ethanol control; Lanes 3-8, triplicate cultures treated with probucol, loaded in duplicate; Lane 9, pure rHSP70. (C) shows the densitometry analysis of the western blot, using ImageJ. Values are means \pm SE; ns:(non-significant); $p>0.05$.

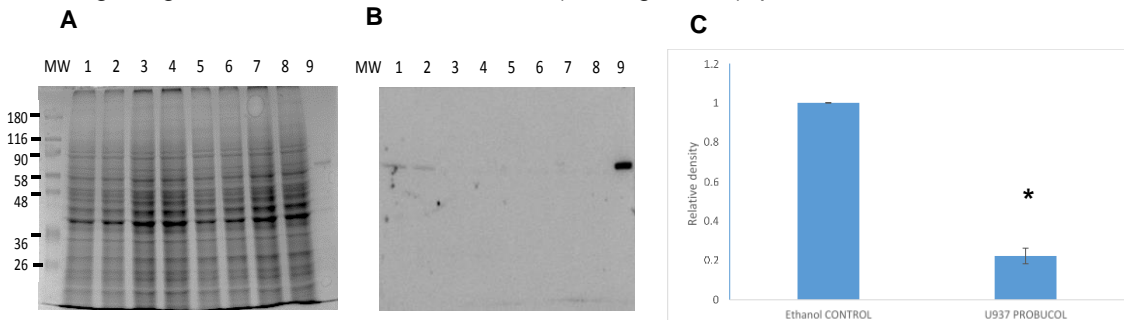

Figure 5.27: HSP70 protein expression in U937 cells incubated with probucol and heat shocked

The cells were treated with 70 $\mu\text{g/ml}$ of probucol for 18 h at 37°C, then heat shocked for 2 h at 40°C, and allowed to rest for 2 h at 37°C. The cell lysates were run on a reducing 10% SDS-PAGE gel (A). The corresponding western blot (B) was probed with affinity-purified anti-rHSP70 antibodies at 1 $\mu\text{g/ml}$. Rabbit anti-chicken HRPO was used as the secondary antibody at (1:10000). The western blot was viewed using ECL. MW: Molecular weight marker; Lanes 1-2, Ethanol control; Lanes 3-8, triplicate cultures treated with probucol, loaded in duplicate; Lane 9, pure rHSP70. (C) shows the densitometry analysis of the western blot, using ImageJ. Values are means \pm SE; * $p<0.05$; ($p=0.000037$).

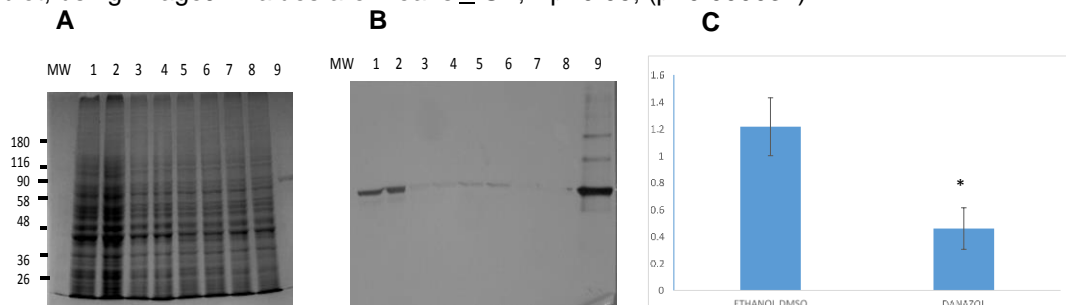

Figure 5.28: HSP70 expression in J774A.1 cells incubated with danazol and heat shocked

The cells were treated with 1 $\mu\text{g/ml}$ of danazol for 18 h at 37°C, then heat shocked for 2 h at 40°C, and allowed to rest for 2 h at 37°C. The cell lysates were run on a reducing 10% SDS-PAGE gel (A). The corresponding western blot (B) was probed with affinity-purified anti-rHSP70 antibodies at 1 $\mu\text{g/ml}$. Rabbit anti-chicken HRPO was used as the secondary antibody at (1:10000). The western blot was viewed using ECL. MW: Molecular weight marker; Lanes 1-2, Ethanol control; Lanes 3-8, triplicate cultures treated with danazol, loaded in duplicate; Lane 9, pure rHSP70. (C) shows the densitometry analysis of the western blot, using ImageJ. Values are means \pm SE; * $p<0.05$; ($p=0.044$).

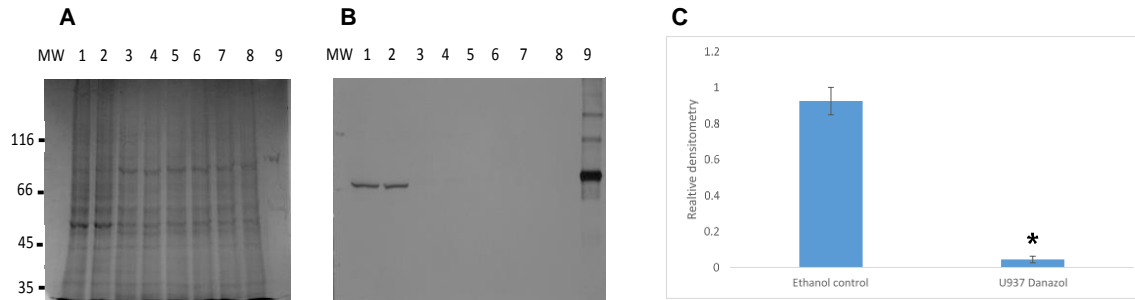

Figure 5.29: HSP70 protein expression in U937 cells incubated with danazol and heat shocked

The cells were treated with 1 $\mu\text{g/ml}$ of danazol for 18 h at 37°C, then heat shocked for 2 h at 40°C, and allowed to rest for 2 h at 37°C. The cell lysates were run on a reducing 10% SDS-PAGE gel (A). The corresponding western blot (B) was probed with affinity-purified anti-rHSP70 antibodies at 1 $\mu\text{g/ml}$. Rabbit anti-chicken HRPO was used as the secondary antibody at (1:10000). The western blot was viewed using ECL. MW: Molecular weight marker; Lanes 1-2, Ethanol control; Lanes 3-8, triplicate cultures treated with danazol, loaded in duplicate; Lane 9, pure rHSP70. (C) shows the densitometry analysis of the western blot, using ImageJ. Values are means \pm SE; * $p < 0.05$; ($p = 0.0000019$).

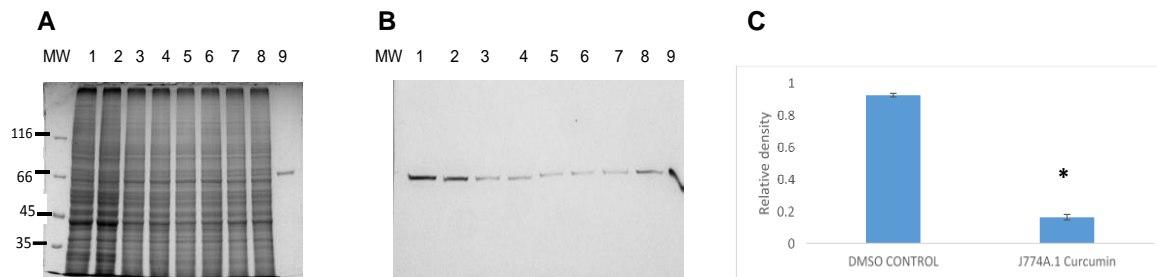

Figure 5.30: HSP70 expression in J774A.1 cells incubated with curcumin and heat shocked

The cells were treated with 10 μM of curcumin for 18 h at 37°C, then heat shocked for 2 h at 40°C, and allowed to rest for 2 h at 37°C. The cell lysates were run on a reducing 10% SDS-PAGE gel (A). The corresponding western blot (B) was probed with affinity-purified anti-rHSP70 antibodies at 1 $\mu\text{g/ml}$. Rabbit anti-chicken HRPO was used as the secondary antibody at (1:10000). The western blot was viewed using ECL. MW: Molecular weight marker, Lanes 1-2, Ethanol control; Lanes 3-8, triplicate cultures treated with curcumin, loaded in duplicate; Lane 9, pure rHSP70. (C) shows the densitometry analysis of the western blot, using ImageJ. Values are means \pm SE; * $p < 0.05$; ($p = 0.00038$).

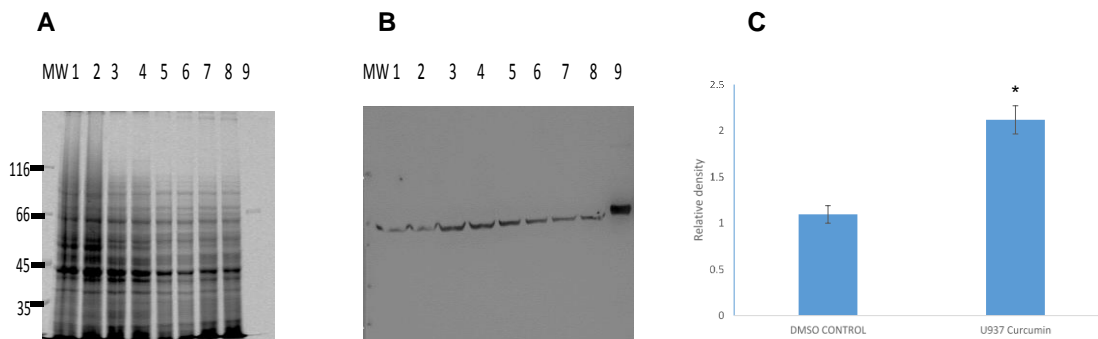

Figure 5.31: HSP70 expression in U937 cells incubated with curcumin and heat shocked

The cells were treated with 10 μM of curcumin for 18 h at 37°C, then heat shocked for 2 h at 40°C, and allowed to rest for 2 h at 37°C. The cell lysates were run on a reducing 10% SDS-PAGE gel (A). The corresponding western blot (B) was probed with affinity-purified anti-rHSP70 antibodies at 1 $\mu\text{g/ml}$. Rabbit anti-chicken HRPO was used as the secondary antibody at (1:10000). The western blot was viewed using ECL. MW: Molecular weight marker; Lanes 1-2, Ethanol control; Lanes 3-8, triplicate cultures treated with curcumin, loaded in duplicate; Lane 9, pure rHSP70. (C) shows the densitometry analysis of the western blot, using ImageJ. Values are means \pm SE; * $p < 0.05$; ($p = 0.011$).

Table 5.2: Summary of the findings of the effect of anti-inflammatory drugs on monocyte HSP70 expression

Anti-inflammatory drugs	Concentration	J774A.1	P value	U937	P value
Ambroxol	44 µg/ml	▲▲	0.017	▼▼	0.00053
Probucol	70 µg/ml	NS	0.19	▼▼	0.000037
Danazol	1 µg/ml	▼▼	0.044	▼▼	0.0000019
Curcumin	3.7 mg/ml	▼▼	0.00038	▲▲	0.011

NS: Non-significant, $p > 0.05$; ▲▲: increase; ▼▼: decrease

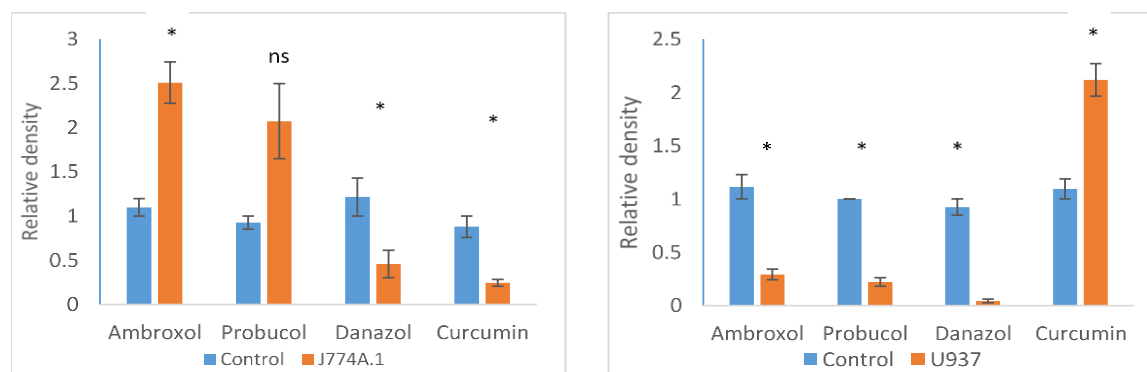

Figure 5.32: Summary of anti-inflammatory drugs on monocyte HSP70 protein expression, after heat shock

The effects of different anti-inflammatory drugs on J774A.1 (A) and U937 cells (B) on monocyte HSP70 protein expression are shown. Densitometry analysis was done using ImageJ. Values are means \pm SE; * $p < 0.05$; ns: non-significant, $p > 0.05$.

Ambroxol and probucol decreased HSP70 protein expression in U937 cells. Danazol decreased HSP70 protein expression in both cell lines. Ambroxol and probucol seemed to increase HSP70 protein expression in J774A.1 cells, which could be because J774A.1 they are more differentiated than U937 cells, with ambroxol being more effective. Curcumin decreased HSP70 protein expression in J774A.1 cells, but increased HSP70 protein expression in U937 monocytes.

5.2.5 Effects of β -haematin, latex beads and hemin on monocyte HSP70 protein expression

J774A.1 cells incubated with β -haematin did not affect HSP70 protein expression at 37°C (Figure 5.33). Monocytes were incubated with β -haematin for 2 h, then heat shocked for 2 h to mimic fever and allowed to rest for 2 h at 37°C. U937 cells, which are non-phagocytic (Ralph *et al.*, 1975), were also incubated with β -haematin, to serve as a negative control. U937 cells would not phagocytose β -haematin, hence, it was hypothesized that β -haematin will not cause any effects in HSP70 protein expression in U937 cells. A summary of the findings is presented in a table at the end of this section (Table 5.3).

β -haematin decreased HSP70 protein expression ($p=0.0002$) in J774A.1 cells (Figure 5.34). It was interesting to note that U937 monocytes which do not phagocytose β -haematin had a higher expression ($p=0.03$) of HSP70 protein expression, in the presence of β -haematin (Figure 5.34). To confirm whether the reduced HSP70 protein expression was due to β -haematin, J774A.1 cells were incubated with latex beads and hemin as controls (Figure 5.35). It was found that protein expression of monocyte HSP70 was decreased in the presence of latex beads ($p=0.0001$), hemin ($p=0.02$) and β -haematin ($p=0.001$), compared to non-treated cultures.

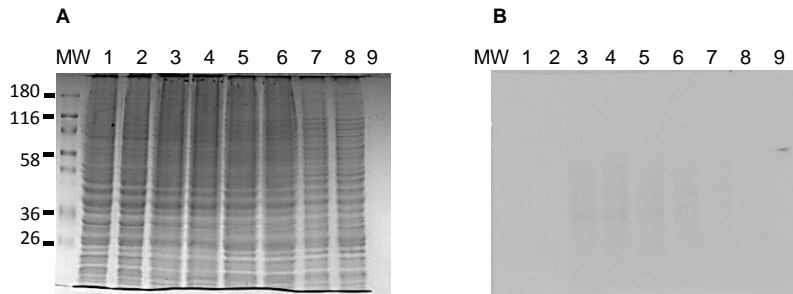

Figure 5.33: HSP70 protein expression in cells incubated with β -haematin

The cells were treated with 25 $\mu\text{g/ml}$ of β -haematin for 2 h at 37°. The cell lysates were run on a 10% reducing SDS-PAGE gel (A). The corresponding western blot (B) was probed with affinity-purified anti-rHSP70 antibodies at 1 $\mu\text{g/ml}$. Rabbit anti-chicken HRPO was used as the secondary antibody at (1:10000). The western blot was viewed using ECL. MW: Molecular weight marker; Lanes 1-2, One culture of non-treated J774A.1 cells loaded in duplicate; Lanes 3-8, three cultures J774A.1 cells fed with β -haematin, loaded in duplicate, Lane 9, pure rHSP70.

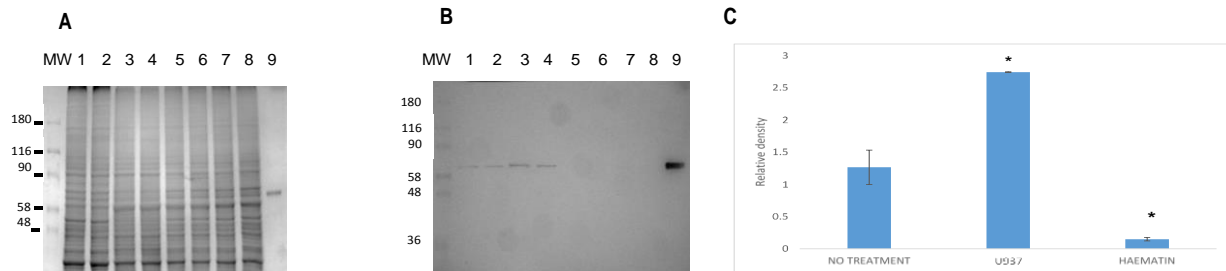

Figure 5.34: HSP70 expression in monocytes incubated with β -haematin and heat shocked

The cells were treated with 25 $\mu\text{g/ml}$ of β -haematin for 2 h at 37°C, then heat shocked for 2 h at 40°C, and allowed to rest for 2 h at 37°C. The cell lysates were run on a 10% reducing SDS-PAGE gel (A). The corresponding western blot (B) was probed with affinity-purified anti-rHSP70 antibodies at 1 $\mu\text{g/ml}$. Rabbit anti-chicken HRPO was used as the secondary antibody at (1:10000). The western blot was viewed using ECL. MW: Molecular weight marker; Lanes 1-2, one culture of non-treated J774A.1 cells loaded in duplicate; Lanes 3-4, one culture of U937 cells fed with β -haematin, loaded in duplicate; Lanes 5-8, two cultures J774A.1 cells fed with β -haematin, loaded in duplicate. *, $p<0.05$.

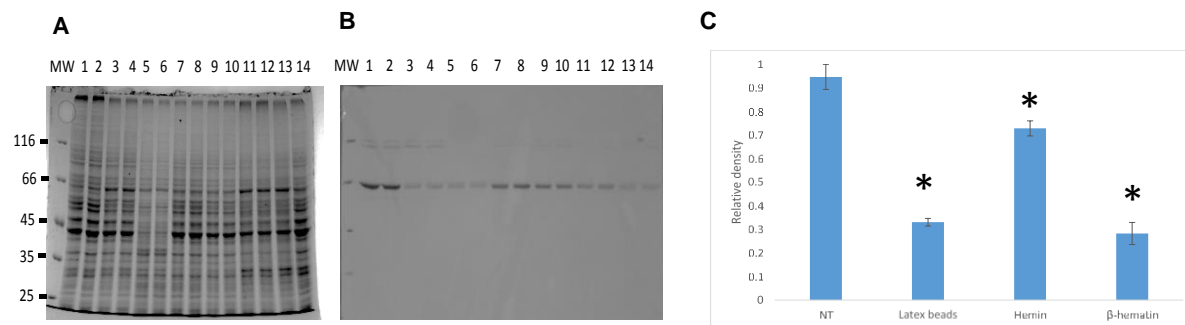

Figure 5.35: HSP70 expression in J774A.1 cells incubated with latex beads, hemin and β -haematin, and heat shocked.

The cells were treated with 0.1% (w/v) latex beads, 25 μ g/ml of hemin or 25 μ g/ml of β -haematin for 2 h at 37°C, then heat shocked for 2 h at 40°C, and allowed to rest for 2 h at 37°C. The cell lysates were run on a reducing 10% SDS-PAGE gel (A). The corresponding western blot (B) was probed with affinity-purified anti-rHSP70 antibodies at 1 μ g/ml. Rabbit anti-chicken HRPO was used as the secondary antibody at (1:10000). The western blot was viewed using ECL. MW: Molecular weight marker; Lanes 1-2, NT- Non-treated cells; Lanes 3-6, two cultures treated with latex beads, loaded in duplicate; Lanes 7-10, two cultures treated with hemin, loaded in duplicate; lanes 11-14, two cultures treated with β -haematin, loaded in duplicate; (C) shows the densitometry analysis of the western blot, using ImageJ. Values are means \pm SE; * $p < 0.05$; ns: non-significant, $p > 0.05$.

Table 5.3: Summary of the findings of the effect of β -haematin, latex beads and hemin on monocyte HSP70 expression, after heat shock

	Concentration	J774A.1	P value	U937	P value
β -haematin	25 μ g/ml	↓	0.001	↑	0.03
Latex beads	0.1% (w/v)	↓	0.0001	NA	-
Hemin	25 μ g/ml	↓	0.02	NA	-

NS: Non-significant, $p > 0.05$; ; ↑: increase; ↓: decrease

β -haematin, latex beads and hemin all decreased HSP70 protein expression in J774A.1 cells, with latex beads being most effective, and hemin being the least effective.

5.3 Discussion

5.3.1 Characterisation of cell lines

Monocytes are essential immune cells defending the host against pathogens (Serbina *et al.*, 2008, Mac-Daniel and Menard, 2015). They circulate in the blood and respond very quickly to an infected area by actively recruiting more monocytes to the area, and secreting pro-inflammatory cytokines (Mac-Daniel and Menard, 2015). The J774A.1 and U937 monocytic cell lines were used in this study as a model for monocyte responses in the presence of antimalarial, anti-inflammatory drugs and β -haematin. J774A.1 and U937 cells were characterized morphologically using the Giemsa and methyl green stains. They had characteristic kidney-shaped nuclei and were mostly round in shape (Ralph *et al.*, 1975, Sundström and Nilsson, 1976, Cumming, 2009). Peroxidase and alkaline phosphatase activity were both detected in the monocytes as reported in other studies (Warnock *et al.*, 1987, Ogawa *et al.*, 1978, Reale *et al.*, 1995, Deimann, 1984,

Cumming, 2009). The U937 cells had lower alkaline phosphatase activity here than J774A.1 cells. Harris and Ralph (1985) have reported that U937 cells have weak alkaline phosphatase activity. Cumming (2009) did not observe peroxidase activity in fully differentiated U937 cells, but observed peroxidase activity in non-differentiated U937 cells, similar to this study.

J774A.1 cells are derived from differentiated lymphomas, and the cells have macrophage-like characteristics (Ralph *et al.*, 1976). They have been reported to exhibit high levels of phagocytosis, pinocytosis, antibody-dependent phagocytosis, and to secrete lysozyme (Ralph *et al.*, 1976). U937 cells are reported to bear similar characteristics to monoblast cells (Harris and Ralph, 1985) and secrete lysozymes. They express fewer receptors on their surface including Fc, C3 and chemotactic receptors compared to fully differentiated monocytes. They also express lower quantities of hydrogen peroxide and oxygen radicals (Harris and Ralph, 1985).

Using two different cell lines with different states of differentiation might give an idea on how anti-malarial and anti-inflammatory drugs affect monocytes at different stages of differentiation in the human host.

5.3.2 Antimalarial drugs and HSP70 expression

The effects of nine antimalarial drugs (artemisinin, artesunate, artemether, chloroquine, quinine, quinidine, pyrimethamine, primaquine and quinacrine) on monocyte HSP70 protein expression were investigated. It was found that artemisinin, quinine, quinacrine, quinidine, primaquine and quinacrine decreased HSP70 protein expression, while artemether, chloroquine and artesunate increased HSP70 protein expression in monocytes.

A search of the literature did not show any studies investigating the effects of antimalarial drugs on monocyte HSP70 expression. Dihydroartemisinin (DHA), the main metabolite of artemisinin was reported to decrease HSP70 expression in prostate cancer cells (Xu *et al.*, 2016). Only artemisinin decreased HSP70 expression in monocytes, while artemether and artesunate increased HSP70 expression in monocytes. Artemisinin is reported to be metabolized to inactive metabolites including deoxyartemisinin and dihydroxydeoxyartemisinin, while artemether is metabolized to active metabolites which retain their activity (Figure 5.36) (Balint, 2001). Artesunate is metabolized to only dihydroartemisinin (Balint, 2001). Artemisinin derivatives have been reported to be metabolized by cytochromes P450 (CYPs) in the liver (De Vries and Dien, 1996, Gómez-Icazbalceta *et al.*, 2013) (Figure 5.36). Drug metabolism in the monocytes is not well explored, but it was reported that monocytes express CYPs at low concentration and could

metabolize drugs (Gómez-Icazbalceta *et al.*, 2013). The different pathways by which artemisinin derivatives are metabolized might explain the difference in HSP70 protein expression between artemisinin, artesunate and artemether.

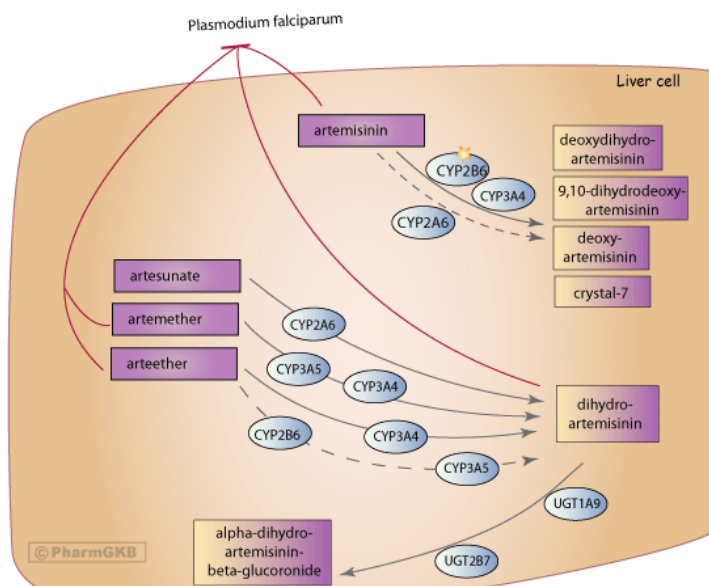

Figure 5.36: Artemisinin metabolism in the liver

Artesunate, artemether and arteether share metabolic pathways in the liver, while artemisinin has a different metabolic pathway which results in the production of four inactive metabolites (Whirl-Carrillo *et al.*, 2012).

Neznanov *et al.* (2009) found that quinacrine inhibited HSP70 protein expression in HeLa cells by affecting the heat shock response pathway, by inhibiting HSF1 from activating HSP70 transcription. In this study, quinacrine inhibited HSP70 expression in monocytes most effectively. Quinine was found to increase HSP70 protein expression in HSV-1 infected HaCat (keratinocyte) cells (Baroni *et al.*, 2007). The difference in HSP70 expression could be because monocytes and keratinocytes are different cells and might respond differently to quinine. Quinidine inhibited HSP70 protein expression to a lower extent than quinine. It is possible that the different structures of quinine and quinidine might be responsible for the different levels of HSP70 expression observed in monocytes. Quinidine is the *d*-stereoisomer of quinine (Achan *et al.*, 2011). However, this is speculative and needs more work to confirm this suggestion.

5.3.2.1 Antimalarial drugs, monocyte HSP70 and monocyte responses

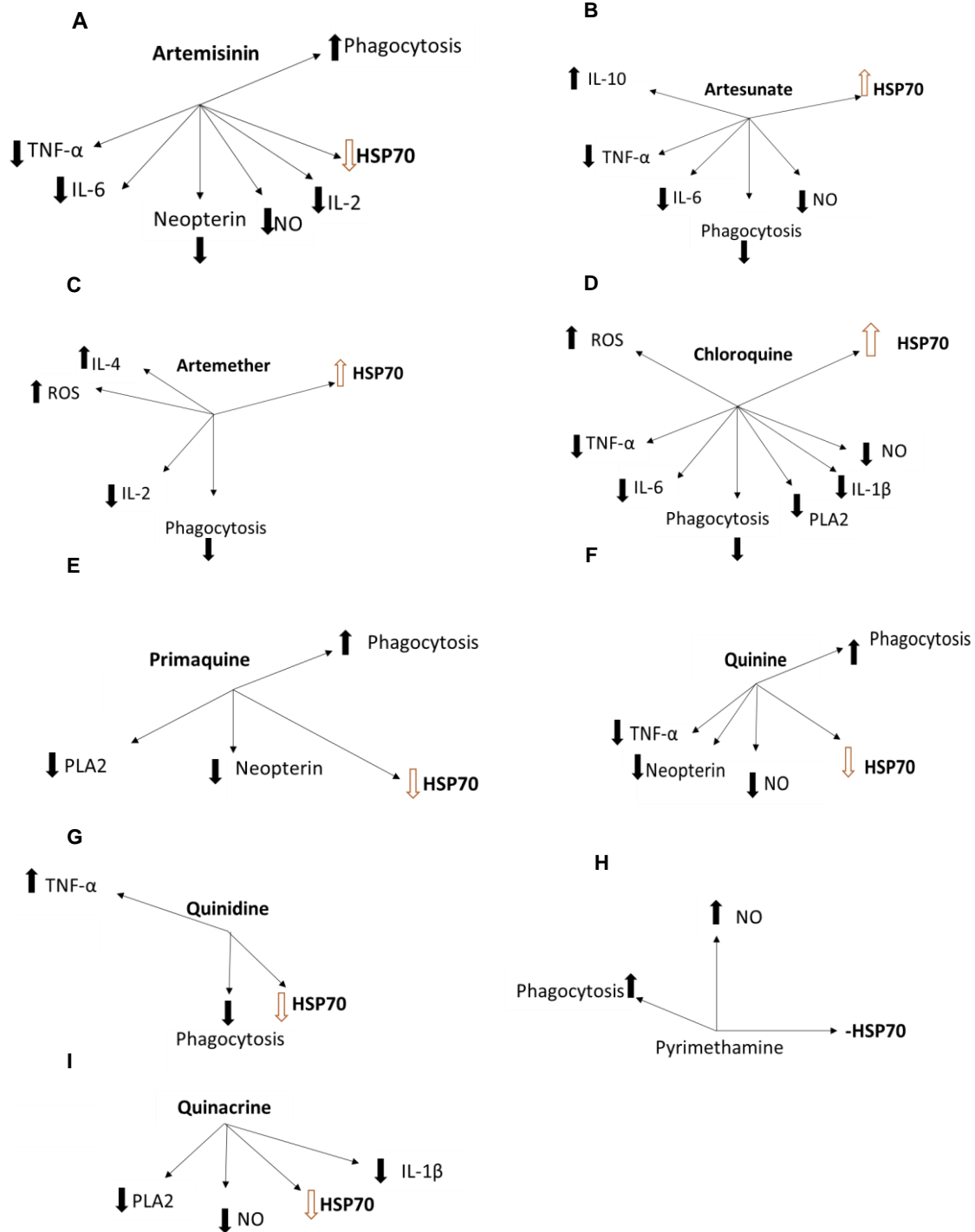

Figure 5.37: Effects of antimalarial drugs on monocyte responses

The effects of artemisinin (A), artesunate (B), artemether (C), chloroquine (D), primaquine (E), quinine (F), quinidine (G), pyrimethamine (H), quinacrine (I) on cytokine expressions, oxidative stress, neopterin, phospholipase A2 secretions (PLA2) and phagocytosis obtained from literature, are shown. The effects of these antimalarial drugs on monocyte HSP70 are shown.

5.3.2.1.1 Antimalarial drugs, monocyte HSP70 and TNF- α expression

Artesunate (Li *et al.*, 2008) and chloroquine (López Suárez *et al.*, 2014) which increased monocyte HSP70 expression in this study, were reported to decrease TNF- α expression in monocytes. Quinidine which was reported to increase TNF- α expression in PBMCs (Matsumori *et al.*, 1997), was found here to decrease monocyte HSP70 expression. There seems to be an inverse pattern between TNF- α expression and HSP70 expression in monocytes. There were however, some exceptions. Artemisinin has been reported to decrease TNF- α expression in monocytes (Wang *et al.*, 2006) and it decreased monocyte HSP70 expression in this study. A similar finding was seen with quinine but, quinine was reported to decrease TNF- α expression at very high concentrations, about 100 μ M (Maruyama *et al.*, 1994). Since, increased HSP70 expression was reported to decrease TNF- α secretion in monocytes (Kim *et al.*, 1999), it was thought that the antimalarial drugs could modulate monocyte responses by influencing the expression of HSP70. However, more studies need to be done to confirm the link between antimalarial drugs, TNF- α and monocyte HSP70 expressions.

5.3.2.1.2 Antimalarial drugs, monocyte HSP70 and reactive oxygen species secretion

Artemether, artesunate and chloroquine were found to increase HSP70 expression in monocytes, with artemether and chloroquine being most effective. It is noteworthy to report that artemether (Prada *et al.*, 1996) and chloroquine (Prada *et al.*, 1996, Dey and Bishayi, 2015) have been reported to increase secretion of reactive oxygen species (ROS) by monocytes. It could be suggested that the increase in ROS secretion leads to oxidative stress which leads to an increase in HSP70 protein expression. Artesunate and artemisinin were reported to increase expression of reactive oxygen species in neutrophils (Wenisch *et al.*, 1997). From the literature, the effects of artemisinin and artesunate on monocyte reactive oxygen species levels have not been found. From these results and the literature, there seems to be a relationship between ROS secretion and monocyte HSP70 expression which would be interesting to look at in the future.

5.3.2.1.3 Antimalarial drugs, monocyte HSP70 and phagocytosis

Artesunate, artemether (Wenisch *et al.*, 1997) and chloroquine (Cumming, 2009), which increased monocyte HSP70 expression, were reported to inhibit phagocytosis. Artemisinin, quinine and primaquine were reported to increase monocyte phagocytosis (Cumming, 2009), and in this study, they were found to decrease HSP70 expression. From this pattern, it is suggested that an increased expression of monocyte HSP70 might be associated with a decrease in

phagocytosis. One exception was found here with quinidine which decreased HSP70 protein expression in monocytes, and was reported to inhibit phagocytosis (Abilin *et al.*, 2005).

5.3.2.1.4 Antimalarial drugs, monocyte HSP70 and neopterin secretion

Primaquine, quinine and artemisinin which decreased monocyte HSP70 protein expression have been reported to decrease neopterin secretion, by inhibiting the GTP cyclohydrolase-1 enzyme in monocytes (Cumming *et al.*, 2011). From the literature, a relationship between neopterin secretion and HSP70 expression was not found. Both HSP70 and neopterin levels are markers for inflammation (Awandare *et al.*, 2006, Njemini *et al.*, 2011) and it is thought that a reduction in inflammation by the antimalarial drugs, could result in a decrease in both neopterin and in HSP70 expression.

5.3.2.2 Monocyte HSP70 and the anti-inflammatory responses of antimalarial drugs

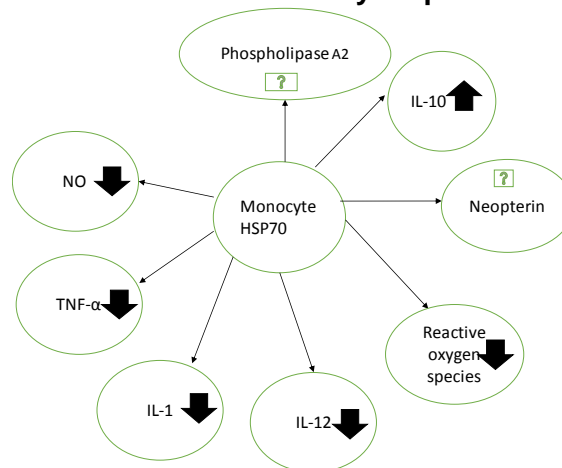

Figure 5.38: Effects of increased expression of monocyte HSP70 in monocyte responses

The influence of increased expression of monocyte HSP70 on cytokine expressions and oxidative stress are shown. The effects of monocyte HSP70 on neopterin and phospholipase A2 secretions are unknown.

HSP70 is considered to have anti-inflammatory properties (Figure 5.38) (Borges *et al.*, 2012) in cells as an increased expression of HSP70 has been reported to protect cells against TNF- α and nitric oxide cytotoxicity (Jäättelä and Wissing, 1993). Increased HSP70 expression was reported to decrease expressions of TNF- α , IL-1 β and IL-12 in activated human peripheral blood-derived monocytes (Ding *et al.*, 2001). HSP70 was also reported to inhibit the pro-inflammatory pathway NF- κ B (Li *et al.*, 2001). Antimalarial drugs which have anti-inflammatory properties (Figure 5.36) include; artemisinin, artemisinin derivatives (Hou and Huang, 2016), chloroquine (Jang *et al.*, 2006), quinine (Maruyama *et al.*, 1994, Lowry *et al.*, 1998), quinacrine (Bondeson and Sundler,

1998, Chumanevich *et al.*, 2016) and primaquine (Zanucoli *et al.*, 2014). Severe malaria and cerebral malaria are associated with the expression of high levels of cytokines (Awandare *et al.*, 2006, Hunt and Grau, 2003). It is possible that the antimalarial drugs also act on suppressing inflammation during malaria, leading to improved recovery. However, this needs to be further explored. Artemether and chloroquine which increased monocyte HSP70 expression in this study, could potentially mediate their anti-inflammatory properties by increasing HSP70 expression in cells.

Artemisinin, quinine, quinacrine and primaquine, seem to have anti-inflammatory properties independent of HSP70 expression, as they decreased HSP70 expression in monocytes in this study. It is noteworthy to mention that quinidine and pyrimethamine seem to be pro-inflammatory as quinidine was reported to increase TNF- α expression in PBMCs (Matsumori *et al.*, 1997) and pyrimethamine was reported to increase nitric oxide secretion in mice (Ramos-Avila *et al.*, 2007). Pyrimethamine had no effect on HSP70 expression, even though it increased nitric oxide and IFN- γ expression in mice (Ramos-Avila *et al.*, 2007, Legorreta-Herrera *et al.*, 2010). Quinidine decreased HSP70 protein expression in monocytes, and this can suggest that quinidine can exert its pro-inflammatory properties by inhibiting HSP70 expression.

5.3.3 Anti-inflammatory drugs and monocyte HSP70 expression

Four anti-inflammatory drugs, ambroxol, danazol, probucol and curcumin were used in this study. Ambroxol, probucol and danazol decreased HSP70 protein expression in U937 cells, with danazol being most effective. Danazol also decreased HSP70 expression in J774A.1 cells. Ota *et al.* (1997) found that danazol inhibited HSP70 protein expression in endometrial cells. Probuco was reported to decrease HSP70 expression in the left atrial tissue of rabbits (Fu *et al.*, 2015). From the literature, studies relating ambroxol to HSP70 expression were not found. Ambroxol increased HSP70 expression in J774A.1 cells, while decreasing HSP70 expression in U937 cells. Curcumin decreased HSP70 expression in J774A.1 cells and increased HSP70 expression in U937 cells. The difference in HSP70 expression between the two cell lines might be attributed to the level of differentiation of the cells. J774A.1 cells are more differentiated than U937 cells (Ralph *et al.*, 1975). Curcumin was reported to increase HSP70 protein expression by increasing nuclear translocation of HSF-1 in myelogenous leukemia cells (Teiten *et al.*, 2009) and in HeLa cells (Dunsmore *et al.*, 2001). HSP70 expression was also enhanced in rat cortical cells in the presence of curcumin (Xia *et al.*, 2015). In another study, rats were subjected to sepsis, and their serum levels of HSP70 expression were increased. When treated with curcumin, their serum levels of HSP70 decreased (Silva *et al.*, 2015) together with pro-inflammatory cytokines. They

suggested that curcumin inhibited expression of extracellular HSP70 (Silva *et al.*, 2015). The effects of these anti-inflammatory drugs on monocyte HSP70 have not been reported elsewhere.

5.3.3.1 Anti-inflammatory drugs, monocyte HSP70 and monocyte responses

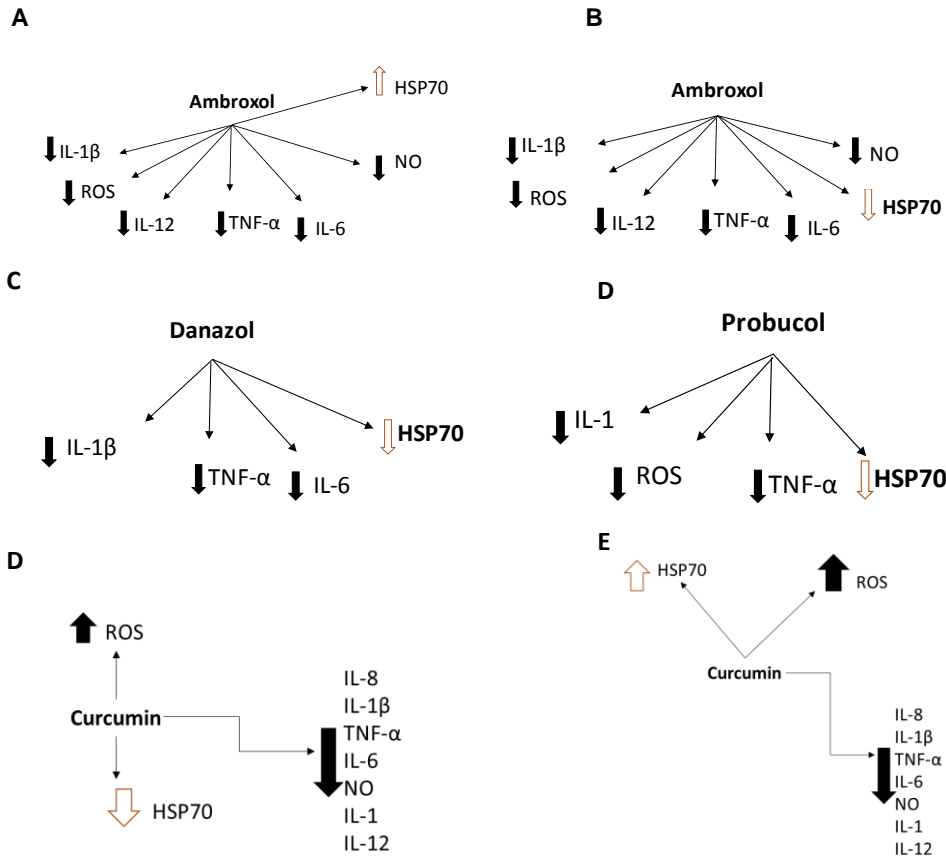

Figure 5.39: Effects of anti-inflammatory drugs on monocyte responses

The effects of (A) Ambroxol on J774A.1 cells; (B) Ambroxol on U937 cells; (C) danazol on monocytes; (D) probucol on cells; (E), curcumin on J774A.1 cells; (F), curcumin on U937 cells.

5.3.3.1.1 Anti-inflammatory drugs, monocyte HSP70 expression and TNF- α and IL-1 expressions

Ambroxol (Pfeifer *et al.*, 1997, Bianchi *et al.*, 1990), danazol (Liu *et al.*, 2000, Mori *et al.*, 1990), probucol (Guo *et al.*, 2015, Akeson *et al.*, 1991) and curcumin (Yun *et al.*, 2011, Abe *et al.*, 1999) decreased TNF- α and IL-1 expressions in monocytes/macrophages (Figure 5.39) and decreased HSP70 expression in monocytes in this study. The decreased monocyte HSP70 expression could be associated with a decrease in these cytokines. However, since ambroxol and curcumin were found to increase HSP70 expression in J774A.1 and U937 cells respectively, more work needs to be done to confirm the correlation between HSP70 expression and TNF- α and IL-1 expressions.

5.3.3.1.2 Anti-inflammatory drugs, monocyte HSP70 expression and ROS secretion

Ambroxol (Lee *et al.*, 1999) and probucol (Fukuda *et al.*, 1995) decreased ROS expression in monocytes while curcumin (Mimche *et al.*, 2012) was reported to increase ROS expression in monocytes. An inverse relationship between monocyte HSP70 and ROS expression could be deduced from the results, but because ambroxol and curcumin expressed HSP70 at different levels in the different monocytic cell lines, more work needs to be done to elucidate the relationship between monocyte HSP70 and ROS expression.

The anti-inflammatory drugs ambroxol, probucol, curcumin and danazol seem to exert their anti-inflammatory properties independent of the expression of HSP70, in monocytes.

5.3.3.2 Effects of β -haematin (haemozoin) on monocyte HSP70 protein expression

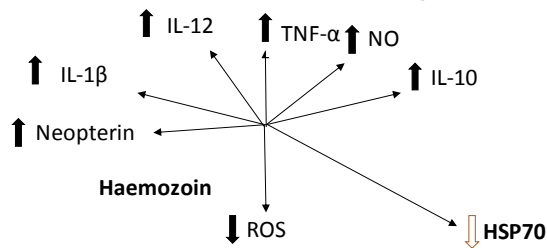

Figure 5.40: Effects of β -haematin on monocyte responses

The effects of β -haematin on cytokine expressions, ROS, neopterin secretion and monocyte HSP70 protein expression are shown.

In this study, it was found that β -haematin (synthetic haemozoin), latex beads and hemin decreased HSP70 protein expression in phagocytic J774A.1 cells. Comparing non-phagocytic U937 to J774A.1 phagocytic cells, HSP70 expression was inhibited in J774A.1 cells, suggesting that either β -haematin or phagocytosis inhibited HSP70 protein expression. J774A.1 cells were then incubated with hemin and latex beads, to determine whether the material phagocytosed decreased the HSP70 expression or whether the process of phagocytosis inhibited HSP70 expression. Phagocytosis of latex beads, hemin and β -haematin all inhibited HSP70 expression, with latex beads and β -haematin being more effective. This suggests that either the process of phagocytosis or the presence of the three materials inhibited the expression of HSP70. It was interesting to note that in the presence of β -haematin, there was an increased monocyte HSP70 protein expression in U937 cells. This defied the hypothesis that since U937 cells do not phagocytose β -haematin, the monocyte HSP70 protein expression will be unaffected. This could suggest that β -haematin interacted with the cells in other ways, which resulted in the overexpression of monocyte HSP70.

β -haematin (haemozoin) was reported to increase pro-inflammatory cytokines (Figure 5.40) (Jaramillo *et al.*, 2009). A decrease in HSP70 expression could be associated with an increase in pro-inflammatory pathways, but more work needs to be done to determine whether phagocytosis of haemozoin decreases HSP70 and induced pro-inflammatory pathways, or whether the inhibition of HSP70 is not related to the activation of the pro-inflammatory pathways by haemozoin.

β -haematin increased HSP27 expression in monocytes but seemed to have no effect on HSP70 expression (Prato *et al.*, 2010), until recently, when Kempaiah *et al.* (2016) found that haemozoin decreased HSP70 protein expression in peripheral blood mononuclear cells (PBMC), in the presence of glutamine. The study did not consider the effect of phagocytosis in the assay. There have been reports of extracellular HSP70 enhancing phagocytosis of latex beads by macrophages (Anand *et al.*, 2010), and reports of increased HSP70 protein expression in U937 macrophages, when they have phagocytosed erythrocytes (Clerget and Polla, 1990). Hemin is reported to increase haem oxygenase activity in alveolar macrophages, and to enhance alveolar macrophage phagocytosis (Hualin *et al.*, 2012). An increase in haem oxygenase was reported to increase HSP70 in macrophages during phagocytosis (Mautes and Noble, 2000), which suggested that hemin could increase HSP70 expression in monocytes. However, this was not observed in this study.

5.4 Conclusion

This study investigated the effects of different antimalarial, anti-inflammatory drugs and β -hematin on monocyte HSP70 protein expression. Chloroquine and artemether were found to increase HSP70 protein expression, while artemisinin, quinine, quinacrine, quinidine and primaquine were found to decrease HSP70 protein expression in monocytes. Quinacrine and quinine were more effective at decreasing HSP70 protein expression. β -hematin, latex beads and hemin all inhibited HSP70 expression in monocytes.

CHAPTER 6: GENERAL DISCUSSION

6.1 Overview of study

Malaria remains a serious threat to the world population, due to the emergence of resistant parasites to anti-malarial drugs (Greenwood *et al.*, 2008). Due to changing environmental conditions, more areas are becoming optimal for the growth of *Anopheles* mosquitoes and increasing transmission of malaria to non-endemic areas (Eckhoff, 2011). *Plasmodium falciparum* causes the most morbidity and mortality due to malaria around the world (WHO, 2015b). Parasites infect red blood cells and remodel them to make the environment suitable for their growth (Cowman and Crabb, 2006). Circulating monocytes are immune cells which act as the first line of defence during an infection (Gordon and Mantovani, 2011). They phagocytose infected red blood cells, free parasites and parasite products including haemozoin (Chua *et al.*, 2013). The monocytes mount a response and secrete a range of cytokines, reactive oxygen species, nitric oxide, neopterin and phospholipase A2 (Gordon and Mantovani, 2011, Chua *et al.*, 2013). It is thought that monocytes play a central part in determining whether the disease will develop from uncomplicated malaria to severe or cerebral malaria (Chua *et al.*, 2013). This is because any imbalance in cytokine expression can aggravate the disease (Chua *et al.*, 2013). Monocytes laden with haemozoin are reported to express dysregulated amount of cytokines, and do not undergo repeated phagocytosis (Giribaldi *et al.*, 2010, Skorokhod *et al.*, 2014, Schwarzer *et al.*, 1992).

Periodic episodes of fever are experienced during malaria (Silvie *et al.*, 2008) which put stress on both the host and the parasites (Kwiatkowski, 1989, Pavithra *et al.*, 2004, Polla, 1991). While fever has been reported to inhibit parasite growth (Kwiatkowski, 1989), it has more often been associated with increased malaria pathogenesis (Oakley *et al.*, 2007). Fever has been reported to increase cytoadherence and rosetting in malaria (Udomsangpetch *et al.*, 2002, Oakley *et al.*, 2007). Human heat shock protein 70 (HSP70) is a stress protein expressed when cells experience any form of stress including pH changes, heat shock, presence of some chemicals or heavy metals (Kregel, 2002, Singh and Hasday, 2013). HSP70 responds to stress by binding to denatured proteins and helping them to fold properly so that they regain their function, maintaining cell homeostasis. HSP70 prevents the aggregation of proteins (Nollen and Morimoto, 2002). Apart from being a cytoprotective protein, HSP70 has been reported to be anti-inflammatory as it inhibits the production of pro-inflammatory cytokines including TNF- α , and stimulates the production of anti-inflammatory cytokines such as IL-10 (Jäättelä and Wissing, 1993, Teshima *et*

al., 1996, Kim *et al.*, 1999). There are more studies on parasite HSP70 than on host HSP70 during malaria.

Antimalarial drugs are given to patients to treat malaria by killing parasites (Blanchard, 1947). Antimalarial drugs decrease the parasitaemia by interfering with parasite metabolism, but the exact mechanisms by which they work are poorly understood (Blanchard, 1947, Cunha-Rodrigues *et al.*, 2006). It is thought that chloroquine, quinidine and quinine inhibit the formation of haemozoin in infected red blood cells, leading to parasite death (Thomé *et al.*, 2013, Achan *et al.*, 2011, Egan *et al.*, 1999). Quinacrine is thought to cause parasite DNA damage (Ehsanian *et al.*, 2011), and primaquine is thought to cause oxidative stress in the parasites (Lalève *et al.*, 2016). Pyrimethamine affects the synthesis of dihydrofolate in parasites (Cui *et al.*, 2015). Artemisinin and its derivatives are thought to induce the formation of free radicals in the parasites, causing oxidative stress (Shakir *et al.*, 2011). Antimalarial drugs have also been reported to have anti-inflammatory properties (Wolf *et al.*, 2000) and to influence monocyte receptor expression (Goldring and Nemaorani, 1999). Nine antimalarial drugs were used in this study, namely, artemisinin, artesunate, artemether, chloroquine, primaquine, quinine, quinidine, quinacrine and pyrimethamine at therapeutic concentrations.

During malaria, reactive oxygen species are expressed to kill parasites, but can also cause oxidative stress to the host (Percário *et al.*, 2012). Expression of high levels of cytokines have been reported in malaria-infected patients, which could lead to severe and cerebral malaria (Lyke *et al.*, 2004, Jason *et al.*, 2001). Four anti-inflammatory drugs namely ambroxol, danazol, probucol and curcumin were chosen because they were also found to have anti-malarial properties. Ambroxol, danazol and probucol were previously reported to inhibit cytoadherence between monocytes and infected red blood cells (Goldring and Ramoshebi, 1999), and curcumin was proposed to be used as an adjunct therapy to malaria as it inhibits cerebral malaria (Reddy *et al.*, 2005). Together with decreasing oxidative stress during malaria (Percário *et al.*, 2012), they could be used as adjunct drugs in malaria treatment together with anti-malarial drugs.

High levels of HSP70 have been reported to show the level of inflammation in infections, hence, HSP70 is used as a marker for inflammation (Njemini *et al.*, 2003). In malaria, host HSP70 is expected to be high due to the presence of inflammation and fever (Polla, 1991). Whether the antimalarial and anti-inflammatory drugs influence monocyte responses, monocyte HSP70 expression was monitored during fever conditions. The effects of the selected antimalarial and anti-inflammatory drugs on monocyte HSP70 expression have not been studied before.

6.2 Aims of the study

The effects of the antimalarial, anti-inflammatory drugs and β -haematin on monocyte HSP70 protein expression, during fever conditions were investigated in this study. It was hypothesized that an understanding of the effects of these agents on monocyte HSP70 protein expression could give a broader understanding on how they affect monocyte responses, through the expression of monocyte HSP70 during malaria fever. The study aimed to express recombinant human HSP70, affinity-purify it and to use it to raise antibodies against rHSP70. The antibodies were then used to study the effects of antimalarial and anti-inflammatory drugs, at therapeutic concentrations, on monocyte HSP70 protein expression during fever. The effects of β -haematin on monocyte HSP70 was also studied, in the presence of heat shock (fever). The monocyte HSP70 protein expression was then discussed in light to the known effects of the drugs and whether they could be inter-related to each other.

6.3 Cloning, expression and purification of recombinant HSP70 (rHSP70)

Human HSP70 was sub-cloned from a pcDNA5/FRT/TO/HIS HSPA1A to a pET-28a plasmid, and the ligated plasmid was used to transform JM109 and BL21-(DE3) *Escherichia coli* (*E. coli*) cells. Recombinant HSP70 (rHSP70) was expressed in BL21-(DE3) cells and affinity-purified using a TALON[®] resin. For future studies, the level of endotoxin in the recombinant protein could be measured using the LAL method to ensure that it is free of endotoxins. The purified rHSP70 was found to form oligomers after gel filtration. The ATPase activity of rHSP70 was studied at various concentrations of rHSP70 and ATP concentrations, using the malachite green assay. For future studies, ATP could be added to the buffer containing rHSP70 and study whether oligomer formation is inhibited by the ATP levels.

6.4 Antibody production

Affinity-purified rHSP70 was used to immunise chickens to raise polyclonal antibodies against rHSP70. The affinity-purified anti-rHSP70 antibodies were specific for human HSP70 and did not cross react with any *E. coli* proteins. The affinity-purified anti-rHSP70 antibodies were comparable to a commercially available anti-HSP70 antibody. The anti-rHSP70 antibodies detected inducible HSP70 from both human and mouse monocyte lysates, after heat shock.

The affinity-purified rHSP70 protein was used to make monoclonal antibodies against HSP70 using phage display technology. From the optimisation steps of panning, it was found that:

- Milk powder was a better blocking agent than BSA

- Phages obtained by tri-ethylamine elution selected for clones with high affinity to rHSP70 when compared to column phages which selected for clones with low affinity to rHSP70 and clones lacking complementarity determining region
- Higher yields of monoclonal soluble scFv were obtained by auto-induction in TEB, compared to IPTG induction in 2xYT media.
- With on column infection, incomplete scFv clones appeared to be selected with every round of panning.

Clones which had high affinity to rHSP70 and were of full size were chosen to detect rHSP70 on a dot blot and western blot format. The clones detected rHSP70 on a dot blot, but not on a western blot, possibly due to the clones recognising only conformational epitopes. For future studies, denatured rHSP70 could be used in the rounds of panning so as to isolate clones against the denatured form of HSP70 which could then be used in western blots. While only two blocking agents were compared in this study, other blocking agents such as PEG6000 and casein could be tested. The specific scFv could be affinity purified using an AminoLink™ column bound to either rHSP70 or to a c-myc tag that would bind only the specific antibodies. The affinity-purified scFv clones could then be used in a sandwich ELISA to detect HSP70 in monocyte lysates.

6.5 Effects of antimalarial, anti-inflammatory and β -haematin on monocyte HSP70 expression

A human (U937) and a mouse (J774A.1) monocytic cell lines were cultured and characterised based on their morphology and their alkaline phosphatase and peroxidase activity. The monocytes were incubated with nine antimalarial drugs namely chloroquine, quinine, quinidine, primaquine, artemisinin, artesunate, artemether, quinacrine, and pyrimethamine at therapeutic concentrations of each drug and heat shocked, to mimic fever. In the absence of fever, the antimalarial drugs had no effect on monocyte HSP70 expression. With heat shock, it was found that chloroquine and artemether increased HSP70 protein expression, with chloroquine being more effective. Artemisinin, primaquine, quinine, quinidine and quinacrine decreased monocyte HSP70 protein expression with quinacrine and quinine being most effective. Artemisinin and quinidine were the least effective at decreasing HSP70 protein expression in monocytes.

Without heat shock, there was no change in monocyte HSP70 expression with the four anti-inflammatory drugs, namely probucol, ambroxol, danazol and curcumin. After heat shock to mimic fever, danazol, ambroxol and probucol were found to decrease HSP70 protein expression in U937 monocytes, with danazol being the most effective. Danazol also decreased HSP70

expression in J774A.1 cells but ambroxol increased HSP70 protein expression in J774A.1 cells. Curcumin decreased HSP70 protein expression in J774A.1 cells but increased HSP70 protein expression in U937 cells.

The difference in HSP70 protein expression between U937 and J774A.1 cells could be attributed to the level of differentiation of the cells. J774A.1 cells are more differentiated than U937 promonocytes (Ralph *et al.*, 1976). In another study, it was found that superoxide anion production was increased in U937 treated with zymosan, but was decreased in J774A.1 cells, attributing the difference between the two cell types to the lack of CR3 expression in the U937 cells (Wu *et al.*, 2010). Overall, the effects of the antimalarial and anti-inflammatory drugs were similar with J774A.1 and U937 cells, suggesting that they may have the same effect in monocytes derived from human blood. Other studies found similar monocyte responses between U937, J774A.1 cell lines and peripheral blood mononuclear cells (Facer, 1995, Paauw *et al.*, 2009).

Patterns in monocyte responses with monocyte HSP70 expression with the antimalarial drugs were observed. It seemed like there was an inverse relationship between HSP70 expression and TNF- α expression by antimalarial drugs. Artemether and chloroquine which increased HSP70 expression were reported to decrease TNF- α expression (Li *et al.*, 2008, López Suárez *et al.*, 2014). Quinidine was reported to increase TNF- α expression (Matsumori *et al.*, 1997), and in this study, it decreased HSP70 expression in monocytes. Artemisinin and quinine, however showed a different pattern, as they have both been reported to decrease TNF- α , and they both decreased HSP70 expression in monocytes (Wang *et al.*, 2006, Picot *et al.*, 1993). It was notable to find that three drugs, primaquine, artemisinin and quinine which decreased GTP cyclohydrolase-1 expression in U937 monocytes, hence a decreased neopterin secretion (Cumming *et al.*, 2011), decreased HSP70 protein expression in monocytes in this study. It would be interesting to evaluate monocyte HSP70 protein expression and neopterin secretion to see if they are linked. The antimalarial drugs which increased monocyte HSP70 protein expression, were reported to increase the expression of reactive oxygen species (ROS) in cells, including artemether and chloroquine. The increased ROS expression could have enhanced the expression of HSP70 protein. ROS expression should be measured together with monocyte HSP70 expression to be able to find a relationship between these two, if any. A pattern with phagocytosis and monocyte HSP70 expression was found, whereby a decreased monocyte HSP70 expression was associated with increased phagocytosis. Quinine, primaquine, artemisinin decreased HSP70 expression in monocytes, and increased phagocytosis of β -haematin (Cumming, 2009). Chloroquine which increased monocyte HSP70 expression, was reported to inhibit β -haematin

phagocytosis (Cumming, 2009). However, an exception was observed with quinidine. Quinidine decreased HSP70 expression in monocytes and was reported to decrease phagocytosis in mouse macrophages (Ablin *et al.*, 2005).

The anti-inflammatory drugs, probucol and danazol inhibited HSP70 expression in monocytes. Ambroxol and curcumin gave different results with the different cell lines. It was difficult to make any inferences between monocyte HSP70 expression and monocyte responses. This might suggest that the anti-inflammatory drugs have a wide range of actions, and they exert their anti-inflammatory properties independent of monocyte HSP70 expression.

Monocyte HSP70 protein expression was reduced in the presence of β -haematin, latex beads and hemin. This might suggest that either phagocytosis or all of the three materials caused a decrease in monocyte HSP70 expression. Phagocytosis of non-infected red blood cells and infected red blood cells can be done in future studies, and monocyte HSP70 expression measured. This might give an insight on whether phagocytosis decreases monocyte HSP70 expression or the presence of these materials caused a decrease in HSP70 expression.

In this study, only monocyte HSP70 protein expression was measured. Measuring cytokine expressions, ROS expression, neopterin and phospholipase A2 secretions entail high costs, as expensive reagents and ELISA kits are needed. For future studies, cytokine levels along with monocyte HSP70 protein expression could be measured to get a better overview of the relationship between monocyte HSP70 expression and cytokine expression, if any. As an alternative, mRNA expression of the cytokines could be measured using specific primers as has been done to measure neopterin secretion by measuring GTP cyclohydrolase-1 mRNA transcripts (Cumming *et al.*, 2011). However, mRNA expression does not show whether all transcripts are being translated, hence, might not reflect what is being expressed.

Other monocytic cell lines, namely THP-1 cells and Mono Mac 6 could have been used in this study. THP-1 is a monocytic cell line derived from a patient with acute monocytic leukaemia (Tsuchiya *et al.*, 1980). THP-1 cells are considered monoblasts as they need to be differentiated to develop macrophage characteristics (Ziegler-Heitbroc *et al.*, 1988). THP-1 cells have monocyte characteristics but are thought to be less differentiated than U937 cells (Chanput *et al.*, 2015). THP-1 cells are homogeneous but cannot be used at high passage numbers as they lose their cell activity (Chanput *et al.*, 2015). U937 cells, on the other hand, can be used at high passage number and keep their genetic integrity (Chanput *et al.*, 2015). Mono Mac 6 is a monocytic cell line developed by Ziegler-Heitbroc *et al.* (1988) and the monocytes are reported to

have monocyte properties, and do not need to be artificially differentiated (Ziegler-Heitbroc *et al.*, 1988). They have phagocytic properties, produce cytokines and express CD14 receptors upon activation (Neustock *et al.*, 1993). The disadvantages of using those cell lines are that they are derived from malignant sources, hence, do not represent a normal monocyte. They need to be cultured in controlled environments which can influence the results obtained (Chanput *et al.*, 2015). Ideally, monocytes isolated from peripheral blood can be used (Damsgaard *et al.*, 2009, Cumming, 2009). In this study, PBMCs were not used as it was important to keep the study fairly simple. For future studies, PBMSc will be used to validate the results obtained from this study.

Monocytes could also be isolated from a malaria-infected patient before and after antimalarial drug treatment. Expression of monocyte HSP70 can be measured to see if malaria infection affects monocyte HSP70 expression in the host. The isolated monocytes could then be treated with the different antimalarial, anti-inflammatory drugs and β -haematin to study how these agents affect monocyte HSP70 expression, with and without heat shock. The cytokine profile could also be monitored with each drug to see if monocyte HSP70 expression is related to the immunomodulatory functions of each drug. HSP70 expression could be measured in monocyte laden haemozoin, isolated from blood obtained from a malaria-infected patient. Monocyte HSP70 protein expression could then be analysed after heat shocking the cells.

6.6 Contribution of the study to current knowledge and its potential impact on the management and treatment of malaria

There is little information available describing the effects of the drugs used in this study on monocyte HSP70 from the literature. This study has helped in understanding more on the effects of the antimalarial, anti-inflammatory drugs and β -haematin on monocyte HSP70. An upregulation of monocyte HSP70 expression would suggest that it will have an anti-inflammatory effect (Yenari *et al.*, 2005) on the host, and the contrary will be observed with a downregulation of HSP70. When a patient has severe malaria, potentially a drug which upregulates HSP70 might be chosen, but severe malaria is also accompanied with dysregulated monocytes due to the accumulation of haemozoin (Schwarzer *et al.*, 1992). An upregulation in monocyte HSP70 would render the cells resistant to apoptosis. A downregulation in monocyte HSP70 might promote apoptosis and clear dysregulated monocytes from the circulation. With the antimalarial effects on the parasites, and getting rid of dysregulated monocytes, the patient can recover more easily. However, further studies are required to test these assumptions and to determine how the drugs will be used in the management and treatment of malaria.

6.7 Contribution of the study on cancer

While this study has been focused on malaria, the findings of this study could also be related to some cancers. Some cancer cells have been reported to overexpress inducible HSP70, namely breast cancer, colon cancer, gastric cancer, melanoma, bladder cancer and tumorigenic cells including HeLa (Shu and Huang, 2008). Overexpression of HSP70 has been associated with malignancy, resistance to anti-cancer drugs, resistance to chemotherapy and to radiation therapy (Shu and Huang, 2008). Increased expression of HSP70 in cancer cells make them resistant to apoptosis, and to harsh environments such as oxygen deprived environment and to glucose deprivation (Shu and Huang, 2008). It was reported that an antisense HSP70 construct which inhibited HSP70 protein expression, rendered cancer cells more vulnerable to apoptosis and more sensitive to drugs (Lee and Schöfl, 1996). Drugs that inhibit HSP70 expression are being used in cancer therapy to make the cancer cells susceptible to apoptosis (Westerheide *et al.*, 2006). Some of the drugs that inhibit HSP70 expression are triptolide and quercetin (Westerheide *et al.*, 2006, Hansen *et al.*, 1997). They inhibit HSP70 expression by inhibiting heat shock factor 1 (HSF1) which is required to activate HSP70 transcription (Antonoff *et al.*, 2009, Mujumdar *et al.*, 2010, Abravaya *et al.*, 1992). Quinacrine was reported to have anti-cancer properties, by inhibiting HSP70 expression in HeLa cells (Neznanov *et al.*, 2009). It was reported to have anti-cancer properties in human gastric cancer cells (Wu *et al.*, 2012), breast cancer cells (Preet *et al.*, 2012) and acute myeloid leukemia (Eriksson *et al.*, 2015). In this study, quinine, primaquine, quinidine, artemisinin, danazol, probucol, and ambroxol were reported to decrease HSP70 expression in monocytes. Quinine and danazol were more effective in decreasing monocyte HSP70 expression. The drugs were used at therapeutic concentrations, which suggest no toxicity to the cells at those concentrations (WHO, 2015a). These drugs can be tested to see if they inhibit HSP70 in other cancer cell lines, and whether have potential in cancer treatment.

APPENDIX I: Densitometry results when total protein was used as the loading control

Artemether

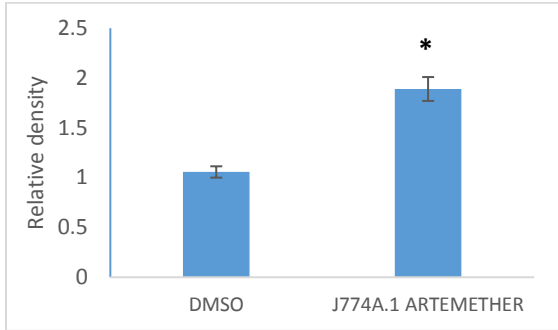

p=0.0091

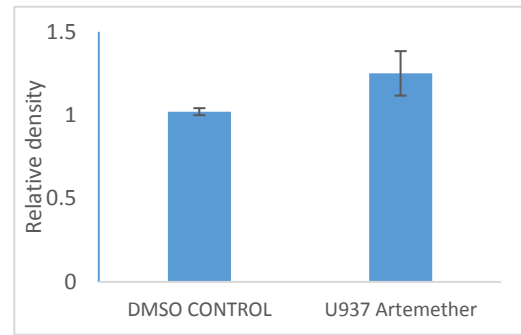

p=0.38

Artemisinin

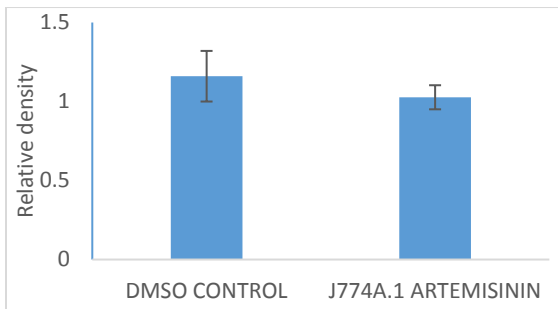

p=0.43

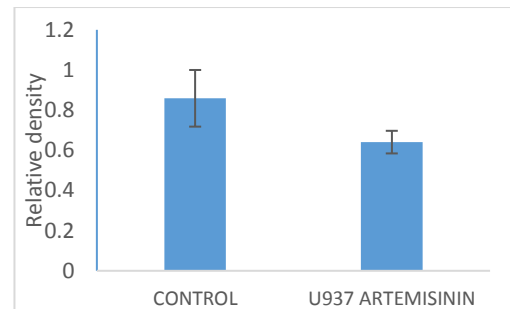

p=0.12

Artesunate

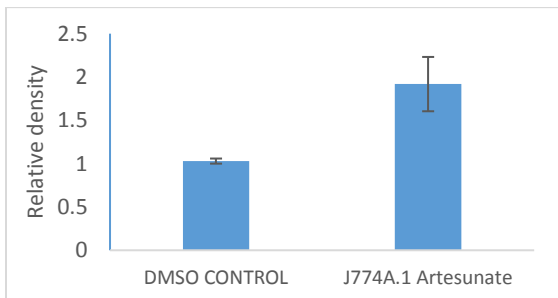

p=0.17

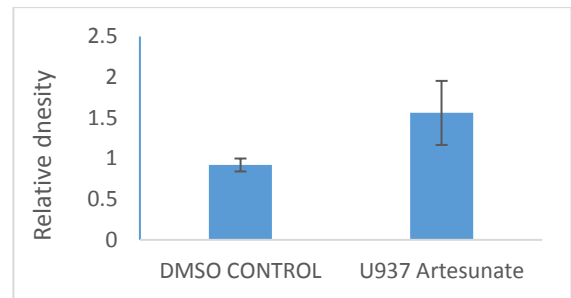

p=0.41

Chloroquine

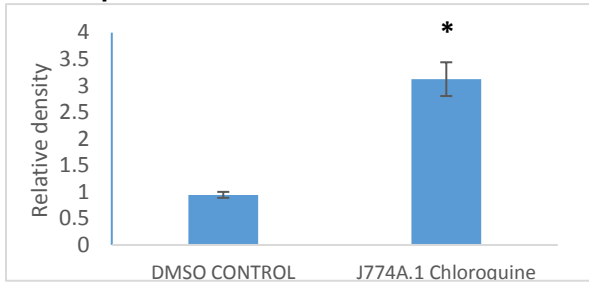

p=0.0095

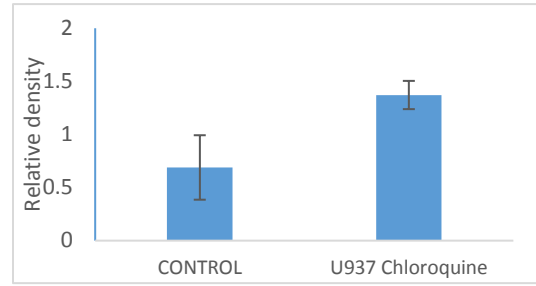

p=0.090

Primaquine

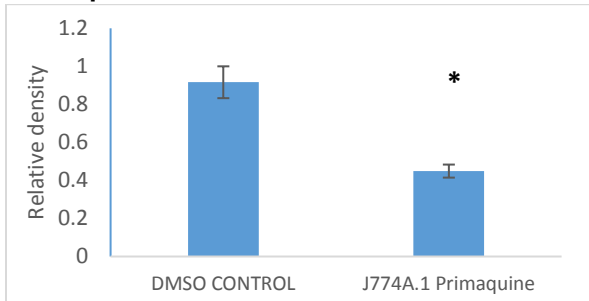

P=0.00074

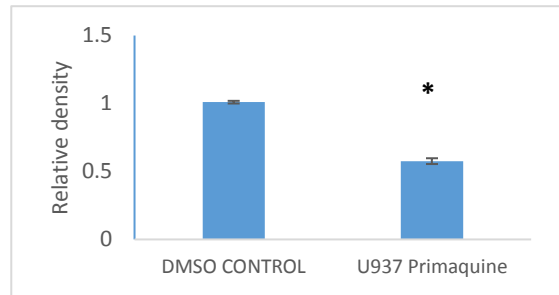

p=0.000032

Pyrimethamine

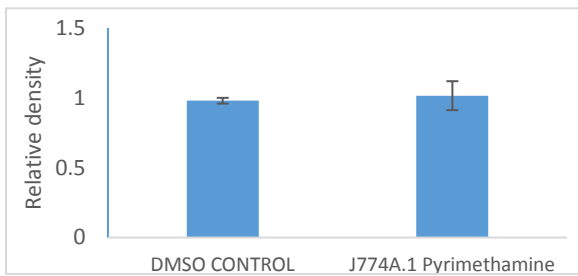

P=0.86

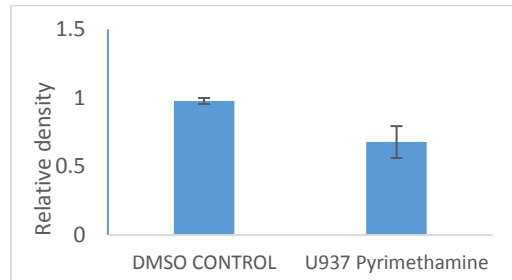

p=0.26

Quinacrine

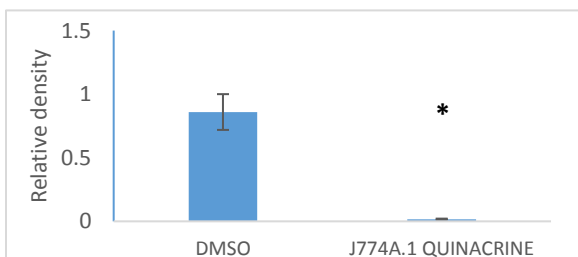

P=0.000098

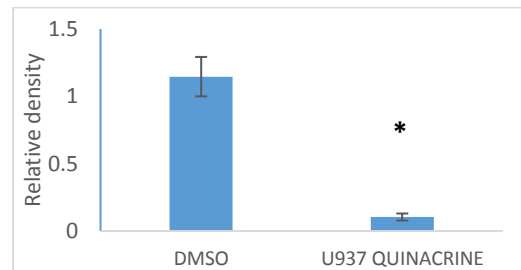

p=0.000017

Quinidine

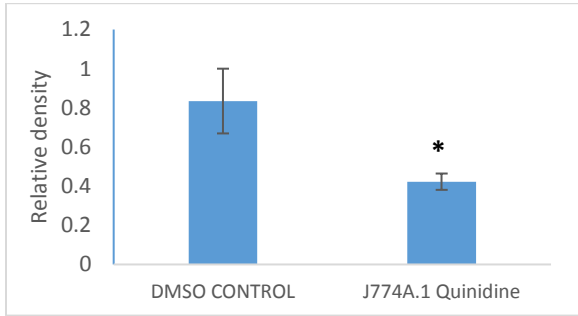

P=0.0091

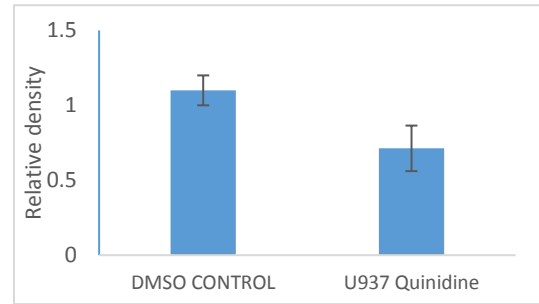

p=0.22

Quinine

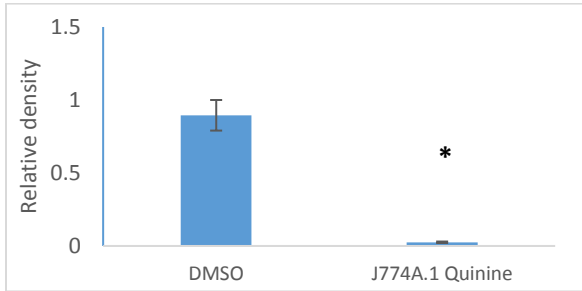

p=0.000024

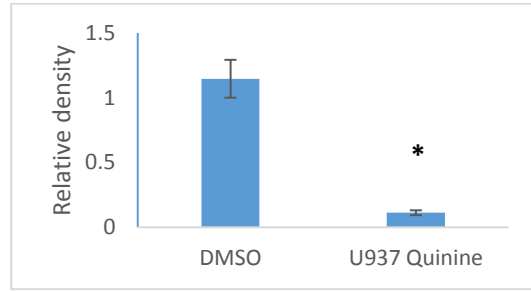

p=0.00001

Ambroxol

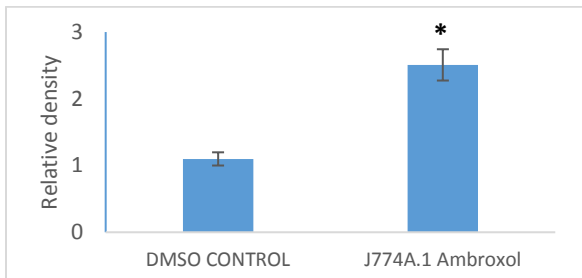

P=0.010

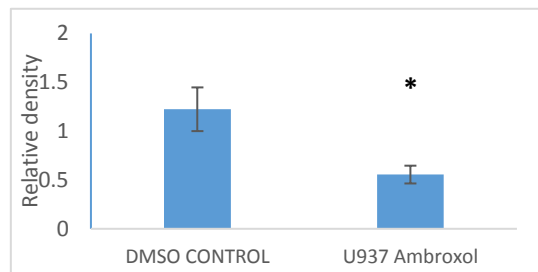

p=0.018

Probucol

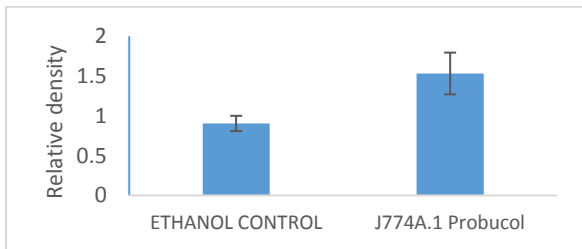

P=0.24

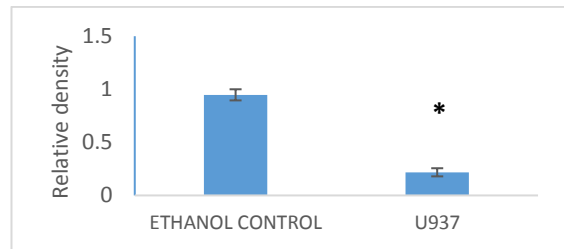

p=0.000063

Danazol

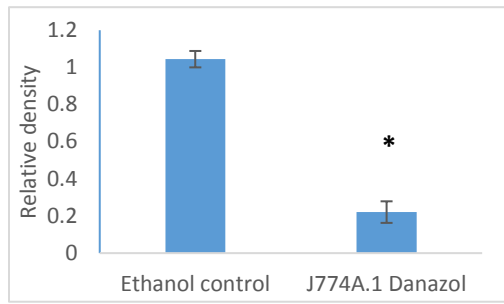

P=0.0003

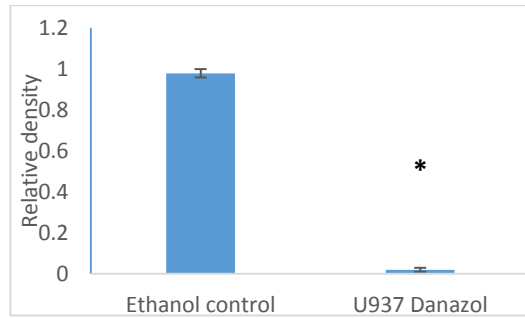

p=0.00000009

Curcumin

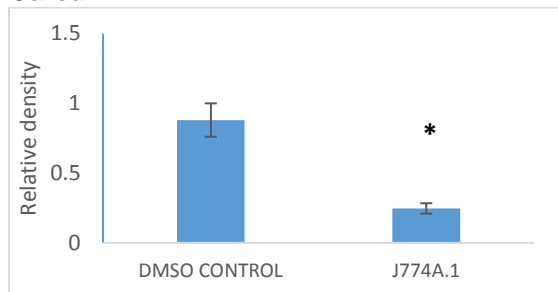

P=0.00038

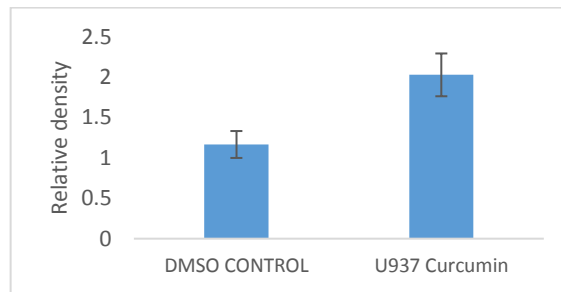

p=0.12

APPENDIX II: Wilcoxon rank sum test (Mann Whitney U test)

Antimalarial/anti-inflammatory drugs	P value	
	J774A.1	U937
Artemether	0.023	0.23
Artemisinin	0.091	0.023
Artesunate	0.023	0.091
Chloroquine	0.023	0.16
Primaquine	0.023	0.023
Pyrimethamine	0.25	0.37
Quinacrine	0.023	0.023
Quinidine	0.023	0.048
Quinine	0.023	0.023
Ambroxol	0.023	0.026
Probucol	0.023	0.023
Danazol	0.048	0.023
Curcumin	0.023	0.023

REFERENCES

- Abdurashitov, M. A., Tomilov, V. N., Chernukhin, V. A. and Degtyarev, S. K., 2008. A physical map of human Alu repeats cleavage by restriction endonucleases. *BMC genomics*, 9(1), pp. 1.(10.1186/1471-2164-9-305).
- Abe, Y., Hashimoto, S. and Horie, T., 1999. Curcumin inhibition of inflammatory cytokine production by human peripheral blood monocytes and alveolar macrophages. *Pharmacological Research*, 39(1), pp. 41-47.
- Ablin, J., Verbovetski, I., Trahtemberg, U., Metzger, S. and Mevorach, D., 2005. Quinidine and procainamide inhibit murine macrophage uptake of apoptotic and necrotic cells: a novel contributing mechanism of drug-induced-lupus. *Apoptosis*, 10(5), pp. 1009-1018.
- Aboge, G. O., Jia, H., Terkawi, M. A., Goo, Y.-K., Nishikawa, Y., Sunaga, F., Namikawa, K., Tsuji, N., Igarashi, I. and Suzuki, H., 2008. Cloning, expression, and characterization of Babesia gibsoni dihydrofolate reductase-thymidylate synthase: inhibitory effect of antifolates on its catalytic activity and parasite proliferation. *Antimicrobial agents and chemotherapy*, 52(11), pp. 4072-4080.
- Abravaya, K., Myers, M. P., Murphy, S. P. and Morimoto, R. I., 1992. The human heat shock protein hsp70 interacts with HSF, the transcription factor that regulates heat shock gene expression. *Genes & Development*, 6(7), pp. 1153-1164.(10.1101/gad.6.7.1153).
- Achan, J., Talisuna, A. O., Erhart, A., Yeka, A., Tibenderana, J. K., Baliraine, F. N., Rosenthal, P. J. and D'Alessandro, U., 2011. Quinine, an old anti-malarial drug in a modern world: role in the treatment of malaria. *Malaria journal*, 10(1), pp. 1.(10.1186/1475-2875-10-144).
- Aditya, N., Patankar, S. and Madhusudhan, B., 2009. Assessment of curcumin-primaquine combination therapy for malaria. *Pharmacology Online*, 3, pp. 49-53.
- Agudelo, O., Bueno, J., Villa, A. and Maestre, A., 2012. High IFN-gamma and TNF production by peripheral NK cells of Colombian patients with different clinical presentation of Plasmodium falciparum. *Malaria journal*, 11, pp. 38.(10.1186/1475-2875-11-38).
- Aguilar, R., Marrocco, T., Skorokhod, O. A., Barbosa, A., Nhabomba, A., Manaca, M. N., Guinovart, C., Quintó, L., Arese, P. and Alonso, P. L., 2014. Blood oxidative stress markers and Plasmodium falciparum malaria in non-immune African children. *British journal of haematology*, 164(3), pp. 438-450.
- Ahmed, A., Cameron, I., Ferriani, R. A. and Smith, S., 1992. Activation of phospholipase A2 and phospholipase C by endothelin-1 in human endometrium. *Journal of endocrinology*, 135(2), pp. 383-390.
- Aihara, M., Dobashi, K., Akiyama, M., Naruse, I., Nakazawa, T. and Mori, M., 2000. Effects of N-acetylcysteine and ambroxol on the production of IL-12 and IL-10 in human alveolar macrophages. *Respiration*, 67(6), pp. 662-671.
- Akeson, A. L., Woods, C. W., Mosher, L. B., Thomas, C. E. and Jackson, R. L., 1991. Inhibition of IL-1 β expression in THP-1 cells by probucol and tocopherol. *Atherosclerosis*, 86(2), pp. 261-270.
- Al-Fadhli, M. A., Saraya, M. A. and Qasem, J. A., 2014. Evaluation of leptin, interleukin-1 beta and tumor necrosis factor alpha in serum of malaria patients as prognostic markers of treatment outcome. *Asian Pacific journal of tropical biomedicine*, 4(6), pp. 441-445.
- Amino, R., Ménard, R. and Frischknecht, F., 2005. In vivo imaging of malaria parasites—recent advances and future directions. *Current opinion in microbiology*, 8(4), pp. 407-414.
- Anand, P. K., Anand, E., Bleck, C. K., Anes, E. and Griffiths, G., 2010. Exosomal Hsp70 induces a pro-inflammatory response to foreign particles including mycobacteria. *PloS one*, 5(4), pp. e10136.(<http://dx.doi.org/10.1371/journal.pone.0010136>).
- Andris-Widhopf, J., Rader, C., Steinberger, P., Fuller, R. and Barbas Iii, C. F., 2000. Methods for the generation of chicken monoclonal antibody fragments by phage display. *Journal of immunological methods*, 242(1), pp. 159-181.
- Antoine, T., Fisher, N., Amewu, R., O'Neill, P. M., Ward, S. A. and Biagini, G. A., 2014. Rapid kill of malaria parasites by artemisinin and semi-synthetic endoperoxides involves ROS-dependent depolarization of the membrane potential. *Journal of Antimicrobial Chemotherapy*, 69(4), pp. 1005-1016.(10.1093/jac/dkt486).

- Antonoff, M. B., Chugh, R., Borja-Cacho, D., Dudeja, V., Clawson, K. A., Skube, S. J., Sorenson, B. S., Saltzman, D. A., Vickers, S. M. and Saluja, A. K., 2009. Triptolide therapy for neuroblastoma decreases cell viability in vitro and inhibits tumor growth in vivo. *Surgery*, 146(2), pp. 282-290.
- Aprile, F. A., Dhulesia, A., Stengel, F., Roodveldt, C., Benesch, J. L. P., Tortora, P., Robinson, C. V., Salvatella, X., Dobson, C. M. and Cremades, N., 2013. Hsp70 Oligomerization Is Mediated by an Interaction between the Interdomain Linker and the Substrate-Binding Domain. *PLoS ONE*, 8(6), pp. e67961.(10.1371/journal.pone.0067961).
- Araujo, T. s. L., Borges, J. C., Ramos, C. H., Meyer-Fernandes, J. R., Oliveira Junior, R. S., Pascutti, P. G., Foguel, D. and Palhano, F. L., 2014. Conformational changes in human Hsp70 induced by high hydrostatic pressure produce oligomers with ATPase activity but without chaperone activity. *Biochemistry*, 53(18), pp. 2884-2889.
- Ariey, F., Witkowski, B., Amaratunga, C., Beghain, J., Langlois, A.-C., Khim, N., Kim, S., Duru, V., Bouchier, C. and Ma, L., 2014. A molecular marker of artemisinin-resistant Plasmodium falciparum malaria. *Nature*, 505(7481), pp. 50-55.
- Artimo, P., Jonnalagedda, M., Arnold, K., Baratin, D., Csardi, G., De Castro, E., Duvaud, S., Flegel, V., Fortier, A. and Gasteiger, E., 2012. ExPASy: SIB bioinformatics resource portal. *Nucleic acids research*, pp. gks400.(10.1093/nar/gks400).
- Asea, A., Kraeft, S.-K., Kurt-Jones, E. A., Stevenson, M. A., Chen, L. B., Finberg, R. W., Koo, G. C. and Calderwood, S. K., 2000. HSP70 stimulates cytokine production through a CD14-dependant pathway, demonstrating its dual role as a chaperone and cytokine. *Nature medicine*, 6(4), pp. 435-442.
- Ashley, E. A., Dhorda, M., Fairhurst, R. M., Amaratunga, C., Lim, P., Suon, S., Sreng, S., Anderson, J. M., Mao, S. and Sam, B., 2014. Spread of artemisinin resistance in Plasmodium falciparum malaria. *New England Journal of Medicine*, 371(5), pp. 411-423.
- Aunpad, R., Somsri, S., Na-Bangchang, K., Udomsangpetch, R., Mungthin, M., Adisakwattana, P. and Chaijaroenkul, W., 2009. The effect of mimicking febrile temperature and drug stress on malarial development. *Annals of Clinical Microbiology and Antimicrobials*, 8, pp. 19.(10.1186/1476-0711-8-19).
- Authi, K. and Traynor, J., 1979. Effects of antimalarial drugs on phospholipase A2 [proceedings]. *British journal of pharmacology*, 66(3), pp. 496P.
- Aviado, D. M. and Salem, H., 1975. Drug action, reaction, and interaction. I. Quinidine for cardiac arrhythmias. *The Journal of Clinical Pharmacology*, 15(7), pp. 477-485.
- Awandare, G. A., Goka, B., Boeuf, P., Tetteh, J. K., Kurtzhals, J. A., Behr, C. and Akanmori, B. D., 2006. Increased levels of inflammatory mediators in children with severe Plasmodium falciparum malaria with respiratory distress. *Journal of Infectious Diseases*, 194(10), pp. 1438-1446.
- Awandare, G. A., Ouma, Y., Ouma, C., Were, T., Otieno, R., Keller, C. C., Davenport, G. C., Hittner, J. B., Vulule, J., Ferrell, R., Ong'echa, J. M. and Perkins, D. J., 2007. Role of monocyte-acquired hemozoin in suppression of macrophage migration inhibitory factor in children with severe malarial anemia. *Infection and immunity*, 75(1), pp. 201-210.(10.1128/IAI.01327-06).
- Ayi, K., Patel, S. N., Serghides, L., Smith, T. G. and Kain, K. C., 2005. Nonopsonic phagocytosis of erythrocytes infected with ring-stage Plasmodium falciparum. *Infection and immunity*, 73(4), pp. 2559-2563.
- Bachelet, M., Adrie, C. and Polla, B., 1998. Macrophages and heat shock proteins. *Research in immunology*, 149(7), pp. 727-732.
- Baek, H.-j., Lee, J.-s., Seo, J.-s. and Cha, S.-h., 2004. Isolation and Characterization of Human scFv Molecules Specific for Recombinant Human Heat Shock Protein (HSP). *Network*, 4(1), pp. 7-15.
- Baird, J. K. and Hoffman, S. L., 2004. Primaquine therapy for malaria. *Clinical infectious diseases*, 39(9), pp. 1336-1345.
- Bakmiwewa, S. M., Weiser, S., Grey, M., Heng, B., Guillemin, G. J., Ball, H. J. and Hunt, N. H., 2016. Synergistic induction of CXCL10 by interferon-gamma and lymphotoxin-alpha in astrocytes: Possible role in cerebral malaria. *Cytokine*, 78, pp. 79-86.
- Balint, G. A., 2001. Artemisinin and its derivatives: an important new class of antimalarial agents. *Pharmacology & therapeutics*, 90(2), pp. 261-265.
- Banumathy, G., Singh, V. and Tatu, U., 2002. Host chaperones are recruited in membrane-bound complexes by Plasmodium falciparum. *The journal of biological chemistry*, 277(6), pp. 3902-3912.(10.1074/jbc.M110513200).

- Barber, B. E., William, T., Grigg, M. J., Piera, K. A., Chen, Y., Wang, H., Weinberg, J. B., Yeo, T. W. and Anstey, N. M., 2016. Nitric Oxide-Dependent Endothelial Dysfunction and Reduced Arginine Bioavailability in Plasmodium vivax Malaria but No Greater Increase in Intravascular Hemolysis in Severe Disease. *Journal of Infectious Diseases*, 214(10), pp. 1557-1564.
- Baroni, A., Paoletti, I., Ruocco, E., Ayala, F., Corrado, F., Wolf, R., Tufano, M. and Donnarumma, G., 2007. Antiviral effects of quinine sulfate on HSV-1 HaCat cells infected: analysis of the molecular mechanisms involved. *Journal of dermatological science*, 47(3), pp. 253-255.
- Bartolini, M., Wainer, I. W., Bertucci, C. and Andrisano, V., 2013. The rapid and direct determination of ATPase activity by ion exchange chromatography and the application to the activity of heat shock protein-90. *Journal of pharmaceutical and biomedical analysis*, 73, pp. 77-81.
- Bate, C., Taverne, J. and Playfair, J., 1988. Malarial parasites induce TNF production by macrophages. *Immunology*, 64(2), pp. 227-231.
- Beeh, K., Beier, J., Esperester, A. and Paul, L., 2008. Antiinflammatory properties of ambroxol. *European journal of medical research*, 13(12), pp. 557-562.
- Beeson, J. and Brown, G., 2002. Pathogenesis of Plasmodium falciparum malaria: the roles of parasite adhesion and antigenic variation. *Cellular and Molecular Life Sciences CMLS*, 59(2), pp. 258-271.
- Bennett, T. N., Patel, J., Ferdig, M. T. and Roepe, P. D., 2007. Plasmodium falciparum Na⁺/H⁺ exchanger activity and quinine resistance. *Molecular and biochemical parasitology*, 153(1), pp. 48-58.
- Bianchi, M., Mantovani, A., Erroi, A., Dinarello, C. and Ghezzi, P., 1990. Ambroxol inhibits interleukin 1 and tumor necrosis factor production in human mononuclear cells. *Agents and actions*, 31(3-4), pp. 275-279.
- Biemba, G., Gordeuk, V. R., Thuma, P., Mabeza, G. and Weiss, G., 1998. Prolonged macrophage activation and persistent anaemia in children with complicated malaria. *Tropical Medicine & International Health*, 3(1), pp. 60-65.
- Bisht, K., Choi, W. H., Park, S. Y., Chung, M. K. and Koh, W. S., 2009. Curcumin enhances non-inflammatory phagocytic activity of RAW264. 7 cells. *Biochemical and biophysical research communications*, 379(2), pp. 632-636.
- Blanchard, K. C., 1947. Antimalarial drugs. *Annual review of biochemistry*, 16(1), pp. 587-604.
- Blommel, P. G., Becker, K. J., Duvnjak, P. and Fox, B. G., 2007. Enhanced Bacterial Protein Expression During Auto-induction Obtained by Alteration of Lac Repressor Dosage and Medium Composition. *Biotechnology progress*, 23(3), pp. 585-598.(10.1021/bp070011x).
- Boeuf, P. S., Loizon, S., Awandare, G. A., Tetteh, J. K., Addae, M. M., Adjei, G. O., Goka, B., Kurtzhals, J. A., Puijalón, O. and Hviid, L., 2012. Insights into deregulated TNF and IL-10 production in malaria: implications for understanding severe malarial anaemia. *Malaria journal*, 11(1), pp. 1.
- Bondeson, J. and Sundler, R., 1998. Antimalarial Drugs Inhibit Phospholipase A 2 Activation and Induction of Interleukin I β and Tumor Necrosis Factor α in Macrophages: Implications for Their Mode of Action in Rheumatoid Arthritis. *General Pharmacology: The Vascular System*, 30(3), pp. 357-366.
- Borges, T. J., Lopes, R. L., Pinho, N. G., Machado, F. D., Souza, A. P. D. and Bonorino, C., 2013. Extracellular Hsp70 inhibits pro-inflammatory cytokine production by IL-10 driven down-regulation of C/EBP β and C/EBP δ . *International Journal of Hyperthermia*, 29(5), pp. 455-463.
- Borges, T. J., Wieten, L., van Herwijnen, M. J., Broere, F., van der Zee, R., Bonorino, C. and van Eden, W., 2012. The anti-inflammatory mechanisms of Hsp70. *Frontiers in immunology*, 3, pp. 95.(10.3389/fimmu.2012.00095).
- Bornhorst, J. A. and Falke, J. J., 2000. [16] Purification of Proteins Using Polyhistidine Affinity Tags. *Methods in enzymology*, 326, pp. 245-254. Available at: <http://www.ncbi.nlm.nih.gov/pmc/articles/PMC2909483/>
- Boswell-Casteel, R. C., Johnson, J. M., Duggan, K. D., Tsutsui, Y. and Hays, F. A., 2015. Overproduction and biophysical characterization of human HSP70 proteins. *Protein Expr Purif*, 106, pp. 57-65.(10.1016/j.pep.2014.09.013).
- Bottger, E., Multhoff, G., Kun, J. F. and Esen, M., 2012. Plasmodium falciparum-infected erythrocytes induce granzyme B by NK cells through expression of host-Hsp70. *PLoS One*, 7(3), pp. e33774.(10.1371/journal.pone.0033774).
- Boura, M., Frita, R., Gois, A., Carvalho, T. and Hanscheid, T., 2013. The hemozoin conundrum: is malaria pigment immune-activating, inhibiting, or simply a bystander? *Trends in parasitology*, 29(10), pp. 469-476.(10.1016/j.pt.2013.07.005).

- Bradbury, A. R. M. and Marks, J. D., 2004. Antibodies from phage antibody libraries. *Journal of Immunological Methods*, 290(1–2), pp. 29-49. (<http://dx.doi.org/10.1016/j.jim.2004.04.007>).
- Bradd, S. J. and Dunn, M. J., 1993. Analysis of membrane proteins by Western blotting and enhanced chemiluminescence. *Biomembrane Protocols: I. Isolation and Analysis*, pp. 211-218.
- Bradford, M. M., 1976. A rapid and sensitive method for the quantitation of microgram quantities of protein utilizing the principle of protein-dye binding. *Analytical biochemistry*, 72(1-2), pp. 248-254.
- Braun, D. P., Gebel, H. and Dmowski, W. P., 1994. Effect of danazol in vitro and in vivo on monocyte-mediated enhancement of endometrial cell proliferation in women with endometriosis*†. *Fertility and sterility*, 62(1), pp. 89-95.
- Bray, P. G., Janneh, O., Raynes, K. J., Mungthin, M., Ginsburg, H. and Ward, S. A., 1999. Cellular uptake of chloroquine is dependent on binding to ferriprotoporphyrin IX and is independent of NHE activity in *Plasmodium falciparum*. *The Journal of cell biology*, 145(2), pp. 363-376.
- Brinker, A., Scheufler, C., Von der Mülbe, F., Fleckenstein, B., Herrmann, C., Jung, G., Moarefi, I. and Hartl, F. U., 2002. Ligand discrimination by TPR domains relevance and selectivity of eevd-recognition in Hsp70· Hop· Hsp90 complexes. *Journal of Biological Chemistry*, 277(22), pp. 19265-19275.
- Brinkmann, V., Kaufmann, S., Simon, M. and Fischer, H., 1984. Role of macrophages in malaria: O2 metabolite production and phagocytosis by splenic macrophages during lethal *Plasmodium berghei* and self-limiting *Plasmodium yoelii* infection in mice. *Infection and immunity*, 44(3), pp. 743-746.
- Brocchieri, L., De Macario, E. C. and Macario, A. J., 2008. hsp70 genes in the human genome: Conservation and differentiation patterns predict a wide array of overlapping and specialized functions. *BMC evolutionary biology*, 8(1), pp. 19.
- Brown, R. B. and Audet, J., 2008. Current techniques for single-cell lysis. *Journal of the Royal Society Interface*, 5(Suppl 2), pp. S131-S138. (10.1098/rsif.2008.0009.focus).
- Bukau, B. and Horwich, A. L., 1998. The Hsp70 and Hsp60 chaperone machines. *Cell*, 92(3), pp. 351-366.
- Cabantous, S., Poudiougou, B., Oumar, A. A., Traore, A., Barry, A., Vitte, J., Bongrand, P., Marquet, S., Doumbo, O. and Dessein, A. J., 2009. Genetic evidence for the aggravation of *Plasmodium falciparum* malaria by interleukin 4. *Journal of Infectious Diseases*, 200(10), pp. 1530-1539.
- Campisi, J., Leem, T. H. and Fleshner, M., 2003. Stress-induced extracellular Hsp72 is a functionally significant danger signal to the immune system. *Cell stress & chaperones*, 8(3), pp. 272-286.
- Cao, E., Chen, Y., Cui, Z. and Foster, P. R., 2003. Effect of freezing and thawing rates on denaturation of proteins in aqueous solutions. *Biotechnology and bioengineering*, 82(6), pp. 684-690.
- Capsoni, F., Ongari, A., Minonzo, F., Lazzarin, A. and Zavattini, G., 1984. Effect of ambroxol on human phagocytic cell function. *Bollettino dell'Istituto sieroterapico milanese*, 64(3), pp. 236-239.
- Cartwright, J., Johnstone, A. and Whitley, G. S. J., 1997. Inhibition of nitric oxide synthase by antisense techniques: investigations of the roles of NO produced by murine macrophages. *British journal of pharmacology*, 120(1), pp. 146-152.
- Carvalho, P., Diez-Silva, M., Chen, H., Dao, M. and Suresh, S., 2013. Cytoadherence of erythrocytes invaded by *Plasmodium falciparum*: Quantitative contact-probing of a human malaria receptor. *Acta biomaterialia*, 9(5), pp. 6349-6359.
- Casali, N., 2003. *Escherichia coli* host strains. *E. coli Plasmid Vectors: Methods and Applications*, pp. 27-48.
- Chadd, H. E. and Chamow, S. M., 2001. Therapeutic antibody expression technology. *Current opinion in biotechnology*, 12(2), pp. 188-194.
- Chakrabarti, R., Rawat, P. S., Cooke, B. M., Coppel, R. L. and Patankar, S., 2013. Cellular effects of curcumin on *Plasmodium falciparum* include disruption of microtubules. *PloS one*, 8(3), pp. e57302. (<http://dx.doi.org/10.1371/journal.pone.0057302>).
- Chamberlain, L. H. and Burgoyne, R. D., 1997. Activation of the ATPase activity of heat-shock proteins Hsc70/Hsp70 by cysteine-string protein. *Biochemical Journal*, 322(3), pp. 853-858.
- Chang, L., Bertelsen, E. B., Wisén, S., Larsen, E. M., Zuiderweg, E. R. P. and Gestwicki, J. E., 2008. High-throughput screen for small molecules that modulate the ATPase activity of the molecular chaperone DnaK. *Analytical Biochemistry*, 372(2), pp. 167-176. (<http://dx.doi.org/10.1016/j.ab.2007.08.020>).
- Channon, J. and Leslie, C. C., 1990. A calcium-dependent mechanism for associating a soluble arachidonoyl-hydrolyzing phospholipase A2 with membrane in the macrophage cell line RAW 264.7. *Journal of Biological Chemistry*, 265(10), pp. 5409-5413.

- Chanput, W., Peters, V. and Wichers, H. (2015) 'THP-1 and U937 Cells', *The Impact of Food Bioactives on Health*: Springer, pp. 147-159.
- Chiliza, T. E. (2008) *Antibody phage-displayed libraries derived from chicken immunoglobulin genes: a source of highly specific diagnostic antibodies*. MSc, University of Pretoria.
- Chinappi, M., Via, A., Marcatili, P. and Tramontano, A., 2010. On the mechanism of chloroquine resistance in *Plasmodium falciparum*. *PloS one*, 5(11), pp. e14064. (<http://dx.doi.org/10.1371/journal.pone.0014064>).
- Cho, Y., Jang, Y. Y., Han, E. S. and Lee, C. S., 1999. The inhibitory effect of ambroxol on hypochlorous acid-induced tissue damage and respiratory burst of phagocytic cells. *European journal of pharmacology*, 383(1), pp. 83-91.
- Choi, J. H., Keum, K. C. and Lee, S. Y., 2006. Production of recombinant proteins by high cell density culture of *Escherichia coli*. *Chemical Engineering Science*, 61(3), pp. 876-885.
- Chu, W.-M., 2013. Tumor necrosis factor. *Cancer letters*, 328(2), pp. 222-225.
- Chua, C. L. L., Brown, G., Hamilton, J. A., Rogerson, S. and Boeuf, P., 2013. Monocytes and macrophages in malaria: protection or pathology? *Trends in parasitology*, 29(1), pp. 26-34.
- Chumanevich, A. A., Witalison, E. E., Chaparala, A., Chumanevich, A., Nagarkatti, P., Nagarkatti, M. and Hofseth, L. J., 2016. Repurposing the anti-malarial drug, quinacrine: new anti-colitis properties. *Oncotarget*, 7(33), pp. 52928-52939.
- Clark, I., Virelizier, J., Carswell, E. and Wood, P., 1981. Possible importance of macrophage-derived mediators in acute malaria. *Infection and immunity*, 32(3), pp. 1058-1066.
- Clark, I. A. and Cowden, W. B., 2003. The pathophysiology of falciparum malaria. *Pharmacology & Therapeutics*, 99(2), pp. 221-260. (10.1016/s0163-7258(03)00060-3).
- Clark, I. A., Rockett, K. A. and Burgner, D., 2003. Genes, nitric oxide and malaria in African children. *Trends in parasitology*, 19(8), pp. 335-337.
- Clerget, M. and Polla, B. S., 1990. Erythrophagocytosis induces heat shock protein synthesis by human monocytes-macrophages. *Proceedings of the National Academy of Sciences*, 87(3), pp. 1081-1085.
- Cooke, B., Coppel, R. and Wahlgren, M., 2000. Falciparum malaria: sticking up, standing out and outstanding. *Parasitology Today*, 16(10), pp. 416-420.
- Coronado, L. M., Nadovich, C. T. and Spadafora, C., 2014. Malarial hemozoin: from target to tool. *Biochimica et biophysica acta*, 1840(6), pp. 2032-2041. (10.1016/j.bbagen.2014.02.009).
- Couper, K. N., Blount, D. G. and Riley, E. M., 2008. IL-10: the master regulator of immunity to infection. *The Journal of Immunology*, 180(9), pp. 5771-5777.
- Cowman, A. F. and Crabb, B. S., 2006. Invasion of red blood cells by malaria parasites. *Cell*, 124(4), pp. 755-766.
- Cowman, A. F. and Lew, A. M., 1989. Antifolate drug selection results in duplication and rearrangement of chromosome 7 in *Plasmodium chabaudi*. *Molecular and cellular biology*, 9(11), pp. 5182-5188.
- Cox, F. E., 2010. History of the discovery of the malaria parasites and their vectors. *Parasites & vectors*, 3(1), pp. 1.
- Crespo-Ortiz, M. P. and Wei, M. Q., 2011. Antitumor activity of artemisinin and its derivatives: from a well-known antimalarial agent to a potential anticancer drug. *BioMed Research International*, 2012(10.1155/2012/247597).
- Cui, L., Mharakurwa, S., Ndiaye, D., Rathod, P. K. and Rosenthal, P. J., 2015. Antimalarial drug resistance: literature review and activities and findings of the ICEMR Network. *The American journal of tropical medicine and hygiene*, pp. 15-0007. (10.4269/ajtmh.15-0007).
- Cui, L., Miao, J. and Cui, L., 2007. Cytotoxic effect of curcumin on malaria parasite *Plasmodium falciparum*: inhibition of histone acetylation and generation of reactive oxygen species. *Antimicrobial agents and chemotherapy*, 51(2), pp. 488-494.
- Cumming, B. M. (2009) *Effect of antimalarial drugs and malaria pigment (β -haematin) on monocyte phagocytosis and GTP-cyclohydrolase 1 gene expression*. PhD Biochemistry, University of KwaZulu-Natal, South Africa (January 2017).
- Cumming, B. M., Watson, G. M. and Goldring, J. D., 2011. *Plasmodium falciparum*: effect of antimalarial drugs, malaria pigment (β -haematin) and *Plasmodium falciparum* lysate on monocyte GTP-cyclohydrolase 1 gene expression. *Experimental parasitology*, 129(3), pp. 312-317.

- Cunha-Rodrigues, M., Prudêncio, M., Mota, M. M. and Haas, W., 2006. Antimalarial drugs–host targets (re) visited. *Biotechnology journal*, 1(3), pp. 321-332.
- Cuzzocrea, S., Saadat, F., Di Paola, R. and Mirshafiey, A., 2005. Artemether: a new therapeutic strategy in experimental rheumatoid arthritis. *Immunopharmacology and immunotoxicology*, 27(4), pp. 615-630.
- Dale, D. C., Boxer, L. and Liles, W. C., 2008. The phagocytes: neutrophils and monocytes. *Blood*, 112(4), pp. 935-945.
- Damsgaard, C. T., Lauritzen, L., Calder, P. C., Kjær, T. M. and Frøkiær, H., 2009. Whole-blood culture is a valid low-cost method to measure monocytic cytokines—a comparison of cytokine production in cultures of human whole-blood, mononuclear cells and monocytes. *Journal of immunological methods*, 340(2), pp. 95-101.
- Das, K. C. and Misra, H. P., 1994. Impairment of raw 264.7 macrophage function by antiarrhythmic drugs. *Molecular and cellular biochemistry*, 132(2), pp. 151-162.
- Daugaard, M., Rohde, M. and Jaattela, M., 2007. The heat shock protein 70 family: Highly homologous proteins with overlapping and distinct functions. *FEBS Letters*, 581(19), pp. 3702-3710.(10.1016/j.febslet.2007.05.039).
- Davies, E. L., Smith, J. S., Birkett, C. R., Manser, J. M., Anderson-Dear, D. V. and Young, J. R., 1995. Selection of specific phage-display antibodies using libraries derived from chicken immunoglobulin genes. *Journal of immunological methods*, 186(1), pp. 125-135.
- De, A. K., Kodys, K. M., Yeh, B. S. and Miller-Graziano, C., 2000. Exaggerated human monocyte IL-10 concomitant to minimal TNF- α induction by heat-shock protein 27 (Hsp27) suggests Hsp27 is primarily an antiinflammatory stimulus. *The Journal of Immunology*, 165(7), pp. 3951-3958.
- de Billy, E., Powers, M. V., Smith, J. R. and Workman, P., 2009. Drugging the heat shock factor 1 pathway: exploitation of the critical cancer cell dependence on the guardian of the proteome. *Cell Cycle*, 8(23), pp. 3806-3808.
- De Vries, P. J. and Dien, T. K., 1996. Clinical pharmacology and therapeutic potential of artemisinin and its derivatives in the treatment of malaria. *Drugs*, 52(6), pp. 818-836.
- Deimann, W., 1984. Endogenous Peroxidase Activity in Mononuclear Phagocytes. *Progress in Histochemistry and Cytochemistry*, 15(2), pp. III-56.([http://dx.doi.org/10.1016/S0079-6336\(84\)80003-0](http://dx.doi.org/10.1016/S0079-6336(84)80003-0)).
- Delves, M., Plouffe, D., Scheurer, C., Meister, S., Wittlin, S., Winzeler, E. A., Sinden, R. E. and Leroy, D., 2012. The activities of current antimalarial drugs on the life cycle stages of Plasmodium: a comparative study with human and rodent parasites. *PLoS Medicine*, 9(2), pp. e1001169.(<http://dx.doi.org/10.1371/journal.pmed.1001169>).
- Dende, C., Meena, J., Nagarajan, P., Panda, A. K., Rangarajan, P. N. and Padmanaban, G., 2015. Simultaneously targeting inflammatory response and parasite sequestration in brain to treat Experimental Cerebral Malaria. *Scientific reports*, 5
- Deshpande, P. and Shastry, P., 2004. Modulation of cytokine profiles by malaria pigment--hemozoin: role of IL-10 in suppression of proliferative responses of mitogen stimulated human PBMC. *Cytokine*, 28(6), pp. 205-213. Available at: <http://www.ncbi.nlm.nih.gov/pubmed/15566949>
- Dey, S. and Bishayi, B., 2015. Killing of Staphylococcus aureus in murine macrophages by chloroquine used alone and in combination with ciprofloxacin or azithromycin. *Journal of inflammation research*, 8, pp. 29-47.
- Dinarelo, C. A., 1991. Interleukin-1 and interleukin-1 antagonism. *Blood*, 77(8), pp. 1627-1652.
- Ding, X. Z., Fernandez-Prada, C. M., Bhattacharjee, A. K. and Hoover, D. L., 2001. Over-expression of hsp-70 inhibits bacterial lipopolysaccharide-induced production of cytokines in human monocyte-derived macrophages. *Cytokine*, 16(6), pp. 210-219.
- do Rosario, A. P. F. and Langhorne, J., 2012. T cell-derived IL-10 and its impact on the regulation of host responses during malaria. *International journal for parasitology*, 42(6), pp. 549-555.
- Dores-Silva, P. R., Barbosa, L. R., Ramos, C. H. and Borges, J. C., 2015. Human mitochondrial Hsp70 (mortalin): shedding light on ATPase activity, interaction with adenosine nucleotides, solution structure and domain organization. *PloS one*, 10(1), pp. e0117170.(<http://dx.doi.org/10.1371/journal.pone.0117170>).
- Dunsmore, K. E., Chen, P. G. and Wong, H. R., 2001. Curcumin, a medicinal herbal compound capable of inducing the heat shock response. *Critical care medicine*, 29(11), pp. 2199-2204.

- Eckhoff, P. A., 2011. A malaria transmission-directed model of mosquito life cycle and ecology. *Malaria Journal*, 10(1), pp. 1.
- Egan, T. J., Hempelmann, E. and Mavuso, W. W., 1999. Characterisation of synthetic β -haematin and effects of the antimalarial drugs quinidine, halofantrine, desbutylhalofantrine and mefloquine on its formation. *Journal of inorganic biochemistry*, 73(1), pp. 101-107.
- Egan, T. J., Ross, D. C. and Adams, P. A., 1994. Quinoline anti-malarial drugs inhibit spontaneous formation of β -haematin (malaria pigment). *FEBS letters*, 352(1), pp. 54-57.
- Ehsanian, R., Van Waes, C. and Feller, S. M., 2011. Beyond DNA binding-a review of the potential mechanisms mediating quinacrine's therapeutic activities in parasitic infections, inflammation, and cancers. *Cell Communication and Signaling*, 9(1), pp. 1.(10.1186/1478-811X-9-13).
- Eisenhut, M., 2010. The role of interleukin-4 in the immune response to Plasmodium falciparum. *Parasite immunology*, 32(6), pp. 470-471.
- Elhussein, A. B., Huneif, M. A., Naeem, A., Fadlelseed, O. E., Babiker, W. G., Rahma, N. E. A., Ahmed, S. A., Ayed, I. A. and Shalayel, M. H., 2015. Correlation of interleukin-4 levels with Plasmodium falciparum malaria parasitaemia in Sudanese children. *Acta Clinica Belgica*, 70(6), pp. 414-418.
- Elinder, L. S., Hådel, K., Johansson, J., Mølgaard, J., Holme, I., Olsson, A. G. and Walldius, G., 1995. Probucol treatment decreases serum concentrations of diet-derived antioxidants. *Arteriosclerosis, thrombosis, and vascular biology*, 15(8), pp. 1057-1063.
- Eriksson, A., Österroos, A., Hassan, S., Gullbo, J., Rickardson, L., Jarvius, M., Nygren, P., Fryknäs, M., Höglund, M. and Larsson, R., 2015. Drug screen in patient cells suggests quinacrine to be repositioned for treatment of acute myeloid leukemia. *Blood cancer journal*, 5(4), pp. e307.(<http://dx.doi.org/10.1371/journal.pone.0051692>).
- Facer, C. A., 1995. Malaria antigens stimulate neopterin secretion by PBMC and U937 cells. *Microbiology and immunology*, 39(3), pp. 207-211.
- Fan, C.-Y., Lee, S. and Cyr, D. M., 2003. Mechanisms for regulation of Hsp70 function by Hsp40. *Cell stress & chaperones*, 8(4), pp. 309-316.
- Farsam, V., Hassan, Z. M., Zavaran-Hosseini, A., Noori, S., Mahdavi, M. and Ranjbar, M., 2011. Antitumor and immunomodulatory properties of artemether and its ability to reduce CD4+ CD25+ FoxP3+ T reg cells in vivo. *International immunopharmacology*, 11(11), pp. 1802-1808.
- Ferat-Osorio, E., Sánchez-Anaya, A., Gutiérrez-Mendoza, M., Boscó-Gárate, I., Wong-Baeza, I., Pastelin-Palacios, R., Pedraza-Alva, G., Bonifaz, L. C., Cortés-Reynosa, P. and Pérez-Salazar, E., 2014. Heat shock protein 70 down-regulates the production of toll-like receptor-induced pro-inflammatory cytokines by a heat shock factor-1/constitutive heat shock element-binding factor-dependent mechanism. *Journal of Inflammation*, 11(1), pp. 1.
- Fernando, D., Rodrigo, C. and Rajapakse, S., 2011. Primaquine in vivax malaria: an update and review on management issues. *Malaria journal*, 10(1), pp. 1.(10.1186/1475-2875-10-351).
- Fidock, D. A., Nomura, T., Talley, A. K., Cooper, R. A., Dzekunov, S. M., Ferdig, M. T., Ursos, L. M., Naudé, B., Deitsch, K. W. and Su, X.-z., 2000. Mutations in the P. falciparum digestive vacuole transmembrane protein PfCRT and evidence for their role in chloroquine resistance. *Molecular cell*, 6(4), pp. 861-871.
- Foey, A. D., Parry, S. L., Williams, L. M., Feldmann, M., Foxwell, B. M. and Brennan, F. M., 1998. Regulation of monocyte IL-10 synthesis by endogenous IL-1 and TNF- α : role of the p38 and p42/44 mitogen-activated protein kinases. *The Journal of Immunology*, 160(2), pp. 920-928.
- Fouchaq, B., Benaroudj, N., Ebel, C. and Ladjimi, M. M., 1999. Oligomerization of the 17-kDa peptide-binding domain of the molecular chaperone HSC70. *European Journal of Biochemistry*, 259(1- 2), pp. 379-384.
- Fu, H., Li, G., Liu, C., Li, J., Wang, X., Cheng, L. and Liu, T., 2015. Probucol Prevents Atrial Remodeling by Inhibiting Oxidative Stress and TNF- α /NF- κ B/TGF- β Signal Transduction Pathway in Alloxan-Induced Diabetic Rabbits. *Journal of cardiovascular electrophysiology*, 26(2), pp. 211-222.
- Fujimoto, J., Hori, M., Itoh, T., Ichigo, S., Nishigaki, M. and Tamaya, T., 1995. Danazol decreases transcription of estrogen receptor gene in human monocytes. *General Pharmacology: The Vascular System*, 26(3), pp. 507-516.
- Fukuda, M., Ikegami, H., Kawaguchi, Y., Sano, T. and Ogihara, T., 1995. Antioxidant, Probucol, Can Inhibit the Generation of Hydrogen-Peroxide in Islet Cells Induced by Macrophages and Prevent Islet Cell Destruction in NOD Mice. *Biochemical and biophysical research communications*, 209(3), pp. 953-958.

- Gabai, V. L., Meriin, A. B., Mosser, D. D., Caron, A., Rits, S., Shifrin, V. I. and Sherman, M. Y., 1997. Hsp70 prevents activation of stress Kinases a novel pathway of cellular thermotolerance. *Journal of biological chemistry*, 272(29), pp. 18033-18037.
- Ganesan, S., Chaurasiya, N. D., Sahu, R., Walker, L. A. and Tekwani, B. L., 2012. Understanding the mechanisms for metabolism-linked hemolytic toxicity of primaquine against glucose 6-phosphate dehydrogenase deficient human erythrocytes: evaluation of eryptotic pathway. *Toxicology*, 294(1), pp. 54-60.
- Gao, X., Kuo, J., Jiang, H., Deeb, D., Liu, Y., Divine, G., Chapman, R. A., Dulchavsky, S. A. and Gautam, S. C., 2004. Immunomodulatory activity of curcumin: suppression of lymphocyte proliferation, development of cell-mediated cytotoxicity, and cytokine production in vitro. *Biochemical pharmacology*, 68(1), pp. 51-61.
- Garcia, C. R., Markus, R. P. and Madeira, L., 2001. Tertian and quartan fevers: temporal regulation in malarial infection. *Journal of biological rhythms*, 16(5), pp. 436-443.
- Garlanda, C., Dinarello, C. A. and Mantovani, A., 2013. The interleukin-1 family: back to the future. *Immunity*, 39(6), pp. 1003-1018.
- Gassmann, M., Thömmes, P., Weiser, T. and Hübscher, U., 1990. Efficient production of chicken egg yolk antibodies against a conserved mammalian protein. *The FASEB Journal*, 4(8), pp. 2528-2532.
- Geladopoulos, T. P., Sotiroudis, T. G. and Evangelopoulos, A. E., 1991. A malachite green colorimetric assay for protein phosphatase activity. *Analytical biochemistry*, 192(1), pp. 112-116.
- Gibbs, B., Schmutzler, W., Vollrath, I., Brosthardt, P., Braam, U., Wolff, H. and Zwadlo-Klarwasser, G., 1999. Ambroxol inhibits the release of histamine, leukotrienes and cytokines from human leukocytes and mast cells. *Inflammation Research*, 48(2), pp. 86-93.
- Gidalevitz, T., Stevens, F. and Argon, Y., 2013. Orchestration of secretory protein folding by ER chaperones. *Biochimica et Biophysica Acta (BBA)-Molecular Cell Research*, 1833(11), pp. 2410-2424.
- Gillissen, A. and Nowak, D., 1998. Characterization of N-acetylcysteine and ambroxol in anti-oxidant therapy. *Respiratory medicine*, 92(4), pp. 609-623.
- Gilson, P. R., Chisholm, S. A., Crabb, B. S. and de Koning-Ward, T. F., 2016. Host cell remodelling in malaria parasites: a new pool of potential drug targets. *International Journal for Parasitology*, (<http://dx.doi.org/10.1016/j.ijpara.2016.06.001>).
- Jimenez, F., de Lagerie, S. B., Fernandez, C., Pino, P. and Mazier, D., 2003. Tumor necrosis factor α in the pathogenesis of cerebral malaria. *Cellular and Molecular Life Sciences CMLS*, 60(8), pp. 1623-1635.
- Giribaldi, G., Prato, M., Ulliers, D., Gallo, V., Schwarzer, E., Akide-Ndunge, O. B., Valente, E., Saviozzi, S., Calogero, R. A. and Arese, P., 2010. Involvement of inflammatory chemokines in survival of human monocytes fed with malarial pigment. *Infection and immunity*, 78(11), pp. 4912-4921.(10.1128/IAI.00455-10).
- Giribaldi, G., Valente, E., Khadjavi, A., Polimeni, M. and Prato, M., 2011. Macrophage Inflammatory Protein-1 α mediates Matrix Metalloproteinase-9 enhancement in human adherent monocytes fed with malarial pigment. *Asian Pacific journal of tropical medicine*, 4(12), pp. 925-930.
- Goldberg, D. E., Slater, A., Cerami, A. and Henderson, G. B., 1990. Hemoglobin degradation in the malaria parasite Plasmodium falciparum: an ordered process in a unique organelle. *Proceedings of the National Academy of Sciences*, 87(8), pp. 2931-2935.
- Goldring, J. and Coetzer, T. H., 2003. Isolation of chicken immunoglobulins (IgY) from egg yolk. *Biochemistry and Molecular Biology Education*, 31(3), pp. 185-187.
- Goldring, J., Padayachee, T. and Ismail, I., 1999. Plasmodium falciparum malaria: rosettes are disrupted by quinine, artemisinin, mefloquine, primaquine, pyrimethamine, chloroquine and proguanil. *Memórias do Instituto Oswaldo Cruz*, 94(5), pp. 667-674.
- Goldring, J. and Ramoshebi, L., 1999. Glucocorticoids, antioxidants and staurosporine modulate the adherence between monocytes and malaria infected erythrocytes. *Inflammation Research*, 48(12), pp. 657-661.
- Goldring, J. D., 2015a. Methods to Concentrate Proteins for Protein Isolation, Proteomic, and Peptidomic Evaluation. *Detection of Blotted Proteins: Methods and Protocols*, pp. 5-18.
- Goldring, J. D., 2015b. Spectrophotometric methods to determine protein concentration. *Western Blotting: Methods and Protocols*, pp. 41-47.

- Goldring, J. D. and Nemaorani, S., 1999. Antimalarial drugs modulate the expression of monocyte receptors. *International journal of immunopharmacology*, 21(9), pp. 599-607.
- Goldring, J. D., Thobakgale, C., Hiltunen, T. and Coetzer, T. H., 2005. Raising antibodies in chickens against primaquine, pyrimethamine, dapson, tetracycline, and doxycycline. *Immunological investigations*, 34(1), pp. 101-114.
- Gómez-Icazbalceta, G., González-Sánchez, I., Moreno, J., Cerbón, M. A. and Cervantes, A., 2013. In vitro drug metabolism testing using blood-monocyte derivatives. *Expert opinion on drug metabolism & toxicology*, 9(12), pp. 1571-1580.
- Gordon, S. and Mantovani, A., 2011. Diversity and plasticity of mononuclear phagocytes. *European journal of immunology*, 41(9), pp. 2470-2472.
- Gordon, S. and Taylor, P. R., 2005. Monocyte and macrophage heterogeneity. *Nature Reviews Immunology*, 5(12), pp. 953-964.(10.1038/nri1733).
- Gramaglia, I., Sobolewski, P., Meays, D., Contreras, R., Nolan, J. P., Frangos, J. A., Intaglietta, M. and Van Der Heyde, H. C., 2006. Low nitric oxide bioavailability contributes to the genesis of experimental cerebral malaria. *Nature medicine*, 12(12), pp. 1417-1422.
- Gravenor, M. and Kwiatkowski, D., 1998. An analysis of the temperature effects of fever on the intra-host population dynamics of Plasmodium falciparum. *Parasitology*, 117(02), pp. 97-105.
- Gray, P. and Goeddel, D., 1982. Structure of the human immune interferon gene. *Nature*, 298(5877), pp. 859-863.
- Greenwood, B. M., Fidock, D. A., Kyle, D. E., Kappe, S. H., Alonso, P. L., Collins, F. H. and Duffy, P. E., 2008. Malaria: progress, perils, and prospects for eradication. *The Journal of clinical investigation*, 118(4), pp. 1266-1276.
- Greer, S., Honeywell, R., Geletu, M., Arulanandam, R. and Raptis, L., 2010. Housekeeping genes; expression levels may change with density of cultured cells. *Journal of immunological methods*, 355(1), pp. 76-79.
- Griffiths, A. D. and Duncan, A. R., 1998. Strategies for selection of antibodies by phage display. *Current opinion in biotechnology*, 9(1), pp. 102-108.
- Gumede, B., Waako, P., Folb, P. and Ryffel, B., 2009. Modulation of IFN- γ , TNF- α , IL-10 and IL-12 production by Artesunate in mitogen treated splenocytes. *International Journal of Tropical Medicine*, 4(2), pp. 65-69.
- Guo, Y.-S., Wang, C.-X., Cao, J., Gao, J.-L., Zou, X., Ren, Y.-H. and Fan, L., 2015. Antioxidant and lipid-regulating effects of probucol combined with atorvastatin in patients with acute coronary syndrome. *Journal of thoracic disease*, 7(3), pp. 368-375.
- Gutierrez, J. A. and Guerriero, V., 1991. Quantitation of Hsp70 in tissues using a competitive enzyme-linked immunosorbent assay. *Journal of immunological methods*, 143(1), pp. 81-88.
- Hageman, J. and Kampinga, H. H., 2009. Computational analysis of the human HSPH/HSPA/DNAJ family and cloning of a human HSPH/HSPA/DNAJ expression library. *Cell Stress and Chaperones*, 14(1), pp. 1-21.
- Hansen, R., Oesterreich, S., Lemieux, P., Sarge, K. and Fuqua, S., 1997. Quercetin inhibits heat shock protein induction but not heat shock factor DNA-binding in human breast carcinoma cells. *Biochemical and biophysical research communications*, 239(3), pp. 851-856.
- Harris, P. and Ralph, P., 1985. Human leukemic models of myelomonocytic development: a review of the HL-60 and U937 cell lines. *Journal of leukocyte biology*, 37(4), pp. 407-422.
- Hau, J. and Hendriksen, C. F., 2005. Refinement of polyclonal antibody production by combining oral immunization of chickens with harvest of antibodies from the egg yolk. *ILAR journal*, 46(3), pp. 294-299.
- Hawkins, R. E., Russell, S. J. and Winter, G., 1992. Selection of phage antibodies by binding affinity: mimicking affinity maturation. *Journal of molecular biology*, 226(3), pp. 889-896.
- Heddini, A., 2002. Malaria pathogenesis: a jigsaw with an increasing number of pieces. *International journal for parasitology*, 32(13), pp. 1587-1598.
- Hellgren, U., Ericsson, O., AdenAbdi, Y. and Gustafsson, L. L. (1995) *Handbook of drugs for tropical parasitic infections*. CRC Press.
- Hengen, P. N., 1995. Purification of His-Tag fusion proteins from Escherichia coli. *Trends in biochemical sciences*, 20(7), pp. 285-286.

- Herbas, M. S., Okazaki, M., Terao, E., Xuan, X., Arai, H. and Suzuki, H., 2010. α -Tocopherol transfer protein inhibition is effective in the prevention of cerebral malaria in mice. *The American journal of clinical nutrition*, 91(1), pp. 200-207.
- Herbas, M. S., Shichiri, M., Ishida, N., Kume, A., Hagihara, Y., Yoshida, Y. and Suzuki, H., 2015. ProbucoL-Induced α -Tocopherol Deficiency Protects Mice against Malaria Infection. *PLoS one*, 10(8), pp. e0136014. (<http://dx.doi.org/10.1371/journal.pone.0136014>).
- Hill, D. L., Eriksson, E. M., Carmagnac, A. B., Wilson, D. W., Cowman, A. F., Hansen, D. S. and Schofield, L., 2012. Efficient measurement of opsonising antibodies to Plasmodium falciparum merozoites. *PLoS One*, 7(12), pp. e51692. (<http://dx.doi.org/10.1371/journal.pone.0051692>).
- Hill, J. A., Barbieri, R. L. and Anderson, D. J., 1987. Immunosuppressive effects of danazol in vitro. *Fertility and sterility*, 48(3), pp. 414-418.
- Hirako, I. C., Ataide, M. A., Faustino, L., Assis, P. A., Sorensen, E. W., Ueta, H., Araújo, N. M., Menezes, G. B., Luster, A. D. and Gazzinelli, R. T., 2016. Splenic differentiation and emergence of CCR5+ CXCL9+ CXCL10+ monocyte-derived dendritic cells in the brain during cerebral malaria. *Nature Communications*, 7(10.1038/ncomms13277).
- Hirako, I. C., Gallego-Marin, C., Ataide, M. A., Andrade, W. A., Gravina, H., Rocha, B. C., de Oliveira, R. B., Pereira, D. B., Vinetz, J. and Diamond, B., 2015. DNA-Containing Immunocomplexes Promote Inflammation Assembly and Release of Pyrogenic Cytokines by CD14+ CD16+ CD64high CD32low Inflammatory Monocytes from Malaria Patients. *MBio*, 6(6), pp. e01605-15. (10.1128/mBio.01605-15).
- Hodek, P., Trefil, P., Simunek, J., Hudecek, J. and Stiborova, M., 2013. Optimized protocol of chicken antibody (IgY) purification providing electrophoretically homogenous preparations. *International Journal of Electrochemical Science*, 5, pp. 113-124.
- Hoogenboom, H. R., de Bruine, A. P., Hufton, S. E., Hoet, R. M., Arends, J.-W. and Roovers, R. C., 1998. Antibody phage display technology and its applications. *Immunotechnology*, 4(1), pp. 1-20.
- Hoppe, H. C., van Schalkwyk, D. A., Wiehart, U. I., Meredith, S. A., Egan, J. and Weber, B. W., 2004. Antimalarial quinolines and artemisinin inhibit endocytosis in Plasmodium falciparum. *Antimicrobial agents and chemotherapy*, 48(7), pp. 2370-2378.
- Hou, L.-F., He, S.-J., Li, X., Wan, C.-P., Yang, Y., Zhang, X.-H., He, P.-L., Zhou, Y., Zhu, F.-H. and Yang, Y.-F., 2012. Sm934 treated lupus-prone NZBx NZW F 1 mice by enhancing macrophage interleukin-10 production and suppressing pathogenic T cell development. *PLoS One*, 7(2), pp. e32424. (10.1371/journal.pone.0032424).
- Hou, L. and Huang, H., 2016. Immune suppressive properties of artemisinin family drugs. *Pharmacology & Therapeutics*, 166, pp. 123-127.
- Hrabák, A., Sefrioui, H., Verduyck, V., Temesi, Á., Bajor, T. and Vray, B., 1998. Action of chloroquine on nitric oxide production and parasite killing by macrophages. *European journal of pharmacology*, 354(1), pp. 83-90.
- Hualin, C., Wenli, X., Dapeng, L., Xijing, L., Xiuhua, P. and Qingfeng, P., 2012. The anti-inflammatory mechanism of heme oxygenase-1 induced by hemin in primary rat alveolar macrophages. *Inflammation*, 35(3), pp. 1087-1093.
- Huang, H., Lamikanra, A. A., Alkaitis, M. S., Thézénas, M. L., Ramaprasad, A., Moussa, E., Roberts, D. J. and Casals-Pascual, C., 2014. Interleukin-10 regulates hepcidin in Plasmodium falciparum malaria. *PLoS one*, 9(2), pp. e88408.
- Hume, D. A., 2006. The mononuclear phagocyte system. *Current opinion in immunology*, 18(1), pp. 49-53.
- Hunt, N. H. and Grau, G. E., 2003. Cytokines: accelerators and brakes in the pathogenesis of cerebral malaria. *Trends in immunology*, 24(9), pp. 491-499.
- Hunter, C. A. and Jones, S. A., 2015. IL-6 as a keystone cytokine in health and disease. *Nature immunology*, 16(5), pp. 448-457.
- Ihekwereme, C. P., Esimone, C. O. and Nwanegbo, E. C., 2014. Hemozoin Inhibition and Control of Clinical Malaria. *Advances in pharmacological sciences*, 2014 (<http://dx.doi.org/10.1155/2014/984150>).
- Ishikawa, S., Uozumi, N., Shiibashi, T., Izumi, T., Fukayama, M., Shimizu, T., Watanabe, J. and Nogami, S., 2004. Short report: Lethal malaria in cytosolic phospholipase A2-and phospholipase A2IIA-deficient mice. *The American journal of tropical medicine and hygiene*, 70(6), pp. 645-650.
- Jäättelä, M., 1999. Heat shock proteins as cellular lifeguards. *Annals of medicine*, 31(4), pp. 261-271.
- Jäättelä, M. and Wissing, D., 1993. Heat-shock proteins protect cells from monocyte cytotoxicity: possible mechanism of self-protection. *The Journal of experimental medicine*, 177(1), pp. 231-236.

- Jain, K., Sood, S. and Gowthamarajan, K., 2013. Modulation of cerebral malaria by curcumin as an adjunctive therapy. *The Brazilian Journal of Infectious Diseases*, 17(5), pp. 579-591.
- James, S. L., 1995. Role of nitric oxide in parasitic infections. *Microbiological Reviews*, 59(4), pp. 533-547.
- Jančinová, V. and Danihelová, E., 2000. Chloroquine: a multipotent inhibitor of human platelets in vitro. *Thrombosis research*, 98(5), pp. 411-421.
- Jang, C.-H., Choi, J.-H., Byun, M.-S. and Jue, D.-M., 2006. Chloroquine inhibits production of TNF- α , IL-1 β and IL-6 from lipopolysaccharide-stimulated human monocytes/macrophages by different modes. *Rheumatology*, 45(6), pp. 703-710.
- Jang, Y. Y., Song, J. H., Shin, Y. K., Han, E. S. and Lee, C. S., 2003. Depressant effects of ambroxol and erdosteine on cytokine synthesis, granule enzyme release, and free radical production in rat alveolar macrophages activated by lipopolysaccharide. *Pharmacology & toxicology*, 92(4), pp. 173-179.
- Jani, T. S., DeVecchio, J., Mazumdar, T., Agyeman, A. and Houghton, J. A., 2010. Inhibition of NF- κ B signaling by quinacrine is cytotoxic to human colon carcinoma cell lines and is synergistic in combination with tumor necrosis factor-related apoptosis-inducing ligand (TRAIL) or oxaliplatin. *Journal of Biological Chemistry*, 285(25), pp. 19162-19172.
- Jaramillo, M., Bellemare, M.-J., Martel, C., Shio, M. T., Contreras, A. P., Godbout, M., Roger, M., Gaudreault, E., Gosselin, J. and Bohle, D. S., 2009. Synthetic Plasmodium-like hemozoin activates the immune response: a morphology-function study. *PloS one*, 4(9), pp. e6957. (<http://dx.doi.org/10.1371/journal.pone.0006957>).
- Jason, J., Archibald, L. K., Nwanyanwu, O. C., Bell, M., Buchanan, I., Larned, J., Kazembe, P. N., Dobbie, H., Parekh, B. and Byrd, M. G., 2001. Cytokines and malaria parasitemia. *Clinical Immunology*, 100(2), pp. 208-218.
- Jindal, S., Murray, P., Rosenberg, S., Young, R. A. and Williams, K. P., 1995. Human Stress Protein hsp70: Overexpression in *E. coli*, Purification and Characterization. *Nature Biotechnology*, 13(10), pp. 1105-1109. Available at: <http://dx.doi.org/10.1038/nbt1095-1105>
- Jobin, C., Bradham, C. A., Russo, M. P., Juma, B., Narula, A. S., Brenner, D. A. and Sartor, R. B., 1999. Curcumin blocks cytokine-mediated NF- κ B activation and proinflammatory gene expression by inhibiting inhibitory factor I- κ B kinase activity. *The Journal of Immunology*, 163(6), pp. 3474-3483.
- Julie, S. and Jurenka, M., 2009. Anti-inflammatory properties of curcumin, a major constituent. *Alternative medicine review*, 14(2), pp. 141-153.
- Kalliolias, G. D. and Ivashkiv, L. B., 2016. TNF biology, pathogenic mechanisms and emerging therapeutic strategies. *Nature Reviews Rheumatology*, 12(1), pp. 49-62.
- Kampinga, H. H., Hageman, J., Vos, M. J., Kubota, H., Tanguay, R. M., Bruford, E. A., Cheetham, M. E., Chen, B. and Hightower, L. E., 2009. Guidelines for the nomenclature of the human heat shock proteins. *Cell Stress and Chaperones*, 14(1), pp. 105-111.
- Kanitkar, M., Gokhale, K., Galande, S. and Bhonde, R., 2008. Novel role of curcumin in the prevention of cytokine-induced islet death in vitro and diabetogenesis in vivo. *British journal of pharmacology*, 155(5), pp. 702-713.
- Karunaweera, N. D., Grau, G. E., Gamage, P., Carter, R. and Mendis, K. N., 1992. Dynamics of fever and serum levels of tumor necrosis factor are closely associated during clinical paroxysms in *Plasmodium vivax* malaria. *Proceedings of the National Academy of Sciences*, 89(8), pp. 3200-3203.
- Kaul, S. C., Deocaris, C. C. and Wadhwa, R., 2007. Three faces of mortalin: a housekeeper, guardian and killer. *Experimental gerontology*, 42(4), pp. 263-274.
- Kempaiah, P., Dokladny, K., Karim, Z., Raballah, E., Ong'echa, J. M., Moseley, P. L. and Perkins, D. J., 2016. Reduced Hsp70 and Glutamine in Pediatric Severe Malaria Anemia: Role of Hemozoin in Suppressing Hsp70 and NF- κ B Activation. *Molecular Medicine*, 22, pp. 570-584.
- Kern, P., Hemmer, C. J., Van Damme, J., Gruss, H.-J. and Dietrich, M., 1989. Elevated tumor necrosis factor alpha and interleukin-6 serum levels as markers for complicated *Plasmodium falciparum* malaria. *The American journal of medicine*, 87(2), pp. 139-143.
- Keswani, T., Sarkar, S., Sengupta, A. and Bhattacharyya, A., 2016. Role of TGF- β and IL-6 in dendritic cells, Treg and Th17 mediated immune response during experimental cerebral malaria. *Cytokine*, 88, pp. 154-166.
- Khan, K. H., 2013. Gene Expression in Mammalian Cells and its Applications. *Advanced Pharmaceutical Bulletin*, 3(2), pp. 257-263.(10.5681/apb.2013.042).

- Khanh, N. X., de Vries, P. J., van Boxtel, C. J., Koopmans, R. and Kager, P. A., 1999. Declining concentrations of dihydroartemisinin in plasma during 5-day oral treatment with artesunate for falciparum malaria. *Antimicrobial agents and chemotherapy*, 43(3), pp. 690-692.
- Kiang, J. G. and Tsokos, G. C., 1998. Heat Shock Protein 70 kDa: Molecular Biology, Biochemistry, and Physiology. *Pharmacology & Therapeutics*, 80(2), pp. 183-201. ([http://dx.doi.org/10.1016/S0163-7258\(98\)00028-X](http://dx.doi.org/10.1016/S0163-7258(98)00028-X)).
- Kim, D., Lee, Y. J. and Corry, P. M., 1992. Constitutive HSP70: Oligomerization and its dependence on ATP binding. *Journal of Cellular Physiology*, 153(2), pp. 353-361. (10.1002/jcp.1041530215).
- Kim, H. D., Kang, H. S., Rimbach, G. and Park, Y. C., 1999. Heat shock and 5-azacytidine inhibit nitric oxide synthesis and tumor necrosis factor- α secretion in activated macrophages. *Antioxidants & redox signaling*, 1(3), pp. 297-304.
- Kim, H. P., Morse, D. and Choi, A. M., 2006. Heat-shock proteins: new keys to the development of cytoprotective therapies. *Expert opinion on therapeutic targets*, 10(5), pp. 759-769.
- Kimura, T., Shirakawa, R., Yaoita, N., Hayashi, T., Nagano, K. and Horiuchi, H., 2014. The antimalarial drugs chloroquine and primaquine inhibit pyridoxal kinase, an essential enzyme for vitamin B6 production. *FEBS letters*, 588(20), pp. 3673-3676.
- King, T. and Lamb, T., 2015. Interferon- γ : the Jekyll and Hyde of malaria. *PLoS Pathogens*, 11(10), pp. e1005118.
- Kinra, P. and Dutta, V., 2013. Serum TNF alpha levels: a prognostic marker for assessment of severity of malaria. *Tropical Biomedicine*, 30(4), pp. 645-653.
- Koch, C., Jensen, S., Øster, A. and Houen, G., 1996. A comparison of the immunogenicity of the native and denatured forms of a protein. *Apmis*, 104(1- 6), pp. 115-125.
- Konkimalla, V. B., Blunder, M., Korn, B., Soomro, S. A., Jansen, H., Chang, W., Posner, G. H., Bauer, R. and Efferth, T., 2008. Effect of artemisinins and other endoperoxides on nitric oxide-related signaling pathway in RAW 264.7 mouse macrophage cells. *Nitric Oxide*, 19(2), pp. 184-191.
- Konthur, Z. and Walter, G., 2002. Automation of phage display for high-throughput antibody development. *Targets*, 1(1), pp. 30-36.
- Korner, H., McMorran, B., Schluter, D. and Fromm, P., 2010. The role of TNF in parasitic diseases: still more questions than answers. *International Journal for Parasitology*, 40(8), pp. 879-88. (10.1016/j.ijpara.2010.03.011).
- Krause, R. G., Grobler, A. F. and Goldring, J. D., 2015. Comparing Antibody Responses in Chickens Against Plasmodium falciparum Lactate Dehydrogenase and Glyceraldehyde-3-phosphate Dehydrogenase with Freund's and Pheroid® Adjuvants. *Immunological investigations*, 44(7), pp. 627-642.
- Kregel, K. C., 2002. Invited review: heat shock proteins: modifying factors in physiological stress responses and acquired thermotolerance. *Journal of applied physiology*, 92(5), pp. 2177-2186.
- Krief, A., Letesson, J.-J. and Billen, D., 2002. Comparison between 'IgY technology' from chickens and 'IgG technology' from mice for production of tailor-made antibodies. *Tetrahedron Letters*, 43(10), pp. 1843-1846. ([http://dx.doi.org/10.1016/S0040-4039\(02\)00142-9](http://dx.doi.org/10.1016/S0040-4039(02)00142-9)).
- Krogstad, D. J. and Schlesinger, P. H., 1986. A perspective on antimalarial action: effects of weak bases on Plasmodium falciparum. *Biochemical pharmacology*, 35(4), pp. 547-552.
- Kuba, H. and Furukawa, K., 2009. An optimized procedure for efficient phage display of antibody fragments with a low folding efficiency. *Protein expression and purification*, 65(2), pp. 148-153.
- Kumar, S., Stokes, J., Singh, U. P., Gunn, K. S., Acharya, A., Manne, U. and Mishra, M., 2016. Targeting Hsp70: A possible therapy for cancer. *Cancer letters*, 374(1), pp. 156-166.
- Kumaratilake, L. M. and Ferrante, A., 2000. Opsonization and phagocytosis of Plasmodium falciparum merozoites measured by flow cytometry. *Clinical and diagnostic laboratory immunology*, 7(1), pp. 9-13.
- Kume, A., Anh, D. T. M., Shichiri, M., Ishida, N. and Suzuki, H., 2016. Probucol dramatically enhances dihydroartemisinin effect in murine malaria. *Malaria Journal*, 15(1), pp. 472. (10.1186/s12936-016-1532-y).
- Kunwittaya, S., Treeratanapiboon, L., Srisarin, A., Isarankura-Na-Ayudhya, C. and Prachayasittikul, V., 2014. In vitro study of parasite elimination and endothelial protection by curcumin: adjunctive therapy for cerebral malaria. *EXCLI journal*, 13, pp. 287.
- Kwiatkowski, D., 1989. Febrile temperatures can synchronize the growth of Plasmodium falciparum in vitro. *The Journal of experimental medicine*, 169(1), pp. 357-361.

- Kwiatkowski, D. and Bate, C., 1995. Inhibition of tumour necrosis factor (TNF) production by antimalarial drugs used in cerebral malaria. *Transactions of the Royal Society of Tropical Medicine and Hygiene*, 89(2), pp. 215-216.
- Kwiatkowski, D., Cannon, J. G., Manogue, K., Cerami, A., Dinarello, C. and Greenwood, B., 1989. Tumour necrosis factor production in Falciparum malaria and its association with schizont rupture. *Clinical and experimental immunology*, 77(3), pp. 361.
- Kwiatkowski, D., Molyneux, M., Stephens, S., Curtis, N., Klein, N., Pointaire, P., Smit, M., Allan, R., Brewster, D. and Grau, G., 1993. Anti-TNF therapy inhibits fever in cerebral malaria. *QJM*, 86(2), pp. 91-98.
- Kwiatkowski, D. P., 2005. How malaria has affected the human genome and what human genetics can teach us about malaria. *The American Journal of Human Genetics*, 77(2), pp. 171-192.
- Laemmli, U. K., 1970. Cleavage of structural proteins during the assembly of the head of bacteriophage T4. *nature*, 227, pp. 680-685.
- Lalève, A., Vallières, C., Golinelli-Cohen, M.-P., Bouton, C., Song, Z., Pawlik, G., Tindall, S. M., Avery, S. V., Clain, J. and Meunier, B., 2016. The antimalarial drug primaquine targets Fe-S cluster proteins and yeast respiratory growth. *Redox biology*, 7, pp. 21-29.
- Landry, J., Lambert, H., Zhou, M., Lavoie, J., Hickey, E., Weber, L. and Anderson, C., 1992. Human HSP27 is phosphorylated at serines 78 and 82 by heat shock and mitogen-activated kinases that recognize the same amino acid motif as S6 kinase II. *Journal of Biological Chemistry*, 267(2), pp. 794-803.
- Larkin, M. A., Blackshields, G., Brown, N., Chenna, R., McGettigan, P. A., McWilliam, H., Valentin, F., Wallace, I. M., Wilm, A. and Lopez, R., 2007. Clustal W and Clustal X version 2.0. *bioinformatics*, 23(21), pp. 2947-2948.
- Lee, C., Jang, Y. and Han, E., 1999. Depressant effects of ambroxol on lipopolysaccharide-or fMLP-stimulated free radical production and granule enzyme release by alveolar macrophages. *Pulmonary pharmacology & therapeutics*, 12(5), pp. 275-284.
- Lee, J. H. and Schöffl, F., 1996. AnHsp70 antisense gene affects the expression of HSP70/HSC70, the regulation of HSF, and the acquisition of thermotolerance in transgenic Arabidopsis thaliana. *Molecular and General Genetics MGG*, 252(1-2), pp. 11-19.
- Lee, K.-J., Kim, Y. M., Kim, D. Y., Jeoung, D., Han, K., Lee, S.-T., Lee, Y.-S., Park, K. H., Park, J. H. and Kim, D. J., 2006. Release of heat shock protein 70 (Hsp70) and the effects of extracellular Hsp70 on matrix metalloproteinase-9 expression in human monocytic U937 cells. *Experimental & molecular medicine*, 38(4), pp. 364.
- Leenaars, P., Hendriksen, C. F., De Leeuw, W. A., Carat, F., Delahaut, P., Fischer, R., Halder, M., Hanly, W. C., Hartinger, J. and Hau, J., 1999. The production of polyclonal antibodies in laboratory animals. *ATLA-NOTTINGHAM*, 27, pp. 79-102.
- Legorreta-Herrera, M., Retana-Ugalde, R., Ventura-Gallegos, J. L. and Narváez, V., 2010. Pyrimethamine induces oxidative stress in Plasmodium yoelii 17XL-infected mice: A novel immunomodulatory mechanism of action for an old antimalarial drug? *Experimental parasitology*, 126(3), pp. 381-388.
- Legorreta-Herrera, M., Rivas-Contreras, S., Ventura-Gallegos, J. and Zentella-Dehesa, A., 2011. Nitric Oxide is Involved in the Upregulation of IFN- γ and IL-10 mRNA Expression by CD8+ T Cells During the Blood Stages of P. chabaudi AS Infection in CBA/Ca Mice. *International Journal of Biological Sciences*, 7(9), pp. 1401-1411.
- Letchumanan, P. and Thumboo, J. 'Danazol in the treatment of systemic lupus erythematosus: a qualitative systematic review'. *Seminars in arthritis and rheumatism*: Elsevier, 298-306.
- Letterer, L. and Schagat, T. (2007) *Protein Expression in Less Time: A Short Induction Protocol for KRX* Promega Corporation Website: Promega Corporation. Available at: <http://www.promega.com/resources/pubhub/enotes/protein-expression-in-less-time/> (Accessed: January 12 2017).
- Levander, O. A., Fontela, R., Morris, V. C. and Ager Jr, A. L., 1995. Protection against murine cerebral malaria by dietary-induced oxidative stress. *The Journal of parasitology*, pp. 99-103.
- Li, B., Li, J., Pan, X., Ding, G., Cao, H., Jiang, W., Zheng, J. and Zhou, H., 2010. Artesunate protects sepsis model mice challenged with Staphylococcus aureus by decreasing TNF- α release via inhibition TLR2 and Nod2 mRNA expressions and transcription factor NF- κ B activation. *International immunopharmacology*, 10(3), pp. 344-350.

- Li, B., Zhang, R., Li, J., Zhang, L., Ding, G., Luo, P., He, S., Dong, Y., Jiang, W. and Lu, Y., 2008. Antimalarial artesunate protects sepsis model mice against heat-killed Escherichia coli challenge by decreasing TLR4, TLR9 mRNA expressions and transcription factor NF- κ B activation. *International immunopharmacology*, 8(3), pp. 379-389.
- Li, C. L., Wang, X. Y., Shao, J., Zhang, J. S., Feng, W. G., Wang, Y. B. and Chang, Z. L., 2001. Heat shock inhibits IL-12 p40 expression through NF- κ B signalling pathway in murine macrophages. *Cytokine*, 16(4), pp. 153-159. Available at: <http://www.ncbi.nlm.nih.gov/pubmed/11792125>
- Lindquist, S., 1980. Varying patterns of protein synthesis in Drosophila during heat shock: implications for regulation. *Developmental biology*, 77(2), pp. 463-479.
- Lipman, N. S., Jackson, L. R., Trudel, L. J. and Weis-Garcia, F., 2005. Monoclonal versus polyclonal antibodies: distinguishing characteristics, applications, and information resources. *ILAR journal*, 46(3), pp. 258-268.
- Literat, A., Su, F., Norwicki, M., Durand, M., Ramanathan, R., Jones, C., Minoos, P. and Kwong, K., 2001. Regulation of pro-inflammatory cytokine expression by curcumin in hyaline membrane disease (HMD). *Life sciences*, 70(3), pp. 253-267.
- Liu, B. and Marks, J. D., 2000. Applying phage antibodies to proteomics: selecting single chain Fv antibodies to antigens blotted on nitrocellulose. *Analytical biochemistry*, 286(1), pp. 119-128.
- Liu, Q. and Hendrickson, W. A., 2007. Insights into Hsp70 chaperone activity from a crystal structure of the yeast Hsp110 Sse1. *Cell*, 131(1), pp. 106-120.
- Liu, Y., Luo, L. and Zhao, H., 2000. [In vitro effect of danazol on cytokine production of macrophages in peritoneal fluid of infertile patients with endometriosis and its relationship with cytosolic free calcium concentration]. *Zhonghua fu chan ke za zhi*, 35(8), pp. 479-481.
- Löffler, B.-M., Bohn, E., Hesse, B. and Kunze, H., 1985. Effects of antimalarial drugs on phospholipase A and lysophospholipase activities in plasma membrane, mitochondrial, microsomal and cytosolic subcellular fractions of rat liver. *Biochimica et Biophysica Acta (BBA)-Lipids and Lipid Metabolism*, 835(3), pp. 448-455.
- Long, H., Lell, B., Dietz, K. and Kremsner, P., 2001. Plasmodium falciparum: in vitro growth inhibition by febrile temperatures. *Parasitology research*, 87(7), pp. 553-555.
- López-Antuñano, F. J., 1999. Is primaquine useful and safe as true exo-erythrocytic merontocidal, hypnozoitocidal and gametocidal antimalarial drug? *Salud Pública de México*, 41, pp. 410-419. Available at: http://www.scielosp.org/scielo.php?script=sci_arttext&pid=S0036-36341999000500010&nrm=iso
- Lopez-Buesa, P., Pfund, C. and Craig, E. A., 1998. The biochemical properties of the ATPase activity of a 70-kDa heat shock protein (Hsp70) are governed by the C-terminal domains. *Proceedings of the National Academy of Sciences*, 95(26), pp. 15253-15258.
- López Suárez, P., Rodríguez Carrio, J. and Suárez Díaz, A. M., 2014. Antimalarial drugs inhibit IFN- α -enhanced TNF α and STAT4 expression in monocytes: Implication for systemic lupus erythematosus. *Cytokine*, 67(1), pp. 13-20.
- Lou, J., Marzari, R., Verzillo, V., Ferrero, F., Pak, D., Sheng, M., Yang, C., Sblattero, D. and Bradbury, A., 2001. Antibodies in haystacks: how selection strategy influences the outcome of selection from molecular diversity libraries. *Journal of immunological methods*, 253(1), pp. 233-242.
- Lourembam, S. D., Sawian, C. E. and Baruah, S., 2013. Dysregulation of cytokines expression in complicated falciparum malaria with increased TGF- β and IFN- γ and decreased IL-2 and IL-12. *Cytokine*, 64(2), pp. 503-508.
- Lowry, M., Goldberg, J. and Belosevic, M., 1998. Induction of nitric oxide (NO) synthesis in murine macrophages requires potassium channel activity. *Clinical and experimental immunology*, 111(3), pp. 597-603.
- Luo, X., Zuo, X., Zhang, B., Song, L., Wei, X., Zhou, Y. and Xiao, X., 2008. Release of heat shock protein 70 and the effects of extracellular heat shock protein 70 on the production of IL-10 in fibroblast-like synoviocytes. *Cell Stress and Chaperones*, 13(3), pp. 365-373.
- Lyke, K., Burges, R., Cissoko, Y., Sangare, L., Dao, M., Diarra, I., Kone, A., Harley, R., Plowe, C. and Doumbo, O., 2004. Serum levels of the proinflammatory cytokines interleukin-1 beta (IL-1 β), IL-6, IL-8, IL-10, tumor necrosis factor alpha, and IL-12 (p70) in Malian children with severe Plasmodium falciparum malaria and matched uncomplicated malaria or healthy controls. *Infection and immunity*, 72(10), pp. 5630-5637.

- Mac-Daniel, L. and Menard, R., 2015. Plasmodium and mononuclear phagocytes. *Microbial Pathogenesis*, 78, pp. 43-51.(10.1016/j.micpath.2014.11.011).
- Macejak, D., Rayfield, M. and Luftig, R., 1990. Isolation and characterization of human HSP70 expressed in Escherichia coli. *Archives of biochemistry and biophysics*, 280(1), pp. 53-60.
- Macfarlane, D. E. and Manzel, L., 1998. Antagonism of immunostimulatory CpG-oligodeoxynucleotides by quinacrine, chloroquine, and structurally related compounds. *The Journal of Immunology*, 160(3), pp. 1122-1131.
- Magri, B., Vigano, P., Rossi, G., Somigliana, E., Gaffuri, B. and Vignali, M., 1997. Comparative effect of the calcium antagonist verapamil and the synthetic steroids gestrinone and danazol on human monocyte phagocytosis in vitro. *Gynecologic and obstetric investigation*, 43(1), pp. 6-10.
- Mahalka, A. K., Code, C., Jahromi, B. R., Kirkegaard, T., Jaattela, M. and Kinnunen, P. K., 2011. Activation of phospholipase A2 by Hsp70 in vitro. *Biochimica et biophysica acta*, 1808(10), pp. 2569-2572.(10.1016/j.bbamem.2011.06.002).
- Malaguarnera, L. and Musumeci, S., 2002. The immune response to Plasmodium falciparum malaria. *The Lancet Infectious Diseases*, 2(8), pp. 472-478.(10.1016/s1473-3099(02)00344-4).
- Mandala, W. L., Msefula, C. L., Gondwe, E., Drayson, M., Molyneux, M. and MacLennan, C., 2016. Monocyte activation and cytokine production in Malawian children presenting with P. falciparum malaria. *Parasite immunology*, 38(5), pp. 317-325.
- Mantovani, A., Cassatella, M. A., Costantini, C. and Jaillon, S., 2011. Neutrophils in the activation and regulation of innate and adaptive immunity. *Nature Reviews Immunology*, 11(8), pp. 519-531.
- Marinkovic, M., Diez-Silva, M., Pantic, I., Fredberg, J. J., Suresh, S. and Butler, J. P., 2009. Febrile temperature leads to significant stiffening of Plasmodium falciparum parasitized erythrocytes. *American Journal of Physiology-Cell Physiology*, 296(1), pp. C59-C64.
- Marks, J. D., Hoogenboom, H. R., Bonnert, T. P., McCafferty, J., Griffiths, A. D. and Winter, G., 1991. Bypassing immunization: human antibodies from V-gene libraries displayed on phage. *Journal of molecular biology*, 222(3), pp. 581-597.
- Marti, M., Good, R. T., Rug, M., Knuepfer, E. and Cowman, A. F., 2004. Targeting malaria virulence and remodeling proteins to the host erythrocyte. *Science*, 306(5703), pp. 1930-1933.(10.1126/science.1102452).
- Maruyama, N., Kakuta, Y., Yamauchi, K., Ohkawara, Y., Aizawa, T., Ohrui, T., Nara, M., Oshiro, T., Ohno, I. and Tamura, G., 1994. Quinine inhibits production of tumor necrosis factor- α from human alveolar macrophages. *American journal of respiratory cell and molecular biology*, 10(5), pp. 514-520.
- Matambo, T. S., Odunuga, O. O., Boshoff, A. and Blatch, G. L., 2004. Overproduction, purification, and characterization of the Plasmodium falciparum heat shock protein 70. *Protein expression and purification*, 33(2), pp. 214-222.
- Matsumori, A., Ono, K., Nishio, R., Nose, Y. and Sasayama, S., 1997. Amiodarone inhibits production of tumor necrosis factor- α by human mononuclear cells a possible mechanism for its effect in heart failure. *Circulation*, 96(5), pp. 1386-1389.
- Mattoo, R. U., Sharma, S. K., Priya, S., Finka, A. and Goloubinoff, P., 2013. Hsp110 is a bona fide chaperone using ATP to unfold stable misfolded polypeptides and reciprocally collaborate with Hsp70 to solubilize protein aggregates. *Journal of Biological Chemistry*, 288(29), pp. 21399-21411.
- Mauter, A. E. and Noble, L., 2000. Co-induction of HSP70 and heme oxygenase-1 in macrophages and glia after spinal cord contusion in the rat. *Brain research*, 883(2), pp. 233-237.
- Mayer, M. and Bukau, B., 2005. Hsp70 chaperones: cellular functions and molecular mechanism. *Cellular and molecular life sciences*, 62(6), pp. 670-684.
- McCall, M. B. and Sauerwein, R. W., 2010. Interferon- γ —central mediator of protective immune responses against the pre-erythrocytic and blood stage of malaria. *Journal of leukocyte biology*, 88(6), pp. 1131-1143.
- McCarty, J. S. and Walker, G. C., 1991. DnaK as a thermometer: threonine-199 is site of autophosphorylation and is critical for ATPase activity. *Proceedings of the National Academy of Sciences*, 88(21), pp. 9513-9517.
- McGilvray, I. D., Serghides, L., Kapus, A., Rotstein, O. D. and Kain, K. C., 2000. Nonopsonic monocyte/macrophage phagocytosis of Plasmodium falciparum-parasitized erythrocytes: a role for CD36 in malarial clearance. *Blood*, 96(9), pp. 3231-3240.

- Memvanga, P. B., Coco, R. and Pr at, V., 2013. An oral malaria therapy: Curcumin-loaded lipid-based drug delivery systems combined with β -arteether. *Journal of Controlled Release*, 172(3), pp. 904-913.
- M nard, D., Andriantsoanirina, V., Khim, N., Ratsimbasoa, A., Witkowski, B., Benedet, C., Canier, L., Mercereau-Puijalon, O. and Durand, R., 2013. Global analysis of Plasmodium falciparum Na⁺/H⁺ exchanger (pfnhe-1) allele polymorphism and its usefulness as a marker of in vitro resistance to quinine. *International Journal for Parasitology: Drugs and Drug Resistance*, 3, pp. 8-19.
- M noret, A., 2004. Purification of recombinant and endogenous HSP70s. *Methods*, 32(1), pp. 7-12.(10.1016/s1046-2023(03)00180-4).
- Merz, D. C., Dunn, R. J. and Drapeau, P., 1995. Generating a phage display antibody library against an identified neuron. *Journal of neuroscience methods*, 62(1), pp. 213-219.
- Michael, A., Meenatchisundaram, S., Parameswari, G., Subbraj, T., Selvakumaran, R. and Ramalingam, S., 2010. Chicken egg yolk antibodies (IgY) as an alternative to mammalian antibodies. *Indian Journal of Science and Technology*, 3(4), pp. 468-474.
- Miller, A. K., Harrell, E., Ye, L., Baptiste-Brown, S., Kleim, J. P., Ohrt, C., Duparc, S., M hrle, J. J., Webster, A. and Stinnett, S., 2013. Pharmacokinetic interactions and safety evaluations of coadministered tafenoquine and chloroquine in healthy subjects. *British journal of clinical pharmacology*, 76(6), pp. 858-867.
- Mimche, P. N., Thompson, E., Taramelli, D. and Vivas, L., 2012. Curcumin enhances non-opsonic phagocytosis of Plasmodium falciparum through up-regulation of CD36 surface expression on monocytes/macrophages. *Journal of antimicrobial chemotherapy*, 67(8), pp. 1895-1904.
- Miyata, Y., Chang, L., Bainor, A., McQuade, T. J., Walczak, C. P., Zhang, Y., Larsen, M. J., Kirchhoff, P. and Gestwicki, J. E., 2010. High-Throughput Screen for Escherichia coli Heat Shock Protein 70 (Hsp70/DnaK) ATPase Assay in Low Volume by Exploiting Energy Transfer. *Journal of biomolecular screening*, 15(10), pp. 1211-1219.
- Mohan, K., Dubey, M., Ganguly, N. and Mahajan, R., 1995. Plasmodium falciparum: role of activated blood monocytes in erythrocyte membrane damage and red cell loss during malaria. *Experimental parasitology*, 80(1), pp. 54-63.
- Mori, H., Nakagawa, M., Itoh, N., Wada, K. and Tamaya, T., 1990. Danazol Suppresses the Production of Interleukin-1 β and Tumor Necrosis Factor by Human Monocytes. *American journal of reproductive immunology*, 24(2), pp. 45-50.
- Mosser, D. D., Caron, A. W., Bourget, L., Denis-Larose, C. and Massie, B., 1997. Role of the human heat shock protein hsp70 in protection against stress-induced apoptosis. *Molecular and cellular biology*, 17(9), pp. 5317-5327.
- Mshana, R., Boulandi, J., Mshana, N., Mayombo, J. and Mendome, G., 1991. Cytokines in the pathogenesis of malaria: levels of IL-1 beta, IL-4, IL-6, TNF-alpha and IFN-gamma in plasma of healthy individuals and malaria patients in a holoendemic area. *Journal of clinical & laboratory immunology*, 34(3), pp. 131-139.
- Mujumdar, N., Mackenzie, T. N., Dudeja, V., Chugh, R., Antonoff, M. B., Borja-Cacho, D., Sangwan, V., Dawra, R., Vickers, S. M. and Saluja, A. K., 2010. Triptolide induces cell death in pancreatic cancer cells by apoptotic and autophagic pathways. *Gastroenterology*, 139(2), pp. 598-608.
- M ller, I. B. and Hyde, J. E., 2013. Folate metabolism in human malaria parasites—75 years on. *Molecular and biochemical parasitology*, 188(1), pp. 63-77.
- Murakami, M., Taketomi, Y., Sato, H. and Yamamoto, K., 2011. Secreted phospholipase A2 revisited. *Journal of biochemistry*, 150(3), pp. 233-255.(10.1093/jb/mvr088).
- Murphy, M. E., 2013. The HSP70 family and cancer. *Carcinogenesis*, 34(6), pp. 1181-1188.
- Nadkarni, A., Kelley, L.-L. C. and Momany, C., 2007. Optimization of a mouse recombinant antibody fragment for efficient production from Escherichia coli. *Protein expression and purification*, 52(1), pp. 219-229.
- Nandakumar, D. N., Nagaraj, V. A., Vathsala, P. G., Rangarajan, P. and Padmanaban, G., 2006. Curcumin-artemisinin combination therapy for malaria. *Antimicrobial agents and chemotherapy*, 50(5), pp. 1859-1860.
- Nasr, A., Allam, G., Hamid, O. and Al-Ghamdi, A., 2014. IFN-gamma and TNF associated with severe falciparum malaria infection in Saudi pregnant women. *Malaria journal*, 13(1), pp. 1.
- Nathan, D. F. and Lindquist, S., 1995. Mutational analysis of Hsp90 function: interactions with a steroid receptor and a protein kinase. *Molecular and Cellular Biology*, 15(7), pp. 3917-3925.

- Nerlich, A. G., Schraut, B., Dittrich, S., Jelinek, T. and Zink, A. R., 2008. Plasmodium falciparum in ancient Egypt. *Emerging infectious diseases*, 14(8), pp. 1317.
- Neustock, P., Brand, J. M., Kruse, A. and Kirchner, H., 1993. Cytokine production of the human monocytic cell line Mono Mac 6 in comparison to mature monocytes in peripheral blood mononuclear cells. *Immunobiology*, 188(3), pp. 293-302.
- Newbold, C., Craig, A., Kyes, S., Rowe, A., Fernandez-Reyes, D. and Fagan, T., 1999. Cytoadherence, pathogenesis and the infected red cell surface in Plasmodium falciparum. *International journal for parasitology*, 29(6), pp. 927-937.
- Newton, C. R. and Krishna, S., 1998. Severe falciparum malaria in children: current understanding of pathophysiology and supportive treatment. *Pharmacology & therapeutics*, 79(1), pp. 1-53.
- Neznanov, N., Gorbachev, A. V., Neznanova, L., Komarov, A. P., Gurova, K. V., Gasparian, A. V., Banerjee, A. K., Almasan, A., Fairchild, R. L. and Gudkov, A. V., 2009. Anti-malaria drug blocks proteotoxic stress response: anti-cancer implications. *Cell Cycle*, 8(23), pp. 3960-3970.
- Niikura, M., Inoue, S.-I. and Kobayashi, F., 2011. Role of interleukin-10 in malaria: focusing on coinfection with lethal and nonlethal murine malaria parasites. *BioMed Research International*, 2011
- Njemini, R., Bautmans, I., Onyema, O. O., Van Puyvelde, K., Demanet, C. and Mets, T., 2011. Circulating heat shock protein 70 in health, aging and disease. *BMC Immunology*, 12, pp. 24.(10.1186/1471-2172-12-24).
- Njemini, R., Lambert, M., Demanet, C., Vanden Abeele, M., Vandebosch, S. and Mets, T., 2003. The induction of heat shock protein 70 in peripheral mononuclear blood cells in elderly patients: a role for inflammatory markers. *Human Immunology*, 64(6), pp. 575-585.(10.1016/s0198-8859(03)00068-5).
- Nollen, E. A. and Morimoto, R. I., 2002. Chaperoning signaling pathways: molecular chaperones as stress-sensing heat shock proteins. *Journal of cell science*, 115(14), pp. 2809-2816.
- Noppe, W., Plieva, F., Galaev, I. Y., Pottel, H., Deckmyn, H. and Mattiasson, B., 2009. Chromato-panning: an efficient new mode of identifying suitable ligands from phage display libraries. *BMC biotechnology*, 9(21), pp. 1.(10.1186/1472-6750-9-21).
- Nosál, R., Jančinová, V. and Petříková, M., 1995. Chloroquine inhibits stimulated platelets at the arachidonic acid pathway. *Thrombosis research*, 77(6), pp. 531-542.
- Nujic, K., Banjanac, M., Munic, V., Polancec, D. and Erakovic Haber, V., 2012. Impairment of lysosomal functions by azithromycin and chloroquine contributes to anti-inflammatory phenotype. *Cellular immunology*, 279(1), pp. 78-86.(10.1016/j.cellimm.2012.09.007).
- Nukarinen, T. (2016) *PRODUCTION AND CHARACTERISATION OF scFv BINDERS AGAINST SELECTED ENTEROVIRUSES*. MSc., University of Eastern Finland, Finland [Online] Available at: http://epublications.uef.fi/pub/urn_nbn_fi_uef-20160477/urn_nbn_fi_uef-20160477.pdf (Accessed: January 2017).
- Oakley, M. S., Kumar, S., Anantharaman, V., Zheng, H., Mahajan, B., Haynes, J. D., Moch, J. K., Fairhurst, R., McCutchan, T. F. and Aravind, L., 2007. Molecular factors and biochemical pathways induced by febrile temperature in intraerythrocytic Plasmodium falciparum parasites. *Infection and immunity*, 75(4), pp. 2012-2025.
- Odeh, M., 2001. The role of tumour necrosis factor-alpha in the pathogenesis of complicated falciparum malaria. *Cytokine*, 14(1), pp. 11-18.(10.1006/cyto.2001.0845).
- Oehler, R., Pusch, E., Zellner, M., Dungal, P., Hergovics, N., Homoncik, M., Munk Eliassen, M., Brabec, M. and Roth, E., 2001. Cell type-specific variations in the induction of hsp70 in human leukocytes by feverlike whole body hyperthermia. *Cell stress & chaperones*, 6(4), pp. 306-315.
- Ogawa, T., Koerten, H. and Daems, W. T., 1978. Peroxidatic activity in monocytes and tissue macrophages of mice. *Cell and tissue research*, 188(3), pp. 361-373.
- Ohara, R., Knappik, A., Shimada, K., Frisch, C., Ylera, F. and Koga, H., 2006. Antibodies for proteomic research: comparison of traditional immunization with recombinant antibody technology. *Proteomics*, 6(9), pp. 2638-2646.
- Okombo, J., Ohuma, E., Picot, S. and Nzila, A., 2011. Update on genetic markers of quinine resistance in Plasmodium falciparum. *Molecular and biochemical parasitology*, 177(2), pp. 77-82.
- Okunieff, P., Xu, J., Hu, D., Liu, W., Zhang, L., Morrow, G., Pentland, A., Ryan, J. L. and Ding, I., 2006. Curcumin protects against radiation-induced acute and chronic cutaneous toxicity in mice and

- decreases mRNA expression of inflammatory and fibrogenic cytokines. *International Journal of Radiation Oncology* Biology* Physics*, 65(3), pp. 890-898.
- Olivier, M., Van Den Ham, K., Shio, M. T., Kassa, F. A. and Fougeray, S., 2014. Malarial pigment hemozoin and the innate inflammatory response. *Frontiers in immunology*, 5, pp. 25.(10.3389/fimmu.2014.00025).
- Osier, F. H., Feng, G., Boyle, M. J., Langer, C., Zhou, J., Richards, J. S., McCallum, F. J., Reiling, L., Jaworowski, A. and Anders, R. F., 2014. Opsonic phagocytosis of Plasmodium falciparum merozoites: mechanism in human immunity and a correlate of protection against malaria. *BMC medicine*, 12(1), pp. 1.
- Ota, H., Igarashi, S., Hatazawa, J. and Tanaka, T., 1997. Distribution of heat shock proteins in eutopic and ectopic endometrium in endometriosis and adenomyosis. *Fertility and sterility*, 68(1), pp. 23-28.
- Overton, T. W., 2014. Recombinant protein production in bacterial hosts. *Drug Discovery Today*, 19(5), pp. 590-601. Available at: <http://www.ncbi.nlm.nih.gov/pubmed/24246684>
- Paauw, A., Leverstein-van Hall, M. A., van Kessel, K. P., Verhoef, J. and Fluit, A. C., 2009. Yersiniabactin reduces the respiratory oxidative stress response of innate immune cells. *PLoS one*, 4(12), pp. e8240.(<http://dx.doi.org/10.1371/journal.pone.0008240>).
- Palleros, D. R., Reid, K. L., Shi, L. and Fink, A. L., 1993. DnaK ATPase activity revisited. *FEBS letters*, 336(1), pp. 124-128.
- Panjwani, N. N., Popova, L. and Srivastava, P. K., 2002. Heat shock proteins gp96 and hsp70 activate the release of nitric oxide by APCs. *The Journal of Immunology*, 168(6), pp. 2997-3003.
- Parcellier, A., Gurbuxani, S., Schmitt, E., Solary, E. and Garrido, C., 2003. Heat shock proteins, cellular chaperones that modulate mitochondrial cell death pathways. *Biochemical and biophysical research communications*, 304(3), pp. 505-512.
- Park, K. H., Yoon, Y. D., Han, S.-B., Oh, S. J., Yun, J., Lee, C. W., Lee, K., Park, S.-K., Kim, H. M. and Kang, J. S., 2012. Artemisinin inhibits lipopolysaccharide-induced interferon- β production in RAW 264.7 cells: Implications on signal transducer and activator of transcription-1 signaling and nitric oxide production. *International immunopharmacology*, 14(4), pp. 580-584.
- Park, Y. C., Pae, H. O., Yoo, J. C., Choi, B. M., Jue, D. M. and Chung, H. T., 1999. Chloroquine inhibits inducible nitric oxide synthase expression in murine peritoneal macrophages. *Pharmacology & toxicology*, 85(6), pp. 188-191.
- Parroche, P., Lauw, F. N., Goutagny, N., Latz, E., Monks, B. G., Visintin, A., Halmen, K. A., Lamphier, M., Olivier, M. and Bartholomeu, D. C., 2007. Malaria hemozoin is immunologically inert but radically enhances innate responses by presenting malaria DNA to Toll-like receptor 9. *Proceedings of the National Academy of Sciences*, 104(6), pp. 1919-1924.
- Pathak, V. A. and Ghosh, K., 2016. Erythropoiesis in Malaria Infections and Factors Modifying the Erythropoietic Response. *Anemia*, 2016
- Pattanapanyasat, K., Sratongno, P., Chimma, P., Chitjamnongchai, S., Polsrila, K. and Chotivanich, K., 2010. Febrile temperature but not proinflammatory cytokines promotes phosphatidylserine expression on Plasmodium falciparum malaria- infected red blood cells during parasite maturation. *Cytometry Part A*, 77(6), pp. 515-523.
- Pavithra, S. R., Banumathy, G., Joy, O., Singh, V. and Tatu, U., 2004. Recurrent fever promotes Plasmodium falciparum development in human erythrocytes. *The journal of biological chemistry*, 279(45), pp. 46692-46699.(10.1074/jbc.M409165200).
- Peng, P., Menoret, A. and Srivastava, P. K., 1997. Purification of immunogenic heat shock protein 70-peptide complexes by ADP-affinity chromatography. *Journal of immunological methods*, 204(1), pp. 13-21.
- Percário, S., Moreira, D. R., Gomes, B. A., Ferreira, M. E., Gonçalves, A. C. M., Laurindo, P. S., Vilhena, T. C., Dolabela, M. F. and Green, M. D., 2012. Oxidative stress in malaria. *International Journal of Molecular Sciences*, 13(12), pp. 16346-16372.
- Perkmann, T., Winkler, H., Graninger, W., Kremsner, P. G. and Winkler, S., 2005. Circulating levels of the interleukin (IL)-4 receptor and of IL-18 in patients with Plasmodium falciparum malaria. *Cytokine*, 29(4), pp. 153-158.(10.1016/j.cyto.2004.10.008).
- Petrovsky, N. and Aguilar, J. C., 2004. Vaccine adjuvants: current state and future trends. *Immunology and cell biology*, 82(5), pp. 488-496.

- Pfeifer, S., Zissel, G., Kienast, K. and Müller-Quernheim, J., 1997. Reduction of cytokine release of blood and bronchoalveolar mononuclear cells by ambroxol. *European journal of medical research*, 2(3), pp. 129-132.
- Phillips, R. E., Warrell, D. A., White, N. J., Looareesuwan, S. and Karbwang, J., 1985. Intravenous quinidine for the treatment of severe falciparum malaria: clinical and pharmacokinetic studies. *New England Journal of Medicine*, 312(20), pp. 1273-1278.
- Picard, D., 2002. Heat-shock protein 90, a chaperone for folding and regulation. *Cellular and Molecular Life Sciences*, 59(10), pp. 1640-1648.
- Picot, S., Peyron, F., Donadille, A., Vuillez, J., Barbe, G. and Ambroise-Thomas, P., 1993. Chloroquine-induced inhibition of the production of TNF, but not of IL-6, is affected by disruption of iron metabolism. *Immunology*, 80(1), pp. 127.
- Polla, B. S., 1991. Heat shock proteins in host-parasite interactions. *Parasitology Today*, 7(3), pp. 38-41.
- Polson, A., von Wechmar, M. B. and Van Regenmortel, M., 1980. Isolation of viral IgY antibodies from yolks of immunized hens. *Immunological communications*, 9(5), pp. 475-493.
- Prada, J., Müller, S., Bienzle, U. and Kremsner, P. G., 1996. Upregulation of reactive oxygen and nitrogen intermediates in Plasmodium berghei infected mice after rescue therapy with chloroquine or artemether. *Journal of Antimicrobial Chemotherapy*, 38(1), pp. 95-102.
- Prato, M., Gallo, V., Valente, E., Khadjavi, A., Mandili, G. and Giribaldi, G., 2010. Malarial pigment enhances heat shock protein-27 in THP-1 cells: new perspectives for in vitro studies on monocyte apoptosis prevention. *Asian Pacific Journal of Tropical Medicine*, 3(12), pp. 934-938.(10.1016/s1995-7645(11)60003-5).
- Preet, R., Mohapatra, P., Mohanty, S., Sahu, S. K., Choudhuri, T., Wyatt, M. D. and Kundu, C. N., 2012. Quinacrine has anticancer activity in breast cancer cells through inhibition of topoisomerase activity. *International Journal of Cancer*, 130(7), pp. 1660-1670.
- Przyborski, J. M., Diehl, M. and Blatch, G. L., 2015. Plasmodial HSP70s are functionally adapted to the malaria parasite life cycle. *Frontiers in molecular biosciences*, 2(34)(10.3389/fmolb.2015.00034).
- Ralph, P., Moore, M. and Nilsson, K., 1976. Lysozyme synthesis by established human and murine histiocytic lymphoma cell lines. *The Journal of experimental medicine*, 143(6), pp. 1528-1533.
- Ralph, P., Prichard, J. and Cohn, M., 1975. Reticulum cell sarcoma: an effector cell in antibody-dependent cell-mediated immunity. *The Journal of Immunology*, 114(2 Part 2), pp. 898-905.
- Ramos-Avila, A., Ventura-Gallegos, J., Zentella-Dehesa, A., Machuca-Rodríguez, C., Moreno-Altamirano, M. M., Narvaez, V. and Legorreta-Herrera, M., 2007. Immunomodulatory role of chloroquine and pyrimethamine in Plasmodium yoelii 17XL infected mice. *Scandinavian journal of immunology*, 65(1), pp. 54-62.
- Rand, K. N., 1996. Crystal violet can be used to visualize DNA bands during gel electrophoresis and to improve cloning efficiency. *Technical Tips Online*, 1(1), pp. 23-24.
- Ranjan, R., Karpurapu, M., Rani, A., Chishti, A. H. and Christman, J. W., 2016. Hemozoin Regulates iNOS Expression by Modulating the Transcription Factor NF-κB in Macrophages. *Biochemistry & molecular biology journal*, 2(2)(10.21767/2471-8084.100019).
- Author (1997-2016) *ImageJ*, U.S.
- Raynes, D. A. and Guerriero, V., 1998. Inhibition of Hsp70 ATPase activity and protein renaturation by a novel Hsp70-binding protein. *Journal of Biological Chemistry*, 273(49), pp. 32883-32888.
- Reale, M., Felaco, M., Grilli, A., Barbacane, R., Placido, F., Porreca, E. and Conti, P., 1995. Induction of alkaline phosphatase generation by il-1β and LPS on human neutrophils and macrophages and lack of inhibition by interleukin-1 receptor antagonist. *Inflammopharmacology*, 3(1), pp. 25-34.
- Reddy, R. C., Vatsala, P. G., Keshamouni, V. G., Padmanaban, G. and Rangarajan, P. N., 2005. Curcumin for malaria therapy. *Biochemical and biophysical research communications*, 326(2), pp. 472-474.
- Rees, A. J. 'Monocyte and macrophage biology: an overview'. In *Seminars in nephrology*, WB Saunders: Elsevier, 216-233.
- Repaske, R., 1958. Lysis of gram-negative organisms and the role of versene. *Biochimica et Biophysica Acta*, 30(2), pp. 225-232.([http://dx.doi.org/10.1016/0006-3002\(58\)90044-1](http://dx.doi.org/10.1016/0006-3002(58)90044-1)).
- Reyes-Gordillo, K., Segovia, J., Shibayama, M., Vergara, P., Moreno, M. G. and Muriel, P., 2007. Curcumin protects against acute liver damage in the rat by inhibiting NF-κB, proinflammatory cytokines production and oxidative stress. *Biochimica et Biophysica Acta (BBA)-General Subjects*, 1770(6), pp. 989-996.

- Richards, A. L., 1997. Tumour necrosis factor and associated cytokines in the host's response to malaria. *International journal for parasitology*, 27(10), pp. 1251-1263.
- Riley, E., Rowe, P., Allen, S. and Greenwood, B., 1993. Soluble plasma IL-2 receptors and malaria. *Clinical & Experimental Immunology*, 91(3), pp. 495-499.
- Riley, E. M. and Stewart, V. A., 2013. Immune mechanisms in malaria: new insights in vaccine development. *Nature medicine*, 19(2), pp. 168-178.
- Rincon, M., 2012. Interleukin-6: from an inflammatory marker to a target for inflammatory diseases. *Trends in immunology*, 33(11), pp. 571-577.
- Ringwald, P., Peyron, F., Vuillez, J., Touze, J., Le Bras, J. and Deloron, P., 1991. Levels of cytokines in plasma during Plasmodium falciparum malaria attacks. *Journal of clinical microbiology*, 29(9), pp. 2076-2078.
- Robert, J., 2003. Evolution of heat shock protein and immunity. *Developmental & Comparative Immunology*, 27(6), pp. 449-464.
- Rockett, K., Awburn, M., Aggarwal, B., Cowden, W. and Clark, I., 1992. In vivo induction of nitrite and nitrate by tumor necrosis factor, lymphotoxin, and interleukin-1: possible roles in malaria. *Infection and immunity*, 60(9), pp. 3725-3730.
- Rosano, G. L. and Ceccarelli, E. A., 2014. Recombinant protein expression in Escherichia coli: advances and challenges. *Recombinant protein expression in microbial systems*, 5(172), pp. 7.(10.3389/fmicb.2014.00172).
- Rowlands, M., McAndrew, C., Prodromou, C., Pearl, L., Kalusa, A., Jones, K., Workman, P. and Aherne, W., 2010. Detection of the ATPase activity of the molecular chaperones Hsp90 and Hsp72 using the Transcreeper™ ADP assay kit. *Journal of biomolecular screening*, 15(3), pp. 279-286.
- Rowlands, M. G., Newbatt, Y. M., Prodromou, C., Pearl, L. H., Workman, P. and Aherne, W., 2004. High-throughput screening assay for inhibitors of heat-shock protein 90 ATPase activity. *Analytical biochemistry*, 327(2), pp. 176-183.
- Rudin, W., Eugster, H.-P., Bordmann, G., Bonato, J., Müller, M., Yamage, M. and Ryffel, B., 1997. Resistance to cerebral malaria in tumor necrosis factor-alpha/beta-deficient mice is associated with a reduction of intercellular adhesion molecule-1 up-regulation and T helper type 1 response. *The American journal of pathology*, 150(1), pp. 257.
- Saeed, M. E., Krishna, S., Greten, H. J., Kremsner, P. G. and Efferth, T., 2016. Antischistosomal activity of artemisinin derivatives in vivo and in patients. *Pharmacological research*,
- Saggy, I., Wine, Y., Shefet-Carasso, L., Nahary, L., Georgiou, G. and Benhar, I., 2012. Antibody isolation from immunized animals: comparison of phage display and antibody discovery via V gene repertoire mining. *Protein Engineering Design and Selection*, 25(10), pp. 539-549.
- Samali, A. and Cotter, T. G., 1996. Heat shock proteins increase resistance to apoptosis. *Experimental cell research*, 223(1), pp. 163-170.
- Sambrook, J., Fritsch, E. F. and Maniatis, T. (1989) *Molecular cloning*. Cold spring harbor laboratory press New York.
- Sanni, L. A., Fu, S., Dean, R. T., Bloomfield, G., Stocker, R., Chaudhri, G., Dinauer, M. C. and Hunt, N. H., 1999. Are reactive oxygen species involved in the pathogenesis of murine cerebral malaria? *Journal of Infectious Diseases*, 179(1), pp. 217-222.
- Sarangi, A., Mohapatra, P. C. and Dalai, R. K., 2012. Serum cytokine TNF-alpha and hemoglobin levels in Plasmodium falciparum malaria – A correlative study in coastal districts of Odisha. *Apollo Medicine*, 9(4), pp. 292-296.(10.1016/j.apme.2012.08.003).
- Sarbeng, E. B., Liu, Q., Tian, X., Yang, J., Li, H., Wong, J. L., Zhou, L. and Liu, Q., 2015. A functional DnaK dimer is essential for the efficient interaction with Hsp40 heat shock protein. *Journal of Biological Chemistry*, 290(14), pp. 8849-8862.
- Schlitzer, M., 2008. Antimalarial drugs—what is in use and what is in the pipeline. *Archiv der Pharmazie*, 341(3), pp. 149-163.
- Schofield, L. and Grau, G. E., 2005. Immunological processes in malaria pathogenesis. *Nature Reviews Immunology*, 5(9), pp. 722-735.
- Schwarzer, E. and Arese, P., 1996. Phagocytosis of malarial pigment hemozoin inhibits NADPH-oxidase activity in human monocyte-derived macrophages. *Biochimica et Biophysica Acta (BBA)-Molecular Basis of Disease*, 1316(3), pp. 169-175.

- Schwarzer, E., Turrini, F., Ulliers, D., Giribaldi, G., Ginsburg, H. and Arese, P., 1992. Impairment of macrophage functions after ingestion of Plasmodium falciparum-infected erythrocytes or isolated malarial pigment. *The Journal of experimental medicine*, 176(4), pp. 1033-1041.
- Scorza, T., Magez, S., Brys, L. and De Baetselier, P., 1999. Hemozoin is a key factor in the induction of malaria-associated immunosuppression. *Parasite immunology*, 21(11), pp. 545-554.
- Serbina, N. V., Jia, T., Hohl, T. M. and Pamer, E. G., 2008. Monocyte-mediated defense against microbial pathogens. *Annual Review of Immunology*, 26, pp. 421-452.(10.1146/annurev.immunol.26.021607.090326).
- Serghides, L., Smith, T. G., Patel, S. N. and Kain, K. C., 2003. CD36 and malaria: friends or foes? *Trends in Parasitology*, 19(10), pp. 461-469.(10.1016/j.pt.2003.08.006).
- Sezonov, G., Joseleau-Petit, D. and D'Ari, R., 2007. Escherichia coli physiology in Luria-Bertani broth. *Journal of bacteriology*, 189(23), pp. 8746-8749.
- Shaffer, N., Grau, G. E., Hedberg, K., Davachi, F., Lyamba, B., Hightower, A. W., Breman, J. G. and Nguyen-Dinh, P., 1991. Tumor necrosis factor and severe malaria. *Journal of Infectious Diseases*, 163(1), pp. 96-101.
- Shakir, L., Hussain, M., Javeed, A., Ashraf, M. and Riaz, A., 2011. Artemisinins and immune system. *European Journal of Pharmacology*, 668(1-2), pp. 6-14.(10.1016/j.ejphar.2011.06.044).
- Shalmiev, G., Krugliak, M., Turrini, F. and Ginsburg, H., 1996. Antimalarial drugs inhibit the phagocytosis of erythrocytes infected with Plasmodium falciparum. *Transactions of the Royal Society of Tropical Medicine and Hygiene*, 90(5), pp. 558-562.
- Sharma, R., Gescher, A. and Steward, W., 2005. Curcumin: the story so far. *European journal of cancer*, 41(13), pp. 1955-1968.
- Shen, W., Li, S., Park, M.-K., Zhang, Z., Cheng, Z., Petrenko, V. A. and Chin, B. A., 2012. Blocking agent optimization for nonspecific binding on phage based magnetoelastic biosensors. *Journal of The Electrochemical Society*, 159(10), pp. B818-B823.
- Shi, C. and Pamer, E. G., 2011. Monocyte recruitment during infection and inflammation. *Nature Reviews Immunology*, 11(11), pp. 762-774.
- Shiloach, J., Kaufman, J., Guillard, A. and Fass, R., 1996. Effect of glucose supply strategy on acetate accumulation, growth, and recombinant protein production by Escherichia coli BL21 (λ DE3) and Escherichia coli JM109. *Biotechnology and bioengineering*, 49(4), pp. 421-428.
- Shu, C.-W. and Huang, C.-M., 2008. HSP70s: from tumor transformation to cancer therapy. *Clinical medicine: Oncology*, 2, pp. 335-345.
- Sigmon, J. and Larcom, L. L., 1996. The effect of ethidium bromide on mobility of DNA fragments in agarose gel electrophoresis. *Electrophoresis*, 17(10), pp. 1524-1527.
- Silamut, K., Molunto, P., Ho, M., Davis, T. and White, N., 1991. Alpha 1-acid glycoprotein (orosomuroid) and plasma protein binding of quinine in falciparum malaria. *British journal of clinical pharmacology*, 32(3), pp. 311-315.
- Silva, L. S. d., Catalão, C. H. R., Felippotti, T. T., Oliveira-Pelegrin, G. R. d., Petenusci, S., de Freitas, L. A. P. and Rocha, M. J. A., 2015. Curcumin suppresses inflammatory cytokines and heat shock protein 70 release and improves metabolic parameters during experimental sepsis. *Pharmaceutical Biology*, 55(1), pp. 269-276.
- Silva, T. H., Oliveira, A. B. and De Almeida, W. B., 1997. Conformational analysis of the antimalarial agent quinidine. *Bioorganic & medicinal chemistry*, 5(2), pp. 353-361.
- Silver, L. L., 2011. Challenges of antibacterial discovery. *Clinical microbiology reviews*, 24(1), pp. 71-109.
- Silvie, O., Mota, M. M., Matuschewski, K. and Prudêncio, M., 2008. Interactions of the malaria parasite and its mammalian host. *Current opinion in microbiology*, 11(4), pp. 352-359.
- Sims, J. E. and Smith, D. E., 2010. The IL-1 family: regulators of immunity. *Nature Reviews Immunology*, 10(2), pp. 89-102.
- Singh, I. S. and Hasday, J. D., 2013. Fever, hyperthermia and the heat shock response. *International Journal of Hyperthermia*, 29(5), pp. 423-435.
- Skorokhod, O. A., Barrera, V., Heller, R., Carta, F., Turrini, F., Arese, P. and Schwarzer, E., 2014. Malarial pigment hemozoin impairs chemotactic motility and transendothelial migration of monocytes via 4-hydroxynonenal. *Free Radical Biology and Medicine*, 75, pp. 210-221.
- Slater, A. F., 1993. Chloroquine: mechanism of drug action and resistance in Plasmodium falciparum. *Pharmacology & therapeutics*, 57(2-3), pp. 203-235.
- Smith, G. P. and Petrenko, V. A., 1997. Phage display. *Chemical reviews*, 97(2), pp. 391-410.

- Smith, R. S., Meyers, D. A., Peters, S. P., Moore, W. C., Wenzel, S. A., Bleecker, E. R. and Hawkins, G. A., 2007. Sequence analysis of HSPA1A and HSPA1B in a multi-ethnic study population: Full Length Research Article. *DNA Sequence*, 18(1), pp. 47-53.
- Sobolewski, P., Gramaglia, I., Frangos, J., Intaglietta, M. and van der Heyde, H. C., 2005. Nitric oxide bioavailability in malaria. *Trends in parasitology*, 21(9), pp. 415-422.
- Soetikno, V., Sari, F. R., Veeraveedu, P. T., Thandavarayan, R. A., Harima, M., Sukumaran, V., Lakshmanan, A. P., Suzuki, K., Kawachi, H. and Watanabe, K., 2011. Curcumin ameliorates macrophage infiltration by inhibiting NF- κ B activation and proinflammatory cytokines in streptozotocin induced-diabetic nephropathy. *Nutrition & metabolism*, 8(1), pp. 1.(10.1186/1743-7075-8-35).
- Sortica, V. A., Cunha, M. G., Ohnishi, M. D., Souza, J. M., Ribeiro-dos-Santos, Â. K., Santos, S. E. and Hutz, M. H., 2014. Role of IL6, IL12B and VDR gene polymorphisms in Plasmodium vivax malaria severity, parasitemia and gametocytemia levels in an Amazonian Brazilian population. *Cytokine*, 65(1), pp. 42-47.
- Srivastava, P. K., Menoret, A., Basu, S., Binder, R. J. and McQuade, K. L., 1998. Heat shock proteins come of age: primitive functions acquire new roles in an adaptive world. *Immunity*, 8(6), pp. 657-665.
- Studier, F. W., 2005. Protein production by auto-induction in high-density shaking cultures. *Protein expression and purification*, 41(1), pp. 207-234.
- Stuehr, D. J. and Marletta, M., 1987. Induction of nitrite/nitrate synthesis in murine macrophages by BCG infection, lymphokines, or interferon-gamma. *The Journal of Immunology*, 139(2), pp. 518-525.
- Sullivan, D. J., Matile, H., Ridley, R. G. and Goldberg, D. E., 1998. A common mechanism for blockade of heme polymerization by antimalarial quinolines. *Journal of Biological Chemistry*, 273(47), pp. 31103-31107.
- Sun, J., Wang, S.-W., Jin, C.-L., Zeng, X.-L., Piao, X.-Y., Bai, L., Tang, D.-L. and Ji, C.-L., 2016. Can hemozoin alone cause host anaemia? *Parasitology Research*, pp. 1-6.
- Sundström, C. and Nilsson, K., 1976. Establishment and characterization of a human histiocytic lymphoma cell line (U-937). *International journal of cancer*, 17(5), pp. 565-577.
- Surrey, E. S. and Halme, J., 1992. Direct effects of medroxyprogesterone acetate, danazol, and leuprolide acetate on endometrial stromal cell proliferation in vitro. *Fertility and sterility*, 58(2), pp. 273-278.
- Taverne, J., Tavernier, J., Fiers, W. and Playfair, J., 1987. Recombinant tumour necrosis factor inhibits malaria parasites in vivo but not in vitro. *Clinical and experimental immunology*, 67(1), pp. 1.
- te Witt, R., van Wolfswinkel, M. E., Petit, P. L., van Hellemond, J. J., Koelewijn, R., van Belkum, A. and van Genderen, P. J., 2010. Neopterin and procalcitonin are suitable biomarkers for exclusion of severe Plasmodium falciparum disease at the initial clinical assessment of travellers with imported malaria. *Malaria journal*, 9(1), pp. 255.
- Teiten, M.-H., Reuter, S., Schmucker, S., Dicato, M. and Diederich, M., 2009. Induction of heat shock response by curcumin in human leukemia cells. *Cancer letters*, 279(2), pp. 145-154.
- Teja-Isavadharm, P., Nosten, F., Kyle, D., Luxemburger, C., Kuile, F. t., Peggins, J., Brewer, T. and White, N., 1996. Comparative bioavailability of oral, rectal, and intramuscular artemether in healthy subjects: use of simultaneous measurement by high performance liquid chromatography and bioassay. *British journal of clinical pharmacology*, 42(5), pp. 599-604.
- Terpe, K., 2003. Overview of tag protein fusions: from molecular and biochemical fundamentals to commercial systems. *Applied microbiology and biotechnology*, 60(5), pp. 523-533.
- Teshima, S., Rokutan, K., Takahashi, M., Nikawa, T. and Kishi, K., 1996. Induction of heat shock proteins and their possible roles in macrophages during activation by macrophage colony-stimulating factor. *Biochemical Journal*, 315(2), pp. 497-504.
- Thomas, D., Tazerouni, H., Sundararaj, K. G. S. and Cooper, J. C., 2016. Therapeutic failure of primaquine and need for new medicines in radical cure of Plasmodium vivax. *Acta tropica*, 160, pp. 35-38.
- Thomé, R., Lopes, S. C. P., Costa, F. T. M. and Verinaud, L., 2013. Chloroquine: modes of action of an undervalued drug. *Immunology letters*, 153(1), pp. 50-57.
- Tilley, L., Dixon, M. W. and Kirk, K., 2011. The Plasmodium falciparum-infected red blood cell. *The international journal of biochemistry & cell biology*, 43(6), pp. 839-842.
- Tilley, L. and Hanssen, E., 2008. A 3D view of the host cell compartment in P. falciparum-infected erythrocytes. *Transfusion clinique et biologique*, 15(1), pp. 72-81.
- Tilley, L., Straimer, J., Gnädig, N. F., Ralph, S. A. and Fidock, D. A., 2016. Artemisinin Action and Resistance in Plasmodium falciparum. *Trends in Parasitology*, 32(9), pp. 682-696.

- Tini, M., Jewell, U., Camenisch, G., Chilov, D. and Gassmann, M., 2002. Generation and application of chicken egg-yolk antibodies. *Comparative biochemistry and physiology part A: molecular & integrative physiology*, 131(3), pp. 569-574.
- Tong, C., Geng, F., He, Z., Cai, Z. and Ma, M., 2014. A simple method for isolating chicken egg yolk immunoglobulin using effective delipidation solution and ammonium sulfate. *Poultry science*, 94(1), pp. 104-110.
- Tsan, M.-F. and Gao, B., 2004. Cytokine function of heat shock proteins. *American Journal of Physiology-Cell Physiology*, 286(4), pp. C739-C744.
- Tsuchiya, S., Yamabe, M., Yamaguchi, Y., Kobayashi, Y., Konno, T. and Tada, K., 1980. Establishment and characterization of a human acute monocytic leukemia cell line (THP-1). *International journal of cancer*, 26(2), pp. 171-176.
- Udomsangpetch, R., Pipitaporn, B., Krishna, S., Angus, B., Pukrittayakamee, S., Bates, I., Suputtamongkol, Y., Kyle, D. and White, N., 1996. Antimalarial drugs reduce cytoadherence and rosetting of Plasmodium falciparum. *Journal of Infectious Diseases*, 173(3), pp. 691-698.
- Udomsangpetch, R., Pipitaporn, B., Silamut, K., Pinches, R., Kyes, S., Loareesuwan, S., Newbold, C. and White, N. J., 2002. Febrile temperatures induce cytoadherence of ring-stage Plasmodium falciparum-infected erythrocytes. *Proceedings of the National Academy of Sciences*, 99(18), pp. 11825-11829.
- Ukkonen, K., Veijola, J., Vasala, A. and Neubauer, P., 2013. Effect of culture medium, host strain and oxygen transfer on recombinant Fab antibody fragment yield and leakage to medium in shaken E. coli cultures. *Microbial cell factories*, 12(73), pp. 1.(10.1186/1475-2859-12-73).
- Urban, B. C. and Roberts, D. J., 2002. Malaria, monocytes, macrophages and myeloid dendritic cells: sticking of infected erythrocytes switches off host cells. *Current opinion in immunology*, 14(4), pp. 458-465.
- Utsugi, M., Dobashi, K., Koga, Y., Masubuchi, K., Shimizu, Y., Endou, K., Nakazawa, T. and Mori, M., 2002. Ambroxol inhibits platelet-derived growth factor production in human monocytic cells. *European journal of pharmacology*, 436(1), pp. 47-51.
- Vadas, P., Taylor, T. E., Chimsuku, L., Goldring, D., Stefanski, E., Pruzanski, W. and Molyneux, M. E., 1993. Increased serum phospholipase A2 activity in Malawian children with falciparum malaria. *The American journal of tropical medicine and hygiene*, 49(4), pp. 455-459.
- Van Agtmael, M. A., Eggelte, T. A. and van Boxtel, C. J., 1999. Artemisinin drugs in the treatment of malaria: from medicinal herb to registered medication. *Trends in Pharmacological Sciences*, 20(5), pp. 199-205.
- Van Furth, R., 1982. Current view on the mononuclear phagocyte system. *Immunobiology*, 161(3-4), pp. 178-185.
- Van Molle, W., Wielockx, B., Mahieu, T., Takada, M., Taniguchi, T., Sekikawa, K. and Libert, C., 2002. HSP70 protects against TNF-induced lethal inflammatory shock. *Immunity*, 16(5), pp. 685-695.
- Van Wyngaardt, W. and Du Plessis, D., 1998. Selection of an scFv phage antibody that recognizes bluetongue virus from a large synthetic library and its use in ELISAs to detect viral antigen and antibodies. *Onderstepoort Journal of Veterinary Research*, 65, pp. 125-131.
- Van Wyngaardt, W., Malatji, T., Mashau, C., Fehrsen, J., Jordaan, F., Miltiadou, D. and Du Plessis, D. H., 2004. A large semi-synthetic single-chain Fv phage display library based on chicken immunoglobulin genes. *BMC biotechnology*, 4(1), pp. 1.(10.1186/1472-6750-4-6).
- Varalakshmi, C., Ali, A. M., Pardhasaradhi, B., Srivastava, R. M., Singh, S. and Khar, A., 2008. Immunomodulatory effects of curcumin: in-vivo. *International immunopharmacology*, 8(5), pp. 688-700.
- Voss, J., 1964. Lysozyme lysis of gram-negative bacteria without production of spheroplasts. *Microbiology*, 35(2), pp. 313-317.
- Wachter, H., Fuchs, D., Hausen, A., Reibnegger, G. and Werner, E. R., 1989. Neopterin as marker for activation of cellular immunity: immunologic basis and clinical application. *Advances in clinical chemistry*, 27, pp. 81-141.
- Wada, K., Itoh, T., Nakagawa, M., Ryou, M., Mori, H. and Tamaya, T., 1992. Estrogen binding sites in peripheral blood monocytes and effects of danazol on their sites in vitro. *General Pharmacology: The Vascular System*, 23(4), pp. 693-700.
- Wang, J., Zhou, H., Zheng, J., Cheng, J., Liu, W., Ding, G., Wang, L., Luo, P., Lu, Y. and Cao, H., 2006. The antimalarial artemisinin synergizes with antibiotics to protect against lethal live Escherichia coli

- challenge by decreasing proinflammatory cytokine release. *Antimicrobial agents and chemotherapy*, 50(7), pp. 2420-2427.
- Wang, J. X., Tang, W., Shi, L. P., Wan, J., Zhou, R., Ni, J., Fu, Y. F., Yang, Y. F., Li, Y. and Zuo, J. P., 2007. Investigation of the immunosuppressive activity of artemether on T-cell activation and proliferation. *British journal of pharmacology*, 150(5), pp. 652-661.
- Wang, S., Diller, K. R. and Aggarwal, S. J., 2003. Kinetics study of endogenous heat shock protein 70 expression. *Journal of biomechanical engineering*, 125(6), pp. 794-797.
- Warnock, M. L., Sniezek, M. and Shellito, J., 1987. Endogenous peroxidase activity as a marker of macrophage renewal during BCG-induced inflammation in the rat lung. *The American journal of pathology*, 128(1), pp. 171-180.
- Watkins, W., Mberu, E., Winstanley, P. and Plowe, C., 1997. The efficacy of antifolate antimalarial combinations in Africa: a predictive model based on pharmacodynamic and pharmacokinetic analyses. *Parasitology Today*, 13(12), pp. 459-464.
- Watters, J. M., Telleman, P. and Junghans, R. P., 1997. An optimized method for cell-based phage display panning. *Immunotechnology*, 3(1), pp. 21-29.
- Weatherall, D. J., Miller, L. H., Baruch, D. I., Marsh, K., Doumbo, O. K., Casals-Pascual, C. and Roberts, D. J., 2002. Malaria and the red cell. *ASH Education Program Book*, 2002(1), pp. 35-57.
- Weinberg, J. B., Volkheimer, A. D., Rubach, M. P., Florence, S. M., Mukemba, J. P., Kalingonji, A. R., Langelier, C., Chen, Y., Bush, M. and Yeo, T. W. (2016) *Monocyte polarization in children with falciparum malaria: relationship to nitric oxide insufficiency and disease severity*. Scientific Reports 6).
- Welinder, C. and Ekblad, L., 2011. Coomassie staining as loading control in Western blot analysis. *Journal of proteome research*, 10(3), pp. 1416-1419.
- Wenisch, C., Parschalk, B., Narzt, E., Looareesuwan, S. and Graninger, W., 1995. Elevated serum levels of IL-10 and IFN- γ in patients with acute Plasmodium falciparum malaria. *Clinical immunology and immunopathology*, 74(1), pp. 115-117.
- Wenisch, C., Parschalk, B., Zedwitz-Liebenstein, K., Wernsdorfer, W. and Graninger, W., 1997. The effect of artemisinin on granulocyte function assessed by flow cytometry. *Journal of Antimicrobial Chemotherapy*, 39(1), pp. 99-101.
- Werner, E. R., Werner-Felmayer, G., Fuchs, D., Hausen, A., Reibnegger, G., Yim, J., Pfeleiderer, W. and Wachter, H., 1990. Tetrahydrobiopterin biosynthetic activities in human macrophages, fibroblasts, THP-1, and T 24 cells. GTP-cyclohydrolase I is stimulated by interferon-gamma, and 6-pyruvoyl tetrahydropterin synthase and sepiapterin reductase are constitutively present. *Journal of Biological Chemistry*, 265(6), pp. 3189-3192.
- Westerheide, S. D., Kawahara, T. L., Orton, K. and Morimoto, R. I., 2006. Triptolide, an inhibitor of the human heat shock response that enhances stress-induced cell death. *Journal of biological chemistry*, 281(14), pp. 9616-9622.
- Westra, D. F., Welling, G. W., Koedijk, D. G. A. M., Scheffer, A. J., The, T. H. and Welling-Wester, S., 2001. Immobilised metal-ion affinity chromatography purification of histidine-tagged recombinant proteins: a wash step with a low concentration of EDTA. *Journal of Chromatography B: Biomedical Sciences and Applications*, 760(1), pp. 129-136. ([http://dx.doi.org/10.1016/S0378-4347\(01\)00261-4](http://dx.doi.org/10.1016/S0378-4347(01)00261-4)).
- Whirl-Carrillo, M., McDonagh, E., Hebert, J., Gong, L., Sangkuhl, K., Thorn, C., Altman, R. and Klein, T. E., 2012. Pharmacogenomics knowledge for personalized medicine. *Clinical pharmacology and therapeutics*, 92(4), pp. 414-417.
- White, N., Warrell, D., Bunnag, D., Looareesuwan, S., Chongsuphajaisiddhi, T. and Harinasuta, T., 1981. Quinidine in falciparum malaria. *The Lancet*, 318(8255), pp. 1069-1071.
- WHO (2010) *World Malaria Report*, Geneva: World Health Organisation.
- WHO (2015a) *Guidelines for the treatment of malaria*, Geneva: World Health Organisation.
- WHO (2015b) *World Malaria Report*, Geneva: World Health Organisation.
- WHO (2016) *World Malaria Report*, Geneva: World Health Organisation.
- Wink, D. A., Hines, H. B., Cheng, R. Y., Switzer, C. H., Flores-Santana, W., Vitek, M. P., Ridnour, L. A. and Colton, C. A., 2011. Nitric oxide and redox mechanisms in the immune response. *Journal of leukocyte biology*, 89(6), pp. 873-891.(10.1189/jlb.1010550).

- Winter, G., Griffiths, A. D., Hawkins, R. E. and Hoogenboom, H. R., 1994. Making antibodies by phage display technology. *Annual review of immunology*, 12(1), pp. 433-455.
- Wolf, R., Wolf, D. and Ruocco, V., 2000. Antimalarials: unapproved uses or indications. *Clinics in dermatology*, 18(1), pp. 17-35.
- Wu, M. L., Huang, T. C., Hung, H. J., Yu, J. H., Chung, W. B. and Chung, H. C., 2010. Investigation of beta-glucans binding to human/mouse dectin-1 and associated immunomodulatory effects on two monocyte/macrophage cell lines. *Biotechnology progress*, 26(5), pp. 1391-1399.
- Wu, X., Wang, Y., Wang, H., Wang, Q., Wang, L., Miao, J., Cui, F. and Wang, J., 2012. Quinacrine inhibits cell growth and induces apoptosis in human gastric cancer cell line SGC-7901. *Current Therapeutic Research*, 73(1), pp. 52-64.
- Xia, C., Cai, Y., Li, S., Yang, J. and Xiao, G., 2015. Curcumin increases HSP70 expression in primary rat cortical neuronal apoptosis induced by gp120 V3 loop peptide. *Neurochemical research*, 40(9), pp. 1996-2005.
- Xu, G., Zou, W.-Q., Du, S.-J., Wu, M.-J., Xiang, T.-X. and Luo, Z.-G., 2016. Mechanism of dihydroartemisinin-induced apoptosis in prostate cancer PC3 cells: An iTRAQ-based proteomic analysis. *Life sciences*, 157, pp. 1-11.
- Yang, Y., Takeda, A., Yoshimura, T., Oshima, Y., Sonoda, K.-H. and Ishibashi, T., 2013. IL-10 is significantly involved in HSP70-regulation of experimental subretinal fibrosis. *PLoS one*, 8(12), pp. e80288. (<http://dx.doi.org/10.1371/journal.pone.0080288>).
- Yenari, M. A., Liu, J., Zheng, Z., Vexler, Z. S., Lee, J. E. and Giffard, R. G., 2005. Antiapoptotic and anti-inflammatory mechanisms of heat-shock protein protection. *Ann N Y Acad Sci*, 1053, pp. 74-83. (10.1196/annals.1344.007).
- Yeo, T. W., Lampah, D. A., Kenangalem, E., Tjitra, E., Weinberg, J. B., Granger, D. L., Price, R. N. and Anstey, N. M., 2014. Decreased endothelial nitric oxide bioavailability, impaired microvascular function, and increased tissue oxygen consumption in children with falciparum malaria. *Journal of Infectious Diseases*, 210(10), pp. 1627-1632.
- Yilmaz, M., Ozic, C. and Gok, İ. (2012) *Principles of Nucleic Acid Separation by Agarose Gel Electrophoresis. Gel electrophoresis-principles and basics*.
- Young, J. C., Moarefi, I. and Hartl, F. U., 2001. Hsp90: a specialized but essential protein-folding tool. *Journal of Cell Biology*, 154(2), pp. 267-274.
- Yu, L., Ternansky, R. J., Crisologo, J. F., Chang, J., Baker, B. L. and Coutts, S. M., 1998. Carbonothioate phospholipids as substrate for a spectrophotometric assay of phospholipase A 2. *Analytical biochemistry*, 265(1), pp. 35-41.
- Yun, J.-M., Jialal, I. and Devaraj, S., 2011. Epigenetic regulation of high glucose-induced proinflammatory cytokine production in monocytes by curcumin. *The Journal of nutritional biochemistry*, 22(5), pp. 450-458.
- Zalis, M. G., Pang, L., Silveira, M. S., Milhous, W. K. and Wirth, D. F., 1998. Characterization of Plasmodium falciparum isolated from the Amazon region of Brazil: evidence for quinine resistance. *The American journal of tropical medicine and hygiene*, 58(5), pp. 630-637.
- Zanucoli, F., Thomé, R., Bonfanti, A. P., Carvalho, A. C., Issayama, L. K., Costa, T. A., Di Gangi, R., Ferreira, I. T., Bombeiro, A. L. and Oliveira, A. L. R., 2014. Primaquine treatment suppresses experimental autoimmune encephalomyelitis severity. *CNS neuroscience & therapeutics*, 20(12), pp. 1061-1064.
- Zapolska-Downar, D., Zapolski-Downar, A., Markiewski, M., Ciechanowicz, A., Kaczmarczyk, M. and Naruszewicz, M., 2001. Selective inhibition by probucol of vascular cell adhesion molecule-1 (VCAM-1) expression in human vascular endothelial cells. *Atherosclerosis*, 155(1), pp. 123-130.
- Zhang, H., Zhang, L., Yu, F., Liu, Y., Liang, Q., Deng, G., Chen, G., Liu, M. and Xiao, X., 2012. HSF1 is a transcriptional activator of IL-10 gene expression in RAW264.7 macrophages. *Inflammation*, 35(4), pp. 1558-1566.
- Zhang, W., Chen, C., Shi, H., Yang, M., Liu, Y., Ji, P., Chen, H., Tan, R. X. and Li, E., 2016. Curcumin is a biologically active copper chelator with antitumor activity. *Phytomedicine*, 23(1), pp. 1-8.
- Zheng, H., Nagaraja, G. M., Kaur, P., Asea, E. E. and Asea, A., 2010. Chaperone function of recombinant Hsp72 produced in insect cells using a baculovirus expression system is retained. *Journal of Biological Chemistry*, 285(1), pp. 349-356.
- Zidovetzki, R., Sherman, I. W. and O'Brien, L., 1993. Inhibition of Plasmodium falciparum phospholipase A2 by chloroquine, quinine, and arteether. *The Journal of parasitology*, pp. 565-570.

Ziegler-Heitbroc, H., Thiel, E., Futterer, A., Herzog, V., Wirtz, A. and Riethmüller, G., 1988. Establishment of a human cell line (Mono Mac 6) with characteristics of mature monocytes. *International Journal of cancer*, 41(3), pp. 456-461.

Ziemienowicz, A., Zylicz, M., Floth, C. and Hübscher, U., 1995. Calf thymus Hsc70 protein protects and reactivates prokaryotic and eukaryotic enzymes. *Journal of Biological Chemistry*, 270(26), pp. 15479-15484.

"Cloning Of Scfv Fragments | Antibody Design Labs". *Abdesignlabs.com*. N.p., 2017. Web. 7 Jan. 2017.

"Free Chicken Clipart - Clip Art Pictures - Graphics - Illustrations". *Classroomclipart.com*. N.p., 2017. Web. 7 Jan. 2017.

<https://www.id-interactive.fr/>, ID. "Rabbit Antibody Development And Production". *Biotem-antibody.com*. N.p., 2017. Web. 7 Jan. 2017.

"Monocyte Cell Clip Art At Clker.Com - Vector Clip Art Online, Royalty Free & Public Domain". *Clker.com*. N.p., 2017. Web. 7 Jan. 2017.

"Project 4A Manual: Experimental Procedures". *Di.uq.edu.au*. N.p., 2017. Web. 7 Jan. 2017.

Protein Expression Service - Creative Biostructure". *Creative-biostructure.com*. N.p., 2017. Web. 7 Jan. 2017.

BIOTEM,. *Phage Display Biopanning*. 2017. Web. 7 Jan. 2017.