

Grid Energy Storage Devices (ESD)

by

Navin Rampersadh

Theses submitted in fulfilment of the requirements for the MScEng Degree in
Electrical Engineering in Power and Energy Systems (HVDC Strand) at the University
of KwaZulu-Natal

School of Engineering

November 2016

Supervisors: Prof I.E Davidson, Dr R. Tiako

DECLARATION

I, Navin Rampersadh, declare that:

1. The research reported in this dissertation, except where otherwise indicated; is my original work
2. This dissertation has not been submitted for any degree or examination at any other University or Institution
3. This dissertation does not contain any other person's writing, unless specifically acknowledged as being sourced from other researchers. Where other written sources have been quoted, then, their words have been re-written but the general information attributed to them has been referenced.
4. This dissertation does not contain any other person's data, graphs, pictures, tables or other information, unless specifically acknowledged in the form of in-text citations, as being obtained from other sources.
5. This dissertation does not contain text, graphics, tables, pictures or graphs copied and pasted from the internet, unless specifically acknowledged in the form of in-text citations and in the reference section of the theses.



Signed: _____

Navin Rampersadh

November, 2016

As the candidate's supervisor, I agree to the submission of this dissertation.

Signed: _____

Prof I.E Davidson

November, 2016

ACKNOWLEDGEMENTS

My sincere gratitude goes to Professor I.E Davidson; and co supervisor Dr. Remy Tiako; for giving me the guidance and support to undertake this work and complete the research and for reviewing the study results and offering advice and direction. To Ashwin Maharaj, Rodney Rueben and Dinesh Boodhraj for providing the motivation to keep going and late night conversations.

To my parents, and sister, for instilling in me at an early age the value of education and for always supporting me in my quests.

To my wife Roma, for being a constant source of encouragement and support, without whom this work would not be possible.

And to my children Cameron and Emma, you are my inspiration.

CONTENTS

1.	CHAPTER 1 - INTRODUCTION.....	10
1.1	BACKGROUND.....	10
1.2	STRATEGIC CONTEXT	10
1.3	OBJECTIVES	11
1.4	DISSERTATION STRUCTURE	11
2.	CHAPTER 2 - LITERATURE REVIEW OF ENERGY STORAGE DEVICES.....	12
2.1	COMPRESSED AIR ENERGY STORAGE (CAES).....	13
2.2	FLYWHEEL ENERGY STORAGE (FES).....	15
2.3	PUMPED HYDROELECTRIC STORAGE (PHS).....	16
2.4	HYDROGEN ENERGY STORAGE (HES).....	17
2.5	SUPER-CAPACITORS	18
2.6	BATTERY STORAGE.....	20
2.6.1	<i>Introduction into Battery Technology.....</i>	<i>20</i>
2.6.2	<i>Different types of battery technologies.....</i>	<i>21</i>
2.6.3	<i>Comparison of Battery Types.....</i>	<i>28</i>
2.6.4	<i>Cost comparison of Battery technology [39], [40], [41], [42], [43], [44]</i>	<i>29</i>
3.	CHAPTER 3 - RESEARCH METHODOLOGY - GRID SCALE BATTERY STORAGE ...	31
3.1	INTRODUCTION	31
3.2	DESCRIPTION OF A BATTERY STORAGE SYSTEM.....	31
3.3	DRIVERS, APPLICATION AND CHALLENGES	32
3.3.1	<i>Drivers and Application [1], [3], [13], [24], [60], [61]</i>	<i>32</i>
3.3.2	<i>Challenges [1], [3], [13], [24], [60].....</i>	<i>33</i>
3.4	REGULATORY FRAMEWORK.....	34
3.5	COMMERCIAL FRAMEWORK.....	35
3.6	PROCUREMENT PATHWAY.....	35
3.7	TYPICAL SINGLE LINE DIAGRAM (SLD) OF A GRID SCALE BATTERY STORAGE DEVICE	37
3.8	TYPICAL LAYOUT DIAGRAM OF A GRID SCALE BATTERY STORAGE DEVICE	38
4.	CHAPTER 4 - CASE STUDIES.....	39
4.1	CASE STUDY: SOUTH AUSTRALIA.....	39
4.1.1	<i>Introduction.....</i>	<i>39</i>
4.1.2	<i>Business case.....</i>	<i>39</i>
4.1.3	<i>Project Innovation.....</i>	<i>40</i>
4.1.4	<i>Benefit.....</i>	<i>40</i>
4.1.5	<i>Design.....</i>	<i>40</i>
4.2	CASE STUDY 2: INTEGRATION OF ENERGY STORAGE FOR RENEWABLE ENERGY	41
4.2.1	<i>Need.....</i>	<i>41</i>
4.2.2	<i>Project innovation.....</i>	<i>41</i>
4.2.3	<i>Benefit.....</i>	<i>42</i>
4.3	WORLDWIDE INSTALLATION OF BATTERY GRID STORAGE	43
4.3.1	<i>Kahuku, Hawaii.....</i>	<i>43</i>
4.3.2	<i>Maui, Hawaii.....</i>	<i>44</i>
4.3.3	<i>Tehachapi, California, United States.....</i>	<i>45</i>

4.3.4	Goldsmith, Texas, United States, Notrees wind farm.....	47
4.3.5	Kodiak Island, Alaska.	48
4.3.6	Copiapo, Atacama, Chile.....	49
4.3.7	University New Mexico, United States of America.	50
4.3.8	Mejillones, Antofagasta, Chile.	51
4.3.9	Luverne, Minnesota, United States.,	52
4.3.10	Fairbanks, Alaska United States of America.	52
4.3.11	Presidio, Texas United States of America.	54
4.3.12	Illinois, United States of America, Jake Energy Storage Centre.	55
4.3.13	West Virginia, United States of America, Beech Ridge.....	56
4.3.14	Gimje-si, South Korea,	56
4.3.15	Elkins, Laurel Mountain Windfarm, West Virginia, USA.....	57
4.3.16	Sendia, Japan, Nishi-Sendai Substation.....	58
4.3.17	Northern Ireland, United Kingdom.	58
4.3.18	Brandenburg, Germany,	59
4.3.19	Kabankalan, Philippines-	60
4.3.20	Minamisoma, Japan.	60
4.3.21	Lünen , North Rhine-Westphalia, Germany.	61
4.3.22	Toronto, Ontario Canada.....	62
4.3.23	Vlissingen, Netherlands.....	62
4.3.24	South Korea.....	62
4.3.25	National Grid, United Kingdom.	63
4.3.26	Roxby Downs, South Australia.....	64
4.3.27	Rokkasho, Japan, Rokkasho Wind Farm.....	65
4.3.28	Italy (3 Projects).....	65
4.3.29	Buzen, Fukuoka Prefecture, Japan.	66
4.4	SUMMARY OF WORLDWIDE INSTALLATIONS.....	67
5.	CHAPTER 5- CONCLUSIONS AND RECOMMENDATIONS.....	68
5.1	RECOMMENDATIONS.....	68
5.1.1	Opportunities.....	68
5.1.2	Development Needs.....	68
5.1.3	Next Steps in Research.....	68
5.2	CONCLUSION.....	70
	REFERENCES.....	71

Figures

Figure 1: Energy Storage Technologies [14]	12
Figure 2: Worldwide installed energy storage capacity in MW, [37]	12
Figure 3 : Schematic Diagram of typical CAES Plant [3]	13
Figure 4 : CAES Model ©2012 Apex	14
Figure 5: System description of a flywheel energy storage device [5].....	15
Figure 6: Pumped hydroelectric storage plant layout [3].....	17
Figure 7: Topology of Hydrogen storage [3].....	18
Figure 8: Typical construction of a supercapacitor [17]	19
Figure 9: Schematic of a typical battery storage system operation.....	20
Figure 10 :Charge and Discharge State of a Lead Acid Battery [31].....	21
Figure 11: Li-ion principle of reversibility [36].....	22
Figure 12: Li-Ion Storage solutions available from SAFT [36].....	23
Figure 13 : Cross section schematic of NaS [NASA Research Centre]	24
Figure 14: Sodium Sulphur Battery System [Courtesy of NGK].....	24
Figure 15: Cause of the Fire at Tsukuba Plant [35].....	25
Figure 16: Fire containment implemented by NGK [35]	25
Figure 17: Schematic overview of a flow cell energy storage system [38]	26
Figure 18: 36 MW Battery Storage for 153 MW Wind Integration, Source@ Duke Energy, Texas	31
Figure 19: Typical Battery Storage System and main power components [courtesy of EPRI]	32
Figure 20: Kahuku, Hawaii Younicos 15MW Lead Acid Battery Storage System [45]	43
Figure 21:Maui, Hawaii, Lead acid battery system [45]	44
Figure 22: Tehachapi, California, United States, 32MWh Lithium-ion battery storage system [45]	46
Figure 23: Tehachapi, California, United States, 32MWh Li-ion battery storage system [45].....	46
Figure 24: Goldsmith, Texas, United States. 36MW advanced lead acid battery system [45]	47
Figure 25: Kodiak Island, Alaska, 3MW advanced lead acid battery system [45]	48
Figure 26: Copiapo, Atacama, Chile, 12MW lithium ion battery storage system [45].....	49
Figure 27: University New Mexico, USA, Ecoult/East Penn Manufacturing battery storage system.....	50
Figure 28: Mejillones, Antofagasta, Chile. 20MW Lithium ion battery storage system.....	51
Figure 29: Luverne, Minnesota, United States, Sodium Sulphur battery storage system [45]	52
Figure 30: Fairbanks, Alaska Untied States of America. 27MW Ni-Cad battery storage system [45].....	53
Figure 31: Presidio, Texas United States of America. 4MW Sodium Sulphur battery system [45].....	54
Figure 32: Illinios, USA, RES Americas 2x19.8 MW lithium iron phosphate batteries [45]	55
Figure 33: West Virginia, United States of America. 31.5 MW lithium iron phosphate batteries [45].....	56
Figure 34: Gimje-si, South Korea. 24 MW Li-ion battery storage system KEPCO / Kokam [45], [50]	57
Figure 35: Elkins, Laurel Mountain Windfarm, West Virginia, USA. 32 MW lithium ion batteries [45].....	57
Figure 36: Sendia, Japan, Nishi-Sendai Substation. 40MW lithium-ion battery system [45].....	58
Figure 37: Northern Ireland, United Kingdom. 10 MW lithium ion batteries [45], [58]	59
Figure 38: Brandenburg, Germany. 10MW lithium ion battery system [45]	59
Figure 39: Kabankalan, Philippines, AES/National Grid of Philippines. [59]	60
Figure 40: Minamisoma, Japan. 40 MW lithium ion battery system	61
Figure 41: Lünen , North Rhine-Westphalia, Germany. 15 MW lithium-ion battery system.....	61
Figure 42: South Korea. West-Ansung (Seo-Anseong) Substation. 52 MW across 2 sites [50]	62
Figure 43: National Grid, United Kingdom.20 MW of energy storage [51].....	63
Figure 44: Roxby Downs, South Australia, Planning 100 MWh of battery storage [52]	64
Figure 45: Rokkasho, Japan. Rokkasho Village Wind Farm using sodium sulphur (NAS) batteries [53]	65
Figure 46: Buzen, Fukuoka Prefecture, Japan. 50 MW Sodium sulphur (NaS) battery system [55]	66

Tables

Table 1: Selected flywheel energy storage devices [7], [9], [10], [11] and [12]	16
Table 2: Lead Acid battery energy storage systems [6], [17], [27], [28] and [29]	21
Table 3 : Comparison of flow batteries [38]	27
Table 4: Comparison of Li-ion and lead acid battery cells [31]	28
Table 5: Technical Comparison of common types of batteries	29
Table 6 : Battery Technology Capital Cost Comparison [39], [40], [41], [42], [43], [44]	29
Table 7: Battery Technology LCOE costs [39], [40], [41]	30

Glossary of Terms

Term	Description
AESKB	Australian Energy Storage Knowledge Bank
ARENA	Australian Renewable Energy Agency
Br	Bromine
CAES	Compressed Air Energy Storage
Cd	Cadmium
DNSP	Distribution Service Network Provider
ESCRI	Energy Storage for Commercial Renewable Integration
EV	Electric Vehicle
FB	Flow Battery
FES	Flywheel Energy Storage
H ₂	Hydrogen
HES	Hydrogen Energy Storage
IP	Intellectual Property
LA	Lead Acid
LCOE	Levelised Cost of Electricity
Li-ion	Lithium Ion (battery)
LP	Low Pressure
NaS	Sodium Sulphur
NEM	National Electricity Market
NiCd	Nickel Cadmium
Pb	Lead
PbO ₂	Lead Oxide
PCS	Power Conversion System
PHS	Pumped Hydro Storage
PSB	Polysulphide Bromide Batteries
PV	Photovoltaic
R&D	Research and Development
RFB	Redox Flow Battery
SCADA	Supervisory Control and Data Acquisition
SLA	Seal Lead Acid
VRLA	Valve Regulated Lead Acid
UPS	Uninterruptable Power Supply
ZnBr	Zinc Bromine

Abstract

Energy storage technologies are projected to transform the way in which the world utilises, controls and dispatches electrical energy in the near future. With the increasing amount of renewable energy being injected into transmission and distribution networks and the rapid uptake of rooftop solar photovoltaic installations in households, energy storage is unlocking a new market in renewable energy and enabling new opportunities. Government subsidies are incentivising consumers to invest aggressively in new and emerging renewable technologies. This trend is expected to overflow into the electricity transmission and distribution arena in the form of Grid-Scale Battery Storage; in the pursuit of greater flexibility, control and utilization of electrical power. Energy storage has been in use for many years, the commonest being pump storage hydroelectricity. The prominent emerging technologies being deployed or considered for transmission grids and distribution networks include: large-scale battery storage, flywheels, compressed air and hydrogen.

This research investigation focusses on grid energy storage devices and their application in electric delivery systems. It describes the emerging technologies and details of grid battery storage. Grid battery storage will complement the vast spread of renewable energy connected to the grid. Whilst this form of storage is being investigated globally, with a handful of utilities installing them for research and development; technology maturity and mass production will drive down lifecycle costs. The introduction and application of cost effective grid-scale battery storage will be a game-changer for the distribution and control of electrical energy. Energy storage is an effective enabler to store unused energy at times of low demand, supplement and store wind and solar energy (when the wind stops or the sun goes down); and also be used for demand side management (peak shaving), grid stability and power quality.

The evolution and integration of new energy storage devices will drive the requirement for:

- Development of international and national standards;
- Development of policy, guidelines and regulation to support utilities, consumers and manufacturers;
- Development of policy and regulation to ensure safety performance for installation, maintenance and disposal (total life cycle);
- Development of Grid-Code for Energy storage;
- Development of tariffs which support grid-scale battery storage.

There is a need to gain hands-on experience to adopt grid-scale battery storage in order to capitalise on this technology in future power grids. This mini-dissertation will aim to identify the requirements and specifications for grid energy storage. The key objectives are to lower net consumer energy costs, encourage innovation, and have protocols in place to ensure mass installation is carried out credibly, safely and consistently

1. Chapter 1 - Introduction

1.1 Background

Energy storage is merely a method to change electrical energy from a power grid network into a configuration that can be stored for changing it back into electrical energy when required [1]. The initial implementation of the storage devices goes back to the 20th century, when electrical stations were shut down, with lead-acid storage devices providing supply to the residual loads on the direct current networks [2].

Transmission, distribution and generation of electrical energy is changing worldwide due to the pressures of greenhouse gas reduction and unpredictable load profiles of renewable energy. The evolution of energy storage devices has the potential to reduce these pressures. Storage will play an important part in increasing competition and increasing the supply of renewable energy by merely allowing renewable energy to be delivered during peak times when it's most required and deliver stored energy when the renewable energy is not efficient.

In the coming years the storage industry will evolve quickly and new technologies could shift the way the power grid has conventionally been operated and maintained. Battery energy storage uptake in the industry is foreseen to be enormous rather than incremental impact. Standards, specifications, processes and procedures will be required to suit this change to ensure safety, quality and reliability of the power grid is maintained.

Battery energy storage systems has already been developed extensively in recent years and the expectation is that it will continue to develop. Although the costs are still prohibitively expensive for large immediate deployment, there is a trend for cost reduction for battery cells such as lithium ion and flow battery systems demonstrates that there will be a considerable shift towards these systems in the next one to two decades.

There will be a need to provide industry learnings to inform key stakeholders such as manufacturers, local communities, consumers, purchasers, electricity asset owners/operators, regulators, retailers and policymakers.

1.2 Strategic context

Utilities are faced with issues regarding large scale renewable energy connected to their grid considering that wind generation capacity is around 20 to 30% and it tends to be the strongest at night which is when the demand is low. Similarly, large scale solar power is ineffective when there isn't sun penetration. The expectations are that storage will position itself to be a vital role in the power sector of the future where it can support the injection of variable grid scale renewable energy. Strategically there is a need to gain real experience to monitor and adopt power grids worldwide so as not to be lagging behind in implementation.

1.3 Objectives

Despite developments and uptake of renewable energy generators, utilities still face technical issues, with the key being intermittent supply of energy. The introduction of energy storage will provide more value to renewable energy and power system operators.

Key objectives set for this dissertation are as follows:

- Demonstrate that energy storage devices increase the value and provide grid support when required
- Demonstrate that storage devices can meet grid standards in terms of safety, quality and reliability
- Commercial sense to deploy energy storage devices, drivers, applications and challenges
- How the regulatory framework can be established, i.e. who can own, operate and maintain storage devices, tariff structures

1.4 Dissertation structure

Battery storage is a versatile type of storage and has many relevant applications including empowering of renewables, therefore this dissertation focus is on battery storage at grid scale. There are many other types of energy storage technologies worth highlighting, some of which have been adopted worldwide.

Chapter Two: This chapter describes literature overview analysis of various energy storage technologies and devices as a lead up to the other chapters. This chapter will also include various categories of energy storage such as their functions, storage duration and response times. The most widely used energy storage technologies in industry and daily life is the rechargeable battery. It focuses on battery technology and battery storage for grid support and ascertain the value it provides to renewable energy and will also include highlights of small scale consumer photovoltaic (PV) and battery storage combination. The main battery systems are included with comparisons of each type

Chapter Three: Research methodology of grid battery storage more in detail, highlighting regulatory framework, reliability, quality, commerciality, procurement, ownership of grid storage devices, drivers, application and challenges which battery storage will face. There are a handful of countries already leading the way with battery storage, and the chapter also researches the approach they took for design and construction. Included in this chapter is also typical single line drawing and a layout of a grid storage battery system.

Chapter Four: Involves case studies of proposed grid support installation in South Australia and review battery storage projects already installed internationally and highlight the valuable properties provided by grid energy storage. Although the total energy storage market is expected to be large, it will remain very sensitive and this leads into Chapter five.

Chapter Five: Conclusions and recommendations. The recommendations focus on opportunities, development needs and next steps required for researching energy storage devices focusing on batteries.

2. Chapter 2 - Literature Review of Energy Storage Devices

Energy storage systems can be categorised into energy ratings with a comparatively small-scale energy making them beneficial for power reliability/quality or uninterruptible power supplies (UPS); and those for administration of energy [6].

Energy storage devices or systems can be grouped in the following different categories [6], [13], [14]:

- Mechanical storage* in the form of potential energy (pumped hydro storage or compressed air) and kinetic energy (flywheels)
- Chemical storage* in the form of hydrogen energy, thermo-chemical energy (solar fuels)
- Electrical energy storage* in the form of capacitors and super-capacitors
- Thermal energy storage* in the form of cold and heat storage
- Electrochemical Energy storage* (secondary and flow batteries)

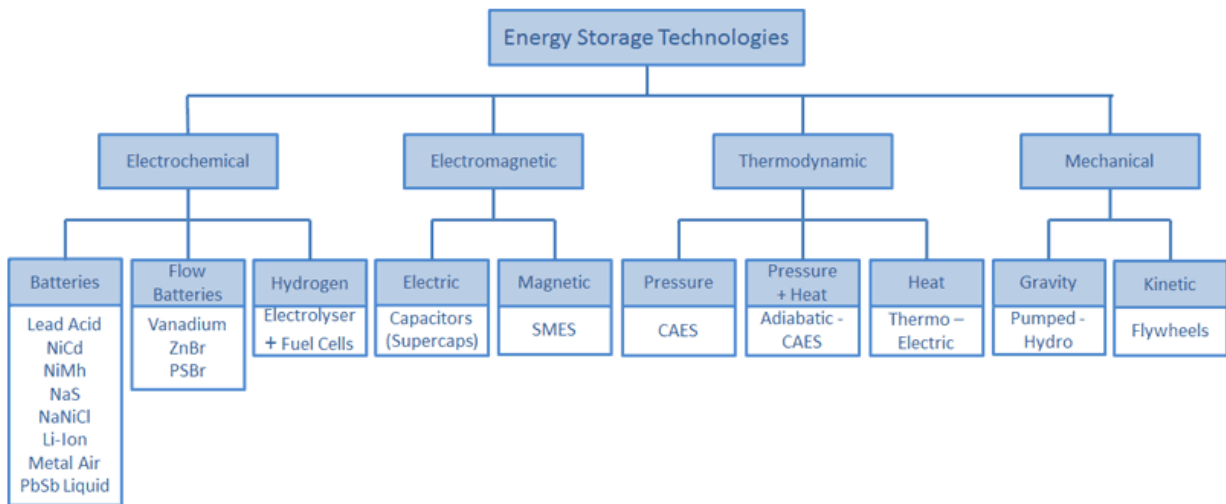

Figure 1: Energy Storage Technologies [14]

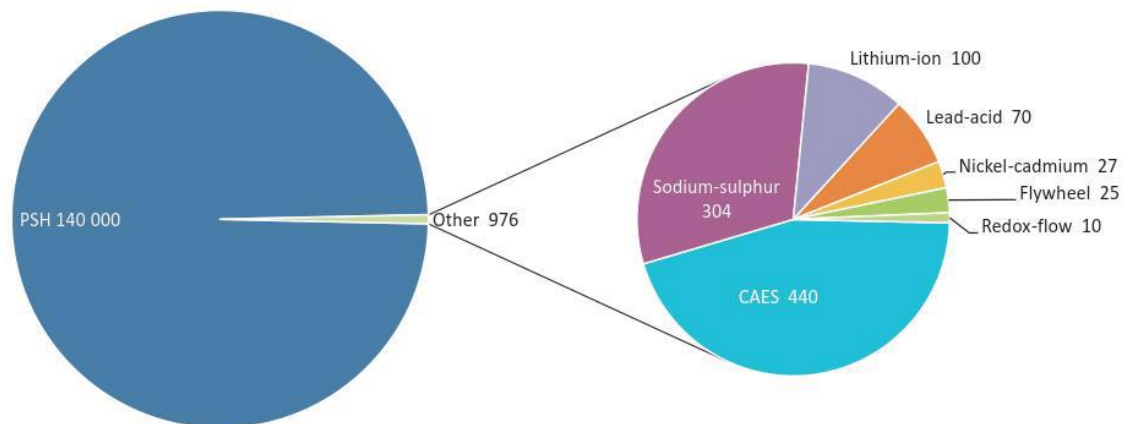

Figure 2: Worldwide installed energy storage capacity in MW, [37]

2.1 Compressed Air Energy Storage (CAES)

CAES stores large amounts of renewable energy by compressing air at very high pressures and storing it in large underground caves, caverns, wells, aquifers or mine shafts. This storage happens normally during periods where demand is low. Basic operation is surplus energy from the renewable steers a reversible generator/motor for compressing air into the storage wells in the form of high pressurised compressed air. For large scale power, storage occurs underground and small scale could be done in above ground tanks. When demand is at its peak, the stored air is delivered and heated by a heating source (fossil fuel or recovered heat via a recuperator) and the heated air is used to drive the turbines. A typical schematic diagram [3] and model of a CAES plant is shown below.

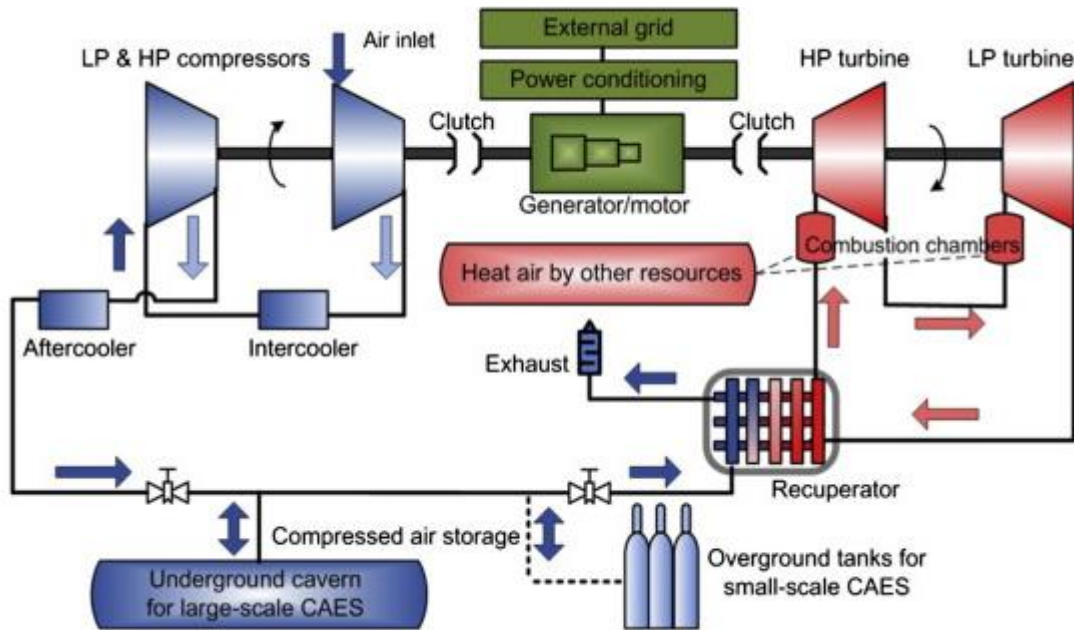

Figure 3 : Schematic Diagram of typical CAES Plant [3]

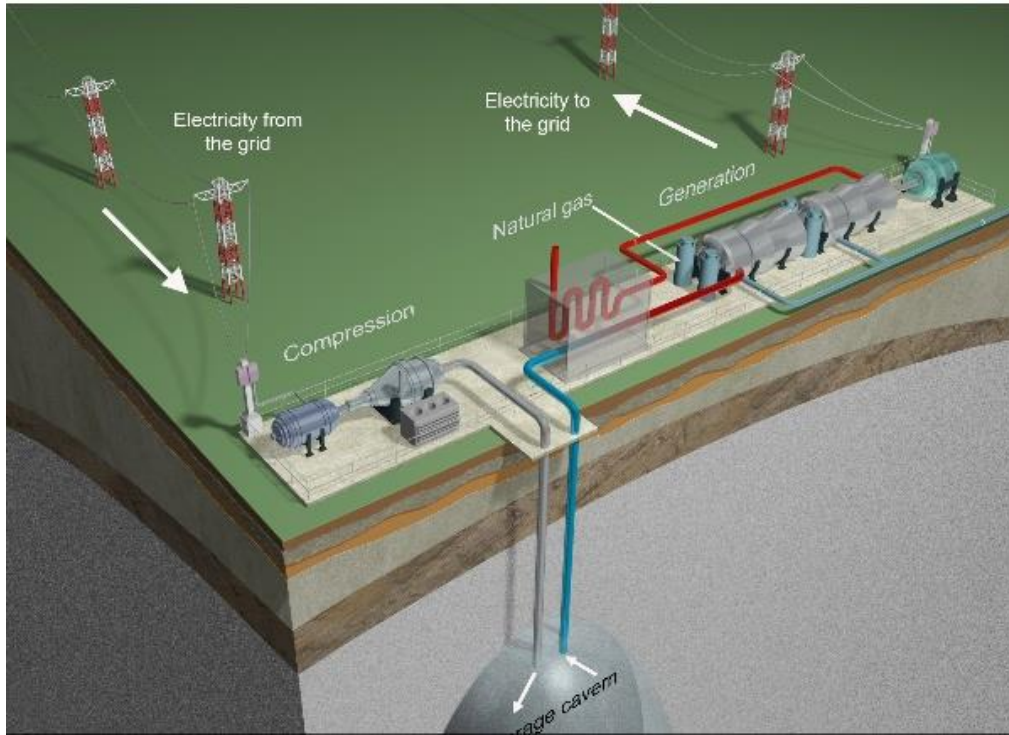

Figure 4 : CAES Model ©2012 Apex

The stored air pressure uses air compressors with intercoolers and after coolers to reduce temperatures to approximately 70 bar at air temperature of 49 °C. The efficiency of a CAES plant depends on the amount of fossil fuel used to heat the compressed air and the amount of exhaust heat being recovered by the recuperator.

The first CAES plant Huntorf, was designed and constructed in Germany [4] in 1978. The plant comprises of two salt storage caves and supply eight hours of pressurised air and two hours of operating at 290 megawatts daily [2]. The CAES system in Huntorf supports black-start capacity to a nuclear power station, support to power grid and power to bridge the supply demand between the electricity and generation.

The second CAES project, McIntosh which was commissioned in 1991 in USA [5]. The McIntosh plant is 110 MW and can deliver for up to 26 hours at full capacity. A salt cavern is used to store the compressed air. A recuperator is employed to recycle the energy delivered from the exhaust heat. Compared to the Huntorf CAES plant, this system decreases the fuel being used by 22–25% and increases the cycle efficiency from 42% to 54% [6].

The efficiency of a CAES plant will increase with less fossil fuel being used. Although the calculation cannot be straight forward as it seems because if the stored energy is grid energy supplied from fossil fuels as compared to renewable energy; to generate the fossil fuel energy in addition to storing makes total efficiency very low. Another important fact when it comes to CAES plant is the economics of the regulated market and spot pricing.

In summary, CAES power plants are a true alternative to hydroelectric pumped storage schemes. Best areas for application of CAES plant would be for balancing supply and demand, higher utilisation and better integration of renewable energy. Disadvantages are low overall efficiency and limited geographical locations.

2.2 Flywheel Energy Storage (FES)

An advanced FES system comprises of 5 main parts: a flywheel, a reversible electrical motor/generator, a power electronic unit, a group of bearings, and a vacuum chamber [7]. Figure below shows an illustration of a modern flywheel.

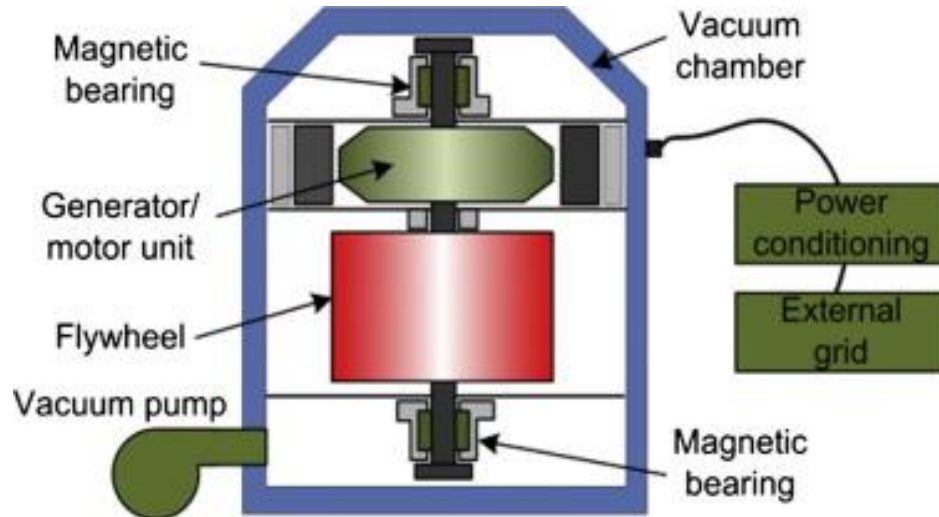

Figure 5: System description of a flywheel energy storage device [5]

FES use electrical energy stored in the formation of kinetic energy. This is basically described as “energy of motion,” and in this instance the motion of a spinning mass, namely a rotor. The rotor rotates in an enclosure chamber which is described as nearly frictionless. When backup power is required for short time intervals because grid power is either loss of fluctuating, the inertia permits the rotor to carry on rotating and the produced kinetic energy is turned to electricity. Some advanced flywheel storage devices consist of a large rotating cylinder secured to a shaft that is braced on a stator by magnetic bearings. The flywheel system functions in a vacuum to limit drag and this assists with the efficiency. The flywheel is attached to a generator/motor that interfaces with the network using power electronics.

Advantages of this technology is low maintenance, negligible environmental impact and long lifespan. Flywheels are more than capable of 100,000 and new models more than 175,000 discharge cycles. The use of flywheels enhances short term power and long term energy storage and produces high efficiency of cyclic and load characteristics. High-speed flywheels have two types of rims which are carbon composite or solid steel [8]. Selection of the materials for the rim will dictate the size, weight, performance and cost. Composite rims are known to be stronger and lighter than steel rims, and therefore can generate much faster speeds.

A few FES facilities are listed in Table 1. A 20 MW modular plant built by Beacon Power in June 2011 was commissioned in New York, [11]

Table 1: Selected flywheel energy storage devices [7], [9], [10], [11] and [12]

Company	Rating	Beneficial use
Active Power Company	100–2000 kW	Backup power supply, UPS
Beacon Power Company	100/150 kW a unit, 20 MW/5 MW h plant	voltage support, frequency regulation and power quality,
Boeing Phantom Works	100 kW/5 kW h, HT magnetic bearings	peak shaving and power quality
Japan Atomic Energy Centre	235 MVA, steel flywheel	increased power support for Nuclear generation
Piller power systems Ltd.	3600–1500 rpm, 2.4 MW for 8 s	fault ride through capability and support as backup power
NASA Glenn research centre	2×10^4 – 6×10^4 rpm, 3.6 MW h	Supply on aerospace aviation & other transports

Beacon Power Corporation, is a provider of energy storage technologies which are fast responding to support a reliable, stable and efficient power grid. The company designed and installed a 20 MW flywheel energy storage system in New York [11]. The flywheels were selected to provide fast response frequency regulation support to the New York power grid. The installation is said to have with no emissions without any fuel consumption. On comparison to other systems, it offers a clean, cost effective benefit for frequency regulation support.

In summary, FES are beneficial to applications including reliability and power quality, area regulation, fast regulation and frequency response and ride through while generators start up for long term backup supply. FES have substantial durability and high energy density which permits them to be cycled frequently with minimal impact to performance [68]. FES have fast response times from full discharge to full charge within few seconds. FES does have a disadvantage of suffering from low current efficiency, it has a high level of self-discharge due to air resistance and bearing losses.

2.3 Pumped Hydroelectric Storage (PHS)

PHS is the largest capacity form of grid storage available worldwide with more than 99% bulk storage capacity equating to more than 130 000MW with efficiency between 70 to 75% [15].

A typical PHS plant, figure below, uses two water reservoirs, located at different elevations separated vertically. During off-peak electricity demand hours, the water is pumped into the higher level reservoir; during peak hours, the water can be released back into the lower level reservoir. In the process, the water powers turbine units which drive the electrical machines

to generate electricity. The amount of energy stored depends on the height difference between the two reservoirs and the total volume of water stored. The rated power of PHS plants depends on the water pressure and flow rate through the turbines and rated power of the pump/turbine and generator/motor units.

Pumped hydro plants have very long lives on the order of 50 years, and fast response times that enable them to participate equally well in voltage and frequency regulation, spinning reserve, and non-spinning reserves markets, as well as energy arbitrage and system capacity support.

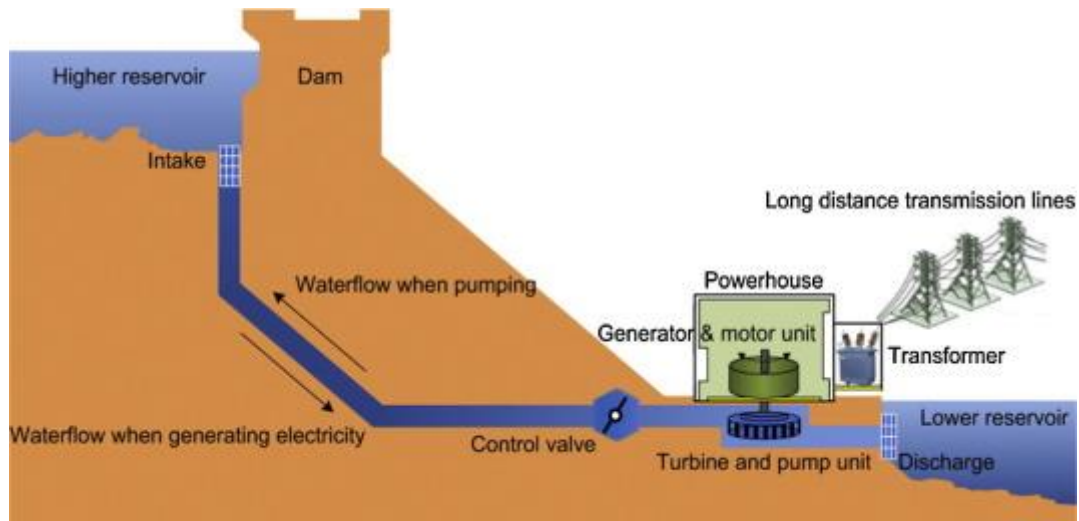

Figure 6: Pumped hydroelectric storage plant layout [3]

In summary PHS is by far the most highly matured of the energy storage technology with a very large energy capacity and long life however does have few significant constraints such as site selection, long construction times, high capital investments and environmental permits. Power ratings of PHS plant can range from 1MW up to 4000MW.

2.4 Hydrogen Energy Storage (HES)

Excess electricity can be converted into hydrogen by water electrolysis. The hydrogen can be then stored in above ground tanks/bottles (900bar), or underground caverns (200bar) for an unlimited time and eventually re-electrified. HES systems use two separate processes for storing energy and producing electricity as per figure below. The use of a water electrolysis unit is a common way to produce hydrogen which can be stored in high pressure containers and/or transmitted by pipelines for later use [16]. When using the stored hydrogen for electricity generation, the fuel cell (also known as regenerative fuel cell) is adopted and this is the key technology in hydrogen storage [17].

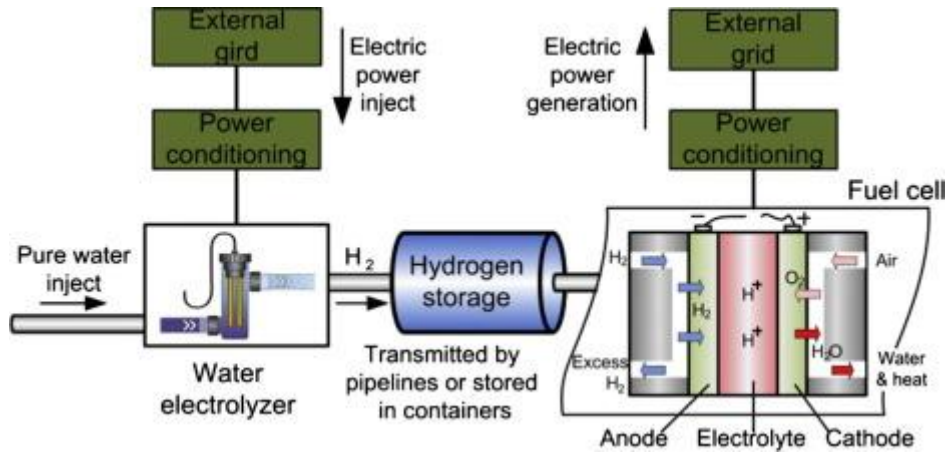

Figure 7: Topology of Hydrogen storage [3]

To generate electricity, both gases flow into the fuel cell where an electrochemical reaction which is the reverse of water splitting takes place: hydrogen and oxygen react and produce water, heat is released and electricity is generated. Fuel cells can convert chemical energy in hydrogen (or hydrogen-rich fuel) and oxygen (from air) to electricity and the overall reaction is: $2\text{H}_2 + \text{O}_2 \rightarrow 2\text{H}_2\text{O} + \text{energy}$ [18].

Summary hydrogen energy storage with fuel cell technology is in the development and demonstration stage. Hydrogen storage efficiency is low due to the conversion losses in electrolysis process and is expensive [19]. Research or demonstration projects are in place and on-going across the world and this concept could allow large amounts of energy to be stored for long periods of time, even as seasonal storage.

2.5 Super-capacitors

A supercapacitor is a high-capacity electrochemical capacitor with capacitance values as large as thousand farads. Supercapacitors combine the properties of traditional batteries and capacitor in a single component. Supercapacitors consist of dual electrodes separated by an ion permeable membrane; which is known as a separator, and an electrolyte connecting both electrodes ionically. When an applied voltage is applied to the electrodes they become polarized and ions in the electrolyte form electric dual layers of opposite polarity to the electrode's polarity [20].

Difference between a normal capacitor and a supercapacitor is that the plates of a supercapacitor have a larger surface area and the distance between them is smaller as compared to normal capacitors.

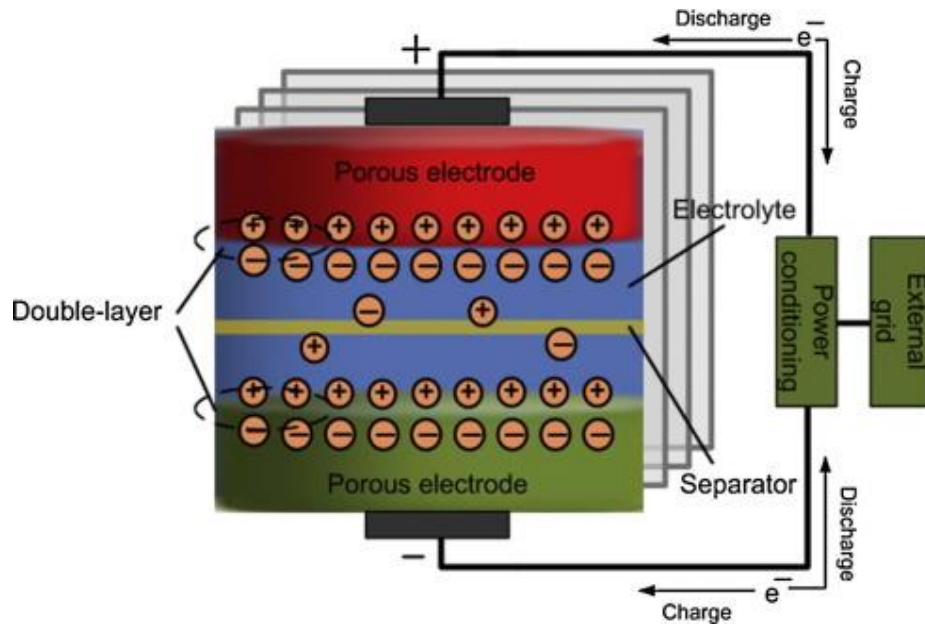

Figure 8: Typical construction of a supercapacitor [17]

Supercapacitors has the ability to produce quick bursts of electrical energy when the energy is required during high demands, then stores energy that is normally lost [21]. They efficiently support a primary energy source in applications due this ability to discharge and recharge efficiently and quickly. Due to their significant benefits, supercapacitors are being utilized in many different applications. Supercapacitors provides benefit to a primary energy source such as a combustion engine, fuel cell or battery which cannot repeatedly distribute quick bursts of power.

In summary, Supercapacitors has a higher lifespan as compared to battery systems. Supercapacitors isn't reliant on chemical change in the electrodes and therefore the rate of evaporation of the liquid present in the electrolyte dictates their lifespan. The rate of evaporation is a function of heat present, voltage, current, cycle frequency and present load. They main advantage is that they can be employed where a high amount of energy is required for shorter periods of time and where large number of charge and discharge cycles are required [72]. The disadvantages of supercapacitors are safety concerns related with electrochemical capacitors which includes fire, (chemical and electrical), leading to explosions. The voltages of double layer supercapacitors are dangerous and therefore have to be handled with the similar precautions as other high voltage plant.

2.6 Battery Storage

2.6.1 Introduction into Battery Technology

The rechargeable battery is regarded as the most popular energy storage technologies in industry. This section will go through some of the different types of technology and general operation leading up to how these technologies can be utilised in grid storage which will be discussed in the next chapter.

The figure below shows a schematic of battery storage system. The system consists of electrochemical cells joined in either series or parallel, and forms an electrochemical reaction which produces electricity. A cell comprises of electrodes (one cathode and one anode) with a solid or liquid electrolyte [22]

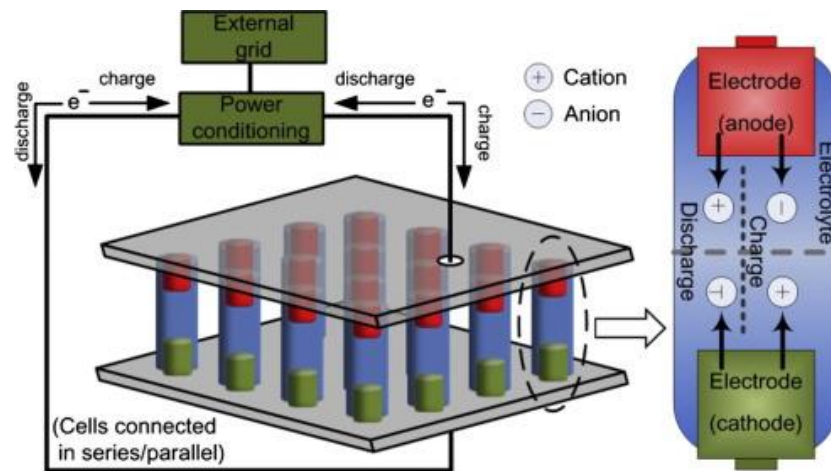

Figure 9: Schematic of a typical battery storage system operation

A cell can convert energy in both directions between chemical and electrical energy. The discharging process is when the electrochemical behaviour happens at the cathodes and the anodes at the same time. The circuit is essentially when electrons are supplied from the anodes and received at the cathode. The charging process is the reverse reactions occurring and the cell is recharged by administering a voltage to the anode and cathode.

Whilst there are a vast amount of different storage technologies and described earlier in this thesis, this section will consider systems which are most favoured to take up at power grids over the next 10-15 years and this is because of their technical maturity and supply chain. For this reason, the next section will discuss few battery technologies however doesn't specifically promote any one type of technology as their application will depend on design criteria to match user requirements.

2.6.2 Different types of battery technologies

Lead Acid (LA) Batteries

They are by far the most matured type and most common of all re-chargeable batteries [25]. In the 1980's this type was being tested for utility peak shaving and proven successful, however due to the high costs, it was not widely deployed. Recently improvements to this technology are starting to see costs decrease.

When fully charged a voltage exists between the cathode and the anode. When in the process of discharging, electrons move through the load externally while internally chemical reactions at the electrolyte and electrodes balance the charge.

The figure below shows the chemical states of a fully charged and discharged lead acid battery.

<u>Fully Charged</u>			<u>Fully Discharged</u>		
Anode	Electrolyte	Cathode	Anode	Electrolyte	Cathode
Pb	H ₂ SO ₄	PbO ₂	PbSO ₄	H ₂ SO ₄	PbSO ₄

Figure 10 :Charge and Discharge State of a Lead Acid Battery [31]

The cathode is constructed with lead dioxide (PbO₂), anode constructed with lead (Pb), and electrolyte is sulphuric acid. This type of battery has fast response times, high cycle efficiency, lower capital costs and little self-discharging. The table below shows lead acid batteries installed worldwide.

Table 2: Lead Acid battery energy storage systems [6], [17], [27], [28] and [29]

Location	Power/Output	Application
Germany, Berlin	8.5 MW	Spare reserve and frequency regulation
USA, California	10 MW	Spare reserve and load regulation
Puerto Rico	20 MW	Spare reserve and frequency regulation
Alaska	1 MW	Stabilising an island grid
Hawaii	15 MW	Wind integration, power management, load control
USA, Texas	36 MW	Wind farm integration

Valve Regulated Lead Acid (VRLA) and Sealed Lead Acid (SLA) are the 2 main types of lead acid batteries and they both have very similar internal chemistry as shown in the figure above. The key differences between the two are that the SLA type has few design

requirements which VRLA doesn't need, i.e. Ventilated environment to diffuse gases created during charge and discharge (cycling), Upright orientation to prevent electrolyte leakage and Routine maintenance of electrolyte.

SLA and VRLA contain both deep cycle and shallow cycles. VRLA batteries shallow cycles are normally used for lighting, automotive start, ignition batteries which delivers high power for short time intervals.

Lithium ion (Li-ion) batteries

These are used in many applications of energy-storage, ranging from megawatt battery storage units in containers to smaller batteries of a few kilowatts in domestic systems with rooftop photovoltaic (PV). The implementation of a lithium-ion battery began in the 1970's and went on to be more frequently used in the 1990's with Sony and Asahi Kasei releasing their first commercial lithium ion battery in 1991[32].

In this type of battery, the anode is constructed from carbon graphite, cathode consists of Li metal oxide and the electrolyte a solution of lithium salt. Basic theory is that the charged lithium ions travels back and forth (reversible) between the anode and the cathode during charge and discharge. Cell performance is affected by chemical differences in the anode, cathode, electrolyte and the way the cells are packaged.

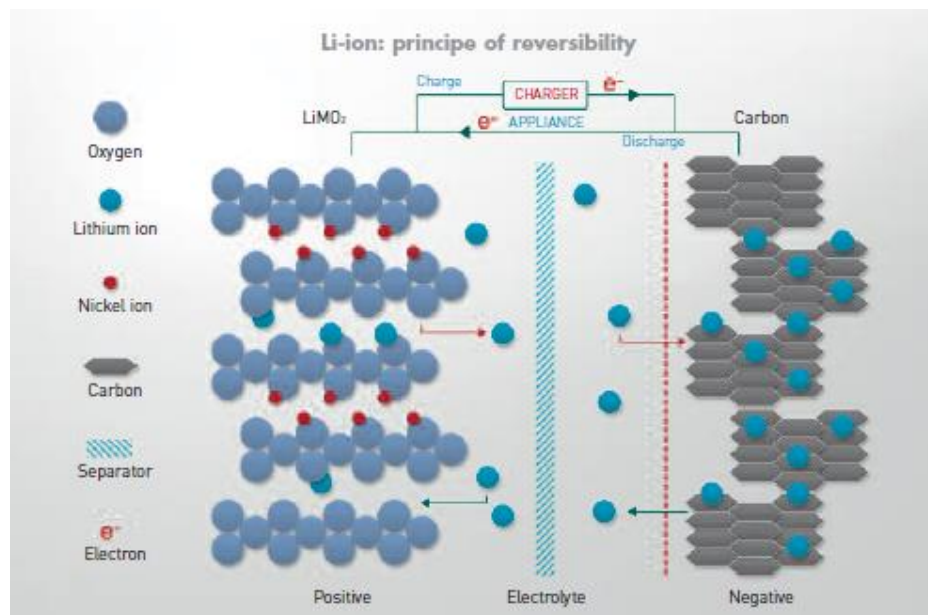

Figure 11: Li-ion principle of reversibility [36]

These cells are deep cycle therefore they have the capability to be charged to the maximum and discharged completely. In terms of rated capacity, the cell life will increase the discharge cycle is limited to 80%.

It is envisaged that Li-ion will take up a significant role over the next few years because of its use for grid scale and deployment at commercial level. The previous complaints often associated with this type of batteries for energy storage i.e. high cost, short lifespan and safety issues are elapsing as manufacturers are spending more in research and development. In

2014/15 lithium ion batteries dominated the emerging grid storage market with almost 90% of proposed grid storage projects selected this type of battery technology [33].

Battery manufacturer Saft [36] is leading the way when it comes to lithium ion battery systems for grid storage. Saft has battery systems specifically designed to facilitate integration of large renewables onto transmission and distribution networks. They have few different module systems (figure below) which can be adapted to suit any solutions.



Figure 12: Li-Ion Storage solutions available from SAFT [36]

Saft Li-ion technology has been used in space vehicles and satellite stations which requires the most demanding performance, and this same design and manufacturing principles have been applied to other sectors like aircrafts, rail, telecoms, vehicles, data centres and energy storage.

Sodium sulphur (NAS) batteries

A sodium sulphur battery is a molten salt type battery which is made from liquid sodium and sulphur. Sodium sulphur has high energy density, high efficiency of charging and discharging cycles and an overall long life cycle [34]. Operating temperatures can range from 300 Degrees Celsius to 350 and the highly corrosive nature of the polysulphides makes this type of battery suitable for stationary energy storage applications. This battery is made from expensive materials however the cells become more economical with increasing size.

The configuration of the cell is cylindrical and it is enclosed by a steel casing which acts as protection. The container on the outside acts as the positive and the sodium acts as the negative. An alumina lid seals the top of the container to ensure it is air tight.

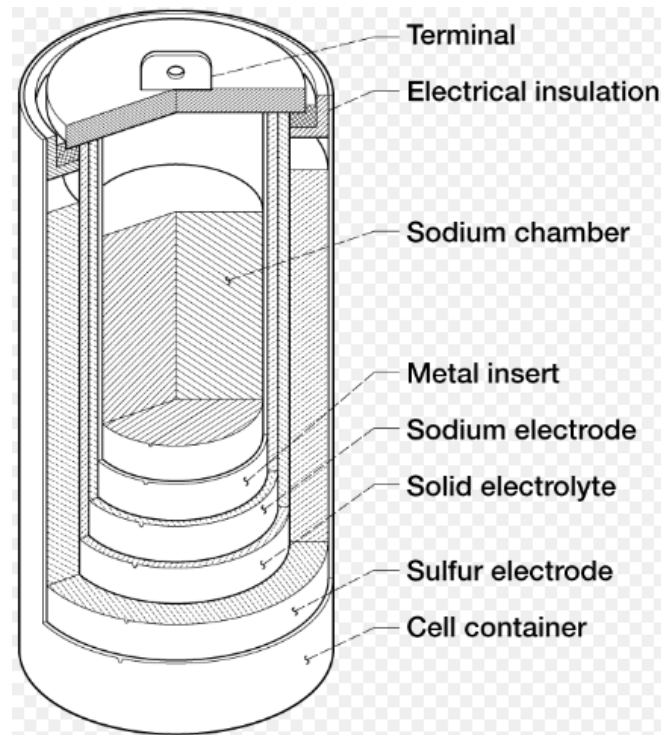

Figure 13 : Cross section schematic of NaS [NASA Research Centre]

A typical NAS battery system is shown below and the consists of an enclosure, modules, cells and a PCS (AC/DC power conversion system) as the key elements.

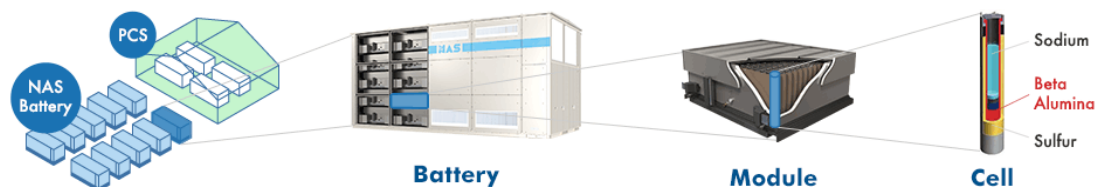

Figure 14: Sodium Sulphur Battery System [Courtesy of NGK]

Sodium presents a hazard when in contact with air and moisture and when it does it spontaneously burns, therefore the unit must be protected from water and air. In 2011 NGK manufactured a system of 40 sodium sulphur batteries in modules with each module having 384 cells [35]. The systems were being used for energy storage at a Japanese plant owned by Tokyo Electric power company, and these batteries caught on fire. An investigation into the fire was completed in 2012 and it was found that a battery cell was faulty and leaked hot molten material which then escaped into the module creating a short circuit between cells in the neighbouring modules. The investigation revealed that there wasn't any fuse designed at the battery cells therefore the current continuously flowed and produced high temperatures which destroyed many adjacent cells and caused a fire which spread. Refer to diagram below which shows the cause of the fire.

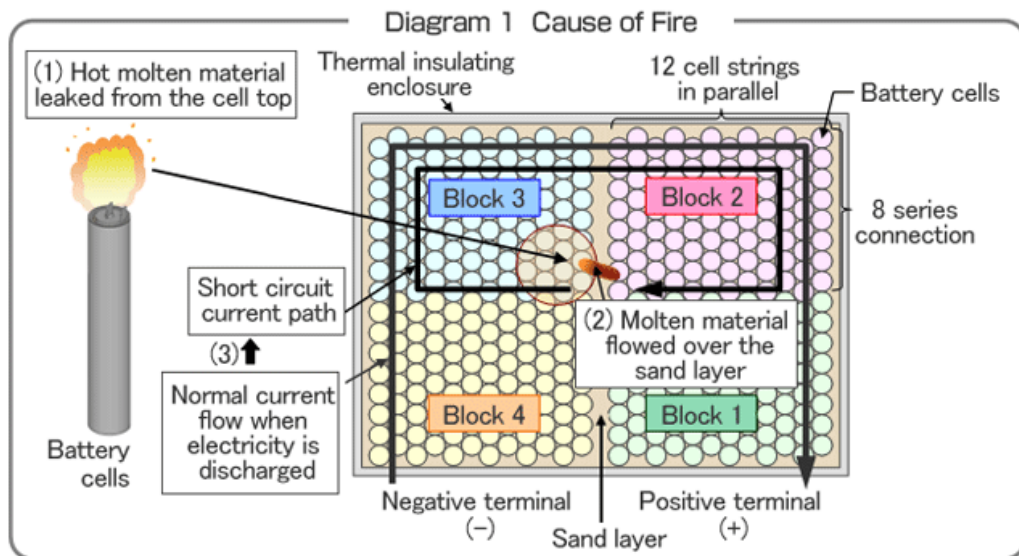

Figure 15: Cause of the Fire at Tsukuba Plant [35]

Post incident NGK temporarily suspended the manufacturing of sodium sulphur batteries however voluntarily implemented safety enhancement measures to provide fire containment, refer figure below.

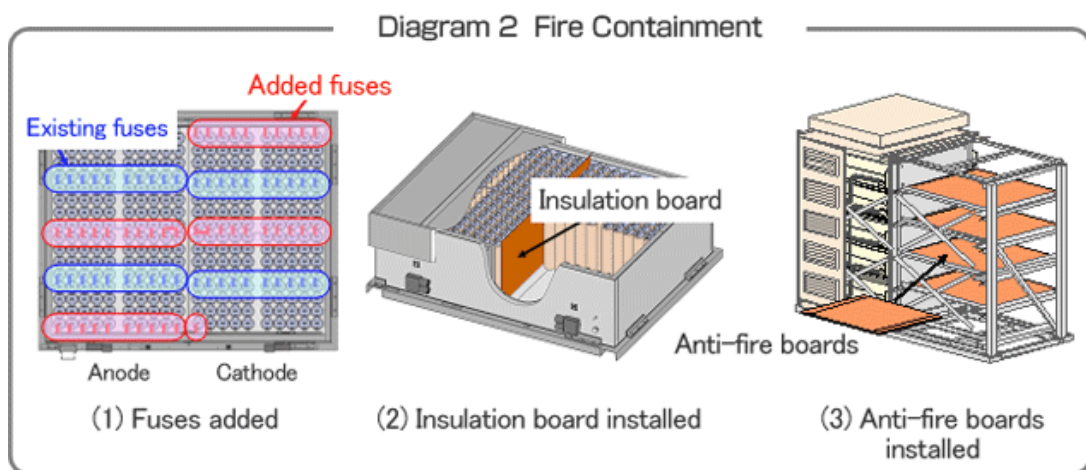

Figure 16: Fire containment implemented by NGK [35]

Late 2012, NGK resumed production operations since the investigation was completed and safety measures installed. NGK projected that sodium sulphur batteries will continue to increase in renewable energy storage and has been working hard to turn around the battery performance to ensure it meet market expectations.

Flow Batteries

Flow batteries is an emerging type of battery which are looking to be attractive for larger-scale power grid use. Flow battery operational principle is essentially different from the conventional batteries, like nickel metal hydride batteries or lead acid. With conventional batteries, having all elements housed within the battery; PCS and the electrolyte are internal hence the energy and power rating are fixed. In comparison to the conventional batteries, flow batteries work differently [38].

The energy and power rating are separated and the system is made very flexible. The electrolytes flow into an electro chemical unit where chemical energy is changed into electrical energy. The design of the cell system determines the power rating. The two electrolytes are housed individually in fully sealed tanks external to the cells. The total storage energy capacity therefore dictates the volume of the tanks and the quantity of electrolyte. The figure below illustrates a simple operating principle of flow battery cell.

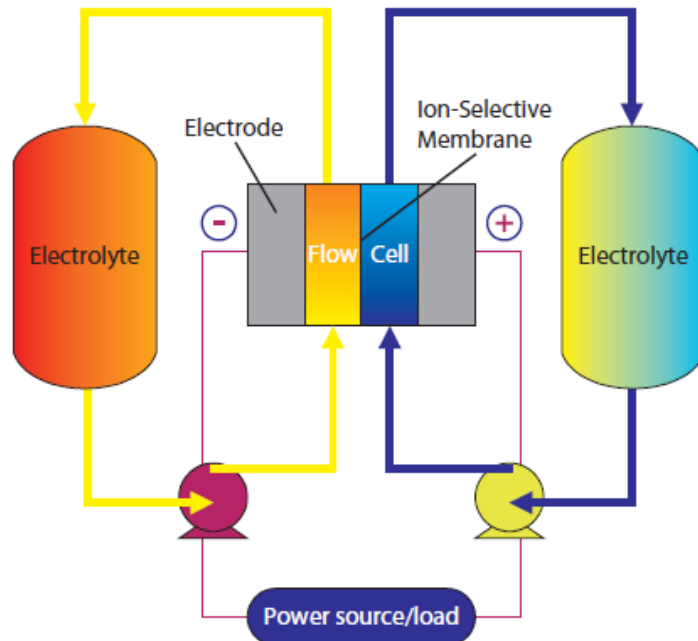

Figure 17: Schematic overview of a flow cell energy storage system [38]

Flow battery cells be divided into costs of the electrolytes in tanks and electrochemical reactor. If the storage capacity of the design increases, then this increases the costs of electrolytic solution, however, the costs of the electrochemical reactor remains un affected.

Flow batteries doesn't have scaling limits because the rating of the storage system will depend on the volume of the tanks which stores the electrolyte therefore this battery system favourable for large grid scale energy storage.

They are referred to as "redox flow" and inherits this name because of the redox behaviour between the electrolytes in the external tanks. "Redox" is simply the abbreviated term for "reduction-oxidation" reaction. 3 most common types of flow batteries exist, namely, Zinc Bromide (ZnBr), Polysulphide Bromine Batteries (PSB) and vanadium batteries (V/V) These battery types all have their individual parameters however, the design could be used for most sizes, and the suppliers each prioritise on their selection of power and energy ratings. Table 3 below shows the comparison of the 3 types.

Table 3 : Comparison of flow batteries [38]

	Vanadium	Zinc bromine	PSB
Typical power range (MW _e) [2]	< 3	< 1	< 15
Typical size range (MWh) [3]	0,5 – 5	0,01 – 5	0 - 120
Energy density (Wh/liter) [1]	16 - 33	60 – 90	20 - 30
Cycle efficiency [Wh ^{out} /Wh ⁱⁿ] (%) [1, 2]	70 – 85	65 – 75	60 – 75
Cycle life (cycles) [1]	>12,000	>2,000	n/a
Life time (years) [1]	5 – 10	5 – 10	15
Stage of development [2]	Demonstration / commercial units	Demonstration / commercial units	Demonstration
Companies involved [3]	VRB, SEI, Pinnacle, Cellenium	ZBB, Premium Power	TVA, VRB (using Regenesys technology)

The main characteristics of flow batteries are summarised as [38], [71]:

- High power: this is dependant by the type and volume of the cells;
- Longer time period: the power rating is determined on the quantity of electrolyte and size of the storage tanks;
- Design and construction of the energy rating and power rating is de-coupled;
- The system can be refilled at various times and the electrolytes can be replaced;
- Redox reactions decrease the reaction time making it shorter. Their response times for charge to discharge in times ranging to 1/1000 s;
- Efficiency during full cycle is low due to the strength required for mixing and to distribute the solution and loss during chemical conversions;
- Self-discharging is non-existent, because the electrolytes can't react when they are stored away from each other;
- The advantage of flow batteries is flexibility in system design for power or energy application.

2.6.3 Comparison of Battery Types

Lithium ion (Li-ion) and lead acid (LA) battery types

Below are brief parameters of Li-ion and lead acid battery technology [31].

Table 4: Comparison of Li-ion and lead acid battery cells [31]

	Flooded lead acid	VRLA lead acid	Lithium-ion (LiNCM)
Energy Density (Wh/L)	80	100	250
Specific Energy (Wh/kg)	30	40	150
Regular Maintenance	Yes	No	No
Initial Cost (\$/kWh)	65	120	600 ¹
Cycle Life	1,200 @ 50%	1,000 @ 50% DoD	1,900 @ 80% DoD
Typical state of charge window	50%	50%	80%
Temperature sensitivity	Degrades significantly above 25°C	Degrades significantly above 25°C	Degrades significantly above 45°C
Efficiency	100% @20-hr rate 80% @4-hr rate 60% @1-hr rate	100% @20-hr rate 80% @4-hr rate 60% @1-hr rate	100% @20-hr rate 99% @4-hr rate 92% @1-hr rate
Voltage increments	2 V	2 V	3.7 V

Li-ion batteries have a higher life cycle as compared to lead acid during deep discharge process and this life cycle increases with an increase in ambient temperature. Lead acid battery life cycle drops as low as 50% of its rating. During colder weather, both lithium ion and lead acid loses capacity, however lithium ion loses much less capacity as the temperature decreases to -20°C.

From an environmental perspective, lead acid battery compares poorly to lithium ion. Lead acid requires much rarer materials to achieve the same energy storage and this therefore makes a much higher environmental impact. Lead industry is also energy intensive which therefore leads to higher pollution for processing plants.

With lithium ion, the major components of the cell require the lithium carbonate, copper, aluminium, and iron ore to be mined. This task is generally resource intensive, but lithium is only a small portion of the battery cell by size, so the copper and aluminium environmental impacts are much higher. Both lead acid and lithium ion can rapidly heat and emit flames and dangerous fumes, which is also called thermal runaway.

Both these technologies offer advantages and disadvantages in terms of energy storage and the choice really depends on the specific application. The initial cost, life cycle, size, volume, temperature sensitivity and maintenance access plays an important role in selection of choice of battery technology.

Technical Comparison of Common Battery Types

Storage technologies utilising batteries are improving significantly and the technical comparison figures below may not fully reflect all current applications. Values have been sourced from vast number of technical papers and may not be fully accurate.

Table 5: Technical Comparison of common types of batteries

	Valve-Regulated Lead-Acid	Advanced lead-acid	Lithium-ion	Sodium-sulphur	Flow batteries
Power Range (MW)	1 – 50	1 – 50	< 100	5 – 100	1 – 100
Storage Duration	2 – 4h	1 min – 8h	1 min – 8h	1 min – 8h	1 – 5h
Cycles	1,000 – 5,000	4,500 – 10,000	1,000 – 10,000+	2,500 – 4,500	>10,000
Operating Life (years)	3 – 15	5 – 15	5 – 15	5 – 15	15 – 20
Efficiency (%)	70 – 90	90 – 94	85 – 98	70 – 90	65 – 85
Response Time	< secs	< secs	< secs	< secs	< secs

2.6.4 Cost comparison of Battery technology [39], [40], [41], [42], [43], [44]

The tables below provide indicative capital costs for the common battery types. While considering these costs battery systems apart from NaS; the systems are suitable for small scale battery storage. Substantial reduction in costs are forecast for most battery types, especially Li-ion and flow batteries. Cost comparison usually considers limitations of each type along with assumptions behind each cost. Levelised cost of electricity (LCOE) also plays an important part when considering storage duration, lifetime and operating principles.

Table 6 : Battery Technology Capital Cost Comparison [39], [40], [41], [42], [43], [44]

Technology	Source/year	USD/W	Assumptions
Lead acid battery	IRENA / 2012	\$1.50 - \$2.00	3-20MW in size, 10 seconds to 4 hours of storage
Lead acid battery	EPRI / 2012	\$2.50 – \$5.00	50kW to 10MW in size, total installed cost
Flow batteries (VRB)	IRENA / 2012	\$3.00 - \$4.00	50kW to 10MW in size, up to 8 hours of storage
Li-ion battery	IRENA / 2012	\$2.50 - \$3.00	Up to 5MW in size, 15 minutes to 4 hours of storage
	EPRI / 2012	\$2.00 - \$6.00	50kW – 1MW in size, total installed cost
	AECOM / 2015	~\$1.00-1.80	Current market price based on recent tenders MW scale systems (includes balance of plant costs) 15 mins to 1 hour storage
NaS battery	EPRI / 2012	\$2.50 - \$3.00	1MW – 50MW in size, total installed cost

Table 7: Battery Technology LCOE costs [39], [40], [41]

Technology	Source/year	USD/kWh	Assumptions
Lead acid batteries	IRENA / 2012	\$0.25 - \$0.35	Small to medium applications, less than 10MW in size
Flow batteries (VRB)	IRENA / 2012	\$ 0.25 - \$0.30	50kW to 10MW in size, up to 8 hours of storage
	EPRI / 2012	\$0.60 - \$1.00	1MW to 50MW in size, total installed cost
Li-ion battery	IRENA / 2012	\$0.25 - \$0.50	Projected costs up to 5MW in size (for large Li-ion cells), 15 minutes to 4 hours of storage
NaS battery	EPRI / 2012	\$0.40 – \$0.60	1MW to 200MW in size, total installed cost

3. Chapter 3 - Research Methodology - Grid Scale Battery Storage

3.1 Introduction

Grid scale battery storage is similar to a power plant which utilises batteries on an electro chemical principle for energy storage. Unlike storage mentioned in chapter 2 such as PHS and CAES which has large capacity storage, battery storage can range from a few kW up to medium MW range. They are similar to other storage plant in that they primary function is to serve to cover during the peak loads in networks with not enough power and the network stabilisation [23]. Their major advantage is that they do not need mechanical mass movement parts in order to start injecting power (like other storage plants) [60]. They have start times typical 20mS. Analysis have showed that energy storage devices along with renewable generators can enhance network transient stability. [73]. Currently there is more than 430MW of grid scale battery storage systems installed in the market and it is expected to rise up to 12GW by the year 2024 [26]. The market leaders for battery energy storage will be America followed by China, Japan and Germany. It is envisaged that the take-off will start in 2017 as the price of batteries decreases.



Figure 18: 36 MW Battery Storage for 153 MW Wind Integration, Source: Duke Energy, Texas

3.2 Description of a Battery Storage System

Battery storage system was briefly discussed in chapter 2 while describing different battery technologies. The battery is just a part of a larger storage system shown in the figure below. The system contains few primary components which includes monitoring and control systems, a power conversion system (PCS) and the battery itself [63]. Battery cells consist of individual cells connected into modules and then into battery packs. A battery management system consists of monitoring and control systems which is there to ensure safety and to essentially maximise performance. The battery management system controls the discharging and charging of the batteries and prevents single cells from over charge.

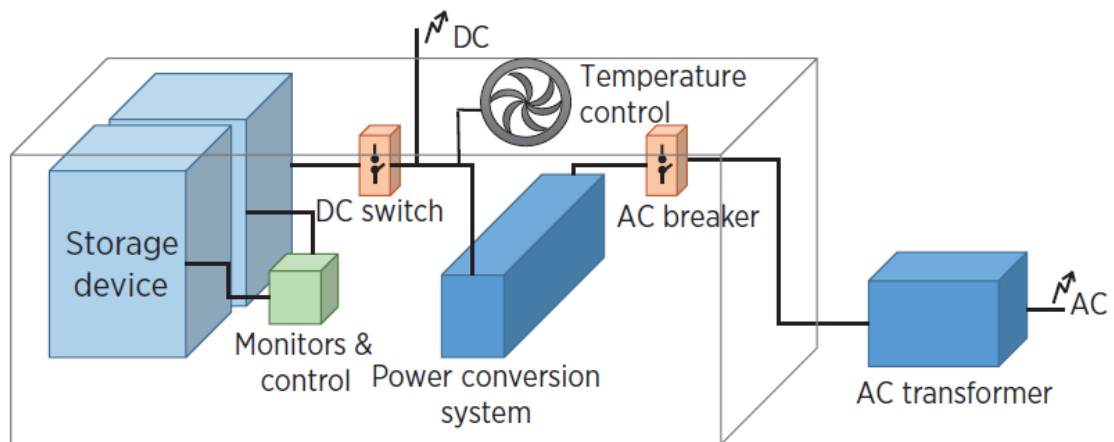

Figure 19: Typical Battery Storage System and main power components [courtesy of EPRI]

The battery storage system also contains a power conversion system. Unlike conventional electric systems which runs on alternating current (AC), batteries deliver direct current (DC) electricity. The power conversion system, using bi directional invertors, converts the DC emitted from the battery into AC for connecting to the power grid and with the use of rectifiers, the AC flows back into the battery during charging.

3.3 Drivers, Application and Challenges

3.3.1 Drivers and Application [1], [3], [13], [24], [60], [61]

- Increases in usage of renewable energy: as we know that there is pressure to increase renewable energy onto power grids worldwide, and that renewable energy is vastly intermittent that energy storage is becoming significantly important in demand management;
- Increases in power grid costs combined with low use of existing assets: The longer the utility assets last, the later capital investment can be deferred hence efficiency of network can be improved by increasing asset utilisation. This is done by reducing the peak demand with the use of energy storage devices. Asset owners could eventually start claiming return on investment for storage devices installed;
- Increasing the requirement for backup power that is reliable: the importance of backup power requirements in utility markets, for example secondary systems, telecommunication and data centres, is becoming more stringent. The improved performance of new energy storage devices is becoming the proven solutions;
- Peaking power: can take up the role to provide peaking power when required and reduce need for fossil fuel peaking plants;
- Demand side management: Battery storage can take up the role for demand side management thereby delaying augmenting the network;
- Tariff changes: Pairing storage with renewables like solar PV can enable end users to go off grid or consume less power from the grid. The electrical vehicle market will eventually take off and increase rapidly especially with car manufacturers continuing to introduce. This increase in electrical vehicles will improve large energy storage

capacity in businesses and homes and an opportunity to utilise the storage to promote use of renewables.

- **Arbitrage:** Generators and consumers of energy can utilise storage to prevent high electricity prices by transferring load during high demand to less costly time of use tariffs.
- **Power Quality:** Utility uses must provide a service to ensure they keep the power supply voltage and frequency to an acceptable tolerance and this can be achieved by adjusting the power supply to the changing demand. Power grids control the frequency by adjusting the output of generators and in a similar way battery storage can provide frequency control.
- **Off or Isolated Grid application:** where utilities provides a power supply to a smaller isolated power grid (an island or rural area), small capacity diesel generators and other renewable generators can be boosted by battery energy storage and this can provide stable power to consumers,
- **Smart Grid:** Energy storage combined with thyristor, valves and other electronic devices will play a significant technical part and will have a major impact on the future of the power industry leading to significant financial benefits. [67]. The future grid will be enhanced by power flow in both directions by using PV, biomass, wind etc. and these renewables will be supplemented with battery storage [69].

3.3.2 Challenges [1], [3], [13], [24], [60]

- **High upfront costs:** A significant barrier being high initial investment for battery energy storage is currently inhibiting widespread take-off and utilities can see this as poor return on this investment. The components which make up the battery system are still expensive due to the unrefined materials, manufacturing prices, materials processing, invertors, and plant costs;
- **Safety:** Deployment is potentially hampered due to safety concerns for batteries being used at a large scale. Overheating, explosions, fire and burns are some of these concerns. Manufacturers will have to work closely with utilities to ease these concerns. Safety specifications are required prior to any grid scale installation of battery technology and to ensure these standards are not too prescriptive so as not hamper innovation;
- **Non standardisation:** There are currently no common standards developed for battery energy storage devices. Manufacturers are developing to their own internal standards which cause issues for installation, maintenance and compatibility;
- **Grid interconnection hurdles and excess power capacity:** Lack of policy, standardisation and electricity infrastructure to allow network connection of energy storage systems;
- **Recycling and environmental:** - battery systems use resources which are rare and expensive hence it is important to have well organised recycling processes that will benefit industries to decrease environmental issues. Typical lifespan for batteries are within a 10-year lifespan, however, there will be occasions to reuse the battery for

new applications. Disposal and recycling standards will be a key challenge to win over users of large scale batteries;

- Temperature of batteries when in storage: in many countries the temperature varies, hence the batteries will need to operate in harsh temperatures, example Australian heat and the freezing conditions in Europe;
- Lack of clear business case and value proposition, also due to low oil and gas prices;
- Not enough incentives and policies,

3.4 Regulatory Framework

Similar to all maturing technologies entering an established market, battery storage systems depend on favourable regulatory frameworks and provision of incentives. Regulators worldwide will eventually see the value in battery storage and incentivize its usage to ensure technology take-off. Few countries worldwide have standards and policy drivers which are leading to energy storage increase with the main purpose to include lowering the integration costs of renewables.

Few examples of incentives [30] provided elsewhere:

- In USA, the regulator offered performance payments to grid operators for faster and accurate power. This led to independent operators to install energy storage systems and this has since been on the rise;
- The regulatory body in California introduced a requirement in 2013 that the utilities must install 1.325 GW of storage capacity by year 2020. This program aims to demonstrate how batteries can influence the electric grid and assist with the integration of wind and solar power;
- Homeowners in Germany, who want to install a package photovoltaic/storage system, can apply for a low interest loan from a German government development bank, and also gain a rebate of up to 30 % on the package. This has increased widespread installation of about 12,000 systems, whilst there were already an 13,000 systems built prior to the incentive being awarded;

Demand management incentive schemes for transmission and distribution business need to be considered by the regulatory bodies, and this could see businesses receive more income for selecting demand management solutions over the transitional infrastructure assets. This will lead to businesses to consider energy storage for demand management opportunities.

Regulatory standards should ideally have the relevant key parameters and outline requirements for businesses to follow:

- Defining the standards of energy storage – highlighting an overview of the regulatory requirements;

- The range of ancillary services which the energy storage system could bring to users which includes accessing revenue;
- For network asset investment applying the regulatory investment test;
- Asset management and ownership – parties who can own the energy storage system;
- Providing an effective commercial standard for operation between various stakeholders;
- Market operation, registration, power grid security, network connection, grid metering;
- Energy storage installation safety guidelines integrated with user training and authorisation of manufacturers and installers is crucial to ensure user confidence, safety and the stability.

3.5 Commercial framework

Various commercial frameworks can exist when employing energy storage systems onto a network. The energy storage could be represented as a producer and consumer of electricity, a contributor of market system ancillary support, or a provider of grid assistance when required. Key terms on what commercial framework applies are, who will own and operate the energy storage system, the location the energy storage system will connect to the grid infrastructure, capacity and dispatch rights.

The owner of an energy storage system will depend on the role the storage system has, i.e. if the main task of the system is to distribute power, then the asset owner is likely to be a generator with significant knowledge in energy trade. If the system's primary role is to provide network benefits, then the grid operator will be better placed in owning the system.

Typical commercial framework is listed below. As mentioned above, determining which framework will apply will depend on the primary role of how the energy storage system will be employed and what benefits will exist.

1. Generator owned- Energy Trading – Market advantage;
2. Network Owner– Operation, Maintainer and provides a network advantage;
3. 3rd party contributor –Network advantage;
4. Mixed network and market advantages.

3.6 Procurement pathway

The procurement stage is after a business case has been justified, a location of the energy storage identified, commercial framework selected. Process will essentially be preparing a specification and inviting tenderers. The aim is to ensure the Specification provides more

detailed technical and performance information of the energy storage system and its potential delivery phase. It introduces the requirements for the energy storage system, the design principles under which it is being progressed, the likely siting and conditions under which it would operate, and the expectations around engineering and related delivery methodology to inform tenderers of what would be expected.

Unless there is significant experience in the preparation of the specification, it should not be overly prescriptive, therefore allowing tenderers to innovate and fit their product capability within the requirements. With this in mind, it is noted that certain standards, functions and requirements of the energy storage system, and contracting preferences, will be mandatory for solutions put forward to meet the risk expectations and appetite of the of the owner within the context and operations of the regulatory framework.

The energy storage system specification should ideally include the following:

- Location of the proposed energy storage system;
- Design philosophy- description and concept, type of energy storage required, environmental conditions, design life, functional requirements of the system and expectations, performance guarantees;
- Connection type, integration to the network, voltages, rating;
- Secondary systems, i.e. protection systems to allow safe isolation and operation with the network, auxiliary requirements, air-conditioning;
- Supervisory Control and Data Acquisition (SCADA) system;
- Earthing system including lightning protection;
- safety system such as a fire protection, emergency crew wash down areas, first aid gear, emergency exit points, exhaust fans and breathing gear;
- maintenance storage, workshop facility, maintenance requirements, warranties, training;
- roads and civil infrastructure scope required to permit access to and design, construction and installation;
- security fencing or security of key assets;
- environmental requirements which includes bunds for spillage and containment.

3.7 Typical Single Line Diagram (SLD) of a Grid Scale Battery Storage Device

This schematic shows a 30MW battery storage system connecting to a utility grid at 33kV. Each battery unit is rated at 4MW and consists of 2x2 MW inverters, 2x 1.35MWH batteries and a step up transformer 0.4kV/33kV. The total of 30MW is made up of 8 identical units.

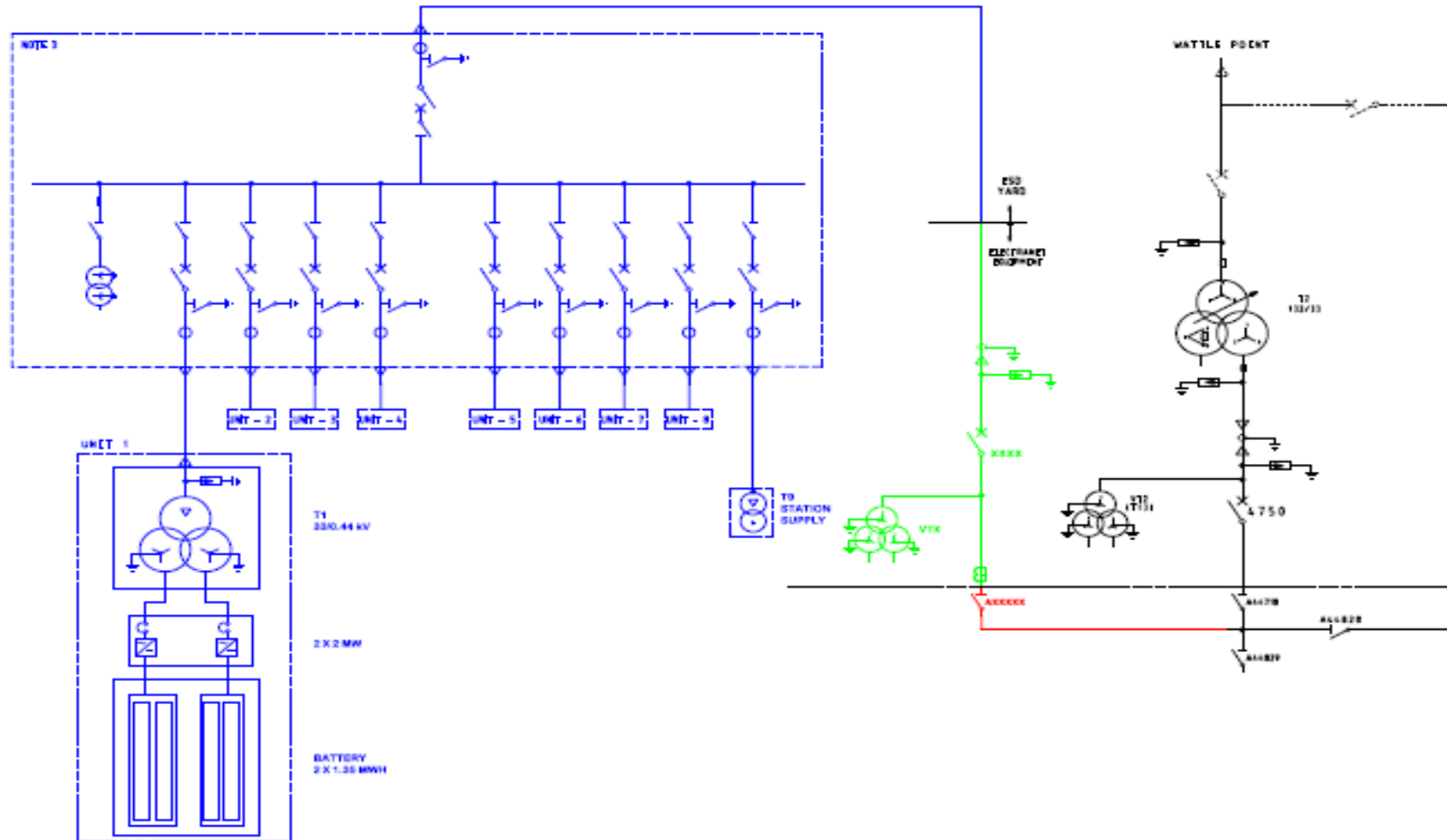

3.8 Typical Layout Diagram of a Grid Scale Battery Storage Device

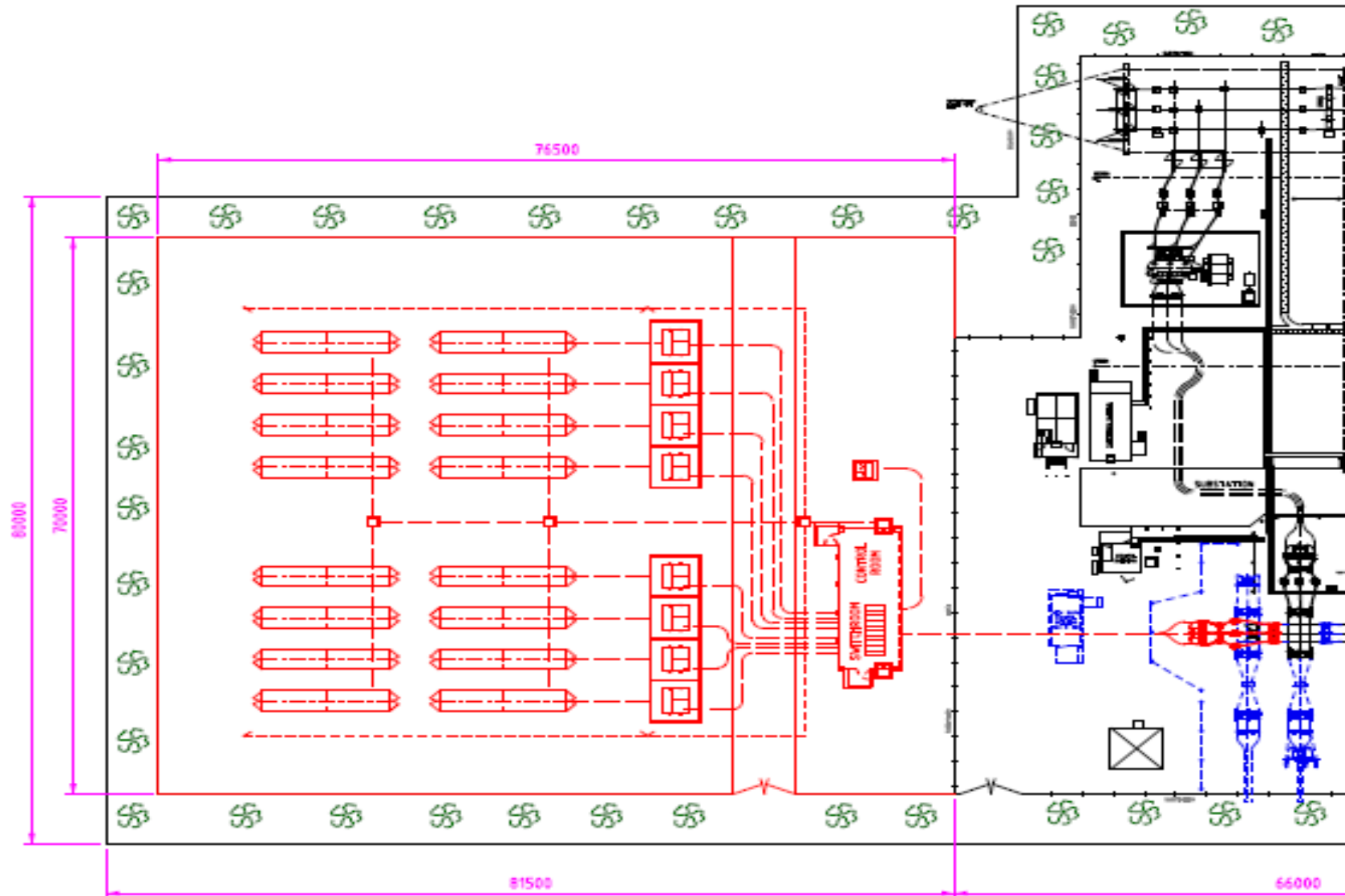

4. Chapter 4 - Case Studies

This chapter discusses a case study being designed and constructed in Adelaide South Australia. The chapter also reviews current 'in operation' grid battery storage systems worldwide.

4.1 Case Study: South Australia

4.1.1 Introduction

The University of Adelaide, South Australia, has received funding for a project to investigate the use of battery energy storage in the Australian environment, and this was mainly because storage will play a major role for the future use of renewable energy. The project is estimated at approximately \$3 million has expectations to provide benefits to the government, power utilities, and the community, and will ensure the university gains expertise and knowledge for energy storage devices. [56]. The project will design and construct an energy storage test container which can be mobile and establish a web database available for Australian energy storage users and researchers. The information will provide industry users and researchers with an understanding of energy storage systems and allow the university to test and have a play with different components making up the energy storage systems.

The University of Adelaide, Australian Energy Storage Knowledge Bank (AESKB), Australian Renewable Energy Agency (ARENA) and SA Power Networks (SAPN) are the major sponsors involved with this project and provides the first stage field application at Cape Jervis south of Adelaide in South Australia.

The expectation is for battery storage systems to play an important role in the industry in Australia over the next 5-10 years, providing options from small domestic to grid scale applications.

The grid battery is a nominally 270kVA/270kWh three-phase device capable of connecting in a parallel arrangement at 415V/3-ph/50Hz. It carries out a variety of both on-grid grid support and off-grid supply functions and it is designed as a mobile testing unit constructed in a 20-foot shipping container.

The author of this thesis is part of the project team and is currently employed as a Principal Substation Engineer at SA Power Networks, who as mentioned above, SA Power Networks being one of the sponsors of this project. At the time this thesis is being written, the grid battery storage system is in construction phase.

Due to the intellectual property (IP) of the electrical and control design, detail information could not be documented into this thesis. The basic operation and physical construction of the battery storage system is however documented.

4.1.2 Business case

At the moment there is insufficient information describing the performance of energy storage systems on Australian environment. Potential users are limited with evaluating how energy storage can integrate with existing systems and help renewable energy effectively operate in power networks.

A central database would allow the collation, storage and sharing of high quality data, learning and case studies between technology developers, end users and the public. This will help build industry confidence and has the potential to accelerate investment in reliable battery energy storage technologies. The project demonstrates ARENA's commitment to funding knowledge sharing activities and will play a key role advancing Australia's energy storage market both on and off the grid. Reliable, cost-effective storage has a vital role to play in smoothing out energy supply and increasing the amount of renewable energy used in Australia. The project is set to build industry confidence in energy storage technologies and has the potential to accelerate investment in grid connected and remote locations, particularly where there are high levels of renewable energy generation.

4.1.3 Project Innovation

The battery system will be constructed as a mobile unit which can be moved around the state and connected to different parts of the network. Each instance real time data will be connected and stored for knowledge sharing. A 20-foot shipping container will be used as a control room where the following main components will be stored: testing equipment, the inverters, load banks, monitoring equipment, weather station and the batteries. The system will also include management system, monitoring system for data such as temperature, current and voltage within the battery system and a fire security system. Installation of remote wide area network for connecting the monitoring system and power management system so as to also allow the unit to be monitored offsite from the university. University of Adelaide will be fitted out to carry out this offsite monitoring and control and also liaise with SA Power Networks to simulate different load conditions.

4.1.4 Benefit

The resources could accelerate battery storage investment in Australia. The mobile energy storage test facility can fully test energy storage systems before deployment and allow the testing of extremes (such as rapid charge and discharge) that may not be possible when grid connected due to impacts on grid stability. This will allow technology developers to fully demonstrate their products and utilities, providing confidence in their performance prior to connecting to the grid. The online energy storage knowledge bank will provide a single, comprehensive database of test results, reports and case studies relating to the reliability, safety, operation, performance and integration of energy storage systems in Australia.

4.1.5 Design

The design of the battery system is drawings and diagrams developed under several headings, namely layouts, mechanical, electrical and control. The design of the battery system is designed as a flexible, mobile device that is used as both

- i. a test bed system for test and study of various grid connected and island network scenarios with distributed energy sources;
- ii. perform electricity network support and stabilisation tasks for distribution utilities and private network operators on the supply side, behind the meter and isolated grids.

The main task of the project in the first phase is distribution utility network support and stabilisation functionality for deployment of the system to a low voltage feeder connected to

SA Power Networks, who is the distribution service network provider (DNSP) in South Australia. With the first phase grid support application, the battery system will perform the following tasks:

- i. Remote Operator controlled Charge/ Discharge;
- ii. Automatically peak-lop demand on the connected feeder or incomer, when connected and the consumer demand exceeds the maximum feeder or incomer load;
- iii. Fixed time interval energy arbitrage;
- iv. Provide voltage and reactive and active power quality support to the grid, when connected;
- v. Segregate (island) the downstream grid section from the distribution grid and become the sole source of supply for the downstream consumers;
- vi. Segregate, when receiving a command, without supply interruption. Vice-versa, seamlessly reconnect the islanded grid section to the distribution grid, when receiving a corresponding command.

4.2 Case study 2: Integration of Energy Storage for Renewable Energy

The Energy Storage for Commercial Renewable Integration (ESCRI) is investigating the role of energy storage will play in the integration of renewable energy into the South Australian electricity system. Target range of this project study for energy storage is from medium to grid scale systems between 5-30MW. [57]

4.2.1 Need

South Australia uses a high amount of renewable energy with majority of this generation comes from solar and wind which is known to be very intermittent. The problem of this intermittent generation becomes more noticeable as conventional generation go offline and decreases. Ensuring proper integration between storage elements into the network is a requirement to ensure stability and reliability of power is delivered to customers for any conditions.

This report highlights, in many chapters, the importance of battery, flywheels and CAES can assist users to overcome network problems such as peak demand management. The addition of storage is being reviewed at a top level by the Government of South Australia, and concluded this technology will have a commercial prospect.

4.2.2 Project innovation

The project findings and recommendations on the ability of a storage device is to take power produced from generators at wind farms overnight or when the wind is blowing at the same time the demand is low. The project has highlighted commercial, technical, and regulatory issues involved with energy storage system implementation.

The project examined the ability of an energy storage system to:

- i. provide assistance to the National Electricity Market (NEM) for fossil power stations with frequency control services and black start processes;
- ii. provide benefits to the transmission grid through peak demand management and delaying installation of capital augmentation; and
- iii. provide increased use of renewable generation within the transmission and distribution grid.

4.2.3 Benefit

The key benefit of the ESCRI project is that it will support a case that ascertains if battery storage is a business possibility for supporting wind and solar into the power grid. If favourable, implementation of energy storage could be a norm when designing and constructing projects having renewable generation installations, and this will therefore increase competition and possibly lead to more rollout of renewable energy. The detail reports for this project can be downloaded from the Arena website. [57]

4.3 Worldwide installation of Battery grid storage

Many countries have a prospect to develop learnings from the steps taken by international users when installing energy storage investments. A developing emphasis in the uptake of renewable energy, politicians of many countries have established incentives and policies to encourage the implementation and development of grid scale energy storage systems. USA, UK, Japan, Germany, and China have all released schemes on establishing and sponsoring the increase of storage systems [62]. Greater use worldwide is considered to be foreseeable as cost are reduced and driven by leading manufacturers and international markets. There are approximately 977 battery storage projects worldwide with an estimated rated power of 3-4 GW. The leaders for battery storage systems are United States (New York, California, Texas, Hawaii), Japan, China, South Korea, UK, Germany and Italy. This section will describe few installations of battery storage in operation in the leading international markets and will also discuss few projects contracted and planned for construction. [45]

4.3.1 Kahuku, Hawaii

Yunicos designed and constructed a 15 MW energy storage system including a power control system using advanced lead acid batteries designed to provide load support for a 30 MW windfarm. The storage system also provided significant grid support services. U.S. DOE Office of Electricity provided support to the project with a loan guarantee. Battery technology used was lead acid batteries. A fire cause damage to the battery control room in August 2012. After investigations the system has been replaced with a Reactive system as it was concluded that energy system had few environmental and safety concerns. The windfarm has been commissioned to full capacity as of 2/13/14 with the battery technology being decommissioned. [45]



Figure 20: Kahuku, Hawaii Yunicos 15MW Lead Acid Battery Storage System [45]

4.3.2 Maui, Hawaii

Yunicos commissioned a project which uses a 1.5 MW Dynamic Power Resource (DPR) to provide control for 3 MW of the existing 30 MW Wind Farm. The battery energy storage and power management system was supplied by Xtreme and the battery technology used was lead acid batteries and has been in operation since July 2014. [45]



Figure 21:Maui, Hawaii, Lead acid battery system [45]

4.3.3 Tehachapi, California, United States

This wind generation and storage project demonstrates the benefits of Li-ion battery and modern inverters to enhance network stability and contribute in the connection of renewable energy generation. Southern California Edison (SCE) provided funding to this project which is based in Tehachapi, California at Monolith Substation and has a 32 MWh battery energy storage system (8MW for 4 hours) and a power management system. The management system will monitor the battery storage system performance and assist with connecting renewable resources. Project evaluation plan to report on specific operational requirements:

- a) Implement grid stabilization and voltage support
- b) reduce transmission system losses
- c) decrease congestion
- d) Enhance system reliability
- e) postpone transmission capital augmentation
- f) Progress and standardise the installation size of new renewable generation projects
- g) Enhance system and the resources
- h) Smoothing renewable resources
- i) Modify wind targets
- j) Regulation of the system frequency
- k) Spinning and non-spinning replacement reserves
- l) Ramping control
- m) Arbitrage of the energy price.

The project, in operation since July 2014, demonstrated the benefits of lithium-ion battery storage to support high capacity requirements for supply to reduce the need for standard generation provided as back up supplies. Approximate project cost in USD 49.9M. [45]



Figure 22: Tehachapi, California, United States, 32MWh Lithium-ion battery storage system [45]



Figure 23: Tehachapi, California, United States, 32MWh Li-ion battery storage system [45]

4.3.4 Goldsmith, Texas, United States, Notrees wind farm

The company Duke Energy designed and constructed a renewable wind generation plant integrated with battery energy storage system at the 153 MW wind farm. The driver is to investigate how energy storage technology can assist wind farm systems address issues of being intermittent by constructing a 36 MW battery energy storage and power control unit with key capabilities of improving efficiency of the flow of energy and support to the grid. Battery technology used was advanced lead acid batteries and has been in operation since January 2013. The windfarm is proposing changing the battery technology to Lithium Ion in 2016. Approximate project cost in USD 43.6M. [45]



Figure 24: Goldsmith, Texas, United States. 36MW advanced lead acid battery system [45]

4.3.5 Kodiak Island, Alaska.

Yunicos installed 3 MW battery storage to provide support to Pillar Mountain Wind farm for voltage and frequency variations generated from the renewable generators. The storage scheme operates as a "bridge" between the renewable energy resources, allowing Kodiak Electric to maximise wind power from 4.5 MW to 9 MW. The battery technology used was lead acid. The installed control system's is such that such it can include Ramp Control when required. [45]



Figure 25: Kodiak Island, Alaska, 3MW advanced lead acid battery system [45]

4.3.6 Copiapo, Atacama, Chile

This is a storage system built in Los Andes substation. The project implements important services to ensure the power grid in Northern Chile is stable and reliable, as this is an important area for mining. The project includes a control system which continuously monitors the grid supply and when a fluctuation in frequency happens, i.e. the tripping of generation or power line, this storage injects up to 12 MW of power almost immediately. The 12MW can be sustained for 20 minutes rated capacity, giving time to the network operator to attend to the loss of supply by bringing standby units onto the network. Battery technology used is lithium-ion and has been in commission since December 2009. [45]



Figure 26: Copiapo, Atacama, Chile, 12MW lithium ion battery storage system [45]

4.3.7 University New Mexico, United States of America.

The grid operator of New Mexico designed and constructed an energy storage scheme made up of 2 units: a 0.5 MW battery for smoothing using Ultra Battery and a 0.25 MW/0.99 MWhr battery to be used for peak shifting. The energy storage system comprised of advanced lead acid batteries, supplied by Ecoult/East Penn Manufacturing. The both systems merged with a 0.75 MW power conditioning system (PCS), and are located with an independently designed 500kW solar PV plant, to provide a firm, dispatch, renewable energy generation capacity. The benefits the hybrid system provides is voltage smoothing and peak shifting controlled by the PCS and other applications, such as energy arbitrage, PV support and peak shaving. As part of the project, dynamic modelling tools was developed and used to calibrate and enhance the battery control management system. Further information and a database containing results are available at www.pnm.com/solarstorage. The project cost \$6,2M and was commissioned on August 2011. [45]



Figure 27: University New Mexico, USA, Ecoult/East Penn Manufacturing battery storage system

4.3.8 Mejillones, Antofagasta, Chile.

This project will use a 20 MW of Li-ion battery system to provide an adaptable and emissions free power system for AES Gener in Northern Chile. The energy storage system introduces support to ensure the stability of the power network is maintained. The system provides benefits by monitoring the state of the power grid and if a predefined frequency fluctuation occurs i.e. tripping of a generator or power line, then the energy storage scheme will inject 20 MW of power almost immediately. The capacity is set to be online for 15 minutes at maximum capacity, ensuring the control room operator has sufficient time to switch in other units on standby. The battery system was in operation in May 2012. [45]



Figure 28: Mejillones, Antofagasta, Chile. 20MW Lithium ion battery storage system

4.3.9 Luverne, Minnesota, United States.,

Xcel Energy commissioned and tested a 1 MW battery storage scheme for storing wind energy and inject it to the power grid when required. NGK Insulators Ltd was the manufacturers of the battery system and was supplied to Xcel Energy in October 2008. The sodium sulphur (NaS) battery is available and various elements of this system is in use by few countries worldwide. The project is being commissioned in Luverne, Minnesota, approximately 45 km east of Sioux Falls, South Dakota. The storage scheme is integrated to the 11 MW wind farm owned and operated by Minwind Energy, LLC. The total funding for the project was \$4.6 million. Xcel Energy's Renewable Development Fund also provided the project with a \$1.0 million grant. The remaining amount was funded through utility rates. [45]



Figure 29: Luverne, Minnesota, United States, Sodium Sulphur battery storage system [45]

4.3.10 Fairbanks, Alaska Untied States of America.

Completed in December 2003, the battery energy storage project is Golden Valley Electric Association (GVEA's) mandates to increase the reliability and reserve support to GVEA. When outage or of loss of generation or power transmission line outage, the system can inject 27 MW of power for 15 minutes. The time chosen was sufficient for the operations to start up standby generation. The battery system main components were: The Nickel-Cadmium (Ni-Cad) battery, designed and manufactured by Saft Batteries, converter was designed and manufactured by ABB. [45]

The project received the following awards:

- a) Platts 2003 Global Energy Award was awarded to ABB the converter;
- b) During the National Rural Electric Cooperative Association Annual Meeting, members presented the project with the Electric Power Research Institute Technology Award;
- c) Guinness World Record acknowledging that the battery energy storage system on December 10, 2003 was the world's most powerful battery system. A demonstration test showed when at its highest capacity, it injected 46 MW, 5 minutes.

Statistics:

- a) Ni-Cad cells was filled with 13,760 liquid electrolyte,
- b) The size of each battery weighs 75kg,
- c) 1,500 tons was the full battery energy storage system weight,
- d) Lifespan of the batteries was estimated to be between 20 to30 years,
- e) Can inject 46 MW for five minutes,
- f) Operational limit was over 5 kV DC
- g) Capital expenditure \$35M



Figure 30: Fairbanks, Alaska United States of America. 27MW Ni-Cad battery storage system [45]

4.3.11 Presidio, Texas United States of America.

Sodium Sulphur (NaS) Energy Storage system provided by NGK. The name given to the project was the Big Old Battery (BOB) and is a 4 MW NaS battery implementing power back up to Presidio in Texas, USA. Presidio has an old power network which is susceptible to loss of supply from the Texas dangerous weather disasters. BOB will solve this issue as described below. Project cost was approximately \$25M and was commissioned in September 2009. [45]

- . BOB offers the grid the following benefits:
 - a) the system provides support for voltage deviations and outages due to its ability to provide a quick response;
 - b) the battery system can provide 4 MW of power for 8 hours continuously without being interrupted for a loss of the radial power line supplying Presidio. This will ensure that the control system operators can transfer power by sourcing from the Texas power during critical events;
 - c) The system can also allow for the maintenance of the power line without any outages;



Figure 31: Presidio, Texas United States of America. 4MW Sodium Sulphur battery system [45]

4.3.12 Illinios, Untied States of America, Jake Energy Storage Centre.

RES Americas developed and constructed 2 x 20 MW battery storage devices, with each having the storage capability of 7.8 MWh. The Elwood Energy Storage Centre was the first of the 2 installations. The predicted lifespan of the project is at least ten years. In September of 2014, RES Americas purchased both projects during the initial phase from Glide Path Power.

The energy storage systems provide frequency fluctuation support to the power grid. In order to maintain power quality, the frequency regulation support balances the time differences in generation and load by storing surplus energy at times of high generation and injecting energy at times of low generation. This energy storage system delivers efficient higher reliability and power quality, with reduced cost to power users than local generation sources and this mainly due to their very fast response time.

The batteries technology uses lithium ion with the scheme consisting of 11 similar storage modules, each being housed in a self-contained system having many of single battery cells, conditioning equipment and management systems to allow a safe operation. This design and construction of the modular units increases system reliability and allowed for ease of installation, construction, operation and maintenance phases. The capital cost of the project was estimated at \$20M. [45]



Figure 32: Illinios, USA, RES Americas 2x19.8 MW lithium iron phosphate batteries [45]

4.3.13 West Virginia, United States of America, Beech Ridge

The 31.5 MW storage system was installed by Invenergy is situated near a 100.5 MW windfarm. Beech Ridge will use stored wind generation to support frequency deviations to the PJM Interconnection power grid. The storage device is designed for 31.5 MW, consisting of 18 x 1.8 MW units. The 1.8 MW unit consists of a 20-foot shipping container having 4 battery modules installed; 4 x 450 kW inverters; an air-conditioning; and a power transformer. The battery technology used was lithium ion and was commissioned in November 2015. [45]

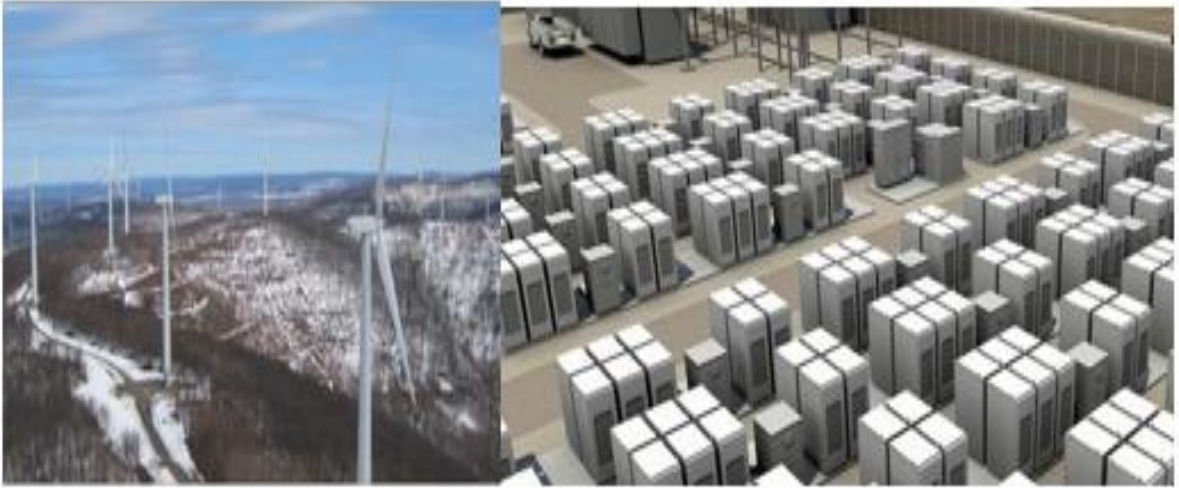

Figure 33: West Virginia, United States of America. 31.5 MW lithium iron phosphate batteries [45]

4.3.14 Gimje-si, South Korea,

Shin-Gimje Substation ESS - 24 MW ESS - KEPCO / Kokam. Korea Electric Power Corporation (KEPCO) installed 24 MW (9 MWh) of Li-ion storage system in July 2015. The battery system was mainly used for frequency regulation, transmission congestion relief and voltage support. In August 2015, KEPCO also started construction of a Kokam 16 MW (6 MWh) of Li-ion at Shin-Chungju Substation with the battery system being operation in July 2016. KEPCO has also awarded Kokam a design and construct award to manufacture a 36 MW capacity / 13 MWh storage scheme to prevent frequency fluctuation at the Non-Gong substation. The project includes a combination of 2 Kokam Li-ion batteries and a Nickel Manganese Cobalt (NMC) which is ultra-high powered and its NANO battery system. Construction started in June 2016 and will be completed in December of 2016. [45]



Figure 34: Gimje-si, South Korea. 24 MW Li-ion battery storage system KEPCO / Kokam [45], [50]

4.3.15 Elkins, Laurel Mountain Windfarm, West Virginia, USA

AES commissioned a wind farm comprising of 98 megawatts of wind energy and 32 megawatts of battery technology. The development is providing wind energy and emissions free, reserve power to the PJM connection. Battery technology used is lithium ion and was commissioned in October 2011. [45]



Figure 35: Elkins, Laurel Mountain Windfarm, West Virginia, USA. 32 MW lithium ion batteries [45]

4.3.16 Sendia, Japan, Nishi-Sendai Substation

Tohoku-Electric Power Co Inc published in Feb 20, 2015, that they have commissioned a large scale storage battery system installed at Nishi-Sendai Station in Sendai City. It is a lithium-ion (Li-ion) rechargeable battery system with a capacity of 20,000kWh and output of 20,000kW (40,000kW for a short period of time). It was introduced as a countermeasure against frequency fluctuation caused by the introduction of solar ...power generation facilities, and Tohoku-Electric Power will check its effects. The project was selected as the "Urgent Verification Project for Large-scale Storage Battery System in Fiscal 2012," for which New Energy Promotion Council (general incorporated association) called for proposals from the public. And Tohoku-Electric Power has been installing the system since November 2013. [45]



Figure 36: Sendia, Japan, Nishi-Sendai Substation. 40MW lithium-ion battery system [45]

4.3.17 Northern Ireland, United Kingdom.

AES owns and operates a 10 MW / 5 MWh battery storage system at Kilroot station. The Advancion Array is known to be the biggest battery storage facility in Northern Ireland, and is installed inside Kilroot coal-fired generation plant. It enhances grid reliability by supplying support to control frequency fluctuations, for the All Island Electricity System, which has a high injection of intermittent onshore wind generation. The system is integrated to the System Operator of Northern Ireland (SONI). The overall storage scheme includes approximately 53,000 lithium ion batteries, designed in 136 individual modules, and is the stage one of a planned 100 MW storage next to the to Kilroot coal plant. The battery system was commissioned in December 2015. [45]



Figure 37: Northern Ireland, United Kingdom. 10 MW lithium ion batteries [45], [58]

4.3.18 Brandenburg, Germany,

Feldheim Regional Regulating Power Station (RRKW) is a state of art energy storage system for renewable generation and is constructed in a town called Feldheim and operates as a 'regulating power station'. State of Brandenburg and the European Union also provided a grant and funding from Enercon was also received. The battery technology was lithium ion, had a capital cost of \$14, 3M and was commissioned in September 2015. [45]



Figure 38: Brandenburg, Germany. 10MW lithium ion battery system [45]

4.3.19 Kabankalan, Philippines-

40 MW - AES / National Grid Corp. of the Philippines. This consortium is designing and constructing a 40 MW battery storage system in Kabankalan, Negros Occidental. National Grid Corp. of the Philippines (NGCP), contracted AES Philippines to design and construct this facility. The benefits for the system is that battery storage helps in improving the ancillary support services. Construction has started in July 2015 and the battery technology being used is lithium ion. AES Philippines envisages that the company sees the opportunity to install 200 to 250 megawatts (MW) of battery energy storage systems around the country. [47]



Figure 39: Kabankalan, Philippines, AES/National Grid of Philippines. [59]

4.3.20 Minamisoma, Japan.

Tohoku Electric Power Company (TEPCO) has installed the battery energy storage system in a transmission substation in Minami-Soma, town of Fukushima. The battery storage system will support and enhance the integration of renewable generation, which is constrained by weather disturbances and power deviations, by storing surplus renewable generation during peak demand and injects stored power during high demand. Toshiba has supplied 2 of these 40 MW systems to TEPCO. The contract was awarded after technical evaluations of a 40 MW / 20 MWh and was then commissioned in 2014 for a TEPCO in Fukushima, to control frequency fluctuations caused by power surges. The battery technology is lithium ion and was commissioned in February 2016.



Figure 40: Minamisoma, Japan. 40 MW lithium ion battery system

4.3.21 Lünen, North Rhine-Westphalia, Germany.

This project is a 15 MW Energy Storage at Lünen Cogeneration Plant. It consists of 6 LG Chem Li-ion battery storage units. The entire program is estimated at 100 M Euro and will see 15 MW energy storage systems installed in power stations at various locations in the German power grid. ASI was awarded a contract in the value of 70 M Euros with German power grid operator STEAG for designing and constructing the 90 MW energy storage system. This design is based on Nidec ASI energy conversion systems and will use batteries provided by LG Chem, which the power grid will utilise to provide various ancillary support to Germany's power grid. [48]



Figure 41: Lünen , North Rhine-Westphalia, Germany. 15 MW lithium-ion battery system

4.3.22 Toronto, Ontario Canada

13 MW / 53 MWh IESO Energy Storage Procurement Phase 1 - Hecate Energy (Toronto Installation). The Independent Electricity System Operator in the Canadian province of Ontario installed six energy storage systems to stabilize its grid. Leclanche SA, the Swiss company providing the technology, signed a deal with the grid operator valued at \$50 million to \$75 million, according to Chief Executive Officer Anil Srivastava. The combined capacity of the six systems will be 53 megawatt hours. The contract with IESO functions as a power purchase agreement for three years, with electricity distributor Toronto Hydro Corp. taking over the agreement for an additional 12 years. The battery technology is lithium ion and phase 1 was commissioned in January 2016. [45]

4.3.23 Vlissingen, Netherlands

The Netherlands Advancion Energy Storage Array has begun operating and provides 10 MW /10 MWh of storage to Dutch transmission system operator. The project, which is AES's first installation on the European continent, will provide Primary Control Reserve (PCR), matching supply and demand on the local grid by using power stored in its batteries to respond quickly to grid imbalances. PCR is known by a number of other terms, such as frequency regulation, in the US and elsewhere. The battery technology is lithium ion and was commissioned in December 2015 [49].

4.3.24 South Korea.

West-Ansung Substation Pilot Project - 28 MW ESD - KEPCO / Kokam / LG Chem. KEPCO established a plan to build 500 MW of energy storage devices (ESD) for frequency control in stages over four years (2014-2017). In 2014, for the first stage, KEPCO successfully installed 52 MW of ESD for frequency regulation across two sites, 28 MW at West-Ansung Substation and 24 MW at Shin-Yongin Substation. KEPCO installed 28 MW (7 MWh) of Li-ion battery storage for frequency regulation. Kokam provided Lithium-titanate (LTO) based Lithium Polymer battery energy storage for 16 MW /5.4 MWh and LG Chem provided 12 MW. The ESD is currently in commercial operation as of June 2015. [50]



Figure 42: South Korea. West-Ansung (Seo-Anseong) Substation. 52 MW across 2 sites [50]

4.3.25 National Grid, United Kingdom.

National Grid, sole operator of Britain's electricity transmission system, has contracted RES Renewable Energy Systems to install 20 MW of energy storage for dynamic frequency response on its networks. RES is one of the suppliers to have pre-qualified for the tender following a request last September that drew responses from more than 70 suppliers offering a combined capacity of more than 7 gigawatts. National Grid's enhanced frequency response tender is in response to a loss of inertia across the U.K. Grid as coal-fired plants are retired. The grid operator is looking to buy fast-reaction capacity in blocks of between 1 megawatt and 50 megawatts per vendor, for an initial contract period of four years starting between fall 2017 and spring 2018. [51]



Figure 43: National Grid, United Kingdom. 20 MW of energy storage [51]

4.3.26 Roxby Downs, South Australia.

The Kingfisher Project will feature a solar PV plant and a battery storage facility that uses sophisticated system management processes and is connected to a grid with operational mining activities. The project will be connected to the National Electricity Market (NEM) the wholesale electricity market in Australia and features two stages of development: Stage 1 will deliver 20 MWdc of solar PV plus a minimum of 2 MWhr lithium-based battery storage. This stage will enable analysis and performance assessment of the plant in harsh desert conditions. Commercial operations are scheduled to get under way before September 2017 Stage 2 will deliver 100 MW of solar PV with a 100 MWh of battery storage and is expected to operate commercially before the end of 2017. The combination of solar and storage means the facilities can provide high quality, reliable power to large energy users while also potentially avoiding the costs of grid upgrades. [52]



Figure 44: Roxby Downs, South Australia, Planning 100 MWh of battery storage [52]

4.3.27 Rokkasho, Japan, Rokkasho Wind Farm

Japan Wind Development (JWD) commissioned a wind generation plant near Rokkasho village in Aomori. Sodium sulphur (NAS) battery system is used to store electricity for support to the national utility and this project uses smart grid technology. The NAS batteries are charged when the power demand is low, and the stored energy is injected into the grid along with the energy produced by the wind farm during the day or at peak demand. The control systems for the energy storage system uses STARDOM controllers and the NAS battery provider was NGK Insulators Ltd. [53]



Figure 45: Rokkasho, Japan. Rokkasho Village Wind Farm using sodium sulphur (NAS) batteries [53]

4.3.28 Italy (3 Projects)

NGK Insulators, Ltd and Terna S.p.A, Italy's transmission system operator (TSO) came to a framework agreement for supply of a NaS battery system. This represents the first large scale NaS battery energy storage system installation in European grid system. According to the framework agreement, maximum quantity equal to 70,000 kW (490,000 kWh for 7 hours discharge) of the NaS battery system will be supplied for installation in the Italian transmission grid. The first phase order under ...this agreement is expected with the volume of 35,000 kW (245,000 kWh) for about 100 million euros. TERNA plans to utilize the NaS battery at a substation in order to balance the demand and supply of electricity instantaneously and stabilize the transmission grid for optimum performance under the massive increase of intermittent renewable energy. All 3 projects are in operation. [54]

4.3.29 Buzen, Fukuoka Prefecture, Japan.

This project was undertaken by Kyushu Electric for the Buzen Substation. A consortium of Mitsubishi Electric and NGK Insulators from Japan has installed this energy storage scheme which is known to be the largest battery storage installation to the power grid operator Kyushu Electric Power Co. The system is rated at 50 MW with a 300 MWh rated capacity and is stage 1 of a project to provide overall management of power to the Japanese grid. The battery technology used was sodium sulphur (NaS) batteries. Benefits of the installation to the grid was smoothing frequency fluctuations and power flow caused by renewable energy. [55]



Figure 46: Buzen, Fukuoka Prefecture, Japan. 50 MW Sodium sulphur (NaS) battery system [55]

4.4 Summary of Worldwide Installations

Majority of the battery storage devices investigated internationally is connected to the medium voltage (MV) side of the power network. The reason for connecting these devices on the MV side is due to cost of major components. The battery energy storage systems essentially are all low voltage (LV) plant ranging from the battery being between 12-24VDC and the inverter systems converting this DC source into 400VAC. For a 400VAC supply to connect to the power grid, a step up transformer is required. Having to step up of voltage from 400VAC to very higher voltages (greater than 33 kV) will increase the size of the step up transformer adding high costs to the storage system. From the above installations investigated it was uncommon to discover step up transformers larger than the MV range. The worldwide installations demonstrate that battery storage is a growing trend amongst many countries and the key benefits it provides to these power grids are for integration of renewable energy due to their intermittent injection of power to the grid, when power is required.

5. Chapter 5- Conclusions and Recommendations

5.1 Recommendations

5.1.1 Opportunities

Energy storage is poised to become a game changer to the power grid and market place of the future because it has unique characteristics and features for existing and emerging utility related challenges and opportunities. Few key opportunities are summarised below [70]:

- Storage has the ability to offset the requirement for more peaking generators;
- Storage enhances the operation of the installed generator systems, hence reduces generator ramping, in turn, reduces asset deterioration, use of fuel;
- Storage has the ability to provide efficient, optimised integration of renewable energy which is known to be intermittent;
- Storage has the ability to provide ancillary services, such as regulation, voltage support and reserve capacity;
- Storage assists with lowering the capacity of a congested power grid, temporary reduce the requirement for major capital investment, and postpone sub-transmission and distribution augmentation;
- Storage will play a vital role in the application of Smart Grid.

5.1.2 Development Needs

- Increasing acknowledgment and awareness by Government of the vital part storage will take up in the modern network;
- Promoting tax at the same time providing regulatory benefits for storage;
- Introduction of the electric and hybrid with plug in power facilities;
- Increasing connection of intermittent renewable generation;
- Growing need for improved power quality and reliability into the grid;
- Develop energy storage engineering standards, data centres, and tools.

5.1.3 Next Steps in Research

- Develop a framework for storage ownership and procurement;
- Communication of the value of storage to the society;

- Establish consensus about priorities and actions and work towards a common understanding amongst stakeholders;
- Identify and introduce attractive incentives to benefit individual user needs;
- Identify important challenges and possible solutions to aid the deployment of storage and prevent delay;
- Identify and learn from other countries worldwide to create engineering standards and tools;
- Ensure smooth integration of storage with Smart Grid and Demand Response initiatives

5.2 Conclusion

The power networks were designed and constructed when energy couldn't be viably stored in bulk capacity. When electricity was required, it had to be generated and as soon as it was generated, it had to be used. The Government has set renewable energy targets and this is simply pressure being posed on utilities and power asset owners to accept renewable energy to essentially reduce greenhouse emissions. The reduction in greenhouse emissions is driving away the coal fired plant and other traditional generation sources and driving in renewable generation. Renewable energy poses tremendous issues to power grid operators, the key being the energy isn't available when required, and when the energy is available, it isn't required. So why waste the energy?

The mini thesis has highlighted that energy storage devices could potentially reshape the network and pave the way for a modern power grid. The value they bring to the power grid operator clearly out ways any challenges foreseen and will become the 'must have asset' when designing the power grid of the future.

Key benefits energy storage device brings to an asset owner is:

- Increase the use of renewable energy and this in turn will meet the emission targets posed by Government
- Provide peaking power and reduce the need for fossil fuelled peaking plant
- Power quality improvement in terms of voltage stability, frequency regulation,
- Demand side management, thereby deferring capital investment for augmentation
- Off grid or isolated grid applications in rural areas and islands
- Smart grid applications where use of PV, wind and biomass can be supplemented with the use of energy storage devices which will enhance the power flow in both directions

As more energy storage devices are being commissioned, the manufacturers are learning and adapting from the past safety concerns. Overheating, explosion, fire and burns are few of these concerns, however with the proper infrastructure in place, these concerns can be easily mitigated. Each country planning on installation of storage devices shall ensure reliable technical standards and specifications are prepared in conjunction with the manufacturers. The high upfront costs are a significant barrier inhibiting wide spread take off however for how long will these high costs last. Manufacturers will be required to work closely with asset owners to ease these concerns.

Different market models have been described of who can own and operate an energy storage device. Similar to all maturing technologies entering an established market, energy storage devices depend favourably on regulatory frameworks being in place and the provision of incentives. With regulatory framework being in place and the incentives for its usage, this will aid the wide spread take-off.

The energy storage devices will occur as a 'megashift' to the industry and key learning for the stakeholders such as manufacturers, consumers, purchasers, asset owners, regulators, retailers and policy makers all liaising with each other to ensure the 'megashift' support the next generation of the power grid.

References

- [1]. J.N. Baker, A. Collinson, Electrical energy storage at the turn of the millennium, *Power Eng J*, 6 (1999), pp. 107–112
- [2]. Australian Greenhouse Office. Advanced electricity storage technologies programme. ISBN: 1 921120 37 1, Australian Greenhouse Office; 2005, p. 1–35
- [3]. Xing Luo, Jihong Wang, Mark Dooner, Jonathan Clark, Overview of current development in electrical energy storage technologies and the application potential in power system operation. 09/2014
- [4]. Succar S, Williams RH. Compressed air energy storage: theory, resources, and applications for wind power. Princeton Environmental Institute. Energy Anal Group; 2008.
- [5]. R. Madlener, J. Latz Economics of centralized and decentralized compressed air energy storage for enhanced grid integration of wind power *Appl Energy*, 101 (2013), pp. 299–309
- [6]. H. Chen, T.N. Cong, W. Yang, C. Tan, Y. Li, Y. Ding, Progress in electrical energy storage system: a critical review *Nat Science Program*, 19 (2009), pp. 291–312
- [7]. Zhou L, Qi ZP. A review of flywheel energy storage system. Proceedings of ISES World Congress 2007 (Vol. I – Vol. V). Berlin, Heidelberg: Springer, Berlin Heidelberg; 2009. p. 2815–19
- [8]. R. Sebastián, R. Peña Alzola, Flywheel energy storage systems: review and simulation for an isolated wind power system - *Renewable Sustainable Energy Rev*, 16 (2012), pp. 6803–6813
- [9]. Pena-Alzola R, Sebastian R, Quesada J, Colmenar A Review of flywheel based energy storage systems. In: 2011 Int. Conf. Power Eng. Energy Electr. Drives, IEEE; 2011. p. 1–6
- [10]. I. Hadjipaschalis, A. Poullikkas, V. Efthimiou Overview of current and future energy storage technologies for electric power applications, *Renew Sust Energy Rev*, 13 (2009), pp. 1513–1522
- [11]. Source from Beacon Power Corporation. Beacon Power inaugurates 20MW flywheel plant in NY. Published 21st July 2011. <<http://www.pennenergy.com/articles/pennenergy/2011/07/beacon-power-inaugurates.html>>
- [12]. Piller power systems products. Energy storage. <http://www.piller.com/205/energy-storage>
- [13]. Electrical energy storage: white paper. Technical report. Prepared by electrical energy storage project team. International Electrotechnical Commission (IEC), Published December 2011. <<http://www.iec.ch/whitepaper/pdf/iecWP-energystorage-LR-en.pdf>>
- [14]. Brito AV, editor. Dynamic modelling. Molina MG. Chapter 4: Dynamic modelling and control design of advanced energy storage for power system applications. InTech; 2010. M.G.
- [15]. Energy storage — packing some power". *The Economist*. 3 March 2011. Retrieved 2016-06-15.
- [16]. Taylor P, Bolton R, Stone D, Zhang XP, Martin C, Upham P, et al. Pathways for energy storage in the UK. Technical report. Centre for low carbon futures. Published 27th March 2012.
- [17]. F. Díaz-González, A. Sumper, O. Gomis-Bellmunt, R. Villafáfila- Robles. A review of energy storage technologies for wind power applications. *Renew Sust Energy Rev*, 16 (2012), pp. 2154–2171

- [18]. S. Mekhilef, R. Saidur, A. Safari. Comparative study of different fuel cell technologies. *Renew Sust Energy Rev*, 16 (2012), pp. 981–989
- [19]. Eberle, Ulrich; Mueller, Bernd; von Helmolt, Rittmar. "Fuel cell electric vehicles and hydrogen infrastructure: status 2012". (15 July 2012). Royal Society of Chemistry. Retrieved 2013-01-08.
- [20]. *Ho, J.; Jow, R.; Boggs, S.* "Historical Introduction to Capacitor Technology" (*Jan* 2010). *IEEE Elect. Insul. Mag. IEEE*. 26 (1): 20–25.
- [21]. A brief history of Supercapacitors AUTUMN 2007 Batteries & Energy Storage Technology
- [22]. W. Earle Waghorne , *Philos. Viscosities of electrolyte solutions- Trans Roy Soc A Math Phys Eng Sci*, 359 (2001), pp. 1529–1543
- [23]. Daniel H. Doughty, Paul C. Butler, Abbas A. Akhil, Nancy H. Clark, and John D. Boyes. Batteries for Large-Scale Stationary Electrical Energy Storage (PDF; 826 kB), *The Electrochemical Society Interface*, 2010, (engl.)
- [24]. A storage market review and recommendations for funding and knowledge sharing priorities, AECOM Australia Pty Ltd
- [25]. <http://lead-acid.com/lead-acid-battery-history.shtml> "The History of the Lead Acid Battery" retrieved 2014 Feb 22
- [26]. Applications & Installations, Global PV markets, Industry & Suppliers, Market & Trends By: Becky Beetz
- [27]. Zhang W, Qiu M, Lai X. Application of energy storage technologies in power grids. *Power Syst Technol* 2008:32.
- [28]. Wind drives growing use of batteries. *New York Times*. Published 28th July 2010. Wald ML
- [29]. Texas-sized battery aims to green up the grid. Hodson H. <https://www.newscientist.com/article/mg21729026-000-texas-mega-battery-aims-to-green-up-the-grid/>
- [30]. Battery energy storage systems: Positive developments regarding battery costs and improved regulatory frameworks will drive a remarkable growth- source: solar server-Global Solar industry website
- [31]. Comparison of Lead Acid to Lithium-Ion in Stationary Storage Applications, AllCell, March 2012
- [32]. Energy Storage Association- Lithium Ion Batteries
- [33]. Report: Lithium ion batteries dominate emerging grid storage market-: <http://www.pv-magazine.com/news/details/beitrag/report--lithium-ion-batteries-dominate-emerging-grid-storage-market> by Johnathan Gifford
- [34]. Wen, Z.; Hu, Y.; Wu, X.; Han, J.; Gu, Z "Main Challenges for High Performance NAS Battery: Materials and Interfaces".. (2013).
- [35]. Q&A Concerning the NAS Battery Fire | NAS Battery Fire Incident and Response | NGK INSULATORS, LTD. ngk.co.jp. Retrieved on 2014-06-26.
- [36]. Saft Battery systems, www.saftbatteries.com
- [37]. IEA, "Technology Roadmap - Energy Storage," 2014.
- [38]. Boer PD, Raadschelders J. Flow batteries. Briefing paper. Leonardo ENERGY; June 2007. http://www.epqu.agh.edu.pl/archives/magazine/mv3i1/mv3i1_22.pdf
- [39]. A. A. D. G. E. C. Dan Raslter, "Energy storage system costs, 2011 update, executive summary," 2012.
- [40]. IRENA, "Renewable Energy Technologies: Cost analysis series. Hydropower," 2012.
- [41]. IRENA, "Electricity Storage," ETSAP, 2012.
- [42]. IRENA, "Renewable Energy Technologies: Cost analysis series. Concentrating Solar Power," 2012.

- [43]. IRENA, “Hydropower - Overview,” IRENA, 2014. [Online]. Available: <http://costing.irena.org/technology-costs/powergeneration/hydropower.aspx>. [Accessed 14 04 2015].
- [44]. G. Edmond G. Brown Jr., “Estimated cost of new renewable and fossil generation in California,” 2014.
- [45]. DOE, “DOE Global Energy Storage Database,” 2014. [Online]. Available: <http://www.energystorageexchange.org/projects>. [Accessed 15 1 2015].
- [46]. <http://cleantechnica.com/2015/09/21/new-10-mw-storage-plant-opened-feldheim-germany-europes-largest>.
- [47]. AES eyes battery storage facilities across Philippines, By Danessa O. Rivera <http://www.philstar.com/business/2015/07/20/1478738/aes-eyes-battery-storage-facilities-across-philippines>
- [48]. <http://www.energymatters.com.au/renewable-news/battery-storage-germany-em5190/>
- [49]. <http://energystorage.cleantechnology-business-review.com/news/aes-unveils-10-mw-advancion-energy-storage-array-in-netherlands-180216-4814870>
- [50]. KOKAM Batteries. <http://kokam.com/adv/news.php>, <http://home.kepco.co.kr/kepco/main.do>
- [51]. <http://www.windpowermonthly.com/article/1396062/res-national-grid-agree-fast-balancing>
- [52]. <http://reneweconomy.com.au/2016/lyon-confirms-plans-for-two-big-solar-storage-plants-in-australia-19683>
- [53]. NGK Batteries. https://www.ngk.co.jp/nas/case_studies/rokkasho/, <http://www.yokogawa.com/iab/suc/power/iab-suc-jwd-en.htm>
- [54]. http://www.terna.it/default/home_en/the_company/about_terna/Terna_Storage_en.aspx
- [55]. <http://electronics360.globalspec.com/article/6402/mitsubishi-installs-50mw-energy-storage-system-to-japanese-power-company>
- [56]. <https://www.adelaide.edu.au/news/news78482.html>
- [57]. <http://arena.gov.au/project/energy-storage-for-commercial-renewable-intergration/>
- [58]. <http://www.belfasttelegraph.co.uk/news/northern-ireland/europes-biggest-wind-battery-to-slash-cost-of-northern-ireland-electricity-bills-30971106.html>
- [59]. <http://microgridmedia.com/aes-adding-battery-storage-capacity-to-philippine-power-grids/>
- [60]. M. Anderson, D. Carr, Battery energy storage technologies, Proceedings of the IEEE 81 (3) (1993) 475–479.
- [61]. W. Lachs, D. Sutanto, Application of battery energy storage in power systems, Proceedings of the International Conference on Power Electronics and Drive Systems, 2, February 21–24, 1995, pp. 700–705.
- [62]. I. Gyuk, P. Kulkarni, J.H. Sayer, J.D. Boyes, G.P. Corey, G.H. Peek, The united states of storage, IEEE Power and Energy Magazine 3 (2) (2005) 31–39.
- [63]. K.C. Divya, Jacob Ostergaard, Battery energy storage technology for power systems—An overview, Technical University of Denmark, Kgs. Lyngby 2800, Denmark, Journal of Power Sources, <http://www.journals.elsevier.com/journal-of-power-sources>
- [64]. Eric Hittingera, J.F. Whitacre, Jay Apt. What properties of grid energy storage are most valuable? Elsevier Journal of Power Sources
- [65]. S. Schoenung, Characteristics and Technologies for Long- vs. Short-term Energy Storage, Sandia National Laboratories, 2001
- [66]. S. Schoenung, W. Hassenzahl, Long- vs. Short-Term Energy Storage Technologies Analysis: A Life-Cycle Cost Study, Sandia National Laboratories, 2003
- [67]. Egon Ortjohann, Alaa Mohd, Andreas Schmelter, Nedzad Hamsic, Danny Morton- Challenges in integrating distributed energy storage into future smart grid, IEEE Conference Paper · August 2008
- [68]. E.Ortjohann, N.Hamsic , A.Schmelter ., et al., Increasing Renewable Energy Penetration in Isolated Grids Using a Flywheel Energy Storage System, the first International

Conference on Power Engineering, Energy and Electrical Drives
(POWERENG,IEEE),Portugal, April 2007.

- [69]. Wade, N.S., et al., Evaluating the benefits of an electrical energy storage system in a future smart grid. Energy Policy (2010),
- [70]. Energy Storage for the Electricity Grid: Benefits and Market Potential Assessment Guide, Sandia National Laboratories
- [71]. Nansheng Xu, Xue Li, Xuan Zhao., et al., A novel solid oxide redox flow battery for grid energy storage, Energy Environ. Sci., 2011, 4, 4942
- [72]. Chad Abbey, Géza Joos, Supercapacitor Energy Storage for Wind Energy Applications; IEEE Transactions on Industry Applications Vol.43, NO.3
- [73]. Anurag K. Srivastava, Aarti Asok Kumar, Noel N. Schulz, Impact of Distributed Generations with Energy Storage Devices on the Electric Grid; IEEE Systems Journal, Vol. 6, No.1, March 2012