



Distributed Piecewise Approximation Economic Dispatch for Regional Power Systems Under Non-Ideal Communication

Hao, Ran; Lu, Tianguang; Wu, Qiuwei; Chen, Xinyu; Ai, Qian

Published in:
IEEE Access

Link to article, DOI:
[10.1109/ACCESS.2019.2908680](https://doi.org/10.1109/ACCESS.2019.2908680)

Publication date:
2019

Document Version
Publisher's PDF, also known as Version of record

[Link back to DTU Orbit](#)

Citation (APA):

Hao, R., Lu, T., Wu, Q., Chen, X., & Ai, Q. (2019). Distributed Piecewise Approximation Economic Dispatch for Regional Power Systems Under Non-Ideal Communication. *IEEE Access*, 7, 45533-45543. <https://doi.org/10.1109/ACCESS.2019.2908680>

General rights

Copyright and moral rights for the publications made accessible in the public portal are retained by the authors and/or other copyright owners and it is a condition of accessing publications that users recognise and abide by the legal requirements associated with these rights.

- Users may download and print one copy of any publication from the public portal for the purpose of private study or research.
- You may not further distribute the material or use it for any profit-making activity or commercial gain
- You may freely distribute the URL identifying the publication in the public portal

If you believe that this document breaches copyright please contact us providing details, and we will remove access to the work immediately and investigate your claim.

Received March 15, 2019, accepted March 23, 2019, date of publication April 1, 2019, date of current version April 16, 2019.

Digital Object Identifier 10.1109/ACCESS.2019.2908680

Distributed Piecewise Approximation Economic Dispatch for Regional Power Systems Under Non-Ideal Communication

RAN HAO¹, (Student Member, IEEE), TIANGUANG LU², (Member, IEEE),
QIUWEI WU³, (Senior Member, IEEE), XINYU CHEN⁴, (Member, IEEE),
AND QIAN AI¹, (Senior Member, IEEE)

¹School of Electronic, Information and Electrical Engineering, Shanghai Jiao Tong University, Shanghai 200240, China

²School of Engineering and Applied Sciences and Harvard China Project, Harvard University, Cambridge, MA 02138, USA

³Center for Electric Power and Energy, Department of Electrical Engineering, Technical University of Denmark, 2800 Kongens Lyngby, Denmark

⁴School of Electrical and Electronic Engineering, Huazhong University of Science and Technology, Wuhan 430074, China

Corresponding author: Tianguang Lu (tlu@seas.harvard.edu)

This work was supported in part by the National Natural Science Foundation of China under Grant U1866206, and in part by the National Key R&D Program of China under Grant 2016-YFB0901300.

ABSTRACT Appropriate distributed economic dispatch (DED) strategies are of great importance to manage wide-area controllable generators in wide-area regional power systems. Compared with existing works related to ED, where dispatch algorithms are carried out by a centralized controller, a practical DED scheme is proposed in this paper to achieve the optimal dispatch by appropriately allocating the load to generation units while guaranteeing consensus among incremental costs. The ED problem is decoupled into several parallel sub-problems by the primal-dual principle to address the computational issue of satisfying power balance between the demand and the supply from the distributed regional power system. The feasibility test and an innovative mechanism for unit commitment are then designed to handle extreme operation situations, such as low load level and surplus generation. In the designed mechanism, the on/off status of units is determined in a fully distributed framework, which is solved using the piecewise approximation method and the discrete consensus algorithm. In the algorithm, the push-sum protocol is proposed to increase the system adaptation on the time-varying communication topology. Moreover, consensus gain functions are designed to ensure the performance of the proposed DED under communication noise. Case studies on a standard IEEE 30-bus system demonstrate the effectiveness of our proposed methodology.

INDEX TERMS Communication uncertainties, distributed economic dispatch, on/off status, piecewise approximation.

I. INTRODUCTION

With the increasing penetration of distributed energy resources (DERs), the flexibility and scalability of ED are necessary to ensure the reliable operation of regional power systems. Appropriate scheduling strategies must allow system expansion and be robust against topology perturbation. In addition, renewal / expansion expense should be drastically curtailed to meet the increasing load demand and the growing number of DERs. Recently, there has been much interest in studying ED for large-scale integration of DERs and robust operation of extensible regional power systems.

The associate editor coordinating the review of this manuscript and approving it for publication was Zhiyi Li.

ED problem is one of the most significant problems in the power system. Its main objective is to provide optimal dispatch strategy to reduce operation costs while satisfying global demand constraints and local generation constraints [1]. Many methods contribute to the solution of ED problems. Conventional convex optimization includes quadratic programming [2], Lagrangian relaxation [3] and etc. Artificial intelligence algorithms provide a state-of-the-art technique to search the optimal solution [4]–[6]. It is worthy to emphasize that all these methods are based on a dispatch center, where the centralized controller collects information from all generators to obtain and order the optimal power allocation. However, centralized scheduling is usually

inextensible and costly in wide-area distributed system [7]. Different from traditional centralized framework where a leadership node is able to pick up global complete information, DED, which is pioneered by works, such as [8], [9], decomposes the original problem into several parallel subproblems with coupling. Participants, intelligent equipment generators and load, interact local incomplete information with each other to solve these subproblems, through which the feasible solution can be updated and the global objective cost can be minimized.

Moreover, the increase of distributed devices puts more complexity on information interaction and global optimization, which causes the following unprecedented challenges for traditional centralized control strategy. First, a powerful computation center and vertical control are indispensable to be deployed in wide-area distributed system management, to cope with intractable computation burden and to reduce single point failure risks. Second, due delay and server capacity, rolling correction of centralized scheduling strategies has difficulties in achieving satisfactory tracking performance. Third, centralized management leads to an invasion of electrical equipment's privacy and vicious competition.

With the application of wireless communication and sensor network technology, DED approaches have drawn considerable attention in research on regional power systems [10], [11]. A novel coordinated power controller framework with DED module is designed in [12]. For a constrained optimization problem in a large-scale multi-cluster agent system, the study in [13] establishes a distributed hierarchical algorithm based on projected gradient, using synchronous iteration to exhibit better performance in communication. References [14], [15] consider a multi-agent-based convex optimization problem where all agents are subject to a global inequality constraint and a global equality constraint. A distributed power sharing control method is proposed in [16] with merged AC-DC characteristics through an extensive cyber network for low-voltage DC microgrids. The method in [17] develops a distributed control by combining frequency control with consensus protocol. References [18], [19] define the stealthy attack through false data injection and provide sufficient conditions to ensure the convergence of the algorithm when an attacker injects false data into broadcast information. In addition, communication delay and line losses in DED are discussed in [20] and [21], respectively. The authors in [22] propose a distributed energy management based on the alternating direction method of multipliers. In the above-mentioned literatures, day-ahead unit commitment and global supply-demand balance are rule-based designing, and lack of rigorous designs to extend algorithm applicability. In addition, existing works have the following limitations. 1) It is difficult for participants to obtain some global information via neighbor communication, whose absence will make a global optimization unable to be solved. 2) Some key information is required to be shared with each other, which fails to protect users' privacy effectively. 3) Global constraint of supply-demand power balance is hard

to be satisfied for each local agent in real-time. 4) The on/off status of units is not considered in DED, which may lead to an infeasible solution under extreme operation circumstances.

To address the above limitations from the perspective of regional power systems operators, a novel DED strategy is proposed considering smart startup and shutdown of units as well as the computation-saving realization of global power balance. In addition, model-solving methods are modified for adaptive topology update and communication noise. This paper provides an insight into realizing DED with incomplete information interacted. The technical novelty and main contributions are threefold:

- 1) The proposed DED strategy is realized in a completely distributed framework where single-node congestion is avoided [23]. The strategy protects the privacy of participants' local information such as cost function and power consumption [24], and is robust against single point failures.
- 2) Different from conventional decentralized methods, this paper takes the lead in optimizing on/off status of units in real-time to handle extreme operation situations such as low load level and surplus generation. Global supply-demand balance is also considered and satisfied in a computation-saving way through neighboring interaction with time-varying perturbation.
- 3) Push-sum protocol is used to avoid neighbor topology information update before each iteration, which greatly simplifies the neighboring interaction and guarantees the convergence based on time-varying communication topology. Appropriate gain functions are also proposed to remove the adverse effect caused by communication noise and improve the convergence accuracy.

The reminder of this paper is organized as follows. In Section II, an ED optimization problem is decoupled into several subproblems. Then, piecewise approximation and discrete consensus algorithm are employed to solve the problem. Feasibility test and unit withdrawal mechanism are designed in Section III. Section IV provides push-sum protocol to avoid neighbor topology information update. Consensus gain functions are also designed to remove the negative effect caused by communication noise. Section V analyzes real-time simulation results, followed by concluding remarks in Section VI.

II. DISTRIBUTED PIECEWISE APPROXIMATION DESIGN

A. MULTI-AGENT BASED ARCHITECTURE FOR DED

Unlike conventional centralized ED, scheduling center and radial communication do not require to be configured in a fully decentralized scheduling strategy. Depending on the system size, system operators may be isolated system operators or generation company with scheduling authority. Fig. 1 shows the DED framework for regional power systems, where load and generators are dispersed across a vast terrain. There are two kinds of agents deployed in bus nodes: load agent and generator agent. Load agents monitor load infor-

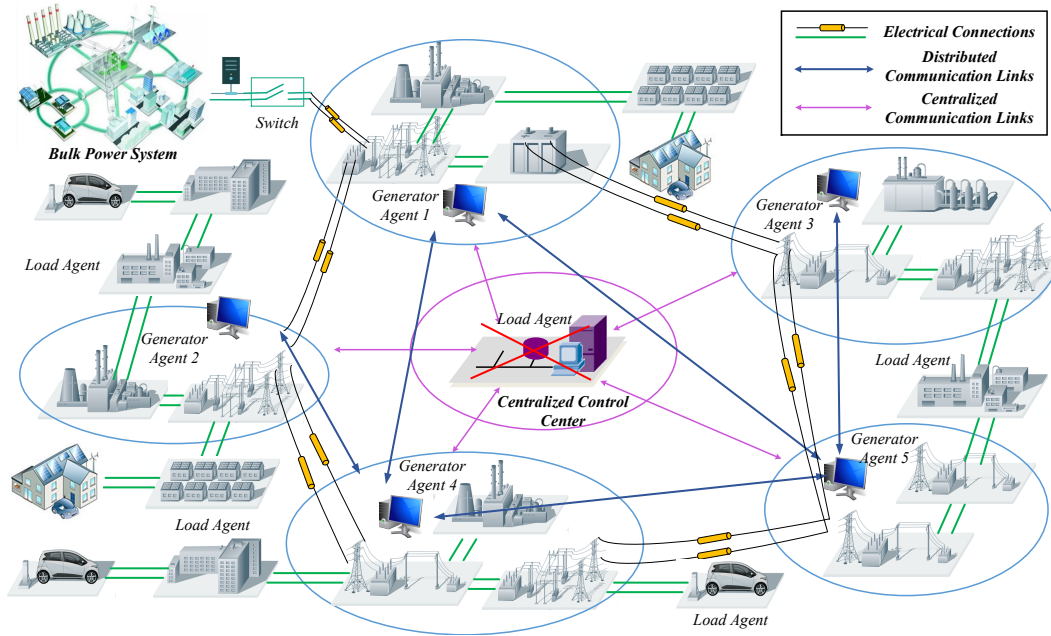

FIGURE 1. Diagram of DED framework for regional power systems.

mation of local bus nodes and interact with neighbors, and generator agents optimize local generation power based on the interactive auxiliary variables.

This multi-agent based DED architecture can benefit a lot from using neighbor communication instead of radial communication. The major advantages of distributed methods are listed here. First, removal of central controller brings lots of benefits in land and central server investment. Second, local decision-making can quickly perceive topological perturbations. There is no communication delay introduced in issuing dispatch orders, which contributes to rapid reference tracking. Local decision-making is also robust against single point failures. Third, distributed methods avoid software updates when new load and generators are accessed to the system. Finally, some key information can be encrypted via auxiliary variables, which protects participants' privacy during the interaction process.

The operation mechanism of multi-agent based DED framework can be briefly summarized as: (a) load and generator agents check the feasibility of scheduling, and generator agents determine the optimal unit commitment scheme based on the minimum marginal cost principle. (b) Designed distributed iterations enable each generator agent to obtain some globally consistent auxiliary variables, where auxiliary variables design and handling power balance constraints are two difficulties. (c) Each generator agent independently makes scheduling plan according to global auxiliary information and its own operation characteristics.

Based on the DED framework, assume that the communication network is a strongly connected digraph. The communication connection of universal nodes corresponds to the connection of physical systems. Power line carrier communication is very suitable for this situation. Establish

bidirectional communication graph $G_m = (V_m, E_m)$, $G_n = (V_n, E_n)$, where V_m and V_n are sets of universal nodes and generator nodes, respectively. The numbers of total nodes and generator nodes in regional power system are denoted as m and n ($m \gg n$). E_m denotes the set of directed edges G_m , and E_n represents that of G_n .

B. PROBLEM FORMULATION FOR DED

According to actual operation characteristics of generators, we have the following hypothesis to ensure that the original optimization problem has an optimal solution.

Hypothesis: For each generator node $\forall i \in V_n$, the cost function of generator $i C_i(x_i) : \mathbb{R}_+ \rightarrow \mathbb{R}_+$ is continuous, differentiable, it and has an inverse function.

According to the superposition theorem, the cost function of the sum of multiple generators is also continuous, differentiable and has an inverse function. For the convenience of analysis, cost functions are assumed as quadratic functions, and its Hessian matrix is strictly positive definite.

Suppose that L_j is the load of node j . P_i is the generation of node i . Due to power balance, the sum of power generation should be equal to the total load P^* .

$$\sum_{i=1}^n P_i v_i = \sum_{j=1}^m L_j = P^* \quad (1)$$

where $v_i \in \{0, 1\}$ is the on/off state variable of the generator i . $v_i = 1$ means that generator i is in operation and vice versa.

To minimize the operation cost, the distributed optimal dispatch model is established as follows:

$$\begin{aligned} \min_{v_i, P_i} & \sum_{i=1}^n C_i(v_i P_i) \\ \text{s.t.} & P_i \leq P_i \leq \bar{P}_i \end{aligned}$$

$$\begin{aligned} \sum_{i=1}^n v_i P_i &= P^* = \sum_{j=1}^m L_j \\ v_i \bar{P}_i &\geq P^* + R = P^*(1 + \delta) \\ v_i &\in \{0, 1\} \end{aligned} \quad (2)$$

where P_i and \bar{P}_i denote the lower and upper output bounds of generator i , respectively. R is a given value denoting reserve capacity which equals to the product of the total load and reserve percentage δ . Since objective function (2) is convex and all the constraints are linear, it can be proven that the solution satisfying the KKT conditions is optimal.

Define the incremental cost of generator i as:

$$\gamma_i(P_i) = \frac{dC_i(P_i)}{dP_i}, \forall i \in V_n \quad (3)$$

According to the above formulation, $\gamma_i(P_i)$ is a continuous and monotonically increasing function. Similarly, γ_i^{-1} is continuous and monotonically increases with a larger $\gamma_i(P_i)$.

Under the circumstance of optimal unit commitment, i.e. 0-1 variables are at optimum, the original problem (2) is a linear programming, and can be described as a Lagrange primal-dual problem:

$$\begin{aligned} \max_{\lambda \geq 0} \{ \min_{P_i \in \mathbf{P}} \sum_{i=1}^n C_i(v_i P_i) + \lambda(P^* - \sum_{i=1}^n v_i P_i) \} \\ s.t. \quad v_i \bar{P}_i \geq P^* + R \end{aligned} \quad (4)$$

where \mathbf{P} represents the feasible region of P_i . $\lambda \in \mathbb{R}^+$ is a Lagrange multiplier.

The objective function of the duality problem can be recast as:

$$\begin{aligned} \max_{\lambda \geq 0} \sum_{i=1}^n C'_i(\lambda) + \lambda P^* \\ C'_i(\lambda) = \begin{cases} C_i(P_i) - \lambda P_i, & \lambda < \gamma_i(P_i) \\ C_i(\gamma_i^{-1}(\lambda)) - \lambda \gamma_i^{-1}(\lambda), & \gamma_i(P_i) \leq \lambda \leq \gamma_i(\bar{P}_i) \\ C_i(\bar{P}_i) - \lambda \bar{P}_i, & \lambda > \gamma_i(\bar{P}_i) \end{cases} \end{aligned} \quad (5)$$

Define g_i as the piecewise mapping g_i from λ to P_i . Since $P'_i = \gamma_i^{-1}(\lambda_i)$ is the mapping based on the optimal condition $\lambda_i = \gamma_i(P'_i)$, λ are independent of P_i in the optimization process and the derivation of the objective function with respect to multiplier λ can be written as:

$$g_i(\lambda) = \frac{dC'_i(\lambda)}{d\lambda} = \begin{cases} -P_i, & \lambda < \gamma_i(P_i) \\ -\gamma_i^{-1}(\lambda), & \gamma_i(P_i) \leq \lambda \leq \gamma_i(\bar{P}_i) \\ -\bar{P}_i, & \lambda > \gamma_i(\bar{P}_i) \end{cases} \quad (6)$$

If the problem is feasible, the optimal solution of the problem (3) by the following formula:

$$P^* + \sum_{i=1}^n g_i(\lambda^*) = 0 \quad (7)$$

Thus, each generator agent can obtain P_i by $P_i = -g_i(\lambda^*)$.

C. DECOMPOSITION ANALYSIS AND DISTRIBUTED SOLUTION

All generator agents should acquire global power balance information $P^* = \sum_{j=1}^m L_j$ in a completely distributed manner. The global power balance constraint can be rewritten as:

$$\sum_{j=1}^m L_j = P^* \Rightarrow \sum_{i=1}^n P_i = P^* \quad (8)$$

Define the normalized adjacency matrix of G_m as $\mathbf{H} \in \mathbb{R}^{m \times m}$. Construct doubly-stochastic matrix \mathbf{H} according to [17], [20], [25]:

$$\begin{aligned} [\mathbf{H}]_{ij} &= h_{ij} = \begin{cases} \frac{1}{\max\{d_{m,i}^+, d_{m,j}^+\} + 1}, & (\mathbf{j}, \mathbf{i}) \in \mathbf{E}_m \\ 0, & \text{o.w.} \end{cases} \\ [\mathbf{H}]_{ii} &= h_{ii} = 1 - \sum_{(\mathbf{j}, \mathbf{i}) \in \mathbf{E}_m} h_{ij} \end{aligned} \quad (9)$$

where the out-degree of point j in graph G_m is described as $d_{m,j}^+$. Similarly, $d_{n,j}^+$ denotes the out-degree of point j in graph G_n . Define the normalized adjacency matrix of G_n :

$$\begin{aligned} [\mathbf{R}]_{ij} &= r_{ij} = \begin{cases} \frac{1}{\max\{d_{n,i}^+, d_{n,j}^+\} + 1}, & (\mathbf{j}, \mathbf{i}) \in \mathbf{E}_n \\ 0, & \text{o.w.} \end{cases} \\ [\mathbf{R}]_{ii} &= r_{ii} = 1 - \sum_{(\mathbf{j}, \mathbf{i}) \in \mathbf{E}_n} r_{ij} \end{aligned} \quad (10)$$

For $i \in V_m$, construct auxiliary variable $y_i[k]$ and initialize it to $y_i[0] = L_i$. The discrete iteration rule of $y_i[k]$ are designed as follows:

$$y_i[k + 1] = h_{ii}y_i[k] + \sum_{j \in \Theta_{m,j}^-} h_{ij}y_j[k] \quad (11)$$

where $\Theta_{m,j}^-$ is the neighbor set of i in G_m . Through the above iteration, auxiliary variables converge to a common value $y_j^* = \lim_{k \rightarrow \infty} y[k] = P/m$. In addition, load information of each agent is included in auxiliary variable y_j^* .

Agents can get the estimation of some global information by constructing auxiliary variables. Referring to [25], we construct scaled variables $s_i[k]$, $\forall i \in V_m$ to describe the gap between generation nodes and load nodes, and initialize them based on the following principle:

$$s_i[0] = \begin{cases} y_i^*, & i \in V_n \\ 0, & i \in V_m \& i \notin V_n \end{cases} \quad (12)$$

The parallel iteration is shown as follows:

$$s_i[k + 1] = h_{ii}s_i[k] + \sum_{j \in \Theta_{m,j}^-} h_{ij}s_j[k] \quad (13)$$

Auxiliary variable s_i transfers the load information from G_m to G_n . After several iterations, auxiliary variables converge to the same value:

$$s^* = \lim_{k \rightarrow \infty} s[k] = n/m^2 \times P^* \quad (14)$$

For $\forall i \in V_n$, construct auxiliary variable u_i . Each agent set the value of u_i^* as:

$$u_i^* = \frac{(y_i^*)^2}{s_i^*} = \frac{1/m^2}{n/m^2} P^* = \frac{P^*}{n} \quad (15)$$

Through the above equations (11)-(15), the scaled load information u_i of the whole regional system is informed to all generator agents. The average generation is denoted by u_i for $\forall i \in V_n$, which satisfies the power balance constraint. However, this process requires a number of iterations. To reduce the computational burden, a piecewise approximation algorithm is designed to accelerate the convergence.

For generator i , $\forall i \in V_n$, define upper and lower bounds of Lagrange multiplier as $\lambda^+[k]$ and $\lambda^-[k]$, respectively:

$$\lambda^-[0] = \min_{i \in V_n} \gamma_i(P_i) \quad \lambda^+[0] = \max_{i \in V_n} \gamma_i(\bar{P}_i) \quad (16)$$

Define critical value $\lambda^{j/N}[k]$ for multi-section:

$$\lambda^{j/N}[k] = \lambda^-[k] + j/N(\lambda^+[k] - \lambda^-[k]),$$

$$j = 1, 2, \dots, N - 1 \quad (17)$$

Each generator agent calculates section boundaries:

$$P_i^{j/N}[k] = -g_i(\lambda^{j/N}[k]) \quad (18)$$

Construct auxiliary variables $z_i^{j/N}[k]$ and initialize it as $z_i^{j/N}[0] = P_i^{j/N}[k]$. The iteration process is designed as follows:

$$z_i^{j/N}[k+1] = r_{ii}z_i^{j/N}[k] + \sum_{p \in \Theta_{n,i}^-} r_{ij}z_p^{j/N}[k] \quad (19)$$

When all $z_i^{j/N}$ converge, we obtain:

$$z_i^{j/N*} = 1/n \sum_{i=1}^n P_i^{j/N}[k], \forall i \in V_n \quad (20)$$

where $z_i^{j/N*}$ is the piecewise generation of section boundary $\lambda^{j/N}[k]$. $z_i^{j/N*}$ denotes the average generation for $\forall i \in V_n$ on each segment boundary. To narrow this feasible region, each agent compares $z_i^{j/N*}$ with the identical u_i^* and upgrade the upper bound $\lambda^+[k+1]$ and lower bound $\lambda^-[k+1]$:

$$\left\{ \begin{array}{l} \lambda^+[k+1] = \lambda^{1/N}[k], \lambda^-[k+1] = \lambda^-[k], \\ \quad z_i^{1/N*} > u_i^* \\ \lambda^+[k+1] = \lambda^{2/N}[k], \lambda^-[k+1] = \lambda^{1/N}[k], \\ \quad z_i^{1/N*} \leq u_i^* < z_i^{2/N*} \\ \quad \vdots \\ \lambda^+[k+1] = \lambda^+[k], \lambda^-[k+1] = \lambda^{N-1/N}[k], \\ \quad z_i^{N-1/N*} \leq u_i^* \end{array} \right. \quad (21)$$

Piecewise update makes Lagrange multiplier approximate to the optimal point λ^* . The terminating condition is $\lambda^+[k] - \lambda^-[k] \leq \varepsilon$. When the condition is met, the optimal Lagrange multiplier can be calculated by the mean value of upper and low bounds $\lambda^* = 1/2(\lambda^+[k] + \lambda^-[k])$.

After applying piecewise approximation method for T times, the error of λ can be harnessed in a target range $\eta \leq 1/2N^{T+1}$.

Each agent can compute the global optimal solution through the formula: $P_i^* = -g_i(\lambda^*)$, $\forall i \in V_n$.

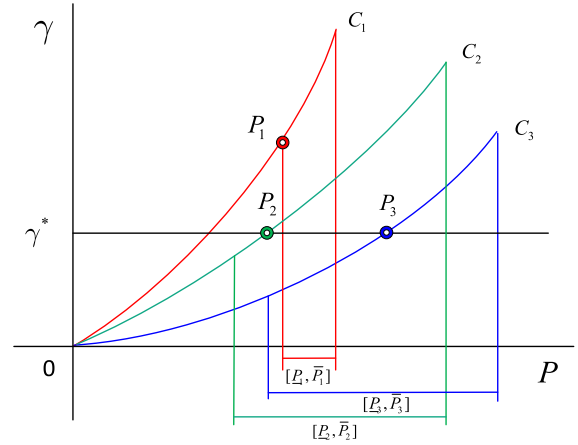

FIGURE 2. Diagram of incremental cost - power generation.

III. IMPROVEMENT FOR UNIT COMMITMENT IN SOLUTION ALGORITHM

This part designs three necessary mechanisms or algorithms that contribute to the solution of our proposed DED.

A. FEASIBILITY TEST

Construct two auxiliary variables $y_i[k]$, $\bar{y}_i[k]$ to describe the generation bounds assigned to generator i . We initialize them to $y_i[0] = v_i P_i$, $\bar{y}_i[0] = \bar{P}_i / (1 + \delta)$.

Run the following iterations in parallel:

$$y_i[k+1] = r_{ii}y_i[k] + \sum_{j \in \Theta_{n,i}^-} r_{ij}y_j[k]$$

$$\bar{y}_i[k+1] = r_{ii}\bar{y}_i[k] + \sum_{j \in \Theta_{n,i}^-} r_{ij}\bar{y}_j[k] \quad (22)$$

Assume that y_i converges to y_i^* and \bar{y}_i converges to \bar{y}_i^* . Only when $y_i^* \leq \bar{y}_i^*$, original problem is feasible. Note that if $y_i^* \leq \bar{y}_i^*$ holds for one of the generators, it holds for all generators and this unit commitment scheme is feasible.

B. UNIT WITHDRAWAL MECHANISM

This subsection proposes a state-of-art units withdrawal mechanism to further reduce the operation cost.

Fig. 2 demonstrates the relationship between incremental cost and power generation. Since C_i are nonnegative convex functions, all units are desired to operate at a lower power level. Because the marginal cost is low when the generation of a unit is small, default is that all generators are in operation during the initial stage. The optimization of unit commitment is to choose some costly units that need to exit operation. There are two situations that can determine the withdrawal of a generator. First, the generator with the highest incremental cost should be selected. Second, the unit with minimum power output should be selected, since if the incremental costs of all unit are equal, the generator that output minimum operation power are likely to cause a higher future incremental cost, as illustrated by the comparison of points P_2 and P_3 in Fig. 2.

C. EXTREME VALUE DISTRIBUTED COOPERATIVE ALGORITHM

This subsection introduces a distributed cooperative algorithm to search for the extreme value, which is used in unit withdrawal mechanism. In a multi-agent system with n interconnected agents, let x_i be a target variable of generator i and set $X_i \in \{0, 1\}$ be the flag to check whether x_i is the extreme value. x_i is initialized to 1. Each agent repeats the following iteration for $n-1$ times:

$$x_i \leftarrow \min_{j \in \Theta_i^-} \{x_j\}, \quad x_i \leftarrow \max_{j \in \Theta_i^-} \{x_j\} \quad (23)$$

If x_i changes, set the flag $X_i = 0$. After the iterations, each agent can obtain the extreme state in this multi-agent system. Besides, an agent will be aware of whether its value $x_j, j \in \Theta_i^-$ is the extreme value.

IV. IMPROVEMENT FOR DISTRIBUTED ITERATION

Non-ideal communication is widespread in actual engineering program. Generally speaking, the delay of neighbor communication is small, and the discrete consistency iteration applied in this paper can eliminate the impact of delay by extending sampling time. *Olfati-Saber et al.* have proved that $\pi/2\lambda_n(\mathbf{L})$ is the maximum delay that a multi-agent system can tolerate during consensus iteration in [26], where $\lambda_n(\mathbf{L})$ is the maximum eigenvalue of topology Laplacian matrix. Thus, this paper focuses on the other three non-ideal conditions: disconnection, reconnection and noise interference. These three communication problems are modeled as follows:

a. Agents Disconnection: An agent may be suddenly disconnected from the multi-agent system in time-varying topology. Take the discrete communication process of y_i in (11) as an example. If agent a is disconnected, the update formulas are:

$$y_a[k+1] = h_{aa}y_a[k] \\ y_i[k+1] = h_{ii}y_i[k] + \sum_{j \in \Theta_{m,j}^- - \{a\}} h_{ij}y_j[k], \quad i \neq a \quad (24)$$

where the doubly-stochastic matrix \mathbf{H} remains unchanged before agent a is disconnected.

b. Agents Reconnection: Similarly, if agent a is reconnected, the update formulas of agent a and its neighbors are reformulated as:

$$y_a[k+1] = \frac{1}{d_{mi}^+ + 1} \left(y_a[k] + \sum_{j \in \Theta_{m,j}^- - \{a\}} y_j[k] \right) \\ y_i[k+1] = h_{ii}y_i[k] + \sum_{j \in \Theta_{m,j}^-} h_{ij}y_j[k] + \frac{y_a[k]}{d_{mi}^+ + 1}, \quad (a, i) \in E'_m \quad (25)$$

where the doubly-stochastic matrix \mathbf{H} remains unchanged before agent a is reconnected. E'_m is the new edge set.

c. Noise Interference: Random communication noise $\omega_{ij}[k]$ exists between any two agents in the network and undermines

interprocess communication. To mitigate the noise interference, the discrete iteration of y_i in (11) can be reformulated as:

$$y_i[k+1] = h_{ii}y_i[k] + \sum_{j \in \Theta_{m,j}^-} h_{ij}y_j[k] + \omega_{ij}[k] \quad (26)$$

A. PUSH-SUM PROTOCOL FOR TIME-VARYING DIRECTED GRAPH

As is demonstrated in (9-10), $[\mathbf{H}]_{ij}$ and $[\mathbf{R}]_{ij}$ require the maximum out-degree information between two nodes, which means that they should be upgraded in real-time to accurately describe the time-varying topology. This increases the burden of communication and calculation. To solve this problem, push-sum protocol is leveraged to only interact with local out-degree information. The push-sum is a consensus-like method where every node updates its values by taking linear combinations of the values of its neighbors [27], [28]. Due to linear combinations, some nodes are more influential than others. To offset the effect of nodes imbalances, \mathbf{w}' is used to describe topology perturbation and the equation $y_i[k] = w_i[k]/w'_i[k]$ ensures $y_i[k]$ converges to the mean value.

Taking the iteration process of y_i as an example, we define two variable vectors $\mathbf{w}, \mathbf{w}' \in \mathbb{R}^n$.

$$\mathbf{w}[k+1] = \mathbf{B}[k]\mathbf{w}[k] \\ \mathbf{w}'[k+1] = \mathbf{B}[k]\mathbf{w}'[k] \quad (27)$$

Let $w_i[0] = y_i[0], w'_i[0] = 1$ for agent i . For $i = 1, \dots, n, y_i[k+1] = \frac{w_i[k+1]}{w'_i[k+1]}$:

$$B_{ij}[k] = \begin{cases} 1/d_{n,j}^-[k], & \text{whenever } j \in \Theta_{i,N}^-[k] \\ 0, & \text{o.w.} \end{cases} \quad (28)$$

where $d_{n,j}^-[k]$ is time-varying out-degree of node j in G_m , which reflects topology perturbation.

B. CONSENSUS ANTI-NOISE GAIN FUNCTIONS

In order to effectively reduce the negative impact of communication uncertainties, it is necessary to introduce the gain function $F[k]$ in the iteration. Hence, the new autonomous system is given as:

$$y_i[k+1] = h_{ii}y_i[k] + F[k] \sum_{j \in \Theta_{m,j}^-} h_{ij}y_j[k] + \omega_{ij}[k] \quad (29)$$

If random communication noise is bounded by white noise, Then, there exists an average consistency condition [29] for communication noise. See the lemma below:

Lemma 1 ([29]): Based on the above hypothesis, if $\sum_{k=0}^{\infty} F[k] = \infty$ and $\sum_{k=0}^{\infty} F^2[k] < \infty$, discrete consensus iteration converges to a consistent value:

$$\lim_{k \rightarrow \infty} y_i[k] = y^*, \quad \forall i = 1, 2, \dots, n \quad (30)$$

Based on equations (11), (30), y^* is not only determined by initial values $y_i[0]$, but also by the doubly-stochastic

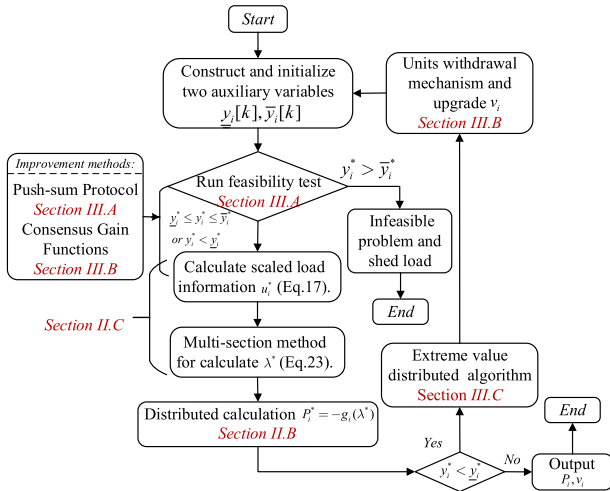

FIGURE 3. Diagram of incremental cost - power generation.

matrix \mathbf{H} :

$$\sigma^2(y^*) \leq \frac{\sigma_W^2 |E| \sum_{i=1}^n \sum_{j \in \Theta_i} h_{ij}}{n^2} \sum_{t=0}^{\infty} y_i[k] \quad (31)$$

where $|E|$ is the edge number of G_m . $\sigma^2(y^*)$ denotes the variance of y^* . σ_W represents the maximum standard deviation of matrix \mathbf{H} .

From the above analysis, the attenuative consensus gain functions reduce the communication weight with the increase of iterations, which eliminates the consensus residuals caused by uncertain noise. This helps agents to effectively use the information of adjacent agents to search the objective value.

Function $F[k]$ is designed according to the conditions of the aforementioned lemma 1. We design two functions here:

$$F[k] = \frac{1}{c_1 k + 1}, F[k] = \frac{\ln(c_2 k + 1)}{c_2 k + 1} \quad (32)$$

where c_1 and c_2 denote attenuation coefficients and $c_1, c_2 > 0$.

We define deviation S_{y_i} to evaluate the convergence property and efficiency of variable y_i .

$$S_{y_i} = \frac{1}{TM} \sum_{k=1}^M \sum_{j=1}^T |y_i[j] - y_i^{ideal}[j]| \quad (33)$$

where y_i^* is the ideal iterative value under ideal communication environment. T denotes the iteration number. Sampling number is described as M .

C. PROCEDURE OF PIECEWISE APPROXIMATION DED

Our DED strategy considers the optimization of unit commitment to further reduce the operation cost and guarantees the power balance when applying the distributed algorithm, as illustrated in Algorithm 1.

Fig. 3 demonstrates the overall flow chart of the proposed DED strategy.

Algorithm 1 Distributed ED for Regional Power Systems

Initialization:

Set $v_i = 1$ for all generators. Set feasibility flag as $a = 0$.

DoFeasibility test.

If $y_i^* \leq \bar{y}_i^* \leq \bar{y}_i^*$ holds, then

Distributed calculation for λ^* : Equations (8)-(21).

Calculate P_i : Equation (7).

Else if $y_i^* > \bar{y}_i^*$.

Problem is infeasible. Set $a = 1$.

Request for load shedding.

Else if $y_i^* < \underline{y}_i^*$

Distributed minimum value search for γ_i .

If $\gamma_i \neq \gamma^*$

The agent with minimum γ_i set $v_i = 0$.

Else

Distributed minimum value search for P_i : Equation (23).

Correspondingly, set $v_i = 0$.

End

End

While $a = 0$.

Output P_i, v_i .

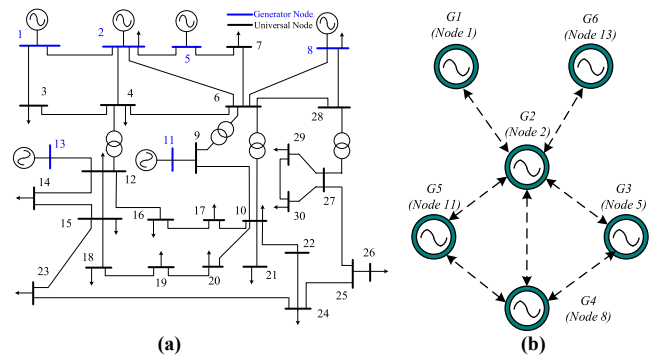

FIGURE 4. Test system based on IEEE 30 bus system. a. IEEE 30-bus system topology b. Communication topology.

V. CASE STUDY

To verify the effectiveness of our DED scheme, we take standard IEEE 30-bus system as an example, as shown in Fig. 4(a). Assume that the communication topology of load nodes G_m is the same as the electric connection topology. Let communication topology of all generation nodes G_n be a directed connected graph, as depicted in Fig. 4(b).

A. PERFORMANCE OF DISTRIBUTED PIECEWISE APPROXIMATION ED

Set reserve percentage $\delta = 0.2$. Table 1 demonstrates the cost coefficients of generators. Table 2 considers 2 scenarios with different load level for IEEE 30-bus test system where real-time simulations are carried out.

Fig. 5 shows the iterative process of auxiliary variables y_i and s_i . 30 auxiliary variables, corresponding to 30 load nodes, converge after about 60 iterations. For each auxiliary variable,

TABLE 1. Generators information.

No.	a_i	b_i
G1	0.000862	0.382
G2	0.00111	0.462
G3	0.00156	0.323
G4	0.00119	0.355
G5	0.00134	0.329
G6	0.00147	0.342

TABLE 2. Parameters of 2 scenarios for IEEE 30-bus test system.

P^s /MW	Scene 1	Scene 2
Total load	331.8	165.9
Load distribution	Standard power flow	0.5 scaling-down
Minimum generation (G1-G6)	50,30,30,40,30,40	50,30,30,40,30,40
Maximum generation (G1-G6)	100,80,80,100,80,80	100,80,80,100,80,80

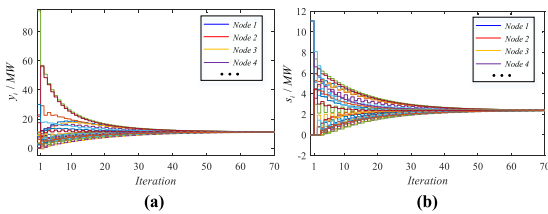

FIGURE 5. Iterative process of auxiliary variables. a. y_i , b. s_j .

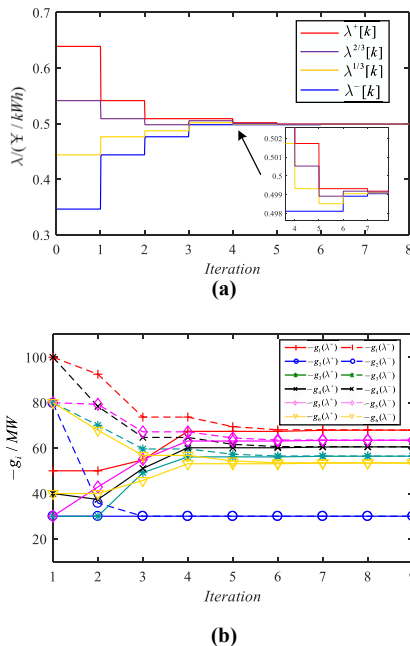

FIGURE 6. Convergence process (Scene 1) of the distributed optimization. a. λ , b. $-g_i$.

there is no overshoot in the whole process, and only slight oscillations appear in the local area.

Fig. 6(a) demonstrates section boundaries of Lagrange multiplier at each iteration. Multi-section method guarantees error ranges within $1/N^K$. The convergence process of upper bound and low bound of $-g_i(\lambda)$ is shown in Fig. 6(b). According to $P_i = -g_i(\lambda^*)$, convergence accuracy of P_i can be improved at the expense of more iterations or sections.

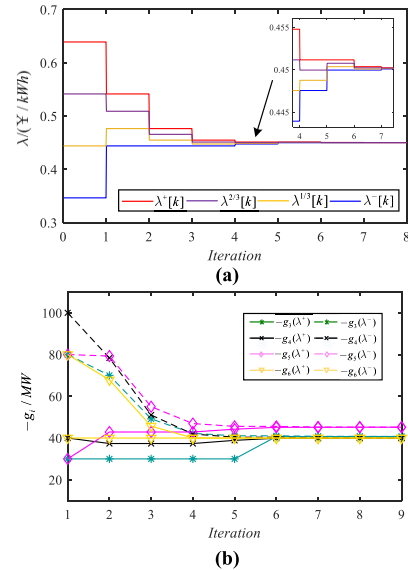

FIGURE 7. Convergence process (Scene 2) of the distributed optimization. a. λ , b. $-g_i$.

Fig. 7 shows the convergence process of scene 2. Fig. 6(a) and Fig. 7(a) prove our distributed piecewise approximation algorithm has good convergence in each scenario. Because of load shortage, some generators must exit operation in scene 2. Based on the proposed strategy, the generators on node 2 and node 1 quit operation one after another. Demand for load and reserve capacity can be satisfied by the remaining 4 generators. As shown in Fig. 7(b), the remaining generators share the total load and operate at low incremental costs.

B. PERFORMANCE OF IMPROVED METHODS

We compare the control performance under different types of noise in Fig. 8. Standardized Gaussian noise with $\sigma = 0.5$ is applied in Fig. 8(a) and Fig. 8(b), and white noise subject to continuous distributions $[-0.3, 0.3]$ is applied in Fig. 8(c) and Fig. 8(d). Gain function is chosen as $0.5[\frac{1}{0.3r+1} + \frac{\ln(0.3r+1)}{0.3r+1}]$. It can be easily obtained that for both types of noise, the iterative variables without gain functions undergo relatively smaller fluctuation. The designed gain functions can reduce consensus convergence error caused by Gaussian noise and white noise.

In general, we analyze the statistical properties of the algorithm errors under noise and gain functions. Table 3 shows the convergence of consensus gain function under different types of noise with $M = 100$ and $T = 100$. From the simulation results, we can see that convergence precision decreases with the increase of distribution interval $[-A, A]$, and the error became larger with the increase of standardized normal distribution variance σ . Note that gain functions can improve convergence accuracy and attenuation coefficients, c_1 and c_2 in the consensus gain functions, have influence on the speed and accuracy of discrete consensus algorithm. The smaller c_1 and c_2 are, the higher the convergence precision is.

Fig. 9 shows the comparison of push-sum and conventional consensus method. In Fig. 9(a), the communication topology is changed each 30 iteration. According to Fig. 9(b),

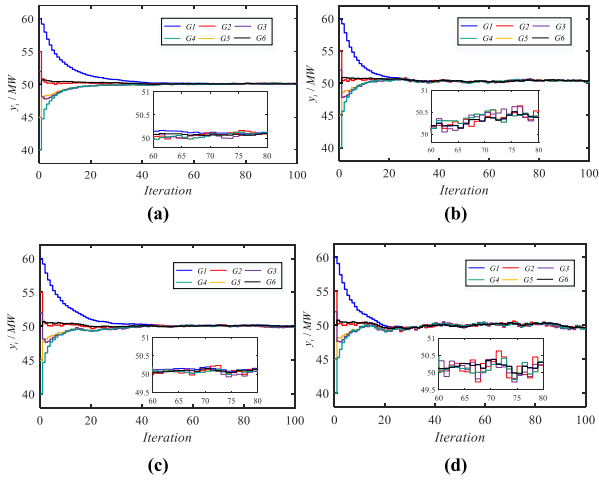

FIGURE 8. Control performance comparison under different noise.
a. Gaussian noise with gain functions **b.** Gaussian noise without gain functions **c.** White noise with gain functions **d.** White noise without gain functions.

TABLE 3. Convergence property S_{y_i} of consensus gain function under different noise.

Gain Function, F	White noise, A				
	0.1	0.2	0.3	0.4	0.5
1	0.1786	0.3720	0.7663	1.3540	1.7721
$0.5[\frac{1}{k+1} + \frac{\ln(k+1)}{k+1}]$	0.2765	0.3349	0.5423	0.7173	0.7917
$0.5[\frac{1}{0.5k+1} + \frac{\ln(0.5k+1)}{0.5k+1}]$	0.2443	0.2989	0.4531	0.6830	0.7544
$0.5[\frac{1}{0.3k+1} + \frac{\ln(0.3k+1)}{0.3k+1}]$	0.2371	0.2678	0.4213	0.6077	0.7219
$0.5[\frac{1}{0.1k+1} + \frac{\ln(0.1k+1)}{0.1k+1}]$	0.2124	0.2550	0.3255	0.5258	0.6956
Gain Function, F	Gaussian noise, σ				
	0.1	0.2	0.3	0.4	0.5
1	0.2112	0.4673	0.7121	1.0426	1.8068
$0.5[\frac{1}{k+1} + \frac{\ln(k+1)}{k+1}]$	0.2721	0.3354	0.4925	0.7364	0.9063
$0.5[\frac{1}{0.5k+1} + \frac{\ln(0.5k+1)}{0.5k+1}]$	0.2531	0.3107	0.4543	0.5862	0.8485
$0.5[\frac{1}{0.3k+1} + \frac{\ln(0.3k+1)}{0.3k+1}]$	0.2586	0.3035	0.4143	0.5396	0.7644
$0.5[\frac{1}{0.1k+1} + \frac{\ln(0.1k+1)}{0.1k+1}]$	0.2330	0.2628	0.3361	0.4847	0.6079

push-sum protocol can guarantee that all states converge to the mean value only without local out-degree B interacted. In Fig. 9(c), state variables diverge through conventional consensus method just with local out-degree B rather than information $[H]_{ij}$ or $[R]_{ij}$. Comparing the convergence performance under time-varying topology, it is obvious that the astringency will be weakened when any communication link exits. Although transition matrix B (column-stochastic) is not a doubly-stochastic matrix, the convergence can also be ensured through the proposed push-sum protocol, which in comparison cannot be obtained by traditional consensus method.

C. COMPARATIVE ANALYSIS OF ALGORITHMS

Four benchmarks are compared with the proposed distributed piecewise approximation (DPA) in terms of economy and iteration number: primal-dual interior point (PDIP) algorithm [30] combined with branch and bound centralized

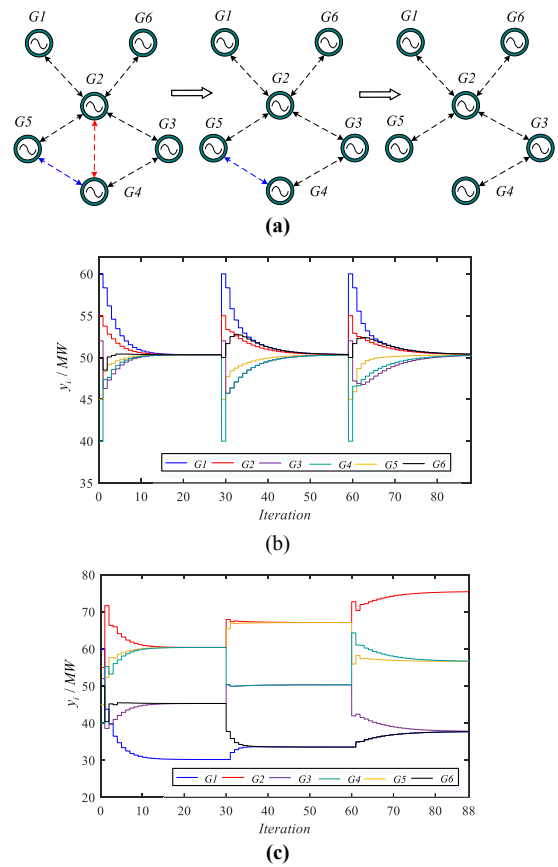

FIGURE 9. Comparison between push-sum and consensus method.
a. Time-varying topology **b.** Push-sum protocol without local out-degree. **c.** Consensus method with local out-degree.

method (BBM), an improved distributed alternating direction method of multipliers (ADMM) with regret [22], distributed Lambda iteration (DLI) [31] with BBM and state-of-art distributed auction-based (DAB) algorithm [32].

Table 4 presents the comparison results in 2 scenes of IEEE-30-node system. Based on the results, PDIP+BBM can obtain the optimal solution in each scene. Since the optimal lambda should be shared with unit by a center, DLI could combine centralized BBM and obtain the global optimal solution. However, the fully distributed algorithms, such as ADMM with regret and DBA, fail to optimize 0/1 variables, which causes the infeasibility in scene 2. ADMM with regret has to decompose global constraints into multiple boundary coupling constraints based on the auxiliary problem principle, this complicates the problem and increases the number of iterations. Auction process in DBA requires many iterations in matching listed tasks and agents and clearing. Thus, more iterations are indispensable in these two fully distributed algorithms.

Table 5 shows the comparison results under different scales problems. The simulation results illustrate that as algorithms with centers, such as PDIP and DLI couple with BBM, can obtain the global optimal solution in each test system. While the problem becomes infeasible for ADMM and DBA when it comes to some periods with low load level. However, com-

TABLE 4. Comparative analysis of different algorithms in 2 scenes.

Items		PDIP [30]+ BBM	ADMM with regret [22]	DLI [31]+ BBM	DAB [32]	Proposed DPA
Scene 1	Hour operation cost/\$	2.640*10 ⁴	2.640*10 ⁴	2.640*10 ⁴	2.640*10 ⁴	2.640*10 ⁴
	Iterations	6	19	10	16	8
Scene 2	Hour operation cost/\$	1.5344*10 ⁴	Infeasible	1.5344*10 ⁴	Infeasible	1.5344*10 ⁴
	Iterations	6	18	9	17	8

TABLE 5. Comparative analysis of different algorithms in 3 cases.

Algorithm	Type	Average operation costs (\$/d)			Average iteration	Remarks
		IEEE-30	IEEE-57	IEEE-118		
PDIP [30]+ BBM	Centr.	1.8721*10 ⁴	3.6506*10 ⁴	7.9256*10 ⁴	7	Optimal
ADMM with regret [22]	Fully Distr.	2.2014*10 ⁴	4.0166*10 ⁴	8.7391*10 ⁴	22	Infeasible in some periods
DLI [31]+ BBM	Distr.	1.8723*10 ⁴	3.6507*10 ⁴	7.9256*10 ⁴	12	Optimal
DAB [32]	Fully Distr.	2.1975*10 ⁴	4.0171*10 ⁴	8.7391*10 ⁴	19	Infeasible in some periods
Proposed PDA	Fully Distr.	1.8721*10 ⁴	3.6506*10 ⁴	7.9256*10 ⁴	10	Optimal

binning the results in table 4 and table 5, our proposed DPA can obtain the optimal solution in all cases as the algorithms with centers do. This demonstrates the effectiveness of the proposed DPA in handling unit commitment and global power balance constraints. Besides, DPA also outperforms other two fully distributed algorithms since it has the advantage in fewer agent iterations, especially in dealing with large-scale problems.

VI. CONCLUSION

This paper proposes a DED strategy for regional power systems to operate in a distributed framework subject to time-varying communication uncertainties with topology scalability. A distributed piecewise approximation-based algorithm is developed to achieve consensus among individual incremental costs while handling the global power balance without decomposing global constraints into boundary coupling constraints. A unit commitment optimization is designed to address extreme operation situations by controlling the on/off status of units. Moreover, two improvements are integrated into the proposed algorithm: push-sum protocol and gain functions. The former can avoid neighbor topology information update before each iteration to ensure the convergence of the proposed algorithm under time-varying topology. The later can reduce the disturbance from the communication noise. The proposed DED strategy is tested by IEEE standard systems, with real-time experiments. According to the simulation, our method has the following features: 1) Based on the feasible test and unit withdrawal mechanism, the optimal on/off status of generators can be determined in a fully distributed manner, where designed reserve capacity can be deployed; 2) Local agents could automatically optimize real-time local generation by neighbor communication, which is free of topology initialization; 3) Push-sum protocol can ensure mean convergence even though transition

matrix is column-stochastic, which avoids topology updates; 4) Designed consensus gain functions improve the robustness against communication noise.

REFERENCES

- [1] F. Guo, C. Wen, J. Mao, J. Chen, and Y.-D. Song, "Hierarchical decentralized optimization architecture for economic dispatch: A new approach for large-scale power system," *IEEE Trans. Ind. Informat.*, vol. 14, no. 2, pp. 523–534, Feb. 2018.
- [2] T. Lu, Q. Ai, and Z. Wang, "Interactive game vector: A stochastic operation-based pricing mechanism for smart energy systems with coupled-microgrids," *Appl. Energy*, vol. 212, pp. 1462–1475, Feb. 2018.
- [3] T. Lu et al., "A data-driven stackelberg market strategy for demand response-enabled distribution systems," *IEEE Trans. Smart Grid*, to be published. doi: 10.1109/TSG.2018.2795007.
- [4] X. Chen, H. Zhang, Z. Xu, C. P. Nielsen, M. B. McElroy, and J. Lv, "Impacts of fleet types and charging modes for electric vehicles on emissions under different penetrations of wind power," *Nature Energy*, vol. 3, pp. 413–421, Apr. 2018.
- [5] X. Chen, M. B. McElroy, and C. Kang, "Integrated energy systems for higher wind penetration in china: Formulation, implementation, and impacts," *IEEE Trans. Power Syst.*, vol. 33, no. 2, pp. 1309–1319, Mar. 2018.
- [6] X. Han, X. Chen, M. B. McElroy, S. Liao, C. P. Nielsen, and J. Wen, "Modeling formulation and validation for accelerated simulation and flexibility assessment on large scale power systems under higher renewable penetrations," *Appl. Energy*, vol. 237, pp. 145–154, Mar. 2019.
- [7] S. Yang, S. Tan, and J.-X. Xu, "Consensus based approach for economic dispatch problem in a smart grid," *IEEE Trans. Power Syst.*, vol. 28, no. 4, pp. 4416–4426, Nov. 2013.
- [8] F. Guo, C. Wen, J. Mao, and Y.-D. Song, "Distributed economic dispatch for smart grids with random wind power," *IEEE Trans. Smart Grid*, vol. 7, no. 3, pp. 1572–1583, May 2016.
- [9] W. Meng and X. Wang, "Distributed energy management in smart grid with wind power and temporally coupled constraints," *IEEE Trans. Ind. Electron.*, vol. 64, no. 8, pp. 6052–6062, Aug. 2017.
- [10] S. Fang and Y. Xu, "Multiobjective coordinated scheduling of energy and flight for hybrid electric unmanned aircraft microgrids," *IEEE Trans. Ind. Electron.*, vol. 66, no. 7, pp. 5686–5695, Jul. 2019.
- [11] S. Fang, Y. Xu, Z. Li, T. Zhao, and H. Wang, "Two-step multi-objective management of hybrid energy storage system in all-electric ship microgrids," *IEEE Trans. Veh. Technol.*, to be published. doi: 10.1109/TVT.2019.2898461.
- [12] Z. Wang, L. Jiang, and C. He, "Optimal price-based power control algorithm in cognitive radio networks," *IEEE Trans. Wireless Commun.*, vol. 13, no. 11, pp. 5909–5920, Nov. 2014.
- [13] F. Guo, C. Wen, J. Mao, G. Li, and Y.-D. Song, "A distributed hierarchical algorithm for multi-cluster constrained optimization," *Automatica*, vol. 77, pp. 230–238, Mar. 2017.
- [14] M. Zhu and S. Martinez, "On distributed convex optimization under inequality and equality constraints," *IEEE Trans. Autom. Control*, vol. 57, no. 1, pp. 151–164, Jan. 2012.
- [15] Z. Yang, J. Xiang, and Y. Li, "Distributed consensus based supply-demand balance algorithm for economic dispatch problem in a smart grid with switching graph," *IEEE Trans. Ind. Electron.*, vol. 64, no. 2, pp. 1600–1610, Feb. 2017.
- [16] S. Peyghami, H. Mokhtari, P. C. Loh, P. Davari, and F. Blaabjerg, "Distributed primary and secondary power sharing in a droop-controlled LVDC microgrid with merged AC and DC characteristics," *IEEE Trans. Smart Grid*, vol. 9, no. 3, pp. 2284–2294, May 2018.
- [17] Q. Li, D. W. Gao, H. Zhang, Z. Wu, and F.-Y. Wang, "Consensus-based distributed economic dispatch control method in power systems," *IEEE Trans. Smart Grid*, vol. 10, no. 1, pp. 941–954, Jan. 2019.
- [18] C. Zhao, J. He, P. Cheng, and J. Chen, "Analysis of consensus-based distributed economic dispatch under stealthy attacks," *IEEE Trans. Ind. Electron.*, vol. 64, no. 6, pp. 5107–5117, Jun. 2017.
- [19] P. Li, Y. Liu, H. Xin, and X. Jiang, "A robust distributed economic dispatch strategy of virtual power plant under Cyber-attacks," *IEEE Trans. Ind. Informat.*, vol. 14, no. 10, pp. 4343–4352, Oct. 2018.
- [20] G. Chen and Z. Zhao, "Delay effects on consensus-based distributed economic dispatch algorithm in microgrid," *IEEE Trans. Power Syst.*, vol. 33, no. 1, pp. 602–612, Jan. 2018.

- [21] I. Kouveliotis-Lysikatos and N. Hatzigiorgiou, "Fully distributed economic dispatch of distributed generators in active distribution networks considering losses," *IET Gener. Transmiss. Distrib.*, vol. 11, no. 3, pp. 627–636, Feb. 2017.
- [22] W.-J. Ma, J. Wang, V. Gupta, and C. Chen, "Distributed energy management for networked microgrids using online ADMM with regret," *IEEE Trans. Smart Grid*, vol. 9, no. 2, pp. 847–856, Mar. 2018.
- [23] T. Zhao and Z. Ding, "Distributed agent consensus-based optimal resource management for microgrids," *IEEE Trans. Sustain. Energy*, vol. 9, no. 1, pp. 443–452, Jan. 2018.
- [24] X. Chen, J. Lv, M. B. McElroy, X. Han, C. P. Nielsen, and J. Wen, "Power system capacity expansion under higher penetration of renewables considering flexibility constraints and low carbon policies," *IEEE Trans. Power Syst.*, vol. 33, no. 6, pp. 6240–6253, Nov. 2018.
- [25] H. Xing, Y. Mou, M. Fu, and Z. Lin, "Distributed bisection method for economic power dispatch in smart grid," *IEEE Trans. Power Syst.*, vol. 30, no. 6, pp. 3024–3035, Nov. 2015.
- [26] R. Olfati-Saber and R. M. Murray, "Consensus problems in networks of agents with switching topology and time-delays," *IEEE Trans. Autom. Control*, vol. 49, no. 9, pp. 1520–1533, Sep. 2004.
- [27] A. Nedić and A. Olshevsky, "Distributed optimization over time-varying directed graphs," *IEEE Trans. Autom. Control*, vol. 60, no. 3, pp. 601–615, Mar. 2015.
- [28] F. Iutzeler, P. Ciblat, and W. Hachem, "Analysis of sum-weight-like algorithms for averaging in wireless sensor networks," *IEEE Trans. Signal Process.*, vol. 61, no. 11, pp. 2802–2814, Jun. 2013.
- [29] T. Li and J.-F. Zhang, "Mean square average-consensus under measurement noises and fixed topologies: Necessary and sufficient conditions," *Automatica*, vol. 45, no. 8, pp. 1929–1936, 2009.
- [30] T. Xu, W. Wu, W. Zheng, H. Sun, and L. Wang, "Fully distributed quasi-newton multi-area dynamic economic dispatch method for active distribution networks," *IEEE Trans. Power Syst.*, vol. 33, no. 4, pp. 4253–4263, Jul. 2018.
- [31] J. Hu, M. Z. Q. Chen, J. Cao, and J. M. Guerrero, "Coordinated active power dispatch for a microgrid via distributed lambda iteration," *IEEE Trans. Emerg. Sel. Topics Circuits Syst.*, vol. 7, no. 2, pp. 250–261, Jul. 2017.
- [32] G. Binetti, A. Davoudi, D. Naso, B. Turchiano, and F. L. Lewis, "A distributed auction-based algorithm for the nonconvex economic dispatch problem," *IEEE Trans. Ind. Informat.*, vol. 10, no. 2, pp. 1124–1132, May 2014.

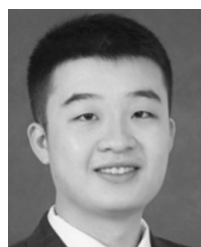

RAN HAO (S'16) received the B.S. degree in electrical engineering from Xi'an Jiaotong University, Xi'an, China, in 2016. He is currently pursuing the Ph.D. degree in electrical engineering with Shanghai Jiao Tong University, Shanghai, China.

He is the author of one book, more than ten articles, and three inventions. His research interests include regional energy systems, distributed algorithms, and microgrid and renewable energy resources integration.

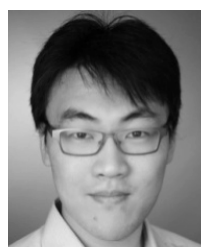

TIANGUANG LU (S'16–M'18) received the B.S. degree in electrical engineering from Shandong University, Shandong, China, in 2013, and the Ph.D. degree in electrical engineering from Shanghai Jiaotong University, Shanghai, China, in 2018.

He was an Electrical Engineer Intern with ABB (China), Inc., Beijing, China, in 2015, and a Visiting Student Researcher with The University of Texas at Arlington, Arlington, TX, USA, in 2016, and Iowa State University, Ames, IA,

USA, in 2017. He is currently a Postdoctoral Researcher with Harvard University, Cambridge, MA, USA. His research interests include power distribution systems, microgrids, intelligent algorithms, and renewable energy.

Dr. Lu was a recipient of the IEEE Industrial Application Society Prize Paper Award, in 2016. His doctoral dissertation was nominated as the Excellent Dissertation Papers in Shanghai Jiaotong University, in 2018.



QIUWEI WU (M'08–SM'15) received the Ph.D. degree in power system engineering from Nanyang Technological University, Singapore, in 2009.

He was a Senior R&D Engineer with VESTAS Technology R&D Singapore, Pte., Ltd., from 2008 to 2009. Since 2009, he has been with the Department of Electrical Engineering, Technical University of Denmark (DTU), where he held a postdoctoral position, from 2009 to 2010, was an Assistant Professor, from 2010 to 2013, and has

been an Associate Professor, since 2013. In 2012, he was a Visiting Scholar with the Department of Industrial Engineering and Operations Research (IEOR), University of California at Berkeley, funded by the Danish Agency for Science, Technology and Innovation (DASTI), Denmark. He was a Visiting Professor, named by Y. Xue, with the Academician of Chinese Academy of Engineering, Shandong University, China, from 2015 to 2017. From 2017 to 2018, he was a Visiting Scholar with the Harvard China Project, School of Engineering and Applied Sciences, Harvard University, funded by the Otto Mønsted Fond. His research interests include operation and control of power systems with high penetration of renewables, including wind power modeling and control, active distribution networks, and operation of integrated energy systems.

Dr. Wu is currently an Editor of the IEEE TRANSACTIONS ON SMART GRID and IEEE POWER ENGINEERING LETTERS. He is also an Associate Editor of the *International Journal of Electrical Power and Energy Systems* and *Journal of Modern Power Systems and Clean Energy*. He is also a Subject Editor of the *IET Generation, Transmission & Distribution* and *IET Renewable Power Generation*.



XINYU CHEN (M'14) received the B.S. and Ph.D. degrees in electrical engineering from Tsinghua University, Beijing, China, in 2009 and 2014, respectively.

In 2012, he was an Exchange Ph.D. Student with Harvard University, where he was a Postdoctoral Researcher, from 2015 to 2016, and has been a Lecturer, since 2016. He is currently a Full Professor with the Huazhong University of Science and Technology. He has published over 40 papers on different journals, including *Nature Energy* and *Science Advances*. His research interests include power system operation and planning, multi-energy system optimization, renewable energy integration, and energy policy.



QIAN AI (M'03–SM'16) received the bachelor's degree from Shanghai Jiao Tong University, Shanghai, China, in 1991, the master's degree from Wuhan University, Wuhan, China, in 1994, and the Ph.D. degree from Tsinghua University, Beijing, China, in 1999, all in electrical engineering.

He was with Nanyang Technological University, Singapore, for one year. He was with the University of Bath, Bath, U.K., for two years. He was with Shanghai Jiao Tong University, where he is currently a Professor with the School of Electronic Information and Electrical Engineering. His current research interests include power quality, load modeling, smart grids, microgrid, and intelligent algorithms.

Dr. Ai was a recipient of the IEEE Industrial Application Society Prize Paper Award, in 2016.

• • •