

Tracking Object based on GPS and IMU Sensor

Wahyudi

Department of Electrical Engineering
Diponegoro University
Semarang, Indonesia
wahyuditinom@elektro.undip.ac.id

Meita Sukma Listiyana

Department of Electrical Engineering
Diponegoro University Semarang,
Indonesia
meitasukma5@gmail.com

Sudjadi

Department of Electrical Engineering
Diponegoro University
Semarang, Indonesia
ksudjadi@gmail.com

Ngatelan

Department of Electrical Engineering
Diponegoro University
Semarang, Indonesia
ngatelan@undip.ac.id

Abstract— Unmanned vehicles required a tracking system to monitor the movement of the object. Tracking system required because the object is controlled remotely and the movement of an object is too far from an operator. This tracking system requires object location and attitude. Global Positioning System (GPS) and Inertial Measurement Unit (IMU) sensor can be used to obtain information about object location and attitude. This IMU consists of some sensors, i.e. accelerometer, gyroscope, and magnetometer. In IMU system, angle data from gyroscope and accelerometer sensor must be combined using a complementary filter because each sensor data still has a noise signal. This paper discusses tracking object using GPS and IMU sensor and then processed by the microcontroller to display in Personal Computer (PC). Object tracking system that designed works well. The result of testing, the average of error for GPS and IMU system, respectively, are 2.67 m and 0.96°.

Keywords— tracking system; GPS; IMU sensor; position and attitude

I. INTRODUCTION (HEADING 1)

The increasing of unmanned vehicles or unmanned objects, such as Unmanned Aerial Vehicle (UAV) and Unmanned Surveillance Vehicle (USV), required a tracking system to know the movement of the object[1]. Tracking system required because the object is controlled remotely and the movement of an object is too far from an operator. This tracking system requires object location and attitude. Object location indicated by latitude and longitude coordinates where the object is placed, while attitude indicated by roll, pitch, and yaw angle.

Global Positioning System (GPS) and Inertial Measurement Unit (IMU) sensor can be used to obtain information about object location and attitude[2]. IMU consists of several sensors, such as accelerometer, gyroscope, and magnetometer sensor[3]. Such of the sensors provide information about data angle, data from each sensor must be combined because each sensor data still has a noise signal. The sensor data must be filtered with complementary filter, so the result turned to good[4].

This paper discusses about tracking object using GPS and IMU sensor; that object is static and moving. The obtained data is processed by microcontroller, then sent to Personal Computer (PC) using receiver and transmitter antenna of 433MHzfrequency radio. Tracking object is monitored by PC in real time.

II. METHODOLOGY

A. Block Diagram

The GPS, accelerometer, gyroscope, and magnetometer sensor are used as input for the system. Microcontroller is used to process input data. The output system is PC, receiver and transmitter antenna of 433MHzfrequency radio. Block diagram of tracking object is shown in Fig. 1.

GPS is giving information about location for the object, i.e. latitude and longitude coordinate. Accelerometer, gyroscope, and magnetometer sensor are giving information about attitude of the object, there are roll, pitch, and yaw angle. Complementary filter is used to combine the sensor data, because the sensor data still has a noise signal. The data inputs of GPS, accelerometer, gyroscope, and magnetometer are processed on microcontroller. Data inputs are sent using the transmitter antenna of 433MHzfrequency radio after processed by microcontroller, then received by the receiver antenna of 433MHzfrequency radio. Finally, the data are displayed on PC.

B. Design of Hardware Components

The assembly of hardware components from the tracking object system is made by following components as shown in Fig. 2.

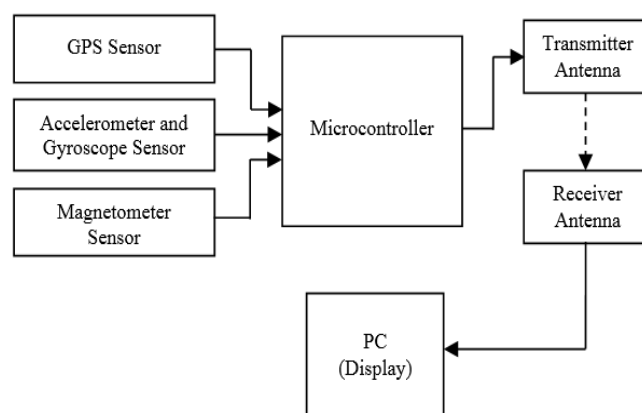

Fig. 1. Block diagram of tracking object based on GPS and IMU sensor

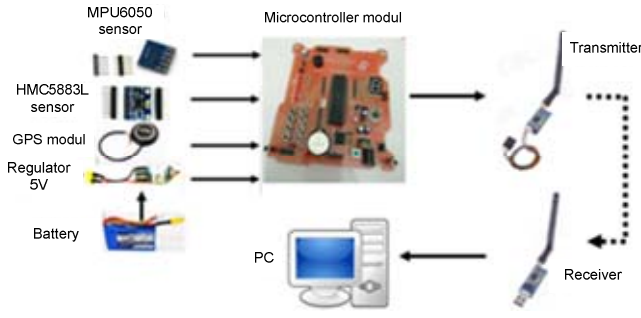

Fig. 2. Design of Hardware Components

MPU6050 is a module that has accelerometer and gyroscope sensor in one board. Accelerometer measures the linear motion of an object's acceleration by gravity reference. Accelerometer gives information about roll (ϕ) and pitch (θ) angles, which is given in equation 1 and equation 2[6]. Gyroscope measures the angular velocity of an object and gives information about roll (ϕ), pitch (θ), and yaw (ψ) angles, which is given in equation 3[7]. Both of accelerometer and gyroscope work using the principle of capacitance change. Magnetometer measures the direction and magnitude of the earth's magnetic field. Magnetometer only gives information about a yaw (ψ) angles, which is given in equation 4[7]. This sensor works using the principle of Hall-effect or magneto-resistive effect. Accelerometer, gyroscope, and magnetometer are connected to microcontroller by two-wire inter-integrated circuit (TWI) using Serial Data (SDA) and Serial Clock (SCL) pin.

$$\phi = \tan^{-1} \left(\frac{f_y}{f_z} \right) \quad (1)$$

$$\theta = \tan^{-1} \left(\frac{-f_x}{\sqrt{f_y^2 + f_z^2}} \right) \quad (2)$$

$$\begin{bmatrix} \phi \\ \dot{\theta} \\ \psi \end{bmatrix} = \begin{bmatrix} 1 & \sin \phi \tan \theta & \cos \phi \tan \theta \\ 0 & \cos \phi & -\sin \phi \\ 0 & \frac{\sin \phi}{\cos \theta} & \frac{\cos \phi}{\cos \theta} \end{bmatrix} \begin{bmatrix} p \\ q \\ r \end{bmatrix} \quad (3)$$

$$\psi = \text{atan} \left(\frac{-m_y \cos \phi + m_z \sin \phi}{m_x \cos \theta + m_y \sin \theta \sin \phi + m_z \sin \theta \cos \phi} \right) \quad (4)$$

GPS is a system that consisted of three main segments. These segments are space segment, control system segment, and user segment. Satellites as space segment must be controlled by control system segment, in order not to collide with each other. GPS provides information about coordinate values; they are latitude and longitude. Latitude and longitude are represented an x-axis and a y-axis of the earth, respectively. GPS is connected to microcontroller by serial communication Receiver (Rx) and Transmitter (Tx) pin with baud-rate used is 9600 bps. The data from GPS module has the National Marine Electronics Association (NMEA) standard with minute type format, so it must be changed to degree type format in order to validate to Google Maps[5].

Pythagorean theorem in equation 5 is used to calculate the error in kilometers or meters. R is the radius of earth that given value 6.371 km.

$$d = R \cdot 2 \cdot \arcsin \sqrt{\sin^2 \left(\frac{\Delta \varphi}{2} \right) + \cos \varphi_1 \cdot \cos \varphi_2 \cdot \sin^2 \left(\frac{\Delta \lambda}{2} \right)} \quad (5)$$

Complementary filter is used to combine the same data from several different sensors to get good data. The filter is used also to remove noise signals. The filter has two input signals; one of them is a signal with high-frequency noise, and the other is a signal with low-frequency noise. High-pass filter is used to remove the high-frequency noise, while a low-pass filter is used to remove the low-frequency noise. Accelerometer and magnetometer have a signal with high-frequency noise, while gyroscope has a signal with low-frequency noise. The equation of complementary filter is given by equation 6. K_G is a coefficient for gyroscope and K_A for accelerometer and magnetometer.

$$\text{Angle} = (K_G) \times \left(\int \omega_{Gyro} dt \right) + (K_A) \times (\theta_{Acc}) \quad (6)$$

A microcontroller is an Integrated Circuit (IC) which can be reprogrammed repeatedly for automatic and manual controls on electronic devices. Atmega1284p has 8 pin for each Port A, B, C, and D. Port A is used as I/O pin and ADC input. Port B is used as I/O pin with particular function, such as timer/counter, analog comparator, interrupt, and SPI. Port C is used as I/O pin with particular function, such as TWI, interrupt, and timer oscillator. Port D is used as I/O pin with particular function, such as timer/counter, interrupt, and serial communication. The microcontroller is used to process input data of the sensors and calculate in complementary filter.

An antenna is a device that has two components, they are transmitter and receiver. Transmitter is used to radiate to free space (receiver), while receiver is used to capture electromagnetic waves from free space (transmitter). The antenna can be divided into directional and omnidirectional antennas. Directional antenna has a directional radiation pattern of signals (in one direction), whereas omnidirectional antenna has signal radiation pattern in all direction in 360° angles. This paper used communication module that has type of omnidirectional type. Similarly with GPS, transmitter antenna also connected using serial communication to microcontroller using Rx pin and Tx pin. The receiver antenna is connected to PC by USB communication. The receiver and transmitter should be on the same baudrate, so the data sent is successful. The baudrate used is 57600 bps.

C. Design of Tracking Object System

Tracking object system has main program flow diagram. The main program flow is shown by Fig.3. Firstly, the main program has to start and the input/output register must be initialization. The ports that must be initialization are port C and port D. After that, system read sensor to get the data.

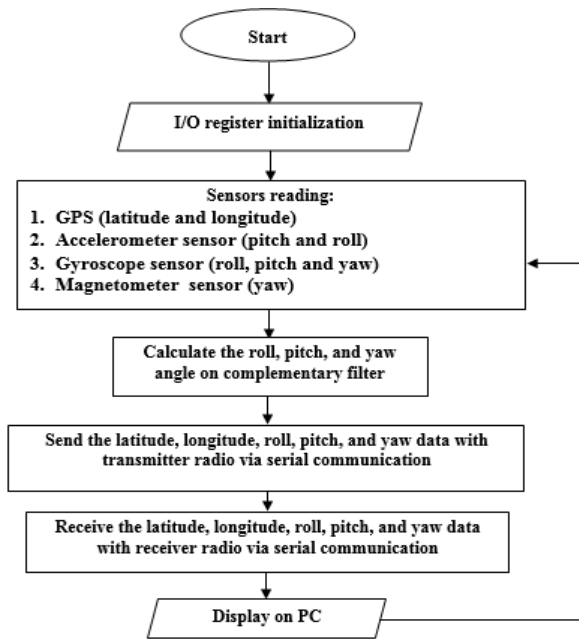

Fig. 3. Main program flow diagram

The calculation of latitude and longitude coordinate is shown on the example formula below.

Latitude= 0732.19545 S (typeddmm.mmmmm)
 Degree latitude= 7
 Minute latitude= 32.19545

$$\text{decimallatitude} = \frac{\text{minutes}}{60}$$

$$= \frac{32.19545}{60}$$

$$= 0.536591$$
 Latitude = degree latitude + decimal latitude

$$= 7 + 0.536591$$

$$= 7.536591$$
 Converted latitude = latitude x indicator
 Indicator S = -1, so
 Converted latitude = 7.536591 x (-1) = -7.536591

Longitude = 11039.08988 E (typeddmm.mmmmm)
 Degree longitude = 110
 Minute longitude = 39.08988

$$\text{decimallongitude} = \frac{\text{minutes}}{60}$$

$$= \frac{39.08988}{60}$$

$$= 0.651498$$
 Longitude= degree longitude + decimal longitude

$$= 110 + 0.651498$$

$$= 110.651498$$
 Converted longitude = latitude x indicator
 Indicator E = 1, so
 Converted latitude = 110.651498 x 1

$$= 110.651498$$

Raw data of accelerometer is obtained from the register address 0x3b, 0x3c, 0x3d, 0x3e, 0x3f and 0x40. Raw data of gyroscope are obtained from the register address 0x43, 0x44, 0x45, 0x46, 0x47 and 0x48. Raw data of magnetometer are obtained from the register address 0x03, 0x04, 0x05, 0x06, 0x07, and 0x08. Slave address of

MPU6050 is 0xD0, while the magnetometer is 0x3C. The angle data from accelerometer, gyroscope, and magnetometer must be combined using complementary filter. The filter has coefficient K_A and K_G . The sum of K_A and K_G is equal to 1. In this system, coefficient of K_A is 0.04 and K_G is 0.96, then the data are sent by radio frequency and displayed on PC.

III. RESULT

A. Static Posistion

The static position test of latitude and longitude coordinate is performed in three different places. The coordinates, latitudes and longitudes of benchmark I, benchmark II, and benchmark III are respectively -7.050028, 110.4381627; -7.0495714, 110.4391432, and -7.0494008, 110.4399553. Fig.4 is shown the positions of benchmarks. The result of testing latitude and longitude coordinate with static position is presented in Table I.

Table I shown that coordinate data is taken every 10 second until 120 second. The average error of benchmark I is 2.02 m, benchmark II is 3.46 m, and benchmark III is 2.56 m. The farthest error from the three places is 5.05 m and the average error is 2.66 m.



Fig. 4. Static position test of latitude and longitude coordinate

TABLE I. STATIC POSITION TEST RESULT OF LATITUDE AND LONGITUDE COORDINATE

No.	Time (second)	Error (meter)		
		Benchmark I	Benchmark II	Benchmark III
1.	10	0.45	3.33	1.42
2.	20	0.45	3.22	1.42
3.	30	0.38	2.55	2.30
4.	40	0.63	2.89	3.20
5.	50	1.92	3.05	3.22
6.	60	1.92	3.39	2.36
7.	70	2.86	3.95	2.39
8.	80	2.03	3.88	2.55
9.	90	1.85	3.88	2.71
10.	100	2.53	3.68	2.71
11.	110	4.17	3.91	2.83
12.	120	5.05	3.37	3.15
Average Error		2.02	3.42	2.56

B. Tracking Position

Tracking position testing takes place from coordinate -7.0499725, 110.438256 until coordinate -7.0496875, 110.43892. The blue line is the actual path through which the object passes, while the red line is the path result of sensor reading. The test result is shown that tracking system can work properly and path of the object has passed is appropriate though still has error in the system. The result of tracking object is shown by Figure 5.

C. Attitude Testing

The attitude testing that taken are roll, pitch, and yaw angle data. That angles are obtained from accelerometer, gyroscope, and magnetometer sensor. The testing angle is rotated from 0° to 30°, 0° to 45°, 0° to 60°, and 0° to 90°.

Figure 6 is graph of roll angle testing. The first graph shown roll angle testing of 0° to 30°, the second graph for 0° to 45°, the third graph for 0° to 60°, and the fourth graph for 0° to 90°. The first graph shown that the final magnitude is 29.41°, the second graph is 45.45°, the third graph is 59.87°, and the fourth graph is 89.3°.

Figure 7 is graph of pitch angle testing. The first graph shown pitch angle testing of 0° to 30°, the second graph for 0° to 45°, the third graph for 0° to 60°, and the fourth graph for 0° to 90°. The first graph shown that the final magnitude is 30.5°, the second graph is 45.97°, the third graph is 59.77°, and the fourth graph is 86.63°.

Figure 8 is graph of yaw angle testing. The first graph shown yaw angle testing of 0° to 30°, the second graph for 0° to 45°, the third graph for 0° to 60°, and the fourth graph for 0° to 90°. The first graph shown that the final magnitude is 29.14°, the second graph is 45.54°, the third graph is 58.37°, and the fourth graph is 88.58°. The error of rotation testing is shown in Table II.

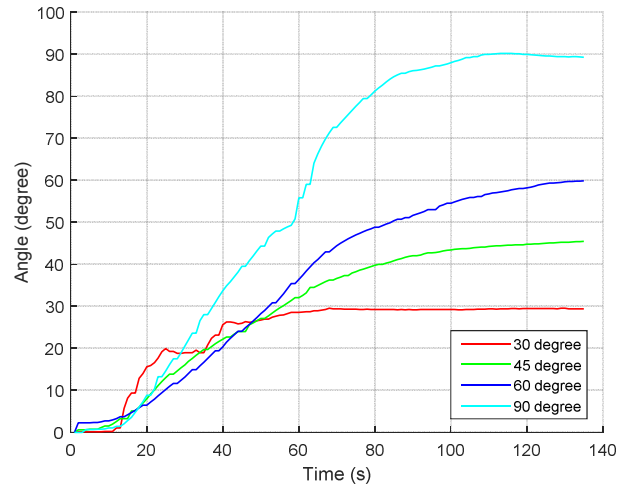

Fig. 6. Graph of roll angle testing

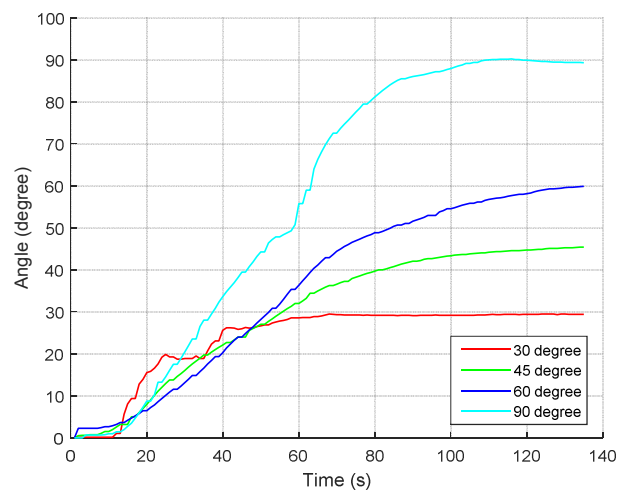

Fig. 7. Graph of pitch angle testing

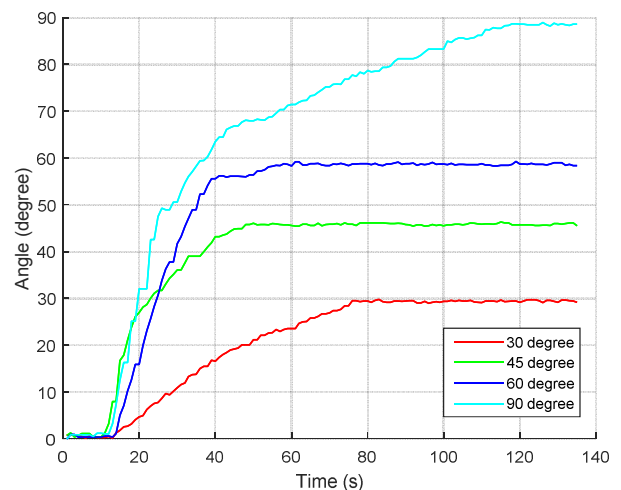

Fig. 8. Graph of yaw angle testing

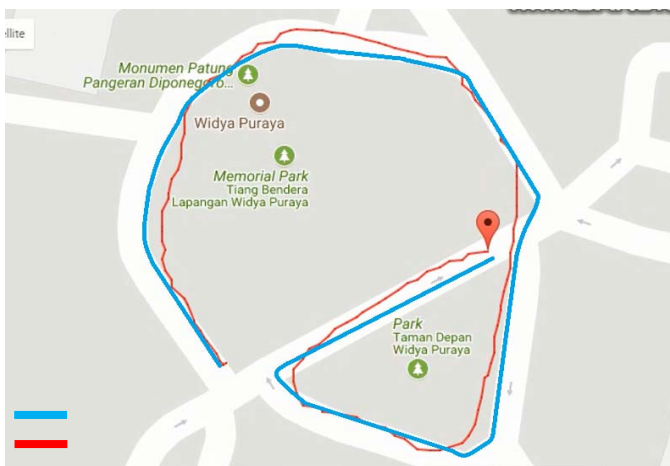

Fig. 5. The result of tracking position testing

TABLE II. THE ERROR OF ROTATION TESTING

No.	Angle (°)	Error (°)		
		Roll	Pich	Yaw
1.	30	0.45	3.33	1.42
2.	45	0.45	3.22	1.42
3.	60	0.38	2.55	2.30
4.	90	0.63	2.89	3.20
Average Error		0.47	1.25	1.10

IV. CONCLUSION

Object tracking system that is designed works well. The static position testing in the three different places are shown in the right place. The farthest error from the three places is 5.05 m in Benchmark I and the average error of static position testing in three Benchmarks is 2.66 m. Object tracking position shown that the object is well monitored from the coordinate -7.0499725, 110.438256 until the coordinate -7.0496875, 110.43892. The attitude rotation also well monitored at the angle of 0° to 30°, 0° to 45°, 0° to 60°, and 0° to 90°. The average of error in all rotation testing is 0.96°.

REFERENCES

- [1] H. Li, Q. Yuan, and X. Li, "Ground-target tracking UAVs system via nonlinear distbuted model predictive control," *Ind. Electron. Soc. IECON 2017 - 43rd Annu. Conf. IEEE*, 2017.
- [2] E. Choi and S. Chang, "A consumer tracking estimator for vehicles in GPS-free environments," *IEEE Trans. Consum. Electron.*, vol. 63, no. 4, pp. 450–458, 2017.
- [3] P. A. Catur, WidagdoHsin-Huang, and L.-H. Kuo, "Limb motion tracking with inertial measurement units," *IEEE Int. Conf. Syst. Man, Cybern.*, 2017.
- [4] S. Zhang, W. Jin, and Y. Zhang, "Implementation and complexity analysis of orientation estimation algorithms for human body motion tracking using low-cost sensors," *2nd Int. Conf. Front. Sensors Technol.*, 2017.
- [5] S. C. Brown, "Understanding Mapping Coordinate Systems," vol. MAK-00041, pp. 60–61, 2016.
- [6] M. Pedley, "Tilt Sensing Using a Three-Axis Accelerometer," *Free. Semicond. Inc.*, vol. Rev 6, pp. 1–22, 2013.
- [7] T. S. Yoo, S. K. Hong, H. M. Yoon, and S. Park, "Gain-scheduled complementary filter design for a MEMS based attitude and heading reference system," *Sensors*, vol. 11, no. 4, pp. 3816–3830, 2011.