

**Enhancing the Effectiveness of Companies' Open Innovation Efforts for
Firm Performance: A Comprehensive Network Perspective**



TECHNISCHE
UNIVERSITÄT
DARMSTADT

Dem Fachbereich Rechts- und Wirtschaftswissenschaften
der Technischen Universität Darmstadt

zur Erlangung des akademischen Grades

Dr. rer. pol.

vorgelegte Dissertation von

M.Sc. Dace Daldere,

geboren in Riga, Lettland

Erstgutachter: Jun.-Prof. Dr. Nicolas Zacharias

Zweitgutachter: Prof. Dr. Alexander Kock

Darmstadt 2018

D17

Daldere, Dace: Enhancing the Effectiveness of Companies' Open Innovation Efforts for Firm Performance: A Comprehensive Network Perspective
Darmstadt, Technische Universität Darmstadt,
Jahr der Veröffentlichung der Dissertation auf TUpriints: 2019
Tag der mündlichen Prüfung: 23.05.2018

Veröffentlicht unter CC BY-NC-ND
<https://creativecommons.org/licenses/>

Table of Contents

List of Figures	V
List of Tables.....	VII
List of Abbreviations.....	VIII
List of Journals	X
1 Introduction.....	1
1.1 Relevance of the Thesis	1
1.1.1 Managerial Relevance of the Thesis	1
1.1.2 Scientific Relevance of the Thesis	4
1.2 Major Goals of the Thesis	8
1.3 Structure of the Thesis	11
2 Open Innovation: Conceptual Foundations and Empirical Findings	13
2.1 Conceptual Foundations	13
2.1.1 Origins of the Open Innovation Concept	13
2.1.2 Defining Open Innovation: Closed vs. Open Innovation Model.....	15
2.1.3 Two Main Approaches of Open Innovation.....	17
2.1.4 Different Angles of Open Innovation.....	19
2.1.5 Application of OI-related Conceptual Foundations in this Thesis	20
2.2 Current State of Research	21
2.2.1 Types of Open Innovation Activities.....	22
2.2.2 Interaction Intensity of Open Innovation Activities	24
2.2.3 Open Innovation and Firm Innovation Performance	25
2.2.4 Risk of Partner's Opportunistic Behaviour in Open Innovation	29
2.3 Summary.....	33
3 Inter-organizational Networks: Conceptual Foundations and Empirical Findings.....	35
3.1 Conceptual Foundations	35
3.1.1 Networks in the Context of Open Innovation	35
3.1.2 Network Characteristics	36
3.1.2.1 Structural Network Characteristics	36

3.1.2.2	Relational Network Characteristics	40
3.1.3	Application of Network-related Conceptual Foundations in this Thesis	42
3.2	Current State of Research: Network Characteristics and Firm Performance	43
3.3	Summary.....	47
4	Study 1 – How Different Types of Partner Alignment Influence the Effectiveness of Highly and Weakly Interactive Open Innovation Activities for Firm’s Adaptiveness	49
4.1	Introduction to Study 1	49
4.2	Theoretical Background – Social Network Theory	52
4.3	Framework and Hypotheses	53
4.3.1	Study Framework	53
4.3.2	Hypotheses	56
4.3.2.1	Main Effects Hypotheses	56
4.3.2.2	Moderating Effects Hypotheses	57
4.4	Methodology.....	60
4.4.1	Sample and Data Collection	60
4.4.2	Measures.....	61
4.4.3	Measurement Properties	63
4.4.4	Hypotheses Testing Procedure	64
4.5	Results	66
4.6	Discussion.....	69
4.6.1	Implications for Research.....	69
4.6.2	Implications for Managerial Practice	71
4.6.3	Limitations and Avenues for Further Research.....	72
4.7	Appendix	74
5	Study 2 – Structural and Relational Network Characteristics as Determinants for Managing Upsides and Downsides of Open Innovation Relationships	76
5.1	Introduction to Study 2	76
5.2	Theoretical Background – Aligning Social Network Theory with Relational View	79
5.3	Framework and Hypotheses	81
5.3.1	Study Framework	81
5.3.2	Hypotheses	83
5.3.2.1	Main Effects Hypotheses	83
5.3.2.2	Moderating Effects Hypotheses	84
5.4	Methodology.....	87
5.4.1	Sample and Data Collection	87
5.4.2	Measures.....	88

5.4.3	Measurement Properties	90
5.4.4	Hypotheses Testing Procedure	92
5.5	Results	93
5.5.1	Main effects results	93
5.5.2	Moderated effects results	94
5.6	Discussion.....	95
5.6.1	Implications for Research.....	95
5.6.2	Implications for Managerial Practice	96
5.6.3	Limitations and Avenues for Further Research.....	97
5.7	Appendix	99
6	Study 3 – Which Collaborative Activities Should Firms Perform to Become a Gatekeeper? A Longitudinal Analysis of a Large-scale Collaboration Network.....	101
6.1	Introduction to Study 3	101
6.2	Theoretical Background – Aligning Social Network Theory with Literature on Distant Knowledge	104
6.3	Framework and Hypotheses	106
6.3.1	Framework of the Study	106
6.3.2	Hypotheses	107
6.4	Methodology.....	112
6.4.1	Sample and Data Collection	112
6.4.2	Measures.....	115
6.4.3	Model Specification and Hypotheses Tests	117
6.5	Results	120
6.6	Discussion.....	122
6.6.1	Implications for Research.....	122
6.6.2	Implications for Managerial Practice	124
6.6.3	Limitations and Avenues for Further Research.....	125
7	Conclusion of the Thesis.....	127
7.1	Research Implications of the Thesis	127
7.2	Concluding Remarks for Managerial Practice.....	133
	References	139
	Appendix	XI

List of Figures

Figure 1-1: Adoption of Open Innovation across Different Industries in %.....	2
Figure 1-2: Open Innovation Research Streams.....	6
Figure 1-3: Contributions of the Thesis.....	7
Figure 1-4: Overarching Conceptual Framework and Research Questions of the Thesis..	10
Figure 2-1: Simplified Overview of the Broader Open Innovation Research Field.....	14
Figure 2-2: Closed Innovation Model.....	16
Figure 2-3: Open Innovation Model.....	16
Figure 2-4: Two Main Approaches of Open Innovation.....	18
Figure 2-5: Different Angles of Open Innovation.....	20
Figure 2-6: Open Innovation Activities.....	23
Figure 2-7: Open Innovation Activities and their Interaction Intensity.....	25
Figure 2-8: Overview of Extant Research on the OI-Performance Relationship.....	28
Figure 3-1: Illustration of Direct Ties, Indirect Ties, and Structural Holes.....	37
Figure 3-2: Actor's Network Centrality.....	39
Figure 3-3: Overview of Extant Research on Network Characteristic-Performance Relationship.....	46
Figure 4-1: Framework (Study 1).....	54
Figure 5-1: Study Framework (Study 2).....	82
Figure 5-2: Results of Structural Equation Modelling (Study 2).....	94
Figure 6-1: Study Framework (Study 3).....	106

Figure 7-1: Openness of Open Innovation Research.....128

Figure 7-2: Networks as Open Innovation Supporters..... 136

Figure 7-3: Overarching Managerial Implication.....138

List of Tables

Table 4-1: Sample Composition (Study 1).....	61
Table 4-2: Descriptive Statistics and Correlations (Study 1).....	64
Table 4-3: Results, First Regression Analyses (Study 1).....	67
Table 4-4: Results, Second Regression Analyses (Study 1).....	69
Table 4-5: Measures and Measurement Properties (Study 1).....	74
Table 5-1: Sample Composition (Study 2).....	88
Table 5-2: Descriptive Statistics and Correlations (Study 2).....	91
Table 5-3: Measures and Measurement Properties (Study 2).....	99
Table 6-1: Sample Composition (Study 3).....	115
Table 6-2: Descriptive Statistics and Correlations (Study 3).....	119
Table 6-3: Results, First Fixed-effects Model (Study 3).....	121
Table 6-4: Results, Second Fixed-effects Model (Study 3).....	122
Table 7-1: Overview of the Three Studies.....	132

List of Abbreviations

α	Cronbach's alpha
AC	Absorptive capacity
AVE	Average variance extracted
B2B	Business-to-business
B2C	Business-to-customer
Coef.	Coefficient
CR	Composite reliability
CS	Cross-sectional study
df	Degrees of freedom
EU	European Union
ICT	Information and communication technology
IP	Intellectual property
LS	Longitudinal study
M&A	Mergers and acquisitions
N	Number of observations
na	not applicable
NPD	New product development
ns	non-significant
OI	Open innovation
OLS	Ordinary least squares
p	p-value
r	Pearson's correlation coefficient
R&D	Research and development
RA	Regression analysis

RMSEA	Root mean square error of approximation
RoA	Return on assets
RoS	Return on sales
RQ	Research question
SD	Standard deviation
SE	Standard error
SEM	Structural equation modelling
SNT	Social network theory
SRMR	Standardized root mean square residual
t	Time period
US	United States
VHB	Verband der Hochschullehrer für Betriebswirtschaft e.V.

List of Journals

AMJ	Academy of Management Journal
ET&P	Entrepreneurship Theory and Practice
JMR	Journal of Marketing Research
JPIM	Journal of Product Innovation Management
JSBM	Journal of Small Business Management
R&D Mgmt.	Research and Development Management
RP	Research Policy
SMJ	Strategic Management Journal

1 Introduction

1.1 Relevance of the Thesis

1.1.1 Managerial Relevance of the Thesis

“In a world of widely diffuse useful knowledge, much of the real value can be gained not from developing yet another piece of knowledge, but rather from creating systems and architectures that combine these disparate pieces of knowledge” (Chesbrough 2011).

Traditional approaches to innovation management, where a single firm functions as an innovator and solely brings new products and services to the market, are often not viable in a modern business world characterized by globalization trends and increased technology and market-related pressures (Chesbrough 2011; Dahlander and Gann 2010). Such approaches require “too much money, too much time, and carry too much risk for the innovating firm” (Chesbrough 2011). As Jonny Combe—the general manager of product development at BMW—argues: “It’s crucial for the modern business to explore every sense of the word “innovation”, you can’t ever stand still because your customers don’t, and neither does the competition. Everywhere we turn we see technology transforming products, services and customer’s expectations” (Combe 2017). Due to the high pace of technology and market changes more and more companies in diverse industries recognize that they cannot rely solely on internal innovation efforts (Drechsler and Natter 2012; Oerlemans and Knobens 2010).

Consequently firms build relationships with different types of partners—customers, competitors, suppliers, or research institutes, and perform such activities as crowdsourcing, co-development, joint ventures, alliances, in/out-licencing, and spin-offs, to complement their internal innovation efforts (Berchicci 2013; Köhler, Sofka, and Grimpe 2012). This phenomenon, called open innovation (OI), offers considerable opportunities for firms to acquire and integrate widely diffuse knowledge and thereby foster innovation and firm performance (Berchicci 2013; Chesbrough 2003, 2011; Drechsler and Natter 2012). Whereas traditional,

closed innovation requires too much money, too much time, and involves too much risk, open approaches to innovation can perform better on all three dimensions (Chesbrough 2011).

OI, which is “the purposive use of inflows and outflows of knowledge to accelerate innovation in one’s own market, and expand the use of internal knowledge in external markets, respectively” (Chesbrough 2006, p. 1), has become a major trend in innovation practice (Fu 2012). Firms increasingly recognize the importance of inter-organizational relationships as a source of competitive edge and “openness develops into a new dimension of competition” (Henkel et al. 2014, p. 879). Most of the firms perform OI at least to some degree. As one of the first large-scale OI studies shows, 78% of large companies in Europe and US, with revenues annually in excess of US\$ 250 million and more than 1,000 employees, make use of OI (see Figure 1-1; 2,840 surveyed companies). A closer look at the different industry sectors shows that OI is most common in high-tech manufacturing sectors and wholesale, trade and retail. Low-tech manufacturing sectors and financial services exhibit the lowest degrees of OI adoption (Chesbrough and Brunswicker 2013).

Figure 1-1: Adoption of Open Innovation across Different Industries in %
(Chesbrough and Brunswicker 2013)

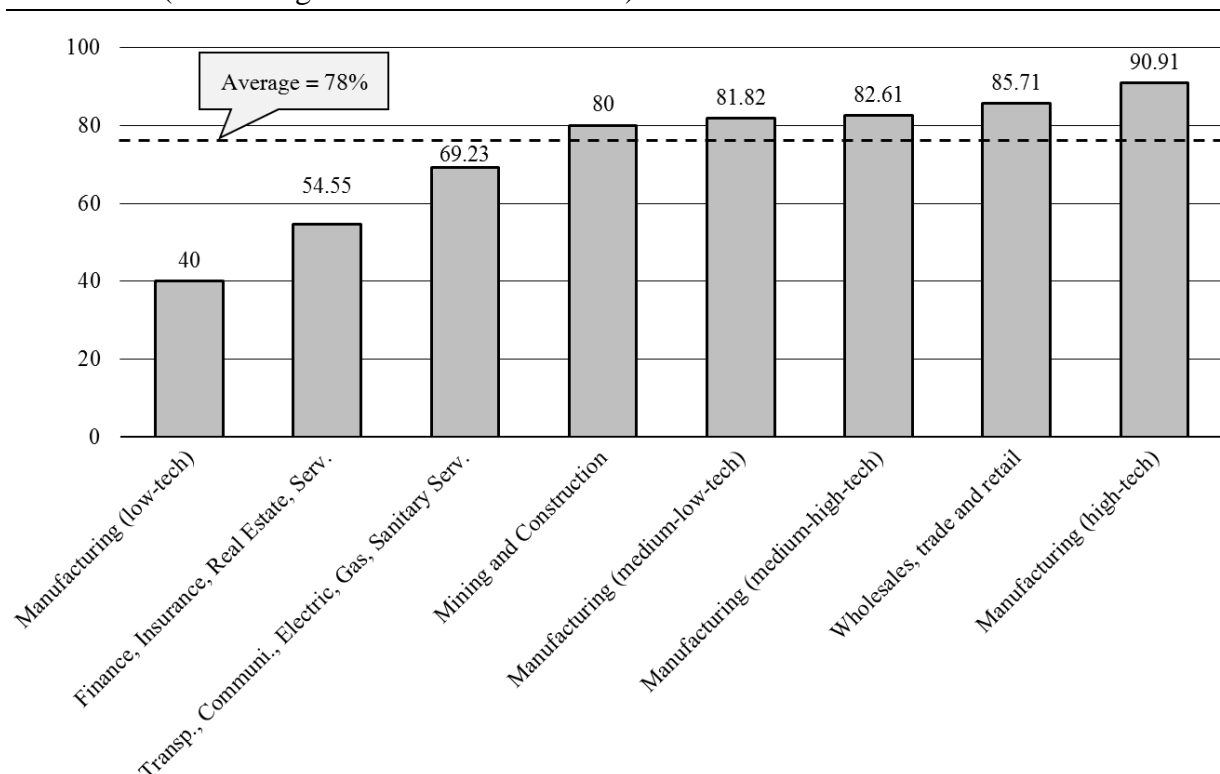

Whereas OI started as collaboration between two firms to open up the internal innovation process, nowadays there are many companies that apply OI extensively and involve a significant number of collaboration partners and activities in the innovation process, and are

hence embedded in larger innovation networks (Chesbrough 2013). Even industry sectors that used to be fairly “closed”, such as pharmaceutical and energy sectors, have started increasingly to apply OI practices (Chesbrough 2017a; Jhoti 2015). Although almost every company practices OI, not many are successful in their OI efforts. Statistics show that, despite the growing use and importance of inter-organizational innovation networks, up to 50% of all inter-firm partnerships fail—which is an intriguing managerial problem (Michelfelder and Kratzer 2013). Thus, the question of how to increase the *effectiveness of OI efforts* is vital for every company practicing OI.

A central aspect related to the effectiveness of OI is how firms can manage their dynamic OI relationships such that they can achieve the highest outcomes of their OI efforts and foster their firms’ performance (Bogers et al. 2016). The effectiveness of OI efforts is contingent on many internal and external factors (Ozcan and Eisenhardt 2009; Salge et al. 2013). Among internal factors, firms’ internal knowledge base is especially important for determining the effectiveness of companies’ OI efforts (Berchicci 2013). Among external factors, the characteristics of the networks in which firms are embedded influence firms’ success in performing OI activities. Several structural network characteristics, such as network size and network position (Li et al., 2013), as well as relational characteristics, such as the strength of a relationship (Michelfelder and Kratzer 2013) and partner alignment (Emden, Calantone, and Droge 2006), significantly determine how effective firms’ OI efforts will be.

It is crucial for firms to be aware of the great impact that network characteristics have on the effectiveness of their OI efforts—a matter that is not well recognized in managerial practice, because it is not (yet) a common practice for managers to comprehensively analyse the networks in which their firms are embedded. Hence, this thesis seeks to raise managerial awareness of the importance of network characteristics and provides answers to several questions that are of great interest for managers in companies performing OI.

First, when firms engage in OI activities they face the question of *when to strive for a particular type of alignment with OI partners, and when to avoid it*. Whereas there is a consensus that alignments with partners are generally beneficial for all OI activities (Green et al. 2012; Seggie, Kim, and Cavusgil 2006; Tan et al. 2009), contradictory opinions suggest that if a firm is too tightly aligned with its partners, it cannot achieve benefits from its OI efforts that result from diversity of knowledge (Santos and Eisenhardt 2005; Sapienza, Parhankangas, and Autio 2004). This thesis shows that, depending on the type of OI activity performed (e.g., crowdsourcing,

joint ventures, spin-offs), different types of alignment with partners can make these activities thrive or fail, in terms of their effectiveness (Faria, Lima, and Santos 2010).

Second, OI involves many risks, such as the risk that collaboration partners might behave opportunistically. Companies tend to publish only their success stories and information about failed OI practices is far less available, causing the misleading interpretation that OI is always beneficial (Chesbrough 2017a). Since abstaining from OI is no longer a viable choice in an increasingly open world (Baker, Grinstein, and Harmancioglu 2015; Roy and Sivakumar 2010), managers need to *know how to manage the threat of opportunistic behaviour in order to profit from the benefits that OI offers*. Especially, this question relates to how firms can counter partner's opportunistic behaviour by adjusting network characteristics.

Third, since the effectiveness of OI strongly depends on network characteristics, firms should know how to influence these characteristics in order to achieve the desired OI performance. In specific, firms that have a more beneficial network position than their peers are able to foster their performance more. For example, centrally located firms often serve as gatekeepers for network partners' resource exchange (Carnovale and Yenyurt 2015). By controlling the communication flow, they gain accurate, timely information about activities throughout the network and can identify partners with complementary resources for their OI efforts more easily (Dyer and Singh 1998; Freeman 1979). Hence, managers want to *know how they can become gatekeepers in their networks*.

Altogether, this thesis is devoted to a phenomenon that is currently reshaping the global business architecture: OI networks. This phenomenon has overthrown the dominant organizational paradigm and manner of competing. Starting from single firms innovating alone and moving to dyadic collaborative relationships and complex dynamic collaboration networks, joint innovation development is nowadays not only the trend but also a necessity (Parkhe, Wasserman, and Ralston 2006). Managers need to know how to construct and manage their networks such that they are beneficial for their OI efforts and allow them to create systems and architectures that combine disparate pieces of knowledge in today's global world (Chesbrough 2011).

1.1.2 Scientific Relevance of the Thesis

Due to the increased application of OI in companies across industries, OI has become one of the hottest topics in innovation management research, attracting wide scholarly attention (Bogers et al. 2016; Huizingh 2011; Stanko, Fisher, and Bogers 2017). In about 15 years of research since the term "open innovation" was first introduced by Henry Chesbrough (2003),

OI research has gone a long way and scholars have attempted to provide insights into how firms use inflows of knowledge to accelerate internal innovation and outflows of knowledge to expand the markets for external use of innovation (Bogers et al. 2016; Chesbrough 2006). On the way, scholars have showed that OI is a very rich concept that companies can apply in many different ways. Starting from a few descriptive case studies of early adopters of OI and moving towards large-scale quantitative studies later on, scholars have advanced the OI research field significantly (Huizingh 2011).

Over the past years, authors have published many bibliometric reviews of OI and developed classifications of OI papers (e.g., Bogers et al. 2016; Dahlander and Gann 2010; Randhawa, Wilden, and Hohberger 2016; West and Bogers 2014). Figure 1-2 illustrates that the broader OI research field can be segmented into papers that investigate firm-centric aspects of OI, management of OI networks, or focus on the role of users and communities in OI (Randhawa et al., 2016). Firm-centric aspects of OI are the most explored area in OI research. These concentrate on how firms can acquire and exploit needed knowledge by engaging in OI. In particular, the central question is how firms can interpret distant, novel knowledge acquired from their partners and integrate it with already existing knowledge in the company (e.g., Piezunka and Dahlander 2015).

The second dimension—management of OI networks—is a far less researched area. This can be attributed to the complexity of this research field. The main interest of scholars is to determine how different network aspects support or hinder firms' OI efforts, and how firms can manage their networks by taking the specifics of their OI efforts into account (e.g., Li, Veliyath, and Tan 2013). The third dimension focuses on users as innovators and on the free revealing of their innovation-related outputs. This dimension belongs to the open and distributed innovation concept rather than open innovation concept in the sense of Chesbrough (2003, 2006; also see section 2.1.3).

The focus of this thesis is on the second dimension—management of OI networks, and the three empirical studies of this thesis are devoted to the question of *how firms can increase the effectiveness of their OI efforts by managing the structure of their collaboration network as well as relationships between collaboration partners*. The third study in this thesis also slightly touches upon the first dimension and considers the integration of distant, novel knowledge as a firm-centric aspect in enhancing firms' OI efforts.

Figure 1-2: Open Innovation Research Streams (Randhawa et al. 2016)

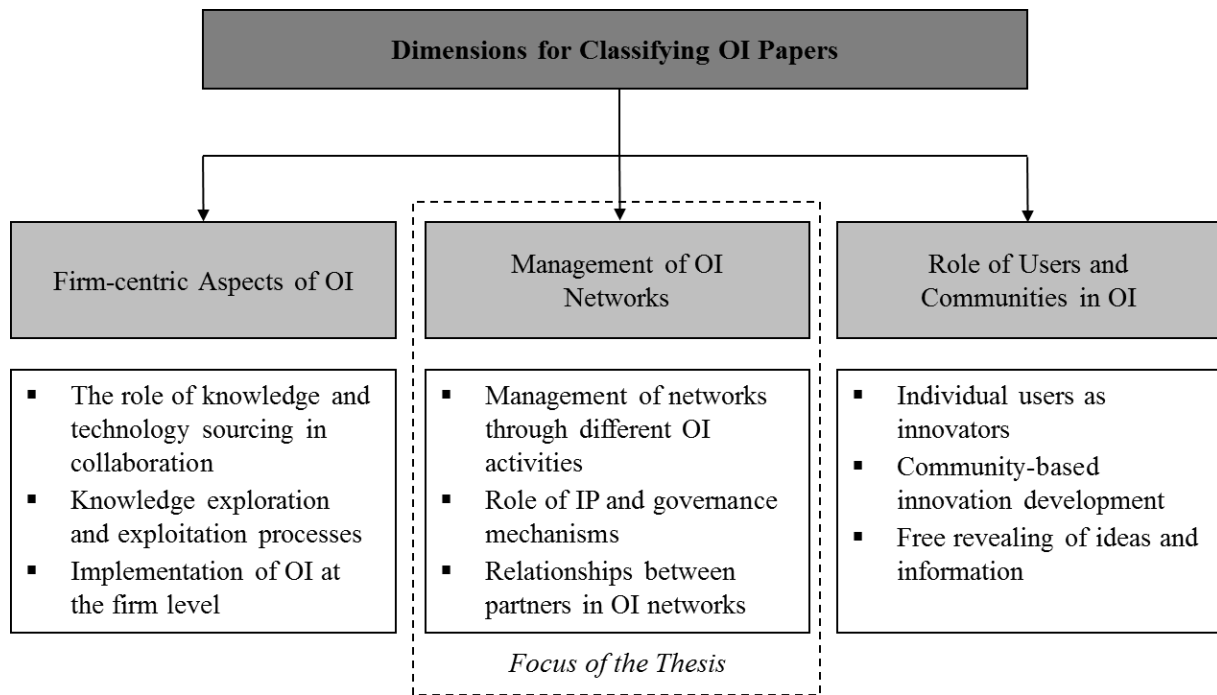

Despite the growing importance of OI networks for managerial practice, research on the management of OI networks has been so far underdeveloped (Randhawa et al. 2016). The context-dependency of OI is one of the least-researched and understood topics (Huizingh 2011). How firms can foster the effectiveness of their OI efforts by managing different aspects of their collaboration networks is a question that remains to be unanswered (Pemartin, Rodriguez-Escudero, and Munuera-Aleman 2017) resulting in calls for further research examining how network characteristics influence the OI-performance relationship (Huizingh 2011).

Research in the field of OI networks requires a more in-depth understanding with respect to several research gaps. Figure 1-3 gives an overview of the research gaps and the corresponding contributions of the studies in this thesis. First, OI is a complex concept consisting of many OI activities and partners as well as multiple network aspects that relate to their structure or relationships between collaboration partners. Firms constantly enter and exit network relationships such that “OI depicts novel dynamic network structures that emerge from dynamic interactions of a diverse set of actors throughout the innovation process” (Bogers et al. 2016, p. 16). Hence, researchers face the challenge of how to grasp firms’ openness. Practice needs a holistic perspective on the entire nexus of OI relationships that a firm holds with its collaboration partners. Thereby, all three studies in this thesis contribute to the OI research, which has concentrated primarily on how to ensure the success of single OI activities (e.g., Chai

and Shih 2016; Xu, Wu, and Cavusgil 2013) and offers guidance to managers concerning how to manage their innovation networks to create network-based value.

The second research gap relates to the interplay between different types of OI activities and network characteristics. OI research calls for more studies that provide a deeper understanding of how network characteristics influence the effectiveness of OI (Huizingh 2011). All three studies in the thesis contribute to this call, however, with each contributing to different aspects of the OI-network interplay.

Figure 1-3: Contributions of the Thesis

Contribution 1:	Grasping the Entire Nexus of OI Relationships		
	Studies 1-3		
Contribution 2:	Examining the Interplay between OI Relationships and Network Characteristics; How Firms Can Foster the Effectiveness of OI		
	Contribution 2-1: Study 1	Contribution 2-2: Study 2	Contribution 2-3: Study 3
	Examining how relational network characteristics in terms of partner alignment can foster or harm the effectiveness of OI.	Examining how structural and relational network characteristics in terms of network centrality and knowledge protection can foster or harm the upsides and downsides of OI.	Examining how firms can influence their structural network characteristics in terms of gatekeeper position by managing their OI efforts.

The first study fills a research gap that relates to the fact that extant research has not yet been able to explain how and when firms should strive for alignment with their partners. A recent stream of research suggests that partner alignment might increase collaboration effectiveness (e.g., Dahlander and Gann 2010; Lavie, Haunschild, and Khanna 2012). Several studies suggest that alignments with partners are generally beneficial for all OI activities (Green, Whitten, and Inman 2012; Seggie et al. 2006; Tan et al. 2009), but a contradictory line of research indicates that if a firm is too tightly aligned with its partners, it cannot adapt to changes quickly due to relationship inertia (Santos and Eisenhardt 2005; Sapienza et al. 2004).

The second study takes into consideration that, besides network characteristics influencing the upsides of OI—the positive outcome effects of different OI activities—it is also crucial to examine how they influence the downsides of OI in terms of partner's opportunistic behaviour (Stanko et al. 2017). From a more academic perspective, Dahlander and Gann (2010) and

Hottenrott and Lopes-Bento (2016) note that almost all published research on OI focuses on its potential benefits. Thus this study contributes to extant OI research by addressing opportunistic behaviour in OI relationships along with the opportunities for resource acquisition. In so doing, it extends the OI literature stream, which has neglected the “dark side” of OI (e.g., Cheng and Huizingh 2014; Chiang and Hung 2010).

The third study applies a different perspective on the OI-network interplay and takes into consideration that firms can influence their network characteristics by managing their OI efforts. The study contributes to extant research that has recognized that structural network position, in which firms acquire distant knowledge, can offer substantial benefits in terms of differentiation from the competition through novel knowledge (Piezunka and Dahlander 2015). However, it is yet to be explained how firms can achieve such a position i.e., become gatekeepers in their networks (Rodan and Galunic 2004).

1.2 Major Goals of the Thesis

As the previous sections of the thesis show, management of OI networks is an increasingly relevant concern for managers, which has led to the emergence of OI network research as a substantial research stream in extant OI literature (Randhawa et al. 2016). In particular, managers are concerned with finding determinants that increase the effectiveness of firms’ OI efforts. They are eager to discover such factors that foster the effectiveness of different types of OI activities and those that help firms to manage upsides (e.g., resource acquisition) and downsides (e.g., partner’s opportunistic behaviour) of OI. To provide implications for managerial practice in terms of how to foster the effectiveness of OI, scholars have started to focus on different network characteristics (Dong, McCarthy, and Schoenmakers 2017; Li et al. 2013). Previous findings with respect to network characteristics and their impact on OI effectiveness are ambiguous—whereas some characteristics foster OI effectiveness, others hinder it. Therefore, more research is necessary to examine how exactly different network characteristics determine OI success. Accordingly, the first major goal of this thesis is:

Major goal 1: Determining how network characteristics influence the effectiveness of different types of OI activities and how they might help firms to manage the upsides and downsides of OI.

On the one hand, managers should be aware of the fact that OI network characteristics determine the success of firms’ OI efforts. On the other hand, they also should know that, by shaping their OI endeavours, they can directly influence their OI network characteristics. For

example, firms can choose their position in a collaboration network, which is a structural network characteristic, by selecting cooperation partners and cooperation forms. That is, one firm might have many collaboration partners with whom it interacts frequently and therefore it is central in its network, whereas another firm might have very few collaboration partners with whom it rarely interacts and therefore it is peripheral in its network. Although this perspective on OI networks is established in network research examining network formation (e.g., Ahuja 2000; Granovetter 1973), in OI research stream, answers are still missing regarding how firms can achieve a certain network position by performing different types of OI activities. Against this backdrop, the second major goal of this thesis is:

Major goal 2: Determining how firms can influence their network position by performing different types of OI activities.

To achieve both goals, this thesis is based on three empirical studies that answer three overarching research questions. Figure 1-4 gives an overview of these research questions and anchors them in an overarching framework of the thesis. Studies 1 and 2 are tailored at achieving major goal 1.

Study 1 investigates how firms should arrange network characteristics to realize the full potential of different types of open innovation activities and foster firms' adaptiveness. In specific, this study concentrates on different types of partner alignment as relational network characteristics, and examines how they can make different OI activities thrive or fail.

Study 2 investigates how firms should arrange their network characteristics to mitigate the potential downsides of OI related to partners' opportunistic behaviour, and to unfold its positive influences to foster firms' OI product performance. This study considers network centrality as a structural network characteristic and knowledge protection as a relational network characteristic as contingency factors in this context.

Study 3 is tailored to the major goal 2. It investigates how firms can influence their network characteristics by performing different OI activities to achieve a valuable structural network position i.e., become gatekeepers in their OI networks by performing the right OI activities.

Figure 1-4: Overarching Conceptual Framework and Research Questions of the Thesis

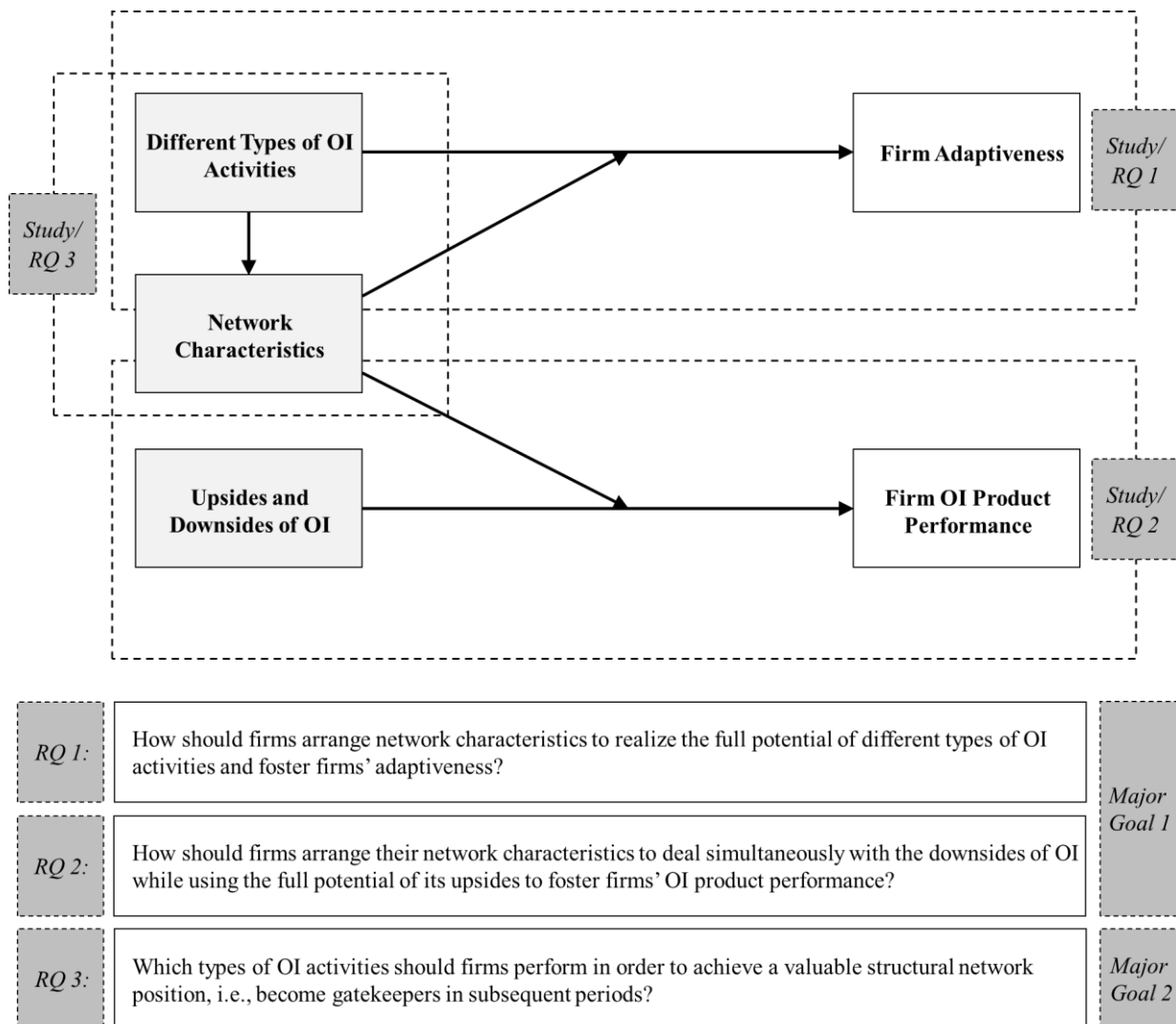

Notes: RQ = Research question.

In order to provide a comprehensive network perspective on how firms can foster the effectiveness of their OI efforts, all three studies draw on social network theory (Coleman 1988; Granovetter 1973) as an overarching theoretical framework to develop the theoretical reasoning for the proposed hypotheses. In addition, Study 2 aligns social network theory with the relational view (Dyer and Singh 1998; Lavie 2006) to examine on a more strategic level how firms can accumulate benefits (relational rents) in OI by successfully managing the upsides and downsides of OI. Moreover, Study 3 aligns social network theory with the literature on distant knowledge (Afuah 2013; Piezunka and Dahlander 2015) to integrate firm-centric aspects such as the firm's knowledge base in the context of OI and to investigate how firms can benefit from it. Altogether, by applying social network theory and extending this theoretical basis with

relational view and literature on distant knowledge, this thesis provides insights into the management of OI networks and the relevant contextual factors.

To provide a more comprehensive understanding of OI networks, the studies in this thesis also employ different methodological approaches. Regarding the databases for the empirical tests, Studies 1 and 2 are both cross-sectional analyses based on a multisource and multi-industry dataset gathered from managers via surveys in 181 companies, together with secondary data from a financial database. Study 3 is a longitudinal study and its empirical analyses are based on multi-industry panel data collected from two secondary data sources that allow examination of dynamic network formation. Collaboration data is collected by crawling press releases over nine years to reconstruct networks between the 500 largest companies in Germany, and then matched with performance data collected from annual reports over five years.

Regarding the hypotheses testing procedures, Study 1 employs hierarchical multiple regression analysis and the two-stage least squares regression with instrumental variables (Larcker and Rusticus 2010), Study 2 employs structural equation modelling (Muthén and Muthén 2012), and Study 3 employs panel analysis with two fixed-effects models (Wooldridge 2002). The combination of large-scale survey data and data from multiple secondary data sources, as well as cross-sectional and longitudinal data, provide comprehensive insights into the management of OI networks. They allow to discover industry-wide, long-term effects of OI on different aspects of firm performance and how firms can foster the effectiveness of their OI efforts by managing their OI networks.

1.3 Structure of the Thesis

So far Chapter 1 has discussed the relevance of this thesis from a managerial and scientific point of view, and defined the major goals. Chapters 2 and 3 consist of a review of the conceptual foundations and the empirical findings regarding OI and inter-organizational networks. These chapters serve as a foundation for the following three empirical studies presented in Chapters 4-6. Concluding remarks and implications for science and managerial practice are presented in Chapter 7.

To provide a deeper understanding of OI and its core aspects, the first part of Chapter 2 (2.1) provides the conceptual foundations of OI i.e., it offers definitions of OI, explains how OI differs from closed innovation, and gives an overview of the different angles on OI. The second part of Chapter 2 (2.2) reviews the current state of research regarding the aspects of OI that are

of particular importance for the following three empirical studies. Overall, the main aspects of conceptual foundations and empirical findings are summarized in Section 2.3.

Chapter 3 is structured in a similar way. The first part of the Chapter (3.1) explains the conceptual foundations of inter-organizational networks, clarifies their role in OI, and discusses both structural and relational conceptions within the network research. Section 3.2 reviews the current state of research focusing on a broad set of network characteristics and examining their influence on various aspects of firm performance. The summary of Chapter 3 (3.3) reveals the key aspects of the development of OI network research.

The following three Chapters 4-6 encompass the three empirical studies of this thesis that answer the three core research questions stated in Figure 1-4. All three studies are constructed in a way that is common for every scientific article in the field, and consist of an introduction, theoretical background, framework and hypotheses, methods, results, and discussion.

The final chapter of the thesis (Chapter 7) derives overarching research contributions based on all three empirical studies and states how this thesis contributes to the OI research. Moreover, this chapter offers concluding remarks for managerial practice regarding how decision makers can foster the effectiveness of their firm's OI efforts.

2 Open Innovation: Conceptual Foundations and Empirical Findings

Because OI is a broad concept, it requires a clear definition and further clarification. A special focus in section 2.1 is put on the conceptual foundations of OI including the origins of the OI concept and its definitions. To further narrow this concept, this section also sketches the differences between the user innovation model and the OI model and describes multiple angles of OI. At last, this section explains how the conceptual foundations are applied in this thesis. Section 2.2 further discusses the current state of research regarding different types of OI activities, their classification, and performance outcomes as well as provides deeper insights into the “dark side” of OI. The last section of this chapter (2.3) summarizes the key points regarding the conceptual foundations and the main results of extant research.

2.1 Conceptual Foundations

2.1.1 Origins of the Open Innovation Concept

Although the term “open innovation” was first introduced 15 years ago in 2003 by Henry Chesbrough and is considered to be new (Chesbrough 2003), the concept of OI has existed long before that. The newly emerged OI literature is *per se* not a new research field as it envelops multiple pre-existing research areas and works of renowned scholars in innovation, alliance, collaboration, and organizational learning management (Spithoven, Vanhaverbeke, and Roijakkers 2013). Whereas some critics of OI view it as “old wine in new bottles”, others see OI as an umbrella concept linking several research areas that have been well established before (Stanko et al. 2017).

As Figure 2-1 shows, some research streams have focused on specific types of collaboration partners. For example, the user innovation research stream examines firm-customer/user relationships (e.g., von Hippel 1986) and relationship marketing investigates firm-customer and firm-supplier relations (e.g., Ganesan et al. 2010). Moreover, alliance research mainly investigates firm-firm collaboration (e.g., Gnyawali and Park 2011).

Furthermore, there are several other research fields that examine firms' entire nexus of relationships to external stakeholders and thereby focus on different aspects of the collaboration. For instance, network research (e.g., Faems, Janssens, and Neyens 2012) often applies mathematical approaches to examine firm's position in a broader collaboration network and investigates how firms can create network-based value by gaining social capital embedded in networks. Inter-organizational collaboration management (e.g., Perrons 2009) mainly focuses on how firms can foster their innovation capacity by engaging in R&D collaboration with different partners. Organizational learning (e.g., Katila and Ahuja 2002) also applies a broader perspective on firms' collaboration and investigates how firms can learn and complement their internal knowledge base through learning from external sources.

Figure 2-1: Simplified Overview of the Broader Open Innovation Research Field

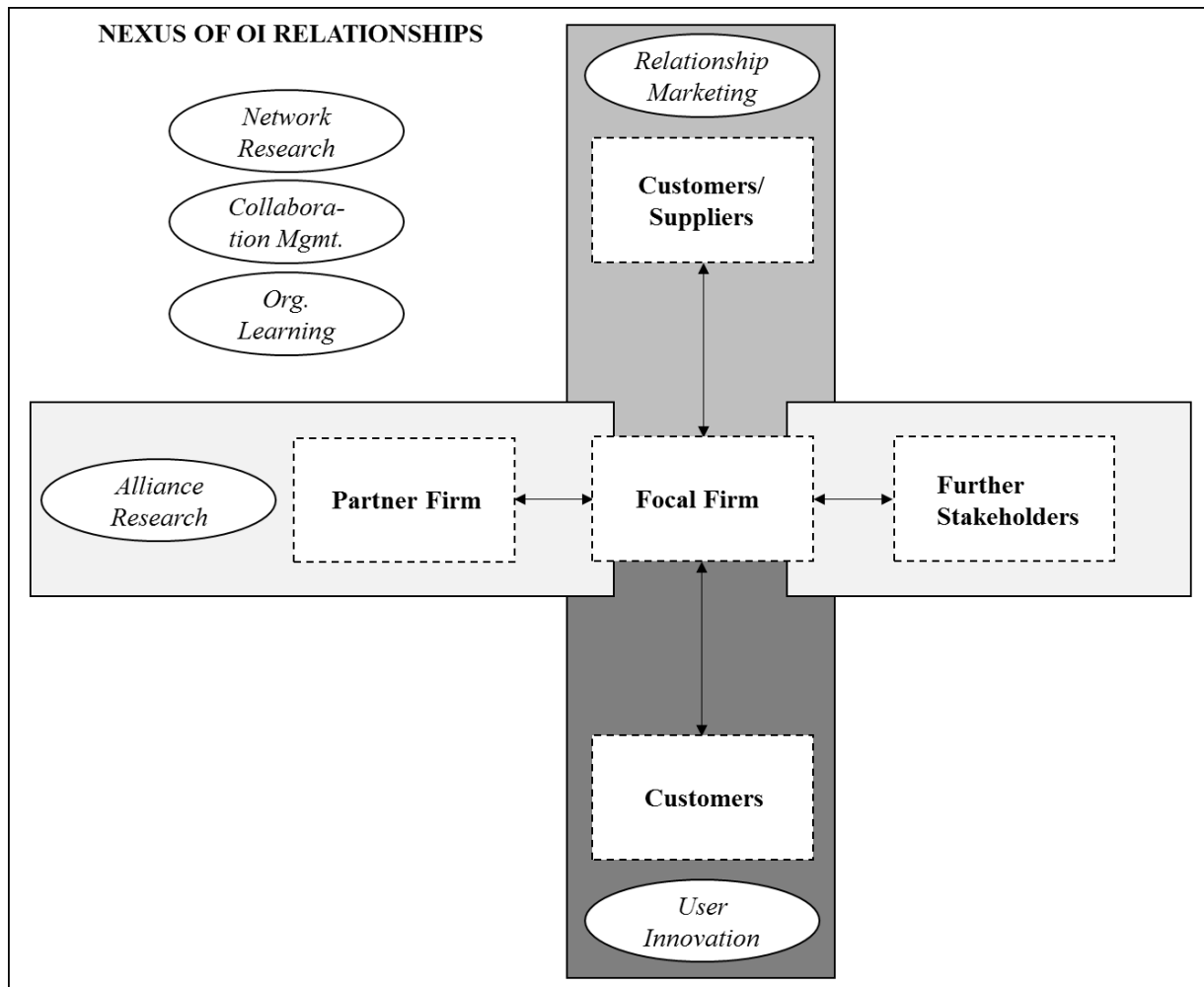

These research streams can be seen as subsectors of the broader OI research. Of course, there are other research fields that address collaboration and examine joint value creation.

Figure 2-1 gives an overview only of the most prominent research streams within the context of OI. In addition, the boundaries between these subsectors are not clear-cut. Overlaps and interdependencies exist between different research fields and authors often investigate certain aspects of the collaboration that join two or more of these fields to bring new insights to OI research (e.g., Frankort 2016; Tiwana 2008). However, a multitude of these studies have not all been consistently and explicitly connected to the larger body of OI research (Stanko et al. 2017). One must acknowledge that OI is a very broad and complex concept which encompasses a wide variety of research streams. Therefore, every OI researcher faces the challenge of considering many other research fields to gain holistic insights of any particular area of OI at focus.

2.1.2 Defining Open Innovation: Closed vs. Open Innovation Model

Extant research on OI is based on insights from multiple different research fields. As a consequence, authors have developed and applied a variety of OI definitions. Gianiodis, Ellis, and Secchi (2010) provide an overview of seven different definitions. Despite this variety, all definitions have in common that they emphasize knowledge inflows and outflows (e.g., Chesbrough 2006) and exploration of outside sources in the context of OI (e.g., West, Gallagher, and Square 2006). According to Dahlander and Gann (2010), the most often used definition at the time is Chesbrough's (2003, p. xxiv) original definition of OI: "open innovation is a paradigm that assumes that firms can and should use external ideas as well as internal ideas, and internal and external paths to market, as firms look to advance their technology". In 2006, Chesbrough slightly expanded the definition and instead of seeing OI as a possibility to advance technology he emphasizes innovation in general: OI is the "use of inbound and outbound knowledge flows to accelerate internal innovation and expand markets to externally use innovation, respectively" (Chesbrough et al. 2006, p. 1). Recently Chesbrough offered another definition that slightly differs from the original ones and sees OI as a process that must be aligned with firm's business model: OI refers to "a distributed innovation process based on purposively managed knowledge flows across organizational boundaries, using pecuniary and non-pecuniary mechanisms in line with the organization's business model" (Chesbrough and Bogers 2014, p. 17).

Overall, Chesbrough (2006, 2012) argues that OI is understood as the antithesis of a "closed innovation" model, where products are developed internally out of firm's internal R&D activities and thus are commercialized by the firm. In this model firm's boundaries are closed such that a firm does not rely on external ideas and does not allow internal ideas to be commercialized outside firm's boundaries (see Figure 2-2).

Figure 2-2: Closed Innovation Model (Chesbrough 2003)

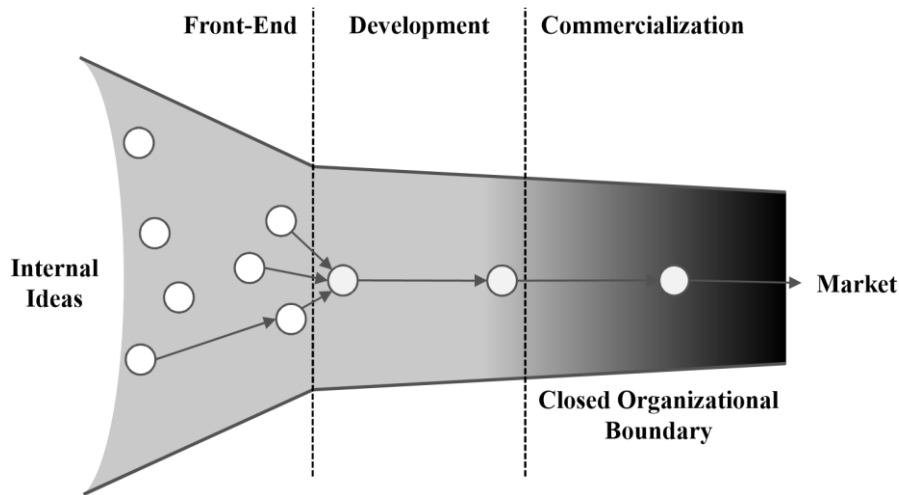

On contrary, the OI paradigm assumes that firms combine external ideas as well as internal ideas to innovate and use internal and external ways to market their innovations (Chesbrough 2003). Thus, in open innovation model firm's boundaries are permeable, i.e., firm uses external ideas from different stakeholders, such as competitors, customers, research institutes, and suppliers, to foster innovation as well as allow internal ideas to be commercialized by other organizations, for instance, in form of spin-offs and out-licencing (see Figure 2-3; Chesbrough 2006).

Figure 2-3: Open Innovation Model (Chesbrough 2006)

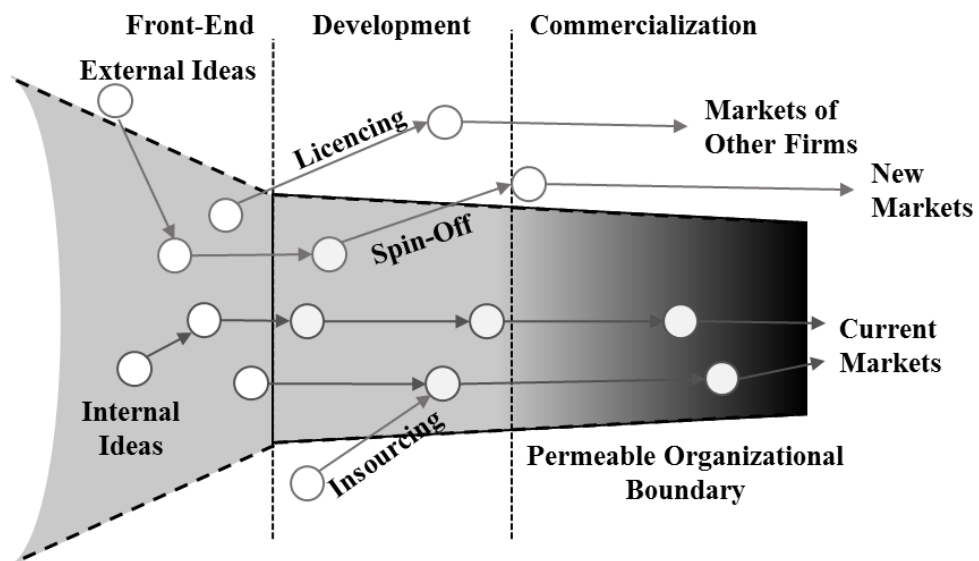

Moreover, it is important to emphasize that when Chesbrough argues that OI has the potential to foster internal innovation, he does not refer only to the development of new products or services. “Innovation” or “innovation-related knowledge” that firms acquire from external sources in OI does not only refer to technical knowledge. It includes the knowledge necessary to develop and commercialize an innovation. For instance, the acquisition of the knowledge of the customers, market segments, product applications or knowledge to foster firm’s internal processes is the subject of OI (Chesbrough 2003, 2006). Many OI scholars agree to this conception of OI and argue that OI “may involve collaboration with various partners for different purposes related to innovation, including R&D, resources, skills, production, and marketing” (Fu 2012, p. 514). In line with these arguments, OI includes such collaboration that fosters immediate new product and service development as well as such collaboration that is tailored to foster supplemental processes and structures for innovation development.

2.1.3 Two Main Approaches of Open Innovation

To further narrow the broad OI concept, it is necessary to distinguish between two main approaches of OI that have emerged over the past decades. The user innovation concept and the OI concept both incorporate the idea that company is supposed to open its boundaries and search for external ideas to foster internal innovation. Both of these concepts have moved away from the manufacturer-as-only-innovator assumption towards a more collaborative way of innovating (Chesbrough 2003; von Hippel 1986). Thus, they have revolutionized the conventional innovation process (Gassman and Enkel 2004).

Apart from these similarities, both concepts contain several contrary views regarding value-creation in collaboration. Figure 2-4 summarizes the most distinctive differences in both models. User innovation paradigm has its origins in the concept of open source software which then has been applied to other industries that can profit from open source development processes (e.g., sports equipment; Euchner 2010; Raasch, Herstatt, and Balka 2009). Its core idea is that users share their knowledge freely and voluntary within a community to increase joint benefits of the innovation, thus, they do not expect any monetary reward (von Hippel 1986). The concepts of intellectual property and business model do not play a role in the conception of user innovation. Knowledge transfer between users and the firm relies on informal, non-contractual ties. Another important characteristic of this conception is that extant research makes no reference to the so-called “false negative” projects—projects that turn out to be irrelevant or not-worth-pursuing for the innovator in course of time (Chesbrough 2003).

Furthermore, the unit of analysis in this conception are the relationships between innovators in the user community (Euchner 2010).

Figure 2-4: Two Main Approaches of Open Innovation

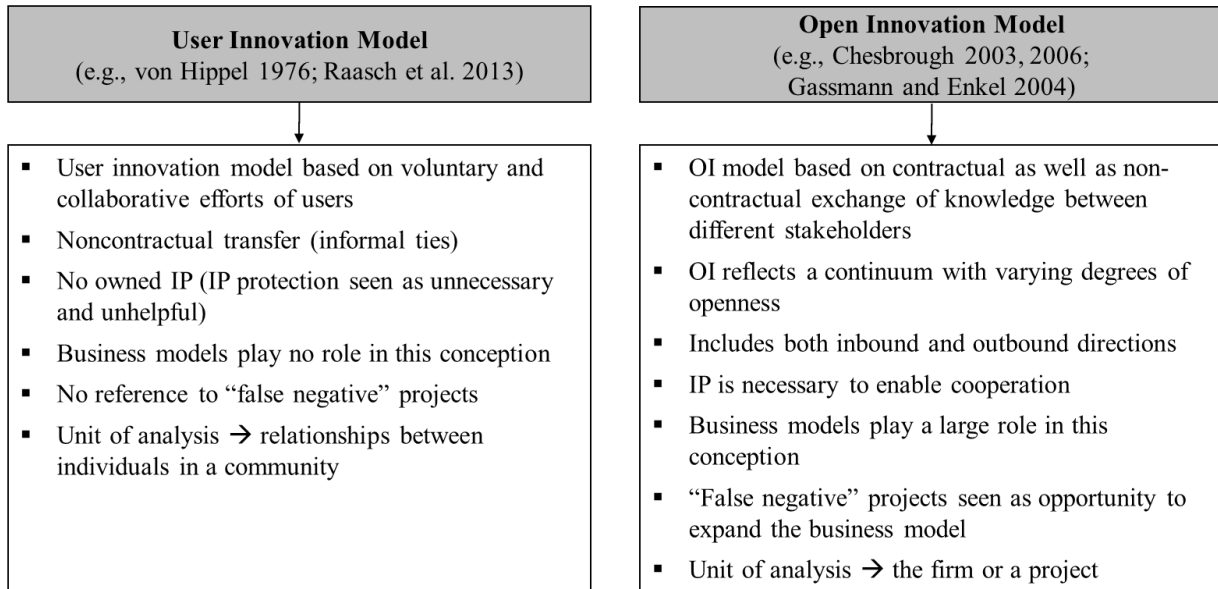

On contrary, OI paradigm in the sense of Chesbrough incorporates non-contractual as well as contractual knowledge exchange between customers/users but also between many other stakeholders, such as research institutes, suppliers, and competitors. OI concept reflects a continuum of varying degrees of openness. There are companies that collaborate only with one partner and thus are less open, and there are companies that cooperate with many different partners profoundly and thus are very open. Moreover, intellectual property and business model are seen as necessary to enable and profit from the collaboration (Chesbrough 2012). Another unique characteristic of the OI model is the distinction between *inbound*, *outbound*, and *coupled* directions (Gassman and Enkel 2004, p. 6):

- (1) Inbound: Enriching the company’s own knowledge base through the integration of suppliers, customers, and external knowledge sourcing.
- (2) Outbound: Earning profits by bringing ideas to market, selling IP, and multiplying technology by transferring ideas to the outside environment.
- (3) Coupled: Coupling the inbound and outbound processes by working in alliances with complementary partners in which give and take is crucial for success.

In the context of outbound direction, “false negative” projects play a particular role, because results of projects that a firm cannot or does not want to commercialize itself, can be out-licenced or sold to other companies. In so doing, firm has the potential to expand its business model and find new ways to profit from internally developed inventions (Chesbrough 2012; Euchner 2010). At last, unit of analysis in the OI model is either a company or a project (Chesbrough 2006).

Chesbrough emphasizes that there is a considerable schism in the understanding of what being “open” means, which can be partly attributed to the fact that scholars from the user innovation field often do not cite works of OI scholars (Chesbrough 2012). Whereas the OI concept stretches the concept of the traditional “closed” innovation model in many important ways, the user innovation model is more radical and redefines the organization itself (Euchner 2010).

2.1.4 Different Angles of Open Innovation

As mentioned in Chapter 2.1.1, OI research field is broad and has its roots in many different literatures. Due to this fact, studies have so far examined OI phenomenon from various angles. Figure 2-5 summarizes the core aspects of OI. For a start, OI can be segmented in internal and external OI. Internal OI refers to applying the principles of OI (e.g., search for new ideas across different divisions) inside the firm boundaries. In contrast, external OI incorporates search for new ideas and commercialization of them across firm boundaries. Moreover, especially in the context of outbound OI, there is a distinction between market and nonmarket exploitation of innovations. Nonmarket exploitation refers to free revealing of ideas and is at the core of the user innovation model. OI relationships to partners can also be classified in business-to-business (B2B) or business-to-customer (B2C) relationships.

Furthermore, OI practice can be applied to both product and service development. Extant research examines inbound OI practices, such as in-licencing and cooperation with research institutes, outbound OI practices, such as spin-offs and out-licencing, and coupled OI activities, such as joint ventures and co-development. Finally, Dahlander and Gann (2010) distinguish four types of openness. Firms can acquire external ideas or source them without any financial investment. Accordingly, they can sell the results of the collaboration or reveal them freely.

Figure 2-5: Different Angles of Open Innovation

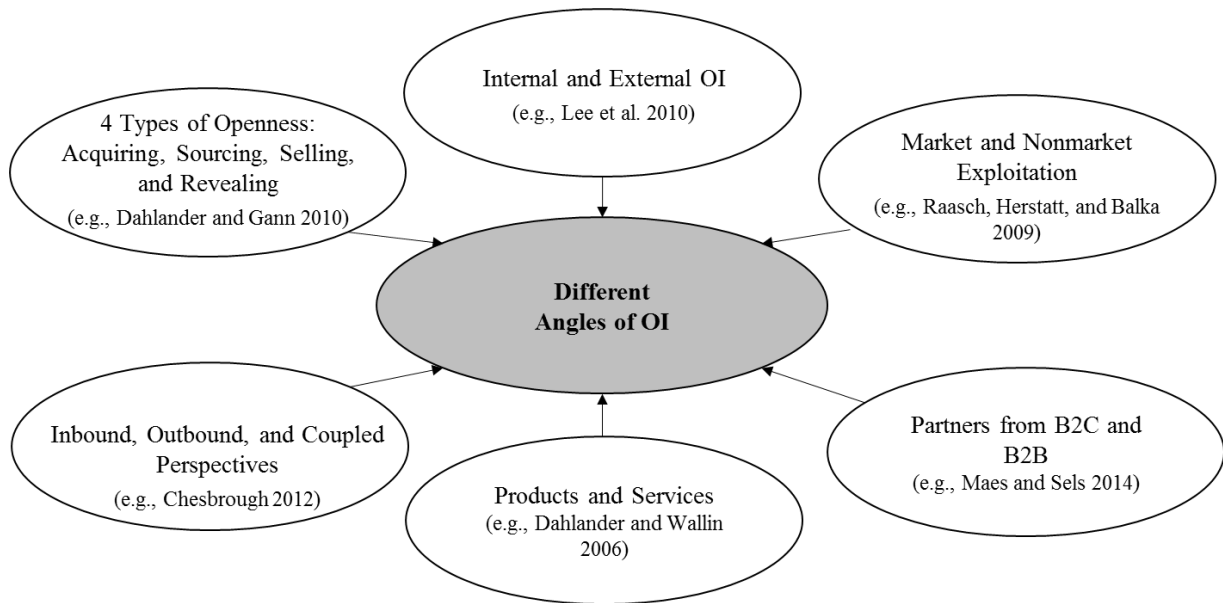

2.1.5 Application of OI-related Conceptual Foundations in this Thesis

This section explains how the OI-related conceptual foundations are applied in this thesis regarding to the definition of OI, distinction between the user innovation model and the OI model, and the different angles of OI. First, regarding the definition of OI, this thesis understands OI in the sense of Chesbrough’s (2003, 2006) original definitions and defines OI as the “use of inbound and outbound knowledge flows to accelerate internal innovation and expand markets to externally use innovation, respectively” (Chesbrough et al. 2006, p. 1). In addition, this thesis perceives OI as a concept that resides at the level of the organization—a paradigm rather than a process (Bogers et al. 2016).

Moreover, this thesis perceives OI, collaboration, and OI collaboration as synonyms, which refer to “joint development of knowledge through relationships with external partners, such as competitors, suppliers, and customers or universities, and research institutes” (Drechsler and Natter 2008, p. 439). Within a collaboration partners share their resources and knowledge and follow a common mission, such as joint development of new products and services (Drechsler and Natter 2008).

Regarding the distinction between the user innovation model and the OI model, in the course of this thesis the concept of OI in the sense of Chesbrough is applied. Hence, this thesis takes only the financial mechanisms and not the free revealing mechanisms of innovations into

account. The three core studies of this thesis investigate firms' collaboration with a wide variety of partners for the sake of fostering internal innovation and as means of finding new possibilities to enhance business model, and consequently foster firm performance. The collaboration examined in this study takes all three core directions of OI (see 2.1.3) into account and sees intellectual property as necessary to enable collaboration. The concept of user innovation is not in the focus of this thesis and thus works of the scholars representing this concept are not considered in the review of current OI research in Chapter 2.2.

Regarding the different angles of OI, this thesis applies the external angle and investigates the search for new ideas and commercialization of them across the firms' boundaries rather than the search for new ideas inside the firms' boundaries. Furthermore, the conceptualization of OI concentrates on market exploitation of OI results which is the core idea of OI in the sense of Henry Chesbrough rather than the concept of free revealing of innovations within the user innovation model in the sense of Eric von Hippel. Regarding the different types of OI partners, this thesis considers firms' relationships to such B2B partners as competitors, suppliers, and research institutes as well as customers, which can belong to either B2B or B2C categories. Furthermore, OI practice can be applied to both product and service development and both angles are taken into account in this thesis. To provide a comprehensive perspective of OI, all three inbound, outbound, and coupled perspectives are applied in this thesis. Namely, this thesis examines such inbound OI activities as cooperation with suppliers, such outbound activities as out-licencing, and such coupled activities as participation in a cluster. At last, this thesis investigates how firms can acquire, source, and sell the results of their OI efforts. However, free revealing mechanisms are not considered in this thesis, since they are a part of the user innovation model.

2.2 Current State of Research

After the broader concept of OI has been explained and narrowed down in Chapter 2.1, the following sections offer an overview of extant OI research. The first section deals with different types of collaboration activities and classifies these according to their interaction intensity in the following section. Section 2.2.3 offers an overview of previous work related to the firm-innovation performance relationship. The last section (2.2.4) provides deeper insights into the "dark side" of OI and summarizes the results of extant research examining partner's opportunistic behaviour.

Relevant articles for the review of the current state of research are selected through various databases of academic journals, such as Business Source Premier, Science Direct, and Elsevier,

as well as are accessed on the websites of academic journals from the OI research field. The review includes mainly journals ranked on the A+, A, or B levels according to the VHB-ranking (VHB 2018). Articles from the C-level journals are included in the review if they are of a particular importance to the OI research field. The literature review includes only quantitative empirical studies. The presentation of the empirical findings of extant research is accompanied with tables in the Appendix containing detailed information about the previous OI studies, their theoretical and empirical settings, as well as the key results (Tables A-1 and A-2 in the Appendix).

2.2.1 Types of Open Innovation Activities

When firms search for external knowledge and look for new ways to market their internal knowledge they can perform a wide variety of collaborative activities—also called OI activities (Chesbrough and Brunswicker 2013). Some of the activities are specific to a certain collaboration partner, such as cooperation with research institutes or start-up competitions. Other activities are not tailored to be performed with one specific type of partner. For instance, firms can engage in co-development with B2C customers, B2B customers, suppliers, or other firms.

Chesbrough and Brunswicker (2013) suggest a classification of OI activities according to two dimensions: the direction of the knowledge flows (inbound vs. outbound) and the direction of the financial flows during an OI activity (pecuniary vs. non-pecuniary). Figure 2-6 offers an overview of the classification of OI activities that are mostly performed by the companies. In the category of inbound pecuniary activities firms engage, for example, in in-licencing, cooperate with research institutes, suppliers, and start-up companies to enrich their internal resource and knowledge base with external resources and knowledge. These activities are characterized by financial flows between partners. Spin-offs and out-licencing are typical examples of pecuniary activities where firms earn profits by bringing ideas to market and hence, fall into the category of pecuniary outbound activities. There are many OI activities that usually do not involve any financial flows such as crowdsourcing or participation in networking events in the field of inbound activities and participation in standardization in the field of outbound activities (Chesbrough and Brunswicker 2013).

Figure 2-6: Open Innovation Activities (Chesbrough and Brunswicker 2013)

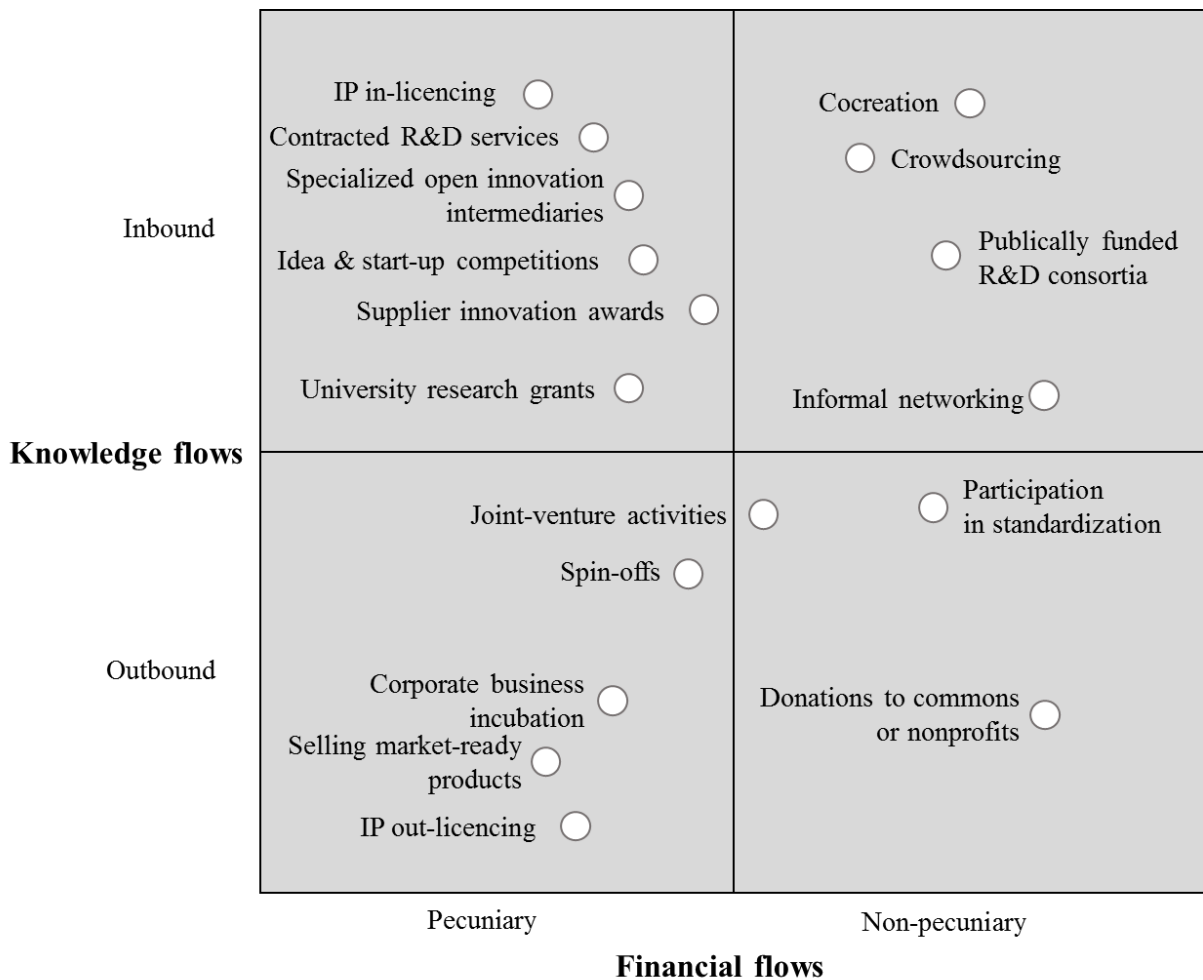

The broad spectrum of OI activities defines firms' openness. Over the past years, extant OI research has developed two concepts to capture the degree of firms' openness: external search *breadth* and *depth*. A company that engages in a broad external search performs many different OI activities (Laursen and Salter 2006). Different OI partners and activities might bring firms various benefits. For example, by collaborating with competitors in the form of a strategic alliance a firm may gain greater access to different national and international markets. Collaboration with customers in the form of crowdsourcing can bring the benefit of greater commercial success of new products, whereas collaboration with suppliers may increase quality of new products and lower production costs. Cooperation with research institutes can offer firms complementary knowledge that firms lack internally (Fu 2012). Thus, to acquire different types of resources firms might search broadly and perform many OI activities. Firms can also search deeply and perform one or few OI activities very intensively. For example, a company might

have a very close and long-lasting relationship with a research institute to develop a new technology (Laursen and Salter 2006; Fu 2012).

Extant research has found that firms who are very open, i.e., search widely and deeply, can foster their innovation performance to a certain point after which the firm experiences diminishing returns on performance. Hence, there seems to be an optimal degree of performing OI activities widely and deeply (Berchicci 2013; Laursen and Salter 2006).

2.2.2 Interaction Intensity of Open Innovation Activities

To distinguish between inbound, outbound, and coupled OI activities is a common practice in extant research (Gassmann and Enkel 2004). However, it is not the only way to classify OI activities. Multiple authors postulate that interaction intensity between collaboration partners might be an even more important characteristic of OI activities than the direction of knowledge flows (Capaldo 2007). As early as the seminal works of scholars who studied relationships between individuals or companies (Burt 1992; Granovetter 1973), the strength of the relationships has been a central phenomenon in collaboration research (Levin and Cross 2004; Schleimer 2016). Extant research agrees that relationship strength consists of three dimensions: duration, frequency, and intensity (Capaldo 2007). Accordingly, a collaborative relationship is considered to be strong, when it is close, long-lasting, deep, and exhibits frequent interactions and good information flow between collaboration partners (Capaldo 2007). On contrary, infrequent interactions, shorter duration, and less intensive resource exchanges between collaboration partners characterize weak relationships (Michelfelder and Kratzer 2013). Moreover, strong and weak relationships are the two poles of a continuum regarding relationship strength, such that there are also relationships that exhibit medium strength (Levin and Cross 2004).

Given these insights from previous research, OI activities that firms perform and thus establish relationships with their OI partners can be classified according to their interaction intensity (see Figure 2-7). Hence, weak, medium, and strong relationships correspond to weakly, medium, and highly interactive OI activities. For example, when firms cooperate in form of licencing, crowdsourcing, or perform informal networking, the relationship within these activities is of short duration, partners communicate infrequently, and the knowledge exchange is less intensive (Michelfelder and Kratzer 2013). Such activities as publically funded R&D consortia, spin-offs, and contracted R&D services are characterized by greater interaction intensity between partners—they communicate with each other more frequently, the relationship is deeper, and the knowledge flow is much better organized as in the case of weakly interactive

activities (Capaldo 2007; Granovetter 1973). The third category is highly interactive activities, such as joint ventures and cocreation/codevelopment that exhibit strong, long-lasting, relationships with very frequent interactions between the collaborating parties.

Figure 2-7: Open Innovation Activities and their Interaction Intensity

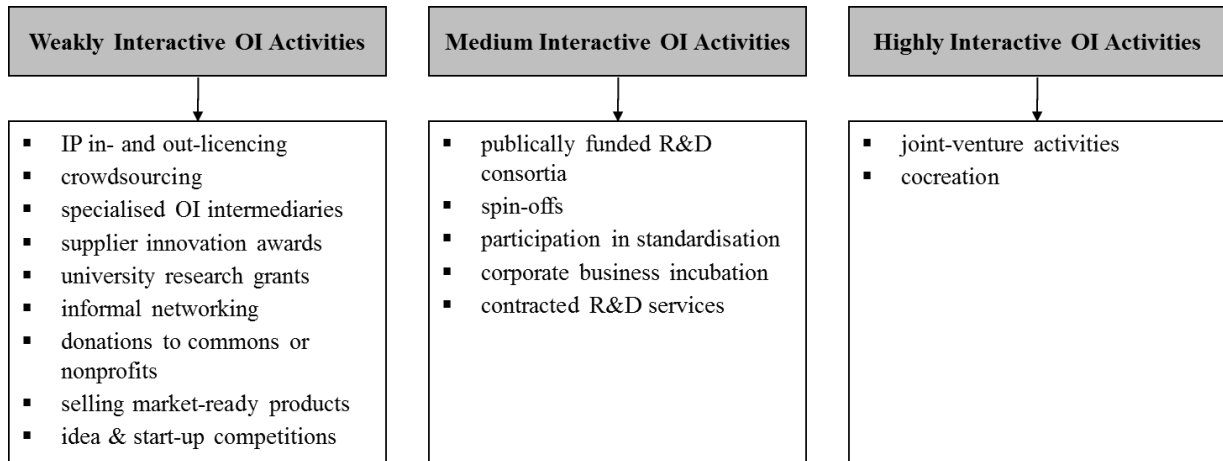

2.2.3 Open Innovation and Firm Innovation Performance

Firms strive to foster their innovation performance to be able to survive and prosper in changing business environments (Dittrich and Duysters 2007). In this context, OI can help firms to foster their innovation performance (Belderbosa, Careeb, and Lokshin 2004; Frankort 2016). Many studies within the broader OI research field have examined the link between different aspects of OI and innovation performance (e.g., Beers and Zand 2014; Jiang and Li 2009), however, the multitude of such studies does not imply that studying the OI-performance relationship has been straightforward. This can be attributed to the fact that OI, just as innovation performance, comes in many different forms (Cheng and Huizingh 2014). The following section provides an overview of studies examining the OI-performance relationship, which have most significantly shaped the OI research field. This overview applies a *content-related perspective* and discusses previous findings regarding the operationalization of innovation performance, conceptualization of OI phenomenon, the characteristics of the OI-performance relationship, and its most significant determinants. It also applies a *theoretical perspective* and discusses the main theoretical foundations that serve as a background for the studies examining the OI-performance relationship. Finally, it applies a *methodological perspective* and offers

information about empirical settings of these studies. A detailed analysis of all the studies discussed in this section is presented in Table A-1 in the Appendix.

From a content-related perspective, innovation performance itself is a broad concept encompassing different aspects, thus, its measurement also varies across studies in extant literature. Broadly, extant research can be classified in studies that make a distinction between the number of radical and incremental innovations (e.g., Beers and Zand 2014; Schleimer and Faems 2016), studies that explicitly capture the degree of innovativeness of firms' products and distinguish between products new to the world and new to the firm (e.g., Köhler et al. 2012; Laursen and Salter 2006), and studies that differentiate between the number of process and product innovations (e.g., Tsinopoulos, Sousa, and Yan 2017). Besides accounting for the number of various innovation types in the company, some studies also consider innovation efficiency (e.g., Fu 2012), creativity, (e.g., Salge et al. 2013), and financial success of innovations (e.g., Köhler et al. 2012).

The picture of the *conceptualization of the OI phenomenon* as independent variable(s) is even more complex. The distinction can be made between studies that examine single OI activities and those that encompass the entire portfolio of firms' OI activities. For example, Belderbosa, Careeb, and Lokshin (2004) and Un, Cuervo-Cazurra, and Asakawa (2010) differentiate between multiple OI activities (e.g., collaboration with customers, suppliers, and universities etc.) finding that most of them have positive effects on innovation performance. Other studies have grouped multiple OI activities in categories, for instance, in market-based and science-based OI activities (e.g., Köhler et al. 2012) or in intra-industry and inter-industry OI activities (e.g., Filiou and Massini 2017). Regarding studies that encompass the entire portfolio of firms' OI activities, extant research has investigated how performing of OI activities broadly and deeply affects firm performance (e.g., Katila and Ahuja 2002; Laursen and Salter 2006). Apart from using the terms "breadth" and "depth", studies refer to the diversity of the entire collaboration portfolio (e.g., Beers and Zand 2014; Faems et al. 2010).

Regarding the *characteristics of the OI-performance relationship*, another interesting observation can be made regarding the direct effects of OI on innovation performance. Studies that examine a single OI activity and how it influences firms' innovation performance mostly discover linear effects. For instance, Belderbosa, Careeb, and Lokshin (2004) show that competitor and supplier collaboration increase innovation performance, whereas customer and university cooperation have non-significant effects. However, Un, Cuervo-Cazurra, and Asakawa (2010) provide slightly contrary results and show that collaboration with universities

positively influences innovation performance, whereas collaboration with competitors significantly hinders it. To provide more clarification, Köhler, Sofka, and Grimpe (2012) investigated two facets of innovation performance and showed that whereas collaboration with market-based partners fosters firms' innovations, collaboration with science-based partners fosters market innovations.

Furthermore, studies that examine firms' entire portfolio of OI activities, discover non-linear effects on innovation performance. There exists a large body of research that discovers inverted U-shaped effects of firms' openness (Berchicci 2013; Filiou and Massini 2017; Katila and Ahuja 2002; Salge et al. 2013). These findings have greatly shaped the view of OI as being only beneficial to innovation performance, namely, they illustrate that OI can also have detrimental effects and that firms have to determine the right degree of their firms' openness. Searching too deeply and broadly hinders firms' innovativeness (Laursen and Slater 2006).

Discovering non-linear effects in extant research provides the first clues that the OI-performance relationship might not be straightforward. In this vein, researchers have attempted to find *determinants that influence the OI-performance relationship*. These determinants can be classified in three categories: firm, relationship, and industry characteristics. Regarding firm characteristics, studies show that internal R&D capacity (e.g., Berchicci 2013; Laursen and Slater 2006), firm size and age (e.g., Chai and Shih 2016), and strategic orientation (e.g., Cheng and Huizingh 2014) moderate the OI-performance relationship. There is a substitution effect between internal R&D capacity and firms' external collaboration efforts. Regarding the relationship characteristics, studies find that partner technological alignment and product-market competition between partners (e.g., Frankort 2016), trust (e.g., Pemartin et al. 2017), and collaboration purpose (exploration vs. exploitation; Salge et al. 2013) determine how successful firms will be in their OI activities. Finally, scholars argue that such industry characteristics as technological turbulence and market-related dynamism also influence the effectiveness of firms' OI efforts (e.g., Wu 2012). Figure 2-8 summarizes the constructs and relationships examined in extant research regarding the OI-performance relationship.

Figure 2-8: Overview of Extant Research on the OI-Performance Relationship

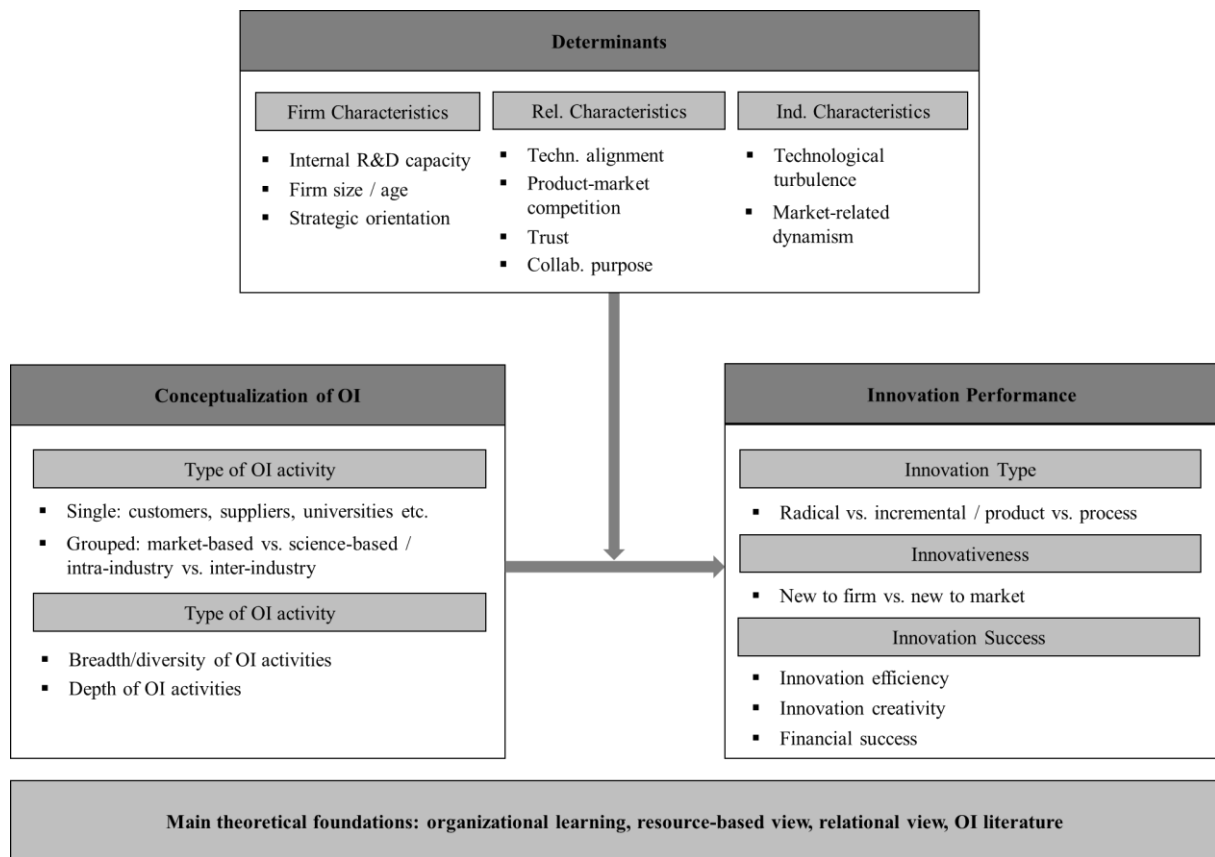

In the pursuit to provide new insights on OI from different standpoints, previous studies draw on various *theoretical backgrounds*. Previous research has applied the literature on organizational learning to a substantial extent for developing theoretical mechanisms and explaining the relationships between OI-performance and the relevant determinants (e.g., Jiang and Li 2009; Katila and Ahuja 2002; Xu et al. 2013). Additionally, studies draw upon resource-based and/or relational view (e.g., Pemartin et al. 2017; Schleimer and Faems 2016). A great amount of studies do not employ a specific theory, but rather develop their theoretical reasoning based on OI literature and the OI model introduced by Henry Chesbrough (e.g., Berchicci 2013; Cheng and Huizingh 2014; Salge et al. 2013).

Regarding the empirical settings of these studies from a *methodological perspective*, most of the researchers use large-scale, cross-industry quantitative data (e.g., Chai and Shih 2016; Jiang and Li 2009). Many studies are based on community innovation surveys in various countries: Netherlands (e.g., Beers and Zand 2014), U.K. (e.g., Laursen and Salter 2006), and all EU member states (e.g., Köhler et al. 2012). Some research has also been done outside Europe. For

example, in Taiwan (e.g., Cheng and Huizingh 2014), Japan (e.g., Katila and Ahuja 2002), China (e.g., Wu 2012), and in other continents: USA (e.g., Frankort 2016) and Australia (e.g., Schleimer and Faems 2016). Regarding empirical methods, there has been approximately an equal number of longitudinal studies (e.g., Beers and Zand 2014; Lokshin, Hagedoor, and Letterie 2011) that employ panel analysis to examine their data, and the number of cross-sectional studies (e.g., Jiang and Li 2009; Laursen and Salter 2006) that most often employ regression analysis or structural equation modelling.

To conclude, over the past two decades OI research has experienced a significant development. The scholars from diverse research streams have discovered the complexity of the OI concept and attempted to tailor their research at different angles to gain as holistic insights on OI as possible. Although much research has been done towards the conceptualization of OI as well as towards the finding of additional determinants that enhance the effectiveness of firms' OI efforts, research on OI is still developing. As new cooperation forms and partners constantly emerge and as increased number of organizations open their boundaries and collaborate, the research field of OI will only increase in complexity. So far, OI research has mostly focused on the benefits of OI and how companies can advance these benefits. It has severely lacked research on the downsides and risks of OI offering only couple of investigations in this direction. This research gap is profoundly addressed in the following section.

2.2.4 Risk of Partner's Opportunistic Behaviour in Open Innovation

To survive and prosper in increasingly turbulent environments, OI offers extensive opportunities to acquire resources that firms lack internally. However, OI collaboration also poses several substantial challenges regarding an unwanted appropriation of valuable knowledge by OI partners (Oxley and Sampson 2004). The assumption is that given a chance, partners would try to maximize their own interests and thus, behave opportunistically at the cost of another partner. Partners might seek their self-interest by secretly capturing the resources of the partner, distorting information, and stealing the partner's skills, clients, and personnel (Das and Teng 1996). As a result, partner's opportunistic behaviour which stems from imperfect information about partner's intentions and actions (Sutcliffe and Zaheer 1998; Yang, Lin, and Lin 2010) is a serious risk that firms face when conducting OI (Afuah 2013). Therefore, managers have to devote significant amounts of time, money, and other resources to establish formal and informal practices to reduce the risk of partner's opportunistic behaviour (Perrons 2009).

This section discusses previous findings regarding partner's opportunistic behaviour in OI and is structured in *content-related, theoretical, and methodological perspectives*. The content-related perspective first offers general remarks on extant research examining opportunistic behaviour in OI. In the following it addresses three questions that scholars have attempted to provide answers to when examining partner's opportunistic behaviour:

- (1) What firms fear in light of potential opportunistic behaviour by partners?
- (2) How does firms' perception of opportunistic behaviour influence certain outcomes?
- (3) How can firms counter risk of partner's opportunistic behaviour by introducing effective measures?

A detailed overview of the empirical findings regarding these three questions is provided in Table A-2 in the Appendix and the main findings are summarised in the following. Thereby, it is important to mention that only a very limited number of studies explicitly capture opportunism as a variable in their research. Most of the findings are implications resulting from investigations of opportunism-related factors and contexts.

Several *general remarks on extant research examining opportunistic behaviour in OI* can be drawn from a *content-related perspective*. Almost all of the published papers that explicitly use the term "open innovation" after it was introduced by Henry Chesbrough concentrate on the potential benefits of openness (Dahlander and Gann 2010; Faems et al. 2010). Only few studies mention negative factors of OI (Berchicci 2013), for instance, by suggesting that there is an optimal level of openness and thus there are factors that diminish OI performance at a certain level (e.g., Berchicci 2013; Leiponen and Helfat 2010; Salge et al. 2013). But most of the prior OI research has fairly neglected risks related to the opening of organizational boundaries in general and has particularly failed to sufficiently address risk of partner's opportunistic behaviour. Literature addressing potential remedies to counter risk of opportunistic behaviour has been even scarcer (Faems et al. 2010).

To gain more insights into the management of opportunistic behaviour in OI, attention must be drawn to other research streams that have existed before the OI research stream which emerged with the introduction of the term "open innovation". For example, opportunistic behaviour of collaboration partners has been widely addressed in the literature adopting the transaction cost perspective (e.g., Chiles and McMackin 1996). Also alliance management (e.g., Narula and Santangelo 2009), collaboration management (e.g., Afuah 2013), and relationship marketing (e.g., Ganesan et al. 2010) research streams provide extensive insights into the management of

opportunism. Opportunistic behaviour can be defined as the “transgression of the norms of a specific business relationship through behaviours such as evading obligations, taking advantage of contractual loopholes, and exacting unfair concessions when market conditions allow” (Ganesan et al. 2010, p. 362). Collaboration always involves at least some degree of behavioural uncertainty due to the fact the firms possess imperfect information about the capabilities and intentions of their partners (Yang et al. 2010).

Regarding the question of *what firms fear in light of potential opportunistic behaviour by partners*, extant research shows that leakage of critical knowledge about firms’ innovation efforts is what firms fear most in OI collaboration (Laursen and Salter 2014). In the case of lacking management attention, opportunistic behaviour can lead to serious loss of knowledge and markets (Gnyawali and Park 2011). Thus, firms fear that a partner might become a competitor in the case of one-sided unplanned knowledge flows (Helm and Kloyer 2004). This fear is particularly extensive if a firm has multiple collaboration partners (Li et al. 2011). Moreover, firms fear the loss of competitive advantage as a result of unwanted imitation (Henkel and Schöberl 2014). Whereas such an outcome would be perceived as a severe form of opportunism and betrayal of the relational contract (Ganesan et al. 2010), there are also milder forms of opportunism that result in general fear of lack of security, reliability, and increased collaboration cost (Henkel and Schöberl 2014).

Of course, *if managers perceive that their collaboration partners might behave opportunistically, it will influence their own behaviour*. First, extant research implies that perception of opportunistic behaviour can limit resource exchange between collaboration partners and hinder the integration of partner’s knowledge (Jean, Sinkovics, and Hiebaum 2014). Second, when firms fear partner’s opportunism, external cooperations might seem less attractive (Mata and Woerter 2013) such that firms might decide to limit the scope of their OI activities and become less open (Oxley and Sampson, 2004). It will more likely happen if firms engage in R&D cooperations where the technology is characterised by a large amount of uncertainty (Cassiman and Veugelers 2002). In that case, firms will reduce their collaborative relationships to those that require limited amount of knowledge sharing (Oxley and Sampson 2004).

To avoid any negative collaboration outcomes as a result of partner’s opportunistic behaviour, firms strive to implement countermeasures. Extant research suggests several of them. All countermeasures can be classified in two categories: formal and informal. The most important formal countermeasure is effective IP protection. If a company does not have proper

mechanisms, processes, and structures to protect its IP, it will possibly be less open (Drechsler and Natter 2012; Mina, Bascavusoglu-Moreau, and Huges 2014). Moreover, Helm and Kloyer (2004) suggest to include an option for the post contractual negotiations and continuous return sharing in collaboration contracts as formal countermeasures. In similar vein, Oxley and Sampson (2004) suggest to establish equity joint ventures as a protective governance structure, but argue at the same time that such a formal measure might not be enough to protect firm from partner's opportunistic behaviour.

Several other scholars, however, have a contrary opinion and imply that increased formalization (such as IP protection) leads to opportunism and that managers should avoid over-formalizing collaboration (Walter, Walter, and Müller 2014). Instead they place value on informal protection mechanisms. They suggest to introduce trust-based governance which is tailored at increasing firm's capability to assess partner's trustworthiness and detect opportunism as soon as possible (e.g., Carson et al. 2003; Jean et al. 2014; Perrons 2009). Furthermore, Wu (2012) implies that firms should focus on long-term goals to avoid opportunism and Walter, Walter, and Müller (2014) emphasize the role of good communication flow to counter opportunism. Some scholars suggest that by choosing collaboration partners with whom the firm is technologically and relationally aligned (Emden, Calantone, and Drodge 2006; Narula and Santangelo 2009) or by being centrally located in a collaboration network (Yang et al. 2010) firm can decrease the potential for partner's opportunistic behaviour even prior to engaging in collaborative activity.

Reviewing extant research from a *theoretical perspective* offers clues as to why a substantial focus is put on the beneficial-side of OI. Namely, a substantial part of the OI research body applies the resource-based perspective and therefore focuses only on the beneficial aspects of OI (Yang et al. 2010). Scholars who address opportunistic behaviour in exchange relationships acknowledge this fact and increasingly also apply other theoretical foundations. For example, relationship or exchange-based theories, such as relational view (e.g., Kale, Singh, and Perlmutter 2000) and social exchange theory (e.g., Li et al., 2011). Furthermore, some studies also apply transaction cost theory to explain how partner's opportunistic behaviour influences collaboration outcomes (Helm and Kloyer 2004; Oxley and Sampson 2004). The examination of extant research also shows that many studies do not apply a specific theory but rather develop their argumentation based on the wider OI literature in general (e.g., Drechsler and Natter 2012; Laursen and Salter 2014). Although there have been first attempts to draw on various theoretical backgrounds to explain the outcomes of opportunistic behaviour and the relevant determinants,

research still lacks a coherent theoretical body to fully grasp the complexities of the research matter.

From a methodological perspective, most researchers use large-scale, cross-industry quantitative data (e.g., Carson et al. 2003; Mata and Woerter 2013). But there are also cases in which scholars use data from one industry, such as computer industry (e.g., Henkel, Schöberl, and Alexy 2014), automobile industry (e.g., Jean, Sinkovics, and Hiebaum 2014), and IT industry (e.g., Narula and Santangelo 2009). Many studies are based on community innovation surveys in various countries: Belgium (e.g., Cassiman and Veugelers 2002), Germany (e.g., Drechsler and Natter 2012), U.K. (e.g., Laursen and Salter 2014), and Switzerland (e.g., Mata and Woerter 2013). Regarding empirical methods, most of the studies are cross-sectional studies (e.g., Carson et al. 2003; Henkel, Schöberl, and Alexy 2014) that often employ regression analysis (e.g., Laursen and Salter 2014; Spithoven, Canhaverbeke, and Roijakkers 2013). There have been a few longitudinal studies (e.g., Mata and Woerter 2013; Narula and Santangelo 2009) that employ logit models to analyse their data (e.g., Narula and Santangelo 2009).

Overall, it is difficult to derive universal suggestions for managers regarding how to manage the risk of partner's opportunistic behaviour in OI, because it requires reviewing extant literature from various research streams. Another challenge emerges from the fact, that countermeasures suggested in alliance literature can hardly be applied to different OI activities, because alliance research mostly includes only firm-firm collaboration. Hence, many formal protection mechanisms might not be applicable to "newer" OI activities such as crowdsourcing and cocreation. Therefore, research should increasingly consider different types of OI activities to develop conclusive implications for managerial practice.

2.3 Summary

OI is a very broad and complex concept which encompasses a wide variety of research streams that investigate multiple collaboration forms, partners, and outcomes. Therefore, every OI researcher faces the challenge of narrowing down the OI concept to his/her main questions of interest. Especially, many other research fields must be considered to gain holistic insights of any particular area of OI at focus—a single OI activity, a specific type of collaboration partner, a nexus of multiple OI relationships, or specific determinants on the OI-performance relationship. Thus, considering research only since 2003 when the term "open innovation" was first introduced and taking into account only those findings where authors explicitly link their research to the broader OI concept, might not be sufficient.

Specifically, scholars face the challenge of how to grasp and operationalize firms' openness, since there is a multitude of OI activities that firms perform. Introducing breadth and depth dimensions to the OI research has been the first major attempt to capture the degree of firms' openness. However, further conceptualizations are necessary. Another challenge lies in grasping the differences in the nature of OI activities, because they offer a substantial variation (e.g., joint venture vs. spin-off vs. crowdsourcing). Distinguishing OI activities according to the direction of knowledge flows or whether they encompass financial flows, as well as the interaction intensity they involve, have so far been established and useful practices.

The complexity of the OI concept, of course, does not only pose challenges for researchers, but also offers a very dynamic and challenging research field for further investigations. For instance, research investigating the OI-performance relationship has by far not exhausted itself. There are many determinants (positive as well as negative) on this relationship yet to be discovered—on firm, single relationship, or relationship nexus level. The same applies for investigations regarding potential risks in OI. Whereas scholars identify partner's opportunistic behaviour as a serious matter for firms conducting OI, they have lacked to explicitly capture opportunistic behaviour in their empirical settings. This shortcoming also attests for the limited number of suggestions regarding how to counter opportunistic behaviour in OI. In the pursuit of finding determinants that increase the effectiveness of firms' OI efforts, scholars often draw on the literature addressing inter-organizational networks. The following chapter discusses how network characteristics might serve as important influencers in the OI context.

3 Inter-organizational Networks: Conceptual Foundations and Empirical Findings

OI research probably would have never developed the way it has without researchers drawing on previous and current works of network scholars. Meanwhile, the OI and network research streams are intertwined to a degree that one can hardly be separated from the other. However, both of them have their special focus of attention and thus provide complementary insights for understanding inter-organizational collaboration. Whereas OI research focuses more on how to grasp and conceptualize openness and what are its performance implications, research on inter-organizational networks strives to answer the question of what determines the effectiveness of firms' openness. This chapter provides conceptual foundations of networks and network characteristics (3.1) and further discusses the current state of research regarding different network characteristics and their performance outcomes (3.2). The last section of this chapter (3.3) summarizes the key points regarding the conceptual foundations and the main results of extant research.

3.1 Conceptual Foundations

3.1.1 Networks in the Context of Open Innovation

Starting from the original works of network scholars, network research has long recognized that actors (individuals and organizations) need to build networks to access complementary resources (Burt 1992; Granovetter 1973). Thus, networks are defined as channels for the exchange of resources (Owen-Smith and Powell 2004) and they play a significant role in organizations' survival and success (Demirkan, Deeds, and Demirkan 2013). Networks include all "external sources or search channels that firms rely upon in their innovative activities" (Laursen and Salter 2006, p. 134). When firms collaborate with partners they establish collaborative linkages, i.e., network relationships, that are "voluntary arrangements between independent organizations for the purpose of sharing resources" (Ahuja 2000, p. 426). These theoretical arguments imply that network relationships and OI relationships (also see Chapter

2.1) incorporate the same aspects—building relationships with external partners to access internally lacking resources, and thus can be used as synonyms.

It is further important to specify the role of networks in the context of OI. Networks are generally seen as “vehicles” or “pipes” necessary to transfer resources between actors (Demirkan et al. 2013; Owen-Smith and Powell 2004). Thus, firms build networks to enable and support firms’ OI efforts. As enablers, networks create opportunities for OI such that by establishing a network tie to a partner, firm has the opportunity to acquire needed resources within its broader OI strategy (Laursen and Salter 2006). Mostly firms collaborate with different partners and perform several OI activities, hence, they have constructed a network of other organizations around themselves with whom they exchange resources. In this context, research often speaks about the so-called OI networks (Dittrich and Duysters 2007; Gianiodis, Ellis, and Secchi 2010).

3.1.2 Network Characteristics

Having networks that firms can rely on in search for external knowledge and other resources is *per se* not beneficial for firm performance. Firms’ ability to profit from OI networks depends to a large extent on different network characteristics that raise or lower the effectiveness of firms’ OI activities for firm performance (Li et al. 2013). In the pursuit of explaining how firms can benefit from networks, network theorists have applied two main, equally important conceptions: structural and relational (Rodan and Galunic 2004). Whereas the structural conception focuses on structural network characteristics, such as the centrality of an actor’s position in a network (Burt 1992; Dong et al. 2017; Gulati 1998), the relational conception considers relational network characteristics in terms of the qualitative nature of network relationships (Uzzi, 1996). Both types of network characteristics are explained in detail in the following sections.

3.1.2.1 Structural Network Characteristics

To understand and analyse networks, scholars have developed a wide variety of different network characteristics that relate to an actor’s structural position in a network (Burt 1992; Granovetter 1973). Such attributes of network structure as direct and indirect ties (Ahuja 2000), actor’s centrality (Dong et al. 2017), the extent of network closure (Coleman 1988), and the presence of “structural holes” between contacts (Burt 1992) are well suited characteristics to analyse actor’s network position (Rodan and Galunic 2004). The central tenet in the network research is that actors should strive to achieve a beneficial network position regarding their

direct and indirect ties, their embeddedness in a network, and their ability to bridge structural holes to achieve higher firm performance (Ahuja 2000; Capaldo 2007).

In extant network research a debate has arisen over the question what counts as a beneficial network structure (Ahuja 2000). According to one view, an actor profits from its network relationships the most, when it is embedded in a dense network, where every partner is connected to every other network partner by direct ties (Coleman 1988). For instance, in Figure 3-1, actor *A* has three direct ties, to partners *B*, *C*, and *D*. These direct ties can be either strong or weak, however, when actor's partners are also connected with each other, as *B*, *C*, and *D* are, it is more likely that the linkages between them will be characterised by strong ties (Granovetter 1973). Moreover, *A* also has seven indirect ties (*F* through *M*). These partners *A* can reach through its partners or their partners. Regarding the connectivity, *A*'s partners *B*, *C*, and *D* are all connected to each other by direct ties, creating a dense network structure (Ahuja 2000). In such a dense network partners are likely to possess redundant knowledge and resources, thus *A* would have the possibility to strengthen its basic knowledge (Granovetter 1973; Capaldo 2007).

Figure 3-1: Illustration of Direct Ties, Indirect Ties, and Structural Holes (Ahuja 2000)

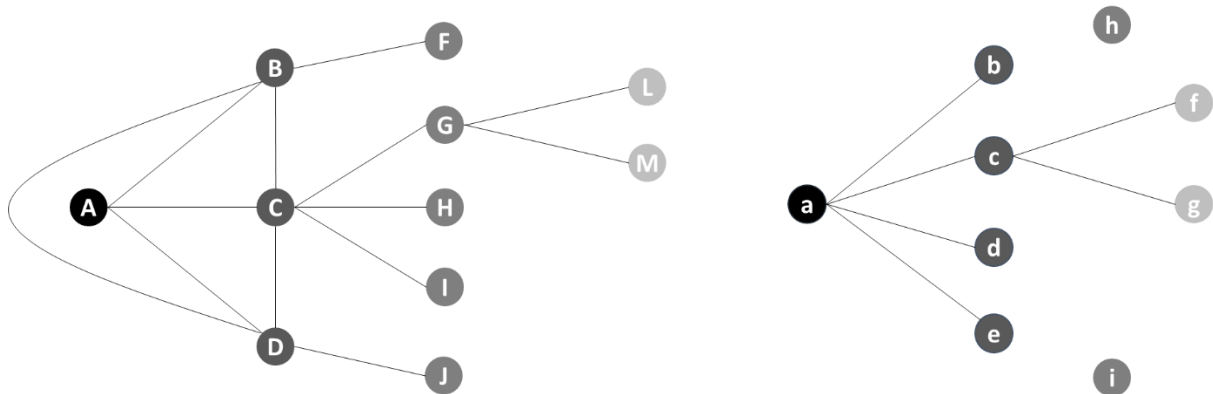

The other view posits, that an actor profits most from a loose network, where it is connected to partners that are otherwise not connected to each other. Hence, it maintains ties to multiple disconnected clusters of partners (Burt 1992). In Figure 3-1, actor *a* has more direct ties than actor *A* (partners *b*, *c*, *d*, and *e*), but only two indirect ties (*f* and *g*). Moreover, the partners of *a* are not connected to each other, creating a loose network with multiple structural holes. For instance, there is a gap between partner *b* and *c*, or between *c* and *d*. In such a loose network, it is likely that *a* has weaker ties to otherwise disconnected partners. Hence, it spans structural

holes (e.g., to reach *c*, *b* has to contact *a*) and is connected to different partners who represent different knowledge clusters. Thus, *a* has the possibility to profit from diverse and distant knowledge, that is new to *a* (Capaldo 2007; Granovetter 1972). Both views of dense and loose network structures provide good arguments in explaining how actors benefit from their networks (for a detailed review of extant research examining which aspects of network structure impact firm innovation and financial performance see Chapter 3.2).

Extant network research has recognised that considering the entire nexus of actor's direct and indirect ties simultaneously is a valuable strategy to determine how well an actor is positioned in its network. In order to do so, network scholars consider actor's network centrality, arguing that actors who are more central in their networks, profit from several benefits (Kratzer et al. 2016; Leenders and Dolfma 2016). Central actors can reach more partners and thus enter new relationships more easily (Gulati 1999), allowing them to identify complementary resources they need to foster their performance (Dong and Yang 2015; Wang and Chen 2016; Yang et al. 2010). In addition, centrally located actors have extensive relationships with many collaboration partners (Freeman 1979; Gulati 1999; Li et al. 2013) and so are likely to be exposed to a larger diversity of available resources, have easier access to them, and acquire higher-quality resources (Lin, Yang, and Arya 2009; Wang and Chen 2016).

In order to identify centrally located actors in a network, network scholars have developed several indices (Li et al. 2013). Three of these indices that describe an actor's centrality have received the highest acceptance in network research due to their validity and easiness of computation (Iacobucci and Hoeffler 2016, p. 219):

- (1) *degree centrality*, which captures the volumes and strengths of incoming and outgoing ties to each actor;
- (2) *betweenness centrality*, which captures the extent to which an actor functions as a gatekeeper between groups within the network;
- (3) *closeness centrality*, which captures the extent to which an actor can reach most of the other actors in the network in few degrees of separation.

Each of these centrality indices captures a slightly different aspect of an actor's position in the network (Iacobucci and Hoeffler 2016). Degree centrality refers to the number of direct ties that an actor has. For instance, in Figure 3-2, A has degree centrality of eight, because it has eight direct partners. Degree centrality has often been applied to measure actor's network size

(Kratzer et al. 2016). In order to account for the fact that some ties might be more valuable to an actor than others, network scholars apply weighted degree centrality, whereby a specific weight is added to each tie (e.g., Drechsler and Natter 2012). Betweenness centrality measures to what extent an actor serves as a gatekeeper for network partners' exchanges of resources (Carnovale and Yeniyurt 2015). It is evident that *A* is also located on many shortest paths within its network. For example, in order to reach *M*, *I* has to go through *A*, just as *F* has to go through *A* to reach *J*. Being in a gatekeeper position, *A* can access partners, who are otherwise not connected with each other. Such partners offer benefits of novel and distant knowledge and by controlling the communication flow, *A* gains accurate, timely information about activities throughout the network and can identify partners with complementary resources more easily (Dyer and Singh 1998; Freeman 1979). Finally, *A* is also the closest to all other network members, i.e., it has the lowest sum of shortest distances to all other network members. Thus, *A* can easily receive knowledge originating from the different subgroups in the entire network through its indirect ties (Aalbers, Dolfsma, and Koppius 2013).

Figure 3-2: Actor's Network Centrality

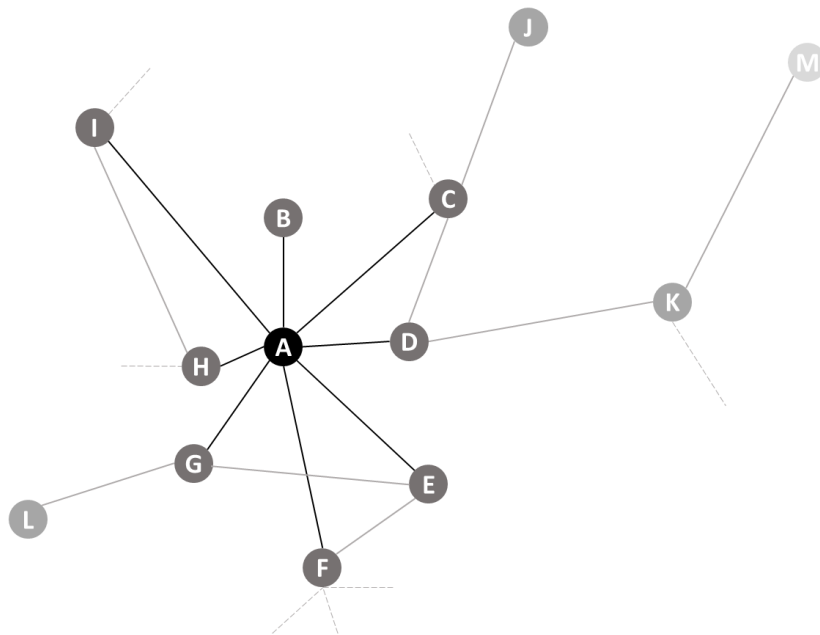

Structural network characteristics play a large role in analysing OI networks. Firms participating in OI are actors in collaboration networks and the relationships they establish with their partners by performing different OI activities are network ties. These ties can be either direct or indirect. By applying measures from network research, firms as well as scholars can

illustrate and further analyse firms' entire collaboration network, to determine firms' centrality in particular. A simple count of firms direct partners represents degree centrality. Betweenness and closeness centrality measures are more complicated and consider firms' entire network by taking direct and also indirect relationships into account. Although analysing network structure provides deep insights into collaboration networks, the structural conception must be augmented with the relational conception to fully understand how firms create network-based value (Rodan and Galunic 2004).

3.1.2.2 Relational Network Characteristics

In contrast to the structural conception, the relational conception analyses how the characteristics of network relationships determine whether firms will profit from their collaborative networks (Lin et al. 2009). In this context, the strength of network ties (e.g., Granovetter 1973), certain aspects of knowledge transferred between partners (Rodan and Galunic 2004), alignment between collaboration partners (Emden et al. 2006), and the presence of IP protective measures within a collaborative relationship have attracted particular attention in network research.

Tie strength describes a concept ranging from *strong ties* to *weak ties* (Granovetter 1973; Levin and Cross 2004). Whereas strong ties are characterised by close, long-lasting, deep relationships with frequent interactions and good information flow between network partners (Capaldo 2007), weak ties entail infrequent interactions and less intensive knowledge exchange between network partners (Michelfelder and Kratzer 2013). Since strong and weak ties are two poles of a continuum regarding the strength of a collaborative relationship (Levin and Cross 2004), firms can also establish ties with partners that exhibit medium strength and are characterised by medium levels of interaction intensity and of duration between partners. Network research has so far rarely distinguished this category of ties and has concentrated only on strong and weak ties.

Regarding the content of network ties, network research implies that firms establish strong ties (e.g., M&A and joint ventures) mostly with partners from the same knowledge fields and acquire redundant, familiar knowledge (Capaldo 2007; Granovetter 1973). Thus, with strong ties firms have the potential to strengthen their basic knowledge (Capaldo 2007; Sullivan and Ford 2013). On contrary, firms enter weak ties (e.g., participation in networking events and outsourcing) and team up with unfamiliar partners to search for non-redundant, distant knowledge (Capaldo 2007; Granovetter 1973). Hence, in weak ties firms have the potential to explore innovative opportunities (Michelfelder and Kratzer 2013; Oerlemans and Knobens 2010). Ties

that exhibit medium levels of strength (e.g., joint research projects and spin-offs) have characteristics of both strong and weak ties. On the one hand, firms perform medium interactive activities with partners from other knowledge fields to acquire distant knowledge. On the other hand, they also perform them to broaden the redundant knowledge and cooperate with partners from the same knowledge fields as their own (Levin and Cross 2004). Hence, by having medium ties firms can profit from broadening their basic knowledge as well as exploring novel opportunities. The concept of strong, medium, and weak ties correspond to the classification of OI activities according to their interaction intensity (also see Chapter 2.2.2). Highly interactive activities represent strong ties, medium interactive activities are ties characterised by medium levels of strength, and weakly interactive activities represent weak ties.

Another distinctive characteristic of network ties is the extent to which collaboration partners are aligned regarding, for example, their resources, technologies, strategies, and corporate cultures (Borgatti and Halgin 2011; Simonin 1999). Mostly scholars distinguish between *technological alignment* that encompasses resource and technological alignments and *relational alignment* that encompasses strategic and cultural alignments (Emden et al. 2006; Lambe, Spekman, and Hunt 2002).

Firms enter collaborative relationships to gain resources and capabilities necessary to develop and maintain competitive advantage (Lambe, Spekman, and Hunt 2002). In order for a collaboration to be successful firms' resource base should be complementary with the partner's resource base (Emden et al. 2006). That is, partners should be able to "eliminate deficiencies in each other's portfolio of resources [...] by supplying distinct capabilities, knowledge, and other entities" (Lambe et al. 2002, p. 144). Although some researchers argue that too much resource alignment can harm firms' performance (Faems et al. 2012), others emphasize that at least some degree of similarity within resource base is required to understand the potential and applicability of new knowledge (Emden et al. 2006; Heil and Bornemann 2017). Supplementing the resource perspective, Emden, Calantone, and Droge (2006) argue that firms look for partners that have special technical capabilities such as an innovative technology or expertise in a particular field and hence, consider technology as one of the most important resources that firms can gain from their collaborative relationships.

Even if partners have technological alignment network relationship still may not be successful if partners lack relational alignment. Besides technological correspondence, strategic and cultural congruence has been distinguished as another important aspect of network relationships (Emden et al. 2006). Regarding the strategic congruence, alignment in partners' motivations is

crucial. It shows whether collaboration partners have mutually beneficial intentions. Another crucial characteristic that ensures the flow of information is partner's goal correspondence. In order to establish a common understanding, objectives and strategies of collaborative activities must be clearly stated (Pullen et al. 2012). Regarding cultural congruence, there has to be at least a minimum alignment in norms and values for a communication and exchange of knowledge between partners to be successful. Moreover, partners must have a long-term orientation or otherwise they might not be willing to take short-term sacrifices to foster long term collaboration success (Emden et al. 2006).

Another relational network characteristics that determines the success of knowledge flow in network relationships is the presence of *IP protective measures*. Some partners might be less transparent and less willing to cooperate. Such partners adopt strict policies or deploy shielding mechanisms that are aimed at protecting their core competencies—behaviour that might be encouraged by the fear of losing ownership of valuable knowledge (Simonin 1999). Whereas knowledge protection has the potential to reduce partner's opportunistic behaviour (Drechsler and Natter 2008), too extensive protective measures account for extensive formalization of network relationships and might impair partner motivation to collaborate (Amara, Landry, and Traore 2008; Walter et al. 2014). Hence, there is an optimal extent of knowledge protection and firms have to determine it in order to profit from the knowledge sharing.

Overall, relational network characteristics determine to a large extent whether firms will generate network-based value and foster their performance. Relationship strength, the type of knowledge that is transferred between partners, technological and relational alignments between partners, and partner protectiveness raise or lower the effectiveness of firms' network relationships for firm performance (Li et al. 2013).

3.1.3 Application of Network-related Conceptual Foundations in this Thesis

This section explains how the network-related conceptual foundations are applied in this thesis regarding to the role of networks in the OI context and several structural and relational network characteristics. Regarding the role of networks in OI, this thesis considers them as “vehicles” for resource transfer between partners within firms' overall OI endeavors. When firms collaborate with different partners and perform OI activities, they construct a network of relationships, which allows them to exchange resources with these partners.

Furthermore, this thesis investigates how several structural and relational network characteristics influence the effectiveness of firms' OI efforts, hence, it applies both structural and relational conceptions. Within the structural conception, network centrality plays an

important role. In this thesis, Studies 1 and 3 particularly focus on firms' degree centrality in form of OI activities that firms perform with their direct partners. Study 1 examines how direct ties to different partners influence firms' adaptiveness and Study 3 investigates how these ties influence firms' success in becoming a gatekeeper in their networks. Betweenness centrality also takes firms' indirect partners into account and is particularly addressed in Studies 2 and 3. Study 2 considers betweenness centrality as an important determinant in managing the upsides and downsides of OI and Study 3 offers implications as to how firms can achieve higher degree of betweenness centrality and thus become gatekeepers in a network.

Within the relational conception, this thesis particularly focuses on the concept of strong, medium, and weak ties which corresponds to the classification of OI activities according to their interaction intensity. The tie strength is an important relational characteristic, because it determines when firms should strive for a particular type of alignment with their collaboration partners (Study 1), as well as what type of knowledge firms can acquire within a collaborative relationship (Study 3).

Moreover, this thesis answers the question when managers should strive for a particular type of alignment with their OI partners to foster their firms' adaptiveness. Study 1 examines technological and relational alignments as determinants on the OI-adaptiveness link and shows that not all types of alignments are beneficial for specific types of OI activities.

This thesis considers another relational network characteristics that determines the success of knowledge flow in network relationships—IP protection. Study 2 specifically addresses notions in extant literature that IP protection might serve as a countermeasure for partner's opportunistic behaviour in OI. At the same time, such protective practices might constrain firms in profiting from the acquired resources through their OI networks.

To conclude, centrality, tie strength, partner alignments, and IP protection are all conceptually and empirically examined as network characteristics in this thesis. Thus, it develops implications for scholars and practitioners as how to foster the effectiveness of OI networks and consequently firm performance.

3.2 Current State of Research: Network Characteristics and Firm Performance

The origins of network research lie in the 1970s in psychology and social sciences, when researchers examined intraorganizational knowledge networks, i.e., how an individual's network position influences his/her access to knowledge (Aalbers 2013; Cross et al. 2001). Over time, measures to access network position (e.g., centrality, structural holes) were applied to

alliance research with scholars attempting to examine collaboration networks between companies (Ahuja 2000; Gulati 1998). Since 2003 when the term “open innovation” was first introduced, network measures have been applied to broader collaboration networks that consider a wide variety of possible network partners (e.g., customers and suppliers; Faems et al. 2010; Laursen and Salter 2006). This section provides an overview of the current state of quantitative research since 2000 focusing on inter-organizational collaboration networks and their performance outcomes. Relevant articles for the review of the current state of research in this chapter were selected according to the same criteria outlined in Chapter 2.2, namely the review includes mainly journals ranked on the A+, A, or B level according to the VHB-ranking (VHB 2018). The literature review includes only quantitative empirical studies.

This overview applies a *content-related perspective* and discusses previous findings regarding the performance outcomes of the network characteristics, the direct effects of network characteristics on performance, and the results of studies employing network characteristics as moderators. It also applies a *theoretical perspective* and discusses the main theoretical foundations that serve as a background for the studies examining the network characteristic-performance relationship. Finally, it applies a *methodological perspective* and offers information about the empirical settings of these studies. A detailed analysis of this research is presented in Table A-3 in the Appendix.

Regarding the *performance outcomes of the network characteristics* from a *content-related perspective*, some of the studies that concentrate on inter-organizational collaboration networks consider several structural and relational network characteristics and examine their effects on firm financial performance, for example, return on assets (e.g., Li et al. 2013; Lin, Yang, and Arya 2009) and return on sales (e.g., Goerzen 2007). However, most of the studies examine the effects of network characteristics on firm innovation performance (e.g., Ahuja 2000; Gilsing et al. 2008). Whereby, researchers have assessed different aspects of innovation performance, such as the number of breakthrough innovations (e.g., Dong et al. 2017), patenting frequency (e.g., Ahuja 2000), and success of exploration and exploitation strategies in innovation networks (e.g., Dittrich and Duysters 2007). Since the main motivation of firms to engage in inter-organizational networks is to gain access to external resources to foster innovation (Chesbrough 2006), it is obvious that extant research has attempted to measure the success of the engagement in networks in terms of firms’ innovation performance.

Regarding the *direct effects of structural network characteristics on performance*, extant research shows that firms’ direct and indirect network ties foster innovation output (e.g., Ahuja

2000). However, not all types of ties lead to higher innovation performance. For instance, Tsai (2009) showed that only ties with research organizations increase innovation output. Moreover, the positive effects of network ties can be observed only up to a certain point. Especially in the case of direct network ties, scholars have found non-linear, inverted U-shaped effects (e.g., Guan and Liu 2016) suggesting that maintaining direct ties with collaborative partners requires substantial efforts such that significant amount of such ties hinders innovation performance. Similar effects have been found regarding firms' degree and betweenness centrality. Whereas some authors find a positive effect of firms' degree centrality (e.g., Sullivan and Ford 2013; Tan, Zhang, and Wang 2015) and betweenness centrality (e.g., Carnabuci and Dioszegi 2015; Kratzer et al. 2016) on innovation performance, others show that degree centrality (e.g., Dong et al. 2017) as well as betweenness centrality (e.g., Gilsing et al. 2008) both have inverted U-shaped effects on innovation performance.

Regarding the *direct effects of relational network characteristics on performance*, researchers have examined how tie strength, stability, and quality influence firms' innovation performance and showed that only tie stability has a positive effect, whereas tie strength has no effect and tie quality has a negative effect (e.g., Li et al. 2013). Although, tie strength has been a widely applied concept in conceptual network studies (e.g., Granovetter 1973; Capaldo 2007), only few studies have empirically measured tie strength. Similarly, whereas resource and goal complementarity is often mentioned in conceptual research (e.g., Emden et al. 2006), studies rarely capture it in their empirical models. Some exceptions are made by Pullen et al. (2012), who measure goal and resource complementarity and the study by Lin, Yang, and Arya (2009) who assess resource complementarity. Regarding the performance outcomes of alignments the results are inconsistent. Whereas some authors find beneficial effects (e.g., Pullen et al. 2012), others find detrimental effects (e.g., Lin et al. 2009).

Extant research also often considers *structural and relational network characteristics as moderators* on the collaboration-performance link to examine how they foster or hinder collaboration effectiveness. In other cases network characteristics are examined as moderators on the relationship between network characteristics and performance. Thus, in some empirical settings network characteristics are examined as independent as well as moderator variables. For instance, Ahuja (2000) found that the number of indirect ties that a firm maintains on a global network level is negatively moderated by the number of direct ties. Moreover, researchers have found that such tie characteristics as strength, stability, and quality strengthen or weaken the collaboration-performance relationship (e.g., Li et al. 2013; Sullivan and Ford 2013). Regarding the knowledge transfer in collaboration networks, previous research suggests

that firms need to build up internal knowledge base in order to be able to interpret external knowledge from network ties (e.g., Tsai 2001, 2009). Figure 3-3 summarizes constructs and relationships examined in extant research regarding the relationship between network characteristics and firm performance.

Figure 3-3: Overview of Extant Research on Network Characteristic-Performance Relationship

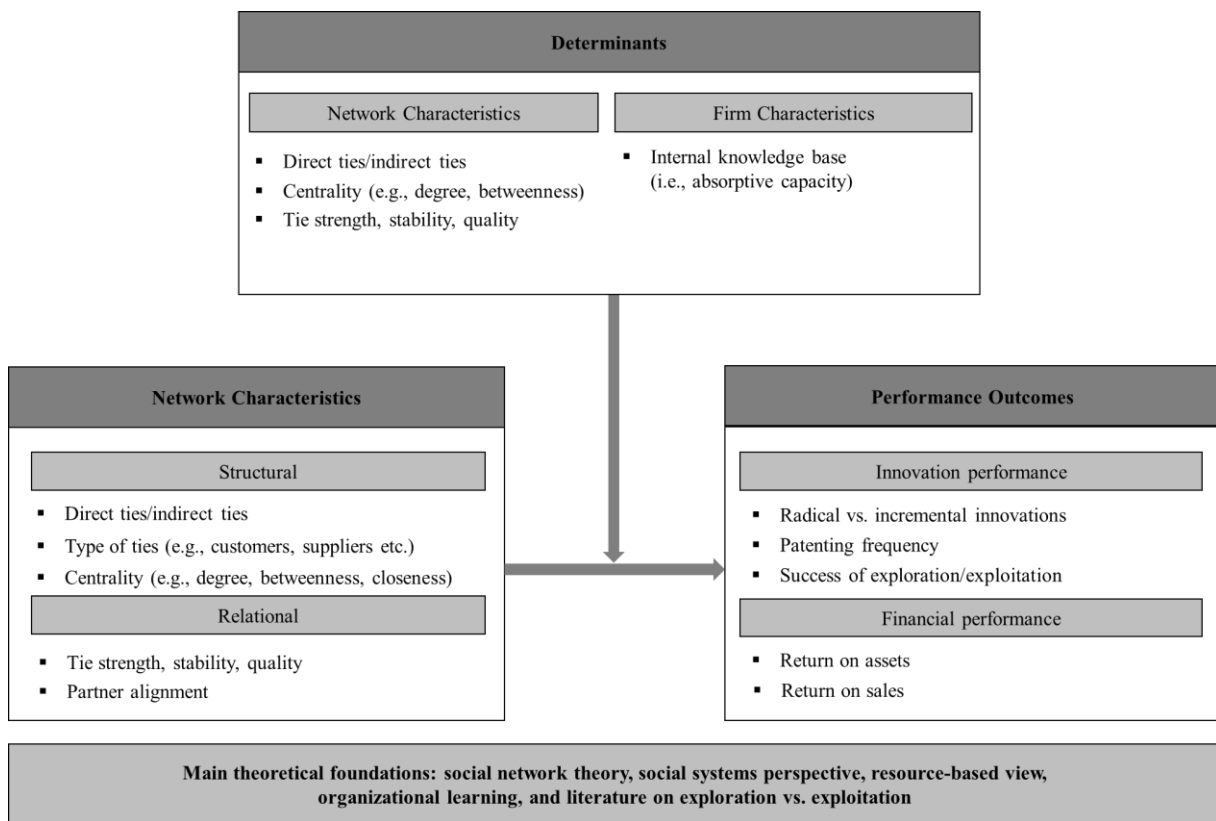

From a *theoretical perspective*, social network theory has been the most often applied theoretical foundation in extant research examining inter-organizational networks (e.g., Carnabuci and Dioszegi 2015; Gilsing et al. 2008; Kratzer et al. 2016). This is so far not surprising, because measures to operationalize network characteristics have their origins in social network theory. Some researchers apply social network theory but refer to it in their research as network theory (e.g., Dong et al. 2017). Besides social network theory, researchers draw on different perspectives and use multiple theoretical backgrounds for their research. For instance, studies draw on social systems theory (e.g., Pullen et al. 2012), resource-based view (e.g., Lin et al. 2009), organizational learning (e.g., Tsai 2001), and literature on exploration and exploitation (e.g., Dittrich and Duysters 2007; Guan and Liu 2016).

Reviewing the empirical settings of these studies from a *methodological perspective*, most of the researchers use large-scale, quantitative data stemming across industries (e.g., Lin et al. 2009; Sullivan and Ford 2013) as well as from a single industry, such as chemicals (e.g., Ahuja 2000), manufacturing (e.g., Carbanbuci and Dioszegi 2015), information technology (e.g., Dittrich and Duysters 2007), and nano-energy (e.g., Guan and Liu 2016). Often data stem from USA (e.g., Gilsing et al. 2008; Lin et al. 2009), but there are also studies carried out in European settings (e.g., Carbanbuci and Dioszegi 2015; Pullen et al. 2012) and Asian settings (Goerzen 2007; Li et al. 2013). Regarding the empirical methods, there has been approximately equal number of longitudinal studies (e.g., Ahuja 2000; Gilsing et al. 2008) that employ panel analysis to examine their data, and number of cross-sectional studies (e.g., Goerzen 2007; Li et al. 2013) that most often employ regression analysis or structural equation modelling.

3.3 Summary

Overall, network research has gone a long way from the first studies examining individual's ties in a knowledge network to the development of useful and enhanced network measures to access an actor's position in a collaboration network towards an integration in a larger OI context. On its development path, network research has provided a substantial basis for analysing complex OI networks between firm and a wide variety of different stakeholders. Researchers see networks as “vehicles” that firms need to build in order to enable resource transfer between OI partners. OI scholars have started to analyse OI network characteristics by applying measures from network research and thus meanwhile OI research field has merged with network research and one cannot be clearly separated from one another.

Network theorists have discovered a broad set of structural and relational network characteristics that help to analyse different aspects of networks. Whereas network characteristics as such are well-examined, the relationships between them are far more puzzling and extant research shows several backdrops. First, previous research often fails to align structural and relational conceptions such that there are studies that examine only structural or only relational aspects of networks. This has led to an unclear understanding of how structural and relational characteristics influence each other. Second, several scholars have employed a broad set of network characteristics as independent variables and examined their effect on firm performance. Others employ them as moderator variables and investigate how they influence the effectiveness of collaborative ties for firm performance. Moreover, further scholars examine how some network characteristics (moderator variables) determine the effectiveness of other network characteristics (independent variables) for firm performance. For instance, the

effectiveness of firms' direct ties depends on the number of firms' indirect ties. In this context, current research offers extensive, yet somewhat contradictory results. Certainly, the complex and dynamic nature of collaborative networks accounts for some of the ambiguity. The first study of this thesis focuses on the different types of partner alignments as relational network characteristics and how firms must arrange them to make their OI activities thrive.

4 Study 1 – How Different Types of Partner Alignment Influence the Effectiveness of Highly and Weakly Interactive Open Innovation Activities for Firms’ Adaptiveness¹

4.1 Introduction to Study 1

Charles Darwin’s theory of the evolution of species can be summed up as “it is not the strongest of the species that survives, nor the most intelligent, but the one most responsive to change” (Megginson 2016). In the modern business world, this statement is remarkably pertinent; a vast multitude of emerging new technologies shape the fates of firms and industries (Daneels 2004), in contexts of rapidly increasing complexity and shifts in market conditions (Day 2011). These changes certainly offer great opportunities, but they require firms to adapt. As Samsung’s CEO recognizes, “we should adapt ourselves to the new environment instead of sticking to our success in the past” (Kennemer 2015). To survive in changing environments and grasp the resulting opportunities, firms must expand their adaptiveness or “ability to identify and capitalize emerging market and technology opportunities” (Tuominen et al. 2004, p. 496).

The need to adapt thus seems clear, but the question remains: *How?* Opening organizational boundaries and collaborating with external partners offer great opportunities for enhanced adaptiveness to change (Laursen and Salter 2006; Teece 2007). Extant research also postulates that open innovation (OI) activities that involve “the use of purposive inflows and outflows of knowledge to accelerate internal innovation and expand the markets for external use of innovation, respectively” (Chesbrough 2006, p. 1) provide paths for firms to follow in turbulent environments (Grimaldi et al. 2013; Teece 2007). That is, OI activities (e.g., cocreation, cooperation with research institutes, licencing) can provide continuous streams of new information about technologies and markets, as well as resources that firms lack but require before they can adapt to their changing conditions (Grimaldi et al. 2013; Schweitzer et al. 2011).

¹ This chapter is based on a joint working paper (together with Nicolas A. Zacharias).

But not all firms profit equally from OI activities, and extant research offers surprisingly limited explanations for why (Dahlander and Gann 2010). In search of answers, researchers have taken close looks at the OI activity–performance link, seeking to determine which contingencies influence the effectiveness of OI activities (e.g., Berchicci 2013; Cheng and Huizingh 2014). This research stream considers both internal and external factors as contingencies (Drechsler and Natter 2012). Among *internal* factors, scholars investigate the interplay of OI activities with diverse strategy-related aspects. For example, firms’ strategic (e.g., entrepreneurial, market) orientation may determine whether OI activities lead to increased performance (e.g., Baker et al. 2015; Cheng and Huizingh 2014). Firms’ internal capabilities, such as alliance management and absorptive capability, also are important determinants of OI effectiveness (e.g., Rothaermel and Deeds 2006; Tsai 2009). Berchicci (2013) and Xu et al. (2013) thus assert that whether firms profit from their OI endeavors depends strongly on their internal R&D investments.

In contrast, research investigating *external* factors remains relatively sparse. Overall, scholars recognize that the networks in which firms are embedded and their characteristics influence firms’ success in performing OI activities. Some research focuses on structural network characteristics, such as network size and network position strength (e.g., Li et al. 2013; Pullen 2012). A few other studies look at relational network characteristics, such as the governance structure or relational embeddedness (e.g., Du et al. 2014; Tranekjer and Knudsen 2012). Although this research stream is growing, it also is very fragmented. For example, some conceptual research indicates the overarching importance of partner alignment as an external relational factor (e.g., Emden et al. 2006; Faria et al. 2010), yet no conceptual or empirical studies investigate how different types of alignment influence the effectiveness of OI activities. Addressing this gap is critical to research and managerial practice alike, because alignment with collaboration partners is key to successful OI activities and adaptation to changing markets (e.g., Emden et al. 2006; Enkel et al. 2009).

A recent stream of research suggests that partner alignment might increase collaboration effectiveness (e.g., Dahlander and Gann 2010; Lavie et al. 2012). Alignment is particularly important in an OI context, because by aligning technologies and business practices with partners, firms can significantly enhance the performance of their collaboration (Lavie et al. 2012; Murphy et al. 2015). Several studies suggest that alignments with partners are generally beneficial for all OI activities (Green et al. 2012; Seggie et al. 2006; Tan et al. 2009), but a contradictory line of research indicates that if a firm is too tightly aligned with its partners, it cannot adapt to changes quickly, due to relationship inertia (Santos and Eisenhardt 2005;

Sapienza et al. 2004). To resolve these inconsistencies, we propose that, depending on the kinds of OI activities performed, different types of alignment with partners can make these activities thrive or fail, in terms of their effects on adaptiveness (Faria et al. 2010). Managers thus need to know when to strive for a particular type of alignment with OI partners, and when to avoid it.

Against this backdrop, we investigate the contingency effects of different alignments and how they influence the relationships between two categories of OI activities and adaptiveness. Specifically, we focus on the different interaction levels of OI activities and distinguish two categories: highly interactive and weakly interactive OI activities. We further differentiate technological alignment, which refers to technology and resource complementarity between OI partners (Emden et al. 2006; Lee et al. 2001), and relational alignment, or the fit between partners' business practices, goals, and cultures (Kale et al. 2000; Lavie et al. 2012). Formally, we ask: *How should firms arrange technological and relational partner alignments to realize the full potential of different OI activities and foster firms' adaptiveness?*

By answering this question, we offer several contributions to extant literature. First, we contribute to OI research that addresses the effectiveness of OI activities, by providing initial insights into how different types of partner alignment can make OI activities with different interaction intensities thrive or fail, in terms of their effects on adaptiveness. With these insights, we close a relevant gap, which emerged from inconsistent findings regarding whether partner alignment is beneficial for all OI activities (Green et al. 2012; Seggie et al. 2006) or if too much alignment creates relationship inertia (Santos and Eisenhardt 2005; Sapienza et al. 2004). We resolve these inconsistencies by theoretically and empirically explaining which alignments represent conditions that enable OI activities to thrive—or not.

Second, we align social network theory (SNT) with extant OI research to explain how a network structure comprising strong and weak ties with collaboration partners in combination with specific network attributes (e.g., partner alignment), influence firms' adaptiveness. By relying on a theoretical mechanism based on knowledge integration and flexibility, rooted in SNT, we offer a novel explanation of how firms can maximize the benefits of their highly interactive OI activities (strong ties) and weakly interactive OI activities (weak ties) by arranging different partner alignments to foster adaptiveness. When firms choose the right alignment for their OI activities, they can integrate knowledge from OI partners and remain flexible, thus fostering their adaptiveness. If they choose suboptimal alignments, firms will hinder their own adaptiveness.

Third, several studies in extant OI research have urged managers to perform a broad range of OI activities (e.g., Beers and Zand 2013; Salge et al. 2013) and offered some ideas about circumstances in which particular OI activities might benefit performance (e.g., Belderbos et al. 2004; Drechsler and Natter 2012). However, not all OI activities are available to every firm, due to their limited resources, existing contracts, or intellectual property restrictions, for example. Therefore, managers need to know how to increase the chances of success of OI activities that are already in place or that they might perform, given their resources. Our study offers valuable suggestions for managers who must choose the optimal partner alignments for their highly and weakly interactive OI activities to increase their firms' adaptiveness and innovation success. That is, we provide implications for firms that are planning new OI activities but also those that have made OI decisions in the past and now must strive to execute their ongoing OI activities more effectively.

For the empirical test of our predictions, we use large-scale, quantitative data representing 181 companies, solicited from key managerial informants who are highly knowledgeable about their firms' innovation activities. To validate these managers' assessments, we enriched the survey data with secondary data, namely, profit information available in a financial database.

4.2 Theoretical Background – Social Network Theory

For this study, we draw on SNT (Coleman 1988; Granovetter 1973) as an overarching theoretical framework to develop the theoretical reasoning for our hypotheses. Its main proposition is that network structure and network attributes interact and lead to certain performance implications (Borgatti and Halgin 2011). It also identifies two opposing types of network structure—strong relationships/ties (Coleman 1988) and weak relationships/ties (Granovetter 1973)—and posits that both of them are important for achieving the highest level of knowledge reception. That is, both strong ties and weak ties are necessary for firms to achieve greater adaptiveness (Michelfelder and Kratzer 2013; Tiwana 2008).

Yet strong and weak ties with collaboration partners exhibit different characteristics and therefore offer different benefits as means to increase performance (Michelfelder and Kratzer 2013). Close, long-lasting, deep relationships with frequent interactions and good information flow between network partners characterize strong ties (Capaldo 2007). They are particularly useful for strengthening and broadening basic knowledge, because partners generally possess redundant information. That is, such ties offer the benefit of *knowledge integration* (Capaldo 2007; Tiwana 2008). On the contrary, weak ties entail infrequent interactions and less intensive resource exchanges between network partners, which makes them very useful for the

exploration of innovative opportunities (Michelfelder and Kratzer 2013). Usually firms team up with unfamiliar partners to search for non-redundant information, which is critical for adapting to rapid technological and market changes (Granovetter, 1973). Hence, weak ties offer the benefit of *flexibility* (Capaldo 2007; Tiwana 2008). Overall, SNT provides a theoretical foundation that suggests that strong ties, such as highly interactive OI activities, and weak ties, such as weakly interactive OI activities, both are necessary for firms to achieve greater adaptiveness (Michelfelder and Kratzer 2013); it results from maximizing both knowledge integration and flexibility benefits.

Furthermore, SNT offers clear ideas for how firms can maximize these benefits, namely, by arranging network attributes to reflect the characteristics of the relationship between network members, such as partner alignments (Borgatti and Halgin 2011). In the case of strong ties, firms seek OI partners with whom they have technological and relational fit, to integrate their knowledge. When firms look for novel and distant inputs from weak ties though, these alignments are less beneficial, because aligned partners suffer inertia, hindering the firms' flexibility (Santos and Eisenhardt 2005; Tiwana 2008).

Overall, the OI activities that firms perform create a unique structure of strong and weak ties, and partner alignments are network attributes that relate to the technological and relational fit between partners and determine the effectiveness of OI activities (Michelfelder and Kratzer 2013). By drawing on the theoretical mechanism of knowledge integration and flexibility, we detail how firms can maximize the benefits of their highly interactive OI activities (strong ties) and weakly interactive OI activities (weak ties), by arranging technological and relational partner alignments to foster firms' adaptiveness.

4.3 Framework and Hypotheses

4.3.1 Study Framework

Figure 4-1 depicts the study framework, which is strongly rooted in SNT. Firms must increase their ability to adapt to rapidly changing technological and market-related conditions (Grimaldi et al. 2013; Miles et al. 1978; Tuominen et al. 2004), so they form strong ties by engaging in highly interactive OI activities to integrate and broaden their basic knowledge. They also establish weak ties by engaging in weakly interactive OI activities to remain flexible and access distant knowledge (Tiwana 2008). Thus, our proposed framework features two main effects of highly and weakly interactive OI activities on adaptiveness. In addition, alignments, as network attributes, influence how firms leverage the benefits of their OI activities to enhance their adaptiveness. Therefore, we conceive of technological and relational alignments as contingency

variables. Adaptiveness also relates to firms' *innovation success*, or the commercialization and achievement of sales growth for new and OI products (e.g., Hottenrott and Lopes-Bento 2016). Adapting to technological and market-related changes eventually should result in greater innovation success.

Because emerging new technologies and market complexity are the main sources of change to which firms must constantly adapt (Daneels 2004; Day 2011), we conceptualize *adaptiveness* as a firm-level construct with two dimensions (Akgün et al. 2012). Technology adaptiveness refers to “organizational learning in the context of the technologies deployed” (Tuominen et al. 2004, p. 496) and involves monitoring technological change and acquiring the technologies needed to adapt to this change (Akgün et al. 2012). Market adaptiveness is the “ability of firms to address the complexity and velocity of change in their markets” (Day 2011, p. 194), so it includes monitoring changes in customers or competitors, as well as adjusting the firm's own marketing activities in response (Akgün et al. 2012).

Figure 4-1: Framework (Study 1)

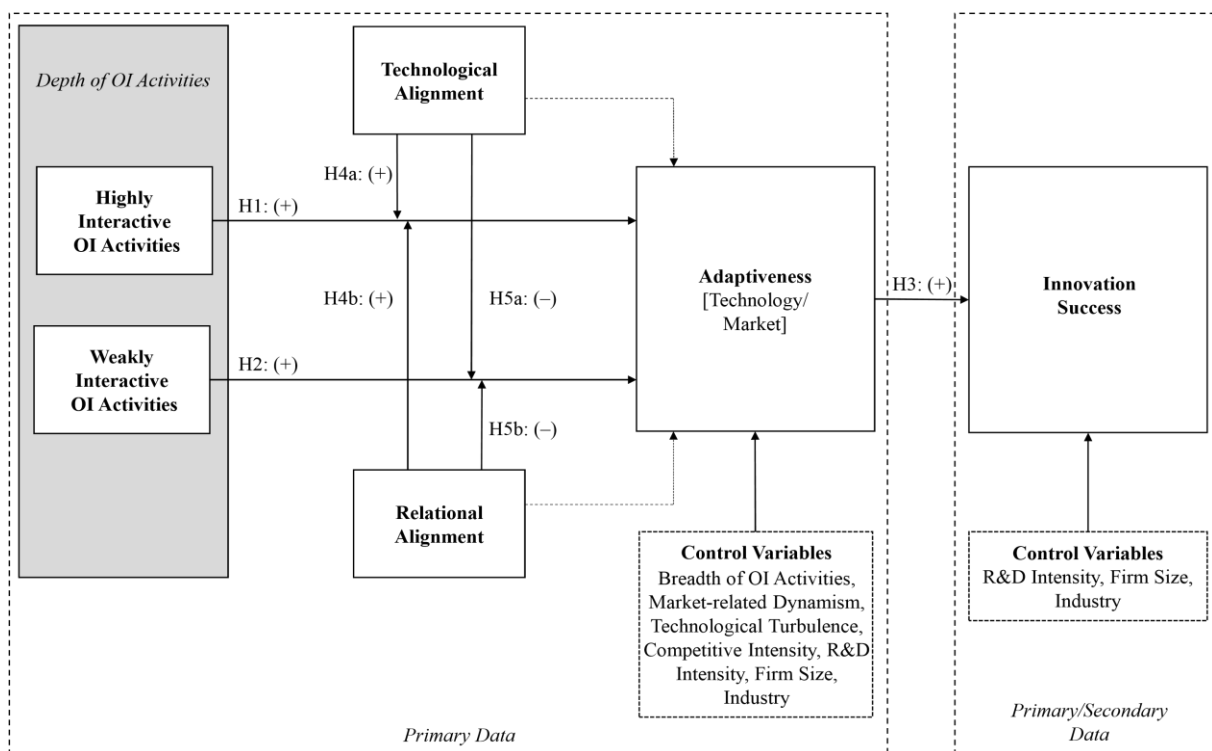

To examine how different OI activities directly influence adaptiveness and how alignments moderate this influence, we consider four of the most important OI activities that firms perform and categorize them according to their interaction intensity (Lee et al. 2001; Schleimer and

Faems 2016). Frequent face-to-face interactions, long durations, and extensive transfers of complex or specialised knowledge characterize highly interactive OI activities (Hansen 1999; Jones et al. 1997; Sullivan and Ford 2013), whereas weakly interactive OI activities involve infrequent interactions, less intensive resource exchanges, and explorations of innovative opportunities (Hansen 1999; Michelfelder and Kratzer 2013; Oerlemans and Knobens 2010). We represent *highly interactive OI activities* by cocreation and cooperation with research institutes. Cocreation enables firms to capture customers' needs and desires by intensively engaging them in innovation processes (Gassmann and Enkel 2004; Heidenreich et al. 2015); its relevance makes it among the most important OI practices (Chesbrough and Brunswicker 2013). When firms confront large knowledge gaps, they also might access complex, technology-related knowledge by cooperating with research institutes (Drechsler and Natter 2008), which are critical science-based partners (Du et al. 2014). In contrast, in-licencing and spin-offs represent *weakly interactive OI activities*. Through in-licencing or buying external technologies, a company can keep moving along a development path without engaging in much actual interaction with partners (Drechsler and Natter 2008). Spin-offs emerge when companies divest some business units to create new business models or enter new markets (Chesbrough and Brunswicker 2013; Feldman et al. 2014), but here again, the interactions of the incumbent firm and the spin-off are infrequent and not very collaborative.

Finally, we include two forms of alignment in the framework as moderator variables. *Technological alignment* between OI partners implies that they possess complementary technologies and resources that they can leverage in innovation activities (Emden et al. 2006; Lee et al. 2001). By integrating complementary technologies, partners create and exploit opportunities, often due to changes in technologies and markets, that would be beyond their individual reach (Emden et al. 2006; Lee et al. 2001; Murphy et al. 2015). However, a complementary technology basis can also restrict firms from finding new, distant opportunities and create inertia, thus restricting their adaptation to the changed environment (Santos and Eisenhardt 2005; Sapienza et al. 2004). When *relational alignment* exists, partners instead exhibit similar business practices, goals, and corporate cultures (Kale et al. 2000; Lavie et al. 2012), which implies consistent decision making and actions (Tan et al. 2009). Such similarity between OI partners can enhance knowledge transfers and, by extension, knowledge integration. Yet it also might hamper firms' openness to the new ideas required to foster adaptiveness (Tiwana 2008). According to SNT, these two types of alignment correspond to network attributes that determine how well firms are able to realize the benefits of knowledge integration and flexibility from strong and weak ties (Borgatti and Halgin 2011).

4.3.2 Hypotheses

4.3.2.1 Main Effects Hypotheses

Across industries, firms perform external search activities to access continuous streams of new information about technologies and markets and thus to increase their ability to adapt to increasingly turbulent competitive environments (Grimaldi et al. 2013; Teece 2007). To use this information effectively and foster adaptiveness, firms must integrate and exploit it, through technology refinement and product development (Michelfelder and Kratzer 2013). According to SNT, strong ties particularly foster knowledge integration, providing firms with opportunities to exploit the collectively generated information about technologies and markets to increase their adaptiveness (Tiwana 2008), for several reasons.

First, frequent face-to-face interactions encourage intensive information flows among partners, which supply firms with constant streams of new information about changes in relevant technological and market-related conditions (Rosenkopf and Nerkar 2001; Schweitzer et al. 2011). Second, when firms perform highly interactive OI activities, partners develop personal relationships, characterised by mutual respect and knowledge-based trust, so they can integrate high-quality information about new markets and technologies (Grimaldi et al. 2013; Kale et al. 2000). Third, highly interactive OI activities grant firms valuable, internally lacking resources (e.g., technologies, distribution channels) that they need to take action and exploit the collectively generated knowledge and respond to changes (e.g., Berchicci 2013; Drechsler and Natter 2012). Therefore, we hypothesize:

H1: Highly interactive OI activities positively affect adaptiveness.

Whereas strong ties are beneficial for strengthening and broadening basic knowledge (Granovetter 1973), it might not be sufficient simply to integrate knowledge if firms want to foster their adaptiveness. Being adaptive implies that firms also must be flexible enough to respond quickly to changes in technologies and markets (Akgün et al. 2012), which demands access to unfamiliar, non-redundant information about new technologies and market opportunities, because rapid market changes often result from unexpected developments outside firms' core industry or focal vantage point (Tiwana 2008). According to SNT, weak ties, such as weakly interactive OI activities, offer the necessary flexibility and are particularly suitable for acquiring novel and disparate knowledge (Granovetter 1973; Tiwana 2008). When firms perform weakly interactive OI activities, such as in-licencing and spin-offs, they profit from infrequent interactions and team up with unfamiliar partners with varying interests and

different approaches to problems, which should foster creativity and the exploration of innovative opportunities (Michelfelder and Kratzer 2013; Perry-Smith and Shalley 2003).

In addition, greater flexibility results from the higher autonomy that firms enjoy through weakly interactive OI activities, which are unlikely to cause companies to identify with their OI partners. Due to the infrequent interactions, less intensive resource exchanges, and limited maintenance efforts, firms also can enter and exit such relationships more easily, allowing them to maintain their autonomy, flexibility, and adaptiveness (Perry-Smith and Shalley 2003). For example, firms might enter short-term relationships with other companies to licence innovative technologies, adapt to rapid changes in the market, and grasp emerging opportunities. We predict:

H2: Weakly interactive OI activities positively affect adaptiveness.

We also consider how adaptiveness affects downstream variables, namely, firms' innovation success. Adaptiveness is positively associated with high levels of innovation success, because firms that possess high levels of adaptiveness seek out and use the newest technology, which informs their new product development (Akgün et al. 2012; Tuominen et al. 2004). Their improved technological expertise enables these firms to address new customer needs and compete with improved products (Akgün et al. 2012). Firms with high adaptiveness also invest substantial resources in marketing and adopt new marketing techniques to foster sales of newly developed products (Akgün et al. 2012; Oktemgil and Greenley 1997). Accordingly,

H3: Adaptiveness positively affects innovation success.

4.3.2.2 Moderating Effects Hypotheses

Contingency Effects in the Relationship between Highly Interactive OI Activities and Adaptiveness

When firms perform highly and weakly interactive OI activities to foster their adaptiveness, they are looking for ways to maximize the benefits offered by both types of OI activities, and technological and relational partner alignments thus are crucial contingencies (e.g., Borgatti and Halgin 2011; Emden et al. 2006). According to SNT, highly interactive OI activities imply extensive transfers and integration of complex knowledge and substantial investments to manage the collaboration (Oerlemans and Knobens 2010). Therefore, firms should look for

partners that align with them, such that they need to achieve different types of alignment (Tiwana 2008).

According to SNT, with strong ties firms need a complementary technological basis to realize the potential of their knowledge integration (Tiwana 2008). Firms that strive for technological alignment with OI partners thus have a sort of guarantee that they will receive and be able to integrate desired technologies from the collaboration to expand their adaptiveness (Nahapiet and Ghoshal 1998). Technological alignment between OI partners can reduce uncertainty related to whether firms can interpret or integrate technology-related inputs from partners sufficiently, so it should foster smoother adaptations to change. Finally, when partners in highly interactive activities exhibit technological alignment, they contribute complementary technologies and other resources that enable them to achieve goals beyond their individual reach, so they likely profit from resource synergies that are important to adaptiveness (Akgün et al. 2012). Altogether, we hypothesize:

H4a: The effect of highly interactive OI activities on adaptiveness is stronger when technological alignment is high rather than low.

Beyond a complementary technological basis, collaboration partners should exhibit fit in their goals, business practices, and cultures; such relational alignment can help them realize the potential of their knowledge integration from highly interactive OI activities (Murphy et al. 2015; Tiwana 2008). The SNT-based theoretical foundation suggests that relational alignment is beneficial for strong ties, because similarity in partners' goals and cultures allows them to embrace shared values, cooperative norms, and a sense of reciprocity. These aspects collectively enhance knowledge transfers and, by extension, knowledge integration. If partners share a common language, they are better able to absorb and integrate new ideas from each other's domain of specialization, as is necessary to foster adaptiveness (Tiwana 2008).

From a more practical perspective, when firms' collaboration partners have compatible strategic goals, it reduces the risk of strategic manipulation, which is particularly dangerous in cohesive relationships that entail extensive resource transfers and close dependence between firms (e.g., Walter et al. 2014; Wu 2012). The better the fit between partners' goals and cultures, the more likely they can integrate resources and experience fewer incompatibilities (e.g., unexpected strategic or operational differences) during their collaboration (Murphy et al. 2015; Nahapiet and Ghoshal 1998). To secure the technological and market-related capabilities needed for

adaptation, firms also want to foster mutual trust and commitment, and relational alignment provides a basis for those outcomes (Kale et al. 2000; Lavie et al. 2012). We propose:

H4b: The effect of highly interactive OI activities on adaptiveness is stronger when relational alignment is high rather than low.

Contingency Effects in the Relationship between Weakly Interactive OI Activities and Adaptiveness

In the case of weakly interactive OI activities, alignments also are crucial contingencies that determine how well firms can leverage the benefits of their OI activities. However, alignments as network attributes may work differently than they do for highly interactive OI activities. For weak ties, alignments with partners tend to be harmful, according to SNT, because they restrict firms from applying the flexibility benefits that those weak ties offer (Tiwana 2008). Firms that engage in weakly interactive OI activities, characterised by loose ties and less intensive resource exchanges, often seek to acquire resources beyond their core technological field to adapt to a radical change (Dittrich and Duysters 2007; Granovetter 1973; McEvily and Zaheer 1999). For example, they might in-licence a foreign technology (Drechsler and Natter 2008). If firms exhibit technological alignment when they perform weakly interactive OI activities, it might restrict their flexibility and adaptiveness, because they acquire complementary, not distant, inputs (Sapienza et al. 2004). We hypothesize:

H5a: The effect of weakly interactive OI activities on adaptiveness is weaker when technological alignment is high rather than low.

Finally, it might not be beneficial to strive for relational alignment when firms look for ways to increase their adaptiveness through weakly interactive OI activities. With their infrequent interactions and less intensive resource exchange (McEvily and Zaheer 1999; Oerlemans and Knoblen 2010), partners engaged in weakly interactive activities aim to profit from flexibility, so aligning their goals, business practices, and cultures might be harmful (Tiwana 2008). That is, relational alignment could hinder the positive effect of weakly interactive OI activities on adaptiveness. With weakly interactive OI activities, firms seek access to sources that offer non-redundant, novel information about technologies and markets (Borgatti and Halgin 2011; Nahapiet and Ghoshal 1998). If partners are relationally aligned, they share the same goals and thinking, which might hamper their openness to the new ideas required to foster adaptiveness through weakly interactive OI activities (Crescenzi et al. 2016). We therefore propose:

H5b: The effect of weakly interactive OI activities on adaptiveness is weaker when relational alignment is high rather than low.

4.4 Methodology

4.4.1 Sample and Data Collection

This study relies on large-scale, quantitative, multi-industry data representing 181 German companies. We obtained the sample with the support of a commercial research service provider. To ensure the firms' suitability and respondents' competency, we implemented several checks. First, responses were obtained only from companies with more than 50 employees. Second, all respondents were decision makers with management experience and leadership responsibility within their firm. We asked these respondents to rate their knowledge of their firms' innovation activities, then assessed their responses on a seven-point scale (1 = "minor knowledge" to 7 = "extensive knowledge"). To ensure the respondents were highly knowledgeable about innovation activities in their firm, we included only responses from managers who exhibited at least medium-level knowledge (score of at least 4). The mean score of the qualified respondents was 5.82 (SD = .91). Altogether, we obtained 145 valid responses using this approach. Next, we extended the sample with further respondents. We contacted 322 companies and received 60 responses (response rate = 18.6%), which we added to the sample. These respondents again were highly knowledgeable about the innovation activities carried out by their firms. The mean score of these qualified respondents was 6.10 (SD = .89). The t-tests of the means revealed no significant differences between the two segments of the sample. The combined data collection procedures thus generated 205 responses. After accounting for missing variables, our analyses are based on 181 usable questionnaires, from managing directors (45.3%), R&D managers (14.4%), innovation managers (14.4%), product managers (6.1%), and others (19.8%).

We ensured that the respondents represent diverse industry sectors (see Table 4-1), which helped increase the generalizability of our findings and avoid potential biases resulting from diverse industry characteristics. The sample also covers a wide range of firm sizes; sales volumes range from less than €10 million to more than €5 billion (average is €100 million), with an average of 8,596 employees and average firm age of 53 years. Our sample includes relatively closed firms that perform only a few OI activities as well as very open firms that perform many OI activities profoundly. This heterogeneity offers no evidence of self-selection by firms that are more open in their innovation activities.

To increase the validity of our findings, we also used triangulation to assess innovation success (Homburg et al., 2012), such that we enriched our survey data with secondary data. We retrieved firms' annual net profit (year 2014) from a financial database as a proxy for innovation success, because sales growth and profit tend to be closely related (e.g., Lumpkin and Dess 2001; Zhou et al. 2005). Specifically, we retrieved profit information for 64 of the sample companies for which these data were available. To test for potential selection bias, we conducted t-tests to compare the means of OI activities, adaptiveness, and innovation success between firms with and without profit data; the results revealed no significant differences, so there is little potential for a selection bias based on the availability of objective performance data. We also found a strong, positive, significant correlation between the survey-based measure of innovation success and the secondary firm profit data ($r = .30, p < .05$), indicating the validity of the managers' assessments.

Table 4-1: Sample Composition (Study 1)

Industry sector	Number of full-time employees		
Chemicals/pharmaceuticals	9.9%	< 100	12.8%
Machinery/electronics	23.2%	101–200	11.1%
Software/IT	13.8%	201–500	25.0%
Retail/consumer goods	6.1%	501–1,000	15.0%
Services	17.7%	1,001–5,000	22.2%
Other	29.3%	5,001–10,000	1.7%
		> 10,001	12.2%
Sales volume	Firm age		
< €10 million	23.2%	< 5	6.1%
€10–€25 million	16.6%	6–10	8.3%
€25–€50 million	7.7%	11–15	12.3%
€50–€100 million	9.4%	16–20	6.6%
€100–€250 million	7.2%	21–50	30.6%
€250–€500 million	8.3%	> 51	36.1%
€500–€1,000	10.5%		
€1,000–€5,000	11.0%		
> €5,000 million	6.1%		

4.4.2 Measures

To develop the survey, we conducted 10 field interviews with academics and practitioners to ensure the relevance of our research goals and determine relevant constructs for our study. To operationalize the dependent, independent, and control variables, we relied on existing multiple-item measurement scales, identified using a comprehensive literature review. All items appear in the Table 4-5.

For the four *OI activities* of cocreation, cooperation with research institutes, in-licencing, and spin-offs (Chesbrough and Brunswicker 2013), we asked respondents to evaluate the degree to which their firm performed each of these OI activities in the previous three years, from (1) “not used” to (7) “very high degree of use.” Our measurement of OI activities corresponds with the depth dimension of firm openness introduced by Laursen and Salter (2006), which refers to the extent to which firms use different OI activities.

Prior research has not provided scales of technological and relational alignments, though other established scales evaluate different aspects of alignment (Emden et al. 2006). Therefore, we rely on extant scales to measure the focal aspects when possible, then supplement them with self-developed items that reflect our construct definitions, to develop valid measures. The *technological alignment* scale, adopted from Lambe et al. (2002), consists of three items that assess resource complementarity between partners. We supplemented this scale with a self-developed item to assess technological complementarity (Emden et al. 2006). For *relational alignment*, we adopted two items from Simonin (1999) that refer to the fit between collaboration partners’ corporate cultures and business practices. The concept of relational alignment also encompasses the partners’ long-term orientation (Emden et al. 2006), so we incorporate this measure with an item adapted from Lui and Ngo (2012). The alignment measures were assessed on a seven-point Likert-type scale (1 = “strongly disagree” to 7 = “strongly agree”).

The measure of *adaptiveness*, adopted from Akgün et al. (2012), is a first-order construct comprised of five items for technology adaptiveness and another five items for market adaptiveness. The original scale from Akgün et al. (2012) also includes management system adaptiveness, but we excluded this form from our study, because it cannot be interpreted as an outcome of the interaction between OI activities and alignments. All items were measured on another seven-point Likert-type scale (1 = “strongly disagree” to 7 = “strongly agree”). The scale for firms’ *innovation success* comprises four items that assess the number of new and OI products (Bianchi et al. 2015), as well as their sales growth (Hottenrott and Lopes-Bento 2016).

Seven variables help control for the influences of specific environmental and firm characteristics on the dependent variables. To fully capture the nature of firms’ openness, we consider the breadth dimension of OI activities as a control variable for adaptiveness. *Breadth of OI activities* refers to the number of OI activities that firms use, computed by applying the technique suggested by Laursen and Salter (2006), such that we combine the two highly and two weakly interactive OI activities (see the Appendix). Thereby, each of the OI activities is coded as a binary variable (0 = “not used” to 1 = “used”). In the next step, we added the four

OI activities; a score of 0 means the firm used no OI activities, but a score of 4 indicates it used all the OI activities. Furthermore, *market-related dynamism* (Stock and Zacharias 2011), *technological turbulence*, and *competitive intensity* (Jaworski and Kohli 1993) represent important environmental influences in contexts marked by innovation and environmental changes (e.g., Cheng and Huizingh 2014; Zhou et al. 2005). As such, they are particularly important for adaptiveness. For both adaptiveness and innovation success, we incorporated *R&D intensity*, operationalized as a percentage of the R&D expenditures of a company's total revenue, because extant research has shown that the effectiveness of OI might depend on internal R&D investments (Berchicci 2013; Laursen and Salter 2006). *Firm size* was included, measured as the number of full-time employees. Finally, we included *industry* as a control (Laursen and Salter 2006), using an effect-coded dummy variable for the chemical/pharmaceutical, machinery/electronics, software/IT, retail/consumer goods, and service industries, with other industries as the reference category.

4.4.3 Measurement Properties

To ensure the reliability and validity of our scales, we conducted exploratory and confirmatory factor analyses. To measure the internal consistency and reliability of the reflective constructs, we computed Cronbach's alpha values (.67 to .94), which indicated high scale reliabilities. The composite reliability (CR) of our reflective constructs was greater than the recommended minimum of .6, ranging from .67 to .94, which suggests strong convergent validity. In addition, all factor loadings were statistically significant at $p < .01$. To test for discriminant validity, we applied Fornell and Larcker's (1981) rigorous criterion. The average variances extracted (AVE) ranged from .50 to .79 and were greater than the respective shared variances between any two specific constructs. Thus, discriminant validity was not an issue. Table 2 exhibits the correlation coefficients, AVEs, shared variances, means, and standard deviations for the study variables; the full list of constructs, corresponding items, sources, and Cronbach's alpha, CR, and AVE values is in Table 4-5.

Table 4-2: Descriptive Statistics and Correlations (Study 1)

Variables	1	2	3	4	5	6	7	8	9	10	11	12
1 Highly interactive OIA	<u>n/a</u>	.34	.16	.11	.24	.09	.53	.19	.16	.04	.07	.01
2 Weakly interactive OIA	.58	<u>n/a</u>	.05	.16	.30	.12	.66	.21	.09	.02	.19	.01
3 Technological alignment	.40	.22	<u>.79</u>	.22	.28	.07	.06	.12	.15	.11	.02	.00
4 Relational alignment	.33	.40	.47	<u>.60</u>	.23	.08	.09	.10	.03	.00	.09	.00
5 Adaptiveness	.49	.55	.53	.48	<u>.55</u>	.08	.20	.29	.16	.10	.06	.00
6 Innovation success	.30	.35	.26	.29	.28	<u>.62</u>	.08	.18	.10	.01	.62	.00
7 Breadth of OI activities	.73	.81	.24	.30	.45	.29	<u>n/a</u>	.17	.08	.01	.10	.02
8 Market-related dynamism	.44	.46	.35	.31	.54	.42	.41	<u>.64</u>	.36	.18	.10	.00
9 Technological turbulence	.40	.30	.39	.17	.40	.32	.29	.60	<u>.55</u>	.19	.06	.00
10 Competitive intensity	.20	.15	.33	.01	.32	.09	.12	.43	.44	<u>.54</u>	.00	.00
11 R&D intensity	.26	.44	.15	.30	.24	.79	.32	.31	.25	-.03	<u>n/a</u>	.00
12 Firm size	.08	.08	.03	-.02	-.03	-.03	.13	.00	.07	-.04	-.02	<u>n/a</u>
Mean	4.12	3.27	5.03	4.45	5.10	2.88	3.06	4.46	4.45	4.92	2.25	8596
Standard Deviation	1.56	1.79	1.17	1.12	1.01	1.70	1.28	1.15	1.18	1.01	1.70	36961

Notes: N = 181; correlations are reported in the lower half of the matrix; $r > .15, p = .05$; $r > .19, p = .01$. The underlined elements on the diagonal are the average variances extracted for constructs measured reflectively with multiple items. The shared variances appear in the upper half of the matrix. OIA = open innovation activities.

4.4.4 Hypotheses Testing Procedure

To test our direct and moderating effects hypotheses, we performed two regression analyses. In the first, we tested H1, H2, H4, and H5 and employed hierarchical multiple regression analysis (Aiken and West 1991; Cohen et al. 2003). In the initial step of this first regression analysis, we ran a model with the control variables (Model 1). Then in a second step, we ran a model that also included the direct effects of highly and weakly interactive OI activities (Model 2). In the following steps (Models 3–6), we included each of the four interaction terms of highly and weakly interactive OI activities with technological and relational alignments separately, to test for moderating effects. Finally, in Model 7, we included all interaction terms at once. Our empirical model for the first regression analysis is as follows:

$$\text{Adaptiveness} = \beta_0 + \beta_1 \text{HI_OIA} + \beta_2 \text{WI_OIA} + \beta_3 \text{TA} + \beta_4 \text{RA} + \beta_5 \text{HI_OIA} \times \text{TA} + \beta_6 \text{HI_OIA} \times \text{RA} + \beta_7 \text{WI_OIA} \times \text{TA} + \beta_8 \text{WI_OIA} \times \text{RA} + \beta_9 \text{Breadth_OIA} + \beta_{10} \text{MRD} + \beta_{11} \text{TT} + \beta_{12} \text{CI} + \beta_{13} \text{R\&D intensity} + \beta_{14} \text{Firm size} + \beta_{15-19} \text{Industry (Dummies)} + \text{Error},$$

Where

HI_OIA	= Highly interactive OI activities
WI_OIA	= Weakly interactive OI activities
TA	= Technological alignment
RA	= Relational alignment
MRD	= Market-related dynamism
TT	= Technological turbulence
CI	= Competitive intensity

In the second regression analysis, we tested H3 (Bascle 2008; Wooldridge 2008). Specifically, we estimated the coefficients and tested for potential endogeneity by applying two-stage least squares (Bascle 2008; Larcker and Rusticus 2010; Wooldridge 2008). In accordance with our research design, we selected competitive intensity as an appropriate exogenous instrumental variable: It should be highly correlated with adaptiveness but not with the error terms of innovation success. We also conducted tests to ensure its strength and validity as an instrumental variable (see the Results section and Table 4). Our empirical model for the second regression analysis is as follows (i.e., empirical formula for the second stage of the two-stage least squares regression; see the Results section for details):

$$\text{Innovation success} = \beta_0 + \beta_1 \text{Adaptiveness} + \beta_2 \text{R\&D intensity} + \beta_3 \text{Firm size} + \beta_{4-8} \text{Industry (Dummies)} + \beta_9 \text{Standardised residual} + \text{Error.}$$

Both the first and second regression analyses were estimated using IBM SPSS Statistics 24. We applied mean-centering to all independent and control variables, to facilitate their interpretation (Cohen et al. 2003). To compute the interaction terms, we multiplied the mean-centered values of the corresponding constructs (Atuahene-Gima et al. 2005). To measure the effect size, we use Cohen's r (Pearson's correlation) and partial η^2_p (variance explained by the effect) as standardised, objective measures of the continuous variables (Cohen 1988).

To test for multicollinearity (Aiken and West 1991), we calculated the variance inflation factors, which were all below 4 (Hair et al. 2013) for all main variables, so multicollinearity does not appear to be an issue. By validating managers' assessments of the dependent variable with objective financial performance measures, the research design already had reduced the threat of common method bias (Podsakoff et al. 2003), but we also conducted empirical tests to confirm it. First, we applied Harman's single-factor test, which indicates that common method bias exists only if one general factor accounts for the majority of the variance in a factor analysis (Podsakoff et al. 2003), which was not the case in this study. Second, we conducted a marker variable test according to Lindell and Whitney's (2001) approach, using the years the respondent had been working in the current position as a marker variable, which theoretically should not correlate with the dependent variables. All correlations remained significant after we controlled for the marker variable's effect, except for that between technological alignment and R&D intensity, which was significant at the 10% level after the correction. The mean correlation coefficient of the marker variable with all other variables in the study framework was $-.07$. Third, Podsakoff et al. (2012) suggest testing for common method bias by adding instrumental variables to the model and conducting a two-stage regression analysis (e.g., Bascle

2008), as we did to test the link between adaptiveness and innovation success (see the Results section). All three tests affirm that common method bias was not a threat to our study.

Because the respondents in the sample represent different hierarchical levels, we checked for potential key informant bias by looking for potential mean differences between managing directors at the top management level (45.3%) and other R&D, innovation, and product managers at lower levels (54.7%). The t-tests of the means revealed no significant differences between these two informant groups, so key informant bias should not be a concern.

4.5 Results

We present the step-wise development of the first regression model, including the standardised regression coefficients and their significance levels, in Table 4-3. Moving from Models 1 and 2 to Models 3–7 (i.e., models with interaction effects), the exploratory power increases significantly with each step. The adjusted R-square in the final Model 7 is fairly high ($R^2_{\text{adj}} = .55, p < .01$), such that we can explain 55% of the total variance in our dependent variable.

For the main effect hypotheses, we find support for H1, which predicted a positive relationship between highly interactive OI activities and adaptiveness ($\beta = .18, p < .05$). The values of the effect size are medium ($r = .49; \eta^2_p = .03, p < .01$) (Cohen, 1988). Weakly interactive OI activities also exert a positive influence on adaptiveness ($\beta = .34, p < .01$), in support of H2, with fairly high effect sizes ($r = .55; \eta^2_p = .07, p < .01$) (Cohen 1988).

For the moderating effects hypotheses, we turn to Models 3–6. We find support for the moderating effect in H4a; the link between highly interactive OI activities and adaptiveness is positively moderated by technological alignment ($\beta = .12, p < .05$), which suggests some interesting implications for companies that engage in OI. According to Cohen (1988), these effect sizes are medium ($r = .60; \eta^2_p = .01, p < .05$). We do not find support for H4b though. Relational alignment has no moderating effect on the link between highly interactive OI activities and adaptiveness ($\beta = -.02, \text{ns}$), so relational alignment does not increase the effectiveness of weakly interactive OI activities for adaptiveness.

Technological alignment also does not negatively moderate the link between weakly interactive OI activities and adaptiveness, as we predicted in H5a ($\beta = .02, \text{ns}$). We find a significant, negative moderating effect of relational alignment though, in line with H5b ($\beta = -.17, p < .01$), suggesting that relational alignment significantly harms the effectiveness of weakly interactive OI activities for adaptiveness. The effect size is medium ($r = .40; \eta^2_p = .03, p < .01$).

Table 4-3: Results, First Regression Analyses (Study 1)

Dependent Variable	Adaptiveness						
	Model 1	Model 2	Model 3	Model 4	Model 5	Model 6	Model 7
Control Variables							
Breadth of OI activities	.22**	-.04	-.10	-.03	-.05	.01	-.08
Market-related dynamism	.37**	.27**	.23**	.21**	.24**	.20**	.19**
Technological turbulence	.07	.04	.00	.05	.00	.06	.02
Competitive intensity	.07	.10	.03	.13	.03	.17*	.12
R&D intensity	.04	-.04	-.04	-.08	-.05	-.07	-.04
Firm size	.07	.04	.04	.04	.04	.04	.04
Chemicals/pharmaceuticals	.03	.00	-.03	.00	-.01	.02	-.02
Machinery/electronics	.02	.02	.00	.04	.00	.02	-.01
Software/IT	-.08	-.02	.00	.00	-.02	.00	.02
Retail/consumer goods	.11	-.02	.07	-.03	.07	-.02	.05
Services	.00	.07	.02	.04	.12	.01	-.01
Technological alignment (TA)			.37**		.34**		.27**
Relational alignment (RA)				.28**		.26**	.17**
Main Effects							
H1: Highly interactive OI activities (HI_OIA)		.18*	.10	.13	.08	.12	.12
H2: Weakly interactive OI activities (WI_OIA)		.34**	.38**	.29**	.36**	.29**	.35**
Interaction Effects							
H4a: HI_OIA × TA			.12*				.20**
H4b: HI_OIA × RA				-.02			.02
H5a: WI_OIA × TA					.02		.01
H5b: WI_OIA × RA						-.17**	-.24**
R ²	.37	.45	.54	.51	.53	.53	.60
Adjusted R ²	.33	.40	.50	.46	.49	.49	.55
F-Value	8.88**	10.40**	12.97**	11.37**	12.39**	12.54**	12.62**
Incremental R ²	.37	.08	.09 ^a	.06 ^a	.08 ^a	.09 ^a	.15 ^a
F-Value for incremental R ²	8.88**	12.27**	16.84*** ^a	10.21*** ^a	14.45*** ^a	15.05*** ^a	10.08*** ^a
N	181	181	181	181	181	181	181

Notes: Standardised regression coefficients are reported. * $p < .05$. ** $p < .01$. Two-tailed tests.

^aValues of incremental R² and F-value for incremental R² of Model 3–7 refer to Model 2 of the regression analysis.

Finally, to complete the hypothesised causal chain, we conducted a second regression analysis to test the adaptiveness–innovation success relationship (H3). The results appear in Table 4-4. In estimating this causal relationship, we contemporaneously checked for potential endogeneity by applying a two-stage least squares regression with instrumental variables (Bascle 2008; Larcker and Rusticus 2010; Wooldridge 2008), with the recognition that endogeneity could arise from omitted variables. That is, some unobservable effects might influence innovation success, so we used competitive intensity as an exogenous instrumental variable, which should be highly correlated with adaptiveness but not with the error terms of innovation success. Companies in highly competitive environments are forced to be adaptive to remain competitive (Eisenhardt and Tabrizi 1995), such that they regularly monitor changes in markets and technologies and adopt new marketing practices and technologies. This increased adaptiveness

should result in more innovation (Tuominen et al. 2004). Yet competitive intensity cannot influence innovation success directly; this external condition is not affected by our focal study variables, so we consider it exogenous and valid (Wooldridge 2008). In the first step of the two-stage regression, we regressed our potentially endogenous independent variable (adaptiveness) on all exogenous independent variables (control variables) and the instrumental variable (competitive intensity). We saved the standardised residuals of this first-stage regression in a single, new residual variable. With this step, we confirmed competitive intensity's strength as an instrumental variable, according to Staiger and Stock's (1997) test, which requires the F-value in the first-stage regression to exceed 10. In our case, the F-value is 20.3, so we can reject the null hypothesis that competitive intensity is a weak instrument.

After confirming the strength and validity of the instrument, we carried out the second step of the two-stage least squares regression (Larcker and Rusticus 2010) by running a regression with endogenous (adaptiveness) and exogenous (control variables) independent variables on our dependent variable (innovation success), while also including the residual variable as an independent variable to control for its effect. As we show in Table 4, the results indicate a good overall model fit ($F = 34.76, p < .001$). We find a positive, significant effect of adaptiveness on innovation success ($\beta = .36, p < .05$), in line with prior research (e.g., Akgün et al. 2012; Tuominen et al. 2004). The effect size is slightly lower than the previous effects in our model ($r = .28; \eta^2_p = .01, p < .05$). We also checked for endogeneity with a control function approach (Lee 2007; Liu et al. 2016), in which the residual terms from the first-stage regression are included in the second-stage regression. The significance levels of the residuals enable us to test for the presence of endogeneity (Liu et al. 2016). Because the residuals of the control function are not significant ($\beta = .26, ns$), endogeneity does not appear to be a concern for this study. To ensure the robustness of our results, we ran a further two-stage regression with objective profit data as the dependent variable ($N = 64$). This analysis yielded the same results as the two-stage regression with the subjective four-item measure for innovation success, such that we find a positive and significant effect of adaptiveness on innovation success ($\beta = .79, p < .05$). Furthermore, the control effect of the residual variable again is not significant, so endogeneity does not appear to be a concern. Altogether, we find strong robustness for our results.

Table 4-4: Results, Second Regression Analyses (Study 1)

Dependent Variable	Innovation Success
Control Variables	
R&D intensity	.69**
Firm size	-.05
Chemicals and pharmaceuticals	-.12
Machinery/electronics	.10
Software/IT	.09
Retail/consumer goods	-.05
Services	-.05
Standardised residual	-.26
Main Effect	
H3: Adaptiveness	.36*
R ²	.62
Adjusted R ²	.60
F-Value	34.76**
N	181

Notes: Standardised regression coefficients are reported. * $p < .05$. ** $p < .01$. Two-tailed tests.

4.6 Discussion

To adapt to changing technological and market conditions, firms collaborate with external partners and perform OI activities. But not all firms profit equally from OI activities in terms of their adaptiveness. This difference likely depends on the influences of different types of partner alignment. We investigate how firms must arrange their technological and relational partner alignments to realize the full potential of their highly and weakly interactive OI activities to foster their adaptiveness and thus their innovation success. The results provide implications for academics, practitioners, and policy makers regarding when alignments will cause different types of OI activities to thrive or fail.

4.6.1 Implications for Research

This study provides new insights for research into the factors that influence OI activities and their effectiveness (e.g., Cheng and Huizingh 2014; Du et al. 2014), in that we propose and confirm that alignment with collaboration partners is a key determinant of the effectiveness of OI activities. Addressing evidence in extant literature that partner alignment may be either beneficial (e.g., Green et al. 2012) or detrimental (e.g., Santos and Eisenhardt 2005) for OI activities, we confirm that different types of alignment can make OI activities with different interaction intensities thrive or fail, in terms of the effects on adaptiveness. We thus resolve some substantial inconsistencies in extant research. The results of our moderating effects hypotheses also offer interesting implications. As exhibited by the positive moderating effect

of technological alignment on the link between highly interactive OI activities and adaptiveness, alignment can foster the effectiveness of OI activities in terms of adaptiveness and innovation success if it is applied to appropriate OI activities. But alignment also can harm the effectiveness of OI activities, as when relational alignment is applied to weakly interactive OI activities, so we extend current knowledge about the detrimental aspects of alignment. Examining the different types of alignment as conditions that make different kinds of OI activities thrive or fail helps explain the inconsistent findings in prior research regarding the positive and negative performance implications of alignment (e.g., Santos and Eisenhardt 2005; Tan et al. 2009).

Building on this implication, our findings suggest that interaction intensity is a distinctive characteristic of OI activities (Dangelico et al. 2013; Lee et al. 2001). Overall, interaction intensity involved in OI activities determines the types of alignment needed to foster adaptiveness and innovation success. If the firm engages in highly interactive activities, technological alignment is highly beneficial, but striving for relational alignment is not important. If it features weakly interactive activities, alignments do not offer any benefits, and relational alignment even harms the firm's ability to adapt to change. These findings are consistent with extant research that suggests that weakly interactive OI activities are broader in scope and aim for more distant knowledge, such that alignments are unnecessary (e.g., Piezunka and Dahlander 2015). Thus, our distinction between highly and weakly interactive OI activities provides a more detailed view of how different types of alignment might foster effectiveness. Accordingly, our study advances and challenges research that suggests firms should strive to achieve the same type of alignment across all OI activities they perform (e.g., Green et al. 2012; Seggie et al. 2006).

We extend the theoretical basis for OI research by drawing on SNT (Coleman 1988; Granovetter 1973) and proposing a new theoretical mechanism based on knowledge integration and flexibility. This mechanism explains how firms can leverage the benefits of different types of network structure (strong and weak ties) by arranging network attributes to foster adaptiveness. The alignments with collaboration partners represent network attributes that characterize the relationships among network members and that firms can use to maximize the benefits of their strong and weak ties (Borgatti and Halgin 2011). Not all types of network attributes combine beneficially with all types of network structure, so more attention should focus on the specific arrangement of network attributes. Our proposed theoretical mechanism, based on knowledge integration and flexibility, suggests ways to arrange alignments, as attributes, according to the strength of ties. We find partial support for the notion that

alignments foster knowledge integration from strong ties for adaptiveness, as suggested by SNT (Tiwana 2008), though only for technological alignment, not for relational alignment. We also find partial support for the proposition rooted in SNT that alignments keep firms from leveraging the benefits of flexibility attained from weak ties. Although true for relational alignment, technological alignment does not harm firms' flexibility and thus adaptiveness. These insights can inform research that seeks to examine the interplay of network structure and network attributes and its performance implications (e.g., Li et al. 2013).

4.6.2 Implications for Managerial Practice

Substantial literature advocates for the benefits of alignment as a means to enhance performance (Lavie et al. 2012; Murphy et al. 2015). As we show, when applied to the right OI activities, aligned firms can exhibit higher adaptiveness. Yet these alignments in combination with different OI activities might be detrimental too, especially for the longer-term goal of fostering adaptiveness, beyond enhancing immediate collaboration performance. When firms perform highly interactive OI activities (e.g., cocreation and cooperation with research institutes), they should strive for technological alignment with their partners to enhance their adaptiveness. Complementarity in technologies and resources will allow the firms to integrate the collectively generated knowledge and use it to foster their adaptiveness. Managers also should realize that, for adaptiveness, it is not important whether partners match in their goals, cultures, or business practices if they already engage in highly interactive OI activities. Relational alignment might invoke greater inertia in the relationships, preventing partners from viewing certain issues differently (Santos and Eisenhardt 2005; Sapienza et al. 2004). Therefore, the expected positive outcomes of aligning goals and cultures when performing highly interactive OI activities may not occur. Firms do not need to devote effort to achieving relational alignment with their OI partners, though it does no real harm.

For firms that perform weakly interactive OI activities (e.g., in-licencing, spin-offs), technological alignment is neutral, without impairing flexibility. If partners have technological complementarity, they might acquire mainly complementary inputs, but they still might also access some distant inputs that broaden their firms' technology portfolio. That is, technological alignment does not hamper firms' flexibility. In contrast, firms explicitly should not seek relational alignment with OI partners if they perform weakly interactive OI activities, because it significantly harms their adaptiveness. When the goals and organizational cultures of the partners are aligned, they share the same mind-set, which reduces their openness to new and distant knowledge (Crescenzi et al. 2016; Piezunka and Dahlander 2015). Managers should

avoid aligning their goals and cultures with partners in weakly interactive activities, so that they can remain flexible and acquire novel information about technologies and markets, which is crucial for their adaptiveness and innovation success.

Firms' ability to adapt to changing technological and market environments also is an increasingly pertinent concern for policy makers. They need to be aware that emerging technologies and markets can prompt considerable changes, to which firms must adapt. Due to the increasingly turbulent environments and increased openness and interconnectedness of the modern world (Baker et al. 2015; Roy and Sivakumar 2010), firms are forced to collaborate to foster their adaptiveness. Increased policy attention therefore should be devoted to how firms with OI activities can foster their adaptiveness. Policy makers might avoid imposing alignment requirements on in-licencing and spin-off agreements. For example, they should support spin-off initiatives by partners with diverse organizational goals and cultures, to foster these collaborating firms' adaptiveness and innovation success. Programs and initiatives that help firms find research institutes or cocreation partners with complementary technologies instead might be more helpful for increasing firms' adaptiveness.

4.6.3 Limitations and Avenues for Further Research

The present study contains several limitations that suggest avenues for further research. First, our aim was to investigate how different types of partner alignment can cause OI activities with different interaction intensities to thrive or fail, in terms of their effects on adaptiveness. Enhancing adaptiveness and innovation success are long-term goals for most companies, but in the short term, firms might pursue other goals through their collaboration, such as an efficient execution of OI projects. Researchers might attempt to link the combinations of OI activities and alignments with other outcomes, perhaps by modeling time effects and considering both short- and long-term outcomes in one study. Such an approach might further refine and clarify the performance implications for firms that strive for partner alignment.

Second, this study does not examine the reasons firms engage in external collaboration or perform specific OI activities, such as whether they strive to acquire a particular type of resources, are working with already existing collaboration partners, or have previous experience with certain OI activities. The implications thus are mainly pertinent for firms planning new OI activities and those that have made the decisions but want to execute their ongoing OI activities more effectively. Further research might investigate factors that influence the choice of a particular OI activity, to provide insights into the effective management of such activities, including the optimal partner alignment forms.

Third, we cannot offer conclusions about the performance outcomes for firms with OI activities and a specific partner alignment over time. A longitudinal approach may help determine whether different types of alignment might be more or less important for firms, depending on the duration of their OI activities. For example, when firms perform in-licencing over a longer period, combining it with technological complementarity might be neutral in the short term, as in our study, but beneficial for their adaptiveness in the longer term, by helping firms avoid overloading their technology portfolio. A longitudinal perspective could offer valuable insights into the possible causes of changes in the moderating effects of alignments over time.

4.7 Appendix

Table 4-5: Measures and Measurement Properties (Study 1)

Construct	Items	α/CR/AVE
Highly Interactive Open Innovation Activities ^{a)} (adapted from Chesbrough and Brunswicker 2013)	To what degree has your company performed the following open innovation activities over the last 3 years? If a particular OI activity has not been performed by your company please select the option “not used”. - Cocreation - Cooperation with research institutes	.67/.67/.50
Weakly Interactive Open Innovation Activities ^{a)} (adapted from Chesbrough and Brunswicker 2013)	To what degree has your company performed the following open innovation activities over the last 3 years? If a particular OI activity has not been performed by your company please select the option “not used”. - In-licencing (patents, copyrights, trademarks) - Spin-offs	.78/.78/.64
Technological Alignment ^{b)} (based on Emden et al. 2006; Lambe et al. 2002)	Our open innovation partners have an innovative technology or an expertise in a certain field. Our company and our OI partners contribute different resources to the relationship that help us achieve mutual goals. Our company and our OI partners have complementary strength that are useful to our relationship. Our company and our OI partners each have separate abilities that, when combined together, enable us to achieve goals beyond our individual reach.	.94/.94/.79
Relational Alignment ^{b)} (based on Lui and Ngo 2012; Simonin 1999)	The business practices and operational mechanisms of your OI partners are very similar to yours. The corporate culture and management style of your OI partners is very similar to yours. We and our OI partners have the same long-term plans and goals for our relationship.	.81/.81/.60
Adaptiveness ^{b)} (Akgün et al. 2012)	Technology Adaptiveness: We have ability to capture technical capabilities. We have ability to monitor technical changes. We have ability to get access to desired technologies. We have ability to achieve technical complementarity. We have ability to avert potential risks. Market Adaptiveness: We have capability to regularly monitor changes in our markets. We have capability to frequently adopt new marketing techniques. We have capability to continuously monitor competitors’ actions. We have capability to allocate a substantial part of our resources to marketing practices. We have capability to give close attention to after-sales services.	.92/.92/.55
Innovation Success ^{c)} (based on Bianchi et al. 2015; Hottenrott and Lopes-Bento 2016)	Number of commercialised new products over the last three years expressed as a percentage of all products of the company Number of products generated and commercialised from open innovation projects expressed as a percentage of all products of the company over the last three years Sales growth of new products Sales growth of OI products	.86/.86/.62

Control Variables:

Breadth of OI Activities ^{d)} (Laursen and Slater 2006)	-/-/-
- Cocreation	
- Cooperation with research institutes	
- In-licencing (patents, copyrights, trademarks)	
- Spin-offs	
Market-Related Dynamism ^{b)} (Stock and Zacharias 2011)	.90/.90/.64
In our market, major changes occur frequently in the area of... products offered by our competitors. Market development strategies of our competitors. Customer preferences in product features. Customer preferences in product quality/price relationship. New competitors.	
Technological Turbulence ^{b)} (Jaworski and Kohli 1993)	.80/.84/.55
The technology in this industry is changing rapidly. Technological changes provide big opportunities in our industry. It is very difficult to forecast where the technology in our industry will be in the next 2 to 3 years. A large number of new service ideas have been made possible through technological breakthroughs in our industry. Technological developments in our industry are rather minor. ^{e)}	
Competitive Intensity ^{b)} (Jaworski and Kohli 1993)	.84/.86/.54
Competition in our industry is cutthroat. There are many “promotion wars” in our industry. Anything that one competitor can offer, others can match readily. Price competition is a hallmark of our industry. One hears of a new competitive move almost every day. Our competitors are relatively weak. ^{e)}	

Notes: α : Cronbach's alpha. CR: Composite reliability. AVE: Average variance extracted.

a) Items measured with seven-point rating scales, with anchors at 1 = “not used” and 7 = “very high degree of use.”

b) Items measured with seven-point rating scales, with anchors at 1 = “strongly disagree” and 7 = “strongly agree.”

c) Items measured with nine-point scales, with anchors at 1 = “0–10%” and 9 = “more than 80%.”

d) Each OI activity coded as a binary variable, 0 = “not used” and 1 = “used.” The construct represents the sum of the four binary variables.

e) Reversed item.

5 Study 2 – Structural and Relational Network Characteristics as Determinants for Managing Upsides and Downsides of Open Innovation Relationships²

5.1 Introduction to Study 2

Companies build relationships with many types of partners, including customers, competitors, and research institutes, in order to acquire needed resources and complement their internal innovation endeavors (Berchicci 2013; Chesbrough 2003). Because of the opportunities that attend these so-called open innovation (OI) relationships, most companies seek them out and engage in OI to at least some degree (Chesbrough 2003). As firms have gained experience in OI, they have discovered increasing numbers of ways to profit from external resources, with the result that many firms perform multiple OI activities—such as crowdsourcing, cooperation with suppliers, forming alliances, and in-licencing—simultaneously (Cheng and Huizingh 2014; Laursen and Salter 2006). As a consequence, firms become embedded in a complex nexus of OI relationships with a series of OI partners (Capaldo 2007; Iacobucci and Hoeffler 2015). Because of the diverse nature of such relationships, their effective management is challenging for firms.

To profit from OI relationships, firms have to handle both their upsides and their downsides. In this context, the greatest challenge refers to performing two tasks effectively: benefitting from OI's upsides by acquiring partners with maximum potential to offer valuable resources and exploiting these resources during collaboration (Pemartin, Rodriguez-Escudero, and Munuera-Aleman 2017), and minimizing OI's downsides by finding partners that are unlikely to behave opportunistically and managing such behaviours when they occur (Lokshin, Hagedoorn, and Letterie 2011). Aligning these two tasks across multiple OI relationships is fairly difficult.

² This chapter is based on a joint working paper (together with Nicolas A. Zacharias), this paper received the Technology and Innovation Management Research Award 2016 from the Förderkreis Gründungs-Forschung e.V.

Because countless success stories, including those of Procter & Gamble, General Electric, Lego, and Samsung (Lindegaard 2014), emphasize OI's positive side, managers are usually aware of OI's upsides and appear to be more skilled in the first task of managing those upsides. However, because companies have little interest in publishing their failures, information about failed OI activities is less common, so managers tend to be less aware of the downsides of OI relationships—particularly partners' opportunistic behaviour (Hottenrott and Lopes-Bento 2016). Opportunistic behaviour refers to breaching the norms of a business relationship through behaviours like manipulation of the collaboration's operations, doing things other than promised, and doing things to assert one's own interests over the interests of the collaboration (Das and Teng 2001; Ganesan et al. 2010). For example, Cisco suffered two failed alliances, one with Motorola and one with Ericsson, because the collaborating partners' incompatible objectives led them to pursue their own interests. In both cases, Motorola and Ericsson acquired young companies that offered products similar to Cisco's and eventually became competitors (Arndt 2009). Even though partners' such opportunistic behaviour is a serious matter for firms and can lead to loss of knowledge and markets (Gnyawali and Park 2011), abstaining from OI is no longer a viable choice in an increasingly open world (Baker, Grinstein, and Harmancioglu 2015; Roy and Sivakumar 2010). Therefore, managers need to know how to manage the threat of opportunistic behaviour in order to profit from the external resources that OI relationships offer.

From a more academic perspective, Dahlander and Gann (2010) and Hottenrott and Lopes-Bento (2016) note that almost all published research on OI focuses on its potential benefits, although some studies in the OI research stream mention the downsides. For example, Laursen and Salter (2006), Jean, Sinkovics, and Hiebaum (2014), and Hottenrott and Lopes-Bento (2016) are among the first scholars to show that the benefits of OI have decreasing returns that result primarily from high transaction costs (e.g., Berchicci 2013; Christensen, Olesen, and Kjær 2005) and knowledge leaks (e.g., Fu 2012; Laursen and Salter 2014; Mina, Bascavusoglu-Moreau, and Hughes 2014).

Whereas the extant OI research only sporadically mentions partners' opportunistic behaviour, alliance research, which focuses on dyadic firm-firm collaboration, goes farther in addressing opportunistic behaviour as the main downside of collaboration (e.g., Das and Teng 2001; Kale, Singh, and Perlmutter 2000; Krishnan, Geyskens, and Steenkamp 2016; Oxley and Sampson 2004). For example, a few studies identify factors like over-formalization (e.g., Walter, Walter, and Müller 2014) and short-term orientation (e.g., Wu 2012) that foster opportunistic behaviour in alliances. Other studies offer clues as to how firms can buffer opportunistic behaviour by,

for example, introducing open communication and establishing durable relationships (e.g., Walter, Walter, and Müller 2014; Wu 2012). Although alliance research offers some useful information, deeper investigation of opportunistic behaviour and its countermeasures remains largely missing in the OI context (Faems et al. 2010), and only recently have authors acknowledged that examining the downsides of OI relationships is a research gap that should be addressed (Dahlander and Gann 2010). As Chesbrough (2015) made clear in a recent interview, “further research still needs to be done to document the risks of open innovation.”

Considering both the relevance to practice and the state of the art in the OI research domain, OI relationships should be examined from a holistic perspective by considering both the upsides and the downsides of OI relationships, including research on opportunistic behaviour in these relationships. Therefore, this study seeks to answer the key question: *How should firms manage OI relationships in order to deal simultaneously with these relationships’ downsides in terms of opportunistic behaviour while using the full potential of their upsides in terms of resource acquisition?*

To answer this research question comprehensively, we consider the contingency effects of structural and relational network characteristics on the relationship between the upsides and the OI product’s performance and that between the downsides and the OI product’s performance. Based on the relational view and insights from network theory, we employ as contingency factors network centrality as a structural network characteristic, and knowledge protection as a relational network characteristic. Firms that occupy a central position with strong ties to other OI network members or that use processes that govern and protect their proprietary knowledge (Carson and John 2013; Jean et al. 2014) may be more able to deal with opportunistic behaviour (Li, Veliyath, and Tan 2013). However, by protecting their knowledge, firms might impede their OI opportunities in terms of resource acquisition, which refers to the extent to which firms are able to acquire important resources from their OI partners (Leenders and Dolfsma 2015).

In answering the central research question, this study makes three primary contributions to the literature and practice. First, we apply a holistic relational perspective by addressing opportunistic behaviour in OI relationships along with the opportunities for resource acquisition. In so doing, we extend the OI literature stream, which has neglected the “dark side” of OI (e.g., Cheng and Huizingh 2014; Chiang and Hung 2010). Managers need a comprehensive view to understand both the upsides and downsides of OI relationships before they can implement and conduct OI successfully (Faems et al. 2010). Moreover, we also provide a holistic perspective by focusing on the entire nexus of OI relationships that a firm

holds with its innovation partners as the central phenomenon. Thereby, we contribute to the OI research, which has concentrated primarily on how to ensure the success of single OI activities (e.g., Chai and Shih 2016; Xu, Wu, and Cavusgil 2013). Hence, we offer guidance to managers concerning how to manage their innovation networks to create network-based value.

As a second contribution, this study integrates the relational view (Dyer and Singh 1998; Lavie 2006) and network theory (Ahuja 2000; Gulati 1999), thereby linking theoretically the extant research on the relationships between network characteristics and innovation output to the OI literature (e.g., Almirall and Casadesus-Masanell 2010; Li et al. 2013). In particular, we develop theoretical mechanisms to explain how structural and relational network characteristics simultaneously influence the negative relationship between opportunistic behaviour and OI product performance and the positive relationship between resource acquisition and OI product performance. These efforts complement research that focuses on the benefits of network resources but does not examine network characteristics or their interference with the downside of OI relationships—partners' opportunistic behaviour (e.g., Demirkan, Deeds, and Demirkan 2013; Li et al. 2013; Wang and Li-Ying 2015).

Third, by building on alliance research (e.g., Kale et al. 2000), this study identifies potential remedies for opportunistic behaviour in OI relationships. As the results from alliance research regarding how to manage opportunistic behaviour in interfirm alliances could apply only partly to the case of OI relationships, we fill a gap in the OI literature by identifying potential solutions and countermeasures (Faems et al. 2010). Managerial practice shows that firms frequently abstain from pursuing big, high-risk opportunities (Cooper 2011) when they lack information about effective ways to deal with the downsides associated with the OI relationships that are necessary to grasp such opportunities. By systematically examining network centrality (Ahuja 2000) and knowledge protection (Jean et al. 2014) as countermeasures for opportunistic behaviour, we provide evidence that firms must carefully implement countermeasures so that they do not impede firms' ability to acquire needed resources from OI relationships.

5.2 Theoretical Background – Aligning Social Network Theory with Relational View

The relational view (Dyer and Singh 1998; Lavie 2006) and social network theory (further: network theory; Ahuja 2000; Freeman 1979; Granovetter 1973) both offer explanations for the impact of external collaboration on firms' competitive advantages (Lavie 2006; Mesquita Anand, and Brush, 2008). The relational view centers on the accumulation of relational rents between partners on a strategic level (Dyer and Singh 1998), while network theory establishes

a set of opportunities and constraints on rent accumulation based on the firm's network position (Lavie 2006).

In more detail, the relational view proposes that resources that are embedded in interfirm links lead to relational rents, or "supernormal profit jointly generated in an exchange relationship that cannot be generated by either firm in isolation" (Dyer and Singh 1998, p. 662). Network partners jointly generate relational rents through synergetic combinations of their complementary resources and by adopting a governance structure that facilitates resource-sharing (Dyer and Nobeoka 2000; Dyer and Singh 1998; Mesquita et al. 2008) and increases the potential for rent accumulation (Lavie 2006). According to the relational view, one source of relational rents is the ability to acquire complementary resources and capabilities (Dyer and Singh 1998), and this ability depends on the firm's network position. For example, firms in central network position have better access to resources and it is easier to find the right partners, so they can increase the efficiency of their interfirm resource exchanges because of their high volume of interfirm transactions, which then fosters their ability to generate relational rents (Dyer and Nobeoka 2000; Dyer and Singh 1998). Network partners can also increase their share of rents by behaving opportunistically because collaboration contracts are usually incomplete (Lavie 2006). Therefore, firms may invest in isolating mechanisms, such as knowledge protection efforts, to prevent unwanted diffusions of the rents (Kale et al. 2000; Lavie 2006). That is, firms employ processes and legal remedies to determine the scope of shared resources (Lavie 2006) and increase their potential to generate relational rents (Dyer and Singh 1998).

Although network theory is consistent with the relational view in these propositions (Ahuja 2000; Freeman 1979; Granovetter 1973), it adds insights regarding how resource acquisition, opportunistic behaviour, and network characteristics jointly influence rent accumulation (Lavie 2006). In specific, network theory seeks to explain how different network characteristics influence certain effects (Borgatti and Halgin 2011). Network theorists distinguish structural characteristics (e.g., network centrality, network size) and relational characteristics (e.g., knowledge protection, trust) that determine how firms generate rent and foster their performance in OI contexts (e.g., Hoffmann 2007; Lavie, Haunschild, and Khanna 2012; Lavie and Miller 2008). Network theory cites network centrality as a key determinant of firms' ability to gain access to diverse network resources (Li et al. 2013) and cites knowledge protection as an important mechanism for avoiding partners' opportunistic behaviour (Jean et al. 2014).

The insights from both the relational view and network theory provide a theoretical basis that helps to clarify inter-organizational competitive advantages (Dyer and Singh 1998). Both

theories suggest that OI offers opportunities for resource acquisition but that it is also prone to opportunistic behaviour, which could be addressed through network centrality and knowledge protection. The extant research applies these theories to the investigation of how firms can extract value from network resources, generally identifying opportunistic behaviour as a source of rent erosion but not explicitly operationalizing it (e.g., Dobrzykowski, Callaway, and Vonderembse 2015; Mesquita et al. 2008; Wang and Li-Ying 2015). Therefore, we apply the relational view and network theory in a new way to derive our study's framework and hypotheses.

5.3 Framework and Hypotheses

5.3.1 Study Framework

Figure 5-1 illustrates the study's framework, which acknowledges that OI relationships have both upsides and downsides. Upsides relate to the potential resource acquisition from OI relationships, while downsides relate to partners' opportunistic behaviour. Our framework recognizes that the effects of these two facets of OI relationships on OI product performance can differ to be beneficial in the case of resource acquisition and detrimental in the case of opportunistic behaviour. To determine how firms should deal with these two sides of OI relationships to foster their OI product performance, we consider the moderating effects of structural network characteristics (network centrality) and relational network characteristics (knowledge protection) on the relationship between the upside and the OI product performance and that between the downside and the OI product performance. We also predict that OI product performance relates to the firms' market success because if products generated from OI collaboration achieve better (for example) time to market or product quality, they should enhance the firm's overall revenue.

Firms open their innovation processes to gain the resources they need for their new product development (Albers, Dolfsma, and Leenders 2015; Dittrich and Duysters 2007; Pullen et al. 2012), so fostering new product performance is a central goal of OI collaboration (Frankort 2016; Leenders and Dolfsma 2015). We define *OI product performance* as the degree of success achieved by the products that result from OI collaboration. With this conceptualization, we can capture the performance of products that stem from firms' entire network of OI relationships.

Figure 5-1: Study Framework (Study 2)

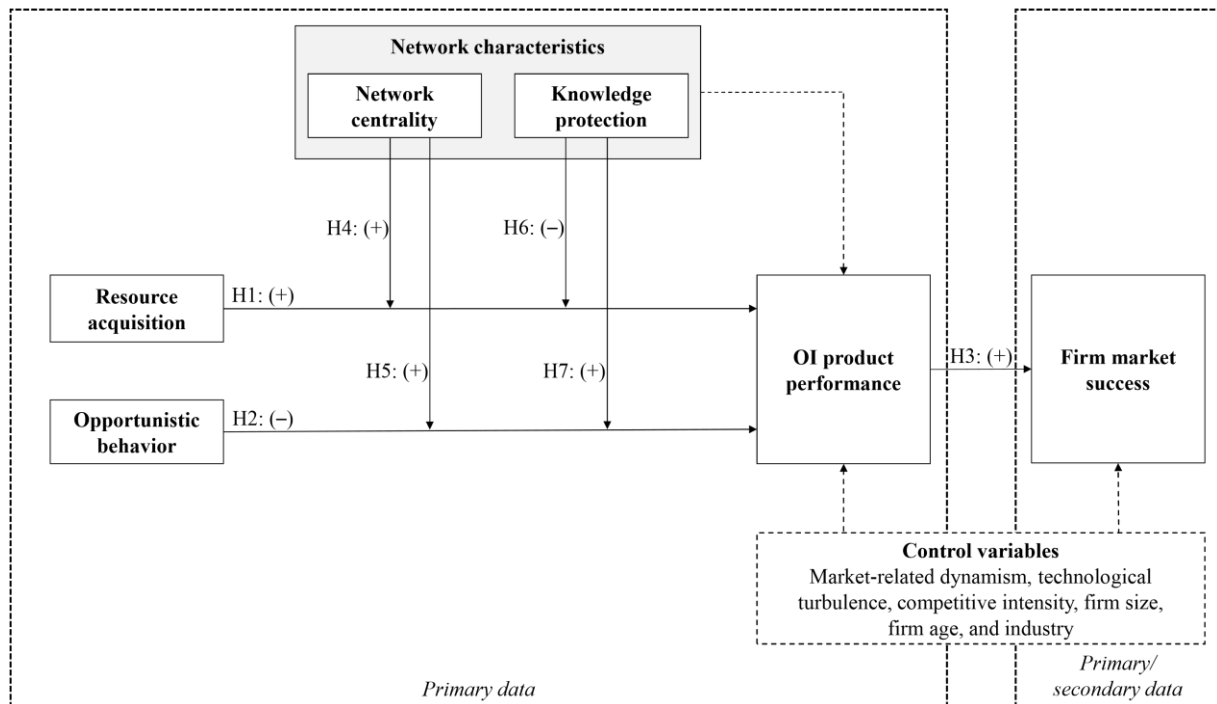

Network research differentiates between structural and relational network characteristics as important contingencies of innovation performance (e.g., Baum, Cowan, and Jonard 2014; Gilsing et al. 2008; Koka and Prescott 2008). In particular, network centrality, defined as the extent to which a firm carries out and mediates knowledge exchanges and technology exchanges in its OI network (Iacobucci and Hoeffler 2015; Li et al. 2013), is a key determinant of the successful transformation of external resources into OI product performance (Li et al. 2013). Because centrally located firms are exposed to diverse network resources, they can develop more successful innovations (Afuah 2013; Ozcan and Eisenhardt 2009; Tsai 2001). Network centrality also lessens power asymmetries, so it may buffer partners' opportunistic behaviour (Ozcan and Eisenhardt 2009).

Knowledge protection, defined as “the extent to which firms use certain processes to govern and protect their proprietary knowledge” (Jean et al. 2014, p. 103), is a formal relational network characteristic that influences the generation of relational rents. Firms might implement measures to protect their proprietary knowledge and prevent partners' opportunistic behaviour (Oxley and Sampson, 2004; Ozcan and Eisenhardt 2009), but such measures may be detrimental to open resource-sharing (Jean, Sinkovics, and Hiebaum 2014; Kale, Singh, and Perlmutter 2000) by impeding the transformation of acquired resources into OI product performance.

5.3.2 Hypotheses

5.3.2.1 Main Effects Hypotheses

In this section, we root our research in the extant literature to explain the central hypotheses regarding the relationships of resource acquisition and opportunistic behaviour with performance and to provide a sufficient background for the hypotheses regarding moderating effects. Resource acquisition should improve OI product performance (e.g., Albers et al. 2015; Dittrich and Duysters 2007). Regardless of their size or age, virtually all firms face resource constraints (Xu, Wu, and Cavusgil 2013), so they engage in OI relationships to gain valuable resources they lack internally (Leenders and Dolfma 2015). Their ability to identify and acquire complementary resources can help them generate relational rents and improve the performance of jointly developed products (Dyer and Singh 1998). For example, by successfully tapping into financial, human, technology-based, or market-based resources, firms can enhance their products to keep pace with technological progress (Drechsler and Natter 2012).

From a competitive perspective, firms also face challenges that are due to short product life cycles and increasingly competitive environments in which innovation is key to sustainable growth (Dittrich and Duysters 2007; McNally, Akdeniz, and Calantone 2011). Collaborating with external partners and gaining access to needed resources may help firms address these challenges. For example, the ability to acquire diverse resources rapidly helps firms to shorten their product-development cycles (Chandy et al. 2006; McNally et al. 2011) and enter markets with new or enhanced products before their competitors do. Thus, successful resource acquisition should be associated with good OI product performance (Berchicci 2013; Dittrich and Duysters 2007; Frankort 2016).

H1: Resource acquisition is positively associated with OI product performance.

Opportunistic behaviour can increase the proportion of relational rent a partner appropriates from the partnership (Lavie 2006), and firms can risk losing their core proprietary resources to network partners who engage in such behaviour (Kale et al. 2000). If firms worry that their collaboration partners will be unfair and manipulative (Das and Teng 2001), they are likely to reduce the intensity of their collaborative relationship and be less devoted to it (Dyer and Singh 1998; Oxley and Sampson 2004). In such cases, collaboration partners are more cautious, constrain their communication, and suffer from a lack of transparency, compromising the purpose of collaborative new product development and risking poor OI product performance.

As part of opportunistic behaviour, some collaboration partners adopt policies and programs that fail to support the OI collaboration because they have incompatible objectives (Das and Teng 2001; Pullen et al. 2012). In such cases, even if they contribute the promised inputs, the partners cannot work seamlessly, (Das and Teng 2001) and the relational rents will erode (Dyer and Singh 1998). In contrast, shared objectives can enhance the accumulation of relational rents by reducing the chance of conflicts between partners (Lavie, Haunschild, and Khanna 2012; Pullen et al. 2012).

H2: Opportunistic behaviour is negatively associated with OI product performance.

With OI, partners can pool complementary resources (Hottenrott and Lopes-Bento 2016; Pullen et al. 2012), which should improve the resulting product's technological performance (e.g., superior quality) and market-based performance (e.g., time to market) (Eisend, Evanschitzky, and Calantone 2016). When products that are generated through OI are of high quality, enjoy customer satisfaction and loyalty, and are introduced before competitors' products, the firm is likely to gain substantial market share and revenue growth (Faems et al. 2010; Zaheer and Bell 2005). In addition, strong OI product performance enhances the firm's reputation among customers, which should benefit its market success (Barringer and Harrison 2000). This reasoning suggests that OI product performance increases the market success for all of firms' new products.

H3: OI product performance is positively associated with the firms' overall market success.

5.3.2.2 Moderating Effects Hypotheses

Network centrality

Firms that are centrally located in a collaboration network can transform the resources they acquire into OI product performance more effectively than those that are not centrally located (Mazzola, Perrone, and Kamuriwo 2015), because central firms act more dynamically and enter new relationships more easily (Gulati 1999), allowing them to identify the complementary resources they need for their new product development (Dong and Yang 2015; Wang and Chen 2016; Yang et al. 2010). In addition, centrally located firms have extensive relationships with many collaboration partners (Freeman 1979; Gulati 1999; Li et al. 2013) and so are likely to be exposed to a larger diversity of available resources, have easier access to them, and acquire higher-quality resources (Lin, Yang, and Arya 2009; Wang and Chen 2016). By applying these

resources to collaborative product development, they can enhance their success with OI products (Tsai 2001).

In addition to being able to transform the resources into OI product performance more effectively, centrally located firms can also achieve this more efficiently than other firms (Dyer and Singh 1998). Centrally located firms often serve as gatekeepers for network partners' exchanges of resources (Carnovale and Yeniyurt 2015). By controlling the communication flow, they gain accurate, timely information about activities throughout the network and can identify partners with complementary resources for their OI endeavors more easily (Dyer and Singh 1998; Freeman 1979). Central firms also interact more frequently and easily with partners, which increases the efficiency of interfirm exchanges by, for example, reducing response times (Borgatti and Halgin 2011; Dyer and Singh 1998). This more effective, more efficient resource exchange should increase relational rents in terms of enhanced generation of innovations, thereby increasing OI product performance.

H4: The positive effect of resource acquisition on OI product performance is stronger when the firm is more centrally located in its network.

Despite the benefits of a central location, these firms might be exposed to their partners' opportunistic behaviour (Das and Teng 2001), but they have more tools to deal with such behaviours than other firms do. Because of their central network position and mediating role in exchanging resources between OI partners, they have experience with OI relationships and can buffer the negative effects of opportunistic behaviour on collaboration and its performance outcomes. That is, centrally located firms are likely to have in place appropriate, informal measures, such as joint problem-solving processes and shared norms, that limit the negative impact of opportunistic behaviour on OI product performance (Guan and Liu 2016; Kale, Dyer, and Singh 2002; Kale et al. 2000; Leenders and Dolfsma 2015).

Network theory also predicts that centrally located firms can create beneficial knowledge overlaps, because they are able to acquire similar resources from different partners in their network (Lee and Veloso 2008). In addition, they can also enter new relationships more easily than other firms can (Demirkan et al. 2013; Gulati 1999). Therefore, centrally located firms know that if a particular OI relationship is to suffer or fail due to partner's opportunistic behaviour, they can compensate for the negative outcomes of this relationship by turning to other network members with good connections (Demirkan et al. 2013). Even though they are

exposed to opportunistic behaviour, they do not allow such behaviours to hinder their OI collaboration and OI product performance.

H5: The negative effect of opportunistic behaviour on OI product performance is weaker when the firm is more centrally located in its network.

Knowledge protection

Knowledge protection is a formal governance mechanism that aims to minimize knowledge appropriation through the use of contracts and patents (Jean et al. 2014; Roy and Sivakumar 2010). When firms exchange resources in OI relationships, they fear the leakage of critical expertise and seek to protect their core knowledge assets (Kale et al. 2000). Formal knowledge protection can encourage firms to share sensitive knowledge that can enhance their innovation development, although too much protection might hinder the extent of the resources shared and trust between cooperating partners (Jean et al. 2014; Lavie 2006). Nielsen and Nielsen (2009) argue that, if a firm protects its own resources too firmly, partners will be reluctant to share theirs, which would prevent collaborating partners from securing relational rent streams as part of their OI collaboration (Jean et al. 2014; Lavie 2006).

In addition, isolating mechanisms that govern proprietary assets might be associated with increased organizational effort, such as processes for formally approving the sharing of certain firm resources in OI relationships. Firms would also have to undertake costly efforts to monitor and control their OI partners' use of their proprietary assets (Kale et al. 2000). Therefore, firms with stronger intellectual property regulations might be less effective in exchanging the resources necessary for new product development and in transforming these resources into improved OI product performance (Jean et al. 2014; Nielsen and Nielsen 2009).

H6: The positive effect of resource acquisition on OI product performance is weaker when knowledge protection is stronger.

OI relationships are also associated with partners' opportunistic behaviour, which can impair new product performance (Das and Teng 2001; Hottenrott and Lopes-Bento 2016). Knowledge protection, as an isolating mechanism, can buffer this negative effect and help to generate rents in terms of new product development (Lavie 2006). When firms introduce knowledge-protection mechanisms, they specify each party's rights, duties, and goals in formal operating procedures (Jean et al. 2014). Even if firms worry that their OI partners might be dishonest, the some guarantee that they can rely on the previously accepted terms, limit imitations and thefts

of their resources, and minimize the diffusion of rents (Lavie 2006). Hence, clear agreements about goals and duties provide a certain level of certainty that encourages partners to commit to the relationship as set.

According to network theory and the relational view, knowledge protection is a relational network characteristic that can decrease uncertainty and tension and serve as a safeguard against opportunistic behaviour in OI relationships (Bogers 2011; Jean et al. 2014). When firms employ knowledge protection, they can minimize the negative consequences of their partners' opportunistic behaviour in several ways. Knowledge protection mechanisms clearly regulate the knowledge appropriation and significantly reduce OI partners' undesired behaviours and attitudes. Formal specifications regarding the exchange of proprietary knowledge can also be used as a reference for partners' actions, as they may allow firms to discover undesired developments in collaboration quickly so they can take measures to prevent opportunistic behaviour from harming their collaborative OI and their intended rents.

H7: The negative effect of opportunistic behaviour on OI product performance is weaker when knowledge protection is stronger.

5.4 Methodology

5.4.1 Sample and Data Collection

The hypotheses tests rely on large-scale, quantitative data from 181 German companies in diverse industry sectors, which increases the generalizability of the findings and mitigates the potential for biases that are due to industry characteristics (Table 5-1). With the support of a commercial research service provider, we obtained a sample of respondents that were highly knowledgeable about their firms' innovation activities (at least a 4 on a self-assessment of their knowledge on a 7-point scale: 1 = "minor knowledge" to 7 = "extensive knowledge", with a mean self-assessed score of 5.82 and a SD of .91). We obtained 145 valid responses and then extended the sample by contacting an additional 322 companies ourselves. We selected from these companies respondents who were highly knowledgeable about their firms' innovation activities (mean self-assessed score on the same knowledge scale was 6.05 and the SD was .89). We received 60 responses (response rate = 18.6%), which we added to the sample. A t-test of the means revealed no significant differences between the two segments.

Table 5-1: Sample Composition (Study 2)

Industry sector	Number of full-time employees		
Chemicals/pharmaceuticals	9.9%	<100	12.8%
Machinery/electronics	23.2%	101–200	11.1%
Software/IT	13.8%	201–500	25.0%
Retail/consumer goods	6.1%	501–1,000	15.0%
Services	17.7%	1,001–5,000	22.2%
Other	29.3%	5,001–10,000	1.7%
		>10,001	12.2%
Sales volume	Firm age		
<€10 million	23.2%	<5 years	6.1%
€10–€25 million	16.6%	6–10 years	8.3%
>€25–€50 million	7.7%	11–15 years	12.3%
>€50–€100 million	9.4%	16–20 years	6.6%
>€100–€250 million	7.2%	21–50 years	30.6%
>€250–€500 million	8.3%	>51 years	36.1%
>€500–€1,000 million	10.5%		
>€1,000–€5,000 million	11.0%		
> €5,000 million	6.1%		

The two data-collection approaches generated 205 responses, but after accounting for missing data, we retained 181 usable questionnaires completed by decision-makers with management experience and leadership responsibility, including managing directors (45.3%), R&D managers (14.4%), innovation managers (14.4%), product managers (6.1%), and others (19.8%). The sample covers a wide range of firm sizes, with sales volumes ranging from less than €10 million to more than €5 billion (average €100 million). The firms employed an average of 8,596 people and had an average firm age of fifty-three years.

We used triangulation (Homburg et al. 2012) to increase the validity of our findings and determine how OI product performance affects the downstream variables. As secondary data, we retrieved firm profits from a financial database as a proxy for the firms' market success because sales growth and profit tend to be closely related (Lumpkin and Dess 2001; Zhou et al. 2005). We retrieved profit information for the sixty-four sample companies for which data were available in the database. We also confirmed a strong, positive, and significant correlation between the survey-based measure of the firms' market success and the profit data ($r = .31$, $p < .01$), indicating the validity of the managers' assessments.

5.4.2 Measures

Before developing our survey, we ensured that our research goals were relevant to science and managerial practice and determined the constructs that were relevant to our study by conducting ten field interviews with academics and practitioners. We also conducted a comprehensive

literature review to identify existing multiple-item measurement scales that we could use to operationalize the dependent, independent, moderator, and control variables. All items and factor loadings appear in Table 5-3.

To assess *resource acquisition*, we asked the survey respondents to name the five most important resources that their companies strive to acquire from OI partners. We relied on the classifications suggested by Barney (1991), Newbert (2008), and Wu and Chen (2010), who distinguish financial, human, technology-based, and market-based resources. The respondents used a seven-point scale (1 = “totally unable” to 7 = “perfectly able”) to indicate the extent to which their companies have been able to acquire from their OI partners each of the five named resources. For the measure of *opportunistic behaviour*, we adapted a scale from Das and Teng (2001), refining the scale by eliminating three items that exhibited the lowest content validity and factor loadings and leaving seven items to assess opportunistic behaviour, measured on a seven-point Likert-type scale (1 = “strongly disagree” to 7 = “strongly agree”).

We developed a new measurement scale for *OI product performance* that comprises four items to measure both technological performance (quality) and market-based performance (time to market, customer satisfaction, and loyalty) (Eisend et al. 2016). Using an approach similar to that Narver et al. (2004) describe, we asked the respondents to rate the success of products generated through OI projects in their companies relative to the success of products resulting from all innovation projects (open or closed) of their three strongest competitors. The participants assessed the items on a seven-point scale (1 = “much worse” to 7 = “much better”). For *firm market success*, we used a single item to measure the sales growth of all new products developed by their companies (Hottenrott and Lopes-Bento 2016) (from 1 = 0–10% to 9 = more than 80%).

Adopted from Li et al. (2013), the scale for *network centrality* consists of five items that assess the extent to which a firm carries out and mediates knowledge exchange and technology exchange in the OI network, measured on a seven-point Likert-type scale (1 = “strongly disagree” to 7 = “strongly agree”). In this context, “OI network members” refers to partners with which the company is currently cooperating. We assess *knowledge protection* with six items: four items from Jean et al. (2014) that measure the extent to which firms use different processes to govern and protect their proprietary knowledge, and two items from Kale et al. (2000) that assess the extent to which firms can protect their proprietary assets. These answers also used seven-point Likert-type scales.

We included six environmental and firm-related control variables in the analysis to reduce the potential for a bias from confounding effects. *Market-related dynamism* (Stock and Zacharias 2011), *technological turbulence* (Jaworski and Kohli 1993), and *competitive intensity* (Jaworski and Kohli 1993) are likely environmental determinants of a company's ability to acquire the critical resources required for innovation (e.g., Schweitzer, Gassmann, and Gaubinger 2011; Oerlemans and Knobens 2010). We also included *firm size*, operationalized as the sales volume (1 = up to €10 million to 9 = €5000 and more) (Drechsler and Natter 2012; Faems et al. 2010), as firm size can affect firms' innovation and performance (Tsai 2001). For *firm age*, we used the number of years since the firm was founded, as firm age can be an important determinant in a collaboration context (Krammer 2016). Finally, we included *industry sector* as a control variable (Laursen and Salter 2006), operationalized as an effect-coded dummy variable for the chemical/pharmaceutical, machinery/electronics, software/IT, retail/consumer goods, and service industries, with an "other industries" category as the reference.

5.4.3 Measurement Properties

We conducted exploratory and confirmatory factor analyses to assess the reliability and validity of our measurement scales. The global measurement model revealed an acceptable fit of the model to the data ($\chi^2/df = 2.401$; root mean square error of approximation [RMSEA] = .088; square root mean residual [SRMR] = .070). We tested the internal consistency and reliability of the reflective constructs by computing Cronbach's alpha values, which exceeded the threshold level of .7, indicating high scale reliabilities (.86 to .94). For the reflective constructs, the composite reliability ranged from .86 to .94, well in excess of the recommended minimum of .6, which supports strong convergent validity. The factor loadings on their respective constructs were all statistically significant. We also assessed discriminant validity by applying Fornell and Larcker's (1981) rigorous criterion. The square roots of the average variances extracted (AVE) were greater than the respective correlation between any two specific constructs, ranging from .78 to .84, in support of discriminant validity. Table 5-2 contains the correlation coefficients, square roots of the AVEs, means, and standard deviations for the study's variables. The Appendix contains a full list of constructs and corresponding items, along with their sources, Cronbach's alphas, composite reliability, and AVE values.

Table 5-2: Descriptive Statistics and Correlations (Study 2)

Variables	1	2	3	4	5	6	7	8	9	10	11
1 Resource acquisition	.82										
2 Opportunistic behaviour	-.20	.84									
3 OI product performance	.56	-.24	.78								
4 Firm market success	.24	.11	.24	n/a							
5 Network centrality	.64	-.16	.48	.18	.80						
6 Knowledge protection	.57	-.19	.44	.15	.58	.80					
7 Market-related dynamism	.44	.07	.41	.28	.39	.42	.80				
8 Technological turbulence	.32	-.05	.33	.23	.32	.34	.60	.82			
9 Competitive intensity	.20	.00	.18	.03	.28	.23	.43	.44	.80		
10 Firm size	.29	.05	.06	.16	.24	.33	.22	.16	.22	n/a	
11 Firm age	.01	-.13	.00	-.16	.09	.10	-.12	-.14	.05	.28	n/a
Mean	4.96	3.68	4.83	2.81	4.87	5.03	4.46	4.45	4.92	4.19	53.13
Standard deviation	1.13	1.26	1.17	1.79	1.25	1.19	1.15	1.18	1.01	2.73	51.27

Notes: N = 181; $r > .15$, $p = .05$; $r > .19$, $p = .01$. Diagonal elements in bold are the square roots of the average variance extracted for constructs measured reflectively with multiple items.

By validating managers' assessments of the dependent variable using objective financial performance measures, our research design reduces the problems—mainly the threat of common method bias—that are associated with performance assessments that are based entirely on self-reported data (Podsakoff et al. 2003), although we conducted additional empirical tests to confirm it. First, we applied Harman's single-factor test, to determine if the fit of a single-factor model was significantly worse than our multifactor measurement model. The χ^2/df value of 6.195 revealed that the fit of the single-factor model was worse than that of our measurement model with all constructs. Therefore, a single factor does not explain the correlations between the observed variables. Second, we conducted a marker variable test (Lindell and Whitney 2001) using company age as a marker variable because it has the lowest correlation with our dependent variable of OI product performance. After correcting the correlation matrix, all of the correlations' significance levels remained significant. Third, using correlated uniqueness confirmatory factor analyses (Podsakoff et al. 2003) for all latent constructs, we established a model in which each observed variable is caused by a trait factor and a measurement error term. To estimate the method effects, we allowed the error terms (uniqueness) of the variables that were measured by the same method to correlate (Brown 2015; Podsakoff et al. 2003). The standardised parameter estimates revealed that the trait factor loadings are consistently large (.70 to .88; all p-values below .001), suggesting high convergent validity when we adjust for the effects of the assessment method. In addition, discriminant validity is adequate, as indicated by the modest correlations among trait factors (-.22 to -.27), with the exception of the

correlation between resource acquisition and OI product performance (.57). To determine whether method effects might be responsible for these correlations, we examined the results of the correlated uniqueness values. The method effects were significant in some cases, but their sizes were modest at best (-.49 to -.26), so our results were unlikely to have been caused by common method variance. Therefore, common method bias does not appear to be a concern.

To mitigate potential endogeneity concerns, we first relied on our strong theoretical background to develop our study framework and hypotheses. By combining the relational view, network theory, and extant OI research, we attained strong theoretical grounds for the directional relationships of resource acquisition and opportunistic behaviour with OI product performance and the moderating effects of network characteristics. We also included several control variables to limit the potential for endogeneity that might arise from omitted variables. Although self-selection might cause endogeneity concerns, our sample includes relatively closed firms that perform only a few OI activities, in contrast with very open firms that perform many, profound OI activities. Thus, we have no evidence of self-selection by firms that are more open in their innovation activities. Overall, then, endogeneity does not appear to be a major concern.

5.4.4 Hypotheses Testing Procedure

We employed structural equation modeling (SEM) in Mplus 7 (Muthén and Muthén 2012), based on maximum likelihood estimation, to test our hypothesised relationships and SEM with latent interactions to test the moderating effects of network centrality and knowledge protection (Jaccard and Wan 1996). In contrast to multigroup SEM, which splits the data into subsamples and uses only some of the variance available in the data set, SEM with latent interactions avoids information loss by building case-wise interactions (Jaccard and Wan 1996; Marsh, Wen, and Hau 2006).

We applied an analytical procedure similar to a hierarchical moderated regression analysis for the tests of the hypothesised relationships. First, we estimated a baseline model that included the main effects and the effects of the six control variables on OI product performance and the firms' market success. Second, we tested the moderating hypotheses by estimating two models, each of which included the latent interaction terms. We also included the direct effects of the moderator variables on OI product performance to avoid confounding the main and interaction effects (Irwin and McClelland 2001). To measure the effect sizes, we used two objective parameters for continuous variables: Cohen's rho (Pearson's correlation) and its confidence intervals based on the Fisher r-to-z transformation, and the standardised parameter estimates

from SEM, which indicate the effect size of a one-unit standardised deviation of the covariate (Cohen 1988; Muthén and Muthén 2012).

5.5 Results

5.5.1 Main effects results

Following the hypotheses-testing procedure, we ran the basic model with the main and control effects and without any interaction terms. The global fit indices revealed that the model has acceptable fit with the data ($\chi^2/df = 2.065$; RMSEA = .077; SRMR = .080). We detail the standardised path coefficients and their significance levels in Figure 5-2.

In support of H1, we find a strong, highly significant effect of resource acquisition on OI product performance (.43; $p < .01$), which is in line with previous findings (e.g., Berchicci 2013; Frankort 2016). The standardised parameter estimate and Cohen's rho suggest a moderate to high effect size ($r = .56$; 95% two-tailed confidence interval [.45, .65]; Cohen 1988). In addition, the estimation of the link between opportunistic behaviour and OI product performance indicates that perceptions of partners' opportunistic behaviour are associated with lower OI product performance (-.14; $p < .05$), with a moderate effect size ($r = -.24$; confidence interval [-.37, -.10]), so this estimation supports H2. This finding is particularly important for research and practice, as it exposes the downsides of OI and its consequences for firms' innovation success. To complete the hypothesised causal chain, the results for H3, that OI product performance enhances firms' market success, offer strong support for this hypothesis (.18; $p < .05$), with a moderate effect size ($r = .24$; confidence interval [.10, .37]). The findings regarding the impact of the control variables revealed mostly nonsignificant effects, with few exceptions: firm size impacts OI product performance (-.15; $p < .05$), with a very small effect size ($r = .6$; confidence interval [-.9, .20]); firm age impacts firms' market success (-.18; $p < .05$), with a small effect size ($r = -.16$; confidence interval [-.30, -.02]); and the industry sector of machinery and electronics impacts firm' market success (.35; $p < .01$), for which the standardised parameter estimate indicates a moderate effect size. Cohen's rho cannot be computed for the industry sector because industry sector is an effect-coded dummy variable. Overall, we find support for all of our main hypotheses.

Figure 5-2: Results of Structural Equation Modelling (Study 2)

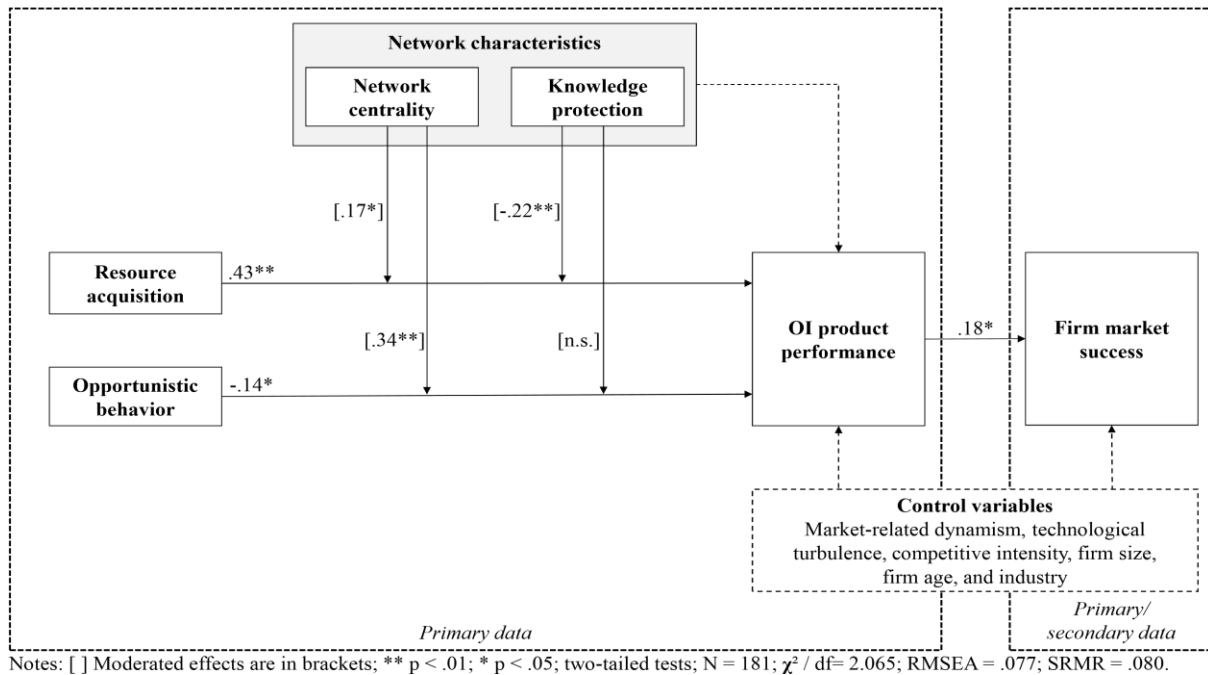

5.5.2 Moderated effects results

To test the moderated effects, we included latent interactions between each moderator (network centrality and knowledge protection) and each independent variable (resource acquisition and opportunistic behaviour) in our SEM. Before specifying the interaction terms and multiplying the item values of the corresponding constructs (Marsh et al. 2006), we mean-centered all of the indicators (Algina and Moulder 2001).

H4 hypothesised that the positive effect of resource acquisition on OI product performance is stronger for firms that are more central in their networks. In support of our prediction, the moderating effect is significant and in the hypothesised direction (.17; $p < .05$). These values indicate a moderate to large effect size ($r = .57$; confidence interval [.46, .66]). In support of H5, we find that network centrality also positively moderates the negative relationship between opportunistic behaviour and OI product performance (.34, $p < .01$), with an effect size that ranges from small to moderate ($r = .12$; confidence interval [-.03, .27]; Cohen 1988). That is, a central position in an innovation network can be a countermeasure for partners' opportunistic behaviour and a buffer against the negative consequences of such behaviours on OI product performance.

The hypotheses related to the moderating effect of knowledge protection produce more diverse results. In line with H6, the positive effect of resource acquisition on OI product performance is weaker when a firm engages in more knowledge protection ($-.22, p < .01$), with a moderate to large effect size ($r = .55$; confidence interval $[.44, .64]$). These results are in line with research that suggests that, if a firm protects its resources, its partners will be reluctant to share theirs, which can hamper the transformation of resources into new products' success (Jean et al., 2014; Nielsen and Nielsen 2009). However, contrary to H7, the negative effect of opportunistic behaviour on OI product performance does not vary significantly when a firm engages in more knowledge protection ($-.05$; ns).

Therefore, the hypothesised moderating effects of network centrality receive full support, and we find partial support for the moderating effect of knowledge protection. Knowledge protection does not appear to function as a countermeasure for opportunistic behaviour; instead, it hinders the transformation of resources acquired from OI network partners into higher OI product performance.

5.6 Discussion

The extant research has long recognised the upsides of OI relationships, but their downsides have attracted surprisingly little attention, and examinations of remedies to counter these downsides are even scarcer. Because managing the downsides of OI relationships is essential for business practice, this study investigates remedies for partners' opportunistic behaviour by considering relevant contingency factors. Specifically, we suggest ways firms can manage the complex nexus of OI relationships by dealing with both the upsides and the downsides through adjustments in structural and relational network characteristics in order to support OI product performance and the firms' market success. In so doing, we provide multiple implications for scholars as well as practitioners.

5.6.1 Implications for Research

This study informs ongoing debates about the potential upsides and downsides of firms' networks of OI relationships. Regarding the upsides, the extant research has long recognised that OI offers considerable opportunities for firms to address their technology-related and market-related knowledge gaps by acquiring external resources (e.g., Berchicci 2013; Drechsler and Natter 2012). Our study's findings are consistent with these findings, as we find that OI provides access to external resources that allow firms to enhance their OI product performance. By assessing upsides and downsides simultaneously in collaborative innovation efforts, we provide a holistic perspective and extend the neglected downside perspective on OI (Hottenrott

and Lopes-Bento 2016; Mata and Woerter 2013). Our findings show that opportunistic behaviour impairs the success of products generated in OI relationships and, thus, firms' market success.

From a theoretical perspective, the relational view (Dyer and Singh 1998; Lavie 2006) and network theory (Ahuja 2000; Gulati 1999) together constitute a valid theoretical background for investigating the benefits and pitfalls of OI relationships. We provide theoretical mechanisms related to how firms can increase or harm the benefits of network resources' for their performance. This study adds to the research stream that examines the role of network characteristics in facilitating the acquisition of resources from innovation networks and causing variations in firms' innovation success (e.g., Li et al. 2013; Pullen et al. 2012). Our research also offers new insights for network research regarding the otherwise neglected downside perspective and develops mechanisms by which structural and relational network characteristics can counteract opportunistic behaviour. Thus, this study advances academic discussions about successful network management as a way to enhance the generation of relational rents by extending the benefits of network resources and avoiding the negative outcomes of opportunistic behaviour.

Because of the potential for partners' opportunistic behaviour that comes with OI, firms might be reluctant to engage in external collaboration on innovations (Hottenrott and Lopes-Bento 2016), thereby impairing their new product development (Baker et al. 2015). Therefore, we provide new insights on measures to counter the downsides of OI relationships that are related to partners' unfair dealings (Kale et al. 2000). By investigating network centrality and knowledge protection, we offer countermeasures for opportunistic behaviour and demonstrate that not all network characteristics buffer the negative effect of opportunistic behaviour on OI product performance. Instead, our findings suggest that increasing network centrality can reduce these negative outcomes, whereas knowledge protection constrains firms from transforming their valuable resources into OI product success.

5.6.2 Implications for Managerial Practice

To manage relationships with many types of partners, managers must acknowledge both the benefits and the threats that come along with such collaborative efforts. This comprehensive view entails being aware of the opportunities that cooperating with partners offers for the acquisition of external resources to increase their firms' product performance and market success. Yet when managers develop strategies to foster OI product performance, they must also consider that partners might behave opportunistically. If they fail to manage these

behaviours properly, the resulting jointly developed products will perform poorly, lowering the firms' market success. However, recognizing the downsides of OI relationships should not discourage firms from adopting OI because firms can counter opportunistic behaviour by applying appropriate measures while benefiting from the upsides of OI through resource acquisition.

In particular, managers should recognize the unique role of their firms' network position. With a more central network position, firms can access more diverse resources, have more control over resource outflows, gain collaboration experience, and earn the trust from partners that fosters the transformation of network resources into OI product performance. If managers fear that OI partners will behave opportunistically, they should pursue a central position in their network that allows them to have intensive interactions with other network members and perform mediating roles when they exchange resources with one another. To achieve such a position, they must expand their own reach while also functioning as gatekeepers who support network partners in their efforts to exchange resources, even if just as intermediaries (Iacobucci and Hoeffler 2015). If a firm does not have a central network position and its managers worry that their partners might be unfair, it might be preferable to abstain from OI.

Introducing processes that protect valuable knowledge assets may benefit new product development generally (Jean et al. 2014), but knowledge protection hinders the transformation of network resources into OI product performance, and it does not buffer the negative impact of opportunistic behaviour on this performance. As such, firms that implement formal knowledge-protection mechanisms like trademarks, patents, and copyrights cannot expect that such mechanisms protect them against the negative outcomes of partners' opportunistic behaviour. Therefore, they might still suffer negative impacts from such behaviours. Moreover, too much knowledge protection can be detrimental to the effort to transform acquired resources into OI product performance. Of course, protecting valuable assets is not harmful to exchange partnerships, but managers must determine the right degree of protection and find an optimal trade-off between protective measures that minimize the threat of knowledge leaks and the open interaction between OI partners that is necessary for transforming resources in new OI products.

5.6.3 Limitations and Avenues for Further Research

Several limitations of this study suggest avenues for further research. First, we limit our investigation to two network characteristics—network structure and knowledge protection—as moderators, as these are important contingencies in the context of using opportunities to acquire resources and countering the negative outcomes of partners' opportunistic behaviour. Because

network theory is a useful theoretical background for investigating the benefits of network resources as well as partners' opportunistic behaviour and its remedies, researchers might investigate other network characteristics as contingency factors in the context of OI relationships, such as geographic proximity and network density (Li et al. 2013). Such investigations could advance the debate on countermeasures of opportunistic behaviour and facilitators of resource use in OI relationships.

Second, the extant research offers mixed findings regarding knowledge protection: Some studies reveal a positive impact on new product development (e.g., Jean et al. 2014), while others indicate detrimental effects (e.g., Nielsen and Nielsen 2009). Our results show that knowledge protection neither increases nor decreases the negative impact of opportunistic behaviour on OI product performance. Future research could investigate whether our findings hold in other research contexts (e.g., emerging markets) and how other aspects of networks (e.g., partners' characteristics) might affect the buffering influence of knowledge protection. Such efforts would help to clarify how knowledge protection functions to counter opportunistic behaviour or enhance resource-sharing in OI.

Third, this study assesses the upside of OI relationships that is related to external resources and the downside of partners' opportunistic behaviour. To provide more comprehensive view of the upsides and downsides of OI relationships, future research might investigate the influence of factors like the benefits of risk-sharing and the disadvantages of financial cost on OI performance and how managers can deal with these influences. In particular, information about failed OI relationships is difficult to obtain, and the resulting lack of information might create the dangerous impression that OI is always beneficial. Therefore, researchers should investigate the causes and particularities of failed OI relationships to identify additional upside and downside aspects of these relationships that are important to manage if firms want their OI endeavors to succeed.

5.7 Appendix

Table 5-3: Measures and Measurement Properties (Study 2)

Construct	Items	α /CR/AVE
Resource acquisition	(Barney 1991; Wu and Chen 2010; Newbert 2008)	
	Please name the five most important resources for your company that you strive to acquire from your OI partners.	
	<ul style="list-style-type: none"> - Financial capital (debt and equity) - Technology - Plant and equipment - Raw materials - Land - Know-how/capabilities of employees - Human resources - Relationships with other firms - Distribution channels - Corporate culture - Patents - Copyrights - Brand names - Trade secrets 	
	Please assess to what extent your company has been able to acquire the resources you named above from your OI partners ^{a)} .	.91/.91/.68
	<ul style="list-style-type: none"> - Resource 1 named from the list above - Resource 2 named from the list above - Resource 3 named from the list above - Resource 4 named from the list above - Resource 5 named from the list above 	
Opportunistic behaviour	^{b)} (Das and Teng 2001)	.94/.94/.70
	When cooperating with our OI partners we perceive risk that:	
	<ul style="list-style-type: none"> - they may have incompatible objectives in the collaboration. - they may manipulate the collaboration's operations. - they may alter the facts in order to get what they need. - they may not always do things that they promise to do. - they may do anything within their means that will help them further their interests. - they may not be fair in their dealings. - the OI partner policies and programs may not benefit the OI collaboration. 	
OI product performance	^{c)} (adopted from Eisend, Evanschitzky, and Calantone 2016)	.86/.86/.61
	<ul style="list-style-type: none"> - How would you rate the <i>quality</i> of the products generated from OI projects in your company in relation to the quality of products resulting from all innovation projects (open and closed) of your three strongest competitors? - How would you rate the <i>time-to-market</i> of the products generated from OI projects in your company in relation to the time-to-market of products resulting from all innovation projects (open and closed) of your three strongest competitors? - How would you rate the <i>customer satisfaction</i> with products generated from OI projects in your company in relation to the customer satisfaction with products generated from all innovation projects (open and closed) of your three strongest competitors? - How would you rate the <i>customer loyalty</i> regarding products generated from OI projects in your company in relation to the customer loyalty regarding products generated from all innovation projects (open and closed) of your three strongest competitors? 	

Firm market success ^{d)} (adopted from Hottenrott and Lopes-Bento 2016)	-/-/-
<ul style="list-style-type: none"> - What is the sales growth of all new products developed and commercialised by your company? 	
Network centrality ^{b)} (Li, Veliyath, and Tan 2013)	.90/.90/.64
<ul style="list-style-type: none"> - Most OI network members know our company's name. - These OI network members have no difficulty exchanging knowledge and technology with our company. - These OI network members usually exchanged knowledge and technology through our company when they needed technical advice or support. - These OI network members often relied on our company to obtain technology or business know-how. - These OI network members often provided us technical or business knowledge when we needed technical advice or support. 	
Knowledge protection ^{b)} (Jean, Sinkovics, and Hiebaum 2014; Kale, Singh, and Perlmutter 2000)	.91/.91/.64
<ul style="list-style-type: none"> - Our company has formal and systemised processes for protecting knowledge, e.g., contracts, regulations, and procedures. - Our company relies on patents and trademarks to protect our critical knowledge from inappropriate use. - Our company has processes to protect knowledge from inappropriate use inside or outside the organization. - Our company has incentives that encourage the protection of knowledge. - Our company has been able to protect its core capabilities or skills from the partners. - Our company has been successful in protecting its crown jewels from being appropriated by the partners. 	
Control variables:	
Market-related dynamism ^{b)} (Stock and Zacharias 2011)	.90/.90/.64
In our market, major changes occur frequently in the area of...	
<ul style="list-style-type: none"> - products offered by our competitors. - market development strategies of our competitors. - customer preferences in product features. - customer preferences in product quality/price relationship. - new competitors. 	
Technological turbulence ^{b)} (Jaworski and Kohli 1993)	.88/.89/.67
<ul style="list-style-type: none"> - The technology in this industry is changing rapidly. - Technological changes provide big opportunities in our industry. - It is very difficult to forecast where the technology in our industry will be in the next 2 to 3 years. - A large number of new service ideas have been made possible through technological breakthroughs in our industry. 	
Competitive intensity ^{b)} (Jaworski and Kohli 1993)	.89/.89/.63
<ul style="list-style-type: none"> - Competition in our industry is cutthroat. - There are many "promotion wars" in our industry. - Anything that one competitor can offer, others can match readily. - Price competition is a hallmark of our industry. - One hears of a new competitive move almost every day. 	

Notes: α : Cronbach's alpha. CR: Composite reliability. AVE: Average variance extracted.

a) Items measured with seven-point rating scales, with anchors at 1 = "totally unable" and 7 = "perfectly able."

b) Items measured with seven-point rating scales, with anchors at 1 = "strongly disagree" and 7 = "strongly agree."

c) Items measured with seven-point rating scales, with anchors at 1 = "much worse" and 7 = "much better."

d) Items measured with nine-point scales, with anchors 1 = "0-10%" and 9 = "more than 80%."

6 Study 3 – Which Collaborative Activities Should Firms Perform to Become a Gatekeeper? A Longitudinal Analysis of a Large-scale Collaboration Network³

6.1 Introduction to Study 3

One of the largest automobile manufacturers—BMW AG, announced this year that in the course of the digitalisation trend, it is partnering up with leaders from other industry sectors to bring the world's first fully self-driving car to market by 2021 (Theil 2017). It is collaborating with Intel in chips (Theil 2017), Mobileye and Delphi in sensors (BMW 2017), and has purchased Nokia's maps business for \$3 Billion (Newcomb 2016). BMW has recognised the importance of acquiring knowledge from other distant knowledge fields to survive and prosper in today's dynamic, complex, and global business world (Drechsler and Natter 2008). BMW initiates partnerships between firms outside the automotive industry and thus establishes knowledge flows between different knowledge fields. It functions as a gatekeeper in the collaboration network—someone who connects partners with distant knowledge (Rodan and Galunic 2004), i.e., knowledge that does not reside within a focal firm's boundaries (Piezunka and Dahlander 2015).

To some extent, every company strives to grasp distant knowledge. It has become a common practice to aim for non-redundant, distant knowledge which can be used, for instance, to foster innovation and achieve a competitive edge (Tsinopoulos et al. 2017). A gatekeeper position or “the extent to which a firm maintains ties beyond the focal industry network to organizations from other fields” (Stam and Elfring 2008, p. 98) allows to access partners, who are otherwise not connected with each other, and hence can offer firms novel, non-redundant knowledge (Rodan and Galunic 2004). Although firms have recognised that a gatekeeper position can offer substantial benefits in terms of differentiation from the competition through novel knowledge (Piezunka and Dahlander 2015), managers are left in the dark regarding how to achieve such a position.

³ This chapter is based on a joint working paper (together with Nicolas A. Zacharias and Oliver Hinz).

Extant research shows a similar picture: whereas multiple studies empirically show the beneficial effect of a gatekeeper position on firms' innovation and financial performance (Carnabuci and Dioszegi 2015; Gilsing et al. 2008; Tan, Zhang, and Wang 2015), no study offers explanations for how firms can achieve such a position. What is well established, however, is that firms perform different types of collaborative activities with partners, such as weakly interactive (e.g., participation in networking events), medium interactive (e.g., joint research projects), and highly interactive (e.g., joint ventures) activities, to gain access to external knowledge (Belderbos et al. 2004; Piezunka and Dahlander 2015). Hence, they are embedded in a network of collaborative relationships (Capaldo 2007). Accordingly, firms gain a particular network position by choosing different types of collaborative activities and not all of the activities are equally suitable for every network position (Michelfelder and Kratzer 2013; Perry-Smith and Shalley 2003).

More specific, a gatekeeper position requires firms to be able to access and interpret distant knowledge, which is a process that requires substantial amounts of expert attention. Not every type of collaborative activity allows firms to devote enough attention to distant knowledge in order to benefit from it (Piezunka and Dahlander 2015). Although there are studies that offer some hints as to which collaborative activities might be more successful for acquiring distant knowledge (Capaldo 2007; Michelfelder and Kratzer 2013), previous research has so far not been able to explain how different types of collaborative activities influence firms' gatekeeper position (Rodan and Galunic 2004; Uzzi 1996), and why firms often fail to grasp distant knowledge within their collaborative relationships and thus fail to achieve a gatekeeper position.

Against this backdrop, we investigate how three different types of collaborative activities—weakly, medium, and highly interactive—influence firms' gatekeeper position. Furthermore, we consider firms' knowledge base as an important characteristic that determines how successful firms are in achieving a gatekeeper position with their collaborative activities. Extant research shows that firms face the difficult task of combining newly gained, distant knowledge with their previously held, familiar knowledge (Katila and Ahuja 2002; Piezunka and Dahlander 2015). Thus, our research question is: *Which collaborative activities should firms perform in order to achieve a gatekeeper position in subsequent periods contingent on the strength of firms' knowledge base?*

By answering this research question this study offers several contributions. First, this is the first study that explicitly examines factors that influence firms' gatekeeper position in a

collaboration network and shows that not all collaborative activities are beneficial for this purpose. As early as the seminal work of Burt (1992) extant network research agrees that being a gatekeeper connecting distant partners in a network, who are otherwise not connected with each other, is an advantageous network position for firm performance (Rodan and Galunic 2004; Stam and Elfring 2008). However, the driving factors that lead to such a position have so far not been theoretically and empirically disentangled (Rodan and Galunic 2004). By examining how different types of collaborative activities influence firms' gatekeeper position in subsequent periods we extend knowledge about the circumstances that determine which collaborative activities are beneficial and which are detrimental for a gatekeeper position. Thus, we offer scholars and managers first specific implications for how to become a gatekeeper.

Second, the lack of studies that directly link collaborative relationships to a gatekeeper position might be attributed to the fact that network research is spitted in structural and relational conceptions (Rodan and Galunic 2004). Whereas the structuralist conception investigates the advantages of particular structural network characteristics, such as centrality (Tan, Zhang, and Wang 2014), the relational conception analyses how the characteristics of network relationships, such as knowledge diversity, influence certain outcomes (Lin et al. 2009). Only very few studies have applied both conceptions simultaneously (e.g., Gilsing et al. 2008; Li, Veliyath, and Tan 2013). By drawing on social network theory (Ahuja 2000; Burt 1992) and the literature on distant knowledge (Afuah 2013; Piezunka and Dahlander 2015), we align both structural and relational conceptions and examine the underlying theoretical mechanisms by which characteristics of collaborative relationships within the relational conception influence firms' structural network position within the structural conception. Hence, we respond to an urgent call to augment the structural view of network value by considering the effectiveness of certain collaborative activities to access and interpret distant knowledge (Rodan and Galunic 2004). Given the importance of distant knowledge for achieving a competitive advantage (Piezunka and Dahlander 2015), this study offers important insights for the network research community regarding which collaborative ties offer the benefits of distant knowledge such that it is possible for an actor to connect distant knowledge clusters in a network and function as a gatekeeper in subsequent periods.

Third, this study also contributes to the literature regarding successful knowledge transfer in collaboration networks (Katila and Ahuja 2002; Tsai 2001). Previous studies have shown that whether firms will be able to integrate external knowledge from network relationships strongly depends on the strategic context, such as firms' capacity to interpret external knowledge (Tsai 2001). Firms face difficult challenges of combining the externally gained, distant knowledge

with their currently held, familiar knowledge which serves as the capacity to interpret distant knowledge (Katila and Ahuja 2002; Piezunka and Dahlander 2015). Given the strategic importance of firms' current knowledge base in profiting from external knowledge, we consider the strength of firms' current knowledge base as a contingency factor on the relationships between collaborative activities and a gatekeeper position. Thereby, we investigate circumstances under which the strength of firms' knowledge base fosters or hinders the transfer and integration of distant knowledge and explain why firms, that perform the same activities, are not equally successful in benefiting from distant knowledge, i.e., becoming gatekeepers.

6.2 Theoretical Background – Aligning Social Network Theory with Literature on Distant Knowledge

For this study, we align social network theory (SNT) (Burt 1992; Granovetter 1973) and literature on distant knowledge (Afuah 2013; Piezunka and Dahlander 2015) as an overarching conceptual framework to develop the theoretical reasoning for our hypotheses. The main proposition of SNT is that by engaging in collaborative relationships firms strive for social capital that refers to “the actual and potential resources available to a firm through its network of relationships” (Nahapiet and Ghoshal 1998, p. 243). That is, social capital is embedded in the network relationships that actors accumulate over time (Coleman 1988; Rodan and Galunic 2004). Those actors who are better connected in a network have potential to gain even more social capital and thus foster performance (Faraj, Kudaravalli, and Wakso 2015; Tan et al. 2015).

In the pursuit of explaining how actors gain social capital from networks, social network theorists have applied two main, equally important conceptions: structural and relational (Rodan and Galunic 2004). The structural conception focuses on structural properties of networks, such as the centrality of an actor's position (Dong et al. 2017), especially betweenness centrality or the so-called gatekeeper position (Burt 1992; Carnabuci and Dioszegi 2015; Gulati 1998). This position is powerfully illustrated by Burt's (1992) famous ‘structural hole’ metaphor—by ‘filling the hole’ between two network actors, the gatekeeper connects them and generates value by (1) transferring resources from one actor to another, (2) doing matchmaking between the third parties, and (3), coordinating third parties actions without creating a direct relationship (Sapiro, Acton, and Butts 2013). Through these actions a gatekeeper generates immediate access to more distant knowledge than those in other positions (Sapiro et al. 2013), because disconnected partners are likely to provide access to diverse approaches, perspectives, and ideas that are not well-known in the gatekeeper's industry (Faraj

Kudaravalli, and Wakso 2015; Stem and Elfring 2008). Thus, a gatekeeper position is valuable for conceiving distant knowledge to foster firm performance (Carnabuci and Dioszegi 2015).

In contrast to the structural conception, the relational conception considers the characteristics of the network actors and the qualitative nature of the relationships/ties (Uzzi 1996). Tie strength has gained particular attention within this conception and describes a concept ranging from strong ties to weak ties (Granovetter 1973; Levin and Cross 2004). Whereas strong ties, created by highly interactive activities, are characterised by close, long-lasting, deep relationships with frequent interactions and good information flow between network partners (Capaldo 2007), weak ties, created by weakly interactive activities, entail infrequent interactions and less intensive knowledge exchanges between network partners (Michelfelder and Kratzer 2013). SNT implies that firms establish strong ties mostly with partners from the same knowledge fields and acquire redundant, familiar knowledge while firms enter weak ties with unfamiliar partners to search for non-redundant, distant knowledge (Capaldo 2007; Granovetter 1973).

Within the relational dimension, the content of the network relationships, i.e., the characteristics of knowledge transferred through collaborative ties, has gained particular attention (Rodan and Galunic 2004). Especially, distant knowledge and firms' ability to access and interpret such knowledge has attracted substantial attention. Extant research implies that the step of gaining access to distant knowledge must thus be considered separately from the step of paying attention to distant knowledge (Piezunka and Dahlander 2015). Whereas firms may establish collaborative ties particularly tailored to access distant knowledge, they might not be able to pay enough attention to such knowledge to be able to interpret and process it (Levy 2005; Piezunka and Dahlander 2015). Moreover, they often find it difficult to combine distant knowledge with their currently held, familiar knowledge (Katila and Ahuja 2002).

The insights from both, SNT and literature on distant knowledge provide a theoretical basis that helps to clarify how companies can become gatekeepers. The structuralist conception of SNT posits that in order to achieve this valuable position in the collaboration network, firms have to be able to connect partners with distant knowledge. The relational conception implies that firms have to engage in the right collaborative relationships that allow them to access and interpret distant knowledge to connect partners from different knowledge fields (Michelfelder and Kratzer 2013; Perry-Smith and Shalley 2003). In addition, processing of distant knowledge depends on whether firms are able to supply enough attention to distant knowledge and integrate it in previously held familiar knowledge (Piezunka and Dahlander 2015). By integrating both

structural and relational conceptions this study develops theoretical mechanisms to explain which collaborative ties offer benefits of distant knowledge such that it is possible for a firm to become a gatekeeper.

6.3 Framework and Hypotheses

6.3.1 Framework of the Study

Figure 6-1 depicts the study framework, which is strongly rooted in SNT and in literature regarding search for distant knowledge. Firms strive for a gatekeeper position, where they maintain ties beyond the focal industry network to firms from other fields to profit from constant access to distant knowledge (Sapiro et al. 2013; Stem and Elfring 2008). To reach such a structural network position, they engage in collaborative ties, i.e., perform various kinds of collaborative activities with partners (Belderbos et al. 2004). Firms engage in weak ties by performing weakly interactive activities, in ties which are of medium strength by performing medium interactive activities, and in strong ties by performing highly interactive activities (Granovetter 1973) to access and make use of distant knowledge. Thus, our proposed framework features three main effects of weakly, medium, and highly interactive activities on a gatekeeper position.

Figure 6-1: Study Framework (Study 3)

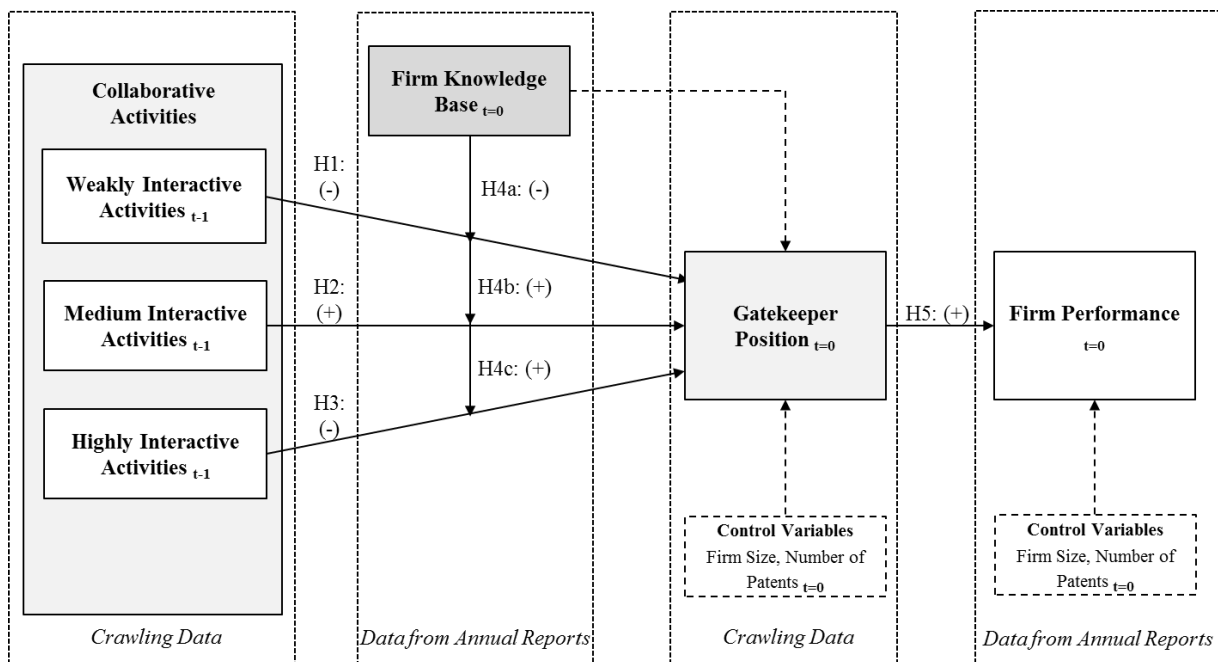

In addition, whether firms are successful in accessing and making use of distant knowledge to be gatekeepers, strongly depends on whether they can integrate distant knowledge in their currently held, familiar knowledge (Katila and Ahuja 2002). Therefore, we include firms' knowledge base, which refers to firm's entire repository of R&D-related competences reflected in both individual skills, business routines, and processes (Inkpen 2000), as a contingency variable. A gatekeeper position also relates to firm performance, assessed as financial profit, because integrating distant approaches and perspectives from other knowledge fields increases potential for innovation and advancement in all company areas of activity fostering its financial wellbeing (Faraj et al. 2015; Un et al. 2010).

To examine how different types of collaborative activities directly influence a gatekeeper position and how firms' knowledge base moderates this influence, we consider multiple collaborative activities that firms perform and categorize them according to their interaction intensity (for a full list of collaborative activities see Measurement Section; Lee et al. 2001; Schleimer and Faems 2016). Extant network research suggests that firms perform weakly interactive activities that are characterised by infrequent interactions and not intensive resource exchanges between network partners (e.g., participation in networking events and out-sourcing) to explore innovative opportunities (Michelfelder and Kratzer 2013; Oerlemans and Knobens 2010). So they team up with unfamiliar partners to search for distant, non-redundant information (Burt 1992, 2004; Granovetter 1973). In contrast, firms perform highly interactive activities that are characterised by close, long-lasting, deep relationships with frequent interactions and good information flow between network partners (e.g., M&A and joint ventures) to mainly strengthen their basic knowledge (Capaldo 2007; Sullivan and Ford 2013). So they team up with partners who possess familiar rather than distant knowledge (Coleman 1988; Granovetter 1973). Since weakly and highly interactive activities are two poles of a continuum regarding interaction intensity (Levin and Cross 2004), firms can also perform medium interactive activities (e.g., joint research projects and spin-offs). Extant research has so far not distinguished this category of activities and has concentrated only on strong and weak relationships/ties, therefore it is yet to determine whether such activities help firms to acquire distant knowledge.

6.3.2 Hypotheses

According to SNT, weakly interactive activities are particularly suitable for exploring innovative opportunities (Michelfelder and Kratzer 2013; Oerlemans and Knobens 2010) and firms team up with unfamiliar partners to search for distant, non-redundant information (Burt

1992; Granovetter 1973). With greater access to distant knowledge firms are exposed to a great diversity of different ways of thinking. Intuitively, we would expect these firms to be successful in gaining a gatekeeper position by collaborating with partners from different knowledge fields. However, processing of the distant knowledge requires great amount of expert attention. Because managers and further specialists in firms have a limited attention capacity (Ocasio 1997), they can attend to only a subset of this distant knowledge. So firms tend to focus their attention to narrow, familiar knowledge, which is easy to process (Piezunka and Dahlander 2015).

In addition, the very low interaction intensity between partners during weakly interactive activities hinders firms in recognizing the benefits of the distant knowledge for their companies. They do not know their collaboration partners well enough and the collaboration environment is not stable enough for firms to be able to assess the validity and potential of distant knowledge (Michelfelder and Kratzer 2013). This is because such knowledge and its usefulness is associated with high uncertainty (Katila and Ahuja 2002). Besides, it is hard for firms to act on distant knowledge, since they mostly offer potential for future product, process, or service advancements (Piezunka and Dahlander 2015). Overall, the greater the access to distant knowledge, the harder it is for a firm to process it and assess its validity, so they focus their attention on narrow, familiar knowledge (Levy 2005; Piezunka and Dahlander 2015). Distant knowledge acquired through weakly interactive activities is potentially too distant, making it hard to apply and thus firms are unable to connect distant partners in a network and function as gatekeepers. Therefore, we propose:

H1: Weakly interactive activities are negatively associated with a gatekeeper position.

Medium interactive activities entail ties to partners that have characteristics of both strong and weak ties. On the one hand, firms perform medium interactive activities with partners from other knowledge fields to acquire distant knowledge. On the other hand, they also perform them to broaden the redundant knowledge and cooperate with partners from the same industry as their own (Levin and Cross 2004). Hence, knowledge that firms acquire through medium interactive activities is less distant than in the case of weakly interactive activities. Due to lower knowledge distance firms are able to provide enough attention to distant knowledge. They are not overwhelmed by the diversity of new approaches and ideas as in the case of weakly

interactive ideas and thus can process and make better use of the acquired knowledge (Piezunka and Dahlander 2015).

In addition, during medium interactive activities partners communicate with each other more frequently, the relationship is deeper, and the knowledge flow is much better organised as in the case of weakly interactive activities (Capaldo 2007; Granovetter 1973). Thus, during medium interactive activities firms get to know their collaboration partners better, they are able to discover who possesses what knowledge, and they know how to best establish links between these partners such that synergy effects can be created between distant parts in a network. Overall, they can assess better how to maximize the value of the distant knowledge they are exposed to. Due to this more effective dealing with distant knowledge firms can profit from it in a way that they are able to connect distant partners in the network and be gatekeepers. Accordingly, we propose:

H2: Medium interactive activities are positively associated with a gatekeeper position.

Highly interactive activities are particularly useful for strengthening and broadening basic knowledge (Granovetter 1973). There is less distance to knowledge acquired through highly interactive activities, because firms mostly cooperate with partners from their industry and acquire narrow, familiar knowledge (Capaldo 2007). Such knowledge is less complex and therefore easy for firms to process and internalize. Whereas knowledge similarities between partners might be beneficial for generating, for example, economies of scale or fostering communication processes between partners (Filiou and Massini 2017), they are not beneficial for achieving a gatekeeper position, because redundant knowledge does not help firms to connect distant parts in a network. To bridge different knowledge clusters in a network firms have to find and process distant knowledge (Spiro, Acton, and Butts 2013).

Furthermore, Granovetter (1973) strongly posits that strong ties such as highly interactive activities, characterised by long-lasting, emotional, deep knowledge exchange cannot lead to a gatekeeper position, because firms that have strong ties to other network partners are usually embedded in a dense network (Capaldo 2007). In dense networks partners are interconnected with each other, that is, every network member is connected to any other network member by strong ties (Carnabuci and Dioszegi 2015). Hence, a focal firm is less likely to be a gatekeeper, linking partners who are otherwise not connected to each other (Granovetter 1973). Moreover, when a focal firm is linked to partners by strong ties, these partners are more likely to have

knowledge that is similar to focal firm's knowledge and thus partners cannot provide distant knowledge. Therefore, it is not beneficial for the focal firm to act as a gatekeeper and connect similar partners. Thus, the focal firm would not be a gatekeeper anymore. We hypothesize:

H3: Highly interactive activities are negatively associated with a gatekeeper position.

When firms strive to access and interpret distant knowledge by performing different collaborative activities, their currently held knowledge significantly determines whether they will be successful in this task or not. Only those firms that are able to integrate distant knowledge in their currently held, familiar knowledge can discover the value of distant knowledge for their organization and thus link different network partners who supply such knowledge (Katila and Ahuja 2002). Extant research also shows that firm's knowledge that is embedded in individual skills, business routines, and processes, determines if a firm is able to provide an environment needed to facilitate the integration of external knowledge (Inkpen 2000; Un et al. 2010).

When firms perform weakly interactive activities firms focus their attention on narrow knowledge and neglect distant knowledge, because it is too distant and firms cannot relate to it (Piezunka and Dahlander 2015). And due to very low interaction intensity they are also unable to discover the benefits of distant knowledge for their organization. Hence, it harms their gatekeeper position. The stronger firms' knowledge base, the stronger should be the negative effect of weakly interactive activities on a gatekeeper position. In weakly interactive activities firms tend to focus on familiar, redundant knowledge and if a firm has strong knowledge base, their focus is even more directed towards already existing, familiar knowledge. Exploratory search for distant knowledge requires conscious efforts to move away from current organizational routines and ways of thinking and a strong knowledge base hinders firms to do so, because firms tend to stick to the familiar ways of thinking (Katila and Ahuja 2002). Thus, firms are unable to connect network partners with distant knowledge. We propose:

H4a: The negative effect of weakly interactive activities on a gatekeeper position is stronger when the firm has stronger knowledge base.

In the case of medium interactive activities the moderating effect of firm knowledge base might work differently. The knowledge acquired is less distant and firms are able to process it more easily, so they put enough focus of attention to distant knowledge—they direct their focus

outwards. This outward focus combines well with firms' knowledge base because, firms with a strong knowledge base know better what kind of knowledge they are looking for and how to bridge different knowledge clusters to find it (Katila and Ahuja 2002). It might be easier for them to recognize their knowledge deficits and they might be more skilled in finding and linking partners in the network to maximize the benefits of distant knowledge. In the case of medium interactive activities firm knowledge base serves as the absorptive capacity (Cohen and Levinthal 1990), such that firm use their accumulated knowledge to recognize and internalize distant knowledge (Katila and Ahuja 2002). Thus, strong knowledge base should strengthen the benefits that firms gain from medium interactive activities in terms of bridging different knowledge fields. Hence, we hypothesize:

H4b: The positive effect of medium interactive activities on a gatekeeper position is stronger when the firm has stronger knowledge base.

Generally firms are less likely to be gatekeepers in a network by performing highly interactive activities because knowledge they acquire through these activities is not distant enough (Granovetter 1973; Capaldo 2007). However, a strong knowledge base makes them skilled in finding and connecting the right partners from other knowledge fields during their highly interactive activities hence buffering the negative effects of highly interactive activities on a gatekeeper position (Katila and Ahuja 2002). Although, firms perform highly interactive activities mainly with partners from the same knowledge fields and acquire redundant knowledge, long relationships with frequent, deep interactions between partners just as other collaborative relationships also bear the potential for distant knowledge (Capaldo 2007). Firms just need strong knowledge base to be able to discover this distant knowledge while collaborating intensively with their partners. The high interaction intensity during the collaboration combines well with strong knowledge base and it is what allows firms to discover distant knowledge. When partners establish deep, trustful ties, they get to know each other's competencies very well and firms with strong knowledge base are able to discover distant knowledge and its usefulness for their own organization within these ties (Michelfelder and Kratzer 2013). Therefore, we propose:

H4c: The negative effect of highly interactive activities on a gatekeeper position is weaker when the firm has stronger knowledge base.

SNT, proposes two interlinked mechanisms to explain how a gatekeeper generates social capital (Rodan and Galunic 2004). The first mechanism suggests that disconnected partners in a network represent a source of non-redundant, distant information, such as novel approaches, perspectives, and ideas, that are not well known in their industry (Faraj et al. 2015; Stem and Elfring 2008) and may be applied to overall firm activities to increase firm performance (Piezunka and Dahlander 2015; Sapiro et al. 2013). The other mechanism relies on arbitrage and strategic manoeuvrability as a source of advantage (Rodan and Galunic 2004). By acting as a broker between network partners, gatekeeper can gain certain power over the bridging ties it maintains, without having to maintain costly direct ties. A gatekeeper thus achieves a strategic benefit by making other network members dependent on itself and exercising certain power over these members (Sapiro et al. 2013). Thus, a gatekeeper profits by making use of the acquired social capital in form of distant knowledge and by making use of network dependencies to foster firm performance (Carnabuci and Dioszegi 2015). Altogether, we hypothesize:

H5: A gatekeeper position is positively associated with firm performance.

6.4 Methodology

6.4.1 Sample and Data Collection

This study relies on a unique dataset consisting of large-scale, quantitative longitudinal data from the 500 largest companies in Germany. To identify the 500 largest companies in Germany, we relied on a list issued by a well-recognised national daily newspaper (“Die Welt”), listing 500 companies that had the highest sales in 2013 including companies listed on the stock market as well as privately held firms. These companies stem from various industry sectors and regions of Germany. We collected data for our empirical analysis from two secondary data sources, namely, we match cooperation data collected via a machine-based data crawling approach with performance data manually collected from annual reports of these 500 companies. In following, both data collection processes are described in detail.

First, we developed an innovative machine-based data crawling approach to obtain cooperation data. This crawling tool was developed in 2015 over a time period of two months and was tailored at collecting and analysing press releases about the 500 largest companies. Press releases have been often used as reliable source to obtain company-related information in studies analysing prices on the stock markets (e.g., Schumaker and Chen 2006). In our study, we rely on press preleases to obtain valuable information about company’s collaborative

activities, because firms are generally eager to announce new cooperations in their press releases to inform relevant stakeholders and to gain a positive image. Thus, press releases might be one of the best source to obtain cooperation data. With this innovative approach we gathered panel data about collaborative activities of the 500 largest companies in Germany over the time period of nine years and apply a five-year moving time window to analyse this data (also see Results section). Thus, we are able to dynamically reconstruct the collaboration network between these 500 companies over a long period of time such that we capture new network ties that firms establish every year during the period of observation.

To gain information about firm's collaborative activities, the data crawling tool scanned multiple national databases containing press releases of German companies—"Wisonet", "Spiegel Online", "Presseportal", and "Google News". In order for the data crawling tool to be able to extract press releases of interest, we entered a list of company names of the 500 largest companies as well as a list of various keywords referring to a collaborative activity (e.g., alliance, spin-off, cluster etc.). Hence, the crawling tool extracted a press release if it contained at least two company names of the 500 company list and at least one keyword referring to a collaboration between these companies (e.g., BMW; SAP; alliance). Using this approach, we collected press releases about these 500 companies over the time period of nine years (2006-2014) and identified companies that have engaged in different kinds of collaborative activities (e.g., joint ventures, spin-offs, alliances, research projects). Altogether using this machine-based approach we identified 3,818 company-pairs entailing cooperation (e.g., BMW cooperating with SAP or Unilever cooperating with Nestle).

In another step, we manually carried out a check of quality and validated, whether an actual collaboration existed between each pair of the companies identified by the data crawling tool. Thereby, we carefully analysed each of the 3,818 press releases to determine if we can count the collaboration entailed in it as a valid company-pair. This process lasted 3 months and required over 200 working hours. After the manual validity check, we had 1,453 valid company-pairs. On the basis of these validated company links, we calculated the number collaborative activities and network centrality of each of the 500 companies using social network analysis software Gephi 9.1.

When computing network measures we accounted for the fact that in some cases the same collaboration between two companies was mentioned in multiple press releases. If the press release had exact the same wording, we sorted it out as a redundancy and did not consider this copy of the press release when computing network measures. If, however, different press organs

reported about the same cooperation and the press releases were not identical, we considered this collaboration to be more important, because it had attracted more attention from the press. Thus, we used the number of the times that a collaboration appeared in different press releases as the weight of the collaboration activity and considered it when computing the number of collaborative activities of each firm.

Second, we enriched our cooperation data with financial performance data. We manually extracted financial data from annual reports of the 500 companies and when an annual report was not present, we relied on financial data bases, such as “Bundesanzeiger” and “Hoppenstedt” to obtain the data. We extracted data regarding R&D intensity (R&D expenditures/revenue), number of registered patents, firm performance (Ebitda), and number of employees over the time period of five years (2010-2014). These five years from 2010 to 2014 is our time frame for the analysis. Cooperation data was, however, collected over the time period of nine years (2006-2014) due to a special and innovative way of computing the measure for firms’ gatekeeper position (also see Measurement section for detailed information). Altogether, data collection on firms’ financial performance took 4 months and required over 300 working hours. With both data collection processes we are able to use a data set collected from two independent secondary sources, which significantly increases data validity and reduces the potential for a common method bias (Podsakoff et al. 2003).

Our sample companies represent diverse industry sectors (see Table 6-1). Most of our sample companies stem from machinery/electronics industry sector (20.2%) as well as retail/consumer goods sector (24.5%). Approximately one fifth of our sample firms are service providers (17.4%). The sample also entails firms from chemicals/pharmaceuticals (9.0%), software/IT (4.4%). And further industries (24.2%). This diversity helps increase the generalizability of our findings and avoid potential biases resulting from diverse industry characteristics.

The sample entails the 500 largest firms in Germany; on average they have 19,813 employees. About one fifth of the sample firms employs less than 1,000 people (18.1%). Most of the firms have 1,000 to 5,000 employees (28.3%). Most of the firms are larger in our sample: 16.7% of them have 5,000 to 10,000 employees, 10.9% up to 15,000, and 14,2% have the number of employees within the range of 15,000 to 50,000. Around 10% are large multinational corporations with more than 50,000 employees. Regarding sales volumes, on average firms have € 6,3 billion in sales. Whereas 13,2% have less than 1,000 in sales, 60% of the sample’s firms have € 1-5 billion in sales. For around one fifth (20,6%) of the companies sales volumes range from € 5 to € 25 billion and 6,2% of the companies have sales volumes above € 25 billion.

Table 6-1: Sample Composition (Study 3)

Industry sector		Sales volume in million	
Chemicals/pharmaceuticals	9.0%	< €1,000	13.2%
Machinery/electronics	20.2%	€1,000–€1,500	18.9%
Software/IT	4.4%	€1,500–€2,000	12.0%
Retail/consumer goods	24.5%	€2,000–€3,000	17.3%
Services	17.4%	€3,000–€5,000	11.8%
Other	24.2%	€5,000–€10,000	10.2%
		€10,000–€25,000	10.4%
Number of full-time employees		> €25,000	6.2%
< 1,000	18.1%		
1,001–2,500	14.6%		
2,501–5,000	13.7%		
5,001–10,000	16.7%		
10,001–15,000	10.9%		
15,001–50,000	14.2%		
> 50,001	11.8%		

Regarding collaboration intensity, our sample includes firms that perform only a few collaborative activities as well as firms that perform many collaborative activities profoundly. This heterogeneity offers no evidence of self-selection by firms that are rather closed and do not engage in much cooperation as well as such firms that are more open towards collaboration. More detailed information about performed collaborative activities, R&D expenditures, and profit of our sample companies is provided in Section “Model specification and hypotheses tests”.

6.4.2 Measures

To operationalize the dependent, independent, and control variables, we rely on objective data from secondary data sources. During the manual validity check of the company links extracted by the data crawling tool, we identified altogether 19 collaborative activities that our sample firms performed. Based on extant literature (Capaldo 2007; Schleimer and Faems 2016) we classified these activities according to their interaction intensity in three categories: weakly, medium, and highly interactive activities. (1) Agreements regarding joint interests, (2) participation in associations, (3) participation in competitions and campaigns, (4) out-sourcing, and (5) participation in networking events were classified as *weakly interactive activities*. (6) Interest in a company with less than 50% shares, (7) joint interests of multiple network partners in a company, (8) cluster, (9) joint project, (10) joint research project, (11) consortium, (12) joint sales activities, (13) partnerships, and (14) spin-off were classified as *medium interactive activities*. And (15) M&A, (16) joint ventures, (17) joint organization, (18) strategic

partnerships, and (19) strategic alliances were classified as *highly interactive activities*. In the next step, for every company in our sample we counted the number of collaborative activities that a firm performed in each category. The collaborative activities represent direct ties that a firm has with its network partners.

The *gatekeeper position* is operationalized by betweenness centrality, which has been widely used in prior research and measures how often a node appears on shortest paths between nodes in the network (Carnabuci and Dioszegi 2015; Faraj, Kudaravalli, and Wakso 2015). It is computed by the following formula:

$$C_B(v) = \sum_{s \neq v \neq t \in V} \frac{\sigma_{st}(v)}{\sigma_{st}}$$

where

σ_{st} = the total number of shortest paths from node s to node t and

$\sigma_{st}(v)$ = the number of those paths that pass through a node v .

To compute the betweenness measure for each firm in our study, we consider all collaboration a firm has entered over the past five years. Thereby, we consider that collaboration last a few years and generally vary in their duration depending on the purpose of the collaboration and the type of collaborative activity that partners perform. Some activities are of shorter duration, such as participation in competitions and campaigns, whereas others last much longer, such as joint projects and joint ventures. When considering firm's position in a broader collaboration network at a given point in time ($t = 0$), it is crucial to take into account that this position results from collaborative activities that a firm has performed in the last few years. To account for this fact, we consider all collaborative activities that a firm has performed over the past five years. For example, firm's betweenness centrality measure in year 2014 results from collaborative activities in 2010, 2011, 2012, 2013, and 2014. Hence, we use an innovative measure that depicts firm's gatekeeper position at a certain point of time that results from firm's past and present collaborative activities.

We use R&D intensity operationalized as a percentage of the R&D expenditures of a company's total revenue as a proxy for *firm's knowledge base*. This measure represents firm's entire repository of R&D-related competences reflected in both individual skills, business routines, and processes (Inkpen 2000). Thus, by investing in company's R&D, firms build up R&D-related knowledge—they invest in the know-how of the employees, who further use this know-how to enhance firm's routines and processes. Altogether, this accumulated knowledge

determines how well firms can absorb new approaches, trends, and concepts to foster their firm's entire actions.

We assess *firm performance* as financial profit (Ebitda; earnings before interest, taxes, depreciation, and amortisation), which is in line with extant studies in the field (e.g., Green, Whitten, and Inman 2012; Tuominen, Rajala, and Möller 2004). Regarding control effects, we reduced the possibility that other non-measured company-specific characteristics might account for the variance in our dependent variable by employing fixed-effects models that already captured time-invariant unobserved heterogeneity at the firm level (Wooldridge 2002). Nevertheless, similar as other scholars in this research field who have relied on fixed-effects models (e.g., Frankort 2016; Lin et al. 2009), we included further variables to control for the influences of specific firm characteristics on the dependent variables. *Firm size* was included, measured as the number of full-time employees, as well as the *number of registered patents* to control for the fact that some companies might be more innovation-oriented than others and hence collaborate more. Registered patents is an often-employed control variable in extant research examining collaboration (e.g., Beers and Zand 2014).

6.4.3 Model Specification and Hypotheses Tests

To test our direct and moderating effects hypotheses, we employed two fixed-effects models with two-way OLS-estimates that captured time-invariant unobserved heterogeneity at the firm level (Wooldridge 2002). In the first model, we test H1-H4 and use cross-sectional ($N = 500$ companies) and time-series ($t = 5$ years) data with a panel structure with 2,500 observations ($N * t$). We further include one-year time-lagged effects of our independent variables ($t = -1$), because it takes time to observe any performance effects of collaborative activities. Namely, the data for weakly, medium, and highly interactive activities stem from years 2009-2013 ($t = -1$; time series length 5), whereas the data for the rest of our variables in the model stem from 2010-2014 ($t = 0$; time series length 5). It is important to indicate that for the variable "gatekeeper position" we also have time series length 5, namely 2010-2014. The score of betweenness centrality in each of these years stem from firm's collaboration from the past 5 years. To compute betweenness centrality for 2010-2014, we thus use collaboration data from 2006-2014.

Hence, the first fixed-effects model includes the direct effects of time-lagged weakly, medium, and highly interactive activities and three interaction terms of the three categories of collaborative activities and firm knowledge base, to test for moderating effects. We also

controlled for firm size, number of patents, and the direct effect of firm knowledge base. Our first empirical model is as follows:

$$\text{Gatekeeper position}_t = \alpha_0 + \alpha_1 \text{W_IA}_{t-1} + \alpha_2 \text{M_IA}_{t-1} + \alpha_3 \text{H_IA}_{t-1} + \alpha_4 \text{W_IA}_{t-1} \times \text{FKB}_t + \alpha_5 \text{M_IA}_{t-1} \times \text{FKB}_t + \alpha_6 \text{H_IA}_{t-1} \times \text{FKB}_t + \gamma_1 \text{Firm size}_t + \gamma_2 \text{Patents}_t + \gamma_3 \text{FKB}_t + \text{Error}_t,$$

where

W_IA	= Weakly interactive activities
M_IA	= Medium interactive activities
H_IA	= Highly interactive activities
FKB	= Firm knowledge base

In the second model, we tested H5. Specifically, we estimated the direct effect of a gatekeeper position on firm performance and employed again firm size and the number of patents as controls. For the second fixed-effects model our sample size is 340 companies, because data on financial performance was not available for every of the 500 companies. Some companies, for instance, provide profit data only for parent (or daughter) company, or are exempted from publishing their profit publically. To test H5, we use cross-sectional ($N = 340$ companies) and time-series ($t = 5$ years) data with a panel structure with 1,700 observations ($N * t$). Our second empirical model is:

$$\text{Firm performance}_t = \alpha_0 + \alpha_1 \text{Gatekeeper position}_t + \gamma_1 \text{Firm size}_t + \gamma_2 \text{Patents}_t + \text{Error}_t$$

To compute the interaction terms, we multiplied the mean-centered values of the corresponding constructs (Atuahene-Gima et al. 2005). We further applied Hausman's test for random effects to determine whether the fixed-effects model was suitable for our data. The test result was significant at the 0.01%-level indicating that a fixed-effects model should be applied.

Table 6-2 shows correlations and descriptive statistics for all variables. Our sample companies have performed on average 3 weakly and 3 medium interactive activities over the time period 2010-2014. Comparatively, they perform less highly interactive activities (approximately one within the same time period). Furthermore, companies invest about 2% of their sales in R&D and have registered on average 237 patents. We see, however, a relatively large variation in our sample regarding the number of registered patents.

Table 6-2: Descriptive Statistics and Correlations (Study 3)

Variables	1	2	3	4	5	6	7	8	VIF
1 Weakly interactive activities									1.3
2 Medium interactive activities	0.30								1.2
3 Highly interactive activities	0.16	0.17							1.2
4 Gatekeeper position	0.56	0.54	0.26						1.2
5 Firm knowledge base	0.02	0.03	0.02	0.02					1.1
6 Number of patents	0.04	0.04	0.01	0.04	0.05				1.0
7 Firm size	0.27	0.24	0.13	0.42	0.03	0.15			1.3
8 Firm performance	0.44	0.38	0.23	0.58	0.01	0.23	0.78		n/a
Mean	0.27	0.30	0.07	3.20	2%	237	19,813	684 Mio.	
Standard Deviation	1.39	1.72	0.45	10.88	11.7%	3,325	58,382	2,1 Bil.	

Notes: Number of observations in sample = 2,500 (N * t); for firm performance = 1,700 observations; $r > 0.09$, $p = 0.05$; $r > 0.12$, $p = 0.01$; two-tailed tests.

The correlation coefficients between our study variables are on low or medium levels. Especially, the correlations between weakly, medium, and highly interactive activities range from $r = 0.16$ to $r = 0.30$ indicating weak correlations. We observe correlations on a medium level between weakly interactive activities and a gatekeeper position and medium interactive activities and a gatekeeper position. Moreover, a gatekeeper position is correlated with firm performance at a medium level. The correlation between firm size and firm performance is at a higher level, which is common, since larger companies tend to have higher profit. Altogether, to test for multicollinearity (Aiken and West 1991), we calculated the variance inflation factors, which were all below 4 (Hair et al. 2013) for all variables, so multicollinearity does not appear to be an issue.

We applied a preliminary analysis to test whether we find support in our data for the proposition from SNT that firms mainly enter weak ties (perform weakly interactive activities) with partners outside their own industry and enter strong ties (perform highly interactive activities) mostly with partners from the same industry (Granovetter 1973; Michelfelder and Kratzer 2013). Thus, we calculated how many collaborative activities firms performed with partners outside their own industry within the category of weakly, medium, and highly interactive activities. We find that 64.4% of the weakly interactive activities firms perform with partners from other industries. This percentage is lower in medium interactive activities (58.9%) supporting the notion that firms cooperate with partners from other industries as well as with partners from their own industry. Only 31.8% of highly interactive activities are performed with partners from other industries, again strongly supporting the proposition of SNT that firms carry out highly

interactive activities mostly with partners from their own industry to acquire familiar and often redundant knowledge (Granovetter 1973).

6.5 Results

We present the results of the step-wise development of the first fixed-effects model with OLS-estimator, including the regression coefficients, their significance levels, and standard errors, in Table 6-3. These results are based on 2,500 ($N=500 * t=5$) observations. To determine the fit of our model, we rely on R^2_{within} and F-values as other scholars in the field employing fixed-effect models that capture within-variance (e.g., Lin et al. 2009). Our final Model (Model 3) shows a good exploratory power such that we are able to explain 53% of the within-variance (variance between different points in time) in our dependent variable (adjusted $R^2_{\text{within}} = 0.53$; F-value = 308.27, $p < 0.01$).

For the main effect hypotheses, we find support for H1, which predicted a negative relationship between weakly interactive activities and a gatekeeper position ($\beta = -14.85$, $p < 0.01$). Medium interactive activities exert a positive influence on a gatekeeper position ($\beta = 16.56$, $p < 0.01$), in support of H2. However, we do not find support for H3, which predicted that highly interactive activities would harm a gatekeeper position ($\beta = -0.69$, ns). Highly interactive activities as strong ties do not exert any influence on such a structural network position.

For the moderating effects hypotheses, we find partial support for the moderating effect in H4a; the link between weakly interactive activities and a gatekeeper position is only negatively moderated by firm knowledge base ($\beta = -7.50$, $p < 0.10$), however this effect is significant at the 10%-level. We find a similar negative moderating effect of firm knowledge base on the link between medium interactive activities and a gatekeeper position ($\beta = -11.52$, $p < 0.01$), which is contrary to our hypothesis H4b. So, firms' knowledge base does not increase the benefits of medium interactive activities for a gatekeeper position. As predicted in H4c, firm knowledge base positively moderates the link between highly interactive activities and a gatekeeper position ($\beta = 3.56$, $p < 0.05$), which suggests some interesting implications for companies that perform highly interactive activities. Regarding the control effects, firm size ($\beta = 0.0003$, ns) as well as the number of patents ($\beta = -0.0005$, ns) did not exert significant effects in this fixed-effect model.

Table 6-3: Results, First Fixed-effects Model (Study 3)

Dependent Variable	Gatekeeper Position					
	Model 1		Model 2		Model 3	
	Coef.	SE	Coef.	SE	Coef.	SE
Control Variables						
Firm size	0.00	0.00	0.00	0.00	0.00	0.00
Number of patents	0.00	0.01	0.00	0.01	0.00	0.01
Firm knowledge base (FKB)	-0.04	0.20	-0.04	0.19	-0.24	0.20
Main Effects						
H1: Weakly interactive activities (W_IA)			-16.61**	1.98	-14.85**	2.06
H2: Medium interactive activities (M_IA)			15.86**	1.20	16.56**	1.21
H3: Highly interactive activities (H_IA)			-0.82	4.59	-0.69	4.77
Interaction Effects						
H4a: W_IA × FKB					-7.50†	4.33
H4b: M_IA × FKB					-11.52**	2.87
H4c: H_IA × FKB					3.56*	3.36
R ² _{within}	0.16		0.52		0.53	
Adjusted R ² _{within}	0.16		0.52		0.53	
F-value	159.47**		453.55**		308.27**	
Observations	2,500		2,500		2,500	

Notes: ** $p < 0.01$; * $p < 0.05$; † $p < 0.10$; two-tailed tests; number of observations in sample = 2,500 (N * t); R²_{adj} in Model 3 = 0.53; coef.: unstandardized coefficients for main and standardised for interaction effects; SE: standard errors; fixed-effects model; OLS-estimator; time series length 5.

Finally, to complete the hypothesised causal chain, we employed a second fixed-effect model to test the relationship between a gatekeeper position and firm performance (H5). We present the results of the step-wise development of the second fixed-effects model in Table 6-4. These results are based on 1,700 (N=340 * t=5) observations. Again, the explanatory power of the final Model (Model 2) is fairly high as we are able to explain 71% of the within-variance in our dependent variable (adjusted R²_{within} = 0.71; F-value = 1349.86, $p < 0.01$). We find a positive, significant effect of a gatekeeper position on firm performance ($\beta = 452.62$, $p < 0.05$), in line with prior research (e.g., Kratzer et al., 2016; Tan et al., 2015). Regarding the control effects, firm size has a positive effect on firm performance ($\beta = 12.98$, $p < 0.01$), but the number of patents does not exert a significant effect ($\beta = 20.03$, ns).

Table 6-4: Results, Second Fixed-effects Model (Study 3)

Dependent Variable	Firm Performance			
	Model 1		Model 2	
	Coef.	SE	Coef.	SE
Control Variables				
Firm size	12.57**	1.47	12.98**	1.48
Number of patents	21.18	45.93	20.03	45.86
Main Effect				
H5: Gatekeeper position			452.62*	200.7
R ² _{within}	0.64		0.71	
Adjusted R ² _{within}	0.64		0.71	
F-value	1443.44**		1349.86**	
Observations	1,700		1,700	

Notes: ** $p < 0.01$; * $p < 0.05$; † $p < 0.10$; two-tailed tests; number of observations in sample = 1,700 (N * t); R²_{adj} in model 2 = 0.71; coef.: unstandardized coefficients; SE: standard errors; fixed-effects model; OLS-estimator; time series length 5.

To increase the confidence in our results' robustness, we performed further analyses. To do so, we tested our baseline model with various lags of our independent variables. First, we tested our model with no lagged-effects ($t = 0$) of the independent variables and second, we applied two-year lagged effects of our independent variables ($t = -2$). The results remained as in our main model with one year lagged effects ($t = -1$). Altogether, we find strong support for the robustness of our results.

6.6 Discussion

Extant research has long recognised that a gatekeeper position in a collaborative network is highly valuable for acquiring distant knowledge and thus achieving a competitive edge. However, it has failed to provide suggestions for how to achieve such a network position. Because firms constantly look for distant knowledge and strive to become gatekeepers, this study explicitly investigates which collaborative activities firms should perform contingent on the strength of their firms' knowledge base to be able to access and interpret distant knowledge and to achieve a gatekeeper position in subsequent periods. Thereby, we provide multiple implications for scholars as well as practitioners.

6.6.1 Implications for Research

A gatekeeper position as such is not a scarcely addressed phenomenon in network research. After Granovetter's (1973) classic work on the strength of weak ties, sociologists have attempted to refine the measurement of a gatekeeper position (e.g., Brandes 2001; Everett and Valente 2016; Freeman 1977) and further authors to examine the outcomes of a gatekeeper

position on individual and firm-levels (e.g., Rodan and Galunic 2004; Spiro et al. 2013). However, the entire research field of network formation has not succeeded in explaining how firms can become gatekeepers in their networks (Rodan and Galunic 2004; Walker, Kogut, and Shan 1997). This is to the best of our knowledge the first study that explicitly examines factors that influence firms' gatekeeper position from a longitudinal perspective in a collaboration network and shows that not all collaborative activities are helpful to achieve a promising position in the network of firms. Hence, social network theorists must acknowledge that a network position where actors transform the network structure by connecting otherwise disconnected partners is challenging and hard to achieve. In order to be able to profit from social capital residing in a gatekeeper position, network actors have to carefully plan and execute their collaborative activities.

In the pursuit to explain how an actor becomes a gatekeeper in its network, it is vital to draw on both structural and relational conceptions within network research (Rodan and Galunic 2004). Whereas the structuralist conception helps to investigate and interpret the particularities and benefits of a gatekeeper position, alone it might not be sufficient to provide enough clues as to how an actor becomes a gatekeeper. For that, the structural perspective must be augmented by the relational perspective to take specific relationship/tie-specific aspects into account (Rodan and Galunic 2004). Within the relational dimension, the characteristics of a relationship between partners itself and of the content transferred through the network ties are of particular importance. Especially, by drawing on literature on distant knowledge (Afuah 2013; Piezunka and Dahlander 2015), this study shows that network actors must be able to access, and more importantly interpret, distant knowledge acquired through their ties to function as gatekeepers. Thus, the theoretical concept of distant knowledge is suitable for developing theoretical mechanisms by which network ties influence firms' structural network position.

Furthermore, this study extends knowledge about the circumstances which determine whether collaborative activities will offer the benefits of distant knowledge such that it is possible for an actor to connect distant knowledge fields in a network and function as a gatekeeper in subsequent periods. We show the network research community that interaction intensity of collaborative activities significantly determines whether firms can access and make use of distant knowledge. Whereas previous research postulates that weak ties are suitable for acquiring distant knowledge, we show that if the collaborative ties are too weak, firms will not be able to interpret distant knowledge and they will not become gatekeepers. Moreover, according to the core arguments of SNT, strong ties are supposed to harm a gatekeeper position. We find that they are neither beneficial nor detrimental for such a position. Besides weak and

strong ties, it is also important to distinguish a third type of collaborative activities that is characterised by medium interaction intensity. Our results show that this type of collaborative activities is particularly suitable for achieving a gatekeeper position.

Building on the previous implication regarding the circumstances which determine when collaborative activities will benefit firms' gatekeeper position, we also show that a firm knowledge base is an important contingency. Currently held knowledge in a company has the potential to either hinder or foster the integration of distant knowledge. In the case of weakly and medium interactive activities it blocks the assimilation of distant knowledge and hinders firms in becoming gatekeepers, because firms place too much attention on familiar knowledge. However, in the case of highly interactive activities it enables firms to become gatekeepers. The high interaction intensity during the collaboration combines well with strong knowledge base and it is what allows firms to discover distant knowledge and its usefulness for the firm. Hence, our results provide implications for research regarding knowledge transfer and show that a strong knowledge base is not always beneficial for integrating distant knowledge and consequently becoming a gatekeeper.

6.6.2 Implications for Managerial Practice

Every company regardless of its size and industry performs collaborative activities with partners at least to some extent. Hence, they are all embedded in a network of collaborative relationships (Capaldo 2007). However, in everyday practice, managerial attention and resources are often devoted to the management of one or few collaborative activities at the same time. Managers concentrate on how to access and make use of distant knowledge within single collaborative activities. They often lack a "bird's-eye view" on their entire portfolio of collaborative relationships. Thus, they rarely explicitly consider their network position—a fact that might be attributed to somewhat abstract nature of networks and firms' position in it. Firms must acknowledge their network position, i.e., apply tools of social network analysis to determine their gatekeeper position. In addition, they have to realize that they can achieve a gatekeeper position by choosing different types of collaborative activities and not all of them are equally suitable to foster it and consequently firm performance (Iacobucci and Hoeffler 2016; Michelfelder and Kratzer 2013).

To become gatekeepers in their networks firms should ideally perform medium interactive activities. Such activities as joint research projects, clusters, and spin-offs that are characterised by medium levels of interaction between partners, medium depth and duration, and good knowledge flow, allow firms to discover which partners possess distant knowledge and allows

them to connect these partners in joint collaborative activities. When firms perform medium interactive activities they also have to make sure that the firms' internal knowledge base does not narrow their interpretation lens of distant knowledge to be able to connect partners that possess distant knowledge. Thus, managers may need to re-evaluate the individual skills, business routines, and processes they promote during collaboration. To summarize, medium interactive activities are particularly suitable for firms with weak knowledge base to become gatekeepers.

When firms perform weakly interactive activities they have a good possibility to acquire distant knowledge, because they perform such activities mostly with partners from other industries. However, due to a greater knowledge distance and very low interaction intensity between partners as compared to medium interactive activities, firms shift their focus on familiar knowledge that is easy to interpret. Whereas weakly interactive activities might be beneficial for other network-related outcomes, firms cannot gain a gatekeeper position by performing only weakly interactive activities. However, probably every company has them in its collaboration portfolio and benefits from these activities in another way apart from gaining a gatekeeper position. And when weakly interactive activities are performed alongside with medium interactive activities, firms might also advance their gatekeeper position.

Generally, firms should perform highly interactive activities to access narrow, familiar knowledge and put firms' focus on it. Such activities are neither suitable for gaining a gatekeeper position, nor are they harmful. If firms want to access distant knowledge, they can perform medium interactive activities alongside their highly interactive activities to have a combination of distant and familiar knowledge. However, when firms have a strong knowledge base, they should use this advantage to look for distant knowledge within their highly interactive activities and absorb it. High interaction intensity between collaborating partners allows them to get to know their partners' competences and expertise better, also beyond those that are shared within immediate collaboration.

6.6.3 Limitations and Avenues for Further Research

This study takes into consideration that collaboration networks change over time and thus responds to the call for more investigations that examine the dynamics of network relationships (Spiro, Acton, and Butts 2013). Drawing on a large-scale longitudinal data set, we are able to investigate how engaging in different network relationships influences an actor's position in a collaboration network in long-term. Moreover, by determining firm's gatekeeper position that results from the past 5 years, we take the dynamics of the actor's past network relationships

into account. Another aspect of dynamic network relationships that we do not account for in our study is that the interaction intensity of a network relationship might change over time. In current research, collaborative activities that firms perform are considered to be stable over long periods of time. Future research should consider the fact that a particular collaborative activity might have lower/higher interaction intensity at the beginning of the relationship than in later periods of time. Such investigations would offer new insights regarding how firms might shift their focus from familiar to distant (or distant to familiar) knowledge in the course of a single activity and its implications for firms' gatekeeper position.

Spiro, Acton, and Butts (2013) take into consideration that a gatekeeper can fulfil many different roles in a network. For instance, a gatekeeper can function as a coordinator between two other network members who belong to the same industry, or act more as a representative or a broker between members from different industries. Our study does not differentiate between these roles and operationalizes a gatekeeper position by the assessing firms' betweenness centrality. This quantitative measure does not allow to make any assumptions whether a gatekeeper is more active in one role rather than the other. By augmenting a quantitative assessment of a gatekeeper position with a qualitative measurement of the exact gatekeeper role, future studies could enhance our understanding of which collaborative activities are particularly useful for a particular gatekeeper role.

The largest 500 companies in Germany represent an interesting and relevant data base for investigating collaborative links between companies of diverse industry sectors. These companies have become closely intertwined over the past 10-15 years and thus allow a close examination of their gatekeeper positions. However, one must take into account that this sample represents large companies that mostly have the necessary resources to perform a wide variety of different collaborative activities to access distant knowledge. Whereas it makes these firms an interesting research subject, the assumption that managers have a perfectly free choice to perform whichever collaborative activities they want, may not be generalizable. Future studies should look at how small and young companies can become gatekeepers given their limited resources, limited collaborative experience, and thus collaborative activities they can actually perform. Apart from several restriction that young companies face, they might be generally more open towards distant knowledge and not let firms' knowledge base hinder absorption of distant knowledge. Hence, the proposed effects in our study framework might be different for small and/or young firms.

7 Conclusion of the Thesis

Finding determinants that foster the effectiveness of firms' OI efforts is an increasingly relevant concern for managers, which has led to a growing interest of scholars in research on OI networks. Hence, OI network research has emerged as a substantial research stream in extant OI literature (Randhawa, Wilden, and Hohberger 2016).

The results of the three studies provide overarching contributions for research and managerial practice regarding the interplay between firms' OI efforts and network characteristics. The first two studies investigate how different network characteristics influence the effectiveness of firms' OI efforts. The third study takes a different perspective on the OI-network characteristic interplay and examines how firms can influence their OI network characteristics by shaping their OI efforts. Hence, the three studies serve the two overarching goals of the thesis (see Chapter 1.2):

Major goal 1: Determining how network characteristics influence the effectiveness of different types of OI activities and how they might help firms to manage the upsides and downsides of OI.

Major goal 2: Determining how firms can influence their network position by performing different types of OI activities.

7.1 Research Implications of the Thesis

OI is a very broad and complex concept which encompasses a wide variety of research streams that investigate different aspects: collaboration forms and their management, external knowledge integration, partner selection, and network-based value creation. Every study on the topic of OI faces the challenge of having to consider many other research fields to gain holistic insights of any particular area of OI at focus. Whereas OI research has gone a long way and achieved significant advancements since the term "open innovation" was first introduced in 2003, "OI is evolving into a diverse and fragmented body of knowledge, with a lack of common

understanding of what constitutes OI and its theoretical underpinnings” (Randhawa et al. 2016, p. 750).

Figure 7-1 illustrates that *OI research is in fact open itself*. It has a fuzzy front-end which started with the first studies examining dyadic collaborative relationships and ended with the introduction of the term by Henry Chesbrough in 2003. This phase illustrates that there are many research streams that OI research draws upon, such as alliance research, network research, and organizational learning. All of these research streams have contributed and shaped OI research as it is in these days. After 2003 a distinct OI research field started to emerge. However, it is questionable to say that there is only one OI research stream. It is rather a broad research field with several OI research streams that all have roots in one or more of the research areas that existed long before 2003. For example, there are studies published after 2003 that have roots in network research and authors explicitly link their study to the broader OI research field (e.g., Dittrich and Duysters 2007; Leenders and Dolfsma 2015).

Figure 7-1: Openness of Open Innovation Research

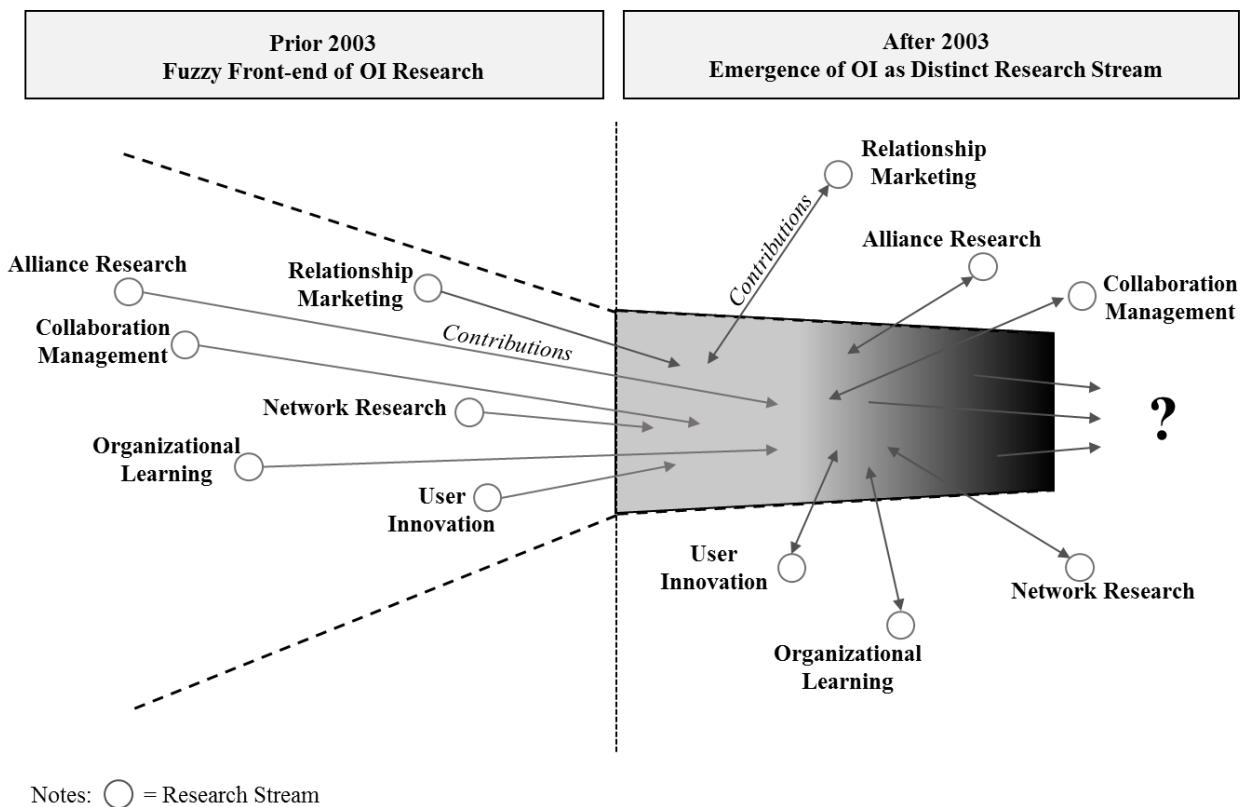

In Figure 7-1, the grey area represents the results of the studies that have roots in one or more of the research areas existing before 2003 and in which authors explicitly link their work to the OI research. The results of such kind of studies provide twofold contributions. They provide contributions to the OI research field and they also provide contributions to the original field/s from which authors derive most of their theoretical underpinnings (e.g., network research, relationship marketing, collaboration management etc.). Furthermore, these “original” research streams keep existing as independent streams also after 2003 and even if authors do not explicitly link their studies to the OI research, they still implicitly contribute to it. Hence, there is an ongoing bi-directional contribution between OI research and several other much older research streams.

This openness of OI research has caused the fact that OI is a fragmented body of research. An intriguing question that remains is how the OI research field will develop in the future. A prediction in this thesis is that there will be an increasing number of studies that mention OI concept, link their research to it, and base the theoretical underpinnings on studies coming from OI research field. Thus the “openness funnel” as presented in Figure 7-1 will become narrower. Since the OI field is currently quite diffuse, *researchers should work on narrowing the OI phenomenon and advancing the understanding of what constitutes OI*. However, they should not abstain from drawing on other research fields to enrich OI concept with additional insights.

Overall, much work still needs to be done to better understand the complexities of the OI concept. To begin with, scholars face the challenge of how to grasp and operationalize firms’ openness, since there is a multitude of OI activities that firms perform. Introducing breadth and depth dimensions to the OI research has been the first major attempt to capture the degree of firms’ openness (Laursen and Salter 2006). However, further conceptualisations are necessary to capture the entire nexus of firms’ OI relationships. As firms gain more and more experience in OI, they discover increasing numbers of ways to profit from external resources, with the result that many firms perform multiple OI activities simultaneously (Cheng and Huizingh 2014; Laursen and Salter 2006). As a consequence, firms become embedded in a complex nexus of OI relationships (Capaldo 2007; Iacobucci and Hoeffler 2015) and *researchers have to find ways to capture this nexus of OI relationships to offer managers guidance regarding its management*. Another related challenge lies in grasping the differences in the nature of OI activities, because they offer a substantial variation (e.g., joint venture vs. spin-off vs. crowdsourcing). Because of the diverse nature of such relationships, their effective management is very challenging for firms.

All three studies in this thesis contribute to those OI studies in extant literature that have examined only inbound or outbound practices (e.g., Symeonidou and Bruneel 2017) or have focused on one specific OI activity (e.g., Xu et al. 2013) and capture firms' entire nexus of OI relationships (see contribution 1 in Figure 1-3). Thereby, all three studies provide additional insights in management of firms' entire OI efforts. Table 7-1 gives an overview of the three studies, their contents, theoretical and conceptual foundations, methods, and main implications. In order to grasp the differences in firms' openness Studies 1 and 3 apply an innovative way to classify firms OI activities according to the interaction intensity between collaboration partners. Network research has often implied that network tie strength is one of the basic and most important characteristics of a relational tie. However, to the best of the author's knowledge, no OI study has attempted to apply this classification to firms' OI activities. The results of Studies 1 and 3 show that according to whether firm performs highly, medium, or weakly interactive OI activities different types of alignments are effective to foster firms' adaptiveness (Study 1). Moreover, the interaction intensity of OI activities also determine whether a firm will become a gatekeeper in a collaboration network (Study 3). Thus, one of the main research implications of this thesis is that *interaction intensity is a distinctive characteristic of OI activities and researchers should further examine how it impacts OI outcomes under additional circumstances.*

Study 2 also grasps the differences in firms' openness and captures the upsides of firms' entire OI efforts in terms of resource acquisition and the downsides of OI efforts in terms of partner's opportunistic behaviour. This is the first study that has explicitly and empirically captured the negative aspects of firms' entire nexus of OI relationships. Thus, another research implication is that *in order to provide a comprehensive perspective on firms' OI efforts research has to assess OI upsides and downsides simultaneously.* Especially, researchers have to divert extended attention to the neglected downside perspective of OI.

Regarding the first contribution of this thesis, all three studies capture firms' entire openness by assessing all OI activities they perform and thus can apply a comprehensive network perspective on firms' OI efforts. At the same time, these studies also further categorize this openness according to the OI activities that firms perform or according to whether firms OI efforts relate to beneficial or detrimental aspects of OI. Hence, such an approach allows to develop more specific implications for managerial practice.

Regarding the second contribution (see Figure 1-3), all three studies provide more detailed insights into the interplay between firms' OI efforts and network characteristics as currently

available in extant research. Thereby, all studies explain how firms can increase the effectiveness of their OI efforts by arranging the characteristics of their networks. In specific, Study 1 looks at relational network characteristics in terms of partner alignment and shows that *not all types of partner alignment are beneficial for every OI activity*. Given that a firm is technologically or relationally aligned with a collaboration partner it can hurt the effectiveness of OI activities.

Study 2 also contributes to the extant research attempting to explain how firms can foster their OI endeavors. In specific, it shows that structural and relational network characteristics can help firms to profit from resource acquisition, at the same time they can serve as countermeasures for partner's opportunistic behaviour. It implies that *researchers have to look at upsides and downsides of OI simultaneously if they want to derive implications regarding the effects of network characteristics*. Whereas a specific network characteristic might counter a certain risk of OI, it can, at the same time, restrict firms' ability to profit from OI.

Since network characteristics play such an immense role for firms and their OI efforts, managers need to know how to take action and actively influence these characteristics. Study 3 is the first attempt in extant research to explain how firms can achieve a highly valuable structural network position and become gatekeepers in a long-term perspective. The implication for research is that *when actors choose the right OI activities and take their existing knowledge base into consideration, they can achieve a gatekeeper position*. In the future, the scholarly attention should be increasingly devoted to how firms can influence other network characteristics for their own benefit.

In addition to the research implications mentioned in this chapter that relate to the *content* of the three studies, they also provide *theoretical* implications. When examining OI networks, social network theory (SNT; Coleman 1988; Granovetter 1973) definitely provides major theoretical foundations for the analysis. SNT is rich in content and provides several mechanisms, such as knowledge integration vs. flexibility, to explain how firms can leverage the benefits of different types of OI activities for firm performance. *Whereas SNT is a valuable theoretical foundation for examining how certain network aspects constitute a set of opportunities and constraints on firms OI efforts, it can be beneficial to align this theory with underpinning from other theoretical perspectives*. For instance, the relational view (Dyer and Singh 1998; Lavie 2006) and literature on distant knowledge provide additional insights for the management of OI networks and the relevant contextual factors.

Table 7-1: Overview of the Three Studies

Criteria for comparison	Study 1	Study 2	Study 3
Conceptualization of openness	Multiple highly and weakly interactive OI activities	Upsides and downsides of firms' entire nexus of OI relationships	Multiple highly, medium, and weakly interactive OI activities
Research question	How should firms arrange technological and relational partner alignments to realize the full potential of different OI activities and foster firms' adaptiveness?	How should firms manage OI relationships in order to deal simultaneously with these relationships' downsides in terms of opportunistic behavior while using the full potential of their upsides in terms of resource acquisition?	Which collaborative activities should firms perform in order to achieve a gatekeeper position in subsequent periods contingent on the strength of firms' knowledge base?
Examined network characteristics	Relational: technological and relational partner alignment	Structural: network centrality Relational: knowledge protection	Structural: Gatekeeper position (betweenness centrality)
Theoretical foundation	Social network theory	Social network theory, relational view	Social network theory, literature on distant knowledge
Dataset	Cross-sectional survey-data from 181 companies; secondary data from a financial database	Cross-sectional survey-data from 181 companies; secondary data from a financial database	Longitudinal data from 500 largest companies in Germany, two secondary data sources: cooperation data from data crawler, performance data from annual reports
Empirical methods	Hierarchical multiple regression analysis; two-stage least squares regression	Structural equation modelling	Panel analysis with two fixed-effects models
Key results/implications	Firms with highly interactive OI activities should strive for technological alignment; relational alignment is not important. Firms with weakly interactive OI activities, technological alignment is neither beneficial nor detrimental, but relational alignment harms their effectiveness.	Network centrality counters opportunistic behavior and facilitates the transformation of acquired resources into OI product performance. Knowledge protection does not serve as a countermeasure for opportunistic behavior, and it hinders the transformation of resources into OI product performance.	Medium interactive OI activities lead to a gatekeeper position but this effect is weakened by a strong knowledge base. Highly interactive OI activities lead to a gatekeeper position only when firms have a strong knowledge base. In any case, weakly interactive OI activities have a detrimental effect on a gatekeeper position.

This thesis also provides implications from a *methodological perspective*. OI networks are a complex and dynamic matter and their investigation requires different methodological approaches. On the one hand, it is important to investigate managerial assessment of different aspects of OI via large-scale survey data. This way, researchers can zoom into specific aspects of OI according to the focus of the study. On the other hand, *it is important to use secondary data bases and innovative approaches to grasp the complexities of OI networks*. In many cases, asking managers about their network position and other very complex and partly abstract

matters would not be fruitful, because they would not be able to provide accurate answers. In order to examine the dynamic network formation, it is crucial to conduct longitudinal studies and investigate how certain OI activities in previous periods of time will influence firms' network characteristics and consequently performance in subsequent periods of time. OI network is a matter that is constantly changing—firms enter new OI relationships and terminate other ones every year. In order to develop any performance implications for managers, a long-term perspective is crucial. Ideally, researchers should combine cross-sectional and longitudinal study designs.

Altogether, OI is a very dynamic and challenging research field for further investigations. Its complexity and fragmentation certainly pose several challenges for researchers—content, theory, and method-related. But more importantly, it offers multiple new questions of interest for both scientific community and managerial practice as new forms of cooperation emerge continuously.

7.2 Concluding Remarks for Managerial Practice

OI is not a new concept for managerial practice. Firms have been collaborating with external stakeholders to develop new products and services in the past (Spithoven, Vanhaverbeke, and Roijakkers 2013). What has changed in the last 5-10 years, however, is the extent to which firms perform OI. OI increasingly involves the whole ecosystems with multiple partners rather than the simple two-party collaboration models. Due to technological advancements, new OI activities and ways to collaborate emerge daily. Such developments severely increase the complexities of innovation management, but they also bring new opportunities for firms, countries, and the entire economies (Chesbrough 2017b).

The fundamental idea of OI is that useful knowledge is spread across the globe. Whereas that is *per se* nothing new, nowadays the technological advancements—especially in the field of information and communication technology—offer firms entirely new opportunities to access this knowledge. No firm has a monopoly on innovative ideas and regardless of how successful the firm internally might be, it has to consider how to best profit from external knowledge and such considerations must be a part of the daily business practice (Chesbrough 2011). It means that also firms and industries which have been rather “closed” in the past, will have to open their firms' boundaries more and more and engage in collaboration with external partners. Every company has and will increasingly have to figure out *how to survive and prosper in a modern networked business world*.

However, no company should blindly follow the OI trend without carefully evaluating when, how, and with whom to cooperate. Especially smaller firms might be overwhelmed by the positive success stories of other firms, who have established OI platforms, for example, in the form of idea competitions and might think that they have to follow just to keep up with this trend. It is far more important to assess the upsides and downsides of such activities and evaluate when they will advance firms' internal innovation efforts. OI is costly and time consuming, thus it is important for firms to perform OI well, if they want to profit from it. In a more negative scenario, firms will just waste their time, money, and might even suffer more severe consequences, such as loss of proprietary resources and market share (Oxley and Sampson 2004). Especially for small firms, such outcomes might be lethal. *In order to profit from OI, firms need well-elaborated risk and network management practices that are applied to the main decisions that managers have to make regarding firms' entire OI efforts.*

When considering firms' entire OI efforts, there are three main OI-related decisions that decision makers responsible for innovation management in a firm have to make. The first decision—to open or not to open firms' boundaries—seems rather easy (see Figure 7-3), as abstaining from OI is no longer a viable choice in an increasingly open world (Baker, Grinstein, and Harmancioglu 2015; Roy and Sivakumar 2010). The second decision that managers have to make is: to what degree they should open their firms' boundaries. This question relates to how many collaboration partners should firms have, which OI activities to perform, and what should be the intensity of these OI activities. Furthermore, before starting any new OI activities as well as in the course of carrying out these activities, managers must develop strategies and implement measures to increase the effectiveness of each OI activity they perform and the effectiveness of firms' entire OI efforts in general. The third decision relates to these effectiveness issues. The aim of OI is to foster firms' internal innovation efforts. In order to achieve this goal firms have to effectively execute OI activities. If a firm performs OI without clear strategies and approaches that foster the effectiveness of OI, it will end up spending more time, money, and other resources than without OI.

All of these main decisions regarding firms' OI efforts are a dynamic process that should be embedded in managerial routine agendas. *Every single decision requires careful consideration of the potential risks and how to counter them.* Regarding the first decision, firms that are exposed to immense risks that cannot be countered at the given point of time might choose to stay “closed” and consider introducing OI practices later. Regarding the second decision, if firms face significant risks, for instance, loss of proprietary knowledge, they might choose to cooperate with a limited number of partners and share only a very limited amount of knowledge.

Hence, risk assessment plays a very important role when making decisions related to the degree of firms' openness and is a permanent decision process. Firms have to constantly re-evaluate the degree of their firms' openness. As new risks emerge, firms might terminate OI relationships or even the entire OI efforts and start new OI activities as new opportunities emerge.

Regarding the third decision, assessing risks that come along with each OI activity is vital before executing this activity as well as in the course of collaboration—risks must be permanently monitored so that firms can implement necessary countermeasures before these risks negatively influence firm performance. Every OI activity has a “dark side” and in some cases it can be better for a firm not to cooperate and not to share knowledge. But these are rather exceptional cases. Mostly risks that come along with OI can be managed when caught early. As Henry Chesbrough puts it: “for most companies, being more open is a better approach. For small companies, if you never share, you might never gain any attention and you might be condemned to obscurity. For large companies, if you never share, you reduce your ability to attract others who can enhance your offering and make it more compelling” (Chesbrough 2017c). In the course of all three decisions, risk management plays a central role. Firms have to avert or at least minimize risks that occur in cooperation to effectively conduct their OI activities.

However, careful risk consideration in all of these three decisions might not be enough to profit from firms' OI efforts. *Managers also have to constantly consider network-related aspects when making decisions about their OI endeavors.* Especially regarding the third decision, firms have to be aware of all the factors that might help them to increase the effectiveness of OI activities. Firms must acknowledge the immense role that network characteristics play in determining how successful a firm will be with its OI efforts. OI activities and network characteristics cannot be separated from each other as one influences the other. Figure 7-2 illustrates this interplay. OI networks function as supporters for firms' OI efforts. By establishing a certain link to a collaboration partner in a network, a firm is able to carry out a certain OI activity. Structural and relational network characteristics then determine the effectiveness of OI activities for firm performance. For instance, *different types of partner alignment as a relational network characteristic determine how effective OI activities will be for firm adaptiveness.* And by being central in a collaboration network (structural network characteristic), firms can counter the risk of partner's opportunistic behaviour in OI relationships and foster the resource acquisition. Altogether, *network characteristics can help firms to increase the potentials of the upsides of OI and at the same time they can reduce the risks of the downsides of OI.*

On the one hand, network characteristics influence the effectiveness of OI activities. On the other hand, firms can influence the characteristics of their collaboration networks by choosing certain OI activities. For instance, *certain types of OI activities are more or less suitable for achieving a gatekeeper position in a network and fostering firm performance*. So firms should perform the right types of OI activities according to their interaction intensity between the collaboration partners to become gatekeepers so that they can gain accurate, timely information about activities throughout the network and can identify partners with complementary resources for their OI efforts more easily.

In order to fully comprehend the OI-network characteristic interplay (see Figure 7-2), *firms need to integrate their collaboration and network perspectives*. In means that whenever firms enter or adjust a relationship with an OI partner, they have to interpret it as a network tie with certain characteristics apart from just seeing it as another collaboration that their firm has. At the same time, when seeing a collaboration as a network tie, firms also have to see it through the collaboration perspective to be able to determine which firm-centric characteristics might influence the effectiveness of this network tie. For instance, firms’ internal knowledge base determines how well firms can become gatekeepers by performing certain OI activities.

Figure 7-2: Networks as Open Innovation Supporters

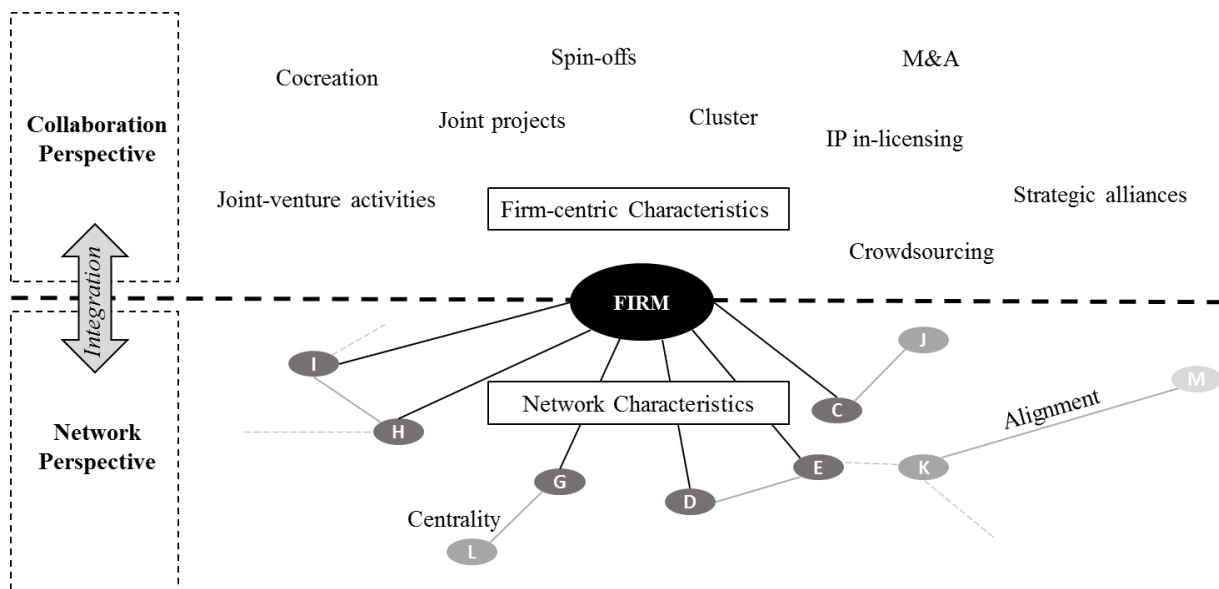

To have such an integrative perspective on firms’ entire OI efforts that involves considering risks and network characteristics is certainly a very dynamic and challenging task for firms. Such perspective cannot be guaranteed by single departments or teams of a firm because they cannot have a “bird’s-eye view” on the entire portfolio of firms’ OI efforts due to the complexity

of the matter. In order to be successful with their OI efforts, firms desperately need *a portfolio perspective on firms' entire OI relationships and activities*—which is something that is often lacking in managerial practice. One team in the product management department might be responsible for managing R&D collaboration with a research institute, while another team in marketing department is working with customers in idea competitions to create new designs for the latest product. It is often the case that one department is not even aware of OI activities performed by the other department—a case often in large multinational organizations.

In order to provide such a portfolio perspective on firms' entire OI relationships, firms should institutionalize their OI efforts. It means that they are in need of a *central OI coordination entity* that might help to realize the full potential of internal as well as external aspects that influence the effectiveness of OI activities. Such a firm-level measure does not imply that all OI activities must be centralised at the top-level. Instead, the aim of such central coordination office is to develop a long-term, dynamic perspective on firms' entire portfolio of OI activities. As such it examines risks related to opening organizational boundaries in each particular case and suggests and/or implements the necessary countermeasures. Furthermore, it adopts a long-term view of OI efforts and limits the possibility that company would achieve short-term goals, but sacrifice long-term competitiveness by means of losing R&D as core competence or losing valuable proprietary resources (Lichtenthaler 2010). Moreover, a central OI coordination entity could help firms to raise the awareness of the role of OI networks and firms position in them, to foster their OI efforts. In particular, determining firms' position and other network-related characteristics should be, at least partly, the task of a central OI coordination entity that consequently applies tools of social network analysis to determine firms' network-related characteristics.

Figure 7-3 summarizes the concluding remarks for the managerial practice derived from the results of this thesis. The overarching managerial implication is that firms should institutionalize their OI efforts by establishing a central OI coordination entity that interprets the three main OI-related decisions through the lens of firms' entire OI portfolio. Thus, such an entity has two main tasks. First, it advises decision makers and when necessary implements measures regarding risk assessment in OI efforts. Second, it determines firms' network characteristics by applying tools of the network analysis and advises decision makers regarding how to foster the effectiveness of the firms' OI efforts. These two tasks should be performed while applying the portfolio perspective on the firms' entire OI efforts. Such a perspective represents a lens through which an OI entity sees the main OI-related decisions made by the company. The establishment and successful functioning of such a central entity certainly poses

significant challenges for a firm such as gaining the acceptance that is required on all hierarchical levels of the company. However, the benefits of such an entity would be immense helping firms to increase the effectiveness of their OI efforts.

Figure 7-3: Overarching Managerial Implication

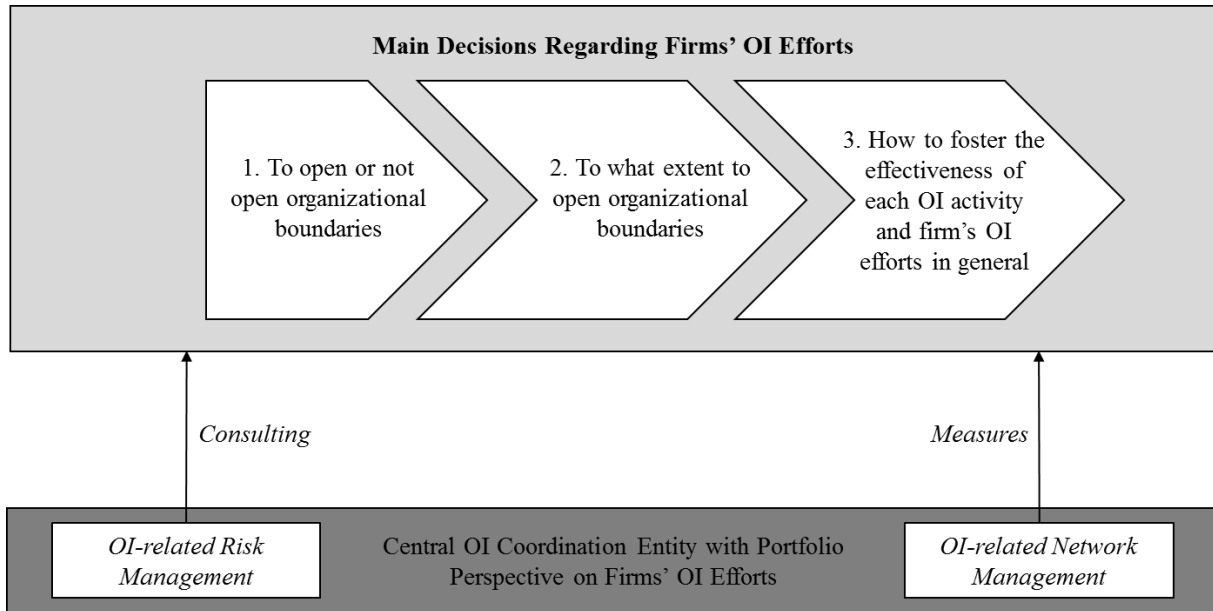

To conclude the managerial remarks, managers must consider OI as an opportunity-rich possibility to foster their firms' internal innovation efforts. In specific, with OI activities firms can enrich their innovation efforts with external ideas, but OI is even more—it can shape the entire business model of a firm offering entirely new opportunities for value creation, capture, and commercialisation. Managers should increasingly evaluate these opportunities and grasp them to develop and reinvent the whole existence and functioning of their firm, because OI is already shaping the entire mode of competing in every industry sector.

References

- Afuah, A. 2013. Are Network Effects Really All About Size? The Role of Structure and Conduct. *Strategic Management Journal*, 34: 257–273.
- Ahuja, G. 2000. Collaboration Networks, Structural Holes, and Innovation: A Longitudinal Study. *Administrative Science Quarterly*, 45, 4: 425–455.
- Aiken, L. S. and S. G. West. 1991. *Multiple Regression: Testing and Interpreting Interactions*. Newbury Park, CA: Sage.
- Akgün, A. E., H. Keskin, and J. Byrne. 2012. Antecedents and Contingent Effects of Organizational Adaptive Capability on Firm Product Innovativeness. *Journal of Product Innovation Management* 29(S1): 171–189.
- Aalbers, R., W. Dolfsma, and O. Koppius. 2013. Individual Connectedness in Innovation Networks: On the Role of Individual Motivation. *Research Policy* 42: 624–634.
- Albers, R., W. Dolfsma, and R. Leenders. 2015. Vertical and Horizontal Cross-ties: Benefits of Cross-hierarchy and Cross-unit Ties for Innovative Projects. *Journal of Product Innovation Management* 33(2): 141–153.
- Algina, J., and B. C. Moulder. 2001. A Note on Estimating the Jöreskog-Yang Model for Latent Variable Interaction Using LISREL 8.3. *Structural Equation Modeling: A Multidisciplinary Journal* 8(1): 40–52.
- Almirall, E., and R. Casadesus-Masanell. 2010. Open versus Closed Innovation: A Model of Discovery and Divergence. *Academy of Management Review* 35(1): 27–47.
- Amara, N., R. Landry, and N. Traore. 2008. Managing the Protection of Innovations in Knowledge-Intensive Business Services. *Research Policy* 37: 1530–1547.
- Arndt, M. 2009. Cisco's Failures in Corporate alliances. Available at: http://www.businessweek.com/innovate/next/archives/2009/12/ciscos_failures_in_corporate_alliances.html [25 April 2016].
- Atuahene-Gima, K., S. F. Slater, and E. M. Olson. 2005. The Contingent Value of Responsive and Proactive Market Orientations for New Product Program Performance. *Journal of Product Innovation Management* 22, 464–482.
- Baker, W. E., A. Grinstein, and N. Harmancioglu. 2015. Whose Innovation Performance Benefits More from External Networks: Entrepreneurial or Conservative Firms? *Journal of Product Innovation Management* 33(1): 104–120.
- Barney, J. 1991. Firm Resources and Sustained Competitive Advantage. *Journal of Management* 17(1) 99–120.
- Barringer, B. R., and J. S. Harrison. 2000. Walking a Tightrope: Creating Value through Inter-organizational Relationships. *Journal of Management* 26(3): 367–403.

- Bascle, G. 2008. Controlling for Endogeneity with Instrumental Variables in Strategic Management Research. *Strategic Organization* 6(3): 285–327.
- Baum, J. A. C., R. Cowan, and N. Jonard. 2014. Does Evidence of Network Effects on Firm Performance in Pooled Cross-Section Support Prescriptions for Network Strategy? *Strategic Management Journal* 35: 652–667.
- Beers, C., and F. Zand. 2013. R&D Cooperation, Partner Diversity, and Innovation Performance: An Empirical Analysis. *Journal of Product Innovation Management* 31(2): 292–312.
- Belderbos, R., M. Carree, and B. Lokshin. 2004. Cooperative R&D and Firm Performance. *Research Policy* 33: 1477–1492.
- Berchicci, L. 2013. Towards an Open R&D System: Internal R&D Investment, External Knowledge Acquisition and Innovative Performance. *Research Policy* 42: 117–127.
- Bianchi, M., A. Croce, C. Dell’Era, C. A. Di Benedetto, and F. Frattini. 2015. Organizing for Inbound Open Innovation: How External Consultants and a Dedicated R&D Unit Influence Product Innovation Performance. *Journal of Product Innovation Management* 33(4): 492–510.
- BMW. 2017. BMW Group, Intel and Mobileye Announce Delphi as a Development Partner and System Integrator for their Autonomous Driving Platform. Available at: <https://www.press.bmwgroup.com/global/article/detail/T0270913EN/bmw-group-intel-and-mobileye-announce-delphi-as-a-development-partner-and-system-integrator-for-their-autonomous-driving-platform?language=en> [09.11.2017].
- Bogers, M. 2011. The Open Innovation Paradox: Knowledge Sharing and Protection in R&D Collaboration. *European Journal of Innovation Management* 14(1): 93–117.
- Bogers, M., et al. 2016. The Open Innovation Research Landscape: Established Perspectives and Emerging Themes across Different Levels of Analysis. *Industry and Innovation* 24(1): 8–40.
- Borgatti, S. P., and D. S. Halgin. 2011. On Network Theory. *Organization Science* 22(5): 1168–1181.
- Brandes, U. 2001. A Faster Algorithm for Betweenness Centrality. *Journal of Mathematical Sociology*, 25, 2: 163–177.
- Brown, T. A. 2015. *Confirmatory Factor Analysis for Applied Research*. Second Ed., The Guilford Press: New York.
- Burt, R. S. 1992. *Structural Holes: The Social Structure of Competition*. Harvard University Press, Cambridge, MA.
- Burt, R. S, J. E. Jannotta, and J. T. Mahoney. 1998. Personality Correlates of Structural Holes. *Social Networks* 20: 63–87.
- Capaldo, A. 2007. Network Structure and Innovation: The Leveraging of a Dual Network as a Distinctive Relational Capability. *Strategic Management Journal* 28: 585–608.
- Carlson, B. D., G. L. Frankwick, and K. L. Cumiskey. 2011. A Framework for Understanding New Product Alliance Success. *Journal of Marketing Theory and Practice* 19(1): 7–25.
- Carnabuci, G., and Dioszegi, B. 2015. Social Networks, Cognitive Style, and Innovative Performance: A Contingency Perspective. *Academy of Management Journal*, 58, 3: 881–905.

- Carnovale, S., and S. Yeniyurt. 2015. The Role of Ego Network Structure in Facilitating Ego Network Innovation. *Journal of Supply Chain Management* 51(2): 22–46.
- Carson, S. J., and G. John G. 2013. A Theoretical and Empirical Investigation of Property Rights Sharing In Outsourced Research, Development, and Engineering Relationships. *Strategic Management Journal* 34: 1065–1085.
- Cassiman, B., and R. Veugelers. 2002. R&D Cooperation and Spillovers: Some Empirical Evidence from Belgium. *The American Economic Review* (September): 1169–1184.
- Chai, S., and W. Shih. 2016. Bridging Science and Technology through Academic–Industry Partnerships. *Research Policy* 45: 148–158.
- Chandy, R., B. Hopstaken, O. Narasimhan, and J. Prabhu. 2006. From Invention to Innovation: Conversion Ability in Product Development. *Journal of Marketing Research* XLIII(August): 494–508.
- Cheng, C. C., and E. K. Huizingh. 2014. When Is Open Innovation Beneficial? The Role of Strategic Orientation. *Journal of Product Innovation Management* 31(6): 1235–1253.
- Chesbrough, H. 2003. *Open Innovation: The New Imperative for Creating and Profiting from Technology*. Boston: Harvard Business Review Press.
- Chesbrough, H. 2006. Open Innovation: A New Paradigm for Understanding Industrial Innovation. In *Open Innovation: Researching a New Paradigm*, ed. H. Chesbrough, W. Vanhaverbeke, and J. West, 1–12. London: Harvard Business School Press.
- Chesbrough, H. 2011. Henry Chesbrough, First Interview: By Bob Morris. Available at: <https://bobmorris.biz/henry-chesbrough-first-interview-by-bob-morris> [27.01.2018].
- Chesbrough, H. 2012. Open Innovation: Where We've Been and Where We're Going. *Research-Technology Management* (July-August): 20–27.
- Chesbrough, H. 2013. Open Innovation Past and Present: an Exclusive Interview with Henry Chesbrough. Available at: <http://www.innovationmanagement.se/2013/07/17/open-innovation-past-and-present-an-exclusive-interview-with-henry-chesbrough/> [27.01.2018].
- Chesbrough, H. 2015. The Biggest Benefit of Open Services Innovation Is that It Can Help Firms to Escape the Commodity Trap. Available at: <http://www.esade.edu/web/eng/about-esade/aboutus/inspiring-futures/testimonialscampaign/henry-chesbrough> [25 April 2016].
- Chesbrough, H. 2017a. Interview with Prof. Henry Chesbrough. Available at: <http://www.innoenergy.com/interview-with-prof-henry-chesbrough-an-exciting-time-for-open-innovation-in-the-energy-sector/> [27.01.2018].
- Chesbrough, H. 2017b. The Advance of Open Innovation. Available at: <https://news.sap.com/henry-chesbrough-interview-advance-of-open-innovation/> [27.01.2018].
- Chesbrough, H. 2017c. Open Innovation – An Interview with Henry Chesbrough, Adjunct Professor, Haas School of Business, University of California Berkeley. Available at: <http://imba.aueb.gr/newsletterpost/open-innovation-an-interview-with-henry-chesbrough-adjunct-professor-haas-school-of-business-university-of-california-berkeley/> [27.01.2018].

- Chesbrough, H., and M. Bogers. 2014. Explicating Open Innovation: Clarifying an Emerging Paradigm for Understanding Innovation. In H. Chesbrough, W. Vanhaverbeke, and J. West, eds., *New Frontiers in Open Innovation*, Oxford: Oxford University Press.
- Chesbrough, H., and S. Brunswicker. 2013. *Managing Open Innovation in Large Firms*. Stuttgart: Fraunhofer IAO.
- Chiang, Y., and K. Hung. 2010. Exploring Open Search Strategies and Perceived Innovation Performance from the Perspective of Inter-Organizational Knowledge Flows. *R&D Management* 40(3): 292–299.
- Chiles, T., and J. F. McMackin. 1996. Integrating Variable Risk Preferences, Trust, and Transaction Cost Economics. *Academy of Management Review*, 21(1): 73–99.
- Christensen, J. F., M. H. Olesen, and J. S. Kjær. 2005. The Industrial Dynamics of Open Innovation—Evidence from The Transformation of Consumer Electronics. *Research Policy* 34: 1533–1549.
- Cohen, J. 1988. *Statistical Power Analysis for the Behavioural Sciences*. Lawrence Erlbaum Associates: 2. Hillsdale, NJ.
- Cohen J., P. Cohen, S. G. West, and L. S. Aiken. 2003. *Applied Multiple Regression/Correlation Analysis for the Behavioural Sciences*, 3. Hillsdale, NJ: Lawrence Erlbaum Associates.
- Cohen, W. M., and D. A. Levinthal. 1990. Absorptive Capacity: A New Perspective on Learning and Innovation. *Administrative Science Quarterly*, 35: 128–152.
- Coleman, J. S. 1988. Social Capital in the Creation of Human Capital. *American Journal of Sociology* 94: 95–120.
- Combe, J. 2017. The Importance of Creativity and Innovation and How BMW Is Driving Both. Available at: <https://realbusiness.co.uk/tech-and-innovation/2017/10/19/the-importance-of-creativity-and-innovation-and-how-bmw-is-driving-both/> [27.01.2018].
- Cooper, R. G. 2011. Perspective: The Innovation Dilemma: How to Innovate when the Market Is Mature. *Journal of Product Innovation Management* 28(1): 2–27.
- Crescenzi, R., M. Nathan, and A. Rodríguez-Pose. 2016. Do Inventors Talk to Strangers? On Proximity and Collaborative Knowledge Creation. *Research Policy* 45: 177–194.
- Cross, R., et al. 2001. Knowing What We Know: Supporting Knowledge Creation and Sharing in Social Networks. *Organizational Dynamics* 30(2): 100–120.
- Dahlander, L., and D. M. Gann. 2010. How Open is Innovation? *Research Policy* 39: 699–709.
- Dahlander, L. and M. W. Wallin. 2006. A Man on the Inside: Unlocking Communities as Complementary Assets. *Research Policy* 35: 1243–1259.
- Daneels, E. 2004. Disruptive Technology Reconsidered: A Critique and Research Agenda. *Journal of Product Innovation Management* 21: 246–258.
- Dangelico, R. M., P. Pontrandolfo, and D. Pujari. 2013. Developing Sustainable New Products in the Textile and Upholstered Furniture Industries: Role of External Integrative Capabilities. *Journal of Product Innovation Management* 30(4): 642–658.
- Das, T. K., and B. S. Teng. 1996. Risk Types and Inter-Firm Alliance Structures. *Journal of Management Studies* 33(6): 0022–2380.

- Das, T. K., and B. S. Teng. 1998. Between Trust and Control: Developing Confidence in Partner Cooperation in Alliances. *Academy of Management Review*, 23(3): 491–521.
- Das, T. K., and B. S. Teng. 2001. Relational Risk and Its Personal Correlates in Strategic Alliances. *Journal of Business and Psychology* 15(3): 449–465.
- Day, G. S. 2011. Closing the Marketing Capabilities Gap. *Journal of Marketing* 75: 183–195.
- Demirkan, I., D. L. Deeds, and S. Demirkan. 2013. Exploring the Role of Network Characteristics, Knowledge Quality, and Inertia on the Evolution of Scientific Networks. *Journal of Management* 39(6): 1462–1489.
- Dittrich, K., and G. Duysters. 2007. Networking as a Means to Strategy Change: The Case of Open Innovation in Mobile Telephony. *Journal of Product Innovation Management*. 24: 510–521.
- Dobrzykowski, D. D., S. K. Callaway, and M. A. Vonderembse. 2015. Examining Pathways from Innovation Orientation to Patient Satisfaction: A Relational View of Healthcare Delivery. *Decision Sciences* 46(5): 863–899.
- Dong, J. Q., K. J. MsCarthy, and W. Schoenmakers. 2017. How Central Is Too Central? Organizing Inter-organizational Collaboration Networks for Breakthrough Innovation. *Journal of Product Innovation Management*, Online Edition.
- Dong, J. Q., and C. Yang. 2015. Information Technology and Organizational Learning in Knowledge Alliances and Networks: Evidence from U.S. Pharmaceutical Industry. *Information & Management* 52: 111–122.
- Drechsler, W., and M. Natter. 2012. Understanding a Firm's Openness Decisions in Innovation. *Journal of Business Research* 65: 438–445.
- Du, J., B. Leten, and W. Vanhaverbeke. 2014. Managing Open Innovation Projects with Science-based and Market-based Partners. *Research Policy* 43: 828–840.
- Dyer, J. H., and K. Nobeoka. 2000. Creating and Managing a High-Performance Knowledge-Sharing Network: The Toyota Case. *Strategic Management Journal* 21: 345–367.
- Dyer, J. H., and H. Singh. 1998. The Relational View: Cooperative Strategy and Sources of Inter-organizational Competitive Advantage. *Academy of Management Review* 23(4): 660–679.
- Eisend, M., H. Evanschitzky, and R. J. Calantone. 2016. The Relative Advantage of Marketing over Technological Capabilities in Influencing New Product Performance: The Moderating Role of Country Institutions. *Journal of International Marketing* 24(1): 41–56.
- Eisenhardt, K. M., and B. N. Tabrizi. 1995. Accelerating Adaptive Processes: Product Innovation in the Global Computer Industry. *Administrative Science Quarterly* 40: 84–110.
- Emden, Z., R. J. Calantone, and C. Droge. 2006. Collaborating for New Product Development: Selecting the Partner with Maximum Potential to Create Value. *Journal of Product Innovation Management* 23: 330–341.
- Enkel, E., O. Gassmann, and H. Chesbrough. 2009. Open R&D and Open Innovation: Exploring the Phenomenon. *R&D Management* 39(4): 311–316.
- Euchner, J. A. 2010. Two Flavors of Open Innovation. *Research-Technology Management* (July-August): 7–8.

- Everett, M. G., and T. W. Valente. 2016. Bridging, Brokerage and Betweenness. *Social Networks*, 44: 202–208.
- Faems, D., M. Janssens, and I. Neyens. 2012. Alliance Portfolios and Innovation Performance: Connecting Structural and Managerial Perspectives. *Group & Organization Management* 37(2): 241–268.
- Faems, D., M. Visser, P. Andries, and B. Van Looy. 2010. Technology Alliance Portfolios and Financial Performance: Value-Enhancing and Cost-Increasing Effects of Open Innovation. *Journal of Product Innovation Management* 27: 785–796.
- Faraj, S., S. Kudaravalli, and M. Wakso. 2015. Leading Collaboration in Online Communities. *Mis Quarterly*, 39, 2: 393–412.
- Faria, P., F. Lima, and R. Santos. 2010. Cooperation in Innovation Activities: The Importance of Partners. *Research Policy* 39: 1082–1092.
- Feldman, E. R., S. C. Gilson, and B. Villalonga. 2014. Do Analysts Add Value When They Most Can? Evidence from Corporate Spin-Offs. *Strategic Management Journal* 35. 1446–1463.
- Filiou, D., and S. Massini. 2017. Industry Cognitive Distance in Alliances and Firm Innovation Performance. *R&D Management*, Online Edition.
- Fornell, C., and D. F. Larcker. 1981. Evaluating Structural Equation Models with Unobservable Variables and Measurement Error. *Journal of Marketing Research* 18(1): 39–50.
- Frankort, H. T. 2016. When Does Knowledge Acquisition In R&D Alliances Increase New Product Development? The Moderating Roles of Technological Relatedness and Product-Market Competition. *Research Policy* 45: 291–302.
- Freeman, L. C. 1977. A Set of Measures of Centrality Based on Betweenness. *Sociometry*, 40, 1: 35–41.
- Freeman, L. C. 1979. Centrality in Social Networks: Conceptual Clarification. *Social Networks* 1: 215–239.
- Fu, X. 2012. How Does Openness Affect the Importance of Incentives for Innovation? *Research Policy* 41: 512–523.
- Ganesan, S. *et al.* 2010. Buffering and Amplifying Effects of Relationship Commitment in Business-to-Business Relationships. *Journal of Marketing Research* 47: 361–373.
- Gassmann, O., and E. Enkel. 2004. Towards a Theory of Open Innovation: Three Core Process Archetypes. *Proceedings of the R&D Management Conference* Lisbon, Portugal, July 6–9.
- Gianiodis, P. T., S. C. Ellis, and E. Secchi. 2010. Advancing a Typology of Open Innovation. *International Journal of Innovation Management* 14(4): 531–572.
- Gilsing, V., B. Noteboom, W. Vanhaverbeke, G. Duysters, and A. van den Oord. 2008. Network Embeddedness and the Exploration of Novel Technologies: Technological Distance, Betweenness Centrality and Density. *Research Policy* 37: 1717–1731.
- Gnyawali, D. R., and B. Park. 2001. Co-opetition between Giants: Collaboration with Competitors for Technological Innovation, *Research Policy* 40: 650–663.
- Goerzen, A. 2007. Alliance Networks and Firm Performance: The Impact of Repeated Partnerships. *Strategic Management Journal* 28: 487–509.

- Granovetter, M. S. 1973. The Strength of Weak Ties. *American Journal of Sociology* 78(6): 1360–1380.
- Green, K. W., D. Whitten, R. A. Inman. 2012. Aligning Marketing Strategies throughout the Supply Chain to Enhance Performance. *Industrial Marketing Management* 41: 1008–1018.
- Grimaldi, M., I. Quinto, and P. Ripa. 2013. Enabling Open Innovation in Small and Medium Enterprises: A Dynamic Capabilities Approach. *Knowledge and Process Management* 20(4): 199–210.
- Guan, J., and N. Liu. 2016. Exploitative and Exploratory Innovations in Knowledge Network and Collaboration Network: A Patent Analysis in the Technological Field Of Nano–Energy. *Research Policy* 45: 97–112.
- Gulati, R. 1998. Alliances and Networks. *Strategic Management Journal*, 19: 293–317.
- Gulati, R. 1999. Network Location and Learning: The Influence of Network Resources and Firm Capabilities on Alliance Formation. *Strategic Management Journal* 20: 397–420.
- Gulati, R., D. Lavie, and H. Singh. 2009. The Nature of Partnering Experience and the Gains from Alliances. *Strategic Management Journal* 30: 1213–1233.
- Hair, J. F., W. C. Black, B. J. Babin, and R. E. Anderson. 2013. *Multivariate Data Analysis*. Harlow: Pearson.
- Hansen, M. T. 1999. The Search-Transfer Problem: The Role of Weak Ties in Sharing Knowledge across Organization Subunits. *Administrative Science Quarterly* 44(1): 82–111.
- Heidenreich, S., K. Wittkowski, M. Handrich, and T. Falk. 2015. The Dark Side of Customer Co-creation: Exploring the Consequences of Failed Co-created Services. *Journal of the Academy of Marketing Science* 43: 279–296.
- Helm, R., and M. Kloyer. 2004. Controlling Contractual Exchange Risks in R&D Interfirm Cooperation: An Empirical Study. *Research Policy* 33: 1103–1122.
- Henkel, J., S. Schöberl, and O. Alexy. 2014. The Emergence of Openness: How and Why Firms Adopt Selective Revealing in Open Innovation. *Research Policy* 43: 879–890.
- Heil, S., and T. Bornemann. 2017. Creating Shareholder Value via Collaborative Innovation: The Role of Industry and Resource Alignment in Knowledge Exploration. *R&D Management* (online version).
- Hoffmann, W. H. 2007. Strategies for Managing a Portfolio of Alliances. *Strategic Management Journal* 28: 827–856.
- Homburg, C., M. Klarmann, M., Raimann, and O. Schilke. 2012. What Drives Key Informant Accuracy? *Journal of Marketing Research* 49: 594–608.
- Hottenrott, H., and C. Lopes-Bento. 2016. R&D Partnerships and Innovation Performance: Can There Be too Much of a Good Thing? *Journal of Product Innovation Management* published online: 14 March 2016.
- Huizingh, E. 2011. Open Innovation: State Of The Art and Future Perspectives. *Technovation* 31: 2–9.
- Iacobucci, D., and S. Hoeffler. 2015. Leveraging Social Networks to Develop Radically New Products. *Journal of Product Innovation Management* 33(2): 217–223.

- Inkpen, A. C. 2000. Learning through Joint Ventures: A Framework of Knowledge Acquisition. *Journal of Management Studies*, 37, 7: 1019–1043.
- Irwin, J. R., and G. H. McClelland. 2001. Misleading Heuristics And Moderated Multiple Regression Models. *Journal of Marketing Research* 38(1): 100–09.
- Jaccard, J., Wan C. K. 1996. *LISREL Approaches to Interaction Effects in Multiple Regression*. Sage Publications: Thousand Oaks, CA.
- Jaworski, B. J., and A. K. Kohli. 1993. Market Orientation: Antecedents and Consequences. *Journal of Marketing* 57(3): 53–70.
- Jean, R. B., R. R. Sinkovics, and T. P. Hiebaum. 2014. The Effects of Supplier Involvement and Knowledge Protection on Product Innovation in Customer–Supplier Relationships: A Study of Global Automotive Suppliers in China. *Journal of Product Innovation Management* 31(1): 98–113.
- Jhoti, H. 2015. Open Innovation: The Answer to Slow Pharmaceutical Productivity. Available at: <https://www.europeanceo.com/business-and-management/open-innovation-the-answer-to-slow-pharmaceutical-productivity/> [27.01.2018].
- Jiang, X., and Y. Li. 2009. An Empirical Investigation of Knowledge Management and Innovative Performance: The Case of Alliances. *Research Policy* 38: 358–368.
- Jones, C., W. S. Hesterly, and S. P. Borgatti. 1997. A General Theory of Network Governance: Exchange Conditions and Social Mechanisms. *Academy of Management Review* 22(4): 911–945.
- Kale, P., J. H. Dyer, and H. Singh. 2002. Alliance Capability, Stock Market Response, and Long-Term Alliance Success: The Role of the Alliance Function. *Strategic Management Journal* 23: 747–767.
- Kale, P., H. Singh, and H., Perlmutter. 2000. Learning and Protection of Proprietary Assets in Strategic Alliances: Building Relational Capital. *Strategic Management Journal* 21: 217–237.
- Katila, R., and G. Ahuja. 2002. Something Old, Something New: A Longitudinal Study of Search Behaviour and New Product Introduction. *Academy of Management Journal*, 45, 5: 1183–1194.
- Kennemer, Q. 2015. Samsung CEO Acknowledges the Need to Adapt to New Environment. Available at: <http://phandroid.com/2015/11/04/samsung-adapting-to-change/> [11.08.2016].
- Koka, B. R., and J. E. Prescott. 2008. Designing Alliance Networks: The Influence of Network Position, Environmental Change, and Strategy on Firm Performance. *Strategic Management Journal* 29: 639–661.
- Köhler, C., W. Sofka, and C. Grimpe. 2012. Selective Search, Sectoral Patterns, and the Impact on Product Innovation Performance. *Research Policy* 41: 1344–1356.
- Krammer, S. M. 2016. The Role of Diversification Profiles and Dyadic Characteristics in the Formation of Technological Alliances: Differences between Exploitation and Exploration in a Low-Tech Industry. *Research Policy* 45: 517–532.
- Kratzer, J., C. Lettl, N. Franke, and P. A. Gloor. 2016. The Social Network Position of Lead Users. *Journal of Product Innovation Management*, 33, 2: 201–216.

- Krishnan, R., I. Geyskens, and J. E. M. Steenkamp. 2016. The Effectiveness of Contractual and Trust-Based Governance in Strategic Alliances under Behavioural and Environmental Uncertainty. *Strategic Management Journal* published online.
- Lambe, C. J., R. E. Spekman, and S. D. Hunt. 2002. Alliance Competence, Resources, and Alliance Success: Conceptualization, Measurement, and Initial Test. *Journal of the Academy of Marketing Science* 30(2): 141–158.
- Larcker, D. F., and T. O. Rusticus. 2010. On the Use of Instrumental Variables in Accounting Research. *Journal of Accounting and Economics* 49: 186–205.
- Laursen, K., and A. Salter. 2006. Open for Innovation: The Role of Openness in Explaining Innovation Performance among U.K. Manufacturing Firms. *Strategic Management Journal* 27: 131–150.
- Laursen, K., and A. Salter. 2014. The Paradox of Openness: Appropriability, External Search and Collaboration. *Research Policy* 43: 867–878.
- Lavie, D. 2006. The Competitive Advantage of Interconnected Firms: An Extension of the Resource-Based View. *Academy of Management Review* 31(3): 638–658.
- Lavie, D., P. R. Haunschild, and P. Khanna. 2012. Organizational Differences, Relational Mechanisms, and Alliance Performance. *Strategic Management Journal* 33: 1453–1479.
- Lavie, D., and S. R. Miller. 2008. Alliance Portfolio Internationalization and Firm Performance. *Organization Science* 19(4): 623–646.
- Lee, S. 2007. Endogeneity in Quantile Regression Models: A Control Function Approach. *Journal of Econometrics* 141: 1131–1158.
- Lee, S., et al. 2010. Open Innovation in SMEs—An Intermediated Network Model. *Research Policy* 39: 290–300.
- Lee, C., K. Lee, and J. M. Pennings. 2001. Internal Capabilities, External Networks, and Performance: A Study on Technology-based Ventures. *Strategic Management Journal* 22: 615–640.
- Lee, S., Park, G., Yoon, B., and Park, J. 2001. Open Innovation in SMEs—An Intermediated Network Model. *Research Policy*, 39: 209–300.
- Lee, J., and F. M. Veloso. 2008. Interfirm Innovation under Uncertainty: Empirical Evidence for Strategic Knowledge Partitioning. *Journal of Product Innovation Management* 25: 418–435.
- Leenders, R. T., and W. A. Dolfsma. 2015. Social Networks for Innovation and New Product Development. *Journal of Product Innovation Management* 33(2): 123–131.
- Leiponen, A., and C. E. Helfat. 2010. Innovation Objectives, Knowledge Sources, and the Benefits of Breadth. *Strategic Management Journal* 31: 224–236.
- Levin, D. Z., and R. Cross. 2004. The Strength of Weak Ties You Can Trust: The Mediating Role of Trust in Effective Knowledge Transfer. *Management Science*, 50, 11: 1477–1490.
- Levy, O. 2005. The Influence of Top Management Team Attention Patterns on Global Strategic Posture of Firms. *Journal of Organizational Behaviour*, 26: 797–819.
- Li, D., et al. 2011. Governance in Multilateral R&D Alliances. *Organizational Science* (online version).

- Li, W., R. Veliyath, and J. Tan. 2013. Network Characteristics and Firm Performance: An Examination of the Relationships in the Context of a Cluster. *Journal of Small Business Management* 51(1): 1–22.
- Lin, Z. J., H. Yang, and B. Arya. 2009. Alliance Partners and Firm Performance: Resource Complementarity and Status Association. *Strategic Management Journal* 30: 921–940.
- Lindgaard, S. 2014. 3 Successful Open Innovation Cases: GE, Samsung and LEGO. Available at: <http://www.15inno.com/2014/11/15/3successfultocases/> [25 April 2016].
- Lindell, M. K. and D. J. Whitney. 2001. Accounting for Common Method Variance in Cross-sectional Research Designs. *Journal of Applied Psychology* 86(1): 114–121.
- Liu, A. X., Y. Liu, and T. Luo. 2016. What Drives a Firm's Choice of Product Recall Remedy? The Impact of Remedy Cost, Product Hazard, and the CEO. *Journal of Marketing* 80: 79–95.
- Lokshin, B., J. Hagedoorn, and W. Letterie. 2011. The Bumpy Road of Technology Partnerships: Understanding Causes and Consequences of Partnership Mal-Functioning. *Research Policy* 40: 297–308.
- Lui, S. S., and H. Ngo. 2012. Drivers and Outcomes of Long-term Orientation in Cooperative Relationships. *British Journal of Management* 23: 80–95.
- Lumpkin, G. T., and G. G. Dess. 2001. Linking Two Dimensions of Entrepreneurial Orientation to Firm Performance: The Moderating Role of Environment and Industry Life Cycle. *Journal of Business Venturing* 16: 429–451.
- Maes, J., and L. Sels. 2014. SMEs' Radical Product Innovation: The Role of Internally and Externally Oriented Knowledge Capabilities. *Journal of Small Business Management* 52(1): 141–163.
- Marsh, H. W., Z. Wen, and K. T. Hau. 2006. Structural Equation Models of Latent Interaction and Quadratic Effects. In *Structural Equation Modeling: A Second Course*, eds. Hancock G. R., and R. O. Mueller. IAP Information Age Publishing: Greenwich, CT.
- Mata, J., and M. Woerter. 2013. Risky Innovation: The Impact of Internal and External R&D Strategies upon the Distribution of Returns. *Research Policy* 42: 495–501.
- Mazzola, E., G. Perrone, and D. S. Kamuriwo. 2015. Network Embeddedness and New Product Development in the Biopharmaceutical Industry: The Moderating Role of Open Innovation Flow. *International Journal of Production Economics* 160: 106–119.
- McEvily, B., and A. Zaheer. 1999. Bridging Ties: A Source of Firm Heterogeneity in Competitive Capabilities. *Strategic Management Journal* 20: 1133–1156.
- McNally, R. C., M. B. Akdeniz, and R. J. Calantone. 2011. New Product Development Processes and New Product Profitability: Exploring the Mediating Role of Speed to Market and Product Quality. *Journal of Product Innovation Management* 28(S1): 63–77.
- Meggison, L. C. 2016. Available at: <http://www.goodreads.com/quotes/18875-it-is-not-the-strongest-of-the-species-that-survives> [05.09.2016].
- Mesquita, L. F., J. Anand, and T. H. Brush. 2008. Comparing the Resource-Based and Relational Views: Knowledge Transfer and Spillover in Vertical Alliances. *Strategic Management Journal* 29: 913–941.

- Michelfelder, I., and J. Kratzer. 2013. Why and How Combining Strong and Weak Ties within a Single Inter-organizational R&D Collaboration Outperforms Other Collaboration Structures. *Journal of Product Innovation Management* 3(6): 1159–1177.
- Miles, R. E., C. C. Snow, A. D. Meyer, and H. J. Coleman. 1978. Organizational Strategy, Structure, and Process. *Academy of Management Review* 7: 546–562.
- Mina, A., E. Bascavusoglu-Moreau, and A. Hughes. 2014. Open Service Innovation and the Firm's Search for External Knowledge. *Research Policy*, 43: 853–866.
- Murakami, H. 2016. Available at: <http://www.goodreads.com/quotes/482453-where-there-is-light-there-must-be-shadow-and-where> [7 October 2016].
- Murphy, M., D. Arenas, and J. M. Batista. 2015. Value Creation in Cross-Sector Collaboration: The Roles of Experience and Alignment. *Journal of Business Ethics* 130: 145–162.
- Muthén, L. K., and B. O. Muthén. 2012. *Mplus User's Guide*. Muthén and Muthén: Los Angeles, CA.
- Nahapiet, J., and S. Ghoshal. 1998. Social Capital Intellectual Capital and the Organizational Advantage. *Academy of Management Review* 23(2): 242–266.
- Narula, R., and G. D. Santangelo. 2009. Location, Collocation and R&D Alliances in the European ICT Industry. *Research Policy* 38: 393–403.
- Narver, J. C, S. F. Slater, and D. L. MacLachlan. 2004. Responsive and proactive market orientation and new-product success. *Journal of Product Innovation Management* 21: 334–347.
- Newbert, S. L. 2008. Value, Rareness, Competitive Advantage, and Performance: A Conceptual-Level Empirical Investigation of the Resource-Based View of the Firm. *Strategic Management Journal* 29: 745–768.
- Newcomb, D. 2016. Inside Audi, BMW and Daimler's \$3 Billion Bet On HERE's Mapping Business. Available at: <https://www.forbes.com/sites/dougnewcomb/2016/06/27/inside-audi-bmw-and-daimlers-3-billion-bet-on-heres-mapping-business/#39ead0da6343> [10.11.2017].
- Nielsen, B. B, and S. Nielsen. 2009. Learning and Innovation in International Strategic Alliances: An Empirical Test of the Role of Trust and Tacitness. *Journal of Management Studies* 46(6): 1031–56.
- Ocasio, W. 1997. Towards an Attention-based View of the Firm. *Strategic Management Journal*, 18: 187–206.
- Oerlemans, L. A., and J. Knobens. 2010. Configurations of Knowledge Transfer Relations: An Empirically Based Taxonomy and Its Determinants. *Journal of Engineering and Technology Management* 27: 33–51.
- Oktemgil, M., and G. Greenley. 1997. Consequences of High and Low Adaptive Capability in UK Companies. *European Journal of Marketing* 31(7): 445–466.
- Oxley, J. E., and R. C. Sampson. 2004. The Scope and Governance of International R&D Alliances. *Strategic Management Journal* 25: 723–749.
- Owen-Smith, J., and W. W. Powell. 2004. Knowledge Networks as Channels and Conduits: The Effects of Spillovers in the Boston Biotechnology Community. *Organization Science* 15(1): 5–21.

- Ozcan, P., and K. M. Eisenhardt. 2009. Origin of Alliance Portfolios: Entrepreneurs, Network Strategies, and Firm Performance. *Academy of Management Journal* 52(2): 246–279.
- Parkhe, A., S. Wasserman, and R. Ralston. 2006. New Frontiers in Network Theory Development. *Academy of Management Review* 31(3): 560–568.
- Pemartin, M., A. I. Rodriguez-Escudero, and J. L. Munuera-Aleman. 2017. Effects of Collaborative Communication on NPD Collaboration Results: Two Routes of Influence. *Journal of Product Innovation Management* online issue.
- Perrons, R. K. 2009. The Open Kimono: How Intel Balances Trust and Power to Maintain Platform Leadership. *Research Policy* 38: 1300–1312.
- Perry-Smith, J. E. and C. E. Shalley. 2003. The Social Side of Creativity: A Static and Dynamic Social Network Perspective. *Academy of Management Review* 2a(1): 69–106.
- Piezunka, H., and L. Dahlander. 2015. Distant Search, Narrow Attention: How Crowding Alters Organizations' Filtering of Suggestions in Crowdsourcing. *Academy of Management Journal* 58(3): 856–880.
- Podsakoff, P. M., S. B. MacKenzie, J. Y. Lee, and N. P. Podsakoff. 2003. Common Method Biases in Behavioural Research: A Critical Review of the Literature and Recommended Remedies. *Journal of Applied Psychology* 88(5): 879–903.
- Podsakoff, P. M., S. B. MacKenzie, and N. P. Podsakoff. 2012. Sources of Method Bias in Social Science Research and Recommendations on How to Control It. *Annual Review of Psychology* 63: 539–69.
- Pullen, A. J. J., P. C. de Weerd-Nederhof, A. J. Groen, and O. A. M. Fisscher. 2012. Open Innovation in Practice: Goal Complementarity and Closed NPD Networks to Explain Differences in Innovation Performance for SMEs in the Medical Devices Sector. *Journal of Product Innovation Management* 29(6): 917–934.
- Raasch, C., C. Herstatt, and K. Balka. 2009. On the Open Design of Tangible Goods. *R&D Management* 39(4): 382–393.
- Randhawa, K., R. Wilden, and J. Hohberger. 2016. A Bibliometric Review of Open Innovation: Setting a Research Agenda. *Journal of Product Innovation Management* 33(6):750–772.
- Rodan, S., and C. Galunic. 2004. More than Network Structure: How Knowledge Heterogeneity Influences Managerial Performance and Innovativeness. *Strategic Management Journal*, 25: 541–562.
- Rosenkopf, L., and A. Nerkar. 2001. Beyond Local Search: Boundary-Spanning, Exploration, and Impact in the Optical Disk Industry. *Strategic Management Journal* 22: 287–306.
- Rothaermel, F., T. and D. L. Deeds. 2006. Alliance Type, Alliance Experience and Alliance Management Capability in High-technology Ventures. *Journal of Business Venturing* 21: 429–460.
- Roy, S., and K. Sivakumar. 2010. Managing Intellectual Property in Global Outsourcing for Innovation Generation. *Journal of Product Innovation Management* 28: 48–62.
- Salge, T. O., T. Farchi, M. I. Barrett, and S. Dopson. 2013. When Does Search Openness Really Matter? A Contingency Study of Health-Care Innovation Projects. *Journal of Product Innovation Management* 30(4): 659–676.
- Santos, F. M., and K. M. Eisenhardt. 2005. Organizational Boundaries and Theories of Organization. *Organization Science* 16(5): 491–508.

- Sapienza, H. J., A. Parhankangas, and E. Autio. 2004. Knowledge Relatedness and Post-spin-off Growth. *Journal of Business Venturing* 19: 809–829.
- Schleimer, S. C., and D. Faems. 2016. Connecting Interfirm and Intrafirm Collaboration in NPD Projects: Does Innovation Context Matter? *Journal of Product Innovation Management* 33(2): 154–165.
- Schumaker, R., and H. Chen. 2006. Textual Analysis of Stock Market Prediction Using Financial News Articles. In 12th Americas Conference on Information Systems (AMCIS), Acapulco, Mexico.
- Schweitzer, F. M., O. Gassmann, K. Gaubinger. 2011. Open Innovation and Its Effectiveness to Embrace Turbulent Environments. *International Journal of Innovation Management* 15(6): 1191–1207.
- Seggie, S. H., D. Kim, and S. T. Cavusgil. 2006. Do Supply Chain IT Alignment and Supply Chain Interfirm System Integration Impact upon Brand Equity and Firm Performance? *Journal of Business Research* 59: 887–895.
- Sikimic, U., V. Chiesa, F. Frattini, and V. G. Scalera. 2016. Investigating the Influence of Technology Inflows on Technology Outflows in Open Innovation Processes: A Longitudinal Analysis. *Journal of Product Innovation Management* 33(6): 652–669.
- Simonin, B. L. 1999. Ambiguity and the Process of Knowledge Transfer in Strategic Alliances. *Strategic Management Journal* 20: 595–623.
- Spiro, E. S., R. M. Acton, and C. T. Butts. 2013. Extended Structures of Mediation: Re-Examining Brokerage in Dynamic Networks. *Social Networks*, 35: 130–143.
- Spithoven, A., W. Vanhaverbeke, N. Roijackers. 2013. Open Innovation Practices in SMEs and Large Enterprises. *Small Business Economics* 41: 537–562.
- Staiger, D., and J. H. Stock. 1997. Instrumental Variables Regression with Weak Instruments. *Econometrica* 65(3): 557–586.
- Stam, W., and T. Elfring. 2008. Entrepreneurial Orientation and New Venture Performance: The Moderating Role of Intra- and Extra-industry Social Capital. *Academy of Management Journal*, 51, 1: 97–111.
- Stanko, M. A., G. J. Fisher, and M. Bogers. 2017. Under the Wide Umbrella of Open Innovation. *Journal of Product Innovation Management* (online version).
- Stock, R. M., and N. A. Zacharias. 2011. Patterns and Performance Outcomes of Innovation Orientation. *Journal of the Academy of Marketing Science* 39: 870–888.
- Sullivan, D. M., and C. M. Ford. 2013. How Entrepreneurs Use Networks to Address Changing Resource Requirements During Early Venture Development. *Entrepreneurship Theory and Practice* January: 1–24.
- Sutcliffe, K. M., and A. Zaheer. 1998. Uncertainty in the Transaction Environment: An Empirical Test. *Strategic Management Journal* 19: 1–23.
- Symeonidou, N., and J. Bruneel. 2017. Determinants, Causal Connections and Outcomes of Corporate Technology Licencing: A Systematic Review and Research Agenda. *R&D Management* (online version).
- Tan, J., H. Zhang, and L. Wang. 2015. Network Closure or Structural Hole? The Conditioning Effects of Network-Level Social Capital on Innovation Performance. *Entrepreneurship Theory and Practice*, September: 1042–2587.

- Tan, K. C., V. R. Kannan, C. Hsu, and G. K. Leong. 2009. Supply Chain Information and Relational Alignments: Mediators of EDI on Firm Performance. *International Journal of Physical Distribution & Logistics Management* 40(5): 377–394.
- Teece, D. 2007. Explicating Dynamic Capabilities: The Nature and Microfoundations of (Sustainable) Enterprise Performance. *Strategic Management Journal* 28: 1319–1350.
- Theil, S. 2017. When Start-Up Brain Meets Corporate Brawn. Available at: <https://global.handelsblatt.com/our-magazine/when-brain-meets-brawn-722594> [09.11.2017].
- Tiwana, A. 2008. Do Bridging Ties Complement Strong Ties? An Empirical Examination of Alliance Ambidexterity. *Strategic Management Journal* 29: 251–272.
- Tranekjer, T. L., and M. P. Knudsen. 2012. The (Unknown) Providers to Other Firms' New Product Development: What's in it for them? *Journal of Product Innovation Management* 29(6): 986–999.
- Tsai, K. 2009. Collaborative Networks and Product Innovation Performance: Toward a Contingency Perspective. *Research Policy* 38: 765–778.
- Tsai, W. 2001. Knowledge Transfer in Intraorganizational Networks: Effects of Network Position and Absorptive Capacity on Business Unit Innovation and Performance. *Academy of Management Journal*, 44, 5: 996–1004.
- Tsinopoulos, C., C. Sousa, and J. Yan. 2017. Process Innovation: Open Innovation and the Moderating Role of the Motivation to Achieve Legitimacy. *Journal of Product Innovation Management*, Online Edition.
- Tuominen, M., A. Rajala, and K. Möller. 2004. How Does Adaptability Drive Firm Innovativeness? *Journal of Business Research* 57: 495–506.
- Un, C. A., Cuervo-Cazurra, A., and Asakawa, K. 2010. R&D Collaboration and Product Innovation. *Journal of Product Innovation Management*, 27: 673–689.
- Uzzi, B. 1996. The Sources and Consequences of Embeddedness for the Economic Performance of Organizations: The Network Effect. *Sociological Review*, 61, August: 674–698.
- von Hippel, E. 1986. Lead Users: A Source of Novel Product Concepts. *Management Science* 32(7): 791–805.
- Walker, G., B. Kogut, and W. Shan. 1997. Social Capital, Structural Holes and the Formation of an Industry Network. *Organization Science*, 8, 2: 109–125.
- Walter, S. G., A. Walter, and D. Müller. 2014. Formalization, Communication Quality, and Opportunistic Behaviour in R&D Alliances between Competitors. *Journal of Product Innovation Management* 32(6): 954–970.
- Wang, M., and M. Chen. 2016. The More, the Better? The Impact of Closure Collaboration Network and Network Structures on Technology-Based New Ventures' Performance. *R&D Management* 46(S1): 174–192.
- Wang, J., and J. Li-Ying. 2015. Licencing Foreign Technology and the Moderating Role of Local R&D Collaboration: Extending the Relational View. *Journal of Product Innovation Management* 32(6): 997–1013.

- West, J., and M. Bogers. 2014. Leveraging External Sources of Innovation: A Review of Research on Open Innovation. *Journal of Product Innovation Management* 31(4): 814–831.
- West, J., S. Gallagher, and O. W. Square. 2006. Challenges of Open Innovation: The Paradox of Firm Investment in Open-source Software. *R&D Management* 36(3): 319–331.
- Wooldridge, J. M. 2002. *Econometric Analysis of Cross Section and Panel Data*. The MIT Press, Cambridge: MA.
- Wooldridge, J. M. 2008. *Introductory Econometrics*. 4th ed, Hampshire: Cengage Learning Emea.
- Wu, B., and J. Chen. 2010. Investment Allocation in Innovation Resources in Open Innovation: A Research in Chinese Power Equipment Manufacturing Firms. *Proceedings of the 2010 IEEE ICMIT*.
- Wu, J. 2012. Technological Collaboration in Product Innovation: The Role of Market Competition and Sectoral Technological Intensity. *Research Policy* 41: 489–496.
- Xu, S., F. Wu, and E. Cavusgil. 2013. Complements or Substitutes? Internal Technological Strength, Competitor Alliance Participation, and Innovation Development. *Journal of Product Innovation Management* 30(4): 750–762.
- Yang, H., Z. J. Lin, and Y. L. Lin. 2010. A Multilevel Framework of Firm Boundaries: Firm Characteristics, Dyadic Differences, and Network Attributes. *Strategic Management Journal* 31: 237–261.
- Zaheer, A., and G. G. Bell. 2005. Benefiting from Network Position: Firm Capabilities, Structural Holes, and Performance. *Strategic Management Journal* 26: 809–825.
- Zhou, K. Z., C. K. Yim, and D. K. Tse. 2005. The Effects of Strategic Orientations on Technology- and Market-Based Breakthrough Innovations. *Journal of Marketing* 69: 42–60.

Appendix

Table A-1: Empirical Studies Examining the Link between Open Innovation and Firm's Innovation Performance

Table A-2: Studies Examining Risk of Partner's Opportunistic Behaviour in Open Innovation

Table A-3: Empirical Studies Examining the Link between Network Characteristics and Firm's Innovation and Financial Performance

Table A-1: Empirical Studies Examining the Link between Open Innovation and Firm's Innovation Performance

Author(s) (Year) / Journal	Data / Method	Theoretical Foundation	Independent Variable(s)	Mediating Variable(s) / Moderating Variable(s)	Dependent Variable(s)	Key Results / Implications
Beers/Zand (2014) / JPIM	N = 12,811 firms, data stem from Community Innovation Survey, cross-industry, Netherlands, LS / panel data analysis based on random-effects Tobit estimates	Literature on R&D collaboration	Functional diversity (+/ns)	-	Radical innovation / incremental innovation	Functional diversity leads to a variety of knowledge intake and synergetic effects necessary to develop and commercialize novel products. Geographical diversity results in successful adaption of existing products to different local requirements such as technical standards, market regulations, and customer preferences.
			Geographical diversity (ns/+)			
Belderbosa /Carreeb/ Lokshin (2004) / RP	N = 2,056 firms, data stem from Community Innovation Survey, cross-industry, Netherlands, LS / RA	Organizational learning, knowledge spillovers	R&D cooperation (+/+)	-	Growth innovative sales productivity / growth labour productivity	Supplier and competitor cooperation have a significant impact on labour productivity growth, while cooperation with universities and research institutes and again competitor cooperation positively affects growth in sales per employee of products and services new to the market.
			Competitor cooperation (+/+)			
			Supplier cooperation (+/ns)			
			Customer cooperation (ns/ns)			
			University cooperation (ns/+)			
			Incoming spillovers (+/+)			
			Competitor spillovers (ns/ns)			
			Supplier spillovers (ns/ns)			
			Customer spillovers (ns/+)			
University spillovers (+/+)						

Berchicci (2013) / RP	N = 2,905 firms, data stem survey of manufacturing firms, cross-industry, Italy, LS / panel data analysis	Literature on open innovation model introduced by H. Chesbrough.	External R&D activities (\cap)	Mod: R&D Capacity (-)	Innovative performance	Firms that increasingly rely on external R&D activities have a better innovative performance, yet up to a point. Beyond this threshold, a greater share of external R&D activities reduces a firm's innovative performance. And such substitution effect is larger for firms with greater R&D capacity.
Chai/Shih (2016) / RP	N = 206 firms, cross industry, Denmark, LS / panel analysis, Poisson count and OLS regression models with firm fixed effects	Literature on academic-industry partnerships	Academic-industry partnership funding (+/ns/+ four years after funding)	<i>Three types of sample used:</i> Small and medium enterprises	Publication count / patent count / proportion of cross-institutional publications	Receiving academic-industry partnership funding affects firms' innovative behaviour differently depending on the type of firm, where peer-reviewed publications increased significantly more for SMEs and larger projects, granted patents increased significantly up to 4 years after funding for young firms and those in larger projects, and proportion of cross-institutional publications increased significantly more 3 years after funding for all three sample specifications.
			Academic-industry partnership funding (++) two years after funding/+ four years after funding)	Young firms		
			Academic-industry partnership funding (++) all three years after funding)	Size of collaboration projects		
Cheng/Huizingh (2014) / JPIM	N = 223 firms, senior managers, service industry, Taiwan, CS / SEM	Literature on open innovation model introduced by H. Chesbrough.	Open innovation activities (+)	Mod: Entrepreneurial orientation (+)	Innovation performance	Performing open innovation activities is related to innovation performance. Having a more explicit strategic orientation enhances the effectiveness of open innovation. Entrepreneurial orientation strengthens the positive performance effects of open innovation significantly more than market orientation and resource orientation do.
				Mod: Market orientation (+)		
				Mod: Resource orientation (+)		

Faems et al. (2010) / JPIM	N = 305, manufacturing firms, data stem from Belgian Community Information Survey, cross-industry, Belgium, CS / SEM	Literature on open innovation and alliances	Technology alliance portfolio diversity (ns)	<i>Med</i> : Product innovation performance (-)	Personnel costs in value added	Technology alliance portfolio diversity has an indirect positive impact on financial performance via increased product innovation performance. However, a direct cost-increasing effect of technology alliance portfolio diversity on financial performance is observed. Moreover, in the short-term, the direct cost-increasing effect of technology alliance portfolio diversity exceeds the indirect value-generating effect of technology alliances.
			Internal innovation efforts (+)			
Filiou/Massini (2017) / R&D Mgmt.	N = 110 firms, UK bio-pharmaceutical sector, LS / Poisson and the Negative Binomial models for panel data	Literature on technological cognitive distance in alliances	Intra-industry alliances (\cap)	-	Innovation performance	Intra-industry alliances offer lower opportunities for innovation compared to inter-industry alliances and are less demanding on firm management. Trade-offs between innovation opportunities and management efforts result in an inverted U and a U-shaped relationship between the number of intra- and inter-industry alliances and innovation performance, respectively.
			Inter-industry alliances (U)			
Frankort (2016) / RP	N = 44 manufacturing firms engaged in R&D alliances, ICT industry, USA, LS / panel data analysis, Poisson quasi-maximum likelihood estimator (fixed effects)	Literature on R&D alliances	Knowledge acquisition through R&D alliances (+)	<i>Mod</i> : technological relatedness between the firm and its alliance partners (+)	New product development	Knowledge acquisition is on average positively associated with firms' numbers of new products. However, it is substantially more beneficial for new product development both when firms and their partners are active in similar technology domains and when they operate in distinct product markets.
				<i>Mod</i> : product-market competition between the firm and its alliance partners (-)		

Fu (2012) / RP	N = 2,130 firms, SMEs, senior managers, manufacturing and business services industry, Great Britain, CS / Tobit model	Literature on innovation efficiency and open innovation	Long-term incentives (+)	<i>Mod</i> : Openness of firm's innovation activity (-)	Innovation efficiency	Openness and incentives are positively associated with innovation efficiency, a substitution effect is found between openness and incentives. Whilst long-term incentives appear to enhance efficiency to a greater extent than short-term incentives, the substitution effect of openness is stronger regarding long-term incentives
			Short-term incentives (+)			
Jiang/Li (2009) / RP	N = 127 firms involved in alliances, senior managers, cross-industry, Germany, CS / SEM	Organizational learning	Alliance scope (+)	<i>Med</i> : Knowledge sharing (+)	Innovative performance	The scope of alliance activities, while positively associated with knowledge sharing, has no direct relationship with knowledge creation. Knowledge sharing, knowledge creation and their interaction significantly contribute to partner firms' innovative performance.
			Alliance governance (+)	<i>Med</i> : Knowledge creation (+)		
			Knowledge sharing × Knowledge creation (+)			
Katila/Ahuja (2002) / AMJ	N = 124, firms, global robotics industry, Europe, Japan, and North America, LS / panel Poisson regression	Organizational learning theory	Search depth (\cap)	-	Number of new products introduced by a firm	Firms' search efforts vary across two distinct dimensions: search depth and search scope. Search depth has an inverted U-shaped relationship with new product innovation. There is a positive, linear relationship between scope and product innovation. Search depth and search scope leverage each other, yielding a combined positive effect on product innovation.
			Search scope (+)			
			Search depth × search scope (+)			

Köhler/ Sofka/ Grimpe (2012) / RP	N = 4,933 firms, data stem from Community Innovation Survey, cross- industry, EU member states, senior, R&D, and innovation managers, LS / Tobit model	Organizational learning, external search strategies	Market-driven search (ns/+)	-	Share of sales of market novelties / share of sales of firm novelties	Firms adopting a science-driven or supplier-driven knowledge search can create new-to-market innovations. Market-driven knowledge search almost always increases imitation performance. It seems to be very limited in providing highly novel knowledge to firms that would consequently result in new-to-market innovations.
			Science-driven search (+/ns)			
			Supplier-driven search (+/ns)			
Laursen/ Salter (2006) / SMJ	N = 2,707 firms, data stem from Innovation Survey, managers in manufacturing firms, cross- industry, U.K., CS / Tobit model	Organizational learning, external search strategies	Search breadth (\cap)	<i>Mod</i> : R&D intensity (-)	products new to the world / products new to the firm / significantly improved products	Searching widely and deeply is curvilinearly related to innovation performance. External sources need to be managed carefully so that search efforts are not dissipated across too many search channels. There is a substitution effect between internal R&D and openness.
			Search depth (\cap)	<i>Mod</i> : R&D intensity (-)		
Lokshin/ Hagedoor/ Letterie (2011) / RP	N = 2,839 firms, data stem from Community Innovation Survey, cross- industry, Netherlands, LS / Probit model	Literature on partnership portfolio management	Persistence in innovation strategies (-)	-	'Bumpy road' (experienced instability in partnership)	Firms that persistently pursue a product-oriented innovation strategy are less likely to encounter a 'bumpy road'. Increasing technology partnership diversity has a negative impact on the probability of experiencing a 'bumpy road.' Firms that experience a 'bumpy road' in their technology partnerships exhibit lower innovative performance. Technology partnering positively impacts performance.
			Partnership portfolio diversity (-)			
			Occurrence of 'bumpy road' (-)	-	Innovative performance	
			Presence of technology partnerships (+)			

Pemartin/ Rodriguez- Escudero/ Munuera- Aleman (2017) / JPIM	N = 207 NPD collaboration projects of innovative firms, senior executives in charge of NPD, cross-industry, Spain, CS / covariance- based path analysis	Relational and resource- based views	Frequency (ns/+) <i>Direct effects on dependent variables</i>	<i>Med: Trust (-) Effects of independent variable on mediator</i>	Product quality / adherence to budget and schedule	Reciprocal feedback–rationality and frequency play an important role in product quality and adherence to budget and schedule, respectively, even without trust. The trust between partners substantially reinforces the positive influence of reciprocal feedback– rationality on NPD collaboration results and makes the effect of formality significant.
			Formality (ns/ns) <i>Direct effects on dependent variables</i>	<i>Med: Trust (+) Effects of independent variable on mediator</i>		
			Reciprocal feedback rationality (+/ns) <i>Direct effects on dependent variables</i>	<i>Med: Trust (+) Effects of independent variable on mediator</i>		
Salge/ Farchi/ Barrett/ Dopson (2013) / JPIM	N = 62 NPD projects, health- care industry, UK, CS / double-censored Tobit estimator and standard OLS	Literature on open innovation	Search openness (\cap/\cap)	<i>Mod: Explorative NPD projects (+/+)</i> <i>Mod: Exploitative NPD projects (ns/ns)</i> <i>Mod: Prior experience of the NPD project leader (+/+)</i> <i>Mod: Perceived NPD work group support (ns/+)</i>	New product creativity / new product success	Explorative NPD projects have more to gain from search openness at the ideation stage than their exploitative counterparts. The project-level payoff from search openness tends to be greater, when the project leader has substantial prior innovation and management experience, and when the immediate work environment actively supports creative endeavors.
Schleimer/ Faems (2016) / JPIM	N = 195 interfirm NPD projects, senior product development managers, high- technology industries, Australia, CS / RA	Relational view	Interfirm collaboration engagement (+/+)	<i>Mod: Intrafirm collaboration engagement (-)</i>	Radical NPD project performance / incremental NPD project performance	There is a negative interaction effect between interfirm and intrafirm collaboration engagement in radical, but not in incremental interfirm NPD projects. The negative interaction effect between interfirm and intrafirm collaboration engagement points to potential trade-offs between inward-looking and outward- looking absorptive capacity.
			Intrafirm collaboration engagement (+/+)	<i>Mod: Intrafirm collaboration engagement (ns)</i>		

Tsino- poulos/ Sousa/ Yan (2017) / JPIM	N = 7,645 firms, data stem from the European Community Innovation Survey, cross-industry, UK, LS / Logit models	Resource-based view and institutional theory	Cooperation with external parties (+)	<i>Mod:</i> Motivation to achieve legitimacy (+)	Process innovation	Open innovation increases the likelihood of introducing new processes and the motivation to achieve legitimacy affects this relationship. This moderating effect is positive on co-operation with external parties, and negative on the use of information. However, the effect is opposite in the case of use of external information.
			Use of external information (+)	<i>Mod:</i> Motivation to achieve legitimacy (-)		
			Acquisition of external R&D (+)	<i>Mod:</i> Motivation to achieve legitimacy (ns)		
Un/ Cuervo- Cazurra/ Asakawa (2010) / JPIM	N = 781 manufacturing firms, cross-industry, Spain, LS / panel data analysis, pooled Logit with clustered errors, random effects panel Logit	Literature on R&D collaboration	R&D collaboration with universities (+)	-	Product innovation	R&D collaboration with suppliers have the highest positive impact on product innovation, followed by collaboration with universities. R&D collaboration with customers do not affect product innovation, and collaboration with competitors harm it. The positive influence of R&D collaboration with universities and suppliers is sustained over the long-term, but the negative influence of R&D collaboration with competitors is short-lived.
			R&D collaboration with suppliers (+)			
			R&D collaboration with customers (ns)			
			R&D collaboration with competitors (-)			
Xu/Wu/ Cavusgil (2013) / JPIM	N = 64 firms, pharmaceutical industry, USA, LS / panel data analysis with random effect negative binomial estimators	Knowledge-based view	Internal technological strength (\cap/\cap)	<i>Mod:</i> External competitor alliance participation (-/+)	Radical innovation / incremental innovation	Internal technological knowledge strength has an inverted U-shaped relationship with radical and incremental innovation. Competitor alliance participation strengthens the effect of internal technological strength on incremental product innovation while it weakens the above effect on radical product innovation. Internal and external sources complement each other for incremental innovation while they represent trade-offs for radical innovation.
			External competitor alliance participation (+/ns)			

Wu (2012) / RP	N = 944 firms, five manufacturing sectors, senior and personnel managers, China, CS / Poisson model	Literature on strategic alliances and innovation	Technological collaboration (+)	<i>Mod:</i> Market competition (-) <i>Mod:</i> High tech sectors (+)	New product sales	The positive effect of technological collaboration on product innovation is diluted in highly competitive markets. The negative interaction of market competition and technological collaboration is negated by sectoral technological intensity, because technological collaboration entails joint problem- solving arrangement that encourages trust and long-term relationships that benefit all partners.
			Technological collaboration × Market competition	<i>Mod:</i> High tech sectors (+)		

Notes: N=Number of companies surveyed; Type of data collection (CS=Cross-sectional study, LS=Longitudinal study); OLS= Ordinary least squares; RA=Regression analysis; SEM=Structural equation modelling; ×= Interaction term; (+) Significant positive effect; (-) Significant negative effect; (ns) non-significant effect.

Table A-2: Studies Examining Risk of Partner’s Opportunistic Behaviour in Open Innovation

Author(s) (Year) / Journal	Data / Method	Theoretical Foundation	Independent Variable(s)	Mediating Variable(s) / Moderating Variable(s)	Dependent Variable(s)	Key Results / Implications
Carson et al. (2003) / Organization Science	N = 129 firms, R&D managers, cross industry, CS / RA	Literature on organization information- processing	Trust-based governance (+)	<i>Mod:</i> client’s task- related skills (+) <i>Mod:</i> teachability of the task skills (+) <i>Mod:</i> Collocated clients and suppliers (ns) <i>Mod:</i> parallel task execution by clients and suppliers (+)	Task performance for outsourced R&D arrangements	Trust-based governance allows firms to assess partner trustworthiness better, which reduces the risk of misplaced trust and monitoring and auditing costs. Trust-based governance lacks legal remedies for opportunism, which places a premium on the client’s abilities to assess partner trustworthiness and detect opportunism as quickly as possible.
Cassiman/ Veugelers, (2002) / The American Academic Review	N = 411 firms, data stem from Community Innovation Survey, cross-industry, manufacturing firms, Belgium, CS / Probit model	Organizational learning, knowledge spillovers	Incoming spillovers (+) <hr/> Appropriability (+)	-	Firm’s decision to cooperate	Incoming spillovers have a positive effect on the probability of firms cooperating. The more effective is strategic protection, the better firms control the outflow of commercially sensitive information. Firms for which risk is an important barrier to innovate are less likely to cooperate. Minimizing opportunistic behaviour in cooperative efforts is more difficult when the technology is characterised by a large amount of uncertainty.

Drechsler/ Natter (2012) / Journal of Business Research	N = 2,422 firms, data stem from German Community Innovation Survey, cross-industry, CS / zero-inflated negative binomial regression model	Literature on open innovation	Internal R&D (-/+)	-	Degree of Openness in Innovation = 0 / Degree of openness > 0	The factors that prevent firms from being open are a lack of market and technological knowledge (knowledge gaps), ineffective intellectual property (IP) protection mechanisms, and competitor threats such as market entries and imitation. The most important factors that increase the degree of openness are a firm's need for financial funding in innovation. The efficiency of intellectual property rights as barriers to imitation and opportunistic exploitation, is important for firms when deciding on the degree of openness.
			Acquisition of knowledge (-/+)			
			Financial gaps (-/+)			
			Knowledge gaps (+/ns)			
			Effectiveness of formal IP protection (-/ns)			
			Effectiveness of strategic IP protection (-/+)			
			Technological change (-/ns)			
			Uncertain demand (-/ns)			
Competitive threats (+/ns)						
Ganesan et al. (2010) / JMR	N = 440, three studies with undergraduate students, executive MBA and working MBA students, and professionals, USA / factorial experiments	Literature on relationship marketing	Ethical violations (not reported; results interpreted as interaction effects)	<i>Mod:</i> calculative commitment (+)	Buyers' switching intentions	Supplier misbehaviour in inter- organizational relationships is likely to provoke a sense of betrayal of trust in the aggrieved party. Affectively committed buyers assimilate mild incidences of opportunism, whereas they perceive severe opportunism as betrayal of the relational contract. The most consistent buffering effect was that of calculative commitment in response to mild ethical violations.
			Opportunism (not reported; results interpreted as interaction effects)	<i>Mod:</i> calculative commitment (+)		

Helm/Kloyer (2004) / RP	N = 94 firms, cross-industry, Germany, CS / analysis of variance	Literature on interfirm R&D collaboration, transaction cost theory	Group with medium contractual provisions (group comparisons)	-	Satisfaction of the R&D supplier	Suppliers and buyers of R&D results perceive the risk to achieve a lower profitability on the innovation return than the exchange partner, and the risk of the partner becoming a competitor by unplanned, one-sided knowledge flows. The model of an option on the post contractual negotiation of an additional continuous return sharing is useful in reducing the perceived exchange risks and thus the motivation for opportunistic behaviour. The group with few provisions is more satisfied with the risk control than the group with a medium number of provisions.
			Group with low contractual provisions (group comparisons)			
			Control of profitability risk (group comparisons)			
			Control of competitor creation risk (group comparisons)			
Henkel/Schöberl/Alexy (2014) / RP	N = 67 firms, computer components industry, CS / RA, Probit and Tobit models	Literature on open innovation	Customer pressure (+/ns)	-	Revealing in general / revealing to open source software project	Selective revealing is not without risk. Beyond the obvious concern about imitation and loss of competitive advantage, also issues of reduced compatibility, reliability, safety and security, and an increase in maintenance cost may arise. Downstream customer demand for openness is a trigger of companies' initial opening up. Selective revealing is a potential first step toward more intensive collaboration.
			Marketing-related benefits (ns/-)			
			Technical benefits (ns/+)			
			Experience with embedded Linux (-/-)			
			Developing Linux drivers since the firm's foundation (ns/ns)			
			Experience with selective revealing of driver source code (+/+)			

Jean/ Sinkovics/ Hiebaum (2014) / JPIM	N = 170 firms, multinational automobile suppliers, China, CS / partial least squares	Transaction cost economics, resource- based view	Supplier Involvement in Codesign (+)	<i>Med:</i> Product Innovation in Customer-Supplier Relationships (+)	Relationship performance	Supplier involvement in the codesign process has an inverted U-shaped relationship with product innovation in emerging markets. Knowledge protection, trust, and technological uncertainty are all found to drive greater product innovation. The risks of knowledge leakage may limit the effective flow and integration of foreign partners' knowledge.
			Knowledge Protection (+)			
			Trust (+)			
			Technological Uncertainty (+)			
Kale/Singh/ Perlmutter (2000) / SMJ	N = 212 firms involved in alliances, senior and alliance managers, cross- industry, USA, CS / OLS regression	Organizational learning and relational view	Relational capital (+/+)	-	Learning from the alliance partner / protection of proprietary assets	Relational capital based on mutual trust and interaction between alliance partners creates a basis for learning and know- how transfer across the exchange interface. At the same time, it curbs opportunistic behaviour of alliance partners, thus preventing the leakage of critical know-how between them. Conflict management reduces motivation of firms to engage in opportunistic behaviour.
			Conflict management (+/+)			
			Partner fit (ns/ns)			
Laursen/Salter (2014) / RP	N = 2,931 firms, data stems from UK Innovation survey, cross- industry, CS / Poisson RA	Literature on open innovation	Appropriability strategy (concave/concave)	<i>Mod:</i> absence of competitors in firms' knowledge sourcing portfolios or collaboration partner portfolios (-)	External search breadth / innovation collaboration breadth	There are substantial risks from openness, the most extreme being theft. There is a concave relationship between firms' breadth of external search and formal collaboration for innovation, and the strength of the firms' appropriability strategies. The positive relationship between both forms of openness and appropriability strategy are moderated resulting

						in a weaker relationship if competitors are not exploited.
Li et al. (2011) / Organization Science	N = 2,423 R&D alliances, data stem from Securities Data Corporation (SDC) Database on Alliances, high-technology industries, USA, CS / logistic RA	Social exchange theory	Multilateral vs. bilateral R&D alliance (+)	<i>Med</i> : Alliance governance structure (+) <i>Mod</i> : Alliance scope (+)	Alliance duration	Given the difficulty of monitoring and identifying opportunistic behaviour, a partner in a multilateral R&D alliance may have a stronger incentive to behave opportunistically than it would in a bilateral R&D alliance. Alliance scope moderates the relationship between the type of alliance and governance structure. Multilateral R&D alliances with predicted (aligned) governance structures perform better, in terms of alliance longevity, than those with misaligned structures.
			Net vs. chain trilateral R&D alliance (+)	<i>Mod</i> : Alliance scope (ns)		
Mata/Woerter (2013) / RP	N = 5963 firms, data stem from Swiss Innovation Survey, cross-industry, Switzerland, LS /quantile regressions	Literature on internal and external innovation strategies	Internal innovation strategy (+)	-	Profit (price cost margin)	Opportunistic behaviour from the collaboration partners or precaution measures for the possibility of information leaks regarding valuable technologies may increase coordination costs and make external R&D less attractive. External strategies are risky and may require a very large number of attempts before average returns are obtained. This puts smaller firms into a position of disproportionately high risk. The effect of external strategies are greater than the effect of internal innovation.
			External innovation strategy (+)			

Mina/ Basca- vusoglu-Moreau/ Hughes (2014) / RP	N = 788-819 firms across estimations, data stem from IRC Open Innovation Survey, cross- industry, UK, CS / OLS models	Literature on open innovation	R&D expenditures (+/+/+)	-	Total OI activities / informal OI activities / formal OI activities	Firms R&D and human capital intensity is positively associated with openness Effectiveness of IP protection is positively associated with formal, but not informal, open innovation practices. Business services are more active open innovators than manufacturers; they are more engaged in informal relative to formal open innovation practices than manufacturers.
			Human capital (+/+/+)			
			Effectiveness of IP protection (+/ns/+)			
			Business service dummy (+/+/+)			
Narula/ Santangelo (2009) / RP	N = 14 firms, N = 100 alliances, data stem from patent and alliance database, the world's largest ICT hardware companies, European ICT industry, LS / binomial logit models	Social network theory	Firms co-locating their R&D activity in ICT patent classes in the same European countries (+)	-	Likelihood of concluding an alliance with technological similar firms	The likelihood of concluding alliances is complementary to prior geographical proximity of research activities in technologies core to a given industry both at the country and sub-national regional level. Firms may be inclined to take the risk of opportunistic behaviour if they believe that the potential to enhance their competence portfolio, thus seeking to identify the most appropriate partners from a technological point of view regardless of nationality.
			Firms co-locating their R&D activity in ICT patent classes in the same European sub-national regions (+)			
			Countries hosting co-localised R&D activity in ICT patent classes by firms (+)			
			Number of sub-national regions hosting co-localised R&D activity in ICT patent classes by firms (+)			
			Firms whose headquarters are located in different countries (+)			

Oxley/ Sampson (2004) / SMJ	N = 208 R&D alliances, data stem from Securities Data Company (SDC) Database on Alliances and Joint Ventures, electronic and telecommunications equipment industries, USA, Japan, CS / Probit model	Transaction cost economics, resource-based view	Product market competition (-/-)	-	Alliance scope / alliance governance (probability that firms select an equity joint venture)	The more extensive, interdependent, complex, and uncertain are the alliance activities, the greater is the potential risk of opportunism. When partner firms are direct competitors in end product or strategic resource markets even 'protective' governance structures such as equity joint ventures may provide insufficient protection to induce extensive knowledge sharing among alliance participants. Rather than abandoning potential gains from cooperation altogether in these circumstances, partners choose to limit the scope of alliance activities to those that can be successfully completed with limited (and carefully regulated) knowledge sharing.
			Geographic market competition (-/ns)			
			Market leaders and laggards (+/na)			
			Technology overlap (+/na)			
Spithoven/ Vanhaverbeke/ Roijakkers (2013) / Small Business Economics	N = 967 firms, data stem from innovation survey, cross-industry, Belgium, CS / Probit and fractional logit RA	Literature on open innovation	OI practices (+/+)		Introduction of new products or services on the market / turnover from product or service innovations	OI has a positive effect on the introduction of new offerings for both SMEs and large companies. SMEs are less effective in generating new products and services through OI. SMEs benefit relatively more from the use of protection mechanisms than large firms. Many SMEs do not take a systematic approach to IP, and this leads to unintended knowledge spillovers.
			Use of search strategies (+/+)			
			Use of external R&D (+/ns)			
			Use of research collaboration (+/ns)			
			Use of protection mechanisms (+/+)			

Sutcliffe/ Zaheer (1998) / SMJ	N = 308 managers, students enrolled in graduate-level business administration classes experimental research design, USA, CS / RA	Literature on environmental uncertainty	Primary uncertainty (-)	<i>Mod:</i> Primary uncertainty information (-)	Decision to vertically integrate	Behavioural uncertainty arises from the possibility of ex ante or ex post opportunism on the part of the exchange partner firm. Primary and competitive uncertainty were negatively associated with the decision to vertically integrate, but supplier uncertainty was positively related to the vertical integration decision. Primary uncertainty information use strengthens the negative relationship between primary uncertainty and vertical integration, and supplier uncertainty information use strengthens the positive relationship between supplier uncertainty and vertical integration.
			Competitive uncertainty (-)	<i>Mod:</i> Competitive uncertainty information (ns)		
			Supplier uncertainty (+)	<i>Mod:</i> Supplier uncertainty information (+)		
			Primary uncertainty information (ns)			
			Competitive uncertainty information (ns)			
			Supplier uncertainty information (ns)			
Walter /Walter/ Müller (2014) / JPIM	N = 82 R&D alliances between competitors, cross- industry, operative and managerial informants, Germany, CS / RA	Literature on opportunism in R&D Alliances	Formalisation (ns/+)	-	Strategic manipulation / Knowledge appropriation	This study differentiates two forms of opportunistic behaviour, strategic manipulation and knowledge appropriation. Extensive formalisation fuels the insidious problem of perceived opportunistic behaviour in R&D alliances between competitors. In contrast, communication quality mitigates the dysfunctional effect on strategic manipulation and also alleviates both forms of opportunism directly.
			Communication Quality (-/-)			
			Formalisation × Communication quality (-/ns)			

Notes: N=Number of companies surveyed; Type of data collection (CS=Cross-sectional study, LS=Longitudinal study); OLS=Ordinary least squares; RA=Regression analysis; ×= Interaction term; (+) Significant positive effect; (-) Significant negative effect; (ns) non-significant effect.

Table A-3: Empirical Studies Examining the Link between Network Characteristics and Firm's Innovation and Financial Performance

Author(s) (Year) / Journal	Data / Method	Theoretical Foundation	Independent Variable(s)	Mediating Variable(s) / Moderating Variable(s)	Dependent Variable(s)	Key Results / Implications
Ahuja (2000) / Administrative Science Quarterly	N = 97 firms, international chemicals industry, Europe, Japan, USA, LS / panel analysis, random- effects Poisson estimators	Inter- organizational network theory	Direct ties (+)	<i>Mod:</i> direct ties (-)	Innovation output (patenting frequency)	Direct and indirect ties both have a positive impact on innovation but the impact of indirect ties is moderated by the number of a firm's direct ties. Increasing number of structural holes has a negative impact on innovation in collaborative networks.
			Indirect ties (+)			
			Structural holes (-)			
Carnabuci/ Dioszegi (2015) / AMJ	N = 68 employees of a small Italian design and manufacturing firm, CS / ordinary least squares	Social network theory	Network brokerage (+)	<i>Mod:</i> adaptive cognitive style (+) <i>Mod:</i> innovator cognitive style (-)	Innovative performance	A social network rich in structural holes enhances the innovative performance of employees with an adaptive cognitive style; however, individuals with an innovative cognitive style are most innovative when embedded within a closed network of densely interconnected contacts.
Dittrich/ Duysters (2007) / JPIM	N = 2,500 R&D alliance projects, data stem from Merit-Cati database, ICT industry, LS /in- depth semi- structured interviews, descriptive analysis	Social network theory and literature on exploration and exploitation	Partners' capabilities (+/+)	-	Exploration in innovation networks / exploitation in innovation networks	In exploration networks partner turnover is higher than in exploitation networks. Regarding the type of alliance contract, exploration networks make use of flexible legal organizational structures, whereas exploitation alliances are associated with legal structures that enable long-term collaboration.
			Type of partner (+/+)			
			Alliance type (+/+)			

Dong/ McCarthy/ Schoen- makers (2017) / JPIM	N = 2,298 alliances, pharmaceutical industry, USA, LS / panel analysis, negative binomial model	Network theory	Partner-weighted alliance centrality (\cap)	<i>Mod:</i> Private- Public Ratio (higher proportion of private relative to public partners in a firm's alliances flattens the shape of the inverted U- shaped relationship)	Breakthrough innovation	For breakthrough innovation, collaborating with more partners that are more central in alliance networks the better, but only to a point. Firms with a greater share of private partners, relative to public partners, suffer less from the diminishing benefits of collaboration with central partners when developing breakthrough innovation.
Gilsing et al. (2008) / RP	N = 116 firms, pharmaceutical, chemical and automotive industries, USA, LS / panel analysis, Poison RA	Social network theory and literature on exploration and exploitation	Technological distance (\cap)		Exploration of novel technologies	Different network positions yield different pay-offs in terms of the number of explorative patents. Exploration success also depends on the technological distance and network density. If working from a central position with partners that operate at a large® technological distance, performance drops rapidly. High levels of network density in combination with high levels of centrality offer a fairly high impact on exploration.
			Betweenness centrality (\cap)			
			Density (\cap)			
			Technological distance × betweenness centrality (–)			
			Technological distance × density (ns)			
			Betweenness centrality × density (+)			
Goerzen (2007) / SMJ	N = 580 firms, multinational cooperations, cross-industry, Japan, CS / SEM	Transaction cost economics, social network theory	Propensity to enter into repeated relations with prior partners (–)	<i>Mod:</i> technical uncertainty (–)	Economic performance in terms of operating RoS, RoA, and operating return on capital	Firms that enter into repeated equity-based partnerships with a greater propensity experience inferior economic performance. The negative effect of repeated partnerships on performance is particularly strong in environments of greater technological uncertainty.

Guan/Liu (2016) / RP	N = 919 innovative firms, nano-energy field, USA, Europe, Asia, LS / random-effects negative binomial panel regression	Literature on exploitative and exploratory innovations	Knowledge network direct ties (\cap /ns)	-	Exploitative innovation / explorative innovation	Direct ties of an organization's knowledge elements in a knowledge network have an inverted U-shaped effect on its exploitative innovation. Direct ties in a collaboration network have an inverted U-shaped effect on both innovation types. Indirect ties of an organization's knowledge elements affect its exploitative innovation. Indirect ties in a collaboration network affect exploratory innovation. Non-redundancy among ties in a knowledge network hinder exploitative innovation, but favour exploratory innovation. Non-redundancy among ties in a collaboration network favours exploitative innovation.
			Knowledge network indirect ties (+/ns)			
			Knowledge network non-redundancy (-/+)			
			Collaboration network direct ties (\cap / \cap)			
			Collaboration network indirect ties (+/-)			
			Collaboration network non-redundancy (+/ns)			
Kratzer et al. (2016) / JPIM	N = 267 adolescents in 11 high school groups; N = 126 real-world lead users; N = 141 non-lead users, cross-industry, international, CS / latent class analysis	Social network theory	Degree centrality (ns)	-	Extent to which user displays lead user characteristic with high potential for innovation	Lead users have a distinctive social network position: They exhibit an unusually high level of "betweenness centrality," meaning that they are positioned as bridges between different social groups. As this information can be retrieved easily from the Web, it might be possible to make the identification of lead users easier, faster, and more cost-effective.
			Betweenness centrality (+)			

Li/Veliyath/ Tan (2013) / JSBM	N = 252 firms, mold industry, China, CS / RA	Social network theory	In-cluster ties (+)	<i>Mod:</i> Centrality (+) <i>Mod:</i> Tie strength (+) <i>Mod:</i> Tie stability (+) <i>Mod:</i> Tie quality (ns)	Firm performance (scale measuring both innovation and financial performance)	Both in-cluster ties and extra-cluster ties positively impacted performance. However, the effects of distant ties are more pronounced. Tie stability has a positive effect whereas tie quality has a negative effect on performance. Network centrality, tie strength, and tie stability strengthen the relationship between in-cluster ties and performance. By contrast, all network tie characteristics weaken and change the form of the relationship between extra-cluster ties and performance.
			Extra-cluster ties (+)	<i>Mod:</i> Centrality (-) <i>Mod:</i> Tie strength (-) <i>Mod:</i> Tie stability (-) <i>Mod:</i> Tie quality (-)		
			Centrality (ns)	-		
			Tie strength (ns)	-		
			Tie stability (+)	-		
			Tie quality (-)	-		

Lin/Yang/ Arya (2009) / SMJ	N = 195 firms, involved with 3,498 alliances, cross-industry, USA, LS / cross- sectional time- series regression models with fixed effects	Resource- based view, institutional perspective	Resource complementarity (-)	-	Financial performance (RoA)	<p>A joint consideration of resource complementarity and status effects, as well as important firm- and environmental-level contingent factors, are critical for understanding the underlying mechanisms of alliance formations and their effects on firm performance. It is necessary to consider both societal and network status as they can have distinct effects under certain conditions.</p> <p>Firms with low societal and/or network status will benefit more from partners with resource complementarity, while firms with high societal and/or network status will be less likely to do so. A large status asymmetry, especially in terms of societal status, will bring more benefits for firms with low status.</p> <p>Stable environment, rather than a dynamic environment, will facilitate the synergy creation between firms with resource complementarity in alliances.</p>
			Own societal status (ns)			
			Own network status (ns)			
			Partner societal status (-)			
			Partner network status (ns)			
			Societal status asymmetry (ns)			
			Network status asymmetry (ns)			
			Resource complementarity × Partner societal status (+)			
			Resource complementarity × Partner network status (+)			
			Resource complementarity × Own societal status (-)			
			Resource complementarity × Own network status (-)			
			Societal status asymmetry × Own societal status (-)			
			Network status asymmetry × Own network status (ns)			
			Resource complementarity × Environmental dynamism (-)			
			Societal status asymmetry × Environmental dynamism (-)			
			Network status asymmetry × Environmental dynamism (+)			
			Societal status asymmetry × Firm age (-)			
Network status asymmetry × Firm Age (ns)						

Pullen et al. (2012) / JPIM	N = 60 firms in quantitative survey, N = 50 firms in qualitative interviews, NPD, R&D managers, CTOs, and CEOs, medical devices industry, Netherlands, CS / Euclidean distance and correlation analysis	Social systems perspective, configuration theory	Ideal network profile consisting of (+): - High goal complementarity - High fairness trust - High reliability trust - High network position strength - High resource complementarity	-	Innovation performance	The more a company's NPD network profile differs from the ideal profile, the lower the innovation performance. The NPD network profiles of successful and less successful firms significantly differ in terms of "goal complementarity". A relatively closed, focused, and consistent "business-like" NPD networking approach, which is characterised by result orientation and professionalism, is related to high innovation performance.
Sullivan/Ford (2013) / ET&P	N = 174 start-ups, respondents were founders, cross-industry, USA, LS / RA	Network theory and resource-dependence theory	Network size ₁ (+/+/ns/+)	-	Network size ₂ / Network knowledge heterogeneity ₂ / Weak ties ₂ / Strong ties ₂	Network size at launch is positively related to network size, network knowledge heterogeneity, and strong ties in early venture development. Weak ties are positively related to weak ties and negatively related to strong ties in early venture development. Overall, during early venture development, entrepreneurs systematically manage their networks to refine the overall number of resource and the diversity of knowledge resources that they have access to.
			Weak ties ₁ (ns/ns/+/-)			

Tan/Zhang/ Wang (2015) / ET&P	Data generate from simulation	Social network theory	Degree centrality (+)	<i>Mod</i> : Network density (-)	Innovation performance	Network density, a measure of network-level social capital, negatively moderates the impacts of firm-level social capitals, measured separately by degree centrality and structural hole, on a firm's innovation performance
			Structural holes (+)	<i>Mod</i> : Network density (-)		
Tsai (2001) / AMJ	N = 24 business units in a petrochemical company and N = 36 business units in a food manufactur- ing company, CS / RA	Network perspective on organizational learning	Centrality of an organizational unit's network position (+/ns)	<i>Mod</i> : absorptive capacity (+)	Business unit's innovation performance / business unit's business performance	By occupying a central network position, a unit is likely to access useful knowledge from other units. There is no significant association between a unit's network position and its business performance. The interaction between AC and network position has significant, positive effects on business unit innovation and performance.
			Absorptive capacity (AC) (+/+)	<i>Mod</i> : absorptive capacity (+)		
Tsai (2009) / RP	N = 753 firms, data stem from Technological Innovation Survey, manufacturing firms, cross- industry, Taiwan, CS / RA	Literature on partner types and absorptive capacity	Collaborative networks of Suppliers (ns/ns)	<i>Mod</i> : Absorptive capacity (AC) (+/ns)	Significant innovation / marginal innovation	There is a positive effect of AC on the supplier-new product performance relationship. AC negatively affects the relationship between customer collaboration and the performance of marginal innovation. It positively affects the relationship between competitor collaboration and the performance of new products. AC negatively affects the relationship between collaboration with research organizations and the performance of technologically new or products. AC positively affects the impact of collaboration with research organizations on the performance of marginally changed products.
			Clients (ns/ns)	<i>Mod</i> : Absorptive capacity (+/-)		
			Competitors (ns/ns)	<i>Mod</i> : Absorptive capacity (+/+)		
			Research Organizations (-/+)	<i>Mod</i> : Absorptive capacity (-/+)		

Notes: N=Number of companies surveyed; Type of data collection (CS=Cross-sectional study, LS=Longitudinal study); RA=Regression analysis; SEM=Structural equation modelling; ×= Interaction term; (+) Significant positive effect; (-) Significant negative effect; (ns) non-significant effect.