

**School of Media, Culture and Creative Arts
Department of Internet Studies**

Digital Inequality: The Internet in Mauritius

Shafiq Muhammad Gopee

**This thesis is presented for the Degree of
Doctor of Philosophy
of
Curtin University**

September 2016

<<Page left Blank>>

Declaration

To the best of my knowledge and belief this thesis contains no material previously published by any other person except where due acknowledgment has been made.

This thesis contains no material which has been accepted for the award of any other degree or diploma in any university.

Human Ethics (For projects involving human participants/tissue, etc.) The research presented and reported in this thesis was conducted in accordance with the National Health and Medical Research Council National Statement on Ethical Conduct in Human Research (2007)—updated March 2014. The proposed research study received human research ethics approval from the Curtin University Human Research Ethics Committee (EC00262), Approval Number # MCCA-04-12.

Abstract

The pervasiveness of the Internet and its potential to enhance socio-economic development is no longer questioned, despite some dystopian voices in Internet narratives. However, more than twenty years after the commercial release of the Internet, access is still poor and the gap between those who have access and those who do not, the so-called Digital Divide, is still present. Research has shown that developing countries, especially Small Island Developing States (SIDS), are the most severely affected in their socio-economic development by such lack of connectivity. Additionally, there has been some criticism as to the dichotomous approach of the Digital Divide, thereby leading to the conceptualisation of Digital Inequality, often referred to as the second level Digital Divide. The Digital Inequality approach encompasses not only the access issue (Digital Divide) but also the differences among formal Internet users and the potential benefits they reap. Although there is a growing literature on Digital Inequality in developed countries, the phenomenon is almost not investigated at all in developing countries and SIDS, which offer unique settings from a socio-economic and demographic prospects.

This research, therefore, proposes to bridge the gap in the literature and investigates Digital Inequality in a SIDS environment like Mauritius. Using DiMaggio and Hargittai's Digital Inequality model, this study approaches the issue from two angles. The first, from a user perspective, by investigating the perception of Mauritian Internet users on the relative differences in access and use. The second, by evaluating other major stakeholders' viewpoints on the issues of Digital Divide and Digital Inequality.

Such investigation is achieved through a mixed method approach. On one hand, quantitative methods, in the form of surveys, are used to gather local Internet users' perception on their Internet use. On the other hand, qualitative methods, through semi-structured interviews, are used to gather the views and perceptions of major local Internet stakeholders, divided into three

categories: The Government of Mauritius; civil society organisations; and Internet Service Providers.

The results of the research provide a unique and holistic understanding of the state of Internet, with regard to the Digital Divide and Digital Inequality. For example, the study uncovers that in spite of concerted efforts by stakeholders to curb the Digital Divide, the rate of Internet penetration is still low on the island. From a Digital Inequality perspective, the study reveals that while socio-demographic factors such as sex and location have almost no impact on Digital Inequality, age and education play an important role in determining differences in access and use. The study also reveals the different, and sometimes contentious views within and between the stakeholders with regard to the two issues, but also when it comes to the strategies that need to be implemented to curb the effects of the two phenomena.

This research is conclusive on three main areas. First, it reiterates the importance of ongoing research on Digital Divide, especially in developing countries and SIDS. Second, the research underlines the specificities of SIDS and asserts that Digital Inequality is contextually dependent and needs to be researched further in different milieus. Third, from a policy perspective, the research uncovers the relevance and importance of having a multi-stakeholder approach to researching and understanding such phenomena.

Digital Inequality research is still burgeoning, and although this research fills some gaps in the literature, it also uncovers some new avenues for further research in three main areas, namely theory, methodology and context. This study argues the need for further research and better understanding of the theoretical aspects surrounding Digital Inequality to ensure a common understanding of the term. From a methodology perspective, this research outlines some of the limitations of existing methods and metrics and lays the groundwork for more effective methods to research this evolving phenomenon. Although this research focuses on Mauritius, it opens the doors for similar research to be conducted in other countries facing similar challenges.

Keywords: Digital Inequality, Digital Divide, Mauritius, Small Island
Developing State, SIDS, Internet, Internet use, Multi-stakeholder perspective.

“I would like to pay my respect to the traditional owners and custodians of the land where Curtin University is located, the Wadjuk Nyungar people and acknowledge their Elders past and present.”

Acknowledgement

A PhD is a challenging enterprise, and doing it on a part time basis some 6,000 km away from campus has made it even more challenging. As I pen down the last words of this thesis, I cannot but reflect on the past years. I feel humbled and blessed to have met the right people at the right time, who have all, one way or the other, brought about something to this journey.

First and foremost, I am grateful to have had Assoc. Prof. Michele Willson as supervisor, the best I could have hoped for. She has given me the latitude to explore, experiment, and has allowed me to learn from my mistakes. I am grateful for her relentless encouragement when I felt overwhelmed and for her support and wisdom when obstacles would arise along the journey. Additionally, I am grateful to have received the guidance and support of Dr. Mike Kent, my co-supervisor, for whom I have also worked as a tutor. His positive outlook and unconventional mode of providing feedback have inspired me beyond this research. I am also indebted to Prof. Matthew Allen and Dr. Helen Merrick, who have sparked my curiosity and inspired me to undertake research in Internet Studies. Prof. Allen has also been, although for a short time, of invaluable help as a supervisor.

None of this would have been possible without a scholarship from Curtin University. I am thankful for the opportunity and for the funding received to present at the ANZCA conference and to attend the QUT CCI Digital Research Methods Summer School. Both events have been amazing learning experiences, and I have a special thought for the wonderful people of ANZCA for their feedback, which has certainly been disseminated throughout this thesis. The staff of the School of Media, Culture and Creative Arts, and specially the Department of Internet Studies, deserve my appreciation for their help and support.

Back home, I would like to thank Odylle Charoux, Director of Academic Affairs of the Charles Telfair Institute. She has never stopped believing in me, right from the first time we met some 16 years ago, and has since been

providing me with countless opportunities to learn and to grow—for that, I will be forever grateful and I am proud to have been among her students. I also extend my appreciation and thanks to Prof. Eric Charoux, Executive Director of the Charles Telfair Institute, who has introduced and welcomed me to his Self-Awareness group—the learning has been immense.

The Charles Telfair Institute is certainly a place I call home and I would like to convey my appreciation and thanks to all the staff, academic and non-academic. I will not venture into listing individual names of fear that I miss some—they have all, in a way or the other, supported me on this journey. Dr. Karlo Jouan, perhaps, deserves a special mention for having always been there to listen, to provide insight and to offer a shoulder on which I could cry on. I am thankful to Vikash Rowtho, Christel Ramloll and Sarita Ramanan for their friendship, support and advices. I am also deeply grateful to Mariam Ramankhan-Inder, for some last-minute proof-reading.

My academic journey would not have been possible without my family. I am humbled by the unconditional love and support I received from my grandma, Abeida, my uncles, Mohammad, Habeebullah, Abdullah, Ibrahim, Sanaoollah and their wives, during the most difficult times of my life; they never asked for anything and yet gave me everything—God bless them. My gratitude and thanks to my parents, siblings and Dawood for their love and prayers. A special thank-you to Shamsiya, Noorrany and their kids for hosting me during my short visits to Perth—their hospitality was beyond any expectations.

Last and perhaps more importantly, my heartiest thanks to my wonderful wife, Nidaa, and our PhD baby Aidaa Sofiia. Nidaa, thank you for being the superwoman who has concurrently handled a full-time job, master's degree, pregnancy and above all a doctoral student husband—I am so proud of you; thank you for being by my side and for everyday showing me how beautiful and creative my other half is. Aidaa Sofiia, my darling, you came right in the middle of this journey as a blessing; your hugs and laughs have been my daily inspiration and encouragement over the final years of this wonderful journey. You are such a beautiful soul and I wish for you a thousand-fold of what I wish for myself. *Je t'aime.*

For Nidaa and Aidaa Sofiia, with all my love.

Table of Contents

Declaration	III
Abstract.....	IV
Acknowledgement.....	VIII
Table of Contents	XI
List of Figures.....	XVII
List of Table	XIX
List of Acronyms	XXII
Chapter 1: Introduction	1
1.1. Background.....	1
1.2. Research Problem.....	4
1.2.1. Digital Divide.....	4
1.2.2. Digital Inequality	6
1.2.3. Developing Countries and Small Island Developing States.....	7
1.2.4. Multi-Stakeholder Perspective	9
1.3. Objectives.....	10
1.4. Significance	12
1.5. Structure of the Thesis	13
Chapter 2: Theories of Digital Divide and Digital Inequality	16
2.1. Introduction.....	16
2.2. Digital Divide	16
2.2.1. Digital Divide—a Historical Perspective	16
2.2.2. Defining the Digital Divide	17
2.2.3. The Evolution and Measurement of the Digital Divide	20
2.2.4. Criticism of the Digital Divide Approach and Measurements	22
2.3. Digital Inequality.....	23
2.3.1. Defining Digital Inequality.....	23
2.3.1.1. Defining Access.....	24
2.3.1.2. Defining Use	24

2.3.2.	Models of Digital Inequality.....	25
2.3.2.1.	Bourdieuan Approach to Digital Inequality.....	26
2.3.2.2.	DiMaggio and Hargittai’s Model of Digital Inequality.....	31
2.3.2.2.1.	Inequality in Technical Apparatus.....	32
2.3.2.2.2.	Inequality in Autonomy of Use.....	32
2.3.2.2.3.	Inequality in Skill.....	33
2.3.2.2.4.	Inequality in the Availability of Social Support.....	34
2.3.2.2.5.	Inequality in Purpose of Use.....	35
2.3.2.3.	Determinants of Digital Inequality.....	35
2.3.2.4.	A Case for DiMaggio and Hargittai.....	36
2.3.3.	Measuring Digital Inequality.....	39
2.3.3.1.	Mossberger, Tolbert and Stansbury on Virtual Inequality.....	40
2.3.3.2.	Ono & Zavodny.....	41
2.3.3.3.	DiMaggio and Hargittai’s Digital Inequality Framework.....	43
2.3.3.4.	Yang et al.....	43
2.3.3.5.	Hargittai.....	45
2.4.	Conclusion.....	48
Chapter 3:	Mauritius and the Internet.....	49
3.1.	Introduction.....	49
3.2.	Mauritius.....	49
3.2.1.	Economic Development—A Historical Perspective.....	51
3.2.2.	Political System.....	53
3.2.3.	Socio-Demographic Development.....	54
3.2.3.1.	Education System.....	56
3.2.3.2.	Employment and Income Inequality in Mauritius.....	58
3.3.	The Internet in Mauritius.....	60
3.3.1.	Infrastructure.....	60
3.3.2.	Penetration.....	63
3.3.3.	Price Basket.....	71
3.3.4.	Mauritius and International Benchmark.....	73
3.3.5.	Governmental Policies and Initiatives.....	74
3.3.6.	ICT Industry.....	76
3.4.	Digital Divide and the Future of Internet in Mauritius.....	77
3.5.	Conclusion.....	77

Chapter 4: Methodology	80
4.1. Introduction	80
4.2. Mixed Method Approach	81
4.3. Quantitative Methods	85
4.3.1. Questionnaire Design	89
4.3.1.1. Demographics	89
4.3.1.2. Inequality in Technical Apparatus	92
4.3.1.3. Inequality in Autonomy of Use	94
4.3.1.4. Inequality in Skill	96
4.3.1.5. Inequality in Social Support in Internet Use	99
4.3.1.6. Inequality in Purpose of Use	101
4.3.1.7. Closing Remarks.....	104
4.3.1.8. Thank You Page	104
4.3.1.9. Web Survey Design—Survey Monkey	104
4.3.2. Survey Pre-Test.....	106
4.3.3. Questionnaire Distribution	108
4.3.4. Quantitative Data Analysis	109
4.4. Qualitative Methods	110
4.4.1. Interviewee Selection	110
4.4.2. Interview Questions	112
4.4.3. Interview Procedures	114
4.4.4. Interview Analysis	116
4.5. Ethical Considerations	116
4.6. Conclusion	118
Chapter 5: Quantitative (Survey) Findings	120
5.1. Introduction	120
5.2. Reliability and Validity	121
5.2.1. Test of Reliability (Cronbach’s alpha)	122
5.2.2. Test for Validity and Sample Adequacy (KMO).....	123
5.2.3. Test for Normality.....	125
5.3. Descriptive Statistics	126
5.3.1. Demographics	126
5.3.2. Technical Apparatus	134
5.3.3. Autonomy of Use.....	139

5.3.4.	Skill	143
5.3.5.	Social Support	147
5.3.6.	Purpose of Use	153
5.4.	Inferential Statistics	154
5.4.1.	Grouping of Variables	155
5.4.2.	Mann Whitney (U) and Kruskal-Wallis (H) Test.....	156
5.4.2.1.	Technical Apparatus.....	158
5.4.2.2.	Autonomy of Use.....	161
5.4.2.3.	Skill.....	165
5.4.2.4.	Social Support	169
5.4.2.5.	Purpose of Use	173
5.4.3.	Factor Analysis	177
5.4.4.	Regression Analysis.....	183
5.5.	Conclusion	186
Chapter 6:	Quantitative (Survey) Discussion	188
6.1.	Introduction	188
6.2.	Demographics.....	188
6.3.	Inequality in Technical Apparatus	193
6.4.	Inequality in Autonomy of Use	198
6.5.	Inequality in Skill	201
6.6.	Inequality in Social Support	205
6.7.	Inequality in Purpose of Use.....	209
6.8.	Digital Inequality—The Mauritian Model.....	212
6.9.	Conclusion	215
Chapter 7:	Qualitative (Interview Results) Discussion	216
7.1.	Introduction	216
7.2.	Governmental Organisations	217
7.2.1.	Digital Divide.....	220
7.2.1.1.	Internet Development	220
7.2.1.2.	Access.....	223
7.2.2.	Digital Inequality	225
7.2.3.	Overall Governmental Perspective	230
7.3.	Civil Society Organisations.....	231

7.3.1.	Digital Divide.....	233
7.3.1.1.	The Role of the Internet.....	233
7.3.1.2.	Access.....	235
7.3.1.3.	Use.....	237
7.3.2.	Digital Inequality	238
7.3.3.	Overall Civil Society Perspective	242
7.4.	Internet Service Providers.....	243
7.4.1.	Digital Divide.....	244
7.4.1.1.	Access.....	244
7.4.1.2.	Use.....	246
7.4.2.	Digital Inequality	246
7.4.3.	Overall ISP Perspective	248
7.5.	Cross-Stakeholder Analysis	248
7.5.1.	Digital Divide.....	249
7.5.1.1.	Role of the Internet.....	249
7.5.1.2.	Access.....	250
7.5.2.	Digital Inequality	251
7.5.2.1.	Inequality in Technical Apparatus	251
7.5.2.2.	Inequality in Autonomy of Use	252
7.5.2.3.	Inequality in Skill.....	252
7.5.2.4.	Inequality in Social Support.....	252
7.5.2.5.	Inequality in Purpose of Use	253
7.6.	Current Situation and Implications.....	255
7.6.1.	Digital Divide.....	255
7.6.2.	Digital Inequality	256
7.7.	Conclusion	259
Chapter 8:	Conclusion.....	261
8.1.	Research Questions	261
8.1.1.	Digital Divide.....	262
8.1.2.	Digital Inequality	267
8.2.	Research Limitations	272
8.2.1.	Theoretical Limitations.....	273
8.2.2.	Methodological Limitations	273
8.2.3.	Analytical Limitations.....	274

8.3. Future Directions	275
References	277
Appendix A: List of Small Island Developing States	301
Appendix B: Survey Questionnaire.....	302
Appendix C: Interview Questions.....	318
Appendix C.1	318
Appendix C.2	321
Appendix C.3	323
Appendix C.4	327
Appendix C.5	331
Appendix D: Inferential Statistics: Factor Analysis.....	335
Appendix D1.....	335
Appendix E: Image Permissions	336

List of Figures

Figure 1.1: Archipelago of Disconnection (Adapted from Straumann and Graham 2016)	8
Figure 2.1: Individuals Using the Internet per 100 Inhabitants Worldwide (Source: ITU 2015a).....	21
Figure 2.2: Kvasny's Conceptual Framework (Source: Kvasny 2002)	31
Figure 2.3: Determinants of Digital Inequality (Source: Yang et al. 2010)	44
Figure 3.1: Map of Mauritius (Adapted from http://freevectormaps.com).....	50
Figure 3.2: Mauritian GDP at Market Price 2000-2013 (Source: World Bank 2015).....	52
Figure 3.3: Mauritian Population Age Demographics 2014/ 2039 (Source: Statistics Mauritius 2015c).....	56
Figure 3.4: Education System in Mauritius	57
Figure 3.5: Income Inequality - Lorenz Curves 2006/07 and 2012 (Source: Statistics Mauritius 2013c).....	59
Figure 3.6: African Undersea Cables (Source: Song 2015 Under Creative Common Licence BY)	62
Figure 3.7: Mauritius International Bandwidth Capacity (Source: ICTA 2015b).....	63
Figure 3.8 Fixed Line Penetration for Republic of Mauritius (Source: ICTA 2015b)	64
Figure 3.9: Internet Subscription from 2010-2014 (Source: ICTA 2015b).....	67
Figure 3.10: Broadband Subscription vs. Narrowband Subscription (Source: ICTA 2015b)	68
Figure 3.11: Broadband Connection (Fixed vs. Mobile) (Source: ICTA 2015b).....	69
Figure 3.12: Narrowband Subscription Type (Source: Statistics Mauritius 2015a) ..	70
Figure 3.13: Total Dial-Up Internet Traffic (Source: ICTA 2015b)	70
Figure 3.14: Ebene Cyber Tower 1 (Source: BPML 2015) Courtesy of Business Parks of Mauritius Ltd.....	76
Figure 4.1: Parallel (QL+QN) Mixed Methods Design (Source: Tashakkori and Newman 2010, 516)	85
Figure 5.1: Sex of Respondents.....	127
Figure 5.2: Age Group of Respondents.....	128
Figure 5.3: Residential Area of Respondents.....	129
Figure 5.4: Occupation of Respondents	130
Figure 5.5: Highest Education Level of Respondents	131
Figure 5.6: Current Level of Education of Respondents	132

Figure 5.7: Highest Education Level of Respondents' Parents.....	133
Figure 5.8: Device Ownership of Respondents.....	134
Figure 5.9: Main Internet Connection Mode (Owners)	135
Figure 5.10: Main Internet Access Location (Owners)	136
Figure 5.11: Main Internet Access Location (Non-Owners)	137
Figure 5.12: Technical Apparatus - Factors Limiting Effective Internet Use	138
Figure 5.13: Connection Status of Respondents.....	139
Figure 5.14: Monitoring of Internet Use of Respondents.....	140
Figure 5.15: Blocking of Online Content.....	141
Figure 5.16: Autonomy of Use - Factors Limiting Effective Internet Use.....	142
Figure 5.17: Year Respondents Started Using the Internet	143
Figure 5.18: Formal Training Received by Respondents	144
Figure 5.19: Skill: Familiarity with Internet-related Terms	145
Figure 5.20: Skill - Factors Limiting Effective Internet Use.....	146
Figure 5.21: Reasons for Starting to Use the Internet.....	147
Figure 5.22: Help Seeking in Internet Use	148
Figure 5.23: Availability of Help	149
Figure 5.24: Sources of Help.....	150
Figure 5.25: Sources of Best Help	151
Figure 5.26: Social Support - Factors Limiting Effective Internet Use	152
Figure 5.27: Purpose of Use - Factors Limiting Effective Internet Use	154
Figure 5.28: Scree Plot Component Number Against Eigenvalue	180
Figure 6.1: Mauritian Digital Inequality Model	214

List of Table

Table 3.1: Tariffs of Internet Connection Rs./Month (Adapted: ICTA 2015b; Statistics Mauritius 2015a; Orange 2015).....	71
Table 3.2: Average Monthly Income (Source: Statistics Mauritius 2015c, 23).....	72
Table 4.1: Demographics Variables	92
Table 4.2: Inequality in Technical Apparatus Variables	94
Table 4.3: Inequality in Autonomy of Use Variables.....	96
Table 4.4: Web-Use Skill Index Items (Adapted from Hargittai and Hsieh 2012).....	98
Table 4.5: Inequality in Skill Variables.....	99
Table 4.6: Inequality in Social Support Variables.....	101
Table 4.7: Inequality in Purpose of Use	103
Table 4.8: Digital Inequality Rating Variable	104
Table 5.1: Cronbach's alpha Test results.....	123
Table 5.2: KMO and Bartlett's Test Results	124
Table 5.3: Summary of Reliability Coefficients for Inequality Concepts.....	155
Table 5.4: Mean Score of Gender for each Inequality.....	157
Table 5.5: Results of Mann-Whitney (U) Test	157
Table 5.6: Results of Kruskal Wallis (H) Test.....	157
Table 5.7: Summary of Significant Pairwise Comparison of Age Group in Inequality in Technical Apparatus Distribution	159
Table 5.8: Median Scores Across Highest Education Level in Inequality of Technical Apparatus	159
Table 5.9: Summary of Significant Pairwise Comparison of Highest Education Level Achieved and Inequality in Technical Apparatus.....	160
Table 5.10: Median Scores Across Current Education Level in Inequality in Technical Apparatus.....	160
Table 5.11: Statistically Significant Pairwise Comparison of Current Education Level Achieved and Inequality in Technical Apparatus.....	161
Table 5.12: Median Scores Across Age Group in Inequality in Autonomy of Use .	161
Table 5.13: Statistically Significant Pairwise Comparison of Age Group and Inequality in Autonomy of Use.....	162
Table 5.14: Mean Scores Across Occupation in Inequality in Autonomy of Use ...	162

Table 5.15: Median Scores Across Highest Education Level Achieved in Inequality in Autonomy of Use	163
Table 5.16: Statistically Significant Pairwise Comparison of Highest Level of Education and Inequality in Autonomy of Use	163
Table 5.17: Median Scores Across Current Education Level in Inequality in Autonomy of Use	164
Table 5.18: Statistically Significant Pairwise Comparison of Current Education Level and Inequality in Autonomy of Use	164
Table 5.19: Median Scores Across Age Group in Skill.....	165
Table 5.20: Statistically Pairwise Comparison of Age Group in Skill.....	165
Table 5.21: Median Scores Across Occupation in Skill.....	166
Table 5.22 Median Scores Across Highest Education Level Achieved in Skill	167
Table 5.23: Statistically Significant Pairwise Comparison of Highest Education Level Achieved and Inequality in Skill	167
Table 5.24: Median Scores Across Current Education Level in Inequality in Skill .	168
Table 5.25: Statistically Significant Pairwise Comparison of Current Education Level and Inequality in Skill.....	168
Table 5.26: Median Scores Across Age Group in Inequality in Social Support.....	169
Table 5.27: Statistically Significant Pairwise Comparison of Age Group Level in Inequality in Social Support	169
Table 5.28: Mean Ranks across Occupation in Inequality in Social Support.....	170
Table 5.29: Median Scores Across Highest Education Level Achieved in Inequality in Social Support	171
Table 5.30: Statistically Significant Pairwise Comparison of Highest Education Level Achieved and Inequality in Social Support	171
Table 5.31: Median Scores Across Current Education Level in Inequality in Social Support	172
Table 5.32: Statistically Significant Pairwise Comparison of Current Education Level and Inequality in Social Support	172
Table 5.33: Median Scores Across Age Group in Inequality in Purpose of Use	173
Table 5.34: Statistically Significant Pairwise Comparisons of Age Group and Inequality in Purpose of Use.....	173
Table 5.35: Mean Ranks Across Occupation in Inequality in Purpose of Use	174
Table 5.36: Median Scores Across Highest Education Level Achieved in Inequality in Purpose of Use	175

Table 5.37: Statistically Significant Pairwise Comparisons of Highest Education Level Achieved and Inequality in Purpose of Use	175
Table 5.38: Mean and Median Scores Across Current Education Level in Inequality in Purpose of Use	176
Table 5.39: Mean Scores across Highest Education Level of Parents in Inequality in Purpose of Use	176
Table 5.40: Initial Extraction Based on Eigenvalue	179
Table 5.41: Parallel's Test with Monte Carlo Simulated Values	180
Table 5.42: Six Factors Rotated Component Matrix	181
Table 5.43: Descriptive Statistics of Independent Variables	184
Table 5.44: Pearson Correlation Results between Dependent and Independent Variables	184
Table 5.45: Summary of Coefficients Table for Regression Analysis	186
Table 6.1: Summary of Determinants Affecting Digital Inequality in Mauritius (Adapted from Yang et al. 2010)	212
Table 7.1: Summary of Codes Used for Interviewees	217
Table 7.2: Summary of Cross-Categorical Analysis of Stakeholders	254
Table 8.1: Summary of 2015 ICT Statistics (Source: ITU 2015a)	263

List of Acronyms

BPO	Business Process Outsourcing
CPE	Certificate of Primary Education
CSO	Civil Society Organisations
DOI	Digital Opportunity Index
FTTH	Fibre To The Home
HSC	Higher School Certificate
ICT-OI	ICT Opportunity Index
ICTA	Information and Communication Telecommunication Authority (Mauritius)
IDI	ICT Development Index
ITU	International Telecommunication Union
MITIA	Mauritius IT Industries Association
NCB	National Computer Board (Mauritius)
OECD	Organisation for Economic Co-operation and Development
OTAM	Outsourcing and Telecommunication Association of Mauritius
Rs.	Mauritian Rupees
SAFE	South African Far East (Cable)
SC	School Certificate
SIDS	Small Island Developing States

<<Page Left Blank >>

Chapter 1: Introduction

1.1. Background

It is indisputable that “the Internet has revolutionised the computer and communications world like nothing before” (Leiner et al. 2015, para. 1), let alone our life. From its early development for military uses to its commercial release and the development of the World Wide Web (WWW) in the 1990’s, this network of networks has, in such a short span of time, not only affected and changed the way we do things, but has inconspicuously had a profound impact on the things we do. There is perhaps not a single aspect of modern life that is not directly or indirectly linked to the Internet. Castells (2010) argues that there is a complex pattern of interaction between technology and society. However, in opposition to proponents of the social and technological determinism schools of thought, he postulates that neither does technology determine society nor does society determine technology; instead, there exists a rather complex multi-factorial dialectical interaction between these two.

As a result, the Internet has brought with it a social revolution. It has opened the gates to an unprecedented and unparalleled level of interaction and communication within and across societies, lowering in its passage the physical barriers that prevented such communications in previous generations. Despite dystopian discourses that technology is alienating people, Rainie and Wellman (2012) describe how this new form of communication has brought about the networked individualism; i.e. people who are more than ever networked with others, spanning far beyond their geographical, social and political spheres, rather than being confined to small groups around themselves.

Since the early days of commercial Internet, Rheingold (Rheingold 1993) predicted the potential benefits and opportunities of online (virtual) communities and online gaming platforms. Over the years, the Internet has opened up new avenues for creating, collaborating and sharing of

information. This (r)evolution in the way people create, disseminate, access and collaborate has been the catalyst of a new culture—the participatory culture (Cacciatore et al. 2012). Jenkins et al. (2009, 21:12) describe the participatory culture as creating the conditions for “relatively low barriers to artistic expression and civic engagement, strong support for creating and sharing creations, and some type of informal mentorship whereby experienced participants pass along knowledge to novices”. Hoffman, Lutz and Meckel (2015, 1) argue that such participatory uses of the Internet are bound to bring about “both group- and individual-level benefits”. In addition, Robinson et al. (2015) argue that “those who function better in the digital realm and participate more fully in digitally mediated social life enjoy advantages over their digitally disadvantaged counterparts”.

The benefits of the Internet are immense and the opportunities for socio-economic development are boundless, allowing societies to develop and enhance their social capital (Wellman et al. 2001; Hooghe and Oser 2015; Stern and Adams 2010; Chen 2013; Hargittai 2008a), human capital (Ono 2005; Hsieh, Rai, and Keil 2010), financial and economic capital (Choi and Hoon Yi 2009; Dutta and Bilbao-Osorio 2012; Stiakakis, Kariotellis, and Vlachopoulou 2010; Litan and Rivlin 2001) and cultural capital (Thornham and McFarlane 2011; Halford and Savage 2010; Hargittai 2008a). In this respect, much hope has been placed on the social levelling dimension of the Internet (Willis 2006; Wijetunga 2014; Pruijt 2002; Warschauer 2003a; Witte and Mannon 2010). Negroponte (1995, quoted in Peter and Valkenburg 2006, 4) recognises that “digital technology can be a natural force drawing people into world harmony” and Gunkel (2003, 2) adds that “IT was routinely celebrated for creating a new world of limitless opportunity that was liberated from problematic sociocultural determinants, such as race, gender, age, and geography”. boyd (2014, 15) contends that the “utopian rhetoric assumes that when a particular technology is broadly adopted, it will transform society in magnificent ways...”. Indeed, there is a growing literature on Internet (the subject), mainly on Information and Communication Technology for

Development (ICT4D) and the potential for technology, especially the Internet, to help drive development.

The technology itself evolved with time (Cerf 2004b), with each increment further widening the spectrum of possibilities. From the outset, the duo Vint Cerf and Bob Kahn developed the basic protocol—Transfer Control Protocol (TCP) and Internet Protocol (IP), which would serve as the base for data transmission on the Internet (Brown 2009). Cerf (2004a) suggests that the characteristics of the IP allowed for different types of data to be transmitted over the Internet and also for other services to be layered to the IP. With time, the Internet grew from a closed local area network to accommodate long distance wireless communication through satellite, and even to use mobile cellular network for data transmission, thereby allowing for different services to be deployed. Another hallmark of the technological development of the Internet was the elaboration of the WWW by Tim Berners-Lee and his colleagues at the European Organisation for Nuclear Research (CERN) in Switzerland (Berners-Lee and Fischetti 2000). The World Wide Web or Web provided a novel, simple, user-friendly graphical user interface (GUI) through a browser to display information. Over the years, this static Web would also evolve into what Tim O'Reilly (2007) would term as the Web 2.0, allowing for more interaction between users (peer to peer) and service providers. Aghaei, Nematbakhsh and Farsani (2012, 3) argue that the Web 2.0 is also known as the “wisdom web, people-centric web, participative web, and read-write web”, which enables people to network more than ever and thereby strengthening the participatory culture.

The bandwidth for data transmission, interchangeably known as Internet speed, is yet another significant area of Internet development. At the dawn of the Web, the connection speed was merely 56 Kilobits per second (Kbps) through a modem and a telephone line, thus the term Dial-up. A 56 Kbps transmission meant that 1 Megabyte (MB) of data would take roughly 2.5 minutes to download under good uninterrupted conditions (Simpson 2016). As the Internet evolved from a unidirectional to a more dynamic, multi-directional, sharing platform, the need for faster transmission and bigger

volumes surged and the technology progressed to enable higher Internet speed. Today, thanks to high-speed undersea and land optical fibre cables linking continents around the world, users can enjoy the Internet at a speed of up to 100 Megabits per second (Mbps), allowing for faster and better quality multimedia being transmitted at a faster rate. Comparatively, a 1MB of data would be downloaded in just 8 seconds with a 1 Mbps Internet connection.

Broadband (high-speed) Internet, further discussed in Chapter 3, even became a major tool to achieve global development through the United Nations (UN) Millennium Development Goals—a series of eight goals agreed by all UN Member States, including the eradication of extreme poverty and hunger; achieving universal primary education; promoting gender equality; reducing child mortality; improving maternal health; combatting HIV/AIDS, malaria and other diseases; ensuring environmental sustainability and lastly developing a global partnership for development (Broadband Commission 2014). Broadband Internet is seen as a major enabler of socio-economic development and governments have been investing massively in setting up the infrastructure (Dutta and Mia 2011).

1.2. Research Problem

1.2.1. Digital Divide

In spite of offering undeniable socio-economic advantages, globally, access to the Internet is still poor. A recent report from the International Telecommunication Union (ITU) suggests that more than half of the world's population do not use the Internet (ITU 2015b). The report further pinpoints that non-Internet users are not evenly spread around the globe. Indeed, the vast majority of those non-users are unfortunately from developing countries. As with other inequalities, the divide between North and South, developed and developing countries, is more than ever present in the Internet domain. The rate of Internet penetration in developed countries is more than double the rate of Internet penetration in developing countries—the Americas and

Europe have a much higher Internet penetration rate than other regions of Africa, which have the least Internet penetration rate (ITU 2015b).

This gap between those who have and those who do not have access to the Internet—the so-called Digital Divide—is still a fortiori present in contemporary societies. Interestingly, the issue of Digital Divide is not a new one, with its origin dating back to the early days of Internet commercialisation (discussed further in Chapter 2). However, the notion of Digital Divide has evolved over time, initially focusing on the basic notion of a dichotomised difference in access to the technology, and later expanding to encompass other forms of divides.

In the 1990's, bridging the Digital Divide became the battle horse of policy makers and civil rights activists alike. It was seen as the right opportunity to end social cleavages and inequalities once for all. For example, in the United States, the Clinton administration made “closing the Digital Divide a major public policy goal” (Chakraborty and Bosman 2002, 3). Governments around the globe were investing massively in laying the infrastructure and supporting access to the Internet and devices.

Still, inequalities persist. On one hand, global access to the infrastructure needed is not even. Sparks (2013, 8) argues that “in general, Internet connectivity closely correlate[s] with the per capita gross domestic product: more developed countries tended to have higher access than developing countries”. On the other hand, even in countries that have a high rate of Internet penetration, there are still deep schisms in these societies.

Warschauer (2003b) explains that the technological deterministic mind-set of governments and philanthropists alike to provide technology to populations and hoping to solve “social ills” proved pointless mainly because the social contexts were not taken into account. Barzilai-Nahon (2006), in a similar manner, castigates the overly simplistic view of the Digital Divide and the technological deterministic perspective adopted by policy makers, and argues that the focus has been too much on inter-country differences rather than on the deep schism at national, regional and individual level. Pena-Lopez (2009, 404) explains that the reasons behind such ‘inefficient’

measurement of the Digital Divide is either due to “a specific and applied purpose that fits the general goals of the fostering organisation” or indices that are “adapted to the availability of data, reverting to the use of proxies or soft data—in the best of cases, or the exclusion of variables in the worst ones—potentially relevant to the subject to be measured”.

1.2.2. Digital Inequality

In response to the political and theoretical imbroglio concerning the Digital Divide and the fact that providing access to the Internet did not yield the expected outcomes, several authors presented new paradigms to investigate and understand the issue (discussed in greater detail in Chapter 2). These paradigms, although sometimes divergent, offer contemporary perspectives on the issue, especially as the Internet and societies evolve. The core of these frameworks resides in the rejection of the over-simplistic Digital Divide measure and builds upon the core metric of access and use to offer different understandings of the issue. Chapter 2 explores in greater detail some of these paradigms and discusses the pertinence of DiMaggio and Hargittai’s model as a basis to research Digital Inequality.

The Digital Inequality framework coined by DiMaggio and Hargittai (2001) has been widely received as a hallmark in understanding the Internet and the underlying forces impeding the socio-economic development of nations and individuals alike. The pair argue that there is a mismatch between access and use; a claim supported by studies carried out in the United States showing that firstly, “more people have access to the Internet than use it” and secondly, even though households have access to the Internet, there are differences in the way family members use the Internet—teenagers would use the Internet more than their parents (DiMaggio and Hargittai 2001, 4). These would be the premise of the formulation of the Digital Inequality framework/model comprising of five dimensions of inequality: inequality in technical apparatus; inequality in autonomy of use; inequality in skill; inequality in social support; and inequality in purpose of use (DiMaggio and Hargittai 2001). The model, as well as the variations brought by other

authors, is further discussed in Chapter 2 and the rationale for using this method to investigate Digital Inequality is justified.

The notion of Digital Inequality is, however, not limited to the dimensions of inequality but also to the socio-demographic variables that impact on these dimensions. These underlying forces offer singular insights on the causes or the determinants of the inequalities. With each nation having its specifications, challenges and social uniqueness, it is important to understand the nature of the determinants of Digital Inequality, especially with societies constantly evolving and entangled in the globalisation phenomenon. Ono and Zavodny (2005) argue that the underlying forces of Digital Inequality cannot be generalised to all societies and that it is imperative to understand the issue from different contexts. For example, research on Digital Inequality in the United States showed that race (Afro-Americans/White/Hispanic) has a significant impact on Digital Inequality, with the 'Afro-Americans' and 'Hispanic' perceived as being socially and economically disadvantaged (DiMaggio et al. 2001), but that such factor would not be present in other societies. Gender is yet another variable which profoundly impacts upon the adoption and use of Internet. Globally, gender inequality is still an issue, especially in developing countries, with women not having the same opportunities as men in exploiting the benefits of the Internet (ITU 2015b). On another note, within some countries, there are deep schism between rural and urban areas (Park 2015) with the quality of life and access to infrastructures being dissymmetric. Consequently, it is imperative to research further Digital Inequality in different contexts and also to understand the manifestations, effects and causes in various contexts.

1.2.3. Developing Countries and Small Island Developing States

There is a plethora of research and monitoring on the global Digital Divide. Developing countries and Small Island Developing States (SIDS) are the most affected by the Digital Divide, so much so that Straumann and Graham (2016) have termed these dark spots of disconnection "The Archipelago of Disconnection", as shown in Figure 1.1. However, as Internet penetration

increases, these societies offer new settings to explore and expand the research in Digital Inequality.

There is a dearth of research on Digital Inequality in such contexts. Indeed, much of the research on Digital Inequality has been carried out in developed countries. Initially, research on Digital Inequality focused on western societies and it is only recently that there has been a move to investigate this phenomenon in Asian countries. Goggin and Mc Lelland (2008), in an attempt to push for the internationalisation of Internet studies, argue that for too long, research on Internet studies has been too western-centric and that other societies offer altogether different interesting settings to understand issues differently.

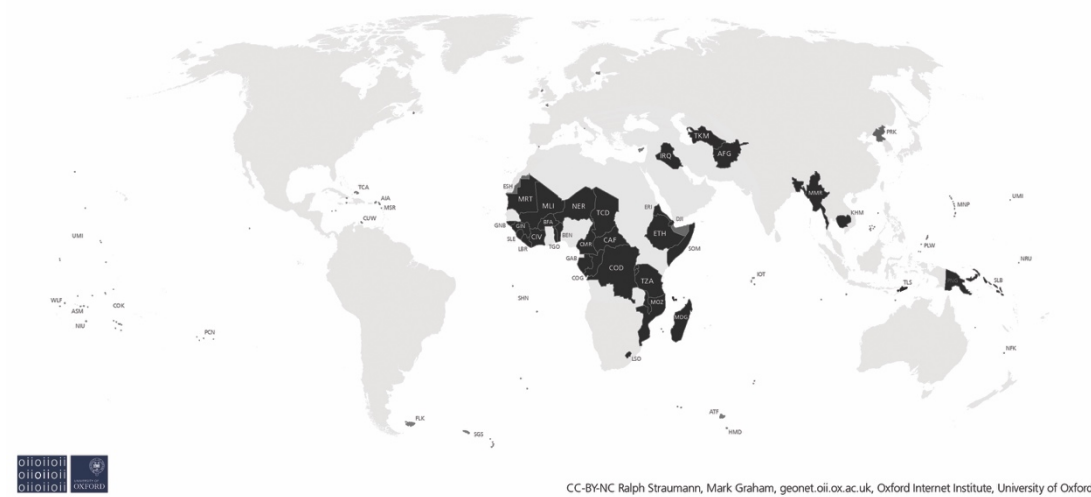

The Archipelago of Disconnection

■ Territories with Internet penetration below 10%

■ Territories for which no data exists

For territories coloured orange no individual data exists from the World Bank. Potential reasons include: unavailability of data, lacking statehood of such

territories, or that they are counted together with larger entities with which they are in some way affiliated.

This visualization uses 2013 data from the World Bank's Worldwide Development Indicators project and data from Natural Earth.

Figure 1.1: Archipelago of Disconnection (Adapted from Straumann and Graham 2016)

There is a growing literature in Internet studies in Asia, especially in China, Korea and Japan. However, research in Internet studies on the African continent, and especially on SIDS, is almost non-existent. As at the onset of this research project, the only known major research being carried out in Digital Inequality on the African continent was that initiated by the Oxford

Internet Institute (OII) in Eastern mainland Africa.

As the name suggests, SIDS are a group of 39 developing island states (see Appendix A for the full list of SIDS countries) spreading over three geographical regions: the Caribbean; the Pacific and the Atlantic; Indian Ocean, Mediterranean and South China Sea (AIMS), that face “specific social, economic and environmental vulnerabilities” (United Nations-OHRLLS 2011, 1). These islands have particular challenges with regard to their socio-economic development due: to their small size—they cannot compete because of economies of scale; their remoteness—making communication and infrastructural development expensive; to being highly prone to natural disasters; and being highly vulnerable to external political and economic forces beyond their control (Briguglio 1995). However, they do offer some advantages, whereby their small size allows for some faster inland infrastructural development. These singular contexts have not been researched and very little is known on the issue of Digital Inequality in such milieus.

Therefore, this research sets out to bridge the gap in the literature by exploring the case of Mauritius—a Small Island Developing State off the east coast of Africa. The case of Mauritius is justified because it provides a unique and interesting setting for two reasons. Firstly, it is an African country and is, thus, subjected to the same economic and infrastructural incentives and aids provided to African countries for development. Secondly, Mauritius is a small island and albeit not having the same geographical limitations of mainland African countries, it does share some of the challenges and characteristics of Small Island Developing States (SIDS). Moreover, since the early 2000’s, the country has positioned itself to make ICT and ICT-related services a major pillar of its economy (PWC 2007)—as discussed further in Chapter 3.

1.2.4. Multi-Stakeholder Perspective

Digital Divide and Digital Inequality are complex multi-factorial issues, with deep roots in different domains of the society and the issue is further

compounded by the many and sometimes opposing parties having somehow divergent interests. Most research carried out on Digital Inequality investigated mainly the user perspective or the policy perspective. There are limitations in looking at a particular issue from a single sided view, especially from users when they do not have control over the infrastructure, the cost and the services available to them. Conversely, from a government or an ISP perspective, the argument is to strike the right balance between investment, return and the benefits to the nation, and not necessarily in the best interest of individual users or organisations. It is believed that to get a clearer and more holistic understanding of the Digital Inequality issue, it is important to understand the phenomena from each of the various stakeholders' angle. This research, therefore, proposes to identify the main stakeholders of the Internet ecosystem in Mauritius and to investigate their views on the issue of Digital Divide and Digital Inequality. These stakeholders would be primarily the users, the government, Internet Service Providers and civil society organisations that have a stake and are working towards the development of the Internet.

1.3. Objectives

This research brings together the four notions outlined thus far. First, the Digital Divide as a premise to investigate and understand the current situation with regard to Internet penetration and evolution. Second, Digital Inequality as the central contemporary issue to investigate its manifestations and the underlying forces affecting the socio-economic development of a nation. Third, the setting of a Small Island Developing State where there are still unanswered questions as to the evolution of Digital Divide, the determinants of Digital Inequality in such developing country settings and the impact of stakeholders on the issue. Lastly, a multi-stakeholder perspective on the matter rather than a single-sided focus. The aim of this study is to research and investigate the issue of Digital Inequality in a developing country like Mauritius. This will be achieved through the following four objectives:

1. To develop a clear understanding of the term Digital Inequality.

The rationale is to bring together the different definitions and perspectives of the concept of Digital Inequality to provide a theoretical basis upon which to build the research. One of the problems of Digital Inequality is the nonexistence of a single universal definition of the term. Moreover, the Digital Divide is inalienable to the Digital Inequality issue and, therefore, this objective attempts at reconciling these two terms and laying the theoretical basis to support the research.

2. To investigate the diffusion of Internet among the Mauritian population since its mainstream dissemination and to explore the current state of affairs.

The issues of Digital Divide and Digital Inequality are interrelated, and to better understand the ramifications of Digital Inequality, it is important to have a deep understanding of the Digital Divide in the society under investigation. Subsequently, one of the objectives is to review the diffusion and the evolution of the Internet in Mauritius and explore further the situation with regard to some of the fundamental aspects of Internet penetration.

However, it is to be noted that, in general, research in Digital Divide (OII, Pew and World Internet Project) undertakes further investigations on the underlying issues and reasons of non-adoption of the technology by the population. Although, it is understandable that similar recourse would have been beneficial in understanding the issue further, there has been a deliberate and pragmatic choice to avoid such investigation mainly to keep this project within the Digital Inequality focus and more manageable. Instead, the discussion surrounding Digital Divide will be based mainly on a review of existing literature, namely publicly available reports from the Mauritian Government (Statistics Mauritius, National Computer Board, ICTA) and International Organisations (ITU, World Economic Forum, World Bank).

3. To identify the main causes and determinants of Digital Inequality in the Mauritian society.

Through the use of quantitative methods, this study explores the issue of Digital Inequality from a user perspective. The study investigates the existence of Digital Inequality in Mauritius and identifies the socio-demographic determinants of such inequality.

4. To situate governmental and non-governmental initiatives in relation to Digital Inequality on the island.

To get a holistic view on Digital Inequality, the study uses qualitative methods to investigate other stakeholders' view on the issue. This study, therefore, attempts at understanding Digital Inequality from the perspective of the government, ISP's and civil society organisations.

1.4. Significance

In line with the gap in the literature, the research objectives and the methodology chosen, the significance of this study is threefold. Firstly, from a theoretical standpoint, the research will not only add to the growing literature on Digital Divide and Digital Inequality but will more specifically address the need for a different perspective on the issue—that of a SIDS context. The notion of Digital Inequality is very much westernised, and although there is some research on the Asian continent, there is almost no such research to date on African or Small Island Developing States. This study will, in so doing, lay the foundation upon which to build future studies such as comparative studies between different contexts, and deepen the understanding of the Digital Inequality phenomenon. As Dutton (2013) claims, we are only at the dawn of Internet studies research and the scope of such research is vast.

Secondly, from a practical and policy standpoint, this research will be significant primarily to stakeholders of the Mauritian ecosystem. The research aims at bringing together existing data to provide a comprehensive

narrative of the evolution and development of the Internet on the island. This study will also help understand the determinants of Digital Inequality in Mauritius. This will be a significant development in understanding the Internet landscape of the island and serve as a primary tool for policy makers and other stakeholders, such as, potential investors, ISP and civil society organisations. It is expected that the results of the study will offer governmental bodies better insight to setup or re-align strategies for the development of Internet in Mauritius. By extrapolation, the study will also enable other developing nations, in particular Small Island Developing States or any other country sharing some commonalities with the island, to learn from the Internet development and underlying forces of Digital Inequality in order to better steer their development initiatives.

Thirdly, this research will add to the existing literature on Digital Inequality and will address the lack of such research in developing nations, especially Sub-Saharan African countries and Small Island Developing States. Both the theoretical and policy findings will consolidate and improve the existing thin literature in SIDS, but also lay the foundation for further work in the field.

1.5. Structure of the Thesis

This thesis is organised into eight chapters as follows, each aimed at providing an in-depth insight into the phases of the study. The following outlines each of the chapters.

Chapter 1, Introduction, sets out the scene of the study and starts by situating the research in relation to the utopian discourse of the Internet. It looks at the current situation regarding the development of the Internet in societies, with a particular emphasis on developing economies.

Subsequently, the introduction discusses the four guiding themes of this research: Digital Divide; Digital Inequality; Small Island Developing States; and multi-stakeholder perspective before outlining the research objectives. The introduction closes by discussing the significance of the research and the structure of the thesis.

Chapter 2, Theories of Digital Divide and Digital Inequality, is a literature review of the theories surrounding these two phenomena. The aim of the chapter is twofold: firstly, to situate the relevant issues within the broad area of research, and secondly, to provide a working definition of the two phenomena discussed in this thesis. As such, the section on Digital Divide reviews the evolution of the phenomenon over time before providing a working definition for this study. The criticisms surrounding the topic will also be discussed, thereby providing the rationale for a shift towards Digital Inequality. Similarly, the section on Digital Inequality attempts at providing a working definition of the term before reviewing the relevant models developed so far. It further evaluates and justifies the chosen model for this research.

Chapter 3, Mauritius and the Internet, firstly provides the background of the research context. Reviewing existing literature, it provides an overview of the socio-economic development of the island since the first settlement and, and its economic ambition. Secondly, the chapter investigates the evolution of the Internet in Mauritius from its first commercial launch in 1997 to provide an understanding of the evolution of Digital Divide in this particular context.

Chapter 4, Methodology, outlines the methodology used to approach this research. After describing and justifying the use of Mixed Method approach, the chapter focuses on the quantitative and qualitative methods used. From a quantitative methods angle, a section is devoted to explaining and describing the utilisation of an online survey to gather data on Internet use amongst the Mauritian population. Furthermore, the section on quantitative methods describes the process of questionnaire design, pre-testing and distribution, before detailing the results of the reliability and validity tests carried out on the survey responses. As for the qualitative methods used, Chapter 4 outlines the rationale behind the selection of the interviewees, before explaining the interview process and the techniques used for analysing the data gathered. Finally, the chapter discusses the ethical consideration and the data storage requirements for conducting this research.

Chapter 5, Quantitative Findings, details the results of the survey carried out by the Mauritian Internet users. The first part of the chapter, using tables and figures, presents the descriptive statistics of the responses, including the demographics distribution of the respondents as well as the frequencies of the answers around the five dimensions of Digital Inequality. The second part of the chapter provides the results of the inferential analysis carried out on the answers to determine the differences, if any, within the various groups of users, and also conducts an exploratory factor analysis and regression analysis to understand the underlying forces driving Digital Inequality in Mauritius.

Building on the results presented in the previous chapter, Chapter 6, Quantitative Discussion, discusses the major findings of the survey with respect to Digital Inequality. Starting with a discussion on the demographic distribution obtained from the survey, the chapter looks into each of the five dimensions of Digital Inequality and discusses the findings with regard to the differences within each of the groups (demographics) of Internet users. The chapter also discusses the results of the inferential analysis and its impact on understanding Digital Inequality in Mauritius.

Chapter 7, Qualitative Discussion, presents and discusses the findings of the interviews conducted with key stakeholders of the Mauritian Internet ecosystem. The chapter is structured around the three categories of stakeholders and looks into each stakeholder's perception of the issues of Digital Divide and Digital Inequality. Thereafter, the chapter undertakes a cross-stakeholder analysis and unveils the similarities and differences in the stakeholder's perception of Digital Divide and Digital Inequality. This is particularly relevant to the discussion as it provides the perceptions of the policy makers and civil society on the issues and their strategies.

Chapter 8, Conclusion, presents a summary of the key findings in line with the questions set in this research. It also discusses the limitations of the study from a theoretical, methodological and analytical angle. Lastly, it discusses future research that can unfold from the bases laid out in this research project.

Chapter 2: Theories of Digital Divide and Digital Inequality

2.1. Introduction

This chapter aims at providing an understanding of the Digital Divide and Digital Inequality phenomena by reviewing relevant research carried out on the respective topics over the years. The first section, Digital Divide, focuses on the historical perspective of the issue, allowing for the formulation of a working definition of the term used throughout this thesis. It will also briefly discuss the measurement of the Digital Divide and the current state of affairs before considering the criticism surrounding such endeavour, leading to the formulation of the Digital Inequality paradigm.

The subsequent section, Digital Inequality, starts by situating the birth of the term amidst the debate and criticism of the Digital Divide, and further justifies the importance and relevance of investigating Digital Inequality. Likewise, the section on Digital Inequality reviews the different authors' perspectives on the issue and undertakes the formulation of a working definition of the term. This section further highlights the various models of Digital Inequality before justifying the use of DiMaggio and Hargittai's (2001) model as best suited for this study. Lastly, the chapter outlines the determinants of Digital Inequality in various studies and the need to explore this issue further.

This chapter should, thus, enable a clearer understanding of the two phenomena and additionally provide the theoretical framework to justify and support this research. It will also provide the working definition of key terms used throughout this thesis.

2.2. Digital Divide

2.2.1. Digital Divide—a Historical Perspective

Since its inception, the term Digital Divide has been used to define, broadly, the antipodes of technology adoption in societies, and more recently that of

the Internet. Over the last two decades, scholars, politicians and institutions have been debating the notion of Digital Divide with the aim to (or "intending to") understand, measure and solve the issue albeit with different and somehow divergent perspectives at times. So much so that van Dijk (2006, 222) states, "the term digital divide has caused probably more confusion than clarification."

Even the origin of the term is highly debated (Gunkel 2003) and its exact source is hard to pinpoint. Larry Irving, Assistant Secretary of the Department of Commerce for the Clinton Administration, is often cited as being among the first to coin the term (Cilan, Bolat, and Coşkun 2009). Conversely, Warschauer (2010b, 2) attributes the first usage of the term in 1995 and 1996 to New York Times journalist Gary Andrew Poole, noting that the term was then taken up by Al Gore and Bill Clinton in a speech in Tennessee in 1996. However, it is commonly accepted that it is the US National Telecommunication and Information Administration (NTIA) that was the first to formalise the term.

Indeed, since 1995, the NTIA has been gathering data on telephone and computer usage in the United States, focusing mainly on the disparity between those who had access to the services (the "haves") and those who did not (the "have-nots") (NTIA 1995). It is only in 1998 that an update of the original report explicitly mentioned the term 'Digital Divide', yet without providing a precise definition. It states, "in fact, the 'digital divide' between certain groups of Americans has increased between 1994 and 1997 so that there is now an even greater disparity in penetration levels among some groups" (NTIA 1998, para. 7). In spite of the debate over the origins of the term, it is clear that it is from 1995 onwards that the term has gained in popularity in the spheres of academia and policy makers.

2.2.2. Defining the Digital Divide

Similarly, a single universal definition of the term is hard to pinpoint. With the evolution of research in technology and society, it became apparent that with

the lack of a proper standardised definition, different authors would have different meanings for the term. Bornman (2015, 267) acknowledges that Digital Divide is a polysemous term. Undeniably, this lack of one definition for all resulted in further confusion around the term, whereby various scholars, institutions and governments have each attempted to define the term based on their own perspective.

At the grass-roots level, it is agreed that when referring to a 'divide', reference is made to a gap or the inequalities between two things (Warschauer 2010). However, in the case of Digital Divide, there has been few or almost no consensus as to what differences or dichotomies are taken as the basis for defining the Digital Divide. Gunkel (2003) gives compelling evidence that the term has been used to describe almost any gap in technology; from Al Gore's educational gap to Steward's more technical use of the term to describe the difference between Time Division Multiple Access (TDMA) and Code Division Multiple Access (CDMA).

Nonetheless, it is clear that the definition used by the NTIA in 1999 refers to the gap in user access to the technology. As such, the NTIA (1999, pt. I), in its 'Falling through the net II' report, states that "the data reveal that the digital divide—the disparities in access to telephones, personal computers (PCs), and the Internet across certain demographic groups—still exists and, in many cases, has widened significantly".

Since the primary focus of the NTIA at that time was on gathering data on the rate of telephone uptake by the population, 'access' evidently meant ownership of the devices used to access the Internet. Consequently, the early definition of the Digital Divide would focus on the ownership of the technologies to access the Internet. As mentioned by DiMaggio et al. (2004, 8) "the view of the 'Digital Divide' as a gap between people with and without Internet access was natural at the onset of diffusion...". Such representation is also greatly due to the NTIA's policy of ensuring full penetration of technologies in American households (DiMaggio et al. 2004).

As the Internet became ubiquitous, people started to have access to the Internet at various locations such as schools, work or public areas, and the meaning of access, as in ownership, no more held the line (Harambam, Aupers, and Houtman 2012). Building on the NTIA's definition, the Organisation for Economic Co-operation and Development (OECD) went further and defined the Digital Divide as being

the gap between individuals, households, businesses and geographic areas at different socio-economic levels with regard to both to their opportunities to access information and communication technologies (ICTs) and to their use of the Internet for a wide variety of activities. (OECD 2001, 6)

The OECD, thus, shifted the focus from a mere technological ownership dichotomy to encompass the 'usage' aspect of the divide. Various authors (Ono 2005; Sparks 2013; Balaban, Cilan, and Kaba 2010; Grazzi and Vergara 2008; M. R. Hanafizadeh, Saghaei, and Hanafizadeh 2009; Cuervo and Menendez 2005; Husing and Selhofer 2004) and institutions (ITU 2010b) alike have adopted the OECD's definition when referring to the Digital Divide. The definition proposed by the OECD brings together some of the key elements of Internet access. It encompasses a wider scope of disparities, both at the individual level and global level; at various socio-economic levels—i.e. the difference between the rich and the poor; and moves beyond ownership to adopt opportunities to access and use. On a global scale, Norris (2000; 2001) drew attention to a cross-national Digital Divide and the resulting growing disparities between rich countries and poorer ones.

The definition of the term is perpetually evolving, and although it is hard to pinpoint a specific definition, it is clear that today the Digital Divide refers primarily to the gap in 'access' and 'use' of the technology and, in particular, the Internet. Although some of the definitions brought forward are more complex and encompass many factors, this research uses a rather simplistic definition of the Digital Divide, that is, the difference between those who have access to the technology and those who do not. The rationale behind such conscious simplistic move is to enable a distinct identification and to better

situate each phenomenon in relation to the other. With the evolution of the Internet and the progress in Digital Divide understanding, there is an increasingly nuanced and blurred intersection between these two concepts. Since the scope of this study is to explore Digital Inequality, it was natural to provide a definition of Digital Divide that would allow for the exploration of Digital Inequality and not overshadow the latter.

2.2.3. The Evolution and Measurement of the Digital Divide

Pena-Lopez (2009, 32), in his thesis, pointed out that "the different approaches to model and measure the Information Society have determined what is meant by the concept of access to Information and Communication Technologies and digital development". He detailed and analysed no less than 55 models, each with a set of indicators that aim at measuring the Information Society. Although the accuracy and methodologies used in some models can be criticised, as discussed further in the next section, Pena-Lopez (2009, 299) recognised that each of the metrics served "specific purposes and, quite often, serve this purposes quite well". Consequently, the measurements provide insightful observations on the development of Internet over the years.

The ITU, amongst others, developed indicators for measuring the state and progress of the development of Internet globally. As the Internet evolved, the indicators used to measure the information societies also changed to adapt to the new perspective. The ITU used the ICT Diffusion Index until 2006. After this time, the ITU developed the Digital Opportunity Index (DOI) (ITU 2005b) for three years between 2004 and 2006. The focus of the Digital Opportunity Index (DOI) relied mainly on three clusters of variables: opportunity; infrastructure; and use (James 2007). Later, the ITU would adopt the ICT Development Index (IDI).

The latest statistics from the ITU (2015a) show that Internet connectivity has been on a constant rise over the last fourteen years, with roughly 43.4% of the world's population using the Internet in 2015, as shown Figure 2.1.

However, there is a stark contrast with regard to the spread between developed and developing countries, with the rate of Internet penetration in developed countries reaching an estimated 82.2% in 2015 while that in developing countries was only at 35.3%. These figures show clearly the deep schism between developed and developing countries. More importantly, the numbers show that over the last years, the gap has remained more or less constant, suggesting that although connectivity is on the rise, the Digital Divide is more than ever present.

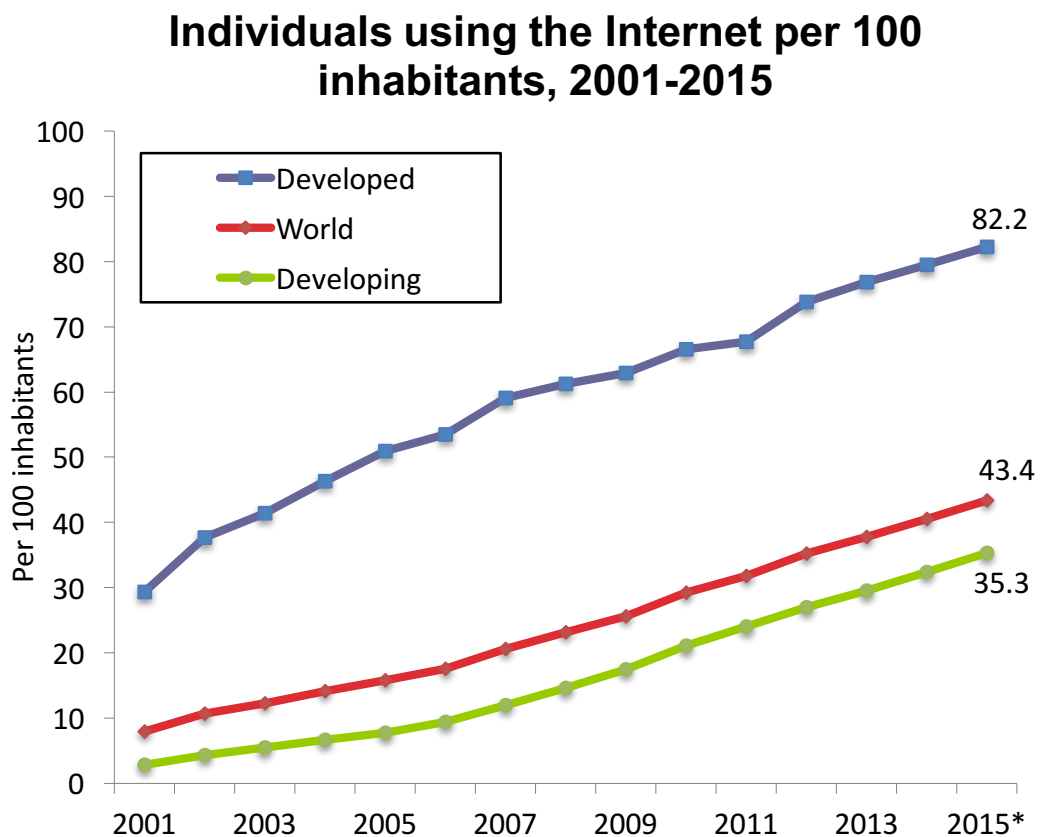

Figure 2.1: Individuals Using the Internet per 100 Inhabitants Worldwide (Source: ITU 2015a)

This analysis is supported by the ITU's (2015b) Measuring the Information Society Report 2015, which uses the ICT development Index (IDI) to measure ICT and particularly Internet development worldwide. The report suggests that all countries have progressed and have higher IDI scores in 2015 than in previous years. Nonetheless, the report also comments "that there continues to be great differences in the levels of ICT development

between countries and regions around the world" (ITU 2015b). The IDI uses 11 indicators divided into three sub-indices, namely ICT Access (5 indices) weighting 40%, ICT Use (3 indices) weighting 40% and ICT Skill (3 indices) weighting 20%.

Although the IDI provides a rather general view of the development of Internet at a global level, Bruno et al. (2011, 13), assessing the indices used in the IDI and the ICT-OI, warn that "both indexes are strongly correlated with gross domestic product", whereby countries with lower GDP are at the bottom of the ranking and vice versa. They further argue that the approach of the measurements are highly "reductionistic" and overemphasised technological access and use, to the detriment of other "socio-economic, political, cultural and social factors"(Bruno et al. 2011, 27).

2.2.4. Criticism of the Digital Divide Approach and Measurements

Barzilai-Nahon (2006) argues that determining the degree of connectivity of a country just by measuring access and infrastructure is too simplistic because there are other factors influencing the adoption of Internet by a particular population. James (2007), Bucy (1999), Bruno et al. (2011), van Dijk (2006), Mossberger, Tolbert, and Stansbury (2003), Barzilai-Nahon (2006), amongst others, also dispute the effectiveness and efficiency of the measurement of the Digital Divide and the picture it gives of ICT, more specifically Internet take-up and use by nations.

Mossberger, Tolbert, and Stansbury (2003), criticising the actual digital divide concept, advocate a more holistic approach and suggest that the issue should be seen not only as an access divide but as an aggregation of four different divides: the access divide; the skills divide; the economic opportunity divide; and the democratic divide. This approach recognises the importance of the skills users need, as well as the economic opportunity that needs to be set up for the population to take full advantage of the technology. The researchers further add the democratic issue of information access in a world profoundly marked by censorship.

Along the same line of thought, DiMaggio and Hargittai (2001) argue that the drive to bridge the Digital Divide has created in its passage another form of inequality, not in access but in the use and benefit people make of the technologies, which would turn out to be the founding stone of the concept of Digital Inequality. It is important to state that proponents of the Digital Inequality do acknowledge the importance and ramifications of the Digital Divide issue (DiMaggio and Hargittai 2001); they salute the continuous effort made to provide access to technology, but argue that solving the access problem only does not bring about the expected result. It is time to move forward and cater for the divide-cum-inequality that is building up within the technology user community and impeding the socio-economic development of individuals and nations alike. Katz and Gonzales (2016, 238) argue that DiMaggio and Hargittai “were among the first to suggest that the ‘digital divide’ was not binary, but rather consisted of multiple dimensions of inequality related to technical concerns, autonomous use, range of uses, support networks, and personal skills”.

2.3. Digital Inequality

2.3.1. Defining Digital Inequality

Since the Digital Inequality and the Digital Divide phenomenon are closely connected, with both looking at the use of Internet, it was almost natural that the earliest definition of Digital Inequality be strongly related to the Digital Divide issue. As such, DiMaggio and Hargittai (2001, 2) define Digital Inequality more as a comparison to Digital Divide and commented that, whereas the Digital Divide focuses on the “difference between those who have and those who do not have access to the Internet”, the Digital Inequality refers “not just to differences in access but also to inequality among persons with formal access to the Internet”. Ono and Zavodny (2007, 1136) also adopted this definition of Digital Inequality and further added that these differences “persists both across countries and across certain socio-economic and demographic groups within countries.”

While there are some differences in the form of the above definitions, there are nonetheless two central themes in the definition of Digital Inequality. Firstly, the shift from the dichotomous and quantitative aspects of access (Digital Divide) to a more qualitative nature (differences in access or the types of access as discussed further). Secondly, more emphasis on the uses people make of the Internet (Internet users) and as such, by proxy, the benefits they derive from it. The following section looks at these two themes more closely.

2.3.1.1. Defining Access

DiMaggio and Hargittai (2001) warn that the use of the word 'access' in relation to both the Digital Divide and Digital Inequality phenomena has caused confusion and it is imperative to understand and clarify its meaning before embarking on any discussion on access. They argue that the word 'access' is used by some authors to define the physical access to the technology, whereas others use it to describe the utilisation of the technology (DiMaggio and Hargittai 2001). Such ambiguity can lead to confusion in the Digital Inequality discourse as 'access to technology', denoting the physical access to technology, is different to 'access to technology' which implies the utilisation of the technology. The authors support this claim by quoting research by the National Telecommunication and Information Administration (NTIA) demonstrating that people having physical access to the technology do not necessarily use the technology (NTIA 1998). It is, therefore, imperative to define such term before embarking on any discussion of such issues. This thesis uses the term access to describe the physical technology used to obtain access to the Internet (the computer/mobile technology used and also the type of connection—broadband or dial-up).

2.3.1.2. Defining Use

If the Digital Inequality issue deals mainly with differences in how people use the Internet, it is crucial to investigate the variants in the use people make out of the Internet. It is clear that "the uses of ICT can differ considerably with

divergent outcomes for one's life chances" (Hargittai 2008a, 939). It is also important to note that people do not use technology in isolation but rather in a complex societal structure, and such use is highly affected by the surrounding environment. According to Hargittai (2008a, 940) the Internet brings out the following benefits:

i) Human Capital: the capacity of the Internet to bring about personal effectiveness and efficiency through the vast amount of material online.

ii) Financial Capital: the capacity of the Internet to increase the financial capital of the user, either directly or indirectly, for example, through new strategies of job search online.

iii) Social Capital: the bonding nature of the Internet, and the tools available that allow the user to expand his/her social potential. Online communities are growing and the Internet's ability to increase one's social capital cannot be ignored.

iv) Cultural Capital: refers to Bourdieu's (1986/ 2002) three forms of cultural capital, namely the embodied state, the objectified state and the institutionalised state (discussed further in Section 2.3.2.1). For example, Hargittai (2008a, 940) argues that it "is no longer necessary to go see a museum's exhibition on display since many galleries now put their pieces online", thus 'benefiting' from a cultural capital standpoint.

2.3.2. Models of Digital Inequality

In so far as Digital Inequality is concerned, this thesis outlined some of the complexities in getting a universally accepted definition of the term. Likewise, over the years, several scholars have brought forward models and frameworks based on different contexts and perspectives on the issue of Digital Inequality. However, although from different angles, two main overarching approaches emerged from the literature on Digital Inequality, namely the Bourdieuan (sometimes referred to a Bourdieusian) approach and the DiMaggio and Hargittai's approach. Models from both approaches

have both strong roots in the intricate relationship between technology and society, and a strong focus on the Internet use and the derived benefits. They do, however, differ mainly in terms of the context, the aim, the methodology and the outcome. Models and frameworks in the Bourdieuan approach are, as the name suggests, deeply grounded in Bourdieu's social theories and tend to focus more on the higher societal and cultural issues. Although not to the opposite, the Hargittai and DiMaggio's approach is slightly different and tends to look at the issue of inequality more from a set of specific dimensions of inequality with the socio-economic factors impacting on those dimensions.

The following section reviews a sample of the most pertinent frameworks that have been proposed under each of these two umbrella approaches. The aim is to help deepen the understanding of this complex phenomenon before arguing that the most suitable framework to be used in this thesis is that of DiMaggio and Hargittai (2001).

2.3.2.1. Bourdieuan Approach to Digital Inequality

Santoro (2011) argues that there are

many good reasons to consider Bourdieu's conceptual framework [as] one of the most insightful and strategically useful we have today for doing sociology, especially a sociology attuned to actors, their relations, institutional grounds, space and historicity, a framework theoretically dense but empirically-grounded. (p12)

Bourdieu's work on 'the forms of capital' has been highly instrumental in providing a new paradigm (other than the economic) for understanding the intricacies that "account for the structure and functioning of the social world (Bourdieu 1986, 46). Brock, Kvasny and Hales (2010, 1041) explain that for Bourdieu, "capital refers to the skills, abilities, and resources that allow an individual or group to wield influence and power over what is at stake in a given social arena...". As such, Bourdieu (1986) contends that

capital can present itself in three fundamental guises: as *economic capital*, which is immediately and directly convertible into money and

may be institutionalised in the form of property rights; as *cultural capital*, which is convertible, on certain conditions, into economic capital and may be institutionalised in the form of educational qualifications; and as *social capital*, made up of social obligations ('connections'), which is convertible, in certain conditions, into economic capital and may be institutionalised in the form of a title of mobility. (p47)

The concepts of cultural capital and social capital are extensively used in Digital Inequality literature. Bourdieu's concepts offered a suitable framework to investigate and understand issues of Internet use, especially in societies facing inequality challenges towards technology, and where the economic aspect does not suffice to explain the differences. In this respect, Witte and Mannon (2010, 61) argue that Bourdieu's work is "particularly significant because of the emphasis he gave to the concept of cultural capital" and further add, by quoting Bourdieu (1986), that "it is through the unequal distribution of cultural capital that the unequal scholastic achievements of children originating from the different social classes may be explained". This is perhaps the main reason that has pushed scholars to use Bourdieu in understanding and explaining some of the differences and inequalities that individuals are subjected to in the Digital Inequality domain.

For Bourdieu (1986),

cultural capital exists in three forms: the embodied state, in the form of long-lasting dispositions of the mind and body; in the objectified state, in the form of cultural goods (pictures, books, dictionaries, instruments, machines, etc.) ...; and in the institutionalised state, a form of objectification which must be set apart because, ..., it confers entirely original properties on the cultural capital which it is presumed to guarantee. (p47)

Brock, Kvasny and Hales (2010, 1042) explain that the embodied cultural capital "presupposes a process of accumulation through labour of inculcation and assimilation capable of securing a return on that investment". For example, skill is something that cannot be acquired, other than through a personal investment, in time and effort, and once acquired forms an integral part of the person (body). Brock, Kvasny and Hales (2010, 1042) further

explain that the institutionalised cultural capital “provides a certification of cultural competence that confers to its holder a legally recognised and guaranteed value”. For example, academic qualifications, which, depending on the scarcity, confer to the holder some “material and symbolic” profits. The objectified cultural capital relates to the objects owned by the agent and although the objects can be transferred from one agent to another through economic capital, it requires the agent to have the necessary embodied cultural capital to “appropriate [the objects] and use them in accordance with their specific purpose” (Bourdieu 1986, 50). For example, an object—a computer—can be acquired or transferred but requires the necessary skill to be used.

The concept of social and cultural capital offered a singular theoretical basis to explore differences in technology access and use. For example, in the early days of digital skills research, van Dijk and Hacker (2000), commenting on the need for individuals to have the right skills to harness the power of technology, argue that people will need the social and cultural capital, as outlined by Bourdieu, to select and process the information. They further argue that “the importance of cultural capital for the ability to extract relevant information from innumerable sources is even stronger in the network society” and a lack of such capital can result to exclusion within the network society. Bourdieu’s theory is deeply entrenched in van Dijk’s works (van Deursen and van Dijk 2008; van Dijk and Hacker 2000), especially in understanding digital skills within a network society.

Another Bourdieuan concept in Digital Inequality literature is that of ‘habitus’. Meyen et al. (2010, 874) argue that the habitus “as a system of predispositions, a matrix of schemes, judgements and behaviours, is not innate but is constructed upon an individual’s life experiences [which] in turn depend primarily on social position and lead to systems of permanent positions”. North, Snyder and Bulfin (2008, 898–99) argue that habitus “is formed from people’s personal history in relation to the social, cultural and political structures they are caught up in”. They further add that “new experiences, objects, actions and accomplishments are accepted as valuable

or rejected depending on how well they fit with already existing thoughts and processes incorporated in the habitus” (North, Snyder, and Bulfin 2008, 898–99). Technology use cannot be alienated with the environment or habitus in which it is used and researchers have been using Bourdieu’s notion of habitus to explore the relationship between the user and the environment. For example, Iske et al. (2008), investigating Internet usage among the youth in education, use Bourdieu’s notion of habitus to explain how the difference in usage and the resulting inequalities are milieu-specific. Similarly, North, Snyder and Bulfin (2008), also investigating differences in use among young adults, use the same notion of habitus and capitals to explain the relationship between technology use and social class.

In Digital Inequality studies, another work deeply rooted in Bourdieu’s theories is that of Robinson (2009) on the effects of Digital Inequality on disadvantaged American youths. Robinson uses the notion of *skholé* and habitus of Bourdieu to explain the differences between “playful or exploratory stance” adopted by those with different types of Internet access (high quality versus low quality) (Robinson 2009, 1). Within the same area of research of the socio-economically disadvantaged, Hsieh, Rai and Keil (2010) use Bourdieu’s forms of capital and habitus to investigate the differences between socio-economically advantaged and socio-economically disadvantaged people in a small American city (27000 inhabitants). The main premise of their research is that Digital Inequality, “or unequal access to and use of information and communication technologies (ICT), is a severe problem preventing the [socio-economically disadvantaged] (SED) from participating in a digital society” (Hsieh, Rai, and Keil 2010, 1). They built a model around the social capital, cultural capital and habitus to demonstrate “key differences in the forms of capital for using ICT” between people from different socio-economic background.

Kvasny’s (2002) model is worth exploring deeper for it attempts at consolidating and perhaps providing the link between the Bourdieuan approach and that of DiMaggio and Hargittai (2001). The conceptual framework brought forward by Kvasny (Figure 2.2) is deeply rooted in

Bourdieu's theory of cultural and social reproduction. It is more centred on the role of the society in which the user evolves and examines "the role of technology, culture capital, social capital, economic capital, and institutions in shaping the emerging pattern of Digital Inequality that reflects disparities in the structure of access to and use of ICT" (Kvasny 2002, 1). In this framework, the cultural capital refers to the social background of the user and the fact that the Internet is bound to offer content to satisfy such background. The 'Social Capital' of the model refers to the benefits and support the user receives from their immediate social environment, which can be related to DiMaggio and Hargittai's social support dimension. The 'Economic Capital' refers to the economic opportunities and trade-offs of getting and using technology. 'Technical Means' refers to the connectivity and availability of the hardware, which is similar to DiMaggio and Hargittai's technical apparatus dimension of inequality. 'Institutional Reforms' refer to the impact, the effort and policy towards technology of the institutions to which the user belongs. Another particularity of this model is the time element, which Kvasny (2002) argues denotes the "persistence of the gap in access".

One of the fundamental assumptions of Kvasny (2002, 1804) is "that unequal access is rooted in historical, institutional, economic, cultural and social conditions that underline technology use and distribution as well as capital development". She thus uses Bourdieu's capital to explain the differences in technology use within a community technology initiative.

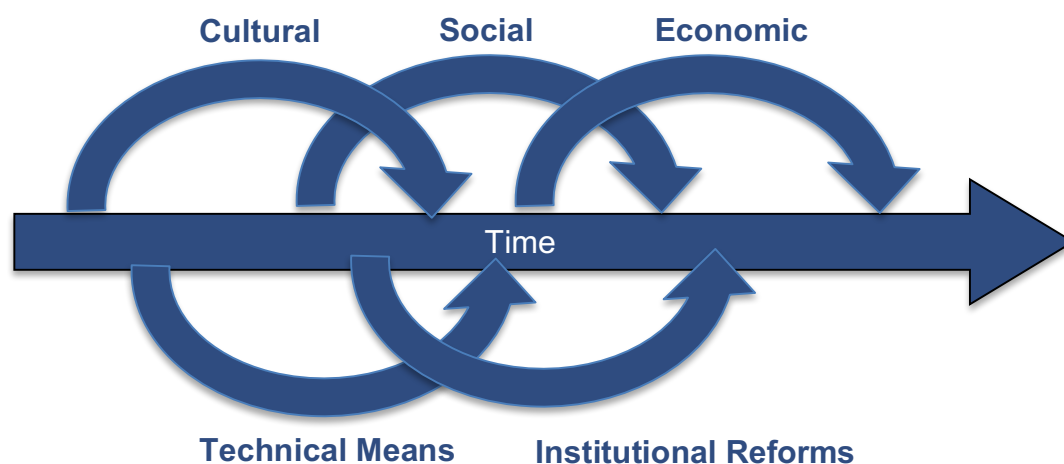

Figure 2.2: Kvasny's Conceptual Framework (Source: Kvasny 2002)

Schradie (2011, 148–149) summarises quite well the two main components of the Bourdieuan approach and states that within Digital Inequality research, “many of these studies on cultural factors build on a Bourdieuan analysis linking practices with class”. Specifically, she argues that the “mechanism for online activity is rooted in Bourdieu’s description of how one’s background affects one’s habitus, or disposition, in this case, toward digital technology”. Indeed, other than the works mentioned, most of the research in Digital Inequality falling under the Bourdieuan approach (Zillien and Hargittai 2009; Meyen et al. 2010; Gilbert 2010; Halford and Savage 2010; Sims 2013) tend to look at digital practices and Internet uses between different classes (socio-economic background).

2.3.2.2. DiMaggio and Hargittai’s Model of Digital Inequality

DiMaggio and Hargittai’s (2001) recognise to some extent Bourdieu’s theories but take a different and more nuanced approach to Digital Inequality, especially from an exploratory and broader context of the differences in access and use. They advocate five dimensions of Digital Inequality: inequality in technical apparatus—what are the means used to connect to the Internet; inequality in autonomy of use—can the users access the Internet by themselves, for themselves, without any monitoring or competition; inequality in skill—do the users have the required technical and non-technical skill to

use the Internet; inequality in social support—do new users get support from ‘older’ users to upgrade their use of the Internet; and inequality of use or purpose of use—what influences the reasons that make people go online (DiMaggio and Hargittai 2001). The following section, thus, attempts at providing a more detailed exploration of DiMaggio and Hargittai’s five dimensions of Digital Inequality.

2.3.2.2.1. Inequality in Technical Apparatus

Inequality in technical apparatus refers to the difference in the technology used to access the Internet (DiMaggio and Hargittai 2001). Inequality in access thus relates to the difference in the means and capacity in accessing the Internet. DiMaggio and Hargittai (2001) argue that the difference in the means and capacity of the technology will impact on the benefits users get out of the Internet but also on the use people make out of it. The type of access would seriously limit or increase significantly the use people make out of the Internet; for example, broadband access allows for a much more interactive and media rich content than a dial-up connection. Thus, a lower connection speed will affect the type of content that can be accessed, which in turn, will limit the benefits the user gets out of the Internet. Similarly, the device used impacts on the advantages users reap from the Internet.

2.3.2.2.2. Inequality in Autonomy of Use

The concept of autonomy of use relates to the freedom people get in their consumption of the Internet. As a matter of fact, DiMaggio and Hargittai (2001) argue that the fundamental question of ‘autonomy of use’ relates to where users access the Internet. The location of access will impact significantly on the freedom users get in accessing content. For example, using the Internet in a public library will or might be subjected to some restrictions (time, content). The same applies to using the Internet in the workplace where organisational policy might limit the content that can be accessed online. Interestingly, connecting to the Internet from home does not guarantee freedom of access outright. The authors quote Lessig (1999) who

argues that using the Internet at home does not automatically increase the autonomy of use since “freedom may be limited by the actions of other family members and the policies of the Internet Service Provider (ISP)” (DiMaggio and Hargittai 2001,9).

Although the location or point of access will significantly impact on the autonomy of use, another aspect worth investigating is the time factor. Freedom of use will be influenced largely by the amount of time available to spend online. Whether or not there is a competition for time online will impact on the use people make out of the Internet. Very often, there is an enormous demand for Internet use in public access points and users are constrained by the amount of time they can spend online, thereby limiting the benefits they get out of being online. In this regard, DiMaggio and Hargittai (2001,9) hypothesise that the “greater the autonomy, the greater the benefits” of being online.

2.3.2.2.3. Inequality in Skill

Inequality in skill is an important concept in the Digital Inequality discourse. van Deursen and van Dijk (2009) argue that once the barrier of access is crossed, skill becomes a dominant factor in Internet use. Stiakakis, Kariotellis, and Vlachopoulou (2010,48) add that the “Internet users differ regarding the level of their expertise, education, and technical skills”. The authors believe that there is a strong correlation between the knowledge and skill of using the Internet and the level of exploitation of the latter by users (Stiakakis, Kariotellis, and Vlachopoulou 2010). Clear distinctions need to be made between the skill required to operate the device (PC, mobile phone, tablet, etc.) and the skill needed to manipulate a web browser, search the information and ultimately being able to make sense and integrate the information (DiMaggio and Hargittai 2001). As such, van Deursen and van Dijk (2009) argue that there are four types of skills needed for efficient use of the Internet: ‘Operational Skill’, which refers to the skills required to operate the technology (both the hardware and the software) to use the Internet; ‘Formal Internet Skill’, which includes the notion of hypermedia and

navigation within and between websites; 'Information Internet Skill', where the user can recognise and locate information using search queries and evaluate the information retrieved; and 'Strategic Internet Skill', which according to van Dijk (2005), as quoted by the authors, refers to "the capacity to use computer and network sources as the means for particular goals and for the general purpose of improving one's position in society" (van Deursen and van Dijk 2009,94).

2.3.2.2.4. Inequality in the Availability of Social Support

DiMaggio and Hargittai (2001) hypothesise that the social support plays a significant role in getting the most of the Internet. Unfortunately, although some of the skills are self-taught at the beginning, as the users reach their skills limit, the benefits they reap from the Internet stagnate. They argue that the Internet is not static and its uses evolve, hence the importance of the social support from which the user can draw more technical knowledge from more experienced users to increase their skills. As the Internet penetrates deeper into the social spheres, users can become more isolated from such support. The lack of support needed to enhance their knowledge and skills can seriously limit the benefits they can get out of the Internet.

DiMaggio and Hargittai (2001) argue that there are three kinds of support. Firstly, 'Formal Technical Assistance', which relates to the assistance received from people specifically employed to provide such assistance in schools, public access points among others. Secondly, 'Technical Assistance' from friends and family members who are more knowledgeable than the users. Thirdly, 'Emotional Reinforcement' from friends and family on their success and failures or as a motivation to use the technology. Stiakakis, Kariotellis and Vlachopoulou (2010, 48) argue that "the people whose friends and families are more familiar with new technologies, are usually more motivated to adopt and use ICT's".

2.3.2.2.5. Inequality in Purpose of Use

Although it is not expected that everyone uses the Internet the same way, it is expected, according to DiMaggio and Hargittai (2001, 11), that its use will “empower citizens, build social capital and increase economic productivity”. The authors here make reference to Bourdieu’s forms of capital when mentioning social capital. They further argue that it is important to distinguish between different uses that “increase economic productivity... or political or social capital... and those that represent consumption of entertainment” (DiMaggio and Hargittai 2001, 11). They explain this distinction on the basis that “the Internet prophets who foresaw that the Web would empower citizens, increase social capital, and enhance equality of opportunity probably did not have gambling or pornography sites in mind when they made these predictions” (DiMaggio and Hargittai 2001, 11). The authors, thus, make clear distinctions between capital-increasing activities and entertainment, although it can be argued that entertainment, to some extent, could be a capital-increasing activity. As Warschauer (2003,44) points out, the key is to acknowledge that the Internet brings about “widely varying opportunities... and disparate reasons for wanting the level of access they may desire”. Alvarez (2003) joins DiMaggio and Hargittai in emphasising the human capital that Internet use should bring, and separates Internet use as either for human capital gain or recreational purposes. The argument then revolves around the inequality in the human capital gain when using the Internet. Both DiMaggio and Hargittai (2001) and Alvarez (2003) acknowledge the importance of delving in the determinants of this inequality.

2.3.2.3. Determinants of Digital Inequality

Grusky and Ku (2008, 3) argue that “describing the contours of inequality and explaining its causes, has come to be viewed as an increasingly important and central endeavour” in Social Inequality. Likewise, there has been much interest in the underlying causes or determinants of Digital Inequality (Liao et al. 2016; Gutierrez and Gamboa 2010; Močnik and Širec 2010; Al-Hammadany and Heshmati 2011; Beilock 2003; Ono and Zavodny 2007;

Hargittai and Hsieh 2013; ITU 2005a) and its dimensions. The context, as well as the historical perspective of Digital Inequality, have been leading researchers to investigate the causes in order to provide suitable frameworks or recommendations to policy makers with regard to the inequalities within the society.

Fuchs (2008, 45) argues that “during the past couple of years, more and more scholars have argued that the Digital Divide is not a technological issue, but a social problem and the consequence of underlying societal inequalities”. Although the terms of Digital Divide and Digital Inequality are very often used interchangeably in literature, Fuchs’ reasoning has been applied to the Digital Inequality issue in the sense that offline social inequalities are shown to impact on the online inequalities.

In the same vein, it was found that determinants of Digital Inequality are country specific, and the ICT maturity of the country plays a significant role in the types of inequalities (Ono 2005). Socio-demographic variables as determinants of Digital Inequality are further supported, amongst others, by Yang et al. (2010) in their research on Digital Inequality in South Korea.

All of the above studies point to different variables as determinants of inequality. Whereas in the USA, race is a major determinant of inequality (Zickuhr and Smith 2012a), Yang et al. (2010) find age and education as the primary determinants of inequality in South Korea. It is thus clear that regarding Digital Inequality, both the inequalities and the determinants of inequalities are context-specific and, more importantly, evolve with time.

2.3.2.4. A Case for DiMaggio and Hargittai

Deciding on a particular approach, and thereafter a particular model, can be a major conundrum in research. In Digital Inequality research, the plethora of models and perspectives offers a broad spectrum for inquiry and all are potential avenues to bring about new understanding on the matter. However, from the onset of this research it was clear that the DiMaggio and Hargittai’s model offered the most suitable theoretical framework to build upon. The

following uses the aim and the context of this research to explain the suitability of DiMaggio and Hargittai's model.

It is worth, at this point, to reiterate the research context. As discussed further in chapter 3, the research context is that of a small island developing state. The country is still struggling to bridge the Digital Divide but is well ranked among developing countries with regard to the ICT Development Index (IDI).

Most of the research under the Bourdieuan approach applied to small cities with a strong focus on socio-economically disadvantaged population. Although there is scope to bring some of these to a national level, the aim of this research did not allow for such models to be used. For example, one of the most suitable models under the Bourdieuan approach would have been that of Kvasny (2002) which offers a broad scope for understanding the multiple inequalities. However, one of the major weaknesses of Kvasny's (2002) model is the focus on underserved people. This study aims at exploring Digital Inequality in a broader context where no prior research has been undertaken to establish any categorisation or classification of people affected by technological inequalities. Another weakness that can be attributed to Kvasny's model is in the relatively complex dimensions that pose potential methodological implications when applied to a broader national context. For instance, the methods employed were highly ethnographic centred, where participants were sourced at community technology centres of a small town and this posed some serious impediments resource-wise for application at the national level within the scope of this study.

Additionally, Yang et al. (2010,145), comparing DiMaggio and Hargittai's framework, Kvasny's framework and Barzilai-Nahon's framework, argue that DiMaggio and Hargittai's framework is the "foundation for the other two models with high similarities as regards their explanation". DiMaggio and Hargittai's model provides a more constructive and holistic approach to understanding inequality and separate the factors that affect those dimensions as being determinants of inequality. For example, in the

DiMaggio and Hargittai model, socio-economic status and culture, in general, are considered as factors that influence or affect Digital Inequality rather than dimensions of Digital Inequality. Contrarily, Kvasny (2002) incorporates culture as a dimension in its own right rather than a factor that would affect or determine Digital Inequality. Although both are valid approaches, the DiMaggio and Hargittai model is more appropriate as a first incursion into the Digital Inequality realm in a specific context.

The exploratory nature of this research warrants a comprehensive model (Pena-Lopez 2009) that would allow for a holistic perspective of the issue at a broader national level. Alvarez (2003) argues that with the DiMaggio and Hargittai model,

the emphasis is making the causal mechanisms between technology and inequality clearer by analytically separating the dimensions along which differences may be found, while hypothesising on the relationship between the dimensions of difference, its effect on Internet use and then finally on how differential effects produce differential outcomes. (p110)

Consequently, DiMaggio and Hargittai's model offers an interesting approach to exploring Digital Inequality in Mauritius.

Moreover, DiMaggio and Hargittai's model has been used quite extensively in literature (Stiakakis, Kariotellis, and Vlachopoulou 2010; Vicente and Lopez 2010; Hargittai 2002b; Vehovar et al. 2006; Oyelaran-Oyeyinka and Lal 2005; Oyedemi 2011). For instance, Yang et al. (2010) used DiMaggio and Hargittai's model to investigate Digital Inequality in remote areas of South Korea, thereby broadening the context to bigger geographical areas. Oyedemi (2011) used the same model to investigate Internet penetration among university students in South Africa.

DiMaggio and Hargittai's model, thus, offers a solid theoretical framework to explore the existence of Digital Inequality in Small Island Developing States. The comprehensive nature of the model and the clear definition and separation between dimensions and causes make DiMaggio and Hargittai's model most suitable to explore Digital Inequality in this particular context.

2.3.3. Measuring Digital Inequality

Inequality research and measurement has for long been at the centre of geopolitical debates. Although mainly observed from an economic aspect, the issue of inequality has, at times, been used to assess, rank, categorise and sometimes discriminate nations and societies alike depending on the metrics used to measure and assess. Likewise, Cowell (1998,6) writing on the measurement of income inequality, argues that "inequality measurement [in general] is a subject where a lot of energy can be spent arguing about the meaning of terms".

In so far as research in Digital Inequality measurement is concerned, researchers agree on the core of the phenomenon (difference in ICT access and usage), but the issue of measurement is still highly dependent on the context and perspective. At times, depending on the framework, or lack thereof, used to investigate measurement, the results and methodology vary. Puckett (2010), quoting DiMaggio et al. (2004), argues that "measurement is the most difficult challenge..." and that this is further compounded by the fact that new "technology generates new forms of skill (making old ones obsolete)", thereby making the methodology obsolete altogether. Therefore, adding to the already existing difficulty in measuring inequality, Digital Inequality measurements are made even more difficult by the rapid change in technology and the associated device, skill, and purpose needed to take full advantage of Internet use. Having a one size fits all methodology or measuring instruments is, thus, exceedingly inappropriate. Nevertheless, the issues mentioned above in no way undermine the quest for understanding and measuring the Digital Inequality phenomenon. Throughout the past decade, several attempts (all fruitful and instructive in their own right) have been made to measure the impact and extent of Digital Inequality within and across societies.

Since various measuring instruments have been used in different contexts, it is important to examine some of the fundamental research that have been carried out on Digital Inequality measurement or research using specific metrics to explore and understand the phenomenon. The aim is to

understand the various methodological approaches that have been used to investigate Digital Inequality. This should allow to determine what lessons can be learned to inform the design of a suitable measuring instrument for examining such phenomenon as specified in this thesis. The following section, therefore, by canvassing the various literature, attempts at providing an insight on the varied and complex methods of measuring Digital Inequality.

2.3.3.1. Mossberger, Tolbert and Stansbury on Virtual Inequality

Mossberger, Tolber and Stansbury's (2003) book, *Virtual Inequality: Beyond the Digital Divide*, is quite pertinent in Digital Inequality literature from an empirical perspective. Although the authors do not mention Digital Inequality explicitly in their work, the central theme remains the need to move beyond the initial dichotomous view of the Digital Divide concept (haves v/s have-nots) to a more holistic approach to understanding Internet adoption and use. As such, they extend the simplistic view of access divide and advocate a model of Digital Divide that consists of four divides: access divide, dealing with the differences in access; skills divide; economic opportunity divide; and democratic divide (Mossberger, Tolbert, and Stansbury 2003). The research further investigates the implications of "gender, education, age, ethnicity and political affiliation" on these divides (Kvasny 2004, 409). Their research was carried out in the United States.

A nationwide survey was conducted on a random sample and a second sample was determined based on their poverty level. The aim was to use the general sample to validate the data on the high poverty level (Mossberger, Tolbert, and Stansbury 2003). The survey questions focused on access and use, as well as demographics of respondents. The results later allowed for multivariate regression analysis.

The results showed that although gender inequality is no longer a factor affecting the Digital Divide-cum-Digital Inequality, the four divides are strongly evident in the American society. Income, ethnicity and education

seemed to be the most salient causes of the gaps, with age also being a non-negligible factor. Another worthy finding from this research is that “underserved groups tend to hold the most positive attitudes and beliefs about the potential of information technology to improve their economic opportunities” (Kvasny 2004, 409).

Mossberger, Tolbert and Standbury’s research is instructive for two main reasons. Firstly, it suggests that the availability of nationwide data, together with a large sample, provided a far more accurate picture of the inequalities when compared to other research. Secondly, the quantitative methods employed in the form of a questionnaire provided insight into the use of such methods to research Digital Inequality.

2.3.3.2. Ono & Zavodny

The work of Ono and Zavodny is quite instructive in the sense that firstly, there is the acknowledgement of the Digital Inequality phenomenon and secondly, the research has been replicated at a later stage in different contexts. The initial research of Ono focused on a cross-country analysis of Digital Inequality. Although no reference is made to any framework, Ono (2005, 1137) argues and recognises the increasing importance of moving from the dichotomous view of technology access and move “beyond ... to examine patterns of IT use”. The aim of the research was to understand the magnitude and extent of Digital Inequality—defined as being the “difference in IT access and usage” (Ono 2005)—within and between three Asian countries (Japan, South Korea and Singapore). As per the definition given above, and in the absence of a particular framework, the author focused on access, usage and skills only.

The research used already existing data collected by the Cyber Life Observations (CLO) of the Nomura Research Institute in the form of a survey. It is worth noting that the same questionnaire was used in all three countries, thereby allowing for “consistent comparisons to be made across countries and over time” (Ono and Zavodny 2007, 1141). Proxies were used

during the data gathering; for example for access, the research used “PC ownership” and “PC use at home”. To measure use, data on Internet use at home and Internet use from any other location was gathered. The author further hypothesised that Digital Inequality “reflects pre-existing inequalities in other areas of the society” and as such, examined the likely impact of inequalities induced by socio-demographic variables such as gender, age, education and household income on the three selected countries (Ono and Zavodny 2007, 1152).

As postulated by the authors, the research proved the existence of Digital Inequality in the three countries, and as predicted, the determinants of such inequalities correlated highly with the pre-existing inequalities in those countries. However, what the results also showed was that the “magnitude” of the determinants were not the same in the three countries. For example, gender inequalities did not prove to be of concern in Singapore, but education and income had a more pronounced effect than in the other two countries.

The research was then replicated a couple of years later with the addition of US and Sweden in the picture (Ono and Zavodny 2007). The same survey was used to gather data over time, with the exception of Sweden, where data was available for one year only. Logistic regression analysis was carried in order to establish the differences across the five countries over time. The results were almost as predicted by the researchers in confirming that “access does not necessarily imply usage” (Ono and Zavodny 2007, 1146) and there is substantial evidence that “social and economic inequalities carry over to IT usage” (Ono and Zavodny 2007, 1452). The result obtained is quite instructive for the research proposed. The study confirmed that factors affecting Digital Inequality are country specific and that there “is a high correlation between Digital Inequality and pre-existing” social inequalities (Ono and Zavodny 2007, 1150).

The fundamental definition the authors gave to Digital Inequality determined the research direction. The authors did not focus on the type of the technology used (dial-up vs. broadband) nor the difference in the use as

such. They rather merely determined the inequality in terms of the number of people having access to a computer at home and the use of Internet at home. This was further articulated with the determinants of those inequalities. It is interesting to note that the two studies (Ono and Zavodny 2007; Ono 2005) used identical measuring instruments and found that over four years, the determinants of Digital Inequality have remained static and were deeply grounded in pre-existing socio-economic inequalities.

2.3.3.3. DiMaggio and Hargittai's Digital Inequality Framework

Although not extensive, a lot of the research on the existence and determinants of Digital Inequality have used DiMaggio and Hargittai's initial Digital Inequality framework as a foundation and built upon it or developed measurements for it. Yang et al. (2010) used this framework for understanding Digital Inequality between rural and urban areas of South Korea. Hargittai, contrarily, focused more on the skill factor among the five factors making up DiMaggio's and Hargittai's Inequality Framework.

2.3.3.4. Yang et al.

Yang et al. (2010, 144) posit that as "ICT evolves and spreads ..., the discussions regarding difference of access to ICT become less meaningful without significant new insights. As the phenomenon changes, the issues arising from it should also be refocused and restudied from different perspectives". Consequently, they set out to investigate the existence and determinants of Digital Inequality in South Korean rural areas.

After comparing various frameworks of Digital Inequality, including Kvasny's Digital Inequality framework (Kvasny 2002) and Barzilai-Nahon's view on a holistic approach to Digital Divide (Barzilai-Nahon 2006), Yang et al. (2010, 145) acknowledged the framework established by DiMaggio and Hargittai (2001) as being the most suitable framework for their research "because their model was the foundation for the other two models with high similarities as regards their explanation". They developed a research model (Figure 2.3)

that included both the five elements of the Digital Inequality framework as established by DiMaggio and Hargittai and selected determinants of those inequalities, which the authors argue, are mainly demographics.

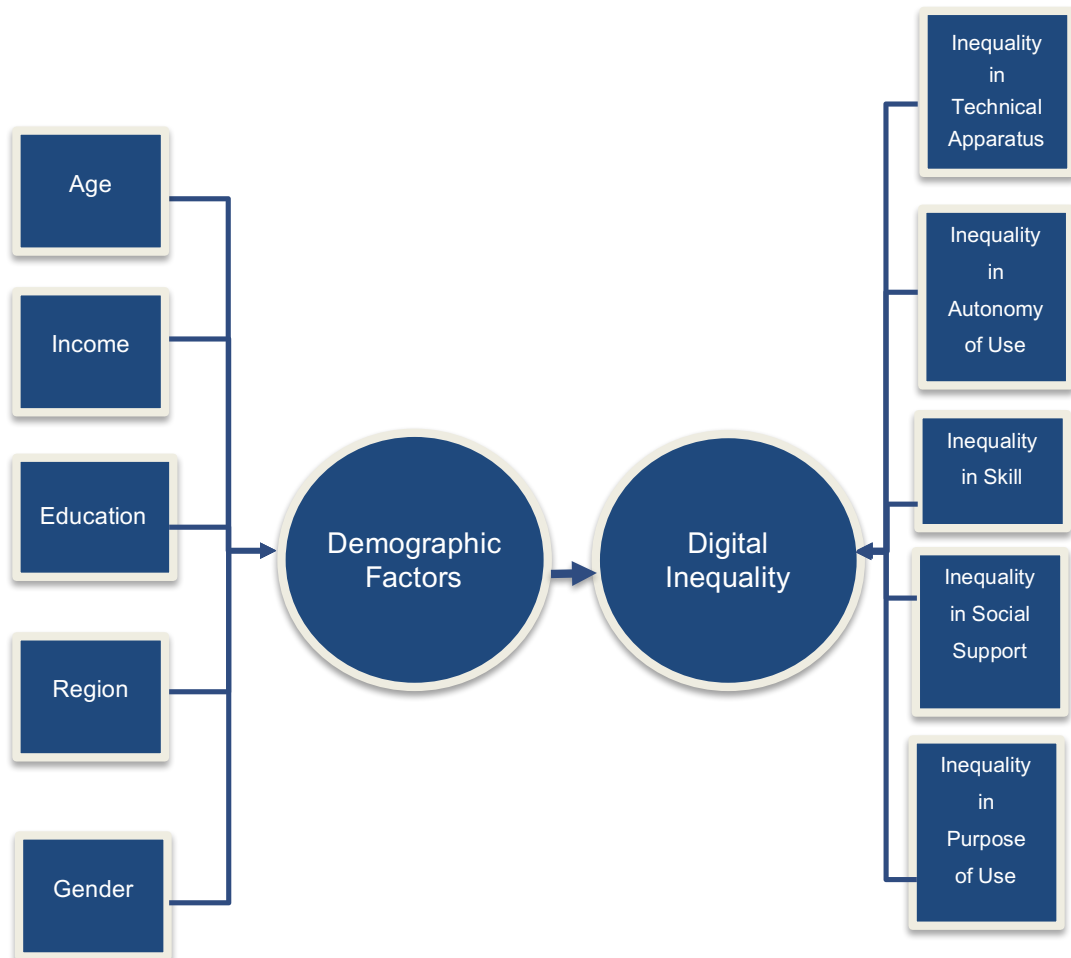

Figure 2.3: Determinants of Digital Inequality (Source: Yang et al. 2010)

The authors further argue that literature mentions race as a major determinant of Digital Inequality in societies in which such research was conducted. However, South Korea, being a mono-racial society, does not experience such an issue and therefore race does not need to be considered in such context. Subsequently, they set out to investigate the impact of age, income, education, region and gender on the five inequalities in the South Korean rural communities by generating hypotheses about the possible effects of each determinant on each inequality, thereby having five hypotheses to test for each inequality. A survey was carried out in selected

villages in the provinces of South Korea. A total of 75 villages were targeted, and five residents of each village were interviewed.

Apart from the descriptive analysis, *F*-Test was carried out to test the hypotheses mentioned above. The results showed that all of the five demographics factors identified influenced the patterns of Digital Inequality as a whole, but that different factors influenced each of the five dimensions of Digital Inequality. For example, inequality in technical apparatus was mainly determined by age and education, whereas inequality in skill was primarily determined by age, education and region. However, the factors that were constant across all dimensions of Digital Inequality were age and education. This new and more pertinent perspective on Digital Inequality allowed the authors to recommend sound policy and strategies on these two fronts to tackle the issue of Digital Inequality in rural South Korea.

Although the methodology used has not been dealt with in detail, the research is quite instructive in the sense that it did not measure actual inequality, but rather the perception users have of inequality. For example, the study asked users to give an estimate of their time spent online (perception) rather than measuring the actual time spent online. The research also uncovered some of the difficulties and shortcomings of using proxies for some variables. Some of the proxies assumed some technical knowledge from the users, which they may not have, for example, on the type of connection used or the speed of the connection. The issue is that such generic assumption can bring or exacerbate an element of bias in the research. However, it is also understood that in some cases, there is no better approach other than using proxies. Therefore, it is important to ensure the right balance and that all possibilities are explored before choosing proxies.

2.3.3.5. Hargittai

Hargittai has been among the first to formalise the issue of Digital Inequality in academia. Together with DiMaggio, the framework mentioned earlier was

developed to understand further the different inequalities in the access and use of the Internet. In recent years, her work has shifted more to measuring the skill differences. She argues that understanding people's skills is fundamental in understanding the usage people make out of the Internet (Hargittai 2002b). Hargittai and Hsieh (2012, 1) noted that there is a "dearth of survey instruments for measuring skill" and as such, much of Hargittai's research has evolved and revolved around devising sound methodological approaches to measuring Internet skill.

Unfortunately, for most research on Internet Skill, due to the lack of data or the cost of collecting such data, proxies have been used for measuring Internet skill. It is far easier and cheaper to ask people about their perceived skill rather than measuring their real abilities (Hargittai 2008b). However, this measure does not always give a good indication of one's digital ability.

Nonetheless, Hargittai (2005) developed and tested a series of measures that would allow the relative measurement of digital skill. The measure would be subsequently refined (Hargittai 2008b) before devising an instrument for measuring digital skill (Hargittai and Hsieh 2012). Although Hargittai and Hsieh (2012) warn that the ever changing nature of ICT requires that such instrument be constantly updated, it does provide a sound, validated and reliable basis for undertaking research in digital skills. The authors devised three sets of measures (6, 10, 15 and 27-items instrument). They argue that unless a research is solely focused on measuring Internet skill, it is not practical to have a 27 items instrument in a survey. The shorter 6, 10 and 15-items instruments, derived from the original 27 items, offer researchers greater flexibility in choosing the most appropriate tools without forfeiting reliability and validity of their research. Thus, depending on the length of their survey, researchers can use either a 6, 10 or 15-items list.

On a different note, two reports are worth outlining in the measurement of Digital Inequality. Although not built around any specific theoretical model, the work of the Pew Internet Research Centre (pewinternet.org) and the UK Oxford Internet Institute Oxford Internet Survey (OXIS) offer some thought provoking insights into the tools and metrics that can be employed in Digital

Inequality measurement. The Pew Internet Research Centre has been surveying and monitoring the development and the evolution of the Internet in the American society since the year 2000 (Zickuhr and Smith 2012b). At the heart of this evolution is the transition from surveying access to exploring the different uses Americans make out of the Internet and the disparities in access and use among the various strata of the American society. The Pew Research Centre is also highly active in developing and strengthening the methodological approach to gathering data and is, as such, a treasure trove for Digital Inequality scholars when it comes to survey design and methodological conundrums. The questionnaire used provide deep insights and key lessons on the construction of survey and measures of Internet use.

Additionally, the Oxford Internet Survey is a biennial report of the Oxford Internet Institute. It is the “longest-running academic survey of Internet use in Britain, describing how Internet use has evolved from 2003 to the present day” (Oxford Internet Institute 2014). One of the particularities of the OXIS is the face-to-face survey method employed in the data collection. They argue that such a method “increases the quality of the data” since the survey is a comprehensive and rather long one, but also targets users and non-users (those who have never used the Internet and also those who have stopped using the Internet) (Oxford Internet Institute 2014). Again, as with the Pew Internet Research Centre, the methodological approach and the survey questions offer powerful insights on survey design when investigating Digital Inequality.

To summarise, as with the definition and the theoretical models, measurement of Digital Inequality is broad and highly based on the perspective and aim of the research. The above section has highlighted some of the main research on the empirical investigation of the Digital Inequality and has brought forward some of the intricate avenues for measuring the Digital Inequality.

2.4. Conclusion

This chapter thus sets the theoretical basis for further research on the Digital Inequality phenomena and provides the support for such research to be carried out in different and unexplored contexts. This chapter reviewed Digital Divide and its evolution from the first definition of the NTIA to the OECD's definition, with the latter being used as the working definition for the term throughout this thesis. As societies embraced the digital world and provided their population with access to the Internet, the hope of having more equal and socially-just communities were unfortunately not met. The criticisms of the Digital Divide opened the door to explore another inequality (Digital Inequality) that settled within the user community.

This chapter examined the shift in research attention from the Digital Divide to Digital Inequality. The issues of Digital Inequality were further explored, from its definition to the different models that helped explain this phenomenon. This chapter outlined some of the models before justifying DiMaggio and Hargittai's model as most suitable for this research.

Digital Divide and Digital Inequality are closely linked, even more so in a developing country, as explored in the next chapter, where the struggle to bridge the gap between the haves and the have-nots is not over. Yet to fully understand the ramifications of the Digital Inequality phenomenon, it is important to understand the context. The following chapter, therefore, sets out to explore Mauritius, a Small Island Developing State, with high ambitions when it comes to ICT. Since Digital Divide and Digital Inequality patterns are linked, the next chapter also provides an overview of the development of the Internet on the island since its mainstream dissemination.

Chapter 3: Mauritius and the Internet

3.1. Introduction

The aim of this chapter is twofold. Firstly, it will provide a background and the context of the developing island of Mauritius, on which the whole research analysis is based. This will be achieved by providing a brief historical background of the economic and socio-demographic development of the country since its first settlement up till the current state. It will detail some of the characteristics of Mauritius as a Small Island Developing State and the unique context of the island.

Secondly, this chapter aims at answering the second objective of this research, which is to investigate the diffusion of Internet among the Mauritian population since its mainstream dissemination and to establish the current state of affairs in relation to the Digital Divide. This will be achieved by examining the evolution of the Internet in Mauritius with regard to the infrastructure, penetration, bandwidth and price basket. This chapter will also outline the progress of the country as to major international measures of Internet development, namely ITU's Internet Development Index (IDI). It will further dedicate a section at outlining the government's current policies and vision with regard to the Internet on the island and provide the rationale for choosing Mauritius as a research case.

Ultimately, this chapter should allow a better understanding of the context in which this research has been carried out. This should act as a base for understanding the forthcoming chapters and the relevant assumptions made in the research methodology and during the analysis of the results.

3.2. Mauritius

Born out of undersea volcanic activity, the Republic of Mauritius is a group of islands in the Western Indian Ocean. With an area of approximately 2,040 square kilometres, the Republic of Mauritius is among the few countries that

20have a much larger exclusive economic zone (sea area) than land, spanning some 1.9 million square kilometres (Statistics Mauritius 2013a) due to the spread of the islands making up the Republic. The main island, Mauritius as shown in Figure 3.1, with an area of 1,865 square kilometres is home to the vast majority¹ of the islanders and the heart of the country's economic and social activities.

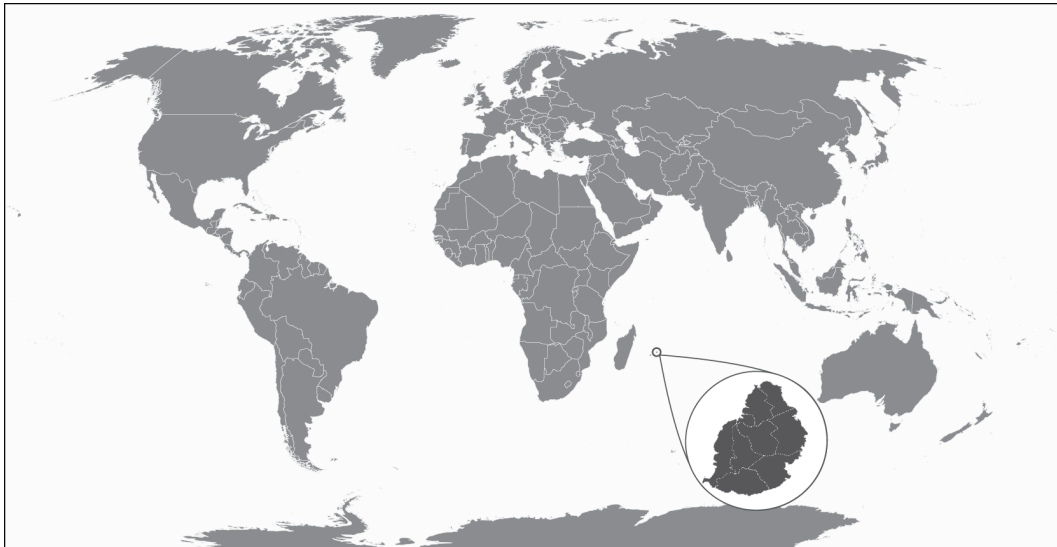

Figure 3.1: Map of Mauritius (Adapted from <http://freevectormaps.com>)

The geographical location of Mauritius has been, over centuries, its most valuable asset, mainly for vessels linking Europe and Asia. As such, the island has been colonised by Europeans, starting with the Dutch in the sixteenth century, who found in the island's lush tropical forest a haven to rest and repair ships after going through the notoriously rough seas of the Southern Indian Ocean. Later on, in the seventeenth century, the French and British found in the island a strategic position for military purposes to protect their assets and merchant navy sailing in the Indian Ocean.

¹ The Island of Mauritius is home to 1,196,833 of the 1,237,091 citizens of the Republic (Statistics Mauritius 2012a)

3.2.1. Economic Development—A Historical Perspective

Although the Dutch occupied the island from 1598 to 1710, it was under French rule (from 1715) that a permanent settlement was founded, bringing with it significant development, especially in agriculture. The island's tropical weather was suitable for the cultivation of sugarcane and the French started the cultivation on a large scale. Upon taking the island in 1810, the British brought a new impetus to the agricultural sector and soon much of the island was under sugar cane culture. Sugarcane mills were built and the bulk of the sugar produced was exported to England. After independence, having secured some preferential trade agreement for sugar export to the UK and later the EU, the island would, for some time, rely mostly on agriculture for its economic development.

Additionally, around half of the island is surrounded with coral reefs providing safe turquoise lagoons and white sandy beaches, making it a boon for the tourism industry. Nonetheless, it is only after independence and an explosion in global travel that the tourism sector expanded and has since the late 80's undergone rapid growth. Its relative isolation has made the island an upmarket destination with the EU being its primary target market. However, recently effort has been made to steer away from the EU market towards more emerging market such as China and the Emirates. The tourism sector remains, until today, an essential pillar of the Mauritian economy.

In the 1980's the Mauritian government undertook a vast programme to diversify its economy with the creation of the manufacturing sector. The country learned from Asian success stories and building on its stable democratic political situation, boosted its existing low-performing Export Processing Zone (EPZ) by providing tax incentives to foreign companies and focusing mainly on textile manufacturing for export (Yeung Lam Lo 1998; Subramanian 2001). Again this move was highly motivated and aided by the country's ability to secure preferential rates with major US and EU market (Zafar 2011).

Unfortunately, in recent decades, the trade agreements have begun to fall out with the EU phasing out the 'Multi-fibre' Agreement for textile (Kasenny 2011; Sobhee 2009) and the ending of the price guarantee for sugar, forcing the industries to embark on a process of readjustment to face global competition (Zafar 2011). This has resulted in the government's push to further diversification into other sectors such as Financial Services, Business Process Outsourcing (BPO) and Information, Communication and Technology and over the last decade, these emerging industries are making an increasing contribution to the Mauritian Gross Domestic Product (GDP).

Mauritius MUS GDP (current US\$)

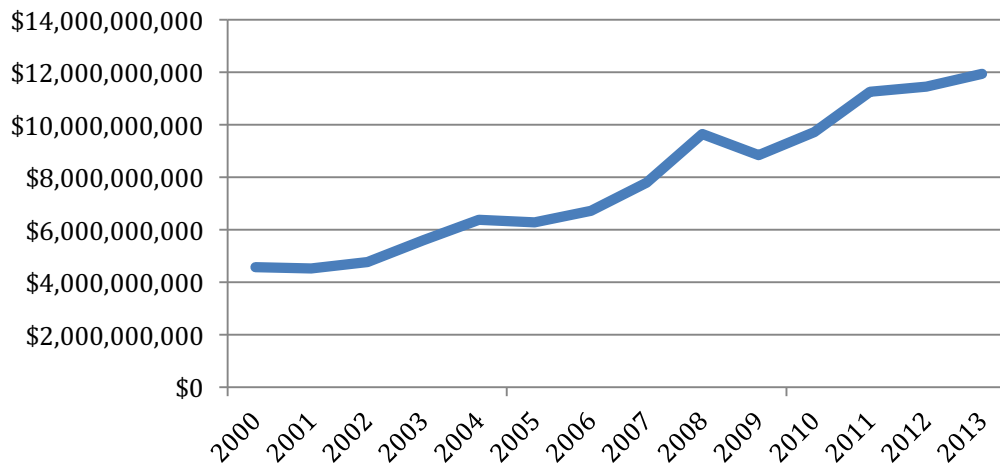

Figure 3.2: Mauritian GDP at Market Price 2000-2013 (Source: World Bank 2015)

Mauritius has been paving its way from a Low-Income Economy in the 1960's to an Upper Middle-Income Country (World Bank 2015) and with a GDP of US\$ 11.9 billion in 2013, as shown in Figure 3.2, it is well set to climb to the US\$ 12.6 billion required to graduate as a High-Income Economy in the coming years (World Bank 2013). Unfortunately, the Mauritian economy is highly exposed to exogenous shocks (Zafar 2011), due to its high dependence on the US and the EU market and any economic or social issues in these markets have a direct impact on the local economy. Despite this vulnerability, one of the characteristics that has enabled the development of the island is its continuity in implementing active economic policy despite changing governments. Although there is "harsh individual and factional

politics" (Frankel 2010), successive governments have always put the country first and continued, if not supported, strong policies set up by previous regimes especially with regard to macroeconomic policies (Subramanian 2001). Political stability throughout its history has largely contributed to the constant and sound economic development of the island.

3.2.2. Political System

The political regime of the island has steadily been evolving to cope with the needs of the time. As with every country under colonialism, Mauritius engaged in asserting its independence but in a rather atypical way. Added to the British desire to move out of the island, Bunwaree and Kasenally (2005) argue that the battle for independence was more of a "ballot" rather than a "bullet" fight, mainly due to the lack of a nationalist sentiment. Another exclusive event for Mauritius as a post-colonialism state has been the setting up of a democratic system right at the onset of independence (Frankel 2010).

Indeed, it was amid strong ethnic tension that the elections for independence were held in 1967 and the solution to relieve the country of such social instability would turn out to be a political one. On 12 March 1968, Mauritius obtained its independence from the British colony and embarked on a development agenda, starting by reinforcing a series of democratic institutions that would safeguard political, economic and social stability.

The country opted for a unicameral democratic system with parliaments elected by the population and a clear separation of powers, although with a strong Westminsterian flavour in light of its colonial heritage. With Mauritius still being a member of the Commonwealth, the Queen would remain head of state and the Prime Minister would hold executive powers. A series of provisions embedded in the constitution ensured representation of the ethnic minority groups thereby dissipating, or at least, reducing any tension between the different ethnicities. Successive governments would ensure representative of minorities be nominated in the main positions within the government, which would help alleviate the social tension amongst co-

existing religious groups. This model, with its imperfections, would be adopted by successive regimes and would prove highly beneficial in providing social stability, even at times of dire economic conditions.

In 1992, the country chose to reinforce its democratic pledge and endorsed the status of Republic. Again, the Republican model selected by the country would help strengthen the political and social stability by keeping its Westminsterian unicameral system with elected members of parliament but still continuing representation of ethnic minorities. The President of the Republic, appointed by the parliament, became the head of state and had more of a ceremonial role. The Prime Minister, elected by the people, holds most of the executive powers. Although, since independence, the island has known only Hindu Prime Ministers, the other executive roles, such as President, Vice-President, Deputy Prime Minister, Speaker of the Assembly, amongst others have been used to represent other minority ethnic groups. Such general representation has mitigated any social tension that could wreck the fragile multi-ethnic social web of the Mauritian community. This allowed the island to pursue its socio-economic development harmoniously.

3.2.3. Socio-Demographic Development

The socio-demographic evolution of the island is closely linked or has been highly influenced by the economic growth of the island throughout its history. The following section thus attempts to illustrate the factors that have over time influenced and somehow moulded the island's socio-economic and demographic landscape.

Starting with the settlement of the French in the eighteenth century, the development of the agricultural economy required labour, much of which was sourced from slave trade from nearby Madagascar and mainland Africa, which according to Frankel (2010, 5) was "the ultimate evil of the time". Upon taking over the island in 1810, the British, holding the political power, allowed the French landowners to keep their estates and develop the country further. This would turn out to be a defining moment in the country's history with a

society made up of British governing the island but also of French landowners developing their estates and slaves working for their French masters. Despite the fact that slavery was abolished in the British Empire in 1807, the need for labour on the island forced the British to defer its implementation until 1835, where slavery was finally abolished on the island.

However, the issue of manpower would persist, if not worsen, since a lot of the freed slaves were reluctant to work for their former masters (Frankel 2010). The solution came from another then British colony—India. Frankel (2010) argues that nearly half a million of indentured labourers, also known as 'coolies', were brought from India between 1849 and 1923. This new wave of 'immigration' would bring not only manpower for the sugar cane fields but also tradesmen and craftsmen. Traders from China would also join in and this little piece of land would thus become the melting pot of African (slaves and their descendants), European (French and British) and Asian (Indian and Chinese) cultures. As such, it is believed that to this day, the Mauritian population is made up of 68% Indo-Mauritian, 27% Creole (of African origins/mixed race), 3% Sino-Mauritian (of Chinese descent) and 2% Franco-Mauritian (people of French and British origin) (Central Intelligence Agency 2016).

Over the years, the population demographics have undergone constant changes. With economic development, increased life expectancy as a result of better health care and reduction in fertility (United Nations Department of Economic and Social Affairs 2013), Mauritius has not escaped the global phenomenon of an ageing population. Figure 3.3, below, shows the current demographics for both sexes in years and the projected demographics in 2039.

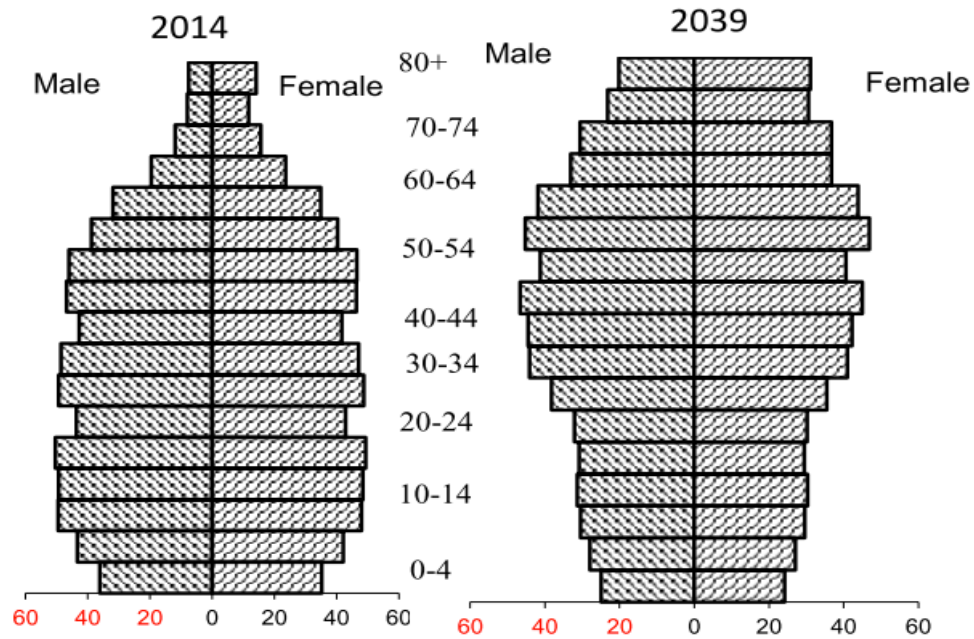

Figure 3.3: Mauritian Population Age Demographics 2014/ 2039 (Source: Statistics Mauritius 2015c)

Added to the issue of an ageing population, projected statistics suggest that the population size will shrink in the coming decades (Statistics Mauritius 2015c). As for the sex ratio, Mauritius is at par with global trends, with the latest statistics suggesting that out of the 1.26 million inhabitants, 49.5% are males and 50.5% are females (Statistics Mauritius 2015c).

3.2.3.1. Education System

Bunwaree (2001, 1) argues that "Mauritius, like many other countries in the world, places a lot of faith in the power of education to contribute to the country's social and economic development" and within less than a decade after independence, free schooling up to Secondary level was established. Later in 1988, tuition fees at the University of Mauritius would be abolished. This, coupled with compulsory education up until the age of 16, laid the foundation for social and economic development.

Like its political system, the education system of the island is highly westernised and is widely based on the British system, with a 6-5-2 years education structure (Bunwaree 2001; Ajaheb-Jahangeer and Jahangeer

2004). Children enter mainstream Primary schooling at the age of five and spend six years, at the end of which is the Certificate of Primary Examination (CPE). They are then directed to Secondary schools for another five years, leading to the Cambridge School Certificate Exams (S.C), after which, students spend the last two years of Secondary schooling to prepare for the Cambridge Higher School Certificate Exam (HSC). They then pursue tertiary education—Vocational and Technical training runs in parallel with the mainstream academic system as shown in Figure 3.4.

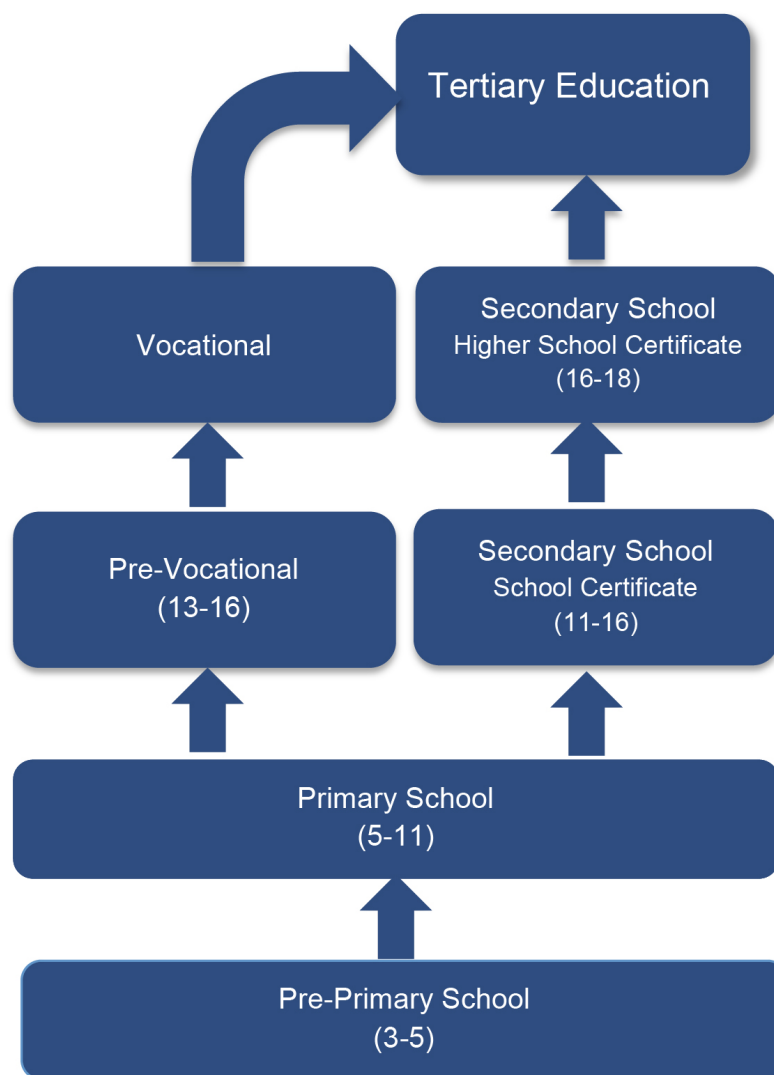

Figure 3.4: Education System in Mauritius

The education system of the country, like in other countries, is undergoing constant change. The high failure rate at the CPE exam over the years has

contributed to a rethink of the current system and successive governments have all brought minor changes amid tense lobbying from parents, teachers and trade unions. Pre-Vocational education has been set up to cater for those unable to pursue the highly academic mainstream system. Despite these numerous efforts, the enrolment rates fail to reach the 100% with 97% at Primary schools and 73% at Secondary schools (Statistics Mauritius 2015c). With regard to literacy rate as defined by international standards, the latest statistics show that in 2011 the country had an overall literacy rate of 89.8%, with literacy amongst males being 92.3% and 87.3% amongst females (Statistics Mauritius 2014c).

3.2.3.2. Employment and Income Inequality in Mauritius

The growth and diversification of the economic activity have impacted on employment and standard of living of the Islanders. The unemployment rate has been stagnating at around 8% over the last years, with 7.8% in 2014, largely due to an increasing labour force (Statistics Mauritius 2015b) and in spite of unfavourable economic situations in EU countries and the US. The tertiary sector remains by far the largest sector of employment on the island.

The disposable income of the Mauritian households has been increasing over the years from Rs. 14,230 in 2002 to Rs. 29,360 in 2012, which is an adjusted increase of 22.3%, taking into consideration the increase in the price of goods and services as well as a shrink in household size from 3.7 to 3.5 persons (Statistics Mauritius 2013c). However, despite an increase in the disposable income, income inequality has been growing. The measure of inequality, the Gini Coefficient, shows that the gap between top earners and low-income earners has increased. Indeed, the Gini Coefficient (0 for complete equality and 1 for complete inequality) shows that inequality has risen from 0.388 in 2006/07 to 0.413 in 2012 (Statistics Mauritius 2013c), noting that a score above 0.4 is usually considered as an increasingly unequal society (The National Economic and Social Council 2014). The Lorenz curve Figure 3.5, a pictorial representation of the Gini-Coefficient,

shows the increase in income inequality and how it is departing from the equality line.

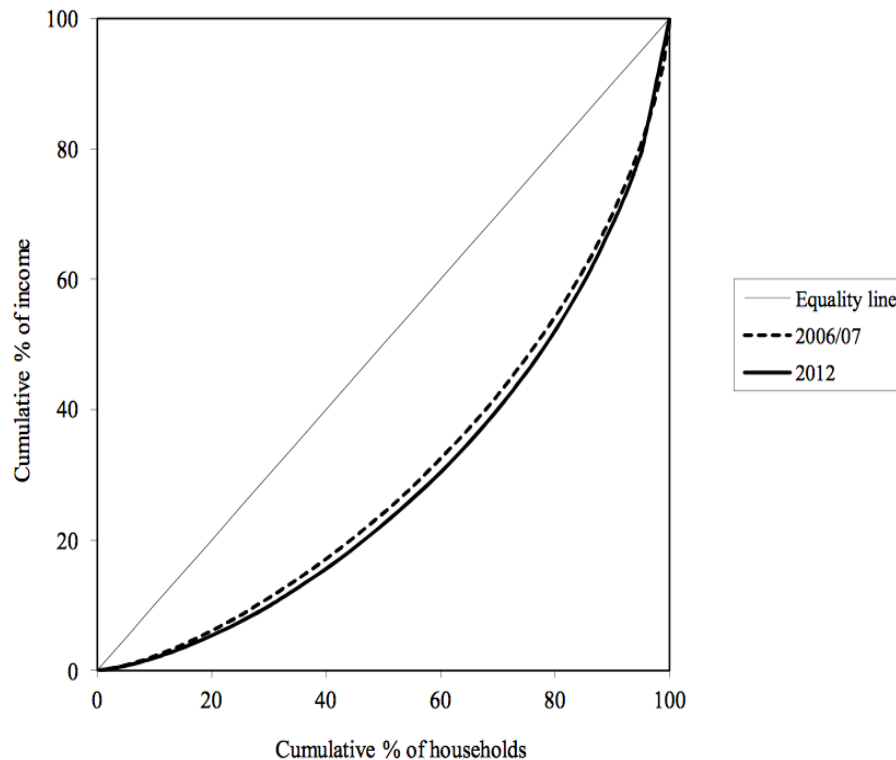

Figure 3.5: Income Inequality - Lorenz Curves 2006/07 and 2012 (Source: Statistics Mauritius 2013c)

The ramifications of an increasing inequality are broad and far-reaching, both from an economic perspective, with the possibility of a reduction in economic growth and also from social dimension, creating a sense of injustice impacting on productivity, the standard of living and health. Kawachi and Subramanian (2014), using the case of the United States, argue that income inequality creates a situation where those on the lower rung of the income ladder not only have to strive for their fundamental rights but are unable to participate fully in such societies due to their incapacity to access services such as the Internet. Although faring well on the economic development, Mauritius is facing some serious challenges to ensure justice and fairness to its population.

As seen so far, Mauritius, with its geographical positioning and economic ambitions, has progressed from a mono-crop economy to a diverse multi-sectorial upper middle-income developing country and the Internet is bound to play a significant role in its advancement. Having overviewed the context, the following section will explore the development of the Internet on the island.

3.3. The Internet in Mauritius

It is back in 1883, just seven years after its invention, that the first telephone system was set up on the island, linking the Governor's residence and the Government House (Mauritius Telecom 2015d). From then on, the British Colonial Government encouraged the development of telecommunication, both within and outside of the island, as back then the only means of communication with the outside world would have been by mail through merchant ships. It was in 1893 that the first offshore communication system was established with an undersea cable linking Mauritius with Zanzibar in Tanzania (Mauritius Telecom 2015d). Since then, the country embarked on developing the telecommunication sector, both for onshore and offshore communication. ICT would thus turn out to be pivotal in the development of the island.

The following section explores the evolution and development of telecommunications and more specifically the Internet on the island. Using Digital Divide as the central theme, it discusses the progress over the years with regard to infrastructure, access and pricing. Furthermore, the effort and progress of Mauritius in relation to international benchmarks, namely the ITU's measurement on Information Society is discussed. Lastly, the government's role in setting up the legal framework and efforts is outlined.

3.3.1. Infrastructure

The infrastructural development of telecommunications on the island has been through successive phases. It was under British colony, in 1938, that

the Department of Electricity and Telephones was established to manage telecoms on the island (Mauritius Telecom 2015d). However, it is only in 1985 that the government would give a new impetus to the development of telecoms on the island. Reddi (2005) comments that a major turning point in the history of telecommunications on the island is the creation, in 1992, of Mauritius Telecom, a private company but nonetheless highly controlled by the government, with the Government of Mauritius, the State Bank of Mauritius (itself having the Government of Mauritius as a major shareholder), and the National Pensions Fund (also a government body) holding 59% of shares of the company. Mauritius Telecom would thus, until the 2010's, hold the monopoly with regard to fixed telecommunication network.

In line with global trends, mobile telephony would be offered on the island as from 1989 by a private company, Emtel, with the first generation (1G) analogue system (Emtel 2015). The first GSM network would subsequently be set up in 1996 by Orange, a subsidiary of Mauritius Telecom (Mauritius Telecom 2015a), followed by Emtel three years later (Emtel 2015). Both companies, would over the years, upgrade their services until recently, in 2012, to offer 4G networks across the island. With regard to Internet, Mauritius Telecom remains the main provider of fixed Internet and Orange together with Emtel are the two major mobile Internet Service providers.

The Internet on the island has also experienced significant development. From a fixed connection perspective, testing of the Internet started on the island in 1995 and in February 1997, Mauritius Telecom, in partnership with France Telecom, commercially launched the Internet in Mauritius (Mauritius Telecom 2015b) with a connection speed of 56 Kbps. This would serve as the foundation for future development and the speed of Internet for individual subscription would keep on increasing. With the adoption of ADSL technology to 128 Kbps, 256 Kbps, 512 Kbps, 1 Mbps and more recently with the adoption of Fibre to the Home (FTTH), individuals can enjoy up to 10 Mbps or up to 30 Mbps (depending on the subscription) download speed (Mauritius Telecom 2015b). This development has been made possible

thanks to the adoption of undersea optical fibre technology linking Mauritius to the rest of the world as shown in Figure 3.6.

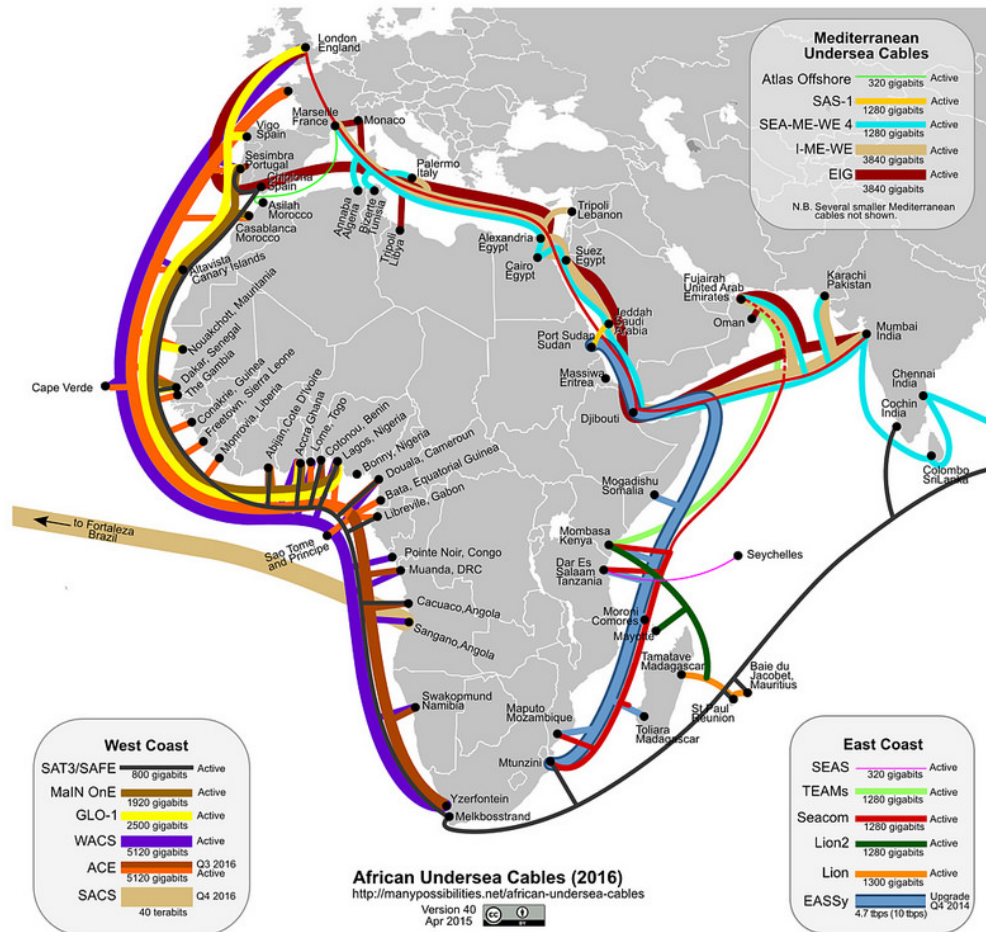

Figure 3.6: African Undersea Cables (Source: Song 2015 Under Creative Common Licence BY)

The first such cable connecting the island to the rest of the world is the South African Far East (SAFE) cable that links South Africa to China through Mauritius and India and has been operational since 2002; the SAFE cable is in turn connected to the Western Africa Cable System (WACS), connecting South Africa and Europe. The second cable to connect the island is the Lower Indian Ocean Network (LION) connecting Mauritius to mainland Africa through the LION and LION2 cables. The LION network is further connected to the East Africa Submarine Cable System (EASSy) providing a link to Djibouti and from then to Europe through the Europe India Gateway (EIG) system (Mauritius Telecom 2015c).

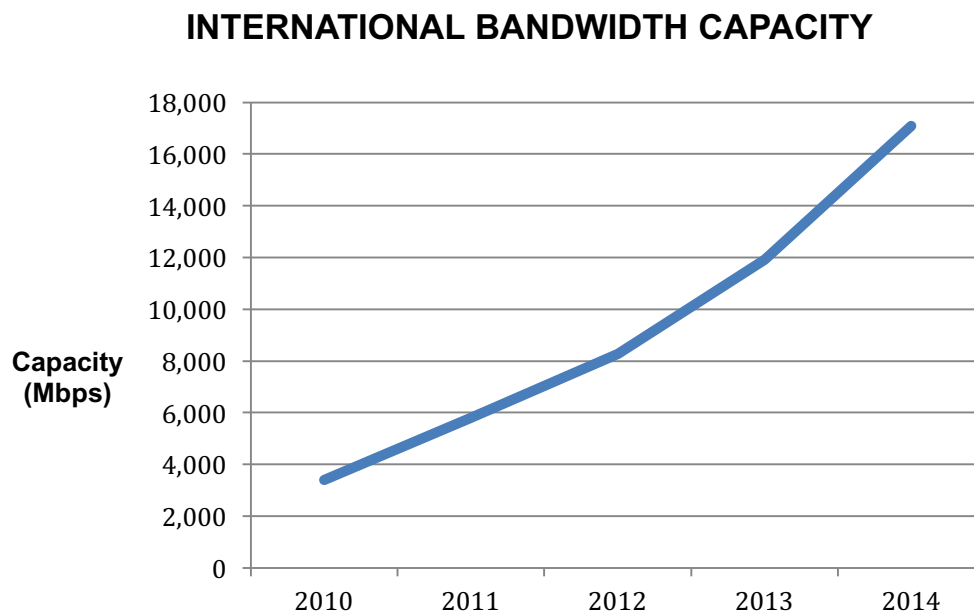

Figure 3.7: Mauritius International Bandwidth Capacity (Source: ICTA 2015b)

As the island secured high-speed physical Internet infrastructure, the International Bandwidth kept on increasing over the years and is set to increase further in the coming years. As shown in Figure 3.7, the International Bandwidth Capacity of Mauritius increased from 3,390 Mbps in 2010 to 17,077 Mbps in 2014, thanks to the cumulative effect of the undersea cable and satellite Internet infrastructure available.

3.3.2. Penetration

The rate of Internet penetration and devices uptake is very often one of the most significant indicators of Digital Divide. Over the years, the penetration rate of telephone, mobile and Internet has progressed but not as expected (MICT 2011). The following section outlines the evolution in adoption of the various technologies associated with the Internet.

Initially, the only possible way to connect to the Internet was through a computer connected to a fixed telephone line. The adoption of fixed telephone lines has been gradual and even decreased over recent years. As shown in Figure 3.8, although the number of business lines has shown a small increase from 93,000 in 2010 to 97,400 in 2014, the number of

residential lines, on the other hand, decreased from 294,700 to 274,800. Although a decline at face value, the rate of fixed line uptake by household was 102.19% (ICTA 2015b), indicating that a high proportion (but not all) of households have a fixed line connection. The 2011 population census conducted on the island suggests that on the isle of Mauritius, out of the 331,291 households, 231,643 had a fixed telephone line connection, representing a penetration rate of 69.92% (Statistics Mauritius 2011a).

NUMBER OF FIXED LINE SUBSCRIPTION

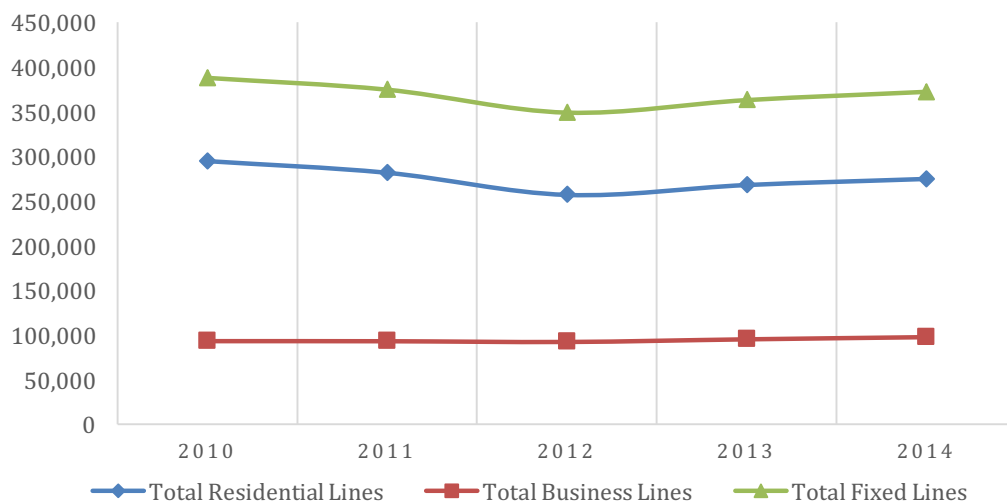

Figure 3.8 Fixed Line Penetration for Republic of Mauritius (Source: ICTA 2015b)

The discrepancy in the number is largely explained by the fact that firstly, the data shown in Figure 3.8 relates to the Republic of Mauritius (as opposed to the island of Mauritius) and takes into account 342,358 households (11,067 households of the other islands have been included) and secondly some households could have two or more fixed line connections. Nonetheless, the figures suggest that a good proportion of the population has access to a fixed telephone line, which by extrapolation could allow them to connect to the Internet.

Parallel to fixed line adoption, computer adoption has been relatively slow. The population census of 2011 again highlights this fact, suggesting that for the island of Mauritius, only 126,228 out of the 331,291 households have a

computer, representing 38.10% of households as compared to 37.7% for the Republic (Statistics Mauritius 2011a). According to Statistics Mauritius, the percentage of households for the Republic of Mauritius having computers in 2006 and 2008 was 24.2% and 29.9% respectively (Statistics Mauritius 2009) and the figures increased to 37.7% and 44.9% for the year 2011 and 2012 respectively (Statistics Mauritius 2013b). Despite some inconsistencies in the numbers, the overall picture indicates a slow uptake of computers in households. While the number of households with computers is increasing, the Government of Mauritius argues that the "... real value lies in the services that accrue from connectivity" (MICT 2011, 21).

With regard to Internet penetration, both fixed Internet connection and mobile Internet connection enabled the population to have access to the technology. However, the rate of uptake has been different for the two types of connection, with mobile Internet growing at a faster rate than fixed Internet connection as discussed later.

The government uses the ITU methodology for calculating the penetration of Internet. As per ITU definition, the estimated number of Internet users is defined as

The estimated number of Internet users out of the total population. This includes those using the Internet from any device (including mobile phones) in the last 12 months. A growing number of countries measure this through household surveys. In countries where household surveys are available, this estimate should correspond to the estimated number derived from the rate of Internet users collected. (If the survey covers percentage of the population for a certain age group (e.g. 15-74 years old, the estimated number of Internet users should be derived using this percentage, and note indicating the scope and coverage of the survey should be provided). In situations where surveys are not available, an estimate can be derived based on the number of Internet subscriptions. (ITU 2010a, 5)

For the case of Mauritius, the government, in line with the definition of the ITU, calculates Internet penetration as the sum of fixed and mobile Internet subscriptions. Although there is no perfect measure, using the total number of subscriptions to estimate the number of Internet users poses some

challenges. Firstly, with regard to fixed Internet subscriptions, it is understood that the subscription, using a fixed line, is for a household. In essence, there could be more than one user using the Internet through such connection and, therefore, using one fixed subscription as being one user induces a bias in the estimate. A potential solution would be to use the average household size, which is 3.6 (Statistics Mauritius 2015c) to calculate the number of potential users, which would be calculated as the number of fixed Internet connection multiplied by 3.6. Again this solution induces the same bias as the previous measure, whereby not all household members may necessarily be Internet users.

Secondly with regard to mobile subscriptions, although it can be assumed that a subscription is for one user, it is conceivable that with technologies like mobile Wi-Fi dongles and Hotspot Internet sharing, a mobile subscription could be shared among multiple users. Over and above, this method also assumes that there is no overlapping between mobile Internet and fixed Internet users, when it can be assumed that some users can have both fixed and mobile Internet subscription.

Although it is clear that these measures cannot be used to know the number of Internet users on the island, they do provide some essential information on the overall trend of Internet uptake, which has not ceased to evolve since the inception of Internet on the island. As such the total number of subscriptions (both fixed and mobile) has increased over the years, as shown in Figure 3.9, going from 284,200 in 2010 to 735,000 in 2014, which represents a 159% increase in just four years.

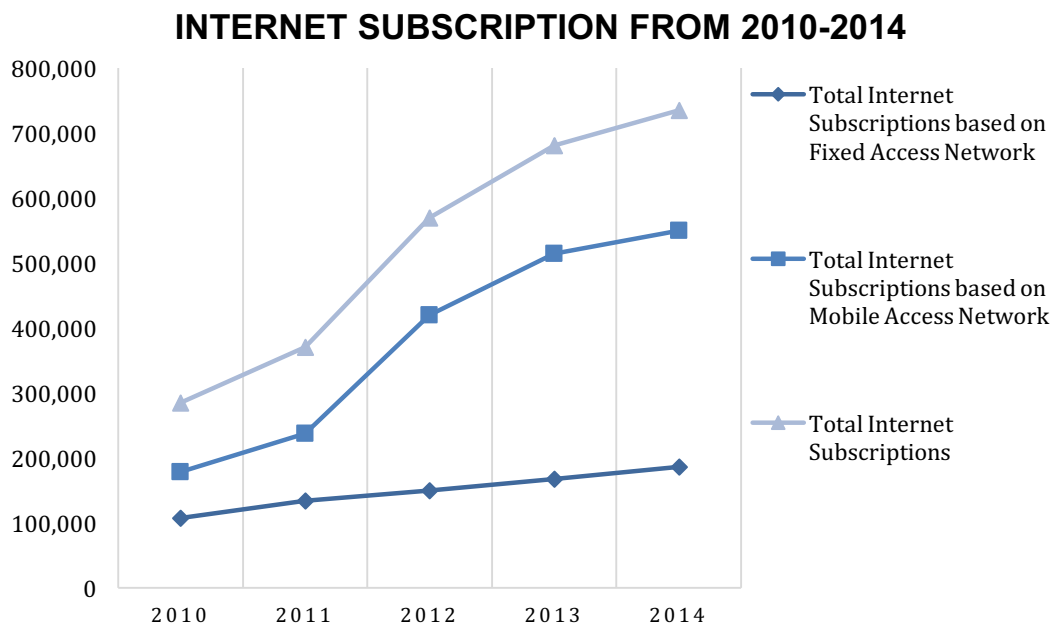

Figure 3.9: Internet Subscription from 2010-2014 (Source: ICTA 2015b)

It is an interesting fact to note that it is mobile subscription that has accounted primarily for the surge in Internet subscription, with an increase of slightly above 200% from 77,500 subscriptions in 2010 to 549,000 subscriptions in 2014 (ICTA 2015b). Although on the rise too, fixed Internet subscription has experienced a slower growth, with an average annual growth rate of 12% over the last three years (ICTA 2015b).

Mauritius has both Broadband and legacy Narrowband technologies. As defined by the ITU, Narrowband is the data speed of less than 256 Kbps, whereas Broadband is regarded as a speed of 256 Kbps and above (ITU 2010a). When comparing Broadband and Narrowband subscriptions on the island, Figure 3.10 shows that over the years, as Broadband subscriptions soared, Narrowband subscriptions gradually levelled off and even started to decline in 2014.

BROADBAND SUBSCRIPTION VS. NARROWBAND SUBSCRIPTION

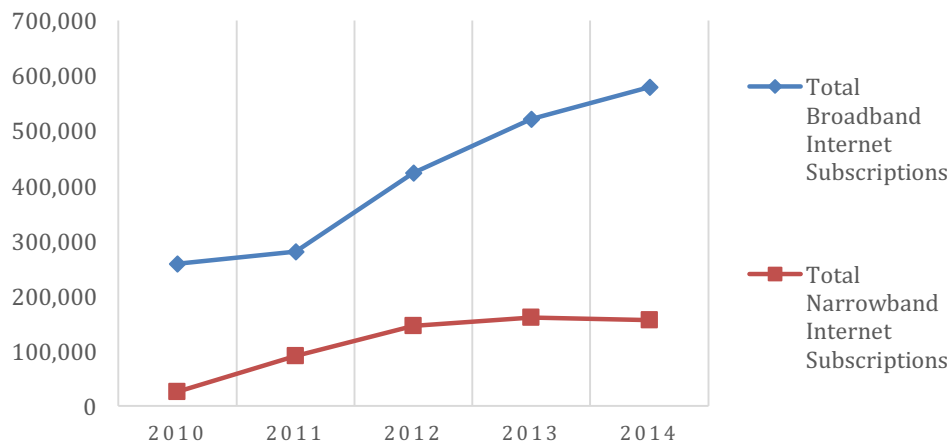

Figure 3.10: Broadband Subscription vs. Narrowband Subscription (Source: ICTA 2015b)

With regard to Broadband connection, there is a high correlation between Internet subscription and Broadband subscription, both having more or less similar curves as shown in Figure 3.11, with a constant growth for fixed subscriptions and a surge in mobile subscriptions from 2011 onwards. It suggests that the country has embraced Broadband Internet and is slowly moving towards high-speed Internet and that more users are now interested in mobile Internet.

BROADBAND CONNECTION (FIXED VS. MOBILE)

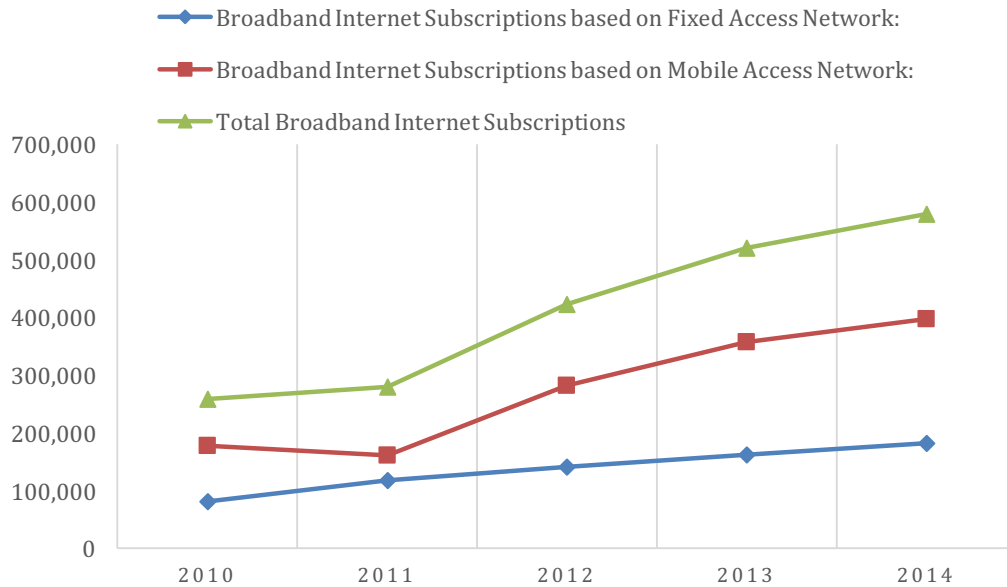

Figure 3.11: Broadband Connection (Fixed vs. Mobile) (Source: ICTA 2015b)

Narrowband subscriptions type, as shown in Figure 3.12, follows the same pattern as Broadband subscriptions type, with a surge in mobile subscription, increasing from 75,200 subscriptions in 2011 to 152,000 subscriptions in 2015. Contrary to fixed Broadband subscription that increased, fixed Narrowband subscriptions experienced a decline over the years, from 25,700 in 2010 to 4,000 in 2014 (ICTA 2015b).

NARROWBAND SUBSCRIPTION TYPE

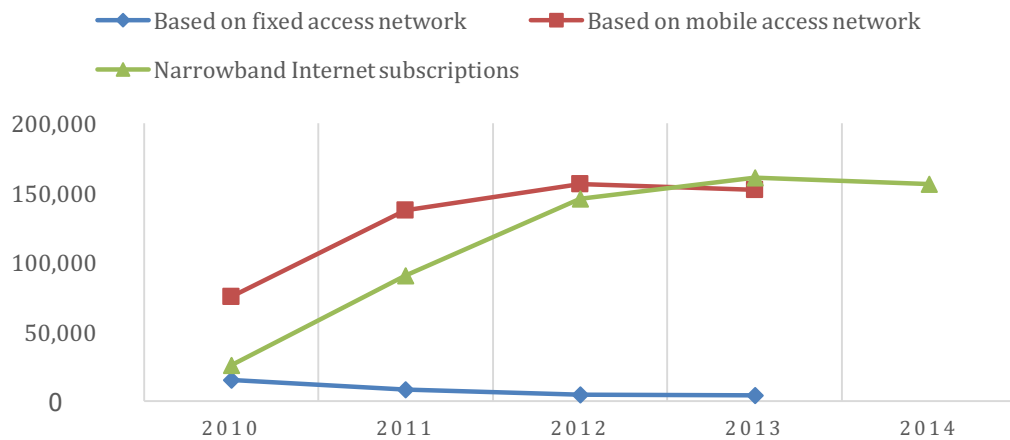

Figure 3.12: Narrowband Subscription Type (Source: Statistics Mauritius 2015a)

The fixed Narrowband subscription rate decline corresponds with the decline in Internet Traffic on Dial-up connection Figure 3.13. Indeed, Dial-up connection is billed on a per minute basis and the number of Internet traffic on Dial-up connection has undergone a systematic decline since 2010, going from 124 million of minutes for 2010 to just 5 million minutes for 2014.

TOTAL DIAL-UP INTERNET TRAFFIC (MILLION MINS)

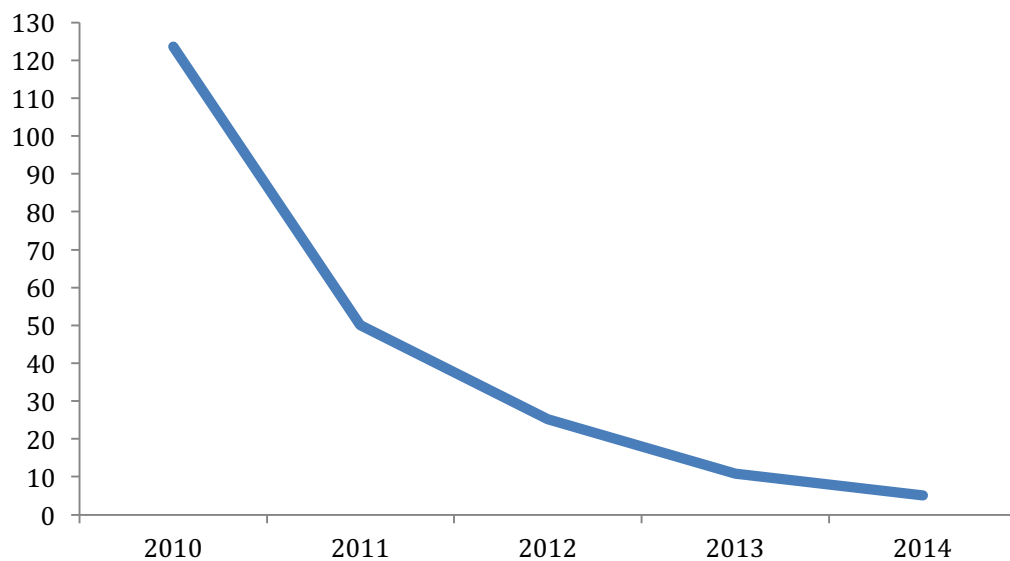

Figure 3.13: Total Dial-Up Internet Traffic (Source: ICTA 2015b)

3.3.3. Price Basket

Pricing is a major element in technology adoption, especially with the Internet. Just as the technology evolved with an increasing Broadband penetration and the decline of Narrowband, the tariffs of Internet connection have also changed with time. Table 3.1 provides a selection of Internet subscriptions being offered on the Mauritian market and the tariffs presented re the cheapest being offered.

	2009	2010	2011	2012	2013	2014
FIXED WIRED—ADSL						
ADSL 512 Kbps (Unlimited Volume Usage)	750.00	673.00	621.00	621.00	621.00	621.00
ADSL 1 Mbps (Unlimited Volume Usage)	1,360.00	1,190.00	708.00	708.00	708.00	708.00
ADSL 2 Mbps	NA	NA	1,186.00	1,186.00	1,186.00	1,186.00
FTTH 10 Mbps (Fair Usage Policy)	NA	NA	NA	NA	NA	800.00
DIAL-UP (Fixed)						
Dial up Peak time (per minute)	0.57	0.57	0.57	0.57	0.57	0.57
Dial up Off Peak time (per minute)	0.27	0.27	0.27	0.27	0.27	0.27
MOBILE DATA—3G / HSDPA / GPRS						
Post-paid plan of 500 MB capacity	300.00	300.00	250.00	229.57	175.00	175.00
Post-paid plan of 1 GB capacity	299.00	299.00	299.00	299.00	275.00	216.52

Table 3.1: Tariffs of Internet Connection Rs./Month (Adapted: ICTA 2015b; Statistics Mauritius 2015a; Orange 2015)

Generally speaking, the price of Internet, with the exception of Dial-up connection, has been going down over the years. For example, a fixed Broadband subscription for a connection speed of 512 Kbps went from Rs. 1,360 in 2009 to Rs. 708 in 2012 and the price remained unchanged. It is

also worth noting that the decrease in the pricing is also linked with new higher connection speed being offered. This phenomenon can be seen with the fixed Broadband (ADSL) 1 Mbps where the price went down from Rs. 1,190 in 2010 to Rs. 708 in 2011. Those who were paying a 512 Mbps at the Rs. 708 had been upgraded to 1 Mbps. The same approach was used as the Fibre to the Home (FTTH) was being deployed on the island; those who were on the 1 Mbps were upgraded to the FTTH 10 Mbps for almost the same price, depending upon availability of the technology in the user's area.

One of the measures commonly used to assess affordability of the Internet is the Gross National Income (GNI) (UNCTAD 2006; Broadband Commission 2012; Tongia, Subrahmanian, and Arunachalam 2004; Brimacombe and Skuse 2013; P. Hanafizadeh, Hanafizadeh, and Khodabakhshi 2009). Using the GNI as a base, Statistics Mauritius (Statistics Mauritius 2015c) notes that the price of Internet is getting cheaper. The Internet tariff for 20 hours of use per month (from the main ISP) accounted for 2.5% of the per capita GNI in 2010 and decreased to 2.0% in 2014 (Statistics Mauritius 2015c).

However, there are criticisms on the use of GNI as a valid measure of affordability. For example, Barzilai-Nahon (2006, 272) argues that such measure is "... more aggregative at the international and national level rather than at the community and individual levels" and that it is important to look at the Digital Divide issue from an individual level. Thus, the use of average household income might offer a more realistic and personal view of the state of affordability on the island. However, about the only data available on the average monthly income is limited to a difference between three periods (2001-2002, 2006-2007 and 2012) as shown in Table 3.2.

	2001/2002	2005/2006	2012
Average monthly income (rupees)	14,232	19,083	29,420

Table 3.2: Average Monthly Income (Source: Statistics Mauritius 2015c, 23)

As shown, the average monthly income of Mauritians has increased over time to Rs. 29,420 in 2012. It is interesting to note that both measures (GNI and Average Monthly Income) leads to the same conclusions in terms of

affordability. Aggregating data from Table 3.1 and Table 3.2 shows that for 2012, the cheapest fixed Internet subscription was Rs. 621 (Table 3.1), which is roughly 2.1% of the average monthly income for that year (Rs. 29,420 as shown in Table 3.2). It is clear from both measures that the Internet is has become more affordable over the years. Despite these figures suggesting that Internet is relatively affordable, the reality is that the quality of the connection is a major impediment as discussed in subsequent chapters.

3.3.4. Mauritius and International Benchmark

The ITU and other organisations developed some indicators for measuring the state and progress of the development of Internet. Although the accuracy and methodologies used can be criticised as discussed in the previous chapter, they can be useful to situate and understand the evolution of a country's Internet development.

As Pena-Lopez (2009, 32) points out, “the different approaches to model and measure the Information Society have determined what is meant by the concept of access to Information and Communication Technologies and digital development”. Thus, as the development of Internet progressed, the indicators used to measure the information societies also evolved. From the standpoint of the ITU, the measurements of the Information Society changed with time, using the ICT Diffusion Index until 2006, the Digital Opportunity Index (DOI) for three years, from between 2004 and 2006, after which the ICT Development Index (IDI), which is mainly used.

Although highly critiqued, these measures, using different indicators but all with a strong focus on Infrastructure, access and use/skills, provide a relative understanding of the current situation and progress of a country with regard to the development of the Information Society. Although not comparable, each of these three measures can provide a snapshot of a country's performance with regard to the Information Society.

The country's ranking has been fluctuating between the 62nd and 74th place globally over the years, albeit some significant development on the island in

the ICT. The data for the ICT Diffusion Index shows that in 1997 Mauritius was ranked at the 69th place, its lowest ranking for this measure, and gradually improved, with some fluctuations to the 62nd place in 2004 (UNCTAD 2006). Despite undertaking some major development, for the ICT Development Index the global ranking of the country fell from the 62nd place in 2007 (ITU 2009) to the 70th place in 2013 (ITU 2014b), although the country reached its lowest ranking of 74th in 2011 (ITU 2012).

Despite not faring so well from a global perspective, on a regional level, Mauritius has been among the top countries in Africa. As such, Mauritius was ranked 2nd in Africa after Seychelles in 2010 and 2011 (ITU 2012) and for the following two years, 2012 and 2013, Mauritius has been ranked first in the African region. These rankings demonstrate to some extent the progress and the position of the island with regard to Internet development.

3.3.5. Governmental Policies and Initiatives

In line with its economic policy on diversification, the government had the vision of developing the ICT sector as far back as 1998 (Chan-Meetoo 2007) in its National IT Strategic Plan. As ICT development gained momentum, so did the government's ambition of making the country a 'cyber-island', the 'technology hub' of the region (Chan-Meetoo 2007) and later of making ICT the fifth pillar of the Mauritian economy (ITU 2004; Soyjaudah et al. 2002; MICT 2011). The government would formalise its commitment to draft and implement successive policy documents on ICT over the years with the National ICT Policy 2007-2011, which would later be renewed as the National ICT Strategic Plan 2011-2014. Although perceived as overambitious with regard to the developmental milestones (MICT 2011), the policies would aim at providing the right environment conducive to business but also ensuring the development of highly digitally skilled workforce and the population at large.

One of the first policies implemented was the liberalisation of the telecommunication sector as penned in the 1997's White Paper on

Telecommunications (MTCI 2015). This allowed companies, both local and international, to offer telecommunication services, in particular the Internet. The rationale was that the liberalisation of the telecommunications industry would bring competition to the market and would naturally bring down the price of telecommunication services, mainly the Internet.

Again from a policy perspective, in 2012 the Government of Mauritius, in line with the development of Broadband worldwide, came up with the National Broadband Policy 2012-2020 (MICT 2012), outlining the challenges and direction of the government in the development of the Internet on the island. The government did not play down its role in making the island an information society, and in 2013 came up with the e-Government policy 2013-2017 with the aim of “ ... improving effectiveness and efficiency of Ministries and Departments, with emphasis on improving productivity, quality and service delivery” (MTCI 2013).

The development of ICT would not be possible without the proper legal framework that would support and safeguard stakeholders’ interests. As such, over the years, the government came up with appropriate legislations on Data Protection, Computer Misuse and Cybercrime and Electronic Transactions, to cite a few (MTCI 2015a). These laws are regularly updated to face the fast-changing nature of ICT development.

The government also set up some public bodies to oversee the development and implementation of its strategies. The National Computer Board (NCB) was established with the vision of being “the key enabler in transforming Mauritius into a cyber-island and a regional ICT hub” (NCB 2014), focusing its action on empowering digitally the people, businesses and government. The NCB has been active in providing basic digital literacy courses to the population. The government also set up the Information Communication and Technology Authority (ICTA) to regulate the telecommunication sector on the island. With the liberalisation of the telecommunication sector, the role of the ICTA is also to ensure that the market is functioning in an optimal way both for companies and for consumers.



Figure 3.14: Ebene Cyber Tower 1 (Source: BPML 2015) Courtesy of Business Parks of Mauritius Ltd.

Other than public bodies, the government has also as ambition of making Mauritius a cyber-island and, in this respect, has embarked on the creation of ‘cyber-cities’ providing the necessary infrastructure (building and telecom) for ICT companies to invest on the island. The Business Parks Mauritius Limited is a government-owned company that manages the infrastructure around those cyber-cities. The first cyber-city was set up in Ebene with the Cyber Tower 1 (Figure 3.14) and has since then known more development with Cyber Tower 2 and more such infrastructures in other areas of the island. The aim of these cyber-cities was to enhance the development of the ICT industry on the island.

3.3.6. ICT Industry

The Mauritian ICT industry is highly service-centric (ICTA 2010), focusing mainly on Outsourcing, Software Development, Telecommunications and Web Services, although manufacturing and trade make up for part of it. The geographical location (time zone) and the bilingualism of its population, compounded by a stable socio-political environment and increasingly fast Internet connection, have made the island favourable to the implementation

of outsourcing activities. Indeed, most of the companies within the sector are outsourcing companies providing services, mainly call centre activities, software development, web publishing (Soyjaudah et al. 2002) and solution support to the European and American market.

The Mauritian ICT industry has thus known a steady growth in recent years. The number of establishments having 10 or more employees operating within the ICT sector has increased from 52 in 2000 to 130 in 2010, and stagnating at this number since, with 139 in 2013 (Statistics Mauritius 2006; Statistics Mauritius 2013b). Although the number of establishments has not increased per se, the industry has grown with an increasing workforce and contribution to the GDP. Back in 2000, the ICT industry employed some 4,260 employees and the number soared to 14,094 in 2013 and the overall contribution of the ICT sector to the GDP jumped from 4.3% in 2000 to 6.3% in 2013 (Statistics Mauritius 2006; Statistics Mauritius 2013b).

3.4. Digital Divide and the Future of Internet in Mauritius.

Although the Digital Divide still exists, there is much evidence that the country has embarked on a mission of reducing the gap between those who have and those who do not have access to the Internet.

As the country is gearing up to move from a middle-income country to a high-income country, the role of the Internet is becoming more and more important in sustaining such development.

Subscriptions to the Internet, both fixed and mobile are on the rise, Internet Access Tariffs are going down and all indicators tend to point to the conclusion that the country is on its way to reducing the Digital Divide.

3.5. Conclusion

This chapter provided an overview of the island of Mauritius, which can be said to have a rich cultural and economic history. Dating back to the Dutch tradesmen, the country has undergone fundamental changes, both from an

economic and a demographic perspective. From a mono-crop economy relying mainly on the export of sugar to Europe, the country has forged strong economic allies and diversified to Tourism, Textile, Banking and Finance (including the offshore sector) and recently the ICT and BPO sector. The country has, within less than half a century, moved from a third world country to a middle-income economy and has the ambition of becoming a high-income country in coming years.

The various turns in history have also shaped the country's demographics, with the slave trade followed by indentured labourers, making this small plot of land a melting pot for different cultures to co-exist. The political system played a significant role in strengthening and holding the otherwise fragile social web of multi-cultural countries tight. The education system has enabled the country to go into the next phase of its economic development.

This chapter also looked at the development of telecommunications, with a focus particularly on the Internet on the island since its inception. It has been noted that the political will and ambition of the government, in line with its plan to diversify the economy, has given an impetus for the development of ICT on the island. Starting with the liberalisation of the telecommunication sector, through legislating on key issues pertaining to ICT and Internet, to the development of infrastructure to support a budding ICT sector, the government has played a major role in boosting the growth of the Internet on the island.

Over the years, the country has undergone subsequent changes in the infrastructure as the technology evolved, starting with Dial-up connectivity to Broadband connection of 10 Mbps with the setting up of Undersea Optical Fibre cables to offer international connection. Today both fixed and mobile Broadband connectivity are offered on the market. Parallel to developing the infrastructure, the price of the Internet has been going down but at a rather slower rate; there is still much criticism from users with regard to the quality of the connection as discussed further in chapters 6 and 7, and the accessibility of the Internet for low-income households.

This chapter explored the background and context of Mauritius. Despite struggling with Digital Divide, Mauritius offers an interesting setting to delve into the issue of Digital Inequality. As discussed previously, most research on Digital Inequality has been undertaken in developed countries and mainly OECD countries. Looking at the phenomenon in a developing country with specificities such as Mauritius can provide additional clues on the inception and development of Digital Inequality. The following chapter, therefore, sets out to describe the methodology used to investigate Digital Inequality and its determinants in Mauritius.

Chapter 4: Methodology

4.1. Introduction

De Vaus (2001, 9) contends that the "function of a research design is to ensure that the evidence obtained enables us to answer the question as unambiguously as possible". Furthermore, the methodology adopted has a high impact on the reliability and the validity of the research. It is, therefore, crucial that the aim of the study be well understood before designing and selecting the appropriate methods.

As outlined in Chapter 1, the goal of the research is to understand the phenomenon of Digital Inequality in a developing island state context. Chapters 2 and 3 discussed the theoretical background of Digital Divide and Digital Inequality and explained the particular context of Mauritius while emphasising the dearth of research in the area, especially from a developing country perspective.

This chapter, thus, sets out to describe and explain the research design and methods used to answer research objectives three and four, namely to identify the main causes/determinants of Digital Inequality in the Mauritian society and to situate governmental and non-governmental initiatives in relation to the main determinant of Digital Inequality. The research questions warranted the use of the Mixed Methods approach allowing a deeper understanding of the Digital Inequality phenomenon and its ramifications. Consequently, this chapter starts by explaining the rationale behind such methods and justifies the qualitative and quantitative methods used.

The tools used for each of the aforementioned methods are also outlined. For the quantitative method, the use of snowballing technique and the use of an online survey are discussed and justified. The questionnaire design, as well as the survey distribution, is further explained, and the statistical tools used for the inferential analysis are outlined.

As for the qualitative methods, the rationale for choosing semi-structured interviews is put forward. The use of purposive sampling is further discussed and the selected candidates' organisation is justified. The interview procedures are detailed, and the choice of the key Internet stakeholders is stated.

Lastly, the chapter discusses the ethical considerations of the research. It outlines how the ethical issues related to research with human subjects and outlines the procedures undertaken to ensure that the research complies with the Health and Medical Research Council Statement on Ethical Conduct in Human Research and the Australian Code for the Responsible Conduct of Research.

4.2. Mixed Method Approach

Researchers have been successfully mixing both qualitative and quantitative methods since the late twentieth century, arguing that neither of the two paradigms (positivism and constructivism) could fully answer some of the research questions on their own. This gave rise to a third research paradigm—the pragmatist approach, which aims at bringing together the best of both traditional breeds. Rejecting the incompatibility thesis of the two approaches (positivism and constructivism) (Johnson, Onwuegbuzie, and Turner 2007), the pragmatism approach “allows researchers to study what interests and is of value to (them), study it in the different ways that (they) deem appropriate, and use the results in ways that can bring about positive consequences within (their) value system” (Tashakkori and Teddlie 1998,30 cited in Graff 2014, 47). Furthermore, Creswell (2011, 276) argues that “pragmatism emphasises the importance of the research questions, the value of experiences, and practical consequences, action, and understanding of real world phenomena”.

By putting the research question first, the pragmatist approach allows for a mix of both the quantitative and qualitative approach. Creswell and Plano

Clark (2010, 25) contend that “calls have been made to embrace pragmatism as the best philosophical foundation for Mixed Methods Research”.

Additionally, in their meta-analysis of the various definitions of Mixed Methods Research, Creswell and Plano Clark (2010) argue that there is no one single definition of Mixed Methods Research (MMR). They contrast the various attempts at defining MMR by scholars focusing on specific areas such as methods, philosophy, purpose, qualitative and quantitative research, and research design amongst others (Creswell and Plano Clark 2010). However, they argue that MMR should possess the following core characteristics, namely, one, that the researcher collects and analyses persuasively and rigorously both qualitative and quantitative data (based on research questions). Two, mixes (or integrates or links) the two forms of data concurrently by combining them (or merging them), sequentially by having one build on the other, or embedding one within the other. Three, gives priority to one or both forms of data (in terms of what the research emphasises). Four, uses these procedures in a single study or in multiple phases of a program of study; frames these procedures within philosophical worldviews and theoretical lenses. Five, combines the procedures into concrete research designs that direct the plan for conducting the study (Creswell and Plano Clark 2010, 5)

The primary benefit of using Mixed Method approach lies in the fact that it allows researchers to answer questions or to gain insight into the phenomenon that could not be possibly be solved either by a quantitative method or a qualitative method alone (Tashakkori and Newman 2010). Tashakkori and Newman (2010, 514) further argue that the mixed methods allow for issues to be “examined from multiple perspectives and types of evidence from multiple sources, leading to conclusions that may be complementary and/or confirmatory”. It is, therefore, legitimate to use MMR for this research as it provides a clear and sound philosophical and methodological support in answering the research objectives. As outlined in the previous chapters, Digital Inequality is a complex phenomenon that can only be understood from multiple perspectives. Using only a qualitative or

quantitative method alone would have allowed answering either the question of what are the determinants of Digital Inequality in Mauritius or what are the government and non-government organisations' stake in the Digital inequality, but not both. However, with MMR, using a mix of quantitative and qualitative methods should allow answering both research questions and also provide a better insight into the Digital Inequality phenomenon.

In the case of this study, two main research questions needed to be answered. The first, investigating the determinants of Digital Inequality among Internet users in Mauritius, and secondly, exploring the stakeholders' understanding and initiatives with regard to Digital Divide and Digital Inequality. Clearly from the above discussion and from the theoretical approach discussed in Chapter 2, quantitative approach is best suited to investigate the existence and determinants of Digital Inequality in Mauritius. The rationale for such method is that firstly, a model testing approach (DiMaggio and Hargittai's model) is used to explore Digital Inequality in Mauritius. Secondly, it pertains to large group of users, from which the same data needs to be sourced. Bryman (2012, 175–77) argues that there are four preoccupations in quantitative techniques, namely measurement, causality, generalization and replication. Quantitative methods thus provided the best approach to measuring and exploring the causes of Digital Inequality from a representative sample of the Mauritian Internet user population but also offered the possibility of generalising to the larger population, and finally it offered the opportunity for the research to be replicated at a later stage within the same context or in a different context.

As for the second question, it was first important to identify the stakeholders of the Mauritian Internet ecosystem. As discussed later, three main categories of stakeholders were identified, namely the government, civil society organisations (CSO) and Internet Service Providers (ISP). The rationale for using a qualitative approach to investigate their perceptions and initiatives was primarily motivated by the fact that the population from which data would be sourced is so diverse and have different focus that the same question could not be addressed to all of them. For example, the focus of the

government and that of ISP's are different and distinct that having the same questions to both would not provide enough insight into the issues. Additionally, the aim was not to measure but rather to understand deeper the contextual challenges for dealing with these issue and as such, it was important to explore these through finer and unstructured methods. Users were deliberately excluded from this survey because the investigation related more to policy and organisational initiatives rather than personal and individual understanding of the issue.

Once the philosophical rationale was clearly understood, it was important to investigate how to mix best the quantitative and qualitative methods. Just as there is no one single definition to MMR, there is also no unified agreement as to the ways in which qualitative and quantitative methods can be mixed. Scholars have proposed several models for mixing methods (Creswell and Plano Clark 2010). Tashakkori and Newman (2010) argue that there are mainly three main broad families in terms of how the methods are mixed; they are mainly sequential, parallel or convergent. In parallel designs, two sets of data are independently collected (QL and QN) and analysed, whereas in sequential design (QL then QN or QN then QL), the second round of data gathering is informed by the first round; as for convergent, it occurs where one type of data can be converted in another type of data for further insight (Tashakkori and Newman 2010). Despite these different strands, the model for mixing methods remains tightly and fundamentally linked with the research question(s).

For this study, it was evident that since the two approaches were distinct, with no approach influencing or requiring insight from another, that the most suitable MMR approach would be the parallel model as shown in Figure 4.1 turns out to be best suited for this research.

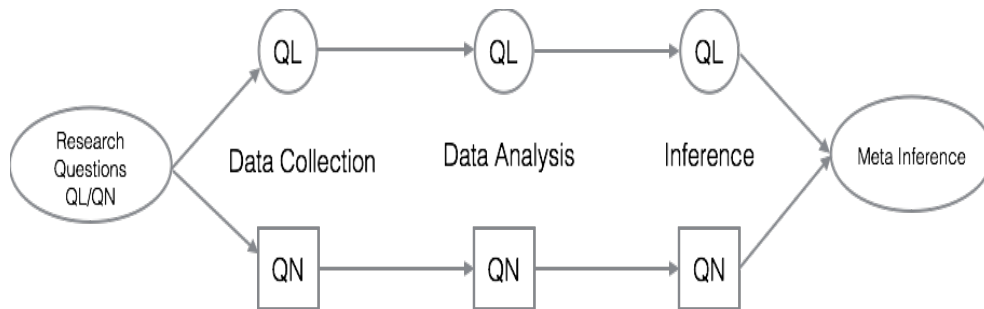

Figure 4.1: Parallel (QL+QN) Mixed Methods Design (Source: Tashakkori and Newman 2010, 516)

In this model, both the quantitative methods (QN) and qualitative methods (QL) will be conducted in parallel, without any of them influencing or having any impact on the other. It is expected that at the end both methods will provide enough insight for a meta-inference on the Digital Inequality phenomenon. The tools for each of the methods used are further explained below.

4.3. Quantitative Methods

The quantitative research method was used to answer the third objective of this research, which is to identify the main causes/determinants of Digital Inequality in the Mauritian society. To achieve this goal, it was imperative to collect data from a representative sample of Mauritian Internet users with regard to their demographics and the parameters around which they use the Internet. This information would then allow, through inferential statistics, to identify the main causes of Digital Inequality at population level. Since the same information needed to be gathered from different cases (users), a survey was used as data gathering technique (De Vaus 2002).

As with any survey, it is important to ensure that a random sample of the population is obtained to enable generalisability of the results. Traditionally, in research involving Internet users, a random sample of people are sourced through geographical stratification, followed by random selection of postal addresses (Oxford Internet Survey) or phone directories (Pew Internet Survey) since the research also involved non-users or focused on the whole

family. This method guarantees randomness but also gathers information on Internet users and non-Internet users alike.

However, for this research, such method was not suitable for a couple of reasons. Firstly, there is no publicly available database of postal addresses in Mauritius from which a sample could have been sourced. A suitable proxy could have been the Electoral Supervisory Commission list of voters or the fixed line phone book registry but all of these potential solutions have limitations that do not allow for the objective to be answered. For example, the electoral supervisory list would exclude anyone below 18 years of age and the fixed line phone registry would exclude de facto people who rely solely on mobile for communication. Moreover, with the low fixed Internet penetration on the island, the fixed line phone book registry would have turned out to be problematic or almost impossible, due to lack of information, to source Internet users, or rather phone numbers, with an Internet subscription from the population.

Secondly, as outlined in previous chapters, the scope of this research is focused on the ways people use the Internet and are constrained in their use. Non-users, although they can be of high importance in Digital Divide research, are not within the scope of this study. Therefore, sampling the whole Mauritian population in search for Internet users would have been cumbersome and impractical. Nonetheless, administering the survey to members of the family would not have provided a representative sample of Internet users.

Thirdly, there exists no such defined and accurate list of Internet users. Although one way to get around the issue would have been to use the list of Internet subscribers, which would be closer to Internet users, still there would have been an element of bias since there could be multiple users for one subscription and in addition, this method would exclude Internet users who are not subscribers. Furthermore, the said method's success would have been highly dependent on the collaboration of all ISP's to allow access to their database of subscribers. In an attempt to use this method, ISP's were

approached to collaborate but unfortunately, for legal, marketing and privacy issues, the requests were turned down.

De Vaus (2002, 7) argues that “a basic difficulty when trying to describe how to do research is the gap between textbook accounts of how research should be done and how it actually is done”. Some real-life uncontrolled parameters invariably affect how the research is carried out. This research is no exception and some parameters affected the ‘textbook’ flow of the research. With Mauritian Internet users constituting a hidden population, the snowball technique offered the most reasonable approach to disseminate the survey (Saunders, Lewis, and Thornhill 2009). Considering its known limitations and without any better alternatives, several procedures were put in place to ensure that the selected sample is a fairly good representative sample of Mauritian Internet users. These procedures are explained in further detail in section 4.3.3, detailing the survey distribution.

In order to reach the maximum Mauritian Internet user population, irrespective of demographics and geographical limitations, a web survey was used to gather the data. In contrast to other survey instruments, web surveys offered some advantages that best suited this research. Firstly, members of the population selected are Internet users and can thus be assumed to have access the survey online. To ensure that both frequent users and non-frequent users are given equal chances to respond, the survey was kept live for six months to give ample time for users to access and share the survey. Secondly, since the research also encouraged users to share the survey, web survey provided this added advantage of being easy to share, both online and offline. The relative cost effectiveness, faster response time, freedom of respondents to answer questions on their own and in their own time, coupled with the characteristic of web surveys as having fewer unanswered questions and enhanced data accuracy (Bryman 2012), made such tool ideal for this study.

However, there are some limitations to the use of web-surveys. Such limitations can be said to be either of a methodological nature (Wright 2005) or design nature (Bryman 2012). From a methodical perspective, Wright

(2005) argues that there are some challenges associated with online surveys when it comes to sampling issues and access issues. Online sampling is quite problematic but Hewson et al. (2003) contend that the potential of online surveys in getting more or less the same sample as offline survey should not be undermined. In the same vein, Bryman (2012) argues that

when there is no sampling frame, which is normally the case with samples to be drawn from the general population, the main approach taken to generating an appropriate sample is to post an invitation to answer a questionnaire on relevant newsgroup message boards, to suitable mailing lists or on web pages. (p674)

In the case of this research, there is no sampling frame and several channels were used to recruit respondents as discussed further in Section 4.3.3. Although this does not counteract the limitation, it nonetheless reduces its impact on the research.

Insofar as access is concerned, there are two main limitations. The first, concerns access to the technology where the respondents need to have access to the Internet to take the survey. Since the target population of this research are Internet users only, it can be argued that the issue of access to the technology is not a major constraint to the good running of the research. Besides, as mentioned earlier, the survey was live for a period of six months to allow for irregular Internet users to access the survey. The second issue relating to access to the survey pertains to the skill the users need to complete the survey. Indeed, Internet users need to have the required digital competency to navigate through the online survey, however, Great care was taken when designing the survey to ensure that users with low digital literacy skills could take the survey without any difficulty (discussed in more detail in Section 4.3.1.9). Despite such precautions, there could be a portion of the target population that might not be able to take the survey due to their limited digital/online skills.

It is therefore important to acknowledge that there are some limitations when it comes to the use of web-survey. Such limitations should be taken into consideration when appreciating the relevance and pertinence of the results.

4.3.1. Questionnaire Design

The purpose of the survey is twofold. Firstly, it aims at gathering pertinent information on Internet use according to a number of factors, including demographics in Mauritius, and secondly in identifying the main causes/determinants of Digital Inequality in the Mauritian society. Thus, the Mauritius Digital Inequality Survey (MDIS) was built around the five core factors of Digital Inequality, as identified by DiMaggio's model in Chapter 2.

The questionnaire was divided into eight sections:

Section 1 – Demographics

Section 2 – Inequality in Technical Apparatus

Section 3 – Inequality in Autonomy of Use

Section 4 – Inequality in Skill

Section 5 – Inequality in Social Support

Section 6 – Inequality in Purpose of Use

Section 7 – Closing Remarks

Section 8 – Thank You Page

Each of the above sections is explained below.

4.3.1.1. Demographics

Section 1 of the survey consisted of eight questions revolving around the demographic data of respondents. The data gathered would be vital in identifying the various determinants of Digital Inequality and understand the differences between the different demographic strata of Mauritian society. Since the survey was to be released/distributed online, it was necessary to include a filter question to ensure that all respondents were Mauritian residents. Therefore, the first question probed respondents' residential status. Since the survey would be available online and accessible to the whole world, it was imperative to have such filter question to ensure that only Mauritian Internet users would take the survey. Thus, non-residents would be redirected to a page thanking them for their interest in the survey and asking

them to share the survey with their Mauritian friends. Key demographic variables were requested from the respondents, such as sex, which is a significant demographic variable in assessing differences within a population. Age was also requested, but instead of asking respondents to tick age group boxes, they were to select their actual age from a drop-down list. This would allow for more flexibility in determining the age group range to be used for analysis. Since there would be no interaction with another person and privacy was ensured with this online method, it is believed that respondents would be more inclined to divulge their real age.

Another important variable in demographics is the residential area. This is an important variable because the infrastructure in different areas differs—some coastal villages have state of the art infrastructure because of hotels welcoming tourists, who request high-speed Internet. Additionally, new high-end Internet infrastructure is usually deployed in urban areas before the rest of the country. Therefore, respondents were invited to choose their residential location between urban, suburban, coastal rural and rural area. They were also provided with the option of writing down their residential location since the use of these categories is not natural to Mauritians. Ideally, using postcodes would have been more convenient, but the Mauritian postal system did not use postcode as at the time of the research (although it is a project that is being implemented).

The next demographic variable queried was the occupation of the respondents. The rationale for getting occupation was to situate the socio-economic status of respondents by having them choose their current situation among the ten categories provided. The choices offered were: student, self-employed, educator/trainer, admin/clerical, middle management, top management, retired, technician/specialist, manual worker, unemployed. Additionally, another variable that could help in situating the socio-economic status of respondents would be their highest level of education achieved, which was asked in the following question in the section. Although asking respondents their income would have been more straightforward, it was deemed not to be a useful measure because the target audience consisted

of a large proportion of youngsters and students, whose income is not representative of their socio-economic status (Hargittai 2010). Hargittai (2010) suggests that the education level of parents is a better proxy for the socio-economic level of the students. Therefore, respondents were also asked the highest education level of their parents and had to select only the highest one. Besides, since there might be students responding to the survey, it was logical to have another question asking respondents their current education level if they are studying. The following table (Table 4.1), outlines the variables used in the Demographics section and their measurement.

Variable	Choices	Measurement
Sex	Male Female	Nominal
Age	Actual Age (select 12-100)	Scale
Residential Area	Urban Suburban Rural (inland) Rural (coastal)	Nominal
Occupation	Student self-employed educator/trainer admin/clerical middle management top management, retired technician/specialist manual worker unemployed	Nominal
Highest Level of Education	Primary School (CPE or below) Vocational SC (or equivalent) HSC (or equivalent) Certificate/Diploma Professional Course (ACCA, ICSA, ABE, etc) Undergraduate degree Postgraduate degree or above	Nominal
Current Education Level	Primary School (CPE or below) Vocational SC (or equivalent) HSC (or equivalent) Certificate/Diploma Professional Course (ACCA, ICSA, ABE, etc) Undergraduate degree Postgraduate degree or above Not studying	Nominal
Highest Education Level of Parents	Primary School (CPE or below) Vocational SC (or equivalent) HSC (or equivalent) Certificate/Diploma Professional Course (ACCA, ICSA, ABE, etc) Undergraduate degree Postgraduate degree or above	Nominal

Table 4.1: Demographics Variables

4.3.1.2. Inequality in Technical Apparatus

Section 2 of the survey questionnaire focused on the first dimension of the Digital Inequality model used in this thesis, which is inequality in technical apparatus. Questions in this section focused on the devices used, the Internet connection type and the connection location and whether any of these limited the respondents' effective use of the Internet. The first question was a filter question to differentiate between those who own the device used

to connect to the Internet and those who do not. The rationale is that people who do not own the device would not have any subscription or have less information about the type of connection used to access the Internet, as opposed to those who own a device. As such, only those who owned a device were asked questions relating to the type of devices used (Desktop/laptop versus mobile devices) and the type of connection used (Broadband, narrowband, mobile). They were also asked about the location of their connection over the past three months. However, since they could access the Internet from multiple locations, there were also questions about their main access point (location).

Alternatively, respondents who did not own their device were asked the location type (workplace, public access, etc.). Finally, both groups (owners and non-owners) were queried on whether hardware, software, bandwidth and reliability of the Internet connection limited their effective use of the Internet. This section thus provides data about device ownership but also information about the type of devices used and the connections and perception on whether technical apparatus limits the effective use of the Internet. Table 4.2 summarises the variables used in measuring Inequality in technical apparatus, which are all independent variables.

Variable	Choices	Measurement
Device Ownership	Yes No	Nominal
Owners Main Connection mode	Computer (desktop/Laptop) with a fixed (ADSL) Internet connection (including MyT Wi-Fi) Computer (desktop/Laptop) with a fixed (dial up) Internet connection Computer (desktop/Laptop) with a mobile Internet connection (Internet dongle) Mobile phone or a tablet device with a fixed Internet connection (e.g. MyT Wi-Fi) Mobile phone or a tablet device with a mobile Internet connection Did not connect to the Internet in the past 3 month	Nominal
Owners Connection Location	Home Workplace Place of study (School, college, university) Public location On the go (mobile Internet) Did not connect in the past three months	Nominal
Owners Main Connection Location	Home Workplace Place of study (School, college, university) Public location On the go (mobile Internet) Did not connect in the past three months	Nominal
Non-Owners Main Connection Location	Workplace School, college, university Friend's/family's place Free public location (e.g. Library, Post) Paid public location (e.g. cybercafé) Did not connect in the past three months	Nominal
Technical Apparatus Internet Effective User	Hardware (including computers and other devices) Software (programs and applications) Bandwidth (speed of connection) Reliability of the connection (interruption in connection)	Ordinal (5 point Likert Scale)

Table 4.2: Inequality in Technical Apparatus Variables

4.3.1.3. Inequality in Autonomy of Use

The following section focuses on the second dimension of Digital Inequality, which is autonomy of use. The aim of this section is to investigate the relative freedom that users have in accessing and using the Internet without assistance or interference.

While the frequency of use has been a meaningful and useful measure in past research on Internet use, Liang (2007, 43) argues that “with the emergence of cheap monthly paid broadband and always-on access, questions about frequency of Internet use have become less relevant”. In the pre-testing of the survey, some of the respondents were unable to quantify

their frequency of use since they would be receiving push messages from different sources (email, Facebook, messages) throughout the day. Nonetheless, it is important to understand the relative frequency of Internet use as it gives an idea of the extent of Internet use. It can be assumed that someone who is more connected is more likely to use the Internet 'more' than someone who is less connected. Therefore, rather than having a question about frequency of Internet use, users were questioned on their feeling of connectivity, that is, whether they felt always connected as opposed to connecting to the Internet only when there is a need for it. This would then act as a proxy for the frequency of use in this study.

The following question in the survey probed respondents on the monitoring of their Internet use. They were asked whether they could access the Internet without being monitored at all or whether their access was monitored either at organisation level (work, university, school) or individual level (parents, partners), as discussed by DiMaggio and Hargittai (2004). Respondents were also queried if any of the content they wish to access was blocked by governmental policies, organisations (ISP, university, work), third parties (cybercafé, library), and parents or not blocked at all. This section closes with a set of questions measuring respondents' perception of the importance of issues such as lack of time spent online, cost of Internet, blocking of online content, monitoring and sharing of Internet connection with others, limited their effective use of the Internet. The following table (Table 4.3) outlines the variables used to measure inequality in autonomy of use, which are all independent variables.

Variable	Choices	Measurement
Connection Status	<p>I think of myself as 'always connected' because I can access the Internet anytime</p> <p>I regularly connect to the Internet, but I don't think of myself as 'always connected'</p> <p>I only connect to the Internet when I need to do a specific task.</p>	Nominal
Monitoring Use	<p>I can access the Internet without being monitored if I want</p> <p>I can only access the Internet while being monitored by an organisation (work, university, etc.)</p> <p>I can only access the Internet while being monitored by other people</p>	Nominal
Blocking of Online content	<p>No content that I wish to access is blocked</p> <p>Some content I wish to access is blocked by Governmental policies</p> <p>Some content I wish to access is blocked by the organisation (school/college/university/work)</p> <p>Some content I wish to access is blocked by third parties (cybercafé, library, etc.)</p> <p>Some content I wish to access is blocked by my parents</p>	Nominal
Autonomy of Use Internet Effective User	<p>Lack of time to spend online</p> <p>Cost of Internet connection</p> <p>Blocking of Internet content and services</p> <p>Monitoring of my Internet use</p> <p>Sharing of devices with other people</p> <p>Place where I use the Internet</p> <p>Lack of accessibility to the Internet</p>	Ordinal (5 point Likert Scale)

Table 4.3: Inequality in Autonomy of Use Variables

4.3.1.4. Inequality in Skill

The next set of questions dealt with another aspect of Digital Inequality, namely skill. According to Hargittai (2002), users' online skill is perhaps the most important factor when investigating Digital Inequality. However, according to Hargittai and Hsieh (2012, 1), one of the challenges of measuring Internet user skill is the absence of "reliable measures". Measuring skill by observation can be quite daunting and expensive, especially when the main focus of the research is not to measure skill alone, add Hargittai and Hsieh (2012). In light of this scarcity of measuring tools, Hargittai developed and refined a survey instrument for measuring online skill—"the Web-use skill measure index"(Hargittai 2006; Hargittai 2002a; Hargittai 2007; Hargittai 2008b; Hargittai and Hsieh 2012).

The Web-use skill measure index, which initially consisted of 27 Internet-related items, also proposes a set of 6, 10 or 15 related items that can be used for general population and another set for people with low Internet skill level (Hargittai and Hsieh 2012). It must be emphasised that the test and items were designed for use in the American context: The Mauritian context is different, with the Internet still struggling to get into the mores, requiring that some specific features be given additional consideration. The scope and the length of the survey allowed for a 15 items measure to be used. Thus, Hargittai's 15 items web-use skill measure tool was reviewed and contextualised for the Mauritian context, resulting in an 11 items list. Respondents were then asked to evaluate their understanding of these Internet-related terms on a 5-point (0-4) Likert scale. Table 4.4 shows the different terms suggested by the Web-use Skill index and the final list of items used in the Mauritius Digital Inequality Survey.

Full List of 27 Items	Abbreviated Web-Use Skill Indexes for General Population			Mauritius Digital Inequality Survey items
	6 items	10 items	15 items	
Reload				
Bookmark				
Advanced Search	Advanced Search	Advanced Search	Advanced Search	Advanced Search
Favourites				
Tagging		Tagging	Tagging	Photo Tagging
Preference Setting			Preference Setting	Privacy setting
PDF	PDF	PDF	PDF	
Spyware	Spyware	Spyware	Spyware	Spyware
Tabbed Browsing			Tabbed Browsing	Tabbed Browsing
Firewall			Firewall	
Blog				
Wiki	Wiki	Wiki	Wiki	
JPG		JPG	JPG	
Weblog		Weblog	Weblog	
Podcasting			Podcasting	
Torrent				
Web feeds				
Newsgroup				
Bcc (on email)				
Frames				
Cache	Cache	Cache	Cache	Cache
Widget				
Bookmarklet				
Malware		Malware	Malware	
Phishing	Phishing	Phishing	Phishing	Phishing
Social Bookmarking				
RSS			RSS	
				Cookies
				Modem
				Wi-Fi router/Livebox
				Content Upload

Table 4.4: Web-Use Skill Index Items (Adapted from Hargittai and Hsieh 2012)

The factors that were taken into consideration when modifying Hargittai's list of items are time, location, level of Internet development in the country and current technology available. Indeed, Hargittai's research was carried in 2012 in the United States, whereas the current Digital Inequality survey was conducted in 2013 and items such as PDF and JPG was considered as being then too common to be included in the list. Moreover content upload is not an activity that is favoured much by Mauritians (Statistics Mauritius 2006). Therefore, it was natural to remove items such as wiki, weblog and podcasting and replace with a much broader term—content upload. At the time of the survey design, the Mauritian Internet infrastructure still had a quite high percentage of dial-up connections but was gradually phasing out and migrating towards new technologies. It was, therefore, deemed valid to

include items such as modem, Wi-Fi router and Livebox, which together encompassed the old and the new Internet technologies.

Lastly, respondents' Internet familiarity would be inferred by asking the year in which they started to use the Internet. This would allow determining their relative experience, in years. Also, a question relating to whether they received formal training to use the Internet was included in the survey. The last question in this section related to the effectiveness of their Internet use and whether they perceived their lack of knowledge of software, hardware, online interaction and information search as limiting the effectiveness of their Internet use. The aim of the questions is to gather reliable and valid data on the relative perceived skill and experience of each respondent in their use of the Internet. Table 4.5 outlines the independent variables used to measure inequality in skill.

Variable	Choices	Measurement
Internet use Experience	Year you started using the Internet – (select year)	Ordinal
Received Formal Training	Yes No	Nominal
Internet Skill (Rate Familiarity with terms)	Advanced search Photo tagging Content Upload Tabbed Browsing Wi-Fi router/Livebox Modem Privacy settings Cookies Cache Phishing Spyware	Ordinal (5 point Likert Scale)
Skills Internet Effective User	Lack of knowledge in using the software Lack of knowledge in using the hardware Lack of knowledge in finding information online Lack of knowledge in interacting online with others Lack of knowledge of Internet security issues.	Ordinal (5 point Likert Scale)

Table 4.5: Inequality in Skill Variables

4.3.1.5. Inequality in Social Support in Internet Use

Section 5 of the survey dealt with the inequality in social support. The objective of the questions in this section was to gather information on the

reasons why respondents started to use the Internet (first question) and also investigate the help they received from their immediate social environment. Indeed, Yang et al. (2010) argue that social support consists of three types of support, namely formal technical assistance, informal technical assistance and emotional reinforcement. They further argue that social support will "increase users' motivation to use and reuse technology" (Yang et al. 2010, 149). The questions were built on Yang et al. research and examined issues such as respondents' perception of help available to them in their use of the Internet. Thus, in line with Yang et al. concept of emotional reinforcement, the last question asked respondents to rate the effectiveness of their Internet use with regard to factors such as lack of help, lack of encouragement to use the Internet, lack of reasons to use the Internet or just lack of access to the Internet. The information gathered should allow for analysis of the technical, social and emotional help available to the different groups. The following table (Table 4.6) summarises the independent variables used to measure inequality in social support.

Variable	Choices	Measurement
Reason for starting to use the Internet	I thought it would be interesting Someone else recommended it to me I started simply because Internet is readily accessible at home/work/educational institution I had to use it at work I used it to make money I used it to improve my career I had to use it for educational purposes (school/college/university/helping the children) To keep in touch with family/friends To develop my Internet-use skills	Nominal
Help Seeking in use	Never, Occasionally, Sometimes, Often, Almost all the times	Ordinal (5 point Likert Scale)
Help availability	Yes No	Nominal
Source of Help	Family members Friends and neighbours Teachers/lecturers/trainers (from educational institutions) Classmates/peers Colleagues Organisational IT department Cybercafé/Library help desk Online help forums	Nominal
Source of Best help	Family members Friends and neighbours Teachers/lecturers/trainers (from educational institutions) Classmates/peers Colleagues Organisational IT department Cybercafé/Library help desk Online help forums	Nominal
Social Support Internet Effective Use	Lack of help/support when I needed it Lack of encouragement to use the Internet No clear idea of why I should use the Internet No safe place where I could use the Internet	Ordinal (5 point Likert Scale)

Table 4.6: Inequality in Social Support Variables

4.3.1.6. Inequality in Purpose of Use

The next section of the survey dealt with the inequality in use. There are different approaches that can be used to understand the use people make out of the Internet. For example, Dutton, Helsper and Gerber's (2009), as part of the Oxford Internet Surveys (OXIS) classify Internet use into five broad categories; Information Seeking, Communication and Social Networking, Entertainment, Services, and finally Creation and Production. Alternatively, Zickuhr and Smith (Zickuhr and Smith 2012a), in the Pew Internet and American Life Project, list down a series of activities for users to

rate. Another interesting list of online activities is that of Allen (2010), in his research on the experience of connectivity in the Australian context. After taking into account the different list/categories available in the literature and the different contexts in which these lists were developed and used, it was clear that any list would have to be reviewed for several reasons. First, the fact that some of the lists were quite long and would not fit the research aim. Second, the items were selected based on uses in developed countries and might not fit a developing country setting and it was important to capture as truly as possible the different uses that Mauritians make out of the Internet.

Therefore, using Dutton, Helsper, and Gerber (2009) categories as basis and a combination of items from Zickuhr and Smith (Zickuhr and Smith 2012a) and Allen (2010), the following categories and items were formulated:

- Information seeking (research, following contacts, newsletters, etc.)
- Communicating directly with other people (email, chat, video calls, etc.)
- Making and maintaining social networks (Facebook, LinkedIn, Twitter, etc.)
- Performing online transaction (online banking, shopping, online selling, etc.)
- Playing Games (either alone or with other people)
- Listening, downloading and sharing music (streaming, downloading and sharing)
- Viewing, downloading and sharing videos (streaming, downloading and sharing)
- Publishing Information (blogging, maintaining a website, writing articles online, etc.)
- Distributing multimedia production of your own (photography, videos, audios, etc.)
- Working collaboratively in a team or organisation to achieve a goal (Whether entirely online or with people you also meet in person)
- Supporting political parties online (e.g. through online discussion and debate)

- Support a cause you highly believe in (animal welfare, social cause, etc.)

Although not exhaustive, the above list covers most of the activities that can be conducted online while giving the respondent enough information/examples in each category. Respondents were thus asked to rate on a 5-point Likert scale, how important these activities are in their use of the Internet. The data gathered in this section thus allows for a more comprehensive analysis of Internet use among the different groups that make up the Mauritian society. Table 4.7 outlines the variables used to measure inequality in purpose of use. They are all independent variables.

Variable	Choices	Measurement
Purpose of Use Effective Internet use	Information seeking (research, following contacts, newsletters, etc.) Communicating directly with other people (email, chat, video calls, etc.) Making and maintaining social networks (Facebook, LinkedIn, Twitter, etc.) Performing online transaction (online banking, shopping, online selling, etc.) Playing Games (either alone or with other people) Listening, downloading and sharing music (streaming, downloading and sharing) Viewing, downloading and sharing videos (streaming, downloading and sharing) Publishing Information (blogging, maintaining a website, writing articles online, etc.) Distributing multimedia production of your own (photography, videos, audios, etc.) Working collaboratively in a team or organisation to achieve a goal (Whether entirely online or with people you also meet in person) Supporting political parties online (e.g. through online discussion and debate) Support a cause you highly believe in (animal welfare, social cause, etc.)	Ordinal (5 point Likert Scale)

Table 4.7: Inequality in Purpose of Use

4.3.1.7. Closing Remarks

Section 7 of the survey (Closing section) asked respondents a general question about their overall perception of Digital Inequality in Mauritius based on the five dimensions (technical apparatus, autonomy of use, skill, social support and purpose of use). A horizontal rating Likert scale (1-10) was used to query respondents on how far they agreed that all Mauritian Internet users derive maximum benefits in every aspect (devices used/connection, freedom of use, skill, help and purpose of use) of their Internet use. The rationale for such question and a finer rating scale was guided by the use of regression analysis in determining the dimensions of Digital Inequality. Table 4.8 outlines the choices and the measurement use for the dependent variable.

Variable	Choices	Measurement
Rating on Perception of Digital Inequality	Extremely agree – Extremely Disagree	Scale (10 point Likert Scale)

Table 4.8: Digital Inequality Rating Variable

4.3.1.8. Thank You Page

The last section of the survey is dedicated to closing the survey and thanking the respondents for their time and effort in answering the questions. A brief thank you note was provided and respondents were given details of how to follow the progress of the survey and results, mainly through social network sites. Moreover, respondents were given the option of leaving an email address, should they be willing to participate further in the research, for example, a focus group. In order not to undermine the respondents' anonymity, the email column was removed from the analysis file and kept in a separate document.

4.3.1.9. Web Survey Design—Survey Monkey

Sue and Ritter (2012) argue that the nature of a web survey is such that they require particular attention in their design. Indeed, they recognise that “online

surveys have more flexibility in how they look, the response options, and the types of media that can be used...” (Sue and Ritter 2012, 59) thereby requiring special consideration when designing such surveys to ensure the right information is gathered. They build on the work of Dillman, Tortora and Bowker (1998) to describe some fundamental principles in designing web survey. Amongst others, they argue for the need to have (i) a ‘Welcome Screen’, which explains the nature of the survey (Sue and Ritter 2012; Dillman, Tortora, and Bowker 1998), (ii) clear explanations and instructions on answering questions (Dillman, Tortora, and Bowker 1998) and (iii) conventional formats that are usually used in paper questionnaires (Sue and Ritter 2012; Dillman, Tortora, and Bowker 1998). These principles were taken into consideration when designing this survey.

Some other user interface design principles were also adopted. For example, Schonlau, Frickler and Elliott (2002) provide a series of guidelines, although not exhaustive, in building Internet surveys. Some of the principles include, “List only a few questions per page; Eliminate unnecessary questions; Use graphics sparingly; Use matrix questions sparingly; Reduce response errors by restricting response choices; Force answers only on rare occasions; provide indication of survey progress” (Schonlau, Frickler, and Elliott 2002, 42–45).

Abiding by most of these principles, careful consideration was given to the page layout, with few questions per page. The survey was designed to provide the respondent with visual cues as to the progress (percentage completed) in the survey. The study contained only two compulsory questions and allowed the respondents to navigate freely forward and backward, to edit and delete their answers (in line with ethical requirements discussed in section 6.5). Furthermore, careful consideration was given to the font size and colour used to allow for users with disabilities (Schonlau, Frickler, and Elliott 2002).

There were various avenues explored with regard to setting up an online survey. Although an option could have been to design a website from scratch with the survey on it, this solution would turn out to be timely and not cost

effective. Some existing commercial online survey providers do offer robust and reliable service and one example is Survey Monkey (www.surveymonkey.com). Marra and Bogue (2006, 6) argue that Survey Monkey is a “popular online survey tool that comes with relatively large set of features considering the pricing structure”. This claim is further supported by Evans et al. (2009) who contend that the online survey has highly customisable features with regard to questions and administration and special features such as skip logic. Also, as part of the design principles, it is important that the survey be accessible on multiple devices and platforms (Schonlau, Frickler, and Elliott 2002) and Survey Monkey provided this added advantage of being cross-platform and compatible with different devices and major browsers (Survey Monkey 2014c; Survey Monkey 2014a).

Lastly, but importantly, careful consideration was given to the coding of the survey. Since the quantitative data was to be analysed using a statistical package, it was necessary to code the data captured by assigning a numerical code to each response (Pallant 2011). The reason for doing this was twofold—firstly, to ensure that the correct categories were being generated for analysis (Bryman 2012); and secondly, to facilitate the data transfer to the statistical package since Survey Monkey allows for data captured to be transferred straight to selected statistical packages, in occurrence SPSS (Survey Monkey 2014b), thereby safeguarding data integrity. The survey was coded before its release, but the code was kept hidden from the respondents so as not to interfere while they are responding to the questions.

4.3.2. Survey Pre-Test

To get reliable and valid responses from respondents, it was important to minimise the ambiguities and any bias that the questionnaire may have. The pre-testing of the questionnaire aimed at having a sample of people with more or less the same characteristics as the survey respondents to go through the survey and provide feedback on the questionnaire before making any adjustments.

De Vaus (2002, 114–16) argues that there are three stages of pre-testing or pilot testing questions. The first phase, which is the question development, ensures that all of the respondents derive the same meaning out of the questions. The second phase, questionnaire development, ensures that the questionnaire is evaluated as a whole regarding meaning but also concerning the time taken and the flow of questions. The last stage, polishing the pilot test, revises and validates all the questions and ensures that the design of the questionnaire is clear and does not lead to any biases.

In line with the stages mentioned above, stage one was carried out throughout the development of the questionnaire; representatives from the Charles Telfair Institute and Curtin University reviewed and commented on individual questions as the questionnaire was developed.

As for stage two, a significant pre-testing was held during the month of September 2012 with representatives from the Charles Telfair Institute and Curtin University as well as members of the Mauritian public aged between 12 years old and 60 years old. Parental consent was given to test the questionnaire on children under 16 years old. The test aimed at ensuring that respondents have more or less the same understanding of the questions. Since the test was done online, it provided the average time taken by respondents as well as feedback on the layout and design of the survey. In light of the feedback received, the following changes were made.

1. Some questions were reworded to ensure that they would be understood by all users aged 2 and above.
2. It became clearer that two questions had to be made compulsory. The first question, about residency, which would allow to filter Mauritian residents and non-Mauritian residents, and a second question, about device ownership, which would direct respondents to specific questions.
3. The initial idea of having one page for each section had to be reviewed since some pages contained too many questions.

4. The sequence of questions was reviewed and it was decided that it would be best to have the demographics at the beginning, rather than the end.
5. Use of bold and underlining to highlight some keywords in specific questions was adopted.

Tests were also carried out to ensure compatibility regarding the layout with various devices and operating systems to guarantee accessibility and usability for diverse Internet users.

Although Mauritius is a multi-lingual country, it was decided that the web survey would be carried out in English. The main reasons supporting such decision is the relative familiarity of Mauritians to answer surveys in English as opposed to French or in the local dialects. Also, using only one language would ensure a standardised understanding of the terms, whose meaning could have been lost during translation.

4.3.3. Questionnaire Distribution

The survey was designed in such a way so as to ensure a reliable and methodologically consistent approach for the data gathering and to minimise any biases of individual methods. Much of the difficulty in this research has been to ensure that there is a reasonable representative sample of Mauritian Internet users to allow for a deeper understanding of the differences in Internet use. To get a representative sample of Mauritian Internet users, several methods were used to promote the online survey across different strata of the Mauritian population. In this regard, a representative sample of Secondary schools across the island was selected and the survey was promoted in these schools. The directors of the schools were approached to share the survey among their students in the form of small invitation cards. Students would then take the survey during their free time or at home. It is important to note here that the promotion was done in line with the ethical requirements discussed further in Section 4.5.

Furthermore, emails were sent to a random sample of companies across the island to promote the survey amongst their employees. A Facebook page was also created for the survey and anyone wishing to obtain further information on the survey could join and ask questions. The reason for such a procedure is that the statistics showed a “high rate” of Facebook subscription among Mauritian Internet users (All in 1 Social 2015). Lastly, people were invited to share the survey with any other Internet users they knew.

Even though with the above-described approach, it is unlikely that the research has effectively given the possibility to every single Mauritian Internet user a chance to answer the survey. However, it can be safely assumed that every effort has been made to offer a majority of Mauritian Internet users a chance to participate in the investigation. It can, therefore, be assumed that the data gathered comes from a reasonably representative sample of Mauritian Internet users. Official statistics were used later to check the representativeness of the sample, as discussed later.

After carefully evaluating the ramifications and fully understanding the limitations of this research, the survey was released on 7 September 2012 and kept live for six months until the end of March 2013. Throughout the six months, considerable effort was put into promoting the survey among Mauritian Internet users. Once the survey was closed, Survey Monkey automatically generated an SPSS file for the survey. However, before continuing any further, it was important to ensure that the data manipulation was done properly. Although Survey Monkey allowed for a direct migration of data to SPSS or Microsoft Excel, some of the variables had to be recoded to ensure a smooth migration.

4.3.4. Quantitative Data Analysis

As mentioned earlier, IBM SPSS software was used for analysis of the survey data. Survey Monkey allowed for all the data captured to be downloaded in the appropriate format for use by SPSS. The coding of the

survey was done during the questionnaire design (see Section 4.3.1.8 above). However, some recoding and data preparation had to be done because of some errors induced in the automatic translation from Survey Monkey to SPSS. Descriptive statistics, tests to investigate differences between groups, Factor Analysis and Regression Analysis, are amongst the tests that were carried out on the dataset.

4.4. Qualitative Methods

Traditionally, quantitative methods entail numerical analysis and qualitative methods relate to narratives. Berg (2001) warns over the simplification of this equation and argues that qualitative methods go far beyond the mere gathering of narratives for analysis by enabling “researchers to share in the understandings and perceptions of others and to explore how people structure and give meaning to their daily lives” (p7). This is the underlying rationale for using qualitative methods to answer the research questions pertaining to situating governmental and non-governmental initiatives in relation to the main determinants of Digital Inequality in Mauritius. The aim is to gain an insight into stakeholders’ perception of the dimensions of Digital Inequality in Mauritius and what is being done in relation to this issue.

Among the qualitative tools available, a Semi-Structured Interview was chosen because it allows for flexibility and puts more emphasis on the interviewee's point of view (Bryman 2012), as opposed to structured interview approach. Subsequently, it gives the researcher the freedom to probe the interviewee on pertinent issues and it also offers "greater insight into what the interviewee sees as relevant and important" (Bryman 2012, 470). This would then allow for an in-depth analysis and understanding of the different forces underpinning the Digital Inequality phenomenon.

4.4.1. Interviewee Selection

In terms of interviewee selection, purposive sampling was used. Bryman (2012, 418) argues that "the goal of purposive sampling is to sample

cases/participants in a strategic way, so that those sampled are relevant to the research questions that are being posed". It was decided to group interviewees into three broad categories, namely: governmental-organisations—consisting mainly of policy makers and ICT regulators on the island; civil society organisations (CSO's)—which comprises of associations of private companies operating in the ICT sector as well as non-governmental Organisations (NGO's) concerned with the advancement of the Internet among the population (these could be local NGO's or chapters of International Organisations); Internet Service Providers—which are the companies providing the Internet to the users.

The aim of the interviews is to situate governmental and non-governmental initiatives in relation to Digital Inequality. To ensure representativeness within each of the three categories outlined, one senior representative from each chosen organisation within the three categories were thus sourced. The organisations chosen and the rationale for their selection are as follows:

Governmental Organisations

- i) Ministry of Information and Communication Technologies (MICT)—the highest governmental authority on issues pertaining to Information and Communication Technologies. The Ministry is responsible to oversee the formulation of all the main policies and legislation surrounding ICT amongst others (MICT 2014).
- ii) The Information and Communication Technology Authority (ICTA)—the governmental body and regulator for the ICT market in Mauritius (ICTA 2014a).
- iii) The National Computer Board (NCB)—the governmental body responsible for promoting the development of ICT on the island (NCB 2014).

Together, these three governmental bodies provide a representative view of the government's view on the issues of Digital Divide and Digital Inequality.

Civil Society Organisations

- i) Mauritius Information and Technology Industry Association (MITIA)—a business association comprising of companies engaged in ICT hardware and data processing activities in Mauritius (MITIA 2014).
- ii) Outsourcing and Telecommunication Association of Mauritius (OTAM)—a business association consisting of companies engaged in Information Technology Outsourcing, Business Process Outsourcing, International Long Distance Operators and Internet Service Providers (OTAM 2014).
- iii) Internet Society—Mauritius Chapter (ISoc)—a non-governmental Organisation consisting of individuals working towards propagating Internet culture in Mauritius (Worldwide Internet Society 2014b).

There are not many civil society organisations focusing on ICT on the island. With the ICT industry being a nascent one, the three main organisations were selected and are used here as being representative of the civil society organisations on the island.

ISP

- i) Orange Mauritius—the largest mobile Internet service provider as well as the largest fixed Internet service provider on the Island.
- ii) Emtel—a Mobile Internet Service Provider.

As at the design of this study, Orange Mauritius was by far the largest Internet service provider – both fixed and mobile and could thus on its own be representative of the ISP. However, for the sake of getting different perspective, the second largest ISP was added to the list.

4.4.2. Interview Questions

A semi-structured interview was used for the qualitative part of the research. This type of interview required that questions be formulated or broad themes identified and allowed for follow up questions or allowed flexibility to contextualise the questions depending on the interviewee (Saunders, Lewis,

and Thornhill 2009). This characteristic seems to be particularly valuable in the research context since the interviewees were from different backgrounds (governmental organisations, civil society organisation and ISP), each with their own perspective on the issue of Digital Inequality. The interview was divided into four main discussion themes, namely:

1. Introduction—focused on building up a rapport with the interviewee
2. Access—focused on Digital Divide
3. Use—focused on Digital Inequality
4. Conclusion—thank you note and concluding remarks

In the 'Introduction' section, participants were asked to talk briefly about their role within their respective organisations as well as the role of the organisation with respect to the Internet in Mauritius. The aim of this question was mainly to set a rapport with the Interviewee at the beginning of the interviews.

The second section on 'Access' focused on the Digital Divide issue. In this section, sub-themes included the role of Internet in the socio-economic development of Mauritius and an evaluation of how far has this been achieved. Questions on the interviewee's perception of the current state of Internet penetration/access on the island and why it was so high/low, and what could be done or was being done, were asked. The next sub-theme within this section was on the future of Internet access development in Mauritius and what were seen to be the major hurdles in developing and providing access to all.

The third and major section of the survey, 'Use', dealt with the Digital Inequality aspect of the research. This section has been further broken down to incorporate the five dimensions of inequality as discussed throughout this thesis. Apart from the five dimensions, other themes included the interviewee's perception of Internet use in Mauritius as well as their understanding of effective use. Furthermore, the role of the participants' respective organisation in promoting Internet use was also examined.

The last section of the interview, 'Conclusion', also consisted in examining the working relationship between the various Internet stakeholders in Mauritius. Thus, participants were questioned on whether or not, and how their organisations partner with other organisations in the development and promotion of Internet in Mauritius and how this was being done.

As for the survey, a pre-test was carried out for the interviews. The aim of the pre-test was twofold. Firstly, to determine the average length of the interview based on the prepared questions, and secondly to review the questions for any ambiguities and explore the types of follow-up questions that could be used for each section. The pilot interview was conducted on a couple of academics at the Charles Telfair Institute and some of the questions were reviewed by academics at Curtin University. Based on the pilot interviews, it was concluded that the interview would take on average one hour. It was also decided to adapt some of the questions to the respondent's background. For example, interviews conducted with governmental organisations would focus more on policy/regulatory issues whereas interviews with ISP would concentrate more on the commercial aspect. The interview questions can be viewed for each of the three categories of interviewees in Appendix C.3 for governmental organisations, in Appendix C.5 for civil society organisations and in Appendix C.4 for ISP's.

4.4.3. Interview Procedures

As from the beginning of the month of May 2013, formal requests for interviews were emailed to the selected interviewees. They were provided with a brief description of the research as well as the Information Sheet (Appendix C.1) and the Interview Consent Form (Appendix C.2).

Unfortunately, due to the unavailability of some interviewees, some of the interviews were conducted late in November 2013.

Before the start of the interviews, interviewees were briefed on the research being carried out and the ethical information contained in the Information Sheet. They were asked to agree to the contents of the Consent Form before

the start of the Interview. The Consent Form, other than outlining the rights of the interviewees and ensuring that they understand the goal of the interviews, also consisted of confidentiality options. Interviewees were, firstly, asked permission for the interviews to be recorded and secondly, asked whether any information provided during the interviews could be attributed to them, or whether no mention of their names should be made in the thesis or any other world publish thereafter. With regard to recording, most interviewees agreed for the conversation to be recorded and later transcribed. One participant disagreed with this method and requested that notes be taken during the interview. His request was accepted in line with the ethical requirements. As for confidentiality, a couple of interviewees opted to remain confidential but generalisations could be made from what they said.

Due to their limited time and lack of availability, interviews were not conducted with two of the interviewees from the NCB and Emtel respectively. Instead they requested that the questions be sent to them by email and that they would send back the answers. However, only the representative of the NCB returned the questions answered. Numerous, unfruitful attempts were made to get the answers back from the representative of Emtel.

As mentioned in Chapter 3, Mauritians are multilingual, with French and Mauritian Creole being predominant languages in the country. As such interviewees were given the freedom to choose in which language they would prefer the conversation to be held. Most interviewees opted for English but there were also cases where interviewees were more at ease with French or sometimes a mix of both English and French. Great care was thus taken during the transcription process to ensure that the meaning was not lost when translating to English. A copy of the original recording has been kept, in line with ethical requirements, for reference purposes.

A thank-you email was also sent to each of the respondents after the interview and they were provided with contact details of the researcher for any queries they should have or if ever they decided to pull out of the research. It is worth noting that as at submission date, no interviewee has withdrawn from the research.

4.4.4. Interview Analysis

After the interviews had been conducted, a transcript of the recording was generated. For easier analysis, the interviews were categorised into the three main stakeholders identified in Section 4.4.1. The transcripts were then analysed and central themes for each stakeholder were identified.

Since there were few interviews and the aim was to gain an insight within each category, no analysis software was used. The analysis was done by simple comparison of the interviews within the categories. Later the themes identified were used for the broader cross-category analysis.

4.5. Ethical Considerations

Ethics are important dimensions that need to be taken into account when conducting research. Indeed, De Vaus (2002, 59) argues that for example, any "survey needs to be technically correct, practically efficient, and ethically sound". He further argues that there are two approaches to viewing ethical issues, either the hard-line approach, to sticking to ethics guidelines per se, or a more contextualised approach, using the guidelines as reference and adapting to the researcher's current situation and context (De Vaus 2002).

This research is being carried out as part of a Curtin University degree; it has to abide by the ethical requirements set out by the university. Since, the research is also being carried out in Mauritius, it is as important to take into consideration local ethical considerations.

Therefore, in compliance with Curtin University's Research guidelines, the research was assessed in terms of whether it includes humans, and the data gathering tools were then designed to be in line with the Health and Medical Research Council (NHMRC) Statement on Ethical Conduct in Human Research and the Australian Code for the Responsible Conduct of Research. An application for research with low risk was thus submitted and approval was obtained (Authorisation number: MCCA-04-12) by the School of Media,

Culture and Creative Arts Human Research Ethics Committee in May 2012 and subsequently renewed in 2013.

In Mauritius, it is the Mauritius Research Council (MRC) that is responsible for laying the “guidelines for, and initiate the formulation of research and development policies on a national basis” (Mauritius Research Council 2014b). Although the research ethics guidelines were still being drafted (Mauritius Research Council 2014a) at the time methodological decisions were being made for this research, the guidelines set out were taken into consideration. It is worth noting that the Australian NHMRC encompasses much of the ethical dimensions set out in the Mauritian draft ethical guidelines.

Thus, a series of measures were put in place for the research to meet the ethical requirements. Amongst others, making the survey anonymous ensured confidentiality of survey respondents. Survey participants were made aware of the research and their respective rights with regard to the information they provided in the survey in a Survey Information Sheet (Appendix B: Survey Questionnaire), and their rights to end the survey at any point in time. Furthermore, children under 16 years old were required to obtain parental consent before engaging in the survey. Since some of the survey recruitments were made in school, the research applied the Mauritian guideline for advertising online surveys in schools.

As for the running of the interviews, as stated earlier in the interview procedures section, interviewees were requested to sign a Consent Form and to agree to the interview being recorded. Interviewees also had the possibility to decide whether they wanted the materials gathered from the interview to be attributable to them or they did not want to be quoted in any publications. They were also informed of the possibility to withdraw from the research at any point, without prejudice, up until the submission of the thesis for examination or any publication that result thereof from the research.

In accordance with Curtin regulations, upon final submission of this thesis, all data will be digitalised and stored for a period of seven years in a safe at the Charles Telfair Institute in Mauritius, after which it will be destroyed.

4.6. Conclusion

This chapter focused on outlining the methodology for answering the two central objectives of this research, namely to investigate the existence and determinants of Digital Inequality in Mauritius and to investigate stakeholders' perception and initiatives on the issue. It provided the philosophical rationale for choosing the Mixed Method Research, which is about mixing quantitative and qualitative methods in the pursuit of answering the research questions. It further elaborated on the distinct nature of these two objectives and thus the need for a parallel mixed method whereby each method would be running concurrently without any interference between the two approaches. The data gathered should then allow for a meta-analysis of the issue.

From a quantitative perspective, this chapter explored and discussed the rationale for using a survey to investigate the existence and determinants of Digital Inequality in Mauritius. It explored in relative detail the questionnaire design as well as the survey distribution strategies used to ensure that a representative sample of the Mauritian Internet user population was sourced.

The second part of the chapter was dedicated to qualitative methods in which the rationale for using this research method to answer the second objective, was exposed. This section also made a case for semi-structured interviews; it further outlined the purposive sampling techniques used to select interviewees and named the organisations that were chosen for interviews. The chapter also expanded on the questions for the interview as well as the procedures put in place for conducting interviews.

Lastly, this chapter outlined the strategies used to align the research with the Australian National Health and Medical Research Council Statement on Ethical Conduct in Human Research and the Australian Code for the Responsible Conduct of Research. It showed how every possible effort was

placed in ensuring that the research conforms to the ethical requirements set by Curtin University.

The following chapter outlines the findings of the survey described above. The limitations of the methodology are discussed in the conclusion of this thesis.

Chapter 5: Quantitative (Survey) Findings

5.1. Introduction

As discussed in the previous chapter, an online survey was conducted and run for six months to gather the Mauritian Internet users' perception on the five dimensions of Digital Inequality. Consequently, this chapter sets out to illustrate the findings of the survey. The chapter is broken down into three main subsections, which cover reliability and validity of the instrument, descriptive statistics and inferential statistics.

The first section outlines some of the tests used to ensure that the survey instrument used is valid and reliable. Tests such as the Cronbach's alpha test of reliability, Kaiser-Meyer-Olkin and Bartlett's test and Kolmogorov-Smirnov test were among those used to ensure that the survey was sound enough to perform further inferential analysis.

The descriptive statistics section is structured around the six sections of the survey, namely demographics, technical apparatus, autonomy of use, skill, social support and purpose of use. This section aims at providing a numerical and graphical representation of the results gathered from the survey.

Although for most questions, the data supplied did not have to be transformed in any way, for questions answered on a 5-point Likert scale (0-4), the method of weighted means was used to facilitate the classification of statements within their respective sets. Though the Likert is inherently ordinal, it is often considered as being interval on the assumption that the gaps between its options are equal, in which case a mean may be calculated. The numerical significance of the mean may not be as important as its accommodation for comparison between statements. Therefore, in some cases, especially with regard to the Internet user's perception of items that had a negative effect on their Internet use, weighted mean was used in an attempt to allow for comparisons between the different items—which would have been impossible without the use of weighted mean.

Lastly, the inferential statistics section describes the results obtained after further analytical operations carried out on the data obtained from the survey. For example, the inferential analysis included significance testing via the Mann-Whitney U and Kruskal-Wallis H tests, along with the advanced pairwise comparisons where suitable, followed by multivariate techniques like factor analysis and multiple regression, to give a better insight into the determinants of Digital Inequality. These analyses have been carried out in an attempt to investigate the existence of Digital Inequality in Mauritius; and to understand the dimensions of Inequality and its underlying factors.

In a nutshell, this chapter exposes the results of the survey. It can be viewed as a prelude to Chapter 6, Quantitative Discussion, which draws on these data to discuss the pertinence and ramifications of such findings.

5.2. Reliability and Validity

To proceed with any further inferential analysis, it is important to test for the validity and reliability of the data gathered. The following section illustrates the tests and results obtained for the test of reliability, validity and normality on the sample data collected. For this research, a total number of 625 responses were captured. Out of the 625 cases, only 571 cases were deemed suitable for analysis. Cases were removed from the dataset either because the respondents were not Mauritian residents (filtered by question 1 of the questionnaire) or there were not enough answered questions (34 of the cases were without any responses to the questions). Although this rather large sample size does not justify inferences to the overall Mauritian Internet use population, the findings and analysis (discussed further in Section 5.3.1) revealed a reasonable approximation of the population and therefore are suggestive of certain trends all within the boundary of some limitations (discussed in Section 8.2.).

5.2.1. Test of Reliability (Cronbach's alpha)

Creswell (2009, 233) defines reliability as "... to whether scores to items on an instrument are internally consistent (i.e. are the item responses consistent across constructs?), stable over time (test-retest correlations) and whether there was consistency in the test administration and scoring". There are indeed different methods and tools available for testing reliability, namely the test-retest method, alternate-form, inter-rater and internal consistency reliability methods (Trochim and Donnelly 2006). The use of these tools depends on the number of times the survey is administered and whether raters are being used.

Test-retest and alternate-form require that the same survey be carried out at different intervals in time before comparison between the two is made to calculate the reliability. As for inter-rater, it looks at the consistency between raters who used the same questionnaire, again requiring that the survey be carried out more than once. However, internal consistency is the only method that requires the survey be run only once. Since the nature of this research does not allow for the survey to be run multiple times nor does it make use of raters, internal consistency method for testing reliability is the most relevant test to be used.

The internal consistency method can be further broken into several strands, with split-half being the most common one. The split-half method consists of splitting the measures into halves and comparing the scores resulting from those splitting, resulting in a coefficient. Although there are different ways, methods and equations to calculate the split-half coefficient, Cronbach's alpha Coefficient remains by far the most common tool used.

Cronbach's alpha is a test that can be used to assess reliability. The result of the test is a coefficient with a value between 0 and 1. Generally speaking, the higher the coefficient value, the more reliable the survey tool is. However, it is usually accepted that if the coefficient value is 0.7 and higher, it can be concluded that the result for reliability is positive and that the survey questions are consistent (De Vaus 2002, 184).

The reliability test for this research included variables from the five sections of the survey (Q14, Q18, Q21, Q22, Q28, Q29). Only questions/variables measured on a 5-point Likert scale and relating to the same concepts were considered. It is accepted that questions of demographic nature, dichotomous or multiple-response questions are subject to a wide variation and are thus avoided in the reliability test. For this test, SPSS was used and the result is illustrated in Table 5.1 below, which shows the Cronbach's alpha value for questions in each of the eight section

RELIABILITY STATISTICS

Section	Cronbach's alpha	N of Items
Inequality in Technical Apparatus (Q14)	0.656	4
Inequality in Autonomy of Use (Q18)	0.759	7
Inequality in Skill (Q21)	0.910	11
Inequality in Skill (Q22)	0.894	5
Inequality in Social Support (Q28)	0.840	4
Inequality in Purpose of Use (Q29)	0.777	12

Table 5.1: Cronbach's alpha Test results

Since the Cronbach's alpha coefficient for the survey questions measuring the same concept is greater than 0.7 (>0.7), it can be safely deduced that the reliability of the questions is acceptable. Furthermore, it can be assumed that the survey responses are internally consistent and the questions were well focused on their objectives.

5.2.2. Test for Validity and Sample Adequacy (KMO)

Stangor (2011, 95) argues that in "addition to being reliable, useful measured variables need to be construct valid". Construct validity is understood as being how well the constructs measure what they are intended to measure (De Vaus 2002). Similarly, there are different methods to measure construct validity. This research uses factor validity as a measure to assess construct validity. This entails that suitability for Factor Analysis implies construct validity. In this respect, Kaiser-Meyer-Olkin (KMO) Measure of Adequacy and

Bartlett's test of sphericity were used to verify the relative adequacy and validity of the measures (Ntoumanis 2001). Factor Analysis test was therefore run on the subset of variables mentioned in section 5.2.1 and output of the KMO and Bartlett's test of sphericity is shown in Table 5.2.

KMO AND BARTLETT'S TEST

Inequality in Technical Apparatus (Q14)	Kaiser-Meyer-Olkin Measure of Sampling Adequacy.		0.538
	Bartlett's Test of Sphericity	Approx. Chi-Square	588.101
		df	6
		Sig.	0.000
Inequality in Autonomy of Use (Q18)	Kaiser-Meyer-Olkin Measure of Sampling Adequacy.		0.805
	Bartlett's Test of Sphericity	Approx. Chi-Square	697.994
		df	21
		Sig.	0.000
Inequality in Skill (Q21)	Kaiser-Meyer-Olkin Measure of Sampling Adequacy.		0.891
	Bartlett's Test of Sphericity	Approx. Chi-Square	3320.90
		df	0
		Sig.	0.000
Inequality in Skill (Q22)	Kaiser-Meyer-Olkin Measure of Sampling Adequacy.		0.826
	Bartlett's Test of Sphericity	Approx. Chi-Square	1567.26
		df	0
		Sig.	0.000
Inequality in Social Support (Q28)	Kaiser-Meyer-Olkin Measure of Sampling Adequacy.		0.782
	Bartlett's Test of Sphericity	Approx. Chi-Square	944.897
		df	6
		Sig.	0.000
Inequality in Purpose of Use (Q29)	Kaiser-Meyer-Olkin Measure of Sampling Adequacy.		0.770
	Bartlett's Test of Sphericity	Approx. Chi-Square	1587.91
		df	5
		Sig.	0.000

Table 5.2: KMO and Bartlett's Test Results

In general, the higher the KMO value (between 0 and 1), the better it is but it is commonly agreed that a value below 0.5 is not acceptable. As indicated in Table 5.2, a KMO obtained from the test for each subset of the variables exceeded the 0.5 acceptable minimum value. It can thus be assumed that the sample is more than adequate and can, therefore, be deemed representative of the population.

The Bartlett's test of sphericity additionally confirmed the validity of the responses by providing a Sig. Value of 0.000, which is less than the minimum required 0.05 (<0.05) for each section. It can thus be safely agreed that the questionnaire is valid for the study. The KMO and Bartlett's tests not only confirmed the reliability and validity of the measures in that the results of analysis of the data can be generalised with a 95% (SPSS default testing level) confidence level, but they also confirmed that Factor Analysis (Section 5.4.3) can be safely run on the data.

5.2.3. Test for Normality

Beside from testing the validity and reliability, it is important to understand the types of testing that is suitable for the data gathered before embarking on further analysis. The test of normality determines whether the data set is normal, thereby allowing for parametric testing (ANOVA, t-test, etc.) to be conducted. Otherwise, if the data is not normal, then non-parametric testing (Chi-Square Test of Independence, etc.) should be used. The test of normality is carried out using a hypothesis testing approach, whereby

H_0 : The variable is normal (Sig. >0.05)

H_1 : The variable is not normal (Sig. <0.05)

Thus, to determine normality, the Kolmogorov-Smirnov test was used on the 44 variables identified in Section 5.2.1. All the variables tested had a Sig. value or p -value of 0.00 (Table D1 in Appendix D1.). Subsequently, the value being less than 0.05, the null hypothesis (H_0) is rejected (p -value $<$ significant level \rightarrow reject H_0), thereby accepting the claim that the variables are not

normal. As a result, non-parametric testing should be used in any inferential analysis technique.

5.3. Descriptive Statistics

5.3.1. Demographics

Section 1 of the survey dealt with the personal information of respondents, which can be used to determine the different strata of the Mauritian society, but which are also the underlying forces that impact on Digital Inequality. The first question in the questionnaire was a filter question about the respondent's country of residence to ensure that only Mauritian Internet users answer the survey. There were very few (15) non-Mauritians who took the survey and these respondents were gently redirected from the survey to a page where they were asked to share the survey with their Mauritian friends. Therefore, all statistics that follow are on Mauritian resident Internet users only.

SEX

	Frequency	Percent	Valid Percent
Male	302	52.9	53.5
Female	262	45.9	46.5
Total	564	98.8	100.0

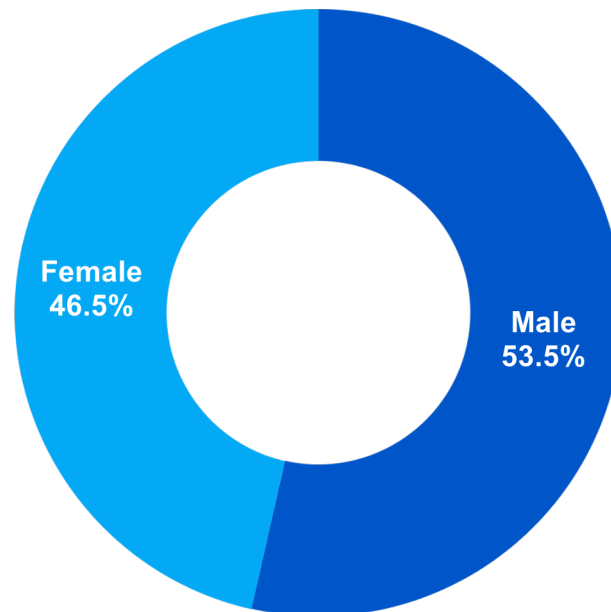

Figure 5.1: Sex of Respondents

The second question of the survey dealt with the sex of the respondents. As indicated in Figure 5.1, out of the total valid responses ($n = 571$), 53.5% of respondents were male and 46.5% female, clearly showing that more males responded to the survey.

Question 3 of the survey asked respondents about their age. Although for the survey respondents selected their actual age (ages 12-100 were made available), these were then grouped, as shown in Figure 5.2, for better analysis. The target audience of the survey was Mauritian Internet users aged 12 years and above, and although the survey was left open, no case was reported with respondent's age less than 12. It can be noted that 58.9% of the respondents were aged 20-29 years and nearly 90% of the respondents are less than 40 years old. On the other hand, only 2.1% of the respondents were aged 60 years and above. Clearly, the results show that

Mauritian Internet users are rather young and the number of users decreases as age increases.

AGE GROUP

	Frequency	Percent	Valid Percent
12-19	80	14.0	14.1
20-29	334	58.5	58.9
30-39	93	16.3	16.4
40-49	29	5.1	5.1
50-59	19	3.3	3.4
60 +	12	2.1	2.1
Total	567	99.3	100

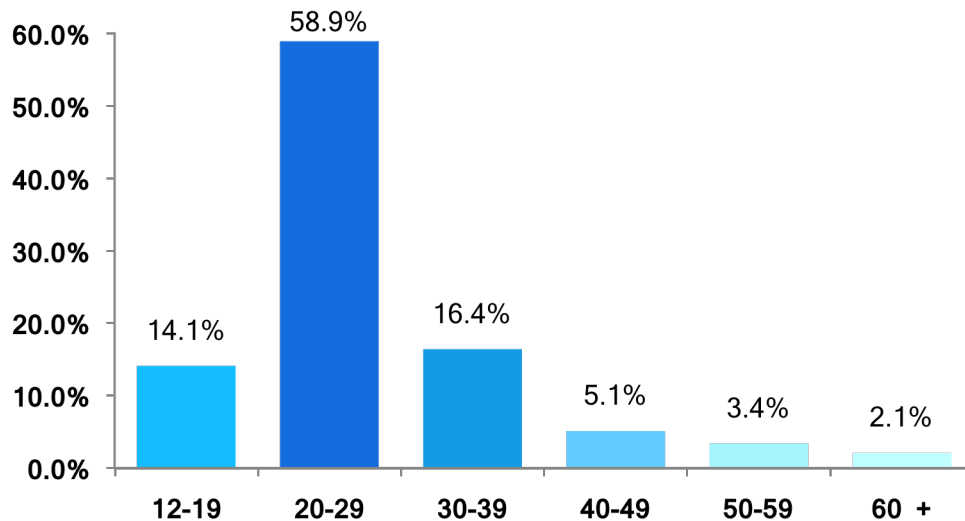

Figure 5.2: Age Group of Respondents.

The fourth question examined the residential area of respondents. They were required to select from the four categories provided. The island being small, sometimes it is difficult to differentiate between urban and suburban, and it is one of the reasons why a text box was provided for respondents to enter the name of their place of residence in case of doubt. Indeed, some respondents gave the name of their residential location, which was then coded into the relevant category.

Figure 5.3 shows that there is a higher proportion (56.2%) of the survey population residing in urban areas, as opposed to a total of 37.1% in rural areas (13.7% coastal + 23.4% inland).

RESIDENTIAL AREA

	Frequency	Percent	Valid Percent
Urban	312	54.6	56.2
Suburban	37	6.5	6.7
Rural (Inland)	130	22.8	23.4
Rural (Coastal)	76	13.3	13.7
Total	555	97.2	100.0

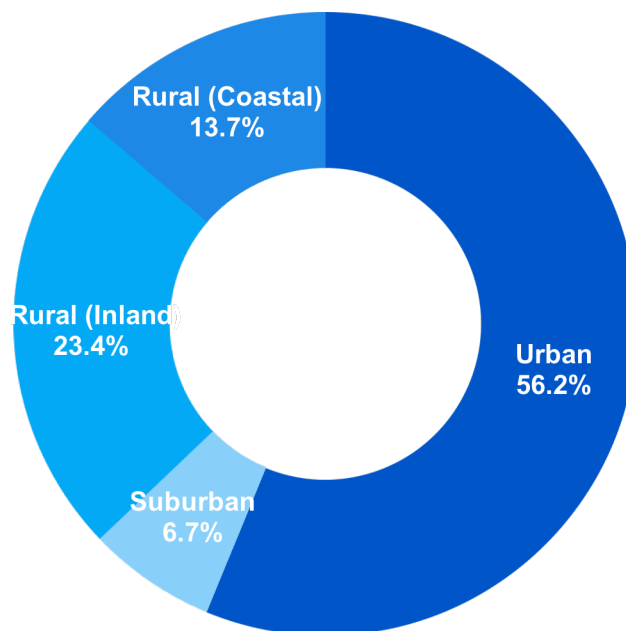

Figure 5.3: Residential Area of Respondents

Figure 5.4 illustrates the occupation of the survey population. It can be noted that 38.9% of the survey population are students, resulting from a high rate of young Internet user population. However, it is worth noting that all the listed categories of occupation were represented in the survey. The figure also shows that only 0.2% of the respondents were manual workers, showing that Mauritian Internet users are, depending on their age, mainly students or office workers.

OCCUPATION

	Frequency	Percent	Valid Percent
Student	213	37.3	39.2
Middle Management	100	17.5	18.4
Admin/Clerical	56	9.8	10.3
Technician/Specialist	43	7.5	7.9
Educator/Trainer	42	7.4	7.7
Self-employed	34	6	6.3
Top Management	30	5.3	5.5
Unemployed	16	2.8	2.9
Retired	7	1.2	1.3
Other	2	0.4	0.4
Manual worker	1	0.2	0.2
Total	544	95.3	100

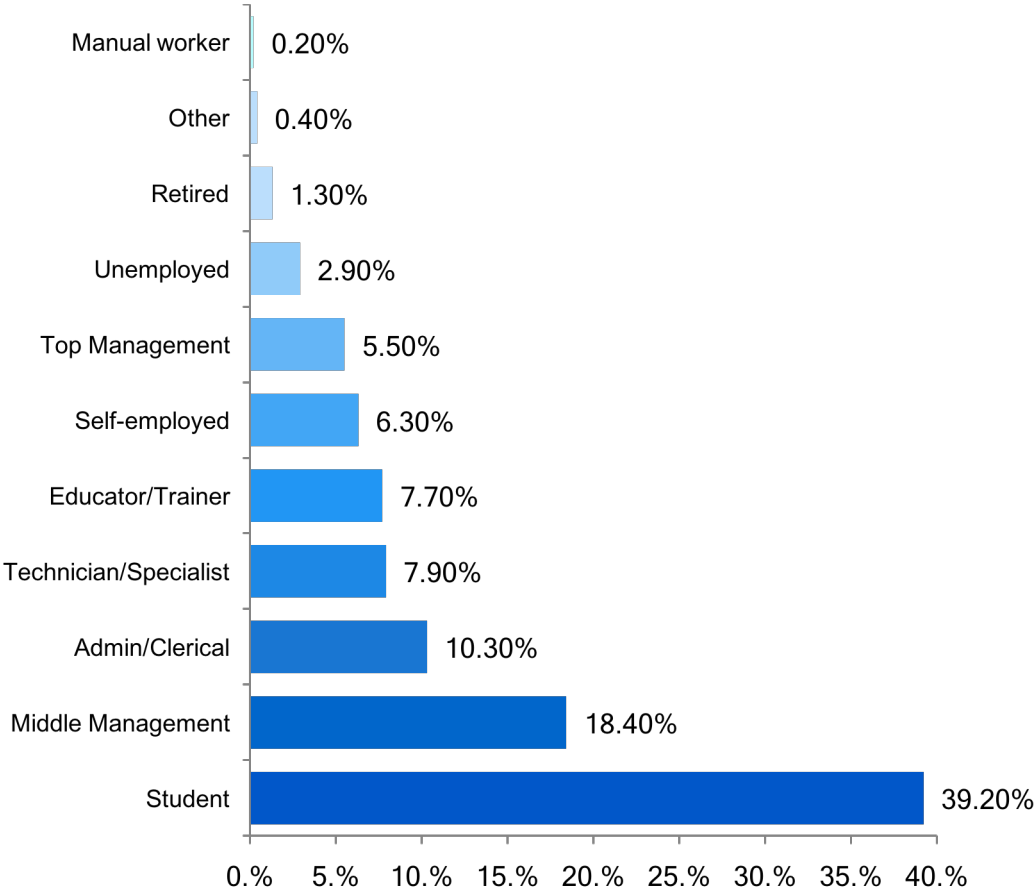

Figure 5.4: Occupation of Respondents

Question 5 surveyed respondents on the highest education level they achieved. As discussed in Chapter 3, the Mauritian education system is

composed of Pre-Primary (<5 years old), Primary (5-11 years old), Secondary (12-18 years old) with exits at School Certificate (SC) Exams (16 years old) or Higher School Certificate (HSC) (18 years old). Post HSC levels are aligned with global university levels (Certificate, Diploma, Undergraduate and Postgraduate). From Figure 5.5, it can be noted that there is a high rate of the survey population who earned a degree (33%) and very few respondents (0.5%) had Vocational training as their highest education level.

HIGHEST EDUCATION LEVEL

	Frequency	Percent	Valid Percent
Primary	40	7	7.1
Vocational	3	0.5	0.5
SC	27	4.7	4.8
HSC	111	19.4	19.8
Cert/Dip	90	15.8	16.1
Professional	15	2.6	2.7
Undergrad	186	32.6	33.2
Postgrad	88	15.4	15.7
Total	560	98.1	100

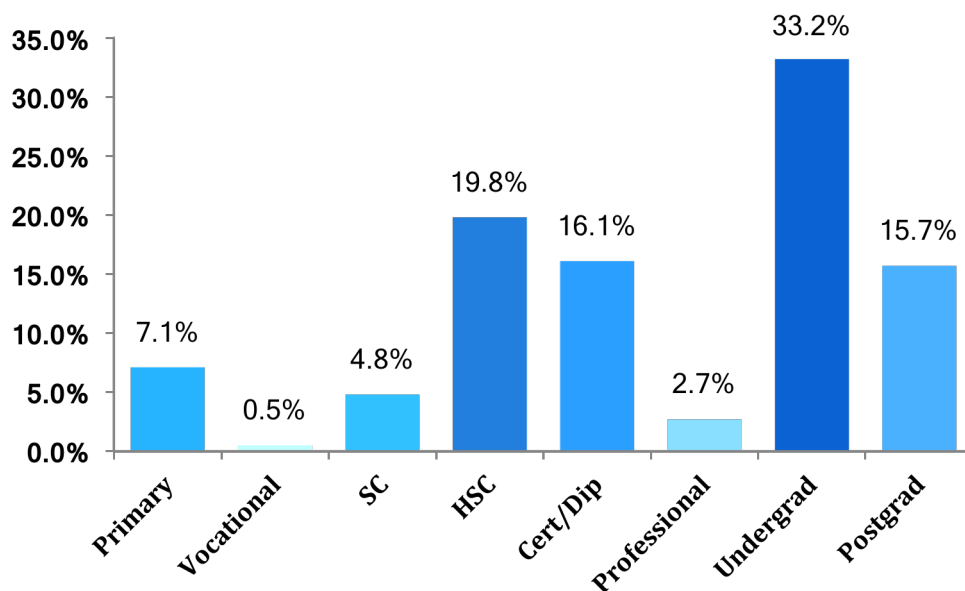

Figure 5.5: Highest Education Level of Respondents

CURRENT EDUCATION LEVEL

	Frequency	Percent	Valid Percent
Primary	31	5.4	7.4
Vocational	1	0.2	0.2
SC	12	2.1	2.9
HSC	18	3.2	4.3
Cert/Dip	27	4.7	6.4
Professional	35	6.1	8.3
Undergrad	133	23.3	31.6
Postgrad	44	7.7	10.5
Not studying	120	21	28.5
Total	421	73.7	100

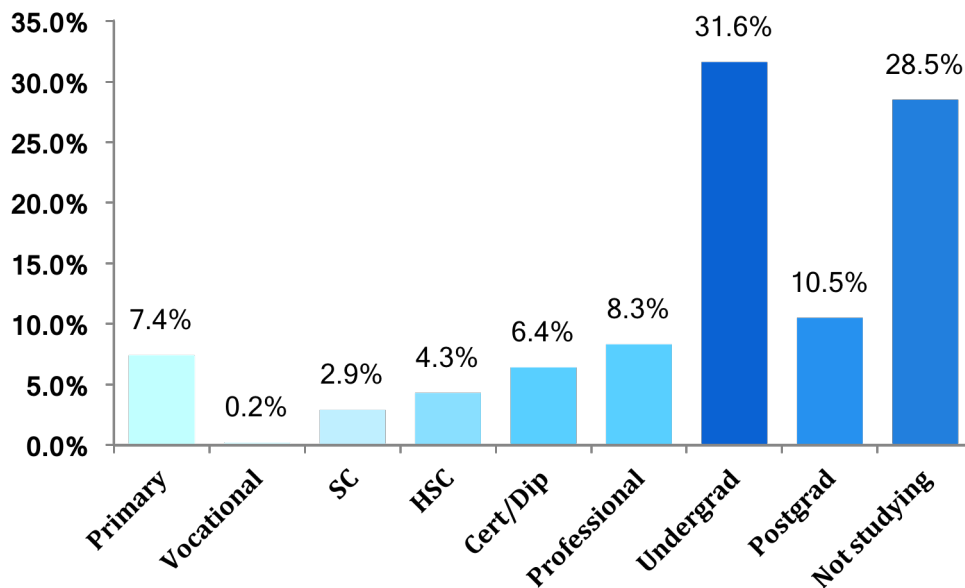

Figure 5.6: Current Level of Education of Respondents

Coupled with their highest education level achieved, respondents were questioned on their current education level. There were only 421 valid responses to this question, and as shown in Figure 5.6, up to 31% of currently studying respondents were studying at the Undergraduate level and 28.5% are not studying at all. The high rate of student responding to the survey shows that they are mainly tertiary level students and it can be assumed that older respondents are not currently studying.

HIGHEST EDUCATION LEVEL OF PARENTS

	Frequency	Percent	Valid Percent
Primary	68	11.9	12.5
Vocational	8	1.4	1.5
SC	141	24.7	25.8
HSC	108	18.9	19.8
Cert/Dip	69	12.1	12.6
Professional	28	4.9	5.1
Undergrad	68	11.9	12.5
Postgrad	56	9.8	10.3
Total	546	95.6	100

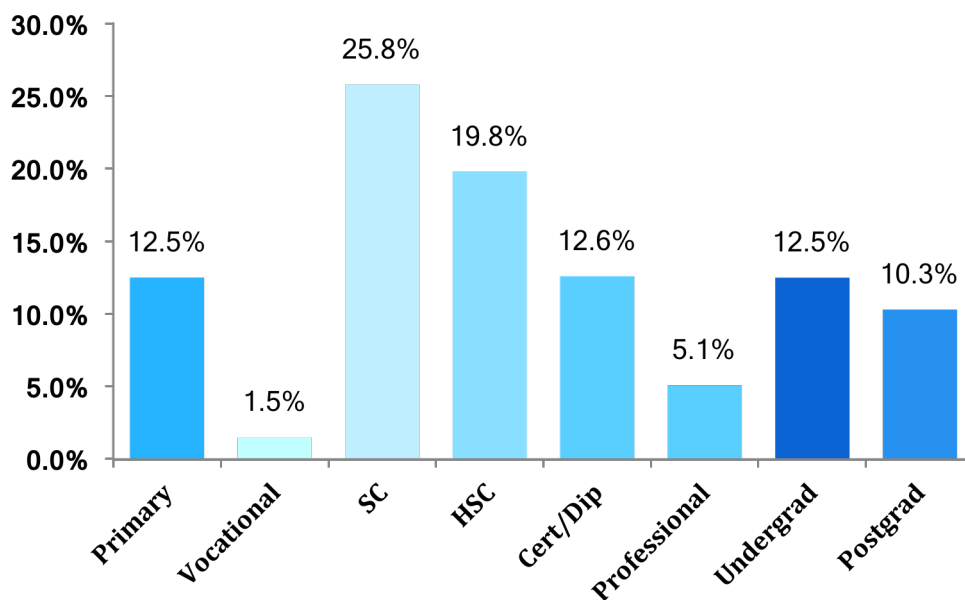

Figure 5.7: Highest Education Level of Respondents' Parents.

Question 8 of the survey examined the highest level of education of the respondents' parents. The aim was to use this variable to situate the socio-economic status of the respondents. Although income is often used for such measure, students, which constitute a large proportion of the respondents, would not be in a position to answer such question or alternatively may not be aware of the household income. Thus, the use of parents' education level to situate socio-economic status. The assumption is that parents with higher education level would have higher socio-economic status. Although it is understood and acknowledged that there are limitations to this approach, the

current research context, unfortunately, did not provide for a better alternative. The results, Figure 5.7, show that the majority of respondents' parents (86%) have studied at least the School Certificate. 12.5% of the respondents' parents studied up to Primary school and only 10.3% of parents studied at post graduate level. In general, it can be argued that the vast majority of respondents would come from the middle class and above.

5.3.2. Technical Apparatus

Section 2 of the survey examined the technical apparatus dimension of Digital Inequality. Respondents were queried on the technical means of connecting to the Internet and the following results were obtained.

DEVICE OWNERSHIP

	Frequency	Percent	Valid Percent
Yes	555	97.2	98.1
No	11	1.9	1.9
Total	566	99.1	100.0

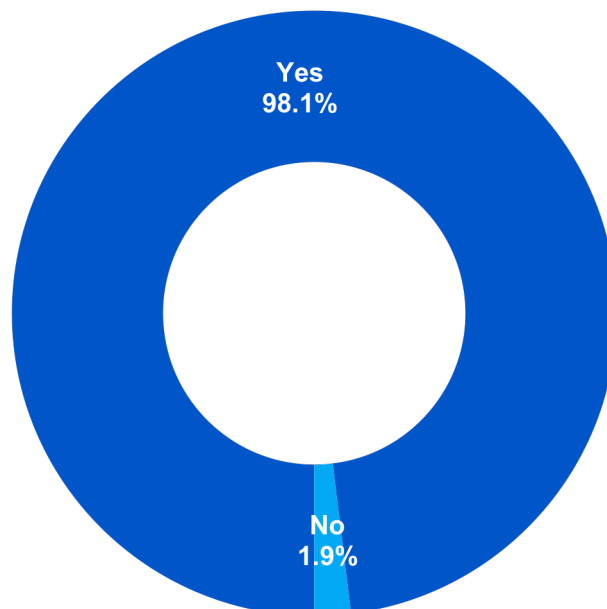

Figure 5.8: Device Ownership of Respondents

Question 9 of the survey examined device ownership and questioned respondent on whether they own a device that they use to connect to the Internet. As noted in Figure 5.8, 98.1% (n = 566) of respondents own a device. Although the question does not differentiate between the types of devices owned (such question is dealt later on), it does give a clear indication about the level of device ownership among the survey population, with nearly all of the Internet users owning their device.

MAIN INTERNET CONNECTION MODE

	Frequency	Percent	Valid Percent
Computer with ADSL	457	82.3	84.2
Mobile device with fixed connection	37	6.7	6.8
Mobile device with mobile connection	28	5.0	5.2
Computer with mobile connection	10	1.8	1.8
Computer with Dial-up	9	1.6	1.7
Did not connect	2	0.4	0.4
Total	543	97.8	100.0

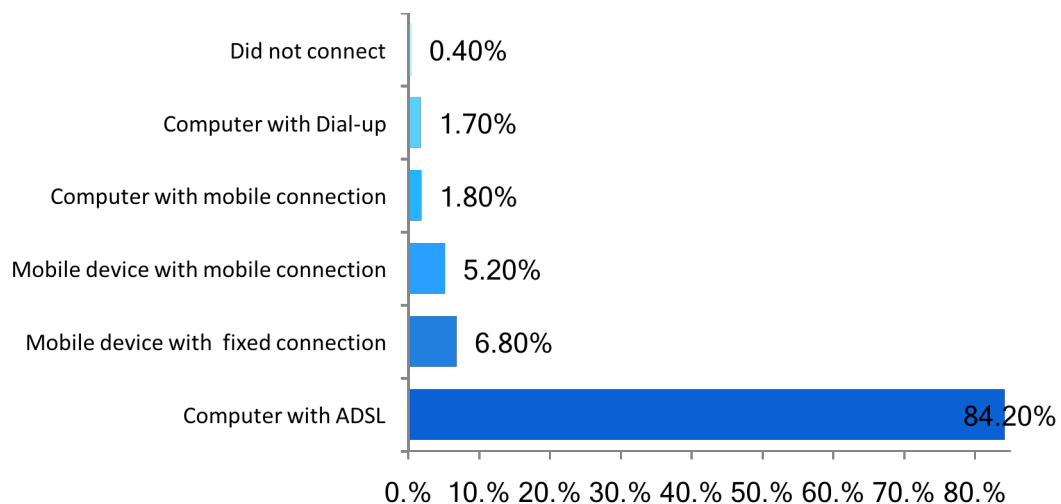

Figure 5.9: Main Internet Connection Mode (Owners)

Figure 5.9 reveals the main Internet connection mode of respondents who own a device. As shown, 84.2% of those who own a device connect to the Internet through a computer with a high speed ADSL connection. The figures also corroborate with official figures about the decline in Dial-up connection, with only 1.7% connecting through such low speed connection. Although there is an increasingly high rate of mobile penetration within the Mauritian

population (130.9%), at the time of the survey was conducted, only 31.5 out of every 100 inhabitants had a mobile Broadband subscription (Statistics Mauritius 2015a). In the same vein, the results reveal that during the year the survey was conducted, very few of the respondents (only 12%) who own a device connected to the Internet mainly through a mobile device.

MAIN INTERNET ACCESS POINT (OWNERS)

	Frequency	Percent	Valid Percent
Home	354	63.8	65.4
Workplace	140	25.2	25.9
Mobile	22	4	4.1
Place of study	20	3.6	3.7
Other	3	0.5	0.6
Public location	2	0.4	0.4
Total	541	97.5	100

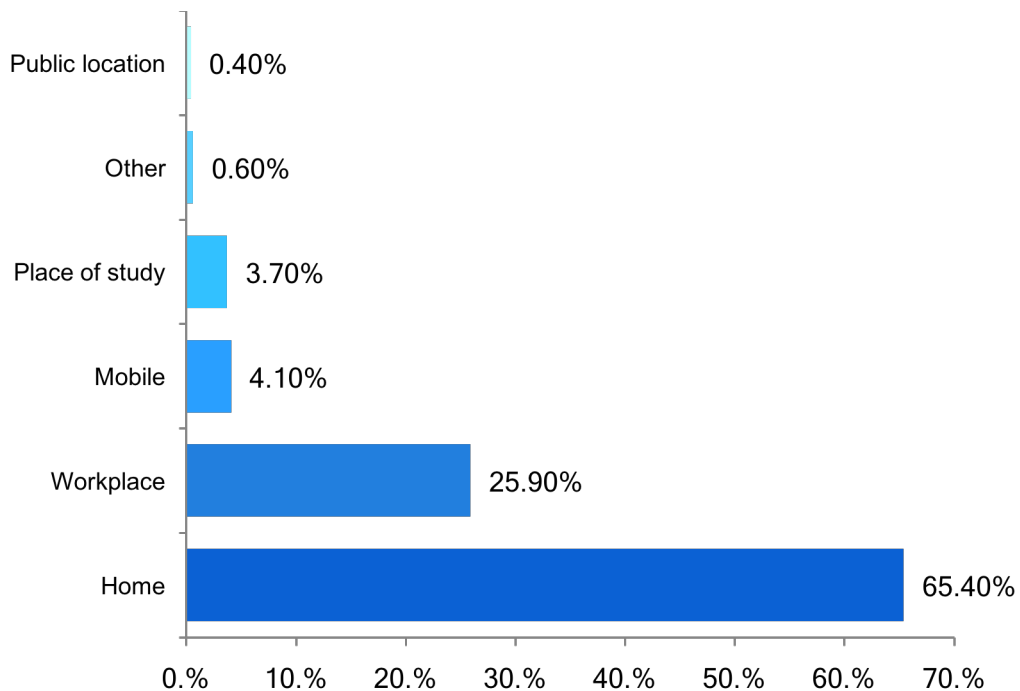

Figure 5.10: Main Internet Access Location (Owners)

Question 12 of the survey examined the location from which respondents who own a device accessed the Internet. Figure 5.10 reveals that 65.4% of the survey population who owns a device accessed the Internet mainly from home, followed by 25.9% who accessed the Internet mainly from work. In line

with the connection mode (Figure 5.10), there is a low proportion of respondents (4.1%) who use mobile devices as their main Internet access point. This result also corroborates with the previous results regarding ownership of devices and main device used to connect to the Internet. The results thus reveal that the typical Mauritian Internet user would own a PC and connect to the Internet through Broadband at home.

MAIN INTERNET ACCESS POINT (NON-OWNERS)

	Frequency	Percent	Valid Percent
Workplace	5	45.5	45.5
Friend/family	3	27.3	27.3
Paid public	1	9.1	9.1
Did not connect	1	9.1	9.1
Other	1	9.1	9.1
Total	11	100	100

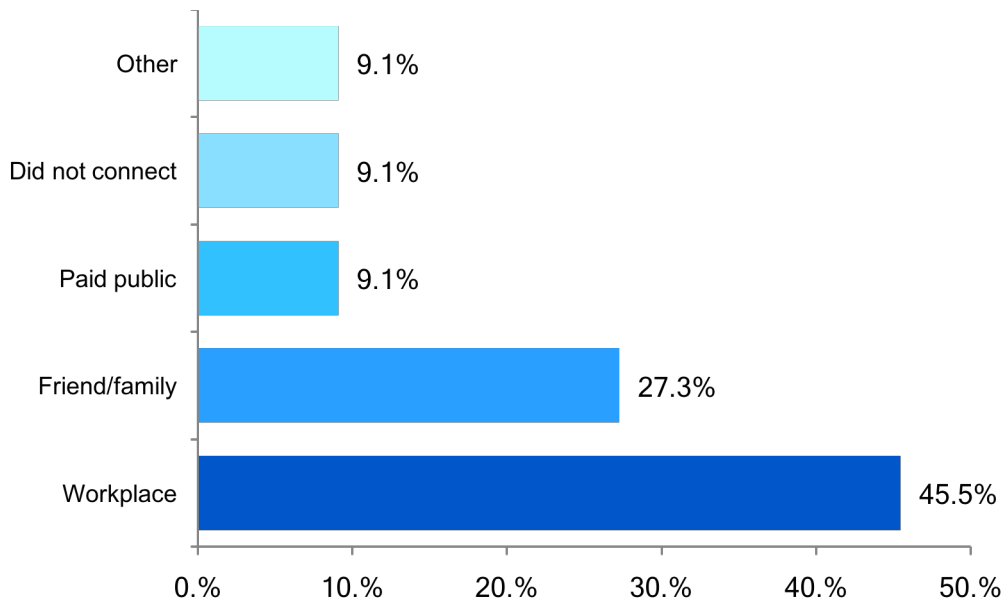

Figure 5.11: Main Internet Access Location (Non-Owners)

Only 11, accounting for 1.9% respondents did not own the device they use to connect to the Internet. Figure 5.11 gives a rather general picture as to the location from where such users access the Internet. It reveals that 45.5% of the survey respondents who do not own a device access the Internet from their workplace and only 27.3% access the Internet at friends and family.

However, the use of paid public location as main Internet connection, such as cybercafés, is limited (1 respondent, 9.1%). Although not shown in the chart, none of the respondents used Free Public (e.g. Library, Post Offices) as their main source of Internet connection.

TECHNICAL APPARATUS: LIMITATIONS OF EFFECTIVE INTERNET USE

Limitations	No effect at all	Little negative effect	Negative effect	Significant negative effect	Very significant negative effect	Weighted Mean
Bandwidth	59	97	135	101	142	2.32
Reliability of connection	74	118	129	107	102	2.08
Software	246	133	85	34	24	0.96
Hardware	301	102	77	24	22	0.79

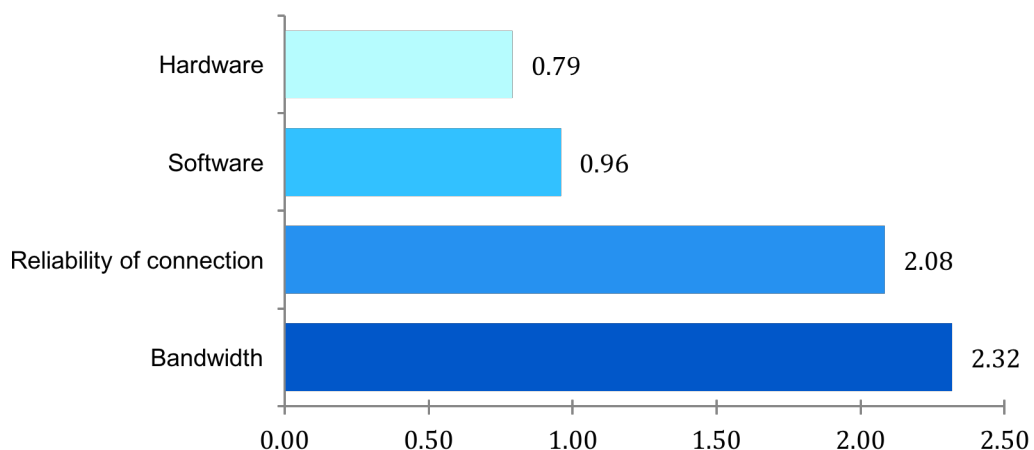

Figure 5.12: Technical Apparatus - Factors Limiting Effective Internet Use

The following question examined to what extent factors, such as Hardware, Software, Bandwidth and Reliability of connection, limited respondents' effective use of the Internet. Figure 5.12 shows the aggregated data and the weighted mean calculated for each of the aforementioned factors. It can be seen from Figure 5.12 that respondents perceived bandwidth (weighted mean of 2.32) as being the factor that mostly limit their effective use of the Internet, followed by the reliability of the connection (weighted mean of 2.08). The same figure suggests that hardware and software is perceived as having

little effect in limiting respondents' effective use of Internet (0.79 and 0.96 respectively).

5.3.3. Autonomy of Use

The third section of the survey investigated the autonomy of use dimension of Digital Inequality. The following is the result obtained.

CONNECTION STATUS

	Frequency	Percent	Valid Percent
Always connected	242	42.4	45.2
Regularly connected	225	39.4	42.1
Selectively connected	68	11.9	12.7
Total	535	93.7	100.0

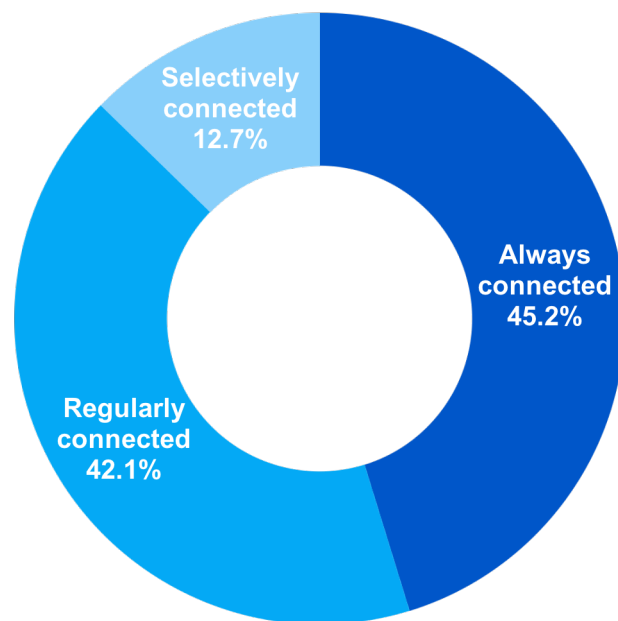

Figure 5.13: Connection Status of Respondents.

Question 15 of the survey dealt with the connection status of the survey respondents. Figure 5.13 indicates that 45.2% of the survey respondents feel that they are 'always connected and that they can access the Internet anytime', followed by 42.1% who 'regularly connect to the Internet but do not think of themselves as always connected'. The figure also indicates that only

12.7% of the survey population connects to the Internet 'only' when they need it to do specific tasks. It can be deduced from the above that users in general have easy access to the Internet, and for nearly half of the users, they are constantly connected to the Internet.

MONITORING

	Frequency	Percent	Valid Percent
No monitoring	485	84.9	91.3
Monitoring by organisation	29	5.1	5.5
Monitoring by others	17	3.0	3.2
Total	531	93.0	100.0

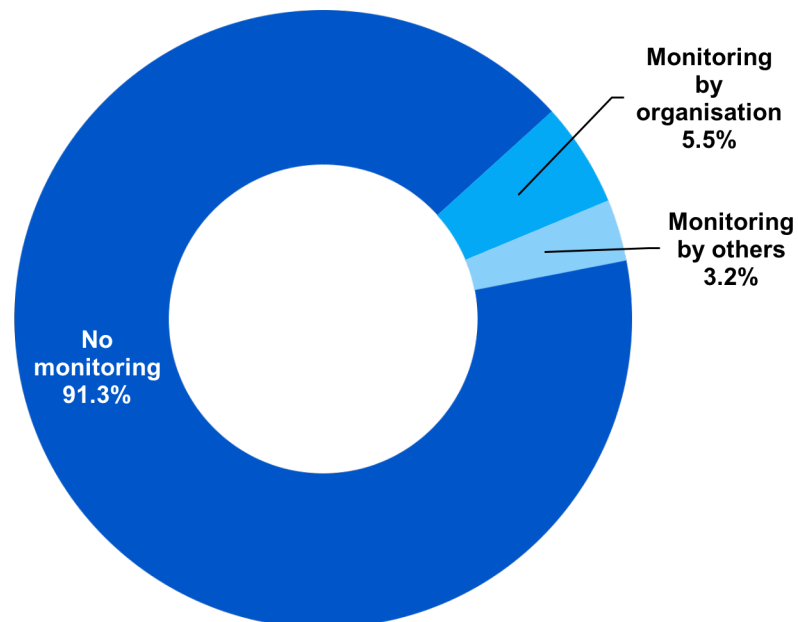

Figure 5.14: Monitoring of Internet Use of Respondents

The next question in the survey examined the feeling of respondents with regard to the monitoring of their Internet use. As shown in Figure 5.14, 91.3% of the respondents feel that there is no monitoring at all in the Internet use, meaning that they can access any content at their own will. However, 5.5% of the respondents feel that their access to the Internet is monitored by an organisation they are affiliated with (work, university, school etc.). Figure 5.14 also shows that other people, such as parents or partners, monitor 3.2% of respondents' Internet use. These figures suggest that, although generally

speaking users are free to access the Internet, there are, nonetheless, some monitoring that are being carried out for a small proportion of users.

BLOCKING OF ONLINE CONTENT

	Frequency	Percent	Valid Percent
No blocking	341	59.7	64.1
Blocked by organisation	135	23.6	25.4
Blocked by governmental policies	38	6.7	7.1
Blocked by third parties	11	1.9	2.1
Blocked by parents	7	1.2	1.3
Total	532	93.2	100.0

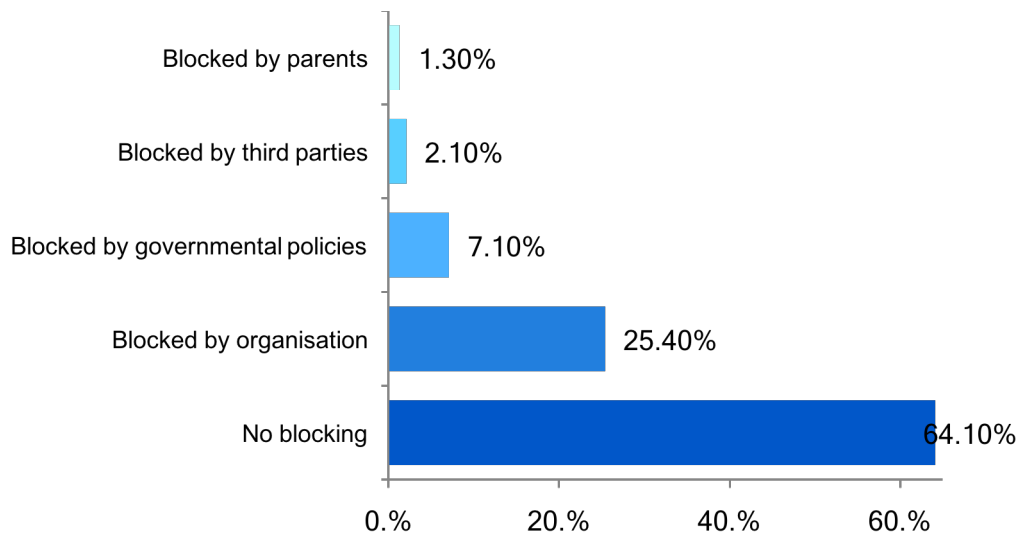

Figure 5.15: Blocking of Online Content

Question 16 of the survey dealt with Internet censorship, and more precisely the question examined respondents' feeling as to whether the material they wished to access online was blocked. It can be noted from Figure 5.15 that the vast majority (64.1%) of respondents felt that no content they wished to access on the Internet was blocked in any way. However, 25.4% agreed that some of the content they wished to access online was blocked by the organisation they work for or study with, amongst others. Very few, 2.1% and 1.3% of respondents, had content blocked by a third party (cybercafé, library) and parents, respectively. Again, these results are directly related to the

freedom to use the Internet, whereby for the vast majority, Internet is not blocked at all but that there are mainly organisational policies that prevent access to some content.

AUTONOMY OF USE: LIMITATIONS OF EFFECTIVE INTERNET USE

Limitations	No effect at all	Little negative effect	Negative effect	Significant negative effect	Very significant negative effect	Weighted Mean
Monitoring of Internet use	354	72	52	23	12	0.57
Sharing of devices with other people	283	95	65	42	24	0.88
Blocking of Internet content and services	246	113	87	40	22	0.97
Cost of Internet connection	271	86	79	33	42	1.00
Lack of accessibility	245	104	70	35	53	1.11
Place of use	237	99	88	42	44	1.13
Lack of time to spend online	221	114	90	47	45	1.19

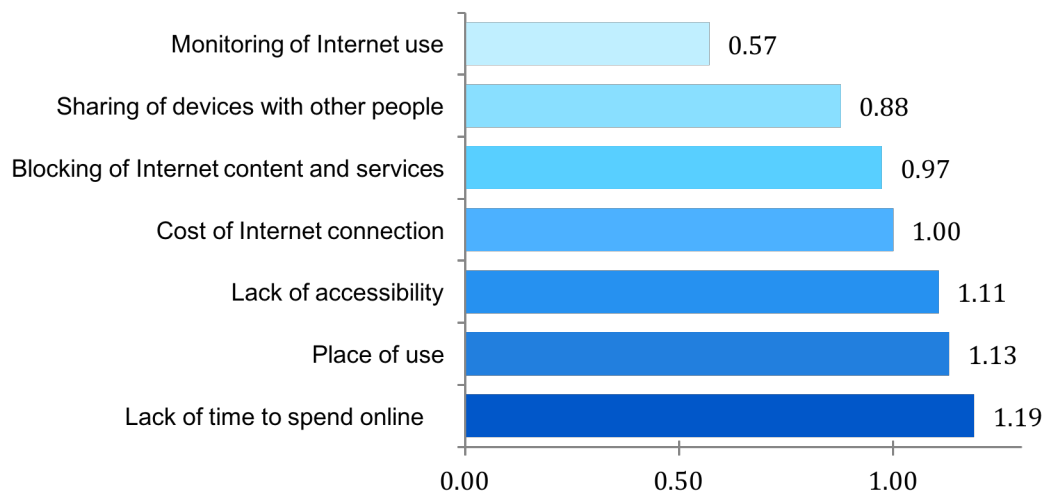

Figure 5.16: Autonomy of Use - Factors Limiting Effective Internet Use

Question 18 of the survey examined the limitations of effective Internet use in terms of autonomy of use. Again, weighted mean was used for this question. As indicated in Figure 5.16, lack of time to spend online (weighted mean of 1.19) has been the main limiting factor in the effective Internet use of

respondents. Place of use (weighted mean of 1.13) and lack of accessibility (weighted mean of 1.11) have also been felt as being factors limiting effective use. The cost of Internet connection (weighted mean of 1.00) is fourth in the ranking of factors that limit effective Internet use.

5.3.4. Skill

Section 4 of the survey investigated another dimension of Digital Inequality, namely skill. The following results were obtained.

YEAR STARTED TO USE THE INTERNET

	Frequency	Percent	Valid Percent
Before 1995	32	5.6	6.6
1995-2000	217	38	44.6
2001-2005	140	24.5	28.7
2006-2010	96	16.8	19.7
After 2010	2	0.4	0.4
Total	487	85.3	100

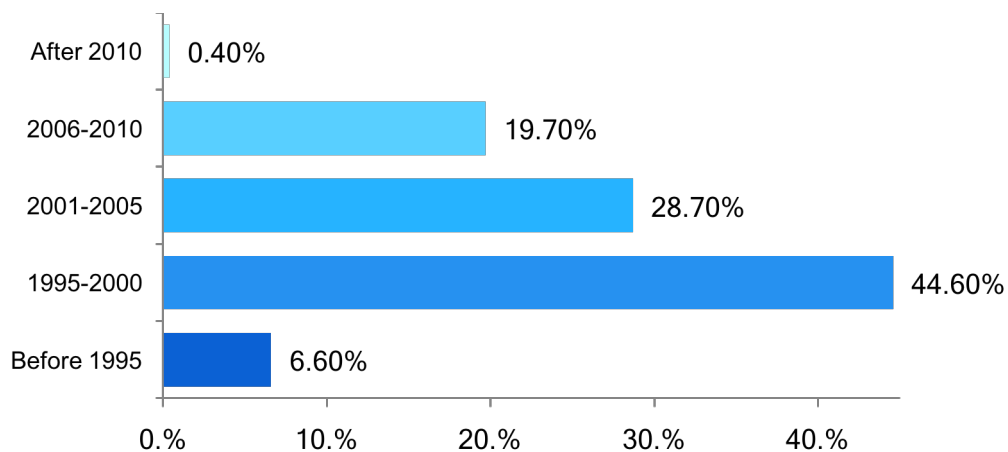

Figure 5.17: Year Respondents Started Using the Internet

Question 19 of the survey examined the relative experience that the respondents have in using the Internet. Figure 5.17 shows that the bulk of the users started using the Internet between 1995 and 2000, in line with the commercial release of the Internet in Mauritius in 1997. Two possible deductions can be made from this data. Firstly, that the average Mauritius

Internet user is quite experienced in Internet use. Secondly, although the number of subscription is slowly increasing, nearly half of users started using the Internet at the onset of its commercial release on the island. It is important to note that the question does not pertain to subscription but rather use, which does not imply ownership of the device nor subscription to the Internet.

FORMAL TRAINING

	Frequency	Percent	Valid Percent
Yes	112	19.6	22.3
No	390	68.3	77.7
Total	502	87.9	100.0

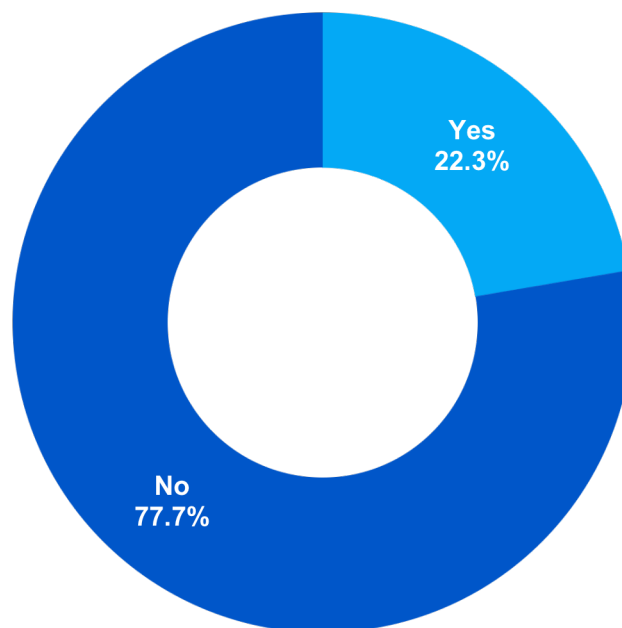
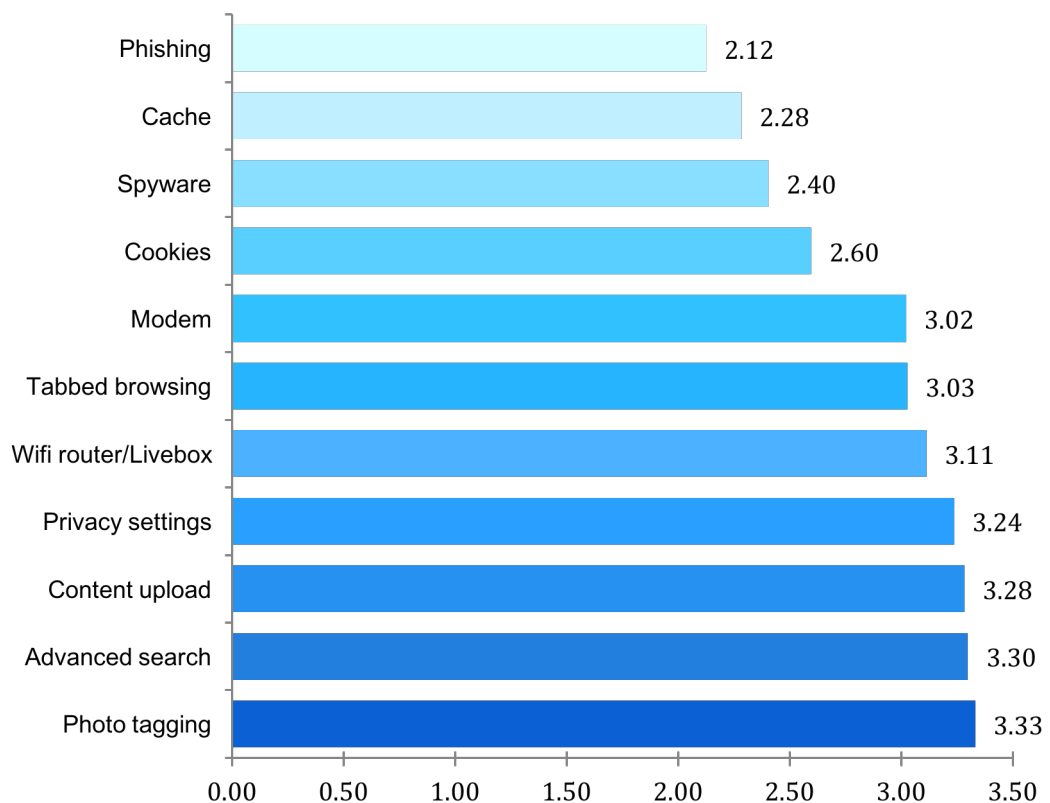

Figure 5.18: Formal Training Received by Respondents

Figure 5.18 shows the responses of the survey population on any formal training undertaken in the use of the Internet. The results show that out of a total of 502 valid responses to this question, 77.7% of respondents never actually had any formal training in the use of the Internet.

SKILL: FAMILIARITY WITH INTERNET RELATED TERMS

Familiarity	Not Familiar at all	Not Familiar	Somewhat Familiar	Familiar	Very Familiar	Weighted Mean
Phishing	116	73	105	73	148	2.12
Cache	94	77	94	88	161	2.28
Spyware	90	60	101	82	183	2.40
Cookies	69	51	94	110	194	2.60
Modem	27	41	88	98	262	3.02
Tabbed browsing	50	36	60	73	295	3.03
Wifi router/Livebox	31	26	75	106	278	3.11
Privacy settings	20	17	76	110	292	3.24
Content upload	19	26	62	92	317	3.28
Advanced search	22	13	60	116	306	3.30
Photo tagging	27	24	44	77	344	3.33

**Figure 5.19: Skill: Familiarity with Internet-related Terms**

Question 21 of the survey examined the skill of the respondents by investigating their familiarity with some key Internet related terms. As shown in Figure 5.19, although respondents are familiar with most of the Internet-

related terms, it can be noted that those terms relating to security, such as phishing (weighted mean of 2.12), spyware (weighted mean of 2.40), cache (weighted mean of 2.28) and cookies (weighted mean of 2.60) are less familiar among the survey respondents.

SKILL: LIMITATIONS OF EFFECTIVE INTERNET USE

	No effect at all	Little negative effect	Negative effect	Significant negative effect	Very significant negative Effect	Weighted Mean
Lack of knowledge of online interaction with others	332	91	39	21	24	0.65
Lack of knowledge in finding information online	315	105	52	16	24	0.69
Lack of knowledge in using hardware	299	99	74	25	13	0.73
Lack of knowledge in using software	291	104	78	28	13	0.77
Lack of knowledge of security issues	248	123	81	39	25	0.97

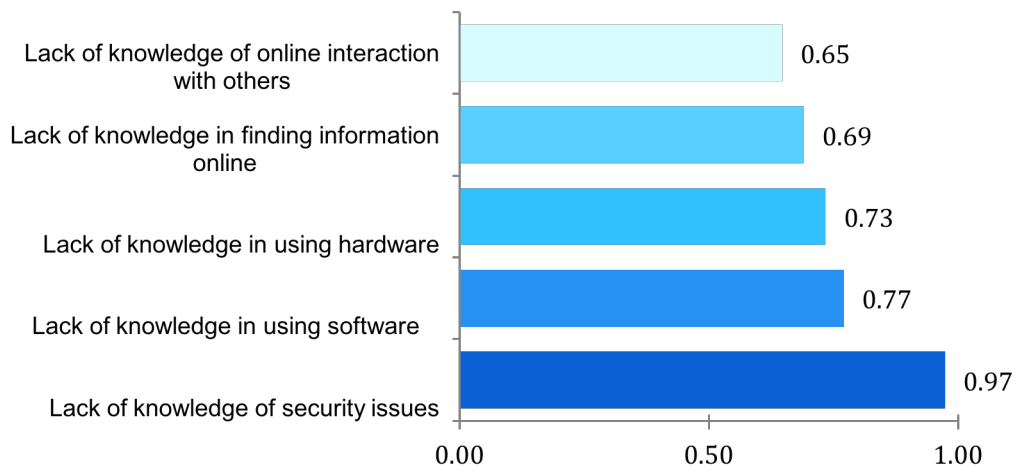

Figure 5.20: Skill - Factors Limiting Effective Internet Use

As shown in Figure 5.20, respondents perceived lack of knowledge of security issues (weighted mean of 0.97) as the most limiting factor of their effective Internet use. This result tends to validate the findings of previous questions suggesting that users are less familiar with Internet security terms. On the other hand, it is worth noting that the survey population feels that lack

knowledge about online interaction with others (weighted mean of 0.65) has little effect on their effective Internet use.

5.3.5. Social Support

The following section of the survey, Section 5, dealt with the social support dimension of Digital Inequality. Following is the result obtained.

REASON FOR STARTING TO USE THE INTERNET

	Frequency	Percent	Valid Percent
I had to use it for educational purposes (school/college/uni)	198	34.7	38.2
Interesting possibility	86	15.1	16.6
Readily accessible	84	14.7	16.2
To develop Internet-use skills	46	8.1	8.9
To keep in touch with family/friends	41	7.2	7.9
Workplace requirement	27	4.7	5.2
Other	12	2.1	2.3
Recommended by someone	11	1.9	2.1
To improve career	10	1.8	1.9
To make money	3	0.5	0.6
Total	518	90.7	100.0

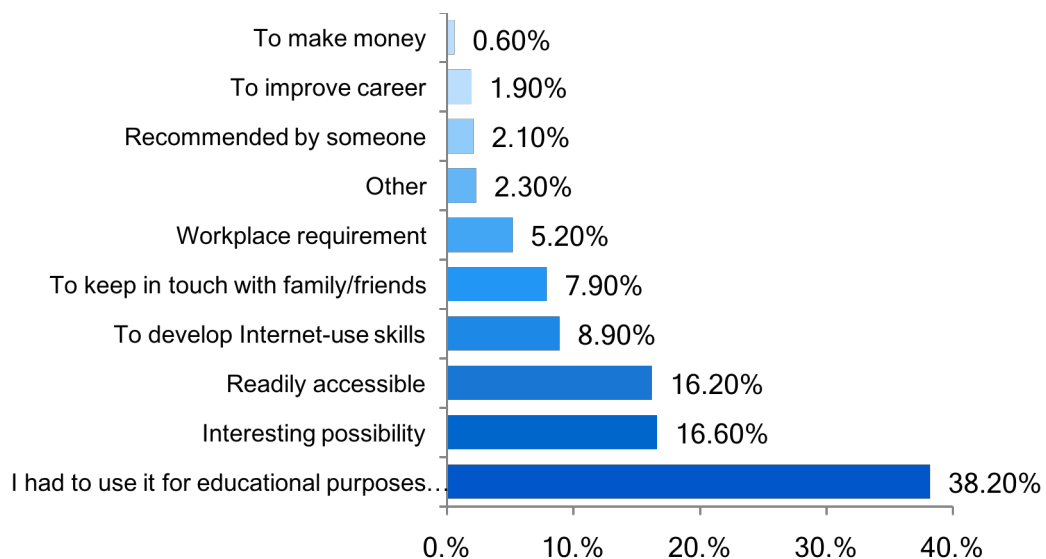

Figure 5.21: Reasons for Starting to Use the Internet

Question 23 of the survey investigated the reasons why the respondents started to use the Internet. As shown in Figure 5.21, the main reason (38.2%) for starting to use the Internet was for educational purposes. The next

important reasons were that it could be interesting (16.6%) and that it was readily available (16.2%). Very few users started to use the Internet to set up a business or to look for a job or improve their career.

HELP SEEKING IN INTERNET USE

	Frequency	Percent	Valid Percent
Never	183	32.0	35.3
Occasionally	233	40.8	44.9
Sometimes	77	13.5	14.8
Often	13	2.3	2.5
Almost all the time	13	2.3	2.5
Total	519	90.9	100.0

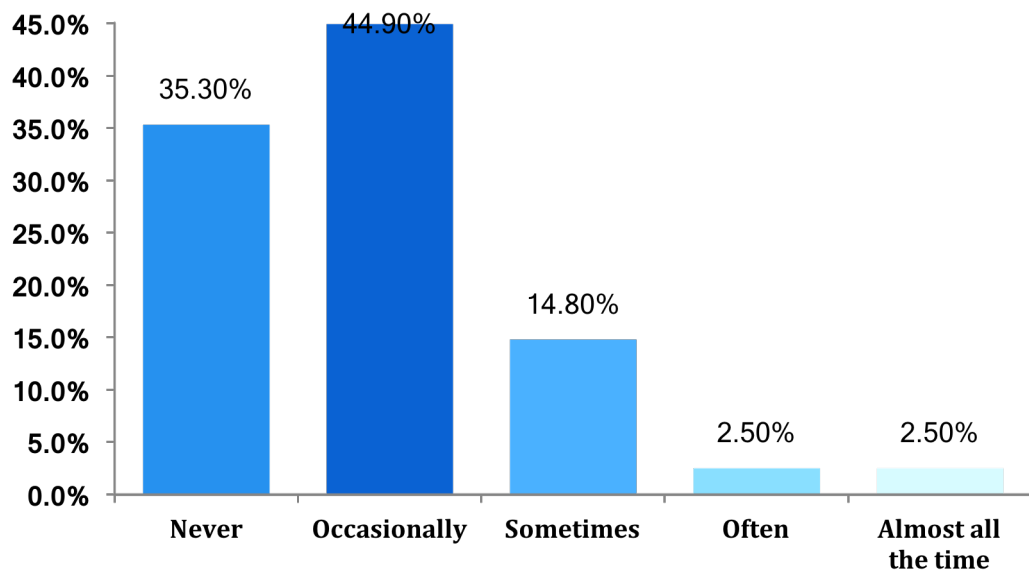

Figure 5.22: Help Seeking in Internet Use

Question 24 of the survey examined how often respondents sought help in their use of the Internet. Indeed in Figure 5.22, it can be noted that 35.3% never sought help in their use of the Internet whilst 44.9% occasionally sought help. Interestingly, 2.5% of the survey population suggested that they seek help almost all the time when using the Internet. In general, the vast majority required some sort of help at some moment in their Internet use.

AVAILABILITY OF HELP

	Frequency	Percent	Valid Percent
Yes	429	75.1	84.0
No	82	14.4	16.0
Total	511	89.5	100.0

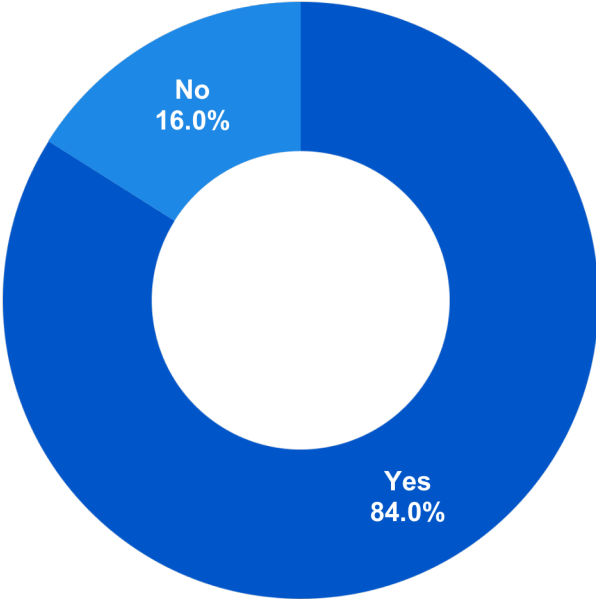

Figure 5.23: Availability of Help

Question 25 of the survey examined whether help is easily available to the respondents. As shown in Figure 5.23, the data reveals that out of a total of 511 valid responses, 84% of the survey population acknowledges that help is easily available to them in their use of the Internet.

SOURCE OF HELP

	Frequency	Percent	Valid Percent
Friends or neighbours	122	21.4	24.4
Family members	119	20.8	23.8
Online help forums	97	17.0	19.4
Colleagues	55	9.6	11.0
Classmates/Peers	48	8.4	9.6
Organisational IT department	38	6.7	7.6
Educators	11	1.9	2.2
Other	9	1.6	1.8
Cybercafé/Library Helpdesk	2	0.4	0.4
Total	501	87.7	100.0

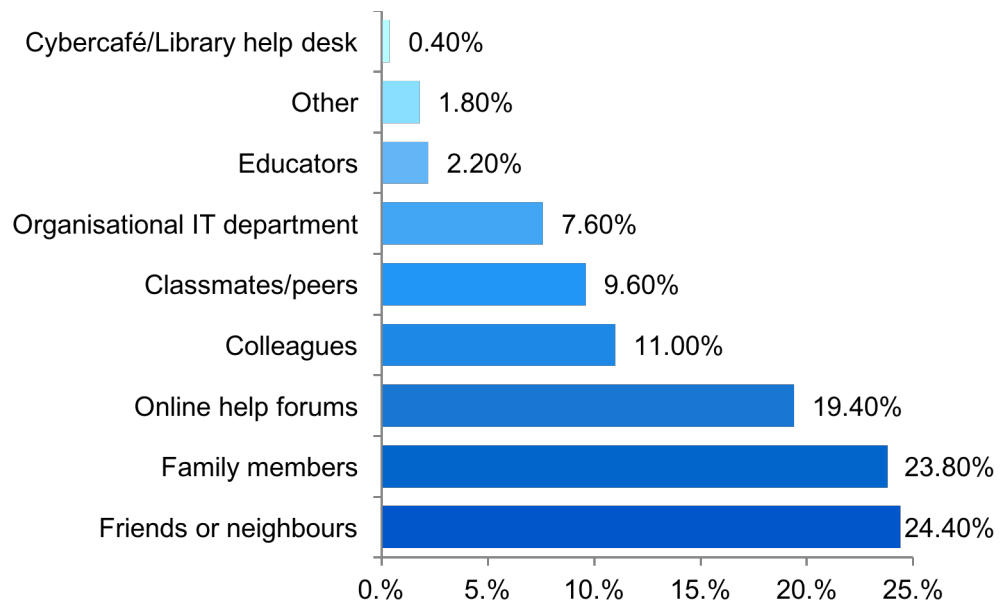

Figure 5.24: Sources of Help

The following question examined the different sources of help. Respondents were asked to select from which single source they mostly get help from. As shown in Figure 5.24, 24.4% and 23.8% of respondents received help mainly from friends or neighbours and family members respectively. The figure also indicates that cybercafés and library help desk (0.4%) are the least common places where Internet users would seek help from.

SOURCE OF BEST HELP

	Frequency	Percent	Valid Percent
Family members	129	22.6	25.7
Online help forums	105	18.4	20.9
Friends or neighbours	97	17.0	19.3
Colleagues	55	9.6	11.0
Classmates/peers	46	8.1	9.2
Organisational IT department	39	6.8	7.8
Educators	20	3.5	4.0
Other	10	1.8	2.0
Cybercafé/Library help desk	1	.2	0.2
Total	502	87.9	100.0

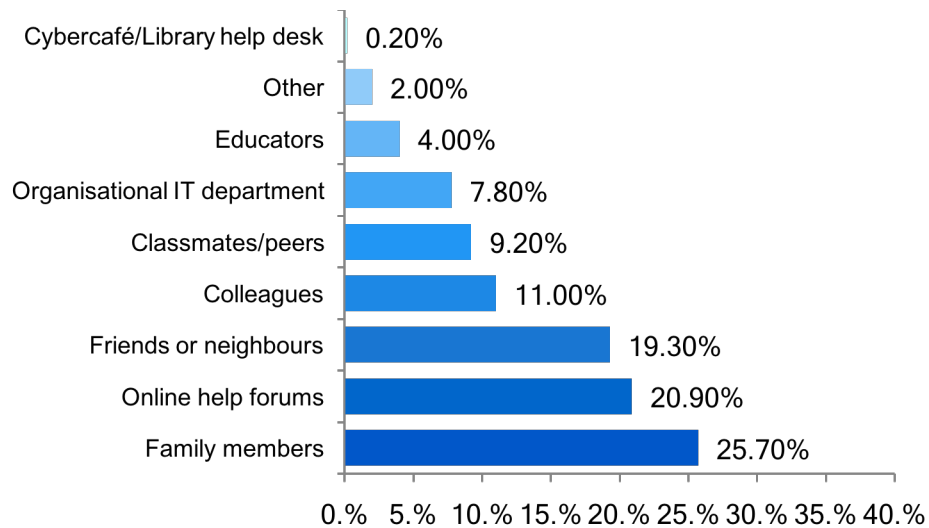

Figure 5.25: Sources of Best Help

Question 27 of the survey examined the quality of the help received by asking respondent to select which single source provided them with the best help. Figure 5.25 indicates that family members (25.7%) provide the best help, closely followed by online help forums (20.9%). On the other hand, as for the previous questions, cybercafé and library help desk (1%) are not perceived as providing the best help.

SOCIAL SUPPORT: LIMITATIONS ON EFFECTIVE INTERNET USE

Social Support: Limitations of effective Internet use.						
Limitations	No effect at all	Little negative effect	Negative effect	Significant negative effect	Very significant negative effect	Weighted Mean
Lack of help/support when I needed it	306	103	68	18	13	0.68
No safe place where I could use the Internet	357	74	28	17	25	0.56
No clear idea of why I should use the Internet	363	74	32	12	21	0.51
Lack of encouragement to use the Internet	358	85	32	11	16	0.49

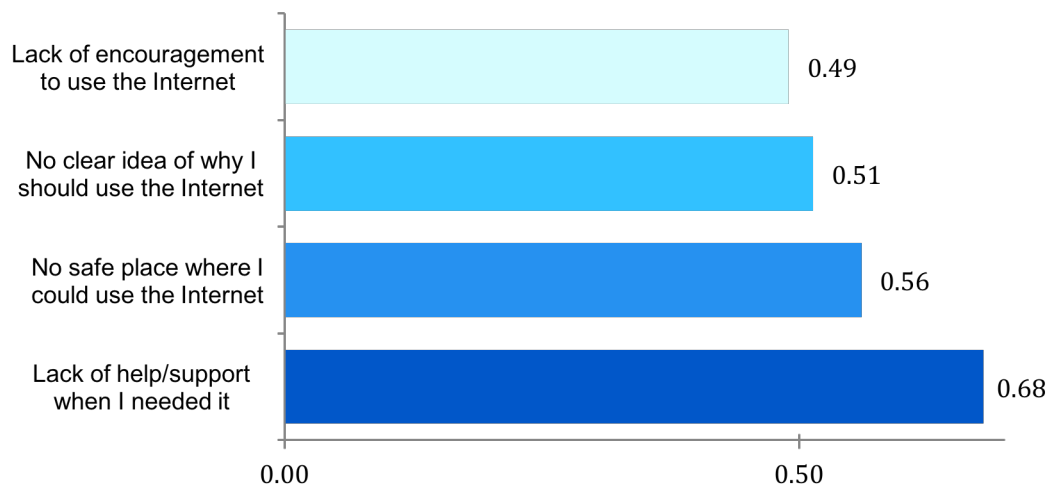

Figure 5.26: Social Support - Factors Limiting Effective Internet Use

As shown in Figure 5.26, question 28 of the survey examined the factors that limit effective Internet use from a social support dimension. The results suggest that a lack of help and support when needed (weighted mean of 0.68) is the factor that is perceived as being the most limiting in the effective Internet use of respondents. Interestingly, the survey population perceived lack of encouragement (weighted mean of 0.49) to use the Internet as being

less limiting in their effective Internet use. Nonetheless, support seems to be very important in Internet use.

5.3.6. Purpose of Use

Section 6 of the survey investigated the use respondents make out of the Internet. They were presented with a list of 12 online activities and were required to rate on a Likert scale ranging from 0 (not important at all) to 4 (very I-important) the relative importance of each activity in their Internet use. The weighted mean was calculated for each of the responses as follows.

As shown in Figure 5.27 information seeking (weighted mean of 3.59) and communicating directly with others (weighted mean of 3.50) are perceived as being the most important online activities performed by respondents. On the other hand, the results suggest that respondents are less keen on producing creative content online. Indeed, they perceive publishing information (weighted mean of 1.72) and distributing own media (weighted mean of 1.63) as being less important. However, least important of all is supporting a political party online (weighted mean of 0.79). The findings tend to suggest that the Mauritian Internet users are rather consumers of online content rather than producers.

PURPOSE OF USE: IMPORTANCE OF ACTIVITIES ON THE INTERNET

Importance of activities on the Net	Not important at all	Not important	Somewhat important	Important	Very important	Weighted Mean
Supporting a political party	365	667	28	19	22	0.79
Distributing own multimedia production	154	98	109	64	78	1.63
Publishing information	137	107	103	71	84	1.72
Playing games	132	103	98	59	113	1.84
Performing online transactions	91	72	97	91	148	2.27
Supporting a cause	13	108	107	68	89	2.29
Collaborative work	90	70	91	105	150	2.31
Viewing, downloading and sharing videos	33	58	84	104	225	2.85
Listening to, downloading and sharing music	31	48	76	116	234	2.94
Making and maintaining social networks	23	49	84	123	226	2.95
Communicating directly with other people	5	15	46	97	343	3.50
Information seeking	5	13	31	87	371	3.59

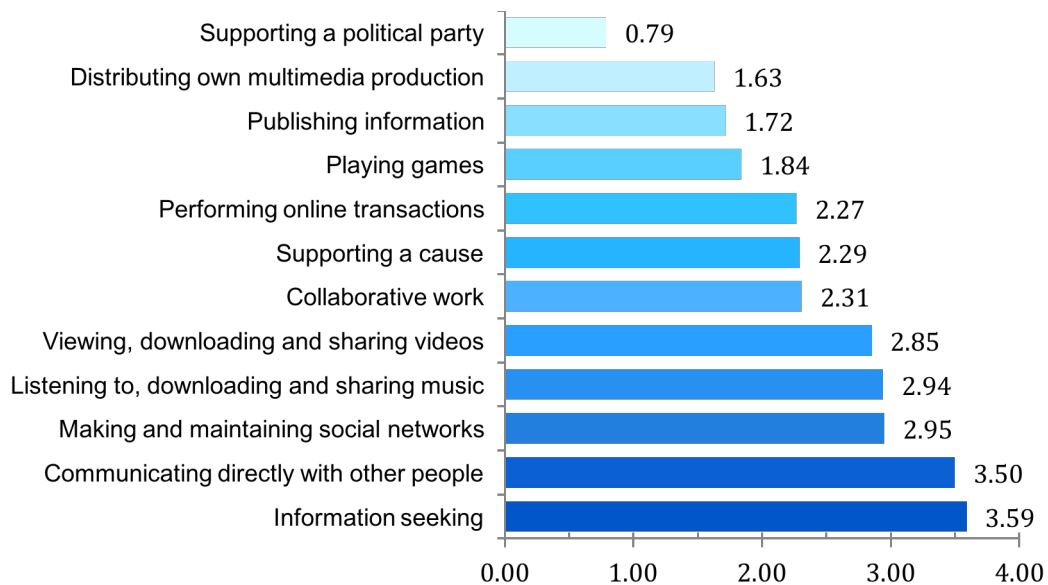

Figure 5.27: Purpose of Use - Factors Limiting Effective Internet Use

5.4. Inferential Statistics

The following section outlines the various analyses carried out on the data set. In order to investigate the determinants of Digital Inequality in Mauritius, the Mann-Whitney (U) and Kruskal-Wallis (H), both non-parametric tests were used. The objective is to investigate the differences, if any, among the

various groups of each demographic variable within each of the five dimensions. This section also investigates underlying factors of Digital Inequality in Mauritius through Factor Analysis and the relative strength of these factors in Digital Inequality perception through a Regression Analysis.

5.4.1. Grouping of Variables

Throughout the survey, indicators were used to measure concepts (De Vaus 2002, chap. 4) such as inequality in technical apparatus, inequality in autonomy of use, inequality in skill, inequality in social support and inequality in purpose of use. The literature review and methodology chapters provided the theoretical background for the justification of the indicators used. However, in order to allow for deeper analysis of the concepts, these indicators needed to be regrouped in order to make up for a meaningful representation of the concept.

As suggested by De Vaus (2002), reliability tests were carried out on the scale for each of the concepts identified. The table below outlines the Cronbach's alpha Coefficient for each of the regrouped concepts. Obviously, the concepts were all regrouped under the five dimensions coined by DiMaggio and Hargittai.

Concept	Cronbach's alpha Coefficient (α)
Inequality in Technical Apparatus	0.656
Inequality in Autonomy of Use	0.759
Inequality in Skill	0.894
Inequality in Social Support	0.840
Inequality in Purpose of Use	0.777

Table 5.3: Summary of Reliability Coefficients for Inequality Concepts

Bryman (2012), citing various sources, argues that there is debate as to the minimum acceptable value of the Cronbach's alpha coefficient, but then, as a rule of thumb, a value of more than 0.7 is deemed suitable. However,

Bryman also puts forward the case where values as low as 0.6 can be deemed 'good enough'. As illustrated in Table 5.3, all the values of Cronbach's alpha coefficient were above 0.7, except for inequality in technical apparatus with a value of 0.656, which can still be considered as 'good enough' in light of it being near to 0.7. Therefore, based on the results above, it can be safely assumed that the above five scales are reliable and that it is safe to build a scale for each construct.

Once constructed using the mean values, each scale was re-tested for normality. All of the constructs mentioned in Section 5.2.1 proved to be not normal, as assessed by the Shapiro-Wilk test ($p < 0.05$). The Shapiro-Wilk test was preferred over the Kolmogorov-Smirnov test because the sample size was less than 2000 (Laerd Statistics 2015). This result confirmed the use of non-parametric tests to explore the differences between groups of each of the demographic variables and the five constructs of Digital Inequality.

5.4.2. Mann Whitney (U) and Kruskal-Wallis (H) Test

The nature of the variables required that two tests be used. On one hand, the Mann-Whitney (U) test, which is a non-parametric test, was used to investigate differences between the continuous dependent variables and dichotomous (2 categories) independent variables (sex) (De Vaus 2002). On the other hand, Kruskal-Wallis (H), also a non-parametric test, was used to investigate differences between the continuous dependent variables and independent variables with three or more categories (De Vaus 2002)—age group, residential location, occupation, highest level of education achieved, current education level and highest education level of parents.

	Male		Female	
	Mean	Std. Deviation	Mean	Std. Deviation
Inequality in Technical Apparatus	1.5225	0.88506	1.4864	0.84053
Inequality in Autonomy of Use	1	0.8379	0.861	0.70762
Inequality in Skill	0.6226	0.87096	0.8548	0.88656
Inequality in Social Support	0.5038	0.80448	0.5793	0.81234
Inequality in Purpose of use	2.2882	0.72883	2.3717	0.64032

Table 5.4: Mean Score of Gender for each Inequality

		Inequality in Technical Apparatus	Inequality in Autonomy of Use	Inequality in Skill	Inequality in Social Support	Inequality in Purpose of Use
Mann-Whitney (U) test	Sex	31548.5 z = -0.219, p = 0.827	26609.0 z = -1.400, p = 0.162	36134.5 z = 3.674, p = 0.000	32694.5 z = 1.922, p = 0.055	30403.0 z = 1.518, p = 0.129

Table 5.5: Results of Mann-Whitney (U) Test

The result of the Mann-Whitney (U) Test (Table 5.5) shows that there is a statistically significant difference ($p < 0.05$) between males and females within distribution in inequality in skill only (further explained in the inequality in skill section below). Interestingly, there is no statistically significant difference between sex in the distribution of other inequalities and it can be safely concluded that there is no difference in the perception of males and females with respect to these inequalities. Table 5.4 shows the descriptive statistics (mean scores) for the gender demographics and suggests that females are more affected than males in the inequality of skills.

		Inequality in Technical Apparatus	Inequality in Autonomy of Use	Inequality in Skill	Inequality in Social Support	Inequality in Purpose of Use
Kruskal Wallis (H) test	Age-Group	23.290 (p = 0.000)	29.183 (p = 0.000)	15.985 (p = 0.007)	30.795 (p = 0.000)	51.852 (p = 0.000)
	Residential Location	7.452 (p = 0.059)	2.410 (p = 0.492)	0.929 (p = 0.819)	6.895 (p = 0.075)	4.364 (p = 0.225)
	Occupation	17.504 (p = 0.064)	30.966 (p = 0.000)	27.384 (p = 0.002)	26.611 (p = 0.003)	42.036 (p = 0.000)
	Highest Education Level	14.540 (p = 0.024)	29.872 (p = 0.000)	25.188 (p = 0.001)	47.462 (p = 0.000)	17.510 (p = 0.014)
	Current Education	30.230 (p = 0.000)	43.475 (p = 0.000)	29.274 (p = 0.000)	53.215 (p = 0.000)	17.825 (p = 0.023)
	Highest Education Level of Parents	4.736 (p = 0.692)	4.871 (p = 0.676)	8.900 (p = 0.260)	7.380 (p = 0.390)	19.201 (p = 0.008)

H test: Test Statistics Test Statistic value and Asymptotic Sig. Values.

Table 5.6: Results of Kruskal Wallis (H) Test

Clearly from Table 5.5 and Table 5.6, it can be noted that there is no difference in residential location groups with regard to any of the five inequality constructs. It can therefore be deduced that residential location is not a determinant of any of the five dimensions of Digital Inequality, meaning that Mauritian Internet users are not disadvantaged in their effective Internet use based on their area of residence.

The following section details the post hoc analysis carried out on each of the five dimension of Digital Inequality. The procedure requires that the box plot be visually inspected for their shapes. Similar shape meant that post hoc analysis could be carried out, such as the pairwise comparisons with Bonferroni corrections. Such analysis brings a finer level of differences and shows the statistically significant differences. This allows for more pertinent analysis to be made in so far as the differences between groups are concerned.

5.4.2.1. Technical Apparatus

Results of the Mann-Whitney test (Table 5.5) and Kruskal Wallis test (Table 5.6) show that only age group, highest level of education and current education have statistically significant differences in the distribution of inequality in technical apparatus.

With regard to the differences in inequality in technical apparatus scores between the different age group clusters, further visual inspection of the H test box plot confirmed that the distribution scores similar shape. The median scores for age group 12-19 (1.750) and 20-29 (1.625) were higher than the median scores for age group 30-39 (1.250), 40-49 (1.000), 50-59 (1.500) and 60+ (1.000) and was statistically significant $X^2(5) = 23.290$, $p = 0.000$. Subsequently pairwise comparisons were performed with a Bonferroni correction for multiple comparisons (Table 5.7).

Sample 1 – Sample 2	Ad. Sig Value (<i>p</i>)
40-49 – 20-29	0.003
40-49 – 12-19	0.006
30-39 – 20-29	0.039

Table 5.7: Summary of Significant Pairwise Comparison of Age Group in Inequality in Technical Apparatus Distribution

It can therefore be deduced that Internet users aged between 40-49 years old are less likely to perceive inequality in technical apparatus as negatively affecting their Internet use than those aged between 12-19 years old. The same trend appears in the difference between the 30-39 and the 20-29, showing that those in the higher age group (30-39) are less affected than those in the 20-29 years.

Highest education level achieved is yet another demographic variable where the differences between the different strata have statistically significant scores for inequality in technical apparatus. Further visual inspection of the box plot result showed that the distribution of scores had similar shape for the different age groups. The median scores for highest level of education achieved is shown in Table 5.8 below and the result is statistically significant, $X^2(6) = 25.548$, $p = 0.000$. The results clearly show that respondents who have achieved Primary level as highest education tend to perceive technical apparatus as having a higher limiting factor on their effective use of Internet than the other groups.

Highest Education Level	Median Scores
Primary	1.750
SC	1.000
HSC	1.625
Cert/Dip	1.250
Professional	1.500
Undergrad	1.625
Postgrad	1.500
Total	1.500

Table 5.8: Median Scores Across Highest Education Level in Inequality of Technical Apparatus

Sample 1 – Sample 2	Adj. Sig Value (p)
SC – HSC	0.042
SC – Primary	0.012
Cert/Dip – HSC	0.027
Cert/Dip – Primary	0.013

Table 5.9: Summary of Significant Pairwise Comparison of Highest Education Level Achieved and Inequality in Technical Apparatus

Table 5.9 provide a summary of differences between the different groups that were statistically significant. Although there are no hierarchical differences, the results (Table 5.8) show that between Primary, SC and HSC levels, those having studied up to Primary level perceived technical apparatus as having a more negative effect on their Internet use. It is worth pointing out that a vast majority of those having Primary education as their highest education level could be still studying and exploring new uses of the Internet. This would make them high bandwidth users and quite demanding, with regard to quality and reliability of the connection.

In so far as current education level is concerned, the H test suggests that there are indeed differences in the distribution of inequality in technical apparatus scores across current education level and such differences are statistically significant, $\chi^2(8) = 30.230$, $p = 0.000$. The following table (Table 5.10) outlines the median scores for each group.

Current Educational Level	Median
Primary	2.500
Vocational	2.000
SC	0.500
HSC	1.375
Cert/Dip	1.250
Professional	1.750
Undergrad	1.625
Postgrad	1.500
Not studying	1.500
Total	1.500

Table 5.10: Median Scores Across Current Education Level in Inequality in Technical Apparatus

Sample 1 – Sample 2	Adj. Sig Value (p)
SC – Primary	0.000
Cert/Dip – Primary	0.008
Not Studying – Primary	0.004

Table 5.11: Statistically Significant Pairwise Comparison of Current Education Level Achieved and Inequality in Technical Apparatus

Likewise, visual inspection confirmed that the distribution among the different groups has the same shape. Thus, Table 5.11 provides a summary of the statistically significant differences between the groups. This result correlates with the above demographic variables, showing that students at the lower education level perceive technical apparatus as having a higher negative effect on their Internet use.

5.4.2.2. Autonomy of Use

The Kruskal-Wallis (H) test (Table 5.6) revealed that within the inequality in autonomy of use, there were statistically significant differences in the distribution between groups in four demographic variables, namely age group, occupation, highest education level and current education. The following section explores the result and situates the differences.

With regard to age group, the Kruskal-Wallis (H) test showed statistically significant differences between the various age groups, $\chi^2(5) = 29.183$, $p = 0.000$, with distribution among different age groups having the same shape (assessed visually). The median scores for each age group are shown below (Table 5.12).

Age Group	Median
12-19	1.429
20-29	0.714
30-39	0.571
40-49	0.143
50-59	1.000
60 +	0.786
Total	0.714

Table 5.12: Median Scores Across Age Group in Inequality in Autonomy of Use

Sample 1 – Sample 2	Adj. Sig Value (<i>p</i>)
40-49 – 20-29	0.045
40-49 – 12-19	0.000
30-39 – 12-19	0.000
20-29 – 12-19	0.004

Table 5.13: Statistically Significant Pairwise Comparison of Age Group and Inequality in Autonomy of Use

As shown in Table 5.12, the median of scores for respondents in the 12-19 years old age group (1.429) is higher than the remaining group. Pairwise comparison with Bonferroni correction for multiple comparisons revealed that there were statistically significant differences between the group pairings as shown in Table 5.13. Again although there is no hierarchical ranking, within the differences, it reaffirms that within the pairwise comparisons, the younger generation perceive autonomy as having a higher negative impact on their Internet use than their elder counterparts.

Furthermore, the result revealed that there were statistically significant differences between respondents' occupation group for inequality in autonomy of use scores, $\chi^2(9) = 30.966$, $p = 0.000$. However, since the shape of the distribution is not the same, post-hoc pairwise comparisons could not be conducted on the results. Although it is difficult to situate the differences between groups using median, Table 5.14 shows that student has a higher mean than the remaining groups.

Occupation	Mean
Student	1.114
Self-employed	0.878
Educator/Trainer	0.849
Top Management	0.500
Middle Management	0.829
Admin/Clerical	1.030
Retired	0.229
Technician/Specialist	0.896
Manual worker	0.143
Unemployed	0.543
Total	0.937

Table 5.14: Mean Scores Across Occupation in Inequality in Autonomy of Use

Concerning the highest education level achieved, the Kruskal-Wallis (H) test revealed, as assessed visually, that the distribution of scores between the various highest education levels achieved by respondents were similar. The median scores (Table 5.15) were statistically significant, $\chi^2(6) = 30.311$, $p = 0.000$.

Highest Education Level	Median
Primary	1.857
SC	0.643
HSC	0.857
Cert/Dip	0.571
Professional	0.714
Undergrad	0.714
Postgrad	0.571
Total	0.714

Table 5.15: Median Scores Across Highest Education Level Achieved in Inequality in Autonomy of Use

Sample 1 – Sample 2	Adj. Sig Value (p)
Cert/Dip – Primary	0.000
Postgrad – Primary	0.000
SC – Primary	0.007
Undergrad – Primary	0.000
HSC – Primary	0.003

Table 5.16: Statistically Significant Pairwise Comparison of Highest Level of Education and Inequality in Autonomy of Use

Further pairwise comparisons (Table 5.16) with Bonferroni correction revealed statistically significant differences between the following highest education level pairings: between Cert/Dip and Undergraduate Level; between Postgrad and Primary education level; between SC and HSC level; between Undergrad and Primary education level; and lastly between HSC and Primary education level. The findings clearly show that Internet users with Primary education as their highest education level achieved tend to perceive autonomy of use as having a stronger negative effect on their Internet use than users having achieved higher education level.

Current education level is another demographic variable whose distribution is similar (as assessed visually) between groups and which has statistically significant differences between the median of the various groups, $\chi^2(8) = 43.475$, $p = 0.000$. The medians are shown in the table below.

Current Educational Level	Median
Primary	2.000
Vocational	0.714
SC	0.571
HSC	0.429
Cert/Dip	0.857
Professional	0.786
Undergrad	0.857
Postgrad	1.000
Not studying	0.571
Total	0.857

Table 5.17: Median Scores Across Current Education Level in Inequality in Autonomy of Use

Sample 1 – Sample 2	Adj. Sig Value (p)
SC – Primary	0.002
Not Studying – Primary	0.000
HSC – Primary	0.004
Cert/Dip – Primary	0.003
Professional – Primary	0.002
Undergrad – Primary	0.000
Postgrad – Primary	0.002

Table 5.18: Statistically Significant Pairwise Comparison of Current Education Level and Inequality in Autonomy of Use

The pairwise comparison, with Bonferroni correction, showed that there were statistically significant differences between groups, as shown in Table 5.18. In line with the above results, the findings of this analysis suggest that current students at Primary education level (usually) aged 12 perceived autonomy of use as having a significant negative impact on their Internet use than their counterparts studying at higher level. The findings suggest that this group could be highly subjected to parental control or institutional control (schools) in their daily Internet use.

5.4.2.3. Skill

With regard to the distribution of scores for the inequality of skill construct, the Mann-Whitney (U) test was carried out for the sex demographic variable (2 groups), whereas Kruskal-Wallis (H) test was carried out for the rest of the demographic variables (more than two groups). The results (Table 5.5 and Table 5.6) showed that there were statistically significant differences across groups of sex, age, occupation, and highest education level achieved and current education. The following section outlines the result of the U and H tests and investigates the differences across the respective groups.

The Mann-Whitney (U) test result showed that there were statically significant differences between scores for males and females, $U = 36, 134.50, z = 3.674, p = 0.000$. The distribution was found to be of similar shape, as assessed by visual inspection. Median score in inequality in skill was found to be statistically significantly higher in females (0.600) than males (0.200), suggesting that women generally view lack of skill as having a stronger negative effect on their Internet use than men.

Kruskal-Wallis (H) test revealed that there are statistically significant differences in inequality in skill across the various age groups, $X^2(5) = 15.985, p=0.007$, with median as shown below.

Age Group	Median
12-19	0.900
20-29	0.400
30-39	0.200
40-49	0.400
50-59	0.600
60 +	1.500
Total	0.400

Table 5.19: Median Scores Across Age Group in Skill

Sample 1 - Sample 2	Adj. Sig Value (p)
30-39 – 60+	0.031
20-29 – 60+	0.028

Table 5.20: Statistically Pairwise Comparison of Age Group in Skill

The shape of the distribution being similar, pairwise comparison was conducted (Table 5.20). The result showed that there were statistically significant differences, firstly between the 30-39 age group and the 60+ age group ($p = 0.031$), and secondly between the 20-29 age group and the 60+ age group ($p = 0.028$). The findings thus suggest that those above 60 years old perceived lack of skill as having a greater negative effect on their Internet use than the younger generations aged 20-39.

Additionally, there were also statistically significant differences in purpose of use in skill across the various occupation groups, $\chi^2(10) = 27.384$, $p = 0.002$. However, the shape of the distributions was dissimilar across the various occupation groups, and therefore post-hoc pairwise comparisons could not be carried out.

Occupation	Mean
Student	0.802
Self-employed	0.536
Educator/Trainer	0.574
Top Management	0.331
Middle Management	0.780
Admin/Clerical	0.924
Retired	1.040
Technician/Specialist	0.525
Manual worker	0.000
Unemployed	0.827
Other	1.500
Total	0.733

Table 5.21: Median Scores Across Occupation in Skill

Nonetheless, the mean scores (Table 5.21) suggest, that retired respondents have a higher mean score (1.040) than the remaining groups. This, in turn, could suggest that they are more likely to experience more negative effect in their Internet than the others. This result validates the previous finding with regard to age, where Internet users aged 60 and above viewed lack of skill as having a major negative effect on their Internet use. It can be assumed, in this case, that retired people would be aged 60 years and above.

Highest education level achieved is yet another variable with statistically significant differences across the groups in inequality in skill, $\chi^2(6) = 22.148$, $p = 0.001$, with median scores as shown in the following table.

Highest Education Level	Median
Primary	1.600
SC	0.600
HSC	0.400
Cert/Dip	0.400
Professional	0.200
Undergrad	0.400
Postgrad	0.200
Total	0.400

Table 5.22 Median Scores Across Highest Education Level Achieved in Skill

Sample 1 – Sample 2	Adj. Sig Value (p)
Postgrad – SC	0.000
HSC – Primary	0.000
Undergrad – Primary	0.000
Cert/Dip – SC	0.003

Table 5.23: Statistically Significant Pairwise Comparison of Highest Education Level Achieved and Inequality in Skill

Distribution shape of boxplot for inequality in skill was found to be similar for all groups (visual inspection). Consequently, pairwise comparison (Table 5.23) with Bonferroni correction revealed that there were statistically significant differences among the following pairings: between Postgrad Level and Primary Level ($p = 0.000$); between HSC and Primary ($p = 0.000$); between Undergrad and Primary ($p = 0.000$); and finally between Cert/Dip and Primary ($p = 0.003$). From the results, it can be concluded that Internet users who have achieved Primary education level as their highest education level tend to perceive lack of skill as having a more negative effect on their Internet use than the other groups.

The Kruskal-Wallis (H) test also revealed that there were differences in inequality in skill across current education groups, and that those differences

were statistically significant, $\chi^2(8) = 29.274$, $p = 0.000$, with median scores shown in the Table 5.24 below.

Current Educational Level	Median
Primary	1.800
Vocational	1.000
SC	0.700
HSC	0.700
Cert/Dip	0.600
Professional	0.200
Undergrad	0.400
Postgrad	0.200
Not studying	0.200
Total	0.400

Table 5.24: Median Scores Across Current Education Level in Inequality in Skill

Sample 1 – Sample 2	Adj. Sig Value (p)
Professional – Primary	0.000
Not Studying – Primary	0.000
Postgrad – Primary	0.001
Undergrad – Primary	0.002

Table 5.25: Statistically Significant Pairwise Comparison of Current Education Level and Inequality in Skill

The distribution of inequality in skill being of similar shape for all the current education level groups, pairwise comparison (Table 5.25) with Bonferroni correction was conducted. The results revealed statistically significant differences among the following pairings: between Professional and Primary level ($p = 0.000$); between the Not Studying group and Primary level ($p = 0.000$); between the Postgrad and the Primary ($p = 0.001$); and between the Undergrad and Primary ($p = 0.002$). Clearly, the result suggests that respondents who are currently studying at the Primary level (median = 1.800) perceive skill as having a stronger negative effect on their Internet use than the other groups.

5.4.2.4. Social Support

As shown in Table 5.6, the Kruskal Wallis (H) test revealed that there were statistically significant differences in inequality in social support across the age group, occupation, highest education achieved and current education level, but not in the other demographic variables. The following section, therefore, unpacks the results and explores the differences within the relevant demographic variable.

The H test revealed that there are statistically significant differences in inequality in social support across the different age groups, $X^2(5) = 30.795$, $p = 0.000$, with median scores as follows (Table 5.26):

Age Group	Median
12-19	0.750
20-29	0.000
30-39	0.000
40-49	0.000
50-59	0.000
60 +	0.500
Total	0.000

Table 5.26: Median Scores Across Age Group in Inequality in Social Support

Sample 1 – Sample 2	Adj. Sig Value (p)
40-49 – 12-19	0.001
50-59 – 12-19	0.023
30-39 – 12-19	0.000
20-29 – 12-19	0.000

Table 5.27: Statistically Significant Pairwise Comparison of Age Group Level in Inequality in Social Support

After ensuring that the distribution shape of inequality in social support scores were similar for all groups, as assessed by visual inspection, pairwise comparisons with Bonferroni correction revealed significant differences (Table 5.27) between the 12-19 age group and older age group (20-59). This result revealed that young respondents aged between 12 and 19 years old perceive social support, or rather lack of social support, as having a stronger negative effect on their Internet use than the other groups.

Likewise, there were statistically significant differences in inequality in social support across the various occupations, $\chi^2(10) = 26.611$, $p = 0.003$.

However, distributions of inequality in social support scores were not similar for all groups within occupation. Therefore, post-hoc pairwise comparisons could not be performed. Subsequently, the mean ranks (Table 5.28) were used to give an overview the differences.

Occupation	Mean
Student	0.723
Self-employed	0.420
Educator/Trainer	0.372
Top Management	0.190
Middle Management	0.460
Admin/Clerical	0.564
Retired	0.150
Technician/Specialist	0.369
Manual worker	0.000
Unemployed	0.633
Other	0.500
Total	0.543

Table 5.28: Mean Ranks across Occupation in Inequality in Social Support

The mean ranks, as shown in Table 5.28, suggest that students (mean = 0.723) and unemployed people (mean = 0.633) are more affected by the lack of social support in the effective use of the Internet, as compared to the other groups.

Highest education level achieved is yet another demographic variable across which there were statistically significant differences in inequality in social support, $\chi^2(6) = 39.651$, $p = 0.000$. The median scores are shown in Table 5.29 below.

Highest Education Level	Median
Primary	1.000
SC	0.250
HSC	0.250
Cert/Dip	0.000
Professional	0.125
Undergrad	0.000
Postgrad	0.000
Total	0.000

Table 5.29: Median Scores Across Highest Education Level Achieved in Inequality in Social Support

Sample 1 – Sample 2	Adj. Sig Value (<i>p</i>)
Postgrad – Primary	0.000
HSC – Primary	0.000
Undergrad – Primary	0.000
Cert/Dip – Primary	0.003

Table 5.30: Statistically Significant Pairwise Comparison of Highest Education Level Achieved and Inequality in Social Support

Distribution of inequality in social support was found to have similar shape across all the groups for highest education level achieved, which allowed for pairwise comparisons to be conducted (with Bonferroni correction). The results (Table 5.30) show that there were statistically significant differences between those who achieved Primary education as highest education level and the other groups. Thus, it can be concluded that these users who have Primary education as their highest education level perceive the lack of social support as having a greater negative effect on their Internet use, as opposed to those who have achieved higher education levels. It can be further argued that the majority who have achieved Primary education level would still be students at Secondary level and as they grow with the technology and seek new functions, help and support become increasingly important for this group of users.

Lastly, with regard to inequality in social support, the results showed that there were statistically significant differences in inequality in social support

scores between groups that differed on their current education level, $\chi^2(8) = 53.215$, $p = 0.000$, with the median scores as follows (Table 5.31).

Current Educational Level	Median
Primary	2.000
Vocational	1.250
SC	0.375
HSC	0.250
Cert/Dip	0.500
Professional	0.000
Undergrad	0.250
Postgrad	0.250
Not studying	0.000
Total	0.250

Table 5.31: Median Scores Across Current Education Level in Inequality in Social Support

Sample 1 – Sample 2	Adj. Sig Value (p)
Not Studying – Primary	0.000
Professional – Primary	0.000
HSC – Primary	0.010
Undergrad – Primary	0.000
Postgrad – Primary	0.000
Cert/Dip – Primary	0.013

Table 5.32: Statistically Significant Pairwise Comparison of Current Education Level and Inequality in Social Support

Similar shape distributions (visually assessed through boxplot inspection) across the different current education level groups allowed for pairwise comparisons, with Bonferroni correction, to be conducted. The result (Table 5.32) revealed that there were statistically significant differences between users who were currently studying at Primary level and the remaining groups. From this result, it can be concluded that Mauritian Internet users currently studying at the Primary level perceived lack of social support as having a greater negative effect on their Internet use than those studying at a higher level or not studying at all.

5.4.2.5. Purpose of Use

The Kruskal Wallis (H) test (Table 5.6) revealed that there were statistically significant differences in inequality in purpose of use scores between groups with regard to the age group, occupation, highest level of education achieved, current education and the highest education level achieved by parents. The following section, therefore, explores the results further and tries to establish the differences where possible.

With regard to age group, the H test revealed that there were indeed statistically significant differences in inequality in purpose of use scores between the various age groups, $X^2(5) = 51.852$, $p = 0.000$, with median scores as shown in the table below.

Age Group	Median
12-19	2.250
20-29	2.500
30-39	2.083
40-49	1.750
50-59	1.708
60 +	1.500
Total	2.333

Table 5.33: Median Scores Across Age Group in Inequality in Purpose of Use

Sample 1 – Sample 2	Adj. Sig Value (p)
60+ – 20-29	0.004
50-59 – 20-29	0.003
40-49 – 12-19	0.029
40-49 – 20-29	0.000
30-39 – 20-29	0.007

Table 5.34: Statistically Significant Pairwise Comparisons of Age Group and Inequality in Purpose of Use

Since the distributions on inequality in purpose of use were similar in shape for all groups (assessment based on visual inspection of boxplot), pairwise comparisons, with Bonferroni correction, were conducted. As shown in Table 5.34, pairing involving the younger generations aged between 12-19 and 20-29 with other users were statistically significant with regard to the use they

make out of the Internet. The results suggest that compared to the older age groups, the younger generation has a more diverse use of the Internet.

There were, also, statistically significant differences in inequality in purpose of use scores between the different occupations, $\chi^2(10) = 42.036$, $p = 0.000$. The mean scores are shown in the table below.

Occupation	Mean
Student	2.434
Self-employed	2.636
Educator/Trainer	2.100
Top Management	1.951
Middle Management	2.249
Admin/Clerical	2.294
Retired	1.264
Technician/Specialist	2.457
Manual worker	2.250
Unemployed	2.577
Other	1.833
Total	2.336

Table 5.35: Mean Ranks Across Occupation in Inequality in Purpose of Use

Since the distribution across the inequality in purpose of use was not similar, pairwise comparison could not be conducted. Therefore, based on the mean ranks above, it can be said that the mean rank is higher for the self-employed and the unemployed than for the rest of the group, thus suggesting that they have a wider array of use than the rest. This could be due to the fact that they have more time at their disposal in their Internet use.

The result (Table 5.6) also revealed that there were statistically significant differences in inequality in purpose of use scores between groups that differed in the highest education level achieved, $\chi^2(6) = 22.148$, $p = 0.001$, with the median scores outlined in the table below.

Highest Education Level	Mean
Primary	1.970
SC	2.337
HSC	2.500
Cert/Dip	2.291
Professional	2.430
Undergrad	2.371
Postgrad	2.239
Total	2.335

Table 5.36: Median Scores Across Highest Education Level Achieved in Inequality in Purpose of Use

Sample 1 – Sample 2	Adj. Sig Value (p)
Postgrad – Primary	0.000
HSC – Primary	0.000
Undergrad – Primary	0.000
Cert/Dip – Primary	0.003

Table 5.37: Statistically Significant Pairwise Comparisons of Highest Education Level Achieved and Inequality in Purpose of Use

The distributions of scores were similar for all groups, as assessed by visual inspection of the box plot diagram, thereby enabling pairwise comparisons, with Bonferroni correction, to be conducted. The results (Table 5.37) showed that there are statistically significant differences between the following pairings: between Postgrad level and Primary level ($p = 0.000$); between HSC and Primary level ($p = 0.000$); between Undergrad and Primary level ($p = 0.000$); and between Cert/Dip and SC level ($p = 0.003$).

Current education level is yet another demographic variable where there were statistically significant differences between groups in inequality in purpose of use scores, $X^2(8) = 17.825$, $p = 0.023$, with the mean and median scores given in the table below.

Current Educational Level	Mean	Median
Primary	2.149	2.042
Vocational	2.250	2.250
SC	1.717	1.667
HSC	2.429	2.625
Cert/Dip	2.212	2.125
Professional	2.423	2.458
Undergrad	2.511	2.583
Postgrad	2.447	2.333
Not studying	2.246	2.167
Total	2.358	2.333

Table 5.38: Mean and Median Scores Across Current Education Level in Inequality in Purpose of Use

Although the distribution of inequality in purpose of use scores were similar, as assessed by visual inspection of the boxplot diagram, the pairwise comparisons with Bonferroni correction revealed that there were no statistically significant differences between the median score of any group pairings. It can thus be concluded that those studying at the Undergrad (mean = 2.511) and Postgrad (2.447) have a wider range of Internet use than the other groups.

The Kruskal Wallis (H) test also revealed that there were statistically significant differences in inequality in purpose of use between groups that differed by the highest education level achieved by parents, $\chi^2(7) = 19.201$, $p = 0.008$. The mean scores are shown in the table below.

Highest Education Level of Parents	Mean
Primary	2.161
Vocational	2.448
SC	2.249
HSC	2.462
Cert/Dip	2.297
Professional	2.294
Undergrad	2.434
Postgrad	2.549
Total	2.347

Table 5.39: Mean Scores across Highest Education Level of Parents in Inequality in Purpose of Use

The distributions of scores were not similar across the different education level achieved (highest) by parents. Therefore, based on the mean ranks, it can be concluded that those whose parents have achieved Postgrad level (mean = 2.549) and those who have achieved HSC level (mean = 2.462) have a wider range of Internet use than the rest among the age group.

5.4.3. Factor Analysis

This study uses DiMaggio and Hargittai's model as its theoretical framework to assess the existence of Digital Inequality and the causes of Digital Inequality in Mauritius. As discussed, DiMaggio and Hargittai's model consists of five dimensions or factors of inequality, namely inequality in technical apparatus, inequality in autonomy of use, inequality in social support, inequality in skill and inequality in the purpose of use. Additionally, as discussed in Chapter 2, there are socio-demographic variables that are the causes of Digital Inequality such as sex, age, education and social status amongst others.

To investigate the existence of Digital Inequality on the island, each factor was broken down into more specific items, as discussed in Section 4.3.1. These items, measured on a 5 point Likert scale offered the possibility to investigate the five dimensions of Digital Inequality. Furthermore, Mann Whitney and Kruskal-Wallis test, as described in Section 5.4.2 allowed for an investigation of the causes of those inequalities. Indeed, for each dimension, tests were carried out to investigate whether each of the socio-demographic affect (causes) the inequality, with the results reported in the previous section (further discussion in Chapter 6).

Thus, so far, the analyses have been related to determining the existence of Digital Inequality using the five dimensions of DiMaggio and Hargittai, and exploring the causes of these inequalities with respect to socio-demographic variables. However, as discussed at the onset of this research, Mauritius and Small Islands Developing States offer some unique contexts and already the difference in the causes (socio-demographic variables) have been, amongst

others, the basis for exploring the issue of Digital Inequality in Mauritius (Chapter 2). In the same vein, the dimensions brought forward by DiMaggio and Hargittai was very much context specific and it is important to, at the very least, test whether the same dimensions or forces of inequality are at play in the Mauritian context. To this end, an exploratory factor analysis (EFA) was carried out on the 32 variables that queried respondents on DiMaggio and Hargittai's five dimensions of inequality. The aim was to understand whether the same underlying dimensions that make up Digital Inequality in the US are at play in the Mauritian context or whether there are other dimensions, or perhaps prominent groups or sub groups, that make up Digital Inequality in Mauritius. The EFA would reveal such differences and would provide a more defined picture of Digital Inequality on the island. The scope of this study is limited to exploring the factors, thus the use of EFA.

Thus, before conducting the analysis, the 32 variables were re-tested for reliability (an initial test was carried out with 44 variables—discussed in Section 5.2.1), with a Cronbach's alpha Coefficient of 0.849, which exceeds the 0.7 required to proceed with Factor Analysis (De Vaus 2002). The Kaiser-Meyer-Olkin test gave a value of 0.828 and the Bartlett's test of sphericity was significant ($p = 0.000$) confirming that Factor Analysis could be carried out on the 32 items data set. Running an Exploratory Factor Analysis (EFA), using Principal Components Analysis (PCA) with orthogonal rotation (Varimax) of factors with Eigenvalue less than one, resulted in the retrieval of an initial eight factors (Table 5.40).

Component	Total Variance Explained					
	Initial Eigenvalue			Rotation Sums of Squared Loadings		
	Total	% of Variance	Cumulative %	Total	% of Variance	Cumulative %
1	6.955	21.733	21.733	3.973	12.415	12.415
2	3.719	11.623	33.356	2.977	9.304	21.718
3	2.285	7.14	40.496	2.871	8.971	30.689
4	1.764	5.513	46.009	2.854	8.919	39.608
5	1.644	5.136	51.145	2.204	6.888	46.496
6	1.469	4.59	55.735	1.837	5.74	52.236
7	1.121	3.503	59.237	1.696	5.299	57.536
8	1.076	3.361	62.598	1.62	5.063	62.598
9	0.947	2.961	65.559			
10	0.923	2.884	68.443			
11	0.829	2.59	71.033			
12	0.784	2.449	73.482			
13	0.72	2.25	75.732			
14	0.7	2.188	77.92			
15	0.657	2.052	79.972			
16	0.597	1.865	81.838			
17	0.577	1.803	83.641			
18	0.541	1.692	85.333			
19	0.538	1.682	87.015			
20	0.533	1.665	88.68			
21	0.462	1.443	90.124			
22	0.436	1.362	91.485			
23	0.406	1.267	92.753			
24	0.375	1.173	93.926			
25	0.362	1.131	95.057			
26	0.304	0.949	96.005			
27	0.281	0.877	96.882			
28	0.241	0.752	97.634			
29	0.213	0.666	98.3			
30	0.196	0.614	98.914			
31	0.188	0.586	99.5			
32	0.16	0.5	100			

Extraction Method: Principal Component Analysis

Table 5.40: Initial Extraction Based on Eigenvalue

However, Tabachnick and Fidell (2007) argue that there are several methods that can be used to retain factors, namely (i) a quick estimate of the number of factors obtained from the sizes of Eigenvalues and keeping factors with Eigenvalues > 1 ; (ii) using the Scree test of Eigenvalues plotted against factors resulting in a negatively decreasing curve - the number of factors are selected by visual inspecting where the curve level off; (iii) using Horn's Parallel analysis, which involves comparing the Eigenvalues obtained with that of the Eigenvalues of "a randomly generated data set with the same number of cases and variables", usually through Monte Carlo's Simulation. Components from the real data with Eigenvalues greater than that of the randomly generated data set were then retained.

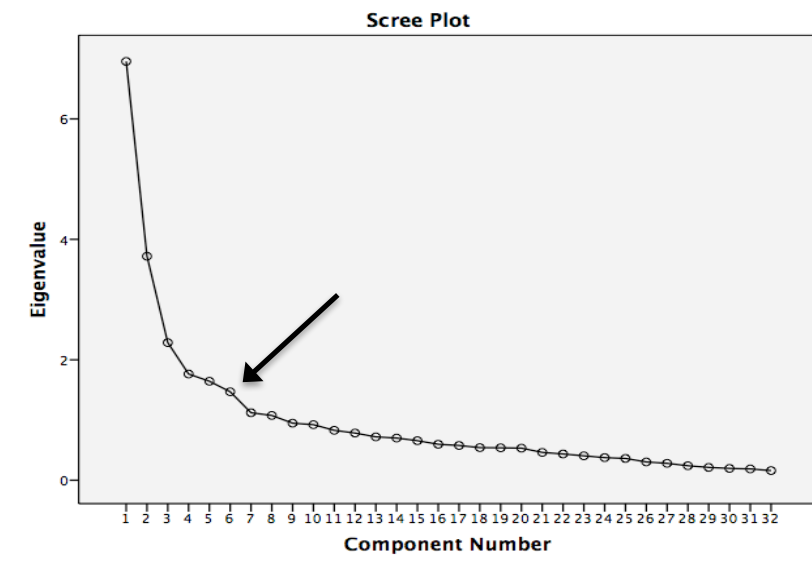

Figure 5.28: Scree Plot Component Number Against Eigenvalue

With regard to the current research, the first method proposed by Tabachnick and Fidell (2007) resulted in the extraction of eight factors (Table 5.40). The Scree plot test (Figure 5.28) shows that there are six factors (arrow indicating the sixth from the left) in a line before the curve levels off.

Component	Current Research Eigenvalue	Monte Carlo Random Eigenvalue	Accepted/Rejected
1	6.955	1.4735	Accept
2	3.719	1.4118	Accept
3	2.285	1.3669	Accept
4	1.764	1.3282	Accept
5	1.644	1.2924	Accept
6	1.469	1.2558	Accept
7	1.121	1.2235	Reject
8	1.076	1.196	Reject

Table 5.41: Parallel's Test with Monte Carlo Simulated Values

Furthermore, the Horn's Parallel test, using Monte Carlo's simulation (Table 5.41) as proposed by Watkins (2005), suggests the retention of only six factors, whose Eigenvalue were higher than that of the randomly generated sample (variables = 32, subjects = 571, replications = 100). Therefore, based on the above analysis, it was evident that only six factors were pertinent. Subsequently, a Factor analysis using Varimax rotation was conducted for a

fixed number of six factors to be extracted, with the result shown in the following table.

Rotated Component Matrix ^a						
	Component					
	1	2	3	4	5	6
Lack of knowledge in using software	0.857	0.081	0.152	-0.025	-0.02	0.026
Lack of knowledge in using hardware	0.846	0.091	0.14	-0.04	0.044	-0.056
Lack of knowledge of security issues	0.804	0.101	0.024	0.043	-0.05	-0.035
Lack of knowledge in finding information online	0.751	0.167	0.339	0.013	0.011	0.049
Lack of knowledge of online interaction with others	0.697	0.127	0.38	0.006	-0.069	0.006
Lack of help/support when I needed it	0.47	0.181	0.31	0.066	0.069	-0.114
Blocking of Internet content and services	0.246	0.646	-0.129	0.123	0.098	-0.152
Bandwidth	-0.019	0.628	0.029	-0.037	-0.011	0.382
Lack of accessibility	0.064	0.602	0.415	0.048	0.043	0.037
Sharing of devices with other people	0.191	0.599	-0.062	0.078	0.104	-0.293
Reliability of connection	-0.031	0.59	-0.112	0.068	-0.066	0.355
Monitoring of Internet use	0.147	0.586	0.132	0.171	-0.043	-0.235
Place of use	0.128	0.567	0.281	-0.056	0.077	0.027
Cost of Internet connection	-0.035	0.548	0.343	0.086	0.036	-0.04
Hardware	0.265	0.445	0.308	0	0.172	-0.157
Lack of time to spend online	0.157	0.368	0.292	-0.117	-0.083	0.119
No clear idea of why I should use the Internet	0.353	0.132	0.806	0.036	0.059	-0.038
No safe place where I could use the Internet	0.263	0.172	0.781	0.113	0.079	-0.023
Lack of encouragement to use the Internet	0.319	0.083	0.78	0.009	0.026	-0.037
Software	0.326	0.382	0.403	0.018	0.154	-0.031
Publishing information	-0.023	0.079	-0.009	0.752	0.185	0.139
Supporting a cause	0.072	-0.038	0.154	0.69	0.077	-0.069
Supporting a political party	0.102	0.045	0.112	0.687	0.035	-0.24
Distributing own multimedia production	-0.053	0.147	-0.078	0.666	0.282	0.122
Collaborative work	-0.023	0.05	-0.114	0.659	0.051	0.252
Performing online transactions	-0.108	0.011	0.109	0.41	-0.138	0.39
Listening to, downloading and sharing music	0.012	0.041	0.054	0.076	0.877	0.138
Viewing, downloading and sharing videos	-0.002	0.026	-0.076	0.165	0.833	0.152
Playing games	-0.045	0.082	0.212	0.179	0.623	-0.061
Communicating directly with other people	-0.003	-0.011	-0.102	0.181	0.134	0.708
Information seeking	-0.044	-0.08	-0.015	-0.082	0.061	0.611
Making and maintaining social networks	0.109	0.04	0.044	0.277	0.363	0.488

Extraction Method: Principal Component Analysis.
 Rotation Method: Varimax with Kaiser Normalization
 a Rotation converged in 7 iterations

Table 5.42: Six Factors Rotated Component Matrix

As shown Table 5.42, the PCA extracted and combined the variables into six factors. However, when regrouping the variables, although the criteria of the weight of loadings are met, three variables do not meet the face or construct validity. For example, item 'Lack of help/support', although loaded in Factor 1, does not provide or reflect a true meaning of the factor in which it is loaded, where most of the items relate to 'lack of knowledge'. Therefore, the

second best loading was examined and found that it would best fit in Factor 3. As such, three revisions were made to meet face validity. The factors were named as follows.

Factor 1: Skill

- Lack of knowledge in using software
- Lack of knowledge in using hardware
- Lack of knowledge of security issues
- Lack of knowledge in finding information online
- Lack of knowledge of online interaction with others

Factor 2: Logistics and Autonomy

- Bandwidth
- Hardware
- Cost of Internet connection
- Reliability of connection
- Monitoring of Internet use
- Blocking of Internet content and services
- Lack of accessibility
- Sharing of devices with other people
- Place of use
- Lack of time to spend online

Factor 3: Support

- No clear idea of why I should use the Internet
- No safe place where I could use the Internet
- Lack of encouragement to use the Internet
- Lack of help/support when I needed it
- Software (although from a technical apparatus perspective, it was clear that this item could fit the Support factor)

Factor 4: Content Creation and Social Activism “Slacktivism”

- Publishing information
- Supporting a cause

- Supporting a political party
- Distributing own multimedia production

Factor 5: Entertainment

- Listening to, downloading and sharing music
- Viewing, downloading and sharing videos
- Playing games

Factor 6: Sociality (Communication and Information Seeking)

- Communicating directly with others
- Information seeking
- Making and maintaining social networks
- Collaborative work
- Performing online transactions

From the above analysis, it can be found that the underlying constructs of Digital Inequality in Mauritius, are by all means different, from what was suggested by DiMaggio and Hargittai. The factor analysis extracted six meaningful factors that provide an insightful picture of the various forces that negatively impact on Mauritian Internet users' utilisation of the Internet. The factors uncovered, though, are not diametrically opposed to the factors proposed by DiMaggio and Hargittai. There are certain factors that are similar, namely skill; autonomy of use and logistic that have been combined into logistics and autonomy; and purpose of use has been expanded into three factors on its own.

5.4.4. Regression Analysis

To further understand the relationship between the above-mentioned factors and Digital Inequality in Mauritius, a standard multiple regression analysis was carried out. The dependent variable used for the regression was the Digital Inequality Rating gathered from the last question from the survey using a 10 point Likert scale (Section 4.3.1.7). It is commonly agreed that for regression analysis, such measures can be assumed to be continuous and

thus meeting the assumptions of regression analysis. In addition to the dependent variables, the six independent variables extracted from the factor analysis (skill, logistics and autonomy, support, content creation and social activism, entertainment, sociality) are also considered to be continuous, thus meeting the first assumptions for regression analysis. Table 5.43 report the descriptive statistics for the independent variables used for the regression

	Mean	Std. Deviation
Skill	0.7867	0.94272
Logistics and Autonomy	1.2652	0.80214
Support	0.6823	0.87294
Content Creation and Social Activism	1.4087	1.00734
Entertainment	2.5445	1.10337
Sociality	2.923	0.73196

Table 5.43: Descriptive Statistics of Independent Variables

A Person product moment correlation was run to assess any correlation between the dependent variable (Digital Inequality rating) with each of the independent variable. The nature of regression analysis and the causality behaviour between independent and dependent variables is such that there should be correlation between them. The Pearson product moment test was conducted to clarify the suspicion and understand the correlation between the dependent and independent variables.

Pearson Correlation Coefficient	
	Digital Inequality Rating (Dependent Variable) $ r $
Skill	0.046
Logistics and Autonomy	0.45
Support	0.14
Content Creation and Social Activism	0.180**
Entertainment	0.84
Sociality	0.100*
** Correlation is significant at the 10% Level (2-tailed). *Correlation is significant at the 5% Level (2-tailed).	

Table 5.44: Pearson Correlation Results between Dependent and Independent Variables

Pearson's correlation coefficient values ($|r|$) between 0.1 and 0.3 are considered as small correlation, values between 0.3 and 0.5 as medium correlation and values above 0.5 as strong correlation. Table 5.44 outlines the results obtained and suggest that there is a significant weak correlation between independent variables 'Content Creation and Social Activism' and 'Sociality' and the dependent variable Digital Inequality Rating.

Over and above having dependent and independent variables as continuous variables, initial analysis ensured that assumptions of linearity, independence of residuals, homoscedasticity, unusual points and normality of residuals are met. For example, a value of 1.93 was obtained for the Durbin-Watson test for independence of residuals. It is agreed that the closer the Durbin-Watson statistic is to two, the better it is. With a value of 1.93, it can be safely assumed that there is independence of residuals.

With all assumptions checked, a standard multiple regression was performed between the users' perception of Digital Inequality as dependent variable and the six factors uncovered in the Exploratory Factor Analysis (skill, logistics and autonomy, support, content creation and social activism, entertainment and sociality—communication and information search) as independent variables. Table 5.45 below displays the unstandardised coefficients (B), the standard error of the coefficient, the standardised coefficient (β) and the significance value (Sig.).

Coefficients ^a						
Model		Unstandardised B Coefficients		Standardised Coefficients	t	Sig.
		B	Std. Error	β		
1	(Constant)	5.346	0.11		48.523	0.000
	Skill	-0.016	0.117	-0.007	-.141	0.888
	Logistics and Autonomy	-0.283	0.114	-0.117	-2.475	0.014*
	Support	-0.167	0.111	-0.071	-1.509	0.132
	Content Creation and Social Activism	0.461	0.115	0.191	4.022	0.000**
	Entertainment	0.132	0.109	0.057	1.211	0.226
	Sociality (Communication and Info Seeking)	-0.052	0.113	-0.022	-.461	0.645
Dependent Variable: Rating of Digital Inequality $R^2 = 0.057$ Adjusted $R^2 = 0.044$ $F = 4.240$ Significant $F = 0.00$ *Significant at the 5% Level ** Significant at the 10% Level						

Table 5.45: Summary of Coefficients Table for Regression Analysis

R for regression was significantly different from zero (Tabachnick and Fidell 2007), $F(6, 421) = 4.240$, $p < 0.01$, with R^2 at 0.057. The adjusted R^2 value of 0.044 suggests that there is a weak correlation between Digital Inequality perception and the variables uncovered, with only 5.7% of the variability in Digital Inequality perception being predicted by skill, logistics and autonomy, support, content creation and social activism, entertainment and sociality. The result suggests that only 'Logistics and Autonomy' and 'Content Creation and Social Activism' added statistically significantly ($p < 0.05$) to the regression as shown in Table 5.45. Despite being a weak model, the regression does provide an insight into the underlying forces of Digital Inequality on the island. The limitations and future work on the model is further discussed in Section 8.2. – Research Limitations and Section 8.3. – Future Directions.

5.5. Conclusion

This chapter, structured around descriptive and inferential statistics, uncovered the main findings of the Digital Inequality survey conducted with a sample of the Mauritian Internet users. The first section outlined the test

carried out to ensure reliability and validity of the survey instrument and the type of tests (parametric or non-parametric) that could be carried out on the dataset. From a descriptive statistics perspective, this chapter used the same structure (DiMaggio and Hargittai's five dimensions) as the survey and displayed the relevant frequencies for the various items queried during the survey. As such the frequencies for demographic variables were presented, as well as the frequencies of the various items under each dimension. In some cases, weighted mean was used for some item to better reflect the results and allow comparisons to be made.

The last section of this chapter engaged in inferential statistics. The results of the Mann-Whitney (U) and Kruskal-Wallis (H) tests were presented. These tests were used to investigate the relationship between the various demographic variables and the dimensions of Digital Inequality to assess the determinants of Digital Inequality in Mauritius. Factor Analysis and Regression analysis were undertaken to understand the underlying factors of Digital Inequality in Mauritius. The results showed that the factors of Digital Inequality are different, although not so different, from those suggested by DiMaggio and Hargittai. The regression analysis confirmed the correlation between these factors, and although weakly positive, there is a correlation between the factors and Digital Inequality in Mauritius. The following Chapter 6 discusses and situates these results within the broader perspective of the research and their relative implications.

Chapter 6: Quantitative (Survey) Discussion

6.1. Introduction

One of the objectives of this research is to investigate the determinants and the main causes of Digital Inequality in the Mauritian society. As such, a survey instrument was used to gather information on Mauritian Internet users with regard to their relative perception of Internet use and Digital Inequality. The previous chapter presented the main findings of the survey by means of descriptive analysis (which is purely observational in nature) and inferential analysis, which helped unveil factors affecting Digital Inequality, as well as determining their impact on the latter.

Subsequently, this chapter uses the findings uncovered to build upon and discuss the main determinants (demographic characteristics) and causes (factors) of Digital Inequality within the particular context of Mauritius. The chapter adopts the same overarching structure used in both the survey questionnaire and in the descriptive statistics section of the previous chapter to lead the discussion. The core of this chapter, thus, uses the five dimensions of Digital Inequality to critically examine the findings and discusses the main determinants of Digital Inequality.

The last section discusses the underlying causes of Digital Inequality in Mauritian society. In light of the results of the inferential analysis supported by the relevant literature, this section posits a new model of Digital Inequality specific to the Mauritian context, and discusses the ramifications of this new model.

6.2. Demographics

A major conclusion that can be derived from the results is that the data gathered is consistent with the demographics information available on Mauritian Internet user population. Although not directly related to Digital Inequality, it has a bearing on the validity and reliability of the survey.

Chapter 4, Methodology, raised much concern on ensuring the relative representativeness of the survey instrument, and subsequently the reliability of the survey. The Internet user population of Mauritius, being unknown and information on the users' characteristics being sparsely available, were unfortunately insufficient to constitute a population framework on which a representative sample could be drawn. To ensure that the sample would be as representative as possible of its parent population, strategies (as discussed in Section 4.3.3) were put in place during the survey distribution to achieve this objective within the limits and scope of the research. The findings revealed that the demographics results of the survey concurred to a large extent with the available information on Mauritian Internet users, thereby reinforcing the representativeness of the sample.

The first demographic variable that reinforces representativeness is sex. As noted in Figure 5.1, the percentage of males who responded to the survey is 53.5%, as opposed to 46.5% females. This number concurs with the latest statistics on Mauritian Internet users (Statistics Mauritius 2012b), which suggests that there are indeed more male Internet users than female Internet users. The second variable that tends to reinforce the reliability of the survey is age. Indeed, as shown in Figure 5.2, a huge majority of the respondents were aged between 12 and 30 years old. Although there is no specific figure, general conclusions from Statistics Mauritius (2014a) suggest that there is indeed a higher proportion of young demographics using the Internet in the country with an average of 66% of the 12-19 years old and 60% of the 20-29 years old who use the Internet on a regular basis. The results of the survey match the same trend, showing more youth responding to the survey, and therefore validating the assumption of the representativeness of the survey. The residential area of respondents is yet another variable that can be used to confirm the reliability of the population. The survey findings, as shown in Figure 5.3, indicate that 56.2% of the respondents resided in urban areas against 43.8% in suburban and rural areas (coastal and inland). The 2011 Mauritian census (Statistics Mauritius 2011b) revealed that 38% of the households in urban areas had Internet access as opposed to 27% of

households in rural areas, thus suggesting that there are more urban Internet users than rural Internet users.

The second main conclusion that can be derived from the demographics data gathered is the disparity between the different strata of the Mauritian Internet user population, at least, in terms of the demographic variables. Although the key focus of this research is on the use of the Internet, it is however interesting to delve shortly on this phenomenon, which might later allow for further inferences. The disparity within each of the demographic variable is in two strands; one being the differences within the variable and the other being the disparity with the Mauritian general population demographics. Both have equality as fundamental assumptions. The first case assumes that all groups are equal within the Internet User population; i.e. there are equal number of males and females. The second assumes that the Internet user population is representative of the general population; i.e. if there are more male than female in the general population, then there should be more males Internet users than females Internet users.

With regard to sex, there exist differences within the demographics of Mauritian Internet user population and also differences between the latter and the general population. The research confirmed previous statistics suggesting that there are indeed more male Internet users than female Internet users, indicating clearly a disparity between males and females in this regard. The male/female disparity is, unfortunately, not unique to Mauritius. The ITU (2012) also demonstrates that in developing countries, women are more disadvantaged than men when it comes to broadband access and use. Antonio and Tuffley (2014) further argue that such gender gap is one of the major elements fuelling Digital Divide in developing countries. As for the causes of such inequalities, Dixon et al. (2014) use 'structuration' theory to explain that gender inequality, in Internet access and use, is a mere extrapolation of already existing divides. Although the scope of this research is limited in exploring the relative causality of such divides offline, it appears that female Mauritian Internet users also face the same social challenges and pressures in their daily use of Internet.

When comparing the male/female Internet user ratio with that of the general population, it is interesting to note the disparity between male and female Internet users with regard to the Mauritian population demographics. The latest statistics show that the Mauritian population is made up of slightly more females (635,792) than males (622,861) (Statistics Mauritius 2014b). The survey, on the contrary, shows that there are more male than female Internet users. Clearly, this discrepancy in gender between the Internet user population and the national demographic ratio suggests that using a representative sample of the general population to represent Internet users is problematic, and in this case, would have resulted in a biased representation of Internet users if a representative sample of Mauritians be chosen. In such contexts, care should be taken when adopting such methods. If a representative sample of the general population is to be selected in Internet studies, researchers need to ensure that the Internet user population maps the general population. However, as the results suggest, it can be argued that in countries where there is a low level of Internet uptake, researchers should ensure prior to sampling that the Internet user demographics reflect the general population demographic. Alternatively, the sample would need to be re-adjusted to map such existing disparities.

Another disparity worth noting is that of age. This survey tends to confirm the existing gap between young and old. Xenos and Foot (2008, 1) suggest that “the young generation has traditionally been at the forefront of new technology use, remaining at top of Internet usage statistics and distinguishing themselves as early adopters”. As shown in Figure 5.2, the majority of the respondents were below 30 years old, which tends to follow the global trend, with the ITU report suggesting that Internet users are rather young in non-European countries (ITU 2010b). However, being in line with international standards does not make the issue less important as it does have a bearing on Digital Inequality. The problem is further escalated with the fact that Mauritius, as with many other developing countries, has an ageing population (Statistics Mauritius 2014b) suggesting, therefore, that a relatively large proportion of the elderly population is not using the Internet

and thus not reaping the benefits such use entails. Lee (J.H) and Kim (2014) argue that the generation gap has been widely researched in the Digital Divide discourse and explains such discrepancies by the diverging attitude of the young and the older generation towards technology. They argue that older users have the tendency to accommodate new media in their old ways of thinking and doing, whereas the younger generation assimilates its way of thinking into the new media (J. H. Lee and Kim 2014, 5). Even though it can be agreed that the generation gap, with regard to technology adoption might fade with time, the ramifications are far-reaching, especially for a country that prides itself as a cyber-island. The socio-economic benefits of Internet use are not being tapped.

The residential area is yet another demographic variable showing inequality. Indeed, as depicted in the sections above, more respondents resided in urban areas than in rural areas. However, the reverse applies to the national demographics whereby more residents live in rural areas than in urban areas (Statistics Mauritius 2014b). The figures suggest that for some reason, rural residents are using the Internet less than their urban counterparts. Autar (2013) forewarns that the legal delimitation of rural and urban areas in Mauritius does not necessarily follow international standards and that all indicators point towards categorising the island of Mauritius as a metropolis. Autar's conclusion shows that Mauritian rural areas are home to the majority of the primary industry sector, namely agriculture, but that there is no significant differences in the relative development index of the areas; in fact some rural areas are better off than urban area (Autar 2013) .

Another conclusion that can be derived from the demographic findings is that socio-economic status of the respondents has a bearing on Digital Divide. As discussed in the Methodology chapter, one of the proxies used for the socio-economic status of respondents was the educational level of parents. As shown in Figure 5.7, very few (15%) of the respondents' parents have achieved lower than the School Certificate level, which suggests that the Internet users are from a rather well educated background. Furthermore, the

survey findings (Figure 5.5 and Figure 5.6) suggest that the Internet users are rather well-educated themselves, with many still studying.

The above discussion, therefore, suggests that there are disparities in Internet use in the case of three demographic variables. Although the scope of this research is not to explore the rationale behind these differences, the latter clearly suggests that Internet use is not homogenous amongst the Mauritian population.

6.3. Inequality in Technical Apparatus

The data on technical apparatus section yielded some interesting patterns among the Mauritian Internet users. For example, it showed that nearly all users (98%, as shown in Figure 5.8) owned an Internet enabled device which they use to connect to the Internet. It is also pointed out that their place of residence remains their preferred location for connecting to the Internet.

Indeed, despite a steep and continuous increase in the number of Internet subscriptions based on Mobile Access Network (Figure 3.9) over the past years, the survey revealed that computers with ADSL were the main Internet connection mode, followed by mobile devices, as depicted in Figure 5.9. From a different angle, the figure also suggests that the majority of the Mauritian Internet users represent just under 40% of the Mauritian household, since the official statistics suggest that only 38% of Mauritian households have access to a computer with fixed Internet (Statistics Mauritius 2011a). A report by the Pew research centre on Internet in 32 developing countries shows that computer ownership is relatively low in developing countries (Pew Research Center 2015) and the case of Mauritius is not different.

Since the majority of Internet users connect to the Internet through a computer and ADSL connection, it can be assumed that the mobile Internet subscription is mostly for secondary connection. Thus, the majority of Mauritian Internet users can be thought of as being multi-device users with a fixed connection (used as their primary mode) but also use a mobile

connection when on the move or away from their computers. Whilst much hope has been put in mobile devices and mobile subscriptions to bridge the Digital Divide, it appears that the majority of Internet users are opting for a multi-device approach. Lee, Park and Hwang (2015) uncovered similar trends in Korea with a high proportion of Internet users being multi-device owners. Similarly, de Lanerolle (2012) finds, to a smaller scale, a growing multi-device based Internet population in South Africa. It appears that the Mauritian Internet users are multi-device users and are as such permanently connected to the Internet, or at least can have access to the Internet anytime. In its 'State of Broadband' report, the ITU (2012) acknowledges this phenomenon, but forewarns that it might blur our reading of Internet penetration figures, where increase in mobile Internet subscription would not necessarily mean an increase in Internet users. This further adds to the already complex issue of researching and understanding Internet users and these figures reveal the difficulties of using general population statistics or mobile devices ownership or even subscription to measure adoption. The Mauritian case shows that although there is a high rate of mobile uptake, fixed Internet subscription remains the preferred connectivity type.

However, great care should be taken when formulating conclusions on this type of data. As noted in Figure 3.9, the increase in mobile Internet subscription has been rather constant and the number of mobile Internet subscription has continued to increase even after the data was collected for this research. This presupposes that there might have been some changes in the Internet ecosystem. Nonetheless, the analysis brings forward a valid point that despite increase in mobile subscription, the preferred connection mode remains the computer for those who have the choice.

Another conclusion that can be derived from the findings is the relative "quality" of connection itself. It suggests that ADSL is by far the most used fixed connection mode, with few users still stuck on legacy Dial-up connection mode. Although offered as a possibility for low-income users, the experience obtained from using a Dial-up connection can be fundamentally questioned with the Internet being increasingly optimised for Broadband

connection. The same challenges apply to the 1.8% of users who connect mainly through a mobile device (Figure 5.8). Clearly, there is a proportion of the Mauritian Internet users who are unable to get the maximum out of the Internet because of the inequalities in the devices and their connectivity.

Irrespective of the type of connection used, residential location remained the prime connection location for users owning an Internet capable device. When it comes to users who do not own any device, workplace (45.5%) remained their primary Internet access location, pictured in Figure 5.11. Indeed, 27.3% of non-owners (of device) connect to the Internet from a friend's or family location. Intriguingly, both device owners and non-owners tend to discard public sites as their main Internet connection location. As discussed, most of the device owners would connect from their own devices, thereby logically rejecting public Wi-Fi (for example) as their primary connection mode.

Essentially, the relative affordability of the Internet contributes to this effect but the quality and geographic positioning of the public connection might also be a reason that deters users from using it as their main Internet connection. Even for those Internet users who do not own a device, public locations (public library, Post office etc.) are not their first choice when connecting to the Internet, preferring to connect either from work or at family and friends. Although some of the items maybe be different, the findings concurs with the Mauritian National Computer Board (2010) showing that over the years, the use of Public Wi-Fi has decreased. However, the results do not infer that public Internet connections are not used at all but suggest that in most cases they are used as secondary access points.

Among the technological factors that limit effective Internet use was Bandwidth (speed of connection), to which respondents agreed to a large extent. Indeed, as shown in Figure 5.12, speed of connection was the factor that had the most limiting effect with a weighted mean of 2.32, followed by the reliability of the connection with a weighted mean of 2.08. Although hardware and software have limiting effects as well, they were less prominent with respective weighted means of 0.79 and 0.96 respectively. These figures suggest that Mauritian Internet users do have the perception

that bandwidth and the reliability of the connection have a severe impact on their ability to reap the maximum benefits that the Internet can offer. As discussed in Chapter 3, although the overall bandwidth of the country has been increasing over the years, it is still perceived as a major limiting factor.

The pricing of the connectivity and the reliability of the connection are also contributing factors that hamper the Internet experience of Mauritians. Hermann and Clements (2001, 10) argue that “the unfavourable structures of telecommunication costs” in developing countries have a direct impact on the cost of Internet, which can be about three times more than the cost of Internet in OECD countries. The cost and reliability of the connection is unfortunately not confined to the individual user. The same issue is brought up by main Internet stakeholders and discussed in the following chapter. The relatively expensive cost of the Internet, coupled with an unreliable connection poses a great challenge to the socio-economic development of the country. However, Oolun, Ramgoolam and Dorasami (2012) argue that over the years, the cost of Broadband has been on the decrease, as shown in Table 3.1. Nonetheless, the issue of affordability and reliability remains a global issue and more pertinent to developing countries (ITU 2014b).

When it comes to the determinants of inequality in technical apparatus, age group, highest level of education and current education are the three demographic variables across which there are significant differences between the groups. For instance, the results showed that there are significant differences between the younger generations (those aged between 12 and 29 years old) and the 40-49 age group, with regard to their perception of the negative impact of technical apparatus on their Internet use. The younger generation perceives technical apparatus as having a more negative effect, thereby preventing them from making the most out of the Internet. Xenos and Foot (2008), amongst others, argue that young generation are always at the forefront of technology development and distinguish themselves as “trendsetters” in technology use. Subsequently, they will tend to be more curious and explore the possibilities and capacities of the Internet further, and in order to achieve these, excellent connection,

both in terms of bandwidth and reliability is essential. As discussed in Chapter 3, although the reliability and bandwidth have increased over time, today's Internet in Mauritius is lagging far behind international standards, a claim supported by other Internet stakeholders, discussed in the following chapter. This study shows, therefore, that the young generation is unable to make the most out of the Internet mainly due to the bandwidth and reliability of the Mauritian Internet connection. This study does not, in any way, postulate or conclude that older generations are making effective use out of the Internet. Within the scope of this study, it was found that there are only significant differences between the groups mentioned above, and that younger generations are more disadvantaged.

From an education perspective, there are statistically significant differences between the different levels of education of the Mauritian Internet users. The results show that Internet users who have achieved the School Certificate level as their highest education level perceive technical apparatus as having a less negative effect on their Internet use than those who have reached Primary level or Higher School Certificate level or even Certificate or Diploma level. A high proportion of those who have achieved the School Certificate level would still be currently studying at the Higher School Certificate level. On the other hand, it is also worth noting that users who have reached Primary level as highest education level perceive technical apparatus as having more negative effect on their Internet use.

The same trend applies for those who are currently studying at the Secondary level, who see technical apparatus as having a strong negative effect on their Internet use. The vast majority of users in this group would arguably fall in the 12-19 years old. This would thus align with the one of the conclusions drawn concerning age group, whereby younger users need high bandwidth in their daily use of the Internet, due of the type of activities they perform online (entertainment and gaming). It is also crucial to take on board other factors that affect young adults' use of Internet, such as trust (Hargittai et al. 2010) and experience (Hargittai and Hinnant 2008) and more importantly, that such use evolves with time as they move into adulthood.

To sum up the discussion on technical apparatus, this study sheds light on the devices and connection used by Mauritians. The majority of Mauritian Internet users are multi-device owners who connect mainly from a computer with fixed Broadband connection but use mobile Internet access to remain connected to the Internet. From a Digital Divide perspective, with a large proportion of households not connected to the Internet, a lot needs to be done to increase their connectivity and ensure adequate and reliable connectivity. This study also unveiled the intricacies of using mobile Internet adoption as a measure for Internet penetration. Furthermore, this study suggests that the quality of connection, at least in terms of speed, is an issue for Mauritian users. Lastly, from an inequality perspective, the study revealed that there is indeed an inequality with regard to technical apparatus and is mainly determined by age and education level, with the younger generation feeling limited in their Internet use.

6.4. Inequality in Autonomy of Use

The data on Autonomy of use unveiled some significant patterns and behaviours amongst Mauritian Internet users. The first question on the matter investigated the connection status, which was used as an alternative measure for frequency of connection. The results showed that nearly every second Internet user in Mauritius is permanently connected to the Internet, with the remaining regularly connecting to the Internet. The feeling of being constantly connected is made possible through mobile connection and concurs with previously discussed findings on the high uptake of mobile Internet on the island. Such findings further support the claim that mobile devices and mobile connections are used as secondary connections, thereby allowing Mauritian Internet users, at large, to have a relative freedom in connecting to and using the Internet on an uninterrupted basis.

Adding to a quasi-permanent connection to the Internet, Mauritian Internet users, at large benefit from the freedom of accessing any content they wish. Indeed, 91.3% of the respondents suggest that there is no monitoring of their Internet use at all, whereas 5.5% are monitored by their organisation and

only 3.2% of respondents are monitored by third parties (parents, spouse etc.). These meaningful results further illustrate the potential of Mauritian Internet users to get the maximum out of the Internet without the feeling of being monitored or being prevented to create or share content (Brake 2014).

Freedom of use is also intrinsically linked with access to contents. As such, a high proportion of Internet users (59.7%), as depicted in Figure 5.15, suggests that none of the material they wish to access is blocked. However, 23.6% of the survey respondents indicate that the organisation they work for blocks some of the content they want to access. Parents and third parties, although to a far lesser extent, also contribute to the blocking of contents. A minority of respondents (6.7%) acknowledged that some of the content they wish to access is blocked by governmental policies. Although the bulk of Mauritian Internet users can access content freely, there is a non-negligible minority who experience restricted use of Internet, mainly due to organisational Internet use control. As discussed further in the following chapter, Mauritians are not subjected to any restrictions to access or publish online contents except in two circumstances: the first being child pornography; and the second is when such content potentially threatens social stability on the island.

With regard to the factors that limited their effective Internet use, as shown in Figure 5.16, respondents perceived lack of time to spend online as their primary limiting factor (weighted mean of 1.19), which is unfortunately not specific to Mauritius but a broader issue globally (ITU 2014a). Place of use (weighted mean of 1.13) and lack of accessibility (weighted mean of 1.11) were less important factors that impacted negatively on users' effective use of the Internet. These figures suggest that on the whole, Mauritian Internet users experience great freedom in accessing the Internet. Although not the only causes, the democratic political structure and the socio-political stability of the country can be thought to be the primary reasons for such freedom of access and use to the Internet.

However, despite such freedom to access the Internet, further analysis revealed that there are schisms within various groups of mainly four

demographic variables. Indeed, the results showed that there are statistically significant differences within groups for age group, occupation, highest education level and current education with regard to the autonomy of use. For the demographic variable age group, the results show that Internet users within the 12-19 years old age group are more affected in their freedom to use the Internet than those aged between 20-49 years. This means that the younger users perceive lack of accessibility, lack of time to spend online, monitoring and blocking of online content, amongst others, as having an adverse effect on their Internet use. Although there is growing evidence that parents play an important role in the monitoring of children's Internet use (Livingstone, Bober, and Helsper 2005), debating the pros and cons of online monitoring is beyond the scope of this research. However, proponents of child Internet use monitoring would be content to find that there is indeed parental supervision for some of the young Internet users. Accordingly, from an inequality perspective, the results show that the younger users are "less" free to use the Internet than older users. The demographic variable occupation tends to confirm this result showing that students, with a vast majority belonging to the 12-19 years old age group, are more likely to perceive the autonomy of use as negatively affecting their Internet use than others.

Within the student community, there are statistically significant differences in the perception of the effect of autonomy on Internet use. The results show that students at Primary level feel that they are more negatively affected in their Internet use than those studying at higher levels (except for Vocational students, where the differences are not statistically significant). Again, this category consists of respondents aged 12-19 years who experience much control over their Internet use, be it from time spent online to the contents accessed. The findings also show that there are significant differences between university students at different levels of study. Indeed, those at the Undergraduate level perceive autonomy of use as having a more significant negative effect on their Internet use than those at the Postgraduate level. Again, although educational institutions are not the main location for Internet

use, it could be argued that Undergraduate students spend more time on campus than Postgraduate students, and are thus more liable to suffer from institutional monitoring and blocking of online contents. The level of maturity and experience could also be factors that cause such differentiation.

Overall, in terms of Autonomy of use, it can thus be argued that the capacity to be connected to the Internet on a permanent basis, coupled with the freedom to access any content provides the Mauritian Internet user with the relatively large freedom to use the Internet. However, age group, occupation, highest education level achieved and current education, are all determinants of inequality in autonomy of use. The results also highlight that that young users or students are more likely to be affected by the lack of freedom to use the Internet than other groups of users.

6.5. Inequality in Skill

Skill is perhaps one of the most researched aspects of Digital Divide and Digital Inequality. It is indispensable to have the necessary competence required to make the most out of the technology (Matzat and Sadowski 2012). There is a growing literature on Internet skill and skill measurements but scholars have until now failed to define what actually makes up Internet skill (van Deursen, van Dijk, and Peters 2011), where each came up with their own methods of measuring Internet skill. This research used two main approaches, namely that of van Deursen and van Dijk (2008) and that of Hargittai (2002a). As explained in Chapter 4, Methodology, Hargittai's web skill measure was used to investigate the relative skill users have with regard to a specific list of items. However, van Deursen and van Dijk provide a different approach that somehow complements and brings a different perspective to understanding skill.

Van Deursen and van Dijk's (2008) approach investigates users' experience and formal training. They hypothesise that users with more experience will tend to use the Internet more efficiently (van Deursen, van Dijk, and Peters 2011). The study found that Mauritian Internet users are quite familiar with

more than 88% having more than five years' experience using the Internet. The scope of this study, unfortunately, did not allow to dig further the extent of experience. However, taking into account that users are highly connected, it can be assumed that they are quite familiar with Internet use. Such assumption is supported by Matzat and Sadowski (2012) who argue that there is indeed a high correlation between frequency of use and the digital (Internet) skills gained, thereby enhancing the efficiency of use.

Matzat and Sadowski (2012) further explain that there is a debate within Internet skill researchers as to the methods and means of acquiring the so-called digital skill. They cite Mossberger et al. (2003), arguing for the need to have formal training to develop Internet skill in contrast with the "do it yourself" approach of van Dijk (2005). This study found that almost 78% of Internet users in Mauritius did not have any formal training but are using the Internet on a regular basis. Although formal training could impact on the quality of the use, there is no evidence, as purported by Matzat and Sadowski (2012), that higher skill increases the frequency of use. This study, nonetheless, found that Mauritian Internet users are almost permanently connected, thereby assuming a high frequency of use.

With regard to the perception of their Internet skills, the study finds that Mauritian Internet users are quite familiar with the Internet-related terms proposed in the study. Hargittai (2012) argues that there is a strong correlation between familiarity with these terms and that of digital skill. The results obtained are more or less in line with the results obtained by Hargittai (2012), with high scores on 'high-level understanding' concepts such as Advanced Search, Photo Tagging and Modem, and lower scores on 'low-level understanding concepts' like Phishing and Cache. This result suggests that Mauritian Internet users are faring well in their understanding of Internet-related concepts and are more or less similar to the users investigated by Hargittai. From a Digital Inequality perspective, it suggests that Mauritian Internet users have more or less the right skill levels to get the maximum benefit out of the Internet and that it cannot be argued that skill is a limiting factor in Internet use.

Such a statement is backed by the perception of users in relation to the limiting factor that lack of skill has on their Internet use. The results show that lack of knowledge in using software and hardware, among others, which can be regrouped under skill, have the lowest scores (weighted mean). This suggests that skill, or the lack thereof, is not perceived as a limiting factor when using the Internet. However, it is interesting to note that out of the five aforementioned knowledge areas, the Mauritian Internet users perceive lack of knowledge of security issues as having a greater negative impact on their Internet use as opposed to the other four areas. Security and especially cyber-security are perhaps key focus areas on which policy makers and other stakeholders need to work on.

Although it appears that Mauritian Internet users have the required skill to benefit from the Internet, the study unearthed significant differences in skills amongst users based on sex, age, occupation, highest level of education achieved and current education level group. The results showed that females rated their familiarity with the Internet related terms lower than males. This result is antithetical to that obtained by Hargittai (2012; 2011) and van Deursen, van Dijk and Peters (2011). However, care should be taken when establishing fundamental conclusions with regard to this result. It should also be noted that both Hargittai and van Deursen et al. confirmed that during their study, they found that females had a lower perception of their Internet skill than males, although there is no evidence that females performed less well than males when given to perform an Internet task. Even while factoring this element into the results, the gap between the mean scores (0.2 and 0.6) would tend to suggest that there is indeed a gap in the Internet skill of males and females in Mauritius, and should thus be taken into consideration when analysing the broader picture of Digital Inequality in Mauritius.

With regard to age, the result suggests that there is a significant difference between the skill of those who are aged between 20 and 39 years old and those who are above 60 years old. It suggests that those who are above 60 years old perceive lack of knowledge of the Internet as a hindrance to their effective use of the Internet. This result is further supported by the effect of

occupation on Internet skill, which shows that the retired (>60years)² perceive the lack of Internet knowledge as having a more negative impact on their Internet use. The elderly users, or 'silver surfers' as they are commonly referred to, have specific requirements and there is growing literature on the benefits that effective use of the Internet can bring to this group of people (Cody et al. 1999). With the country facing the issue of ageing population, the results suggest the need to have proper policies and framework to cater for the silver surfers is vital.

Highest education level achieved is yet another variable that affects inequality in skill. Indeed, the results show that those who have reached Primary education as highest education level tend to perceive Internet skill as an impediment to making effective use of the Internet, as compared to those who have achieved higher educational levels. Although it could be argued that it is not an issue of literacy, since it can be moderately assumed that anyone having the Primary education level can read and write, the study tends to side with van Deursen, van Dijk and Peters' (2011) theory, suggesting that it is more about higher level use, which they termed as information and strategic skill that requires further intellectual skills. In short, those who have lower education level attainment will be able to use the Internet up to a certain limit, and in so doing, may not be tapping the full capabilities of the Internet. Again, the results show that Internet users with lower education attainment struggle more with effective use than other groups.

The same schema applies to students whereby those who are studying at the lower level (Primary) tend to perceive lack of Internet skill as having a more significant negative impact on their Internet use than those studying at higher levels (Vocational, Undergraduate and Postgraduate). The same explanation as above would therefore apply to this group, suggesting that

² Mauritius is currently going through a transition phase of increasing the retirement age to 65 but as at the date of the study, it can be assumed that any retired person would be above 60 years old and vice versa.

although it is not an issue of literacy, being at the lower end of the education ladder does impact on the effective use of the Internet. This is particularly interesting from a policy perspective so as to ensure that children and students are able to make the most out of the Internet right from a very young age, especially in the context of the country's ambition of becoming a cyber-island.

Overall, this study unearthed some interesting facts about skill and the inequality in skill amongst the Mauritian Internet user population. The study found, on one hand, that Mauritian users are experienced users, with very few with formal training in Internet use, but that on the other hand, although there is a fair knowledge of Internet-related terms, Internet security-related terms were less familiar to the users. Moreover, from an inequality perspective, the research found that sex, age, highest education level achieved and current education level were all Determinants of inequality in skill.

6.6. Inequality in Social Support

The findings also suggest that the majority of users started using the Internet mainly for educational purposes, followed by curiosity and then by the fact that the Internet was accessible for use. This finding could be explained by the high proportion of youth, namely students, amongst the current Internet user population in Mauritius. This category of users is more liable to have started using the Internet for education purposes. Older generations would, thus, have used the Internet by curiosity or because it was accessible at home to younger generations. However, it is important to emphasise that this is a dynamic issue and cannot be generalised over the years. With the upcoming generation, the reasons could be altogether different with the Internet being more present in their daily lives than previous generations. The high uptake of mobile Internet will certainly change the reasons for starting to use the Internet in the future. Social media and entertainment are growing interests among the younger strata of the Mauritian society, and coupled with affordable devices and connectivity plan, the reasons for

starting to use the Internet might change in the coming years. Nonetheless, the finding provides some important insight for policy makers. Education remains a sure vector of Internet use and can be seen as a primary medium for Internet diffusion.

Furthermore, social support is closely related to Internet skill (Warschauer and Matuchniak 2010) and it refers to the help that people lacking specific skill get in their use of the Internet. It can be argued that formal and informal help from peers is more than ever important in the Mauritian context. The vast majority of Internet users did not receive any formal training in Internet use, and even for those who had formal training, the depth and quality of the training could largely impact on their Internet use. Therefore, peer coaching and help is perhaps the most important way for users to acquire, develop, maintain and share Internet skill. However, there are other factors not considered in this research that could highly impact on the help obtained and, thus, the social support needed to use the Internet. For example Brooks et al. (2011) argue that the structure of the family plays an important role in the help and support Internet users get. For instance, families with children are more advantaged in their use and have a greater variety of Internet use than families without children. The issue can be further compounded by the family structures and the relationships the members of the family have when it comes to sharing of knowledge and skills.

As such, the findings show that the vast majority of Mauritian Internet users either never or occasionally ask for help when using the Internet. On one hand, this further consolidates earlier findings suggesting that there is a fairly good Internet skill amongst Mauritian users, which by extrapolation allows users to use the Internet without much help, although help is occasionally needed. On the other hand, this research focused on self-perception and appreciation of one's skill and use of the Internet and it could be that users are not aware of the wide spectrum of skills needed to operate fully on the Internet but are rather satisfied with current use. It is therefore altogether important to understand the use that Mauritians make out of the Internet (discussed in the next section) to fully understand the ramifications of the

help required. Further research needs to be conducted to understand the extent of the help needed and whether the users are getting the maximum benefit out of the Internet without any help.

Although help is occasionally needed to use the Internet, the question of the availability of help, when needed, is another dimension that impacts on the effective use of the Internet. As such the findings show that five out of six respondents have help readily available when needed. Although this is a high proportion, from an inequality perspective, it is worth noting that there are still some users who do not have help readily available when needed.

Once the availability of support has been established, the source and quality of the help obtained was investigated. The study finds that friends, neighbours and family members topped the list of those from whom help was more often sought. It is interesting to note that online help forum is the third source of support, thereby once again reiterating the independent and autonomous learning. It further demonstrates the maturity of the users to make use of the larger Internet community to enhance their knowledge or to solve particular issue.

This is further backed by the quality of the help obtained. Indeed, Mauritian Internet users perceive online help forums as providing the best help just after family and friends. Although the first line of help remains the immediate environment (family members), the study finds that Internet users in Mauritius have gone a step further and use the larger Internet community to support their use of the Internet, thereby sidestepping friends and neighbours, educators, IT help desk and the likes.

It can be argued that the quick access to quality help online could explain the perception of Mauritian users that lack of physical support does not affect their Internet use. However, for some, the lack of help and support when needed is still perceived as the main reason limiting the effective use of the Internet. It is also worth noting that lack of encouragement to use the Internet is the least reason for limiting the effective use of Mauritian Internet users.

With regard to differences within groups, the study finds that age group, occupation, highest level of education and current education level are the four main determinants of inequality from a social support perspective. The findings show that there are statistically significant differences in the distribution within the various age groups. Indeed, those who are aged between 12 and 19 years old perceive the lack of help and support as having a more negative effect on their Internet use as compared to users aged between 20 and 59 years old. The results are further supported by the difference within the occupation group showing that students perceive the lack of help and support as being a significant limiting factor in their Internet use. It is clear therefore from the above that younger users are more vulnerable in their use and, as such, require more help than the others. The issue is further compounded when taking into account that online support is mostly used and the suitability and effectiveness of online support for young users are yet to be assessed and proven. Consequently, from a policy perspective, it is important to favour young users' help and support through adequate means to enhance their effective use of Internet.

Additionally, the study suggests that there are significant differences within the student community. As such, the results show that those studying at the Primary level are more vulnerable to the lack of help and support in their daily use of the Internet as opposed to the other groups. Although this research is challenging neither the quality nor the frequency of support from educators, the findings show that although this category of users would have had access to help from educators and educational institutions, these remain ineffective in helping young users.

Overall, with regard to the help needed and received for the effective use of the Internet, the study finds that the vast majority of Mauritian users have access to quality help on a needs basis, with family being the preferred source of quality help. Nonetheless, the study suggests that online help forums play an important role in Mauritian Internet use. From a social support standpoint, although minimal, lack of support remains the main limiting factor for effective Internet use.

6.7. Inequality in Purpose of Use

The purpose of use is yet another dimension of Digital Inequality investigated in this study. Mauritian Internet users were asked to rate the relative importance of a given set of activities with regard to their everyday Internet use. Although this study does not engage in as great detail as those carried out by the Pew American Life Project (www.pew.org) or the Oxford Internet Survey (Dutton and Helsper 2007; Dutton, Helsper, and Gerber 2009; Dutton and Blank 2011; Dutton, Blank, and Groselj 2013), it does, nonetheless, give an indication of the relative use and differences in the use Mauritians make of the Internet. The study uncovered some insightful facts about the Mauritians' use of the Internet.

First, the findings show that information search and communication are the main activities performed by Mauritian Internet users. Although not instructive per se, the findings show that the use Mauritians make of the Internet has evolved over time. The only available data on the matter, dating back to 2000 (National Computer Board 2000), suggests that email and chat were the main activities performed by Internet users. Fifteen years down the road, with constant changes in the Internet itself, information search is the preferred activity performed by Mauritian users.

Secondly, the findings show that online music and video consumption is perceived as being highly important to Mauritian users and is ranked just after information search and communication in importance. The Internet has indeed offered new opportunities and choices for Mauritians in their musical and video consumption. Although this study is just uncovering this trend, further research is needed to investigate the type of music and video being consumed and the type of consumption, whether it is downloading or streaming. However, from a more developing angle, Chen and Wellman (2005, 2) contend that "users in developing countries disproportionately consume rather than produce internet content". This fact is well observed in the case of Mauritius and it is all-important that the use of the Internet is not limited to consumption but also to producing and participating actively in the digital landscape.

Thirdly, it is observed that online media production is not an activity fancied by Mauritians. The results show low mean values for items such as publishing information online and distributing own media. However, playing games is perceived as having a slightly higher importance than the above-mentioned two activities. Therefore, besides information search and communication, entertainment (including social media) is perceived as a high importance activity on the Internet.

Fourthly, although supporting a cause online is perceived as an essential activity, political support and endorsement are seen as not being important and therefore least carried out by Mauritians online. It is also worth noting that there was also no political election during the timeframe of this study, which could have impacted on the users' perception, but still, the findings suggest that online political support is not in the Mauritian mores.

Furthermore, the findings also suggest statistically significant differences within age group, occupation, highest education level achieved, current education level and highest education level of parents. From an age group perspective, the study finds that those who are aged between 12 and 19 years old perform more activities online than those aged between 40-49 and above 60 years old. Likewise, those aged between 20-29 perform on average more activities online than those aged between 30 and 59 years old. Clearly the results suggest that younger generations perform a lot more of the activities set in the study or at least perceive these activities as being more important. It could be argued that some activities, especially entertainment, are more conspicuous with the young generation as opposed to the older generation. From an inequality perspective, the result does suggest that there are significant differences in the way people of different age groups make use of the Internet. From an occupation perspective, the results show that those who are unemployed or self-employed rated activities as being important in their use of the Internet. A possible explanation could be the time available to explore more activities in their use of the Internet, or it could be for job-search activities.

With regard to the highest education level achieved, the result shows that there were statistically significant differences between those who achieved Primary education and those who achieved higher education level such as HSC, Undergraduate or Postgraduate education. Indeed, the findings revealed that those who studied at the Primary level performed less or rated the relative importance of the activities less than those who achieve higher education level. A major conclusion that can be drawn from this finding is that there could be a direct correlation between Internet use and education level. It could be that the lifestyle of those at the Primary education level does not align with the activities mentioned or carried out, but the fact remains that the Internet use is limited to some activities online. This trend seems to be replicated within the student community, with those studying at higher levels having higher rating for the relative importance of online activities, as opposed to those studying at lower levels.

From a socio-economic perspective, the results show that users whose parents have studied at higher levels tend to perform more or rate the importance of online activities higher than the others. In this particular context, it can be argued that the family environment and perhaps affordability of high-speed Internet connection favours some particular use, especially those activities requiring fast Broadband connection such as online gaming. There are profound ramifications from a Digital Inequality perspective since not all users can make the most out of the Internet. The results clearly show that some categories of users are able to perform more tasks than others based on their socio-economic status.

Overall, the findings suggest that Mauritian Internet users favour some particular activities such as information search and communication while disregarding activities such as political support. It is clear that since Internet use has evolved and is bound to evolve with time, questions of equality in the purpose of use might be an important driving force for future generations. Indeed, the research found significant differences within the age group, education level and socio-economic status, suggesting that the inequality in purpose of use is well established within the Mauritian community.

6.8. Digital Inequality—The Mauritian Model

The previous sections explored in relative detail each of the five dimensions of Digital Inequality using Hargittai and DiMaggio's model. The table below summarises the findings with regard to the determinants significantly affecting Digital Inequality in Mauritius.

	Sex	Age Group	Location	Occupation	Highest Education Achieved	Current Education Level	Highest Education Level of Parents
Inequality in Technical Apparatus		✓			✓	✓	
Inequality in Autonomy of Use		✓		✓	✓	✓	
Inequality in Skill	✓	✓		✓	✓	✓	
Inequality in Social Support		✓		✓	✓	✓	
Inequality in Purpose of Use		✓		✓	✓		✓

Table 6.1: Summary of Determinants Affecting Digital Inequality in Mauritius (Adapted from Yang et al. 2010)

The first major conclusion that can be drawn from the table is the issue of equality with regard to the area of residence. Indeed, the study suggests that people living in rural and urban areas enjoy the same facilities and opportunities when it comes to making the most out of the Internet. From an infrastructural standpoint, it could be argued that the relatively small size of Mauritius accommodates rapid diffusion of any technology across the island. Although, in recent years, urban areas have been favoured when upgrading the network or when launching new Broadband services. Second is the relative accessibility of major technology point of sales. Even though there has not been a widespread uptake of e-commerce, the relative size and proximity of technology shops allow for a quick and easy access to latest technologies, thereby levelling any inequalities that could exist in terms of accessibility.

It is also worth noting that apart from skill, sex is not a determinant of Digital Inequality in Mauritius. Although as seen previously, where females tend to connect less to the Internet than males, the findings suggest that once they are given access, there is no difference in access and use. With regard to skill, there are reasons to suggest that further research is needed to confirm the differences and that apart from skill, it can be safely claimed that women and men make the most out of the Internet to an approximately equal extent.

Moreover, the socio-economic background of users does not seem to have a major influence on inequality in access except for the purpose of use. The results suggest that there is almost no difference for users from different socio-economic background, measured using the highest education of parents as a proxy, in their Internet access. The only dimension for which socio-economic background is a determinant of Digital Inequality is purpose of use, suggesting that people from different levels of the Mauritian socio-economic strata use the Internet differently. However, it is important to situate this result in a broader spectrum whereby this study excludes anyone who has not and cannot access the Internet because of his or her socio-economic status. At the same time, it demonstrates that among the existing Mauritian Internet users, socio-economic status is not a cause of Digital Inequality.

The study also investigated the factors of Digital Inequality in Mauritius. Thus, using DiMaggio's model as a basis, the study examined through factor analysis, the underlying forces that make up Digital Inequality in the Mauritian society. Whereby Hargittai and DiMaggio suggested five forces, this research shows that there are six main dimensions of Digital Inequality in Mauritius. Indeed, although the same five underlying dimensions are present or to some extent combined, the result suggests that there are other factors that play an important role such as content creation, entertainment and sociality or techno-sociality (Willson 2012).

The study, therefore, postulates a new model of Digital Inequality illustrating the underlying forces operating within the Mauritian society. The model, taking into consideration the specificities of the country, is a vital tool for

policy makers, practitioners as well as researchers. It enables a deeper understanding of the Digital Inequality phenomenon and also the incongruences with regard to models established for developed countries.

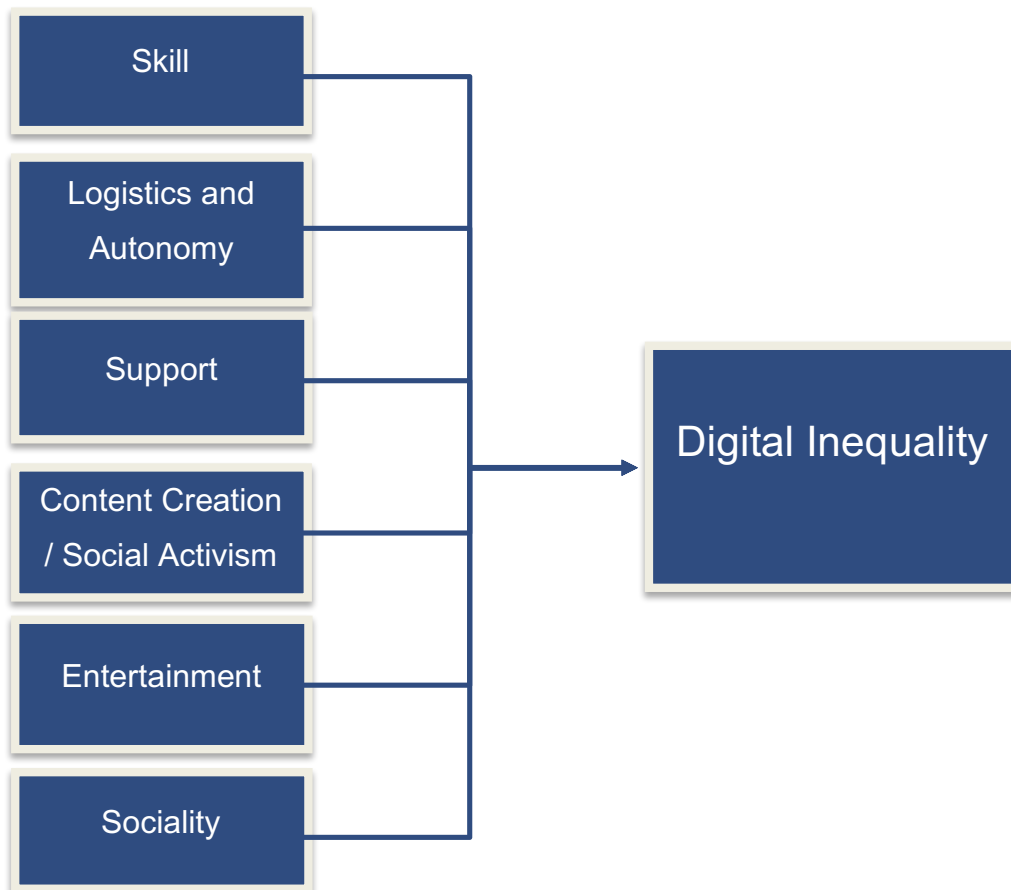

Figure 6.1: Mauritian Digital Inequality Model

The result shows that there is a positive correlation between factors of Digital Inequality and the users' perception of Digital Inequality in Mauritius. However, the model suggests that there is a weak correlation, with the predictors explaining very little of the variability in the dependent variable. Only two of the six factors contributed significantly (statistically) to the model, firstly Logistics and Autonomy and secondly Content Creation and Social Activism. As such, further research is needed to focus more on the issues pertaining to Digital Inequality in Mauritius by investigating more determinants.

6.9. Conclusion

This chapter examined the findings of the survey and discussed the determinants of Digital Inequality in Mauritius. It started by reinforcing the reliability and validity of the survey instrument.

Using the same structure as the previous chapter, the main findings for each of the five dimensions of Digital Inequality were explored. For instance, the chapter demonstrated that there is indeed Digital Inequality in Mauritius but that the determinants of Digital Inequality are different compared to those from studies in other countries. Furthermore, the chapter discussed the main underlying factors of Digital Inequality in Mauritius, which turned out to be different to that proposed in the literature.

The Digital Inequality phenomenon is a complex and diverse topic. Although the survey offered an insight into the differences in access and use from a user perspective, it is important to also look into the issue from various angles. As such, the following chapter discusses the findings of interviews conducted with other stakeholders of the Mauritian Internet ecosystem, which should allow, by the end of the thesis, a broader understanding of the Digital Inequality phenomenon in Mauritius.

Chapter 7: Qualitative (Interview Results) Discussion

7.1. Introduction

This chapter explores Digital Divide and Digital Inequality from Mauritian Internet stakeholders' (other than that the users) perspectives. A series of semi-structured interviews were conducted across three broad categories of Mauritian Internet stakeholders, namely the Government of Mauritius, civil society organisations (CSO) and Internet Service Providers (ISP's). This chapter therefore outlines and discusses the major findings of these interviews.

In line with the previous chapter, this chapter should enable to answer one of the objectives of this research. As such, this chapter will look into the third objective of this study, which is to situate governmental and non-governmental initiatives with regard to Digital Inequality in Mauritius.

The structure of the chapter revolves around the three categories of stakeholders and the two broad themes discussed in this chapter, namely Digital Divide and Digital Inequality. The first three sections provide an analysis and discussion of the interview findings within each category. Each of these sections start with a brief description of the chosen organisations, within the category and their suitability as prime stakeholders in the Mauritian Internet ecosystem, followed by a discussion of their views on the topics of Digital Divide and Digital Inequality. The last section of this chapter is dedicated to a cross-categorical analysis and discussion on the similarities and differences on the approach and perception of the different stakeholders on the aforementioned phenomena.

As discussed in the Methodology chapter, interviewees were requested to sign a consent form, in line with ethical requirements, with regard to whether they would want the information provided to be attributable to them or to remain anonymous. Since some of the interviewees requested to remain anonymous and to ensure consistency in the approach to the discussion, it

was decided to make all the interviewees anonymous. Thus, codes were used, as shown in Table 7.1, to identify the entities and not the person in the discussion.

Entity	Code
Governmental Organisation	
ICTA	G1
MCTI	G2
NCB	G3
Civil Society Organisation	
Internet Society	CSO1
MITIA	CSO2
OTAM	CSO3
ISP	
Orange	ISP1

Table 7.1: Summary of Codes Used for Interviewees

7.2. Governmental Organisations

Within the governmental organisation category, three bodies working within the Internet realm were selected for the interviews. These are, namely the Ministry of Communication, Technology and Innovation (MCTI), formally known as the Ministry of Information and Communication Technology (MICT)³, the National Computer Board (NCB) and the Information and Communication Technology Authority (ICTA).

The MCTI is the preeminent governmental body when it comes to ICT. The mission of the ministry is to “provide the right environment for the harnessing of ICT to generate employment, increase national wealth, improve quality of life and create new opportunities for sustainable socio-economic development of Mauritius” (MICT 2014). The MCTI is at the frontline in formulating policies and providing the proper legal framework for a healthy ICT environment on the island (MICT 2014). One of the objectives is to “promote and facilitate the development of the ICT sector” as well as to

³ After the December 2014 general election on the island, the new government changed the name of the ministry.

“ensure that the ICT culture permeates all levels of the society to bridge the digital divide to the extent possible” (MICT 2014). It is, therefore, altogether important for the government to act as a facilitator and a mediator to ensure a sound and healthy ICT sector, in particular the Internet in Mauritius. In this respect, the government positions itself as a major Internet stakeholder and its views on the current state of affairs and strategic vision are important in understanding both the Digital Divide and the Digital Inequality phenomena.

The NCB, a governmental body acting under the aegis of the MCTI, is responsible for promoting the development of ICT in Mauritius (NCB 2014). The NCB is mainly responsible for implementing core policies of the MCTI. The organisation’s core mission is to “... accelerate the transition of Mauritius into a regional ICT hub and ensure the swift realisation of the government’s objective to make of the ICT sector a key pillar of the Mauritian economy” (NCB 2014). Its vision is “to e-power people, businesses and the public sector by developing and promoting ICT and ICT related services in Mauritius” (NCB 2014) and to deploy programs regrouped under these three broad operations. Examples of programs under the e-powering people are the Universal ICT Education Programme, which aims at training Mauritians of any age to the basic of Internet and computing through the Internet and Computing Core Certification (IC3) for a small fee (NCB 2015b). There is also the Cyber Caravan, which are fully equipped buses, with computers and Broadband Internet connection, touring the island and offering “training on board according to the needs of people, regardless of age, education background or profession” (NCB 2015a). Since its activities are directly targeted at the Mauritian population, the NCB is an important Internet stakeholder.



Figure 7.1 National Computer Board Cyber Caravan (Source: NCB 2015b), Courtesy of the National Computer Board

The ICTA, also operating under the aegis of the MCTI, focuses more on the regulatory framework of the ICT sector and is “playing a leading role in the future of ICT in Mauritius, contributing to an efficient, competitive and optimally regulated ICT sector” (ICTA 2014a). The ICTA’s vision is to “promote affordable and adequate access to quality ICT services through functional market-driven competition and regulatory principles in a trouble-free Networked Information and Knowledge Society” (ICTA 2014a). The Mauritian regulatory body has evolved over time and has adopted clear frameworks to ensure a healthy ICT sector (Oolun 2014). The domain of the ICTA spans across several spheres of the ICT domain, from ensuring a

market driven competition within ICT services to monitoring radio frequency on the island (ICTA 2014a), and as such is a major Internet stakeholder within the government.

7.2.1. Digital Divide

7.2.1.1. Internet Development

All three representatives of the Mauritian government are unanimous on the strategic importance of the Internet for the socio-economic advancement of the island and its citizens. From an economic perspective, G3 reiterates that although “a nascent industry a few years ago, [the ICT sector] is now the third pillar of the Mauritian economy with a GDP contribution nearing 6.8%, a turnover of \$1 billion and directly employing more than 16,000 people with flow-on benefits for many more”. The role of the Internet in the economic development of the island is therefore non-negligible. In the same vein, G1 argues that the Internet “has become a very important vector for development today”, and plays a fundamental role in supporting the other economic pillars, be it agriculture, finance or even the manufacturing industry, since the Internet “has replaced the concept of telecommunication”. The government representatives agree that the Internet supports directly or indirectly most, if not all, of the economic activities around the island and therefore plays a major role in the country’s economic life.

From a social perspective, the government representatives view the Internet highly, so much so that it is aiming at making it a “basic citizen right” (G2), emulating some of the world’s advanced nations (Broadband Commission 2011). Indeed, the Internet is gradually filtering through all of the social strata of the country, and has a primordial role in the government’s ambition to “revolutionise the way we educate our children... and improve knowledge” (G2) but also to make the country as one of “the most connected country in the world” (G2). Representatives of the Mauritian government acknowledge the importance of connectivity, not only for businesses and enterprises but

also for the population and the youth in particular. It also sees the Internet as being a “basic utility... among those that we have in our everyday lives” (G1).

Although the role of the Internet is well understood and highly valued, the role of the government is, nonetheless, essential in facilitating the socio-economic development of the country. As such, governmental representatives agree that the government has an important multifaceted role in the development of the Internet on the island but also that its role is ever evolving. The various roles of the government, amongst others, include the setting up of strategic plans on ICT and Internet in general, the setting up of the proper legislations and policies for the sector, the monitoring of the market and ensuring the diffusion of Internet amongst the population.

An example of the evolving role of the government can be seen with regard to the affordability and quality of Internet access. In the early 2000's, much of the focus of the government's action has been on liberalising the ICT sector (G1) because there was only one operator in the market dictating the price and quality of Internet access. Once the sector has been liberalised, the government's tasks evolved into bringing in competition and ensuring that there was a “level playing field” for any company wishing to enter the Internet or ICT market (G1). Later, the role of the government evolved again into maintaining the competition to ensure that businesses and citizens were able to get an affordable and better quality Internet access. Moreover, from a regulation perspective, the government, through the ICTA, believes that it has a far greater role than that of just regulating the industry and has adopted what it termed as the “fourth generation regulator” (Oolun 2014). Such approach consists mainly of viewing all Internet stakeholders as “partners” in the decision-making process, rather than being the ‘big brother’ institution that dictates policies and rules to be followed by all (G1).

Likewise, representatives of the government firmly believe that the government plays a major role towards its citizens by “democratising access” to the Internet for the community (G3). In this respect, the government has embarked on a range of activities to ensure that the Internet is reaching the maximum number of people on the island. Examples of such activities or

projects are Computer Clubs, the Cyber Caravan, Universal ICT Education Programme (UIEP) and Public Internet Access Points (PIAP) (G3). The Computer Club project, as its name suggests, consists of the setting up of computer clubs around the island, fully equipped with computers and free Internet access, for anyone wishing to use the Internet. So far, there are 213 Computer Clubs around the island with another 63 in the pipeline (G3). The Cyber Caravan project consists of fully equipped Internet ready buses that travel around the island to make ICT more accessible, mainly to “children, students, unemployed, women, staffs of private organisations, planters, farmers, senior citizens, in particular for those who do not have a computer” (G3). According to a government representative, the aim is to “raise the level of knowledge about ICT and the level of competence in using personal computers and common computer applications, to promote and encourage ICT literacy and to enhance the employability of all people...” (G3). Similarly, the Universal ICT Education Programme (UIEP) aims at training “a maximum number of citizens to obtain the internationally recognised Internet and Computing Core Certification (IC3) course” (G3). Lastly, the Public Internet Access Points (PIAP) are computers with Internet access points set up in post offices around the island for citizens to use and access the Internet freely (G3).

The representatives of the government believe that it is taking proactive measures with regard to the Internet in Mauritius. For example, it is exploring new avenues for economic and social development with the Internet as major backbone. For example, Telemedicine is one such application in which the government is highly interested and could be a potential boon for the Mauritian economy and society, especially since Mauritius is remotely located from top-notch medical research centres. From a policy perspective, the government is also proposing the National Cyber Security Strategy⁴ (MTCI 2015b) to look at potential threats, but also to consider how to best

⁴⁴ The National Cyber Security Strategy 2014-2019 was released after the interview was conducted.

protect the Mauritians in their daily use of the Internet. However, despite painting a highly positive and optimistic ambition of Internet on the island, there are still underlying issues impeding such utopic view of the importance and possibilities of the Internet.

7.2.1.2. Access

From an access perspective, although there are differences in opinion with regard to the current state of Internet in Mauritius, there is an underlying agreement that the Internet penetration is much lower than it should be. Most the government representatives interviewed acknowledge the low Internet penetration rate in the country. It nonetheless argues that a lot has been and is being done by the current regime and somehow blames the previous administration for its laxness (G2). The government further argues that even though penetration rate is low, the country is faring well, depending on the parameters used. As such, G1 argues that, taken from a scientific perspective and referring to the ITU's Information Development Index (IDI), there are 13 indices on which the current state of Internet in Mauritius is measured and that, although from a global perspective Mauritius is just below average, there are some parameters in which the country is doing extremely well. For example, when it comes to Internet coverage, the country is covered at "99%" (G1), which is excellent but there are other parameters on which the country is performing poorly, for example the bandwidth threshold, where the country just launched the 10 Mbps Internet connection but is still far behind other countries with 40 Mbps. Such discrepancy is highly detrimental from an Internet experience perspective.

The government officials interviewed put forward three main reasons to explain the low level of Internet penetration on the island, which are, namely, the lack of investment in infrastructure, the economies of scale and the lack of an Internet culture. With regard to lack of investment in the infrastructure, G1 argues that there is a cost to the infrastructure and today there are only two major ISP's investing in the infrastructure. Obviously, from a business perspective, there needs to be a return on the investment, with one, the cost

being transferred to the customer and second that there is a time gap before the next technology is deployed, since companies need to cash in on their initial investment before moving on to the next. This, therefore, delays the deployment of the latest technology on the island. However, a representative of the government argues that it is trying its best to navigate through the complexities using the “stick and the carrot” (G1) approach to attract investment in the infrastructure. Essentially, it is trying to attract investment in the infrastructure by leveraging some of the regulatory barriers and offering exclusivity for some limited time (G1).

Economies of scale are yet another explanation for the low Internet penetration rate, and it has a direct link with technology investment on the island, argue government’s representatives. The small size of Mauritius makes it difficult to attract and maintain major ISP’s, which perhaps would have increased the competition and lowered the price. Briguglio (1995) argues that the issue of economies of scale is common to many small islands. Indeed, G1 argues “one major issue with [Mauritius] is that we do not have a critical mass in [the] market” and all the theories or the economics “do not really work” in such context. This further complicates the role of the regulator, having on one hand to attract investors and competitors, and on the other hand having to regulate the sector. One of the barriers to Internet adoption is the high cost of Internet connection and although the cost has been constantly lowered (in relative terms), Internet price is still perceived as being quite high by the population at large. G1 argues that it is a “chicken and egg situation” whereby the high cost of Internet puts off users, but if there were more users, the price would go down.

The third and perhaps most important factor explaining low Internet uptake according to the majority of the government’s representatives is the lack of an Internet culture. G1 argues that we “do not have a strong Internet culture”, which is perhaps today the single most impeding factor on Internet uptake. G3 further supports the claim stating that “in 2010 around 62.1% of households with no computer did not have any intention to buy one”. When comparing Internet uptake with mobile uptake, G1 argues that “mobile

phones have been marketed throughout the world” as “a phone for everybody” and everyone is identified with the services and the “convenience” of the mobile phone. In contrast, the Internet, which at its inception required firstly a computer and secondly the physical presence of the user in front of the computer to be able to use it, and this, says G1, has “created... a barrier”. However, G1 adds that the problem is mainly with older generations since the young generation is growing up with the Internet.

The majority of government representatives believe that there is a need to push for stronger Internet culture on the island (G1, G3) but are fully aware that it is going to be a gradual process. G1 argues that in order to bring that strong culture, Internet “should not be viewed as a substitute of what you are doing today” but rather as a gradual enhancement to one’s lifestyle and it agrees that “change management is the most difficult thing that we have to do”. Moreover, everyone is responsible for developing an Internet culture, argues G1; “government has got its role, institutions have got theirs, the public, the citizen has got their own role to play and service providers or businesses [have theirs] ...”. The recipe is to have the right mix of top down and bottom up approach (G1). For example, “what banks are successfully doing today is somehow pushing the technology to their customers and once the customers experience the convenience of such technology, they adopt and use the services” (G1). G1 further claims that a similar “integrated or holistic” approach would greatly help with the right balance because forcing Internet use will not bring about a culture, but rather instil distrust among users. G3 argues that the cost of the Internet also needs to be lowered and there needs to be an increased “awareness of the benefits of the Internet” among the population.

7.2.2. Digital Inequality

From a Digital Inequality perspective, among the representatives of the government, there seems to be agreement on some issues but also disagreement on others. The following section details governmental representatives’ opinion on each of the five dimensions of Digital Inequality.

With regard to access to devices, there is disagreement among government representatives on the issue. G2 argues that access to a computer and the Internet is not an issue anymore, mainly due to the fact that the government “has carpeted the island” (G2) with Internet network access and devices put at the disposal of the population, which makes Mauritius on par with major developing countries with regard to coverage and devices availability on the market. However, there is a stream within the government arguing that unfortunately, affordability of devices is still a major obstacle to Internet uptake and use in the country (G1, G3). G2 argues that, for example, the release of the latest devices on the Mauritian market is usually within weeks of their release in major developed countries and therefore Mauritians have access to the latest technological devices on the market. However, G1 and G33 argue that the prices of the devices are quite high and unaffordable to the average citizen. Therefore, from a Digital Inequality perspective, government representatives seem to be aware of the inability of some of the Mauritians to own an Internet ready device but reassures that with its philosophy of “putting people first” (G2), it is doing its best to ensure that everyone is able to have access to such devices.

In line with DiMaggio and Hargittai’s model, government representatives were queried on the freedom of Mauritians to access the Internet—autonomy of use. There seems to be cohesion within the government to support the freedom of the Internet and more importantly to support the freedom of access to the Internet content, except in some very limited cases. The first such case being Child Pornography; a government representative believe that although everyone is free to access any content, it has a responsibility towards its citizens and especially a responsibility to protect the children (G1). As such the government works with the Internet Watch Foundation (IWF) to filter access to any content relating to child sexual abuse (G1). The second case is with regard to social harmony (G2). Mauritius is a multi-cultural and multi ethnic/religious society and one of the priorities of the government is to maintain social harmony and stability. As discussed in Chapter 3, successive governments have strived to maintain this fragile web

and ensure social cohesion. As such, the government has in the past, “on two occasions”, requested “with the help of Interpol” that “blasphemous contents”, deemed to possibly offend and create religious tension, be removed from specific websites, although these websites themselves were not shut down (G1). Other than these two cases mentioned earlier, the Mauritian government believes that its citizen should be free to access any content on the Internet, although it acknowledges and respects institutional Internet usage policies to monitor and filter content (G3) within such institutions. Therefore, from a Digital Inequality perspective, Internet users are free and they have the support of the government to maintain the freedom of using and access content on the Internet except for the cases mentioned above.

Furthermore, most of the government representative believe that, depending on the level of support, it is doing its best to provide support to Mauritians in their Internet use. The first level being that of the infrastructure and access to the Internet, where much of government’s effort is towards providing adequate and free Internet access points to the population (G3). However, there is disagreement with regard to online content and online services provided. The Ministry of ICT believes that it cannot alone do all the current work and simultaneously provides general online content (other than government’s services) to the population (G2). On the contrary, G1 believes that incentives are necessary to encourage people to use the Internet and that these could be either direct or indirect incentives. An example of direct incentive is the latest subsidies given on basic 256 Kbps Internet connection where the cost has been drastically brought down to “Rs. 200” per month, which has unfortunately not attracted many users (G1). As for indirect incentives, the Mauritius Revenue Authority (MRA) is a good example, where it is encouraging or rather pushing citizens to file their tax returns online with a 15 days’ additional penalty free and additionally filling the tax online automatically registers the user for a cash prize lucky draw. G1 contends that these incentives demonstrate that much is being done to encourage and support Mauritians in using the Internet on the island, but that again it is not

the responsibility of the government alone. It has to be within the Mauritian Internet ecosystem, where just like the government and governmental bodies offering online services, each stakeholder must offer such services (for example online bill payments or online forms) that will “pull the citizen into using the Internet” (G1). Furthermore, G1 argues that it is also a matter of culture, and believes that it is only by instilling a strong Internet culture that things will change.

With regard to skill, there are some disagreements on Internet skill level of Mauritians. On one side, there are those (G2 and G3) who argue that a lot of effort has been made to empower citizens with digital literacy skill at a reasonable and decent level for them to make full use of the Internet. G3 argues that, for example, until now some “157,804” citizens have been trained on the IC3 course offered by the government, and the same course has been integrated in the curriculum of college students, thereby promoting digital skill on the island. However, G1 argues that it depends on the skill level, and that although it can be assumed that most of the Internet users have a basic skill, the use of the Internet entails “... more than just browsing” and that more “specialised” skill is needed to “... benefit from the full power of the Internet”. Although the government’s position is that there is a lot being done to train people in the use of Internet, there is no statistic to show that indeed those who have been trained are actually using the Internet and making the most out of it. Additionally, the level of training offered to citizens by the government needs to be aligned with the needs of the Internet users. This study uncovered in the previous chapter that the majority of Mauritian Internet users did not get any formal training in their use of the Internet. Although there is a good policy and initiatives to train users, it is important to ensure that the individuals being trained are actually being converted to users.

Concerning purpose of use and effective use, there seems to be agreement amongst all government representatives that the answer is highly contextual. Indeed, G3, quoting the CSO, suggests that Mauritians use the Internet mainly for ... “Information search (75.3%)” followed by “Email/Chat (73.2%)”

and “Entertainment (50.2%)”. This is somehow aligned with the results obtained in the quantitative section of this study. G1 and G2 both concurs in stating that unfortunately there is a discrepancy in the use of Internet in Mauritius and that not everyone is making full use of the latter. G2 goes further in stating that some people are even using the Internet to cause harm. G1 argues that in order to understand effectiveness of Internet use, one has to take into consideration several parameters, including the quality of the service and also the quality of the experience in using the Internet. G1 further argues that effectiveness is more of an “economic term” that takes into consideration opportunities that one is forgoing in its use of the Internet. For example, comparison is made between downloading an “e-book and actually purchasing physically the book”. G1 argues that the effectiveness will depend greatly on the “speed of the Internet in downloading the book and the experience of reading digitally versus the time taken to go and physically buy the book and the experience of reading a physical book”. In this case, for G1, effective Internet use when users will prefer downloading the book than reading a physical one. However, G1 also contends that it is important to take into consideration the specificity of Mauritius, which is a small island state. Whereas e-commerce has been mainly to bridge the physical gap between the seller and the buyer, allowing the latter to shop without having to move, distance is most of the time not an issue for those doing business within such a small country. Also, Mauritians have a culture of meeting people, which is a factor that is taken into consideration when people decide whether to buy online (G1). Therefore, even though a user has a “10 Mbps” connection, which supposedly should bring more convenience, in reality it might be more convenient to buy in-store because of the “culture” of going out to meet people and the relatively short distance to access such services (G1). It is important to understand the culture and the quality of the experience that users are looking for when trying to understand the use people make out of the Internet. Looking at the issue from this perspective could be a possible explanation to the low level of engagement in e-commerce locally.

7.2.3. Overall Governmental Perspective

Overall, with regard to the Digital Divide, government representatives argue that the government is fully aware of the current situation but also lauds itself for much of the improvements so far and has an ambition to make the Internet a basic citizen's right. Indeed, although it is agreed that there is a relatively low Internet uptake on the island, most of its representative believe that the government has made considerable effort in ensuring access to Internet to a large proportion of the population and is faring well on some parameters, such as connectivity based on the IDI. The government has instilled and is maintaining a competitive environment among ISP's to allow the population to benefit from lower rates but also better quality of service. The government representatives also recognise the need for a sound legal framework and policy for the Internet and as such, has laid down a roadmap for the development and deployment of Broadband on the island in the National Broadband Policy 2012—2020 as well as a National Cyber Security Strategy plan 2014-2019.

E-powering the citizen is another stream where the government has made considerable efforts to ensure Internet access through free public Internet access points (PIAP) as well as in schools and computer clubs around the island. Training plays an important role in the government's mission and several initiatives have been launched to train citizens of different ages and socio-economic background.

With regard to Digital Inequality, the government's role is quite limited. Although, in terms of technical apparatus, a lot is being done to ensure access to the Internet. The cost of devices is perceived as being relatively high and out of reach for many Mauritians. As regard to the quality of the Internet connection, the government representatives believe that the government is trying its best to lower the prices and increase the quality. However, since most investments are made by ISP's, it has limited power on the prices and argues that increasing competition between ISP's should allow for an attractive price. Furthermore, representatives of the government agree to the freedom of the Internet and although applies automatic filtering

for Child Sexual Abuse Content, Mauritians are free to access any other content online. With regard to skill, representatives of the government believe that the government is doing a lot to empower its citizens with the necessary skill needed but some voices within agree that although training is provided, not all Mauritians have the required advanced skill to make maximum use of the Internet. This is translated in the differences in use and also perhaps the high proportion of the population using the latter for basic Internet search and Email/Chat.

To conclude this section, it can be argued that although most of the government representatives interviewed believe that the Mauritian government is putting a lot of effort in bridging the Digital Divide, the situation is still alarming, with a low rate of Internet uptake among the population. The notion of Digital Inequality is, unfortunately, not on the government's agenda. However, government officials are aware of the first signs of Digital Inequality but assumes that this will decrease with time, as the younger techno savvy generation grows older. Although G1 argues for an Internet culture to be instilled and encouraged by all, it appears that government's endeavours are quite specific, focused and somehow isolated.

7.3. Civil Society Organisations

As for governmental bodies, representatives of three civil society organisations (CSO's) were selected for interviews. Each of the three CSO's focus on a specific aspect of the Internet on the island, which has a direct or indirect impact on the users. Under the CSO umbrella, three organisations were chosen, one relating directly to users and two business associations within the ICT sector on the island, whose activities have direct and indirect implications for Internet users on the island. The CSO's selected are categorised under two main strands: civil society associations, namely the Internet Society—Mauritius Chapter (ISOC-MU); and business associations, namely the Mauritius Information Technology Industry Association (MITIA) and the Outsourcing and Telecommunication Association of Mauritius (OTAM). The following section briefly outlines the role and mission of each of

the three CSO's before discussing their views on the Digital Divide and Digital Inequality phenomena.

The Internet Society—Mauritius Chapter was set up in the year 2000 and rejuvenated in 2011 (Internet Society Mauritius 2015) under the “umbrella of the Worldwide Internet Society”. The Worldwide Internet Society (ISOC) is a “cause driven” organisation with over 100 chapters in various countries around the world (Worldwide Internet Society 2015a) and its mission is “to promote the open development, evolution, and use of the Internet for the benefit of all people throughout the world” (Worldwide Internet Society 2014b). As such, the local chapter of ISOC aligns itself with the overall mission of the parent organisation but focuses more on Internet awareness on the island (CSO1). The Mauritian ISOC chapter's motto is “Internet for Everyone” (CSO1) and is mainly engaged in awareness of the Internet and especially “proper usage of the Internet among the youngsters and also among old people” (CSO1) through campaigns such as free initiation to Internet in Mauritius. Such grass root level action of the ISOC-MU, therefore, makes it a major civil society stakeholder in the Mauritian Internet ecosystem.

The second CSO, the Mauritius Information Technology Industry Association (MITIA), is a business association created in 2001 (MITIA 2014) and regroups around 30 ICT companies representing around 80% of the ICT sector in Mauritius (CSO2). The members of the MITIA are key players in the ICT sector, which “provide a whole gamete of services, software [and] hardware” (CSO2). The mission of the MITIA, amongst others, is to “help foster an environment that is conducive to the prosperity and competitive nature of the national information technology industry” and “represents the IT industries' interest in relevant policy issues” (MITIA 2014). The expansion and adoption of ICT is crucial to the survival of companies within the MITIA, which makes it a key stakeholder in the Internet ecosystem of the island.

The third CSO selected for this study is also a business association, the Outsourcing and Telecommunications Association of Mauritius (OTAM). The OTAM was created in 2004 and consists of members from IT Outsourcing

(ITO), Business Process Outsourcing (BPO), International Long Distance Operators and Internet Service Providers (OTAM 2014). The Internet is at the heart of the operations carried out by companies making up the OTAM; all the process outsourcing carried in Mauritius would not have been possible without the Internet. The Internet is the lifeblood of these companies. The mission of the OTAM is “to promote a business friendly competitive environment conducive to the growth of the ICT industry in Mauritius” (OTAM 2014). Among the various fronts on which the OTAM is active, the association is highly active in “negotiations with the Mauritius Telecom, the government and the ICTA on various issues” such as “reduction in bandwidth costs, call termination, ILD licence fees and Interconnection Usage Charge costs” (OTAM 2014). In this capacity, OTAM is a major stakeholder in the Internet ecosystem.

7.3.1. Digital Divide

With regard to Digital Divide and access to the Internet, although there is consensus on some of the burning issues, each stakeholder within the CSO category views the means and ends from their own standpoint. The following outlines the perspectives of the three CSO's with regard to Internet access and use.

7.3.1.1. The Role of the Internet

Access to the Internet is seen as a must by all three organisations but not necessarily for the same reasons. CSO1 argues that the motto “Internet for Everyone” of the Internet Society - Mauritius speaks for itself since it promotes the use of Internet in the community for the advancement of the individual from an “economic, social and cultural...” and also “...educational” perspective. CSO1 further argues that individuals also play an important role in providing content and “sharing information” on the Internet. CSO2, however, perceives the role of the Internet differently. Although CSO2 acknowledges the importance of the Internet for the individuals, CSO2 situates the Internet more from an economic perspective. Indeed, CSO2

argues that Mauritius, unlike other African countries, does not have any natural resources and relies only upon its human capital for its economic development by offering services like business process outsourcing. As such, the quality of service is essential and the Internet is a pre-requisite in offering a high standard of service. The Internet is at the core of a thriving BPO sector, which is increasingly contributing to the Mauritian economy. CSO3 echoes the same argument stating, “Broadband Internet is the key element for ICT industry to go a step further”. CSO3 warns that the current bandwidth and cost of Internet is a major issue and that Mauritius is lagging far behind developed countries, which it cannot afford to do, being in a competitive global environment.

All three organisations perceive the Internet as having a crucial role in the socio-economic development of the country but also voice out concerns about the barriers preventing the Internet from fulfilling its role. Whilst CSO1 identifies the lack of investment as a major barrier to the advancement of the Internet, CSO2 and CSO3 pinpoint the monopoly with regard to the infrastructure and the high connectivity cost as major hurdles impeding democratisation and competition in Internet services. However, all representatives agree that there are currently significant actions being taken by the government to level the playing field, allowing competitors to get into the market, which will hopefully bring about a decrease in the connectivity price in the future.

Furthermore, there is common agreement that more needs to be done with regard to the use of Internet in the socio-economic development of the island. CSO3 argues that “we cannot dissociate the economic and the social” and believes that the ICT industry has a major role in making people use the Internet by leading through example; meaning that “if the industry is not using IT and not showing people how to use the technology, then they won’t use it ... but if the industry uses IT, then people will certainly see it and use it”. Alongside this argument, CSO2 argues that there is “no Internet culture” in Mauritius and it is essential that the development of the Internet, from an infrastructure perspective, be accompanied by an Internet culture.

With regard to their organisation's role in the development of the Internet in Mauritius, only the Internet Society—Mauritius chapter acknowledges their active role in the development of the Internet at the community level. The OTAM and the MITIA favour a higher level of engagement by partnering and 'pushing' the government to come up with legislations and policies with regard to issues relating to Internet development in Mauritius. For example, CSO3 explains that as "key player in the ICT industry... our goal is to push the government to open access the cable/Internet" but also to ensure that there is value for money with regard to the quality of Internet on the island, which is, so far, lacking.

7.3.1.2. Access

From an access perspective, there is consensus on the low penetration rate of Internet among the Mauritian population, at least from the official statistics perspective. CSO2 contends that he is quite "sceptical on the methodology" used to achieve the official figures and that these figures "may not represent the true" penetration rate of Internet on the island, as the official figures accounts for "fixed connection" only. Although not in the same line of thought, CSO3 argues that access is "defined by two factors"; firstly, availability, meaning "do you get access to the Internet from where you live"; and secondly, affordability, understood as "whether an average Mauritian earner can afford the Internet". CSO3 further points out that although Mauritius is doing well from an availability perspective, there is still much improvement to be made as to the affordability and more importantly, the quality of the Internet, which needs to be increased as the country "is far behind in terms of speed of Internet". CSO1 also reiterates the issue of pricing as one of the main causes for low Internet penetration on the island, followed by the technology (speed of Internet). CSO1 argues that in the region "we are still expensive as compared to our sister island, Reunion Island".

Therefore, it is clear that in order to resolve the issue of penetration rate, CSO representatives believe that technology and pricing are two of the major hurdles that need to be overcome. However, there is a debate on the

direction and the responsibilities with regard to overcoming these barriers. CSO1, representing the end users, argues that investment in Internet development is essential but that any investment should be widespread and cascaded to the population and not focused on 'cyber-cities'. There is agreement that the investments are mainly from the private companies (ISP's) and to this end, the development of Internet on the island is largely dependent on the ISP's capacity and willingness to invest in new and faster Internet technologies. CSO2 argues that although there is an opening of the market with new competitors coming in, so far, the competition has been stagnant mainly due to infrastructural issues. CSO2 uses the example of Bharat Telecom, an Indian ISP that announced its implementation on the island with optical fibre connection to the public. "The project got delayed because the machine used to drill the cable conducts could not operate due to the island's volcanic nature, thereby delaying and increasing the cost of the installation and connection" (CSO2). The promise of faster and cheaper Internet connection was thus not met. From a business perspective, there is a need for return on investment and this is perhaps what keeps the price high. CSO3 argues, "maybe the consortium owing the cables [undersea] wants to keep the price high but with independent operators, things could have been better". There thus seems to be a deadlock with, on one side investors wanting a relatively fair return on the investment in the technology and on the other side, users expecting a top-of-the-line Internet connection at an affordable cost.

The majority of the CSO's see government's input and legislation as key to overcoming the availability and affordability barriers. CSO3 argues "it is understandable that they [investors] want to get their return on investment but we need to strike the right balance between investment and consumer price". CSO3 further believes it is the role of the regulator, i.e. the government to strike this balance. In the same line of thought, CSO2 believes that the "government should do more to facilitate investment and fast track procedures for private companies wanting to invest in the ICT sector in general". CSO1 also believes that government has a role to play but

more in setting up the legal framework that will protect and incite end users to use the Internet.

7.3.1.3. Use

Concerning Internet use, the majority of civil society representatives tend to think that information search is the most common use Mauritians make of the Internet, followed by other activities such as emails for businesses and social media for individuals. Moreover, there is common agreement that e-commerce is an activity that has not been adopted vastly by Mauritians. Explaining the reasons for such low uptake of e-commerce, all agree that the size of the market (economies of scale) explains largely the reticence of major global players to offer their products and services to the Mauritian market and the few e-commerce sites with delivery to the island are mainly international companies. In addition, CSO1 suggests that the lack of local content might be another plausible explanation for the low uptake of e-commerce. CSO2 goes further to blame the culture for the low uptake of e-commerce. CSO2 argues that Mauritians have a “family centred culture” and like to “go out” with their family for shopping, and backs the argument with the recent boom in shopping malls on the island. The culture, or rather generation gap, is also a cause brought forward by CSO1, arguing that older generation have “an apprehension” towards online payments and would rather like to “touch the products” before making a purchase as opposed to younger generations who would rather buy online.

Civil society representatives generally disagree on whether Mauritians make effective use of the Internet. For CSO1, the answer is “yes”, Mauritians make effective use of the Internet, because the “Internet has in no way caused frauds or degradation of the Mauritian society” although there have been some “few isolated cases”, which tend to comfort CSO1 that the Internet is being used effectively. For CSO2, the lack of knowledge and skill is a major impediment to the effective use of the Internet on the island. At the same time, CSO2 is highly optimistic of the future, when there will be a generalised acceptable digital skill in the Mauritian society. CSO3 contrarily argues that

“indeed effectiveness is subjective” but in order to make the maximum use of the Internet, “speed” is a major issue and today users are “frustrated” because of the speed. CSO3 reckons that once the speed issue is resolved, Mauritians should be able to use the Internet effectively.

7.3.2. Digital Inequality

The section on Digital Inequality revealed, as with other issues, the commonalities and divergence in awareness and perception within the civil society organisations. With regard to technical apparatus, there is discordance among CSO representatives on the ability of Mauritians to have access to the appropriate technical apparatus. CSO1 is categorical that there is no obstacle preventing Mauritians from accessing the Internet today, especially with the uptake of smartphones and also the quick availability of the latest technologies on the Mauritian market, which as soon as they are released in major markets, are readily available in Mauritius. CSO2 follows the same reasoning, suggesting that although coverage could be an issue, it is being solved and people can access the Internet almost anywhere on the island. CSO3 also shares the idea that there is no issue with regard to devices to access the Internet. CSO3 brings forward the argument that there is no “equipment backlog” and that all devices are available by citing the example of “Samsung phones being released at the same time as they were released in Africa and that Apple products are available on the island within days of their launch”. CSO3 further argues that there is a wide range of devices for any budget, from 100-dollar tablets and more, thereby making affordability a non-issue in Internet access.

However, when it comes to the speed and quality of the Internet, the majority of the CSO representatives argue that the speed of the Internet is a major issue. CSO1, although not explicitly detailing the issue and the responsibilities acknowledges that the actual speed of Internet in Mauritius is a problem that negatively impacts on Internet use in Mauritius. CSO3 is more categorical and argues that Internet speed is a major issue on the island. Additionally, CSO3 contends that the cost of the connection, especially

mobile broadband, is too high, which is also a major impediment in the use of Internet among the population.

When queried on the freedom that Mauritian Internet users have or should have, all CSO representatives commit to the free use of the Internet, but in relative degrees. For example, CSO1 is adamant on the strict and almost constitutional freedom to access any content online. CSO1 argues that ‘today Internet is a human right and filtering the Internet [would amount to] filtering [one’s basic] human right’. CSO1 further argues that his organisation is constantly on the watch and “fighting any kind of filtering to Mauritius or from Mauritius”. CSO1 also adds that it is important to have a certain degree of control from parents on their child’s Internet use and such control is to be exercised with due diligence and care. More importantly, however, is that parents are aware of the dangers of the Internet and how best to protect their child against these. CSO2 advocates a more responsible and moderate view of online freedom, thereby suggesting that it is the responsibility of each and every individual to ensure that the freedom to access any material online is done within moral and legal frameworks and this, he argues, can only be achieved through education and sensitisation. CSO3 echoes the same argument in favour of a responsible use of the Internet, although he advocates freedom of use in the form of “open access to the Internet”. CSO3 further agrees with the other two civil society organisations on the role of parents in ensuring that the right security mechanisms are put in place to protect their wards. Such mechanisms could include “readily available and rather cheap” parental control software, which is being promoted locally by the NCB, affirms CSO3. All of the CSO representatives agree that there is a collective responsibility when it comes to freedom of use and that it is not just a matter of being able to access any content but it has to be in a responsible way.

The stakeholders from civil society organisations see the issue of social support as being of generational causes. Indeed, CSO1 suggests that when it comes to the Internet and technology at large, the Mauritian population is “divided into two groups” characterised by their attitude towards technology

and the Internet. The first group, argues CSO1, is made up mainly of older generations having a negative perception of technology and think of themselves as “being too old to use the Internet” or any other technology. In contrast, the second and much younger group consists of early adopters of the technology and users of this category are eager to “consume” the Internet. It is this attitude, according to CSO1, that increases the older generation’s propensity to discard the Internet and even if they make an effort to use the technology, they are limited in what they can achieve. On a different note, CSO3 argues that a lot has been done by the government through the IC3 training to empower people to use the Internet. It is up to the citizens to take a step forward to benefit from the services.

With regard to the motivation to use the Internet, local content is one of the issues discussed by CSO1. He argues that local content or the lack thereof is a major impediment to Internet use on the island. CSO1 advocates the development of more local content, which he argues, will attract both the young generation and the older generation, since the users would be easily identified with the contents. CSO3 suggests that the “biggest motivation” would be for government and companies to bring their services online to a much larger scale than is being currently done. These thoughts are in contrast with CSO2, who argues that people do not need motivation to use the Internet but rather should be sensitised on the capabilities of the Internet and technology at large and uptake will follow automatically.

Skill is another dimension of Digital Inequality discussed with the interviewees. There is agreement that there is a discrepancy in the level of skill within the Mauritian population and more specifically with regard to age group. All of the CSO representatives affirm the relatively higher Internet skill of the young generation compared to the older ones. Indeed, CSO2 argues that those who are under 18 years old today have no issue when it comes to skill in their Internet use. As for older generations, there is something “lacking” but it is up to the individual to make the effort to acquire the skill needed to use the Internet. CSO3, nonetheless, argues that it is a dynamic issue and that with the opening of the Internet and more and more

businesses and people using the Internet, skill will automatically grow. This view is shared among the other CSO representatives as well and all believe that it is just a matter of time and that with the coming generation, digital skill will increase among the Mauritian population.

However, when queried on their organisation's responsibility with regard to the development of digital skill on the island, there seems to be divergence, and although all confirmed that they do have a role, none of the CSO's ventured into claiming any responsibility per se in the development of digital skills on the island. CSO1 argues that "we have a role, we don't have a responsibility" and "we try to do so [train] in every project we undertake" in an indirect way, "For example, when empowering end users to set up a website for the community and giving them the required tool and training to do so". CSO2, with a different approach, argues that everyone is responsible for training and although the primary onus is on the end user to seek knowledge, companies, CSO's and the government should all position themselves as facilitators in the end users' endeavour to gain digital skill; from government guaranteed computer loans to sensitisation campaigns by CSO's, each has a specific role in the advancement of digital skills on the island. Along this line of thought, CSO3 argues that its members are "already providing [digital] skill development to their employees" but pinpoints the education system as the main trigger or keystone to the development of digital skill on the island. Indeed, the "biggest constraint is the education system" claims CSO3, and a complete overhaul of the education system is needed "with higher Internet use in education", which de facto "increases the [academic] success rate" ... CSO3 further argues that Mauritius is lagging behind and that, for example, "South Africa is ahead of us in terms of ICT use in education".

The fifth dimension of Digital Inequality is purpose of use and all agree that there is indeed differentiated use depending on age group and occupation. As such, all agree that social media is the top use within the younger generation, and communication amongst the professional. However, CSO2 argues that information search would be ranked first for Internet use among the middle class. CSO2 and CSO3 add that there are e-commerce

transactions being carried out online but most of these transactions are in foreign e-commerce sites. Additionally, CSO3 highlights the lack of local contents and hypothesises that “usage is directly proportional to [local] content”, and therefore use will only increase with the creation of local content online.

7.3.3. Overall Civil Society Perspective

Analysis of the three interviews of CSO representatives revealed that although there is no single position on the actions and remedies to the Digital Divide and Digital Inequality issues, there exists among these stakeholders a common underlying ideology of what the Internet is and what it should bring. From a Digital Divide perspective, all agree on the importance of the Internet and giving access to the population is of vital importance, if not a basic human right (CSO1). The Internet plays a crucial role in the socio-economic development of the island with the ICT industry and almost all other industries rely heavily on the Internet for their daily businesses. However, access among the population is still poor and although much effort is being made to increase availability, both affordability and quality of service are today the two biggest hurdles to the mass adoption of the Internet.

As for Digital Inequality, the phenomenon is completely unheard of for most of the CSO’s interviewed. However, with regard to the sub issues of the Digital Inequality and depending on their standpoint, there seems to be agreement on some issues and disagreement on others. One such area where there is agreement concerns technical apparatus, where the CSO community believes that today, with the abundance and wide range of devices, access to an Internet device should no longer be an issue. Nonetheless, there is debate over the quality of the service offered and the relatively low bandwidth (Internet speed) that impedes effective use. Moreover, concerning freedom of use, there is agreement on the principle that the Internet should be free but that parental control is essential to protect children from any harm online. However, when it comes to social support, there seems to be disagreement, especially concerning motivation that

needs to be given to the population to use the Internet. CSO2 is categorical that people need to motivate themselves, although they can be helped in understanding the capabilities of the Internet, which contrasts deeply with the other players' perceptions in this category, who favour more local content and services to entice people to use the Internet. There is also agreement on the high level of skill of the young generation as compared to the older ones but all agree that digital skill is being developed over time. Finally, with regard to use, there is consensus that difference in use would be reflected by differences in age and occupation.

7.4. Internet Service Providers

The Mauritian Internet ecosystem comprises of several Internet Service Providers (ISP). Between those ISP's who offer their services to the general public, Mauritius Telecom Ltd. (MT) and Emtel Ltd (Emtel) are the two major ISP's on the island.

For this study, interviews with representatives of the two above-mentioned ISP's were planned but only Mauritius Telecom agreed to the requests. Numerous attempts were made to interview a top executive from Emtel, all of which were unfruitful. Having both ISP's perspectives on the issues surrounding Digital Divide and Digital Inequality would certainly have offered a more global picture of these phenomena on the island. However, having Mauritius Telecom only is still of high value for this research, mainly because it is the only ISP that offers both fixed and mobile Internet subscription and, besides, is by far the biggest ISP on the island in terms of market share.

Established in 1992, Mauritius Telecom is today "the leading telecommunication operator and service provider in Mauritius" and owned at 33.5% by the Mauritian government⁵ (Mauritius Telecom 2015). Having had the first move advantage in the telecommunication sector on the island, MT

⁵ Mauritius Telecom Shareholding structure: 40% Orange, 33.5% Mauritian government, 19% BM Investments Funds, 6.55% National Pension Fund and 1% by employees of Mauritius Telecom.

established itself as the lead in the development of telecom and later with the advent of the Internet, naturally positioned itself as the sole provider of fixed Internet connection in the island. MT lauds itself as a company that is continually investing in new technologies and more recently moving from “narrowband to Broadband Internet connection” by connecting the island to major global network through sub-marine fibre optic-cable (Mauritius Telecom 2015). As the leading ISP on the island, ISP1 argues that MT has played and is playing a crucial role in the development of the Internet on the island and therefore is conceivably a major Internet stakeholder in the Mauritian Internet ecosystem.

7.4.1. Digital Divide

7.4.1.1. Access

Bridging the Digital Divide has been at the heart of MT’s strategy ever since it started provisioning the island with Internet connection, argues ISP1. Indeed, ISP1 claims that MT’s strategy has always been to “provide access to everyone”. MT believes that everyone “needs to have access to the Internet anytime and anywhere”. For example, the ISP was the first to launch the concept of “...cybercafé [on the island] ... which was not only for tourists who were already familiar with the Internet but also as a means for us to make our people discover the Internet and it worked very well” (ISP1). Over the years, as Internet penetrated the society, bringing with it a decline in the use of such facilities, MT still having at heart its strategy of “access to everybody, shifted to other concepts” such as the Internet social package which consists of offering basic Internet access at a cheap price (Rs. 200).

With regard to the development of the Internet on the island over the last 20 years, ISP1 explains that contrary to popular beliefs, the “development of Internet access is a very complex economic model”. To start with, ISP1 argues that for the operator, “it means buying the bandwidth [from carriers], which is very expensive [especially] for a country that is remotely located [like Mauritius]”. MT has invested massively in undersea fibre optic cable SAFE

and thanks to this “wise” investment, it is able to provide access to the Internet to individuals and companies, asserts ISP1. Another complexity within the bandwidth scope is the fact that companies and individuals do not have the same requirements with regard to bandwidth. In spite of this, MT has been supporting companies by providing “dedicated lines with high speed Internet connections” (ISP1).

ISP1 explains that “access to device” was the major barrier to Internet access. Initially, to use the Internet, a computer was needed, recalls ISP1 and “having a computer was a big thing in Mauritius... [and] only a selected few were able to buy computers”. With time, indeed, the prices have gone down but “quite slowly for computers” and although there are relatively “cheap laptops” on the market nowadays, “the penetration rate of fixed Broadband is [still] around 40%” (ISP1). Therefore, over the past few years, MT has come up with a strategy to remove the cost of device barrier by providing cheap accessible mobile devices (tablets) together with Wi-Fi routers on a fixed line Internet connection, where there has been “big explosion on the sales of tablets”. This leads ISP1 to conclude that “Internet access is available everywhere” although “some technical issue might mean a lesser bandwidth” in some remote location within the island but generally speaking, anyone having a fixed line can have basic Internet access. This, coupled with the expanding 3G/4G network, allows people to connect from their mobile devices (ISP1).

Within such context, ISP1 maintains that the biggest barriers to Internet access and use remains devices and people. Furthermore, ISP1 acknowledges that today there is a generalised perception that Internet is expensive, but that, he explains, is because users “are comparing prices [with] UK, France and US”. ISP1 further blames the high local Internet price of the [international] bandwidth, which is “a major cost component in the pricing of the Internet” and is naturally transferred onto the user. Today MT is making additional investment in undersea fibre-optic cables such as the LION, which ISP1 hopes will make possible a “price crackdown on the bandwidth”, thereby reducing the Internet price. Despite the high bandwidth

cost, ISP1 lauds MT as being the “only ISP in Mauritius that has been bringing its prices down, almost every year or every two years”.

Despite the unfavourable circumstances, ISP1 reiterates MT’s commitment to increasing Internet penetration on the island and one of their objectives, as outlined in its strategic plan, is “to have out of every four citizens, three citizens connecting to the Internet everyday”. This will be achieved, according to ISP1, by focusing on selling more affordable mobile devices and by establishing “daily Internet packages” to ensure access and use by Mauritians.

7.4.1.2. Use

With regard to use, ISP1 affirms that the basic purpose of the Internet is to look “for information, surfing, browsing”, followed by email, which he believes has been the “killer application” in the development of the Internet around the world and in Mauritius”. He argues, “... ‘everyone’ has an email... [which is] like an ID being used to register to many sites” like social network sites.

When it comes to effective use, it is quite subjective, depending on the occupation of the user. ISP1 explains that for example, corporates want their employees to transact, email and send information to corresponding parties and perhaps also to learn through e-learning sites, and would therefore limit access by filtering the information to ensure that the Internet is being used only for the benefit of the company. Thus, in so doing, the company is increasing the effectiveness of the Internet use of employees. On the other hand, students are expected to search for information online and perhaps also access social network sites.

7.4.2. Digital Inequality

With regard to inequality in access, ISP1 argue that MT is doing its best to ensure access to everyone. Measures have been put in place to, on one hand, promote the Internet and on the other hand, to reduce the price barrier, thereby allowing a greater number of users to access and use the Internet.

As for the freedom to access the Internet, ISP1 argues that fundamentally, “the Internet is open” and should remain so and condemns the “many countries putting bans on contents” as “it defeats the purpose”. Additionally, ISP1 believes that the fact that Mauritians have free access to online contents make them vulnerable to “bad contents” and thus believes that some measures like the Child Sexual Abuse Filtering System being used by the ICTA is a good initiative. Furthermore, ISP1 is of opinion that if “Mauritius is to pursue its development spree, we cannot block access to the Internet”.

When it comes to the social support or motivation for users to use the Internet, ISP1 argues that “for people to be motivated to use the Internet, they need to see the interest in it, they must have a gain”. He further argues that although the government had promised a lot in terms of services, such as the e-health, not much has been done. However, companies like the Mauritius Revenue Authority (MRA), in “partnership with MT and banks have made a big leap” allowing people or rather pushing people to fill their income tax returns online and paying or receiving excess payment from the MRA through Internet Banking” (ISP1). ISP1 further argues, “this is [an example of] democratisation of access to services, to mobile services and to online service and criticises the government for not putting enough effort into enticing people to use the governmental platform”. Moreover, ISP1 argues that MT, as an ISP, is also doing a lot to attract people to use the Internet by bringing new services like classified ads and the online digital coach, to cite a few examples.

As for skill, ISP1 believes the Mauritian Internet users are very skilled despite not being given full formal training. Recalling his personal experiences, ISP1 argues that “today everyone, even in the fishing village on the western coast where he lives, knows how to use the Internet”. ISP1 further suggests that all Internet “stakeholders need to join hands and come forward and explain what can be done” with the Internet.

7.4.3. Overall ISP Perspective

The position of the representative of the leading ISP on the island revealed the importance of the Digital Divide phenomenon for this category of stakeholders. Indeed, ISP1 argues that bridging the Digital Divide is at the heart of the company's strategy. Interestingly, the ISP stakeholder defends the high cost of the Internet and rather blames the pricing of devices and people's attitude as the main barriers to Internet's penetration on the island. ISP1 elaborates on the issue, justifying the high cost of Internet by the exorbitant price of international connection and how the price will automatically be seen as high when compared to other countries such as the UK, France and the US. However, regarding use, ISP1 agrees that there is differentiated use between users based on their age and occupation.

From a Digital Inequality perspective, ISP1 argues that devices are the main hurdles to accessing and using the Internet. He argues that a lot is being done at the moment by ISP's to bring down the price of devices, especially mobile devices such as tablets, to allow people to use the Internet. As for the motivation to use the Internet, ISP1 notes that people will only be motivated to use the Internet if there is a benefit for them. He criticises the government's promises of offering services without actually delivering them when other companies such as the MRA have successfully implemented programmes to entice people to use the Internet. He further suggests that as an ISP, MT has also been offering services to its customers and is constantly innovating. Concerning skill, ISP1 believes that Mauritians are highly skilled when it comes to using the Internet but that nonetheless, all stakeholders should collaborate to explain to users what can be done with the Internet.

7.5. Cross-Stakeholder Analysis

After exploring the viewpoint of the representatives within each of the three stakeholder categories identified for this research, the next logical step is to compare the outcome across stakeholder categories. This will enable a deeper understanding of the underlying forces of the Digital Divide and

Digital Inequality phenomena within Mauritian society. The cross-categorical analysis would also allow a better understanding of the relative efforts being made to bridge the Digital Divide and the stakeholders' perception of the Digital Inequality.

The following, therefore, discusses the similarities and differences among the three categories of Internet stakeholders interviewed, namely the Government, civil society organisations and Internet Service Providers.

7.5.1. Digital Divide

7.5.1.1. Role of the Internet

With regard to the role of the Internet in the socio-economic development of the country, all stakeholders agree that the Internet is at the heart of the Mauritian socio-economic development. All agree that the ICT industry, spearheaded by the BPO sector, weighs a lot (6.8%) in the country's GDP (G3). The Internet has a major role in supporting all of the other business activities on the island. As the geographical location of the island poses some constraints on businesses, the Internet legitimately positioned itself as the communication method of choice for businesses. The lack of natural resources or other natural trading resources makes the island vulnerable and forces the latter to rely much on its human capital for economic development. Again, the Internet proves to be the most appropriate medium and the backbone for the service sector.

On the social scale, there is also agreement on the role of the Internet for citizens. There is general consensus that the Internet should be classified as a "basic right" that will enhance the educational and cultural development of the island. Internet for everyone has been a major driving force for all of the stakeholders. Government actions have been focused on regulating the market, democratising access to the population and providing skill development initiatives to the citizens whereas business associations and ISP's have all discussed their commitment and efforts in promoting Internet.

However, there is disagreement as to the current situation and the road ahead. Indeed, business associations, within the CSO category, believe that the monopoly with regard to the distribution of Internet around the island has been harmful to the progress of the Internet. Moreover, the quality of service of the ISP is also pinpointed as a major source of discontent and a major hurdle in the advancement of the Internet. On one hand, CSO's perceive the Internet as being expensive and the quality of service ludicrous. On the other hand, the ISP argues that the complex Internet business model of the island, with an expensive connection cost to major undersea cables, automatically results in a higher Internet cost.

7.5.1.2. Access

Access to the Internet is a highly debated topic. Whereas the vast majority of the stakeholders agree that there is a low level of penetration of the Internet on the island, the underlying justification for such state of affairs is cause for controversy. Government representatives, on one side, point to the lack of investment on the infrastructure, the quality of services and the pricing as being the main culprits and argues that ISP's have a bigger role to play in this respect. Government officials also concede that, unfortunately, the size of the market (economy of scale) and the lack of an Internet culture are also to be blamed. However, most of the government official interviewed ascertain that much is being done to reduce the gap, depending on the parameters taken to measure the Digital Divide. The country is somehow faring well on some parameters such as coverage and it is hoping for a significant uptake of Internet in the coming years. For CSO's, the quality of Internet and its affordability are the main causes for such low penetration, especially with investment in the infrastructure coming predominantly from ISP's. They also acknowledge the lack of effort from the government with regard to the online services that could be offered to the population. Conversely, ISP1 vehemently defends its position as having the interest of the population at heart by doing its best to provide access to everyone. ISP1, for example, argues that the specific and complex economic model of the Internet for an

isolated island such as Mauritius is the primary cause of the high cost of the Internet, but reassures that ISP's have been reducing their prices and increased the quality of the Internet year after year.

7.5.2. Digital Inequality

The analysis of the different perspectives on the Digital Inequality dimensions unveiled somehow mixed feelings from the stakeholders. The following outlines the differences or similarities with regard to the five dimensions of Inequality.

7.5.2.1. Inequality in Technical Apparatus

Inequality in technical apparatus focused on the devices used and the quality of the Internet. Analysis of the various perspectives on the issue revealed not only differences within the categories but also across categories. As noted, there is disagreement among the governmental representatives with regard to the differences in technical apparatus. It is argued that access to devices is not an issue anymore due to the market being flooded with latest devices. Nevertheless, some dispute that availability is not equal to affordability and that currently, many users cannot afford the right device, let alone a device to enjoy the Internet, although such devices are available on the local market. Likewise, the argument of availability is shared among the other two stakeholder categories, suggesting that there is an overall perception that devices are readily available to the Mauritian population, although a minority argue that these may not necessarily be affordable.

As for the quality and cost of Internet, although there is an unstated agreement on the poor quality of the Internet, CSO's are more passionate on the issue, accusing the poor quality and high cost as being the main reasons for warding off potential users. More importantly, business associations argue that the poor quality of the Internet does not allow for a decent user experience. However, from an ISP perspective, ISP1 argues that the

maximum is being done by his company to improve the quality of the connection, while at the same time reducing the cost.

7.5.2.2. Inequality in Autonomy of Use

There is an overall agreement on the need for the Internet to be “free”. Stakeholders are adamant that Mauritian users should be free to access any material they wish, as long as it is within the legal and moral code of the country. The Child Sexual Abuse Protection filter is welcomed by those aware of such mechanism and most of the stakeholders insist on the need to monitor and protect young Internet users.

7.5.2.3. Inequality in Skill

Skill is yet another dimension where there is disagreement, not only within categories but also across categories. For instance, there is divergence among governmental representatives on the issue, with some perceiving skill as a non-issue, in light of the tremendous effort being made to empower citizens with digital skills. However, there are those who believe that training does not necessarily bring about effective use and that in spite of having the basic Internet skill, further skill is needed to make full use of the Internet. This inequality in skill is further echoed by the business associations’ stakeholders, who agree that there is a discrepancy in Internet skill on the island, especially with regard to age groups, with younger generation being more digitally skilled than older ones. On the other extreme, the ISP stakeholder believes that Internet skill is high on the island and people from different background have no problem in using the Internet.

7.5.2.4. Inequality in Social Support

Social support is yet another dimension on which there is disagreement, both within and across the different stakeholders. Within the government category, there are some who believe that the government cannot do it all and there is a limit to what it can do to encourage the use of Internet on the island.

However, there is another stream who believe that it is important to provide incentives to encourage people to use the Internet, be it in the form of direct or indirect incentives, and that more can be done. Additionally, CSO's view the issue as being mainly a generational issue, with the older generations, needing more support than the younger ones. This category of stakeholders also advocates for more local content and online services to increase Internet use. For the ISP's, the belief is that people need to see the interest in order to use the Internet and everyone must act. So overall, although there is some disagreement on the issue, it can be argued that the majority of stakeholders believe that there is a need to encourage Mauritians to use the Internet and this will inevitably be through providing content (mainly local) and services that are of interest to them.

7.5.2.5. Inequality in Purpose of Use

There is general agreement that there is differentiated use among the users. For some, it is a generational issue, with the young using the Internet mainly for social networking, whereas the older users would be more inclined towards using it for information search. For others, the difference is mainly linked to the occupation of the user; for example, those working are more geared towards communication through email and information search whereas students usually use the Internet for socialising and entertainment. However, all agree that effective use is quite hard to define and whether the Internet is being used effectively largely depends on the user's lifestyle.

		Agreement	Stakeholder		
			Government	Civil Society	ISP
Digital Divide	Role of Internet	✓	Internet viewed as being crucial to the socio-economic development of the island.		
	Access	X	Pricing, culture, lack of investment	Quality and Affordability	Culture
Digital Inequality	Technical Apparatus	X	Devices readily available although some question affordability. Quality of Internet is improving	Devices readily available but the biggest impediment is the quality of Internet and cost	Promoting access to mobile devices and doing its best to reduce cost
	Autonomy of Use	✓	Freedom of use is almost seen as a constitutional right. However, there is also agreement that such use must be within legal and moral parameters. Especial consideration is given on protecting young users and the Child Sexual Abuse Protection filter is applauded.		
	Skill	X	Whereas some view Mauritian Internet users as highly skilled due to the training given, others believe that Mauritians lack Internet skill.	There is a discrepancy in the skill level of Internet users, especially from different age group.	Believes that Mauritian Internet users are highly skilled.
	Social Support	X	Two streams: one believing that it is not the role of the Government. The second that it is important to entice and encourage users.	Believes that it is a generational issue with the older needing more help but will decrease with time	Mauritians will use the Internet only if it is of interest to them; i.e. local content and services.
	Purpose of Use	both ✓ and X	Use is very contextual and effectiveness is more of an economic term. More important is the user experience.	Email for businesses and social media for users. Lack of local content.	Mainly used for information search and communication

Table 7.2: Summary of Cross-Categorical Analysis of Stakeholders

7.6. Current Situation and Implications

7.6.1. Digital Divide

Clearly, the above analysis has unveiled deeper issues with far reaching ramifications when it comes to Digital Divide and Digital Inequality. The following section engages in a brief discussion on the current situation, the ramifications and its significance with regard to the issues discussed so far.

From a Digital Divide perspective, it appears that the topic goes further than a mere dichotomy between those who have and those who do not have access to the technology. However, before discussing the underlying implications of the differences, it is important to acknowledge and reiterate the fact that fundamentally, all the stakeholders perceive the Internet as the core of the socio-economic development of the island. This agreement is of utmost importance as it demonstrates the understanding and the place of Internet in the development of the island and more importantly, it lays the foundation of a common goal for developing the Internet on the island.

The divergent perceptions and opinions of the various stakeholders, nonetheless, have a profound impact on the direction and effort being made to reduce the Digital Divide. From the analysis above, it can be noted that the government and enterprises have genuinely endeavoured to ensure availability of the technology (devices and bandwidth) on the market in an attempt to reduce the Digital Divide. It appears from the broader discussions that it is the issue of affordability that is somehow preventing a greater proportion of the population from accessing and using the Internet. All of the stakeholders acknowledge this issue but unfortunately their respective initiatives to curb the issue is not having a significant impact on increasing Internet access and use to the population.

It is also true that the cost of the Internet is still high for a connection of sub-standard quality, as reported by various stakeholders, but ISP's claim that unfortunately it is the high connection cost to international carriers that is cascaded down to users. Much hope is placed on the government to regulate

the pricing and the quality of the connection but so far, as the main regulator, it has failed to attract key players in the sector to offer quality connection at competitive prices. Thus, the majority of the investment befell on the incumbent ISP with the users bearing the overall cost of investment and maintenance of the network.

Furthermore, the lack of Internet culture is blamed by many stakeholders for the low uptake of Internet on the island. Yet, this is an issue that has not been dealt with thoroughly by any of the stakeholders, somehow dismissing it as being either a generational gap that will flatten out with time or not their focus of action. Indeed, tackling the issue of Digital Divide has been compartmentalised, with each stakeholder having a specific aim and goal with clear focus on what to achieve, which in itself is not a bad thing and allows for each to bring specific input to solving the issue. However, the problem is when there is no higher-level body to oversee and coordinate the different avenues of initiatives being carried out and it would seem that, with regard to the issue of Internet culture, no one is entrusted in creating an Internet culture as such on the island. Therefore, although most stakeholders are aware of the issues impeding Internet penetration on the island, their limited scope does not allow them to go beyond and tackle other significant underlying issues.

7.6.2. Digital Inequality

The current situation with regard to Digital Inequality is less positive. All of the stakeholders interviewed were unaware of the Digital Inequality phenomenon. It is to be noted that this research on Digital Inequality is the first of its kind on the island and so far all of the major initiatives have been targeted on bridging the Digital Divide phenomenon. The notion of differences in use among users is still farfetched when the country is struggling to give Internet access to its population. However, there is a growing population of users and one of the purposes of this research is also to understand the onset of the Digital Inequality phenomenon. Despite this lack of awareness on the issue, taking each of the five dimensions separately

resulted in some very good understanding of their opinions on the current state of affairs and the effort being made.

For instance, it is understood that much is being done with regard to the inequality in technical apparatus as discussed above. There is a drive from all stakeholders to ensure that on one hand, Internet devices become more accessible and affordable to the whole population, and on the other hand, to increase the quality and lower the cost of connection. It is clear that there is a discrepancy in the devices being used, and the quality and cost of connection. However, stakeholders are not on the same wavelength when it comes to possible and potential solution to the issue. For instance, whereby civil society organisations criticise the high profit margins made by ISP's on the Internet pricing, ISP's refute the claim, accusing high international costs as the cause for the Internet price. The government, as regulator, sandwiched in between these two forces and is trying hard to strike the right balance. This situation is perhaps causing more harm to the end users who find themselves trapped in a system whereby one main ISP is 'dictating' the quality of the connection and the price. Unless and until there is a proper democratisation of Internet access, users will continue to bear the cost. It is thus important for policy makers and regulators to ensure that there is a fair standard of Internet connection at a decent price.

With regard to autonomy of use, there is a strong commitment from all stakeholders to ensure that Mauritians are free to access contents online as long as it is done with due diligence. This agreement is far reaching in the sense that it creates a climate of trust among stakeholders and potential investors and also the willingness to preserve the free and open nature of the Internet. This freedom is guaranteed as long as it is not in contradiction with existing laws and policies. Government, regulators and ISP's all agree that the Internet should be free but most importantly respect and guarantee the safety of the citizens and users. As such, the government has come up with the Child Sexual Abuse Filtering programme in an attempt to protect users from such material. It is also agreed that private companies and organisations are free to have their own rules with regard to ICT use and

such rules may include blocking or filtering of online content deemed inappropriate by the companies. Also most stakeholders believe that parental control is very important and should be encouraged.

Inequality in skill is another dimension where there is significant disagreement between stakeholders. Amongst all the stakeholders interviewed, the government is perhaps the only stakeholder directly involved in offering Internet training to the Mauritians. There is a shared perception between stakeholders within the government and civil society organisations that there is a discrepancy in the skill level among Mauritian Internet users, especially with regard to age group. Conversely, some within the government and the ISP's believe that, in light of all the training available, Mauritians have the necessary 'high' skill level to get the maximum out of the Internet. Despite such disagreement, it is clear that only the government is undertaking initiatives to train Internet users.

As for social support, there is a generalised perception that help required to use the Internet is generational, with the younger generation needing less help in their use of the Internet than the older generation. However, there is a discrepancy in opinion with regard to the motivation given to citizens to use the Internet. While some believe that much is being done to encourage Mauritians to use the Internet, there are some stakeholders who believe that citizens need to see an interest in using the technology and it is the responsibility of all major stakeholders providing services to entice people in using the Internet. For example, many stakeholders consider lack of local content and services as a major deterrent to Internet use. The majority of stakeholders believe that currently, very few services are available locally and this is an area that requires the participation of everyone.

As for the last dimension of Digital Inequality, the different groups of stakeholders agree that there is differentiated use, mainly on the basis of occupation and age group. But, when questioned on effective use, there is disagreement with some, as discussed above, stating that use is highly contextual and so is effectiveness, whereas others believe that Mauritians

are making the most of the Internet. Such divergence in perception most probably stems from a differentiated understanding of the term.

Without any doubt, the analysis of the different stakeholders has uncovered that much has been done and is being done to bridge the Digital Divide gap. Although unaware of the phenomenon, issues pertaining to Digital Inequality are being tackled by stakeholders at different levels.

However, this study has also uncovered some underlying systemic issues that are not being addressed. Firstly, it is clear that much of the effort is in attracting users to bridge the Digital gap but very few initiatives are directed towards existing users. Secondly, the initiatives are fragmented and somehow, the effects of such initiatives lose intensity and are either not reported or are unknown. Lastly, the research uncovered a lack of common understanding among stakeholders with regard to the definition of some aspect of Internet use.

7.7. Conclusion

This chapter explored the results of the interview undertaken with three broad categories of stakeholders, namely government, civil society organisations and ISP's with regard to the Digital Divide and Digital Inequality.

An intra-categorical analysis unveiled the perceptions and opinions of the representatives of each stakeholder categories. Interestingly the analysis uncovered that on some issues, stakeholders within the same category are not always in agreement with each other. Such divergence can have deep ramifications when it comes to the initiatives to address the Digital Divide and Digital Inequality. For example, it can lead to actions being less efficient without a coordinated and strategic approach.

Moreover, a cross-categorical analysis uncovered the similarities and differences among the different categories of stakeholders. Lastly the chapter

discussed the significance and implications of the results obtained from both analyses.

The aim of this chapter was to answer the fourth and last objective of this research, which was to situate stakeholders' initiatives with regard to Digital Divide and Digital Inequality.

Chapter 8: Conclusion

8.1. Research Questions

This research delved into the nuances of Digital Divide and Digital Inequality. It builds upon two fundamental premises. Firstly, the current high level of disconnection and the disastrous failure to bridge the Digital Divide, 20 years after the commercialisation of the Internet in Mauritius. Secondly, the issue is compounded by the fact that the Internet did not, in general, bring about the so hoped social levelling effect in societies having access to the technology. Worldwide, the Digital Divide is still persistent and alarmingly pervasive (Pew Research Center 2016), and the schism between developed countries and developing ones is deepening, with Africa and Small Island Developing States (SIDS) being more severely affected. So much so, that Straumann and Graham (2016) termed this black spot in connectivity as the 'archipelago of disconnection'. Additionally, much of the literature around Digital Inequality revolve around developed countries, resulting in a dearth of research on Digital Inequality in developing countries, even less so in SIDS.

This study, therefore, set out to bridge that gap in literature by exploring the issue of Digital Inequality and the underlying forces affecting such phenomenon in a developing country and SIDS. The study focused on the case of Mauritius, a SIDS in the Indian Ocean with the high ambition of making ICT a pillar of its economy but also a country that is part of Africa and as such, benefits from the social and economic advantages offered to African countries, especially to the Southern African Developing Countries (SADC). Although the core theme of this study is Digital Inequality, it was apparent at the onset that a discussion on the latter alone would not provide the necessary insight to the understanding of the nuances of the phenomenon in such milieu. Consequently, the study used the Digital Divide concept as a foundation and a natural stepping-stone to embark on a comprehensive investigation of the Digital Inequality phenomenon.

Another, as important, approach used in this study is the multi-stakeholder perspective analysis of the issues. The Digital Divide and Digital Inequality are complex social phenomenon and not as well understood from the single user-centred view. Additionally, with little known on Digital Inequality in such context, it was important to have a holistic understanding on the issues before any further detailed investigation on the underlying mechanisms could be undertaken. Hence, this study differentiates itself through its multi-stakeholder approach, albeit its limitations, as discussed later in this chapter. Using mixed methods, the study investigated the issue from various key stakeholders of the Mauritian Internet ecosystem; Internet users through a survey; ISP's, governmental organisations and civil society organisations, through semi-structured interviews.

This thesis, thus, used these four concepts—Digital Divide, Digital Inequality, SIDS/Developing country and Multi-stakeholder perspective—as an Ariadne's thread to explore and guide the discussion. Additionally, each of the two above mentioned methods' findings were discussed separately in Chapter 6, Quantitative Discussions, and Chapter 7, Qualitative Discussion. The following sections, therefore, attempt at bringing together and synthesise the findings to provide a holistic understanding of the issues of Digital Divide and Digital Inequality in Mauritius, and provide insight into the theoretical and policy implications of the findings.

8.1.1. Digital Divide

As stated at the beginning of this thesis, Digital Divide, despite being researched and getting much attention over the last 20 years, remains a contemporary issue, with the gap between those who have access to the Internet and those who do not, being more than ever present, especially in developing countries. Table 8.1 below summarises some of the key ICT indicators and the relative differences between developed and developing countries and the overall global figures. All of the indicators illustrate the considerable gap between developed and developing countries, except perhaps for mobile-cellular subscription, where the rate of penetration is

approximately 91.8% in developing countries, as opposed to 120% in developed countries. For the remaining indicators, penetration rate in developing countries does not even cross 40%, while developed countries are above the 80% mark. Penetration rate in developing countries has not even reached half of what it is in developed countries, thereby excluding millions of individuals from the advantages and benefits of information societies.

	Penetration Rate (per 100 inhabitants)		
	Developed	Developing	World
Fixed-telephone subscriptions	39.0	9.4	14.5
Mobile-cellular telephone subscriptions	120.6	91.8	96.8
Active mobile-broadband subscriptions	86.7	39.1	47.2
Fixed broadband subscriptions	29.0	7.1	10.8
Households with a computer	80.8	32.9	45.4
Households with Internet at Home	81.3	34.1	46.4
Individuals using the Internet	82.2	35.3	43.4

Table 8.1: Summary of 2015 ICT Statistics (Source: ITU 2015a)

A regional analysis of those indicators suggests that the African region has the lowest penetration rate of technology (ITU 2015a). Straumann and Graham (2016) provide a more detailed view of this gap and argue that small islands and Sub-Saharan countries have less than 10% penetration rate, with some highly populated countries like Ethiopia, Democratic Republic of Congo and Tanzania having a penetration rate not exceeding 2.6%. Bornman (2015, 268) argues that the main reason Sub-Saharan African regions are among the “least computerised” areas in the world is the lack of “network infrastructure and basic electricity infrastructure”, compounded by extreme poverty.

Although this study did not set out to undertake empirical investigation on the underlying causes of Digital Divide in Mauritius, it uncovered some interesting findings, both from a theoretical and policy perspectives. The study reiterated the existence and persistence of the Digital Divide in Mauritius and the severity of the issue in developing countries. A contextual and historical analysis of data over the last five years revealed that the

situation in Mauritius is, unfortunately, aligned with the general view of the persistence of Digital Divide in developing countries, as discussed above. The rate of Internet uptake is disturbingly low, with just 40% penetration rate, which is, however, in stark contrast with the uptake of mobile phones that exceeds the 100% penetration rate (using the number of registration as base).

Despite being relatively advanced from an infrastructure perspective, with the island being linked to mainland Africa and Europe through submarine optical fibre cables and additionally being ranked first among African countries and 73rd worldwide with regard to the IDI (ITU 2015b), the island still suffers from the lack of Internet penetration among the population. The study unveiled a couple of potential explanations for such low Internet uptake.

Firstly, the cost of connection seems to be a major deterrent to Internet connectivity, although this statement is highly subjective. From the standpoint of users and CSO's, the cost of connection is considered high, but ISP's tend to justify the price by a high cost of connection to international networks. Unfortunately, both sides have valid arguments. Broadband connection in developing countries remains excessively expensive, accounting for almost 32.2% of the average monthly income, compared to a mere 1.5% in developed countries (Broadband Commission 2014). Although to a lesser extent in Mauritius (circa 2% of the country's GNI), affordability remains a major obstacle in increasing the rate of Internet uptake on the island. This research uncovered the dissension among representatives of the Mauritian government on the issue; on one hand, those arguing that the Internet is still perceived as being expensive and on the other hand, those arguing that there has been a consistent decrease in the price of the Internet over the years, thanks to a liberalisation of the ICT sector. Although there has been a drive by the government to deregulate the ICT industry, thereby encouraging competition among ISP's with an aim to reduce the price, such effect is still awaited. Whinston and Choi (2004), discussing the state of Internet in Latin America, argue that deregulation is perhaps not always the right approach to increasing affordability of such service. ITU's Broadband Commission adds

that when it comes to service providers, “duopolies can realise some falls in prices, but that markets with at least three licensed operators experience the greatest falls in prices” (Broadband Commission 2014, 39).

In the case of Mauritius, with the deregulation of the ICT sector, the notion of strict monopoly does not apply per se. There is a couple of ISP’s operating on the island but they are unable to compete on a price basis due to a subtler or what can be termed as a ‘hidden’ monopoly, whereby the infrastructure of connecting to International bandwidth still belongs to the incumbent operator. So, any operator wishing to have access to International bandwidth would have to go through the incumbent operator, which controls access to international connections and in so doing, impacts on the cost of connection.

Added to the local cost of connection, it is also true, from an operator’s perspective, that the cost of connecting to international networks remains high, especially for isolated islands like Mauritius (Oolun, Ramgolam, and Dorasami 2012). Inevitably, such high cost is passed on to the user. Another issue uncovered relating to price is with regard to the absolute and relative cost of Internet connection. In absolute terms, the cost of connection has not undergone drastic decreases but has in relative terms, with ISP’s increasing the bandwidth for the same price. This ‘artificial’ reduction in rates does not favour an uptake of the Internet since potential users cannot afford the absolute price of the service in the first place. Fuentes-Bautista (2001), drawing on lessons from six Latin American countries, argues that it is important for governments to keep monitoring the sector and change policy as and when needed to ensure universal service to the population. In Mauritius, the issue is made more complex with the government being a major shareholder of the incumbent ISP.

Secondly, a direct consequence of the pricing strategies of access to the Internet is the impact on the connectivity and reliability of the connection. Over and above the cost issue, the study unveiled the overwhelmingly unsatisfied user with regard to the reliability of the connection. The bandwidth and reliability of the connection turned out to be major limitations in Internet use. In particular, the quality and reliability of the connection are perceived as

major impediments in getting the most out of the Internet. The study further unearthed the underlying incongruity between users and ISP's— users seeing the quality of Internet connection as being poor while ISP's justifying the cost issue as being out of their control due to high international connection costs.

Thirdly, there seems to be agreement among non-user stakeholders (ISP's, government and civil society organisations) that there is a lack of 'Internet Culture'. They explained this by the fact that the Internet is not yet fully integrated into the daily lives of Mauritians, as compared to other technologies, such as mobile phones. Several factors are contributing to such situation, especially with regard to local e-commerce, since the relative proximity of businesses and the cordiality of meeting others while shopping are among the reasons put forward by a government representative to explain the lack of Internet culture. Chen and Wellman (2005, 6) argue that "the adoption of the Internet is contingent on the affordability, simplicity, user-friendliness, and relevance of the Internet in everyday lives". In the case of such a small island, affordability and relevance seem to be an issue for some category of users.

The above three findings revealed some fundamental policy issues with regard to Digital Divide on the island. The UN Broadband Commission (Broadband Commission 2013) stresses the importance of having national policy leadership, especially with regard to universal access to Broadband. Although the Mauritian government has come up with national strategies since 2007 with regard to ICT, Broadband, and more recently the National Cyber Security Strategy, the results are still being awaited and the underlying issue of Digital Divide still prevails. Criticisms of such policies have been the over-optimistic vision of the government in the milestones (MICT 2012) in regard to the uptake of Internet on the island. It is, therefore, important that major governmental and non-governmental stakeholders rethink the national strategies and policies with regard to technology dissemination and also as importantly, policies and best practices to ensure that the Internet enters the mores of the Mauritian Society.

From a theoretical perspective, it is clear that the Digital Divide is still persistent on the island. The island is much aligned with other developing countries when it comes to the challenges in bridging the Digital Divide. However, Mauritius distinguishes itself from other developing countries due to its ambition and consistency in adopting active socio-politico-economic policies to ensure sustainable development. This consistency led the country to move from a highly dependent mono-crop agricultural economy to one that has opened up to the services sector and is aspiring to become a Cyber-Island. The country can boast itself to be among the most advanced countries in Africa with regard to technology infrastructure and uptake. It is also true that the theoretical underpinnings of the Digital Divide are being questioned, and the need to use other metrics is becoming increasingly pressing.

8.1.2. Digital Inequality

From a Digital Inequality perspective, the study unveiled some of the complexities and the challenges of studying the phenomenon, both from theoretical and practical/policy viewpoints. From a theoretical standpoint, the amorphous nature of the phenomenon is a major hindrance to having a universal, standardised and comparable approach. The term Digital Inequality has been used loosely to explain almost any difference that did not fall within the Digital Divide spectrum. This study explored some of the different definitions and models of Digital Inequality before concluding that DiMaggio and Hargittai's model is, thus far, the most comprehensive and coherent model suitable to investigate Digital Inequality.

Secondly, added to the already chaotic environment within the Digital Inequality definition, the study reaffirmed Ono and Zavodny's (2005) notion of non-universality of the underlying forces of Digital Inequality. The study showed that although the same model could be used to investigate Digital Inequality in different contexts, the underlying forces are highly contextual and country specific. Again, using the case of Mauritius, empirical findings underscored the existence of Digital Inequality on the island but highlighted

some fundamental differences in the underlying determinants, as compared to the United States and some Asian countries.

Thirdly, although the model proposed by DiMaggio and Hargittai offered a sound basis to investigate Digital Inequality, the study revealed that some of the dimensions are also contextual. The results showed that an alternative model, with dimensions of inequalities more centred on online participation, activism and sociality, is more pertinent to the Mauritian context, although the five dimensions proposed by DiMaggio and Hargittai are still valid. As the Internet evolves, it is important to revisit some of the fundamental models explaining Internet access and use. More importantly, despite the world being recognised more as a global village, the diversity of the societies making up this 'village' warrants that such models and frameworks be revisited in terms of their relevance to a particular context.

From a policy/practical perspective, the study unearthed some insight into the Digital Inequality realm. Although country-specific, some fundamental lessons can be drawn from other developing countries or SIDS sharing some similar contextual or geographical characteristics. Firstly, regarding the technical apparatus dimension of Digital Inequality, the study showed that there is a high rate of device ownership among Internet users. Although there is an increasing rate of mobile Internet subscription, the study showed that these are mainly for secondary access since the primary connection mode is still through a computer with ADSL connection, which, by extrapolation suggests that the typical Mauritian Internet users are multi-device users. Additionally, the place of residence did not have any bearing on access to the Internet, with rural and urban citizens enjoying the same facilities, but the reliability of the connection nationwide was perceived as a major impediment to Internet use. Although the relatively small size of the island facilitates deployment of the technology easily over the whole island, the issue of reliability of the connection persists. The study thus highlighted that the focus of any policy should be primarily on the affordability of devices and the quality of the connection. Almost all stakeholders concur that these two issues are significant impediments, but unfortunately some major obstacles

such as the relative isolation of the island and the economy of scale persist and inflate the cost. As discussed earlier, the universality of access is central to bridging the Digital Divide, but policy makers should be careful that while ensuring universality of access, the quality of the connection is as important and should not be overlooked.

Secondly, from an autonomy of use perspective, the study reaffirmed the notion of freedom of use and freedom to use the Internet, but at the same time unveiled the importance of security and privacy concepts. Empirical findings showed that overall, Mauritians are free to use and to access any content they like. There is no governmental censorship, except for Child Sexual Abuse Content Filtering, which prevents Mauritian Internet users from accessing child pornography material. Mauritian Internet stakeholders view such freedom to use the Internet almost as a constitutional right and endeavour to ensure that such rights are protected. From a Digital Inequality perspective, such stance is highly conducive to the exploration and use of the Internet. The study also showed that young users are more prone to having their use monitored either by parents or schools. Although there is no formal policy on freedom, all stakeholders agree that such freedom should be enjoyed within specific legal and moral parameters, especially in socially fragile contexts like Mauritius.

Thirdly, inequality in skill is perhaps the most researched aspect of Digital Inequality. The study revealed that, generally speaking, Mauritian users are quite familiar with Internet-related terms, which by proxy suggests that they have a fair knowledge of and skill in using the Internet. However, different stakeholders have different views on the matter. While all agree that users have the required skills for their current Internet use, some argued that in some areas, especially concerning content creation, Mauritians lack certain skills. The government has embarked on a strategy to provide basic Internet training to the masses, but there are some reservations as to the efficiency of such training, especially if those trained do not use the Internet afterwards. The study also uncovered that while Mauritian users may be aware of a range of Internet-related terms, security and privacy terms are less familiar.

Security and privacy are critical dimensions of Internet use and as users increase their immersion into the Internet realm and make the Internet part of their everyday lives, the notions of security and privacy will become even more important. In 2015, the government launched a National Cyber Security Strategy (MTCI 2015b) to provide the necessary legal framework with regard to security issues. There is already an array of legal tools, although limited, to combat computer and Internet misuse. However, it is important that users, one, be aware of the potential security and privacy pitfalls of the Internet, and two, be aware of the vast possibilities to protect themselves. It is also important that there is an awareness campaign by major Internet stakeholders to ensure users are aware of the dangers of Internet use.

Fourth, with regard to the inequality in social support, the study revealed that for the majority of Mauritian Internet users, education has been the leading contributing factor for them to start using the Internet. The study also showed that the Internet users rarely make use of formal support in their daily use of the Internet but rather rely on their close relations to help them. However, the young generation, especially students, find that the lack of support impedes their use of Internet. It could be argued that the exploratory nature of young users pushes them to go beyond the everyday use of the Internet and naturally, to go beyond this boundary requires some additional skills which they may not find from the traditional support systems. Although there is an increased use of online help forums within this group, lack of support remains a key barrier to their Internet use. From a policy perspective, it is, therefore, important to understand and take on board such limitations. As the Internet permeates the daily lives of the young generations, they will look for other higher skills, and it is important to have the necessary structures to help and support this category of users in their quest to bring their Internet use to another level. The government is placing much hope on the young people, through their Internet use, to drive new cultures of Internet. Policy makers should, thus, endeavour in creating the right environment conducive to helping these young generations in exploring Internet use. Stakeholders highly debate the notion of providing services to encourage Internet use,

each believing that it is beyond their role to provide the necessary encouragement for Mauritians to use the Internet. The government representatives, in general, argue that other than offering e-government services, providing other support or content are beyond their role, although there is a school of thought within the government that believes it is the duty of the latter to encourage and entice Mauritians to use the Internet.

Fifth, with regard to the Inequality of use, the study revealed that some online activities are favoured more than others. For instance, the study showed that Mauritian Internet users are rather consumers of information than producers—search, communication and social media use being the most preferred activities and online activism and content creation being at the lowest end. Other stakeholders tend to concur with this observation while at the same time arguing that the lack of local content might be an impediment to a varied use of the Internet. Also, it is argued by some stakeholders that the relatively small size of the island makes e-commerce inefficient and users would rather purchase from international sellers but, unfortunately, either the vast majority of online stores do not ship to Mauritius or there are high shipping costs to deliver to the island. Economies of scale are yet additional factors that could potentially prevent Mauritian Internet users or businesses from producing local content. With such a low rate of Internet penetration, any investment in local content is not readily absorbed. While some major companies can afford to have an online presence and offer e-commerce services, small businesses would be out of the race because of the relatively high investment cost. It is up to policymakers to provide incentives and encourage producers of local content.

With regard to Digital Inequality, the study explored the models and uncovered some of the determinants of Digital Inequality in Mauritius. Although it appears that there is a gender divide when it comes to accessing the Internet, the study revealed that such divide disappears once access is given—sex was not a significant factor in any of the inequalities and although the data suggests some inequalities when it comes to skill, there are counter arguments that women tend to rate themselves lower in such studies and

should, therefore, be taken lightly or investigated further. It appears that education is the highest contributing factor to Digital Inequality on the island, although age could be perceived as a natural determinant when it comes to technology use. Occupation is yet another determinant of inequality on the island, and although a vast proportion of users are students, the study revealed that there are some significant differences in their use of the Internet as compared to other groups.

The study also revealed that there is no common understanding, and sometimes a complete unawareness of the issue of Digital Inequality among stakeholders. Although all stakeholders fully understand the issue of Digital Divide, and have the issue at heart and in their respective agenda, Digital Inequality among Internet users is still widely unknown and unaccounted. With the Digital Divide and Digital Inequality being intrinsically related to another, it is imperative, from policy perspective, to ensure that the race to bridge the Digital Divide does not engender Digital Inequality. The study also revealed that while each stakeholder has the issue of Digital Divide at heart, their self-interest sometimes does not allow for effective strategies to be set up. This study brought to light the pressing need to have a higher non-partisan body to oversee Internet-related matters and coordinate any drive or strategies to bridge the Digital Divide and Digital Inequality.

8.2. Research Limitations

In spite of every effort made to ensure that this research presented the most reliable and accurate picture of Digital Divide and Digital Inequality in the context of a developing country, it is important to understand the limitations of such study in order to appreciate the discussion and outcomes of such research. Throughout this research, it has appeared that the limitations would sometimes guide the latter in a particular direction and sometimes would pose some significant obstacles in investigating and understanding some concepts. These limitations were at times theoretical, methodological or analytical. The following outlines some of the limitations within each of these categories.

8.2.1. Theoretical Limitations

Right at the onset of this study, it was clear that there is a dearth of research in Digital Inequality in developing countries and even less so in Small Island Developing States. Additionally, existing research on Digital Inequality had different theoretical approaches mainly due to the amorphous nature of the phenomenon. Deciding on a particular theory or framework would by default limit the research.

The literature review chapter tried to situate the various approaches and attempted at recognising the most appropriate theoretical model for this research due to the scope of such study. Consequently, it is clear that the model used posed some limitations as to the outcome of this research. Readers should appreciate the wider theoretical spectrum of research in Digital Inequality and not exclude the fact that such research could be undertaken from a different, but not necessarily opposite theoretical model.

8.2.2. Methodological Limitations

The methodological limitations have perhaps been the most challenging part of this study. In so far as no such research had been carried out in such context and that past research used existing data, the context did not allow for such methods to be employed. For example, in the US and Korean based studies, researchers used data gathered from existing broader surveys that were representative of the Internet user population. In the case of this study, no such data existed. Added to that, the sampling for the survey turned out to be a major puzzle. Research carried out in developed countries with high rate of Internet penetration used the phone directory to get a representative sample of Internet users. In such contexts it worked since it could be assumed that if there was a high penetration rate of fixed Internet, the proportion of the names in the directory having access to the Internet would have been high. In developing countries where penetration rate is as low as 40% or less, using such method would, certainly, not yield a representative sample of users and would instead require multiple iterations and errors to get

the proper sampling. As discussed in the methodology chapter, this study had to fall back on snowballing to get Internet users involved.

Although strategies were put in place to ensure that the limitations of such methods were controlled, it is important to bear in mind that such drawbacks can pose some serious limitations on the research. However, it is also important to reiterate that no other better alternatives were available within the scope and available resources for this research. As much as there can be limitations in the methodology employed, this research turned out to provide some essential and novel analysis and perception to the issue of Digital Inequality in SIDS.

8.2.3. Analytical Limitations

The methodological limitations discussed above, in turn, posed some underlying limitations as to the analytical and overall generalisability of the research. In so far as Mauritius is concerned, triangulation of the various information scattered around in official reports tends to confirm the reliability and soundness of the findings and thus the generalisability of the findings to Mauritian Internet users.

However, the same context restricts generalisability to other Small Island Developing States. Although the findings can be extrapolated to other such nations having similar issues and challenges, the results are limited to the island of Mauritius, and a simple, direct generalisability to SIDS is not possible.

Additionally, the timing of the research and the rapid changing nature of the Internet ecosystem provided some challenges in appreciating the data. For instance, the survey captured a snapshot of the state of Digital Inequality at a particular point in time (mid 2012). However, the literature, which has been updated throughout the duration of the research, accounted for data before and, more importantly, after the survey. Thus, the data might not be reflected in the literature and vice-versa. It is therefore, important, to take into consideration such limitations when interpreting the conclusions.

8.3. Future Directions

As stated previously, the aim of this research has been to lay the groundwork for research on Digital Inequality in developing and Small Island Developing States. Robinson et al. (2015, 578) point out that “Digital Inequality research is still in its infancy, and is evolving rapidly along with the object of study”. As the Internet pervades the lives of an increasing number of people across different societies and cultures, the issue of Digital Divide will slowly be replaced by Digital Inequality. Burgeoning research on the phenomenon is picking up pace and there is a broad range of issues to be researched. In light of the findings and the limitations discussed, this research opens the door for multiple avenues of research.

Firstly, within Mauritius, this study provided a background and a holistic view of Digital Divide and Digital Inequality. Although there is a growing literature on Digital Divide, there is a dearth of literature on Internet non-use on the island and researching non-use and the underlying factors are possible avenues for further research. Additionally, the Internet ecosystem witnessed some major changes since the inception of the research. For example, this research uncovered a surge in mobile Internet subscriptions during the last years and such metamorphose opens novel areas for research. It would be interesting to understand the ramifications of such alterations and its impact on Digital Inequality. In so far as Digital Inequality is concerned, this study just unlocked the door to the phenomenon in this milieu. There are still many questions and issues that are yet to be researched and are all potential future directions. For instance, the theoretical model uncovered needs to be tested and validated. Furthermore, each dimension of inequality needs to be researched further to understand the underlying ramifications and possible solutions. These in-depth research undertakings could also be in the form of longitudinal studies to allow for time series analysis to be conducted. From a policy perspective, there are various avenues for applied research in setting up strategies and potential solution to solving the Digital Inequality issue.

Additionally, novel qualitative and quantitative methods could be employed to understand the problem in Mauritius. For instance, there could be research with new sampling methods to corroborate the findings or unveil new issues.

Secondly, with regard to Digital Inequality in Small Island Developing States and developing countries in general, this research provided some groundbreaking evidence that the phenomenon is present in a context that is still struggling with Digital Divide. Although most efforts revolved around the Digital Divide issue, there is still the underlying issue of Digital Inequality that needs to be addressed. As discussed in the limitations, the findings of this research do not allow for a generalisation to be made for such countries. Subsequently, future research directions could be in studying the phenomenon in other similar geo-socio-economic context to allow for generalisations of the model and strategies. Again, the possible avenues are numerous, from specific in-depth research to longitudinal and comparative analysis with other such countries.

Thirdly, within the broader global context of research on Digital Inequality, there are opportunities, from a theoretical perspective, to have an open discussion and a universal understanding of the issue, although the latter is rapidly evolving. This research has also underscored the dearth of tools and metrics for assessing and analysing some of the dimensions of inequality. With the development in Digital Methods Research, there are new avenues that could and should be explored in the quest to understand such phenomenon. Geo-Visualisation and Digital Ethnography are only two examples of Digital Methods that can be employed to research and understand the issue of Digital Inequality globally. Moreover, this research now allows for comparative analysis between developed and developing countries in so far as Digital Inequality is concerned. There is a gargantuan task ahead to explore the nitty-gritty issues underpinning Digital Inequality globally.

References

- Aghaei, Sareh, Mohammad Ali Nematbakhsh, and Hadi Khosravi Farsani. 2012. "Evolution of the World Wide Web : From Web 1.0 to Web 4.0." *International Journal of Web & Semantic Technology* 3 (1): 1–10. doi:10.5121/ijwest.2012.3101.
- Ajaheb-Jahangeer, Shamim, and Abdul Cayum Jahangeer. 2004. "School Culture in a Private Secondary Institution in Mauritius." *International Education Journal* 5 (2): 247–54.
- Al-Hammadany, Firas H., and Almas Heshmati. 2011. "Determinants of Internet Use in Iraq." *International Journal of Communication* 5: 1967–89.
- All in 1 Social. 2015. "Facebook Statistics for Mauritius." Accessed July 15. http://www.allin1social.com/facebook/country_stats/mauritius.
- Allen, Matthew. 2010. "The Experience of Connectivity." *Information, Communication & Society* 13 (3): 350–74. doi:10.1080/13691180903456553.
- Alvarez, Anthony Steven. 2003. "Behavioral and Environmental Correlates of Digital Inequality." *IT&Society* 1 (5): 97–140.
- Antonio, Amy, and David Tuffley. 2014. "The Gender Digital Divide in Developing Countries." *Future Internet* 6 (4): 673–87. doi:10.3390/fi6040673.
- Autar, Bhotish Awtar. 2013. "Reducing the Urban-Rural Gap And Defining Mauritius as a Metropolis." In *The 7th Conference of International Forum on Urbanisam*, edited by Feng-Tyan Lin and Jurgen Rosemann, 1–12. Tainan: College of Planning and Design, National Cheng Kung University.
- Balaban, Erdal, Cigdem Cilan, and Gamze Kaba. 2010. "Comparative Analysis of Turkey with European Union Members." *International Journal of Business Research* 10 (2).
- Barzilai-Nahon, Karine. 2006. "Gaps and Bits: Conceptualizing Measurements for Digital Divide/s." *The Information Society* 22 (5): 269–78. doi:10.1080/01972240600903953.
- Beilock, R. 2003. "An Exploratory Model of Inter-Country Internet Diffusion." *Telecommunications Policy* 27 (3–4): 237–52. doi:10.1016/S0308-5961(02)00100-3.

- Berg, Bruce. 2001. *Qualitative Research Methods for the Social Sciences*. Allyn and Bacon.
- Berners-Lee, Tim, and Mark Fischetti. 2000. *Weaving the Web: The Original Design and Ultimate Destiny of the World Wide Web*. HarperCollins, New York.
- Bornman, Elirea. 2015. "Information Society and Digital Divide in South Africa: Results of Longitudinal Surveys." *Information, Communication & Society* 4462 (July): 1–15. doi:10.1080/1369118X.2015.1065285.
- Bourdieu, Pierre. 1986. "The Forms of Capital." In *Readings in Economic Sociology*, edited by N. W. Biggart. Blackwell Publishers Ltd, Oxford, UK. doi:10.1002/9780470755679.ch15.
- Boyd, Danah. 2014. *It ' S Complicated: The Social Lives of Networked Teens*. New Haven, London: Yale Univeristy Press.
- BPML. 2015. "BPML (Business Parks of Mauritius) Photo Gallery." Accessed July 6. <http://www.e-cybercity.mu/photo-gallery/>.
- Brake, David R. 2014. "Are We All Online Content Creators Now ? Web 2 . 0 and Digital Divides." *Journal of Computer-Mediated Communication* 19 (3): 591–609. doi:10.1111/jcc4.12042.
- Briguglio, Lino. 1995. "Small Island Developing States and Their Economic Vulnerabilities." *World Development* 23 (9): 1615–32. doi:10.1016/0305-750X(95)00065-K.
- Brimacombe, Tait, and Andrew Skuse. 2013. "Gender, ICTs, and Indicators: Measuring Inequality and Change." *Gender, Technology and Development* 17 (2): 131–57. doi:10.1177/0971852413488713.
- Broadband Commission. 2011. "Broadband. A Platform for Progress." http://www.broadbandcommission.org/Documents/publications/Report_2.pdf.
- . 2012. "The State of Broadband 2012: Achieving Digital Inclusion for All." <http://www.broadbandcommission.org/Documents/publications/bb-annualreport2012.pdf>.
- . 2013. "The State of Broadband 2013: Universalizing Broadband." <http://www.broadbandcommission.org/documents/bb-annualreport2013.pdf>.
- . 2014. "The State of Broadband 2014: Broadband for All." <http://www.broadbandcommission.org/Documents/reports/bb->

annualreport2014.pdf.

- Brock, Andre, Lynette Kvasny, and Kayla Hales. 2010. "Cultural Appropriations of Technical Capital." *Information , Communication & Society* 13 (7): 1040–59. doi:10.1080/1369118X.2010.498897.
- Brooks, Brandon, Howard T. Welser, Bernie Hogan, and Scott Titsworth. 2011. "Socioeconomic Status Updates." *Information , Communication & Society* 14 (4): 529–49. doi:10.1080/1369118x.2011.562221.
- Brown, Ian. 2009. "State of the Art Report: Internet Development across the Decades." *Towards a Future Internet (TAFI) Project*. European Commission. SMART 2008/0049. <http://www.internetfutures.eu/wp-content/uploads/2009/07/soa-pt1.pdf>.
- Bruno, Giuseppe, Emilio Esposito, Andrea Genovese, and Kholekile Gwebu. 2011. "A Critical Analysis of Current Indexes for Digital Divide Measurement." *The Information Society* 27 (1): 16–28. doi:10.1080/01972243.2010.534364.
- Bryman, Alan. 2012. *Social Research Methods*. 4th ed. Oxford: Oxford University Press.
- Bucy, E. P. 1999. "Social Access to the Internet." *The Harvard International Journal of Press/Politics* 5 (1): 50–61. doi:10.1177/1081180X00005001005.
- Bunwaree, Sheila. 2001. "The Marginal in the Miracle: Human Capital in Mauritius." *International Journal of Educational Development* 21 (3): 257–71. doi:10.1016/S0738-0593(00)00033-X.
- Bunwaree, Sheila, and Roukaya Kasenally. 2005. "Political Parties and Democracy in Mauritius." *EISA Research Report*. EISA, Johannesburg. <https://www.eisa.org.za/pdf/rr19.pdf>.
- Cacciatore, M. a., a. a. Anderson, D.-H. Choi, D. Brossard, D. a. Scheufele, X. Liang, P. J. Ladwig, M. Xenos, and A. Dudo. 2012. "Coverage of Emerging Technologies: A Comparison Between Print and Online Media." *New Media & Society* 14 (6): 1039–59. doi:10.1177/1461444812439061.
- Castells, Manuel. 2010. *The Rise of the Network Society*. 2nd Ed. Wiley-Blackwell, United Kingdom. doi:10.1002/9781444319514.
- Central Intelligence Agency. 2016. "The World Factbook." <https://www.cia.gov/library/publications/the-world-factbook/geos/mp.html#People>.

- Cerf, V. G. 2004a. "On the Evolution of Internet Technologies." *Proceedings of the IEEE* 92 (9): 1360–70. doi:10.1109/JPROC.2004.832974.
- . 2004b. "On the Evolution of Internet Technologies." *Proceedings of the IEEE* 92 (9): 1360–70. doi:10.1109/JPROC.2004.832974.
- Chakraborty, J, and M. Martin Bosman. 2002. "Race, Income, and Home PC Ownership: A Regional Analysis of the Digital Divide." *Race and Society* 5 (2): 163–77. doi:10.1016/j.racsoc.2004.01.003.
- Chan-Meetoo, Christina. 2007. "ICT, Society and Poverty: The Vision of Mauritius as a Cyber Island from a Development Perspective." In *Poverty in Mauritius: An Agenda for Reflection and Action--Articulating the Local with the Regional* Conference, Rajiv Gandhi Science Centre, Port Louis, 1–2.
<http://christinameetoo.files.wordpress.com/2007/10/ictsocietypoverty-cchan-meetoo-final.pdf>.
- Chen, Wenhong. 2013. "The Implications of Social Capital for the Digital Divides in America." *The Information Society* 29 (1): 13–25. doi:10.1080/01972243.2012.739265.
- Chen, Wenhong, and Barry Wellman. 2005. "Minding the Cyber-Gap: The Internet and Social Inequality." In *Blackwell Companion to Social Inequalities*, edited by Mary Romero and Eric Margolis, 523–545. Blackwell. doi:10.1002/9780470996973.ch23.
- Choi, Changkyu, and Myung Hoon Yi. 2009. "The Effect of the Internet on Economic Growth: Evidence from Cross-Country Panel Data." *Economics Letters* 105 (1). Elsevier B.V.: 39–41. doi:10.1016/j.econlet.2009.03.028.
- Cilan, Çiğdem, Bilge Bolat, and Erman Coşkun. 2009. "Analyzing Digital Divide Within and Between Member and Candidate Countries of European Union." *Government Information Quarterly* 26 (1). Elsevier Inc.: 98–105. doi:10.1016/j.giq.2007.11.002.
- Cody, Michael J., Deborah Dunn, Shari Hoppin, and Pamela Wendt. 1999. "Silver Surfers: Training and Evaluating Internet Use Among Older Adult Learners." *Communication Education* 48 (4): 269–86. doi:10.1080/03634529909379178.
- Cowell, Frank. 1998. "Measurement of Inequality." In *Handbook Of Income Distribution*, edited by A Atkinson and F Bourguignon, 1:87–166. doi:10.1016/S1574-0056(00)80005-6.
- Creswell, John W. 2009. *Research Design: Qualitative, Quantitative, and Mixed Methods Approaches*. 3rd ed. SAGE.

- . 2011. "Controversies in Mixed Methods Research." In *The Sage Handbook of Qualitative Research*, edited by Norman Denzin and Yvonna Lincoln, 4th ed., 269–84. SAGE Publications.
- Creswell, John W, and Vicki Plano Clark. 2010. *Designing and Conducting Mixed Methods Research*. 2nd ed. SAGE Publications.
- Cuervo, Maria Rosalia Vicente, and Ana Jesus Lopez Menendez. 2005. "Inequalities in the Information Society: A Statistical Approach to the Digital Divide." <http://www.uib.es/congres/ecopub/ecineq/papers/257vincente-lopez.pdf>.
- de Lanerolle, Indra. 2012. "The New Wave: Who Connects to the Internet, How They Connect and What Do They Do When They Connect." *South African Network Project*. Wits Journalism. <http://www.networksociety.co.za>.
- De Vaus, David A. 2001. *Research Design in Social Research*. SAGE Publications.
- . 2002. *Surveys In Social Research*. Fifth Edition. Allen & Unwin.
- Dillman, Don A, Robert D Tortora, and Dennis Bowker. 1998. "Principles for Constructing Web Surveys." In *Joint Meetings of the American Statistical Association*, 1–16. <http://survey.sesrc.wsu.edu/dillman/papers/1998/principlesforconstructingwebsurveys.pdf>.
- DiMaggio, Paul, and Eszter Hargittai. 2001. "From the 'Digital Divide' to 'Digital Inequality': Studying Internet Use as Penetration Increases." *Princeton: Center for Arts and Cultural Policy Studies, Woodrow Wilson School, Princeton University*. [http://www.princeton.edu/~artspol/workpap/WP15 - DiMaggio+Hargittai.pdf](http://www.princeton.edu/~artspol/workpap/WP15-DiMaggio+Hargittai.pdf).
- DiMaggio, Paul, Eszter Hargittai, Coral Celeste, and Steven Shafer. 2004. "From Unequal Access to Differentiated Use : A Literature Review and Agenda for Research on Digital Inequality." In *Social Inequality*, edited by K. Neckerman, 355–400. Russell Sage Foundation, New York.
- DiMaggio, Paul, Eszter Hargittai, W Russell Neuman, and John P Robinson. 2001. "Social Implications of the Internet." *Annual Review of Sociology* 27: 307–36.
- Dixon, Laura J., Teresa Correa, Joseph Straubhaar, Laura Covarrubias, Dean Graber, Jeremiah Spence, and Viviana Rojas. 2014. "Gendered Space: The Digital Divide between Male and Female Users in Internet Public Access Sites." *Journal of Computer-Mediated Communication* 19

(May): 991–1009. doi:10.1111/jcc4.12088.

Dutta, Soumitra, and Benat Bilbao-Osorio. 2012. *The Global Information Technology Report 2012: Living in a Hyperconnected World*. World Economic Forum and INSEAD.

http://www3.weforum.org/docs/Global_IT_Report_2012.pdf.

Dutta, Soumitra, and Irene Mia. 2011. “The Global Information Technology Report 2010–2011: Transformations 2.0.”

http://www3.weforum.org/docs/WEF_GITR_Report_2011.pdf.

Dutton, William. H. 2013. “Internet Studies: The Foundations of a Transformative Field.” *The Oxford Handbook of Internet Studies*, no. November: 1–24. doi:10.1093/oxfordhb/9780199589074.001.0001.

Dutton, William H, and Grant Blank. 2011. “Next Generation Users : The Internet in Britain.Oxford Internet Survey 2011.” Oxford Internet Institute.University of Oxford.

<http://oxis.oii.ox.ac.uk/research/publications/>.

Dutton, William H, Grant Blank, and Darja (with) Groselj. 2013. “Cultures of the Internet : The Internet in Britain: Oxford Internet. Oxford Internet Survey 2013.” Oxford Internet Institute, University of Oxford.

<http://oxis.oii.ox.ac.uk/research/publications/>.

Dutton, William H, and Ellen J Helsper. 2007. “The Internet in Britain: 2007.” Oxford Internet Institute, University of Oxford.

<http://oxis.oii.ox.ac.uk/research/publications/>.

Dutton, William H, Ellen J Helsper, and Monica M Gerber. 2009. “The Internet in Britain: 2009.” Oxford Internet Institute, University of Oxford.

<http://oxis.oii.ox.ac.uk/research/publications/>.

Emtel. 2015. “Corporate Information - EMTTEL.” Accessed June 30.

<https://www.emtel.com/corporate-information>.

Evans, Retta R., Donna O. Burnett, Olivia W. Kendrick, David M. Macrina, Scott W. Snyder, Jane P. L. Roy, and Barry C. Stephens. 2009.

“Developing Valid and Reliable Online Survey Instruments Using Commercial Software Programs.” *Journal of Consumer Health On the Internet* 13 (1): 42–52. doi:10.1080/15398280802674743.

Frankel, Jeffrey. 2010. “Mauritius: African Success Story.”

doi:doi:10.3386/w16569.

Fuchs, C. 2008. “The Role of Income Inequality in a Multivariate Cross-National Analysis of the Digital Divide.” *Social Science Computer*

Review 27 (1): 41–58. doi:10.1177/0894439308321628.

Fuentes-Bautista, Martha. 2001. "Universal Service in Times of Reform: Affordability and Accessibility of Telecommunication Services in Latin America." In *29th Research Conference on Communication, Information and Internet Policy, Alexandria, VA, USA, 27 - 29 Oct 2001*, 78712:347–82.

Gilbert, Melissa. 2010. "Theorizing Digital and Urban Inequalities." *Information, Communication & Society* 13 (7): 1000–1018. doi:10.1080/1369118X.2010.499954.

Goggin, Gerard, and McLelland. 2008. *Internationalizing Internet Studies: Beyond Anglophone Paradigms*. Edited by Gerard Goggin and McLelland. Routledge. doi:10.4324/9780203891421.

Gourova, Elissaveta, Christoph Hermann, Jos Leitjen, and Bernard Clements. 2001. "The Digital Divide - A Research Perspective: A Report to the G8 Opportunities Task Force." *Institute for Prospective Technological Studies and The European Commission Joint Research Centre*. <http://ftp.jrc.es/EURdoc/eur19913en.pdf>.

Graff, Carolyn J. 2014. "Mixed Methods Research." In *Evidence-Based Practice: An Integrative Approach to Research, Administration, and Practice*, edited by H.R Hall and L.A Rousell, 45–64. Burlington, MA: Jones & Bartlett Learning.

Grazzi, Matteo, and Sebastián Vergara. 2008. "What Drives ICT Diffusion in Developing Countries ? Evidence from Paraguay." *SSRN Research Papers*. doi:10.2139/ssrn.1801507.

Grusky, David, and Manwai Ku. 2008. "Gloom, Doom and Inequality." In *Social Stratification. Class, Race, and Gender in Sociological Perspective*, edited by David Grusky, Manwai C. Ku, and Szonja Szelényi, 3rd Editio, 3–25. Boulder, CO: Westview Press. http://inequality.stanford.edu/grusky/article_files/gloom_doom_inequality.pdf.

Gunkel, D. J. 2003. "Second Thoughts: Toward a Critique of the Digital Divide." *New Media & Society* 5 (4): 499–522. doi:10.1177/146144480354003.

Gutierrez, Luis, and Luis Gamboa. 2010. "Determinants of ICT Usage among Low-Income Groups in Colombia, Mexico, and Peru." *The Information Society* 26 (5): 346–63. doi:10.1080/01972243.2010.511559.

Halford, Susan, and Mike Savage. 2010. "Reconceptualizing Digital Social Inequality." *Information, Communication & Society* 13 (7): 937–55.

doi:10.1080/1369118X.2010.499956.

- Hanafizadeh, Mohammad Reza, Abbas Saghaei, and Payam Hanafizadeh. 2009. "An Index for Cross-Country Analysis of ICT Infrastructure and Access." *Telecommunications Policy* 33 (7): 385–405. doi:10.1016/j.telpol.2009.03.008.
- Hanafizadeh, Payam, Mohammad Reza Hanafizadeh, and Mohsen Khodabakhshi. 2009. "Taxonomy of E-Readiness Assessment Measures." *International Journal of Information Management* 29 (3): 189–95. doi:10.1016/j.ijinfomgt.2008.06.002.
- Harambam, Jaron, Stef Aupers, and Dick Houtman. 2012. "The Contentious Gap." *Information, Communication & Society*, May, 1–22. doi:10.1080/1369118X.2012.687006.
- Hargittai, Eszter. 2002a. "Beyond Logs and Surveys : In-Depth Measures of People ' S Web Use Skills." *Journal of the American Society for Information Science* 53 (14): 1239–44. doi:10.1002/asi.10166.
- . 2002b. "Second Level Digital Divide: Differences in People's Online Skills." *First Monday* 7 (4). doi:10.5210/fm.v7i4.942.
- . 2005. "Survey Measures of Web-Oriented Digital Literacy." *Social Science Computer Review* 23 (3): 371–79. doi:10.1177/0894439305275911.
- . 2007. "A Framework for Studying Differences in People's Digital Media Uses." In *Cyberworld Unlimited*, edited by Nadia Kutscher and Hans-Uwe Otto, 121–37. VS Verlag für Sozialwissenschaften. doi:10.1007/978-3-531-90519-8_7.
- . 2008a. "The Digital Reproduction of Inequality." In *Social Stratification*, edited by David Grusky, 936–44. Boulder, CO:Westview Press.
- . 2008b. "An Update on Survey Measures of Web-Oriented Digital Literacy." *Social Science Computer Review* 27 (1): 130–37. doi:10.1177/0894439308318213.
- . 2010. "Digital Na(t)ives? Variation in Internet Skills and Uses Among Members of the 'Net Generation.'" *Sociological Inquiry* 80 (1): 92–113. doi:10.1111/j.1475-682X.2009.00317.x.
- Hargittai, Eszter, Lindsay Fullerton, Ericka Menchen-trevino, and Kristin Yates Thomas. 2010. "Trust Online: Young Adults ' Evaluation of Web Content." *International Journal of Communication* 4: 468–94.

- Hargittai, Eszter, and A. Hinnant. 2008. "Digital Inequality: Differences in Young Adults' Use of the Internet." *Communication Research* 35 (5): 602–21. doi:10.1177/0093650208321782.
- Hargittai, Eszter, and Yu-li Patrick Hsieh. 2012. "Succinct Survey Measures of Web-Use Skills." *Social Science Computer Review* 30 (1): 95–107. doi:10.1177/0894439310397146.
- . 2013. "Digital Inequality." In *The Oxford Handbook of Internet Studies*, edited by William H Dutton, 129–50. Oxford.: Oxford University Press. doi:10.1093/oxfordhb/9780199589074.001.0001.
- Hargittai, Eszter, and Steven Shafer. 2006. "Differences in Actual and Perceived Online Skills : The Role of Gender." *Social Science Quarterly* 87 (2): 432–448. doi:10.1111/j.1540-6237.2006.00389.x.
- Hewson, Claire, Peter Yule, Dianna Laurent, and Carl Vogel. 2003. *Internet Research Methods: A Practical Guide for the Social and Behavioural Sciences*. SAGE Publications.
- Hoffmann, Christian Pieter, Christoph Lutz, and Miriam Meckel. 2015. "Content Creation on the Internet: A Social Cognitive Perspective on the Participation Divide." *Information, Communication & Society* 18 (6): 696–717. doi:10.1080/1369118X.2014.991343.
- Hooghe, Marc, and Jennifer Oser. 2015. "Internet, Television and Social Capital: The Effect of 'Screen Time' on Social Capital." *Information, Communication & Society* 18 (6): 1175–1199. doi:10.1080/1369118X.2015.1022568.
- Hsieh, J. J. P.-a., a. Rai, and M. Keil. 2010. "Addressing Digital Inequality for the Socioeconomically Disadvantaged Through Government Initiatives: Forms of Capital That Affect ICT Utilization." *Information Systems Research* 22 (2): 233–53. doi:10.1287/isre.1090.0256.
- Husing, Tobias, and Hannes Selhofer. 2004. "DIDIX : A Digital Divide Index For Measuring Inequality in IT Diffusion." *IT & Society* 1 (7): 21–38. <http://citeseerx.ist.psu.edu/viewdoc/download?doi=10.1.1.137.4016&rep=rep1&type=pdf>.
- ICTA. 2014a. "ICT Authority - Home - Introduction." Accessed May 19. <http://www.icta.mu/home/intro.htm>.
- . 2015b. "ICT Authority - Market - ICT Observatory." Accessed July 1. https://www.icta.mu/market/ICT_figures.html.
- . 2010. "Annual Report on the Development of the Information and

Communication Industry in Mauritius :”

Internet Society Mauritius. 2015. “About Us.” Accessed February 11.
<http://www.isoc-mu.org>.

Iske, Stefan, Alexandra Klein, Nadia Kutscher, and Hans-Uwe Otto. 2008.
 “Young People’s Internet Use and Its Significance for Informal Education
 and Social Participation.” *Technology, Pedagogy and Education* 17 (2):
 131–41. doi:10.1080/14759390802116672.

ITU. 2004. “The Fifth Pillar: Republic of Mauritius ICT Case Study.”
http://www.itu.int/itudoc/gs/promo/bdt/cast_int/86187.pdf.

———. 2005a. “From The Digital Divide to Digital Opportunities: Measuring
 Infostate for Development.” Edited by George Sciadas. NRC Press.
http://www.itu.int/ITU-D/ict/publications/dd/material/index_ict_opp.pdf.

———. 2005b. “World Summit on the Information Society Outcome
 Documents.” <https://www.itu.int/net/wsis/outcome/booklet.pdf>.

———. 2009. “Measuring the Information Society 2009 - The ICT
 Development Index.” [http://www.itu.int/ITU-](http://www.itu.int/ITU-D/ict/publications/idi/2009/index.html)
[D/ict/publications/idi/2009/index.html](http://www.itu.int/ITU-D/ict/publications/idi/2009/index.html).

———. 2010a. “Definitions of World Telecommunication/ICT Indicators.”
[https://www.itu.int/ITU-](https://www.itu.int/ITU-D/ict/material/TelecomICT_Indicators_Definition_March2010_for_web.pdf)
[D/ict/material/TelecomICT_Indicators_Definition_March2010_for_web.p](https://www.itu.int/ITU-D/ict/material/TelecomICT_Indicators_Definition_March2010_for_web.pdf)
 df.

———. 2010b. “Measuring the Information Society 2010.”
<http://www.itu.int/ITU-D/ict/publications/idi/2010/index.html>.

———. 2012. “Measuring the Information Society 2012.”
<http://www.itu.int/ITU-D/ict/publications/idi/index.html>.

———. 2014a. “Manual for Measuring ICT Access and Use by Households
 and Individuals.” [http://www.itu.int/dms_pub/itu-d/opb/ind/D-IND-](http://www.itu.int/dms_pub/itu-d/opb/ind/D-IND-ITCMEAS-2014-PDF-E.pdf)
[ITCMEAS-2014-PDF-E.pdf](http://www.itu.int/dms_pub/itu-d/opb/ind/D-IND-ITCMEAS-2014-PDF-E.pdf).

———. 2014b. “Measuring the Information Society Report 2014.”
 doi:10.3359/oz0303157.

———. 2015a. “ITU Statistics.” [http://www.itu.int/en/ITU-](http://www.itu.int/en/ITU-D/Statistics/Pages/stat/default.aspx)
[D/Statistics/Pages/stat/default.aspx](http://www.itu.int/en/ITU-D/Statistics/Pages/stat/default.aspx).

———. 2015b. “Measuring the Information Society Report 2015.”
 doi:10.3359/oz0303157.

- James, Jeffrey. 2007. "Cumulative Bias in the New Digital Opportunity Index : Sources and Consequences." *Current Science* 92 (1): 46–50. http://www.currentscience.ac.in/cs/Downloads/article_id_092_01_0046_0050_0.pdf.
- Jenkins, Henry (P.I), Ravi Purushotma, Amrgaret Weigel, Katie Clinton, and Alice Robinson. 2009. "Confronting the Challenges of Participatory Culture." Vol. 21. The MT press. doi:10.1108/eb046280.
- Johnson, R. B., A. J. Onwuegbuzie, and L. A. Turner. 2007. "Toward a Definition of Mixed Methods Research." *Journal of Mixed Methods Research* 1 (2): 112–33. doi:10.1177/1558689806298224.
- Kasennally, Roukaya. 2011. "Mauritius: Paradise Reconsidered." *Journal of Democracy* 22 (2): 160–69. doi:10.1353/jod.2011.0023.
- Katz, Vikki S., and Carmen Gonzalez. 2016. "Toward Meaningful Connectivity: Using Multilevel Communication Research to Reframe Digital Inequality." *Journal of Communication* 66 (2): 236–49. doi:10.1111/jcom.12214.
- Kawachi, Ichiro, and S.V. Subramanian. 2014. "Income Inequality." In *Social Epidemiology*, edited by Lisa Berkman, Ichiro Kawachi, and Maria Glymour. Oxford University Press, New York. doi:10.1093/med/9780195377903.001.0001.
- Kvasny, Lynette. 2002. "A Conceptual Framework for Examining Digital Inequality." In *Americas Conference on Information Systems*, 1798–1805. <http://aisel.aisnet.org/amcis2002/246/>.
- . 2004. "Virtual Inequality: Beyond the Digital Divide, by Karen Mossberger, Caroline J. Tolbert, and Mary Stansbury. Washington, DC: Georgetown University Press, 2003. ISBN: 0-87840-999-8." *The Information Society* 20 (5): 409–10. doi:10.1080/01972240490508162.
- Laerd Statistics. 2015. "Testing for Normality Using SPSS Statistics When You Have Only One Independent Variable." <https://statistics.laerd.com/spss-tutorials/testing-for-normality-using-spss-statistics.php>.
- Lee, Hyunjoo, Namsu Park, and Yongsuk Hwang. 2015. "A New Dimension of the Digital Divide: Exploring the Relationship Between Broadband Connection, Smartphone Use and Communication Competence." *Telematics and Informatics* 32 (1). Elsevier Ltd: 45–56. doi:10.1016/j.tele.2014.02.001.
- Lee, Jong Hyuk, and Junghyun Kim. 2014. "Socio-Demographic Gaps in Mobile Use, Causes, and Consequences: A Multi-Group Analysis of the

- Mobile Divide Model.” *Information, Communication & Society* 17 (8). Taylor & Francis: 917–36. doi:10.1080/1369118X.2013.860182.
- Leiner, Barry M., Vinton G. Cerf, David D. Clark, Robert E. Kahn, Leonard Kleinrock, Daniel C. Lynch, Jon Postel, Larry G. Roberts, and Stephen Wolff. 2015. “Brief History of the Internet.” *Internet Society*. Accessed November 18. <http://www.internetsociety.org/internet/what-internet/history-internet/brief-history-internet>.
- Lessig, Lawrence. 1999. *Code and Other Laws of Cyberspace*. New York: Basic Books.
- Liang, Guo. 2007. “Surveying Internet Usage and Its Impact in Seven Chinese Cities.” *Research Center for Social Development - Chinese Academy of Social Sciences*. [http://www.worldinternetproject.com/_files/_Published/_oldis/_China Internet Project Survey Report 2007.pdf](http://www.worldinternetproject.com/_files/_Published/_oldis/_China%20Internet%20Project%20Survey%20Report%202007.pdf).
- Liao, Pei-An, Hung-Hao Chang, Jiun-Hao Wang, and Lih-Chyun Sun. 2016. “What Are the Determinants of Rural-Urban Digital Inequality among Schoolchildren in Taiwan? Insights from Blinder- Oaxaca Decomposition.” *Computers & Education* 95 (April). Elsevier Ltd: 123–33. doi:10.1016/j.compedu.2016.01.002.
- Litan, Robert E., and Alice M. Rivlin. 2001. “Projecting the Economic Impact of the Internet.” *The American Economic Review* 91 (2): 313–17. doi:10.1257/jep.6.3.79.
- Livingstone, Sonia, Magdalena Bober, and Ellen Helsper. 2005. “Inequalities and the Digital Divide in Children and Young People ’ S Internet Use : Findings from the UK Children Go Online Project.” London: LSE Research Online. <http://eprints.lse.ac.uk/archive/00000398>.
- Marra, Rose M, and Barbara Bogue. 2006. “A Critical Assessment of Online Survey Tools.” In *Proceedings of the 2006 Women in Engineering Programs and Advocates Network Conference*. <https://journals.psu.edu/wepan/article/viewFile/58473/58161>.
- Matzat, Uwe, and Bert Sadowski. 2012. “Does the ‘Do-It-Yourself Approach’ Reduce Digital Inequality? Evidence of Self-Learning of Digital Skills.” *The Information Society* 28 (1): 1–12. doi:10.1080/01972243.2011.629023.
- Mauritius Research Council. 2014a. “Guidelines on Research Ethics and Conduct of Research.” <http://www.mrc.org.mu/Projects/REGeneral.pdf>.
- . 2014b. “Research Ethics.” <http://www.mrc.org.mu/REthics.htm>.

- Mauritius Telecom. 2015a. "Mauritius Telecom - Cellplus Mobile Communications Ltd." Accessed June 30.
http://www.mauritiustelecom.com/aboutus/cellplus_mobile_communications_ltd.php.
- . 2015b. "Mauritius Telecom - Development of MT." Accessed June 24. http://www.mauritiustelecom.com/aboutus/development_of_mt.php.
- . 2015c. "Mauritius Telecom - SAFE and Satellite Systems." Accessed June 30.
http://www.mauritiustelecom.com/wholesale/safe_and_satellite_systems.php.
- . 2015d. "Mauritius Telecom - Starting Point." Accessed June 25.
http://www.mauritiustelecom.com/aboutus/starting_point.php.
- . 2015. "Mauritius Telecom - History."
<http://www.mauritiustelecom.com/aboutus/history.php>.
- Meyen, M., S. Pfaff-Rudiger, K. Dudenhoffer, and J. Huss. 2010. "The Internet in Everyday Life: A Typology of Internet Users." *Media, Culture & Society* 32 (5): 873–82. doi:10.1177/0163443710374792.
- MICT. 2014. "Ministry of Technology, Communication and Innovation - Mission and Vision." Accessed May 19.
<http://mtci.govmu.org/English/Pages/default.aspx>.
- . 2011. "National Information & Communication Technology Strategic Plan (NICTSP) 2011-2014 : Towards I-Mauritius." *Management*.
<http://www.gov.mu/portal/goc/telecomit/file/ICTplan.pdf>.
- . 2012. "National Broadband Policy 2012 - 2020."
<https://www.icta.mu/documents/nationalbroadbandpolicy2012.pdf>.
- MITIA. 2014. "About Us ~ MITIA." Accessed May 19.
http://www.mitia.mu/en/about_us.aspx.
- Močnik, Dijana, and Karin Širec. 2010. "The Determinants of Internet Use Controlling for Income Level: Cross-Country Empirical Evidence." *Information Economics and Policy* 22 (3): 243–56.
doi:10.1016/j.infoecopol.2010.01.002.
- Mossberger, Karen, Caroline J. Tolbert, and Mary Stansbury. 2003. *Virtual Inequality: Beyond the Digital Divide*. Washington D.C.: Georgetown University Press.
- MTCI. 2015. "Ministry of Technology, Communication and Innovation -

- Whitepaper -Fostering the Info-Communications Society.” Accessed July 6. <http://mtci.govmu.org/English/Pages/WHITEPAPER-Fostering-theInfo-Communications-Society.aspx>.
- . 2013. “E-Government Strategy.” [http://mtci.govmu.org/English/Documents/eGovernment Strategy finalv1.pdf](http://mtci.govmu.org/English/Documents/eGovernment%20Strategy%20finalv1.pdf).
- . 2015a. “Ministry of Technology, Communication and Innovation - Pages - Legislations.” <http://mtci.govmu.org/English/Rules-Regulations-Policies/Pages/default.aspx>.
- . 2015b. “National Cyber Security Strategy 2014-2019: For Resilient and Secure Mauritius.” [http://mtci.govmu.org/English/Documents/Final National Cyber Security Strategy November 2014.pdf](http://mtci.govmu.org/English/Documents/Final%20National%20Cyber%20Security%20Strategy%20November%202014.pdf).
- National Computer Board. 2000. “IT Household Survey 2000.” [http://www.ncb.mu/English/Documents/Downloads/Reports and Surveys/IThouseholdsurvey2000.pdf](http://www.ncb.mu/English/Documents/Downloads/Reports%20and%20Surveys/IThouseholdsurvey2000.pdf).
- . 2010. “Information Society Outlook.” [http://www.govmu.org/portal/sites/indicators/Newsletter/Newsletter NCB 2010_v1.pdf](http://www.govmu.org/portal/sites/indicators/Newsletter/Newsletter%20NCB%202010_v1.pdf).
- NCB. 2014. “National Computer Board - Vision and Mission.” Accessed May 19. <http://www.ncb.mu/English/AboutUs/Pages/Vision-and-Mission.aspx>.
- . 2015a. “National Computer Board - Cyber Caravan.” <http://www.ncb.mu/English/EPowering-People/Caravan/Pages/default.aspx>.
- . 2015b. “Universal ICT Education Programme.” <http://uiiep.govmu.org/English/Pages/default.aspx>.
- Norris, Pippa. 2000. “The Worldwide Digital Divide : Information Poverty, the Internet and Development.” In *Annual Meeting of Political Studies Association of the UK, London School of Economics and Political Science*, 1–10. www.hks.harvard.edu/fs/pnorris/Acrobat/psa2000dig.pdf.
- . 2001. *Digital Divide: Civic Engagement, Information Poverty, and the Internet Worldwide*. Cambridge University Press. doi:10.1017/cbo9781139164887.015.
- North, Sue, Ilana Snyder, and Scott Bulfin. 2008. “Digital Tastes: Social Class and Young People’s Technology Use.” *Information, Communication & Society* 11 (7): 895–911. doi:10.1080/13691180802109006.

- NTIA. 1995. "Falling Through the Net: A Survey of the 'Have Nots' in Rural and Urban America."
<http://www.ntia.doc.gov/ntiahome/fallingthru.html#2/>.
- . 1998. "Falling Through the Net II: New Data on the Digital Divide."
<http://www.ntia.doc.gov/ntiahome/net2/falling.html>.
- . 1999. "Falling Through the Net: Defining the Digital Divide."
<http://www.ntia.doc.gov/ntiahome/fttn99/contents.html>.
- Ntoumanis, Nikos. 2001. *A Step-by-Step Guide to SPSS for Sport and Exercise Studies*. London: Routledge.
- O'Reilly, Tim. 2007. "What Is Web 2.0 Design Patterns and Business Models for the Next Generation of Software." *Communication & Strategies*, no. 1: 17–37. doi:10.2139/ssrn.1008839.
- OECD. 2001. "Understanding the Digital Divide." *OECD Digital Economy Papers*. doi:10.1787/20716826.
- Ono, Hiroshi. 2005. "Digital Inequality in East Asia: Evidence from Japan, South Korea, and Singapore." *Asian Economic Papers* 4 (3): 116–39. doi:10.1162/asep.2005.4.3.116.
- Ono, Hiroshi, and Madeline Zavodny. 2005. "Gender Differences in Information Technology Usage: A US-Japan Comparison." *Sociological Perspectives* 48 (1): 105–33. doi:10.1525/sop.2005.48.1.105.
- . 2007. "Digital Inequality : A Five Country Comparison Using Microdata." *Social Science Research* 36 (3): 1135–55. doi:10.1016/j.ssresearch.2006.09.001.
- Oolun, Krishna. 2014. "Information Communications Technology: The Mauritian Experience of Regulation and Reform." In *WTO Domestic Regulation and Services Trade: Putting Principles into Practice*, edited by Aik Hoe Lim and Bart De Meester. Cambridge University Press. doi:10.1017/cbo9781107476448.015.
- Oolun, Krishna, Suraj Ramgolam, and Vasenden Dorasami. 2012. "The Making of a Digital Nation : Toward I-Mauritius." In *The Global Information Technology Report 2012: Living in a Hyperconnected World*, edited by Soumitra Dutta and Benat Bilbao-Osorio, 161–68. <http://reports.weforum.org/global-information-technology-2012/>.
- Orange. 2015. "Portail Orange Mauritius - Internet - Broadband on Fibre." Accessed July 9. <http://www.orange.mu/internet/broadband-on-fibre.php>.

- OTAM. 2014. "OTAM - About Us." Accessed May 19.
<http://www.otam.mu/files/about.php?lang=1>.
- Oxford Internet Institute. 2014. "Oxford Internet Survey."
<http://oxis.oii.ox.ac.uk/home/>.
- Oyedemi, Toks Dele. 2011. "Digital Inequalities and Implications for Social Inequalities: A Study of Internet Penetration Amongst University Students in South Africa." *Telematics and Informatics* 29 (3). Elsevier Ltd: 302–13. doi:10.1016/j.tele.2011.12.001.
- Oyelaran-Oyeyinka, B, and K Lal. 2005. "Internet Diffusion in Sub-Saharan Africa: A Cross-Country Analysis." *Telecommunications Policy* 29 (7): 507–27. doi:10.1016/j.telpol.2005.05.002.
- Pallant, Julie. 2011. *SPSS Survival Manual: A Step by Step Guide to Data Analysis Using SPSS*. 4th ed. Allen & Unwin.
- Park, Sora. 2015. "Digital Inequalities in Rural Australia : A Double Jeopardy of Remoteness and Social Exclusion." *Journal of Rural Studies*. Elsevier Ltd, 1–9. doi:10.1016/j.jrurstud.2015.12.018.
- Pena-Lopez, Ismael. 2009. "Measuring Digital Development for Policy-Making: Models, Stages, Characteristics and Causes." Universitat Oberta de Catalunya.
- Peter, J, and P Valkenburg. 2006. "Adolescents' Internet Use: Testing the 'Disappearing Digital Divide' versus the 'Emerging Digital Differentiation' Approach." *Poetics* 34 (4–5): 293–305.
doi:10.1016/j.poetic.2006.05.005.
- Pew Research Center. 2015. "Internet Seen as Positive Influence on Education but Negative on Morality in Emerging and Developing Nations." *Numbers, Facts and Trends Shaping the World*.
<http://www.pewglobal.org/files/2015/03/Pew-Research-Center-Technology-Report-FINAL-March-19-20151.pdf>.
- . 2016. "Smartphone Ownership and Internet Usage Continues to Climb in Emerging Economies." *Numbers, Facts and Trends Shaping the World*.
http://www.pewglobal.org/files/2016/02/pew_research_center_global_technology_report_final_february_22__2016.pdf.
- Pruijt, H. 2002. "Social Capital and the Equalizing Potential of the Internet." *Social Science Computer Review* 20 (2): 109–15.
doi:10.1177/089443930202000201.

- Puckett, C. 2010. "Digital Adaptability: New Construct and Measure for Digital Inequality Research." In *American Sociological Association Annual Meeting*. Hilton Atlanta and Atlanta Marriott Marquis, Atlanta, GA. http://citation.allacademic.com/meta/p410525_index.html.
- PWC. 2007. "National ICT Strategic Plan 2007- 2011." <http://unpan1.un.org/intradoc/groups/public/documents/cpsi/unpan030903.pdf>.
- Rainie, Lee, and Barry Wellman. 2012. *Networked; The New Social Operating System*. Cambridge: MIT Press.
- Reddi, Sandiren. 2005. "Regulatory Reform in the Mauritian Telecommunication Sector. A Vain Quest for Embedded Autonomy." In *International Research Foundation for Development on Small Islands Developing Countries*. http://irfd.org/events/wfsids/virtual/papers/sids_sjreddi.pdf.
- Rheingold, Howard. 1993. *The Virtual Community: Homesteading on the Electronic Frontier*. Addison Wesley.
- Robinson, Laura. 2009. "A Taste for the Necessary." *Information, Communication & Society* 12 (4): 488–507. doi:10.1080/13691180902857678.
- Robinson, Laura, Shelia R. Cotten, Hiroshi Ono, Anabel Quan-Haase, Gustavo Mesch, Wenhong Chen, Jeremy Schulz, Timothy M. Hale, and Michael J. Stern. 2015. "Digital Inequalities and Why They Matter." *Information, Communication & Society* 18 (5): 569–82. doi:10.1080/1369118X.2015.1012532.
- Santoro, Marco. 2011. "From Bourdieu to Cultural Sociology." *Cultural Sociology* 5 (1): 3–23. doi:10.1177/1749975510397861.
- Saunders, Mark, Philip Lewis, and Adrian Thornhill. 2009. *Research Methods for Business Students*. Fifth Edit. Prentice Hall.
- Schonlau, Matthias, Ronald D. Jr. Frickler, and Marc N. Elliott. 2002. *Conducting Research Surveys via E-Mail and the Web*. Santa Monica, CA: RAND Corporation. http://www.rand.org/pubs/monograph_reports/MR1480.html.
- Schradie, Jen. 2011. "The Dgital Production Gap: The Digital Divide and Web 2.0 Collide." *Poetics* 39 (2). Elsevier B.V.: 145–68. doi:10.1016/j.poetic.2011.02.003.
- Simpson, Alan. 2016. "KB, MB, GHz, and All of That Stuff."

<http://www.coolnerds.com/newbies/kbmbgb/sizeandspeed.htm>.

Sims, Christo. 2013. "From Differentiated Use to Differentiating Practices: Negotiating Legitimate Participation and the Production of Privileged Identities." *Information, Communication & Society* 17 (6): 670–82. doi:10.1080/1369118X.2013.808363.

Sobhee, Sanjeev K. 2009. "The Economic Success of Mauritius: Lessons and Policy Options for Africa." *Journal of Economic Policy Reform* 12 (1): 29–42. doi:10.1080/17487870902739186.

Song. 2015. "African Undersea Cables | Many Possibilities." <https://manypossibilities.net/african-undersea-cables/comment-page-1/>.

Soyjaudah, K.M.S., M.K. Oolun, I. Jahmeerbacus, and S. Govinda. 2002. "ICT Development in Mauritius." *IEEE AFRICON. 6th Africon Conference in Africa*,. doi:10.1109/AFRCON.2002.1146805.

Sparks, Colin. 2013. "What Is the 'Digital Divide' and Why Is It Important." *Javnost -The Public, New Media, New Research Challenges* 20 (2): 27–46.

Stangor, Charles. 2011. *Research Methods for the Behavioural Sciences*. 4th. Wadsworth Cengage Learning.

Statistics Mauritius. 2006. "Economic and Social Indicators: Information and Communication Technologies (ICT) Statistics - 2006." <http://statsmauritus.govmu.org>.

———. 2009. "Economic and Social Indicators Information and Communication Technologies (ICT) Statistics - 2009." <http://statsmauritus.govmu.org/English/Pages/cso/ei846/ict.pdf>.

———. 2011a. "Housing and Living Conditions." *2011 Housing and Population Census*. Vol. I. <http://statsmauritus.gov.mu/English/Pages/The-2011-Housing-and-Population-Census.aspx>.

———. 2011b. "Housing and Living Conditions." *2011 Housing and Population Census*. Vol. I. [http://statsmauritus.govmu.org/English/Documents/publications/Housing/economics and social indicators/reports/vol1.pdf](http://statsmauritus.govmu.org/English/Documents/publications/Housing/economics%20and%20social%20indicators/reports/vol1.pdf).

———. 2012a. "Disability." *2011 Housing and Population Census*. Vol. IV. <http://statsmauritus.gov.mu/English/Pages/The-2011-Housing-and-Population-Census.aspx>.

- . 2012b. “Gender Statistics , 2012.”
<http://statsmauritius.govmu.org/English/StatsbySubj/Documents/ei1052/gender.pdf>.
- . 2013a. “Annual Digest of Statistics - 2012.” Vol. 57.
<http://statsmauritius.gov.mu/English/Publications/Documents/Regular Reports/annual digest/annualdig12.pdf>.
- . 2013b. “Economic and Social Indicators Information and Communication Technologies (ICT) Statistics - 2012.”
<http://statsmauritius.gov.mu/English/Publications/Pages/ICT-Stats-Yr-2012.aspx>.
- . 2013c. “Household Budget Survey 2012 – Preliminary Results & Updated Weights for the Consumer Price Index.”
<http://statsmauritius.govmu.org/English/StatsbySubj/Documents/ei1035/hbs.pdf>.
- . 2014a. “Economic and Social Indicators Information and Communication Technologies (ICT) Statistics - 2013.”
<http://statsmauritius.govmu.org/English/StatsbySubj/Documents/ei1119/ict.pdf>.
- . 2014b. “Population and Vital Statistics - Republic of Mauritius, Year 2013.”
<http://statsmauritius.govmu.org/English/StatsbySubj/Documents/ei1092/population.pdf>.
- . 2014c. “Statistics Mauritius - Mauritius in Figures 2013.”
<http://statsmauritius.gov.mu/English/Publications/Pages/Mauritius-in-Figures.aspx>.
- . 2015a. “Economic and Social Indicators Information and Communication Technologies (ICT) Statistics - 2014.” Vol. 9.
<http://statsmauritius.gov.mu/English/Publications/Pages/ICT-Stats-Yr-2014.aspx>.
- . 2015b. “Labour Force, Employment and Unemployment - Fourth Quater 2014.”
<http://statsmauritius.govmu.org/English/Publications/Documents/ei1168/cmphs.pdf>.
- . 2015c. “Mauritius in Figures 2014.”
<http://statsmauritius.govmu.org/English/Publications/Documents/MIF/Mauritius in figures 2014 a.pdf>.
- Stern, M. J., and a. E. Adams. 2010. “Do Rural Residents Really Use the Internet to Build Social Capital? An Empirical Investigation.” *American*

Behavioral Scientist 53 (9): 1389–1422.
doi:10.1177/0002764210361692.

Stiakakis, Emmanouil, Pavlos Kariotellis, and Maria Vlachopoulou. 2010. “From the Digital Divide to Digital Inequality : A Secondary Research in the European Union.” In *Next Generation Society. Technological and Legal Issues*, 43–54. Springer Berlin Heidelberg. doi:10.1007/978-3-642-11631-5_4.

Straumann, Ralph K., and Mark Graham. 2016. “Who Isn’t Online? Mapping the ‘Archipelago of Disconnection.’” *Regional Studies, Regional Science* 3 (1): 96–98. doi:10.1080/21681376.2015.1116960.

Subramanian, Arvind. 2001. “Mauritius: A Case Study.” *Finance & Development: Quarterly Magazine of the IMF* 38 (4). IMF.
<http://www.imf.org/external/pubs/ft/fandd/2001/12/subraman.htm#author>.

Sue, Valerie M., and Lois A. Ritter. 2012. “Designing and Developing the Survey Instrument.” In *Conducting Online Surveys*, Second Edi, 59–87. SAGE Publications. doi:10.4135/9781412983754.n5.

Survey Monkey. 2014a. “Can the Survey Be Aanswered on Smartphones like iPhone or Android?”
http://help.surveymonkey.com/articles/en_US/kb/Can-the-survey-be-answered-on-smartphones-like-iPhone-or-Android.

———. 2014b. “SPSS Exports.”
http://help.surveymonkey.com/articles/en_US/kb/SPSS-Exports.

———. 2014c. “What Browser Versions Do You Support?”
http://help.surveymonkey.com/articles/en_US/kb/What-browser-versions-do-you-support.

Tabachnick, Barbara G, and Linda S Fidell. 2007. *Using Multivariate Statistics*. Fifth Editi. Pearson Education.

Tashakkori, A., and I. Newman. 2010. “Quantitative and Qualitative Approaches to Research - Integration: Mixed Methods.” In *International Encyclopedia of Education*, edited by Penelope Peterson, Eva Baker, and Barry McGaw, 514–20. Elsevier Ltd.
<http://www.sciencedirect.com/science/article/pii/B9780080448947002876>.

The National Economic and Social Council. 2014. “Income Inequality in Mauritius The Role of Wage Policy.”

Thornham, Helen, and Angela McFarlane. 2011. “Discourses of the Digital

- Native." *Information, Communication & Society* 14 (2): 258–79.
doi:10.1080/1369118X.2010.510199.
- Tongia, Rahul, Eswaran Subrahmanian, and V S Arunachalam. 2004. "Information and Communications Technology for Sustainable Development Defining a Global Research Agenda."
- Trochim, William, and James Donnelly. 2006. "The Research Methods Knowledge Base." <http://www.socialresearchmethods.net/kb/>.
- UNCTAD. 2006. "The Digital Divide Report: ICT Diffusion Index 2005." http://unctad.org/en/docs/iteipc20065_en.pdf.
- United Nations-OHRLLS. 2011. "Small Island Developing States: Small Islands Big(ger) Stakes." <http://unohrlls.org/custom-content/uploads/2013/08/SIDS-Small-Islands-Bigger-Stakes.pdf>.
- United Nations Department of Economic and Social Affairs. 2013. "World Population Ageing, 2013." <http://www.un.org/en/development/desa/population/publications/pdf/ageing/WorldPopulationAgeing2013.pdf>.
- van Deursen, Alexander, and J. van Dijk. 2008. "Measuring Digital Skills: Performance Tests of Operational, Formal, Information and Strategic Internet Skills." In *58th Conference of International Communication Association, Canada*, 1–25. http://citation.allacademic.com/meta/p231022_index.html.
- . 2009. "Using the Internet: Skill Related Problems in Users' Online Behavior." *Interacting with Computers* 21 (5–6). Elsevier B.V.: 393–402. doi:10.1016/j.intcom.2009.06.005.
- van Deursen, Alexander, J. van Dijk, and Oscar Peters. 2011. "Rethinking Internet Skills: The Contribution of Gender, Age, Education, Internet Experience, and Hours Online to Medium- and Content-Related Internet Skills." *Poetics* 39 (2). Elsevier B.V.: 125–44. doi:10.1016/j.poetic.2011.02.001.
- van Dijk, J. 2005. *The Deepening Divide Inequality in the Information Society*. Thousand Oaks: Sage Publications, London.
- . 2006. "Digital Divide Research, Achievements and Shortcomings." *Poetics* 34 (4–5): 221–35. doi:10.1016/j.poetic.2006.05.004.
- van Dijk, J., and Ken Hacker. 2000. "The Digital Divide as a Complex and Dynamic Phenomenon." In *50th Annual Conference of the International Communication Association, Acapulco, 1-5 June*, 1–20.

https://www.utwente.nl/bms/vandijk/research/digital_divide/Digital_Divide_overigen/pdf_digitaldivide_website.pdf.

- Vehovar, Vasja, Pavle Sicherl, Tobias Hüsing, and Vesna Dolnicar. 2006. "Methodological Challenges of Digital Divide Measurements." *The Information Society* 22 (5): 279–90. doi:10.1080/01972240600904076.
- Vicente, Maria Rosalia, and Ana Jesus Lopez. 2010. "A Multidimensional Analysis of the Disability Digital Divide: Some Evidence for Internet Use." *The Information Society* 26 (1): 48–64. doi:10.1080/01615440903423245.
- Warschauer, Mark. 2003a. *Technology and Social Inclusion : Rethinking the Digital Divide*.
- . 2003b. "Demystifying the Digital Divide." *Scientific American* 289 (2): 42–47. doi:10.1086/378471.
- . 2010a. "A Literacy Approach to the Digital Divide." In *Las Mulialfabetizaciones En El Espacio Digital*, edited by M. A. Pereyra, 1–40. Malaga, Spain: Ediciones Aljibe. http://www.education.uci.edu/person/warschauer_m/docs/lit-approach.pdf.
- . 2010b. "Digital Divide." In *Encyclopedia of Library and Information Sciences*, Third Edit, 1551–56. doi:10.1081/E-ELIS3.
- Warschauer, Mark, and Tina. Matuchniak. 2010. "New Technology and Digital Worlds: Analyzing Evidence of Equity in Access, Use, and Outcomes." *Review of Research in Education* 34 (1): 179–225. doi:10.3102/0091732X09349791.
- Watkins, Marley W. 2005. "Determining Parallel Analysis Criteria." *Journal of Modern Applied Statistical Methods* 5 (2).
- Wellman, B., a. Q. Haase, J. Witte, and K. Hampton. 2001. "Does the Internet Increase, Decrease, or Supplement Social Capital?: Social Networks, Participation, and Community Commitment." *American Behavioral Scientist* 45 (3): 436–55. doi:10.1177/00027640121957286.
- Whinston, Andrew, and Soon-Yong Choi. 2004. "Internet and Telecommunications Outlook in Latin America." In *Information Technology Policy and the Digital Divide: Lessons for Developing Countries*, edited by Mitsuhiro Kagami, Masatsugu Tsuji, and Emanuele Giovannetti. Edward Elgar Publishing Limited: Cheltenham. doi:10.1017/CBO9781107415324.004.

- Wijetunga, Dinuka. 2014. "The Digital Divide Objectified in the Design: Use of the Mobile Telephone by Underprivileged Youth in Sri Lanka." *Journal of Computer-Mediated Communication* 19 (3): 712–26. doi:10.1111/jcc4.12071.
- Willis, S. 2006. "Beyond the 'Digital Divide': Internet Diffusion and Inequality in Australia." *Journal of Sociology* 42 (1): 43–59. doi:10.1177/1440783306061352.
- Willson, Michele a. 2012. "Being-Together: Thinking through Technologically Mediated Sociality and Community." *Communication and Critical/Cultural Studies* 9 (June 2013): 279–97. doi:10.1080/14791420.2012.705007.
- Witte, James C, and Susan E Mannon. 2010. *The Internet and Social Inequalities*. New York: Routledge. doi:10.4324/9780203861639.
- World Bank. 2015. "GDP (Current US\$) | Data | Graph." Accessed June 23. <http://data.worldbank.org/indicator/NY.GDP.MKTP.CD/countries/MU?display=graph>.
- . 2013. "New Country Classifications | Data." <http://data.worldbank.org/news/new-country-classifications>.
- Worldwide Internet Society. 2015a. "Who We Are." Accessed February 11. <http://www.internetsociety.org/who-we-are>.
- . 2014b. "Worldwide Internet Society - Mission." Accessed May 19. <http://www.internetsociety.org/who-we-are/mission>.
- Wright, Kevin B. 2005. "Researching Internet-Based Populations: Advantages and Disadvantages of Online Survey Research, Online Questionnaire Authoring Software Packages, and Web Survey Services." *Journal of Computer-Mediated Communication* 10 (3): 0. doi:10.1111/j.1083-6101.2005.tb00259.x.
- Xenos, Michael, and Kirsten Foot. 2008. "Not Your Father ' S Internet : The Generation Gap in Online Politics." In *Civic Life Online: Learning How Digital Media Can Engage Youth*, edited by W Lance Bennett, 51–70. MIT Press. doi:10.1162/dmal.9780262524827.051.
- Yang, Kyung Hoon, Sei Kwon Park, Seong No Yoon, and Jaekyung Kim. 2010. "Measurement of the Digital Inequality in Remote Rural Areas: Case of South Korea." *International Journal of Information Technology and Management* 9 (2): 142–61. doi:10.1504/ijitm.2010.030458.
- Yeung Lam Lo, Louis. 1998. "The Economic Development of Mauritius Since

Independence.”

http://www.docs.fce.unsw.edu.au/economics/Research/WorkingPapers/1998_6.pdf.

Zafar, Ali. 2011. “Mauritius: An Economic Success Story.” In *Yes Africa Can - Success Stories From a Dynamic Continent*, edited by Punam Chuhan-Pole and Manka Angwafo, 1–496. The World Bank, Washington, D.C. doi:10.1596/978-0-8213-8745-0.

Zickuhr, Kathryn, and Aaron Smith. 2012a. “Digital Differences.” PEW Research Center. http://www.pewinternet.org/files/old-media//Files/Reports/2012/PIP_Digital_differences_041312.pdf.

———. 2012b. “Digital Differences: New Data and Trends.” http://www.pewinternet.org/files/old-media//Files/Reports/2012/PIP_Digital_differences_041312.pdf.

Zillien, Nicole, and Eszter Hargittai. 2009. “Digital Distinction: Status-Specific Types of Internet Usage.” *Social Science Quarterly* 90 (2): 274–91. doi:10.1111/j.1540-6237.2009.00617.x.

Every reasonable effort has been made to acknowledge the owners of copyright material. I would be pleased to hear from any copyright owner who has been omitted or incorrectly acknowledged.

Appendix A: List of Small Island Developing States











AFRICAN, INDIAN OCEAN, MEDITARRANEAN AND SOUTH CHINA SEAS (AIMS)

	Cabo Verde		Mauritius
	Comoros		Sao Tomé and Príncipe
	Guinea-Bissau		Seychelles
	Maldives		Singapore

CARIBBEAN

	Antigua and Barbuda		Bahamas		Saint Kitts and Nevis
	Barbados		Belize		Saint Lucia
	Cuba		Dominica		Saint Vincent and the Grenadines
	Dominican Republic		Grenada		Suriname
	Guyana		Haiti		Trinidad and Tobago
	Jamaica				

PACIFIC

	Cook Islands		Fiji		Kiribati
	Marshall Islands		Micronesia (Federated States of)		Nauru
	Niue		Palau		Papua New Guinea
	Samoa		Solomon Islands		Timor-Leste
	Tonga		Tuvalu		Vanuatu

Appendix B: Survey Questionnaire

Following is the layout and the question of the survey questionnaire. Please note that the progress bar does not appear on these screenshots.

Digital Inequality: The Internet in Mauritius

Welcome Page

Digital Inequality: The Internet in Mauritius
Online Survey

Consent Statement:

In line with Curtin University Ethics Committee and the Australian National Statement on Ethical Conduct in Human Research, I confirm that I understand and agree to the following:

- I have been informed and understand the purposes of the study as outlined in the [Online Survey Information Sheet](#).
- I can refuse to participate without giving a reason or justification.
- I can contact the researcher on s.gopee@student.curtin.edu.au so that I may ask any question prior to completing this survey.
- I can stop this online survey at any point (exit button on top right corner of page) and that no data will be stored until the "done" button is clicked (at the end of the survey).
- This survey is anonymous and that at any point, any information which might potentially identify me will not be used in published material.
- On submitting the survey, I understand that there will be no way for the researcher to identify me and therefore, I release my right to withdraw my participation from that point on.
- This survey is meant for **Mauritian Residents aged 12 years and above**.
- I understand that I need **parental consent** before participating in this survey if I am under 18 years old.
- I agree to participate in the study and I have sought parental consent if I am under 18 years old.

Digital Inequality: The Internet in Mauritius

*** 1. Are you a Mauritian Resident?**

YES

NO

Digital Inequality: The Internet in Mauritius	
Section 1: Demographics	
2. Sex :	
<input type="radio"/> Male	
<input type="radio"/> Female	
3. Age (in years):	
<input type="text"/>	
4. Residential Area:	
<input type="text"/>	
If not sure, please state locality:	
<input type="text"/>	
5. Occupation:	
<input type="text"/>	
Other (please specify)	
<input type="text"/>	
<hr/>	
6. Highest level of education:	
<input type="radio"/> Primary School (CPE or Below)	<input type="radio"/> Certificate/Diploma
<input type="radio"/> Vocational	<input type="radio"/> Professional course (ACCA, ICOSA, ABE etc)
<input type="radio"/> SC (or equivalent)	<input type="radio"/> Undergraduate degree
<input type="radio"/> HSC (or equivalent)	<input type="radio"/> Postgraduate degree or Above
Other (please specify)	
<input type="text"/>	
7. If still studying, <u>current</u> education level:	
<input type="radio"/> Primary School (CPE or Below)	<input type="radio"/> Professional course (ACCA, ICOSA, ABE etc)
<input type="radio"/> Vocational	<input type="radio"/> Undergraduate degree
<input type="radio"/> SC (or equivalent)	<input type="radio"/> Postgraduate degree or Above
<input type="radio"/> HSC (or equivalent)	<input type="radio"/> Not Studying
<input type="radio"/> Certificate/Diploma	

Digital Inequality: The Internet in Mauritius

8. Highest Level of education of parents:(select whoever has the higher)

<input type="radio"/> Primary School (CPE or Below)	<input type="radio"/> Certificate/Diploma
<input type="radio"/> Vocational	<input type="radio"/> Professional course (ACCA, ICSA, ABE etc)
<input type="radio"/> SC (or equivalent)	<input type="radio"/> Undergraduate degree
<input type="radio"/> HSC (or equivalent)	<input type="radio"/> Postgraduate degree or Above

Other (please specify)

Digital Inequality: The Internet in Mauritius
Section 2. Technical Apparatus
<i>This section investigates the types of devices that you use to access the Internet</i>
*9. With regards to your main Internet connection, are you the owner of at least <u>one of the devices</u> (computer, mobile, tablet) you use to connect?
<input type="radio"/> Yes
<input type="radio"/> No

Digital Inequality: The Internet in Mauritius

10. Which one of the following was the main way of connecting to the Internet during the past three months?

- Computer** (desktop/laptop) with a **fixed (ADSL)** Internet connection (including MyT wifi)
- Computer** (desktop/laptop) with a **fixed (dial up)** Internet connection
- Computer** (desktop/laptop) with a **mobile Internet** connection (**Internet dongle**)
- Mobile** phone or a **tablet** device with a **fixed** Internet connection (e.g MyT wifi)
- Mobile** phone or a **tablet** device with a **mobile Internet** connection
- Did **not connect** to the Internet in the past 3 months

11. From where did you connect to the Internet during the past three months? (tick all that apply)

- | | |
|---|---|
| <input type="checkbox"/> Home | <input type="checkbox"/> Public location |
| <input type="checkbox"/> Workplace | <input type="checkbox"/> On the go (mobile Internet) |
| <input type="checkbox"/> Place of study (school, college, university) | <input type="checkbox"/> Did not connect in the past three months |

Other (please specify)

12. From where did you mainly access the Internet during the past three months? (select the one that best applies)

- | | |
|--|--|
| <input type="radio"/> Home | <input type="radio"/> Public location |
| <input type="radio"/> Workplace | <input type="radio"/> On the go (mobile) |
| <input type="radio"/> Place of study (School, college or university) | <input type="radio"/> Did not connect in the past three months |

Other (please specify)

Digital Inequality: The Internet in Mauritius

*** 13. From where did you mainly access the Internet during the past three months? (select the one that best applies)**

- Workplace
- School, college, university
- Friend's /family's place
- Free public location (e.g. Library, Post)
- Paid public location (e.g. cybercafé)
- Did not connect in the past three months

Other (please specify)

Digital Inequality: The Internet in Mauritius					
<p>On a scale of 0-4, indicate how the following factors <u>prevented you using the Internet well.</u></p> <p>0 = No effect at all</p> <p>1 = Little negative effect</p> <p>4 = Significant negative effect</p> <p>14. My effective Internet use was <u>limited</u> by:</p>					
	0	1	2	3	4
Hardware (including computers and other devices)	<input type="radio"/>	<input type="radio"/>	<input type="radio"/>	<input type="radio"/>	<input type="radio"/>
Software (programs and applications)	<input type="radio"/>	<input type="radio"/>	<input type="radio"/>	<input type="radio"/>	<input type="radio"/>
Bandwidth (speed of connection)	<input type="radio"/>	<input type="radio"/>	<input type="radio"/>	<input type="radio"/>	<input type="radio"/>
Reliability of the connection (interruption in connection)	<input type="radio"/>	<input type="radio"/>	<input type="radio"/>	<input type="radio"/>	<input type="radio"/>

Digital Inequality: The Internet in Mauritius

Section 3: Autonomy of use

This section investigates your relative autonomy (relative freedom) in your use of the Internet.

15. Which one of the following statements **best reflects the way you think about the Internet?**

- I think of myself as **'always connected'** because I can access the Internet anytime I want
- I **regularly connect** to the Internet, but don't think of myself as 'always connected'
- I **only connect** to the Internet when I need it to do specific tasks.

16. Which one of the following **best applies to you, in terms of **monitoring** (recording or watching) of your Internet use?**

- I **can access** the Internet without being monitored if I want
- I **can only** access the Internet while being monitored by an **organisation** (work, university etc.)
- I **can only** access the Internet while being monitored by **other people** (parents, partner)

17. Which one of the following **best applies to you, in terms of **blocked online content** when you connect to the Internet?**

- No content that I wish to access is blocked
- Some content I wish to access is blocked by **Governmental policies**
- Some content I wish to access is blocked by the **organisation** (School/college/university/work)
- Some content I wish to access is blocked by **third parties** (cybercafé, library etc)
- Some content I wish to access is blocked by **my parents**

On a scale of 0-4, indicate how the following factors **prevented you using the Internet well.**

0 = No effect at all

1 = Little negative effect

4 = Significant negative effect

18. My effective Internet use was **limited because of the:**

	0	1	2	3	4
Lack of time to spend online	<input type="radio"/>	<input type="radio"/>	<input type="radio"/>	<input type="radio"/>	<input type="radio"/>
Cost of Internet connection	<input type="radio"/>	<input type="radio"/>	<input type="radio"/>	<input type="radio"/>	<input type="radio"/>
Blocking of Internet content and services	<input type="radio"/>	<input type="radio"/>	<input type="radio"/>	<input type="radio"/>	<input type="radio"/>
Monitoring of my Internet use	<input type="radio"/>	<input type="radio"/>	<input type="radio"/>	<input type="radio"/>	<input type="radio"/>
Sharing of devices with other people	<input type="radio"/>	<input type="radio"/>	<input type="radio"/>	<input type="radio"/>	<input type="radio"/>
Place where I use the Internet	<input type="radio"/>	<input type="radio"/>	<input type="radio"/>	<input type="radio"/>	<input type="radio"/>
Lack of accessibility to the Internet	<input type="radio"/>	<input type="radio"/>	<input type="radio"/>	<input type="radio"/>	<input type="radio"/>

Digital Inequality: The Internet in Mauritius					
Section 4: Skill					
<i>This section looks at your Internet skill.</i>					
19. When did you <u>start using</u> the Internet?					
<input type="text"/>					
20. Have you ever followed or are following a <u>formal training or course</u> on how to use the Internet?					
<input type="radio"/> YES <input type="radio"/> NO					
<hr/>					
21. How <u>familiar</u> are you with the following computer and Internet related terms?					
0 = Not familiar at all					
4 = Very familiar					
	0	1	2	3	4
Advanced search	<input type="radio"/>	<input type="radio"/>	<input type="radio"/>	<input type="radio"/>	<input type="radio"/>
Photo tagging	<input type="radio"/>	<input type="radio"/>	<input type="radio"/>	<input type="radio"/>	<input type="radio"/>
Content Upload	<input type="radio"/>	<input type="radio"/>	<input type="radio"/>	<input type="radio"/>	<input type="radio"/>
Tabbed Browsing	<input type="radio"/>	<input type="radio"/>	<input type="radio"/>	<input type="radio"/>	<input type="radio"/>
Wifi router/Livebox	<input type="radio"/>	<input type="radio"/>	<input type="radio"/>	<input type="radio"/>	<input type="radio"/>
Modem	<input type="radio"/>	<input type="radio"/>	<input type="radio"/>	<input type="radio"/>	<input type="radio"/>
Privacy settings	<input type="radio"/>	<input type="radio"/>	<input type="radio"/>	<input type="radio"/>	<input type="radio"/>
Cookies	<input type="radio"/>	<input type="radio"/>	<input type="radio"/>	<input type="radio"/>	<input type="radio"/>
Cache	<input type="radio"/>	<input type="radio"/>	<input type="radio"/>	<input type="radio"/>	<input type="radio"/>
Phishing	<input type="radio"/>	<input type="radio"/>	<input type="radio"/>	<input type="radio"/>	<input type="radio"/>
Spyware	<input type="radio"/>	<input type="radio"/>	<input type="radio"/>	<input type="radio"/>	<input type="radio"/>
<hr/>					
On a scale of 0-4, indicate how the following factors <u>prevented you using the Internet well.</u>					
0 = No effect at all					
1 = Little negative effect					
4 = Significant negative effect					

Digital Inequality: The Internet in Mauritius					
22. My effective Internet use was <u>limited</u> because of the:					
	0	1	2	3	4
Lack of knowledge in using the software	<input type="radio"/>	<input type="radio"/>	<input type="radio"/>	<input type="radio"/>	<input type="radio"/>
Lack of knowledge in using the hardware	<input type="radio"/>	<input type="radio"/>	<input type="radio"/>	<input type="radio"/>	<input type="radio"/>
Lack of knowledge in finding information online	<input type="radio"/>	<input type="radio"/>	<input type="radio"/>	<input type="radio"/>	<input type="radio"/>
Lack of knowledge in interacting online with others	<input type="radio"/>	<input type="radio"/>	<input type="radio"/>	<input type="radio"/>	<input type="radio"/>
Lack of knowledge of Internet security issues	<input type="radio"/>	<input type="radio"/>	<input type="radio"/>	<input type="radio"/>	<input type="radio"/>

Digital Inequality: The Internet in Mauritius

Section 5: Social Support

23. What was the most important reason why you started using the Internet. (Select the one that best applies)

- I thought it might be interesting.
- Someone else recommended it to me
- I started simply because Internet is readily accessible at home/work/educational institution
- I had to use it at work
- I used it to make money
- I used it to improve my career
- I had to use it for educational purposes (school/college/university/helping the children)
- To keep in touch with family/friends
- To develop my Internet-use skills

Other (please specify)

24. How often do you seek help from others when using the Internet?

- | Never | Occasionally | Sometimes | Often | Almost all the time |
|-----------------------|-----------------------|-----------------------|-----------------------|-----------------------|
| <input type="radio"/> | <input type="radio"/> | <input type="radio"/> | <input type="radio"/> | <input type="radio"/> |

25. Is help easily available when you need it?

- Yes
- No

26. From whom do you mostly get help from in your use of the Internet. (select the one that best applies)

- Family members
- Friends or neighbours
- Teachers/lecturers/trainers (from educational institutions)
- Classmates/peers
- Colleagues
- Organisational IT department
- Cybercafé/Library help desk
- Online help forums

Other (please specify)

Digital Inequality: The Internet in Mauritius

27. Who gives you the best help in your use of the Internet?

Family members
 Colleagues
 Friends or neighbours
 Organisational IT department
 Teachers/lecturers/trainers (from educational institutions)
 Cybercafé/Library help desk
 Classmates/peers
 Online help forums

Other (please specify)

On a scale of 0-4, indicate how the following factors prevented you using the Internet well.

0 = No effect at all
1 = Little negative effect
4 = Significant negative effect

28. My effective Internet use was limited because of:

	0	1	2	3	4
Lack of help/support when I needed it	<input type="radio"/>	<input type="radio"/>	<input type="radio"/>	<input type="radio"/>	<input type="radio"/>
Lack of encouragement to use Internet	<input type="radio"/>	<input type="radio"/>	<input type="radio"/>	<input type="radio"/>	<input type="radio"/>
No clear idea of why I should use the Internet	<input type="radio"/>	<input type="radio"/>	<input type="radio"/>	<input type="radio"/>	<input type="radio"/>
No safe place where I could use the Internet	<input type="radio"/>	<input type="radio"/>	<input type="radio"/>	<input type="radio"/>	<input type="radio"/>

Digital Inequality: The Internet in Mauritius					
Section 6: Purpose of Use					
<i>This section looks at your purpose for connecting and using the Internet.</i>					
29. How important are the following activities for you when you <u>use the Internet</u>?					
0 = Not Important at all					
4 = Very Important					
	0	1	2	3	4
Information seeking (research, following contacts, newsletters, etc.)	<input type="radio"/>	<input type="radio"/>	<input type="radio"/>	<input type="radio"/>	<input type="radio"/>
Communicating directly with other people (email, chat, video calls, etc.)	<input type="radio"/>	<input type="radio"/>	<input type="radio"/>	<input type="radio"/>	<input type="radio"/>
Making and maintaining social networks (Facebook, LinkedIn, Twitter, etc.)	<input type="radio"/>	<input type="radio"/>	<input type="radio"/>	<input type="radio"/>	<input type="radio"/>
Performing online transaction (online banking, shopping, online selling, etc.)	<input type="radio"/>	<input type="radio"/>	<input type="radio"/>	<input type="radio"/>	<input type="radio"/>
Playing Games (either alone or with other people)	<input type="radio"/>	<input type="radio"/>	<input type="radio"/>	<input type="radio"/>	<input type="radio"/>
Listening, downloading and sharing music (streaming, downloading and sharing)	<input type="radio"/>	<input type="radio"/>	<input type="radio"/>	<input type="radio"/>	<input type="radio"/>
Viewing, downloading and sharing videos (streaming, downloading and sharing)	<input type="radio"/>	<input type="radio"/>	<input type="radio"/>	<input type="radio"/>	<input type="radio"/>
Publishing Information (blogging, maintaining a website, writing articles online, etc.)	<input type="radio"/>	<input type="radio"/>	<input type="radio"/>	<input type="radio"/>	<input type="radio"/>
Distributing multimedia production of your own (photography, videos, audios, etc.)	<input type="radio"/>	<input type="radio"/>	<input type="radio"/>	<input type="radio"/>	<input type="radio"/>
Working collaboratively in a team or organisation to achieve a goal (whether fully online or with people you also meet in person)	<input type="radio"/>	<input type="radio"/>	<input type="radio"/>	<input type="radio"/>	<input type="radio"/>
Supporting political parties online (e.g through online discussion and debate)	<input type="radio"/>	<input type="radio"/>	<input type="radio"/>	<input type="radio"/>	<input type="radio"/>
Support a cause you highly believe in (Animal welfare, social cause, etc)	<input type="radio"/>	<input type="radio"/>	<input type="radio"/>	<input type="radio"/>	<input type="radio"/>

Digital Inequality: The Internet in Mauritius										
Section 7: Closing										
How far do you <u>agree</u> with the following statement on a scale of 1 to 10?										
1 = Extremely Disagree										
10 = Extremely Agree										
30. "All Mauritian Internet users derive maximum benefits in every aspect (devices used/connection, freedom of use, skill, help, and purpose of use) of their Internet use."										
1	2	3	4	5	6	7	8	9	10	
<input type="radio"/>	<input type="radio"/>	<input type="radio"/>	<input type="radio"/>	<input type="radio"/>	<input type="radio"/>	<input type="radio"/>	<input type="radio"/>	<input type="radio"/>	<input type="radio"/>	<input type="radio"/>

Digital Inequality: The Internet in Mauritius

Thank you page

Thank you for your precious time in answering this survey. Should you be willing to contribute further to the research by having a face-to-face interview with the researcher, please leave your email address below and you will be contacted in due time.

Your email address will in no way be used to identify you.

31. Email :

Click on 'done' to submit the survey

Appendix C: Interview Questions

Appendix C.1

Interview Information Sheet

Research Title: Digital Inequality: The Internet in Mauritius.

Research Aim:

1. To develop a clear understanding of the term Digital Inequality.
2. To investigate the diffusion of Internet technologies and use among the Mauritian population.
3. To identify the main causes/determinants of Digital Inequality in the Mauritian Society if it is shown to exist
4. To situate governmental and non-governmental initiatives in relation to the main determinants of Digital Inequality

Participant Requirements:

1. Participants will be interviewed on the following issues:
 - a. The role of their organisation in the development and diffusion of Internet access and use among the Mauritian population.
 - b. The initiatives, if any, set up to increase the diffusion and use of Internet access in Mauritius and its relative success. If no initiatives have been set up, why is this so and its relative importance for the organisation.
 - c. Their perception on Internet use and the difference in such use by Mauritians.

- d. Generic questions on the use, social support, skill and purpose of use of Mauritian Internet users.
 - e. The initiatives, if any, set up by their organisation to address the issue of Digital Inequality and their relative effectiveness. If no initiatives have been set up, why this is the case and whether there are plans to address the issue and if not why.
2. Users will have the right to refuse to answer questions if deemed too sensitive.
 3. Interview should last no longer than one hour.

Confidentiality:

1. All Interviewees will be required to sign a consent form.
2. Interviewees will have the right to withdraw their participation at any time up to the publication of thesis and/or any other publications
3. All information will be kept strictly confidential unless permission is given by Interviewee (see Consent Form Confidentiality options).
4. All questions are designed to eliminate bias.

Risks:

This research poses no safety risks to the participants although some personal questions and/or questions related to interviewee's position within the organisation will be asked.

Ethics Approval

The Curtin Humanities Ethics Committee has approved this research with approval number: **MCCA-04-12**

Should Interviewee wish to make a complaint on Ethical Grounds, requests can be made in writing to

Human Research Ethic Committee (Secretary)
 C/- Office of Research and Development
 Curtin University
 GPO Box U1987
 Perth, WA 6845

Contact information

For further information, please contact the following

Shafiiq Gopee	shafiiq.gopee@telfair.ac.mu	PhD Student
A/Prof. Michele Willson	m.willson@curtin.edu.au	Supervisor
Prof. Matthew Allen	m.Allen@exchange.curtin.edu.au	Supervisor

Appendix C.2

Interview Consent form.

Title: Digital Inequality: The Internet in Mauritius

Statements:

In line with Curtin University Ethics Committee and the Australian NHMRC National Statement on Ethical Conduct in Human Research, I confirm that I understand and consent to the following:

- I am aware and understand the purposes of the study as outlined in the Interview Information Sheet.
- I am allowed to refuse to participate without giving any reason or justification.
- I am allowed to end the interview and withdraw from the research at any time without prejudice up till the publication of the thesis and/or other publications.
- I have been given the opportunity to ask questions.
- I agree to participate in the study as outlined to me and as per the confidentiality option circled below.

Confidentiality Options:

Please indicate your acceptance of one of the following options by circling the chosen option.

Option 1: Yes, I give permission for this interview to be recorded and any words spoken by me can be quoted and attributed to me in both doctoral dissertation and/or other publications.

Option 2: Yes, I give permission for this interview to be recorded. However, while I am happy for non-attributable generalisations to be drawn

from this interview, any specific quotes or attributes will require additional authorisation by me in both doctoral dissertation and/or other publications.

Option 3: Yes, I give permission for this interview to be recorded for the purpose of the researcher's later review and analysis but that nothing I say in this Interview will be attributed to me or publicised in a manner that would imply attribution in both doctoral dissertation and/or other academic publications.

Name:

Date:

Signature:

Appendix C.3

Interview Questions: Government and Governmental bodies (ICTA, NCB, Mauritius Post)

1. Can you please tell me a bit about yourself and your organisation in relation to the Internet in Mauritius?

Access

2. What does your government/organisation believe is the role/place of the Internet in the socio-economic development of Mauritius?
3. Do you believe that the Internet has reached that place or fulfil that role? Why and why not?
4. Can you tell me some of the ways in which the Internet is being used to develop Mauritius?
[Follow up on economic, social, cultural and human]
5. What is the role of your ministry/organisation in the development of the Internet in Mauritius?
[Follow up on access, skill, pricing, and use]
6. What is the current state of Internet access in Mauritius?
[Follow up on penetration rate, use, pricing]
7. Can you give me some ideas of what are your perceptions as to why the level of Internet penetration/access is as it is [Low]?
8. What do you think can be or should be done to increase the level of penetration?

9. What are the major obstacles you might think that will impede such progress?
10. What has your ministry/organisation done over the past 5 years to increase the level of penetration?
11. What are your plans for the next 5 years to increase the level of penetration?
12. What do you think will be the main obstacles to your plan? Why?

Use

13. Can you tell me some of the ways in which Mauritians use the Internet?
[Follow up, communication, publishing, social, entertainment, Human Capital, Economic Capital, Social Capital]
14. Speaking of Internet use, what would you qualify as effective (proper) use?
15. Would you think that the Mauritians are using the Internet effectively?
 - If Yes – can you give me some idea of what your perception are as to why people are using the Internet effectively?
 - If No – can you give me some idea of what your perceptions are as to why people are not using the Internet effectively?
16. What do you think might make them use it more effectively?
17. What is the role of your ministry in making Mauritians use the Internet effectively

Devices

18. What do you think are the main issues preventing Mauritian from accessing [using] (in terms of the technology/devices) the Internet

effectively?

19. What is the role of your government in providing for such effective use?

Autonomy of use

20. Do you think Mauritian are free to access any material they wish on the net?

21. Do you think that Mauritians should be free to access any content on the Internet? Why?

22. What do you think should be done to give/or not more freedom to Mauritian Internet users?

Social Support

23. What would you think are the barriers to Internet use in Mauritius?

24. What is your Government's perception on the motivation that needs to be given to Mauritian to use the Internet and to increase their digital competences?

25. Does your organisation have a responsibility in developing such support?

26. What strategies have been put in place to increase such competence other than formal training?

Skill

27. What is your Government's perception on the level of Internet skill (in using the Internet properly) of Mauritian Internet users?

28. What is your Government's role in developing Mauritian Internet user's skill?
29. What do you think are the obstacles in increasing the skill level of Internet users?
30. What relationship do you have with commercial partners (ISP etc.) and other organisations (Internet Society Mu, MTIA, OTAM) in getting more people to use the Internet?
31. How is your organisation using the Internet?
32. How would you qualify your staff competence in the use of Internet?
33. Last question. Assuming that everyone on the island is has Internet access, what major issues do you foresee? [Follow up on devices, autonomy, support, skill and use]
34. Do you think I should be talking to other persons, if so, whom?

Appendix C.4

Interview Questions: Internet Service Provider

1. Can you please tell me a bit more about yourself and your company in relation to the Internet?

Access

2. What does your company believe is the role/place of the Internet in the socio-economic development of Mauritius?
3. Do you believe that the Internet has reached that place or fulfil that role? Why and why not?
4. Can you tell me some of the ways in which the Internet is being used to develop Mauritius?
[Follow up on economic, social, cultural and human]
5. Does your company have a role in the development of the Internet in Mauritius? What is it and why is it important?
[Follow up on access, skill, pricing, use]
6. What does your organisation believe is the current state of Internet access in Mauritius?
[Follow up on penetration rate, use, pricing]
7. Can you give me some ideas of what are your perceptions as to why the level of penetration is as it is?
8. What do you think can be or should be done to increase the level of penetration?

9. What are the major obstacles you might think that will impede such progress?
10. What has your company done over the past 5 years to increase the level of penetration?
11. What are your plans for the next 5 years to increase the level of penetration?
12. What do you think will be the main obstacles to you plan? Why?

Use

13. Can you tell me some of the ways in which Mauritians use the Internet?
14. Speaking of Internet use, what would you qualify as effective use?
15. Would you say that the Mauritians are using the Internet effectively?
If yes – can you give me some idea of what your perception are as to why people are using the Internet effectively?
If No- Can you give me some idea of what your perceptions are as to why people are not using the Internet effectively?
16. What do you think might make them use it more effectively?
17. What is the role of your company in making Mauritians use the Internet effectively?

Devices

18. What do you think are the main issues preventing Mauritian from accessing (in terms of the technology/devices) the Internet effectively?
19. What is the role of your company in providing for such effective use?

Autonomy of use

20. Do you think that Mauritians should be free to access any content on the Internet? Why?
21. What is your role in allowing/preventing such free access?
22. What do you think should be done to give/or not to give more freedom to Mauritian Internet users?

Social Support

23. What is your company's perception on the motivation that needs to be given to Mauritian to use the Internet and to increase their digital competences?
24. Does your company have a responsibility in setting up strategies to increase such competence other than formal training?
25. What strategies do you think should be put in place for Mauritian to increase their digital competence?

Skill

26. What is your company's perception on the level of Internet skill of Mauritian Internet users?
27. What is your company's role in developing Mauritian Internet user's skill?
28. What do you think are the obstacles in increasing the skill level of Internet users?

29. What relationship do you have with other commercial partners (ISP etc.), governmental bodies (MICT, NCB, ICTA) other organisations (MTIA, OTAM) in getting more people to use the Internet?

30. What relationship do you have with other commercial partners (ISP etc.), governmental bodies (MICT, NCB, ICTA) other organisations (MTIA, OTAM) in getting people to use the Internet effectively?

31. How is your organisation using the Internet?

32. How would you qualify your staff competence in the use of Internet?

33. Last question. Assuming that everyone on the island is has Internet access, what major issues do you foresee?

[Follow up on devices, autonomy, support, skill and use]

Appendix C.5

Interview Questions: Civil Society Organisations

1. Can you please tell me a bit about your organisation and its relation to the Internet in Mauritius?

Access

2. What does your organisation believe is the role/place of the Internet in the social and economic development of Mauritius?
3. Do you believe that the Internet has reached that place or fulfil that role? Why and why not?
4. Can you tell me some of the ways in which the Internet is being used to develop Mauritius?
[follow up on economic, social, cultural and human]
5. Does your organisation have a role/responsibility in the development of the Internet in Mauritius? What is it and why is it important?
[follow up on access, skill, pricing, use]
6. What does organisation believe is the current state of Internet access in Mauritius?
[follow up on penetration rate, use, pricing]
7. Can you give me some ideas of what are your perceptions as to why the level of penetration is as it is?
8. What do you think can be or should be done to increase the level of penetration and what is the responsibility of your organisation in this?

9. What are the major obstacles you might think that will impede such progress?

Use

10.
[follow up on Communication, Publishing, Creating ,Social , Entertainment Human capital, economic capital, Social Capital]
11. Would you think that the Mauritians are using the Internet effectively?
If Yes – can you give me some idea of what your perception are as to why people are using the Internet effectively?
If No- Can you give me some idea of what your perceptions are as to why people are not using the Internet effectively?
12. What do you think might make them use it more effectively?
13. Does your organisation have a role/responsibility in making Mauritians use the Internet effectively? If so, what is it that you are doing and what are the obstacles?

Devices

14. What do you think are the main issues preventing Mauritian from accessing (in terms of the technology/devices) the Internet effectively?[follow up on speed of Internet and devices use]
15. Does your organisation have a role in providing for such effective use?
16. What do you think is being done to make Mauritian use the Internet more effectively in terms of the devices used ?
17. What do you think should be done and who should be responsible?

Autonomy of Use

18. Do you think Mauritian are free to access any material on the Internet?
19. Do you think that Mauritians should be free to access any content on the Internet? Why?
20. Does your organisation have a role to play in allowing/preventing such free access?
21. What do you think should be done to give/or not to give more freedom to Mauritian Internet users?

Social Support

22. What would you think are the main barriers to Internet use in Mauritius?
23. What is your organisation's perception on the motivation that needs to be given to Mauritian to use the Internet and to increase their digital competences?
24. Does your organisation have a responsibility in setting up strategies to increase such competence other than formal training?
25. What strategies do you think should be put in place for Mauritian to increase their digital competence?

Skill

26. What is your organisation's perception on the level of Internet skill of Mauritian Internet users?

27. Does your organisation have a responsibility/role in developing Mauritian Internet user's skill?
28. What do you think should be done to increase Mauritian Internet users skill?
29. What relationship do you have with governmental and commercial (ISP etc.) and other organisations (MTIA, OTAM) in getting more people to use the Internet?
30. What relationship do you have with governmental and commercial (ISP etc.) and other organisations (MTIA, OTAM) in relation to those already using the Internet?
31. How is your organisation using the Internet?
32. How would you qualify your staff competence in the use of Internet?
33. Last question. Assuming that everyone on the island has Internet access, what major issues do you foresee?
[Follow up on devices, autonomy, support, skill and use]
34. Do you think I should be talking to other persons regarding the project, if so whom?

Appendix D: Inferential Statistics: Factor Analysis



Appendix D1.

Test of Normality							
		Kolmogorov-Smirnova			Shapiro-Wilk		
		Statistic	df	Sig.	Statistic	df	Sig.
1	Hardware	0.348	413	0.00	0.713	413	0.00
2	Software	0.279	413	0.00	0.774	413	0.00
3	Bandwidth	0.165	413	0.00	0.888	413	0.00
4	Reliability of connection	0.159	413	0.00	0.906	413	0.00
5	Lack of time to spend online	0.251	413	0.00	0.804	413	0.00
6	Cost of Internet connection	0.323	413	0.00	0.736	413	0.00
7	Blocking of Internet content and services	0.296	413	0.00	0.777	413	0.00
8	Monitoring of Internet use	0.412	413	0.00	0.62	413	0.00
9	Sharing of devices with other people	0.34	413	0.00	0.717	413	0.00
10	Place of use	0.267	413	0.00	0.797	413	0.00
11	Lack of accessibility	0.276	413	0.00	0.766	413	0.00
12	Advanced search	0.349	413	0.00	0.681	413	0.00
13	Photo tagging	0.396	413	0.00	0.629	413	0.00
14	Content upload	0.377	413	0.00	0.669	413	0.00
15	Tabbed browsing	0.353	413	0.00	0.704	413	0.00
16	Wi-Fi router/Livebox	0.323	413	0.00	0.74	413	0.00
17	Modem	0.311	413	0.00	0.769	413	0.00
18	Privacy settings	0.345	413	0.00	0.709	413	0.00
19	Cookies	0.229	413	0.00	0.828	413	0.00
20	Cache	0.197	413	0.00	0.856	413	0.00
21	Phishing	0.185	413	0.00	0.859	413	0.00
22	Spyware	0.221	413	0.00	0.839	413	0.00
23	Lack of knowledge in using software	0.344	413	0.00	0.724	413	0.00
24	Lack of knowledge in using hardware	0.358	413	0.00	0.703	413	0.00
25	Lack of knowledge in finding information online	0.361	413	0.00	0.66	413	0.00
26	Lack of knowledge of online interaction with Tests others	0.386	413	0.00	0.622	413	0.00
27	Lack of knowledge of security issues	0.283	413	0.00	0.778	413	0.00
28	Help-seeking to use the Internet	0.279	413	0.00	0.788	413	0.00
29	Lack of help/support when I needed it	0.362	413	0.00	0.688	413	0.00
30	Lack of encouragement to use the Internet	0.424	413	0.00	0.559	413	0.00
31	No clear idea of why I should use the Internet	0.428	413	0.00	0.543	413	0.00
32	No safe place where I could use the Internet	0.42	413	0.00	0.561	413	0.00
33	Information seeking	0.433	413	0.00	0.565	413	0.00
34	Communicating directly with other people	0.401	413	0.00	0.647	413	0.00
35	Making and maintaining social networks	0.253	413	0.00	0.814	413	0.00
36	Performing online transactions	0.176	413	0.00	0.867	413	0.00
37	Playing games	0.184	413	0.00	0.866	413	0.00
38	Listening to, downloading and sharing music	0.274	413	0.00	0.792	413	0.00
39	Viewing, downloading and sharing videos	0.269	413	0.00	0.806	413	0.00
40	Publishing information	0.173	413	0.00	0.874	413	0.00
41	Distributing own multimedia production	0.176	413	0.00	0.868	413	0.00
42	Collaborative work	0.183	413	0.00	0.87	413	0.00
43	Supporting a political party	0.438	413	0.00	0.533	413	0.00
44	Supporting a cause	0.176	413	0.00	0.875	413	0.00
Lilliefors Significance Correction							

Table D.1: Test for Normality.

Appendix E: Image Permissions

All attempts have been made to receive permission for images used in this thesis. Permissions were not sought for images falling under the Creative Commons but authors have been duly acknowledged.

From: [REDACTED]  
Subject: Permission to use CBT1 photo
Date: 13 May, 2016 at 11:26 AM
To: shafiq.gopee@telfair.ac.mu
Cc: [REDACTED]



Dear Mr Gopee,

We thank you for your email and your ethical approach towards asking our permission to use the photo mentioned. We would have no objection if the photo is correctly used in the dissertation and does not in whatsoever way jeopardise the image and credibility of the Business Parks of Mauritius Ltd; Ebene Cybercity and other shareholders and stakeholders. We trust the above will be met and we wish you all success in the research. We would be delighted to know more from you on the topic researched and your findings if you do have time to visit us.

Yours sincerely,



Ramdhur Veena - ACIM
Marketing Manager
Business Parks of Mauritius Ltd
7th Floor, Wing A, Cyber Tower-1,
Ebene, Cybercity, Mauritius
Tel: (230) 467 6900 | Fax: (230) 467 6907
Email: [REDACTED]
www.e-cybercity.mu

From: SHAHEEN GHAZALA RUMMUN [redacted] 
Subject: RE: Permission to use NCB images in PhD Thesis
Date: 9 May, 2016 at 3:27 PM
To: shafiiq.gopee@telfair.ac.mu
Cc: [redacted], [redacted]

SG

Dear Mr. Gopee

We spoke, Please find attached requested pictures for the Cyber Caravan of the NCB.

Kind Regards,

Shaheen Rummun
IT Support Officer | ICT Culture Promotion
National Computer Board
Tel: +230 210 5520
Fax: +230 212 4240
Email: [redacted]
URL: www.ncb.mu

From: Shafiiq Gopee [<mailto:shafiiq.gopee@telfair.ac.mu>]
Sent: 09 May 2016 13:52
To: VIK BHOYROO
Subject: Permission to use NCB images in PhD Thesis

Dear Mr. Bhoyroo,

I am Shafiiq Gopee, from the Charles Telfair Institute (CTI) and currently completing my thesis on Digital Inequality in Mauritius from Curtin University. We spoke at some point and you even gratefully provided me with information to write my thesis.

I am currently finalising my thesis and I would like the authorisation/permission of the NCB to use the attached pictures (retrieved from the NCB website) in my thesis, with the required referencing and acknowledgment.

I would be grateful if you could forward my email to the concerned department if such decisions fall beyond your scope.

Thank you for your co-operation

Regards

Shafiiq Gopee

Senior Lecturer
Charles Telfair Institute
Tel: +230 401 6511
Mob: +230 5250 1124
Fax: +230 433 3005
www.telfair.ac.mu

<<Page left Blank>>