

## Design and Development of Low-Cost Water Tunnel for Educational Purpose

This content has been downloaded from IOPscience. Please scroll down to see the full text.

2015 IOP Conf. Ser.: Mater. Sci. Eng. 78 012040

(<http://iopscience.iop.org/1757-899X/78/1/012040>)

View [the table of contents for this issue](#), or go to the [journal homepage](#) for more

Download details:

IP Address: 134.7.93.129

This content was downloaded on 21/03/2017 at 07:12

Please note that [terms and conditions apply](#).

# Design and Development of Low-Cost Water Tunnel for Educational Purpose

**M Zahari and S S Dol<sup>1</sup>**

Department of Mechanical Engineering, Curtin University  
Sarawak Campus CDT 250, 98009 Miri, Sarawak, MALAYSIA

E-mail: sharulsham@curtin.edu.my

**Abstract.** The hydrodynamic behaviour of immersed body is essential in fluid dynamics study. Water tunnel is an example of facility required to provide a controlled condition for fluid flow research. The operational principle of water tunnel is quite similar to the wind tunnel but with different working fluid and higher flow-pumping capacity. Flow visualization in wind tunnel is more difficult to conduct as turbulent flows in wind dissipate quickly whilst water tunnel is more suitable for such purpose due to higher fluid viscosity and wide variety of visualization techniques can be employed. The present work focusses on the design and development of open flow water tunnel for the purpose of studying vortex-induced vibration from turbulent vortex shedding phenomenon. The water tunnel is designed to provide a steady and uniform flow speed within the test section area. Construction details are discussed for development of low-cost water tunnel for quantitative and qualitative fluid flow measurements. The water tunnel can also be used for educational purpose such as fluid dynamics class activity to provide quick access to visualization medium for better understanding of various turbulence motion learnt in class.

## 1. Introduction

Water tunnels are used for a variety of reasons such as testing a structure under flowing fluid, which affect the forces on the submerged body. Water tunnels are also used for preliminary measurements of prototypes (e.g. vehicles, buildings, towers and bridges) early design such as to conduct flow visualization around models. Water tunnels are generally preferred over wind tunnels for measurement like Particle image velocimetry (PIV). This is because flow visualization in wind tunnels is harder to control and it dissipates quickly [1].

However, a proper research-purposed and commercial water tunnels are too expensive and they are generally huge in size. For example, Model 1520 Water Tunnel (Hills Research Corporation) costs around hundred thousand USD and requires a large amount of lab space approximately  $10 \times 5 \times 2 \text{ m}^3$  (length x width x height) as shown in figure 1 [2]. The velocities at test section vary from 0 up to 0.3 m/s and contain approximately 3785 litres of water. Due to the high cost of commercial water tunnel, it leads to the idea of fabricating a low-cost water tunnel with acceptable quality for the educational purposes.

---

<sup>1</sup> To whom any correspondence should be addressed.





**Figure 1.** Model 1520 Water Tunnel [2].

The present water tunnel is designed to focus on visualizing the effects of vortex-induced vibration (VIV) on the submerged structure. The structure, which is a circular cylinder experiences vortex shedding from turbulent flow. In order to achieve the goal of designing and constructing of an open-typed water tunnel for research and educational purposes, it is carefully built to provide a uniform flow at the test section for wide range of Reynolds numbers. Another aim is to minimize the cost of construction and recognize the capabilities of water tunnel in solving practical fluid flow engineering problems.

## 2. Water tunnel design

This section discusses on the design of open channel water tunnel that can be used to study the turbulent flow phenomena such as flow characteristics of VIV on immersed body. The water tunnel as shown in figure 2 is designed by using the SolidWork2012 and AutoCAD2012 softwares. The design is based on modifications of water tunnels from the previous studies [3-4]. The aim of this water tunnel is to provide a steady and uniform flow speed within data collection area. The term steady implies no change at a point with time while the term uniform implies no change with location over a specified region [5]. Besides, this water tunnel is designed to provide a similar flow speed of ocean current in the range of 0.5 to 1.2 m/s [6] for the VIV application.

### 2.1. Glass tank

In this water tunnel design, a rectangular glass tank which is made from 0.001 m thickness of glass plate with a dimension of  $1.8 \times 0.7 \times 0.7 \text{ m}^3$  (length x width x height) is used to hold a large amount of water. Glass material is chosen due to its high hardenability and transparent surface. A transparent glass plate is important for flow visualization purpose.

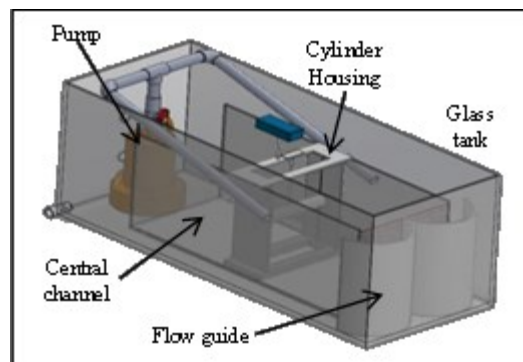

**Figure 2.** Open channel water tunnel designed using SolidWork software.

### 2.2. Central channel

A central channel, which is made from 1.3 x 0.5 m<sup>2</sup> Polyvinyl chloride (PVC) board plates, is placed at the centre of glass tank for data collection area. PVC is chosen because it is easy to construct and cheaper in price. Besides, its smooth surface can reduce friction of water flow and increase flow effectiveness. At the central channel entrance, screen which is made up from 1 cm<sup>2</sup> wire mesh is placed to provide uniform flow (figure 3). Screens have been used to minimize the intensity of the oncoming turbulence and improve the mean flow uniformity [7].

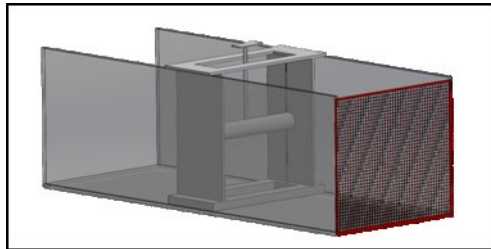

**Figure 3.** Screen positioned at the central channel entrance.

### 2.3. Flow guides

Two clear PVC flow guides with the radius of 17 cm as shown in figure 4 is placed at the end of the glass tank to join the water flow from both side of water tunnels and direct it through the central channel. The aim of this flow guides is to provide a steady flow within the central channel.

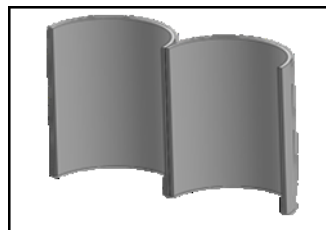

**Figure 4.** Flow guides.

### 2.4. Pump and piping systems

A proper water pump and piping systems (figure 5) is essential in designing water tunnel in order to produce adequate flow rates. This water tunnel is designed with a submersible pump as it can provide higher water flow rates. Other benefits of submersible pump are listed as the following:

- Submersible pump is completely watertight, and risks of leakages and electric contacts are eliminated.
- Submersible pump uses no suction to get the water through to the pipes thus the pressure is optimized.
- Submersible pump minimizes the pump cavitation problems compared to the centrifugal pump [8].

The piping system is designed to fit with the submersible pump. From the discharge of the pump, the water flows upward through a vertical PVC pipe with the diameter of 2 inch pipe. A valve is placed in the between of vertical PVC pipe to allow the adjustment of water flow rates. Then, the water flow is separated at the top using the t-shape pipe fitting and directs it along the side of water tunnel using 90o elbow.

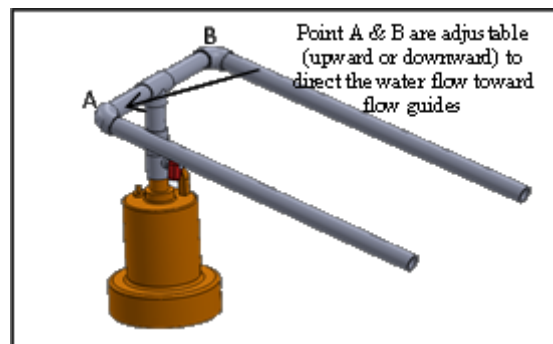

**Figure 5.** Submersible pump and piping systems.

### 2.5. Cylinder housing

The cylinder housing which is made from thick PVC plates is designed to place the testing cylinder at any location within the channel (figure 6). The top of cylinder housing is cut out to allow for cylinder visibility and space for measurement platform to oscillate. The cylinder housing will be placed within the channel and enable to move backward and forward along the channel to find a suitable data collection position. Hooks are connected with the cylinder housing to allow the attachment of springs and cylinder.

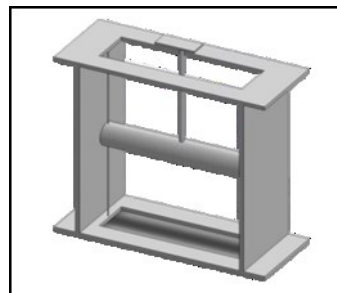

**Figure 6.** Cylinder housing.

The completed parts of water tunnel are assembled together for the clear view of complete water tunnel design as shown in figure 7.

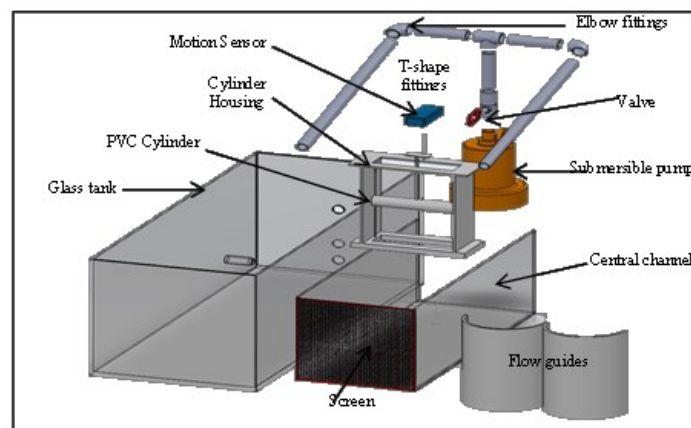

**Figure 7.** Exploded view of water tunnel.

### 3. Water tunnel construction

#### 3.1. Glass tank

This glass tank has a rectangular shape and the most expensive part of the water tunnel. The glass tank plates are assembled using silicone sealant to prevent leaking on tank. For the safety reason, the edges of glass plates are sanded.

#### 3.2. Central channel

The central channel which is made up from PVC boards is glued together to form a rectangular shape. Stapler bullets are used to attach the screen to the central channel as shown in figure 8. Near the edges of the central channel, the PVC board is drilled and the threaded steel rod is fixed inside of each holes. The threaded steel rod is bolted by the nuts to the board in order to ensure the position of central channel is placed centrally inside the glass tank.

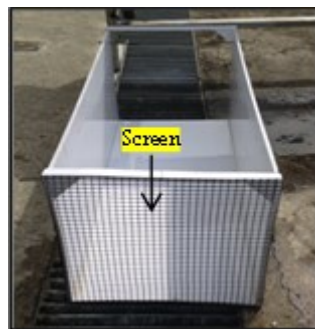

Figure 8. Screen fitted at the central channel entrance.

#### 3.3. Flow guides

Two flow guides are shaped from clear PVC plates to form semi-circular shape with the radius of 17 cm. These flow guides are placed at the end of the glass tank to join flow from both side channels and direct it through the central channel as shown in figure 9. Flow guides are attached to the glass tank using silicone sealant and dried in 2-3 days to ensure the strength of the flow guides to reflect the incoming flow from both sides of the tunnel to the central channel.

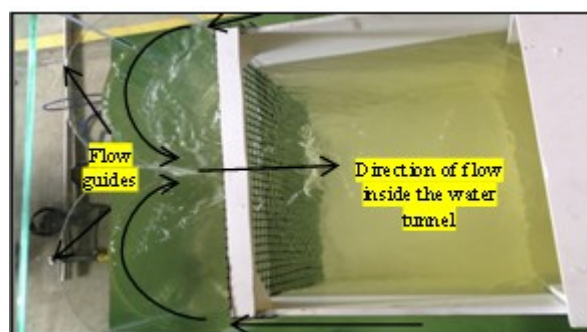

Figure 9. Flow guides are placed inside the water tunnel.

#### 3.4. Pump and piping systems

In this project, submersible pump is used to provide the water flows inside the water tunnel. The pump flow rate is rated at 260 liter/minute with the output of 50 Watt. Thus, a single pump is sufficient to

provide the required flow rate 0.5 m/s within the data collection area. A valve is connected with the pump to allow the adjustment of the flow rates during measurement. Two elbows, a t-shape fitting, 2” and 1” inches pipes are used for the piping systems. All the fittings and valve are joined with pipes using the PVC glue, except on the elbow fittings to allow the adjustment of the flow direction toward the flow guides.

### 3.5. Cylinder housing

The cylinder housing with the height of 0.5 m is formed from four plates of thick PVC, joined together to form a square shape on the front view. It is constructed to place the testing cylinder at any location within the channel. On the top of cylinder housing, a 20 cm x 10 cm rectangular hole is cut to allow movement of measurement platform which is attached with the testing cylinder. The cylinder is oriented horizontally with four springs which is connected in this cylinder housing and created “H” shape. All the parts and equipment is assembled together as shown in figure 10.

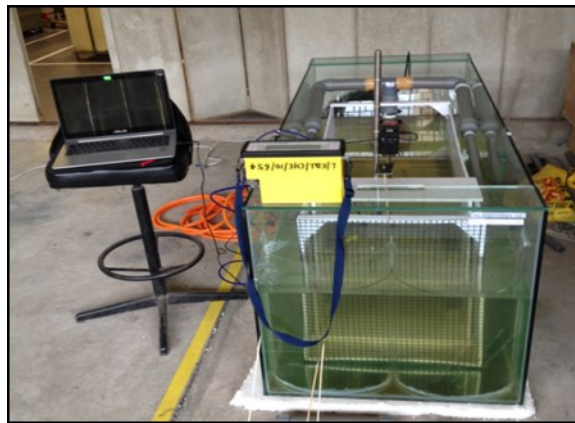

**Figure 10.** Assembled open channel water tunnel.

## 4. Material and construction costs

One of the project objectives is to fabricate the water tunnel with the least cost possible so that the facility becomes affordable for all educational purposes without sacrificing its quality. Table 1 summarizes the overall materials and parts used in this project.

**Table 1.** Summary of material and construction costs

Items	Amount (RM)
1 cm thick glass tank	1500.00
PVC central channel	200.00
260 l/ min submersible pump	700.00
Piping systems (pipes, elbow, t-shape fitting)	100.00
Cylinder housing	150.00
Flow guides	50.00
Motion sensor	200.00
Springs (various size)	80.00
Others (steel rods, screws, bolts, glue, etc.)	200.00
Manufacturing cost	1000.00
<b>TOTAL</b>	<b>4180.00</b>



The total cost of this water tunnel is RM 4180.00 and it is relatively reasonable compared to the commercial water tunnel.

### 5. Flow velocity measurement

The flow within the data collection area needs to be steady and uniform for controlled condition measurement. For verification, flow measurement has been conducted. Flow meter is placed into the central channel, approximately 50 cm away from the flow guides and the flow sensor blade is parallel to the direction of flow. Open channel flow meter is used to determine the water velocity inside the central channel. Figure 11 and 12 below show the positions of flow velocity along the water depth which are measured inside the water tunnel.

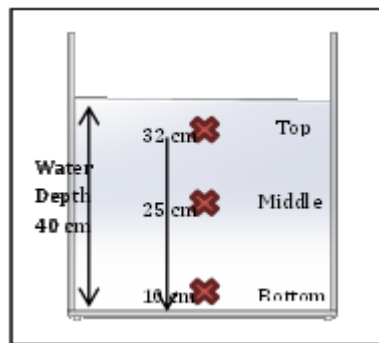

**Figure 11.** Position of measured water velocity.

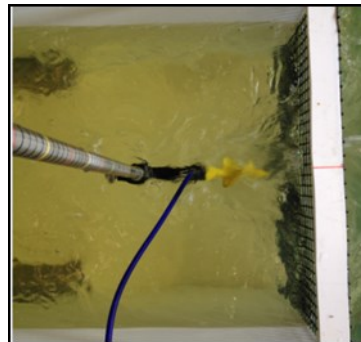

**Figure 12.** Open channel flow meter.

Figure 13 showed graphs of 10 samples of flow rate results. It shows the speed variation is small and within the acceptable region. Moreover, the flow characteristic of this water tunnel is similar to the characteristic of steady flow. This is due to the small different of flow speed changes with time for each trial. Top position gives a better result compared to the middle and bottom positions, indicating uniform flow. As the small different of flow speed along the length of the channel, it suggests the characteristic of this flow is nearly similar with the characteristic of uniform flow [5].



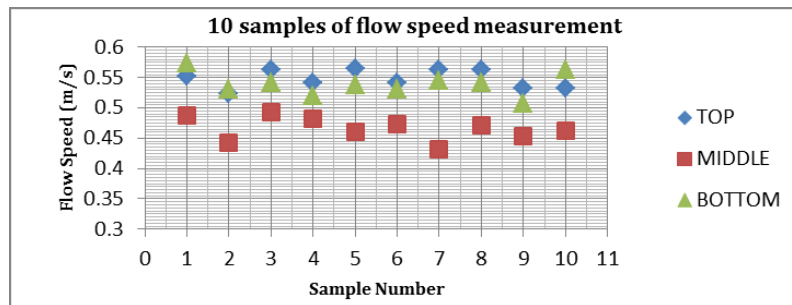

**Figure 13.** Graph of sample number versus velocity.

## 6. Conclusion

The flow measurement results show that the mean flow velocity is in the interest range of ocean current flow which is 0.5 m/s for the vortex-induced vibration measurements. The flow characteristic of this water tunnel is nearly similar with the characteristic of steady and uniform flow. The cost of this water tunnel is very reasonable, which is about four thousands Ringgit Malaysia (RM). Overall, this water tunnel design and development has achieved its objective and has a capability to study the flow around small scale of fundamental structures and behavior of vortex induced vibration (VIV).

## References

- [1] Dol S S and Nor M A M 2006 Flow visualization of the vortex shedding of a stationary circular cylinder by an improved smoke-wire technique *WSEAS Fluid Mechanics Transactions* **1(6)** 745-52
- [2] Rolling Hills Research Corporation 2014 *Research Water Tunnels Specification* USA
- [3] Hennessey T V 2005 The design and construction of an open channel recirculating water tank for the study of biological hydrodynamics *Thesis (B.S) Massachusetts Institute of Technology* USA
- [4] Hall-Stinson A, Lehrman C and Tripp E 2011 Energy generation from vortex induced vibration *Thesis (B.S.) Worcester Polytechnic Institute* USA
- [5] Cengel Y A and Cimbala J M 2006 *Fluid Mechanic: Fundamental and Application* (USA: McGraw-Hill International)
- [6] Omar Y, Tengku T and Mohamad A 2006 Prospects for ocean energy in Malaysia *International Conference on Energy and Environment*
- [7] Mehta R D 1985 Turbulent boundary layer perturbed by a screen *International Journal of American Institute of Aeronautics and Astronautics* **23(9)** 1335-42
- [8] Brennen C 1978 The Bubbly flow model for the dynamic characteristics of cavitating pump *Journal of Fluids Mechanics* **89(2)** 223-40