

Output Tracking of Non-minimum Phase Systems via Reduced Order Sliding Mode Design

Machhindrantah Patil, *Member, IEEE*, Bijnan Bandyopadhyay, *Fellow, IEEE*,
Asif Chalanga, *Member, IEEE*, and Hemendra Arya

Abstract—In this paper, a method to design the reduced order sliding mode control is proposed for the robust output tracking of arbitrary signal for non-minimum phase systems. The main contributions in this paper include design of the reduced order switching function that ensures the asymptotic tracking of an arbitrary reference signal during sliding motion, design of the reduced order sliding mode controller that enforces the sliding motion in finite time and computation of bounds on stable and virtually stable zero dynamics that is required for the output tracking. To show the effectiveness of the proposed design method, results of implementation on the experimental setup of inverted pendulum system are also presented here.

Index Terms—Non-minimum phase systems, Output tracking, Reduced order Control, Sliding Mode control.

I. INTRODUCTION

ASYMPTOTIC tracking of an arbitrary signal is one of the basic objectives of the control system design. If the zero dynamics of the system is stable, all the established controller design methodologies for the stabilization of the system are applicable for the output tracking. However, many of the engineering applications such as flexible-link manipulators [1], [2], aircraft control [3], [4], DC-DC power converters [5], [6], high speed linear motor [7] etc. have unstable zero dynamics. In such class of systems, the control problem becomes challenging.

The tracking problem in a non-minimum phase system is twofold, the stabilization of the unstable zero dynamics and the tracking of the reference signal. However, the basic problem in the output tracking of non-minimum phase system is to get the bounded solution of the unstable zero dynamics.

There have been a few methods found in literature to get the bounded solution to the unstable zero dynamics. For instance, the method of stable system center [8], which essentially is the solution of differential-algebraic equations formed from zero dynamics and output equation. Also, a bounded solution of an unstable zero dynamics can be obtained by computing non-causal inverse if the reference trajectory is known a priori [9], [10]. In [11], it has been shown that inverse dynamics solution

can be used to compute the feed-forward control as well as in regulator approach [12].

In [13], [14], non-causal inverse of a trajectory known for some preview-time is utilized for online computation feed-forward tracking control. However, tracking performance depends on the preview-period. To improve the tracking performance, optimal control is found to be employed with preview based stable inversion method in [15].

In case of uncertain non-minimum phase systems, presence of the disturbance degrades the tracking performance. Such situation demands the robust controller that minimizes the adverse effect of disturbance on the tracking performance.

To achieve robustness, the tracking problem can be formulated as H_∞ control problem that essentially finds the feedback control to decouple the disturbance, e.g. see [16], [17], [18]. Tracking controller performance depends on the predefined L_2 gain between disturbance and the output. Therefore, H_∞ based designs are essentially the controller synthesis for the best performance.

Sliding mode control (SMC) is one of the attractive design methods as design method is simple and ideally it annihilates the matched disturbance completely [19], [20]. Various applications found in literature that employs the sliding mode control for robust performance, for example, slosh-free motion of partially filled liquid container using a nonlinear sliding surface in [21], motion control of a linear motor positioner in [22], robust control of piezoelectric-driven nanopositioning system via third-order integral terminal sliding mode control in [23] and parameter estimation-based time-varying sliding mode controller for the multi-motor driving servo systems in [24].

Also, the strength of SMC has been explored in the area of fractional order switching control [25]. Recently, an adaptive sliding mode technique based on a fractional-order switching-type control for uncertain 3D fractional-order nonlinear systems and exponential switching technique with fractional-order proportional-integral switching surface has been reported in [26] and [27].

Numerous works are found in the area of sliding mode control for output tracking of non-minimum phase systems. In [28], the output tracking has been achieved via sliding mode based tracking control of the redefined output such that the original output tracks the desired trajectory asymptotically. The method of system center is exploited for the causal output tracking using dynamic sliding surface in [29], [30] and using higher order sliding mode observer in [31].

Also, using non-causal system inverse, SMC based tracking

M. Patil is with Department of Instrumentation Engineering, V.E.S. Institute of Technology, Mumbai, Maharashtra, India (corresponding author; e-mail: machhindra.patil@ves.ac.in).

B. Bandyopadhyay is with Systems and Control Engineering Department and H. Arya is with Department of Aerospace Engineering, Indian Institute of Technology Bombay, India (e-mail: bijnan@sc.iitb.ac.in, arya@aero.iitb.ac.in).

A. Chalanga is with Ecole Centrale de Nantes, Pays de la Loire, France. (e-mail: asif@sc.iitb.ac.in)

Manuscript received April 19, 2005; revised August 26, 2015.

of predefined smooth arbitrary reference signal without an exosystem has been found in [32]; and multirate output feedback based sliding mode control for a non-minimum phase system using non-causal inverse has been found in [33].

A sliding surface design with the reduced order state vector is rarely found in literature mainly because of difficulty in proving the finite time reachability, or they are not applicable to systems with unstable internal dynamics. Reduced order sliding mode control for stability of the system has been found in [34], [35], [36]. However, output tracking problem that usually arises in non-minimum phase systems has not been addressed. Also, reduced order switching function design in [34] restricts the sliding motion in ‘quasi sliding band’ that results in poor disturbance rejection. Recently, output tracking of constant reference signal for uncertain non-minimum phase systems using reduced order SMC is addressed in [37], [38]. Also, computation of bounds on the total disturbance has not been addressed.

In this paper, the reduced order sliding mode design is proposed for the output tracking of arbitrary reference signal. The proposed controller design method has two advantages such as (i) a design involves only the part of the state vector, this greatly simplifies the switching function and the controller design. (ii) inherent robustness property of the SMC does not allow the disturbances (in the input channels) to affect the output tracking. Note that, the reduced order control is possible only with sliding mode control as the effect of excluded states can be completely disregarded by considering them as a disturbance.

To validate the proposed method experimentally, we have designed and implemented the reduced order SMC for non-minimum phase inverted pendulum system developed by educational control products [39]. The experimental results are found to be quite satisfactory with respect to simulation results.

II. PROBLEM FORMULATION

Consider a non-minimum phase system,

$$\dot{z} = Az + Bu + B\phi \quad (1a)$$

$$y = Cz \quad (1b)$$

Where $z \in \mathbb{R}^n$, $u \in \mathbb{R}^m$ and $y \in \mathbb{R}^m$ are the state, the input, and the output vectors of the system respectively. $\phi \in \mathbb{R}^m$ is vector of matched disturbances with known bounds. Let the disturbances $|\phi| < L$.

Assume that,

- 1) (A, B) pair is controllable, (A, C) pair is observable and (A, B, C) triplet is invertible. Also, B and C are of full rank i.e. no redundancy in input and output vectors.
- 2) There exists none of the invariant zeros of triple (A, B, C) on origin of s-plane.
- 3) For the purpose of reduced order design of the sliding mode control, we consider that the system (1) is in canonical form as given in the following section. It is always possible to construct the transformation that represents the system into such a canonical form. Please refer Appendix A for construction of such a canonical transformation.

A. Canonical form

The system (1) in canonical form is typically given by

$$\dot{z}_a^- = A_{aa}^- z_a^- + L_{ad}^- F_a z_a^+ + L_{ad}^- C_d z_d \quad (2a)$$

$$\dot{z}_a^+ = (A_{aa}^+ + L_{ad}^+ F_a) z_a^+ + L_{ad}^+ C_d z_d \quad (2b)$$

$$\dot{z}_i = A_{qi} z_i + B_{qi} (E_{ia}^- z_a^- + E_{ia}^+ z_a^+ + E_i z_d + u_i + \phi_i) \quad (2c)$$

$$y = F_a z_a^+ + C_d z_d \quad (2d)$$

Where $z_i^\top = [z_{i1}, \dots, z_{iq_i}] \in \mathbb{R}^{q_i}$ are phase variable for all $i \in \{1, \dots, m\}$. $z_d = [z_1, \dots, z_m]$. Integer q_i can be obtained from structural invariant index list \mathbf{I}_d due to Morse [40]. Also, $z_a^- \in \mathbb{R}^{n_a^-}$ and $z_a^+ \in \mathbb{R}^{n_a^+}$. Note that, $z_d \in \mathbb{R}^{n_d}$, where $n_d = \sum_{i=1}^m q_i$ and $n_a^- + n_a^+ + n_d = n$.

The structure of matrices associated with the above system are as follows,

$$A_{qi} = \begin{bmatrix} 0 & I_{(q_i-1)} \\ 0 & 0 \end{bmatrix}, B_{qi}^\top = [0 \ 0 \ \dots \ 1]$$

$$C_{qi} = [1 \ 0 \ \dots \ 0], C_d = \text{diag}(C_{q_i})$$

and; A_{aa}^- and A_{aa}^+ are in diagonal form.

Remark 2.1: $\lambda(A_{aa}^-)$ and $\lambda(A_{aa}^+)$ represents the stable and unstable invariant zeros of the system respectively. However, $(A_{aa}^+ + L_{ad}^+ F_a)$ is made stable via virtual feedback gain F_a chosen for (A_{aa}^+, L_{ad}^+) pair. Also, subsystem (2a)-(2b) is driven by $C_d z_d = [z_{11}, z_{21}, \dots, z_{m1}]^\top$.

B. Control objective

This paper is aimed to address the design of a reduced order sliding mode control for the output tracking of an arbitrary signal. Advantage of this method is that the output tracking can be achieved by designing the sliding mode control for asymptotic stability of integrator chains only i.e. subsystem (2c). This is possible due to the ability of sliding mode controller to annihilate the disturbance that includes terms in z_a^- and z_a^+ along with external disturbance ϕ in the control space.

Similar approach is found in [38], however that has been designed for a constant reference tracking. For the tracking of constant reference R , the solution z_a^+ was determined for $z_{i1} = G_a R$ with some feed-forward gain G_a that eliminates the steady-state tracking error $F_a z_a^+(\infty)$ in the output equation.

For example, let the system (2) be the single input-single output system (i.e. $i = 1$). Suppose that there exists a control that forces the solution $z_{i1} = G_a R$. Then, from (2b) and (2d) steady state output of the system can be obtained as,

$$\begin{aligned} z_a^+(\infty) &= -(A_{aa}^+ + L_{ad}^+ F_a)^{-1} L_{ad}^+ z_{i1}(\infty) \\ y(\infty) &= F_a z_a^+(\infty) + z_{i1}(\infty) \\ &= [-F_a (A_{aa}^+ + L_{ad}^+ F_a)^{-1} L_{ad}^+ + 1] z_{i1}(\infty) \\ &= [-F_a (A_{aa}^+ + L_{ad}^+ F_a)^{-1} L_{ad}^+ + 1] G_a R \end{aligned}$$

Clearly, if we choose forward gain,

$$G_a = [-F_a (A_{aa}^+ + L_{ad}^+ F_a)^{-1} L_{ad}^+ + 1]^{-1} \quad (3)$$

then we get $y(\infty) = R$. Thus, asymptotically output can be regulated at the constant reference input R .

However, for time varying signal we can not achieve the output tracking with such a feedforward gain as tracking error $F_a z_a^+$ is time varying.

In this paper, a method to design a reduced order sliding mode control for the output tracking of an arbitrary signal is addressed systematically and demonstrated the effectiveness of the design method on Inverted pendulum test bench.

III. BOUNDED SOLUTION OF THE UNSTABLE ZERO DYNAMICS

Let $z^* = (z_a^{*-T}, z_a^{*+T}, z_i^{*T})^T$ be the reference state trajectory for the system (2). As the reference trajectory satisfies the system equations, we can write,

$$\dot{z}_a^{*+} = (A_{aa}^+ + L_{ad}^+ F_a) z_a^{*+} + L_{ad}^+ C_d z_d^* \quad (4)$$

$$y^* = F_a z_a^{*+} + C_d z_d^* \quad (5)$$

Substituting $C_d z_d^*$ from (5) into (4), we get,

$$\dot{z}_a^{*+} = A_{aa}^+ z_a^{*+} + L_{ad}^+ y^* \quad (6)$$

Note that, A_{aa}^+ is unstable zero dynamics of the system. Thus for any arbitrary reference (desired) output y^* , the solution z_a^{*+} is unbounded.

If the reference signal is uniformly bounded and known a priori then it is possible to compute the bounded solution of the system [11]. The solution of the unstable zero dynamics (6) is given by,

$$\begin{aligned} z_a^{*+}(t) &= \exp(A_{aa}^+ t) z_a^{*+}(0) + \int_0^t \exp(A_{aa}^+ (t - \tau)) L_{ad}^+ y^*(\tau) d\tau \\ &= \exp(A_{aa}^+ t) \left(z_a^{*+}(0) + \int_0^t \exp(-A_{aa}^+ \tau) L_{ad}^+ y^*(\tau) d\tau \right) \end{aligned} \quad (7)$$

Choose initial condition,

$$z_a^{*+}(0) = - \int_0^\infty \exp(-A_{aa}^+ \tau) L_{ad}^+ y^*(\tau) d\tau$$

Therefore, from (7), the solution is given by,

$$z_a^{*+}(t) = - \int_t^\infty \exp(A_{aa}^+ (t - \tau)) L_{ad}^+ y^*(\tau) d\tau$$

Define $s := \tau - t$,

$$z_a^{*+}(t) = - \int_0^\infty \exp(-A_{aa}^+ s) L_{ad}^+ y^*(t + s) ds \quad (8)$$

As A_{aa}^+ is unstable and $y^*(t)$ is uniformly bounded, therefore solution (8) is uniformly bounded. With such bounded solution z_a^{*+} , we can generate bounded z_a^{*-} and z_d^* trajectory.

IV. ERROR DYNAMICS

Let z^* be the desired bounded reference trajectory that satisfies the system (1) giving the desired output $y^* = C z^*$. Let this desired trajectory z^* is generated by nominal input u^* . Then the output tracking problem can be converted into stabilization of error between state trajectory and desired trajectory using the control $\Delta u = u - u^*$. Define the output tracking error $y_e := y - y^*$ and error between the

state trajectory and the desired trajectory $e := z - z^*$. Therefore the system (1) can be described in terms of error states as,

$$\dot{e} = A e + B \Delta u + B \phi \quad (9a)$$

$$y_e = C e \quad (9b)$$

Clearly, the output tracking can be achieved if control Δu is designed such that $\|e\| \rightarrow 0$ as $t \rightarrow \infty$.

As the system is in canonical form, therefore error dynamics can be written as,

$$\dot{e}_a^- = A_{aa}^- e_a^- + L_{ad}^- F_a e_a^+ + L_{ad}^- C_d e_d \quad (10a)$$

$$\dot{e}_a^+ = (A_{aa}^+ + L_{ad}^+ F_a) e_a^+ + L_{ad}^+ C_d e_d \quad (10b)$$

$$\dot{e}_i = A_{qi} e_i + B_{qi} (E_{ia}^- e_a^- + E_{ia}^+ e_a^+ + E_i e_d + \Delta u_i + \phi_i) \quad (10c)$$

$$y_e = F_a e_a^+ + C_d e_d \quad (10d)$$

where $e_i = (z_i - z_i^*) \in \mathbb{R}^{q_i}$, $\Delta u_i = u_i - u_i^*$ and u_i^* is the i^{th} nominal input that generates the output y_i^* , given by,

$$u_i^* = y_i^{(q_i)} - E_{ia}^- z_a^- - E_{ia}^+ z_a^+ - E_i z_d^* \quad (11)$$

An objective here is to design reduced order robust control Δu independent of e_a^- and e_a^+ such that full error vector $\|e\| \rightarrow 0$ as $t \rightarrow \infty$, which implies $z \rightarrow z^*$ and $y \rightarrow y^*$ asymptotically. Clearly, exclusion of e_a^- and e_a^+ in the control Δu may not guarantee the asymptotic stability of the system with other control designs. However, the sliding mode control design can ensure the asymptotic stability of (10) by considering the terms e_a^- and e_a^+ in RHS of (10c) as disturbance since e_a^- and e_a^+ states are bounded. This motivates us to design the sliding mode control $\Delta u = u - u^*$ using $e_d = z_d - z_d^*$ vector only. Typical block diagram of the sliding mode control with reduced order design is shown in Fig. 1.

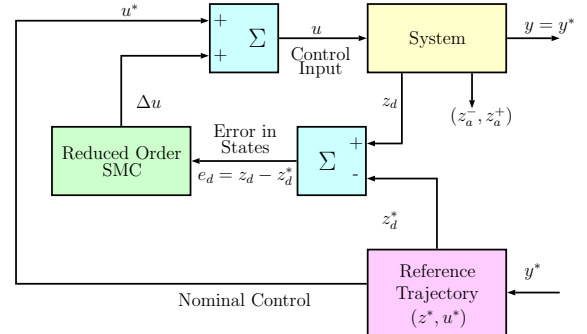

Fig. 1: Block diagram representation of reduced order control design.

In the following section, reduced order sliding mode design is addressed that involves subsystem (10c) only.

V. MAIN RESULTS

Let us define,

$$\psi_i = E_{ia}^- e_a^- + E_{ia}^+ e_a^+ + \phi_i \quad \text{and} \quad |\psi_i| < \gamma_i \quad (12)$$

As the subsystem (10c) is in phase variable form, therefore subsystem dynamics for each i can be given by,

$$\begin{bmatrix} \dot{e}_{i1} \\ \vdots \\ \dot{e}_{i(q_i-1)} \\ \dot{e}_{i(q_i)} \end{bmatrix} = \begin{bmatrix} e_{i2} \\ \vdots \\ e_{i(q_i)} \\ E_i e_d \end{bmatrix} + \begin{bmatrix} 0 \\ \vdots \\ 0 \\ \Delta u_i \end{bmatrix} + \begin{bmatrix} 0 \\ \vdots \\ 0 \\ \psi_i \end{bmatrix} \quad (13)$$

Let $R_i(s)$ be the real Hurwitz polynomial of order $q_i - 1$,

$$R_i(s) = s^{q_i-1} + c_{i1} s^{q_i-2} + c_{i2} s^{q_i-3} + \dots + c_{i(q_i-1)} \quad (14)$$

Theorem 5.1 (Sliding motion): For each $i \in \{1, \dots, m\}$, if the trajectory,

$$e_i = z_i - z_i^* = \begin{bmatrix} e_{i1} & e_{i2} & \cdots & e_{i(q_i-1)} & e_{i(q_i)} \end{bmatrix}^\top \quad (15)$$

of the subsystem (10c) is restricted on the the switching manifold

$$\sigma_i = \begin{bmatrix} c_{i(q_i-1)} & \cdots & c_{i2} & c_{i1} & 1 \end{bmatrix} e_i = 0 \quad (16)$$

then output vector $y \rightarrow y^*$ as $t \rightarrow \infty$.

Proof: As e_i is error vector of length q_i , from (16) we can write

$$e_{i(q_i)} = -c_{i(q_i-1)}e_{i1} - \cdots - c_{i2}e_{i(q_i-2)} - c_{i1}e_{i(q_i-1)} \quad (17)$$

Follow from (13), we can write the sliding motion as,

$$\begin{bmatrix} \dot{e}_{i1} \\ \vdots \\ \dot{e}_{i(q_i-1)} \end{bmatrix} = \begin{bmatrix} 0 & 1 & \cdots & 0 \\ \vdots & \vdots & \ddots & \vdots \\ 0 & 0 & \cdots & 1 \\ -c_{i(q_i-1)} & -c_{i(q_i-2)} & \cdots & -c_{i1} \end{bmatrix} \begin{bmatrix} e_{i1} \\ \vdots \\ e_{i(q_i-1)} \end{bmatrix} \quad (18)$$

A subsystem matrix in (18) is stable as its characteristic polynomial is represented by (14). This implies that, for each i , $\|e_i\| \rightarrow 0$ as $t \rightarrow \infty$.

Also, as (10a) and (10b) subsystems are input-to-state stable and driven by all e_{i1} , so $\|(e_a^-, e_a^+)\| \rightarrow 0$ as every $\|e_{i1}\| \rightarrow 0$. Thus, the full state vector $e = z - z^*$ converges to 0 asymptotically. This implies that $y \rightarrow y^*$ as $t \rightarrow \infty$ if the trajectories e_i are restricted on σ_i .

Remark 5.1: Note that, each e_i subsystem as in (13) always form chain of integrators. Therefore, sliding surface is always designed for the pair

$$G := \begin{bmatrix} 0 & I_{(p-1) \times (p-1)} \\ 0 & 0 \end{bmatrix}_{p \times p} \quad \text{and} \quad H := \begin{bmatrix} 0_{(p-1) \times 1} \\ 1 \end{bmatrix}_{p \times 1}$$

This is typical controllable canonical form. Clearly, pole placement for desired sliding motion can be done simply by utilizing the coefficients of desired polynomial in reverse order as a feedback gain. Therefore, coefficients of desired polynomial (14) are utilized for sliding surface (16) that results into desired sliding motion (18). As the seen in Theorem 5.1, if each trajectory e_i is restricted on the switching manifold σ_i then asymptotic tracking of arbitrary signal can be achieved. Therefore, it is necessary to design the sliding mode control that enforces the trajectory e_i to reach on the corresponding switching manifold and restrict the motion on it.

Proposition 5.1 (Reduced order SMC): For each $i \in \{1, \dots, m\}$, if $k_i > 0$ and $Q_i > \gamma_i$ then reduced order control input,

$$\begin{aligned} \Delta u_i = & -(c_{i(q_i-1)}e_{i2} + \cdots + c_{i2}e_{i(q_i-1)} + c_{i1}e_{i(q_i)} \\ & + E_i e_d + k_i \sigma_i + Q_i \text{sgn}(\sigma_i)) \end{aligned} \quad (19)$$

initiate the sliding motion of error vector $e_i = z_i - z_i^*$ in finite time, so that asymptotic output tracking can be achieved.

Proof: From (16), the time derivative of σ_i is given by,

$$\begin{aligned} \dot{\sigma}_i &= c_{i(q_i-1)}\dot{e}_{i1} + \cdots + c_{i2}\dot{e}_{i(q_i-2)} + c_{i1}\dot{e}_{i(q_i-1)} + \dot{e}_{i(q_i)} \\ &= c_{i(q_i-1)}e_{i2} + \cdots + c_{i2}e_{i(q_i-1)} + c_{i1}e_{i(q_i)} + E_i e_d + \Delta u_i + \psi_i \end{aligned} \quad (20)$$

Let for each i , $V_i(\sigma) = \sigma_i^2/2$ be the Lyapunov function, so the time derivative of V_i along the trajectory e_i is given by,

$$\begin{aligned} \dot{V}_i &= \sigma_i \dot{\sigma}_i \\ &= \sigma_i (c_{i(q_i-1)}e_{i2} + \cdots + c_{i2}e_{i(q_i-1)} + c_{i1}e_{i(q_i)} \\ &\quad + E_i e_d + \Delta u_i + \psi_i) \end{aligned} \quad (21)$$

Substituting the control law (19) in (21),

$$\begin{aligned} \dot{V}_i &= \sigma_i (-k_i \sigma_i - Q_i \text{sgn}(\sigma_i) + \psi_i) \\ &= -k_i \sigma_i^2 - \sigma_i (Q_i \text{sgn}(\sigma_i) - \psi_i) \end{aligned} \quad (22)$$

Define $\eta_i := Q_i - \gamma_i$. If we select $k_i > 0$ and $Q_i > \gamma_i$, we can write

$$\dot{V}_i \leq -k_i \sigma_i^2 - \eta_i |\sigma_i| \quad (23)$$

As $V_i = \sigma_i^2/2$, therefore from (23), we can write

$$\begin{aligned} \dot{V}_i &\leq -2k_i V_i - \eta_i \sqrt{2V_i} \\ \Rightarrow \frac{1}{2k_i V_i + \eta_i \sqrt{2V_i}} dV_i &\leq -dt \end{aligned}$$

Integrating on both th sides, we get

$$\left[\frac{\log(\eta_i + k_i \sqrt{2V_i})}{k_i} \right]_{V(0)}^{V(t_f)} \leq -[t]_0^{t_f}$$

At $t = 0$, $V_i = V_i(0)$ and at $t = t_f$, $V_i = 0$. Therefore,

$$\frac{\log(\eta_i) - \log(\eta_i + k_i \sqrt{2V_i(0)})}{k_i} \leq -t_f$$

Thus, the trajectory reaches the surface in utmost

$$t_f = \frac{\log(\eta_i + k_i \sqrt{2V_i(0)}) - \log(\eta_i)}{k_i} \text{ sec.} \quad (24)$$

Thus with the control (19), the sliding mode is initiated in finite time and as given in Theorem 5.1 output tracking can be achieved.

Remark 5.2: It can be seen from (10), e_a^- and e_a^+ are bounded if e_i is stable. However, stability of e_i is assured by the reduced order control only if the bound γ_i is known. Total disturbance $\psi_i = E_{ia}^- e_a^- + E_{ia}^+ e_a^+ + \phi_i$ is function of error states e_a^- and e_a^+ . Therefore, γ_i can be computed if bounds on the magnitude of e_a^- and e_a^+ are known. The bounds on e_a^- and e_a^+ can be easily obtained if the region for e_d is defined. Refer Appendix B for computation of γ_i .

A. Selection of k_i and Q_i

Suppose that $k_i = 0$, then (23) becomes,

$$\dot{V}_i \leq -\eta_i |\sigma_i| \quad (25)$$

Note that, this inequality also assures finite time reachability with $t_f = \sqrt{2V_i(0)}/\eta_i$. Comparing this reaching time with (24), it is clear that reaching time is less with $k_i > 0$ than reaching time with $k_i = 0$. Thus, $k_i > 0$ increases the rate of convergence of trajectory towards the sliding surface. Note that, as trajectory approaches the sliding surface, rate of convergence decreases and on the surface, k_i s term in the control law (19) plays no role in asymptotic convergence of trajectory towards the equilibrium.

Also, convergence of the trajectory towards surface is possible only when $\eta_i > 0$ i.e. $Q_i > \gamma_i$. Therefore, for sliding mode to exist switching gain Q_i must be greater than bound on the maximum possible absolute value of disturbance. In practice, the bounds of the disturbance are usually computed via statistical analysis. Alternately, one can increase the switching gain gradually by trials until the satisfactory response is achieved.

B. Improvement in tracking performance

To improve the tracking performance, reduced order nonlinear switching surface as given in [38] can be designed instead of a linear switching surface (16). Typically, the nonlinear sliding function can be given by

$$\sigma_{N_i} = \left[C_{0i} - \rho(y_e) A_{12}^\top P \quad 1 \right] e_i \quad (26)$$

Where,

$$\begin{aligned} C_{0i} &= \begin{bmatrix} c_{i(q_i-1)} & \cdots & c_{i2} & c_{i1} \end{bmatrix} \\ A_{12} &= \begin{bmatrix} 0 & \cdots & 0 & 1 \end{bmatrix}^\top \end{aligned}$$



Fig. 2: Laboratory setup of pendulum system, ECP-Model 505.

and P is the positive definite solution of Lyapunov equation solved for a subsystem matrix of the sliding motion (18). Note that, such a matrix P exists as sliding motion (18) is asymptotically stable.

Note that, C_{0i} is designed so that the sliding motion (18) exhibit underdamped response with small rise time. The nonlinear function $\rho(y_e)$ is chosen in such a way that initially its value is 0 and gradually it changes switching gain the from C_{0i} to C_{fi} as $\|y_e\| \rightarrow 0$ and final C_{fi} switching gain ensures the overdamped response that will not exhibit overshoot. For instance, ρ can be chosen as follows,

$$\rho(y_e) = -\beta \frac{\exp(-\|y_e(0)\|) - \exp(-\|y_e\|)}{\exp(-\|y_e(0)\|)} \quad (27)$$

Clearly, initially y_e is $y_e(0)$, therefore $\rho(y_e) = 0$ and finally for $y_e = 0$ we get $\rho(y_e) = -\beta$. This implies, $C_{fi} = C_{0i} + \beta A_{12}^T P$. Therefore, C_{fi} should be designed by selecting parameters β and P in such a way that the sliding motion has overdamped response.

Thus, using nonlinear sliding surface (26) tracking error converges to 0 rapidly without exhibiting the overshoot.

VI. IMPLEMENTATION ON INVERTED PENDULUM SYSTEM

To demonstrate the effectiveness, proposed reduced order sliding mode control scheme is implemented on ECP Model 505 inverted pendulum system [39].

Fig.2 shows the photograph of actual laboratory setup on which experiments have been performed and Fig.3 shows the constructional features of the system. The experimental setup consists of a pendulum with the sliding balance rod at the top. The sliding rod is driven by the dc servo motor, which is mounted below the pendulum, through the drive shaft and belt-pulley mechanism. The balancing of the pendulum rod at the commanded angular position can be achieved by steering horizontal sliding rod. High resolution encoder is connected to the pivoting base of the pendulum rod for the measurement of the angular position (θ) of the pendulum rod. Also, Shaft encoder at the back of motor is connected for the measurement of the translational position (x) of sliding rod. The velocity of the pendulum swing and translational motion of the sliding rod can be obtained numerically using backward difference between two consecutive samples of respective measured displacements. For instance, with a sampling period τ , angular velocity of pendulum can be obtained by $\dot{\theta} = (\theta(t) - \theta(t - \tau)) / \tau$. Alternately, robust exact differentiator [41] can be employed for the measurement of velocity.

A. Dynamical model of inverted pendulum system

The free body diagram shown in Fig.4a. The dynamical model of the pendulum system is given by

$$F(t) = m_1 \ddot{x} + m_1 l_0 \ddot{\theta} - m_1 g \theta^2 - m_1 g \sin \theta \quad (28a)$$

$$0 = m_1 l_o \ddot{x} + J_0(x) \ddot{\theta} + 2m_1 x \dot{\theta} - (m_1 l_0 + m_2 l_c) g \sin \theta - m_1 g x \cos \theta \quad (28b)$$

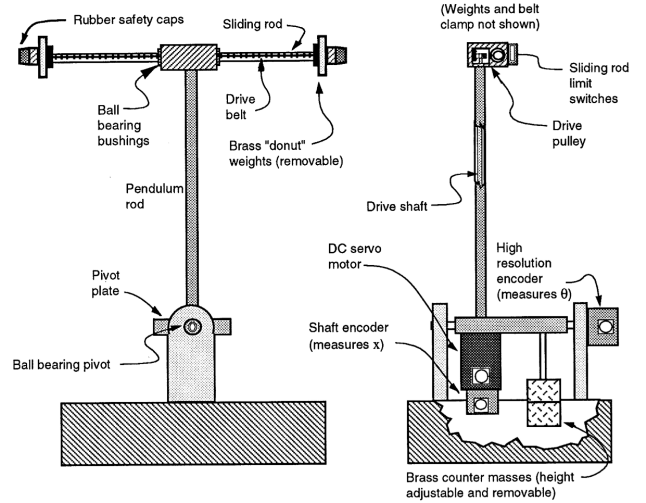

Fig. 3: Constructional features of pendulum system, ECP-Model 505 (Figure courtesy, ECP systems).

Where, x is the displacement traveled by sliding rod and θ is pendulum angle measured from up-right initial position (90^0 to the horizontal plane). m_1, J_1 and m_2, J_2 represent the mass and polar moment of inertia of sliding balance rod and pendulum rod (including motor and counter mass) respectively, while l_0 and l_c are as indicated in Fig. 4a; and J_0 is given by,

$$J_0(x) = J_1 + J_2 + m_1(l_0^2 + x^2) + m_2 l_c^2$$

The system (28) at equilibrium $(x_e, \theta_e) = (0, 0)$ can be represented by linear model,

$$m_1 \ddot{x} + m_1 l_0 \ddot{\theta} - m_1 g \theta = F(t) \quad (29a)$$

$$m_1 l_o \ddot{x} + J_0 \ddot{\theta} - (m_1 l_0 + m_2 l_c) g \theta - m_1 g x = 0 \quad (29b)$$

Define state vector \mathbf{x} with the state variables, $x_1 := \theta$, $x_2 := \dot{\theta}$, $x_3 := x$ and $x_4 := \dot{x}$. Then, with the parameters of the system as in Table I, the system can be represented as,

$$\dot{x}_1 = x_2 \quad (30a)$$

$$\dot{x}_2 = -14.1916x_1 + 57.4827x_3 - 9.0783v \quad (30b)$$

$$\dot{x}_3 = x_4 \quad (30c)$$

$$\dot{x}_4 = 14.4932x_1 - 18.9693x_3 + 7.6907v \quad (30d)$$

$$y = x_1 \quad (30e)$$

where v (external force $F(t)$) be the input and y (pendulum angle θ) be the output of the system.

B. Canonical transformation of inverted pendulum system

The input and state transformations that transform the system (30) into desired canonical form (2) are, $v = -0.1102u$ and

$$\begin{bmatrix} x_1 \\ x_2 \\ x_3 \\ x_4 \end{bmatrix} = \begin{bmatrix} 0 & -0.6455 & 1 & 0 \\ 0 & 1.2909 & -7.4523 & 1 \\ 0.1804 & 0.3664 & -0.8472 & 0 \\ -0.9836 & -2.0772 & 6.3132 & -0.8472 \end{bmatrix} \begin{bmatrix} z_1 \\ z_2 \\ z_3 \\ z_4 \end{bmatrix} \quad (31)$$

Then the pendulum system in the canonical form is given by

$$\dot{z}_a^- = -5.4523z_a^- - 7.4523z_a^+ + 11.5458z_{11} \quad (32a)$$

$$\dot{z}_a^+ = -2z_a^+ + 11.5458z_{11} \quad (32b)$$

$$\dot{z}_{11} = z_{12} \quad (32c)$$

$$\dot{z}_{12} = 10.3699z_a^- + 32.8033z_a^+ - 77.7927z_{11} + 7.4523z_{12} + u_1 \quad (32d)$$

$$y = -0.6455z_a^+ + z_{11} \quad (32e)$$

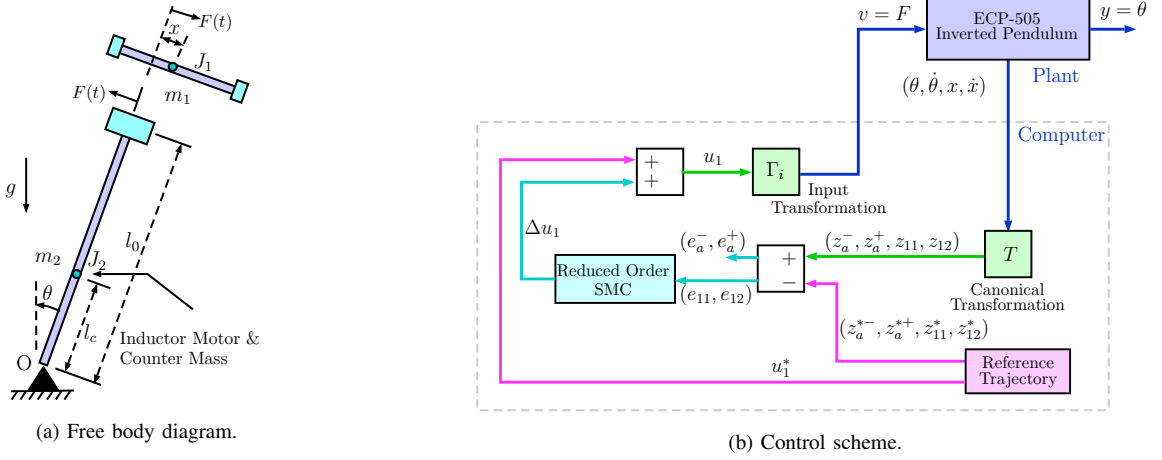

Fig. 4: Free body diagram and control scheme for Inverted pendulum system, ECP-Model 505.

Remark 6.1: The system has two invariant zeros at ± 5.4523 . As one of the zeros of the system is unstable therefore system is non-minimum phase. Also, virtual stabilization of the zero is achieved through a gain $F_a = -0.6455$.

Remark 6.2: Note that, for the system (32), $i = 1$, $q_i = 2$, $A_{aa}^- = -5.4523$, $A_{aa}^+ = 5.4523$, $L_{ad}^- = L_{ad}^+ = 11.5458$, $E_1 = [-77.7927 \ 7.4523]$, $E_{1a}^- = 10.3699$ and $E_{1a}^+ = 32.8033$.

TABLE I: Parameters of inverted pendulum at rest

| Parameter | Quantity | Unit |
|-----------|----------|----------------|
| m_1 | 0.213 | Kg |
| m_2 | 1.7850 | Kg |
| l_0 | 0.33 | m |
| l_c | -0.0295 | m |
| J_0 | 0.0595 | $Kg \cdot m^2$ |
| g | 9.81 | m/s^2 |

C. Reduced order SMC design for inverted pendulum system

Step-by-step procedure to design the reduced order SMC for the inverted pendulum is as follows.

1) *Computation of reference trajectory:* The tracking signal considered for the demonstration is $y^* = 0.1745 \sin t$. As discussed in Section III, the desired trajectory for the system (32) can be obtained using (8) and is given by,

$$\begin{aligned} z_a^{*+} &= -0.06558 \cos t - 0.3576 \sin t \\ z_{11}^* &= y^* + 0.6455 z_a^{*+} = -0.05629 \sin t - 0.04233 \cos t \\ z_{12}^* &= \dot{z}_{11}^* = 0.04233 \sin t - 0.05629 \cos t \\ z_a^{*-} &= 0.065568 \exp(-5.4523 * t) - 0.36346 \cos(t + 1.3894) \end{aligned}$$

and the nominal control as,

$$\begin{aligned} u_1^* &= \ddot{y}^* + 0.6455 \ddot{z}_a^{*+} - 10.3699 z_a^{*-} - 32.8033 z_a^{*+} \\ &\quad + 77.7927 z_{11}^* - 7.4523 z_{12}^* \end{aligned}$$

2) *System representation in error coordinate for tracking:* The tracking of the pendulum angle can be achieved by representing the system into error coordinates and then design the controller for

stabilization of error dynamics. Using (10), we can represent the system into error coordinates as,

$$\dot{e}_a^- = -5.4523 e_a^- - 7.4523 e_a^+ + 11.5458 e_{11} \quad (34a)$$

$$\dot{e}_a^+ = -2 e_a^+ + 11.5458 e_{11} \quad (34b)$$

$$\dot{e}_{11} = e_{12} \quad (34c)$$

$$\begin{aligned} \dot{e}_{12} &= 10.3699 e_a^- + 32.8033 e_a^+ - 77.7927 e_{11} \\ &\quad + 7.4523 e_{12} + \Delta u_1 \end{aligned} \quad (34d)$$

$$y_e = -0.6455 e_a^+ + e_{11} \quad (34e)$$

3) *Reduced order sliding surface design:* As given in (14), we choose the real Hurwitz stable polynomial of order $q_i - 1 = 1$ (with fast possible poles) as,

$$R_1(s) = s + 15 \quad (35)$$

From (35), $c_{11} = 15$. Therefore, the surface σ_i using (16) is designed as,

$$\sigma_1 = c_{11} e_{11} + e_{12} = 0 \quad (36)$$

so that during sliding motion, the e_1 vector dynamics is governed by

$$\dot{e}_{11} = -15 e_{11} \quad (37)$$

4) *Reduced order sliding mode control design:* For the Inverted Pendulum system, we consider bounds on the original states as $|\theta| \leq 0.35 \text{ rad}$, $|\dot{\theta}| \leq 0.3 \text{ rad/s}$, $|x| \leq 0.03 \text{ m}$ and $|\dot{x}| \leq 0.15 \text{ m/s}$, which are well within safe operating limits of the experimental setup.

In order to design the reduced order controller, the upper bound γ_1 on the total disturbance (12) can be computed using results provided in Appendix B.

- Select $\gamma_d = 0.1$ and $P_d = \begin{bmatrix} 200 & 100 \\ 100 & 300 \end{bmatrix}$. From (51), we get $\|e_d\| \leq 0.0166$.
- For e_a -subsystem, the Lyapunov solution P_a for the selected $Q_a = \begin{bmatrix} 0.1 & 0 \\ 0 & 0.1 \end{bmatrix}$ is $P_a = \begin{bmatrix} 0.0433 & -0.025 \\ -0.025 & 0.025 \end{bmatrix}$.
- From (52), $\|e_a\| \leq 0.3301$. Choose $\alpha = 0.4301$ that satisfies (54).
- Hence, from (55), we get total disturbance bound $\gamma_1 = 18.5683$.

Therefore, the reduced order sliding mode controller parameters can be selected as, $Q_1 = 20 > \gamma_1$ and for the faster reachability of e_d towards the surface, we select $k_1 = 10$.

Thus, the designed output tracking control to get the desired output y^* is given by

$$\begin{aligned} u_1 &= -(c_{11} e_{12} + E_1 e_d + k_1 \sigma_1 + Q_1 \text{sgn}(\sigma_1)) + u_1^* \\ &= 77.7927 e_{11} - 22.4523 e_{12} - 10 \sigma_1 - 20 \text{sgn}(\sigma_1) + u_1^* \end{aligned} \quad (38)$$

Finally, the tracking input actually applied to the pendulum is

$$\begin{aligned} v = F(t) &= -0.1102u_1 \\ &= -705.9229e_{11} + 203.7414e_{12} \\ &\quad + 90.7441\sigma_1 + 181.4882\text{sgn}(\sigma_1) - 9.0744u_1^* \end{aligned} \quad (39)$$

Remark 6.3: In the experiment, it is assumed that $\phi_i = 0$. Therefore, upper bound for $E_{ia}^-e_a^- + E_{ia}^+e_a^+$ part of the disturbance is computed in order to disregard it from range space of control, which is quite essential for reduced order design. Q_1 is selected greater than this upper bound and then gradually increase it there on by trial to achieve the satisfactory response.

D. Reduced order control for constant reference tracking

The reduced order sliding mode control for constant reference tracking as given in [38]. This method involves the computation of feed-forward gain G_a as in (3). Feed-forward gain for system in error co-ordinates (32) is computed as,

$$G_a = [-F_a(A_{aa}^+ + L_{ad}^+F_a)^{-1}L_{ad}^+ + 1]^{-1} = -0.3668 \quad (40)$$

The desired trajectory for the system (32) to regulate the output asymptotically at $R = 0.1745 \text{ rad/sec}$ (10 deg.), i.e $y^*(\infty) = -0.6455z_d^+(\infty) + z_{11}(\infty) = R$ is obtained as follows,

$$\begin{aligned} z_{11}^* &= G_a R = -0.0640 \\ z_{12}^* &= z_{11}^* = 0 \\ z_a^{*+} &= -(A_{aa}^+)^{-1}L_{ad}^+z_{11}^* = -0.3696 \\ z_a^{*-} &= -(A_{aa}^-)^{-1}(L_{ad}^-z_{11}^* + L_{ad}^-F_a z_a^{*+}) = 0.3696 \end{aligned} \quad (41)$$

and thus the reference vector can be written as

$$z^* = [0.3696 \quad -0.3696 \quad -0.0640 \quad 0] \quad (42)$$

Therefore, with the nominal control

$$u_1^* = -10.3699z_a^{*-} - 32.8033z_a^{*+} + 77.7927z_{11}^* - 7.4523z_{12}^*$$

we can represent the system in error co-ordinates as in (34). The sliding surface is designed for response with time constant 0.25 sec. Therefore,

$$\sigma_1 = c_{11}e_{11} + e_{12} = 4e_{11} + e_{12} = 0 \quad (43)$$

The sliding mode control designed with the switching gain $Q_1 = 6$ (by trial) and $k_1 = 10$ is given by,

$$\begin{aligned} u_1 &= -(c_{11}e_{12} + E_1e_d + k_1\sigma_1 + Q_1\text{sgn}(\sigma_1)) + u_1^* \\ &= 77.7927e_{11} - 11.4523e_{12} - 10\sigma_1 - 4\text{sgn}(\sigma_1) + u_1^* \end{aligned} \quad (44)$$

Thus, the controlling force applied to the system is given by

$$\begin{aligned} v = F(t) &= -0.1102u_1 \\ &= -705.9229e_{11} + 103.9229e_{12} \\ &\quad + 90.7441\sigma_1 + 54.4465\text{sgn}(\sigma_1) - 9.0744u_1^* \end{aligned} \quad (45)$$

E. Experimental results

The reduced order tracking controller is implemented through MathWorks[®] MATLAB and Simulink[®] RTWT (real time windows target) with sampling time 0.001 second. Fig.4b shows representative block diagram of the implementation of proposed control scheme.

The reference trajectory z^* is generated in real time as discussed in Step 1 of Section VI-C for the known desired output $y^* = \theta_p \sin t$ with $\theta_p = 10\pi/180$ for maximum 10 deg swing of pendulum on either side of the rest position. Measured states of the system are transformed to the canonical form (32) and only z_d states are used for feedback. The error e between the transformed state vector of the system and the reference state trajectory is utilized for the computation of the tracking control signal via reduced order sliding mode control scheme. Initially the pendulum is kept at rest manually

in upright position (at unstable equilibrium point) before applying the control.

Fig.5 shows the simulation and practical implementation results for the ECP-505 inverted pendulum system with reduced order sliding mode control. Note that, designed control (39) is independent of e_a^- and e_a^+ that guarantees error $\|e\| \rightarrow 0$ as $t \rightarrow \infty$, which implies $z \rightarrow z^*$ and $y \rightarrow y^*$ asymptotically. Fig. 5a shows the simulation of output tracking of the reference signal $y^* = \frac{10\pi}{180} \sin t$ using the control (39) whereas Fig. 5b shows the experimental results of output tracking on ECP-505 inverted pendulum system for the same reference signal. Note that, in either case tracking is achieved in about 2sec.. Also, to increase the speed of response in reaching phase the gain $k_1 = 10$ is selected. As a results the trajectory reaches the sliding surface in 0.1sec, see Fig. 5e and Fig. 5f for simulation and implementation results, respectively.

Simulation and practical implementation results with the controller (45) as proposed in [38] are shown in Fig.6. However, arbitrary time-varying reference signal cannot be achieved with such control for the reasons as discussed in Section II-B.

Ideally, sliding motion occurs along the surface with infinite switching frequency of controller. However, Practically, this is impossible to achieve. Therefore, in any sliding mode control design, the practical sliding band is bound to exist, within which the sliding motion is guaranteed. The amount of sliding band depends on the switching frequency that is determined by the sampling time as well as the actuator response time. Overall, in the presented experimental results, sliding band happens to be around 0.6 with few sample exceptions. The experimental results obtained are quite satisfactory when compared to the simulation results.

VII. CONCLUSION

Systematic procedure to design the reduced order sliding mode control for the output tracking of arbitrary signal for non-minimum phase systems is presented. The system is transformed into canonical form, in which the unstable zero dynamics is virtually stable.

The reduced order sliding function is designed with the coefficients of selected Hurwitz polynomial. This is possible, as the subsystem with which SMC is designed is always in phase variable form. During the sliding motion of reduced order error dynamics, the full-state error vector converges towards the equilibrium.

The reduced order controller is designed with the switching gain higher than the total disturbance that includes stable and virtually stable zero dynamic terms to ensure the finite time reachability and exhibition of sliding motion.

In order to make the design possible, the construction of canonical transformation and the guidelines for the computation of the bound on stable and virtually stable zero dynamics is explained systematically.

Finally, results of implementation on the experimental setup of the inverted pendulum system are presented to show the effectiveness of the proposed design method.

APPENDIX A

CONSTRUCTION OF CANONICAL TRANSFORMATION

Let an invertible system is given by,

$$\begin{aligned} \dot{x} &= \mathcal{A}x + \mathcal{B}v \\ y &= \mathcal{C}x \end{aligned}$$

Where, $x \in \mathbb{R}^n$, $v \in \mathbb{R}^m$, $y \in \mathbb{R}^m$.

Suppose $x = \Gamma_1\bar{x}$ and $v = \Gamma_i u$ are state and input transformations that transforms the given system into special coordinate basis (SCB) form [42], [43]. A system can be brought into SCB form using software toolbox for MATLAB [44]. Typically, the system transformed in SCB from is represented as,

$$\dot{\bar{x}}_a^- = A_{aa}^- \bar{x}_a^- + L_{ad}^- C_d \bar{x}_d \quad (46a)$$

$$\dot{\bar{x}}_a^+ = A_{aa}^+ \bar{x}_a^+ + L_{ad}^+ C_d \bar{x}_d \quad (46b)$$

$$\dot{\bar{x}}_i = A_{qi} \bar{x}_i + B_{qi} (\bar{E}_{ia}^- \bar{x}_a^- + \bar{E}_{ia}^+ \bar{x}_a^+ + \bar{E}_i \bar{x}_d + u_i) \quad (46c)$$

$$y = C_d \bar{x}_d \quad (46d)$$

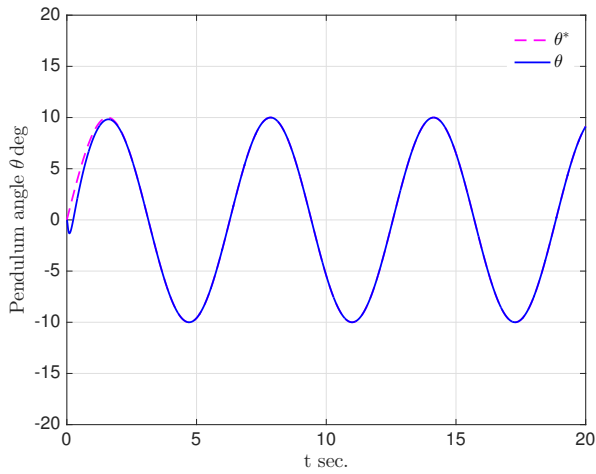

(a) Pendulum angular position (simulation).

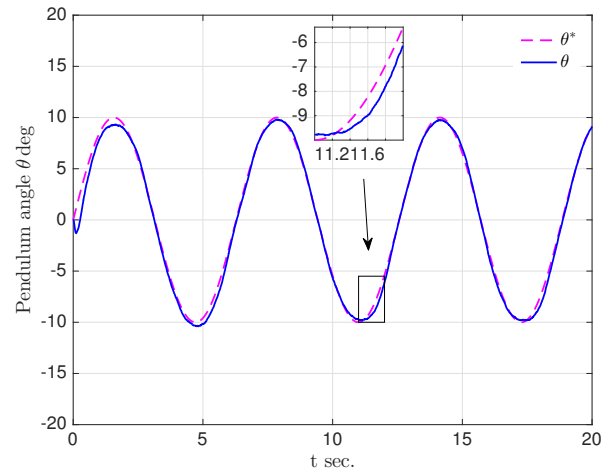

(b) Pendulum angular position (practical).

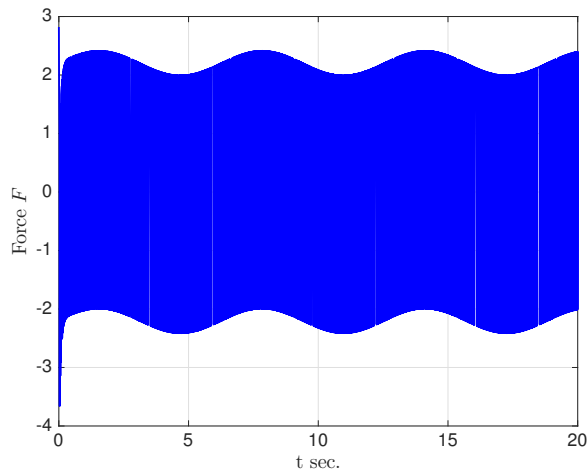

(c) Control input (simulation).

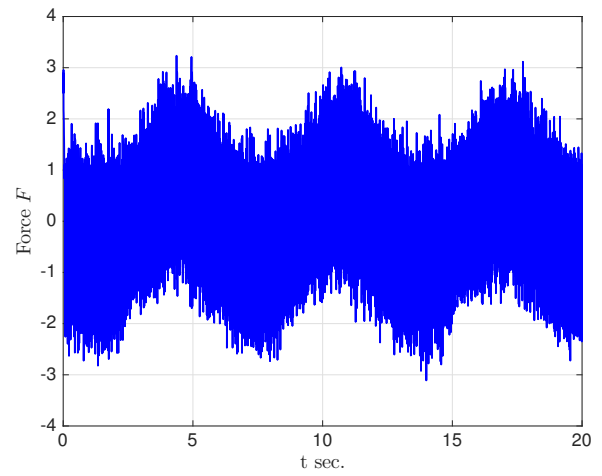

(d) Control input (practical).

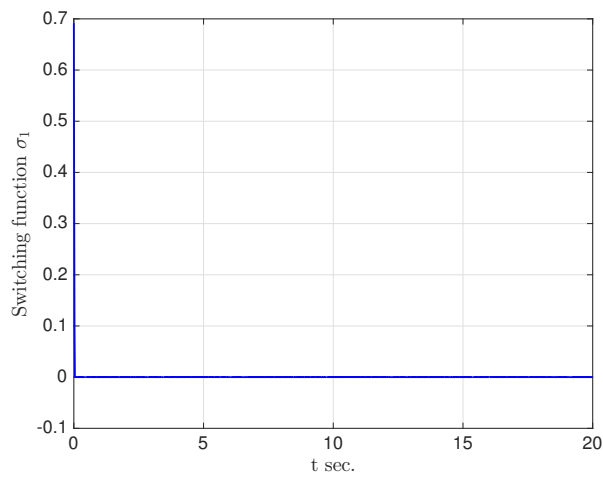

(e) Evolution of switching function σ_1 (simulation).

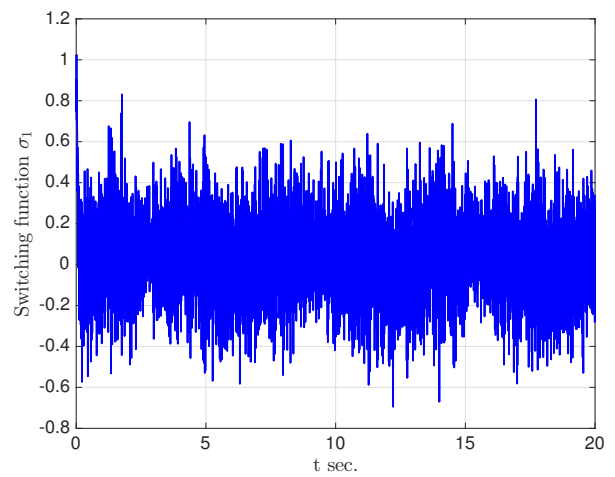

(f) Evolution of switching function σ_1 (practical).

Fig. 5: Simulation and practical implementation results of ECP-505 inverted pendulum system with the proposed reduced order control.

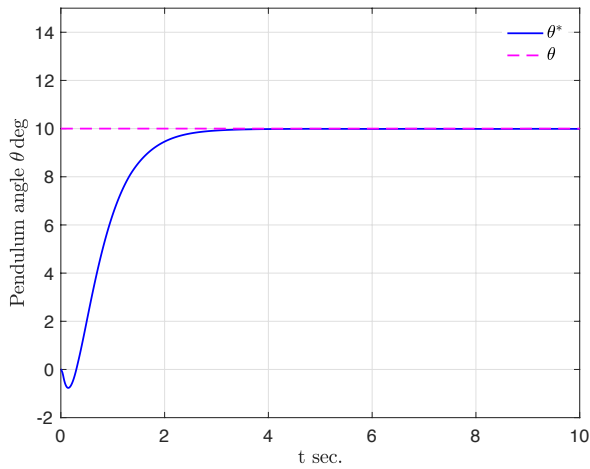

(a) Pendulum angular position (simulation).

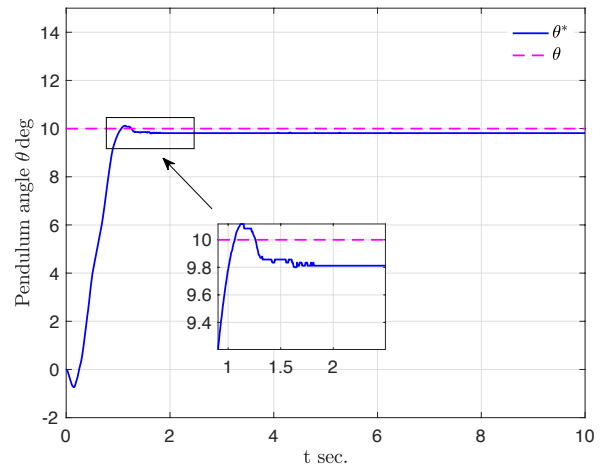

(b) Pendulum angular position (practical).

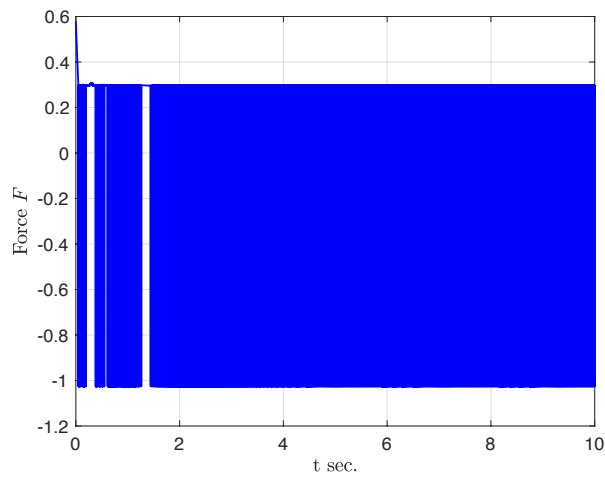

(c) Control input (simulation).

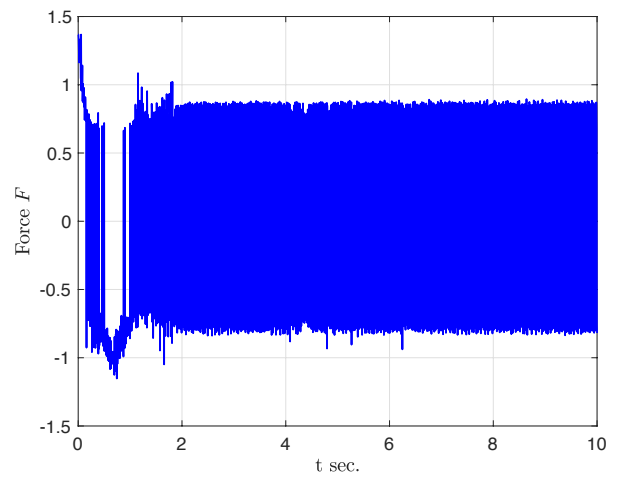

(d) Control input (practical).

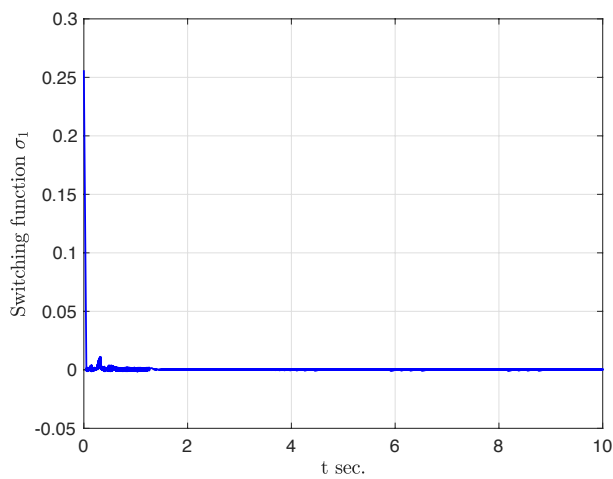

(e) Evolution of switching function σ_1 (simulation).

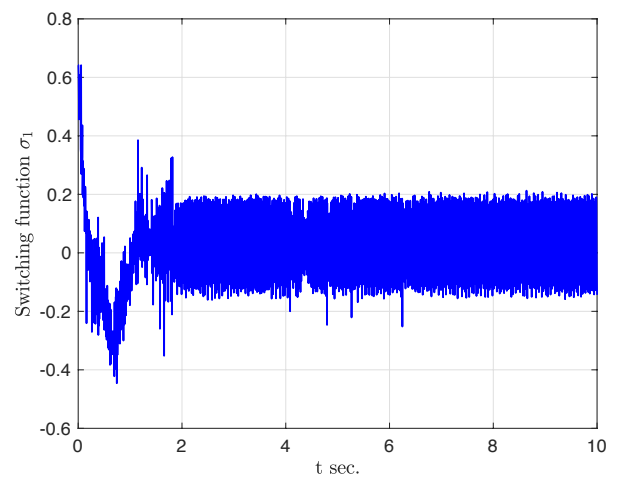

(f) Evolution of switching function σ_1 (practical).

Fig. 6: Simulation and practical implementation results of ECP-505 inverted pendulum system with the reduced order control as given in [38].

Where, $\bar{x}_d = [\bar{x}_1^\top \dots \bar{x}_m^\top]^\top$. Note that, A_{aa}^- and A_{aa}^+ are in diagonal form and contains the stable and unstable invariant zeros of the system respectively.

Let F_a be the matrix chosen such that $(A_{aa}^+ + L_{ad}^+ F_a)$ is Hurwitz. To transform the system (46) into the desired canonical form (2), the state transformation $\bar{x} = \Gamma_2 z$ can be constructed as,

$$z_a^- = \bar{x}_a^- \quad (47a)$$

$$z_a^+ = \bar{x}_a^+ \quad (47b)$$

$$z_{ik} = \bar{x}_{ik} - F_{ai}(A_{aa}^+)^{k-1} \bar{x}_a^+ - \sum_{\rho=1}^m \sum_{j=1}^{k-1} F_{ai}(A_{aa}^+)^{k-1-j} L_{ad(\rho)}^+ \bar{x}_{\rho j} \quad (47c)$$

where $k \in \{1, \dots, q_i\}$, $q_i > 1$, for each $i \in \{1, \dots, m\}$. Note that, $L_{adi}^+ \in \mathbb{R}^{n_a^+ \times 1}$ and $F_{ai} \in \mathbb{R}^{1 \times n_a^+}$. Thus, the state $x = Tz =: \Gamma_1 \Gamma_2 z$ and input transformation $v = \Gamma_i$ transformation the given system into the desired canonical form (2).

APPENDIX B

COMPUTATION OF BOUND ON TOTAL DISTURBANCE

Define, $e_a := [e_a^{-\top} e_a^{+\top}]^\top$,

$$A_{aa} := \begin{bmatrix} A_{aa}^- & L_{ad}^- F_a \\ 0 & A_{aa}^+ + L_{ad}^+ F_a \end{bmatrix} \text{ and } L_{ad} := \begin{bmatrix} L_{ad}^- \\ L_{ad}^+ \end{bmatrix}$$

Therefore, (10a)-(10b) dynamics can be written as,

$$\dot{e}_a = A_{aa} e_a + L_{ad} C_d e_d \quad (48)$$

As A_{aa} is stable, there exists a positive definite symmetric solution P_a to the Lyapunov equation, $A_{aa}^\top P_a + P_a A_{aa} = -Q_a$, for $Q_a > 0$. Define,

$$\Omega_a := \left\{ e_a \in \mathbb{R}^{n_a} \mid e_a^\top P_a e_a \leq \gamma_a \right\} \quad (49)$$

Let P_d be a positive definite symmetric matrix such that,

$$\Omega_d := \left\{ e_d \in \mathbb{R}^{n_d} \mid e_d^\top P_d e_d \leq \gamma_d \right\} \quad (50)$$

As the trajectory of subsystem (13) reaches the sliding surface, stability of the subsystem is guaranteed. This implies that Ω_d is invariant. Since $\Omega_d \subseteq \{e_d \in \mathbb{R}^{n_d} \mid \lambda_{\min}(P_d) \|e_d\|^2 \leq \gamma_d\}$, we use the upper bound for e_d as

$$\|e_d\| \leq \sqrt{\gamma_d / \lambda_{\min}(P_d)} \quad (51)$$

With this bound on e_d , the bound on e_a can be determined. The time derivative of V_a along the solution of (48) is given by,

$$\begin{aligned} \dot{V}_a &= \dot{e}_a^\top P_a e_a + e_a^\top P_a \dot{e}_a \\ &= e_a^\top A_{aa}^\top P_a e_a + e_d^\top C_d^\top L_{ad}^\top P_a e_a + e_a^\top P_a A_{aa} + e_a^\top P_a L_{ad} C_d e_d \\ &= -e_a^\top Q_a e_a + 2e_d^\top C_d^\top L_{ad}^\top P_a e_a \end{aligned}$$

This implies,

$$\begin{aligned} \dot{V}_a &\leq -\lambda_{\min}(Q_a) \|e_a\|^2 + 2 \|L_{ad}\| \|P_a\| \|e_a\| \|e_d\| \\ &\leq - \left(\lambda_{\min}(Q_a) \|e_a\| - 2 \sqrt{\frac{\gamma_d}{\lambda_{\min}(P_d)}} \|L_{ad}\| \|P_a\| \right) \|e_a\| \end{aligned}$$

Therefore, \dot{V}_a is negative outside the ball

$$\{e_a \in \mathbb{R}^{n_a} \mid \|e_a\| \leq \alpha\} \quad (52)$$

where $\alpha := \frac{2 \|L_{ad}\| \|P_a\|}{\lambda_{\min}(Q_a)} \sqrt{\frac{\gamma_d}{\lambda_{\min}(P_d)}}$.

Note that,

$$\begin{aligned} \Omega_a &\subseteq \{e_a \in \mathbb{R}^{n_a} \mid \lambda_{\min}(P_a) \|e_a\|^2 \leq \gamma_a\} \\ \Rightarrow \|e_a\| &\leq \sqrt{\gamma_a / \lambda_{\min}(P_a)} \quad (53) \end{aligned}$$

Thus, from (52)-(53)

$$\alpha \leq \|e_a\| \leq \sqrt{\gamma_a / \lambda_{\min}(P_a)} \quad (54)$$

From (12), total disturbance is $\psi_i = E_{ia}^- e_a^- + E_{ia}^+ e_a^+ + \phi_i$. This implies,

$$\begin{aligned} \psi_i &\leq \|E_{ia}^- + E_{ia}^+\| \cdot \|e_a\| + L \\ &\leq \|E_{ia}^- + E_{ia}^+\| \sqrt{\frac{\gamma_a}{\lambda_{\min}(P_a)}} + L =: \gamma_i \quad (55) \end{aligned}$$

With this upper bound γ_i on the total disturbance, the sliding mode control can be designed.

REFERENCES

- [1] B. Paden, D. Chen, R. Ledesma, and E. Bayo, "Exponentially stable tracking control for multijoint flexible-link manipulators," *Journal of dynamic systems, measurement, and control*, vol. 115, no. 1, pp. 53–59, 1993.
- [2] D. Kwon and W. J. Book, "A time-domain inverse dynamic tracking control of a single-link flexible manipulator," *Journal of dynamic systems, measurement, and control*, vol. 116, no. 2, pp. 193–200, 1994.
- [3] I. A. Shkolnikov and Y. B. Shtessel, "Aircraft nonminimum phase control in dynamic sliding manifolds," *Journal of Guidance, Control, and Dynamics*, vol. 24, no. 3, pp. 566–572, 2001.
- [4] B. L. Stevens, F. L. Lewis, and E. N. Johnson, *Aircraft Control and Simulation: Dynamics, Controls Design, and Autonomous Systems*. John Wiley & Sons, 2015.
- [5] H. Sira-Ramirez and M. Rios-Bolivar, "Sliding mode control of dc-to-dc power converters via extended linearization," *IEEE Transactions on Circuits and Systems I: Fundamental Theory and Applications*, vol. 41, no. 10, pp. 652–661, 1994.
- [6] Y. B. Shtessel, A. S. Zinober, and I. A. Shkolnikov, "Sliding mode control of boost and buck-boost power converters using method of stable system centre," *Automatica*, vol. 39, no. 6, pp. 1061–1067, 2003.
- [7] H. Fujimoto and B. Yao, "Multirate adaptive robust control for discrete-time non-minimum phase systems and application to linear motors," *IEEE/ASME Transactions on Mechatronics*, vol. 10, no. 4, pp. 371–377, 2005.
- [8] Y. Shtessel, "Nonlinear output tracking in conventional and dynamic sliding manifolds," *IEEE Transactions on Automatic Control*, vol. 42, no. 9, pp. 1282–1286, 1997.
- [9] P. Moylan, "Stable inversion of linear systems," *IEEE Transactions on Automatic Control*, vol. 22, no. 1, pp. 74–78, 1977.
- [10] R. Brockett, "Poles, zeros, and feedback: State space interpretation," *IEEE Transactions on Automatic Control*, vol. 10, no. 2, pp. 129–135, 1965.
- [11] L. Lanari and J. T. Wen, "Feedforward calculation in tracking control of flexible robots," in *Decision and Control, 1991., Proceedings of the 30th IEEE Conference on*. IEEE, 1991, pp. 1403–1408.
- [12] A. Isidori and C. I. Byrnes, "Output regulation of nonlinear systems," *IEEE Transactions on Automatic Control*, vol. 35, no. 2, pp. 131–140, 1990.
- [13] Q. Zou and S. Devasia, "Preview-based stable-inversion for output tracking of linear systems," *Journal of dynamic systems, measurement, and control*, vol. 121, no. 4, pp. 625–630, 1999.
- [14] S. Devasia, D. Chen, and B. Paden, "Nonlinear inversion-based output tracking," *IEEE Transactions on Automatic Control*, vol. 41, no. 7, pp. 930–942, 1996.
- [15] Q. Zou, "Optimal preview-based stable-inversion for output tracking of nonminimum-phase linear systems," *Automatica*, vol. 45, no. 1, pp. 230–237, 2009.
- [16] A. J. Van Der Schaft, "L/sub 2/-gain analysis of nonlinear systems and nonlinear state-feedback h/sub infinity/control," *IEEE transactions on automatic control*, vol. 37, no. 6, pp. 770–784, 1992.
- [17] A. Isidori, "Global almost disturbance decoupling with stability for non minimum-phase single-input single-output nonlinear systems," *systems & control letters*, vol. 28, no. 2, pp. 115–122, 1996.
- [18] W. Lan and D. Wang, "Structural design of composite nonlinear feedback control for linear systems with actuator constraint," *Asian Journal of Control*, vol. 12, no. 5, pp. 616–625, 2010.
- [19] C. Edwards and S. Spurgeon, *Sliding mode control: theory and applications*. CRC Press, 1998.
- [20] Y. Shtessel, C. Edwards, L. Fridman, and A. Levant, *Sliding mode control and observation*. Springer, 2014.

- [21] S. Kurode, S. K. Spurgeon, B. Bandyopadhyay, and P. Gandhi, "Sliding mode control for slosh-free motion using a nonlinear sliding surface," *IEEE/ASME Transactions on Mechatronics*, vol. 18, no. 2, pp. 714–724, 2013.
- [22] J. Zheng, H. Wang, Z. Man, J. Jin, and M. Fu, "Robust motion control of a linear motor positioner using fast nonsingular terminal sliding mode," *IEEE/ASME Transactions on Mechatronics*, vol. 20, no. 4, pp. 1743–1752, 2015.
- [23] Q. Xu, "Continuous integral terminal third-order sliding mode motion control for piezoelectric nanopositioning system," *IEEE/ASME Transactions on Mechatronics*, vol. 22, no. 4, pp. 1828–1838, 2017.
- [24] W. Zhao, X. Ren, and S. Wang, "Parameter estimation-based time-varying sliding mode control for multimotor driving servo systems," *IEEE/ASME Transactions on Mechatronics*, vol. 22, no. 5, pp. 2330–2341, 2017.
- [25] B. Bandyopadhyay and S. Kamal, *Stabilization and control of fractional order systems: a sliding mode approach*. Springer, 2015, vol. 317.
- [26] C. Yin, Y. Cheng, Y. Chen, B. Stark, and S. Zhong, "Adaptive fractional-order switching-type control method design for 3d fractional-order nonlinear systems," *Nonlinear Dynamics*, vol. 82, no. 1-2, pp. 39–52, 2015.
- [27] C. Yin, X. Huang, Y. Chen, S. Dadras, S.-m. Zhong, and Y. Cheng, "Fractional-order exponential switching technique to enhance sliding mode control," *Applied Mathematical Modelling*, vol. 44, pp. 705–726, 2017.
- [28] S. Gopalswamy and J. K. Hedrick, "Tracking nonlinear non-minimum phase systems using sliding control," *Int. Journal of Control*, vol. 57, no. 5, pp. 1141–1158, 1993.
- [29] I. Shkolnikov and Y. Shtessel, "Tracking controller design for a class of nonminimum phase systems via the method of system center," *IEEE Transactions on Automatic Control*, vol. 46, no. 10, pp. 1639–1643, 2001.
- [30] I. A. Shkolnikov and Y. B. Shtessel, "Tracking in a class of nonminimum-phase systems with nonlinear internal dynamics via sliding mode control using method of system center," *Automatica*, vol. 38, no. 5, pp. 837–842, 2002.
- [31] S. Baev, Y. Shtessel, C. Edwards, and S. Spurgeon, "Output feedback tracking in causal nonminimum-phase nonlinear systems using hoshm techniques," in *8th Int. Workshop on Variable structure systems*, ser. VSS, 2008, pp. 209–214.
- [32] H. S. Jeong and V. I. Utkin, *Variable structure systems sliding mode and nonlinear control*. London: Springer, 1999, ch. Sliding mode tracking control of systems with unstable zero dynamics, pp. 303–327.
- [33] B. Bandyopadhyay and S. Janardhanan, *Discrete-time sliding mode control: a multirate output feedback approach*. Springer Science & Business Media, 2005, vol. 323.
- [34] B. A. White, "Reduced-order switching functions in variable-structure control systems," in *IEE Proc. D, Control Theory and Applications*, Mar. 1983, pp. 1199–1206.
- [35] A. K. Paul, J. K. Mishra, and M. G. Radke, "Reduced order sliding mode control for pneumatic actuator," *IEEE Transactions on Control Sys. Tech.*, vol. 2, no. 3, pp. 271–276, 1994.
- [36] B. Bandyopadhyay, A. G. Abera, and S. Janardhanan, "Sliding mode control design via reduced order model approach," in *Proc. of IEEE ICIT*, Mumbai, India, Dec. 2006, pp. 1538–1541.
- [37] M. Patil and B. Bandyopadhyay, "Discrete-time sliding mode tracking control for nmp systems using reduced order switching function," *IFAC Proceedings Volumes*, vol. 46, no. 32, pp. 469 – 474, 2013.
- [38] B. Bandyopadhyay and M. Patil, "Sliding mode control with the reduced-order switching function: an scb approach," *International Journal of Control*, vol. 88, no. 5, pp. 1089–1101, 2015.
- [39] "User manual of ecp model 505 inverted pendulum," 2004, Educational Control Products, California, USA.
- [40] A. S. Morse, "Structural invariants of linear multivariable systems," *SIAM Journal on Control*, vol. 11, no. 3, pp. 446–465, 1973.
- [41] A. Levant, "Robust exact differentiation via sliding mode technique," *Automatica*, vol. 34, no. 3, pp. 379–384, 1998.
- [42] P. Sannuti and A. Saberi, "Special coordinate basis for multivariable linear systems—finite and infinite zero structure, squaring down and decoupling," *International Journal of Control*, vol. 45, no. 5, pp. 1655–1704, 1987.
- [43] B. M. Chen, "On properties of the special coordinate basis of linear systems," *International Journal of Control*, vol. 71, no. 6, pp. 981–1003, 1998.
- [44] B. M. Chen, Z. Lin, and Y. Shamash, *Linear systems theory: a structural decomposition approach*. Springer Science & Business Media, 2004.



control, tracking in non-minimum phase systems.

Machhindranath Patil received the B.E. degree in Instrumentation Engineering from North Maharashtra University, India in 1996, M.E. degree in Instrumentation and Control Engineering from Mumbai University, India in 2006 and Ph.D. degree from Systems and Control Engineering, Indian Institute of Technology Bombay, India in 2016. He is currently an Associate professor in Department of Instrumentation Engineering at V.E.S. Institute of Technology, Mumbai University, India. His research interests include sliding mode and higher-order sliding mode



Distinguished Visiting Fellowship in 2009 and 2012 from The Royal Academy of Engineering, London. He is a Fellow of Indian National Academy of Engineering (INAE). He has authored or co-authored 11 books and 376 journal articles, conference papers and book chapters. His research interests include sliding mode control, discrete-time sliding mode, and higher order sliding mode.

Bijnan Bandyopadhyay received the B.E. degree in electronics and telecommunication engineering from the Indian Institute of Engineering Science and Technology, Shibpur, India, in 1978 and the Ph.D. degree in electrical engineering from the Indian Institute of Technology (IIT) Delhi, New Delhi, India, in 1986. In 1987, he joined the Systems and Control Engineering Group, IIT Bombay, Mumbai, India, as a Faculty Member, where he is currently a Professor. He has been a visiting Professor at many Universities around the world. He has been awarded



Asif Chalanga received his B.E. in Electrical Engineering from the University of Bhavnagar, India in 2007, M.Tech in Control Systems from College of Engineering Pune, India in 2010 and Ph.D. in Systems and Control Engineering from Indian Institute of Technology Bombay, India in 2015. He is currently with University College London (UCL). His research interests include the areas of discrete and continuous higher order sliding mode control and application aspects of the sliding mode to real time systems.

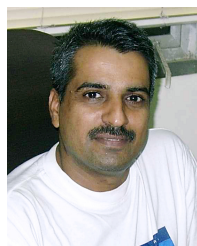

Hardware-in-the loop simulation and Systems Engineering practices.

Hemendra Arya received the B.E. degree in Mechanical Engineering from the Jodhpur University, India in 1988 and M.Tech and PhD degree in Aerospace Engineering from the Indian Institute of Technology Bombay, India in 1991 and 1997 respectively. In 2003, he joined the Aerospace Engineering Dept., Indian Institute of Technology Bombay, India, as a Faculty Member, where he is currently an Associate Professor. His main research interests are in the areas of Flight dynamics and control for unmanned aerial vehicles, Co-operative missions,