

Research Article

RELAP5 Simulation of PKL Facility Experiments under Midloop Conditions

J. F. Villanueva, S. Carlos, F. Sanchez-Saez, I. Martón, and S. Martorell

Department of Chemical and Nuclear Engineering, Universitat Politècnica de València, Valencia, Spain

Correspondence should be addressed to J. F. Villanueva; jovillo0@iqn.upv.es

Received 4 August 2016; Revised 22 November 2016; Accepted 12 December 2016; Published 9 February 2017

Academic Editor: Francesc Reventos

Copyright © 2017 J. F. Villanueva et al. This is an open access article distributed under the Creative Commons Attribution License, which permits unrestricted use, distribution, and reproduction in any medium, provided the original work is properly cited.

Nuclear power plant risk has to be quantified in full power and in other modes of operation. This latter situation corresponds to low power and shutdown modes of operation in which the residual heat removal (RHR) system is required to extract the heat generated in the core. These accidental sequences are great contributors to the total plant risk. Thus, it is important to analyze the plant behavior to establish the accident mitigation measures required. In this way, PKL facility experimental series were undertaken to analyze the plant behavior in other modes of operation when the RHR is lost. In these experiments, the plant configurations were changed to analyze the influence of steam generators secondary side configurations, the temperature inside the pressurizer, and the inventory level on the plant behavior. Moreover, different accident management measures were proposed in each experiment to reach the conditions to restart the RHR. To understand the physical phenomena that takes place inside the reactor, the experiments are simulated with thermal-hydraulic codes, and this makes it possible to analyze the code capabilities to predict the plant behavior. This work presents the simulation results of four experiments included in PKL experimental series obtained using RELAP5/Mod3.3.

1. Introduction

When a pressurized water reactor is in other modes of operation (OM), the reactor coolant system (RCS) water level can be reduced to a height lower than the top of the hot leg pipe, for example, to perform U-tubes or reactor coolant pump maintenance activities. Under these conditions, the residual heat removal (RHR) system is used to extract the decay power heat generated in the reactor core. Some accidental situations may occur in midloop conditions that have a significant contribution to the plant risk, and all involve the loss of the RHR system [1]. In fact, the loss of RHR has occurred several times in pressurized water reactor plants [2, 3]. For these reasons, the study of transients in midloop operation is of great interest to analyze the plant safety.

To better understand the thermal-hydraulic processes following the loss of the RHR in OM, transients of this kind have been simulated using best-estimate codes such as RELAP5 [4] or CATHARE. Such codes have initially been developed to simulate full power operation conditions, which are different physical conditions from the ones faced

in midloop operation mode. Thus, to assess the capability of best-estimate codes in simulating the physical phenomena under OM conditions, it is necessary to compare the code calculation with data obtained from experiments simulating such type of conditions [5–7].

This work focuses on the simulation, using the best-estimate code RELAP5/Mod 3.3, of some experiments belonging to the experimental series E and F conducted at the PKL facility [8]. All of them start with the loss of the RHR system when the plant is in midloop conditions for refueling and with the primary circuit closed. The difference among them are the number of steam generators filled and ready for operation, the temperature inside the pressurizer, level in the hot leg and Emergency Core Cooling (ECC) injection effectiveness. The physical phenomena to investigate in all the experiments are the mechanisms of heat removal in presence of nitrogen, the deboration in critical parts of the primary system, the influence of steam generator secondary side configurations to act as final heat sink, and how to return to a safe condition to restart the RHR through different injections.

2. PKL Facility Description

PKL facility represents a typical 1,300 MWe PWR Siemens/KWU designed with a volume and power scale of 1:145, while all the components' heights on the primary and secondary side correspond to real plant dimensions. It models the entire primary system and the relevant parts of the secondary side. In order to investigate the influence of nonsymmetrical boundary conditions on the system behavior, PKL facility is equipped with four primary loops symmetrically arranged around the reactor pressurized vessel. Each loop contains a reactor coolant pump and a steam generator [5].

The facility also has all the important safety and auxiliary systems as eight accumulators, one in each of the hot legs and one in each of the cold legs, four independent injections from high and low pressure injection system, the residual heat removal system, and the pressure control in the pressurizer. Figure 1 shows an overview of PKL test facility.

3. PKL Experiments Description

Three experimental programs have been conducted at PKL facility. PKL I and PKL II programs were focused on the study of Large Break Loss of Coolant Accidents (LBLOCAs) and Small Break Loss of Coolant Accidents (SBLOCAs) with the aim of testing and validating best-estimate codes. PKL III program started in 1986 [5], with the objective of studying different transients with and without LOCAs. The PKL tests results have also been used for preparation and verification of procedures described in the operating manuals and for answering questions from the regulatory bodies. In particular, series E, F, and G of PKL III program include research on the inadvertent boron dilution events, the effect of primary coolant inventory in transients under OM conditions, and analysis of asymmetric cooldown transients [6, 7, 9–11].

In OM conditions, one of the most important accident scenarios corresponds to the loss of the RHR system. When this happens, other alternatives for heat removal must be available to cool down the reactor core. One possibility consists of using the steam generators as heat sink, by means of using the cooling capacity of reflux condensation. This phenomenon takes place in the steam generators' U-tubes with the secondary side full of water. The vapor generated in the core comes into the U-tubes and transfers the heat to the steam generator secondary side. As a result of this heat exchange, the vapor condenses inside the U-tubes and comes back again into the reactor vessel.

The experimental series E3.1, F2.1, and F2.2 conducted at PKL facility consist of the loss of the RHR system when the plant is in OM conditions, with the reactor coolant system closed and filled up to 3/4 of the loop (partially filled) and considering different steam generators secondary side configurations. The main objective of the experiments was focused on analyzing the effect of the steam generators secondary side on the heat transfer mechanisms when the RHR is lost in OM conditions. Another important objective was to study different accident management measures to

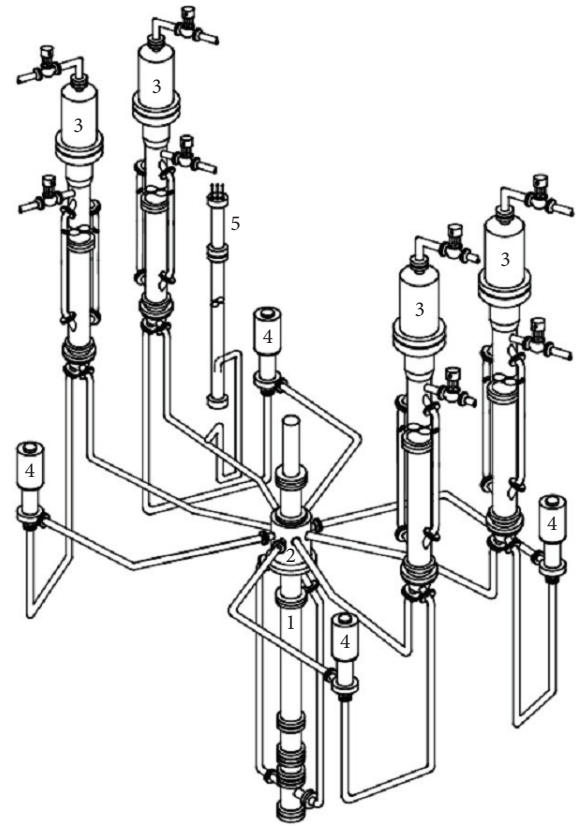

1 Reactor pressure vessel	Volume, power	1 : 145
2 Downcomer	Elevations	1 : 1
3 Steam generator	Max. pressure	45 bars
4 Reactor coolant pump	Max. power	2.5 MW (10%)
5 Pressurizer		

FIGURE 1: PKL facility [8].

reach the reactor coolant system (RCS) conditions that allow the restart of the RHR.

Table 1 presents the plant initial conditions considered for each experiment. It can be observed that the primary side conditions are very similar for all the experiments, except for the hot leg levels and the temperature inside the pressurizer, while in the secondary side the differences among the tests performed are the number of steam generators filled with water and the possibility of controlling the secondary side water level and pressure.

The comparison of experiments E3.1 and F2.1 Run 2 allows analyzing the influence of RCS level in the evolution of the accidental scenario; in particular, 3/4 loop and Reactor Coolant Line (RCL) lower edge are considered. The influence of coolant and wall temperature inside the pressurizer on the plant behavior can be observed by comparing experiments E3.1 and F2.1 Run 1. Finally, the comparison of experiments E3.1 and F2.2 Run 1 allows analyzing the influence of the number of steam generator secondary sides filled with water taking into consideration whether they are operable or not, that is, whether secondary side pressure and water level inventory are controlled.

TABLE 1: E3.1, F2.1, and F2.2 initial conditions.

	PKL III E OECD-SETH E3.1	F2.1 Run 1	PKL III F OECD-PKL F2.1 Run 2	PKL III F OECD-PKL F2.2 Run 1
	<i>Primary side</i>			
Power (kW)	220	220	220	220
Pressure (kPa)	100	100	100	100
Temperature pressurizer (°C)	50	150–170	50	50
Temperature at core outlet (°C)	60	60	60	60
Level (hot legs)	3/4 loop	3/4 loop	RCL lower edge	3/4 loop
	<i>Secondary side</i>			
	Two SGs filled with water and one of them operable (200 kPa)	Two SGs filled with water and one of them operable (200 kPa)	Two SGs filled with water and one of them operable (200 kPa)	One SG filled with water and operable (200 kPa)

TABLE 2: E3.1, F2.1, and F2.2 accident management measures (Phase II).

	PKL III E OECD-SETH E3.1	F2.1 Run 1	PKL III F OECD-PKL F2.1 Run 2	PKL III F OECD-PKL F2.2 Run 1
Safety systems injection			LPIS	
	Cold leg 1	Hot leg 1	Hot leg 1	Hot leg 1
Accumulators injection sequence	Cold leg 2	Cold leg 2	Cold leg 2	Hot leg 2
	Cold leg 3	Cold leg 3	Cold leg 3	Hot leg 3
	Cold leg 4	Hot leg 4	Hot leg 4	Hot leg 4
	Cold leg 4			
Depressurization		SG secondary valves PRZ valves	SG secondary valves PRZ valves	
Safety systems injection		LPIS	LPIS HPIS	HPIS

Under the conditions exposed in Table 1, all the experiments start when the RHR fails. Due to the residual heat generated in the core, there is a rise in the core temperature and void formation in the core starts, with an associated increase in the primary pressure, so primary coolant comes out from the vessel towards the steam generator U-tubes, which act as heat sink. Once the system reaches stable conditions evacuating all the heat through the steam generators, different accident management activities are proposed in order to reach the conditions to restart the RHR system assuming that the causes that led to the failure of the RHR no longer act. All transients can be structured in two phases: Phase I from the start of the transient to the plant stabilization through the steam generators and Phase II from the initiation of the accident management measures to the restoration of the RHR system.

Regardless of the stabilization conditions reached in phase I, the actions proposed to mitigate the accident in Phase II are different depending on the experiment, as shown in Table 2. Thus, with the aim of achieving stable conditions to restore the RHR system, different alternatives are proposed

depending on the plant configuration. The conditions to be met at the RHR suction line are (1) pressure less than 30 bars, (2) temperature below 180°C, and (3) liquid phase coolant to avoid cavitation problems in the RHR pumps. The actions proposed to meet such conditions may include one or several of the following depending on the experiment: (1) safety injections of accumulators, (2) low and high pressure injection systems, (3) reactor coolant system depressurization, and (4) steam generators secondary side depressurization. Table 2 shows the different actions performed in Phase II for each experiment.

Experiment E3.1 studies the effect of the successive discharges from accumulators, whose aim is to recover the level of inventory necessary for restarting the RHR, since the other conditions of pressure and temperature should be satisfied.

In experiment F2.1 Run 1, with a higher pressurizer temperature (see Table 1), it is expected that the plant reaches higher pressure stabilization as compared to E3.1 experiment. The injections from accumulators planned would produce an excessive increase in the primary pressure and the RHR could

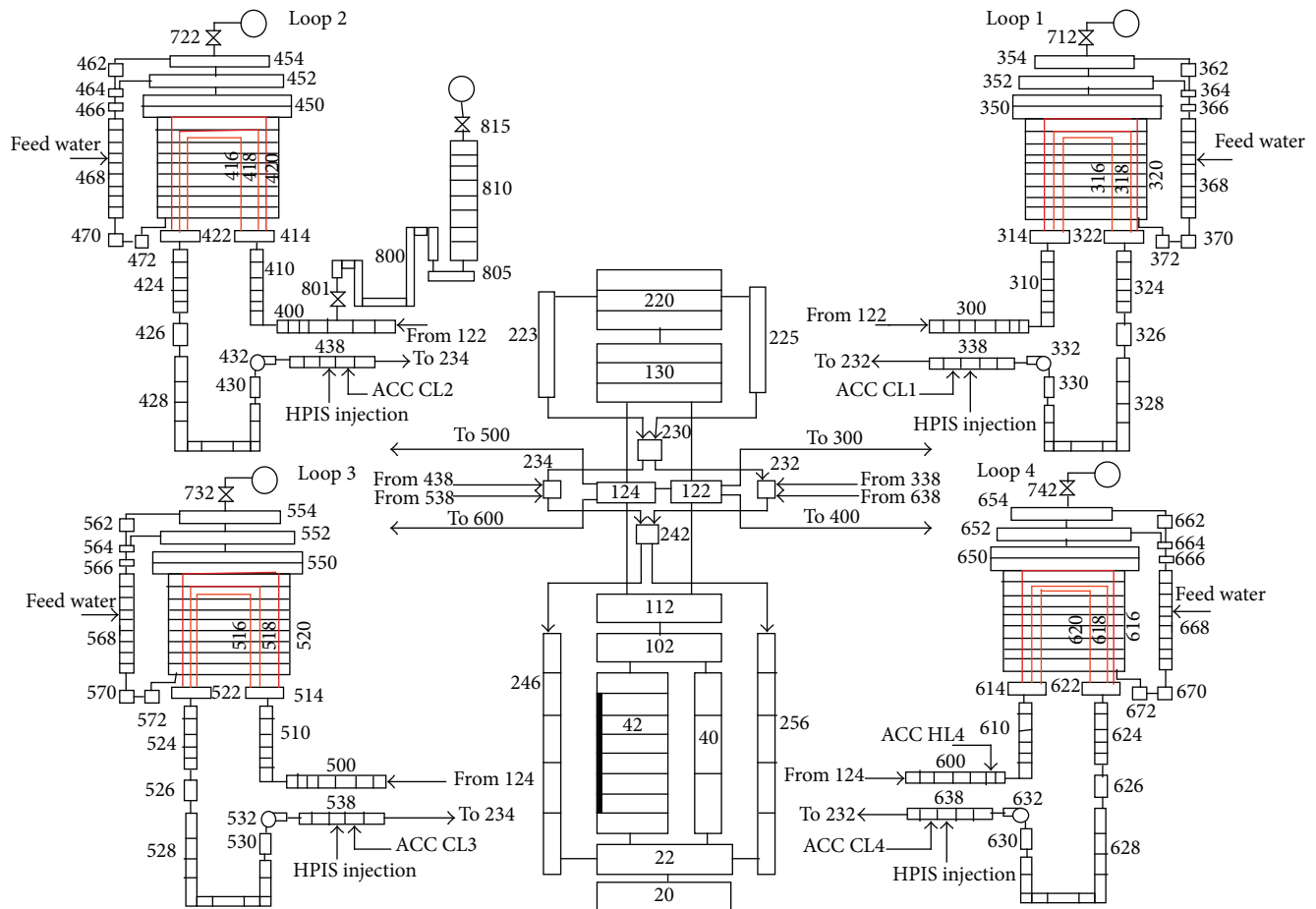

FIGURE 2: RELAP5 nodalization of PKL facility.

not be restored. To reduce the pressure value until the RHR setpoint, depressurization of secondary side steam generators is undertaken, which must be complemented with primary side depressurization through the pressurizer (PRZ) valves. These actions should allow the activation of the low pressure injection system (LPIS), which is necessary to recover the level at the RHR suction and, therefore, all the conditions to restart this system should be reached.

In experiment F2.1 Run 2, with initial primary level up to the lower RCL edge (see Table 1), there is an injection from the LPIS, followed by four injections through the accumulators in the same sequence as in F2.1 Run 1 experiment. Once the injections from the accumulators have finished, there is depressurization of the secondary side of steam generators followed by depressurization through the PRZ valves. These actions are needed to allow a second injection from the LPIS, followed by an injection from the high pressure injection system (HPIS) that should allow reaching the conditions to restore RHR system.

In experiment F2.2 Run 1, all the injections from accumulators are performed in the hot legs, followed by an injection from the HPIS, which are intended to reach enough coolant inventory and appropriate pressure and temperature conditions to restore the RHR.

4. RELAP5 Model of PKL Facility

The simulations were performed using RELAP5-Mod 3.3 code [4]. The RELAP5 model used consists of 600 hydraulic volumes, 622 junctions, and 512 heat structures. This model has been adapted to simulate OM conditions, from the PKL model provided by the facility [12]. Figure 2 outlines the plant nodalization used to simulate the transients.

The core is simulated using a PIPE component of eight volumes. Six of these volumes contain the fuel rods, which are simulated using a HEAT STRUCTURE component that generates the residual power established in Table 1. The vessel of the PKL facility has two external downcomers (see Figure 1) simulated in the RELAP model by means of two external pipes. The cold legs of all four loops are nodalized using PIPE and BRANCH components, which are connected to two branches, which in turn are connected to the downcomer vessel. The facility has four bypasses in the vessel upper head which have been collapsed in this model into two BRANCH components.

The four primary loops are modelled with a pump and a steam generator in each loop using PIPE, PUMP, and BRANCH components. The U-tubes of the steam generators are lumped into three PIPE components of different heights.

The heat transfer between the primary and secondary systems is simulated using three HEAT STRUCTURES, one for each of the three pipes that simulate the steam generators U-tubes.

The RHR system is simulated as boundary conditions; thus, in this model, the RHR operation is modelled using TIME DEPENDENT JUNCTIONS connected to TIME DEPENDENT VOLUMES that extract coolant from the all hot legs and inject the same quantity of cool water into the cold legs.

The injections from accumulators are simulated by ACCUMULATOR component connected to the loops through a VALVE component that opens when the pressure downstream is lower than accumulator pressure setpoint and closes when it is empty.

Finally, the LPIS and HPIS injections are simulated by TIME DEPENDENT VOLUMES connected to the cold leg of each loop through TIME DEPENDENT JUNCTIONS that provide the required mass flow of cold water depending on the safety injection system that is activated.

5. Simulation Results

The PKL experiments introduced in Section 3 have been simulated using the thermal-hydraulic model presented in the previous section adopting the initial conditions, plant configuration, and recovery actions summarized in Tables 1 and 2. These experiments are analyzed in the following according to the main plant configuration differences in order to determine their influence on the plant evolution response. The main configuration differences are (1) level in hot legs, (2) pressurizer temperature, and (3) number and operability of steam generators.

5.1. Influence of Hot Leg Water Level. Comparison of experiments E3.1 and F2.1 Run 2 allows seeing the influence of hot leg water inventory level, 3/4 loop versus RCL lower edge, respectively.

In both experiments, the PWR is initially in OM conditions, closed, with the RHR in operation to remove the residual heat. This study focuses on determining whether the level in the loop improves or not the heat transfer from steam generators primary to secondary side when the RHR is lost. Heat transfer determines the plant stabilization conditions reached at the end of Phase I.

When the RHR fails, due to the residual heat generated in the core, there is a rise in the core temperature and void formation in the core starts, so natural circulation of coolant is established from the vessel towards the steam generator U-tubes, which act as heat sink. As vapor is cooled in the steam generators U-tubes it condenses. Figures 3 and 4 show the water level inside the inlet of the U-tubes for steam generators 1 (SG1) and 2 (SG2), respectively. Only SG1 is operable, which means that it has the secondary side pressure and level controlled. At the start of the transient, both steam generators are full of water and both act as heat sink. When steam SG2 secondary becomes empty, there is a decrease in the U-tubes level as no heat can be transferred (see Figure 4). It can be observed that SG2 maintains heat transfer during 2000 s more

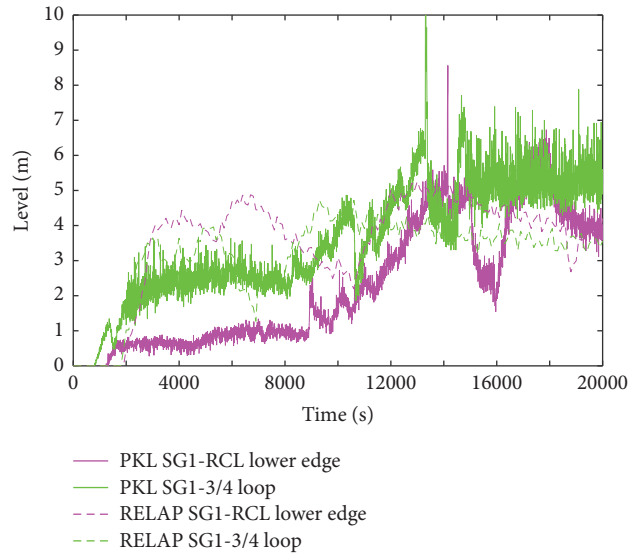

FIGURE 3: Inlet U-tubes SG1 levels. PKL versus RELAP5. Level influence. Phase I.

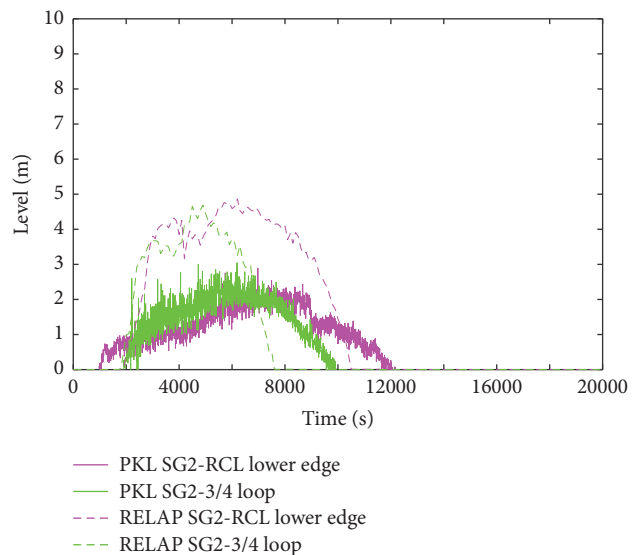

FIGURE 4: Inlet U-tubes SG2 levels. PKL versus RELAP5. Level influence. Phase I.

for the case of the water level at the lower edge of the RCL than for midloop conditions. Then, a redistribution of water inventory inside the reactor coolant system is observed and more water enters the SG1 U-tubes, as shown in Figure 3. This increases SG1 heat transfer and the plant can reach a stable situation due to the SG1 pressure and level controls.

RELAP5 calculations predict higher coolant levels in both steam generator U-tubes, as shown in Figures 3 and 4. In addition, at the beginning of U-tubes filling, significant differences are found between experimental data and simulation results, in particular when the initial reactor coolant circuit level is at RCL lower edge. However, such differences tend to decrease once the stabilization is reached at the end of Phase I and minor differences are found at the end of this phase.

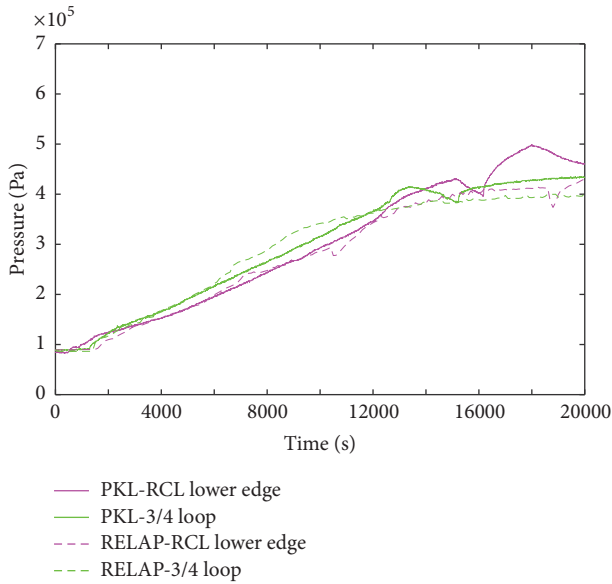

FIGURE 5: Pressure. PKL versus RELAP5. Level influence. Phase I.

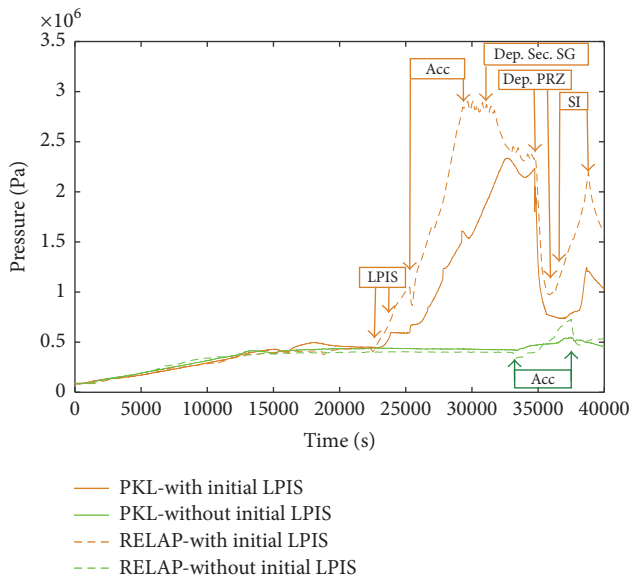

FIGURE 6: Pressure. PKL versus RELAP5. Injections and depressurization (Phase II).

Figure 5 shows the evolution of the primary pressure since the start of the transient until it reaches an almost stable value. In this figure, one can observe that RELAP5 calculations are close to the experimental values.

Once a stable condition is reached, Phase II of the transient starts. In Figure 6, a significant increase in the pressure is observed after LPIS injection previous to the accumulator injections (transient F2.1 Run 2 in Table 2). This pressure rise is due to the fact that, after LPIS injection, the RCS is almost full of water (see Figure 7) and the injections through the accumulators result only in an increase in the RCS pressure. This effect is more evident in the RELAP5 simulation. As expected, in this case, the system pressure must be reduced

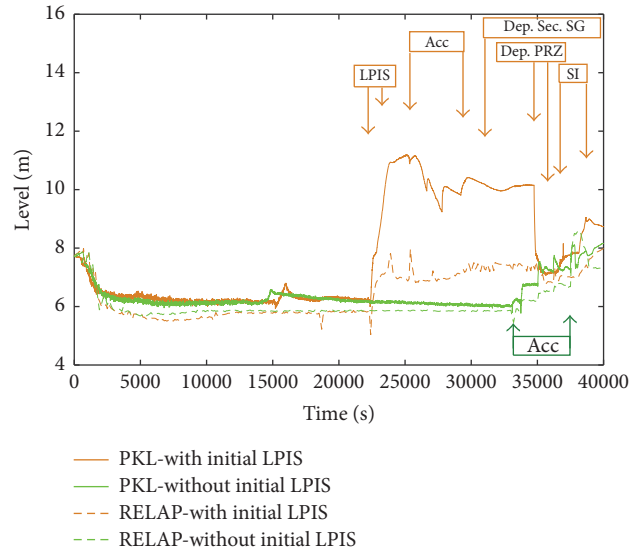

FIGURE 7: Vessel level. PKL versus RELAP5. Injections and depressurization (Phase II).

to allow restarting the RHR. Depressurization of steam generator secondary side, followed by RCS depressurization through the PRZ valves, is needed. This depressurization reduces not only the pressure but also the liquid phase at the RHR suction due to water evaporation (Figure 7), so that new injections from LPIS and HPIS, respectively, are needed to reach the necessary conditions to restart the RHR. The primary system overpressure does not occur for the case in which no LPIS injection is required (transient E3.1), where pressure remains almost stable. Then, injections through the accumulators are able to achieve the RHR restoration conditions. In any of the transients simulated, the pressure values needed to restore the RHR are achieved later than the temperature setpoint and the level in the pump suction line, so in all cases the pressure is the parameter that determines the RHR restoration.

5.2. Influence of Pressurizer Temperature. Comparison of experiments E3.1 (cold pressurizer) and F2.1 Run 1 (hot pressurizer) allows seeing the influence of a difference in the wall and coolant temperature inside the pressurizer.

Figure 8 shows the evolution of the primary pressure in the first phase of the transient in both cases. It can be observed that the pressurizer temperature has a great influence in the system stabilization pressure. When considering the hot pressurizer, the pressure value along the transient is higher than the one observed for a cold pressurizer. Figure 9 shows the water level evolution inside the rising part of the active steam generator U-tubes (SG1), where one can realize that there is a higher level during all the transient for the case of a hot pressurizer, even at the end of Phase I, when the plant reaches an almost stable condition. In both transients, RELAP predicts lower water levels compared with their respective experimental data, and that difference is more evident at the end of Phase I. In addition, at this time, the upper levels of SG1 U-tubes, which are acting as the only final sink, are full

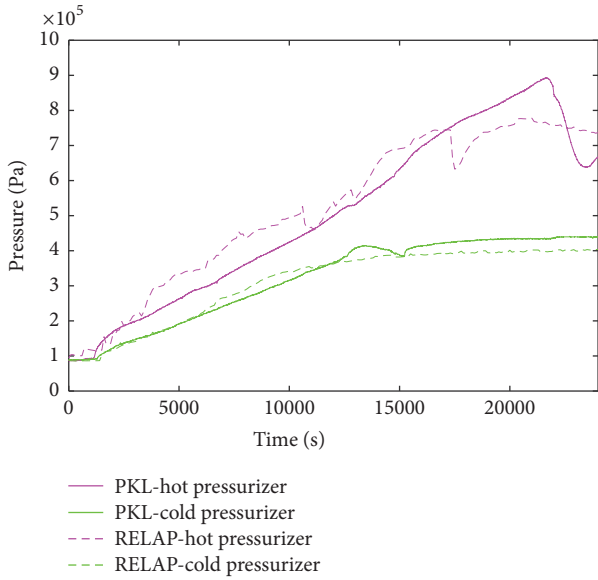

FIGURE 8: Pressure. PKL versus RELAP5. Temperature influence. Phase I.

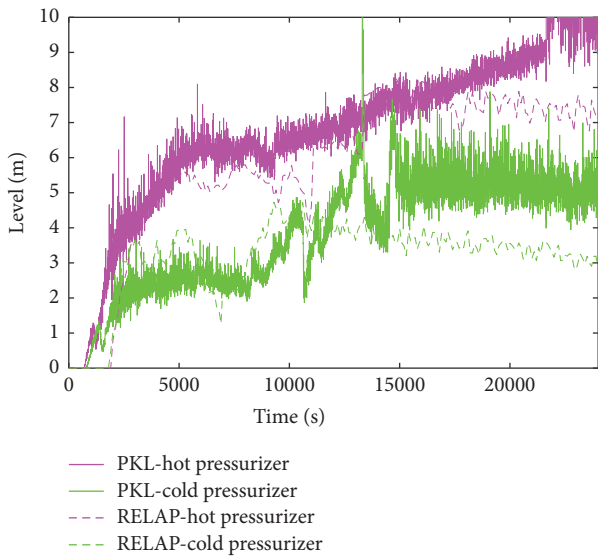

FIGURE 9: Inlet SG1 level PKL versus RELAP5. Temperature influence. Phase I.

of nitrogen, while in the other steam generators, there is a mixture of vapor and nitrogen. This situation is different from the initial condition where the mixture of noncondensable and steam is homogeneously distributed in all the RCS, but as the transient progresses there is a displacement of noncondensable towards the active steam generator.

In the second phase, the effect on the vessel level due to the injections from accumulators is shown in Figure 10 for both cases. One can observe that in both cases the injections increase the level in the RCS since a higher level is observed inside the reactor vessel. However, two-phase flow is present in the hot legs for the case of hot pressurizer (experiment F2.1 Run 1).

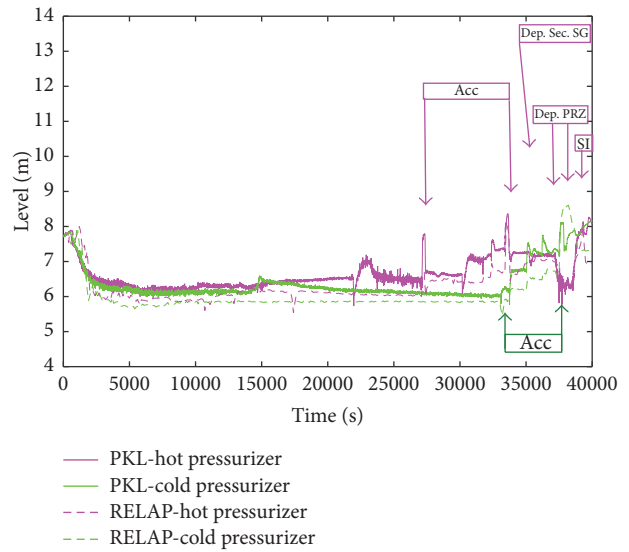

FIGURE 10: Vessel level PKL versus RELAP5. Temperature influence (Phase II).

In order to counteract this phenomenon, different actions were undertaken for the case of the hot pressurizer: first, depressurization of the secondary side of steam generators and depressurization of the RCS through the PRZ valves. These actions aim at improving a greater condensation in the RCS and therefore increasing the liquid phase on the RHR suction line, to avoid cavitation problems in the RHR pumps, previous to LPI injection, which in turn allows recovering the conditions in the RHR suction line necessary to achieve the RHR restoration conditions decreasing the temperature in the inlet of RHR, taking into account the fact that the pressure is always lower than 30 bars.

Figure 10 shows that a difference in the mass inventory between the RELAP5 calculations and experimental data is observed inside the vessel in both cases, particularly important which concerns the case of hot pressurizer. This indicates that simulations predict a lower level in reactor vessel along the transient, which means that more water is displaced from the core towards the reactor coolant circuit. At the same time, RELAP5 simulation shows an important increase of primary pressure after accumulator injections in both cases (see Figure 11), which seems to indicate that there may be problems to simulate nitrogen injection from accumulators when all the water has been discharged. The effect of nitrogen injection is not observed in the experimental data, which could also explain the differences in the vessel level.

5.3. Influence of Steam Generators. Comparison of cases E3.1 and F2.2 Run 1 allows seeing the influence of the number and operability of the steam generators. In experiment F2.2 Run 1, only one steam generator is operable while in E3.1 there is a second steam generator full of water, in addition to the one steam generator operable.

Figure 12 shows the pressure evolution after the RHR is lost. In both transients, the plant reaches a stable situation at the end of Phase I. In fact, the stabilization value reached in

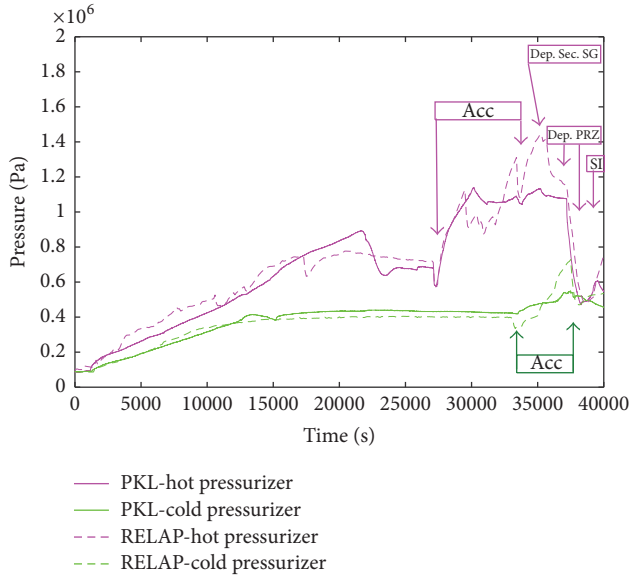

FIGURE 11: Primary pressure PKL versus RELAP5. Temperature influence (Phase II).

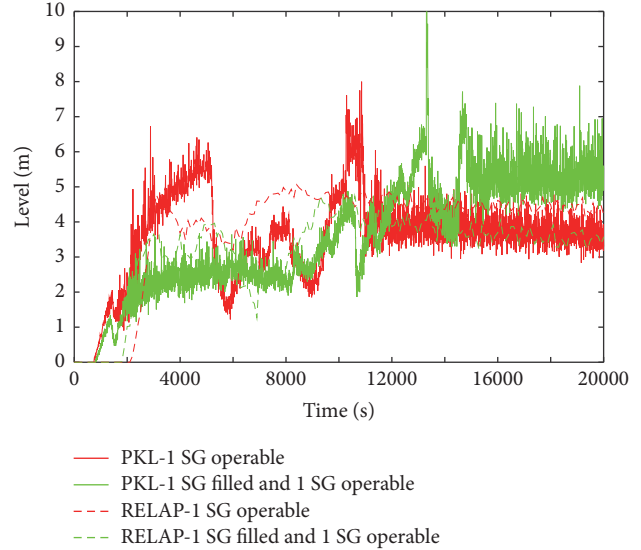

FIGURE 13: Inlet SG1 level. PKL versus RELAP5. Steam generators influence. Phase I.

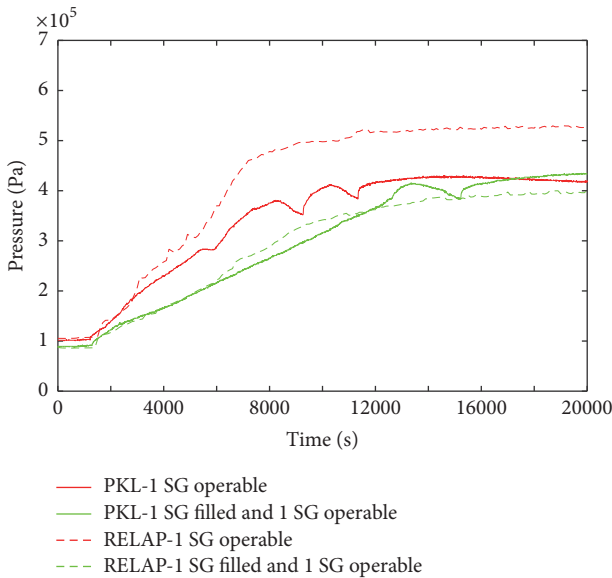

FIGURE 12: Primary pressure. PKL versus RELAP5. Steam generators influence. Phase I.

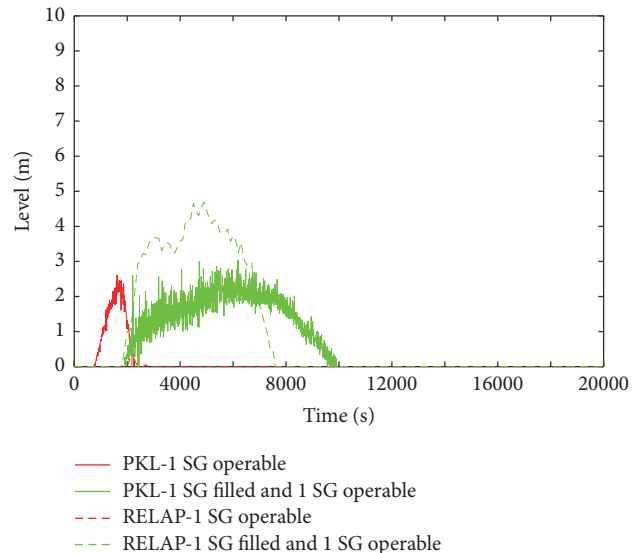

FIGURE 14: Inlet SG2 level. PKL versus RELAP5. Steam generators influence. Phase I.

the experiments does not depend on the number of SG filled (one or two) though the evolution to reach such a value is different. Therefore, as expected, the conditions at the end of Phase I depend only on the steam generator being controlled.

However, it can be observed that the stabilization pressure corresponding to the RELAP5 simulation of experiment F2.2 Run 1 is higher than the PKL experimental data. This indicates that heat transferred through the steam generator in this simulation is lower than in the experiment. On the contrary, simulation and experimental data show a similar evolution for experiment E3.1.

In all situations, the pressure rise produces a displacement of the coolant from the core towards the steam generator U-tubes. Figures 13 and 14 show the evolution of the water level in the rising part of the steam generator U-tubes.

Figure 13 shows the evolution of the water level in SG1, which is operable in both transients. It is observed that RELAP5 calculations are similar to the experimental evolutions; however, some important differences can be appreciated. For example, in both cases, the entrance of water in the U-tubes is delayed with respect to the experiment. Moreover, considering just one steam generator operable, the level simulated is lower than the experimental data until 6000 s. At this time, more level is predicted in the calculation due to the higher pressure predicted (see Figure 12), since

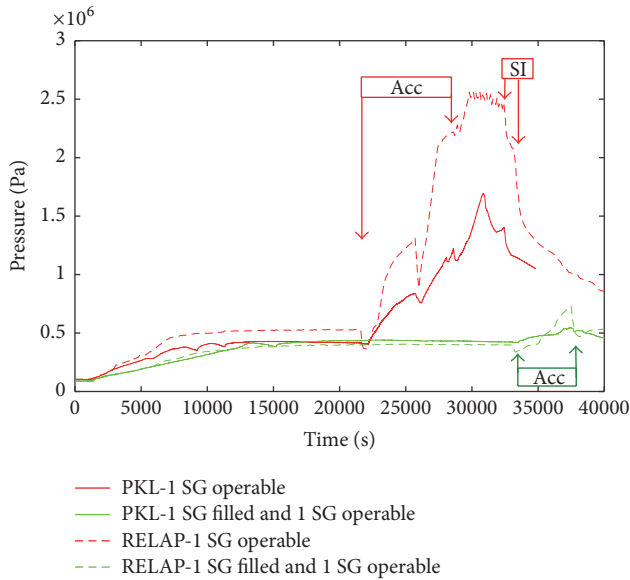

FIGURE 15: Primary pressure. PKL versus RELAP5. Steam generators influence. Injections.

more water is displaced from the core to the steam generators U-tubes.

There are significant differences in the behavior of U-tubes of SG2 (see Figure 14). Thus, in the transient considering 1 SG filled and 1 SG operable (experiment E3.1), RELAP5 predicts the time at which water starts filling the U-tubes but the level in SG2 reaches higher values. U-tubes of SG2 are emptied when SG1 control is triggered and only the steam generator operable acts as final heat sink. In RELAP5 calculations, the U-tubes of SG2 are emptied earlier than in the experiment.

When considering just one steam generator operable (experiment F2.2 Run 1), the evolution of the level of SG2 is not reproduced by RELAP as evidenced in Figure 14. Thus, RELAP calculations cannot predict the water entrance in the U-tubes of SG2 observed in the experiment, which happens between 1000 and 2000 seconds.

Once a stable situation is reached, Phase II starts where the accident management measures are triggered. As observed in Figure 15, with only 1 SG operable, RELAP5 predicts pressure stabilization higher than the experimental data. This situation is maintained until the first injection from the accumulators is produced. The start of the injections from the accumulators produces a sharp rise in the primary pressure. The maximum value predicted by RELAP5 is considerably higher than the value corresponding to the experimental data.

Figure 16 shows the evolution of the reactor vessel level. It shows the mass inside the reactor vessel is similar for both experimental and calculated data for experiment E3.1, although the calculations predict a lower level inside the reactor meaning that more water is displaced from the core towards the reactor coolant system. However, with only 1 SG operable (experiment F2.2 Run 1), an important difference between the mass inventory distribution calculated

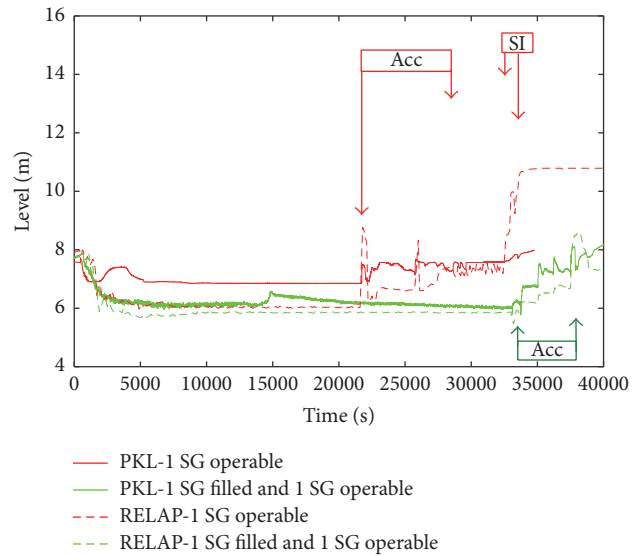

FIGURE 16: Vessel level. PKL versus RELAP5. Steam generators influence. Injections.

by RELAP5 and the experimental data is observed. For both transients, the planned injections are able to recover the water inventory inside the vessel and therefore in the RHR suction line, avoiding cavitation problems in the RHR pumps and decreasing the temperature, taking into account the fact that the pressure is always lower than 30 bars.

A sensitivity analysis considering the nodalization of the steam generators U-tubes with different number, and heights, of PIPE components has been performed to analyze whether with different U-tube nodalization it is possible to eliminate or mitigate the differences found in the mass distribution inside the RCS. This effect is specially observed in the experiment E3.1, so the sensitivity analysis has been undertaken in the simulation of this experiment. The plant configuration of experiment E3.1 considers one steam generator operable and one steam generator filled with water, the other two steam generators are empty.

PKL facility has seven groups of U-tubes in each steam generator at different heights. In a typical transient with the primary full of water, a nodalization with only one PIPE component provides good results in the calculations, but in this case, with reduced reactor coolant inventory, considering that the height difference between groups can reach 2 meters, it is convenient to model the U-tubes with more than one PIPE. In particular, in our base model, the U-tubes are modelled using three PIPE components. Thus, three different nodalization types grouping the U-tubes in 1, 3, or 7 PIPE components have been developed, maintaining the transfer surface and volume at different heights, the last nodalization is the most similar one to PKL facility.

The results presented in Figure 17, which presents the SG1 water level, show that a greater detail in the U-tube nodalization provides a higher U-tube collapsed level and a more agreement with the experimental results. However, the water level in the PRZ is, for the three nodalization

TABLE 3: Most important events.

	3/4 loop Cold pressurizer 1 SG operable and 1 SG filled (E3.1)		3/4 loop Hot pressurizer 1 SG operable and 1 SG filled (F2.1 Run 1)		RCL lower edge Cold pressurizer 1 SG operable and 1 SG filled (F2.1 Run 2)		3/4 loop Cold pressurizer 1 SG operable (F2.2 Run 1)	
	Exp.	RELAP	Exp.	RELAP	Exp.	RELAP	Exp.	RELAP
Void formation	600 s	700 s	580 s	600 s	470 s	600 s	700 s	750 s
Increase of level in U-tubes	1250 s	2000 s	1000 s	1800 s	1000 s	1800 s	1955 s	2000 s
Secondary-side pressure control	7390 s	5600 s	9330 s	10000 s	8920 s	8900 s	8225 s	6600 s
Conditions to restore RHR	37855 s	37600 s	39530 s	39200 s	38810 s	38900 s	33448 s	32600

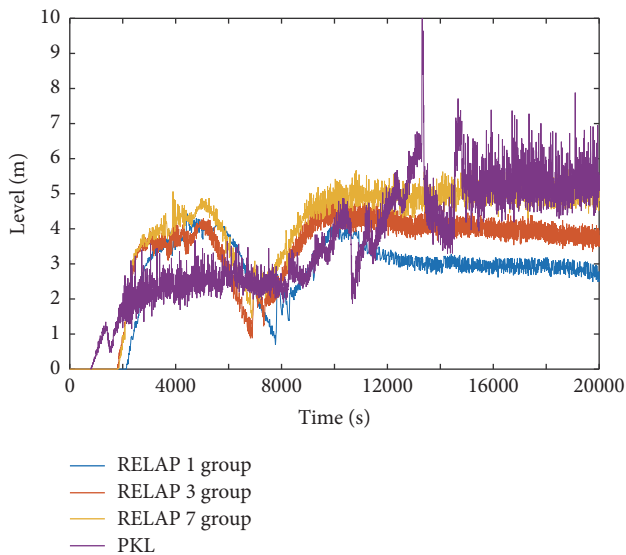

FIGURE 17: SG 1 level 1, 3, and 7 groups.

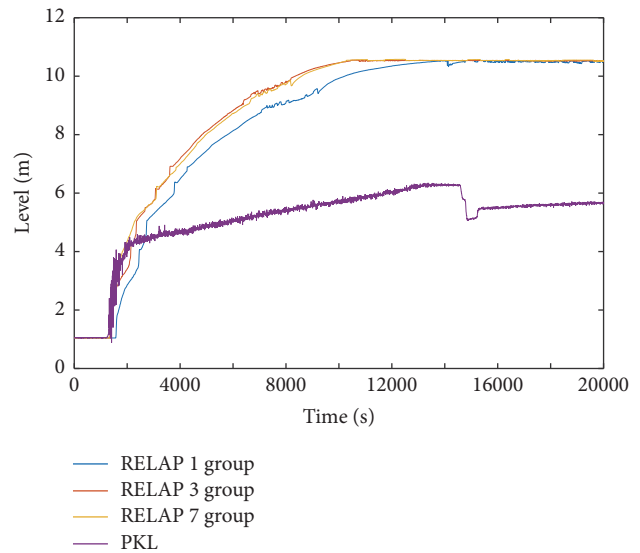

FIGURE 18: Pressurizer level 1, 3, and 7 groups.

types proposed, the same and very large compared with the experimental data, as observed in Figure 18. Thus, although a more detailed nodalization of the U-tubes provides better results in the calculated water level inside the U-tubes, the problem of the coolant mass distribution is also evidenced and a detailed study of the pressurizer and the surge line model is needed.

5.4. Timing of Main Events. Table 3 shows the most important events and their timing for all the transients studied. Four relevant events are considered: (1) void formation in the core, (2) increase of water level in the U-tubes, (3) steam generator secondary side control actuation, and, finally, (4) restoration conditions reached of the RHR.

In general, it is observed that saturation conditions in the core, as well as the start of the filling of U-tubes in the steam generators, are delayed in all simulations as compared to their

corresponding experimental data. Regarding the activation of steam generators pressure control, it is advanced in all simulations except for the case of hot pressurizer (experiment F2.1 Run 1). After the actuation of the accident management actions proposed, the conditions to restore the RHR are met in all cases, but at different times.

6. Conclusions

This work focuses on the simulation by RELAP5 of several RHR failures with the plant in other operational modes conditions with the primary circuit closed, considering different configurations of steam generators and two initial reactor coolant system levels and temperatures in the pressurizer. Four experiments, conducted at PKL facility, to assess the effect of the steam generator secondary side configuration, reactor coolant level, and coolant and wall temperature inside

the pressurizer have been simulated using RELAP5 thermal-hydraulic code and the results of the calculations have been compared against the experimental data. From the simulation results, it can be concluded that the code predictions agree with the experimental results, and the plant reaches a stable situation in all of the transients considered. Thus, RELAP reproduced the expected plant behavior with the different accident management measures proposed. However, significant difference in the mass distribution in the primary circuit is found, as, for example, in the U-tubes water levels.

In all the experiments, two phases are identified. RELAP5 calculations of the stabilization phase, in which the residual heat is evacuated through the steam generator secondary side, present a good agreement with the experimental data in all simulations. Depending on the number of steam generators full of water, the pressure stabilization value is slightly different, with this value being lower as more steam generators are operable or full of water in their secondary side, as it was observed in the experiments. In particular, the initial condition of hot pressurizer also rises the stabilization pressure value. Finally, the different levels of the reactor coolant system do not influence the plant stabilization state significantly.

In Phase II, the effectiveness of the different accident management measures proposed in PKL experiments to make it possible to restore the RHR is analyzed. In this phase, RELAP calculations for any of the transients studied guarantee the plant safety and the plant behavior agrees with the experimental data and the restoration conditions are met in all cases. But, in general, the calculations predict an advancement in reaching the conditions to restore RHR. Moreover, in those transients in which the stabilization pressure is higher, the activation of the accident management measures produces a sharp increase in the pressure evolution, more evident in RELAP calculations than in the experiment, and this is the reason why additional actions are needed, such as primary and secondary system depressurization and safety injections, to reach appropriate RHR restoration conditions.

A sensitivity analysis on the U-tubes nodalization has been performed. The calculated water level inside the U-tubes is improved, the coolant distributions inside the RCS are not the ones observed in the experiments, as observed in the PRZ level.

Future research should aim at reducing further the discrepancies observed between the calculations and the experiments, which may include nodalization improvements, such as the pressurizer and surge line model to obtain a better nodalization of this zone. Also, the injection through the accumulators should be improved to avoid noncondensable injection into the loops.

Competing Interests

The authors declare that they have no competing interests.

Acknowledgments

This study is part of the work developed by the Polytechnic University of Valencia within a project of the OECD, in which

authors are participating under the leadership of the Consejo de Seguridad Nuclear (STN/4524/2015/640). The authors thank PKL III, especially AREVA, program organizers for the information supplied.

References

- [1] K. W. Seul, Y. S. Bang, and H. J. Kim, "Mitigation measures following a loss-of-residual-heat-removal event during shut-down," *Nuclear Technology*, vol. 132, no. 1, pp. 152–165, 2000.
- [2] NUREG-1269, *Loss of Residual Heat Removal System, Diablo Canyon Unit 2, April 10, 1987*, U.S. Nuclear Regulatory Commission, 1997.
- [3] NUREG-1410, *Loss of Vital AC Power and the Residual Heat Removal System during Mid-Loop Operations at Vogtle Unit 1 on March 20, 1990*, U.S. Nuclear Regulatory Commission, 1990.
- [4] NUREG-5535, *RELAP5/MOD3.3 Code Manual. Volume II: User's Guide and Input Requirements*, U.S. Nuclear Regulatory Commission, 2001.
- [5] K. Umminger, R. Mandl, and R. Wegner, "Restart of natural circulation in a PWR-PKL test results and S-RELAP5 calculations," *Nuclear Engineering and Design*, vol. 215, no. 1-2, pp. 39–50, 2002.
- [6] S. Carlos, J. F. Villanueva, S. Martorell, and V. Serradell, "Analysis of a loss of residual heat removal system during mid-loop conditions at PKL facility using RELAP5/Mod3.3," *Nuclear Engineering and Design*, vol. 238, no. 10, pp. 2561–2567, 2008.
- [7] J. F. Villanueva, S. Carlos, S. Martorell, and F. Sánchez, "Effect of steam generator configuration in a loss of the RHR during mid-loop operation at PKL facility," in *Proceedings of the Conference on Advances in Reactor Physics (PHYSOR '12)*, Knoxville, Tenn, USA, April 2012.
- [8] K. Umminger, L. Dennhardt, S. Schollenberger, and B. Schoen, "Integral test facility PKL: experimental PWR accident investigation," *Science and Technology of Nuclear Installations*, vol. 2012, Article ID 891056, 16 pages, 2012.
- [9] E. Coscarelli, A. Del Nevo, and F. D'Auria, "Qualification of TRACE V5.0 code against fast cooldown transient in the PKL-III integral test facility," *Science and Technology of Nuclear Installations*, vol. 2013, Article ID 128305, 11 pages, 2013.
- [10] A. Bousbia Salah and J. Vlassenbroeck, "CATHARE assessment of natural circulation in the PKL test facility during asymmetric cooldown transients," *Science and Technology of Nuclear Installations*, vol. 2012, Article ID 950389, 10 pages, 2012.
- [11] S. Carlos, A. Querol, S. Gallardo et al., "Post-test analysis of the ROSA/LSTF and PKL counterpart test," *Nuclear Engineering and Design*, vol. 297, pp. 81–94, 2016.
- [12] Framatome ANP, "PKL III: RELAP5/Mod3 Input-Model," NGES1/2002/en/0059, 2002.

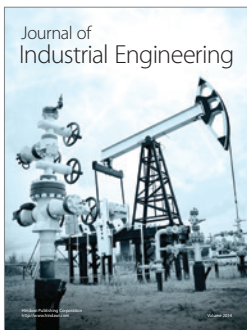
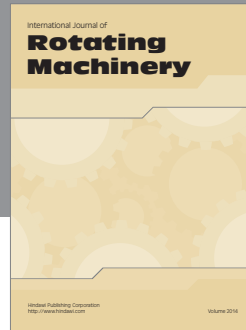
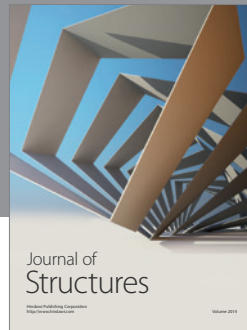
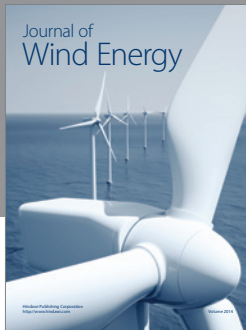

Hindawi

Submit your manuscripts at
<https://www.hindawi.com>

