

Research Article

Near Field UHF RFID Antenna System Enabling the Tracking of Small Laboratory Animals

Luca Catarinucci, Riccardo Colella, Luca Mainetti, Vincenzo Mighali, Luigi Patrono, Ilaria Sergi, and Luciano Tarricone

Department of Innovation Engineering, Salento University, 73100 Lecce, Italy

Correspondence should be addressed to Luigi Patrono; luigi.patrono@unisalento.it

Received 12 April 2013; Revised 31 May 2013; Accepted 1 June 2013

Academic Editor: Iñigo Cuiñas

Copyright © 2013 Luca Catarinucci et al. This is an open access article distributed under the Creative Commons Attribution License, which permits unrestricted use, distribution, and reproduction in any medium, provided the original work is properly cited.

Radio frequency identification (RFID) technology is more and more adopted in a wide range of applicative scenarios. In many cases, such as the tracking of small-size living animals for behaviour analysis purposes, the straightforward use of commercial solutions does not ensure adequate performance. Consequently, both RFID hardware and the control software should be tailored for the particular application. In this work, a novel RFID-based approach enabling an effective localization and tracking of small-sized laboratory animals is proposed. It is mainly based on a UHF Near Field RFID multiantenna system, to be placed under the animals' cage, and able to rigorously identify the NF RFID tags implanted in laboratory animals (e.g., mice). Once the requirements of the reader antenna have been individuated, the antenna system has been designed and realized. Moreover, an algorithm based on the measured Received Signal Strength Indication (RSSI) aiming at removing potential ambiguities in data captured by the multiantenna system has been developed and integrated. The animal tracking system has been largely tested on phantom mice in order to verify its ability to precisely localize each subject and to reconstruct its path. The achieved and discussed results demonstrate the effectiveness of the proposed tracking system.

1. Introduction

The cost-effectiveness and ease of use of passive radio frequency identification (RFID) systems in the Ultra High Frequency (UHF) band are promoting a huge diffusion of such technology in a wide range of scenarios, even quite far from the canonical ones related to logistics. Identification of goods containing liquids or metal [1–3], traceability of sensitive goods, such as pharmaceutical products [4–7], RFID-based sensor data transmission [8–10], RFID-assisted navigation of robots [11], and augmented RFID scenarios [12–15], which are only a few of the many possible examples. A peculiar case study, not yet exhaustively explored [16], consists of the tracking of small-size animals carrying a small-enough RFID tag. Indeed, animal tracking and animal behavior analysis have always had a crucial impact both in dedicated disciplines and in biomedical contexts [17], and different technologies are typically adopted depending on the application context. For instance, in most cases medium/large

size animals (e.g., cows, pigs, etc.) in outdoor environment are monitored, and GPS-based or radar-based tracking solutions are adopted [18, 19]. But when groups of small laboratory animals in indoor environments are considered, a different solution is necessary. This is the most important challenge, because the behavior analysis of small laboratory animals is crucial when, for instance, the effects of new drugs or vaccines for humans must be preliminary evaluated. The literature in this field proposes solutions primarily based on Low Frequency (LF) [16] or High Frequency (HF) [10] RFID systems and, consequently, not exploiting the powerful of the EPC Class-1 Generation-2 standard, which provides, for instance, anticollision mechanisms for the concurrent identification of multiple tags. Other reported solutions, not based on RFID technology, make use of sophisticated and rather expensive vision systems [20], which, though avoiding the animal to carry or having implanted any kind of device, can be strongly inaccurate, especially when colonies of animals very similar to each other must be simultaneously localized and tracked.

In such a context, it is worth highlighting that a first attempt that tries to exploit the passive RFID technology in UHF band in order to implement and validate localization and tracking systems is summarized in [21]. Moreover, a feasibility study on the use of UHF solutions for small animal tracking is reported in [22]. Both works demonstrate the appropriateness of the use of RFID technology in the addressed problem.

In this work, a novel system suitable for the tracking, in indoor environments, of laboratory animals free to move within the cage has been tackled. It relies on the use of passive Near Field (NF) UHF RFID technology. More specifically, the ground of the animal cage is virtually split into partially overlapping cells whose size is comparable with that of the animal. As the system is mainly thought for laboratory mice tracking, squared cells, with side equals to 12 cm, are considered. Under the fundamental working assumption that a passive NF UHF RFID tag is implanted in every animal, customized NF reader antennas covering the cells with a confined and uniform magnetic field are positioned right below the cage and in correspondence with each elementary cell. The individuation of the requirements of such NF antennas and their realization and characterization are the main scientific aspects of this work, as the more uniform and confined is the magnetic field of each antenna, the easier and more effective is the processing procedure of the captured data from antenna system. These requirements are satisfied by means of segmented loop techniques in order to introduce a distributed capacitance along the loop that help to lead in-phase the current distribution. In this way, a rather uniform magnetic field even for loop lengths comparable with the wavelength (λ) can be obtained.

Once the antennas have been realized and singularly characterized, the optimum distance between each couple of antennas has been experimentally estimated, and a matrix of 32 RFID antennas has been assembled. Moreover, in order to minimize both the number of RFID readers and the power radiation, the antennas have been connected to the four ports of a single RFID reader by means of a multiplexing device. In this way, the antennas are fed in time division and, consequently, at any instant, only one of them radiates. Finally, once Far Field (FF) measurements have been performed in order to verify the absence of electromagnetic compatibility problems, a software subsystem driving the hardware components and including an effective algorithm, able to extract reliable information about the animals' position on the basis of the Received Signal Strength Indication (RSSI), has been implemented. Finally, the whole tracking system has been validated successfully.

The paper is structured as follows. In Section 2, the description of the system architecture is given and its requirements individuated. In Section 3, the design of the NF antenna system is presented, whilst the whole system is described and characterized in Section 4. Finally, results are given in Section 5, and conclusions are drawn in Section 6.

2. System Architecture and Main Requirements

The main goal of this work is to design and realize an RFID-based tracking system suitable for the behavior analysis of

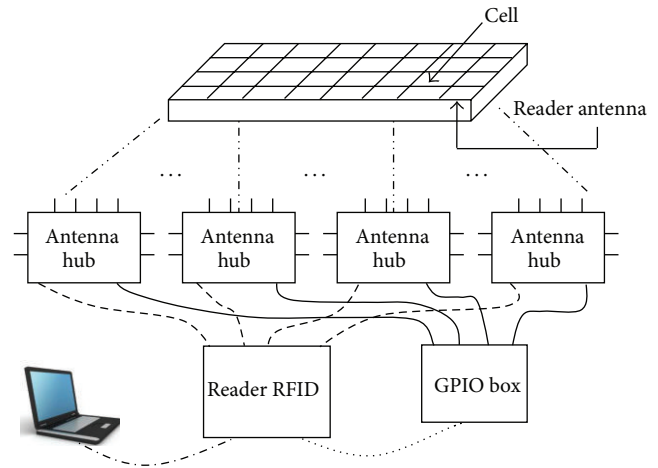

FIGURE 1: Hardware scheme of the proposed tracking system.

groups of animals and even of each single animal belonging to a group. In particular, the system is thought for small-sized laboratory animals, usually mice, free to move within a cage. Consequently, a resolution of the order of the animal size is considered satisfactory. As for the enabling technology, passive UHF RFID typology has been chosen because, compared with other solutions usually based on vision systems, it is cheaper and guarantees better performance even in case of strong similitude among the animals and in absence of illumination. The basic idea is to firstly design and realize a particular NF antenna system suitable for UHF RFID readers to be placed below the animal cage and, then, to validate the integration with software modules developed for management, controlling, storing, and reporting. Each reader antenna should be able to generate a rather uniform magnetic field in a well-defined and confined region representing the generic elementary cell of the system. In such a way, when only one of the antennas reads an RFID tag, the animal position is promptly individuated. Vice versa, if more than one antenna read the same RFID tag, the potential ambiguity can be solved through an algorithm based on RSSI analysis. The general scheme is represented in Figure 1, where a case with 32 elementary cells is considered. As can be observed, a PC is used to control the RFID reader and to elaborate the collected data. In order to minimize the number of readers, the system cost, and the emitted power, a single 4-port RFID reader is used which powers up all the 32 antennas in time division by means of a multiplexer composed of the GPIO box and four antenna hubs. Differently from [22], in which only a preliminary and very simplified hardware system was presented (e.g., the Antenna Hubs were not used) and the focus was only on the software architecture design and implementation, in this work a more complex hardware system is presented. By using such a hardware, it is possible to monitor a larger environment and therefore a greater number of animals, reducing the costs.

It is fundamental to identify the main requirements to be satisfied by the hardware components (e.g., antenna, multiplexer, etc.) as well as by the software infrastructure in order to design an efficient animal tracking system.

As for the antenna system in the RFID UHF bandwidth (860–960 MHz), the main goal is to realize a single antenna able to generate a magnetic field as uniform as possible in a region as large as the elementary cell, which in the mice case is smaller than $12\text{ cm} \times 12\text{ cm}$. It is worth observing that conventional loop antennas cannot be adopted, as they would guarantee a uniform magnetic field only for loop length significantly smaller than $\lambda/2$ [23], that is, for squared antennas with edges significantly smaller than 4 cm at the interested working frequency.

Based on such an antenna system, the software infrastructure should be able to pilot the system, to collect data, to resolve potential ambiguities when more antennas read the same tag, and finally to produce a report for each animal showing paths, interactions with other animals, and potential anomalous behaviors. For such goals, the proposed software architecture should be subdivided into three modules:

- (i) the data acquisition module, that should be able to guarantee an efficient management by exploiting the Low Level Reader Protocol (LLRP) [24] and should provide reading reports of each reader antenna to be stored in a relational database;
- (ii) the processing module, that should be able to transform the intercepted raw data into fine location data;
- (iii) the plotting module, that should be able to provide the end-user (i.e., animals behavioral researcher) with both a synthetic vision and a detailed vision.

3. Antenna Design

In order to obtain an effective localization, each antenna composing the animal tracking system has to be specifically designed in order to (1) irradiate a magnetic field as confined as possible in a cell, (2) ensure an inductive coupling with the RFID tag when the animal is on the cell associated to the reader antenna, and (3) guarantee a uniform magnetic field within the cell in order to minimize the localization uncertainty. Actually, even though NF UHF RFID reader antennas exhibiting good electromagnetic performance are on the market, antennas that contemporaneously cover all the mentioned requirements are not present yet and, consequently, have to be specifically designed. According to the first specification, among all the possible antenna structures [23, 25–27], the loop structure seems to be a good solution to implement NF reader antennas. Nevertheless, in the conventional loop [23, 25], when the antenna perimeter is comparable with the wavelength (λ) at the operating frequency (f), the antenna does not produce a uniform magnetic field because currents are not in phase along the circumference. This aspect does not satisfy the other desired properties. The problem can be overcome by modeling the structure as a segmented loop antenna.

Although segmented loop antennas for RFID applications are in the literature [26], excessive dimensions of such antennas, of about $16\text{ cm} \times 18\text{ cm}$, are not compatible with the size of the cells at the desired frequency. For such reason, in order to reduce the segmented loop antenna size and, at the same time,

preserve the radiative properties of this type of antennas, some modifications have been introduced. In Figure 2(a), the layout of the proposed segmented loop antenna is shown. The parameters L_s and G_p indicate the segment length and the gap distance between each segment respectively, whilst the parameter T_s is the width of the segment and G_s is the distance among inner and outer segments. As can be observed, differently from the segmented loop antennas presented in [26], the proposed structure exhibits two technical improvements which guarantee, on the one hand, a considerable size reduction (even up to 50%) and, on the other hand, fine regulation and a balancing of the current flow along the loop. The former improvement consists of introducing an inner segment at the top of the antenna having size $3 \times L_s$. The effect of this relatively “long” segment is to balance the current distribution, which typically tends to concentrate itself at the bottom of the antenna (near to the feed) when the overall loop dimension is reduced. Actually, the size of this segment is sufficiently small if compared with the wavelength, thus avoiding the current phase inversion, and at the same time it is long enough to favor the current flow along the top side of the antenna. The latter improvement consists of properly modifying the gap G_t at the top of the antenna, which allows a fine tuning of the current distribution in the whole antenna.

On such basis, the antenna in Figure 2(a) has been preliminarily designed on an FR-4 board having dielectric constant $\epsilon_r = 3.7$, substrate thickness $h_s = 1.6\text{ mm}$, and copper thickness $h_c = 0.035\text{ mm}$ and then optimized to work in the European dedicated UHF RFID band. Moreover, a matching network, consisting of a small loop in proximity of the feed (see Figure 2(a)), has been introduced to match the antenna impedance to the reader port impedance of $50\ \Omega$. Table 1 summarizes the antenna parameters obtained after the simulation phase carried out by using CST Microwave Studio software [28].

More in detail, such parameters have been evaluated through a parametric optimization by using a gradient-based interpolated Quasi-Newton optimizer of CST and by setting a resonance frequency of 866 MHz as fitness function.

After such phase, size of the antenna is of $89.0\text{ mm} \times 93.0\text{ mm}$ (becoming $100.0\text{ mm} \times 115.0\text{ mm}$ including the support board) with a reduction in terms of occupied area of 51% with respect to the segmented loop presented in [26]. In spite of such a considerable size reduction, the current flow along the antenna is uniform as can be observed in Figure 2(b), and consequently the expected radiated magnetic field is uniform as well, and rather confined in a region slightly larger than the total area of the antenna. For a better clarification, in Figure 2(c) a slice of the simulated distribution of the radiated magnetic field at 2.5 cm of distance from the antenna is shown, confirming the actual magnetic field uniformity and the proper antenna operation.

Finally, in order to prove also the faultless impedance matching between the antenna and the reader port, in Figure 3, graphs of both simulated and measured $|S_{11}|$ scattering parameters related to the reference impedance of $50\ \Omega$ in the frequency band 700–1100 MHz are reported. Graphs highlight the very good agreement between the two curves with a resonance peak of -29 dB in the first case and -23 dB

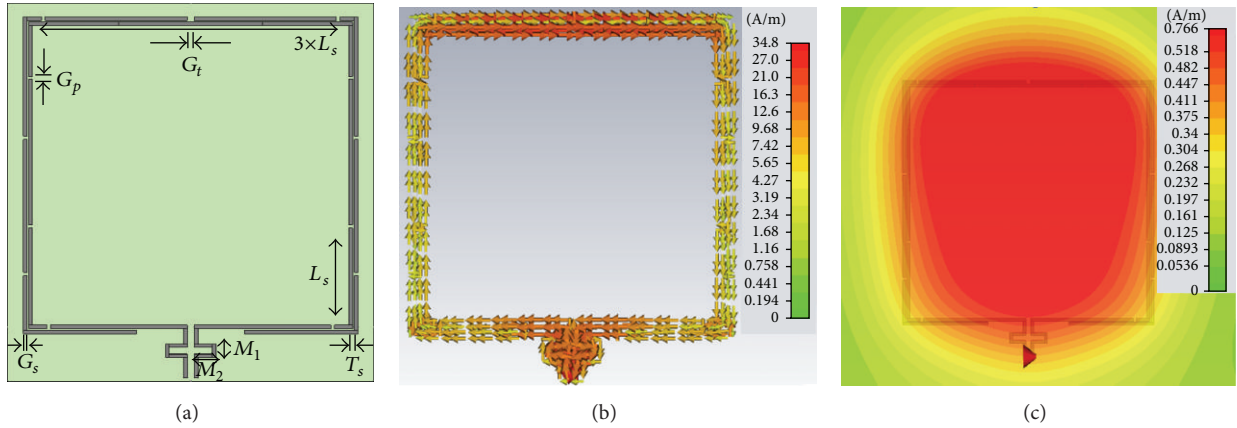

FIGURE 2: (a) Segmented loop antenna for animal tracking system. (b) Current distribution of the segmented loop antenna. (c) Magnetic field distribution of the segmented loop antenna for animal tracking system at 2.5 centimeters of distance.

TABLE 1: Segmented loop antenna parameters.

Parameter	Value (mm)	Description	Type
L_s	30.0	Segment length	Fixed
G_p	1.1	Gap between segments	Fixed
T_s	1.0	Segment width	Fixed
G_s	0.35	Distance inner-outer segment	Fixed
G_t	1.9	Gap at the top of the loop	Tunable
M_1	4.0	Matching element height	Tunable
M_2	5.0	Matching element width	Tunable

in the second one at 866 MHz. The $|S_{11}|$ measure has been carried out by using the Vector Network Analyzer (VNA) model R&S ZVL 6.

4. System Design

The system, as a whole, is designed and implemented so as to provide accurate data on the mice movements during the desired observation period. Macroscopically, the system consists of the blocks represented in Figure 4, in which it is possible to distinguish the hardware subsystem, shown in Figure 1, and the software subsystem, responsible for configuring/controlling the hardware and for processing raw data coming from the antennas.

As already stated, the area of the cage is divided into a matrix of cells and, in correspondence to each cell, one of the antennas designed in Section 3 is positioned. Each antenna sends a readings report at a very high frequency (about 250 ms), so as to detect even very fast mice movements. The hardware subsystem mainly consists of an Impinj Speedway Revolution R420 reader [29] with four antenna ports, an Impinj GPIO adapter [30], and one HD15 cable. The GPIO adapter allows to connect up to four Impinj Antenna Hubs [30], each of which accepts up to 8 reader antennas. In this way, up to 32 different antennas can be powered in time division through a single 4-port RFID reader, but no more than one of them is powered at a certain time, thus reducing potential array effects and preserving energy wasting.

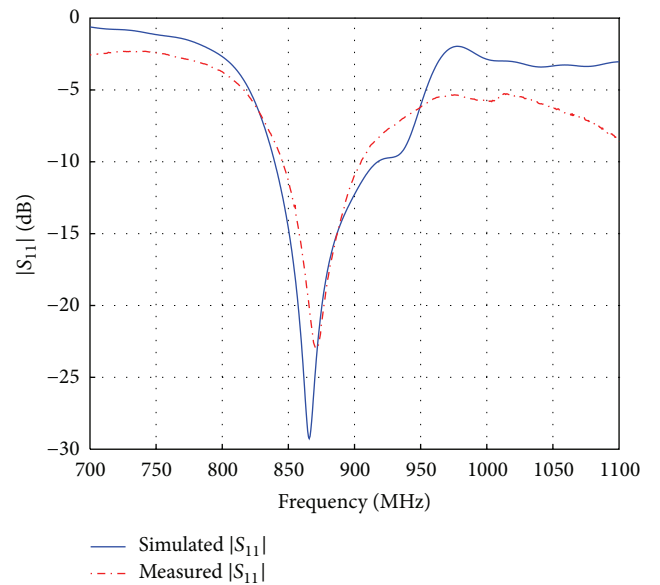

FIGURE 3: Simulated and measured $|S_{11}|$ of the segmented loop antenna.

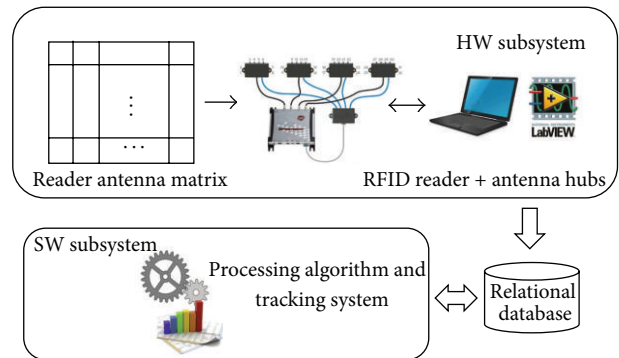

FIGURE 4: Overall schema of the proposed tracking system.

Each Antenna Hub is connected to the GPIO adapter by using a straight Ethernet cable and to the reader by using an SMA-male to R-TNC-female coaxial cable, whereas each reader antenna is connected to its Antenna Hub by using an SMA-male to SMA-male coaxial cable. Finally, the reader is connected to the computer via a cross Ethernet cable. In this way the application will acquire all reader antennas reports and will store them in a relational database. However, it is worth pointing out that, apart from the research activity costs for both software and antenna design, the whole hardware costs do not exceed the amount of 3,000,00 euros. Such costs are considerably lower than costs of other and more adopted solutions based, for instance, on vision systems.

The software subsystem, instead, consists of an application that acquires the data coming from the antennas, a processing algorithm that processes these raw data, and a software module responsible for the plotting of tracking graphs. These three software modules interact with each other by means of a relational database, in which both raw readings and final positional data are stored. One of the main tasks of the acquisition application is to preliminarily configure the RFID reader by specifying some operating parameters such as the transmission power of the antennas. The interaction between this software module and the hardware subsystem is made possible by exploiting the LLRP, according to which packets are formatted. The acquisition application also allows the end-user (i.e., researcher) to preliminarily acquire the identifiers to be traced. In such a way, only the data of interest are collected and processed. The core of the software subsystem is represented by the algorithm that processes raw data. In case of ambiguities due, for instance, to potential simultaneous readings of the same tag by more than one antenna, the algorithm evaluates the RSSI value associated with each reading and, on the basis of specific considerations regarding the succession of cells in the detected path (concept of adjacency between cells based on the Chebyshev distance calculation [31]), resolves the ambiguities. Finally, the data processed and stored in the database are extracted by the plotting module and presented as space and time graphs showing the movement of mice during the observation period. Moreover, many other data, such as the average residence time in each cell, are summarized.

In order to validate the proposed tracking system several tests have been carried out by using plastic test tubes filled with saline solution and on each tube a passive RFID tag has been applied. The saline solution is able to simulate with a good approximation the attenuation caused by the animal tissue during the reading of the tag.

The tag type used in the tests is a commercial passive NF UHF RFID transponder characterized by a memory of 32 bits, whose antenna size is 15 mm × 10 mm and the mounted chip is the Impinj Monza4D [32]. Finally, this tag has an inlay composition characterized by aluminum on the top and polyester PET as substrate.

5. Results

In this section, validation results related to both the designed antenna system as well as the whole tracking system are given.

5.1. Antenna System Results. Once a first prototype on the segmented loop antenna proposed in Section 3 has been realized, a characterization aimed at verifying the capability to effectively read a tag within a cell has been performed through the RSSI measurement of each read tag. In order to verify the proper functioning even when multiple tags are read simultaneously, the test has been performed by using a matrix of 25 NF RFID tags arranged on a 12 cm × 12 cm (the same size of a cell) paperboard substrate as illustrated in Figure 5(a). More in detail, the antenna under test has been firstly connected to the Impinj Speedway Revolution RFID reader, then the tag matrix has been placed in front of the antenna at different distances in a range from 2 cm to 5 cm, in steps of 1 cm, as shown in Figure 5(b). For each step, the average RSSI of each of the 25 tags has been evaluated through the reader by varying the reader output power between 24 dBm and 30 dBm in steps of 3 dBm for a test time of 20 seconds per point.

The goal of such study is the experimental evaluation of suitable combination of antenna distance and emitted power guaranteeing a rather uniform RSSI within a cell. Consequently, gathered RSSI values have been elaborated by using MATLAB [33], and graphs reporting a map of the RSSI distribution at different distances and different power levels have been obtained and reported in Table 2. In particular, for each RSSI map, a single cell represents in gray-scale the average RSSI value in dBm measured for each tag of the matrix. It can be observed that null values of RSSI are present in some cases, whilst in most cases a quite uniform RSSI distribution is appreciated. In particular, the best result is obtained at a distance of 5 cm and power of 27 dBm. In such case, RSSI values vary in a rather narrow range between -55.0 dBm and -65.68 dBm, and the distribution is quite uniform.

Once the proper functioning of a single antenna has been demonstrated, a second test aimed at estimating the optimum distance between two adjacent antennas has been performed in order to validate also the whole animal tracking platform. Such a test has been carried out by placing the antennas (opportunistically connected to an Impinj Speedway reader) with two sides adjacent between them and by locating an NF tag along the separation line at a distance of 5 cm above the antennas surface (Antenna.I and Antenna.II in Figure 6(a)). Consequently, the distance between the two antennas has been gradually increased from 0 cm to 2 cm, in step of 1 cm, in order to evaluate the minimum distance guaranteeing the continuity in the tag identification during a transition between two different antennas. More specifically, for each step the NF tag has been unbalanced towards the Antenna.I and the ratio between the readings performed by the Antenna.I and the overall number of readings of the two antennas has been evaluated. In Table 3, results are reported. As can be observed, optimum values have been obtained for gaps of 1 cm and 2 cm, with a percentage of readings of the Antenna.I greater than 95%.

On such basis an average gap of 1.5 cm has been then set. Finally, in order to verify the proper tag localization even during diagonal transitions along two different antennas, a system of four antennas (Antenna.I, Antenna.II, Antenna.III,

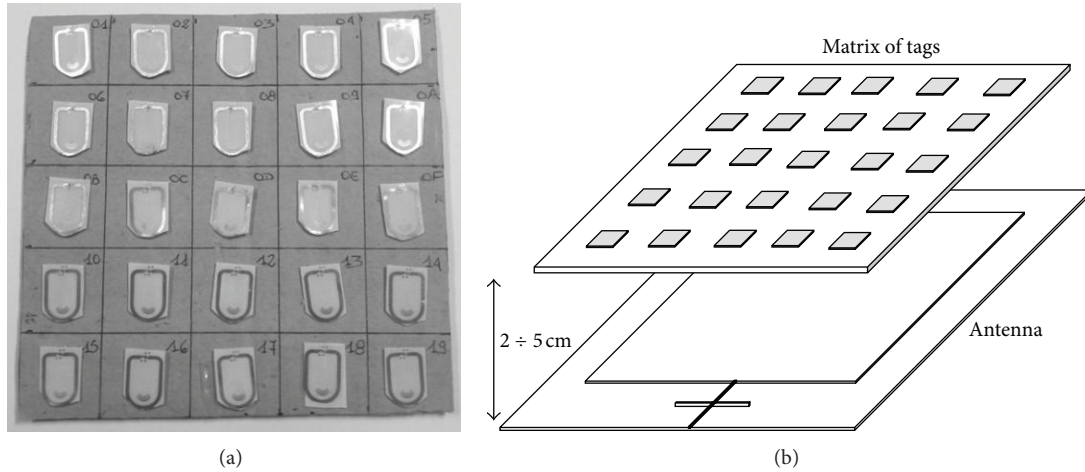
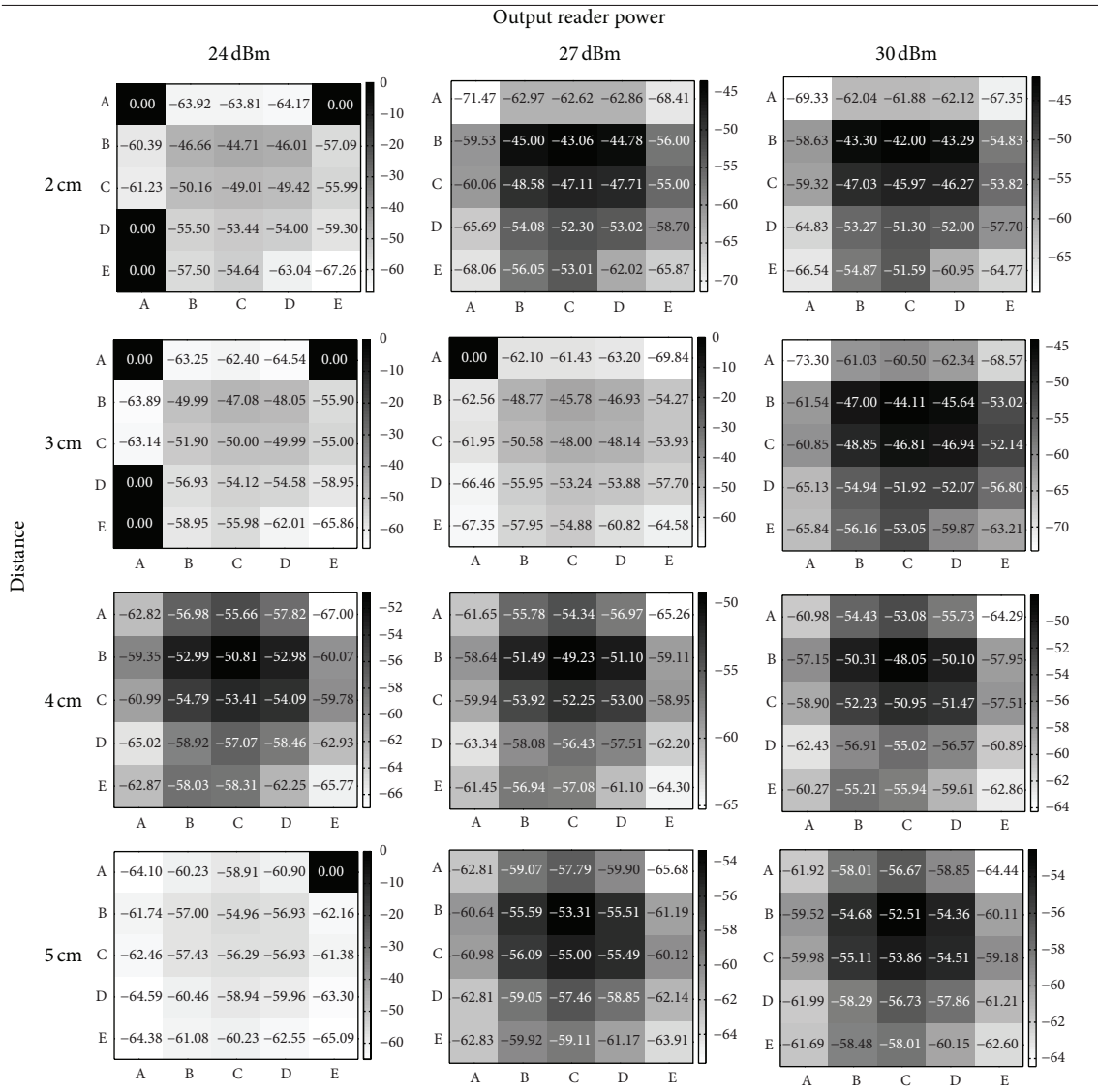

FIGURE 5: (a) A 5 × 5 matrix of RFID NF tags. (b) Schema used for both antenna/tag distance and reader power output evaluation.

TABLE 2: Graphs of the RSSI distribution of the tag matrix.



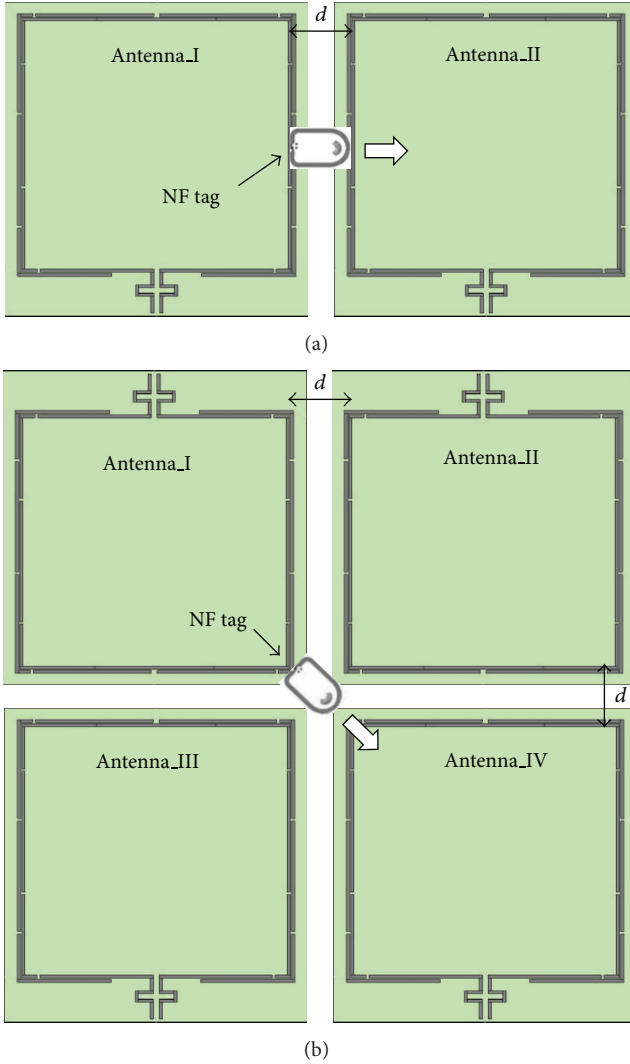

FIGURE 6: (a) Antenna disposition for horizontal tag transition. (b) Antenna disposition for diagonal tag transition.

TABLE 3: Antenna distance results.

	Antenna 1 (Read percentage)	Antenna 2 (Read percentage)
0 cm	53%	47%
1 cm	95%	5%
2 cm	97%	3%

and Antenna_IV) placed reciprocally at 1.5 cm of distance has been arranged as shown in Figure 6(b). The previous test has been replicated unbalancing the tag on Antenna I along a diagonal (Antenna_I–Antenna_IV) and calculating the percentage ratio between the number of readings of the Antenna_I and the sum of the readings of all the antennas. The obtained reading percentage of 95% confirms that the distance of 1.5 cm among the antennas is a suitable choice.

On the basis of the obtained results, the hardware setup for the animal tracking system has been composed by adopting 32 segmented loop antennas and by setting a distance

between antennas and the cage of 5 cm, the separation gap between each couple of antennas of 1.5 cm, and the output reader power of 27 dBm.

Moreover, in order to verify the absence of any electromagnetic compatibility problem potentially due to the array effect, far field measurements have been performed at different distances from the antenna platform. Thanks to the use of the multiplexer, only one antenna is powered at a certain time slot, so that even at very short measurement distances (30 cm) less than 1 V/m has been measured.

As further validation test, the effect of the tilt of a tag (mouse) with respect to the antenna system plane has been studied, so as to take into account the mice attitude to stand up on their hind legs (e.g., to drink or play). In particular, the tagged phantom mouse has been placed at a distance of 5 cm from the antenna system plane and its tilt has been varied from 0° to 90° . Performed measurements have shown negligible RSSI variations, thus guaranteeing the mice localization even in such a particular case.

5.2. System Validation. In order to demonstrate the effectiveness of the whole realized system, a real scenario has been reproduced by moving a plastic tube filled with saline solution and containing an NF UHF RFID tag in a cage placed over the designed antenna system. In such a way the plastic tube emulates the mouse, and it has been moved on the cage floor in order to reproduce many predefined paths. In the meanwhile, data are acquired, interpreted, filtered, and presented thanks to the joint work of the hardware and software subsystems.

In particular, in Figure 7(a), one of the paths actually performed is shown, whereas in Figure 7(b) the sequence of raw readings detected by the proposed antenna system is given. It can be observed that the path is not perfectly reconstructed. In particular, some cells (3, 19, and 21) very close to the real path and even one cell (the number 13) distant from the path more than 30 cm (almost three cells) are erroneously considered. It is worth recalling that at this step no algorithm corrections have been performed yet. Figures 7(c) and 7(d) show, instead, the result of the data processing performed by the software system after a partial step (Figure 7(c)) and at the end of the elaboration (Figure 7(d)). In particular, after the RSSI analysis, the spurious readings performed by antennas related to cells adjacent to the performed path are corrected, and, finally, also the error associated with the cell that does not comply with specific adjacency requirements between cells is eliminated.

It is worth observing that the movement of the plastic tube is perfectly reconstructed in several different conditions, thus demonstrating the effectiveness of the proposed framework, now ready for a validation through a living animal approach. In Figure 8, a real photo of the whole system in order to clarify the experimental setup is shown.

Finally, a further test has been carried out in order to verify the capability of the proposed system to deal with multiple mice at the same time. In Figure 9, two paths are reported. They have been reproduced moving by hand two phantom mice approximately at the same speed (almost two

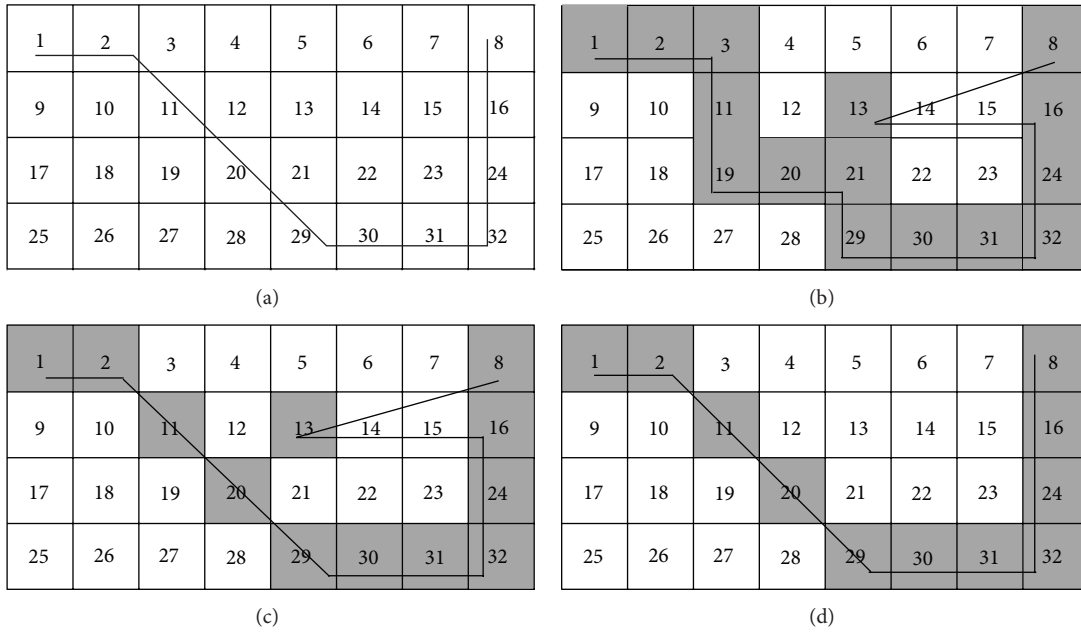

FIGURE 7: Experimental results of the overall tracking system: (a) path actually performed; (b) raw readings detected by antennas; (c) partially processed path; (d) final result of the raw readings processing.

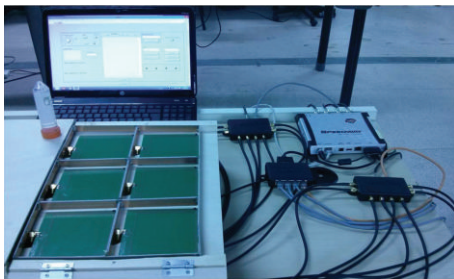

FIGURE 8: A real photo of the experimental setup.

cells per second). In such a way, both phantom mice cross simultaneously some of the cells (i.e., cells number 4, 12, 20, and 28). The paths have been reproduced several times and consequently reconstructed by the software platform. Then, the ratio between the number of erroneously detected cells and the total number of interested cells has been evaluated. Errors inferior to 1% have been calculated in both paths, thus confirming the correct working of the system also for more than an animal.

6. Conclusions

In this work, a tracking system enabling the behavior analysis of small living laboratory animals in cages has been proposed and validated. In particular, the system takes advantages from the functionalities of RFID technology in the UHF band, which guarantees reasonable costs and naturally allows the monitoring of colonies of animals—very similar to one

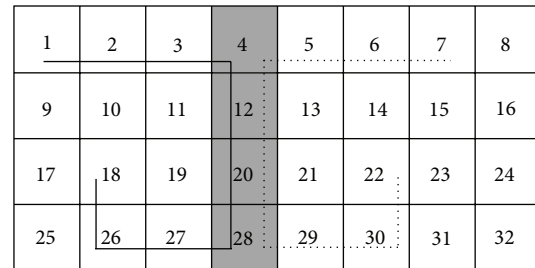

FIGURE 9: Paths used to evaluate the system capability to intercept simultaneously readings of different tags.

another—and even of each single animal both during day and night time.

In particular, an antenna system composed of up to 32 NF antennas in the UHF RFID bandwidth has been realized. Each antenna guarantees a radiated magnetic field almost uniform in a confined and well-defined region as large as a small mouse and representing the generic elementary cell of the system region. The matrix of antennas has been then positioned below the animal cage floor and connected to an UHF RFID reader by means of a multiplexer. The capability of each antenna to read a tag applied on a phantom mouse (a plastic tube filled with a saline solution) in the antenna-related cell has been firstly verified. Finally, a software platform has been realized. It is able to both drive the hardware subsystem and to collect, analyze, and summarize the reading data. Both the antenna system and the whole platform have been then validated, clearly demonstrating the appropriateness of the proposed system to enable an effective animal behavior analysis based on UHF RFID technology.

Acknowledgments

This work has been supported by the University of Salento within “5per1000” project whose title is “An Innovative Small Animals RFID-Based Tracking System (SMART).” The authors thank Dr. Stefano Pieretti of the Italian National Institute of Health, Rome, Italy, for his precious assistance, and Dr. Andrea Secco that collaborates with the IDA Lab group of the University of Salento, Lecce, Italy, for his support in the algorithm implementation.

References

- [1] L. Catarinucci, R. Colella, M. De Blasi, V. Mighali, L. Patrono, and L. Tarricone, “High performance RFID tags for item-level tracing systems,” in *Proceedings of the 18th International Conference on Software, Telecommunications and Computer Networks (SoftCOM '10)*, pp. 21–26, Zagreb, Croatia, September 2010.
- [2] L. Catarinucci, R. Colella, M. De Blasi, L. Patrono, and L. Tarricone, “Enhanced UHF RFID tags for drug tracing,” *Journal of Medical Systems*, vol. 35, no. 6, pp. 3451–3462, 2011.
- [3] G. Calcagnini, F. Censi, M. Maffia et al., “Evaluation of thermal and non-thermal effects of UHF RFID exposure on biological drugs,” *IEEE Transaction on Information Technology in Biomedicine*, vol. 16, no. 6, pp. 1051–1057, 2012.
- [4] A. Guido, L. Mainetti, and L. Patrono, “Evaluating potential benefits of the use of RFID, EPCglobal, and ebXML in the pharmaceutical supply chain,” *International Journal of Healthcare Technology and Management*, vol. 13, no. 4, pp. 198–222, 2012.
- [5] M. Maffia, L. Mainetti, L. Patrono, and E. Urso, “Evaluation of potential effects of RFID-based item-level tracing systems on the integrity of biological pharmaceutical products,” *International Journal of RF Technologies: Research and Applications*, vol. 3, no. 2, pp. 101–118, 2012.
- [6] L. Catarinucci, R. Colella, M. De Blasi, L. Patrono, and L. Tarricone, “Experimental performance evaluation of passive UHF RFID tags in electromagnetically critical supply chains,” *Journal of Communications Software and Systems*, vol. 7, no. 2, pp. 59–70, 2011.
- [7] U. Barchetti, A. Bucciero, M. De Blasi, L. Mainetti, and L. Patrono, “RFID, EPC and B2B convergence towards an item-level traceability in the pharmaceutical supply chain,” in *Proceedings of the IEEE International Conference on RFID-Technology and Applications (RFID-TA '10)*, pp. 194–199, June 2010.
- [8] A. Esposito, L. Tarricone, M. Zappatore, L. Catarinucci, and R. Colella, “A framework for context-aware home-health monitoring,” *International Journal of Autonomous and Adaptive Communications Systems*, vol. 3, no. 1, pp. 75–91, 2010.
- [9] L. Catarinucci, R. Colella, and L. Tarricone, “Sensor data transmission through passive RFID tags to feed wireless sensor networks,” in *Proceedings of the IEEE MTT-S International Microwave Symposium (MTT '10)*, pp. 1772–1775, May 2010.
- [10] L. Catarinucci, R. Colella, and L. Tarricone, “Enhanced UHF RFID Sensor-Tag,” *IEEE Microwave and Wireless Components Letters*, vol. 23, no. 1, pp. 49–51, 2013.
- [11] L. Catarinucci, S. Tedesco, and L. Tarricone, “Customized ultra high frequency radio frequency identification tags and reader antennas enabling reliable mobile robot navigation,” *IEEE Sensors Journal*, vol. 13, no. 2, pp. 783–791, 2013.
- [12] R. Acierno, M. Maffia, L. Mainetti, L. Patrono, and E. Urso, “RFID-based tracing systems for drugs: Technological aspects and potential exposure risks,” in *Proceedings of the IEEE Topical Conference on Biomedical Wireless Technologies, Networks, and Sensing Systems (BioWireless '11)*, pp. 87–90, January 2011.
- [13] L. Catarinucci, D. De Donno, R. Colella, F. Ricciato, and L. Tarricone, “A cost-effective SDR platform for performance characterization of RFID tags,” *IEEE Transactions on Instrumentation and Measurement*, vol. 61, no. 4, pp. 903–911, 2012.
- [14] D. De Donno, L. Catarinucci, and L. Tarricone, “Enabling Self-Powered Autonomous Wireless Sensors with New-Generation I2C-RFID Chips,” in *Proceedings of the IEEE MTT-S International Microwave Symposium Digest (MTT '13)*, pp. 1–4, Seattle, Wash, USA, June 2013.
- [15] U. Barchetti, A. Bucciero, M. De Blasi, L. Mainetti, and L. Patrono, “Implementation and testing of an EPCglobal-aware discovery service for item-level traceability,” in *International Conference on Ultra Modern Telecommunications and Workshops*, October 2009.
- [16] M. Kritzler, L. Lewejohann, A. Krüger, M. Raubal, and N. Sachser, “An RFID-based tracking system for laboratory mice in a semi natural environment,” in *Proceedings of the Pervasive Technology Applied Real-World Experiences with RFID and Sensor Networks*, 2006.
- [17] J. Aguzzi, V. Sbragaglia, D. Sarriá et al., “A new laboratory radio frequency identification (rfid) system for behavioural tracking of marine organisms,” *IEEE Sensors Journal*, vol. 11, no. 10, pp. 9532–9548, 2011.
- [18] F. Bonadonna, M.-A. Lea, and C. Guinet, “Foraging routes of Antarctic fur seals (*Arctocephalus gazella*) investigated by the concurrent use of satellite tracking and time-depth recorders,” *Polar Biology Journal*, vol. 23, no. 3, pp. 149–159, 2000.
- [19] G. Neisen, *Validation of a local positioning monitoring system (LPM) in relation to dairy cow behavior [Ph.D. thesis]*, Sustainable Agriculture ASPSA, 2005.
- [20] SMART video-tracking system. Panlab S.L.U., Barcelona (ES), <http://www.panlab.com/>.
- [21] Y. Zhang, M. G. Amin, and S. Kaushik, “Localization and tracking of passive RFID tags based on direction estimation,” *International Journal of Antennas and Propagation*, vol. 2007, Article ID 17426, 9 pages, 2007.
- [22] L. Catarinucci, R. Colella, M. De Blasi, V. Mighali, L. Patrono, and L. Tarricone, “An innovative animals tracking system based on passive UHF RFID technology,” in *Proceedings of the 20th International Conference on Software, Telecommunications and Computer Networks (SoftCOM '12)*, September 2012.
- [23] J. L. Volakis, *Antenna Engineering Handbook*, McGraw-Hill, New York, NY, USA, 4th edition, 2007.
- [24] Low Level Reader Protocol (LLRP) Standard, <http://www.gs1.org/gsmp/kc/epcglobal/llrp>.
- [25] C. A. Balanis, *Antenna Theory Analysis and Design*, John Wiley & Sons, New York, NY, USA, 2nd edition, 1997.
- [26] X. Qing, C. K. Goh, and Z. N. Chen, “Segmented loop antenna for UHF near-field RFID applications,” *Electronics Letters*, vol. 45, no. 17, pp. 872–873, 2009.
- [27] Z. Xing, L. Wang, C. Wu, J. Li, and M. Zhang, “Characteristics and application of a novel loop antenna to UHF RFID receivers,” *International Journal of Antennas and Propagation*, vol. 2011, Article ID 480717, 7 pages, 2011.
- [28] CST Microwave Studio, <http://www.cst.com/Content/Products/MWS/Overview.aspx>.

- [29] Speedway Revolution RX420 UHF RFID Reader, http://www.impinj.com/Speedway_Revolution_UHF_RFID_Reader.aspx.
- [30] Speedway Reader Antenna Hub, <http://www.impinj.com/searchresults.aspx?searchtext=antenna%20hub>.
- [31] T. Kløve, T.-T. Lin, S.-C. Tsai, and W.-G. Tzeng, "Permutation arrays under the Chebyshev distance," *IEEE Transactions on Information Theory*, vol. 56, no. 6, pp. 2611–2617, 2010.
- [32] Impinj Monza 4 tag chip family, http://www.impinj.com/News_and_Events/Press_Releases/2010/Impinj_Monza_4_Tag_Chip_Family_Raises_Bar_in_RFID_Performance_and_Privacy.aspx.
- [33] MATLAB, <http://www.mathworks.it/products/matlab/>.



Hindawi

Submit your manuscripts at
<http://www.hindawi.com>

