



Durham E-Theses

*Behaviour of *Lucilia sericata* with special reference to genetics*

Nash, D.

How to cite:

Nash, D. (1960) *Behaviour of *Lucilia sericata* with special reference to genetics*, Durham theses, Durham University. Available at Durham E-Theses Online: <http://etheses.dur.ac.uk/9129/>

Use policy

The full-text may be used and/or reproduced, and given to third parties in any format or medium, without prior permission or charge, for personal research or study, educational, or not-for-profit purposes provided that:

- a full bibliographic reference is made to the original source
- a [link](#) is made to the metadata record in Durham E-Theses
- the full-text is not changed in any way

The full-text must not be sold in any format or medium without the formal permission of the copyright holders.

Please consult the [full Durham E-Theses policy](#) for further details.

"BEHAVIOUR OF LUCILIA SERICATA
WITH SPECIAL REFERENCE TO GENETICS".

By

D. Nash.

Being

A Thesis presented in candidature
for the Degree of Doctor of Philosophy
in the
University of Durham, 1960.

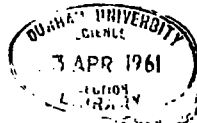

ACKNOWLEDGEMENTS

I should like to thank my supervisor in this work, Dr. J.L. Crosby of the Department of Botany, Durham, for his constant advice, encouragement and assistance throughout this work; and Professor J.B. Cragg, of the Department of Zoology, Durham, for many valuable discussions.

Amongst the many other people for whose assistance I am grateful, I should like to thank Mr. J. Donnelly, of the Ministry of Agriculture, Fisheries and Food Field Research Centre, Carlisle, who provided me with some of the stocks of blowflies used in this work; and the many people who made my short stay in Denmark both profitable and pleasant, particularly Dr. Elinor Bro-Larsen, of the Universitetets Mineralogisk-Geologiske Institut, Mineralogisk Museum, Copenhagen, and Dr. Sjøgaard Andersen and Mr. Leif Lyneborg of the Statens Skadedyrlaboratorium, Springforbi.

CONTENTS

General Introduction	pp 1 - 12.
<u>Part I. Behaviour studies in <i>Lucilia sericata</i></u>	
1. Introduction	pp 13 - 21.
2. Description of apparatus and method	pp 22 - 31.
3. Olfactory reactions of Australian and British <u><i>Lucilia sericata</i></u> .	pp 32 - 58.
4. Wool reactions of Danish <u><i>Lucilia sericata</i></u>	pp 59 - 65.
5. Preening in the choice chamber	pp 66 - 72.
6. Flights in the choice chamber	pp 73 - 77.
7. Comparison of sexes within the stocks	pp 78 - 80.
8. Consideration of possible changes within the laboratory stocks used	pp 81 - 87.
9. Conclusions to studies of behaviour	pp 88 - 105.
<u>Part II. Genetic studies</u>	
1. Introduction	pp 106 - 109.
2. Variation within the stocks in the innate level of <u>W</u> .	pp 110 - 125.
3. Comparison of parent and hybrid generations of <u>A</u> and <u>B</u>	pp 126 - 129.
4. Conclusions to the genetic studies	pp 130 - 133.
<u>Part III. Evolution of behaviour in <i>Lucilia</i></u>	
1. Introduction	pp 134 - 136.
2. Evolution of the sheep strike habit	pp 137 - 143.
<u>Part IV. General discussion</u>	pp 144 - 145.
References quoted	pp i - xiii.

LIST OF TABLES

1. Change of wool reactions with age in A and B females. pp 34 & 35.
2. Change of wool reaction with age in marked females of A and B. pp 39 & 40.
3. Change of wool reactions with age in males of A and B. p 43.
4. Change of wool reactions in males and females of A kept together but without meat. p 46.
5. Change of wool reactions with age in females of A and B kept without access to meat or males. p 48.
6. Change of meat reactions with age in A and B males and females. pp 51 & 52.
7. Change of wool reactions with age in combined stocks of D. p 62.
8. Change in occurrence of preening with age in males and females of A, B and D. pp 68 & 69.
9. Change in frequency of flights with age in males and females of A, B and D. p 74.
10. Variance analysis by samples and by estimated generation of the reactions of males and females of A and B. p 84.
11. Analysis of "within fly" and "between fly" variance. p 124.

LIST OF FIGURES

1. Diagrams of the choice chamber p 23.
2. Change of wool reaction with age in A and B. p 36.
3. Wool reactions of males and females of A kept without meat compared with the wool reactions of other flies of the same stock kept under normal conditions. p 47.
4. Wool reactions of females of A and B kept without access to meat or males compared with the wool reactions of other females of the same stocks kept under normal conditions. p 49.
5. Comparison of meat reactions in A and B. p 53.
6. Comparison of meat and wool reactions in A and B females. p 55.
7. Comparison of meat and wool reactions for A and B males. p 58.
8. Comparison of wool reactions of A, B and D. p 63.
9. Frequency distributions of wool reactions at d0 in A, B and D. p 64.
10. Frequency distributions of wool reactions at d10 in A, B and D. p 65.
11. Change in occurrence of preening with age in A, B and D. p 70.
12. Frequency distributions of the occurrence of preening at d10 in A, B and D. p 72.
13. Change in occurrence of flights with age in A, B and D. p 75.
14. Frequency distribution of the occurrence of flights in A, B and D. p 77.
15. Possible changes in the reactions of A and B during laboratory culture. p 83.
16. Frequency distribution of wool reactions of A, B and their hybrid generations at d0. p 128.

GENERAL INTRODUCTION

The form of an organism is controlled by the interaction between genotype and environment. The genetic basis of the inheritance of specific physical characters has been demonstrated in many organisms ranging from bacteria to man, and for many characters in such widely studied organisms as Drosophila and maize. Control by a single gene has been shown for many of these characters.

The genetic control of the physiology of the organism has also been demonstrated. Examples of this can be found in the studies of biochemical mutants of Aspergillus and Neurospora, and in the study of such abnormal conditions in man as alkaptonuria.

Less study has so far been carried out on the genetic basis of behaviour, and our knowledge in this field is still very limited. Before considering some of the previous work of this type, it is necessary to limit the scope of what is to be accepted as behaviour in the present study.

"Behaviour" is a difficult term to define, and a formal definition of it would probably raise more difficulties than it solved. In this work, observations have been limited to what is usually accepted as normal behaviour. Characters such as intelligence and personality influence behaviour in man, but are far removed from the activities studied here, and have not been considered. Again, abnormalities such as waltzing in mice are behavioural in the broad sense/

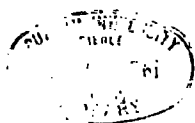

sense, but the present work is concerned with normal, integrated behaviour, and the genetic studies of characters of this kind have been disregarded. This gives the present discussion a reasonable scope, although it does debar a number of interesting studies from consideration.

Previous work on relevant topics can be divided into broad classes on the methods employed. The first of these classes is that in which work was started from a known genetic difference between stocks, the behaviour differences between these stocks then being studied. Scott (1937 and 1943) showed that inbred stocks of Drosophila differing in eye colour differed also in their reactions to light, and that the differences were not due entirely to any direct effect of the eye colour. Bastock (1956) showed that yellow bodied males of Drosophila melanogaster were less successful than normal males in mating with normal females, this being due to differences in the courtship behaviour, and not directly to the effects of body colour.

Comparable work has been carried out on other organisms. Hovanitz (1953) working on the butterfly Colias showed that forms differing by a monofactorial colour character had different reactions in the field to light and temperature; Sheppard (1952) working on the moth Panaxia dominula showed that females tended to prefer males differing for a particular gene of major effect. Keeler (1942) showed that hamsters differing for a gene affecting coat/

coat colour differed also for a number of behavioural factors such as rage reactions, annoyance reactions and olfactory sensitivity. Keeler and King (1942) showed that stocks of the Norway rat differing in colour genes also differed in behaviour, although this work was not as conclusive as that by Keeler on the hamster. These studies suggested that genes with visible morphological effects might also affect behaviour. They did not entirely discount the possibility that the behavioural differences were due to other genetic differences between the stocks; for example, the genes affecting the behaviour might have been linked with those genes of visible effects. Even in Drosophila the complete genotypes of all members of the stocks used could not have been known, and less was known of the genotypes in the other organisms. Also, this method is limited to studies of behaviour characters which are connected genetically with visible characters. However, the results are interesting if not completely conclusive.

Hirsch (1958) stated that individual differences within a population cannot be ignored, or ascribed entirely to experimental error. His study of individual differences in geotaxis in Drosophila (1959) employed the technique of chromosome synthesis. Here the variability of behaviour was compared with the known chromosomal constitution in a method directed at studying the sum of gene effects rather than the effects of single genes. The behaviour was shown to vary as the chromosomal constitution was altered. The manipulation of chromosomes necessary for this technique is perhaps only possible in Drosophila at the/

the moment, but Hirsch (1958) emphasised that there is no reason to suppose that principles discovered in Drosophila should not apply to other animals.

A different approach to behaviour genetics has been to start with a known behavioural situation and attempt to find its genetic background. Studies of this kind can be divided into those which deal with a relatively simple facet of behaviour, and those which deal with a larger more complex behavioural situation.

Few examples have been found of the genetic analysis of a "simple" behavioural situation such as preference. Herter (1933 and 1941) showed that a difference in temperature preference between two strains of mice was controlled by one gene locus. The study by Nachman (1959) of saccharin preference in mice showed that this factor was under some genetic control, but failed to show the nature of this control or the number of genes involved.

The consideration by Hirsch and Tryon (1956) of mass screening for a character such as phototaxis in Drosophila suggested that this technique might have the combined benefits of large numbers and reliable individual measurement. Using this technique, Hirsch and Bondreau (1959) showed that phototaxis in Drosophila was a highly heritable character.

These studies of small facets of behaviour showed in each case that the character in question was under genetic control, and have also produced an example of single gene control of behavioural characters./

characters.

Much of the work on the genetics of behaviour has been directed at complex characters. Hörmann-Heck (1957) studied sexual behaviour in crickets, and Goy and Jakway (1959) studied sexual behaviour in female guinea pigs. In both studies, the behaviour complex in question was analysed, and the results in each case strongly suggested that at least one of the components was controlled by a single gene. Hörmann-Heck showed that stridulation was probably under monofactorial control in the crickets Gryllus campestris and Gryllus maculatus; it is interesting to note that Thorpe (1940) working on the cricket Nemobius fasciatus concluded that the form of song was under polygenic control. Hörmann-Heck also showed that antennal trembling was controlled by one gene, and that the intensity of larval fighting was probably also under monofactorial control. Goy and Jakway showed that lordosis was controlled by one gene in the guinea pig and that oestrus was probably controlled by three genes, which also appeared to control other parts of the sexual behaviour.

Denenberg, Ross, Sawin and Frommer (1957) and Ross, Denenberg, Frommer and Sawin (1959) studied the genetic background of reproductive behaviour in the rabbit, dealing with complex characters such as the retrieving of young by the mother, but reached no clear genetic conclusions. The studies by Clarke, Aronson and Gordon (1954) on mating behaviour in Xiphophorin fishes, by Jakway (1959) on mating behaviour in the male guinea pig, and by Hinde (1956) on some behaviour/

behaviour patterns in Cardueline finches, separated the behaviour concerned into smaller patterns and attempted genetic analyses on these. In each case the characters were found to have some genetic basis, but in no case did the results define the number of genes concerned, the conclusion in each case being that the genetic control was polygenic.

Rats and mice have been subjects for a number of studies of behaviour genetics presumably because they are animals which have been widely studied by psychologists. The characters chosen for study have often been complex, and many of them appear to the non-psychologist to be ill defined and largely without a good available measure. Examples are the studies by Brody (1942) and Rundquist (1933) on spontaneous activity in rats, and by Dice and Hoslett (1940) on spontaneous activity in the deer mouse Peromyscus. In these studies, strain differences were established, and the character of spontaneous activity was shown to have some genetic basis.

Rundquist and Bellis (1933) showed that the respiratory rate of active rats at rest was higher than that of inactive rats, so that the active rats appeared to have a higher basal metabolic rate than the inactive ones. Hall and Lindsay (1938) showed that the activity of rats was controlled at least partly by the thyroid gland. Thus the measurements of spontaneous activity, in rats at least, contained measures of the basal metabolic rate of the animals considered; this character was presumably affected by a number of physiological processes. It also seems likely that the measurement of spontaneous activity, obtained/

obtained in these studies from the number of times the animal voluntarily revolved a recording wheel, would be complicated by the willingness of the animals to use the wheel. Spontaneous activity is clearly a complex character.

Differences between strains were established by Scott (1942) working on social behaviour in the mouse, and by Thompson (1956) on activity in the mouse. These studies of strain differences within a species, where the differences are constant between generations or can be affected by selection, do suggest that the behaviour in question is under some sort of genetic control.

The differences between wild and tame strains of rats and mice have stimulated some genetic study. Yerkes (1913) concluded that no single gene governed savageness, wildness and timidity in rats. Coburn (1922) used the same techniques as Yerkes working with mice and considering only savageness and wildness, concluding that each trait was governed by several genes. Dawson (1932) concluded that wildness and tameness in mice were governed by a few genes, with those for wildness showing average dominance over those for tameness. Stone (1942) working with albino and wild type rats, showed that these types differed heritably in wildness and savageness.

In his study of instinctive behaviour, Tinbergen (1951) has shown that this behaviour is organised on a hierarchical basis, with the complex being made up of a series of smaller parts, these in turn being composed of smaller factors, and so on down to the level of individual neuromuscular/

neuromuscular responses. If, as seems likely, these behaviour complexes are genetically controlled, then presumably each of the parts of the complex will have its own genetic basis.

If the behaviour complex is treated as a whole, then a genetic complex is involved, and a Mendelian analysis is not likely to be very rewarding. Before any genetic analysis is attempted the behaviour should clearly be studied in detail. Relatively small behavioural characters would seem to be more suitable for a Mendelian analysis than complexes; for this type of analysis it seems that the complex should be analysed into its components as far as possible, and these components studied separately.

The studies by Hörmann-Heck and by Goy and Jakway did demonstrate the numbers of genes involved in the genetic control of several factors of behaviour. Had these studies been of whole behaviour complexes instead of smaller components, however, it is highly unlikely that the number of genes concerned would have been discovered.

One method which has been used in an attempt to partition a behaviour complex is the factor analysis, and a good example of this is to be seen in the work on maze learning by the rat, although these studies are rather outside the limits of acceptable behaviour in the present work. This topic has been closely studied by a number of workers, for example Tryon (1940a and b and 1942), Tryon, Tryon and Kuznets (1941 a and b).

The results obtained on maze performance in the rat were analysed by Wherry (1941), using statistical and mathematical techniques; this analysis/

analysis suggested that maze performance could be explained on the basis of three behavioural factors. This type of mathematical factor analysis has been applied to other behavioural characters in an attempt to simplify the undoubted complexity of such phenomena. Thompson (1957) affirmed that complex behaviour must be reduced to simpler units before genetic analysis is possible, and suggested that mathematical factor analysis might be a suitable method of bringing about this simplification. He suggested that these factors might be studied genetically, although a single factor might be governed by a number of genes.

Tryon (1935) had previously criticised very strongly any such approach. His first criticism was that these factors are calculated on the principle of parsimony, the solution involving the smallest number of factors being accepted; this does not agree with the results obtained by psychologists, who find that many psychological components may affect one unit of behaviour. Tryon's second criticism was that factor analysis lumps individuals into set classes, whereas in fact real individual differences do occur. He concluded that these mathematical factors do not correspond to any real components of behaviour, and his criticisms would seem to be well founded. This being so, there would be little point in studying the genetic basis of factors, and factor analysis could not replace careful "psychological" analysis of the components of a behaviour complex as a preliminary to a genetic study. Factor analysis is interesting, but it does not seem likely to/

to help in a close analysis of the genetic basis of a complex behavioural situation.

A different approach has been made to this problem by a number of workers, an example being found in the work of Broadhurst on an emotional response in rats. Hall (1934) showed that rats defecated and urinated in response to certain emotional situations. Following this work, Broadhurst (1957) showed that defecation and ambulation provided reliable measures of emotional response in the rat, and Das and Broadhurst (1959) established differences between strains of rats in the degree of emotional response. Broadhurst (1959) clearly accepted both that this response was a complex pattern of behaviour which would presumably be governed by a number of genes, and that it was not practically possible to separate the components of this behavioural complex. The methods which he used for the genetic analysis were those developed by Mather (1949) and others for studying continuous variation with a polygenic basis. This study by Broadhurst (1959) resulted in an accurate assessment of the degree to which the behaviour was governed genetically, and the influence of additive gene effects, dominance and so on. This method of analysis will not find the number of genes involved, but it will give more information on the genetics of behaviour than an attempted Mendelian analysis of unsuitable material.

Similar methods were used by McClearn (1959) in his study of the genetics of mouse behaviour in novel situations.

Where a behaviour complex cannot be adequately partitioned, this approach would seem to be more rewarding than an attempted Mendelian analysis/.

analysis.

There are other difficulties inherent in the genetic analysis of behaviour, of which the first is the accurate measurement of the behaviour by the operator. It is not easy to find an adequate measure for a character such as savageness, although it is relatively easy to measure a simple preference reaction.

Another difficulty is the plasticity of the response of the animal to the experimental stimulus. Unless the behaviour being studied is so rigid that an individual will always respond in exactly the same way to a given stimulus, then measurement of the behaviour is further complicated by the flexibility of the response.

These features of behaviour studies would increase the difficulty of establishing the number of genes responsible for the behaviour. For example, given a flexible response by the animal and errors in the measurement of this response, it would clearly be difficult to show that a given behavioural difference between two strains was due to one gene rather than to a number of genes, as segregation would be difficult to demonstrate. Possibly the scarcity of good examples of single gene control of behaviour is due to these difficulties of technique, rather than to the fundamental nature of this genetic control.

A number of studies have been quoted in which behaviour was shown to have some genetic basis. It can be accepted that there is a genetic background to behaviour, and further demonstrations of this are of limited interest. Studies which enumerate the genes responsible for particular/

particular behaviour characters would be of more interest now, as would determinations of the relative importance of genotype and environment in fixing behaviour. It would also be interesting to see the way in which genes might affect behaviour, but this is outside the scope of the present study.

Thus, the chief requirements for a genetic analysis would seem to be behaviour which has been closely analysed, and a good technique of measurement. Consideration of previous ecological work on blow-flies suggested that this was a field in which these requirements were met. What appeared to be a difference between strains in a relatively simple olfactory preference had been demonstrated, and a technique for the measurement of this preference in individuals was available. The present work was directed at a genetic analysis of this difference, but first the behaviour had to be studied further.

PART I. BEHAVIOUR STUDIES IN LUCILIA SERICATA

1. INTRODUCTION

It has been known for some time that myiasis in sheep, or sheep strike, is caused by blowflies. Eggs are laid on the living animal; on hatching, the larvae feed on the tissues of the host, making wounds which may seriously impair the condition of the sheep. Insecticides such as DDT and Dieldrin are now used to combat this pest, but before these were available blowflies had been intensively studied in an attempt to find some biological method of control. Salt (1932) concluded that the problem could not be solved by field limitation of the blowfly populations, since their reproductive potential was so great that there was no adequate way of reducing their numbers in the field.

Myiasis is a problem found in most countries which rear large numbers of sheep, but it is not always caused by the same species of blowfly, nor does myiasis in one country involve only one species of blowfly. W.M. Davies (1934) showed that Lucilia sericata was the fly chiefly responsible for sheep strike in North Wales; MacLeod (1943b) showed that this same species was the one chiefly responsible for initiating strike in Britain. Other blowflies are often found associated with strike in Britain, but these almost always oviposit after the sheep has been struck by Lucilia sericata. Thus, Lucilia sericata is the primary sheep blowfly in Britain, the others being secondary.

In Australia, Lucilia sericata is a secondary blowfly, Lucilia cuprina

cuprina being the chief primary sheep blowfly, as shown by I.M. Mackerass and M.J. Mackerass (1944), I.M. Mackerass and Fuller (1937) and the Joint Blowfly Committee (1933). Lewis (1933) stated that both Lucilia sericata and Lucilia cuprina were associated with sheep strike in Kenya, but did not distinguish primary from secondary blowflies. Smit (1931) stated that Lucilia sericata was the most important sheep blowfly in South Africa, but did not differentiate Lucilia sericata from Lucilia cuprina taxonomically; Hepburn (1943a) stated that Lucilia cuprina was the chief primary blowfly in South Africa. Ulliyett (1945) suggested that these two flies were not separate species, at least in South Africa, but Waterhouse and Paramanov (1950) confirmed that they were separate. Waterhouse and Paramanov also stated that Lucilia cuprina occurred in North America, but was not associated with sheep strike there; Messer and McLellan (1935) stated that Lucilia sericata was also present in North America, but did not play any part in sheep strike. Cragg (1950b) stated that Lucilia sericata occurred in Denmark, where myiasis is of very rare occurrence.

This is an interesting biological situation, with the same species in different areas having different relations to sheep. Blowflies, including Lucilia sericata and Lucilia cuprina, can complete their life cycle satisfactorily in the absence of sheep with carrion as the breeding medium, and much work has been devoted to finding the reasons for the females sometimes to oviposit on live sheep.

Where myiasis occurs, the gravid females are attracted to the sheep/

sheep by some olfactory stimuli; this conclusion has been reached by a number of workers, including Smit (1931), I.M. Mackerass (1936) and Waterhouse (1946a), and a wide variety of possible attractants have been studied. Substances produced by the action of bacteria on the fleece have been cited as attractants by Johnston (1923), Seddon (1931), Holdaway and Mulhearn (1934b), Evans (1936), and Belschner (1937). Hobson (1936) showed that wool yolk, a fatty substance found in fleece, was attractive to blowflies, and Bull (1931) showed that dermatitis made a sheep more attractive. Froggatt (1925), Holdaway (1932) and Hobson (1941) showed that scouring and soiling of the fleece by faeces and urine increased the susceptibility of the sheep to attack by blowflies; this is supported by the high incidence of strike on the hindquarters and crutch, mentioned by a number of authors, for example MacLeod (1943). Monnig (1943) showed that strike wounds increased the susceptibility of the sheep to attack. Seddon, Belschner and Mulhearn (1931) showed that sheep differed widely in their susceptibility to blowfly attack, and were able to predict the order of susceptibility of different groups of sheep; Hobson (1936b) also noted the differences between individual sheep in their attractiveness to blowflies.

Hobson (1935b) showed that substances associated with putrefaction encouraged oviposition when placed on live sheep in the field, and this was confirmed by I.M. Mackerass and M.J. Mackerass (1944). A number of putrefactive substances have been tested in the laboratory and in the/

the field for their power to attract blowflies. Freney (1932a) showed that sodium sulphide and decomposed keratin were both attractive to blowflies; Hobson (1936b) showed that indole and skatole were attractive; Cragg (1950a) showed that the breakdown products of cysteine increased the attraction of sheep, and Cragg and Ramage (1945) showed that pads of indole and ammonium carbonate strapped onto sheep increased the amount of oviposition in the field. Cragg and Thurston (1950) compared a number of these chemical attractants for their effects on oviposition. Perhaps the most striking evidence for the importance of olfactory stimuli on oviposition, however, comes from the observation by Hepburn and Nolte (1943) that the flowers of Stapelia flavirostris, which give off an odour like that of decomposing carrion, were strongly attractive to, and encouraged oviposition by, Lucilia cuprina in South Africa.

Thus a number of olfactory stimuli have been considered in relation to strike, and the position is made more complicated by consideration of the effects of different fleece humidities on strike. An important contribution to this topic has been made by MacLeod (1940), who separated strike into two main components; blow, or oviposition on the sheep, and strike, the establishment of the pathological condition. The olfactory stimuli to which the females react are part of the mechanism which brings about blow; fleece humidity is likely to be of more importance in limiting the hatching of the eggs and the establishment of the larvae. It is interesting to note that Cousin (1929) suggested that female Lucilia sericata lay in response to the appropriate/

appropriate stimuli for oviposition, not because of conditions which would favour the survival of the eggs and larvae; this is strongly supported by the effect of the flowers of Stapelia flavirostris on Lucilia cuprina in South Africa.

Oviposition on living sheep is clearly a complex of behaviour, involving a complex of stimuli. Cragg (1950a) suggested that finding the sheep and ovipositing were two separate components, affected by different stimuli. The first part is clearly governed largely by the response of the fly to olfactory stimuli from the sheep. Cragg suggested that the bacterial flora of the skin might be important in determining whether or not the fly then oviposited, and Mackerass and Freney (1933) considered that bacterial activity on the skin was necessary for the establishment of the larvae. Waterhouse (1947a) and Rogoff and Barton Browne (1958) have shown that tactile stimuli are also involved in oviposition on sheep.

Once the eggs have been laid, further factors influence the establishment of strike. Evans (1934) showed that the eggs of Lucilia sericata lost water more readily at low humidity than high, and L. Davies (1948a and b, 1949) showed that high humidities were necessary for the eggs to survive and hatch, especially at high temperatures. Wardle (1930) and Evans (1935a) showed that larvae and pupae could not withstand low humidities, especially at high temperatures.

The need of the eggs for high humidity explains the importance of a high fleece humidity in the establishment of strike, an importance/

importance which was noted by W.M. Davies and Hobson (1935). Holdaway and Mulhearn (1934a) showed that sweating in sheep encouraged strike, while Cragg and L. Davies (1947) and L. Davies (1948) showed that sweating could raise the fleece humidity to a level at which the limiting factor to strike in clean healthy sheep was oviposition, not the development of the eggs. Nolte (1943) suggested that suint, (a waxy substance present in unwashed fleece), being hygroscopic, might help to maintain a high fleece humidity.

A number of studies have been made of the dietary requirements of blowfly larvae, for example by Hobson (1935a, c and d) and Mackerras and Freney (1933). Hobson (1933 and 1935c) showed that larvae cultured on a blood medium grow best if bacteria are present, and that larvae on an aseptic medium lack vitamin B which bacteria can provide. Hobson (1931) also showed that the larvae of Lucilia sericata liquefy their food, taking into the gut liquids with small particles. A very interesting feature here is that Hobson (1931b) showed that the larvae of British Lucilia sericata, which initiate strike, excrete a collagenase which would help them to penetrate the skin of a live sheep; Messer and MacLellan (1935) found no collagenase in the larval excreta of American Lucilia sericata, which are not involved in strike. This difference could clearly be an important factor in determining the efficiency of a primary parasite.

The biochemical changes in pupation have been studied by Evans (1932), and W.M. Davies (1934) showed that, under optimum conditions, larvae/

larvae could pupate after only thirty six hours of feeding.

Sheep strike is clearly a process which comprises a series of parts, each part involving a number of factors. First the female must be attracted to the sheep; this is largely due to olfactory stimuli. Then oviposition must occur; this involves tactile, and possibly other olfactory stimuli. The eggs must then hatch, and this is governed by the temperature and humidity of the fleece, which in turn are affected by sweating and probably by climatic conditions. Finally the larvae must be able to establish themselves and feed; the bacterial flora of the skin might be important here, and possibly the excretion of collagenase by the larvae determines their ability to produce the typical strike wounds. Of this complex, the part studied in the present work was the reaction of the flies to olfactory stimuli.

Hobson (1935b) showed that some substance produced by healthy sheep was a necessary part of the olfactory stimulus which attracts flies to the sheep, and he termed this natural odour the sheep factor. Cragg and Ramage (1945) obtained oviposition on moist clipped fleece on which were placed pads of cotton wool containing indole and ammonium carbonate; this showed that the live sheep was not necessary for oviposition, and suggested that the sheep factor was to be found in fleece. Cragg and Cole (1956) then tested the attractive powers of fleece in the laboratory.

Laboratory reactions of blowflies to olfactory stimuli had previously been studied by several workers. Crombie (1944) used a Y tube olfactometer to study the repellent powers of menthol; a modification/

modification of this well known method was suggested by Lee (1937), and Hepburn (1943d) discussed a laboratory trap method for studying tropisms of blowflies. These methods all have as a common feature the fact that the response by an individual fly is all or nothing; the fly either does or does not enter the tube or the trap containing the test substance. The strength of the reaction is measured by the proportion of flies tested which react to the stimulus.

The method used by Cragg and Cole, described in full by Cole (1955) differs from these in principle. This method, described below, is based on a continuous measurement, made by the fly over a fixed length of time in a choice chamber, of the stimulus; this gives a measure of the degree of reaction of the individual under test, rather than classifying the individual as reactive or non reactive. This method made it possible to study individuals as well as populations, but suffered from the disadvantage of being a rather slow procedure.

Using this choice chamber technique and employing several different types of fleece, Cole (1955) and Cragg and Cole (1956) found that there was little difference in attraction between fleeces from different breeds of sheep, and that this attraction was retained even by fleece which was two years old. Nor were the results different when the floor of the choice chamber was wet, except in the case of Lucilia cuprina.

Their results showed that British Lucilia sericata females gave a slightly higher reaction to fleece at an age of about six days than on the day of emergence, while mature males gave no reaction. If the females were kept with no access to meat the reaction was found to fall slightly/

slightly, as it did in females which were provided with meat but allowed no access to males; if the females had access to neither males nor meat, the reaction at maturity was found to be lower still. For none of these treatments, however, did the wool reaction differ significantly at the .01 level of probability from that of normal females. The ovaries were shown not to develop in the absence of meat, and it was concluded that the wool reaction altered with changes in the physiological state of the females and was affected by the condition of the ovaries.

Having established that the flies reacted to fleece under laboratory conditions, Cragg and Cole then compared the reactions of mature females of different species, and of different strains of Lucilia sericata. All strains of Lucilia sericata were found to give higher reactions than other species of blowflies, while differences were found between strains within the species. British females gave a higher reaction than Australian, while the reaction of Danish females was intermediate between the two. Small differences were found between Danish flies from a stock collected in Copenhagen and those from a stock collected in Mols, Jutland.

Thus Cragg and Cole found, amongst other things, a method of measuring a behaviour character, the wool reaction of these flies, and established a measurable behaviour difference between strains of Lucilia sericata. This method was used in the present work, which was started with a closer study of the behaviour in question, and of the differences between strains.

2. DESCRIPTION OF APPARATUS AND METHOD

The apparatus used in the present work was that used by Cragg and Cole (see Cole 1953) and will be only briefly described here.

The apparatus was a choice chamber consisting of a circular glass tank of diameter 29 cms. in which was closely fitted a Perspex tray two centimetres from the top of the tank. The tray was divided into two equal, shallow compartments, one of which held the test substance while the other held activated charcoal. Over the tray, and fitting closely within the tank, rested a muslin floor held taut by a pair of thin metal hoops. A glass sheet covered the whole, leaving a space of two centimetres between roof and floor in which the flies being tested could move actively and even make short flights. See Figure 1. In this apparatus any substance given off by the fleece which provided an olfactory stimulus for the flies was absorbed by the charcoal so that an olfactory gradient was set up. With no difference in stimulus within the apparatus, the fly being tested would presumably divide its time equally between the two sides. A deviation from equality in these times was assumed to reflect the attractive power of the fleece if this provided the only difference between the two sides.

The apparatus was used in a constant temperature room at a temperature of 23°C and a relative humidity of about 50%. The only illumination was a 40W Argenta type bulb suspended over the centre of the apparatus. Half way through each test the chamber was rotated through 180° to reduce the effect of any external difference between the/

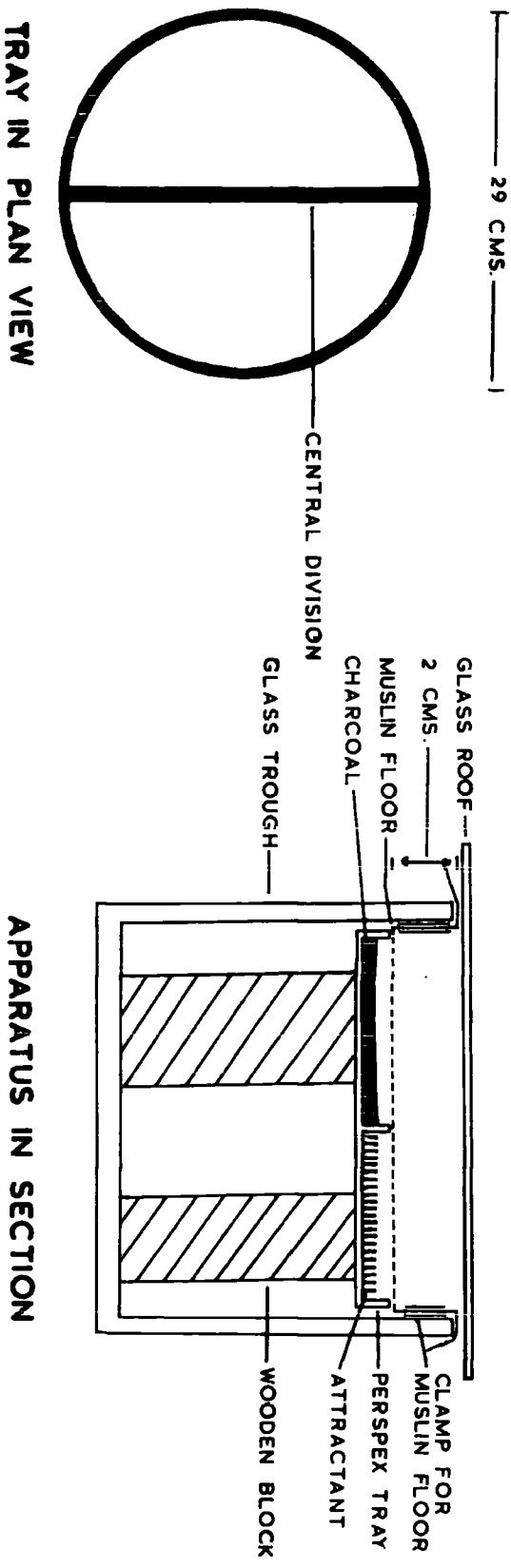

FIG. 1 DIAGRAMS OF THE CHOICE CHAMBER

the two sides.

Cragg and Cole found that the most satisfactory results were obtained by counting with a stop watch the total time spent by the fly on one side of the chamber during the ten minute testing time, each fly being tested separately. The reaction to the fleece was then calculated as 600 seconds minus the time spent on the charcoal side. In the present work, however, this wool reaction was calculated on a different basis. A fly showing no reaction to the wool would be expected to spend 300 seconds on the wool side of the apparatus out of the 600 second testing time. Thus a more accurate measure of the wool reaction is given by subtracting 300 seconds from the time spent on the wool side; this gives the time spent on the wool side due only to the attraction of the fleece. This is a better estimate of the wool reaction time, and is referred to below as 'W'. W was thus measured on a scale from +300 to -300.

The fleece used for the present work was Australian merino which had been stored in the department for some 6-9 years, and which had clearly maintained its powers of attraction since wool reactions approaching the maximum possible were given by some flies. Since the wool reaction is presumably elicited by volatile substances present in the fleece, which are released when the fleece is placed in the choice chamber, it was surprising to find that the fleece had maintained its attraction for such a long period. The important point here, however, is that the fleece used was attractive; the olfactory gradient was found to be present in apparently full strength after the apparatus/

apparatus had been set up for ten minutes, and reactions close to the maximum were elicited from many flies. Further consideration of the period over which the fleece can maintain its attraction concerns the nature of the attractive substances rather than the amount of reaction of the flies tested, and is outside the scope of the present work.

The durability of the attraction of the fleece might suggest that the reaction measured was to some stimulus other than the olfactory one which was considered. One possibility here is that the measurements were of a light reaction. With black charcoal under one side of a thin muslin floor, and cream-grey fleece under the other side, it is conceivable that the two sides of the apparatus differed enough in the amounts of reflected light to elicit some light reaction from the flies being tested. This possibility was studied by Cragg and Cole, who employed such methods as the use of black fleece; testing non-attractive 'animal wool' (a Boots' product); and dusting the charcoal with a neutral white powder. Their results showed that there was no light reaction in the normal use of the choice chamber. These results were conclusive, and there is no reason to assume that the position has changed since the work of Cragg and Cole.

The nature of the olfactory gradient within the choice chamber is not really known. The centre line was an arbitrary division of the chamber into attractive and non-attractive areas, since it was hardly to be expected that the stimulus would cease sharply at the centre line; it is more reasonable to assume that a continuous gradient existed across the/
the/

the chamber. However, the choice made at the centre line was very marked in flies which had a high reaction. All flies tested did cross the centre line, but those with a high reaction moved back very promptly into the fleece side. Presumably the choice made by each fly was for stronger or weaker stimulus, rather than for presence or absence of stimulus.

Many of the flies of one stock tested gave a reaction close to the maximum measurable one of 300, the range of results for this stock being from about 120 to 300. This suggests that the stimulus offered was too strong to differentiate between the flies with a high reaction, a suggestion which is supported by the marked skewness of the frequency distribution for these flies. However, some other flies showed a very low reaction, suggesting that the stimulus was perhaps not strong enough to differentiate between flies with a low reaction. Since this work was comparative rather than absolute, one level of stimulus had to be maintained throughout, and the one used was probably suitable.

A stock of Australian Lucilia sericata was set up from pupae sent from Australia; this stock will be referred to below as 'A'. A stock of British Lucilia sericata was set up from field caught flies; this stock will be referred to as 'B'. An attempt was made to avoid in-breeding in these stocks. Each generation was produced from as many egg batches as possible, in an attempt to have represented in that generation as many as possible of the fertilised females of the previous generation, and numbers of the breeding culture were kept as high as possible. However, the numbers did fall on occasion, and some in-breeding/

inbreeding may have occurred.

After some two years, the original stock of B died out, and was replaced by a stock of highly inbred British Lucilia sericata set up from pupae provided by Mr. J. Donnelly of the Ministry of Agriculture, Fisheries and Food Laboratory, Carlisle. The original stock of B was used for all the studies except the genetic analyses; these were carried out on the second, inbred stock. The only other work done on the inbred material was some limited testing which showed that both B stocks had the same patterns of olfactory behaviour, and that there were only small differences between them in their wool reactions at any given age.

All the flies used in this work were cultured under the same conditions. The adults were kept in muslin cages with metal frame and floor, measuring 14" x 20" x 29". The cages were kept in two banks of five with their backs to a solid wall, each bank being illuminated by a 58" Osram 30 watt "Daylight" fluorescent tube above and behind the row of cages. These cages were kept in a constant temperature room at 25°C, and the light was switched on at 9.0.a.m. and off at 6.0.p.m. by a time switch. When flies were being tested after 6.0.p.m., the lights were switched on again until the tests were finished.

Water was constantly available in the cages from a jar inverted over a filter paper, and a Petri dish of granulated sugar was kept in each cage. Unless otherwise stated in the text, meat was also constantly available to the adults from the time of emergence. This meat was in the form of refrigerated sheep lung, a slice in a Petri dish being/

being placed in each cage. Until oviposition started, this meat was replaced once each day, usually in the morning, by a fresh piece of meat in a clean dish. When the flies were laying, the meat was examined for eggs at least twice a day, when meat with eggs was replaced by fresh meat. Oviposition usually started about one week after emergence.

The dishes containing meat with eggs were labelled and taken to an incubator kept at 28°C. Here they were placed in desiccator jars with the lower compartment filled with water, and the vaselined lid firmly in place, so that the eggs were in an atmosphere with a relative humidity near 100%; incubation was for 24 hours. After this time the pieces of meat carrying larvae were put into labelled conical flasks with about 2 inches of dried peat moss on the bottom, the flasks being closed with cotton wool plugs. Meat with unhatched eggs was discarded at this time, as hatch seldom, if ever, occurred after 24 hours.

Each morning a further piece of sheep lung was added to each flask of feeding larvae. This feeding period lasted for about 7 days, after which the larvae left the meat, becoming pre-pupae, and moved to the bottom of the peat moss. At this stage the flask was taken from the incubator, its contents were tipped into a shallow dish and the meat debris was removed by hand. The inside of the flask was cleaned with a dry tube brush, and the pre-pupae in peat moss were replaced in the flask, more dry peat moss being added if the old peat moss was too wet. The flasks were again firmly plugged with cotton wool.

At the end of the feeding period the pre pupae sometimes forced their/

their way through a faulty cotton wool plug, escaping into the incubator. Free pre pupae and pupae in the incubator were always destroyed, the contents of the incubator being taken out and all the free animals being removed. Fresh plugs were substituted for the faulty ones, if any pre pupae were left in these flasks.

The clean, labelled flasks containing pre pupae were then stacked in the constant temperature room at 23°C . Each flask was carefully examined daily to see how far pupation had progressed. When pupation had been completed in a flask, this taking about 3 to 4 days, the contents of the flask were tipped into a shallow, labelled dish and stored at 8°C . If the pupae were kept at 23°C , emergence took place in about a week, the complete life cycle taking about 4 weeks.

It was found that the emergence of adults from the pupae could be delayed for periods of up to three weeks by storing the pupae at 8°C ; the adults from this pupae were apparently completely normal and healthy, and this method was used to ensure supplies of freshly emerged adults when required. Pupae could be stored in this way for longer periods, but the adults emerging after prolonged storage were often weak and deformed, and the mortality was high, so three weeks was the maximum storage time for flies to be used in the choice chamber.

Flies were taken from the cage in glass tubes, and introduced into the choice chamber for testing as quickly as possible. Each fly was given one minute in the choice chamber to settle down, and the test lasted for 10 minutes. After its test the fly was removed from/

from the choice chamber in a glass tube.

A complete operation took about 12 minutes, and it was possible to test 5 flies in one hour. Because of the time spent on culturing, setting up the apparatus and so on, it was found that 30 flies could be tested in one average day, and about 150 in a week, although more were sometimes tested. Some time was lost in waiting for emergence of a new generation to reach usable proportions, especially when my absence from Durham had put the culturing out of phase, when a delay of one or two weeks sometimes occurred. These factors, together with other aspects of the problem such as the analysis of results and reading, limited the number of flies which could be tested in the course of this work.

In the choice chamber the flies, at some time during the test period, almost always started to preen, apparently without regard to their position in the olfactory gradient. This would have reduced the accuracy of the test of the olfactory reaction, so preening was immediately disturbed by a tap on the glass roof directly over the fly. Observation suggested differences between the stocks in the frequencies of preening and flying in the choice chamber, so these were recorded. Each disturbance brought about at least one flight, so the number of "intentional" flights was calculated as the total number of flights minus the number of preenings. No measurement was attempted of the duration of either flights or preenings.

In the statistical examination of the results of this work, a difference at the .01 or lower levels of probability is considered significant/

significant; a difference above the .05 level is not significant; a difference between the .05 and .01 levels is considered to be suggestive, and each difference in this class will be considered separately.

3. OLFACTORY REACTIONS OF AUSTRALIAN AND BRITISH
LUCILIA SERICATA

a. REACTIONS TO FLEECE

Effect of age on wool reaction of females

The work of Cragg and Cole demonstrated an olfactory difference between Australian and British females, and also suggested that the wool reaction (W) of British females was affected by the state of the ovaries, although the results which they obtained on the effect of maturation on W were not statistically significant.

At the beginning of the present work the age of the flies tested was not controlled, only the differences in reaction between A and B being considered. A number of results were obtained and they showed little difference between these two stocks, what difference there was suggesting that A had a higher reaction than B; this was a very different result from that obtained by Cragg and Cole. The most striking feature about my results was the very wide range of readings obtained within each stock, a range too great to be accepted as due only to experimental error. If the reactions of the flies changed with age, then the uncontrolled age of the flies tested could explain at least some of this variability within stocks.

Consequently the Australian and British stocks were studied for changes in W with age, the flies used being those which had full access to/
to/

to meat and the other sex. The females were studied first.

For each set of results a cage was set up containing only flies which had emerged within a 24 hour period. Each day a sample of ten females taken at random from the cage was tested in the choice chamber. The first test was made on the day of emergence, d0 tests being made daily until the tenth day, d10. The results for d0 were taken as the emergence reaction, while those for d10 were considered to show the reactions of mature females (see Table 1, Fig.2.).

The results obtained in this way with B females showed a fall from the emergence reaction to a low level, followed by a marked rise to the time of maturity. Similar series of tests were made with A females, and these showed the same pattern of change as B, although the absolute size of the reaction differed at most points. The emergence reaction in particular was much higher in A than in B, while the mature reaction was much lower.

Since W clearly changed markedly with the age of the fly, age differences between the flies of any sample tested would bring about errors in the results obtained; it was of obvious importance that the age of the flies used should be known as accurately as possible. Consequently the emergence of flies to be used in the choice chamber was closely watched, so that the age of any fly was known to within half an hour. It was found that the least age at which flies would give reasonably consistent results for W was between 2 and 3 hours, and flies of this age were used in the determination of the emergence reaction/

Table 1. Change of wool reaction with age in A and B females

	d0	d1	d2	d3	d4	d5	d6	d7	d8	d9	d10
1	n	10	10	10	10	10	10	10	10	10	10
	\bar{x}	131.5	36.0	30.9	8.4	-14.9	-9.6	10.0	39.3	-	43.1
	SE	12.6	11.9	12.9	9.2	8.2	5.0	4.2	10.3	-	8.0
2	n	10	10	10	10	10	10	10	10	10	10
	\bar{x}	126.8	114.1	50.0	25.9	2.2	-3.9	4.0	19.2	44.6	38.1
	SE	13.0	10.3	9.2	9.9	13.5	11.5	14.1	7.2	5.2	11.2
3	n	10	10	10	10	10	10	10	10	10	10
	\bar{x}	193.9	125.7	59.6	42.4	10.8	5.9	-10.4	0.1	28.9	43.6
	SE	20.0	15.8	13.1	9.2	9.2	8.1	8.7	6.2	6.5	9.0
4	n	11	10	10	10	10	10	10	9	9	9
	\bar{x}	231.1	135.3	57.5	-1.6	0.2	3.6	3.1	32.8	15.7	16.0
	SE	10.7	7.1	9.8	4.2	5.1	2.7	3.9	11.1	6.1	5.8
Com- bined Scores	n	41	41	40	40	40	40	40	39	29	39
	\bar{x}	181.9	126.9	45.8	24.4	5.4	-2.3	-3.1	15.5	32.5	36.4
	SE	9.3	5.9	9.3	5.6	4.9	4.3	5.3	4.3	4.1	5.5
1	n	10	10	10	10	10	10	10	10	10	10
	\bar{x}	52.8	69.8	64.9	26.2	52.6	34.4	3.3	39.5	59.5	67.4
	SE	7.4	7.7	10.5	5.7	6.5	4.9	11.3	9.2	11.3	3.5
2	n	10	10	10	10	10	10	10	10	10	10
	\bar{x}	62.2	62.5	51.8	21.6	20.8	24.6	55.5	59.8	48.4	53.4
	SE	14.1	9.1	8.0	7.6	8.5	7.9	10.9	8.4	6.2	10.7

cont.....

Table 1. Continued

	d0	d1	d2	d3	d4	d5	d6	d7	d8	d9	d10
\bar{x}	10	10	10	10	10	10	10	10	10	10	10
SE	76.1	81.7	51.0	67.3	35.2	4.3	39.3	48.2	63.0	109.1	64.1
	15.1	13.7	13.0	5.2	7.0	10.4	8.6	7.5	9.5	10.6	3.5
Females											
\bar{x}	11	10	10	10	10	9	9	9	8	8	8
SE	135.5	126.0	100.1	77.9	81.2	73.4	80.3	74.8	65.4	78.9	76.2
	8.8	10.3	12.1	12.1	13.5	5.3	11.1	7.7	11.2	13.8	9.1
Com- bined Scores											
\bar{x}	41	40	40	40	40	39	39	39	38	28	38
SE	83.2	85.0	66.9	48.3	47.5	33.0	43.7	54.9	58.7	80.6	63.9
	7.8	6.5	6.4	5.6	5.9	5.4	6.9	4.7	5.4	8.3	5.6

For sets 1 to 3 of A and B, 10 flies were selected at random each day, on the day of emergence and for the next 10 days, from a cage containing only flies of the same age, and the wool reactions of these flies were recorded. For set 4 of each stock, the same marked flies were tested throughout. These four sets were combined for each stock.

n = number in sample.

\bar{x} = mean score.

SE = Standard error.

* = Marks time of first egg batch in the cage.

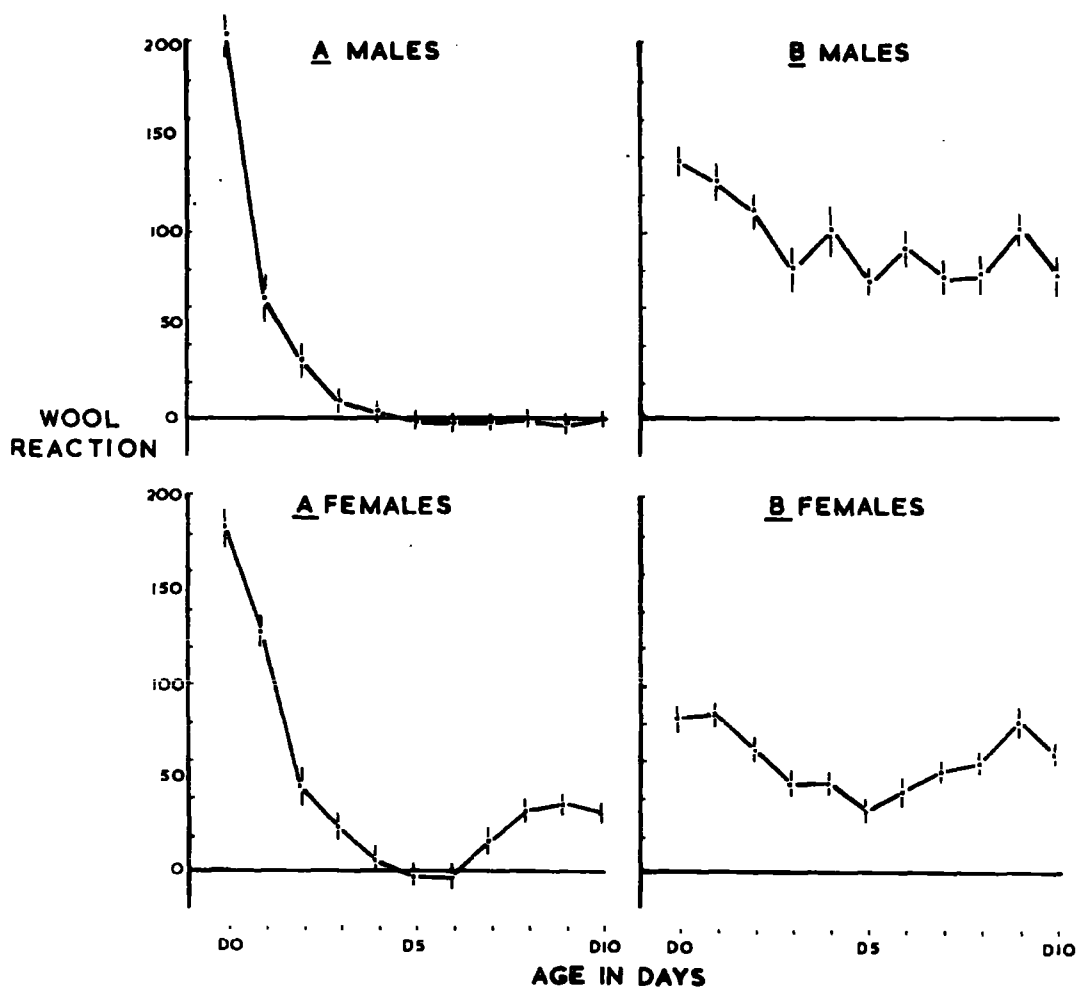

FIG. 2. CHANGE OF WOOL REACTION WITH AGE IN
A AND B

THE WOOL REACTION IN BOTH SEXES OF A AND B HAS BEEN PLOTTED AGAINST THE AGE OF THE FLIES FROM WHICH THE RESULTS WERE OBTAINED. THESE RESULTS ARE FROM TABLE 1, COMBINED SCORES (A AND B FEMALES), AND TABLE 3 (A AND B MALES).

reaction. The results obtained previously, in which the age of the tested flies was not controlled, were rejected.

Since the pattern of change of \underline{W} with age appeared to be affected by the maturation of the ovaries, and since the females did not all reach maturity at the same time, a similar series of tests was made with flies which had been marked so that individuals could be recognised.

It was found that exposure to a temperature of about 8°C for five minutes made the flies inactive so that they could be marked by means of spots of yellow acetate dope applied to the top of the thorax in individually identifiable patterns. The flies showed no ill effects from either the chilling or the marking, and appeared to be completely recovered within a few minutes of their return to the cages.

It was found possible with marked females to determine the day on which individuals had oviposited by recording daily the degree of distension of the abdomen. During the few days before oviposition the abdomen became increasingly distended; immediately after oviposition the abdomen collapsed. This difference was sufficiently obvious with a daily inspection to make it possible to decide on any one day whether or not the female had oviposited since the previous inspection. This gave the time of oviposition as somewhere within a 24 hour period.

It was now possible to consider the results for individuals rather than average scores for flies of the same chronological age. (see Table 2). It was clear from the previous tests that the minimum reaction was short lived. If, as must be assumed, the flies tested were/

were not completely synchronised in their reactions, the size of the minimum reaction would be obscured in average scores. Similarly, with the considerable changes in reaction at about the time of oviposition, differences between females in the time of maturity would affect the average score for the mature reaction. Consideration of individual scores made it possible to avoid these effects, and to obtain better measures of the minimum reactions, and of the reactions immediately before and after oviposition. The latter were particularly interesting since they made it easier to consider the connection between oviposition and the wool reaction.

For A, the combined lowest scores for 10 marked females gave an average of -13.2 ± 2.2 , compared with the lowest mean for 40 unmarked females of -3.1 ± 5.3 . For B, the combined lowest scores for 10 marked females gave a mean of 12.1 ± 3.4 , compared with the lowest mean for 39 unmarked females of 33.0 ± 5.4 . The combined highest scores after the minimum for 10 marked A females gave a mean of 47.4 ± 8.1 , compared with the highest similar mean for 29 females of 36.4 ± 5.5 . The corresponding scores for B females were 126.1 ± 6.9 for 10 marked females, and 80.6 ± 8.3 for 28 unmarked females.

For both stocks the differences between the two sets of results for each reaction are considerable; the maxima and minima are emphasised by selecting the results obtained with marked flies. Since the highest and lowest scores were selected, any sampling errors inherent in the results for an individual would themselves emphasise the maxima and minima. However, it does seem likely that the results obtained/

Table 2. Change of wool reaction with age in marked females of A and B.

Date	Fly	d0	d1	d2	d3	d4	d5	d6	d7	d8	d9	d10
	1	252	124	105	3	31	-2	-6	37	10	26	11
	2	295	165	Died	-	-	-	-	-	-	-	-
	3	247	151	9	-19	4	-4	-20	-18	19	* 18	-8
	4	274	135	27	7	22	-8	-12	-5	-9	7	* 67
	5	197	106	45	-13	-17	4	12	91	* 37	* -4	28
	6	248	170	51	-10	-26	5	16	6	Died	-	-
	7	186	162	44	14	1	21	5	35	-8	* 29	-7
	8	195	114	61	11	6	-10	24	14	3	34	-19
	9	210	109	18	9	-8	7	4	35	5	2	18
	10	253	116	-3	-26	-11	2	2	50	41	-14	0
	11	207	158	30	8	0	15	-2	90	43	46	2

cont.....

Table 2. Continued

Date	d0	d1	d2	d3	d4	d5	d6	d7	d8	d9	d10
Fly											
1	113	72	70	50	36	107	5	15	2	67	60
2	167	49	142	55	Died	-	-	-	-	-	-
3	157	70	121	122	55	49	31	55	132	106	118
4	124	89	177	54	27	85	70	129	108 *	101	127
5	91	187	127	47	103	15	124	76 *	145	132	155
6	85	131	124	6	12	42	60 *	59	130	104 *	85
7	162	106	100	41	2	5	107	122	139	143	67
8	41	91	69	15	122	39	63	43 *	77	101	12
9	71	96	109	4	62	53	74	92	122	41 *	122
10	93	187	186	68	70	130	83	85	94 *	55	49
11	150	131	140	1	-25	84	116	131	25	110 *	93

For both A and B, females of known age were marked so that individuals could be recognised, and their wool reactions measured and recorded individually from d0 to d10, the same flies being tested each day.

* Marks date of oviposition of individuals.

obtained from marked flies gave better estimates of the true reactions, since the results obtained from unmarked flies would presumably be obscured by differences within the samples in the times of minimum reaction and oviposition.

These results show that W fell to a level at or near zero for both A and B, and give better measures of the true reactions at the time of oviposition than were found by the tests carried out on unmarked flies; they also confirmed the rise in reaction just prior to oviposition. Unfortunately, pre and post oviposition results were only obtained for five A and six B females; these suggested that the reactions fell after oviposition, but the results were too few to be conclusive.

Since d0 and d10 were the times at which the differences between A and B were greatest, samples of 100 were taken at these times for both stocks to give a more accurate measure of these differences (see Figs. 8 and 9). These large samples, being composed of a number of smaller samples taken at different times, would be affected by any changes which took place within the stocks for the levels of W while these stocks were being cultured. This possibility has been dealt with in detail in a later section, but it can be said here that any changes which might have occurred between generations in the laboratory stocks used were not of the same order of size as the differences between A and B; there was thus no reason to suppose that any change within the stocks would seriously have affected the question of differences between the stocks.

The differences between A and B females in W at d0 and at d10 were/

were shown to be highly significant.

Effect of age on wool reaction of males.

Daily tests with marked males of A and B showed that the emergence reaction of the males was very similar to that of the corresponding females. The possibility of sex differences in this reaction within the stocks has been examined in a later section. W fell from the level of the emergence reaction in both stocks, and in neither stock was there any secondary rise in W. However, while W soon reached zero in A males, B males still maintained a high reaction by d10 (see Table 3, Fig. 2.). Samples of 100 were taken for the males of both stocks at d0 and d10, which confirmed the differences between the stocks; these were highly significant. (See Figs. 8 and 9).

Pattern of change of W with age.

In both sexes of both A and B, W fell from the emergence level; in the females of both stocks, but not in the males, there was a secondary rise after this minimum. The time at which the rise occurred suggested a causal relationship between the final stages of maturation of the ovaries and this part of the pattern of change of W. This change can be considered in two parts; the initial fall, then the secondary rise.

It is known that female blowflies require meat meals before the ovaries will mature; this was shown for Protophormia terrae-novae by Harlow (1956), for Lucilia sericata by Evans (1935b) and Hobson (1938)/

Table 5. Change of wool reaction with age in males of A and B.

	d0	d1	d2	d3	d4	d5	d6	d7	d8	d9	d10
n	11	11	11	11	11	11	11	11	9	8	8
\bar{x}	205.7	61.7	30.3	8.7	2.6	-2.4	-2.0	-1.5	0	-3.2	-0.1
SE	10.2	13.2	8.9	6.7	5.6	3.1	3.6	2.2	1.7	2.3	1.6
n	11	10	10	10	10	9	9	9	8	8	8
\bar{x}	156.4	126.0	109.1	77.9	99.2	72.8	90.3	74.7	76.6	101.4	76.4
SE	8.4	10.3	8.8	12.1	12.5	5.0	9.2	8.1	11.4	8.2	10.2

For both A and B, the wool reactions of males of known age were measured from d0 to d10, the same flies being tested each day.

n = number in samples.

\bar{x} = mean

SE = standard error.

(1938), and for Lucilia sericata and Lucilia cuprina by Mackerass (1933). An exception to this was found in the cultures of Lucilia cuprina kept by Nicholson (1957); here the ovaries did mature in the absence of meat, but only in one strain produced by intensive selection over a large number of generations, and this strain was described by Nicholson as exceptional. Cragg and Cole, culturing Lucilia sericata under the same conditions as those of the present work, showed that the ovaries of females kept without meat from the time of emergence showed no sign of completing maturation within ten days. The relationship between the changes in W and the maturation of the ovaries could thus be checked by studying the pattern of W in females which had been kept without meat. Tests were also carried out with males of A which had been kept without meat.

Change of wool reaction with age in flies kept without meat.

The two sexes of A were kept together but without access to meat, and daily tests were made with both sexes. The results showed the normal fall from the emergence reaction in both sexes, but no secondary rise in W in the females (see Table 4, Fig. 3). This suggests that the absence of meat from the diet affects the wool reaction of females. Unfortunately it was not possible to repeat this for B because of lack of time.

The results of Cragg and Cole (1956) suggested that females which had access to meat but not to males might differ in their wool reaction from females which had access to meat and to males, although the differences/

differences they showed were not statistically significant. Webber (1955) showed that females of Lucilia cuprina kept without males produced eggs which matured normally in the ovary, but rarely if ever laid them. If, as seems likely, this applies to Lucilia sericata, and if the approach of oviposition affects the level of the mature wool reaction, then the lack of fertilisation might be expected to affect the mature wool reaction of Lucilia sericata females, and this would explain the results of Cragg and Cole.

To test this, it would have been necessary to test daily females which had access to meat but not to males, and this did not prove possible in the time available.

Females of A and B which had access neither to meat nor to males were tested daily for their wool reactions. For both stocks this reaction fell from the emergence level, and there was no secondary rise, but the fall appeared to be less rapid in the absence of males. The numbers tested, however, were too small for firm conclusions to be drawn, and time did not permit the testing of males under comparable conditions as controls. (See Table 5, Fig.4.).

The work in this section was clearly incomplete, and the evidence it provided was fragmentary, as there was insufficient time for all the required data to be found. However, the results which were obtained certainly supported the hypothesis that the wool reaction of the females was affected by the condition of the ovaries. This technique could clearly provide much more information on the relationship between the wool reaction and the development of the ovaries.

Table 4. Change of wool reaction in males and females of A kept together but without meat.

	d0	d1	d2	d3	d4	d5	d6	d7	d8	d9	d10
Females	n	22	20	10	20	20	10	20	20	9	17
	\bar{x}	241.9	192.2	71.0	38.9	33.2	17.5	0.9	0.5	-0.4	-0.9
	SE	6.2	4.8	8.5	8.4	4.9	5.4	7.5	4.2	3.8	5.4
Males	n	22	22	11	21	20	10	20	20	9	19
	\bar{x}	245.1	183.5	23.8	8.5	7.5	3.1	-5.0	3.0	2.7	-0.9
	SE	5.1	2.6	8.4	7.5	3.6	5.4	6.6	4.1	6.7	4.0

On two occasions for both sexes, flies of known age were kept without meat, both sexes being kept together, and the wool reactions of the same flies were tested from d0 to d10.

n = Number in sample.
 \bar{x} = Mean.
 SE = Standard error.

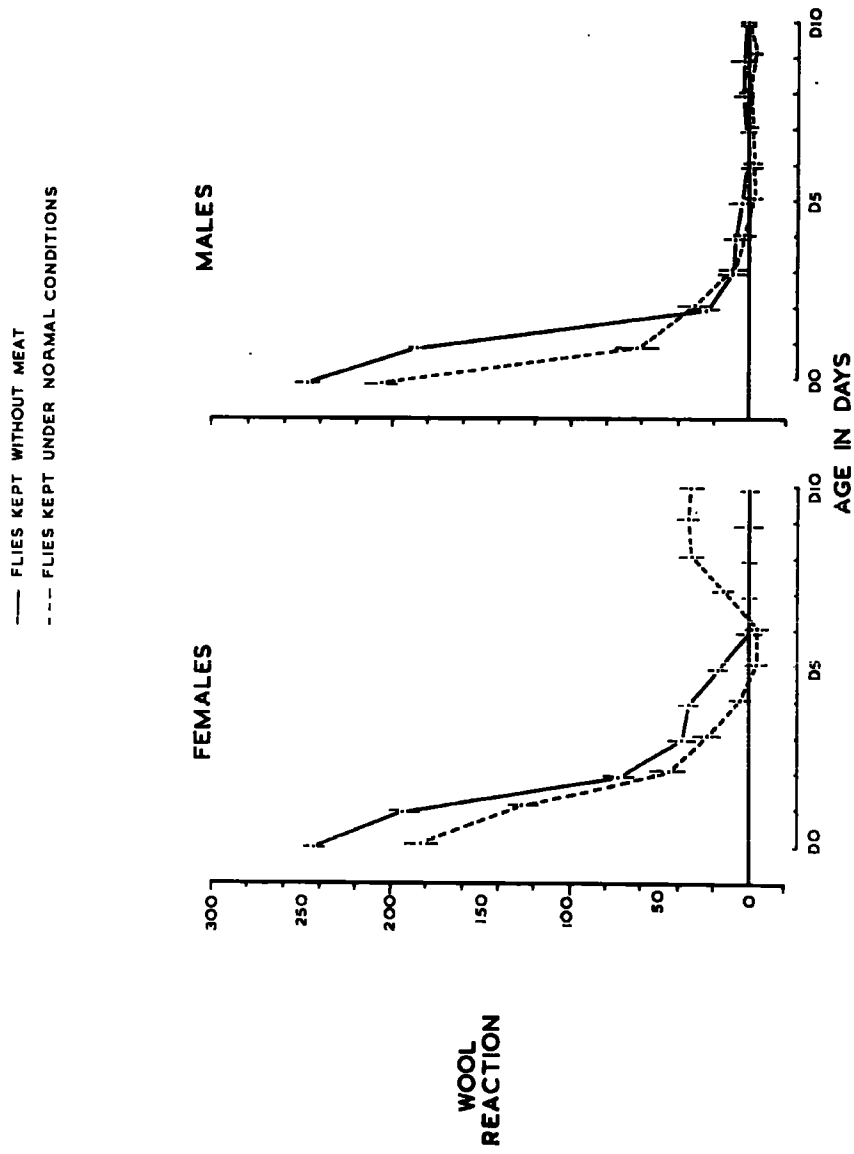

**FIG. 3 WOOL REACTIONS OF MALES AND FEMALES OF
 A KEPT WITHOUT MEAT COMPARED WITH THE
 WOOL REACTIONS OF OTHER FLIES OF THE SAME
 STOCK KEPT UNDER NORMAL CONDITIONS**

Table 5. Change of wool reactions with age in females of A and B
kept without access to meat or males

	d0	d1	d2	d3	d4	d5	d6	d7	d8	d9	d10
n	11	11	11	11	11	11	10	10	10	10	10
\bar{x}	243.7	146.4	143.6	61.5	47.5	76.6	89.5	49.2	71.6	28.2	18.6
SE	9.5	10.7	19.2	16.6	12.7	11.5	17.1	10.1	16.4	10.5	9.6
n	11	11	11	11	11	10	10	10	10	10	10
\bar{x}	89.3	91.2	79.2	47.1	50.6	57.2	72.8	19.1	37.8	21.5	15.1
SE	9.2	11.6	13.7	7.3	12.4	7.7	14.9	10.1	10.5	7.8	7.2

For both A and B, females of known age were kept without access to meat or males and their wool reactions tested daily from d0 to d10, the same flies being tested each day.

n = Number in sample.

\bar{x} = Mean.

SE = Standard error.

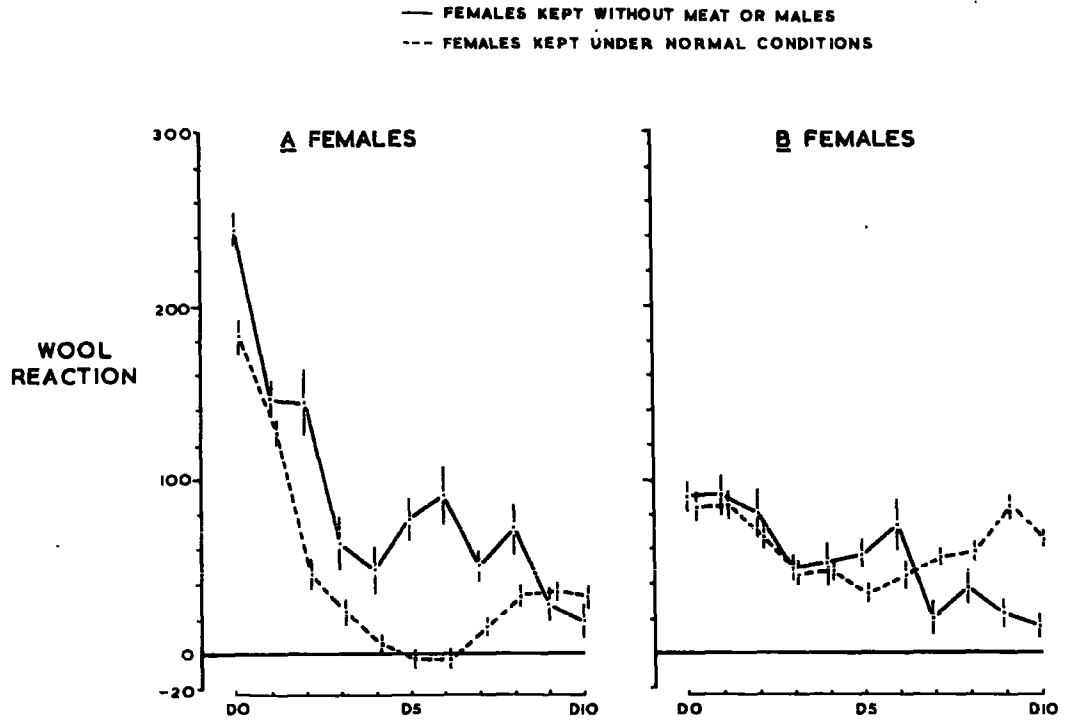

FIG. 4 WOOL REACTIONS OF FEMALES OF A AND B KEPT WITHOUT ACCESS TO MEAT OR MALES COMPARED WITH THE WOOL REACTIONS OF OTHER FEMALES OF THE SAME STOCKS KEPT UNDER NORMAL CONDITIONS

THE WOOL REACTIONS OF THESE FLIES HAVE BEEN PLOTTED AGAINST AGE. THESE RESULTS ARE FROM TABLE 1, COMBINED SCORES (NORMAL FEMALES) AND TABLE 5 (FEMALES KEPT WITHOUT MEAT OR MALES).

b. REACTIONS TO MEAT

Since meat is of such importance in the field, at least to females, the reactions of flies to meat were studied, using the choice chamber technique as before, but with meat as the attractant. With wet meat on one side of the apparatus and dry charcoal on the other, it was necessary to wet the muslin floor so that the high ensuing humidity would cover any humidity differences which might otherwise have arisen between the two sides of the apparatus. This ensured that any reaction shown by the flies was in response to some olfactory stimulus from the meat, and not a humidity preference. A large quantity of sheep lung was ground and stored at -8°C , a temperature at which no decomposition was possible, small pieces being removed and thawed when required. This was presumed to provide a meat medium of constant olfactory properties over the period of these tests, no single piece being used for more than two hours after it had been thawed.

Effect of age on meat reactions of females.

20 females of A, kept in the normal way with full access to meat and males were tested daily in the choice chamber for their reactions to meat. The results showed that the meat reaction, referred to below as M, rose from a low emergence level to a high level which was maintained with little loss until maturity (see Table 6, Fig.5.). A similar pattern was shown by the reactions of 10 B females tested daily in the same way. M for A females rose to a slightly higher level than for B however, and at d10 the reaction for A was considerably higher than for/

Table 6. Change of meat reaction with age in A and B males and females.

	d0	d1	d2	d5	d4	d5	d6	d7	d8	d9	d10
A Females	n	11	11	11	11	10	10	10	10	10	10
	\bar{x}	9.7	5.2	16.8	72.6	109.2	126.0	112.7	101.5	102.2	82.5
	SE	4.1	6.7	5.2	11.4	10.9	8.6	10.8	13.0	7.9	9.3
A Males	n	11	11	11	11	10	10	10	10	10	10
	\bar{x}	13.9	1.6	0	0.2	4.2	-5.0	4.5	5.1	-7.3	3.3
	SE	5.8	7.7	5.0	6.3	5.9	5.7	4.7	5.3	5.2	6.9
B Females	n	11	11	11	11	10	10	10	* 10	10	10
	\bar{x}	36.4	2.4	9.6	40.3	101.5	99.9	60.1	43.2	38.0	35.3
	SE	8.6	6.7	5.7	11.4	13.5	10.6	12.5	7.5	6.7	6.1

cont.....

Table 6. Continued

	d0	d1	d2	d3	d4	d5	d6	d7	d8	d9	d10
\bar{n}	11	11	11	11	11	10	10	10	10	10	10
\bar{x}	34.8	1.5	3.9	4.0	2.2	2.7	7.5	-8.8	1.3	-3.5	1.8
SE	8.7	5.6	5.8	5.8	4.2	6.0	5.6	5.4	4.4	5.3	4.2

B
Males

Flies of known age from A and B were tested for their reactions to meat, daily from d0 to d10, the same flies being tested each day.

\bar{n} = Number in the sample.

\bar{x} = Mean.

SE = Standard error.

* Marks date of first egg batch in the cage.

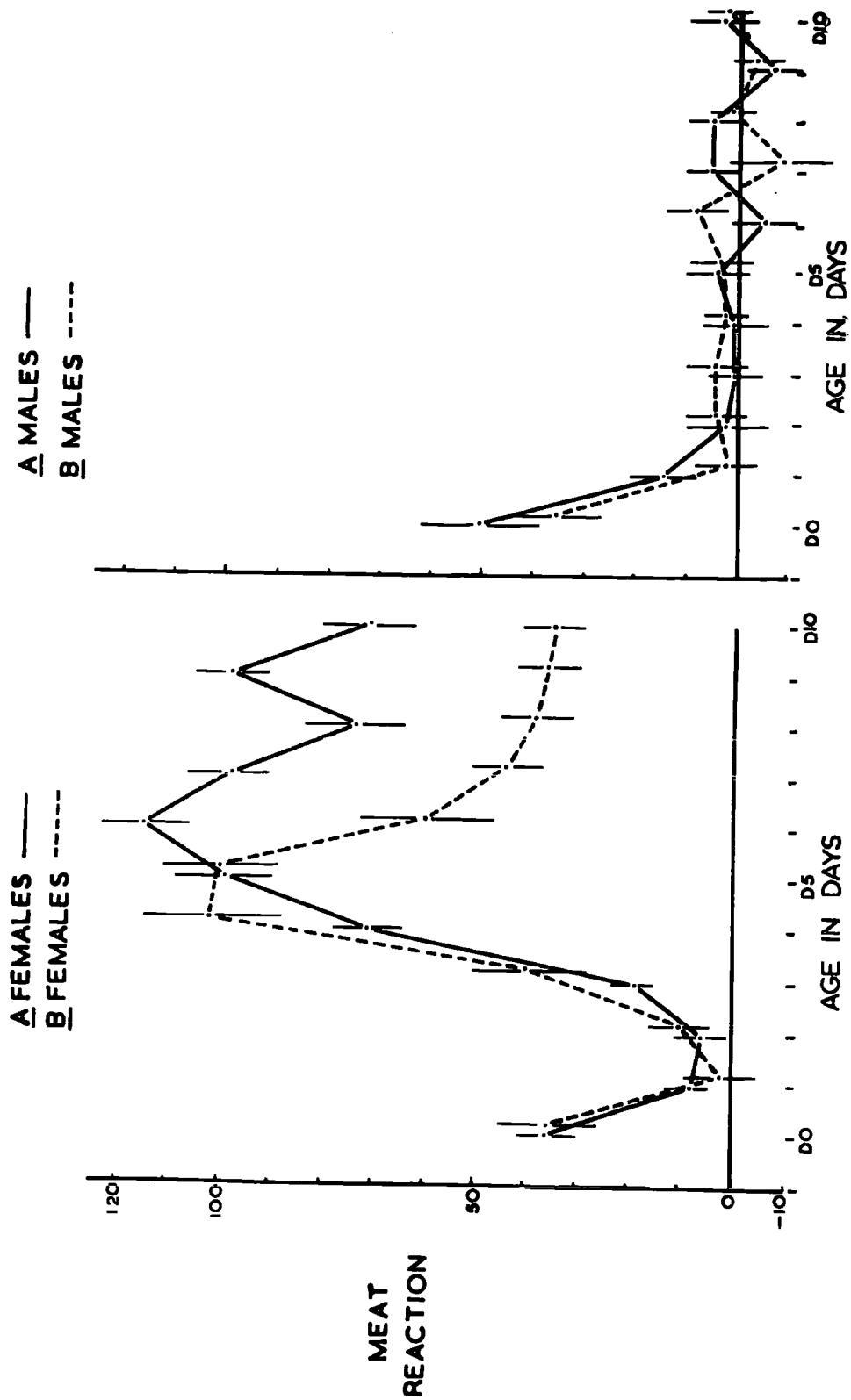

FIG.5 COMPARISON OF MEAT REACTIONS IN A AND B.

TEXT OVERLEAF

for B. There was not sufficient time for these tests to be repeated.

Observation of flies in the cages, suggesting that females were little attracted to meat at emergence but that this attraction increased, fitted the pattern given by the results obtained in the choice chamber.

It is interesting to note that Evans (1935) showed that the maximum development of the ovaries in Lucilia sericata occurred during a period corresponding to my d4 to d6; this is the time at which the reaction to meat in the choice chamber was at its maximum.

A point arising from the consideration of M is that the flies used had full access to meat in the cages during the period of the tests. If, as seems likely, the reaction to meat falls temporarily after a meat meal, the average M for the sample would be reduced by the reactions of those flies which had recently fed, especially during a period of active feeding. However, the fluctuations seen in the results obtained from marked A females were not excessive, suggesting that this effect, if it occurred at all, was not marked.

Restriction of access to meat in the cages was considered as a possible method of reducing this assumed effect, but such restriction was seen to introduce certain difficulties. Either the flies would be underfed, in which case the reactions measured would not be those of normal flies; or the flies would be fully fed, in which case the restriction would have been of no use. Because of these considerations, it was decided that there should be no restriction of access to meat for these flies in the cages.

The/

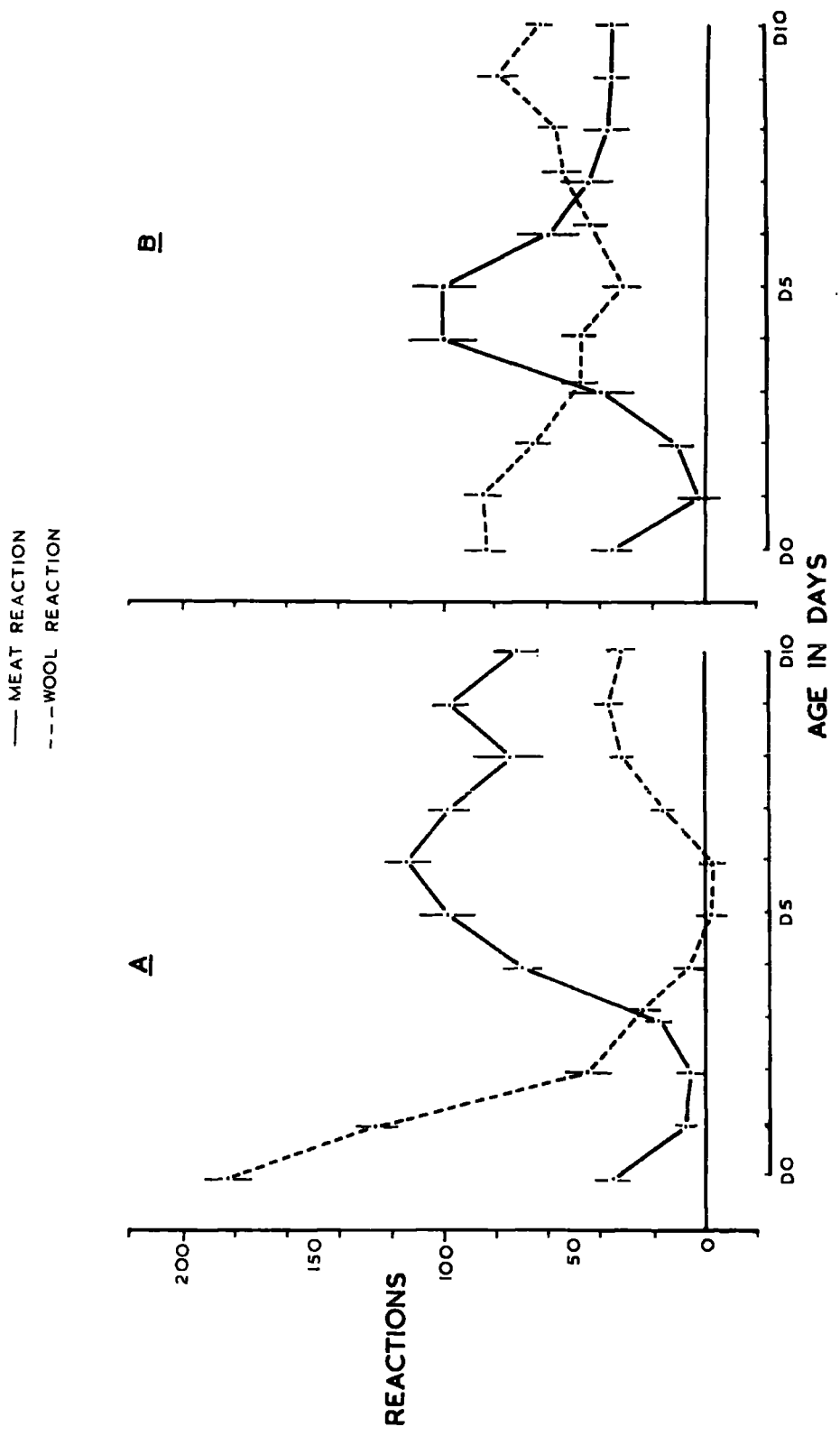

FIG. 6 COMPARISON OF MEAT AND WOOL REACTIONS IN A AND B FEMALES

TEXT OVERLEAF

The absolute levels of \underline{M} and \underline{W} cannot be compared, since there was no way of calibrating the two reactions one against the other. Changes in one can, however, be compared with changes in the other since this requires no absolute standard, and the periods during which these changes in reaction occurred can be compared. (See Fig.6.).

At emergence, \underline{M} was low while \underline{W} was high for both stocks; \underline{M} then rose while \underline{W} fell, the maximum for \underline{M} coinciding with the minimum for \underline{W} ; at the time of oviposition both \underline{M} and \underline{W} were positive, and this pattern was the same for both stocks. The rise in \underline{M} after emergence occurred at a time when the female would presumably be seeking the meat meals necessary for the maturation of the ovaries; coming as it did at a time when \underline{W} was falling, it suggested that the fall in \underline{W} was due to the need of the female at this time for meat rather than live sheep. Thus \underline{W} and \underline{M} would seem to be complementary and the two appear to be co-ordinated.

Effect of age on meat reactions of males.

For both stocks the males gave emergence reactions to meat very similar to the reactions shown by the respective females, and for both sets of males this reaction was quickly lost with no secondary rise. (See Table 6, Figs. 5 and 7). This was again in accordance with the behaviour of the flies observed in the cages, where the males of both stocks showed little interest in meat and were seldom to be seen near it. Also, it was shown by Mackerass (1933) that males of Lucilia sericata/

sericata and Lucilia cuprina needed no meat meals for maturation of the gonads, while Gurney and Woodhill (1926b) found that female Lucilia sericata far outnumbered the males in carrion baited traps in the field.

There can be little doubt that the meat reactions measured in the choice chamber gave reasonable estimates of the intensity with which the flies tested sought protein meals at different stages of their maturation.

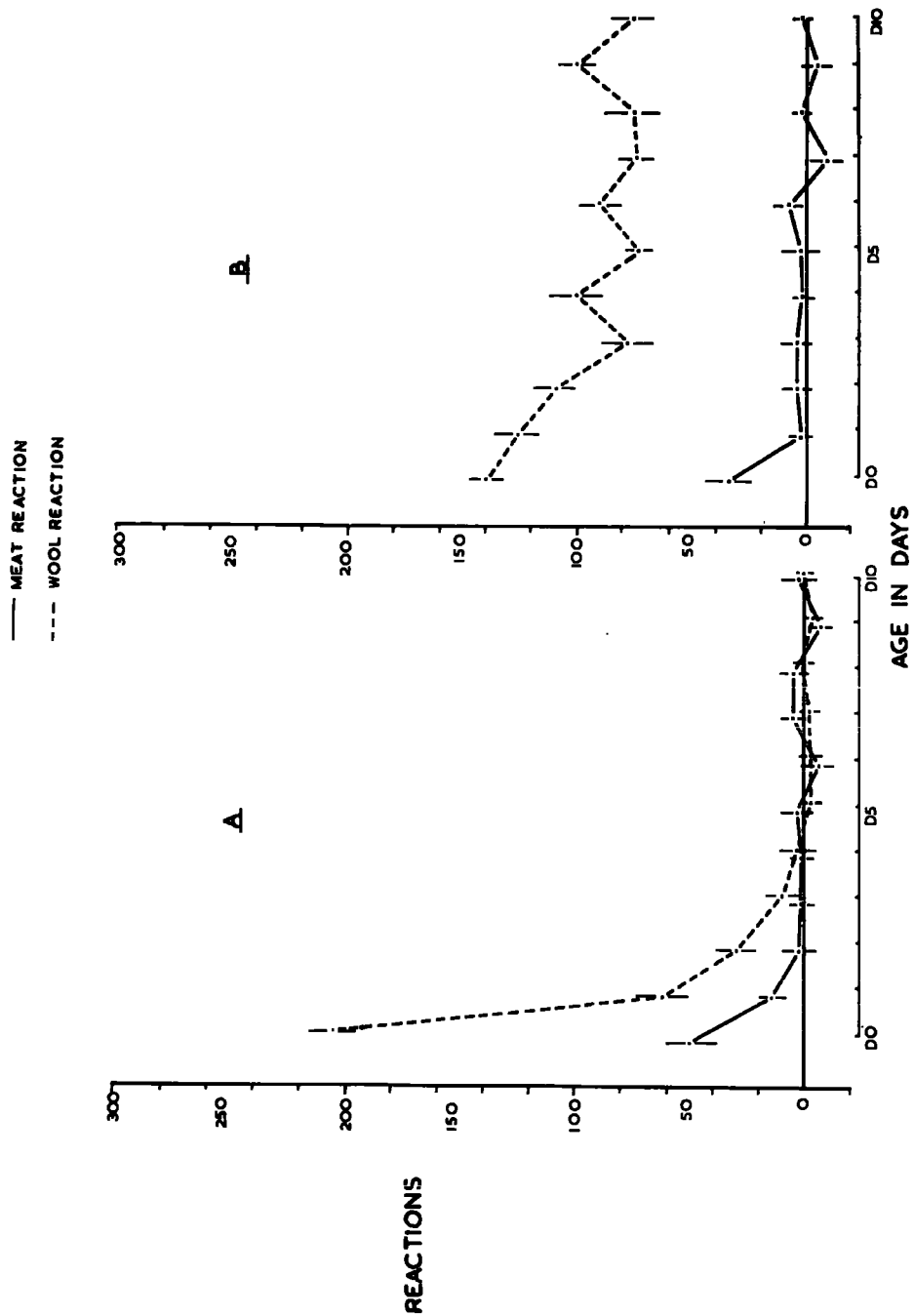

FIG. 7. COMPARISON OF MEAT AND WOOL REACTION FOR A AND B

MALES

TENT OVERLEAF

4. WOOL REACTIONS OF DANISH LUCILIA SERICATA

Myiasis is of very rare occurrence in Denmark, although Lucilia sericata is a common fly of wide distribution in that country. Previous studies by Cragg (1950b) and Cragg and Cole (1956) suggested that there were some small behaviour differences between British and Danish strains, and between stocks from Copenhagen and from Mols in Jutland. In view of my work on the wool reactions of this species, it was considered that these earlier studies on the Danish material should be repeated.

I collected Lucilia sericata from four sites in Denmark. The first site was in the grounds of the Statens Skadedyrlaboratorium in Springforbi, a suburb separated from Copenhagen by a considerable green belt. About 10 egg batches were collected from females taken here, and the feeding larvae brought back to England. The second site was in the garden of a house in the centre of Copenhagen, near the Botanical Gardens. Feeding larvae were again obtained from about 10 females and brought back to England. The third site was in the land of the Mols Laboratoriet, placed in farming country in which sheep were grazed, and four egg batches were brought back to England from females caught here. The fourth site was in a park in the centre of Aarhus, a large town about thirty miles from Mols. Gravid females were brought back to England, but no eggs were obtained from them and the stock died out.

The three stocks which were brought back successfully were kept in culture without any difficulty, and the tests described below were made on/

on them after two generations of laboratory culture.

The four collecting sites were chosen so that town and country stocks could be compared from the Mols and from the Copenhagen areas, and so that stocks from the two parts of the country could also be compared. The collecting sites in Mols and Copenhagen were the same as those from which Cragg obtained his material, so my results could be easily compared with those of Cragg. The loss of the Aarhus stock was not serious in that the main comparisons were still possible.

For each of my stocks, 10 marked males and 10 marked females were tested daily to determine the pattern of change of \underline{W} with age; 30 males and 30 females were also tested at $\underline{d0}$ and $\underline{d10}$ to give samples of 40 for the reactions at these ages, the study being completed within one generation. Thus adequate comparisons were available between all stocks both for the pattern of change of \underline{W} and for the emergence and maturity levels of this reaction.

The results showed no significant differences between the Danish stocks for \underline{W} , or between sexes. Thus the samples for the three have been combined into one large sample referred to below as 'D'.

For \underline{D} , the emergence reaction was about +130, followed by a fall to about 0 by $\underline{d4}$ with no secondary rise, and this pattern was the same for both sexes in the samples of 120 which were now available (see Table 7, Fig. 8).

The importance of these results now lies in the comparisons with \underline{A} and \underline{B} (see Figs. 9 and 10). Both sexes of \underline{D} had emergence reactions at/

at least very similar to those of B, while at d10 neither sex had any reaction to wool. Thus at d10, A females were intermediate between B and D females for wool reaction, while D and A males were alike in having no wool reaction but differed from B males.

Table 7. Change of wool reaction with age in combined stocks of D.

	d0	d1	d2	d3	d4	d5	d6	d7	d8	d9	d10
n	31	21	30	25	30	30	30	30	30	30	30
\bar{x}	132.8	66.9	43.4	19.6	6.4	1.0	-1.4	1.5	-1.3	1.3	-0.5
SE	4.8	8.3	4.9	3.3	2.7	2.6	2.7	2.3	2.7	2.6	2.6
n	32	21	30	25	30	30	30	30	30	30	30
\bar{x}	133.9	56.5	30.7	11.3	9.6	5.2	-0.1	-0.5	0.4	-1.7	-0.6
SE	5.1	10.2	5.3	3.1	3.3	2.7	3.0	2.3	2.6	2.2	3.2

The wool reactions of flies of known age were measured daily from d0 to d10, the same flies being tested each day.

n = Number in sample.

\bar{x} = Mean.

SE = Standard error.

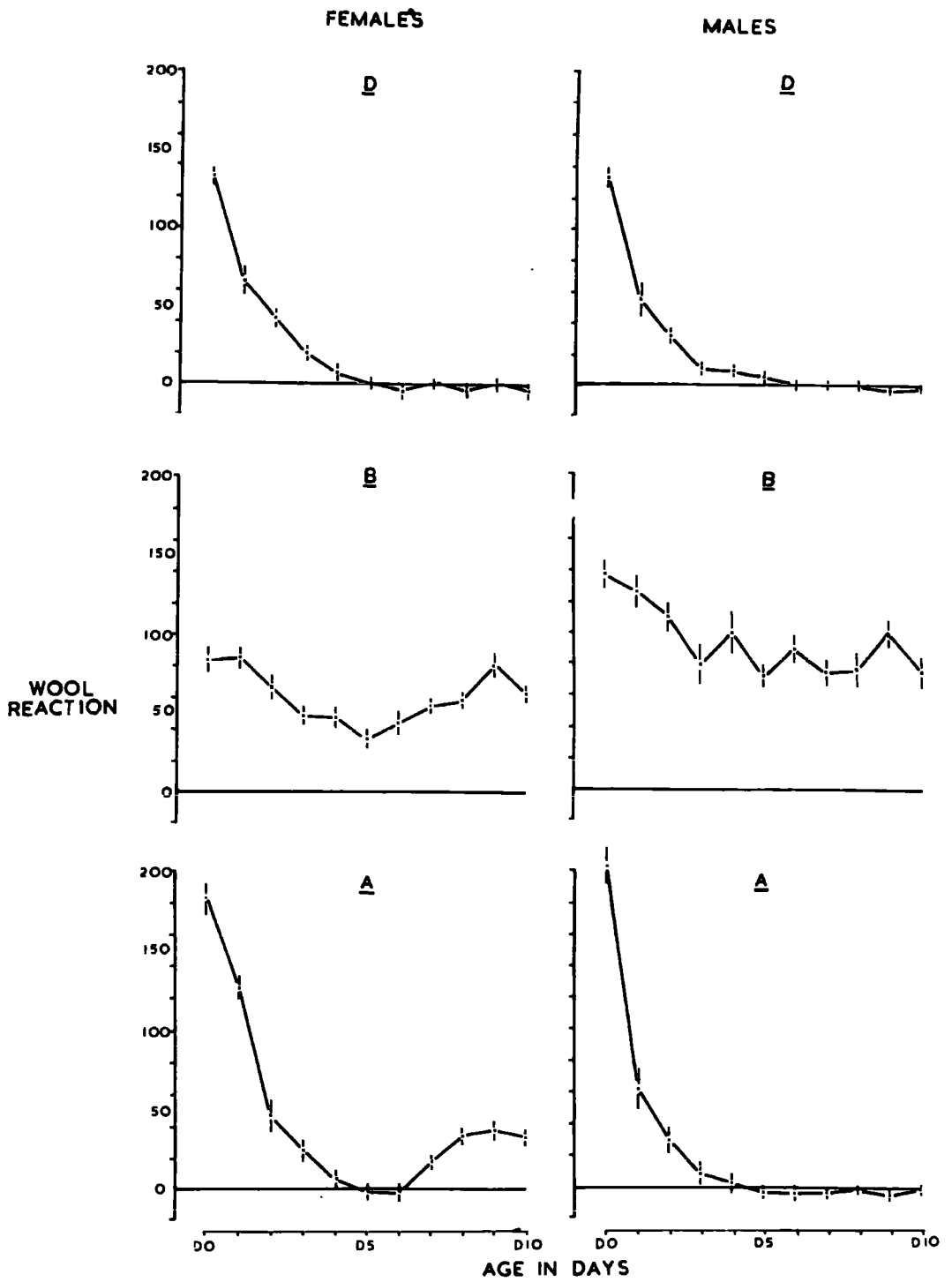

FIG. 8 COMPARISON OF WOOL REACTIONS OF A, B, AND D

TEXT OVERLEAF

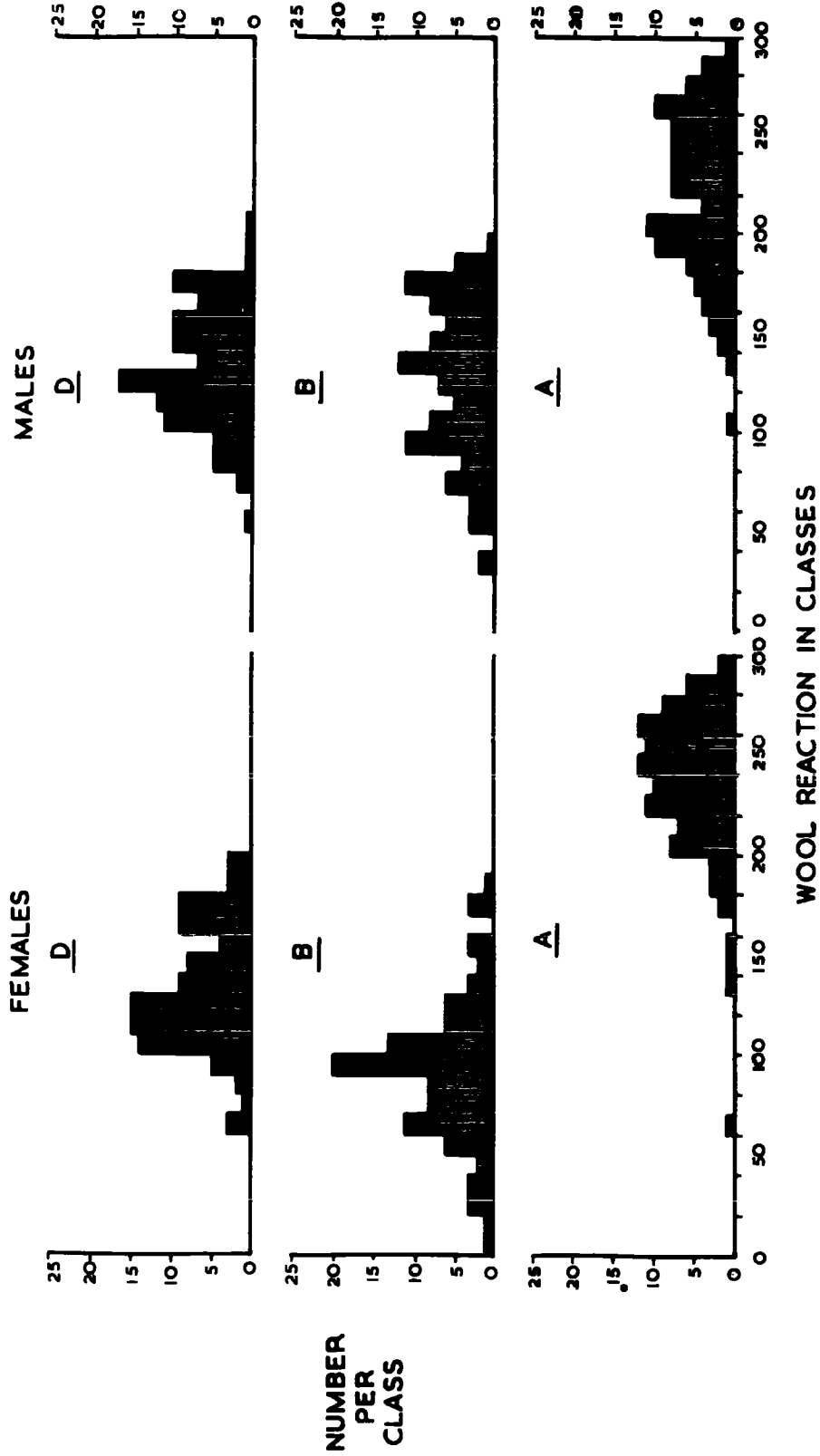
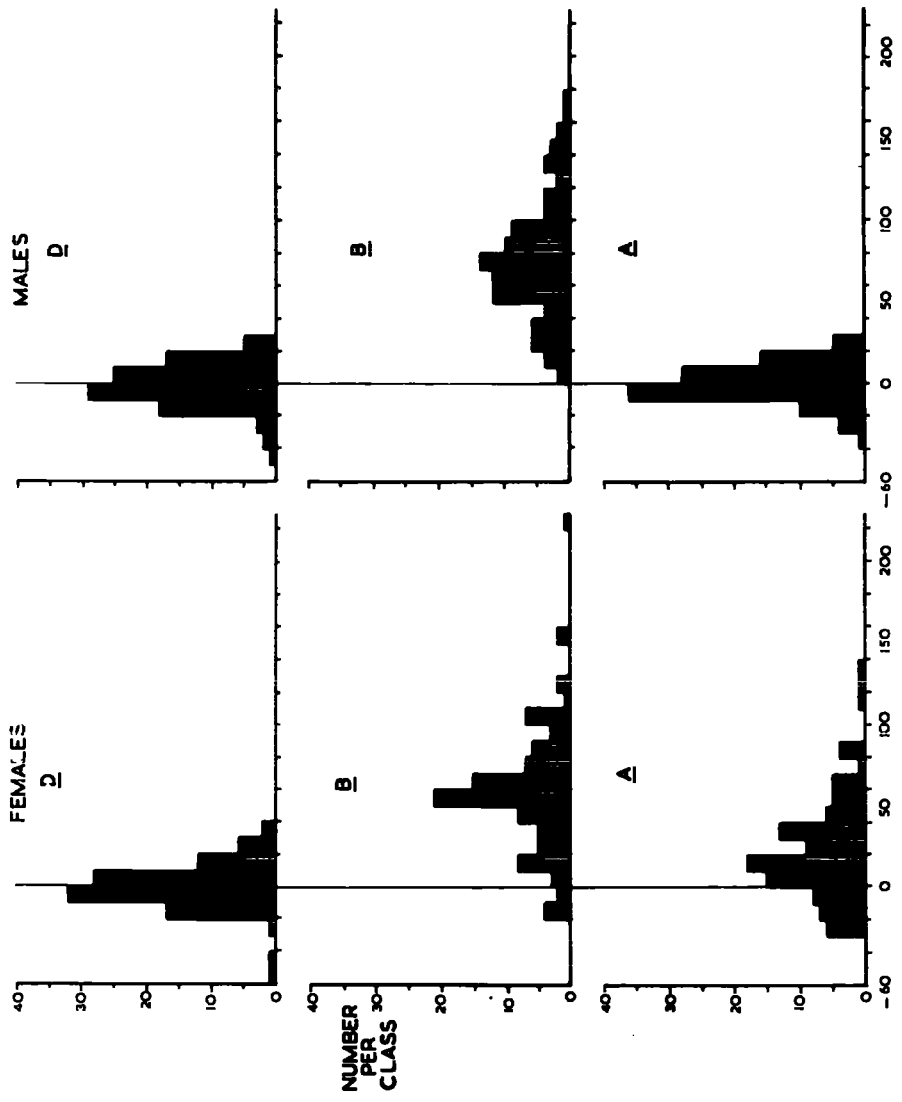

FIG.9. FREQUENCY DISTRIBUTION OF WOOL REACTIONS AT D_0 IN

A, B, AND D.



WOOL REACTION IN CLASSES
 FIG. 10 FREQUENCY DISTRIBUTION OF WOOL REACTION AT D IN
A, B, AND D.

5. PREENING IN THE CHOICE CHAMBER

As has been mentioned above, observation suggested differences between stocks in the frequency with which flies preened in the choice chamber, and the number of preenings was recorded for each fly tested for its olfactory reaction; this number is referred to below as 'P'.

Uninterrupted preening would presumably have affected the accuracy of the measurement, made at the same time, of the olfactory reaction, since preening appeared to take place without regard to the position of the fly in the olfactory gradient. So the fly was disturbed by a tap on the glass cover of the choice chamber as soon as it started to preen. Hence no record could be made of the duration of preening in flies which were being tested for olfactory reaction. This duration would clearly have varied considerably between individuals, since some flies which were allowed to preen without interruption for observation of this factor maintained the preening for several minutes, while others stopped almost immediately. Possibly a fly in which the motivation to preen was strong enough for this activity to be maintained for a long period would start preening again soon after the interruption. This would affect the total number of preenings counted, so this total was presumably influenced by the potential duration of preening.

Thus the simple count of the number of preenings probably included some influence of the duration as well as of the frequency of preening, and was an accurate measure of neither. Since P was counted for flies being tested primarily for an olfactory reaction, the technique could not/

not be modified to increase the accuracy of the measurement of P.

Immediately after emergence, flies spend a considerable amount of time in preening the legs and wings; since the d0 results were taken as soon after emergence as possible, and since the age at which this post emergence extra preening stops is very variable, the results from d0 could not be used for any comparative studies, and have not been kept.

The reasons for the occurrence of preening in the choice chamber are not known. Possibly disarrangement of the bristles caused the fly some discomfort, which was relieved by the smoothing action of preening. Thus preening cannot be related to any field behaviour; in that the conditions of test were kept constant, however, it was still valid to compare the stocks for this character, and to consider for a genetic analysis any differences recorded.

Daily tests, as for W, showed that P changed with age in all stocks, but in a nearly linear way (see Table 3, Fig. 11.). As there were no marked rises or falls in P with age, the accuracy of samples of flies tested for this character at any age would not be seriously reduced by small age differences within the sample. However, fluctuations and individual variation in results were still found, as was to be expected, especially in the results for marked flies.

Preening counts were taken for all the samples of 100 flies which were tested at d10 (see Fig. 12.). Comparison by variance analysis of the small samples, of which the large samples were composed, showed significant/

Table 8. Change in occurrence of preening with age in males and females A, B and D.

	d0	d1	d2	d3	d4	d5	d6	d7	d8	d9	d10
A Females	n	41	40	40	40	40	40	40	39	29	39
	\bar{x}	10.1	13.8	19.0	26.6	25.3	31.6	34.3	35.3	44.3	42.4
	SE	0.8	1.0	1.5	1.9	1.9	2.6	2.7	2.3	3.6	2.6
B Females	n	40	40	40	40	39	39	39	38	28	38
	\bar{x}	8.5	8.1	13.1	13.3	15.4	14.5	16.3	16.8	14.5	19.5
	SE	2.1	1.1	1.6	2.0	1.8	1.4	1.6	1.8	1.8	2.2
D Females	n	21	30	25	30	30	30	30	30	30	30
	\bar{x}	8.1	11.2	12.8	13.9	15.9	20.7	19.6	19.1	19.3	20.6
	SE	0.9	1.6	1.2	1.8	1.8	2.3	1.7	1.9	1.8	1.7
A Males	n	11	11	11	11	11	11	11	9	8	8
	\bar{x}	10.4	15.1	18.3	21.2	20.3	27.0	34.5	22.2	27.1	36.3
	SE	2.3	2.5	1.7	2.4	1.8	3.1	2.4	2.2	3.3	4.4

cont.....

Table 8. Continued.

	d0	d1	d2	d3	d4	d5	d6	d7	d8	d9	d10
B	-	10	10	10	10	9	9	9	8	8	8
Males	-	11.1	12.6	17.6	15.5	17.2	12.6	15.7	19.0	18.5	16.8
	-	2.8	2.2	5.7	5.1	4.5	2.2	5.5	4.1	4.1	4.2
D	-	21	30	25	30	30	30	30	30	30	30
Males	-	9.2	13.0	14.0	17.7	18.6	20.8	20.3	21.4	21.5	20.0
	-	0.5	1.4	0.9	1.5	1.4	2.0	1.3	2.7	2.7	1.8

The frequency of preening in a number of flies of both sexes of each stock has been determined daily from d1 to d10.

n = Number in the sample.

\bar{x} = Mean.

SE = Standard error.

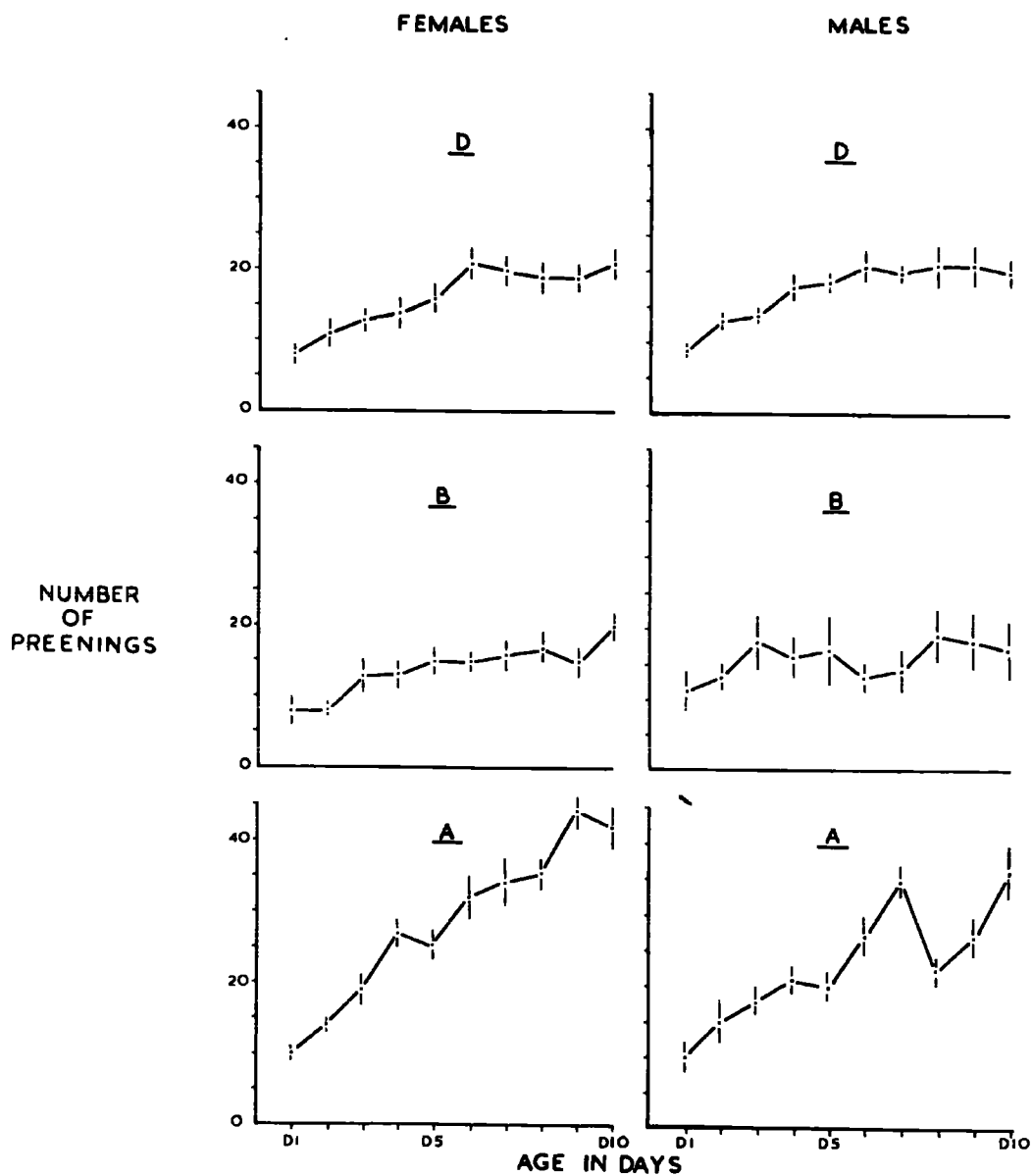

FIG. 11. CHANGE IN OCCURRENCE OF PREENINGS WITH AGE IN A, B, AND D.

THE RESULTS IN TABLE 8 HAVE BEEN PLOTTED AGAINST AGE.

significant differences in the cases of B females and D males, but not in any other case. Comparison of sexes within each stock by the 't' test showed sex differences only in A. Comparison of stocks by the 't' test showed that both sexes of A differed from those of B and D, but that B and D were similar.

D was made up of stocks taken from three different places in Denmark, and comparison of these three gave significant differences between the males but not between the females. Since the separate samples within each of the three Danish stocks were incompatible in each case for the males and in one case for the females, this difference between Danish stocks is highly suspect.

The study of preening was started to determine the suitability of this character for a genetic analysis of any differences between stocks. Although some differences were established, it was decided that these were not of sufficient size to be suitable for genetic analysis. Study of P has, however, provided some information which bears on the questions of sex differences within stocks, and changes within stocks between generations, both of which are considered in detail in a later section.

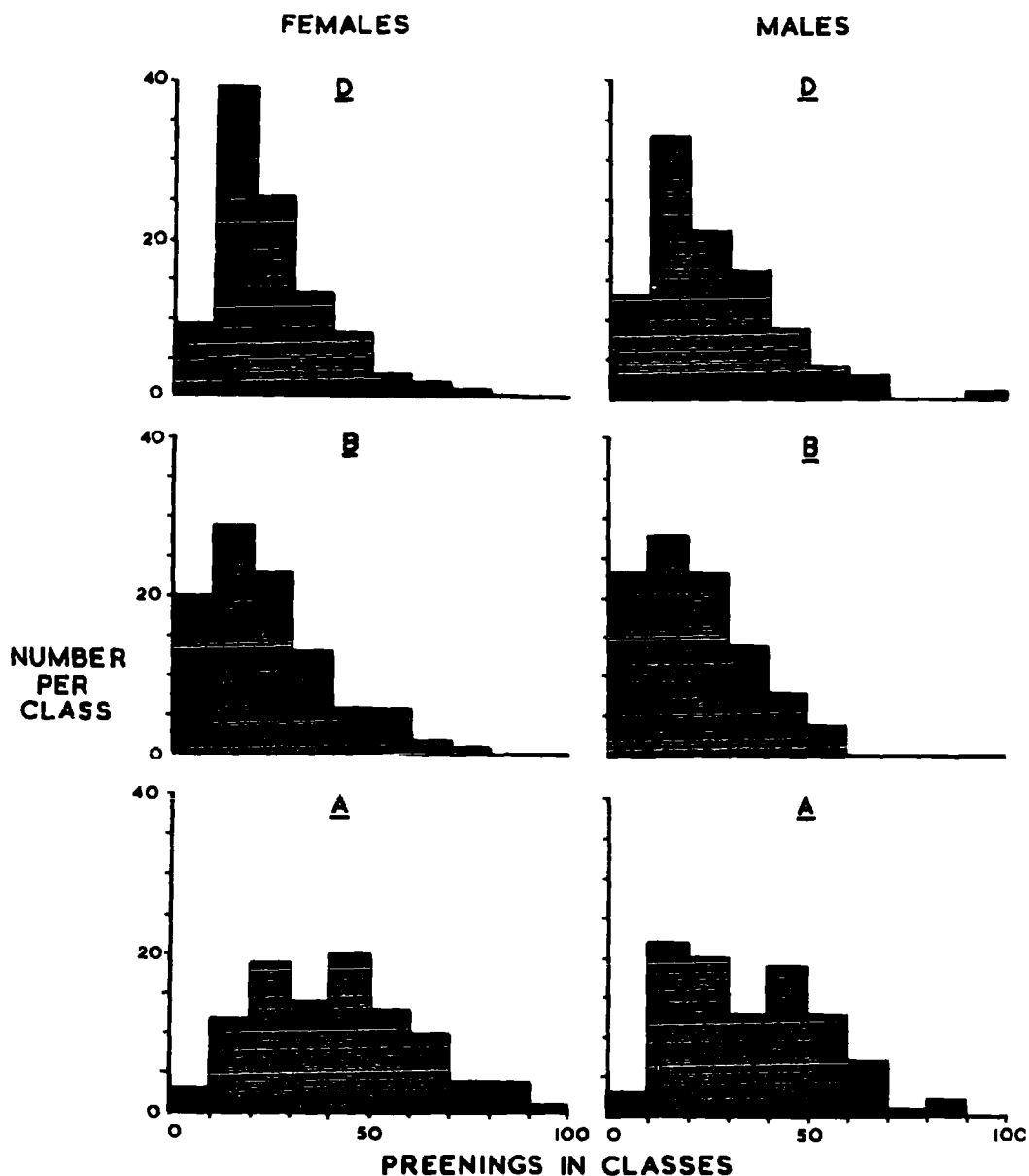

FIG.12 FREQUENCY DISTRIBUTION OF THE OCCURRENCE OF PREENING AT D₁₀ IN A, B, AND D

THE FREQUENCY OF PREENING AT d₁₀ HAS BEEN COUNTED FOR 100 MALES AND 100 FEMALES OF A, B AND D, AND THESE RESULTS PRESENTED AS HISTOGRAMS. THE MEAN AND STANDARD ERROR HAVE BEEN QUOTED FOR EACH SET.

6. FLIGHTS IN THE CHOICE CHAMBER

Observation suggested differences between the stocks examined in the frequency of flights made within the choice chamber, and the number of flights made has been recorded.

The reasons for the occurrence of these flights are not known. Some were almost certainly fright reactions; probably others were simply a means of getting about other than walking. Since the space for flight was limited, the duration of the flights was limited, but some differences between individuals was observed in such features as the angle of take-off. No record was made of such features however, the record being restricted to the frequency of flights.

The number of flights was affected by the number of preenings, in that the disturbance of preening always brought about at least one, and sometimes a number of flights. The only constant feature here was that the animal did fly after each disturbance; thus the best estimate of the number of 'intentional' flights came from subtracting the number of preenings from the total number of flights made during the testing period. The number obtained is referred to below as 'F'.

Daily tests, as with W and P, showed that the frequency of flights changed with age, but in a nearly linear way (see Table 9, Fig. 13.). Thus the accuracy of large samples is probably more similar to that of P than to that of W.

After emergence, normal flight is impossible until hardening is complete/

Table 9. Change in frequency of flights with age in males and females of A, B and D.

	d0	d1	d2	d3	d4	d5	d6	d7	d8	d9	d10
A Females	n	41	40	40	40	40	40	40	39	29	39
	\bar{x}	47.9	45.0	38.3	37.3	36.9	30.6	30.8	28.8	27.1	27.8
	SE	5.7	4.6	4.4	4.5	4.3	2.7	2.8	2.5	2.9	3.5
B Females	n	40	40	40	40	39	39	39	38	28	38
	\bar{x}	80.6	84.6	76.3	71.6	92.2	81.7	96.1	83.4	79.0	86.3
	SE	9.5	13.1	11.6	11.1	12.6	10.8	10.8	8.3	8.5	6.7
D Females	n	21	30	25	30	30	30	30	30	30	30
	\bar{x}	25.4	46.5	41.6	40.6	39.1	35.2	38.0	38.3	37.8	33.8
	SE	4.0	7.6	7.3	4.2	5.5	3.1	3.3	3.8	4.2	3.1
A Males	n	11	11	11	11	11	11	11	9	8	8
	\bar{x}	7.5	17.1	20.7	17.7	22.2	24.5	20.1	14.0	15.9	28.1
	SE	1.8	3.4	3.1	2.9	4.7	3.6	2.7	2.3	2.0	6.8
B Males	n	10	10	10	10	9	9	9	8	8	8
	\bar{x}	35.1	30.5	28.2	18.1	29.3	37.9	46.4	42.4	40.1	30.4
	SE	6.2	6.4	5.0	3.5	6.8	8.2	5.9	5.3	6.1	5.0
D Males	n	21	30	25	30	30	30	30	30	30	30
	\bar{x}	26.9	34.8	43.0	38.9	40.6	38.0	43.4	36.9	36.7	34.8
	SE	3.5	4.1	4.0	3.3	3.8	3.9	3.8	2.8	2.8	2.9

The frequency of flights in a number of flies of both sexes of each stock has been determined daily from d1 to d10.

n = Number in the sample. \bar{x} = Mean. SE = Standard error.

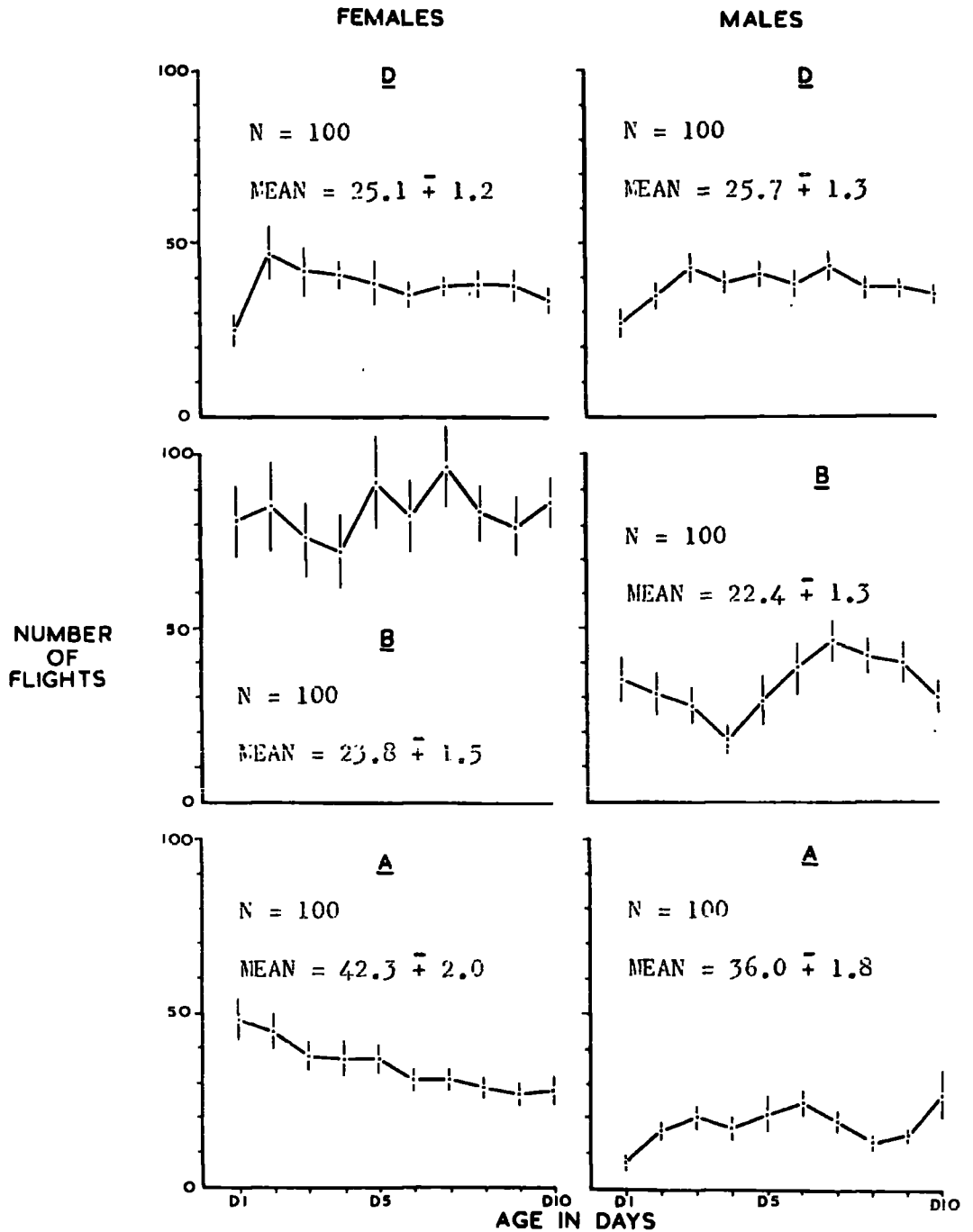

FIG.13 CHANGE IN OCCURRENCE OF FLIGHTS WITH AGE IN A, B, AND D

THE RESULTS IN TABLE 9 HAVE BEEN PLOTTED AGAINST AGE.

complete; for this reason the records taken for F at d0 have been disregarded, as for P.

F was recorded for the samples of 100 flies tested at d10 (see Fig. 14.). Comparison of the small samples within each large sample showed them to be compatible for each stock, and there were no differences between the three Danish stocks of different origins. Comparison of the sexes showed that only in B was there any significant sex difference. Comparison of stocks showed that A differed from B for both sexes, but that only the females of B and D differed, and then only by a small amount.

As with P, this study was started to establish the suitability of the character for a genetic analysis of any differences between stocks. Although some differences were established, these were not of sufficient size for a genetic analysis to be carried out. Study of F has, however, provided some information which bears on the questions of sex differences within stocks, and changes within stocks between generations, both of which are dealt with in detail in the sections devoted to these topics.

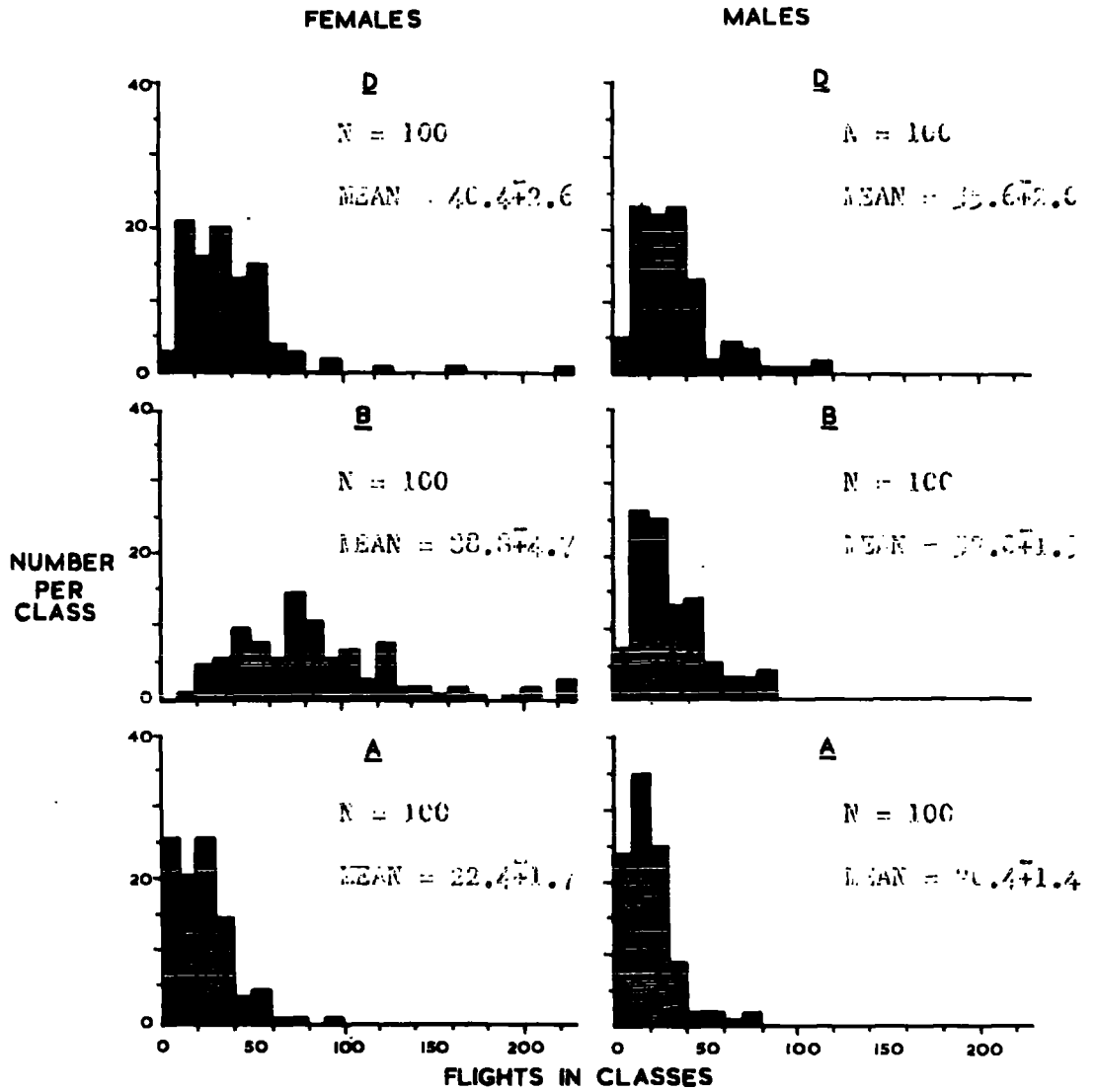

FIG.14 FREQUENCY DISTRIBUTION OF THE OCCURRENCE OF FLIGHTS IN A, B, AND D

THE FREQUENCY OF FLIGHTS AT 110 HAS BEEN COUNTED FOR 100 MALES AND 100 FEMALES OF A, B AND D, AND THESE RESULTS PRESENTED AS HISTOGRAMS. THE MEAN AND STANDARD ERROR HAVE BEEN QUOTED WITH EACH SET.

7. COMPARISON OF SEXES WITHIN THE STOCKS

Comparison of the two sexes within each stock by the 't' test show that, for the early samples of A and B, there were significant differences between the sexes for W at d0 and d10. Since the mature wool reaction of the females is thought to be concerned with oviposition, a sex difference in this character might be expected. For both A and B, however, the mean difference between sexes for W at d0 was very small, and there was no sex difference in D for this character.

A second large sample from the same population of A, taken a number of generations later, showed no differences between sexes for W at d0. Samples of 100 males and 100 females were later taken from a separate, inbred, stock of B, and there was no difference between sexes for W at d0. This evidence casts doubts on the validity of the sex differences in the early samples of A and B for W at d0.

Sex differences were also shown by the comparison of sexes for P at d10 in A, and F at d10 in B.

For D, the two sexes were sampled during the same generations. For the early samples of A and B however, the females were sampled before the males, a number of generations elapsing between the two sets of samples for each stock. A females were tested from November 1957 to October 1958. A males were tested from August 1958 to October 1958. B females were tested from November 1957 to October 1958. B males were tested from October 1958 to December 1958.

Thus/

Thus the sex differences apparent within the stocks could be due to:-

1. Real, inherent sex differences within the stocks.
2. Changes in my methods during the time which elapsed between the tests for the females and those for the males, particularly in the extent to which the age of the flies tested was controlled.
3. Changes within the stocks during the time which elapsed between the tests for the females and those for the males.

The second possibility is a probable explanation of the sex differences in A and B for W at d0; the samples for females at this age in both stocks were taken early in this work, while the samples for the males were taken later, at a time when the effects of age on W were more clearly understood, and when greater care was being taken to control the age of flies tested for the emergence reaction. The third possibility might provide the best explanation for the differences between sexes in P and F.

Conclusions based on the results for one stock cannot immediately be accepted as relevant to consideration of another stock. However, it does seem reasonable on the data available to conclude:-

1. That sex differences for W at d10 are real and inherent in A and B.
2. That the apparent sex differences for W at d0 were due to changes in the control of the age of the flies during the time which elapsed between the tests for the females and those for the males, or to changes in the stock during this time, or to some combination of these/

these two factors.

3. That the apparent sex difference for P in A and for F in B might be due to some change within the stocks.

8. CONSIDERATION OF POSSIBLE CHANGES WITHIN THE LABORATORY STOCKS USED

The results obtained for the early large samples of both sexes in A and B, in each case 10 or 11 small samples totalling one hundred individuals, have been examined for indications of change within the stocks over the periods for which the stocks were sampled. These stocks were sampled at different intervals during this time, and the small samples were taken in groups of varying size.

The periods over which the large samples were built up, and the number of separate months in which the small samples were taken, are listed below.

<u>Stock</u>	<u>Age</u>	<u>No. of months sampled.</u>	<u>Period over which samples taken</u>
A ♀	D0	4	4 months
A ♀	D10	5	12 months
B ♀	D0	3	3 months
B ♀	D10	5	12 months
A ♂	D0	3	3 months
A ♂	D10	2	2 months
B ♂	D0	2	2 months
B ♂	D10	3	3 months

The dates at which the samples were taken were recorded in every case, but not the number of generations over which the stocks had been recorded.

Under/

Under the culturing conditions which applied to this work, a generation took approximately one month to complete; for the present analysis, the generations are assumed to correspond to calendar months. While this is not completely accurate, it is the best estimate which can be obtained from the available data. The distribution of the sample dates is not optimum for evaluation of changes between generations, but they were not arranged with this in mind.

The results available have been plotted against the calculated number of generations involved. (See Fig. 15). For W at d0, all graphs except those for B males suggest an upward trend. The figures for W in A females at d10 suggest a downward trend, while the others suggest an increase. No trends are suggested by the graphs of P and F, except a possible downward trend in F for B females.

An analysis of variance was carried out on the large samples to check the significance of the differences between the component small samples, each sample being treated separately so that "within-sample" variance was compared with "between-sample" variance. (See Table 10). The results show that only for W and P at d10 in B females are these differences significant. This suggests either that there was no real change between generations, or that the "between-sample" variance, due to any change which might have occurred, was masked by the "within-sample" variance, this being due to the inherent variability of the material and the inaccuracy of the method, discussed in detail in a later section on variation. For W at d10 in B females the reaction changed markedly at about the time of oviposition; any difference between samples in what might be/

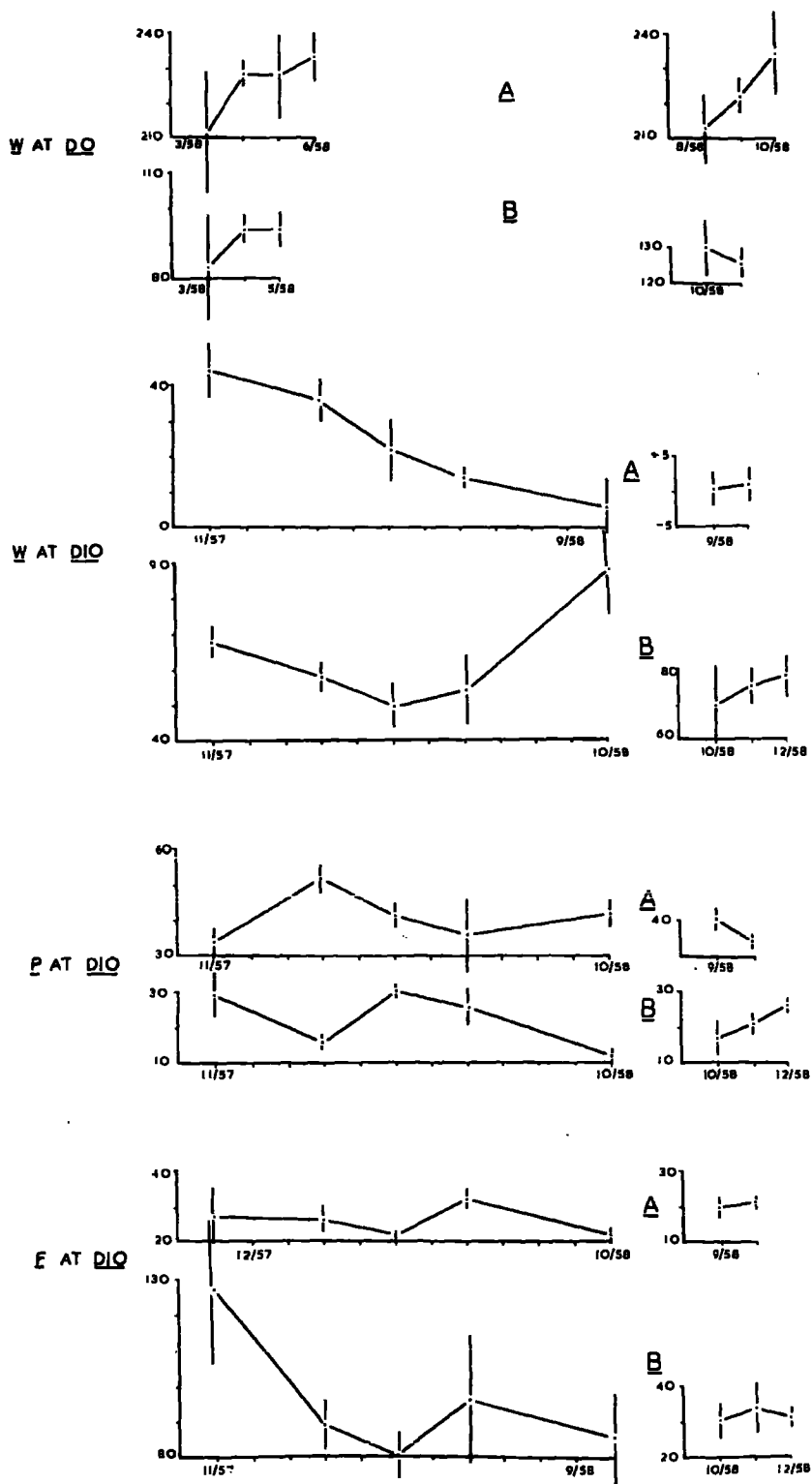

FIG.15 POSSIBLE CHANGES IN THE REACTIONS OF A AND B DURING LABORATORY CULTURE

TEXT OVERLEAF

Table 10. Variance analysis by sample and by estimated generation of the reactions of males and females of A and B.

Stock	Character	i				ii	
		Variable degrees of freedom		Fixed degrees of freedom		F by sample	F by generation
		F by sample	F by generation	F by sample	F by generation		
A ♀♀	W at d0	0.75	99	1.01	3	<1.35	<1.35
	W at d10	1.8	99	*3.9	4	1.5	2.5
	P at d10	1.7	99	1.9	4	1.5	1.5
	F at d10	1.6	99	0.5	4	1.5	<1.35
B ♀♀	W at d0	0.4	99	1.9	2	<1.35	1.5
	W at d10	*2.4	99	2.3	4	2.35	1.7
	P at d10	*3.6	99	*4.5	4	3.05	3.0
	F at d10	1.0	99	2.2	4	<1.35	1.65
A ♂♂	W at d0	1.2	99	0.9	2	<1.35	<1.35
	W at d10	0.1	99	0.2	1	<1.35	<1.35
	P at d10	0.9	99	2.2	1	<1.35	1.5
	F at d10	0.8	99	0.1	1	<1.35	<1.35
B ♂♂	W at d0	0.2	99	0.1	1	<1.35	<1.35
	W at d10	0.1	99	0.1	2	<1.35	<1.35
	P at d10	0.2	99	2.7	2	<1.35	1.65
	F at d10	0.4	99	0.3	2	<1.35	<1.35

The results of this analysis have been listed; the degrees of freedom are quoted with the "between sample or generation" degrees of freedom above the "within sample or generation" degrees of freedom. Total of 100 in each full set. i. Actual degrees of freedom quoted. ii. Variance ratio adjusted to fit arbitrarily chosen "between sample or generation" degrees of freedom = 12, and "within sample or generation" degrees of freedom = 120.

be termed the 'average maturity' of the females would give rise to a high "between-sample" variance. This might explain the incompatibility of the component samples for this character, but the same argument does not apply to P.

The same material was then re-analysed by the same analysis of variance method, the data being grouped by generations instead of by samples (See Table 10.). The results of this analysis show that the component generations differed significantly for W at d10 in A females, and for P at d10 in B females; W at d10 for B females showed no significant difference on this analysis.

For a closer comparison of the two analyses, it was necessary to equate the degrees of freedom throughout the analyses before the variance ratio could be compared, since the significance of any given variance ratio depends on the appropriate degrees of freedom; conversely, the value of this ratio appropriate for any level of significance depends on the degrees of freedom. So all values of the variance ratio were scaled to a "greater variance estimate" degrees of freedom of 12, and a "lesser variance estimate" degrees of freedom of 120. When this was done, it was found that the variance ratio for the analysis by generation was greater than that for the analysis by sample in 5 cases, smaller in 3 cases, and the same in 8 cases.

Thus, this analysis did not establish any significant change between generations for all characters taken together. Nor has it been possible clearly/

clearly to show any significant change in any single character. However, the graphical representation of the data is suggestive in some cases of change between generation, so the possibility of such change cannot be dismissed entirely. The only verdict possible on this evidence alone is one of 'not proven'. Because of the inaccuracy of the method, it is possible that any changes which might have occurred have been masked by the errors inherent in the methods used to measure the characters. However, it is clear that no major changes, in fact no measurable changes, did occur.

The significance of the sex differences apparent in the original samples taken for A and B has already been discussed in detail. For these stocks, the two sexes were not sampled concurrently. The conclusion reached was that the sex differences apparent in both stocks, except for the mature wool reactions, were probably due either to changes in the stocks during the period between the time of testing the females and the later time of testing the males, or to changes in the degree of control of the age of the flies tested during this time, or to some combination of these two factors. The most likely explanation of these differences is an increase in the control of the age of the flies tested, particularly for the emergence wool reaction, and there is no reason to postulate real changes in the stocks.

A second series of tests was made for the same stock of A after a considerable time had elapsed from the first series, and these two series have been compared. Unfortunately, the only character studied in the second series was W at d0, so only this character is available for/

for comparison. The females of the two samples were alike, but the males differed; for this character there was a sex difference in the earlier samples but not in the later ones. The two sexes of the later samples were both similar to the sex which was tested earlier in the early samples. This would be difficult to explain in terms of changes within the stocks.

Hence the evidence, while not entirely conclusive, does not support the suggestion of major changes in the stocks under the conditions of culture used in this work. If any changes occurred at all, they were certainly minor, and would presumably have arisen due to selection imposed accidentally in the cultures. Since these changes were either non-existent, or at least too small to be measured adequately, there is little point in considering possible selective pressures here. However, it would be very interesting to impose selection deliberately on these characters and to study them over a number of generations in a controlled experiment.

9. CONCLUSIONS TO STUDIES OF BEHAVIOUR

The conclusions reached from this study of behaviour are in two parts; first, a consideration of the value of the characters studied as the basis of a genetic analysis, and this will be dealt with in introducing the genetical section: second, the inferences which can be drawn, from the results obtained in the present work, on the field behaviour and ecology of the flies. It is this second part which will be dealt with here.

This work was entirely a laboratory study of behaviour, and there are obvious dangers in relating laboratory studies to field behaviour, but the former are commonly undertaken in order to throw light on the latter.

The possibility of change in the characters studied during the period of laboratory culture has been considered in detail already. Such changes, if they occurred at all, were too small to be shown clearly by statistical analysis, nor was there any change in the pattern of ageing of these reactions. It can be concluded that these reactions were maintained with little or no change over a considerable number of generations of laboratory culture for A and B, when the flies had no access to sheep or to any field conditions. Any minor changes which might have occurred could have had no effect other than to increase slightly the variance of the large samples taken over a number of generations.

Cragg/

Cragg and Cole (1956) showed that larval conditioning had no significant effect on the mature wool reactions of British females. It has also been shown in the present work that the wool reaction characters of A and B were under some measure of genetic control; this is dealt with in detail in the section on genetic studies. These reactions, then, were innate, maintained under the conditions of laboratory culture, resistant to conditioning, and under some genetic control.

It must be concluded that the laboratory behaviour which was studied reflected the normal field behaviour to some extent at least, which would seem to justify cautious argument from laboratory results to field behaviour.

The first of the difficulties in this procedure is that it is necessary to assume that the flies tested were typical of the populations of their respective countries. The only alternative to this assumption would have been to test a number of stocks from each country, and this was not possible in the time available for the present work. It is relevant, but by no means conclusive, that no differences were found between stocks from different parts of Denmark, while Cragg and Cole found no difference between flies from London and those from parts of the country in which sheep are normally kept.

The next difficulty is that there are reasons, discussed in detail in the section on genetic studies, to doubt the accuracy of the methods used in this work. However, since there is no reason to assume that these/

these inaccuracies differed for the different stocks of flies tested, they would presumably tend to decrease the statistical significance of a real difference between stocks by increasing the variance, rather than to show spurious differences. Thus the results obtained are still valid for comparison of the stocks; they are also the best estimates available.

The reasons for the occurrence of flights and preenings in the choice chamber are not known, as has been discussed in detail above. It is at least possible that the frequencies registered for these reactions were the results of responses to a number of stimuli, and these parts of the work are of little value as studies of behaviour per se. It would clearly be most unwise to try to relate P and F to field behaviour.

The consideration of the field behaviour of the flies, as deductions from the present work, will therefore be confined to the olfactory reactions. For these, there would seem to be no reason why the laboratory reactions measured should not be considered in relation to the fly in the field. It must be remembered however that field behaviour is in response to a simultaneous complex of stimuli, while the laboratory studies were of the reactions to single stimuli.

In both sexes of all the stocks tested, the wool reaction decreased from the emergence level. In the females of both A and B, W then rose to a secondary peak. The significance of the wool reaction must clearly be considered in three parts; first, the emergence reaction, second the fall from this level, and third the mature reaction.

The/

The reason for the high emergence reaction is difficult to see. Certainly it does not enable females to oviposit on sheep since they are not ready to lay at this stage. A possible explanation is that this reaction, common to both sexes in all stocks, has a gathering effect on the fly population, bringing the sexes together and facilitating mating. The difficulty with this explanation is that the reaction is so short lived, except in B males. A concentration of flies near sheep due to the wool reaction would hardly facilitate mating unless the flies were ready to mate during the period of the short lived reaction to wool.

Professor Cragg and Dr. Cole have told me that, from their observations, mating could occur in the culture cages during the first few hours after emergence. My observations did not agree; I saw no mating within the first three days, but my study of this behaviour was not extensive. Barton Brown (1958) showed that few, if any, females of Lucilia cuprina were prepared to mate under laboratory conditions until the ovaries had developed considerably; they seldom accepted males within the first three days after emergence, although the males might have been prepared to mate sooner. The work of Johnston and Tieggs (1922) suggested that males of Lucilia sericata were sexually mature soon after emergence, while the females took two to four days to mature. M.J. Mackerass (1935) showed that males of Lucilia sericata and Lucilia cuprina had some active sperms in the testes within twelve hours of emergence, and that these increased markedly in number over the next two days; this suggests that males might be more ready to mate after two or three days than immediately after emergence.

The/

The evidence on the time at which mating occurs is clearly not conclusive; there is very little relevant evidence available. It would be interesting to repeat on Lucilia sericata the work of Barton Brown, extending it to determine the times at which the two sexes were prepared to mate, and determining the effect of a meatless diet on the time of mating of the females. On balance, the evidence now available suggests that mating is more likely to occur when the females, and probably the males also, are at least two to three days old.

By this age, the emergence reaction to wool was largely lost in the stocks which I studied, and it is difficult to see a connection between this reaction and mating, except possibly in the case of B. Here the males retained the reaction, with only a slight decrease, throughout the period of test. Possibly the females visiting sheep, due to the earlier or the later reaction to wool, might be fertilised in the vicinity of sheep by the males which, if W is interpreted as a reaction attracting flies to sheep, would be held there. Thus the connection between the early wool reaction and mating does seem possible in B.

Professor Cragg suggested to me that the presence of flies attracts other flies to the same place. Dethier (1955) showed that the sugar bait in traps for Muscid flies was made attractive by the action of flies on the sugar, producing an attractive volatile brew. If the presence of flies on or near sheep increased that attraction of the sheep for other flies, then the gathering effect of the wool reaction would be enhanced. This might also prolong the stay in that area of any/

any flies which had visited the sheep initially because of a transient reaction to the sheep itself. But there is no indication that the reaction of individual Lucilia sericata to other members of the species would be strong enough to hold near sheep a population of flies unless the majority of these flies were also attracted to the sheep. It would be of considerable interest in this context to know the extent to which there is a population of flies held in the vicinity of sheep in the field, and how much this concentration is due to the wool reaction and how much to the presence of other flies. A study of marked, laboratory reared flies released into the field might give some of this information, since this technique might make it possible to determine not only the population of flies near the sheep, but also the age structure of that population.

The emergence reaction, if it takes flies to the vicinity of sheep, could be of value to the flies in some way other than by the facilitation of mating. Where mammals are present, water is usually available in some form; for example the water supply of the sheep, or their urine or faeces or sweat might serve as a source of water to the blowflies. Possibly the flies need water soon after emergence, and the response to the presence of sheep might increase the chance of their finding a water supply. This would be more important in a drier country like Australia than in the wetter Britain and Denmark, which could explain the greater emergence reaction of A. In this context it would be of interest to know whether the flies find food or water on or near sheep, and this information might be made available by field studies. A comparative study/

study of the laboratory humidity reactions of the flies would also be interesting.

It would also be interesting to know the water requirements of the flies at different ages, and the pattern of change of their humidity reactions. Evans (1935) suggested that the increase in weight of flies soon after emergence in the laboratory was due largely to the uptake of sugar; his work also suggested that water was taken in soon after emergence, since flies which had access only to water lost weight more slowly than flies which had neither sugar nor water available.

If sheep are attractive at this stage because their presence signifies that water is available, then the presence of other animals such as cows would be just as valuable to the flies. It would be interesting to know if the flies react to substances such as cattle hides, and to know the pattern of change of such reactions with age. It is possible that the emergence reaction, and perhaps other parts of the wool reaction pattern, has different field meanings for the different stocks. It would clearly be of considerable value to know what substance, or substances, present in the sheep fleece are responsible for the wool reactions. The reactions to fleece might be highly specific, or they might be evoked by a range of substances present on animals other than sheep.

The second feature of the wool reaction was the drop from the emergence level of this reaction, found in both sexes of all stocks. It will be convenient to consider the sexes separately for this part of the pattern.

It/

It is known that female blowflies require protein meals before the ovaries can mature, and this protein is usually obtained in the field from carrion. The only known exception to this is found in the strain of Lucilia cuprina studied by Nicholson (1957); this strain, after a number of generations of strict selection for completion of the life cycle with the minimum amount of meat available to the adult, was able to mature and oviposit on a diet of sugar and water alone.

The present work has shown that, in A and B females, the laboratory reaction to meat rose from a low emergence level to a peak at the time when the ovaries were maturing; the rise in M coincided with the fall in W. It would be a disadvantage to the female in the field to be strongly attracted to live sheep when the need was for meat meals available on carrion. The reactions to meat and to fleece were clearly co-ordinated. The fact that the secondary rise in W was not seen when the ovaries were unable to mature due to lack of meat in the diet strongly supports this hypothesis. The latter evidence also suggests that the control of the two reactions was by way of the ovaries. It is possible however, that the ovaries controlled one reaction directly, and that this reaction then controlled the other by inhibition. Webber (1955) showed that virgin females of Lucilia cuprina produced and matured eggs in the ovaries, but very seldom laid them. It would be interesting to know the effect of fertilisation on W and on M, since oviposition affects W, and fertilisation probably affects oviposition in Lucilia sericata.

There is little doubt that, if the emergence reaction takes females to the vicinity of live sheep, it subsequently becomes necessary for them to/

to search for carrion. In this case, the search for carrion would be likely to start from the vicinity of live sheep, and the possibility of dead sheep being near might make this an advantage. Again, if carrion other than dead sheep is distributed randomly, eggs are more likely to be laid near sheep if the females start their search for this carrion from the vicinity of sheep. Thus the emergence reaction might still be effective in keeping the population near sheep. It would be interesting to know if the females can mature their ovaries on protein found on live sheep, for example from wounds. More information on the reactions of the flies to meat, and on the sources of protein for the females in the field, would clearly be valuable.

The males of A and D lost their reactions to wool within a few days of emergence; in B males, this reaction decreased, but only slowly, and a high level was still maintained at d10. If it is of some advantage for the males to be attracted to sheep at emergence, then some reason must be sought for the loss of this reaction. It is known that males of Lucilia sericata can mature on a diet of sugar and water without meat, and meat in the diet has little effect on their longevity. It hardly seems likely in the males that W is lost to facilitate feeding on carrion. However, I have seen males feeding on meat in the laboratory and on carrion in the field, so they may sometimes take protein meals, but the males of A quickly lost even their small emergence reaction to meat in the choice chamber. Possibly newly emerged flies have a generally heightened reaction to olfactory stimuli, and the transient emergence reactions shown by the present work may reflect this rather than specific reactions/

reactions to the stimuli considered.

The possibility that the emergence reaction to wool is of some value in facilitating mating has been considered above, and seems reasonable only in B because of the transient nature of the emergence reactions of A and D males. For these two the possibility that this early reaction is connected with the need for water would seem more reasonable. It is the rapid loss of the reaction in A and D males which makes the reaction difficult to explain; it is easier to see a reason for the maintained reaction in B. It is possible that the reactions to the same stimulus could have different field bases in the different stocks.

The third feature of the wool reaction pattern is the rise to a secondary peak. This was not found in any of the males, so only the females need be considered here.

It has been shown that the secondary rise in W was governed, directly or indirectly, by the condition of the ovaries, and that the secondary peak, found in A and B females, occurred at least very close to the time of oviposition. The differences between the three stocks were considerable, with the mature reaction of B females being high, that of A being low, and that of D being zero. The most likely field explanation of this is that the mature reaction of the females reflects the extent to which the mature females seek sheep, and indicates the propensity of the flies for oviposition on living sheep. It is this part of the wool reaction pattern which is most clearly linked with myiasis, and there is no real suggestion here of the reactions to the same stimulus being due to/

to different field reasons.

It was suggested earlier that the reactions to meat and to fleece are co-ordinated, and that one might inhibit the other. This was supported by the finding that the means of M for 20 females of A and 10 of B fell a little as the time of oviposition approached, this being a time when W was rising for both sets of females.

For both A and B the mature females clearly reacted to both meat and fleece. No method was available for comparison of the absolute sizes of the two different reactions, so it was not possible to decide which was the stronger reaction at maturity. However, A had a higher meat reaction than B, and a lower wool reaction. It seems likely that gravid females of A are more attracted to carrion as an oviposition site than are B females, while B females are more attracted to live sheep for oviposition than A.

Having reached these tentative conclusions about the field significance of the laboratory reactions studied, it is now possible to consider the extent to which this work explains the relative importance of these three species in the field as initiators of myiasis.

In terms of their importance in initiating sheep strike, these three strains of Lucilia sericata can be ranked B, A, D. British flies frequently cause sheep strike, or did before the discovery of insect control by means of insecticides; Australian strains are not the common initiators of myiasis, although they are secondary parasites after the strike has been initiated by Lucilia cuprina; myiasis is, and has been, of very rare occurrence in Denmark, although the species is common in districts/

districts in which sheep are kept. Thus, in this respect, A and D are quite similar, while B are different. The work by Cragg and Cole showed that these differences were due to differences between the flies, rather than differences in attraction of fleece between the respective breeds of sheep.

The differences between the flies in their laboratory reactions to fleece fit this order very well, at least in the relative sizes of the reactions to meat and fleece shown by the mature females. Time did not allow the meat reactions of D to be tested. Consideration of the pre-maturity reactions of the females, and more particularly the early reactions of the males, suggests that sheep are more likely to provide a focus for mating in B than in A or D.

On the basis of his field observations, Professor Cragg suggested to me that, in B at least, mating might well occur near sheep, with the males concentrated in this vicinity ready to fertilise arriving females; unfortunately, there are no comparable observations available for the other two strains.

Of the three strains studied, B is the one in which it seems that sheep might be important in the breeding economy of the flies, both as a focus for mating and as a site for oviposition. B is the strain in which the laboratory reactions studied would most clearly be of value to a primary parasite of sheep in the field, that is, to an initiator of sheep strike. Although this is hardly conclusive evidence, it would be difficult to escape the conclusion that the inherent behaviour reaction, measured in the laboratory as W, is important in determining the/
the/

the relative importance of the different strains of this species as initiators of sheep strike.

The eggs of Lucilia sericata, and the early larvae, are known to need conditions of high humidity for successful development. Since the climatic humidity of the range of this species is lower in Australia than in Britain, this requirement has been advanced as the direct reason for the difference between the two strains with regard to myiasis.

The first criticism of this suggestion is that the significant humidity is that found at the site of potential oviposition, the lower layers of fleece, and not the general humidity of the geographic range; the fleece humidity of British sheep has not been shown to be higher than that of Australian or Danish sheep. L. Davies (1948b) has shown that British sheep under the same conditions and at the same time differ individually in their fleece humidity, and that the same sheep varies considerably in its fleece humidity at different times. It seems likely that any normal, healthy sheep will sometimes have fleece humidities adequate for the development of blowfly eggs and larvae, for example after sweating due to exercise, and times when the fleece humidity is too low. Thus the difference between sheep of different countries in fleece humidity is likely to be small, the more so since the fleece would largely insulate the humidity close to the skin.

Even if a real difference in fleece humidity were shown to exist, it is still by no means certain that such humidity differences would affect the gravid female to the extent of stimulating or inhibiting oviposition/

oviposition. The importance of humidity as a stimulus involved in oviposition does not seem to have been studied in Lucilia sericata, but Harlow (1956) showed that oviposition was independent of humidity in the related Protophormia terrae-novae. It is unlikely that climatic differences between the countries should determine the importance of their respective populations of Lucilia sericata by any direct influence on oviposition. It is possible that, if there is a real difference in fleece humidity, then this controls myiasis by limiting the development of eggs and larvae after oviposition. This does not seem likely however. In view of the behaviour differences established between the three strains, it seems more likely that their relative importance in sheep strike is determined by their own innate behaviour patterns.

The wool reaction is not the only factor of behaviour involved in sheep strike. Mature British females with, presumably, a high wool reaction which are in the vicinity of sheep will strike more readily if the sheep is made more attractive by pads of indole and ammonium carbonate, or by such natural phenomena as soiling. Conversely, the mature Danish females with, presumably, no reaction to wool will still lay on sheep which have been made attractive by these chemicals. It was also shown by Rogoff and Barton Brown (1958) that the texture of the fleece is important in determining whether or not a gravid female, having reached the sheep, will oviposit there. It is possible that A, B and D might vary in their oviposition reactions to the same tactile stimulus, for example, as well as in their reactions to wool.

The/



The fact that reactions other than the wool reactions are known to be involved in the production of myiasis does not reduce the importance of this behaviour in sheep strike. It does signify, however, that the status of different strains as initiators of myiasis cannot be fully considered on the evidence of the wool reaction alone, although, in the absence of comparative studies of the other reactions, the wool reaction is the only one which can be considered at the moment.

The differences between Australian, British and Danish flies in their wool reactions, or at least between the laboratory cultured stocks from these countries used in this work, were more than simple differences between females in their sensitivity to fleece; the highest reaction was shown by the A flies at emergence, while the highest mature reaction was found in B females. The conclusions detailed above are that the field differences in respect of myiasis are due at least partly to differences in the whole pattern of W, involving both sexes. Thus the field populations differ in this respect by inherent and complicated behaviour patterns, if the laboratory cultures can be accepted as reasonably representative of the whole populations of their respective countries.

However, I would accept the conclusion of Cragg (1950b), who stated that these strains cannot be rigidly ranked as 'myiasis producers' and 'non myiasis producers' because of the results of his field work in Denmark. Cragg (1950b) recorded that, under natural conditions, there is virtually no myiasis in Denmark, but showed that Lucilia sericata there/

there would oviposit on sheep which carried pads of indole and ammonium carbonate; thus Danish Lucilia sericata will oviposit on sheep which have been rendered particularly attractive.

While accepting his conclusion, the other main reason put forward in support of it is no longer tenable. Cragg suggested that the range of inherent individual differences within the Australian, British and Danish populations which he tested was so great that these strains were not completely separate with regard to their wool reactions. My samples, of all stocks, showed considerable differences between individuals of the same stock at any given age in the measure obtained of their wool reactions. Some of these differences might well have been due to real, inherent individual variation. But the choice chamber method used by Cragg and Cole and for the present work appears not to have been sufficiently accurate to show the real size of inherent differences within stocks; this is considered in detail in a later section of the present work, which deals with variation. It seems likely that much of the range of differences recorded was due to inaccuracies inherent in the method of scoring rather than to real individual differences inherent within the stocks studied.

Although the strains cannot be divided into complete producers and complete non producers of myiasis, the inherent differences between them are enough to justify some division. Probably the best distinction is between efficient and non efficient myiasis producers.

It seems likely that the importance of a high wool reaction in mature/

mature females is that it helps to keep these flies in the vicinity of sheep. If any of these sheep then becomes attractive, mature females are immediately available to take advantage of the situation, by oviposition. Thus strains with a high mature wool reaction are more likely to be present to strike attractive sheep than are strains with a low mature reaction.

This is an efficient mechanism in that a high level of W at maturity does not debar females from laying on carrion, although it does suggest that they will be prepared to lay on attractive sheep if these are available, a factor which would again tend to hold the population in the vicinity of sheep. If sheep were absent from the range of the females, then the high mature reaction to sheep would not be a disadvantage unless it replaced the reaction to carrion, while it would be an advantage if sheep were present. Thus a situation in which the reactions to meat and sheep are coexistent and balanced could only be advantageous to the flies.

An interesting point here is that Cragg and Cole found that flies from London did not differ significantly from flies taken from country in which sheep were kept; they only tested the mature wool reaction of the females. If this is so, then either the high mature level of W carries no selective disadvantage when sheep are absent, or there is a considerable gene flow between London and country populations. Differences between town and country populations, or rather between populations from country in which sheep are present and those from areas in which sheep are absent, would certainly seem to be more likely in Britain/

Britain, where Lucilia sericata causes myiasis, than in Denmark or Australia, where this species is not a primary sheep striker.

It would be of value to compare more strains of this species, for example from town and country districts of Britain, and from America, where the species is not involved in myiasis. It would also be interesting to compare other species of blowflies, including flies associated with myiasis and those which are not. This range of comparisons would make it easier to decide the importance of the wool reaction as a factor in myiasis.

The present work has provided some information on the biological problem of myiasis, and has confirmed that there is some connection between myiasis and the wool reaction. However, this work is clearly far from complete; the interpretation of these results requires that assumptions be made which could with value be checked by further work, and raises in this way a series of fresh problems. There can be no doubt of the scope for further work on this complex biological problem.

PART II. GENETIC STUDIES

1. INTRODUCTION

Genetic studies of behaviour in a variety of animals carried out by a number of workers were described in the General Introduction, and it was clear that there were a number of requirements to be met before a Mendelian analysis was likely to be very profitable. The behaviour in question should have been closely studied; the behavioural unit chosen for the genetic analysis should be a single factor rather than a complex of behaviour factors; and an accurate measure of this behaviour should be available.

The present work was started as a genetic analysis of olfactory differences in Lucilia sericata, but it soon became obvious that a good deal of work was needed on the behaviour per se before the genetic analysis could be attempted. The wool reaction was found to be more complex than had been assumed, and it had to be studied in some detail. Because of the time which this took up, very little time was left for the genetic analysis, which became in fact only a part of the study. Even now the wool reaction is by no means fully understood, and even less is known of the other two characters studied, preening and flight in the choice chamber.

However, differences between A, B and D were established for W at d0, and for W, P and F at d10. (See Figs. 8, 9, 10, 12 and 14). The field significance of these characters has been considered at some length/

length, particularly that of W. A genetic study is of more interest if the character concerned is of some known field importance. But to be of value for a genetic study, it must be possible for the operator to separate the components of the behaviour studied, and to separate in terms of this behaviour the stocks studied.

Of the characters studied in Lucilia sericata, the one for which two stocks were most widely separated was the emergence wool reaction in A and B. Preenings, flights and the mature wool reactions were more similar in the stocks, and the former two were suspected of being a measure compounded of a number of separate responses to different stimuli. The emergence wool reaction was a preference, and was possibly a relatively simple character in terms of its behavioural components. The ecological and behavioural significance of this character are not yet well understood, but it was clearly the most suitable of the characters studied for a genetic analysis.

There was unfortunately the unexplored possibility that the different strains might be reacting to different olfactory stimuli produced by the wool, and there was no chance to study this possibility. What is important here is not the possibility that the reaction was of different ecological significance to the two strains, but the untested assumption that the reaction had the same genetic basis in the two strains considered.

A further factor was the accuracy of the measurement of the reaction. A careful consideration of this, dealt with in detail in the next section/

section, suggests that this measurement was not very accurate. It is possible that a smaller choice chamber, or one of a different shape, might have given a more accurate measurement of the reaction, but there was not time to explore this possibility. Although the measure was undoubtedly a coarse one, it was the best available at the time. In terms of accuracy, the time of emergence was probably the best time at which to measure the wool reaction, since this reaction was uncomplicated at this time by the factors which affected it at other times of the life of the fly, as discussed in the next section.

The possibility of changes in the laboratory stocks during the period of test suggests that this factor might have introduced further inaccuracies into the results. Although, as discussed in an earlier section, this was not likely to be of any great importance, the genetic analysis was carried out in as few generations as possible; this procedure can be assumed to have kept to a minimum any errors due to this unproven factor.

The emergence reaction does not meet all the requirements for an ideal genetic analysis of behaviour set out in the General Introduction. In spite of the work carried out on it this character was not fully understood, and there was at least a possibility that it was influenced by several physiological factors. Nor was a highly accurate measure available. This being so, even the small genetic analysis which was carried out was preliminary rather than definitive. However, although the situation was not ideal, the character chosen for this analysis was the best one available in Lucilia sericata, and the present work has provided/

provided the first information on the genetic situation with regard to the wool reaction differences in blowflies.

A and B have been studied in an attempt to assess their inherent , genetically controlled variability, and their hybrid generations F₁ and F₂ have been studied in an attempt to obtain some information on the genetic basis of W at d0. The flies used for the genetical studies were the original stock of A, and the highly inbred, later, stock of B.

1011

2. VARIETIES WITHIN THE STOCKS IN THE INNATE LEVEL OF \bar{w} .

It is postulated here that each fly tested in the choice chamber had an innate level of reaction to wool, the size of this reaction at any given age being governed by a number of factors which will be discussed. The reaction measured for the fly, \bar{w} , was an estimate of this innate reaction, which will be termed "x".

It was noticeable throughout this work that there was a considerable range of differences between flies of the same stock at any given age for the recorded level of \bar{w} ; for examples of this, see Figs. 9, 10 and 16. It would be of considerable interest to compare different stocks, particularly the parent and hybrid generations of A and B, for the amount of inherent, genetically controlled variability present. Since \bar{w} was an estimate of \underline{x} for each fly, the variation in \bar{w} cannot be accepted as representing the true variation in \underline{x} , however. An attempt was made to separate the true variation in \underline{x} from the measured variation in \bar{w} , and this procedure made it possible to assess the accuracy of the choice chamber method of measuring olfactory reactions.

First the factors which govern the size of \underline{x} for any single fly at a given age must be considered. These factors are:-

1. The extent to which the fly can perceive the olfactory stimulus. The olfactory powers of the fly could be under some genetic control; they could also be affected for example by accidental damage to the nervous system, and might well change with age.
2. The/

2. The reaction made by the fly to the stimulus it receives. This in turn could be controlled by a number of factors:-
- a. Sex. Differences between the sexes have been demonstrated, although there were probably no true sex differences in the emergence reaction.
 - b. Age. It has been shown conclusively that the wool reaction changed with age, and these changes were presumably governed by changes in the overall physiological condition, or physiological age. At any given moment the size of \underline{x} would be affected by the physiological age.
 - c. Sexual maturity. The wool reactions of A and E females were shown to change markedly at about the time of oviposition, so sexual maturity affected the wool reaction, at least in those females.
 - d. Previous experience might possibly affect the size of the wool reaction.
 - e. Chance might play a part in influencing the wool reaction, as for example by better or worse feeding due to the chance of finding more or less food, even in a culture cage.

These factors can be assumed to affect the true, innate reaction of the fly to wool at any given moment, governing the size of \underline{x} . Other factors would presumably govern the accuracy of \underline{y} as an estimate of \underline{x} .

These are:-

1. The accuracy of my measurement of the movements of the fly. The mechanics/

mechanics of this measurement were very simple, and errors due to this source can be assumed to have been small throughout.

2. The accuracy of the "measurement" made by the fly. This "measurement" was made by the movements of the fly within the choice chamber, by which the fly sampled time on both sides of the centre line. Errors due to the fly could have arisen from several sources:-

- a. The amount of active movement about the arena. An active fly, by taking a large number of small samples of time from the two sides of the arena, would presumably have made a more accurate "estimate" than an inactive fly taking a small number of large samples.
- b. The number of flights. Flying increased the speed with which the fly moved about the arena, and so might increase the accuracy of the sampling process. But the direction of flight often appeared to be independent of the olfactory gradient, so flying might decrease the accuracy of the sampling.
- c. Number of preenings. This activity appeared to take place without reference to the position of the fly in the olfactory gradient, and so could increase the error of sampling, both by taking up testing time and by extending the time spent in one place. Also interruption of preening caused the fly to move rapidly, often by flying, in a direction which seemed to be independent of the olfactory gradient.
- d. Since the fly was effectively sampling time, statistical sampling errors are to be expected. These would be affected by the total duration/

duration of the test, but this was kept constant except for a small number of flies used for a variance analysis, described later in this section.

These considerations show, first, the complexity of the mechanism which could determine the size of \underline{x} for any fly, and second, a number of sources of error, none of them adequately measurable, which could affect the accuracy of \underline{W} as an estimate of \underline{x} . If it were possible to make simultaneously a large number of readings of \underline{W} for the same fly, these would be distributed about \underline{x} , probably in a normal distribution, and a good estimate of \underline{x} could be obtained. Since this was obviously not possible, the single reading of \underline{W} had to serve as an estimate of a population of readings of unknown variability.

The differences between individuals within a sample for the level of \underline{W} were presumably due to some combination of real, inherent differences, probably under some measure of genetic control, and what will be termed "error differences". An attempt was made to separate the contributions from these two sources. Given a sample of flies of the same sex, the factors of variation can be listed:-

1. Real differences between individuals

a. Differences in chronological age.

Given the same chronological age, then

b. Differences in overall physiological condition. This depends on:-

i. chronological age, and

ii. the rate of physiological ageing with time, which could be under some/

some genetic control and could also be affected by

iii. climatic conditions.

c. Differences in the stage of sexual maturity. This depends on:-

i. chronological age, and

ii. the rate of maturation with time, which could be under some genetic control, as well as

iii. environmental conditions. Sexual maturity was certainly affected by diet in A and B females, as females kept without meat were unable to mature their ovaries.

Given the same conditions of maturity and general physiological age, then:-

d. Differences in \underline{x} for any given total physiological condition.

Differences between stocks have been shown conclusively, and it seems reasonable to assume differences between individuals within a stock, probably under some genetic control.

Given the same level of reaction to a given perception of stimulus, then

e. Differences in the ability to perceive the olfactory stimulus in the choice chamber. These differences could have some genetic basis.

2. Accidental or error differences.

a. Sampling errors made by the fly in measuring \underline{x} . These could be influenced by differences between individuals in:-

i. Amount of general activity.

ii. Frequency of flying.

iii. Frequency/

iii. Frequency of preening.

These three factors might have some genetic basis.

b. Errors made by the operator in timing.

c. Changes in technique between tests.

For all flies, 2b and 2c should be very small, and can reasonably be ignored. For flies of carefully standardised age at d0, 1a should be negligible and, since it is known that development of the gonads, at least in the females, was not rapid at this time, 1c can also be ignored. 1b would be at its most important at a chronological age when the general physiological condition of the fly was changing most rapidly; unfortunately d0 could well be such a period, and certainly the wool reaction in A changed rapidly soon after emergence.

Even in a sample of flies of carefully standardised chronological age, there were clearly several possible sources of real difference, as well as 2a, a source of "error" difference. Comparison of the total variability of different stocks would be of little interest, since the relative proportions of real and error variability could not be assumed to be the same. It was necessary to separate the variability into these two main kinds, and d0 seemed the best age at which to attempt this separation. No attempt was made to divide the variability further than between the real and error sources.

One of the stocks used for this analysis was a highly inbred stock of B, the other the same stock of A which was used throughout this study. An attempt had been made to avoid inbreeding in the latter, but it cannot be assumed that no inbreeding had occurred. Both stocks were vigorous and fertile, and appeared to be fit.

The/

The attempt to separate the real from the error variability was made by using a variance analysis method. 10 females and 10 males of both A and B were tested, each fly being given four immediately consecutive tests of 5 minutes per test at d0, the age of all flies being standardised as far as possible. If the four consecutive tests are accepted as equivalent to four simultaneous tests for each fly, then the "within fly" variance can be compared with the "between fly" variance, there being four "within fly" and ten "between fly" classes for each sex of each stock.

The results were analysed for any evidence of change in the reactions for a fly over the twenty minute total period of test. The series of first tests were treated as one sample and compared with the series of last tests; any difference between these two samples would indicate that the wool reactions of the flies had changed during this period. No significant differences were found by the 't' test, so it was assumed that the flies had not changed, and the direct variance analysis was carried out.

One of the reasons for differences within a sample in individual, single readings for W was believed to be sampling errors made by the fly in its estimation of x. It is very likely that reduction of the test time from ten to five minutes would increase these errors. However, this factor was of little importance in this analysis since the "between fly" variance could be used to eliminate this sampling error. To find the variance contributed by "real" differences between the flies tested, the situation fitted a variance model with fixed effects. In this case, if/

if S_e^2 is the "within fly", S_r^2 the variance due to "real" differences, S_b^2 is the "between fly" variance, r the number of flies, and c the number of tests per fly, then $S_r^2 = \frac{(c-1)(S_b^2 - S_e^2)}{rc}$

This estimate of the inherent variability would seem to be a good one for a population in which the variance is not affected by any extraneous statistical considerations. Unfortunately, such considerations did apply in this case.

As was discussed earlier, the mean value for a non inbred stock of B was about 150, and the range of readings registered was from about 70 to 200. These results did not approach the maximum measurable, which was 300, and the frequency distribution for B was symmetrical. The mean for A, however, was about 240, and the range from about 120 to 300; in this case the frequency distribution was truncated. This suggests that the range of results recorded for A, their frequency distribution, and presumably their variance, were affected by the limit to which reaction was measurable. That is to say, had it been possible to register a W greater than 300, some flies of A would have reached this value.

Before comparing the variances, it would be necessary to compare A and B for skewness and kurtosis. The most convenient method of doing this would be to compare both A and B with a normal distribution. The indices to be used for these comparisons were:-

Skewness/

Skewness

$$B_1 = \frac{[\sum (x-\bar{x})^3]^2}{N^2 \sigma^6} \quad (\text{expected value for normal} = 0) \quad \text{with S.E. } \sqrt{\frac{6}{N}}$$

Kurtosis

$$B_2 = \frac{\sum (x-\bar{x})^4}{N \sigma^4} \quad (\text{expected value for normal} = 3) \quad \text{with S.E. } \sqrt{\frac{24}{N}}$$

For both these characters, the distribution could be accepted as fitting a normal distribution if the value for the curve was within ± 2 S.E. of the normal value.

Samples of 100 at d0 showed that B fitted a normal distribution, while A proved to be significantly skewed. Adjustment for the effects of Skewness (and Kurtosis) on the variance would be necessary before the variances could be compared.

Having obtained the best possible estimates of the "error" and "real" sources of variability, and having obtained these separately for the stocks which were to be compared, the next operation would be to compare these stocks, and the problems raised by such comparisons will now be considered.

The next difficulty is that the variance of a sample may be affected by the sample mean, and the populations to be compared had widely different mean values. For a number of quantities like g, the mean is m and the standard deviation is s, the variance being s^2 . It can easily be shown that, for a similar number of quantities like g + a, the mean is m + a, and the variance is still s^2 . For a similar number of quantities ag however, the mean is am and the variance is $a^2 s^2$.

It/

It has been shown that the populations to be compared in this work differed in their mean values; before comparing variances, it would be necessary to find whether or not these variances were affected by the differences between the means, and to correct the variances for such effects if necessary.

There was no direct information available from my data for establishing the relationship between the means and variances; so, as was usual in this work, an indirect method had to be used. If the relationship between mean and variance could be established separately for each stock, then the variances for all stocks could be scaled to fit a common mean, which could be arbitrarily chosen at a convenient value such as 0 or 100. The variances appropriate to this common 'mean' could then be compared directly.

The problem, then, was to find the relationship, if any, between mean and variance in each population to be compared. To do this, the variances for different means within a stock could be compared. If, for any stock, different samples for the same age gave different means, then the samples could clearly not be regarded as comparable. Hence it would be necessary to compare samples for different ages, preferably of the same flies. This clearly introduced another set of difficulties.

The factors which contributed to the real differences between flies within a population have been considered in detail earlier, but they will be repeated here to facilitate their consideration in this/

this context. They are:-

- a. Differences in age or general physiological condition.
- b. Genetically determined effect of a on x.
- c. Differences in level of maturity.
- d. Genetically determined effect of c on x.
- e. Differences in level of x for any given combination of these factors; probably genetically determined.
- g. Differences in the ability to measure x, presumably at least partly determined genetically.

In considering the variance at dc, it was possible to discount factors a. to d.; for any other age, all six factors must be considered, as each would presumably contribute something to the variability of measurements made within a population. To this list must be added in this context another factor,

- h. possible effect of the mean on the variance, when populations of different mean values are to be compared.

If all these factors contributed to the variance, then in this respect the factors were related. If this relationship was additive and linear, then the variance can be expressed as:-

$$V = f_1(a) + f_2(b) + f_3(c) + f_4(d) + f_5(e) + f_6(g) + f_7(h).$$

Of these, only the last factor was required. An added problem was that this relationship could not be assumed to be the same at all ages; for example the amount of activity of the fly is known from observation to change in individuals with age, not necessarily in a linear way.

This/

This being so, it is hardly surprising that plotting total variance and total standard deviation against mean and time for W at different ages in a number of stocks showed no obvious relationships.

To make the required comparisons, then, attention must be restricted to the sources of real difference between individuals of the same stock, since the error differences, which presumably will also change with time, add further complications. Thus the variance analysis method, which involves repeated sampling, would be necessary at each age.

The methods available gave no way of allotting values of absolute size to the factors involved in the variability due to real differences, so there was no objective method whereby these factors could be eliminated. Since d0 is the age for which the comparison was required, this age had to be included in the series of tests aimed at eliminating all but the genetically controlled differences. The appropriate tests were at d0 and d1.

Between d0 and d1 the ovaries are known not to be developing rapidly as has been mentioned above; probably factors c. and d. would be of little importance here. Since the mean changes very considerably during this time, especially in A, factors a and b could be of considerable importance. Some measure of factors e and g could be obtained for each stock at d0; it would probably not be unreasonable to use these as estimates of the importance of e and g for d1, although this is at best an approximation.

Thus the results from d0 and d1, aimed at measuring factor h could be complicated chiefly by factors a and b. Since these factors could not be eliminated, the relationship between variance and mean obtained from/

from this age series could not be accurate. If, however, it is assumed that the effects of these factors did not vary widely between populations, then some information could be obtained. If the variance could be related to the sum of the factors a, b and h for all populations, and if a and b were similar in importance in all stocks, then a working approximation could be made to the comparison of inherent variation between stocks.

This is the method which was devised for separating the inherent from the "error" sources of variation in samples taken for W at d0. It was a method based on a number of assumptions which could not easily be tested; estimates obtained this way could not be assumed to give accurate measures of these sources of variability. But it did suggest that a reasonable assessment of them might be found.

When the necessary sampling was completed for A and B, it was found that in no case was there a significant difference between the "within fly" and the "between fly" variances; the variance ratio was not significant in any sample (see Table 11). For both A and B, the variance ratio was bigger at d1 than at d0; this was to be expected since the variable rate of decrease of the emergence reaction would increase the difference between flies within a sample. For A females and B males at d1, the variance ratio was significantly high. However, the age selected for the comparison was d0, and in the absence of any significant measure of inherent variability at this age, there was little to be gained by continuing the analysis.

This/

This lack of significant difference at d0 could be interpreted as showing that there was no inherent difference between individuals of the same stock. This would imply either that the both stocks were completely homogeneous for the genes affecting the emergence wool reaction, which does not seem likely; or that this character was not controlled genetically, which disagrees with the evidence from the other sources. A more reasonable interpretation is that there were inherent differences between individuals, but the "error" differences were large enough to mask them.

This last interpretation implies that the choice chamber technique did not give a very accurate measure of the wool reactions of an individual. Any method of measuring behaviour which is open to a number of unmeasurable influences is hardly likely to be accurate. To the errors already listed must be added another in the results obtained for the population; the statistical error in sampling from any population. Also where these samples were taken over a number of generations, change in the stocks would increase the error, but this has been shown to be at most a very minor source of error.

This is a formidable list of sources of variability between individuals and errors in the method, and it is clear that differences between individuals of the same stock in the results recorded for any age cannot be accepted as measures only of the inherent, real individual differences which are assumed to exist within stocks. The attempt to separate the inherent from the non inherent sources of variability in the results, failed, presumably because the "real" differences were masked/

Table 11. Analysis of "within fly" and "between fly" variance.

		W at d0	W at d1
A	♀♀	"F" = 2.01 P > .05	"F" = 3.91 P < .01 *
	♂♂	"F" = 0.94 P > .05	"F" = 1.97 P > .05
B	♀♀	"F" = 0.96 P > .05	"F" = 1.05 P > .05
	♂♂	"F" = 0.54 P > .05	"F" = 3.01 P < .01 #

"Between fly" degrees of freedom = 9

"Within fly" degrees of freedom = 30.

"F" = variance ratio.

Four immediately consecutive tests of wool reaction were made with 10 males and 10 females of A and B at d0 and d1, and the variance ratio quoted. This has been quoted in each case with the corresponding level of probability.

masked by the "error" differences within the stocks, which could not be adequately measured.

However, careful control of the methods of culturing and testing can be accepted as having kept these errors to a minimum. Also, a standard error was fitted to each mean used, this being a measure of the total variability and error found within the sample, so that it was possible to compare means with some measure of confidence.

Similar considerations apply to the accuracy of the estimates made of the meat reaction. The accuracy of the estimates of preening and flights have been considered separately.

In spite of these inaccuracies, repeatable estimates were obtained of the average wool reactions of the stocks tested at different ages, suggesting that the samples were large enough to give useful information in spite of the errors inherent in the method. For both the genetic analysis and the studies of behaviour per se, the choice chamber technique has given useful information, and it will not be easy to produce a more accurate method of measurement of these olfactory reactions.

3. COMPARISON OF PARENT AND HYBRID GENERATIONS OF A AND B.

A and B were found to cross easily with either stock as the female parent, and the resulting hybrids were both vigorous and fertile. The hybrid with A as the female parent will be referred to as A/B-F₁; the reciprocal hybrid as B/A-F₁. Breeding within these stocks produced the corresponding F₂ stocks, A/B-F₂ and B/A-F₂.

It was found that crossing could not be brought about by putting one male with one female, although this was tried in the standard cages, in small cages, and in inverted lamp glasses; the crosses had to be made by mass matings. The technique for this was to bring a large batch of pupae of each stock to a stage of rapid emergence, and to put these two batches into separate empty cages. These cages were then watched almost continuously because of the possibility of mating occurring soon after emergence. In this way the newly emerged flies were collected, one to a collecting tube, as they reached the top of the peat moss in the emergence dish; all flies used for the crosses were thus virgin. These flies were immediately sexed, using as indicators the spacing of the eyes and the conformation of the tip of the abdomen, and the tubes were placed in appropriately labelled containers in groups of about 10. After they had hardened these flies were re-sexed so that errors could be corrected, flies which were weak or difficult to sex being rejected. Cages were then set up in the usual way, with the combinations of flies appropriate to the required crosses.

The reciprocal F₁s were sampled separately in order to examine the possibility/

possibility of maternal effect on the inheritance of W at d0; similarly, the corresponding F₂s were also sampled separately.

100 males and 100 females were tested from each of the two F₁ and two F₂ stocks. Analysis of these results by the analysis of variance showed that there were significant differences between the small samples within both the F₁ stocks. The most likely explanation of these differences was that dishes of pupae of the parent stocks had somehow been mixed with those of the F₁s, so these results were discarded and all the hybrid stocks destroyed. Further sampling of the parent stocks showed that these were unchanged, so the parent stocks were retained and fresh hybrids were made.

Samples of 100 males and 100 females of both A and B were tested for W at d0 to give the parental levels against which to compare the hybrids. Samples of 50 males and 50 females were taken from A/B-F₁ and B/A-F₁ to establish the F₁ levels, and 50 males and 50 females from A/B-F₂ and B/A-F₂ for the F₂ levels. No significant differences were found between sexes for any of these samples, so the two sexes were combined to give one sample for each stock. No significant differences were found between A/B-F₁ and B/A-F₁, so these were combined to give one large sample for F₁. Similarly no significant differences were found between A/B-F₂ and B/A-F₂, so these were also combined. Thus one sample of 200 was available for W at d0 for A, B, F₁ and F₂ on which to base the comparisons between parent and hybrid generations, (see Fig. 16), and there was no evidence of any maternal effect.

It is clear that A and B differed considerably in the mean value for/

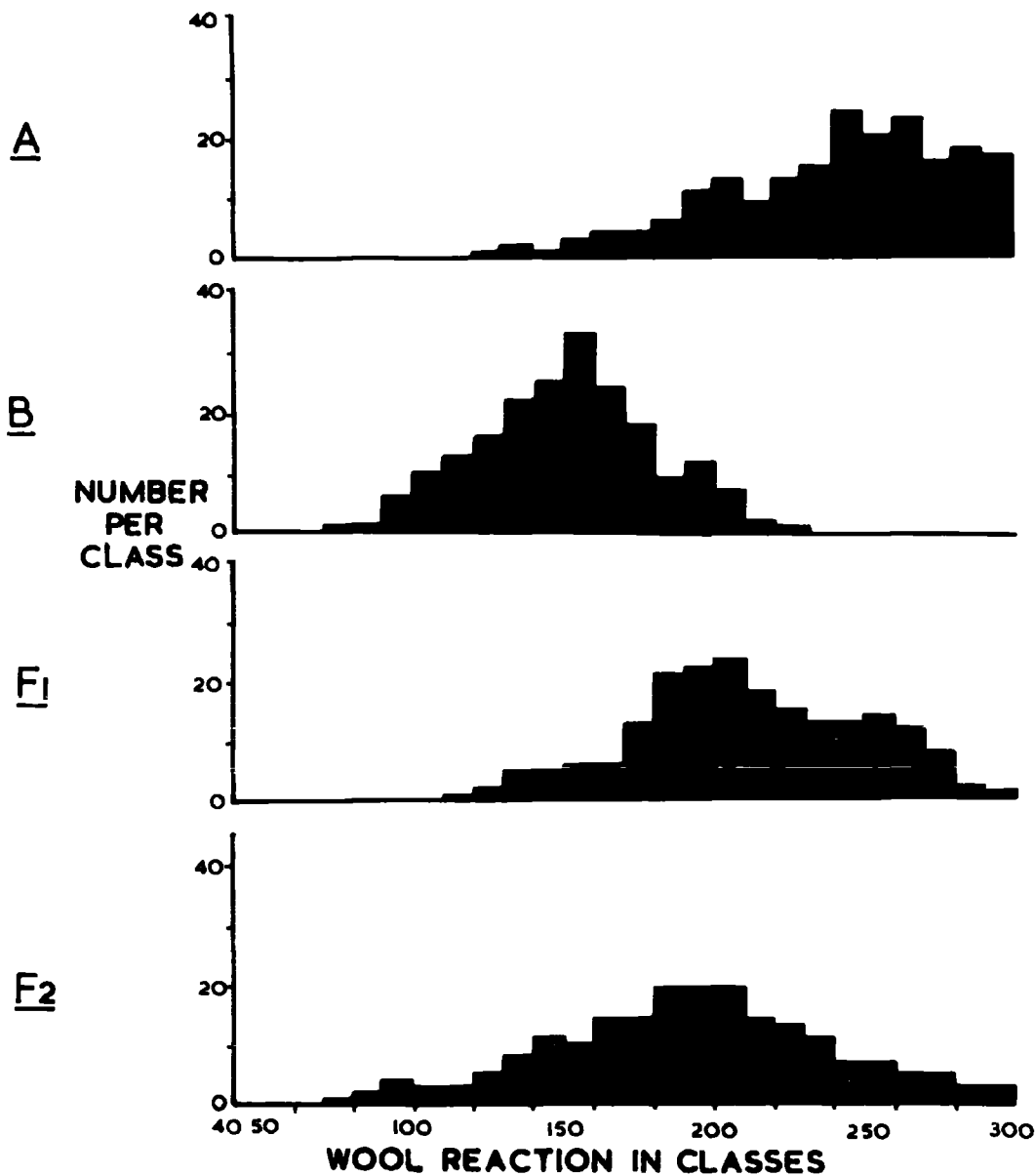

FIG.16 FREQUENCY DISTRIBUTION OF WOOL REACTIONS OF A, B, AND THEIR HYBRID GENERATIONS AT D₀

TEXT OVERLEAF

for V at d0, although their frequency distributions did overlap. Also, the range of results registered within these two strains was considerable, a disadvantage in terms of comparisons with the hybrid generations.

The mean for F1 was intermediate between A and B, lying almost halfway between them, and the frequency distribution of the F1 overlapped those of both parent stocks. There was thus no evidence of dominance in the F1 results.

The F2 generation gave results very similar in mean value to those of the F1, and its frequency distribution again overlapped those of both parents, had a greater variance than the F1 or either parent stock (see Fig. 16) the F1 or of either parent.

There was no time available for backcrosses to be made and tested,

4. CONCLUSIONS TO THE GENETIC STUDIES.

The results obtained for the F1 and F2 generations could be interpreted in terms of multifactorial genetic control of W at d0, with little or no dominance. This would explain the continuous variation in the results for all the stocks; the distribution of F1 and F2 overlapping both parents; and the lack of obvious segregation in the F2. The flatter distribution of the F2 could be explained in terms of segregation of the several genes controlling the reaction.

Unfortunately, this conclusion cannot be accepted as having been adequately supported by the present work. Consideration of previous genetic studies of behaviour has suggested that such results could be explained on grounds other than multifactorial control of a unit character of behaviour. The first possibility is that the lack of obvious segregation in the F2 generation could be due to inaccurate measurement of the character in individual flies, or to a flexible response by the flies to the stimulus, or to some combination of these factors. Previous considerations of accuracy in the present work have shown that the choice chamber technique did not give very accurate measurements of W for individuals. Thus the continuous variation in results, particularly in the F2, could be due to the inability of the technique to differentiate sharply between individuals; this would make it difficult to distinguish between separate classes, even if these did occur.

The/

The second point arising from the survey of previous work is that studies of a complex of behaviour will inevitably fail to show single gene control, and are unlikely to show the number of genes involved, since the units of which the behaviour complex is composed will have separate and interacting genetic mechanisms. This consideration could apply to \bar{w} in Lucilia sericata. It has been shown that \bar{w} changed markedly with age. Although the results for \bar{w} at d_0 were obtained as near to the time of emergence as was technically possible, it is likely that \bar{w} at d_0 was compounded of the true emergence reaction and the mechanism for the fall from this level, each of which could well be under some genetic control.

Thus the results obtained in the present study are capable of at least four interpretations. The first of these is that \bar{w} at d_0 was a unit of behaviour controlled by a number of genes; the second is that this unit of behaviour was controlled by one gene locus, but that the technique used for measurement was not sufficiently accurate for segregations to be demonstrated; the third is that \bar{w} at d_0 was a behaviour complex rather than a unit, controlled by those separate gene mechanisms which controlled the parts of the complex; the fourth interpretation is that the true answer was some combination of the previous possibilities. The present study gave no way of deciding which of these possibilities, if any, was the correct solution.

This adds point to much that was said in the survey of previous studies of behaviour genetics. A study like the present one seldom gives/

gives conclusive results, and should be treated as a preliminary rather than a definitive study. Before the genetic analysis is attempted, an exhaustive study of the behaviour should be completed; the wool reaction in the present work was studied at some length, but this was also a preliminary study, raising more problems than it solved. Also, an accurate measurement is necessary for these studies, and the choice chamber measurement, although the best available, was not highly accurate.

It does seem, however, that W at d0 was under some measure of genetic control in Lucilia sericata. The considerable differences between A and B were maintained with little change over a number of generations of laboratory breeding, and the wool reaction, at least in B, had previously been shown by Cragg and Cole to be resistant to conditioning. The F1 and F2 generations were similar in mean, and both were intermediate to A and B. Thus genetic control of the wool reaction does seem a reasonable hypothesis.

The results obtained have also shown that there was no extra maternal effect on the offspring, and that there was no marked dominance. Thus some genetic information has been obtained from the present work.

It seems likely that further studies would be better directed towards estimating the relative importance of genotype and environment in deterring the level of the wool reaction, rather than at Mendelian analysis, at least in the absence of a much more accurate method of measuring/

measuring the wool reactions of individual flies. W at d0 is still the most suitable, for a genetic analysis, of the behaviour studied in blowflies, and the choice chamber technique, or some modification of it, is still the best method available.

PART III. EVOLUTION OF BEHAVIOUR IN LUCILIA.

1. INTRODUCTION

Heritable differences in behaviour between strains of a species have been established for a number of animals. Denenberg, Ross, Sawin and Frommer (1957), and Ross, Denenberg, Frommer and Sawin (1959) found differences in maternal behaviour between strains of rabbit; Foster (1959) showed that two strains of the deer mouse Peromyscus differed in temperament. Heritable differences in behaviour have also been established between closely related species; Sakagami and Akahira (1960) found differences in stinging behaviour between Apis cerana cerana and Apis mellifera ligustica. These are a few examples of many which could be quoted.

It is generally accepted that differences such as these between strains or between closely related species are the result of evolution; that evolution as a process applies to behaviour as well as to morphological features. Tinbergen (1951) and Lorenz (1958) have accepted the evolution of behaviour and have constructed homologous series of behaviour characters equivalent to the homologous series so widely accepted for morphological structures. For example Tinbergen described a homologous series through a number of species of cranes for preening in fighting display, and Lorenz suggested that head scratching was a character which could be considered homologous throughout the Amniotes.

It/

It is also widely accepted that the mechanism of the evolution of behaviour is the same as that of the evolution of morphology. The results obtained by MacDougall (1927 and 1930) on learning in rats were interpreted by him as indicating Lamarckian evolution, but his results have since been explained by other workers in terms of selection, as by Kuppasawny (1941).

Accepting that behaviour has evolved because of the action of selection, Leopold (1944) explained the heritable difference in wildness between wild and domestic turkeys in terms of the different selective processes which apply in the farmyard and in the field; Scott (1954) suggested that the differences in temperament between races of dogs was due to the selective effects of domestication under different conditions. In man, Cattell (1940) suggested that there was an evolutionary trend towards decreased intelligence due to differential fertility between groups of people with heritable differences in intelligence; this last study was by no means as conclusive as the others.

These are studies in which the mechanism of the evolution of behaviour was considered. Other work has demonstrated the importance of behaviour as a part of the evolutionary mechanism. It is now generally accepted that two populations of a species must be separated before speciation can occur, and the possible importance of behaviour as an agent of this separation has been considered.

An example of this is sexual isolation, which has been widely studied/

studied. Tinbergen has shown that mating behaviour is a very complex system of "questions and answers" in many species, and that any discrepancy in this behaviour sequence might make copulation impossible. This is a factor which could clearly separate populations of a species, and this type of sexual isolation by changes in mating behaviour has been very closely studied, particularly in Drosophila. This work is characterised by the very close analysis which has been applied to the mating behaviour, with numerical measurements being applied to the small factors which have been compared. Bastock and Manning (1955) and Bastock (1958) are examples of such close analytical studies of courtship behaviour in Drosophila, dealing with factors like licking and wing vibration. There have been many published studies of mating behaviour in Drosophila, directed at an examination of the evolutionary significance of reproductive isolation, such as those by Miller (1950), Spieth (1949 and 1952), and Spieth and Hsu (1950).

Sexual isolation has also been shown to affect animals other than Drosophila. For example Blair and Littlejohn (1960), working on the frogs Pseudacris cruata and Pseudacris streckeri showed that the mating calls were of different frequencies in the two species, and that the females of Pseudacris streckeri at least could differentiate between the males of the two species; this is a mechanism which would help to maintain the two separate species although they bred in the same area.

Behaviour has clearly evolved, and it seems reasonable to accept that its evolution has been, and is, due to the same mechanism as that which affects morphological characters. It is clear that behaviour differences, especially those involved in mating, have been important in at least some cases separating populations so that speciation could occur.

2. EVOLUTION OF THE SHEEP STRIKE HABIT

The blowflies are typically carrion feeders, eggs being laid on carcasses and the larval period being completed there. Lucilia sericata and Lucilia cuprina will also complete their life histories this way, as noted by W.M. Davies (1954) and by Monnig and Cilliers (1944). Hepburn and Nolte (1943) tested a number of attractants and repellents, chiefly in the laboratory, and found that carrion was the most effective attractant for sheep blowflies: Mackerass and Mackerass (1944) showed that carrion was even more attractive to Lucilia cuprina than susceptible sheep. In my work, the mature reaction of British Lucilia sericata was higher for fleece than for meat, although it was difficult to compare these two reactions directly, and the meat used showed no signs of putrefaction. Monnig and Cilliers (1944) did show however that Lucilia cuprina oviposited more commonly on live sheep than on carcasses in the Cape Rainfall Area of South Africa. However, it does seem likely that both Lucilia sericata and Lucilia cuprina are both basically carrion breeders.

Both these species are also known to initiate myiasis, breeding in live sheep. Some work by Illingworth (1925a) suggested that Lucilia sericata could breed in hen manure; Thomsen and Hammer (1936) obtained results suggesting that this species could lay and breed in pig manure; and Green (1951) found larvae of this species in pig food which contained no observable meat, and found that these larvae were able/

able to complete their development in the absence of meat. Graham-Smith (1919) collected *Lucilia* in traps baited with excrement, but unfortunately failed to name the species.

These studies are inconclusive, but they do suggest that *Lucilia sericata* can breed in faeces and garbage as well as in carrion and live sheep. However, it still seems likely that carrion is the original breeding medium for both *Lucilia sericata* and *Lucilia cuprina*, and it is interesting to speculate on the reasons for them becoming parasites of sheep.

Froggatt (1915) suggested that sheep strike arose in Australia because the blowflies already there acquired the habit of ovipositing on live sheep due to some process of larval conditioning. The Joint Blowfly Committee (1933) suggested that sheep strike was due first to the introduction of more susceptible sheep such as the merino, and second to the introduction of *Lucilia sericata*, probably from England, and *Lucilia cuprina*, probably from the East, with the ability to oviposit on live sheep already inherent within them. Johnston (1923) suggested that myiasis as a habit arose because of similar stimuli produced by carrion and susceptible sheep. This is supported by the results obtained by Mackerass and Mackerass (1944) and Cragg (1950b), who showed that putrefactive substances increased the susceptibility of live sheep. Cragg also suggested that the absence of myiasis in Denmark was due to microclimatic differences between Denmark and Britain rather than to differences in habit between Danish and British *Lucilia sericata*.

However/

However, the work of Cragg and Cole (1956) suggested that there were some differences in behaviour between Australian, Danish and British strains of this species, and my work has shown that these differences are considerable, affecting the reactions to meat and fleece in a way which suggests that there are innate behavioural differences between these strains which affect their propensity to initiate myiasis in sheep.

Cragg and Cole also showed that there were differences in wool reaction between Lucilia sericata and other blowflies like Lucilia caesar and Lucilia illustris which play a smaller and secondary part in sheep strike. It seems that Lucilia sericata and Lucilia cuprina have evolved some behavioural mechanism adapting them to live sheep as a breeding medium. Putrefactive substances common to carrion and susceptible sheep seem to be important in myiasis, but Lucilia sericata, and probably also Lucilia cuprina have evolved an innate response to wool which is an important part of the reaction to sheep. It is interesting to speculate on the evolution of this behaviour factor.

Holdaway (1930) and Ulllyett (1950) showed that intra and interspecific competition for food amongst larvae in carrion, together with predation and parasitism of these larvae, were important factors in limiting the population size of Lucilia sericata. Fuller (1932) showed that the burial of blown carcasses increased the emergence of Lucilia sericata and Lucilia cuprina because it relaxed this competition. Illingworth (1923b) suggested that the Lucilia sericata population of Hawaii/

Hawaii was decreasing because of the larval competition in carcasses with the recently introduced Chrysomya albiceps, although this was not a conclusive study.

Under these conditions, it would be of considerable selective advantage for the species to be able to breed in a medium for which there was less larval competition. The work of Waterhouse (1947) suggested that live sheep provided a better breeding medium for blowflies because there was little competition here from other species of blowfly, and little predation or parasitism. If this were so, then the ability to breed in sheep would clearly confer a considerable selective advantage to those flies which developed this ability. Since the wool reaction is involved in this ability, then development of the wool reaction would also be advantageous.

Thus the primary sheep blowflies probably have the wool reaction added to the ability to react to putrefactive substances, and this might well be the main difference between primary and secondary sheep blowflies. It would be very interesting to know more about the possibility of a wool reaction being shown by sheep blowflies other than Lucilia sericata and Lucilia cuprina.

Rather more difficult to explain are the differences between strains of Lucilia sericata in their wool reactions. Australian, British and Danish stocks of Lucilia sericata, particularly the former two, showed distinct similarities in their patterns of reaction to wool, which suggests that the three strains might be of common descent; certainly the/

the Joint Blowfly Committee (1933) suggested that the Australian populations of Lucilia sericata were descendents of introduced British stocks. It seems possible that the reactions of the Australian and Danish stocks of this species are modifications of a British type. If this is so, what has caused the divergence?

The humidity requirements of the eggs and larvae of Lucilia sericata have been discussed above, and these might have provided the selective basis for the postulated changes in behaviour. If the fleece humidity is higher in British than in Australian and Danish sheep, and if the three strains of fly are similar in their humidity requirements, then this difference would cause high mortality amongst eggs laid on living sheep in Denmark and Australia. Selection would then be adverse to flies which laid their eggs on live sheep, and favour those which laid on carrion. Under these conditions, divergence from the sheep strike habit might be expected, affecting the complex of olfactory reactions.

On this interpretation, the maintained emergence reaction of D to fleece, and the heightened emergence reaction of A to fleece, would suggest that these reactions had acquired some significance other than in myiasis. It would be necessary to accept the difference in fleece humidity between British and Australian and Danish sheep, which has been doubted in an earlier section of this work; it would also be necessary to postulate that the eggs and larvae of Lucilia cuprina in Australia could withstand lower humidities than those of Lucilia sericata, and there is no evidence for this.

MacLeod/

MacLeod (1949) and Cragg (1950b) referred to the complex interactions between blowflies, climate and myiasis. Holdaway (1933) showed that Lucilia sericata preferred open places and was more tolerant of insolation than the related Lucilia caesar. Nicholson (1934) and I.M. Mackerass (1936) showed that Lucilia cuprina was active at higher temperatures than Lucilia sericata under Australian conditions, and this agrees roughly with the distribution of the two species in Australia, although their ranges do overlap there. This difference, considering the higher temperature in Australia than in Britain, might affect the relative standing of the two species in Australia as initiators; given equal opportunity, the more active flies would, on average, find the sheep more quickly. It is difficult to see why this should result in a changed wool reaction pattern in Australian Lucilia sericata, however, and it does not explain the difference between British and Danish strains.

It is possible that, due to competition for oviposition sites on sheep with Lucilia cuprina which was more efficient in this activity, possible due to its greater activity at Australian temperatures, it was a selective advantage for Lucilia sericata to reduce its activities as a primary sheep striker. However, Lucilia sericata in Australia is now a secondary sheep blowfly; this would seem to involve competition with the established larvae of Lucilia cuprina rather than with its eggs and young larvae, and so make more severe any competition which might exist here for Lucilia sericata.

Competition between Lucilia sericata and Lucilia cuprina for oviposition/

oviposition sites in carcasses has been considered by other workers, but not in much detail. Hepburn (1943a and b) showed that carcasses in South Africa varied in their attraction for blowflies, and that Lucilia sericata and Lucilia cuprina laid on the same carcasses; Monnig and Cilliers (1944) suggested that, in a different area of South Africa, these two species oviposited on carcasses of different size.

The question of competition between these two species, both on carrion and on live sheep, is clearly a difficult one, and no firm conclusions can be reached at the moment. One of the many pieces of evidence which would be of value here is a good estimate of the relative sizes of the field populations of these two species in different areas. Work by Gurney and Woodhill (1926a), Gilmour, Waterhouse and McIntyre (1946) and MacLeod and Donnelly (1956) has shown that good estimates of the population size of blowflies in the field are difficult to make, and no such estimates are available at the moment.

This consideration of the evolution of the sheep strike is obviously highly speculative, and few conclusions can be reached. Much more work is needed on a number of aspects of blowfly behaviour and ecology, particularly comparisons of the wool reactions of more species of blowflies and more strains of Lucilia sericata. In the absence of further information, there would seem to be little value in continued speculation on this point.

PART IV. GENERAL DISCUSSION.

The present work has provided information on the behaviour of Lucilia sericata, and on the ecological importance and genetic basis of this behaviour. In each of these three parts, however, the work is incomplete, raising more problems than it solves, and in each part the work must be considered as a preliminary study.

This work has, however, raised several points of general interest. The first of these is that, in studies of behaviour, an attempt should be made to assess the accuracy of the methods used to measure the behaviour. Only results which are repeatable should be accepted, and since the handling of the experimental animals is known to affect their behaviour, it may be difficult to compare the results obtained by different operators. In the present work, handling had no obvious effect on the wool reaction, but obviously affected preening and flights, and could have affected the measurement of the wool reaction through these.

The next point is that a behaviour pattern should be carefully analysed, and its component parts studied separately before any behavioural explanation of the pattern as a whole is attempted. With the wool reaction, which changed so markedly with age, the separate components clearly had different meanings in terms of field importance; to treat the pattern as a whole could only make the issue more complicated in this case.

This consideration applies with at least equal force to studies of/

of the genetic basis of behaviour, and this is again illustrated by the wool reaction. Here there is a definite pattern of change, and the different parts of the pattern have different behavioural functions. It seems only reasonable to assume that these parts are governed by distinct physiological and genetic factors, although these are certainly co-ordinated. Clearly little is to be gained by lumping these parts together and attempting to study the overall genetic constitution.

From this it follows that the genetic studies cannot be separated from the studies of the behaviour per se. It is necessary to analyse the behaviour very closely before the genetic analysis can be carried out satisfactorily. The genetic studies involve, and are dependent upon, a considerable knowledge of the behaviour, ecology and physiology of the animal as a whole. Realisation of this reduces the value of genetic studies of large complex behaviour patterns treated as a whole. Where the components of the behaviour complex cannot be separated, it is clearly better to study the heritability of the behaviour, rather than to attempt a Mendelian analysis of a situation which is ill adapted to this technique.

REFERENCES QUOTED

BEHAVIOUR AND PHYSIOLOGY OF BLOWFLIES

- BARTON BROWNE, L. 1958. The relation between ovarian development and mating in Lucilia cuprina. Aust. J. Science, 20, No. 8.
- BELSCHNER, H.G. 1937. Studies on the sheep blowfly problem. II. Observations on fleece rot and body strike in sheep, particularly in regard to their incidence, type of sheep susceptible, and their economic importance. N.S.W. Dept. Agric. Sci. Bull. No. 54.
- BULL, L.E. 1931. Some observations on dermatitis of the folds in the breech of sheep, and its possible relationship to blowfly strike. Aust. Vet. J., 7.
- COLE, P. 1955. Studies on the olfactory responses of certain calliphorine flies. Ph. D. Thesis, University of Durham.
- COUSIN, G. 1929. Series of papers in this volume. C.R. Soc. Biol. C.
- CRAGG, J.B. 1950a. Reactions of Lucilia sericata to various substances placed on sheep. Parasitology, 40.
- CRAGG, J.B. 1950b. Studies on Lucilia species under Danish conditions. Ann. App. Biol., 157.
- CRAGG, J.B. 1955. Natural history of sheep blowflies in Britain. Ann. App. Biol., 42.
- CRAGG, J.B. 1956. Olfactory behaviour of Lucilia species under natural conditions. Ann. App. Biol., 44.
- CRAGG, J.B., and P. COLE. 1956. Laboratory studies on the chemosensory reactions of blowflies. Ann. App. Biol., 44.
- CRAGG, J.B., and L. DAVIES. 1947. Sweating in sheep. Nature, Lond., 159.
- CRAGG, J.B., and G.R. RAMAGE. 1945. Chemotropic studies on Lucilia sericata and Lucilia caesar. Parasitology, 36.
- CRAGG, J.B., and E.A. THURSTON. 1950. Reactions of blowflies to organic sulphur and other compounds used in traps. Parasitology, 40.
- CROSBIE/

- CROMBIE, A.C. 1944. On the measurement and modification of the olfactory responses of blowflies. J. Exp. Biol., 20.
- DAVIES, L. 1948a. Laboratory studies on the egg of the blowfly Lucilia sericata (Meig). J. Exp. Biol., 25.
- DAVIES, L. 1948b. Observations on the development of Lucilia sericata (Meig) eggs in sheep fleeces. J. Exp. Biol., 25.
- DAVIES, L. 1949. The temperature and humidity relations of various stages of some calliphorine flies. Ph. D. Thesis, University of Durham.
- DAVIES, W.M. 1934. The sheep blowfly problem in North Wales. Ann. App. Biol., 21.
- DAVIES, W.M., and R.P. HOBSON. 1935. Sheep blowfly investigation. I. The relationship of humidity to blowfly attack. Ann. App. Biol., 22, No.2.
- DETHIER, V.G. 1955. Mode of action of sugar baited fly traps. J. Econ. Entom., 48.
- EVANS, A.C. 1932. Some aspects of chemical changes during insect metamorphosis. J. Exp. Biol., 9.
- EVANS, A.C. 1934. Studies on the influence of the environment on the sheep blowfly Lucilia sericata Meig. I. The influence of temperature and humidity on the egg. Parasitology, 26.
- EVANS, A.C. 1935a. Studies on the influence of the environment on the sheep blowfly, Lucilia sericata Meig. II. The influence of humidity and temperature on prepupae and pupae. Parasitology, 27.
- EVANS, A.C. 1935b. Studies on the influence of the environment on the sheep blowfly, Lucilia sericata Meig. III. The influence of temperature and humidity on the adult. Parasitology, 27.
- EVANS, A.C. 1935c. Some notes on the biology and physiology of the sheep blowfly Lucilia sericata Meig. Bull. Ent. Res., 26.
- EVANS, A.C. 1936. The physiology of the sheep blowfly Lucilia sericata Meig (Diptera). Trans. Roy. Ent. Soc. Lond., 35, Part 15.
- FRENEY, M.R. 1932a. Sheep blowfly investigation. Experiments on artificial baits: Preliminary note on the products of decomposition of wool fibre (Keratin). J. Counc. Sci. Ind. Res. (Aust.).

- FRENEY, M.R. 1932b. The chemical treatment of baits for attracting blowflies I. J. Counc. Sci. Ind. Res. (Aust).
- FRENEY, M.R. 1937. Studies on the chemotropic behaviour of sheep blowflies. Pamphl. Coun. Sci. Ind. Res. Aust., 74.
- FROGGATT, W.W. 1915. Sheep maggot flies. Dept. of Agric. N.S.W. Farmers' Bull. No. 95.
- FULLER, M.E. 1932. The blowfly problem - Notes on the effect of carcass burial. J. Counc. Sci. Ind. Res. Aust., 5.
- GILMOUR, D., D.F. WATERHOUSE, and G.A. McINTYRE. 1946. An account of experiments undertaken to determine the natural population density of the sheep blowfly *Lucilia cuprina* (Wied).
- GRAHAM-SMITH, G.S. 1919. Further observations on the habits and parasites of common flies. Parasitology, 11.
- GREEN, A.A. 1951. The control of blowflies infesting slaughter houses. I. Field observation on the habits of blowflies. Ann. App. Biol., 38.
- GURNEY, W.B., and A.R. WOODHILL. 1926a. Reports of the external parasites in sheep committee of the Departmental Research Council No. 11. - Range and longevity of sheep blowflies. Agric. Gaz. N.S.W., 37.
- GURNEY, W.B., and A.R. WOODHILL. 1926b. Investigations on sheep blowflies. I. Range of flight and longevity. Sci. Bull. Dept. Agric. N.S.W. No. 27.
- HARLOW, P.M. 1956. A study of ovarian development and its relation to adult nutrition in the blowfly *Protophormia terrae-novae*. J. Exp. Biol., 33.
- HEPBURN, G.A. 1943a. Sheep blowfly research. I. A survey of maggot collections from live sheep and a note on the trapping of blowflies. Onderstepoort J. Vet. Sci., 18.
- HEPBURN, G.A. 1943b. Sheep blowfly investigations. V. Carcasses as sources of blowflies. Onderstepoort J. Vet. Sci., 18.
- HEPBURN, G.A. 1943c. Sheep blowfly research. IV. Field tests with chemically treated carcasses. Onderstepoort J. Vet. Sci., 18.
- HEPBURN, G.A. 1943d. A simple insect cage olfactometer. Onderstepoort J. Vet. Sci., 18.

HEPBURN/

- HEPBURN, G.A., and M.C.A. NOLTE. 1943. Sheep blowfly research. III. Studies on the olfactory reactions of sheep blowflies. Onderstepoort J. Vet. Sci., 18.
- HOBSON, R.P. 1931a. Studies on the nutrition of blowfly larvae. I. Structure and function of the alimentary tract. J. Exp. Biol., 8.
- HOBSON, R.P. 1931b. On an enzyme from blowfly larvae (Lucilia sericata) which digests collagen in alkaline solution. Biochem. J., 25.
- HOBSON, R.P. 1933. Growth of blowfly larvae on blood and serum. I. Response of aseptic larvae to vitamin B. Biochem. J., 27.
- HOBSON, R.P. 1935a. On a fat soluble growth factor required by blowfly larvae. II. Identity of the growth factor with cholesterol. Biochem. J., 29.
- HOBSON, R.P. 1935b. Sheep blowfly investigations. II. Substances which induce Lucilia sericata (Ng) to oviposit on sheep. Ann. App. Biol., 22.
- HOBSON, R.P. 1935c. Growth of blowfly larvae on blood and serum. II. Growth in association with bacteria. Biochem. J., 29, No. 6.
- HOBSON, R.P. 1935d. On a fat soluble growth factor required by blowfly larvae. I. Distribution and properties. Biochem. J., 29, No. 6.
- HOBSON, R.P. 1936a. Sheep blowfly investigations. IV. On the chemistry of the fleece with reference to the susceptibility of the sheep to blowfly attack. Ann. App. Biol., 25, No. 4.
- HOBSON, R.P. 1936b. Sheep blowfly investigations. III. Observations on the chemotropism of Lucilia sericata Mg. Ann. App. Biol., 23.
- HOBSON, R.P. 1938. Sheep blowfly investigations. VII. Observations on the development of the eggs and oviposition in the sheep blowfly Lucilia sericata. Ann. App. Biol., 25, No. 3.
- HOBSON, R.P. 1941. II. Recent work on the sheep maggot problem. Ann. App. Biol., 28, No. 3.
- HOLDAWAY, F.G. 1930. Field populations and natural control of Lucilia sericata. Nature, 126.
- HOLDAWAY, F.G. 1932. Fly strike of sheep: A natural phenomenon. J. Counc. Sci. Ind. Res. Aust., 5.

HOLDAWAY/

- HOLDAWAY, F.G. 1933. Differential behaviour of Lucilia sericata Meig and Lucilia caesar in natural environments. J. An. Ecol., 2.
- HOLDAWAY, F.G., and C.R. MULHEARN. 1934a. Sheep sweat a factor in blowfly attack of sheep. Nature, 134.
- HOLDAWAY, F.G., and C.R. MULHEARN. 1934b. Field observations on weather stain and blowfly strike of sheep with special reference to body strike. Counc. Sci. Ind. Res. Aust. Pamph. No. 48; and N.S.W. Dept. Agric. Sci. Bull. No. 10.
- ILLINGWORTH, J.F. 1923a. Insect fauna of hen manure. Proc. Hawaii Ent. Soc., 5.
- ILLINGWORTH, J.F. 1923b. Insects attracted to carrion in Hawaii. Proc. Hawaii Ent. Soc., 5.
- JOHNSTON, T.H. 1923. A survey of the Australian sheep blowfly problem. Trans. and Proc. Roy. Soc. 5th. Aust., 47.
- JOHNSTON, T.H., and C.W. TIEGS. 1922. Notes on the biology of some of the more common Queensland Muscoid flies. Proc. Roy. Soc. Queensland, 34.
- JOINT BLOWFLY COMMITTEE. 1933. The sheep blowfly problem in Australia. Report No. 1. Counc. Sci. Ind. Res. Aust. Pamph. No. 37. Dept. of Agric. N.S.W. Sci. Bull. No. 40.
- LEE, D.J. 1937. A laboratory method for testing tropisms of blowflies. J. Counc. Sci. Ind. Res. (Aust.), 10, No. 4.
- LENNOX, F.G. 1939. The development of a synthetic culture medium for aseptic cultivation of larvae of Lucilia cuprina. Counc. Sci. Ind. Res. (Aust.) Pamph. 90.
- LEWIS, E.A. 1935. Observations on some Diptera and myiasis in Kenya Colony. Bull. Ent. Res., 24.
- MACKERASS, I.M. 1936. The sheep blowfly problem in Australia; results of some recent investigations. Pamphl. Counc. Sci. Ind. Res. Aust., No. 66.
- MACKERASS, I.M., and M.E. FULLER. 1937. A survey of the Australian sheep blowflies. J. Counc. Sci. Ind. Res. Aust., 10.
- MACKERASS, I.M., and M.J. MACKERASS. 1944. Sheep blowfly investigations. The attractiveness of sheep for Lucilia cuprina. Counc. Sci. Ind. Res. Aust. Bull. No. 181.
- MACKERASS/

- MACKERASS, M.J. 1933. Observations on the life histories; nutritional requirements and fecundity of blowflies. Bull. Ent. Res., 24.
- MACKERASS, M.J., and M.R. FRENEY. 1933. Observations on the nutrition of maggots and Australian blowflies. J. Exp. Biol., 10.
- MACLEOD, J. 1940. The moisture balance of the living sheep in relation to blowfly myiasis. Ann. App. Biol., 27.
- MACLEOD, J. 1943a. A survey of British sheep blowflies. II. Relation of strikes to host and edaphic features. Bull. Ent. Res., 34.
- MACLEOD, J. 1943b. A survey of British sheep blowflies. Bull. Ent. Res., 34.
- MACLEOD, J. 1949. The climatology of blowfly myiasis. III. Oviposition and daily weather indices. Bull. Ent. Res., 40, Part 2.
- MACLEOD, J., and J. DONNELLY. 1956. Methods for the study of blowfly populations. I. Bait trapping significance limits for comparative sampling. Ann. App. Biol., 44, No. 1.
- MESSER, F.C., and R.H. McCLELLAN. 1935. Surgical maggots. A study of their functions in wound healing. J. Lab. Clin. Med., 20, No. 12.
- MONNIG, H.C. 1943. Sheep blowfly research. VI. The treatment of myiasis. Onderstepoort J. Vet. Sci., 18.
- MONNIG, H.C., and P.A. CILLIERS. 1944. Sheep blowfly research VII. Investigations in the Cape winter rainfall area. Onderstepoort J. Vet. Sci., 19.
- NICHOLSON, A.J. 1934. The influence of temperature on the activity of sheep blowflies. Bull. Ent. Res., 25.
- NICHOLSON, A.J. 1957. The self adjustment of populations to change. Cold Spr. Harb. Symp. 1957, 22.
- NOLTE, M.C.A. 1943. Sheep blowfly research. II. Suint investigations. Onderstepoort J. Vet. Sci., 18.
- ROGOFF, W.M., and L. BARTON-BROWNE. 1958. The oviposition behaviour of the Australian sheep blowfly Lucilia cuprina (Wied). Proc. Xth International Congress of Entomology, 2, 1956 (1958).

- SALT, G. 1932. The natural control of the sheep blowfly, Lucilia sericata (Weig). Bull. Ent. Res., 23.
- SEDDON, H.R. 1931. Conditions which predispose sheep to blowfly attack. Agric. Gaz. N.S.W., 42.
- SEDDON, H.R., H.G. BELSCHNER, and C.R. MULHEARN. 1931. Studies on Cutaneous myiasis of sheep. (Sheep blowfly attack). Dept. of Agric. N.S.W. Science Bull. No. 37.
- SMIT, B. 1931. A study of the sheep blowflies of South Africa. 17th Rept. Director Vet. Serv. and Anim. Ind., Union S. Africa.
- THOMSEN, M., and O. HAMMER. 1936. The breeding medium of some common flies. Bull. Ent. Res., 27.
- ULLYETT, G.C. 1945. Species of Lucilia attacking sheep in South Africa. Nature, 155.
- ULLYETT, G.C. 1950. Competition for food and allied phenomenon in sheep blowfly populations. Phil. Trans. B., 234.
- WARDLE, R.A. 1930. Significant variables in the blowfly environment. Ann. App. Biol., 17.
- WATERHOUSE, D.F. 1947a. The relative importance of live sheep and of carrion as breeding grounds for the Australian sheep blowfly Lucilia cuprina. Counc. Sci. Ind. Res. Aust. Bull. No. 217.
- WATERHOUSE, D.F. 1947b. Studies of the physiology and toxicology of blowflies. 13. Insectary tests of repellents for the Australian sheep blowfly Lucilia cuprina. Counc. Sci. Ind. Res. Austr. Bull. No. 218.
- WATERHOUSE, D.F., and S.J. PARAMANCV. 1950. The status of two species of Lucilia attacking sheep in Australia. Aust. J. Sci. Res. B., 3.
- WEBBER, L.G. 1955. The relationship between larval and adult size of the Australian sheep blowfly Lucilia cuprina (Wied). Aust. J. Zool., 3.

GENETICS AND EVOLUTION OF BEHAVIOUR

- BASTOCK, M. 1956. A gene mutation which changes a behaviour pattern. Evolution, 10, No. 4.
- BASTOCK, M. 1958. XVth International Congress of Zoology, Sect. XI, Paper 31.
- BASTOCK, M., and A. MANNING. 1955. The courtship of Drosophila melanogaster. Behaviour, 8.
- BLAIR, W.F., and M.J. LITTLEJOHN. 1960. Stage of speciation of two allopatric populations of chorus frogs. (Pseudacris). Evolution, 24, No. 1.
- BROADHURST, P.L. 1957. Determinants of emotionality in the rat: I. Situational factors. Brit. J. Psychol., 48, Part 1.
- BROADHURST, P.L. 1959. Application of biometrical genetics to behaviour in rats. Nature, 184.
- BRODY, E.G. 1942. Genetic basis of spontaneous activity in the albino rat. Comp. Psychol. Monog., 17, No. 5.
- CATTELL, R.B. 1940. The problem of nature-nurture research; effects of human fertility trends upon the distribution of intelligence and culture. Year. Bk. Nat. Soc. Stud. Educ., 29, Part 1.
- CLARK, E., H.R. ARONSON, and E. GORDON. 1954. Mating behaviour patterns in two sympatric species of Kiphochorin fish; their inheritance and significance in sexual isolation. Bull. Amer. Nat. Hist. Mus., 103.
- COBURN, C.A. 1922. Heredity of wildness and savageness in mice. Behav. Monogr., 4, No. 5.
- DAS, G., and P.L. BROADHURST. 1959. The effect of inherited differences in emotional reactivity on a measure of intelligence in the rat. J. Comp. and Physiol. Psychol., 52, (3).
- DATSON, W.M. 1952. Inheritance of wildness and tameness in mice. Genetics, 17.
- DEGENER, V.H., S. ROSS, P.B. SAWIN, and B.P. FROMMER. 1957. Genetic, physiological and behavioural background of reproduction in rabbit. IV. An analysis of maternal behaviour in multiparous rabbits. Behaviour, 13.

DICE/

- DICE, L.R., and S.A. HOSLETT. 1940. Variation in the spontaneous activity of Peromyscus, as shown by recording wheels. Contrib. Lab. Vert. Biol. Univ. Mich., 47.
- FOSTER, D.D. 1959. Differences in behaviour and temperament between two races of the deer mouse. J. Mammal., 40.
- GOY, R.W., and J.S. JAKWAY. 1959. The inheritance of patterns of sexual behaviour in female guinea pigs. Anim. Behav., 7, (3/4).
- HALL, C.S. Emotioanl behaviour in the rat. I. Defecations and urination as measures of individual differences in emotionality. J. Comp. Psychol., 18.
- HALL, V.E., and M. LINDSAY. 1938. The relation of the thyroid gland to spontaneous activity of the rat. Endocrin, 22.
- HERTER, K. 1933. Dressurversuche mit Igelrn. Zs. Vergl. Physiol., 18.
- HERTER, K. 1941. Die Vorsugstemperaturen bei handtiere. Naturwiss, 29.
- HINDE, R.A. 1956. The behaviour of certain Cardueline F1 inter species hybrids. Behaviour, 9.
- HIRSCH, J. 1958. Recent developments in behaviour genetics and differential psychology. Dis. Nerv. Syst. (Monogr. Suppl.), 19.
- HIRSCH, J. 1959. Studies in experimental behaviour genetics. II. Individual differences in geotaxis as a function of chromosome variation in synthesized Drosophila populations. J. of Comp. and Physiol. Psychol., 52, No. 3.
- HIRSCH, J., and J.C. BOUDREAU. 1958. Studies in experimental behaviour genetics. I. The heritability of phototaxis in a population of Drosophila melanogaster. J. Comp. and Physiol., Psychol., 51.
- HIRSCH, J., and R.C. TRYON. 1956. Mass screening and reliable individual measurement in the experimental behaviour genetics of lower organisms. Psychol. Bull., 53.
- "HORMANN-HECK, S. VON. 1957. Untersuchungen " über den Erbgang einiger Verhaltensweisen bei Gryllenbastarden. Z. Tierpsychol., 14.
- HOVANITZ, W. 1953. Polymorphism in evolution. Symp. Soc. Exp. Biol., 7.
- JAKWAY/

- JAKWAY, J.S. 1959. Inheritance of patterns of mating behaviour in the male guinea pig. Anim. Behav., 7, (3/4).
- KEELER, C.E. 1942. The association of the black (non agouti) gene with behaviour. J. Hered., 33.
- KEELER, C.E., and H.D. KING. 1942. Multiple effects of coat colour genes in the Norway rat, with special reference to temperament and domestication. J. Comp. Psychol., 34.
- TUPPUSAWNY, B. 1941. An examination of the results of MacDougall's Lamarckian experiment. J. Mysore Univ.
- LEOPOLD, A.S. 1944. The nature of heritable wildness in turkeys. Condor, 46.
- LORENZ, K. 1958. The evolution of behaviour. Sci. Amer., 199.
- MILLER, D.D. 1950. Mating behaviour in Drosophila affinis and Drosophila algonquin. Evolution, 4.
- MCCLEARN, G.E. 1959. The genetics of mouse behaviour in novel situations. J. Comp. and Physiol. Psychol., 52, (1).
- MCDUGALL, W. 1927. An experiment for the testing of the hypothesis of Lamarck. Brit. J. Psychol., 17.
- MCDUGALL, W. 1930. Second report on a Lamarckian experiment. Brit. J. Psychol., 20.
- NACHMAN, M. 1959. The inheritance of saccharin preference. J. Comp. and Physiol. Psychol., 52.
- ROSS, S., V.H. DENENBERG, G.P. FROMER, and P.B. SAWIN. 1959. Genetic, physiological and behavioural background of reproduction in the rabbit. V. Non retrieving of neonates. J. Mammal., 40, (1).
- RUNDQUIST, E.A. 1933. Inheritance of spontaneous activity in rats. J. Comp. Psychol., 16.
- RUNDQUIST, E.A., and C.J. BELLIS. 1933. Respiratory metabolism of active and inactive rats. Amer. J. Physiol., 116.
- SAKAGAMI, S.F., and Y. AKAHIRA. 1960. Studies on the Japanese honey bee, Apis cerana cerana Fabricius. VIII. Two opposing adaptations in the post stinging behaviour of honey bees. Evolution, 14, Part 1.

SCOTT/

- SCOTT, J.P. 1937. Inherited behaviour in Drosophila. Proc. Indiana Acad. Sci., 46.
- SCOTT, J.P. 1942. Genetic differences in the social behaviour of inbred strains of mice. J. Hered., 33.
- SCOTT, J.P. 1943. Effects of single genes on the behaviour of Drosophila. Amer. Naturalist., 77.
- SCOTT, J.P. 1954. The effects of domestication and selection upon the behaviour of the dog. J. Natl. Cancer. Inst., 15, Part 1.
- SHEPPARD, P.M. 1952. A note on non random mating in the moth Panaxia dominula (L). Heredity, 6.
- SPIETH, H.T. 1952. Mating behaviour within the genus Drosophila. Bull. Amer. Mus. Nat. Hist., 99.
- SPIETH, H.T., and T.C. HSU. 1950. The influence of light on the mating behaviour of seven species of the Drosophila melanogaster species group. Evolution, 4.
- STONE, P. 1942. Maturation and "Instinctive" Functions. Comparative Psychology. Edit. F.A. Moss, New York, Prentice Hall.
- THOMPSON, W.R. 1956. The inheritance of behaviour. Activity differences in five inbred mouse strains. J. Hered., 47.
- THOMPSON, W.R. 1957. Traits, factors and genes. Bugen. Quart., 4, No. 1.
- TINBERGEN, N. 1951. The study of instinct. Oxford Press.
- TRYON, R.C. 1935. A theory of psychological components an alternative to 'mathematical factors'. Psychol. Rev., 42.
- TRYON, R.C. 1940a. Studies in individual differences in maze ability. VII. The specific components of maze ability, and a general theory of psychological components. J. Comp. Psychol., 30.
- TRYON, R.C. 1940b. Genetic differences in maze learning ability in rats. Year Bk. Nat. Soc. Stud. Educ., 39 (1).
- TRYON, R.C. 1942. Individual differences. 'Comparative Psychology'. Edit. F.A. Moss, New York, Prentice Hall.
- TRYON/

- TRYON, R.C., C.E. TRYON, and G. KUZNETS. 1941a. Studies in individual differences in maze ability. IX. Ratings of hiding, avoidance, escape and vocalisation responses. J. Comp. Psychol., 32.
- TRYON, R.C., C.E. TRYON, and G. KUZNETS. 1941b. Studies in individual difference in maze ability. X. Ratings and other measures of initial emotional responses of rats to novel inanimate objects. J. Comp. Psychol., 32.
- WHERRY, R.J. 1941. Determination of the specific components of maze ability for Tryon's bright and dull rats by means of factorial analysis. J. Comp. Psychol., 32.
- YERKES, R.M. 1915. Heredity of savageness and wildness in rats. J. Anim. Behav., 3, No. 4.

MISCELLANEOUS

- LENER, I.M. 1954. "Genetic Homeostasis". Oliver and Boyd.
- LI, C.C. 1955. "Population Genetics". University of Chicago Press.
- MATHER, K. 1949. "Biometrical Genetics". Methuen: London.
- PETERS, C.C., and W.R. VAN VOORNIS. 1940. "Statistical Procedures and their Mathematical Bases". McGraw Hill, New York and London.
- SNEDECOR, G.W. 1946. "Statistical Methods". Iowa State College Press.