



Durham E-Theses

Studies on the movements, population dynamics and food of Apodemus Sylvaticus (L.) and Clethrionomys Glareolus schr

Crawley, Malcolm C.

How to cite:

Crawley, Malcolm C. (1965) *Studies on the movements, population dynamics and food of Apodemus Sylvaticus (L.) and Clethrionomys Glareolus schr*, Durham theses, Durham University. Available at Durham E-Theses Online: <http://etheses.dur.ac.uk/9078/>

Use policy

The full-text may be used and/or reproduced, and given to third parties in any format or medium, without prior permission or charge, for personal research or study, educational, or not-for-profit purposes provided that:

- a full bibliographic reference is made to the original source
- a [link](#) is made to the metadata record in Durham E-Theses
- the full-text is not changed in any way

The full-text must not be sold in any format or medium without the formal permission of the copyright holders.

Please consult the [full Durham E-Theses policy](#) for further details.

Academic Support Office, Durham University, University Office, Old Elvet, Durham DH1 3HP
e-mail: e-theses.admin@dur.ac.uk Tel: +44 0191 334 6107
<http://etheses.dur.ac.uk>

STUDIES ON THE MOVEMENTS, POPULATION DYNAMICS
AND FOOD OF APODEMUS SYLVATICUS (L.) AND
CLETHRIONOMYS GLAREOLUS Schr.

by

Malcolm C. Crawley, B.Sc. (Dunelm)
(Grey College)

.....being a thesis presented in candidature for
the degree of Doctor of Philosophy in the University
of Durham, 1965.

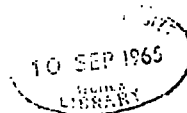

ACKNOWLEDGEMENTS

The writer wishes to express his thanks to Dr. K.R. Ashby who supervised the work, and Professor D. Barker for making available the facilities in the Department of Zoology, Durham.

Thanks are also due to:-

Members of the Department of Zoology for helpful discussion,

Mr. D. Snaith for photographic assistance,

The Peterlee Development Corporation for permission to work in Castle Eden Dene,

Mrs. M. Crawley for help and encouragement throughout the preparation of this thesis, for help in correcting the script, and for typing the preliminary and final drafts.

The work was carried out whilst the writer was in receipt of a D.S.I.R. Research Studentship.

CONTENTS

	Pages
SECTION A. INTRODUCTION AND GENERAL	
I. GENERAL INTRODUCTION.....	1
II. THE STUDY AREA.....	5
A. GENERAL.....	5
1. Location and general physiography.....	5
2. History.....	5
3. Geology.....	6
4. Vegetation.....	6
B. THE TRAPPING GRIDS.....	6
1. Introduction.....	8
2. Grid A (north).....	9
a) General description.....	9
b) Vegetation.....	9
3. Grid B (south).....	12
a) General description.....	12
b) Vegetation.....	13
4. Additional trapping areas.....	14
III. METHODS OF STUDY.....	15
A. TRAPPING AND MARKING PROCEDURE.....	15
1. Trapping procedure.....	15
2. Marking procedure.....	17
B. DATA RECORDED.....	17
1. Sex and sexual condition.....	17
a) Males.....	18
b) Females.....	18

2.	Weight.....	20
3.	Other information.....	20
SECTION B. THE POPULATION DYNAMICS OF <u>APODEMUS</u> <u>AND CLETHRIONOMYS</u>		
I.	THE TRAPPING RESULTS.....	21
1.	The numbers caught.....	21
2.	Trap mortality.....	22
3.	Trap-revealed sex-ratio.....	25
4.	Average recapture index.....	34
II.	THE ESTIMATION OF POPULATION PARAMETERS.....	37
1.	Introduction.....	37
2.	Hayne's Method of Estimation.....	39
3.	The Maximum Likelihood Method of Estimation.....	41
III.	CHANGES IN POPULATION SIZE FROM MARCH 1963 TO JANUARY 1965.....	47
1.	Introduction.....	47
2.	Population trends in the <u>Apodemus</u> and <u>Clethrionomys</u> populations.....	47
a)	The <u>Clethrionomys</u> population on grid A.	47
b)	The <u>Apodemus</u> population on grid A.....	50
c)	The <u>Clethrionomys</u> population on grid B.	52
d)	The <u>Apodemus</u> population on grid B.....	53
e)	A comparison of the performance of the <u>Clethrionomys</u> populations on grid A and grid B.....	53
f)	A comparison of the performance of the <u>Apodemus</u> populations on grid A and grid B.....	56

3.	The population estimates of the sexes treated separately.....	57
4.	The density per acre of the <u>Clethrionomys</u> and <u>Apodemus</u> populations on grid A and grid B.....	58
5.	Summary and discussion.....	62
IV.	SURVIVAL.....	78
1.	Survival of the total population.....	78
a)	<u>Clethrionomys</u> . Grid A.....	78
b)	<u>Clethrionomys</u> . Grid B.....	79
c)	A comparison of the survival of the two sexes of <u>Clethrionomys</u> on grid A...	81
d)	A comparison of the survival of the two sexes of <u>Clethrionomys</u> on grid B...	81
e)	The survival of <u>Apodemus</u> on grid A.....	82
2.	The survival of different cohorts of animals in the total population.....	83
a)	Introduction.....	83
b)	<u>Clethrionomys</u> . Grid A.....	85
c)	<u>Clethrionomys</u> . Grid B.....	86
d)	The survival of the different cohorts of the two sexes of <u>Clethrionomys</u> on grid A and grid B.....	90
3.	The life-span of <u>Clethrionomys</u> and <u>Apodemus</u>	90
4.	Summary and discussion.....	94
V.	BREEDING.....	97
1.	The breeding of <u>Clethrionomys</u> on grid A....	97
2.	The breeding of <u>Clethrionomys</u> on grid B....	101
3.	Pregnant females.....	104

4.	A comparison of the breeding of <u>Clethrionomys</u> on grid A and grid B.....	104
5.	The breeding of <u>Apodemus</u> on grid A and grid B.....	105
6.	Summary and discussion.....	110
VI.	AGE-STRUCTURE OF THE POPULATIONS.....	120
1.	Introduction.....	120
2.	The frequency distributions of body-weights	122
a)	The body-weights of <u>Clethrionomys</u> males on grid A.....	122
b)	The body-weights of <u>Clethrionomys</u> males on grid B.....	125
c)	The body weights of <u>Clethrionomys</u> females on grid A.....	127
d)	The body-weights of <u>Clethrionomys</u> females on grid B.....	130
e)	The body-weights of <u>Apodemus</u> males on grid A.....	131
f)	The body-weights of <u>Apodemus</u> females on grid A.....	134
SECTION C.	THE EFFECT OF HABITAT ON THE POPULATION DYNAMICS, AND THE DISTRIBUTION AND ABUNDANCE OF <u>CLETHRIONOMYS</u> AND <u>APODEMUS</u>	137
I.	INTRODUCTION.....	137
II.	THE POPULATION DYNAMICS OF <u>CLETHRIONOMYS</u> AND <u>APODEMUS</u> IN DIFFERENT HABITATS.....	138
1.	Changes in population size of <u>Clethrionomys</u> on the two halves of grid A from March 1963 to January 1965.....	138
2.	Changes in population size of <u>Apodemus</u> on the two halves of grid A.....	141
3.	Changes in population size of <u>Clethrionomys</u> on the two halves of grid B.....	141

4.	The survival, breeding, and age-structure of populations of <u>Clethrionomys</u> and <u>Apodemus</u> living in different habitats.....	145
III.	SEASONAL CHANGES IN THE DISTRIBUTION OF <u>CLETHRIONOMYS</u> AND <u>APODEMUS</u> WITH REFERENCE TO CHANGES IN THE VEGETATION.....	145
1.	Introduction.....	145
2.	Seasonal changes in the distribution and abundance of <u>Clethrionomys</u> and <u>Apodemus</u> on grids A and B.....	146
a)	<u>Clethrionomys</u> . Grid A.....	146
b)	<u>Clethrionomys</u> . Grid B.....	149
c)	<u>Apodemus</u> . Grid A.....	151
d)	<u>Apodemus</u> . Grid B.....	152
3.	The influence of vegetation type upon the distribution and abundance of <u>Clethrionomys</u> and <u>Apodemus</u>	153
a)	<u>Clethrionomys</u>	153
b)	<u>Apodemus</u>	154
IV.	THE RELATIONSHIP BETWEEN THE DENSITY OF THE VEGETATION COVER AND THE DISTRIBUTION AND ABUNDANCE OF <u>CLETHRIONOMYS</u> AND <u>APODEMUS</u>	155
1.	Introduction.....	155
2.	The general relationship between the density of cover and the distribution of rodents.....	156
3.	The detailed relationship between the degree of protective cover afforded by the vegetation and the distribution and abundance of <u>Clethrionomys</u> and <u>Apodemus</u>	158
a)	<u>Clethrionomys</u> . Grid A.....	158
b)	<u>Clethrionomys</u> . Grid B.....	160

c)	<u>Apodemus</u> . Grid A.....	160
d)	Conclusions.....	161
4.	The utilisation of temporarily-available favourable habitats by <u>Clethrionomys</u>	162
a)	Introduction.....	162
b)	Method of analysis.....	163
c)	Results.....	165
5.	Discussion.....	166
SECTION D. MOVEMENTS AND HOME-RANGE OF <u>CLETHRIONOMYS</u> AND <u>APODEMUS</u>		
(A.)	<u>GENERAL INTRODUCTION</u>	172
1.	The aims of the study.....	172
2.	The procedure followed in the examination of movements and home range.....	173
(B.)	<u>MOVEMENTS</u>	174
I.	INTRODUCTION.....	174
II.	THE NUMBER OF ANIMALS USED IN THE STUDY OF MOVEMENTS.....	176
III.	MAXIMUM MOVEMENTS.....	178
1.	Introduction.....	178
2.	Seasonal variation in the frequency distributions of maximum movements made by both sexes of <u>Clethrionomys</u> and <u>Apodemus</u> ...	179
a)	<u>Clethrionomys</u> . Males.....	179
b)	<u>Clethrionomys</u> . Females.....	181
c)	<u>Apodemus</u> . Males.....	183
d)	<u>Apodemus</u> . Females.....	185

2.	A comparison of the frequency distributions of maximum movements of <u>Clethrionomys</u> and <u>Apodemus</u>	187
	a) Males.....	187
	b) Females.....	187
3.	Sexual differences in the frequency distributions of maximum movements.....	188
	a) <u>Clethrionomys</u>	188
	b) <u>Apodemus</u>	189
4.	A comparison of the frequency distributions of maximum movements of both species on grid A and grid B.....	190
5.	A summary of the results of the analysis of maximum movements of <u>Clethrionomys</u> and <u>Apodemus</u>	195
IV.	MOVEMENT PATTERNS.....	200
1.	Introduction.....	200
	1) Change in home range area.....	201
	2) Transition stage movements.....	202
	3) Exploratory movements.....	202
	4) Dispersal and wandering.....	203
V.	MAXIMUM RANGE LENGTH MEASUREMENTS.....	205
1.	Introduction.....	205
2.	Results.....	205
VI.	DISCUSSION.....	209
(C.)	<u>HOME RANGE</u>	215
I.	INTRODUCTION.....	215
1.	The concept of home range in small mammals.	215
2.	The validity of trap-revealed home range size.....	219

3.	The methods used to estimate home range size.....	222
	a) The Minimum Area Method.....	223
	b) Boundary Strip Methods.....	223
	i. Inclusive Boundary Strip.....	223
	ii. Exclusive Boundary Strip.....	224
	c) Manville's (1949) Method.....	224
	d) Maximum Range Length Methods.....	225
4.	The validity of the methods of estimation of home range size.....	225
II.	THE NUMBER OF ANIMALS UNDER CONSIDERATION....	226
III.	THE ESTIMATES OF TRAP-REVEALED HOME RANGE SIZE.....	226
1.	The influence of sex, number of recaptures and method of estimation on home range size estimates.....	226
	a) <u>Clethrionomys</u> . Males.....	226
	b) <u>Clethrionomys</u> . Females.....	232
	c) <u>Apodemus</u> . Males.....	233
	d) <u>Apodemus</u> . Females.....	236
2.	A comparison of the size of home range in <u>Clethrionomys</u> and <u>Apodemus</u>	239
3.	A comparison of home range size of <u>Clethrionomys</u> and <u>Apodemus</u> on the two grids	240
	a) <u>Clethrionomys</u>	240
	b) <u>Apodemus</u>	245
	c) Conclusions.....	250
4.	Home range size and vegetation type.....	250

IV.	THE EFFECT ON ESTIMATES OF HOME RANGE SIZE OF THE NUMBER OF RECAPTURES PER ANIMAL.....	252
V.	DISCUSSION.....	254
1.	Home range size.....	254
2.	Factors affecting home range size.....	263
a)	Sex.....	263
b)	Age.....	264
c)	Food habits.....	264
d)	Food and cover.....	264
e)	Season.....	265
3.	The value of the home range concept.....	265
SECTION E.	THE BIOCHEMICAL ANALYSIS OF STOMACH CONTENTS OF <u>CLETHRIONOMYS</u> AND <u>APODEMUS</u>	268
I.	INTRODUCTION.....	268
II.	METHODS OF STUDY.....	269
1.	The preparation of the samples for analysis.....	269
2.	The quantitative estimation of fat content using the Soxhlet Apparatus.....	270
a)	The principle of the method.....	270
b)	The Micro-Soxhlet Extraction Apparatus.....	271
c)	The procedure followed in the estimat- ion of fat content in a prepared sample.....	271
3.	The quantitative estimation of 'crude protein' using the Kjeldahl Method for the determination of Total Nitrogen.....	273
a)	The principle of the method.....	273
b)	The Markham Micro-Kjeldahl Apparatus... ..	273
c)	The procedure followed in the estimat- ion of the 'crude protein' content of a prepared sample.....	274

4.	The 'total carbohydrate' portion of the sample.....	276
5.	The final data recorded for each sample after analysis.....	277
III.	RESULTS.....	277
1.	<u>Clethrionomys</u>	277
a)	Water content of the samples.....	278
b)	The 'crude protein' content of the samples.....	278
c)	The fat (ether-extract) content of the samples.....	278
d)	The 'total carbohydrate' content of the samples.....	280
2.	<u>Apodemus</u>	280
a)	Water content of the samples.....	282
b)	The 'crude protein' content of the samples.....	282
c)	The fat (ether-extract) content of the samples.....	282
d)	The 'total carbohydrate' content of the samples.....	283
3.	A comparison of the results of the analyses of the stomach contents of <u>Clethrionomys</u> and <u>Apodemus</u>	283
IV.	CONCLUSIONS.....	284
SECTION F.	GENERAL DISCUSSION AND SUMMARY.....	286
	GENERAL DISCUSSION.....	286
1.	A brief review of the present study.....	286
2.	Factors affecting population size.....	287
3.	Habitat and the ecology of <u>Clethrionomys</u> ...	292

4. The trappability of <u>Clethrionomys</u> and <u>Apodemus</u>	295
5. Suggestions for further research.....	297
SUMMARY.....	299
BIBLIOGRAPHY.....	310
APPENDIX I. LIVE-TRAPPING FOR SMALL RODENTS AND WEASELS IN A 100 ACRE AREA OF CASTLE EDEN DENE.....	337
I. INTRODUCTION.....	337
II. THE STUDY AREA.....	337
III. METHODS OF STUDY.....	338
IV. RESULTS.....	339
APPENDIX II. A SPECIES LIST OF FLEAS TAKEN FROM RODENTS AND SHREWS IN CASTLE EDEN DENE.....	352

SECTION A.

INTRODUCTION AND GENERAL.

SECTION A. INTRODUCTION AND GENERAL

I. GENERAL INTRODUCTION

Since 1930 many investigations into the ecology of small rodents have been carried out in Great Britain. The majority of the earlier studies were concerned with various aspects of the ecology of the Short-tailed Vole, Microtus agrestis (L.), partly because of its importance as an agricultural pest, and partly because of the interest shown in cyclic fluctuations in numbers of many animals, of which Microtus is one. The more important studies made were on the reproduction (Baker and Ranson, 1932, 1933; Rowlands 1936; Brambell and Hall 1939), the rhythmic activity (Davis 1933), the epidemiology (Findlay and Middleton 1934; Elton, Davis, and Findlay 1935), and the population dynamics of the vole (Elton, Ford, Baker, and Gardner 1931; Chitty 1937, 1938, 1952). Some of the investigations, however, were concerned also with the Bank Vole, Clethrionomys glareolus Schr., and the Long-tailed Woodmouse, Apodemus sylvaticus (L.) (Baker 1930; Elton et al 1931; Brambell and Rowlands 1936; Chitty and Kempson 1949). After the original emphasis on investigations concerning Microtus had lessened, Clethrionomys and Apodemus became increasingly important as the subjects of ecological studies.

Evans (1942) carried out studies on the population dynamics, movements, and spatial distribution of Clethrionomys



and Apodemus in mixed woodland in Berkshire, and as a result of these studies he contributed a great deal to the knowledge of the ecology of the two species. Since the work of Evans (1942) a lot of work has been performed on field populations of Clethrionomys and Apodemus, with studies being made on the movements (Brown 1956a; Miller 1958; Hacker and Pearson 1951, 1952; Newson 1960; Kikkawa 1964; Tanton 1965), the home range (Brown 1956a; Miller 1958; Kikkawa 1964), the activity rhythm (Brown 1956b; Miller 1955), and the spatial distribution (Delany 1961; Newson 1960; Kikkawa 1964) of the two species. In addition to these studies others have been performed on more general aspects of the population dynamics (Brown 1954; Miller 1958; Ashby 1962; Newson 1963; Kikkawa 1964; Tanton 1965), and the effects on the regeneration of woodland (Ashby 1959, 1962) of the two species.

The present study was designed to obtain information on the population dynamics, the movements and home range, and the spatial distribution of Clethrionomys and Apodemus in areas of mixed woodland where they existed together. The study had four main aims which were, firstly, to examine the ecology of Clethrionomys and Apodemus in northern England (an area previously neglected except by Ashby 1959, 1962); secondly, to attempt to clarify certain issues concerned with the measurement of home range area; thirdly, to examine the mortality of Clethrionomys in natural populations to see whether it is high

as described by Evans (1942) or lower as was found by Ashby (pers. comm.); and fourthly, to carry out exploratory work on the biochemical analysis of stomach contents of individuals of Clethrionomys and Apodemus to see if any information could be obtained on the nature of the food ingested. Information has been obtained on all the topics mentioned above, and this thesis contributes to the general fund of knowledge of the ecology of the two species and also opens up possibilities for further work on the food taken.

In this thesis the present results have been compared with the results of other workers who have worked on populations of Apodemus and Clethrionomys in Great Britain. (Evans 1942; Newson 1960, 1963; Kikkawa 1964). Also, where relevant, reference has been made to the vast amount of work done in America on the ecology of Peromyscus spp. (the ecological counterpart in America of Apodemus) and of Clethrionomys spp. (red-backed voles). Particularly important work has been done there on the home range (Blair 1940a, 1941, 1951; Burt 1940, 1943; Hayne, 1949b, 1950; Davis 1953; Davis et al 1948), the spatial distribution (Klein 1960; Getz 1960, 1961a 1961b), and the population dynamics (Hayne 1949a; Brant 1962) of Peromyscus, Clethrionomys, Microtus, and many other genera of small mammals. In addition, consideration has been given to work on the Continental Vole, Microtus arvalis Pallas (Frank 1957; van Wijngaarden 1957, 1960), the Yellow-necked Mouse,

Apodemus flavicollis (Gorecki and Gebczyńska 1962; Curry-Lindahl 1956, 1959;) and Clethrionomys glareolus and Apodemus sylvaticus (Andrzejewski et al 1963) in various European countries. Details of this and other work are to be found in the discussions of the results of the present study.

The information in this thesis is presented in four main sections, these dealing with the population dynamics, the distribution and abundance, the movements and home range, and the biochemical composition of the stomach contents of Apodemus and Clethrionomys. A discussion on each section is given in the appropriate place, and the information given in the thesis as a whole is discussed in general terms in the final section.

In this thesis botanical nomenclature follows that of Clapham, Tutin, and Warburg (1952. 2nd. Edition).

II. THE STUDY AREA

A. GENERAL

1. Location and General physiography

All the field work was carried out in Castle Eden Dene, a local Nature Reserve, situated ten miles east of Durham City and midway between the villages of Castle Eden and Shotton (Nat. Grid Ref. NZ4138 and NZ4139). The A19 trunk road, which runs in a north-south direction, passes through Shotton and forms the western boundary of the Dene. (See Fig. 1.) Castle Eden Dene (hereafter referred to as 'the Dene') is a long, narrow, locally precipitous valley running in an east-west direction, opening to the North Sea in the east. A shallow stream polluted by colliery effluent, Castle Eden Burn, flows along the valley bottom. The total area of the reserve is some 530 acres, of which 100 acres at the narrow western extremity were utilised for the present study.

2. History

The Dene has long been known to naturalists because of the wealth of calicolous flora which abounds, associated with the cliffs of magnesian limestone. Entomologists have also been interested in the area, as there is an overlap there in the ranges of two species of butterfly, the southern Brown

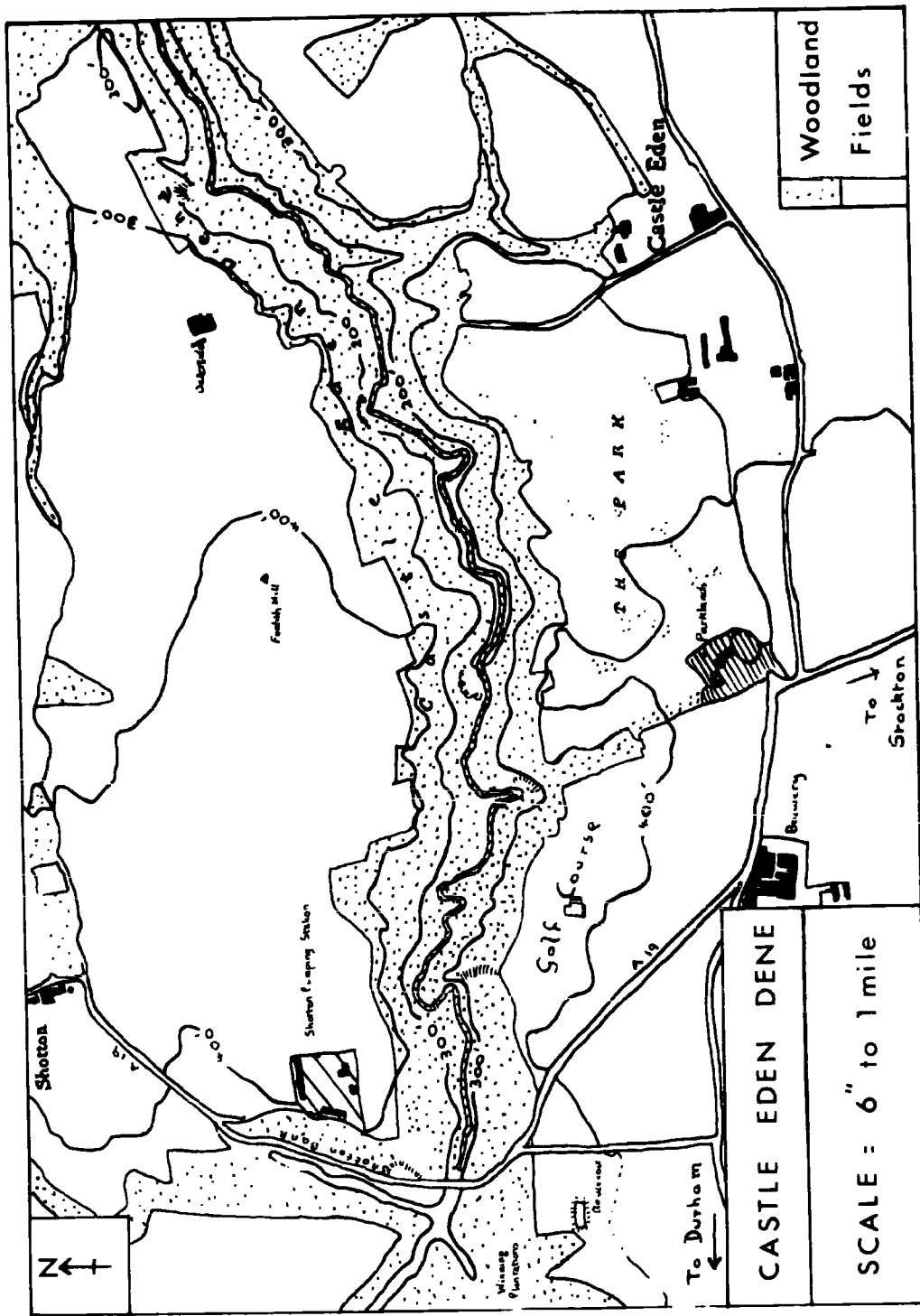

FIGURE 1. Map of Castle Eden Dene showing the woodland, surrounding fields, and the 200', 300', and 400' contours. National Ordnance Survey Map (1923. Durnam. Sheet X.VIII).

Argus (Aricia medon), and the Scotch Argus (Aricia medon artaxerxes), which has resulted in the formation of a variety loosely termed the Castle Eden Argus.

In 1954 the Dene was designated a Local Nature Reserve following the recommendations of Professor Heslop-Harrison (Private Report). However, despite the sporadic interest in the Dene shown by naturalists, no systematic work on the fauna of the region had been performed prior to this study.

3. Geology

The Dene is covered by boulder clay, left as a result of glacial action, and it has not been re-sorted by water as in the centre of the county. The bed rock is magnesian limestone. At the western end of the valley the stream flows on top of the limestone, but as it flows eastward it gradually cuts through the rock, forming a gorge in the middle section of the Reserve. The drainage is rather poor in the study region where the stream has not penetrated the limestone to any great degree, and there is a high level of ground water.

4. Vegetation

The woodland is semi-natural, and is one of the few remaining pieces of such woodland in the eastern half of County Durham. Tree felling in the 1914-18 war, without subsequent replanting, may have been responsible for the

presence of some open heath-like areas. Except for the presence of a few conifer and sycamore plantations, and the felling already mentioned, the area appears to have been interfered with very little. One would expect to find as dominants oak, (Quercus robur) on the heavy boulder clay of the top and flanks of the Dene, and ash, (Fraxinus excelsior) on the limestone below. Oak is almost absent however and where present is not regenerating, while ash is restricted in distribution on the boulder clay. Beech (Fagus sylvatica L.) is replacing itself locally, but this species may have been introduced in the first place. The most frequently occurring dominants in the boulder clay areas are:-

- a) Birch (Betula pubescens. Ehrh.).
- b) Sycamore (Acer pseudoplatanus.L.) which is regenerating freely and spreading.
- c) Elm (Ulmus glabra), rather restricted as a dominant.
- d) Rough grass and bracken (Pteridium aquilinum).

In addition to the dominants mentioned above Wild bramble (Rubus fruticosus) is common and there are large areas where the herb layer is dominated by dogs mercury (Mercurialis perennis), bracken, or Rosebay Willowherb (Chamaenerium angustifolium (L.) Scop.).

B. THE TRAPPING GRIDS

1. Introduction

The 100 acre region mentioned above was marked out in a 50 metre grid pattern (following the National Ordnance Survey Grid), in August, 1962 and a trapping programme was carried out for two weeks to determine the composition and distribution of the small mammal fauna (see Appendix 1, page 337 for full details of this and subsequent surveys). From the results of the survey, distribution maps of the small rodents were drawn, and by reference to these two areas were chosen for the present study, and a grid was marked out on each. One grid was sited on the northern slope of the valley in an area occupied by both Clethrionomys glareolus and Apodemus sylvaticus (Grid A); the other was on the southern slope and was occupied almost exclusively by Clethrionomys (Grid B). Each grid was laid out over an area of one hectare (2.5 acres), and in the shape of a rectangle, being 156 metres long and 62.4 metres wide, with grid intersections every 15.6 metres. The shape, dimensions, and exact spacing of the grids were determined by the nature of the study to be undertaken, and also, in large part, by the nature of the terrain, precipitous slopes restricting the choice of suitable areas. The grids were marked out in November 1962, and were originally of the dimensions quoted above, with eleven trapping points along the longer axis and five along

the short. In July 1963, the arrangement was modified slightly, for the reasons given below, to consist of ten points by five points (50 trapping positions instead of 55). Each grid extended over two clearly demarcated vegetation types, described in the appropriate paragraphs below.

2. Grid A. (North) (Fig. 2)

a) General description

This grid was sited partly in a mature larch wood (Larix decidua. Mill.) and partly in a sycamore wood, the two being separated by a narrow belt of spruce (Picea abies. (L). Karst.). Approximately half of the traps were placed in each vegetation type. After July, 1963, one line of traps at the western end of the grid was abandoned because it was sited in a completely different vegetation type from the other trap lines and was hence unrepresentative. The grid thus consisted of ten trap lines, each with five trapping points, for most of the study. The grid is bounded to the north and east by fields, and, partially, to the south and west by steep slopes.

b) The vegetation

The vegetation in the larch wood differs quite considerable from that in the sycamore wood both in composition and in quantity, thus making the area suitable for the study of possible differences in population density of mice and voles in

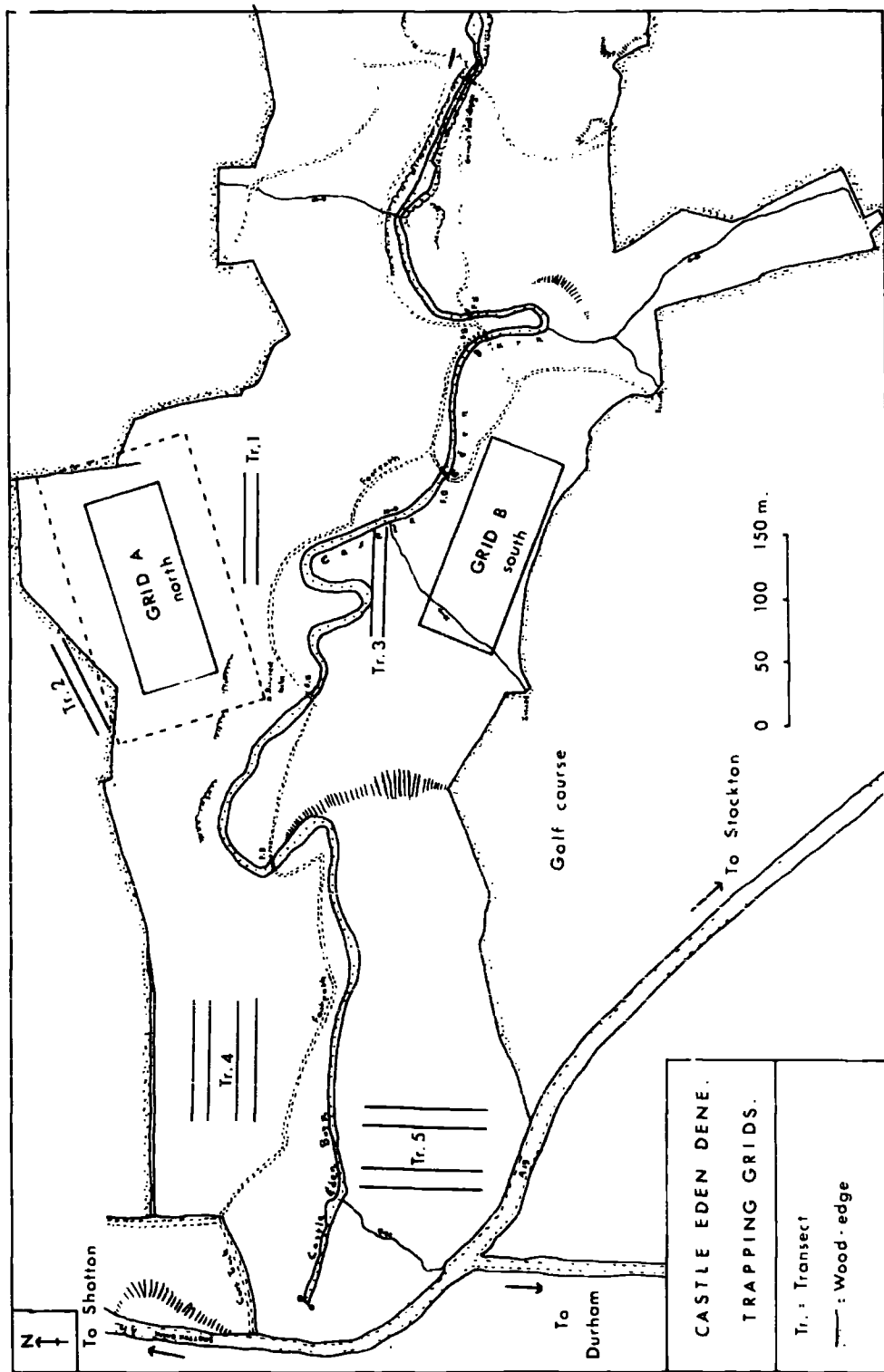

FIGURE 2. Map of the study area in Castle Eden Dene showing details of the pattern of the trapping grids and transects (Nat. Grid Ref. NZ4138 and NZ4139).

GRID A	
Vegetation	No. of trap positions
Dogs mercury	18
Bracken	9
Bramble	9
Larch litter	9
Willowherb	2
Grass	3
GRID B	
Vegetation	No. of trap positions
Dogs mercury	6
Bracken	19
Bramble	4
Larch Litter	4
Willowherb	9
Other vegetation	8

Table 1. The number of trapping sites occurring in areas of different vegetation type on Grids A and B.

areas of different vegetation type. Figure 3 shows the composition of the herb layer in September, and Table 1 shows the number of trap positions occurring in each of the main vegetation types. The larch trees are mature, and, except in the height of summer, there is little ground cover in much of the larch area. A bed of larch-needle litter covers the ground all the year, and in many parts of the larch wood there is no other cover to the soil. There are small areas of grass, bracken, dogs mercury, and bramble present but most of these are limited in extent and are less dense than the corresponding plots in the sycamore wood. The spruce belt is narrow, wet, and virtually devoid of vegetation, except for the presence of small areas of horsetails (Equisetum arvense L.), in its upper (northern) region. Towards the bottom of the grid (south) the spruce thins allowing the growth of horsetails, dogs mercury, willowherb, and various other small herbs.

The sycamore wood has moderately dense vegetation in most parts, particularly in the summer. There are large expanses of dogs mercury, bramble, grasses, bracken, and willowherb. The dogs mercury and willowherb tend to die back in the late summer but the bramble and bracken afford some cover all the year round.

The sequence of vegetational changes occurring on Grid A during the year is as follows. In February-March there is little cover in the larch wood, there being only some bramble,

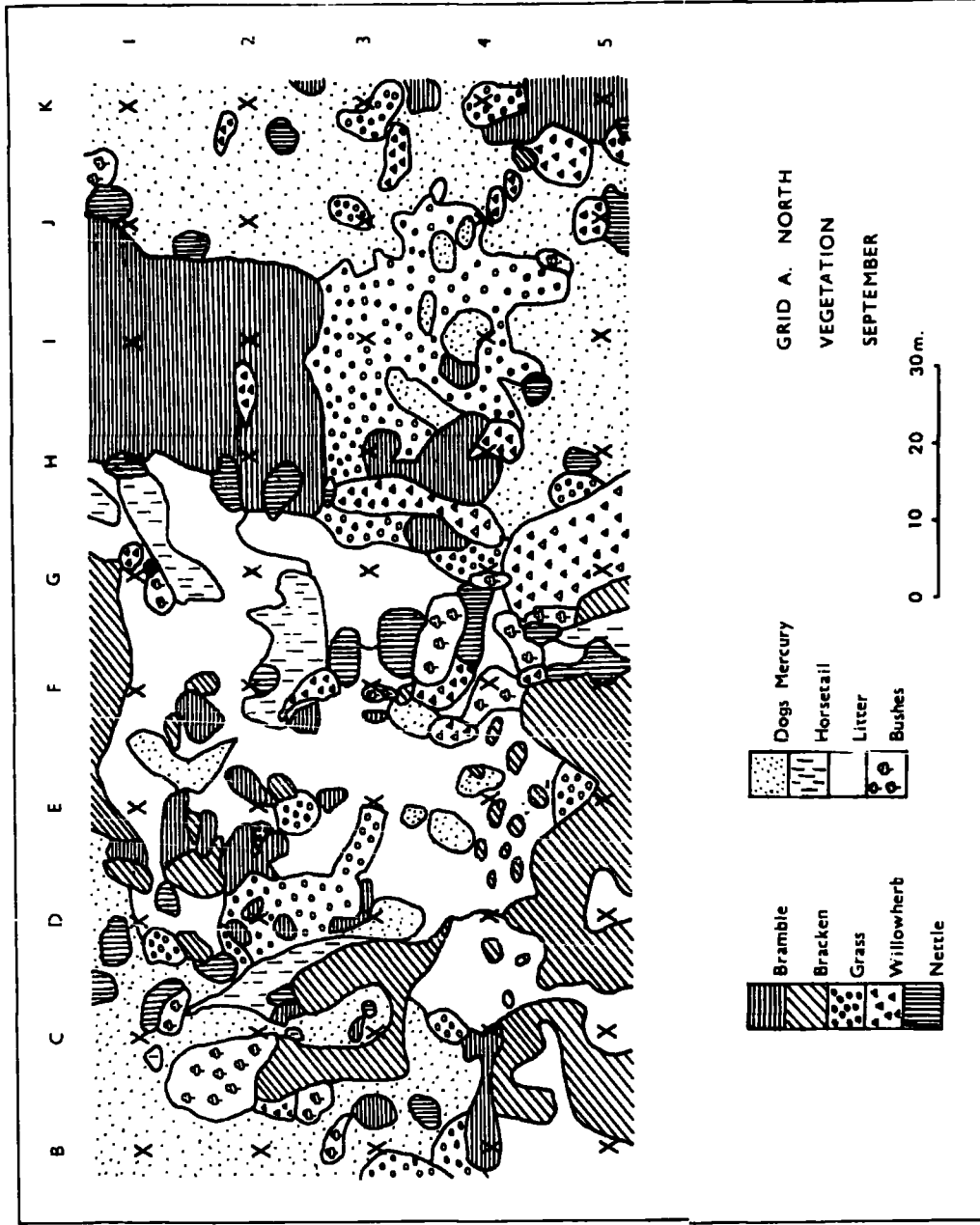

FIGURE 3. Details of the vegetation of the field layer on the north grid (grid A) in September. Each trap position is indicated by a cross (X).

PLATE I

The sycamore wood on the north grid (grid A) showing
the dense carpet of dogs mercury present in the spring
and summer.

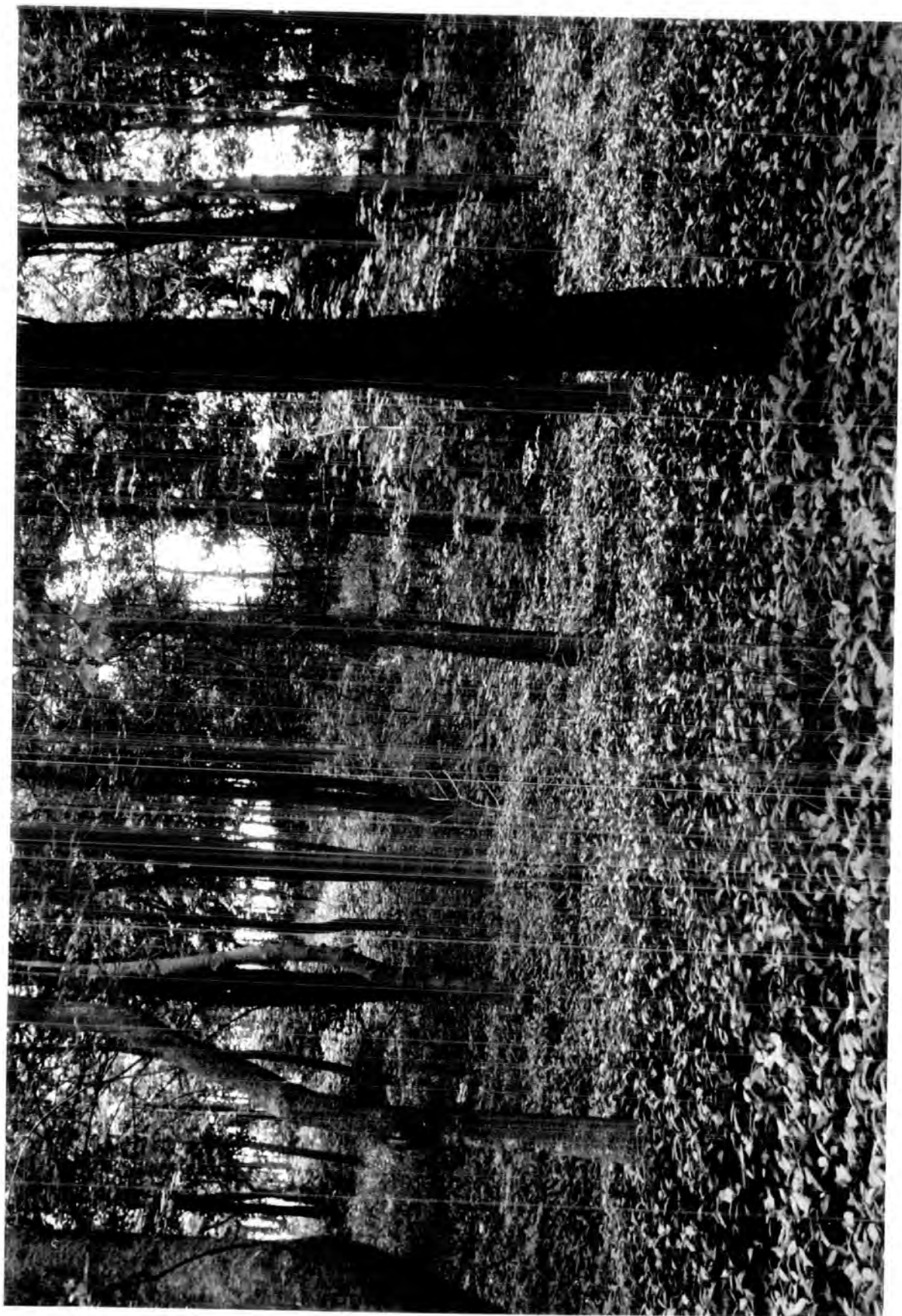

PLATE II

The sycamore wood on the north grid (grid A) showing
areas of bramble, tussocky grass and bracken.



dead bracken, grass, and needle litter. In the spring the dogs mercury grows up quickly, and several species of small herb appear, also some horsetails grow in the wetter areas. In the summer the dogs mercury is still present, and willowherb, nettle, bramble and bracken afford good cover in some parts. Autumn brings a rapid decline of the dogs mercury, willowherb, and nettle, leaving only the bracken and the bramble. By mid-winter the bramble has lost many of its leaves and the bracken has died down; this is the season of least cover. Exactly the same sequence of events occurs in the sycamore, but the larger areas of bracken, bramble, and tussocky grass ensure that there is more cover at all times of the year than there is in the larch wood.

3. Grid B. (South). (Fig. 2.)

a) General description

Grid B was marked out in an area considered to be suitable mainly for Clethrionomys glareolus. Of the original eleven trap lines, four were in an immature larch wood, five in an ash plantation, and two in a treeless bracken zone. In July 1963, the two lines in the bracken were abandoned, and an additional line put in the larch wood; thus making a total of five lines in the larch and five lines in the ash (identical with the arrangement of trap-lines on Grid A - five in each of two vegetation types). This grid is bounded to the south by a

PLATE III

The mature larch wood on the north grid (grid A)
showing areas of larch needle litter and some
scattered clumps of bracken.



PLATE IV

The mature larch wood on the north grid (grid A) showing
an area with a moderately dense covering of bracken.



golf-course, and to the north by steep slopes. To the west the ash plantation is separated from open ground by a deep gully; to the east the larch extends beyond the grid for a further 100 metres.

b) The vegetation

The vegetation in the young larch plantation differs substantially from that in the larch wood on Grid A. The ground cover is moderately dense, and few areas are covered by litter alone. As reference to Fig. 4 shows, large areas of dense bracken, willowherb, and grass occur, with some regions of dogs mercury. The transition to the type of vegetation found in the ash is gradual. The dominant bracken and willowherb of the larch wood are replaced by bramble, raspberry (Rubus idaeus), hogweed (Heracleum sphondylium. L.) and tussocky grass. Table 1 shows the number of trapping points associated with the various vegetation types.

The sequence of seasonal changes in vegetation type and density are much as described for Grid A, with the exception that at no time is the larch so devoid of ground cover as the larch on Grid A. In the winter there is more cover in the larch than in the ash, primarily because of the preponderance of dead bracken fronds in the former.

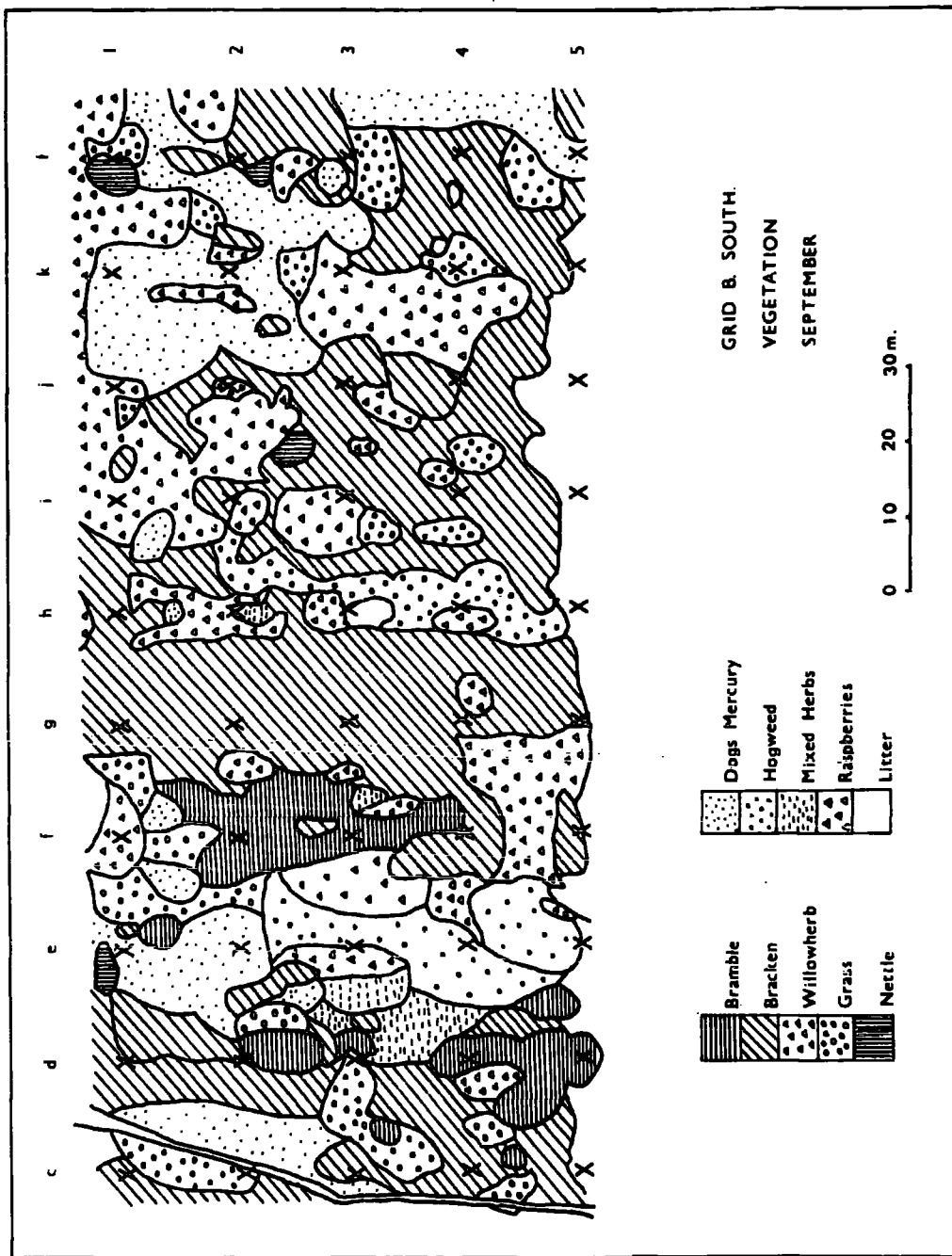

FIGURE 4. Details of the vegetation of the field layer on the south grid (grid B) in September. Each trap position is indicated by a cross (X).

PLATE V

The ash plantation on the south grid (grid B) showing
the mixed summer vegetation including hogweed, bracken
and raspberry.

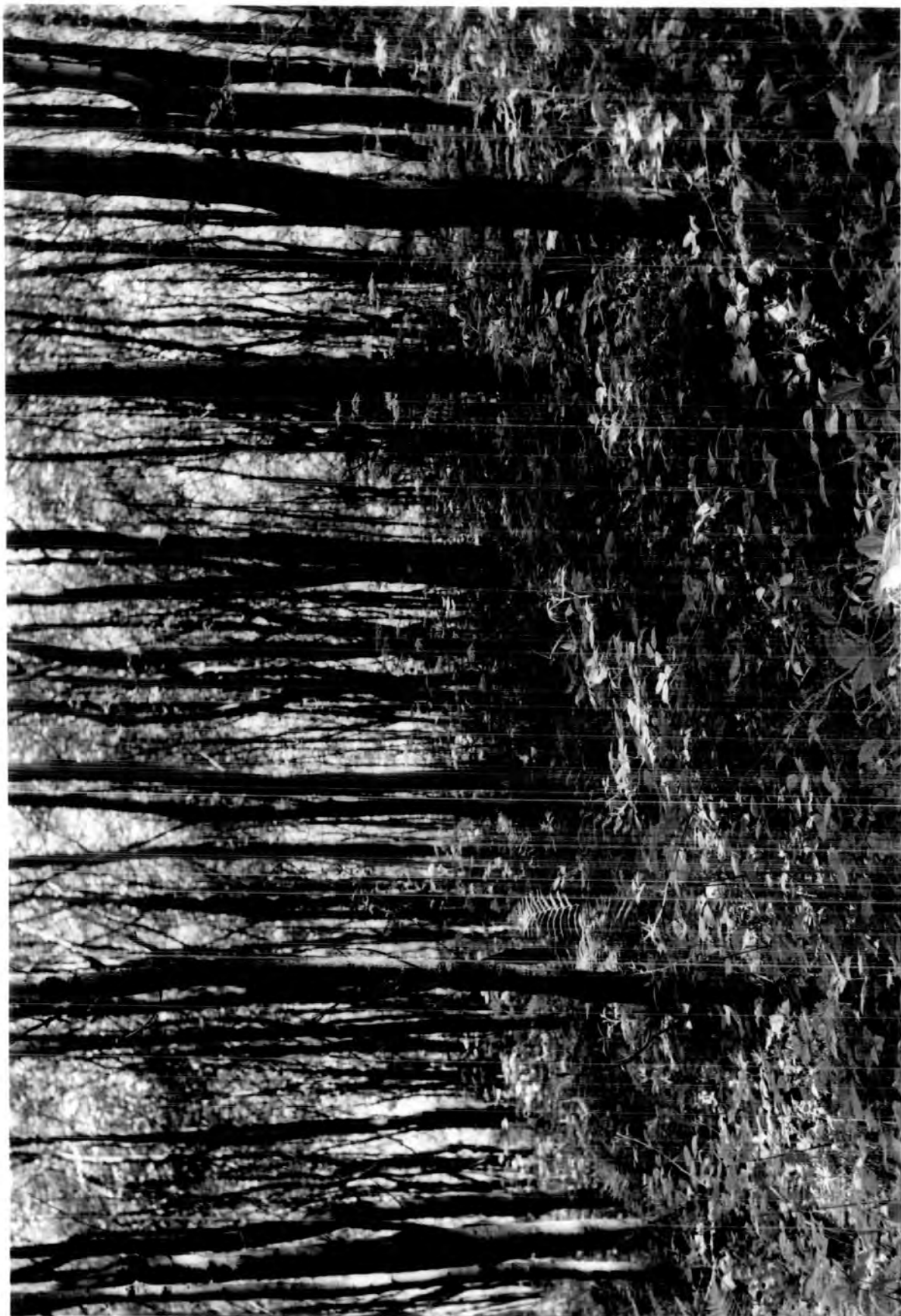

PLATE VI

The immature larch plantation on the south grid (grid B)
showing an area of bracken with an understorey of grass.



4. Additional trapping areas

In addition to the grids described above some traps were placed elsewhere for specific short-term purposes (See Fig. 2). In April, 1964, a cordon of traps was placed round Grid A to investigate 'edge effects'. In August 1964, trap-lines 1 and 2 were run for seven days; and in October 1964 'Grid C' was trapped for four days. Also, in areas well away from the grids, break-back traps were set to catch animals for a study being made on the biochemical composition of stomach contents. (transects 3,4, and 5 in Fig. 2.)

III. METHODS OF STUDY

A. TRAPPING AND MARKING PROCEDURE

1. Trapping procedure

The two small grids, A and B, were designed for the study, by live-trapping procedures, of the movements, population dynamics and other aspects of the general ecology of Apodemus sylvaticus and Clethrionomys glareolus populations.

Both grids were trapped from March 1963 until January 1965 at approximately monthly intervals, for three nights each. The trapping of grid B usually immediately followed that of grid A, but a few days difference occurred when other work interfered with trapping. Occasionally, trapping periods of longer duration were used, when some particular experiment was in progress, but such deviations from the normal pattern were rare, and they are noted in the appropriate sections. Because of the persistent snow of the bad 1962-63 winter no trapping was attempted until January 1963. This attempt to trap on grid A was abandoned as further heavy snow falls occurred, and regular trapping was not commenced until March 1963. The normal four-day (three-nights) trapping procedure followed throughout the study is given in Table 2.

The trapping was carried out using Longworth Live traps (Chitty and Kempson 1949) of which three were placed at each trapping point until September 1963. From September 1963 to

March 1964 five traps were placed at each point. From March 1964 until January 1965 four traps per point were found to be adequate. No pre-baiting period was used as it was considered that a three day trapping period was long enough to avoid the biased sampling of marked animals which pre-baiting procedures were designed to offset (Chitty and Kempson 1949). The 15 metre trap spacing was used following the recommendations of Tanton (pers. comm.), and the four-day trapping period was utilised following the advice of Ashby (pers. comm.). Preliminary field trials indicated that the trap-spacing and the trapping period were satisfactory and they were maintained throughout the study.

Day	Procedure
1	Place traps in position and SET
2	Check traps from 9a.m. onwards. RE-SET Mark and release animals.
3	Check traps from 9 a.m. onwards. RE-SET Mark and release animals.
4	Check traps from 9 a.m. onwards. REMOVE Mark and release animals.

Table 2. The four day trapping procedure used in the study.

2. Marking procedure

All animals captured were marked by the removal of toes by the use of sharp scissors. The animals appeared to suffer no discomfort as a result of the procedure, and no evidence was found to show that subsequent discomfort or lack of mobility was experienced. The marks given were individually specific although duplicated for sexes and for species. Clear and unambiguous marking is essential for studies concerned with movements and population dynamics, and toe-clipping was found to be most satisfactory.

B. DATA RECORDED

In addition to the noting of the identification mark and the site of capture information of the following type was recorded for every animal.

1. The sex and sexual condition

Each animal was identified and sexed and the sexual condition noted. During the breeding season the sexing of adults of both species is simple, using the criteria given below, and no mistakes were discovered. In the non-breeding season Clethrionomys adults are sometimes rather difficult to sex, but usually the penis in the male lies farther from the anus than does the clitoris in the female, and, after some practice, little difficulty is encountered in making an accurate

diagnosis of the sexual condition. Juveniles of both species at all seasons are more difficult to sex, but the note about penis-anus and clitoris-anus applies here also and, with practice, little difficulty is encountered. Below are listed the possible categories of sexual condition into which the animals may be placed, together with the diagnostic ruling followed throughout the study.

a) Males

Males of both species are considered to be fecund i.e. in breeding condition, when the testes are scrotal in position. They are generally regarded as adults if they weigh more than 14 grams (Clethrionomys) or 15 grams (Apodemus). If the testes are abdominal in position then the animal is non-fecund. Males weighing less than 10 grams, with the testes abdominal in position, and with a fluffy, greyish pelage are considered to be juvenile.

b) Females

(i) Perforate

Females with the vaginal orifice without a covering membrane are classed as perforate. They are considered to be adult if they weigh over 14 grams in the case of Clethrionomys and over 15 grams in the case of Apodemus (Baker, 1930).

(ii) Imperforate

Females are considered as imperforate when the vaginal orifice is not visible. An imperforate female may be an adult in non-breeding condition, a sub-adult in non-breeding condition, a pregnant adult, a pregnant sub-adult, or a juvenile. The criteria listed below may be used to distinguish between some of these possibilities - leaving only non-breeding adults and possibly immatures in the 'imperforate' category.

(iii) Pregnant

Females are considered to be pregnant when they are adult and in an imperforate condition during the breeding season. The later stages of pregnancy may be detected by the discovery of embryos in the uterus, determined by palpation of the female's abdomen. A valuable aid in the diagnosis of pregnancies in living animals in the field is the change in body weight of marked females which are regularly trapped.

(iv) Lactating

Females are considered to be lactating when the mammary glands are swollen and easily visible. Lactating animals may also be imperforate, pregnant, or perforate.

(v) Juvenile

Any females which are imperforate, with a fluffy grey pelage, and a weight of under 10 grams are classed as juveniles.

2. Weight

All animals were weighed each time they were captured. The weighing was carried out by placing the animal in a polythene bag of known weight which was then suspended from a regularly-calibrated spring-balance. The weighings were accurate to 0.5 grams. The weight was recorded to assist in the diagnosis of sexual condition and approximate age of the animals (see pp. 97-136).

3. Other information

The presence of ectoparasites on the animals was recorded, and so was the general condition e.g. healthy, comatose etc. In addition, the density of the vegetation cover at each trapping point was noted prior to each trapping period (pp. 155-6) and notes were made of the more obvious changes in the vegetation which had occurred since the previous trapping. Any captures made of Microtus agrestis, Sorex araneus, Sorex minutus, and Mustela nivalis were also recorded.

SECTION B

THE POPULATION DYNAMICS OF

APODEMUS AND CLETHRIONOMYS

SECTION B. THE POPULATION DYNAMICS OF APODEMUS AND CLETHRIONOMYS

I. THE TRAPPING RESULTS

1. The numbers caught

The total number of animals handled on grids A and B from March 1963 to January 1965 is shown in Tables 3 and 4 for Clethrionomys and Apodemus respectively. More Clethrionomys were handled on grid A than on grid B in the course of the study, but as grid B was trapped only sixteen times while grid A was trapped twenty times the actual difference in numbers present on the two grids is not significant. Substantially more Apodemus were trapped on Grid A than on grid B, and with due allowance being made for the disparity in the number of trappings, there is a genuine difference in Apodemus numbers between the two grids.

On grid A Apodemus were less plentiful than Clethrionomys over the period of study as a whole although at times they were temporarily more abundant. The overall ratio throughout the entire study was just over 1.5 Clethrionomys individuals to one Apodemus individual on grid A. On grid B there was an overall ratio of 4.5 Clethrionomys individuals to one Apodemus individual.

The monthly captures of Clethrionomys on grid A and grid B are given in Tables 5 and 7 respectively. The same information for Apodemus on grid A and grid B is given in Tables 6 and 8

respectively. On both grids the highest catches of Clethrionomys were made in the period from August to December in both 1963 and 1964. The lowest catches were made in the period from January to May in both years. The catches of Apodemus on grid A were large from October 1963 to March 1964, and from November 1964 to January 1965, but in most of the remaining months the catches were very low. On grid B appreciable numbers of Apodemus were caught only in December 1963, and May and November 1964.

2. Trap mortality

Tables 5 to 8 give the number of animals found dead in the traps at each trapping period. The total numbers of trap dead for Clethrionomys and Apodemus are given in Tables 3 and 4. In total, trap mortality for Clethrionomys was of the order of 15% of the total capture of individuals on grid A, and 31% on grid B. Trap mortality was negligible for Apodemus on both grids. On grid A the bulk of the deaths in traps occurred in December 1963, and September and October 1964. On grid B the months with a high trap mortality were December 1963, and November and December 1964. In most cases deaths in the traps could be attributed to inclement weather conditions e.g. heavy rain causing the animals to become wet and thus soil their fur and the bedding, or the occurrence of sudden very cold spells of frost and ice as in November 1964 on grid B. On grid A

	No. of Captures			No. of Individuals			Ratio ♂♂ : ♀♀	No. dead in traps		
	Males	Females	Total	Males	Females	Total		Males	Females	Total
Total. Grid A	878	643	1560	257	189	446	1.4 : 1	36	33	69
Total. Grid B	804	625	1437	170	117	287	1.4 : 1	62	26	88
Total. A + B	1682	1268	2997	427	306	733	1.4 : 1	98	59	157

Table 3. The total number of *Clethrionomys glareolus* handled on Grids A and B from March, 1963 to January, 1965 inclusive. The sex ratio is of individuals not total captures. Escapees (not sexed) are included in the totals.

	No. of Captures			No. of Individuals			Ratio ♂♂ : ♀♀	No. dead in traps		
	Males	Females	Total	Males	Females	Total		Males	Females	Total
Total. Grid A.	525	400	944	166	110	276	1.5 : 1	1	2	3
Total. Grid B	160	77	241	46	18	64	2.5 : 1	1	1	2
Total. A + B	685	477	1185	212	128	340	1.6 : 1	2	3	5

Table 4. The total number of *Apodemus sylvaticus* handled on Grids A and B from March, 1963 to January, 1965 inclusive. The sex ratio is of individuals not total captures. Escapees (not sexed) are included in the totals

trap mortality affected males and females equally but on grid B more than two males died to every female which died. Similar reports of trap mortality, and its differential action on Clethrionomys and Apodemus, were made by Chitty (1937), and Evans (1942). Both workers found that Clethrionomys reacted much less favourably to confinement than did Apodemus. Evans (1942), in agreement with the results of the present study, found a high mortality in the traps in October and, particularly, November. On grid A about 65%, and on grid B about 43%, of the trap dead were un-marked. It seems, therefore, that there was no possibility of marked animals being rendered less likely to survive subsequent capture, so the sampling of the population was not biased by the death of marked animals in disproportionate numbers.

Evans (1942) noted that 90% of the few Apodemus dead, and 80% of the Clethrionomys dead, were unmarked and the present results thus confirm his view that marked animals are not more liable to death on subsequent capture. Morris (1955) found that very few deer mice (Peromyscus maniculatus abietorum (Bangs)) died in the traps, but he found red-backed voles (Clethrionomys gapperi) to be far more sensitive to capture.

The high percentage of deaths of Clethrionomys in the traps is disturbing as the mortality thus induced could severely upset the normal population processes. It is probable that trapping at intervals of less than four weeks could severely

disturb the Clethrionomys population and thus render the information obtained on population dynamics unreliable. In the present study, the overall proportion of deaths in the traps was greatly increased by the deaths in November, December, and January, so frequent trapping in months other than these would probably be safe to undertake. It is suggested that the population processes in the present study were unaffected by the high mortality in the traps, as the time in which such mortality occurred was the time when many of the animals would be expected to die in any case.

3. Trap-revealed sex ratio

The overall sex-ratio of Clethrionomys caught on grid A was 1.4 : 1 in favour of the males when the number of individuals captured was considered. On grid B the male to female ratio for Clethrionomys was 1.5 : 1 over the period of study as a whole. The sex-ratio of Apodemus individuals captured over the whole period of study was 1.5 : 1 for males to females on grid A, and 2.5 : 1 on grid B (with small samples). Details of the sex-ratio of animals caught each month are given in Table 9, and the fluctuations in sex-ratio are shown graphically in Figure 5.

A suggestion of seasonal trends in the sex-ratio of the animals captured was evident in the Clethrionomys populations on both grids. On grid A more females than males were captured in only two months, July and August 1963. Equal numbers of the

MONTH	No. of Captures			No. of Individuals			No. found dead		
	♂♂	♀♀	Total	♂♂	♀♀	Total	♂♂	♀♀	Total
1963									
March	26	10	39	18	9	30	1	0	1
April	29	10	40	17	7	25	1	3	4
May	17	9	27	12	7	20	0	0	0
June	28	27	56	19	15	35	1	0	1
July	38	50	94	23	34	63	0	3	3
August	45	56	101	31	35	66	1	2	3
September	50	61	112	37	38	76	2	3	5
October *	35	34	71	30	29	61	1	0	1
November *	40	38	78	30	29	59	0	0	0
December	42	30	72	33	25	58	4	6	10
1964									
January	22	18	42	18	14	34	2	1	3
February	-	-	-	-	-	-	-	-	-
March	42	27	69	29	17	47	3	1	4
April	17	11	28	12	7	19	0	0	0
May †	58	31	98	30	13	45	1	0	1
June	-	-	-	-	-	-	-	-	-
July	57	39	96	32	23	55	1	0	1
August	77	50	127	39	31	70	2	3	5
September	84	50	134	50	34	80	7	6	13
October	68	53	132	50	34	85	4	6	10
November	65	32	99	44	21	67	2	1	3
December	-	-	-	-	-	-	-	-	-
1965									
January	38	7	45	27	7	34	4	0	4

Table 5. Monthly captures of Clethrionomys on Grid A. Trapping period of 3 days except where noted. In column 3 the total catch of animals each month, including recaptures, is shown. In column 6 the total number of individuals comprising the catch is given. The total number of animals found dead in traps is given in column 9. Escapees (not sexed) are included in the totals.

* = Two days trapping
 - = No trapping

† = Four days trapping

MONTH	No. of Captures			No. of Individuals			No. found dead		
	♂♂	♀♀	Total	♂♂	♀♀	Total	♂♂	♀♀	Total
1963									
March	20	15	36	12	8	21	0	0	0
April	5	9	14	4	5	9	0	0	0
May	3	7	11	1	3	5	0	0	0
June	1	4	5	1	2	3	0	0	0
July	5	5	11	5	3	9	0	0	0
August	6	3	9	5	3	8	0	0	0
September	6	7	13	4	5	9	0	0	0
October *	21	12	35	17	9	28	0	0	0
November *	28	13	42	22	12	35	0	0	0
December	44	24	70	31	19	52	0	0	0
1964									
January	64	41	108	38	28	69	1	0	1
February	-	-	-	-	-	-	-	-	-
March	79	70	151	37	38	77	0	0	0
April	34	36	70	24	22	46	0	0	0
May †	13	19	32	18	14	22	0	0	0
June	-	-	-	-	-	-	-	-	-
July	3	6	9	2	5	7	0	0	0
August	3	6	9	2	5	7	0	0	0
September	18	14	33	14	9	24	0	0	0
October	56	31	89	29	20	51	0	1	1
November	77	53	130	40	24	64	0	0	0
December	-	-	-	-	-	-	-	-	-
1965									
January	28	21	50	18	12	31	0	1	1

Table 6. Monthly captures of Apodemus on Grid A. Trapping period of 3 days except where noted. In column 3 the total catch of animals each month, including recaptures, is shown. In column 6 the total number of individuals comprising the catch is given. The total number of animals found dead in traps is given in column 9. Escapees (not sexed) are included in the totals.

* = Two days trapping
 - = No trapping

† = Four days trapping

MONTH	No. of Captures			No. of Individuals			No. found dead		
	♂♂	♀♀	Total	♂♂	♀♀	Total	♂♂	♀♀	Total
1963									
March	34	20	58	17	16	37	0	0	0
April	34	18	55	17	9	29	1	0	1
May	39	28	69	26	13	41	1	0	1
June	33	25	49	20	15	35	0	1	1
July	54	44	99	35	23	60	2	1	3
August	72	62	134	42	36	78	3	2	5
September	87	78	165	44	35	79	0	0	0
October	-	-	-	-	-	-	-	-	-
November	-	-	-	-	-	-	-	-	-
December	88	53	144	53	28	84	13	4	17
1964									
January	-	-	-	-	-	-	-	-	-
February *	19	24	43	15	16	31	2	0	2
March	31	33	65	17	15	33	4	1	5
April	-	-	-	-	-	-	-	-	-
May	31	29	60	20	14	34	1	0	1
June †	24	13	38	15	7	23	0	0	0
July	-	-	-	-	-	-	-	-	-
August	79	46	126	44	29	74	1	1	2
September	83	68	152	49	35	83	4	1	5
October	-	-	-	-	-	-	-	-	-
November	64	57	121	44	36	80	16	11	27
December	32	27	59	24	18	42	14	4	18
1965									
January	-	-	-	-	-	-	-	-	-

Table 7. Monthly captures of Clethrionomys on Grid B. Trapping period of 3 days except where noted. In column 3 the total catch of animals each month, including recaptures, is shown. In column 6 the total number of individuals comprising the catch is given. The total number of animals found dead in traps is given in column 9. Escapees (not sexed) are included in the totals.

* = Two days trapping
 - = No trapping

† = Half-grid only trapped

MONTH	No. of Captures			No. of Individuals			No. found dead		
	♂♂	♀♀	Total	♂♂	♀♀	Total	♂♂	♀♀	Total
1963									
March	4	3	8	2	2	5	0	0	0
April	3	0	3	2	0	2	0	0	0
May	3	0	3	1	0	1	0	0	0
June	0	0	0	0	0	0	0	0	0
July	7	1	8	5	1	6	0	0	0
August	1	0	1	1	0	1	0	0	0
September	3	0	3	2	0	2	0	0	0
October	-	-	-	-	-	-	-	-	-
November	-	-	-	-	-	-	-	-	-
December	27	20	47	14	11	25	0	0	0
1964									
January	-	-	-	-	-	-	-	-	-
February *	16	7	24	13	5	19	0	0	0
March	19	11	30	8	5	13	1	0	1
April	-	-	-	-	-	-	-	-	-
May	15	19	35	7	9	17	0	0	0
June †	4	3	7	3	2	5	0	0	0
July	-	-	-	-	-	-	-	-	-
August	6	3	9	6	2	8	0	0	0
September	10	2	12	8	2	10	0	0	0
October	-	-	-	-	-	-	-	-	-
November	26	6	33	16	3	20	0	1	1
December	16	2	18	9	1	10	0	0	0
1965									
January	-	-	-	-	-	-	-	-	-

Table 8. Monthly captures of Apodemus on Grid B. Trapping period of 3 days except where noted. In column 3 the total catch of animals each month, including recaptures, is shown. In column 6 the total number of individuals comprising the catch is given. The total number of animals found dead in traps is given in column 9.

* = Two days trapping
 - = No trapping

† = Half-grid only trapped

two sexes were caught on three occasions, in September, October and November 1963. On all other occasions more males than females were captured. Although more males than females were captured in the majority of trapping periods, significant differences from a 1 : 1 ratio occurred only in the months of April 1963 ($P < 0.05$), May 1964 ($P < 0.01$), November 1964 ($P < 0.01$), and January 1965 ($P < 0.001$). On grid B there were never more females than males captured, but a 1 : 1 ratio was found in March 1963 and February 1964. Statistically significant variations from a sex ratio of unity were found for May 1963 ($P < 0.05$) and December 1963 ($P < 0.01$) only. From the details of the fluctuations in sex-ratio throughout the two years shown in Fig. 5a it can be seen that the males were most numerous in the catches in winter and spring, and the females were best represented in the summer and autumn. This seasonal variation was more marked on grid A than on grid B.

In the Apodemus populations there was a considerable degree of variation in the sex-ratio throughout the two years, this being particularly evident in the grid A population which was more fully documented than that of grid B. Reference to Fig. 5b shows that more females than males were captured throughout the spring, summer, and early autumn (except in July and August) in 1963, but the sex-ratio favoured the males from October 1963 to May 1964 when the Apodemus catches were larger (see P. 50). A similar pattern of seasonal change in

MONTH	<u>Clethrionomys</u>		<u>Apodemus</u>	
	GRID A	GRID B	GRID A	GRID B
1963	♂ : ♀	♂ : ♀	♂ : ♀	♂ : ♀
March	2.0 : 1	1.0 : 1	1.5 : 1	1.0 : 1
April	2.4 : 1	2.0 : 1	0.8 : 1	NC
May	1.7 : 1	2.0 : 1	0.33 : 1	NC
June	1.25 : 1	1.33 : 1	0.5 : 1	NC
July	0.7 : 1	1.5 : 1	1.66 : 1	5.0 : 1
August	0.9 : 1	1.2 : 1	1.66 : 1	NC
September	1.0 : 1	1.3 : 1	0.8 : 1	NC
October	1.0 : 1	-	2.0 : 1	-
November	1.0 : 1	-	1.8 : 1	-
December	1.3 : 1	1.9 : 1	1.6 : 1	1.3 : 1
1964				
January	1.3 : 1	-	1.4 : 1	-
February	-	1.0 : 1	-	2.6 : 1
March	1.7 : 1	1.1 : 1	1.0 : 1	1.6 : 1
April	1.7 : 1	-	1.1 : 1	-
May	2.3 : 1	1.4 : 1	1.3 : 1	0.78 : 1
June	-	2.0 : 1	-	1.5 : 1
July	1.4 : 1	-	0.4 : 1	-
August	1.25 : 1	1.5 : 1	0.4 : 1	3.0 : 1
September	1.5 : 1	1.4 : 1	1.5 : 1	4.0 : 1
October	1.5 : 1	-	1.4 : 1	-
November	2.1 : 1	1.2 : 1	1.66 : 1	5.0 : 1
December	-	1.33 : 1	-	9.0 : 1
1965				
January	3.9 : 1	-	1.5 : 1	-

Table 9 . Sex ratio of individuals in the monthly samples.

NC = Not calculable. - = No trapping.

(a).

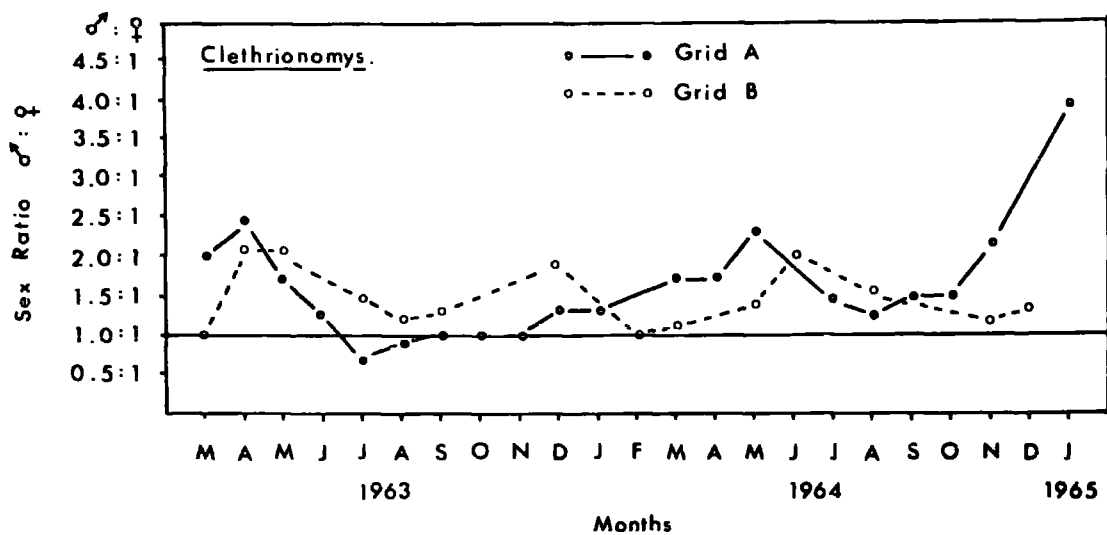

(b).

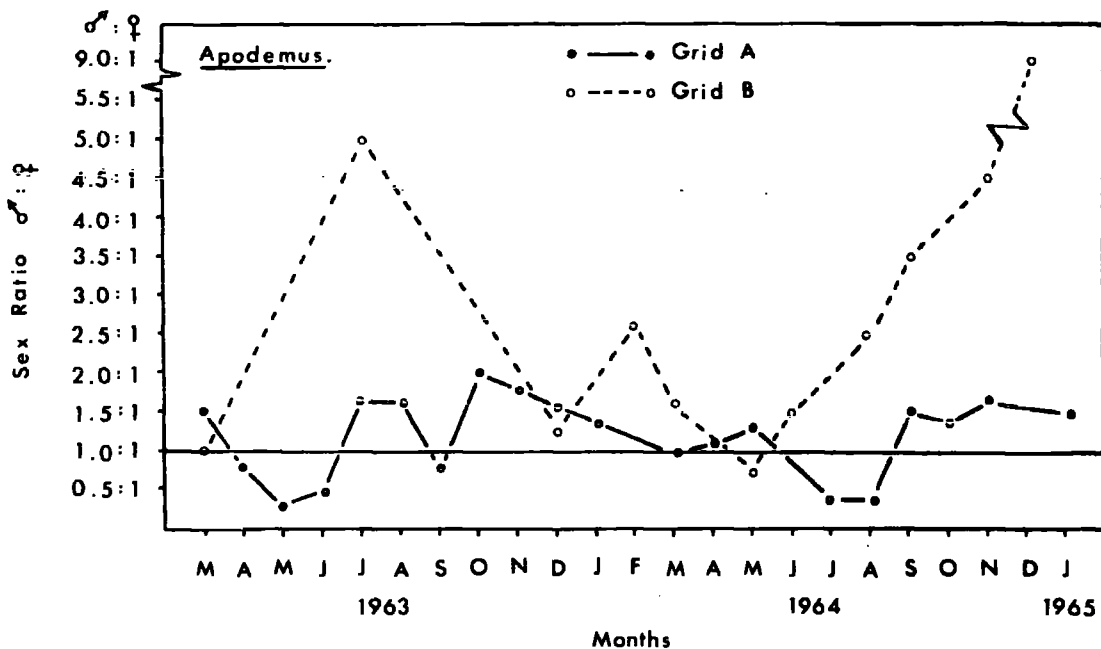

FIGURE 5. Seasonal changes in the sex-ratio of Clethrionomys (a) and Apodemus (b) individuals captured on grids A and B.

sex-ratio was evident for 1964-5 also. On grid B too few animals were captured for much reliance to be placed on variations in sex-ratio, but in general the males predominated in the catches at all times except for May 1964. For Apodemus, as for Clethrionomys, the males particularly dominated the catches in the winter months.

Evans (1942) found variations in the ratio of males to females but found no apparent regularity in the variations. He found a 1 : 1 ratio of males to females when he considered his total numbers, He did note, however, a preponderance of males in the spring and autumn which agrees with the trend on grid B in 1963, and with the trend on grid A in 1964. Elton et al (1931) found the proportion of males in Apodemus to be greatest in late summer and early autumn, dropping to equality with females in winter and spring, similar trends, in fact, to those found in the present study. Ashby (pers. comm.) found with Apodemus that the ratio of males to females was commonly 2 : 1 except in May, or after a good breeding season, when it was more nearly 1 : 1. With Clethrionomys Ashby found a 1 : 1 ratio to be most common, with perhaps a slight tendency for males to be in excess after a poor breeding season. Evans (1942) noted a concentration of Apodemus females in late winter in 1938-39, and Miller (1958) found similar variations to those reported for Elton et al (1931) above. Tanton (1965), however, found no evidence of a seasonal trend in sex-ratio in 1962 in a

population study of Apodemus in Monks Wood in Huntingdonshire, but in 1963 he found spring and summer proportions to be not significantly different from 1 : 1, but to become significant in October-November. He also noted that even when no statistically significant differences were detectable yet the proportion of males was consistently greater than that of females. Newson (1963) also reported a majority of males in Clethrionomys and Apodemus catches but found the variations in sex-ratio to be irregular in occurrence. This was found to be so in the present study when samples were larger than 20 animals. Kikkawa (1964) found the sex-ratio of Apodemus in The Pasticks, a copse in Wytham Woods, Berkshire, to show a slight preponderance of females. He considered that all the resident mice were trapped, and suggested that the balance would be made up by transient males. In other areas Kikkawa (1964) noted that approximately 1.5 : 1 ratios of males to females were obtained with widely spaced traps and less trapping effort, and he thus concluded that males were drawn from a larger area than females - confirming Miller's view (1958) that males move more than females in spring and summer. This was found also in the present study (p. 188). It is well not to read too much into the trap-revealed sex-ratio however, as it may bear little relation to the actual sex-ratio in the field. Crowcroft and Jeffers (1961) demonstrated in the house-mouse (Mus musculus) that social organisation and inherent differences in response

may result in differences in response to traps. They showed that female-only colonies were without division into trap-shy and trap-addicted animals, but when males were present certain of the females became trap-shy, and more males were captured than females. Thus social organisation may allow more males than females to be caught in natural populations of mice and voles, or greater activity of the males may render them more liable to capture.

4. Average recapture index

In Tables 5 to 8 the number of individuals and the number of captures made of those individuals at each trapping period are recorded. If the number of captures is divided by the number of individual animals concerned in those captures then an average recapture index per individual may be calculated. This procedure was followed for both sexes of both species on grids A and B, and the average recapture indices so calculated at each trapping period are given in Table 10, and are shown graphically in Fig. 6.

Reference to Fig. 6 indicates that there was no significant difference between the recapture indices of male and female Clethrionomys on grid A. There was some suggestion of a seasonal variation in recapture rate, there being more likelihood of recapture in the summer months. On grid B the average recapture rate of the females was consistently higher than that

of the males throughout the whole study, contrasting with the situation on grid A. There was less evidence from the Clethrionomys on grid B of a seasonal difference in the likelihood of recapture, but there seemed to be a lowering of the recapture rate of both sexes with the onset of the winter. With Apodemus on grid A there was no evidence of sexual differences in the recapture indices, and, in contrast to the situation in Clethrionomys, the likelihood of recapture appeared to increase in the winter and spring in both 1963 and 1964. However, little reliance may be placed on this latter fact because the number of Apodemus caught in the summer months was very low. On grid B also there appeared to be a higher recapture rate in the winter, but as few individuals were caught at all on this grid no conclusions may be drawn from this.

Kikkawa (1964) suggested that male Apodemus are more likely to escape recapture than are the females, but this was not found to be so in the present study. There is, however, some evidence that male Clethrionomys (on grid B) are more likely to escape recapture than are the females. Ashby (pers. comm.) found no difference between the recapture rates of the sexes in either Apodemus or Clethrionomys, nor did he find any evidence of any regular pattern of seasonal variation in recapture rate. The greater likelihood of recapture in the spring and summer months for Clethrionomys suggested by the results of the present study may be partly due to the increased activity which has been demonstrated to occur at this time.

MONTH	<u>Clethrionomys</u>				<u>Apodemus</u>			
	Grid A		Grid B		Grid A		Grid B	
	Males	Females	Males	Females	Males	Females	Males	Females
1963								
March	1.44	1.11	2.00	1.25	1.66	1.87	2.00	1.50
April	1.70	1.42	2.00	2.00	1.25	1.80	1.50	0
May	1.42	1.28	1.50	2.15	3.00	2.33	3.00	0
June	1.47	1.80	1.65	1.66	1.00	2.00	0	0
July	1.65	1.47	1.54	1.91	1.00	1.66	1.40	1.00
Aug.	1.45	1.60	1.71	1.72	1.20	1.00	1.00	0
Sept.	1.35	1.60	1.98	2.23	1.50	1.40	1.50	0
Oct.	1.17	1.17	-	-	1.23	1.33	-	-
Nov.	1.33	1.31	-	-	1.27	1.08	-	-
Dec.	1.27	1.20	1.66	1.89	1.42	1.26	1.93	1.82
1964								
Jan.	1.22	1.28	-	-	1.68	1.46	-	-
Feb.	-	-	1.26	1.50	-	-	1.23	1.40
Mar.	1.45	1.59	1.82	2.20	2.13	1.84	2.37	2.20
Apr.	1.42	1.57	-	-	1.42	1.64	-	-
May	1.93	2.38	1.55	2.07	1.62	1.36	2.14	2.11
June	-	-	1.60	1.85	-	-	1.33	1.50
July	1.78	1.69	-	-	1.50	1.20	-	-
Aug.	2.26	1.61	1.79	1.59	1.50	1.20	1.00	1.50
Sept.	1.68	1.47	1.69	1.94	1.28	1.55	1.25	1.00
Oct.	1.36	1.56	-	-	1.93	1.55	-	-
Nov.	1.48	1.52	1.45	1.58	1.67	2.21	1.62	2.00
Dec.	-	-	1.33	1.50	-	-	1.78	2.00
1965								
Jan.	1.41	1.00	-	-	1.55	1.75	-	-

Table 10. The average recapture rate per individual for Clethrionomys and Apodemus at each trapping period on grids A and B.

- = No trapping.

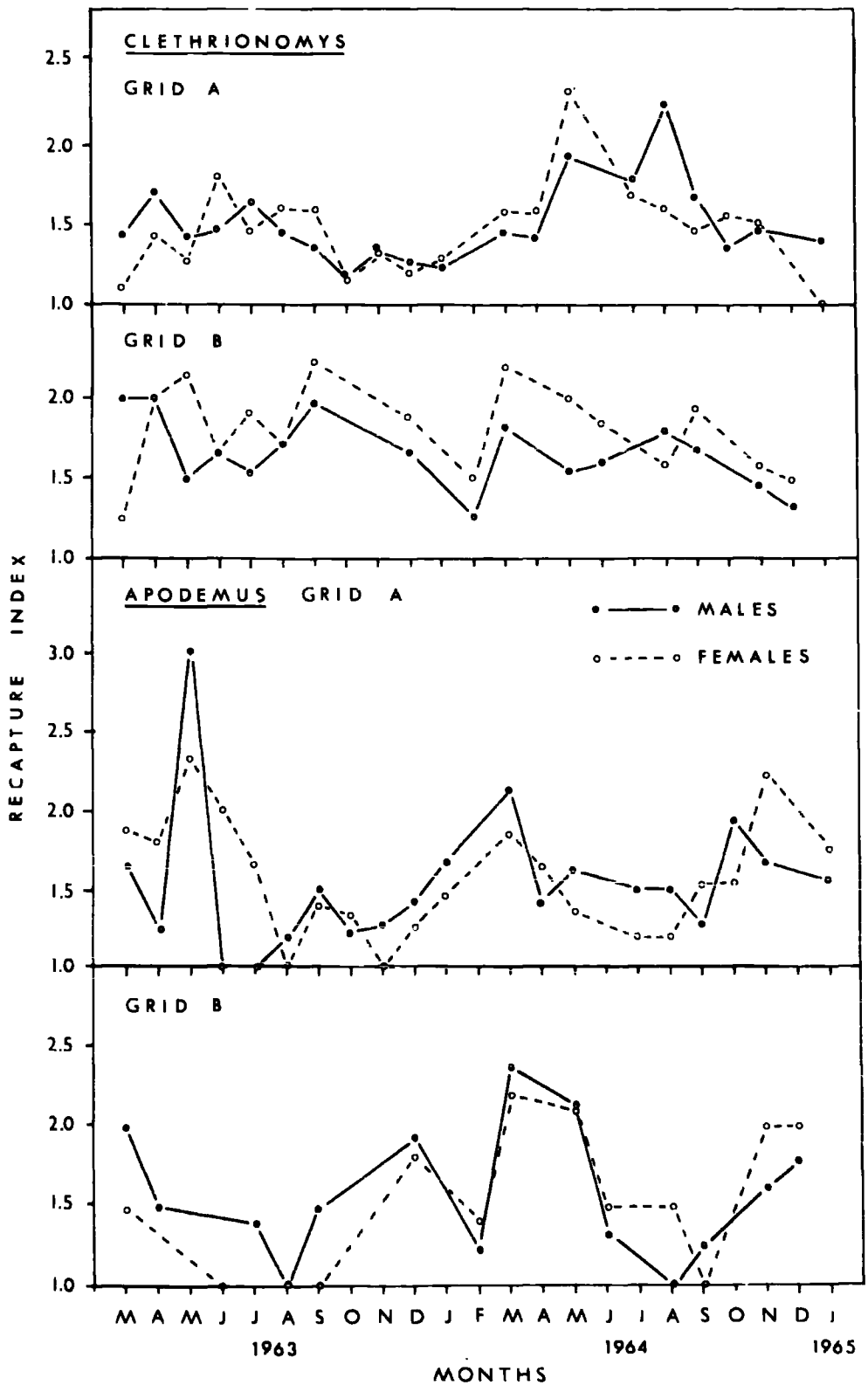

FIGURE 6. Seasonal variation in the average recapture index of Clethrionomys and Apodemus males and females on grid A and grid B.

II. THE ESTIMATION OF POPULATION PARAMETERS

1. Introduction

In the present study estimates of the population size each month were made using the modification of the 'Lincoln Index' method of estimation devised by Hayne (1949a). Also population size and several other population parameters were calculated by the utilisation of maximum-likelihood equations as described by Leslie, Chitty, and Chitty (1953). It is felt to be necessary to give a brief outline of the procedures involved in calculating population parameters of mobile populations, and thus a description of Hayne's (1949a) method, and of Leslie et al's (1953) technique is given here. Also some explanation is given as to why these two methods were chosen from several that have been used in the past by various workers.

Most capture-recapture techniques for estimating population parameters are based upon the 'Lincoln Index'. This index was used by Lincoln (1930) to calculate the total number of certain wildfowl in North America. The method consists of taking a random sample from a population of animals, marking and releasing the sample, and allowing sufficient time for the sample to distribute itself randomly in the population again. A second sample is then taken and the proportion of marked animals in the sample noted. With this information the size

of the total population may be obtained using the general formula given below:-

$$\text{Total population} = \text{Number marked at trapping one} \times \frac{\text{Number caught in sample two}}{\text{Number of marked animals in sample two}}$$

A similar technique was used by Jackson (1933) to analyse capture-recapture data from a tsetse fly (Glossina) population. He later refined the method to allow for birth rates, death rates, and migration, and he described the refinements in a series of papers (Jackson, 1937, 1939, 1940). Many workers, particularly those employed in the study of natural populations of mammals, have since used the 'Lincoln Index' type of calculation.

The validity of the capture-recapture methods of estimating population parameters is dependent upon the validity of certain assumptions, these being that:-

- 1) marked animals become randomly distributed throughout the population,
- 2) marked animals are neither more nor less liable to capture than unmarked animals,
- 3) no significant replacement of the population by unmarked animals from 'outside' populations will occur between marking and sampling periods.

Mortality is considered not to introduce a systematic error so long as its effect is felt equally by marked and unmarked

animals, and so long as dead animals are not replaced by unmarked animals from outside.

2. Hayne's (1949a) Method of estimation

The first of the methods for estimating population size used in the present study was that devised by Hayne (1949a). This method was designed in an attempt to clarify certain issues raised by the Lincoln Index type of calculation.

These issues were:-

- 1) the question of the proper time intervals to be compared,
- 2) the ways of averaging a series of estimates where they are not based upon independent sets of data.

Hayne's method consists of measuring the increase in the proportion of marked animals which is observed in succeeding catches as more animals become marked in the course of the experiment. When 'x' animals have been marked and released into the population 'P' from which they were drawn, the proportion of the catch now marked (y) may be written as:-

$$y = \frac{x}{P}; \quad \text{or,} \quad y = \frac{1}{P} x \dots\dots\dots(1)$$

This is the quantity which a sample drawn from the population will estimate. Each sample will estimate the proportion marked at the different stages in the process. Equation (1) is that of a straight line passing through the origin ($y = 0; x = 0$), and the slope of the line is the reciprocal

of the population size. As the experiment proceeds the proportion of the population which is marked will increase. Marking one additional animal will cause the proportion marked to increase by a certain amount; the increase is inversely proportional to the population number. After finding the average amount by which the marking of one further animal changes the proportion of the population marked it is then possible to estimate the total population size. The formula used to compute the estimate is:-

$$P = \sum \frac{wx^2}{wxy} \dots\dots\dots(2)$$

where P = population size

w = the total number in the catch

x = the number of marked animals in the (catch) population

y = the proportion of 'x' in 'w'
recaptures

This formula, (2), is the inverted form of the usual expression for the slope of a regression line passing through the origin (Snedecor, 1946). Using formula (2), data from short periods in one trapping experiment may be handled separately as though each period was an entire trapping experiment. The data for the month of March 1964 for Clethrionomys on grid B are set out below (p. 41) in the form necessary for an estimation of population size using Hayne's method (Table 11).

Day	No. captures (w)		Propn. (R)	Total (R)	wxy	wx^2
	New	(R)				
1	22 ¹	0	0.00	0	0	0
2	3	13	0.81	21	272	7056
3	8	19	0.70	24	454	15552
				Total	726	22608

$$P = \sum \frac{wx^2}{wxy} = 31 \text{ voles}$$

Table 11. The arrangement of data for the estimation of population size by Hayne's method.

(R) = animal previously handled.
Superscripts denote dead animals.

3. The Maximum Likelihood Method of Estimation

The method due to Hayne (1949a) just described was used throughout the study, mainly because of its simplicity and ease of application. It was decided, however, that a method for estimating several population parameters from data arranged in one way would be desirable. There are several methods of estimating more than one population parameter, taking into account the effects of birth rate, death rate, immigration and emigration (Delury, 1947; Bailey, 1951; Young et al, 1952; Zippin, 1956) but the method developed by Leslie and co-workers was eventually used (Leslie and Chitty, 1951;

Leslie, 1952; Leslie, Chitty, and Chitty, 1953) because of its applicability to the specific problem under study viz. the population dynamics of small rodents. This method, in common with all capture-recapture methods of estimation, depends for its validity upon the truth of the assumptions that the sampling of individuals is entirely at random, and that all classes of marked and unmarked animals are caught with equal facility. This method differs basically from that of Hayne (1949a) in that information from a chain of samples is utilised, whereas only one sampling period is used in Hayne's method. Because the estimates of population parameters for one sample are dependent upon information from subsequent samples then the last link in the chain of samples cannot be dealt with i.e. the final trapping remains unanalysed. A brief description of the method is given here, but reference to the original work is necessary for complete understanding.

The population parameters are calculated using the Maximum-Likelihood equations. The procedure followed in the present study is now described.

The distribution of recaptures each month was tabulated according to the interval since last capture, and the estimates were made from the tables thus constructed. The samples were taken at unequal intervals of time, and as some regular time scale was required for the calculation of various rates e.g. survival rate, an arbitrary interval of 28 days was selected.

Trap mortality was taken into account in the equations for estimating population size. Each trapping was considered as a link in a sampling chain with time ' t_0 ' being the origin of the chain, and time ' t_x ' the end. The symbols used in the equations, with their meanings are as follows:-

C_t = the number of individuals captured at time ' t '

d_t = the number of individuals found dead in the traps
at time ' t '

R_t = the number of individuals released alive at time ' t '.

From the above, $C_t - d_t = R_t$ (1)

u_t = the number of animals in ' C_t ' which had not been
previously captured.

s_t = the number of animals in ' C_t ' which had been caught
at least once previously.

Hence, $C_t = u_t + s_t$ (2)

The ' s_t ' part of ' C_t ' is composed of two further components.

n_t = recaptured individuals not captured at time ' $t-1$ '.

m_{t-1} = recaptured individuals captured at time ' $t-1$ '.

Hence, $s_t = n_t + m_{t-1}$ (3)

ψ_t = the total number of animals captured at least once which
are alive in the population as a whole at time ' t ' then if

$y_t = u_t - d_t$ (4)

then, immediately after the release of the ' R_t ' living animals at time ' t ', the total number of this class in the population will be $\psi_t + y_t$. Then, if:-

P_t = the survival factor over the interval of time ' t ' to ' $t+1$ ' then the number alive at the time of the next trapping will be

$$P_t (\psi_t + y_t) \quad \dots\dots\dots (5)$$

N_t = the total number of individuals alive at the trapping at time ' t '.

λ_t = the rate of population increase from time ' t ' to ' $t+1$ '.

B_t = the rate of dilution of the population over the interval of time ' t ' to ' $t+1$ ', and

$$B_t = \lambda_t - P_t \quad \dots\dots\dots (6)$$

Having explained the symbols used in the equations, the latter may now be presented. In the calculations the value of ' ψ_t ' is first determined, together with its variance (V), then ' N_t ' is estimated, the formula for which incorporates the value of ' ψ_t '. The variance of ' N_t ' is also calculated. Once ' ψ_t ' and ' N_t ' are known, the value of ' λ_t ', and ' B_t ' may be calculated.

Equations used to calculate the population parameters

i. Population size

$$\psi_t = \frac{n_{t+1} R_t}{m_{t,t+1}} + s_t \quad (t = 0, 1, 2, \dots, T-1) \dots\dots(1)$$

$$v(\psi_t) = (\psi_t + u_t)^2 \frac{n_{t+1}}{s_{t+1} m_{t,t+1}} \dots\dots(2)$$

$$N_t = \psi_t \frac{(C_t + 1)}{(s_t + 1)} \quad (t = 0, 1, 2, \dots, T-1) \dots\dots(3)$$

$$v(N_t) = N_t^2 \frac{u_t}{(s_t + 2)(C_t + 1)} + \frac{v(\psi_t)}{\psi_t^2} \dots\dots(4)$$

ii. Rate of increase

$$\lambda_t = \frac{N_{t+1}}{(N_t - d_t)} \quad (t = 0, 1, 2, \dots, T-2) \dots\dots(5)$$

iii. Survival

$$P_t = \frac{\psi_{t+1}}{(\psi_t + u_t)} \quad (t = 0, 1, 2, \dots, T-2) \dots\dots(6)$$

iv. Dilution

$$B_t = \lambda_t - P_t \dots\dots(7)$$

The variances of ' ψ_t ' and ' N_t ' above are corrected by a correction factor. This factor is obtained by summing the ' ψ_t ' values and the ' s_t ' values of the chain of samples, finding the ratio between them and subtracting it from one. The variances are then multiplied by the correction factor. The standard errors of the estimates in the present study were obtained from variances corrected in this way.

The analysis above is preliminary, but if the dilution factor ' B_t ' is found to be low in the non-breeding season (ideally zero or negative) then more exact analysis of death rate (and hence survival rate), and rate of increase, may be entered upon. The equations given below were used in the present study to estimate death rate, rate of increase, and dilution rate, over a standard interval of 28 days.

w_t = unity, if the interval between trappings equals 28 days.

p_t = rate of increase from time ' t ' to ' $t + w$ '.

μ_t = death rate.

β_t = dilution rate.

$$p_t = \log_e \frac{\lambda_t}{w_t} \quad \dots\dots(8)$$

$$\mu_t = -\log_e \frac{P_t}{w_t} \quad \dots\dots(9)$$

$$\beta_t = \mu_t + p_t \quad \dots\dots(10)$$

The results of the calculation of the various population parameters are given in the sub-sections dealing with population size (pp. 47-77), and survival (pp. 78-97).

III. CHANGES IN POPULATION SIZE, MARCH, 1963 TO JANUARY, 1965

1. Introduction

The estimated population sizes of the two Clethrionomys and Apodemus populations are given in Tables 12-15. The population size was estimated for the sexes separately by the method of Leslie et al (1953), and for the sexes combined by this method and that of Hayne (1949a). The estimates obtained by both methods are presented in Tables 16-18. The full details of all the population parameters calculated by the maximum-likelihood equations are given in Tables 12-29. The figures showing population trends (Figs. 7 & 8) are compiled from the ' N_t ' values estimated by the method of Leslie et al (1953). Where ' N_t ' values could not be calculated, either ' C_t ' values or the estimates made using Hayne's (1949a) method were used, details are given where appropriate.

2. Population trends in the Apodemus and Clethrionomys populations

a) The Clethrionomys population on grid A

The population trends of Clethrionomys and Apodemus on grid A are shown in Fig. 7, and the population estimates are given in Tables 12 and 13 respectively.

The numbers of Clethrionomys were low at the time of the first comprehensive trapping of the grid in March, 1963, and

they declined still further to reach what was found to be a minimal value in April. Breeding began to swell the numbers between May and June, and in June the population was twice as large as it had been in April. The population continued to increase in size until August, there being a rapid rate of increase between June and July. From August onwards the population increased greatly in size to eventually reach a peak value in October. The population in October was four times larger than it had been in April. The numbers fell slightly between October and November, and then declined sharply between November and December. The numbers continued to decrease from December 1963 until April 1964. The April 1964 population was some 50% larger than that estimated for April 1963. From May to October 1964 the numbers rose steadily and reached a maximum value in the latter month of similar dimensions to that recorded for October 1963. From October to November, however, there was a considerable decrease in numbers and this decrease continued until January 1965, which was the final trapping on this grid. In January 1965 the population was only one-third of the October population in size. This rapid decline in numbers was due partly to an increased mortality in the traps (see P. 22). The population trends were similar in 1963 and 1964, but there is a suggestion that the population in 1965 will be low, based upon the low number of animals caught in January 1965. This suggestion is

Month	t	ψ_t	N_t	\pm	s	λ_t	P_t	B_t
1963								
Mar.	0	-		-		-	-	-
Apr.	1	15.4	22.0	+	4.8	1.136	0.560	0.576
May	2	13.1	25.0	+	6.0	2.060	1.000	1.060
June	3	23.9	51.5	+	7.3	1.245	0.721	0.524
July	4	25.9	64.1	+	14.3	1.034	0.591	0.443
Aug.	5	36.0	66.3	+	11.1	1.188	0.444	0.744
Sept.	6	29.3	78.8	+	11.4	1.131	0.514	0.617
Oct.	7	38.7	103.3	+	13.1	0.948	1.000	-0.052
Nov.	8	72.0	97.9	+	6.9	0.682	0.721	-0.039
Dec.	9	64.2	66.8	-	4.4	0.757	0.620	0.137
1964								
Jan.	10	46.0	50.6	+	4.2	*1.788	*1.000	*0.788
Mar.	11	*69.1	*90.5	+	5.9	*0.379	*0.334	*0.045
Apr.	12	27.4	34.3	+	5.4	1.860	1.000	0.860
May	13	34.3	63.8	+	7.7	1.100	0.341	0.759
July	14	20.2	70.2	+	15.9	1.111	0.388	0.723
Aug.	15	24.5	78.0	+	16.2	1.073	0.420	0.714
Sept.	16	46.0	83.7	+	19.8	1.196	0.538	0.658
Oct.	17	53.8	100.1	+	11.0	0.615	0.532	0.083
Nov.	18	53.1	61.6	-	19.7	-	-	-
1965								
Jan.	19	-	-	-	-	-	-	-

Table 12 . Estimated population parameters from a preliminary analysis of data from Clethrionomys on Grid A, using the Maximum-Likelihood Method of Leslie et al (1953). Data for the two sexes are combined. For explanation of symbols see Page 43.

* Doubtful estimate.

supported by information from the degree of breeding success attained (p. 101), and the survival rate (p. 78) in 1964.

b) The Apodemus population on grid A

In March 1963 the numbers of Apodemus on grid A were at a similar level to those of Clethrionomys. From March to June, however, the numbers trapped on the grid declined greatly, and, in fact, from April to September 1963 inclusive the catches did not reach double figures. From September to October 1963, however, there was a high rate of increase and the population quadrupled in size. The population continued to increase in size until December 1963, by which time the numbers were in excess of those of Clethrionomys for the first time. The numbers remained at a high level until March 1964, but between March and April the population decreased greatly in size to reach a level of population only 50% of the March value. The numbers continued to decrease, and, as in 1963, only a few individuals were captured in the summer months. From August to September the population increased rapidly in size, and by October was almost as large as it had been in December the previous year. The numbers did not remain high for long, however, and by January 1965 the population had been reduced to one-third of its size in October 1964. This sharp fall in numbers closely paralleled the situation in Clethrionomys, although without the trap-mortality associated with the fall in

Month	t	ψ_t	N_t	\pm	s	λ_t	P_t	B_t
1963								
Mar.	0	-		-		-	-	-
Apr.	1	8.7	13.9	+	2.3	0.539	0.664	-0.125
May	2	7.5	7.5	+	1.2	0.600	0.600	0.000
June	3	4.5	4.5	+	1.2	*5.489	*1.000	*4.489
July	4	*11.0	*24.7	+	4.2	*0.271	*0.125	*0.146
Aug.	5	2.0	6.7	+	-	1.642	0.300	1.342
Sep.	6	2.7	11.0	+	3.9	3.545	0.965	2.580
Oct.	7	8.4	39.0	+	7.8	1.272	0.911	0.361
Nov.	8	27.7	49.6	+	6.2	1.693	0.923	0.770
Dec.	9	39.4	84.0	+	8.3	0.856	0.549	0.307
1964								
Jan.	10	35.9	71.9	+	12.6	1.160	0.808	0.352
Mar.	11	54.9	83.4	+	6.5	0.475	0.276	0.884
Apr.	12	21.8	39.6	+	7.6	0.805	0.866	-0.391
May	13	31.0	31.9	+	-	0.226	0.114	0.112
July	14	4.0	7.2	+	-	1.000	0.090	0.910
Aug.	15	4.0	7.2	+	-	5.472	0.841	4.631
Sep.	16	7.6	39.4	+	10.1	2.053	0.678	1.375
Oct.	17	19.4	80.9	+	14.6	0.842	0.725	0.117
Nov.	18	53.2	68.1	+	9.3	-	-	-
1965								
Jan.	19	-	-	-	-	-	-	-

Table 13. Estimated population parameters from a preliminary analysis of data from Apodemus on Grid A, using the Maximum-Likelihood Method of Leslie et al (1953). Data for the two sexes are combined. For explanation of symbols see Page 43 .

* Doubtful estimate.

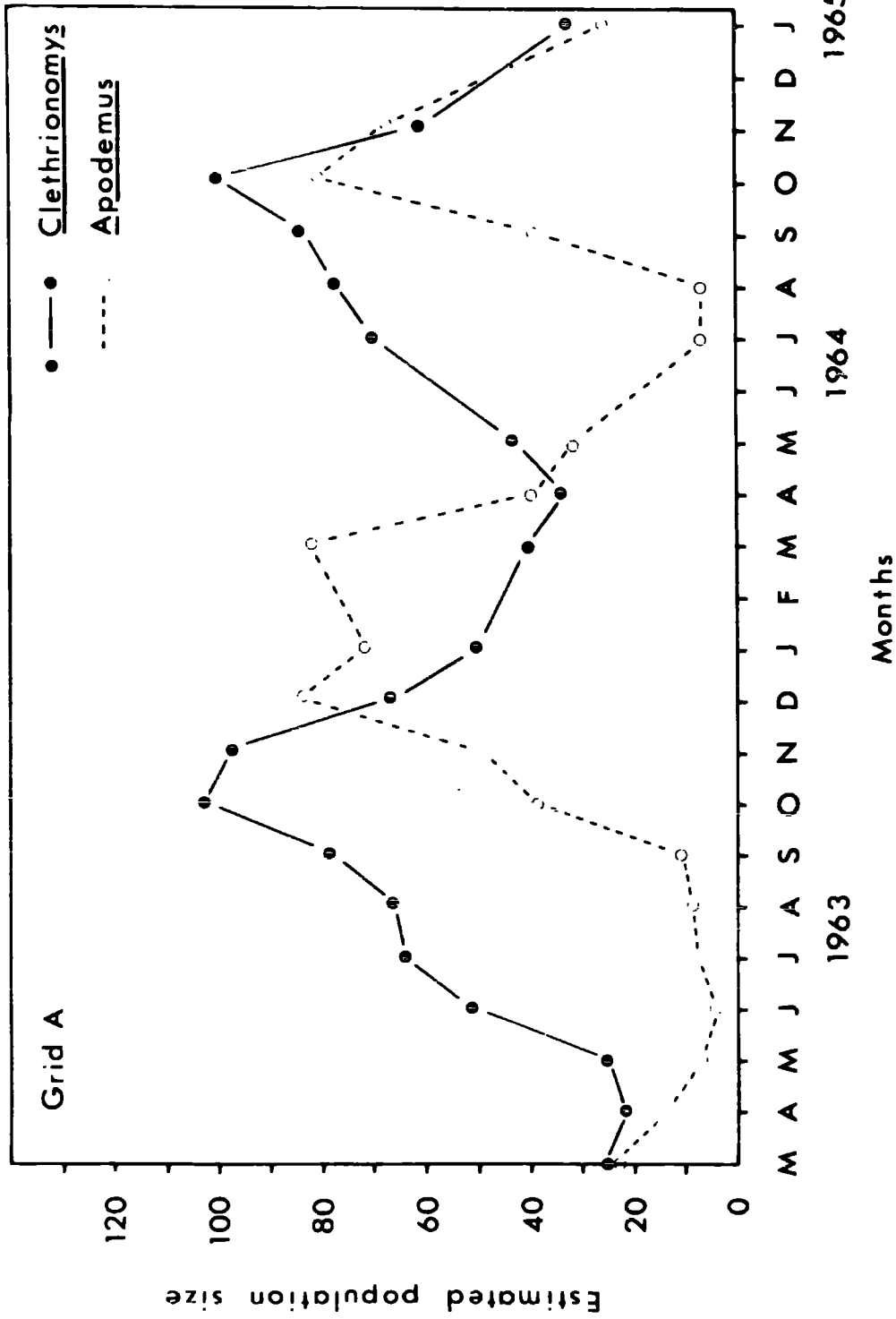

FIGURE 7. Population trends of Clethrionomys and Apodemus on grid A during the study period, as drawn from the best available estimates of population size (N_t).

the latter species. The rapid build up in numbers in the autumn of each year studied was caused by the large influx of sub-adult animals of both sexes into the traps. Thus, with Apodemus as with Clethrionomys, the population changes were of similar pattern in 1963 and 1964, there being a summer low followed by a great increase in numbers in autumn. Some differences between the two years existed, however, for in 1964 the peak numbers occurred in October, two months earlier than in 1963, and also the high population level was not kept up in 1964-65. From December 1963 to April 1964 inclusive the numbers of Apodemus were greater than those of Clethrionomys, the population of the former remaining large after the autumn increase while the Clethrionomys population declined. This situation did not occur in 1964-65 as both populations were in decline at the same time.

c) The Clethrionomys population on grid B

The population trends of Clethrionomys and Apodemus on grid B are shown in Fig. 8 and the population estimates are given in Tables 14 and 15.

When systematic trapping of grid B commenced in March 1963 the Clethrionomys population was in decline. The decline continued until April, and the population remained small in size until after May. The population then increased in size at a high rate from May to July, but then increased less rapidly

until September, by which time the numbers were twice what they had been in May. No trapping was carried out in October and November so it is not known whether the population increased further in size after September. By December 1963, however, the population had declined a great deal from its September level, and the trend continued downward, with minor fluctuations, until May 1964. From May to August 1964 the numbers were trebled, but after September the population decreased rapidly in size until December 1964, the final trapping period. The decrease in the numbers was partly due to high trap mortality in November and December (p. 22).

d) The Apodemus population on grid B

The numbers of Apodemus captured on grid B did not reach double figures in any one month until December 1963. The population remained at the moderate December level (about 20 animals) until March 1964, and then decreased in size throughout the summer. A few more animals were captured in September and November 1964. The estimates showed a downward trend after September 1964, a feature held in common with the Clethrionomys population.

e) A comparison of the performance of the Clethrionomys populations on grid A and grid B

The general pattern of the population fluctuations on the two grids is similar, although the record is less well

Month	t	ψ_t	N_t	\pm	s	λ_t	P_t	B_t
1963								
Mar.	0	-		-		-	-	-
Apr.	1	21.4	40.6	+	5.5	1.010	1.000	0.010
May	2	32.0	41.0	+	6.6	1.390	0.950	0.440
June	3	38.0	57.0	+	5.6	1.395	0.794	0.601
July	4	39.7	79.5	+	9.2	0.999	0.664	0.335
Aug.	5	47.6	79.4	+	11.6	1.057	0.651	0.406
Sept.	6	51.2	83.9	+	16.0	0.639	0.572	0.067
Dec.	7	47.0	53.6	-	-	0.740	0.535	0.205
1964								
Feb.	8	36.4	39.7	+	3.4	1.050	1.000	0.050
Mar.	9	40.1	41.7	+	11.4	0.767	0.568	0.199
May	10	25.6	32.0	+	5.9	*1.250	*0.889	*0.361
June †	11	*29.0	*40.0	+	3.5	*2.475	*0.509	*1.966
Aug.	12	17.3	99.0	+	22.8	0.935	0.754	0.181
Sept.	13	68.1	92.6	+	8.4	0.559	0.616	0.059
Nov.	14	56.3	51.8	+	5.7	-	-	-
Dec.	15	-	-	-	-	-	-	-

Table 14. Estimated population parameters from a preliminary analysis of data from Clethrionomys on Grid B, using the Maximum-Likelihood Method of Leslie et al (1953). Data for the two sexes are combined. For explanation of symbols see Page 43.

* Doubtful estimate. † Half-grid only trapped.

Month	t	ψ_t	$N_t \pm s$	λ_t	P_t	B_t
1963						
Mar.	0	NC	NC	NC	NC	NC
Apr.	1	NC	NC	NC	NC	NC
May	2	NC	NC	NC	NC	NC
June	3	NC	NC	NC	NC	NC
July	4	NC	NC	NC	NC	NC
Aug.	5	NC	NC	NC	NC	NC
Sept.	6	NC	NC	NC	NC	NC
Dec.	7	NC	NC	NC	NC	NC
1964						
Feb.	8	16.7	19.2 \pm 3.7	0.937	0.962	0.025
Mar.	9	18.0	18.0 \pm 2.4	0.700	0.474	0.226
May	10	9.0	12.6 \pm -	0.619	0.500	0.119
June $\frac{1}{2}$	11	6.5	7.8 \pm 1.5	0.961	0.400	0.561
Aug.	12	3.0	7.5 \pm -	\approx 8.067	\approx 1.000	-
Sept.	13	11.0	60.5 \pm 4.5	\approx 0.198	\approx 0.200	\approx 0.002
Nov.	14	4.0	12.0 \pm -	-	-	-
Dec.	15	-	-	-	-	-

Table 15. Estimated population parameters from a preliminary analysis of data from Apodemus on Grid B, using the Maximum-Likelihood Method of Leslie et al (1953). Data for the two sexes are combined. For explanation of symbols see Page 43.

$\frac{1}{2}$ Half-grid only trapped. \approx Doubtful estimate.

NC * Not calculable.

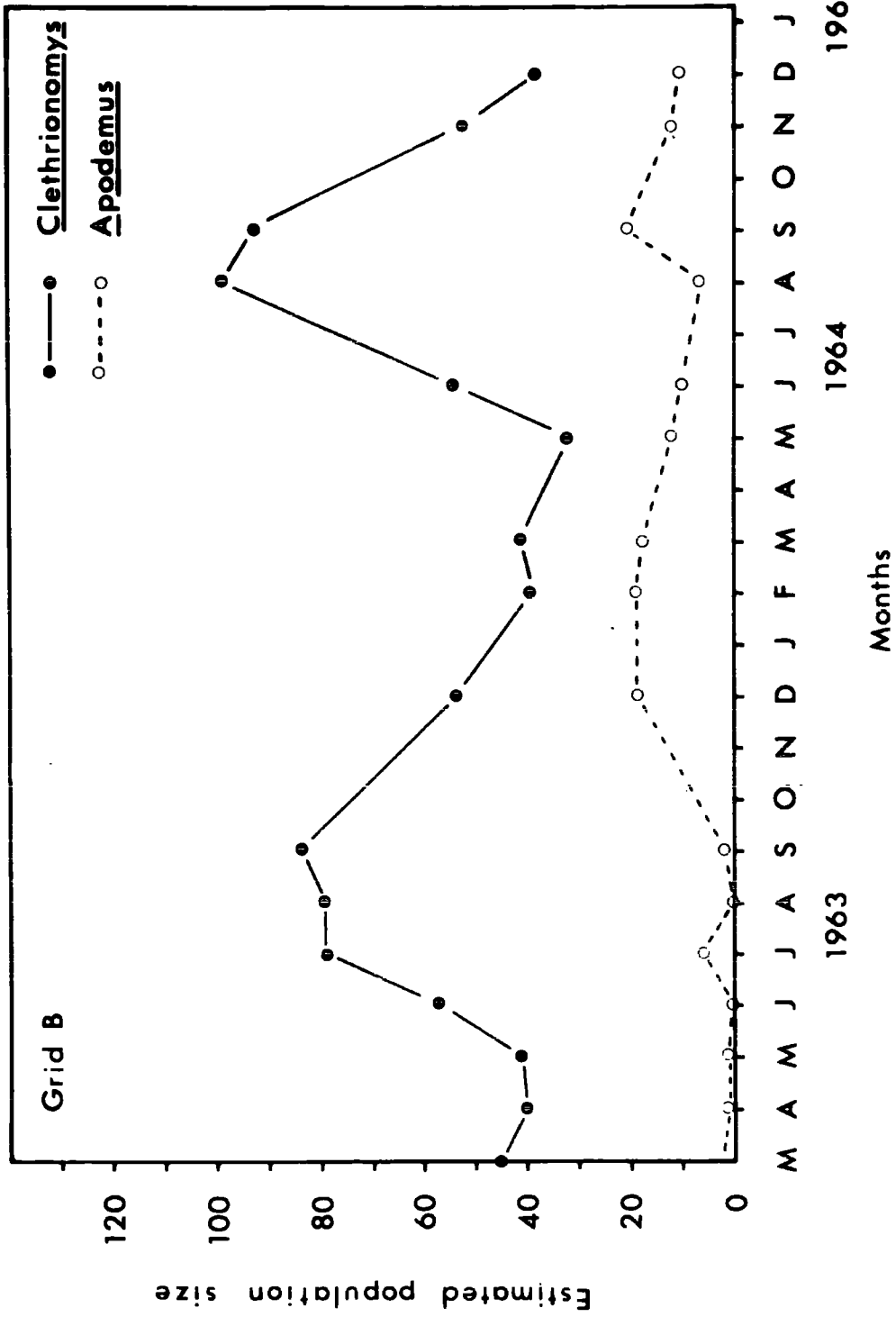

FIGURE 8. Population trends of Clethrionomys and Apodemus on grid B during the study period, as drawn from the best available estimates of population size (N_t).

documented for grid B. In 1963 the most striking difference between the two grids was the greater number of animals present in March on grid B, there being 80% more than on grid A. Despite the extra breeding potential of the grid B population, however, there was no notable difference between the sizes of the late summer populations on the two grids. It is possible that the October peak on grid A would have been repeated on grid B if records had been taken. Later evidence (p. 105) suggests that breeding was less successful on grid B, although survival was better than on grid A (p. 79). In March 1964 the populations were of very similar dimensions and the resulting late summer populations were also of comparable size. The grid A population was apparently declining rapidly. The early winter decline in numbers was common to both populations.

f) A comparison of the performance of the Apodemus populations on grid A and grid B.

There is little material for valid comparison of the two Apodemus populations, there being few Apodemus captured on grid B. One fact which emerged, however, was that the autumn-influx of sub-adults was common to both grids, although on a much smaller scale on grid B. The early decline in numbers in autumn 1964, after the early autumn rise, was common to both populations of Apodemus, and also to both Clethrionomys populations.

3. The population estimates of the sexes treated separately

The population estimates of the sexes treated separately are given in Tables 16 and 18 for Clethrionomys and Table 17 for Apodemus. Also given are the population estimates for the sexes combined, and the summated values of the two sexes. For comparison the population estimates of the sexes combined according to Hayne's (1949a) method are given also. Close agreement may be seen between the estimated populations of the sexes combined, and the sum of the male and female estimates, thus indicating that the smaller numbers involved when the sexes are treated separately do not render the calculations unreliable. In Fig. 9 the population estimates from the method of Leslie et al (1953) are compared with the actual ' C_t ' values. For Clethrionomys on grid A it may be seen that the population trends are similar for both ' N_t ' and ' C_t ' values with the exception of the estimates for October 1963 when the ' C_t ' value is low. There is some suggestion of a seasonal variation in the closeness of ' N_t ' and ' C_t ', there being closer agreement in the summer than in the winter. With Clethrionomys on grid B no regular variation in the closeness of the estimate and the actual catch could be detected. With Apodemus on grid A the estimated ' N_t ' values were of doubtful significance during the summer because of the low numbers of animals, so seasonal variation in the relationship between the numbers caught and those estimated could not be detected. Tanton (1965) found

seasonal variation in the agreement between estimates of the population size and the number of animals caught in Apodemus. He found the greatest disparity between the two values in the late winter and early spring. The closer agreement between the estimated and actual values in the summer is evident in the Clethrionomys population on grid A (above) and is in agreement with Tanton's results for Apodemus.

4. The density per acre of the Clethrionomys and Apodemus populations on grid A and grid B

The calculated density per acre of the Clethrionomys and Apodemus populations on grid A and grid B at each trapping period are given in Table 19. In this table, an 'actual' and an 'adjusted' density per acre are given for both species. The 'actual' density per acre is that density which is calculated if the ' N_t ' values are considered to refer to a population of animals occupying the area of the grid (approximately 2.5 acres). The 'adjusted' density per acre is that density which is calculated to exist if the animals estimated to be present (N_t) are considered to have been drawn from an area equal to that of the grid plus that of a border strip around the grid, the width of the border strip being equal to half the Observed Range Length value calculated for Clethrionomys and for Apodemus. The 'adjusted' density per acre for Clethrionomys is calculated on the basis that the animals could be occupying 6.3 acres; that for

Date.	Maximum Likelihood Method.				Hayne's Method
	1. Males	2. Females	3. Males & Females	1+2	
1963					
Mar.	18.0	8.0	26.0	26.0	52
Apr.	13.6	13.5	22.0	27.1	30
May	14.1	9.3	25.0	23.4	31
June	20.2	18.0	51.5	38.2	42
July	25.1	37.8	64.1	62.9	83
Aug.	25.4	41.9	66.3	67.3	84
Sept.	36.0	42.5	78.8	78.5	102
Oct.	54.6	46.5	103.3	101.1	109
Nov.	51.5	46.2	97.9	97.7	100
Dec.	34.3	36.0	66.8	70.3	105
1964					
Jan.	26.4	28.9	50.6	55.3	74
Mar.	*40.8	*68.9	*90.5	*109.7	60
Apr.	21.0	12.4	34.3	32.4	25
May	36.9	25.8	*63.8	62.7	43
July	36.6	32.6	70.2	69.2	59
Aug.	44.5	34.2	78.0	78.7	78
Sept.	50.2	33.4	83.7	83.6	99
Oct.	55.1	36.5	100.1	91.6	107
Nov.	40.0	23.0	61.6	63.0	89
1965					
Jan.	27.0	6.0	33.0	33.0	54

Table 16. Population estimates of Clethrionomys on Grid A. Estimates calculated for the sexes separately and for the sexes combined. Estimates calculated using Hayne's Method for the sexes combined are also given.

* = Doubtful estimate.

Date.	Maximum Likelihood Method.				Hayne's Method
	1. Males	2. Females	3. Males & Females	1+2	
1963					
Mar.	16.0	8.0	24.0	24.0	21
Apr.	3.0	3.9	13.9	6.6	10
May	1.0	6.0	7.5	7.0	5
June	1.0	3.0	4.5	4.0	3
July	5.0	3.0	*24.7	8.0	15
Aug.	6.0	3.0	6.7	9.0	23
Sept.	5.8	3.0	11.0	8.8	11
Oct.	21.4	14.0	39.0	35.4	42
Nov.	25.2	25.0	49.6	50.2	61
Dec.	52.2	28.9	84.0	81.1	88
1964					
Jan.	48.0	27.4	71.9	75.4	85
Mar.	40.7	35.4	83.4	76.1	83
Apr.	23.9	33.1	39.6	57.0	56
May	14.0	17.8	31.9	31.8	40
July	3.0	4.0	7.2	7.0	11
Aug.	3.0	4.0	7.2	7.0	11
Sept.	47.5	6.0	39.4	53.5	35
Oct.	65.7	22.5	80.9	88.2	57
Nov.	49.9	21.8	68.1	71.7	66
1965					
Jan.	18.0	8.0	26.0	26.0	36

Table 17. Population estimates of Apodemus on Grid A. Estimates calculated for the sexes separately and for the sexes combined. Estimates calculated using Hayne's Method for the sexes combined are also given.

* = Doubtful estimate.

Date.	Maximum Likelihood Method				Hayne's Method
	1. Males	2. Females	3. Males & Females	1+2	
1963					
Mar.	15.0	17.0	32.0	32.0	45
Apr.	25.0	14.0	40.6	39.0	31
May	26.1	14.8	41.0	40.9	48
June	35.4	19.2	57.0	54.6	41
July	45.7	32.8	79.5	78.5	71
Aug.	44.0	33.6	79.4	77.6	87
Sept.	46.2	36.6	83.9	82.8	85
Dec.	30.8	22.8	53.6	53.6	94
1964					
Feb.	23.2	18.4	39.7	41.5	39
Mar.	14.1	17.7	41.7	31.8	31
May	19.4	12.8	32.0	32.2	38
June	19.2	12.5	*40.0	31.7	25
Aug.	55.2	38.6	99.0	93.8	81
Sept.	50.2	42.6	92.6	92.8	87
Nov.	30.2	21.7	51.8	51.9	104
Dec.	21.0	17.0	38.0	38.0	60

Table 18. Population estimates of Clethrionomys on Grid B. Estimates calculated for the sexes separately and for the sexes combined. Estimates calculated using Hayne's Method for the sexes combined are also given.

* = Doubtful estimate.

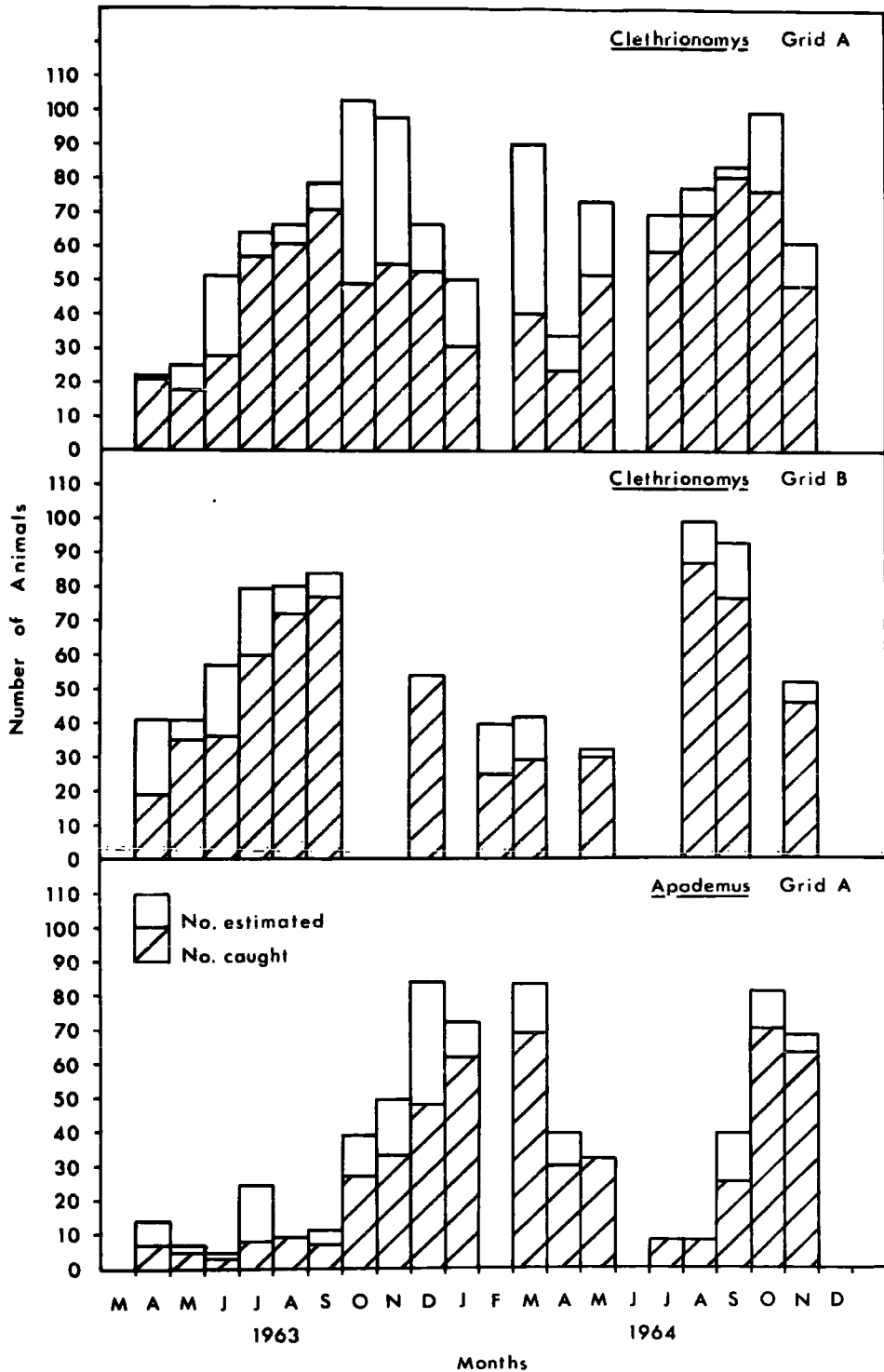

FIGURE 9. Seasonal variation in the number of Clethrionomys and Apodemus caught on grids A and B, and the number estimated to be present. The columns represent the total estimated population.

Apodemus on the basis that the animals could be occupying 7.2 acres. With the 'actual' density per acre the greatest value reached for Clethrionomys was 46.9 per acre on grid A and 45.0 per acre on grid B. For Apodemus the greatest 'actual' densities were 38.2 per acre on grid A and 8.7 per acre on grid B (discounting an obviously aberrant value of 27.5 per acre calculated for September 1964). The 'adjusted' densities per acre were obviously considerably less, never in fact reaching more than 16.4 per acre for Clethrionomys and 11.7 per acre for Apodemus.

These densities per acre for Clethrionomys and Apodemus, even taking the 'actual' densities, are very low compared with those recorded for Microtus agrestis (Chitty 1952)

5. Summary and discussion

The changes in population size of Clethrionomys on grids A and B have been described in detail (pp. 47-56). The basic pattern of change was found to be the same in both years and on both grids. A low population in spring increased steadily in size throughout the breeding season to reach a peak level in late summer or early autumn. The high level of population was maintained during the autumn but decreased over winter to leave only a few animals as the breeding nucleus of the coming year. The modifications to this basic pattern in autumn 1964 have been described and will be discussed in detail in that part of the discussion dealing with survival and breeding (pp. 78-119). Similar population trends to those outlined above have been

MONTH	<u>Clethrionomys</u>				<u>Apodemus</u>			
	Grid A		Grid B		Grid A		Grid B	
	Act.	Adj.	Act.	Adj.	Act.	Adj.	Act.	Adj.
1963								
March	11.8	4.1	14.5	5.1	10.9	3.4	NC	NC
April	10.0	3.5	18.4	6.4	6.3	1.9	NC	NC
May	11.4	3.9	18.6	6.5	3.4	1.0	NC	NC
June	23.4	8.2	25.9	9.0	2.0	0.6	NC	NC
July	29.1	10.2	36.1	12.6	*11.2	*3.5	NC	NC
Aug.	30.1	10.5	36.1	12.6	3.0	0.9	NC	NC
Sept.	35.8	12.5	38.1	13.3	5.0	1.5	NC	NC
Oct.	46.9	16.4	-	-	17.7	5.5	-	-
Nov.	44.5	15.5	-	-	22.5	7.0	-	-
Dec.	30.4	10.6	24.4	8.5	38.2	11.8	NC	NC
1964								
Jan.	23.0	8.0	-	-	32.7	10.0	-	-
Feb.	-	-	18.0	6.3	-	-	8.7	2.7
Mar.	*41.1	*14.4	18.9	6.6	37.9	11.7	8.2	2.5
Apr.	15.6	5.4	-	-	18.0	5.6	-	-
May	29.0	10.1	14.5	5.1	14.5	4.5	5.7	1.8
June	-	-	*36.4	*6.3	-	-	7.1	1.1
July	31.9	11.1	-	-	3.3	1.0	-	-
Aug.	35.4	12.4	45.0	15.7	3.3	1.0	6.8	1.0
Sept.	38.0	13.3	42.1	14.7	17.9	5.5	*27.5	*8.5
Oct.	45.5	15.9	-	-	36.8	11.4	-	-
Nov.	28.0	9.8	23.5	8.2	30.9	9.6	5.4	1.7
Dec.	-	-	17.3	6.0	-	-	NC	NC
1965								
Jan.	15.0	5.2	-	-	11.8	3.7	-	-

Table 19. The calculated density per acre at each trapping period of Clethrionomys & Apodemus.

Act. = Actual density over area of grid.

Adj. = Adjusted density over area of grid plus ranging area (see text).

- = No trapping

* = Doubtful estimate.

NC = Not calculable

Month	Interval	n_{t+1}	$m_{t, t+1}$	C_t	R_t	N_t	μ_t	p_t	β_t
1963									
Mar.	1.46	-	-	26	24	-	-	-	-
Apr.	0.75	-	13 ²	21	19	22.0	0.773	-0.169	0.604
May	1.25	1	8	18	18	25.0	0.062	0.058	0.120
June	1.00	3	13	28	27	51.5	0.327	0.219	0.546
July	1.00	5	17	57	56	64.1	0.526	0.033	0.559
Aug.	1.25	2	29	61	58	66.3	0.649	0.139	0.788
Sept.	1.00	2	23	71	69	78.8	0.665	0.123	0.788
Oct.	1.00	1	16	49	47	103.3	0.355	-0.053	-0.053
Nov.	1.00	12 ¹	26	55	52	97.9	0.327	-0.383	-0.056
Dec.	2.00	17 ¹	26 ³	53	45	66.8	0.239	-0.139	0.100
1964									
Jan.	1.43	8	17 ¹	31	28	50.6	*0.000	*0.407	*0.082
Mar.	1.86	12	16 ²	41	37	*90.5	*0.589	*0.522	*0.067
Apr.	1.53	10	9	24	24	34.3	0.000	0.406	0.406
May	2.00	7	20	52	51	63.8	0.538	0.048	0.586
July	1.00	2	14	59	58	70.2	0.947	0.105	1.052
Aug.	1.25			70	70	78.0	0.694	-0.056	0.638
Sept.	2.00	3 ¹	41 ⁵	98	81	83.7	0.309	0.089	0.398
Oct.	1.00	1	40 ¹	87	77	100.1	0.631	-0.486	0.145
Nov.	2.00	6 ²	36	58	49	61.6	-	-	-
1965									
Jan.	-	5 ³	22 ¹	33	29	-	-	-	-

Table 20. Population parameters of Clethrionomys on Grid A estimated using the Maximum-Likelihood Method of Leslie et al (1953). Data for the two sexes are combined. Estimates of death-rate (μ_t), rate of increase (p_t), and dilution rate (β_t) are with reference to a standard interval of 28 days. For explanation of other symbols see Page 43 .

Superscripts denote dead animals.

* Doubtful estimate.

Month	Interval	n_{t+1}	$m_{t,t+1}$	C_t	R_t	N_t	ρ_t	p_t	β_t
1963									
Mar.	1.46	-	-	24	24	-	-	-	-
Apr.	0.75	-	4	7	7	13.9	0.546	-0.824	0.278
May	1.25	2	3	5	5	7.5	0.409	-0.409	0.000
June	1.00	1	2	3	3	4.5	0.894	NC	*0.894
July	1.00	1	2	8	8	*24.7	*2.079	NC	*2.079
Aug.	1.25	1	1	9	9	6.7	0.963	0.397	1.360
Sept.	1.00	0	1	7	7	11.0	0.036	0.265	0.301
Oct.	1.00	1	4	27	27	39.0	0.093	0.241	0.334
Nov.	1.00	2	16	33	33	49.6	0.080	-0.078	0.002
Dec.	2.00	5	17	48	48	84.0	0.299	0.104	0.405
1964									
Jan.	1.43	8	22 ¹	62	61	71.9	0.149	-0.400	-0.251
Mar.	1.86	4	41	69	69	83.4	0.692	-0.142	0.550
Apr.	1.53	2	14	30	30	39.6	0.094	-	0.094
May	2.00	5	26	32	32	31.9	*1.085	-0.744	0.341
Jul.	1.00	0	4	8	8	7.2	*2.408	0.000	*2.408
Aug.	1.25	0	4	8	8	7.2	0.194	1.360	1.360
Sept.	2.00	0	4	25	25	39.4	0.322	0.359	0.553
Oct.	1.00	2	14	70	70	80.9	-	0.172	0.494
Nov.	2.00	4	44	63	62	68.1	-	-	-
1965									
Jan.	-	2	24	26	26	-	-	-	-

Table 21. Population parameters of Apodemus on Grid A estimated using the Maximum-Likelihood Method of Leslie et al (1953). Data for both sexes are combined. For other details see footnote to Table 20, and Page 43.

* Doubtful estimate.

NC = Not calculable.

Month	Interval	n_{t+1}	$m_{t,t+1}$	C_t	R_t	N_t	ρ_t	p_t	β_t
1963									
Mar.	1.43	-	-	32	31	-	-	-	-
Apr.	0.75	-	9 ¹	19	18	40.6	0.384	0.013	0.397
May	1.25	11	16	35	35	41.0	0.041	0.263	0.304
June	1.00	3	21	36	35	57.0	0.231	0.333	0.564
July	1.00	8	20 ²	60	57	79.5	0.409	-0.001	0.408
Aug.	1.25	7	34	72	69	79.4	0.343	0.047	0.390
Sept.	2.00	4	42	77	76	83.9	0.279	-0.224	0.055
Dec.	2.43	3	44 ⁷	68	54	53.6	0.257	-0.124	0.133
1964									
Feb.	1.14	0	22 ¹	25	24	39.7	0.000	0.043	0.043
Mar.	2.00	9 ¹	15 ²	29	25	41.7	0.283	-0.112	0.171
May	0.86	9 ¹	14	30	29	32.0	*0.137	*0.308	*0.445
June ¹	2.57	1	11	17	17	*40.0	*0.263	*0.353	*0.616
Aug.	1.11	7	7	87	85	99.0	0.254	-0.060	0.194
Sep.	2.00	2	52 ¹	77	74	92.6	0.246	-0.291	0.045
Nov.	1.25	8 ²	42 ¹¹	69	46	51.8	-	-	-
Dec.	-	4	29 ¹⁴	38	21	-	-	-	-

Table 22 . Population parameters of Clethrionomys on Grid B estimated using the Maximum-Likelihood Method of Leslie et al (1953). Data for the two sexes are combined. For other details see footnote to Table 20 , and Page 43 .

¹ Half of grid only trapped.

* Doubtful estimate.

Month	Interval	n_{t+1}	$m_{t,t+1}$	C_t	R_t	N_t	ρ_t	P_t	β_t
1963									
Mar.	1.43	-	-	2	2	NC	NC	NC	NC
Apr.	0.75	0	1	1	1	NC	NC	NC	NC
May	1.25	0	0	1	1	NC	NC	NC	NC
June	1.00	0	0	0	0	NC	NC	NC	NC
July	1.00	0	0	6	6	NC	NC	NC	NC
Aug.	1.25	0	0	0	0	NC	NC	NC	NC
Sept.	2.00	0	0	2	2	NC	NC	1.26	NC
Dec.	2.43	0	0	19	19	NC	NC	0.004	NC
1964									
Feb.	1.14	0	12	14	14	19.2	0.034	-0.057	-0.023
Mar.	2.00	3	9	13	13	18.0	0.373	-0.179	0.194
May	0.86	3	6	13	13	12.6	0.806	-0.558	0.248
June ¹	2.57	0	4	5	5	7.8	NC	-0.015	NC
Aug.	1.11	1	2	9	9	7.5	NC	*1.881	NC
Sept.	2.00	0	1	10	10	*60.5	*0.805	*0.169	*0.974
Nov.	1.25	2	2	14	14	12.0	-	-	-
Dec.		0	6	17	7	-	-	-	-

Table 23 . Population parameters of Apodemus on Grid B estimated using the Maximum-Likelihood Methods of Leslie et al (1953). Data for the two sexes are combined. For other details see footnote to Table 20, and Page 43.

¹ Half-grid only trapped.

* Doubtful estimate.

NC * Not calculable.

described also for Clethrionomys by Evans (1942), Brown (1954), Newson (1963), and Kikkawa (1964). That such patterns of population fluctuation within one year are widespread among small rodents living in a variety of habitats may be illustrated by reference to the work of Chitty (1952) and Godfrey (1955) on wild populations of Microtus agrestis (the short-tailed field vole); Clarke (1955, 1958) on experimental populations of M. agrestis in large enclosures; and Frank (1957) and Van Wijngaarden (1960) on communities of Microtus arvalis (the Continental vole) kept in outdoor cages. In America also, similar trends in population change have been recorded for various species of Peromyscus (a mouse similar to Apodemus) by, among many others, Blair, (1951), Snyder (1956), and Bendell (1959; 1961); for Clethrionomys (Blair, 1941); and Microtus (Getz, 1960; Jameson, 1955). The trends described for Clethrionomys in the present study may therefore be regarded as representative of those displayed by many small rodents.

The population changes described for Apodemus in the present study, however, are unusual in many ways (pp. 50-51). The unnaturally low number of captures made throughout the summer months of each year studied presents a problem of interpretation. It would be expected that the numbers in the population would increase during the breeding season, and that this increase would be indicated in the trapping record. Instead of this occurrence however, there was an autumn influx of

animals which caused the population size to increase enormously in a short period of time. Population studies on Apodemus have been described by Elton et al (1931), Evans (1942), Hacker and Pearson (1944, 1946, 1951, and 1952), Brown (1954), Miller (1958), Ashby (1962), Newson (1963), Kikkawa (1964), and Tanton (1965). Many of these workers observed that low catches were made in the summer and very high ones made in the autumn. The population trend recorded by Newson (1960) for Apodemus was not typical as winter breeding had occurred in his populations, a phenomenon previously described by Baker (1930) and Steven (1957). No winter breeding took place during the present study. Kikkawa (1964) captured considerable numbers of Apodemus during the summer in Wytham Woods, Berkshire, but he still observed an increased capture rate in the autumn.

In the present study only a few of the animals involved in the autumn influx into the traps had been captured previously. This was found also by Miller (1958) and Tanton (1965). Miller (1958) attributed the autumn influx to the immigration of animals into the trapping area from adjoining corn-fields after harvest, inferring that breeding had occurred there. Ashby (pers. comm.) considered that a high degree of breeding success in late summer was the main cause of the autumn increase, and he reported having captured many juveniles. In the present study, and in that of Tanton (1965), the explanation advanced by Miller (1958) and Ashby (1962) is inadequate. Very few

juveniles were involved in the influx in the autumn, most of the animals weighed more than 15 grams and many were in breeding condition, although meriting description as sub-adults from their weight and general appearance. Also, in the present study and that of Tanton (1965), the number of animals caught and the estimated population size continued to increase until the late winter, although breeding had ceased by October-November. Tanton (1965) considered there to be three possible explanations of the autumn influx of animals:-

- 1) they were migrating across the area in a certain direction,
- 2) immigration was occurring from all sides,
- 3) animals were present on the area but were not being caught for behavioural reasons.

Tanton (1965) examined his data statistically to see which of the three stated explanations was the most likely to be the true one. He found no evidence of migration across the area, nor of immigration into it, he thus concluded that the animals were present throughout the summer, and were breeding in the study area, but few were being captured because the majority evaded capture through behavioural reasons. A possible cause of the changed response to traps may be a change in feeding behaviour with a change in the available food. Holisövä (1960) and Miller (1954), recorded that animal food was predominant in the stomachs of Apodemus in the summer, while green food and seeds became more dominant in the autumn and winter.

This could cause a lack of interest in grain-baited traps when animal (mainly insect) food is available. Such a change in response to traps was recorded by Kikkawa (1964) who observed decreased interest in traps by mice in summer and by voles in winter. The increased interest in traps as the cold weather begins could well be, as Tanton (1965) suggests, due to the supply of insect food decreasing at a time when the metabolic requirements of the animals are increasing. Tanton (1965) further maintains that live-trapping of Apodemus in the summer is ineffective for purposes of population estimation as the basic requirements for random sampling are not met. In the present study trap-lines set in adjoining corn-fields during the summer did not catch any Apodemus thus rendering Miller's explanation unlikely. Ashby (pers. comm.) reports that during the years of the detailed part of his study from 1954-1959 inclusive, there was some indication of Apodemus being less easily trapped than usual in mid-summer in some years. However, in view of the generally good representation of juveniles in the catch he believes this to be exceptional. He suggests that the differences in trapping technique between himself and Tanton and the writer may be important factors in producing this marked difference of behaviour.

Month	Interval	n_{t+1}	$m_{t,t+1}$	C_t	R_t	N_t	ρ_t
1963							
Mar.	1.46	-	-	18	16	-	-
Apr.	0.75	-	10 ¹	15	14	13.6	0.726
May	1.25	0	7	12	12	14.1	0.025
June	1.00	1	7 ¹	16	15	20.2	0.434
July	1.00	2	9	23	23	25.1	0.426
Aug.	1.25	1	15	27	26	25.4	0.719
Sept.	1.00	0	11	36	35	36.0	0.564
Oct.	1.00	0	8	25	23	54.6	0.355
Nov.	1.00	6 ¹	11	28	26	51.5	0.357
Dec.	2.00	10 ¹	15 ²	32	27	34.3	0.249
1964							
Jan.	1.43	3	12	19	17	26.4	*0.142
Mar.	1.86	6	12 ²	25	22	*40.8	*0.502
Apr.	1.53	5	7	16	16	21.0	0.054
May	2.00	3	12	32	31	36.9	0.526
July	1.00	10	1	35	34	36.6	0.959
Aug.	1.25	1	8	40	40	44.5	0.820
Sept.	2.00	1	23 ⁵	57	47	50.2	0.391
Oct.	1.00	1	22 ¹	53	48	55.1	0.557
Nov.	2.00	2	24	37	32	40.0	-
1965							
Jan.	-	4 ³	19 ¹	27	23	-	-

Table 24. Population parameters of Clethrionomys males on Grid A estimated using the Maximum-Likelihood Method of Leslie et al (1953). No estimates of rate of increase or dilution rate are given for one sex treated alone. For other details see footnote to Table 20, and Page 43.

* Doubtful estimate.

Month	Interval	n_{t+1}	$m_{t,t+1}$	C_t	R_t	N_t	λ_t
1963							
Mar.	1.46	-	-	8	8	-	-
Apr.	0.75	-	3	6	5	13.5	0.000
May	1.25	1	1	6	6	9.3	0.000
June	1.00	2	6	12	12	18.0	0.208
July	1.00	3	8	34	33	37.8	0.583
Aug.	1.25	1	14	34	32	41.9	0.616
Sept.	1.00	2	12	35	34	42.5	0.746
Oct.	1.00	1	8	24	24	46.5	0.000
Nov.	1.00	6	15 ¹	27	26	46.2	0.190
Dec.	2.00	7	11 ¹	21	18	36.0	0.193
1964							
Jan.	1.43	5	5 ¹	12	11	28.9	0.356
Mar.	1.86	6	4	16	15	*68.9	*0.849
Apr.	1.53	5	2	8	8	12.4	0.000
May	2.00	4	8	20	20	25.8	0.518
July	1.00	1	5	25	25	32.6	0.926
August	1.25	2	7	30	30	34.2	0.772
Sept.	2.00	2 ¹	18	41	34	33.4	0.241
Oct.	1.00	0	17 ³	33	25	36.5	0.644
Nov.	2.00	4 ²	12	21	17	23.0	-
1965							
Jan.	-	1	3	6	6	-	-

Table 25. Population parameters of Clethrionomys females, Grid A, estimated using the Maximum-Likelihood Method of Leslie et al (1953). No estimates of rate of increase or dilution rate are given for one sex treated alone. For other details see footnote to Table 20 and Page 43.

* Doubtful estimate.

Month	Interval	n_{t+1}	$m_{t,t+1}$	C_t	R_t	N_t	λ_t
1963							
Mar.	1.43	-	-	15	14	-	-
Apr.	0.75	-	5 ¹	13	12	25.0	0.059
May	1.25	6	11	22	22	26.1	0.049
June	1.00	2	13	20	20	35.4	0.365
July	1.00	6	10 ²	36	34	45.7	0.322
Aug.	1.25	4	22	39	38	44.0	0.267
Sept.	2.00	3	25	43	42	46.2	0.251
Dec.	2.43	2	26 ⁶	42	31	30.8	0.285
1964							
Feb.	1.14	0	9 ¹	11	10	23.1	0.563
Mar.	2.00	6	5 ¹	15	13	14.1	0.081
May	0.86	5 ¹	6	17	16	19.4	0.596
June [‡]	2.57	1	6	12	12	19.2	0.256
Aug.	1.11	2	5	51	50	55.2	0.307
Sept.	2.00	1	30	44	42	50.2	0.204
Nov.	1.25	4 ¹	26 ⁹	41	27	30.2	-
Dec.	-	2	15 ¹⁰	21	9	-	-

Table 26. Population parameters of Clethrionomys males on Grid B estimated using the Maximum-Likelihood Method of Leslie et al (1953). For other details see footnote to Table 20, and Page 43.

[‡] Half-grid only trapped.

Month	Interval	n_{t+1}	$m_{t,t+1}$	C_t	R_t	N_t	ρ_t
1963							
Mar.	1.43	-	-	17	17	-	-
Apr.	0.75	-	4	6	6	14.0	0.045
May	1.25	5	5	13	13	14.8	0.157
June	1.00	1	8	16	15	19.2	0.070
July	1.00	2	10	24	23	32.8	0.569
Aug.	1.25	3	12	33	31	33.6	0.447
Sept.	2.00	1	17	34	34	36.6	0.319
Dec.	2.43	1	18 ¹	26	23	22.8	0.170
1964							
Feb.	1.14	0	13	14	14	18.4	0.038
Mar.	2.00	3 ¹	10 ¹	14	12	17.7	0.256
May	0.86	4	8	13	13	12.8	0.345
June [‡]	2.57	0	5	5	5	12.5	0.277
Aug.	1.11	5	2	36	35	38.6	0.174
Sept.	2.00	1	22 ¹	33	32	42.6	0.292
Nov.	1.25	4 ¹	16 ²	28	19	21.7	-
Dec.	-	2	14 ⁴	17	12	-	-

Table 27. Population parameters of Clethrionomys females on Grid B estimated using the Maximum-Likelihood Methods of Leslie et al (1953). For other details see footnote to Table 20 and Page 43 .

[‡] Half-grid only trapped.

Month	Interval	n_{t+1}	$m_{t,t+1}$	C_t	R_t	N_t	μ_t
1963							
Mar.	1.46	-	-	16	16	-	-
Apr.	0.75	-	2	3	3	2.7	NC
May	1.25	1	0	1	1	NC	NC
June	1.00	0	1	1	1	NC	NC
July	1.00	0	0	5	5	NC	NC
Aug.	1.25	0	1	6	6	NC	NC
Sept.	1.00	0	1	4	4	5.8	NC
Oct.	1.00	1	3	18	18	21.4	0.228
Nov.	1.00	1	11	20	20	25.2	0.066
Dec.	2.00	2	11	32	32	52.2	0.241
1964							
Jan.	1.43	4	14 ¹	36	35	48.0	0.309
Mar.	1.86	4	19	34	34	40.7	0.423
Apr.	1.53	2	14	22	22	23.9	0.344
May	2.00	1	13	14	14	14.0	NC
July	1.00	0	2	3	3	NC	NC
Aug.	1.25	0	2	3	3	NC	NC
Sept.	2.00	0	1	18	18	47.5	0.115
Oct.	1.00	2	9	44	44	65.7	0.259
Nov.	2.00	4	27	40	40	49.9	-
1965							
Jan.	-	2	16	18	18	-	-

Table 28 . Population parameters of Apodemus males on Grid A estimated using the Maximum Likelihood Method of Leslie et al (1953). For other details see footnote to Table 20 and Page 43 .

NC = Not calculable.

Month	Interval	n_{t+1}	$m_{t,t+1}$	C_t	R_t	N_t	λ_t
1963							
Mar.	1.46	-	-	8	8	-	-
Apr.	0.75	-	2	4	4	3.9	NC
May	1.25	1	3	4	4	6.0	NC
June	1.00	1	1	2	2	3.0	NC
July	1.00	1	2	3	3	NC	NC
Aug.	1.25	0	1	3	3	NC	NC
Sept.	1.00	0	0	3	3	NC	NC
Oct.	1.00	0	1	9	9	14.0	NC
Nov.	1.00	1	5	13	13	25.0	0.137
Dec.	2.00	3	6	16	16	28.9	0.299
1964							
Jan.	1.43	4	8	26	26	27.4	0.118
Mar.	1.86	1	22	36	36	35.4	0.262
Apr.	1.53	0	15	23	23	33.1	0.373
May	2.00	4	13	18	18	17.8	1.099
July	1.00	0	2	5	5	4.0	NC
Aug.	1.25	0	3	5	5	4.0	NC
Sept.	2.00	0	5	7	7	6.0	NC
Oct.	1.00	0	17	26	26	22.5	0.691
Nov.	2.00	0	8	23	22	21.8	-
1965							
Jan.	-	-	-	8	8	-	-

Table 29 . . . Population parameters of Apodemus females on Grid A estimated using the Maximum-Likelihood Method of Leslie et al (1953). For other details see footnote to Table 20 and Page 43 .

NC = Not calculable.

IV. SURVIVAL

1. Survival of the total population

The survival rates (P_t) corrected for a standard interval of 28 days are given in Table 30. The survivorship curves are shown for Clethrionomys in Figs. 10a,b, and 11a, and for Apodemus in Fig. 11b. The corrected ' P_t ' was calculated from the formula $1 - \mu_t$ (μ_t = the death rate per 28 days, calculated as described on pp. 45-46 and is given in Tables 20-29).

a) Clethrionomys. Grid A (Table 30, Figs. 10a, 11a)

The survival rate of overwintered animals (sexes combined) was low between April and May 1963, but very high between May and June (0.94). Throughout the breeding season the survival of the population as a whole became increasingly poor, and was down to just over 30% per 28 days between September and October. During autumn and winter the survival rate improved, reaching a very high level between January and March 1964. Survival was poor between March and April 1964, but was excellent between April and May. As in 1963 the survival rate dropped to a low level as the summer proceeded, recovering after August, but unlike in 1963 the survival rate became poor again after October. This observed drop in survival rate resulted in the previously noted fall in numbers (p. 48).

b) Clethrionomys. Grid B (Table 30, Figs. 10b, 11a)

Survival was moderate (60%) between April and May 1963 on this grid, and it improved between May and June. As on grid A, however, the survival rate declined in the early part of the summer. In contrast to grid A the decline halted between July and August, and the survival rate began to improve again. The survival rate never reached the low value which it did on grid A. The survival rate had improved to over 0.7 by October, and was at a similar level in early winter, it then rose between February and March 1964, but fell again between March and April. There was another slight rise in late spring and a fall in early summer, but after June the survival rate remained at a quite high level (0.7) throughout the summer and early autumn. Thus on grid B the survival of Clethrionomys was consistently better than on grid A, with fewer fluctuations, and less evidence of impaired survival during the breeding season. The drop in survival rate between March and April 1964 on grid A was repeated on grid B, though to a less marked extent. This drop was almost certainly due to a particularly severe cold spell with snow, ice, and low temperatures, its effect perhaps being accentuated by coming after a mild spell of weather.

Date	Clethrionomys Grid A		Clethrionomys Grid B		Apodemus Grid A		Apodemus Grid B	
	Males & Females	Males	Females	Males & Females	Males	Females	Males & Females	Males & Females
1963								
Mar.	-	-	-	-	-	-	-	-
Apr.	0.227	0.274	1.000	0.616	0.941	0.955	0.454	-
May	0.938	0.975	1.000	0.959	0.951	0.843	0.591	-
June	0.673	0.566	0.792	0.769	0.635	0.930	0.106	-
July	0.474	0.574	0.417	0.591	0.678	0.431	-	-
Aug.	0.351	0.281	0.384	0.657	0.733	0.553	0.037	-
Sept.	0.335	0.436	0.254	0.721	0.749	0.681	0.964	-
Oct.	0.645	0.645	1.000	-	-	-	0.907	-
Nov.	0.673	0.643	0.810	-	-	-	0.920	-
Dec.	0.761	0.751	0.807	0.743	0.715	0.830	0.701	-
1964								
Jan.	*1.000	*0.858	0.644	-	-	-	0.851	0.882
Feb.	-	-	-	1.000	0.437	0.962	-	-
Mar.	*0.411	*0.498	*0.151	0.717	0.919	0.744	0.308	0.738
Apr.	1.000	0.946	1.000	-	-	-	0.906	0.627
May	0.462	0.474	0.482	0.863	0.404	0.655	-	0.194
June	-	-	-	*0.737	0.744	0.723	-	-
July	0.053	0.041	0.074	-	-	-	-	-
Aug.	0.306	0.180	0.228	0.746	0.693	0.826	0.806	-
Sept.	0.691	0.609	0.759	0.754	0.796	0.708	0.678	-
Oct.	0.369	0.443	0.356	-	-	-	-	*0.195
Nov.	-	-	-	-	-	-	-	-
Dec.	-	-	-	-	-	-	-	-
1965								
Jan.	-	-	-	-	-	-	-	-

Table 30. Estimated Survival Rate per 28 days for Clethrionomys and Apodemus. The rates for the sexes combined and for the sexes treated separately are given, except for Apodemus on Grid B.

* = Doubtful estimate.

c) A comparison of the survival of the two sexes of
Clethrionomys on grid A (Fig. 10a)

There is close agreement between the general shape of the survivorship curves of the two sexes although there are differences in detail. The survival of the females was considerably better than that of the males between April and May 1963, but the survival of both sexes was good from May to June. The survival rate of both sexes declined during the summer, but that of the males improved a month earlier than did that of the females. After October, however, until January 1964 the survival of the females was superior to that of the males. From January 1964 to April 1964 the survival rate of the males was higher than that of the females, although the males suffered a drop in survival rate between March and April. The rise and fall of the survival rates of the two sexes was extremely close throughout the summer and autumn of 1964.

d) A comparison of the survival of the two sexes of
Clethrionomys on Grid B (Fig. 10b)

There were greater differences between the survival of the two sexes on grid B than on grid A. The females had a survival rate higher than that of the males in June-July 1963, the survival rate of the males having dropped as breeding commenced. However, the next month the survival rate of the

(a).

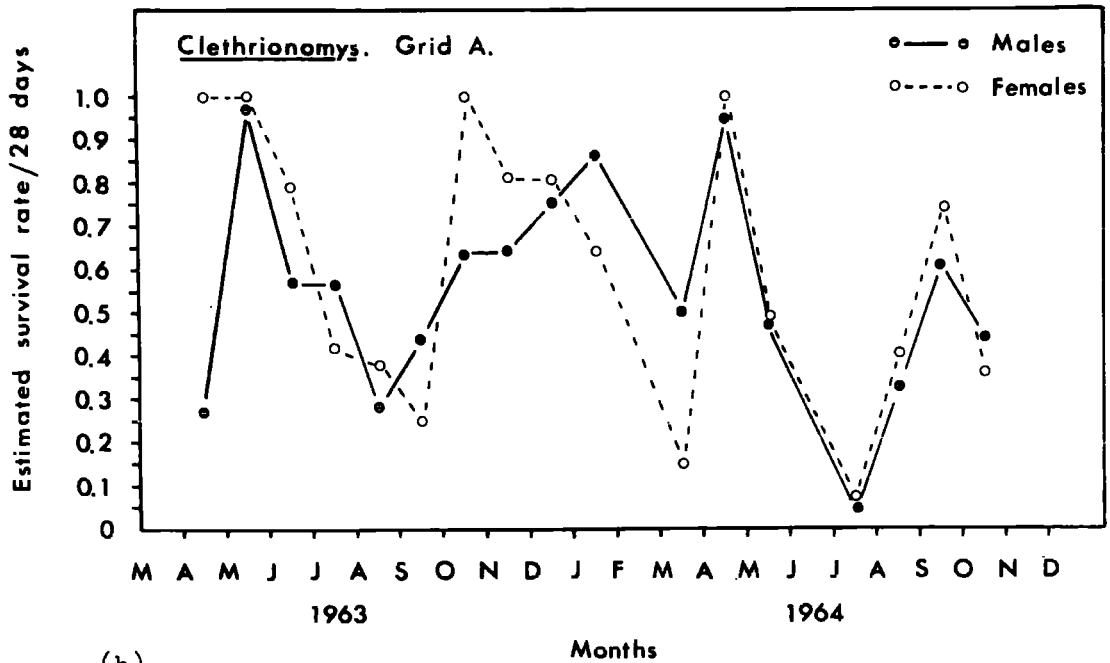

(b).

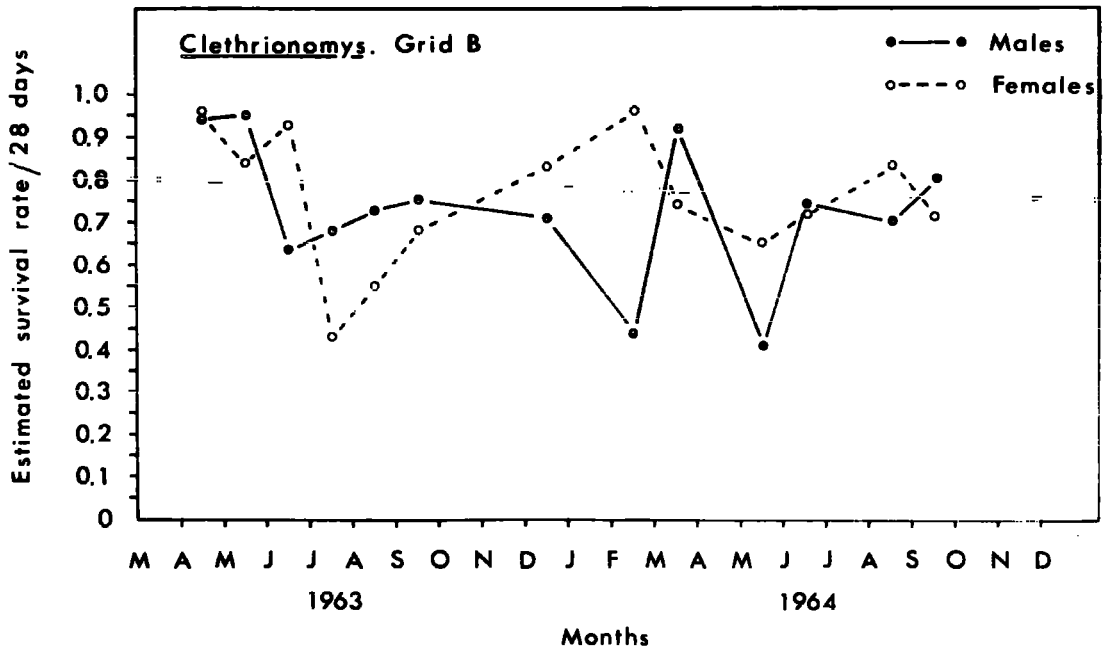

FIGURE 10. Seasonal variation in the estimated survival rate per 28 days (' P_t ') of Clethrionomys males and females caught on grid A (a) and grid B (b) during the study period.

females dropped to a low level just as the survival of the males began to improve. After August the survival rate of both males and females improved, but that of the females was consistently lower. From October 1963 to January 1964 the survival rate of the males remained steady, but it dropped sharply between February and March. In contrast, the survival of the females continued to improve after October, and no winter decline occurred. After March 1964 the survival rate dropped a little, but gradually improved during the summer, then dropped again between September and October. The survival rate of the males fluctuated wildly until July after which it remained steady, and actually improved a little in the autumn. In general form the shape of the survivorship curves was similar over the whole period of study. In 1963 the survival of the females followed the pattern of the males although it was a month out of phase. In 1964 the similarities were less as the violent fluctuations of the male survival rate were not evident in that of the females.

e) The survival of *Apodemus* on Grid A (Fig. 11b)

Because of the low number of animals involved little can be said about the survival of *Apodemus* in summer 1963. The small population present at the beginning of the study quickly disappeared and not until September-October 1963 did appreciable numbers appear on the grid. From September to

(a).

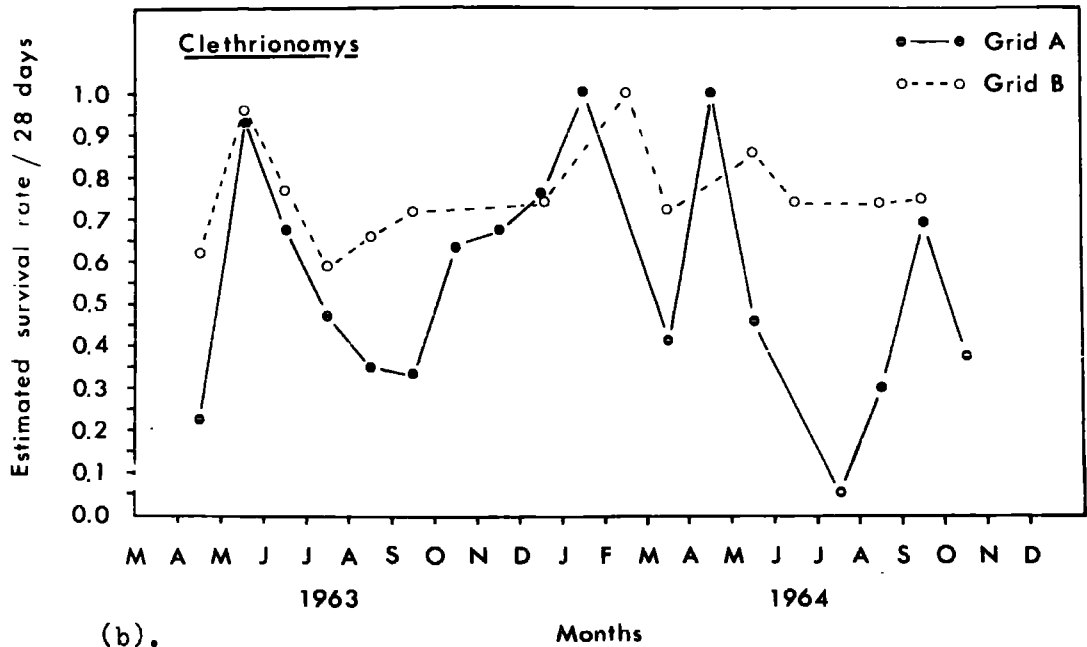

(b).

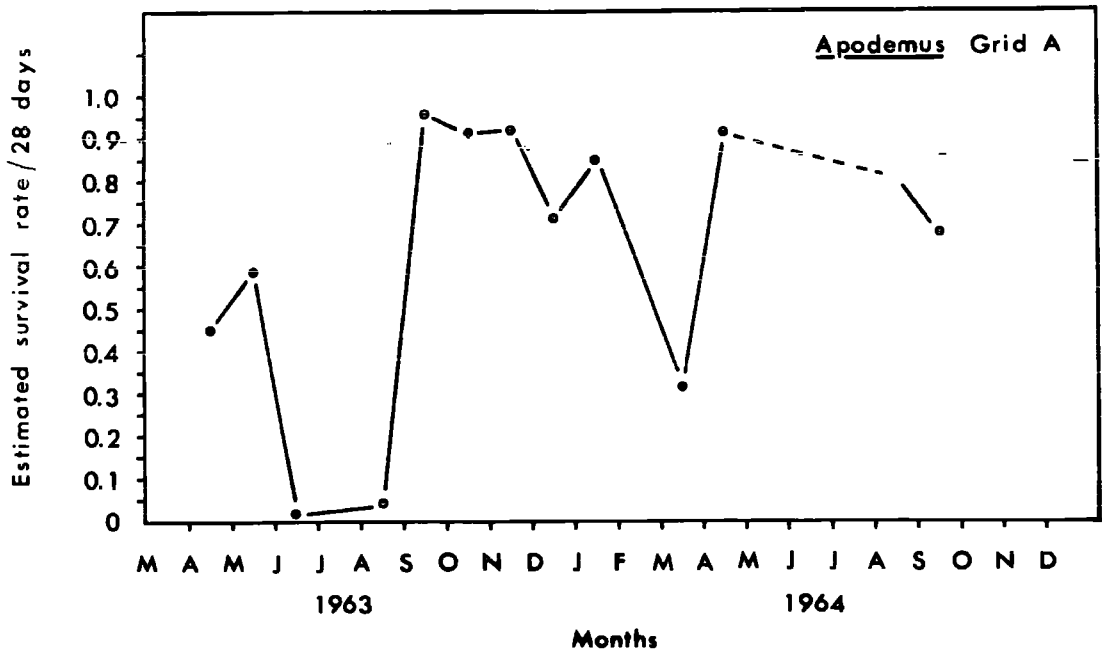

FIGURE 11. Seasonal variation in the estimated survival rate per 28 days ('P') of Clethrionomys (sexes combined) on grids A and B^t (a), and of Apodemus on grid A. (b).

December survival was good, but there was a drop in survival rate between December 1963 and January 1964, the rate then improved again before apparently dropping to a very low level between March and April. The drop in survival rate at this time occurred also in both Clethrionomys populations (pp. 78-79). Again, in 1964, little can be said of the survival rate because of the low numbers of animals caught. The few animals which were alive in May survived the summer and were present when the late summer influx of individuals occurred. In contrast to 1963, the survival rate of Apodemus fell from September-October 1964; again, similar drops in survival rate were reported for the Clethrionomys populations (pp. 78-79). Numbers were too few to allow analysis of the survival rate of the sexes separately.

On grid B all that can be said of the survival of Apodemus is that it was good between February and March 1964, but declined rapidly from March to June.

2. The survival of different cohorts of animals in the total population

a) Introduction

In addition to calculating the survival rates of the populations of Clethrionomys and Apodemus by the maximum-likelihood equations a less refined method of analysis was used also for comparative purposes. This second form of analysis

consisted of measuring the survival of marked animals by noting the number caught at each trapping period of those released at the trapping before. Animals known to be alive at the second trapping, because they were subsequently caught, were included in the re-captured group. The estimated survival rates were adjusted to refer to a 28 day interval. The mean minimum monthly survival rates over certain periods were compared for the cohorts of animals concerned. The survival rates obtained bear no direct relation to the more accurate ones so far discussed, mainly because only the survival of marked animals is considered here. There is no reason, however, why the survival of marked should differ from that of unmarked animals, except perhaps in spring when food is less plentiful, and the grain in the traps is a useful extra supply. In practice the survival rate as calculated by this monthly minimum method was found to be consistently higher than that found by the maximum-likelihood method, but for the sexes combined the form of the survivorship curves was similar over the whole period of study. Using the minimum monthly survival rates an attempt was made to compare the survival of animals entering the population at different times of the year. Three main cohorts of animals were considered in each year:-

- 1) Overwintered animals from the previous year.
- 2) Summer young (entering the trappable population from June-August inclusive).

- 3) Autumn young (entering the trappable population from September-November inclusive).

It was realised that on such a broad basis each cohort would have a mixed composition; but allowing for this the bulk of animals entering the population between June and August must have been born in late spring or early summer, and are distinguishable from over-wintered animals by weight and appearance (p. 18). Similar arguments apply to autumn-young, which are the young of overwintered animals, and of the first summer-young.

b) Clethrionomys. Grid A (Table 31, Fig. 12a)

Data for the two sexes combined were used. In 1963 the animals which had survived the severe winter of 1962-63 had representatives in the population until December 1963. Their survival may thus be compared with that of the spring and early summer-young. In the period from June to December 1963 the overwintered animals had a mean survival rate of 0.81/28 days compared with a mean rate of 0.71/28 days for the summer-young. When the individual monthly rates are considered, it may be seen that the superior survival of the older animals was more evident from June to September 1963 than in the later months. In the period from September to December 1963 the survival of the remaining old overwintered animals was better than that of the summer-young, which latter in turn survived better than the

autumn-young. However, as the numbers of the first two categories of animals were much reduced there was still a great majority of autumn-young in the overwintering population of 1963-64. Few of the summer-born young of 1963 remained alive in April 1964, and none were recorded as being in breeding condition. The mean survival rate of autumn-born young was the same as that of the remaining summer-born young in the period January 1964 to April 1964; but as the numbers of summer-born young were low in early winter the operation of even a moderate death-rate was sufficient to virtually remove them all by spring 1964. The survival rate of the early summer-young of 1964 cannot be compared with that of the overwintered animals of 1963-64 because very few of the latter remained by August 1964. The survival of summer-born young was compared with that of autumn-born young from September 1964 to January 1965, and that of the former was found to be superior. However, as the numbers of summer-born young were low by December 1964 it is unlikely that any would survive to breed in 1965. The rather poor mean survival over this period (0.51) of potential spring-breeding animals suggests that if continued the population may be in a rather critical phase during the biologically-precarious season of spring in 1965.

c) Clethrionomys. Grid B (Table 32, Fig. 12b).

The overwintered animals of 1962-63 had survivors in the population until December 1963, as in the case of grid A.

Cohorts	Mean Monthly Survival Rates		
	Jun./Dec. 1963	Jun./Jan. 1963 1964	Sep./Dec. 1963
1963/64			
(1) Overwintered animals 1962-63	0.81	0.78	0.80
(2) Summer-born young 1963	0.71	0.69	0.75
(3) Autumn-born young 1963	-	-	0.71
1964	Sep./Apr. 1963 1964	Sep./Aug. 1963 1964	Sep./Jan. 1964 1965
(1) Summer-born young 1963	0.73	-	-
(2) Autumn-born young 1963	0.76	0.78	-
(3) Summer-born young 1964	-	-	0.66
(4) Autumn-born young 1964	-	-	0.51

Table 31. Survival of the different cohorts of Clethrionomys on grid A. Sexes combined. Survival rate of marked animals only. The rates given are the means for the periods indicated.

During the period from June to December 1963, the summer-born young of that year were found to survive much better than their parents which had survived from 1962, having a mean monthly rate of 0.88 compared with 0.65 over this period. This situation is in complete contrast to that recorded for grid A. From September to December 1963 the survival of all three cohorts has been compared. The survival of summer-born young was found to be superior to that of both of the other cohorts. In complete contrast yet again to the situation on grid A the summer-born young of 1963 on grid B had survivors in the population until August 1964, and bred in both 1963 and 1964. Their survival rate from September 1963 to August 1964 was found to be higher than that of the autumn-born young which had never attained breeding condition at all. However, the particularly good survival of summer-born young from September to December 1963 weighted the mean survival rate calculated over the longer period, and if the period from December 1963 to August 1964 is considered alone then the autumn-born young had the better mean survival rate. The survival of summer-born young of 1964 was found to be good from August to November 1964 inclusive, and the survival of autumn-born young was also good until November. Survival of all the cohorts was poor between November and December.

Cohorts	Mean Monthly Survival Rates.		
	Jun./Dec. 1963	Sep./Dec. 1963	Sep./Aug. 1963 1964
1963/64			
(1) Overwintered animals 1962-63	0.65	0.54	-
(2) Summer-born young 1963	0.88	0.92	0.82
(3) Autumn-born young 1963	-	0.71	0.79
1964	Dec./Aug. 1963 1964	Jun./Nov. 1964	Aug./Nov. 1964
(1) Summer-born young 1963	0.78	-	-
(2) Overwintered animals 1963-64	0.82	0.77	0.67
(3) Summer-born young 1964	-	0.66	0.80
(4) Autumn-born young 1964	-	-	0.80

Table 32. Survival of the different cohorts of Clethrionomys on grid B. Sexes combined. Survival rates of marked animals only. The rates given are the means for the periods indicated.

(a).

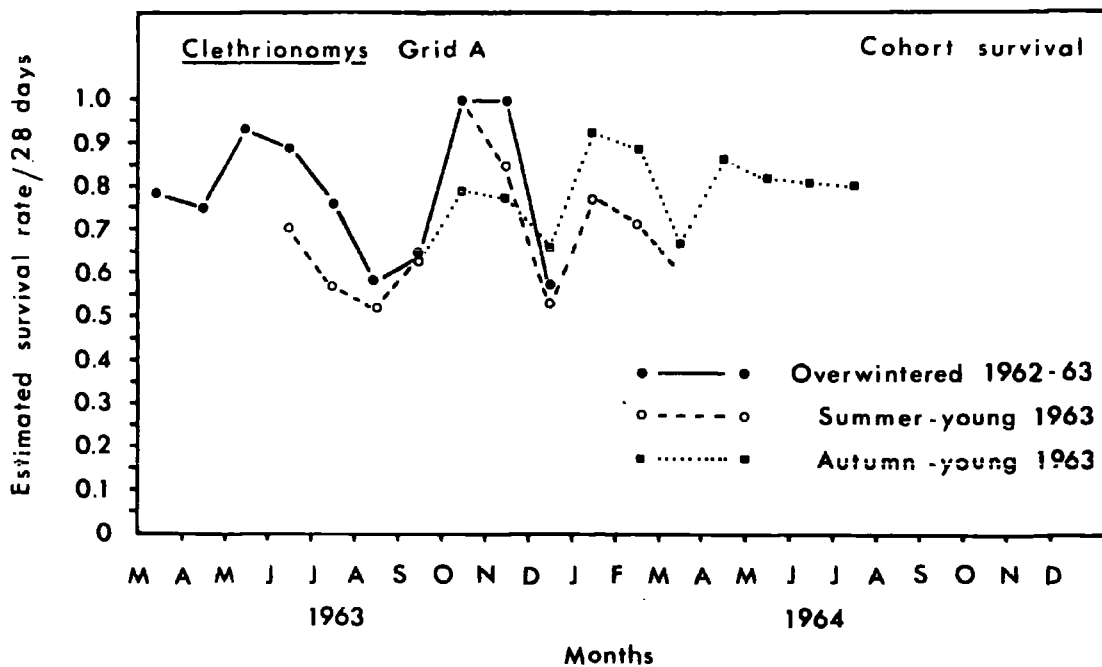

(b).

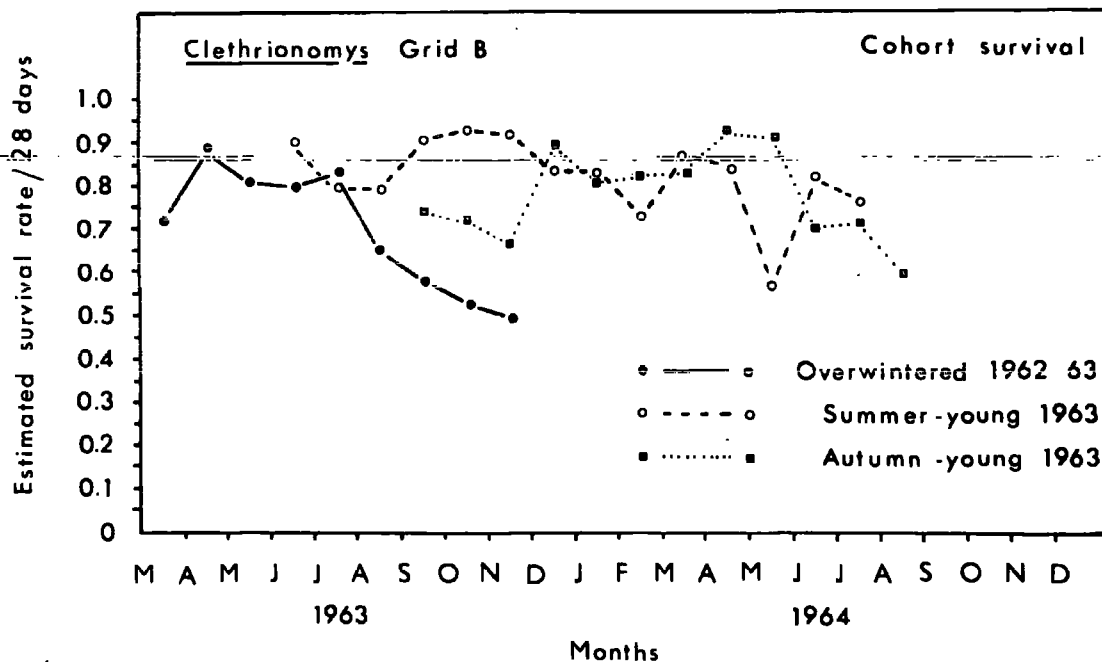

FIGURE 12. The estimated survival rate per 28 days of different cohorts of Clethrionomys on grid A (a) and grid B (b). Survival rates calculated by the ' minimum monthly survival ' method (see text). Sexes combined.

d) The survival of the different cohorts of the two sexes of *Clethrionomys* on grid A and grid B (Tables 33-35)

It was found that there was no significant difference between the survival of the cohorts of animals of both sexes on grid A and that of the cohorts of the sexes treated separately, Similarly, on grid B the cohort survival of the sexes treated separately closely resembled that of the two sexes treated together.

3. The life span of *Clethrionomys* and *Apodemus*

In the present study it was observed that the majority of the animals lived for only a few months. Some few individuals, however, were present on the study area for more than one year. Two *Clethrionomys* males lived for at least fifteen months, three others lived for at least fourteen months, and several survived for more than twelve months. *Clethrionomys* females appeared to live a little longer than the males for three survived for at least sixteen months, three for at least fifteen months, and several for thirteen or fourteen months. It is probable that in *Apodemus* the wandering behaviour prevented the continuous recording of individuals, and the maximum recorded life spans are probably underestimates. Bearing this in mind, it may be stated that the longest-lived *Apodemus* male survived for eleven months, and the longest-lived female for fifteen months. Hacker and Pearson (1946) kept *Apodemus* in captivity for up to 53 months

Cohorts	Mean Monthly Survival Rates		
	Jun./Dec. 1963	Sep./Dec. 1963	Dec./Sep. 1963 1964
1963/64			
(1) Overwintered animals 1962-63	0.86	0.95	-
(2) Summer-born young 1963	0.67	0.71	-
(3) Autumn-born young 1963	-	0.76	0.81
1964/65	Sep./Jan. 1964 1965		
(1) Summer-born young 1964	0.77		
(2) Overwintering animals 1964-65	0.60		

Table 33. Survival of the different cohorts of Clethrionomys males on grid A. Survival of marked animals only. The rates given are means for the periods indicated.

Cohorts	Mean Monthly Survival Rates		
	Jun./Dec. 1963	Sept./Dec. 1963	Sept./May 1963 1964
1963/64			
(1) Overwintered animals 1962-63	0.64	0.58	-
(2) Summer-born young 1963	0.92	0.91	0.77
(3) Overwintered animals 1963-64	-	0.73	0.79
1964	Jun./Sep. 1964	Sept./Dec. 1964	
(1) Overwintered animals 1963-64	0.82	-	
(2) Summer-born young 1964	0.53	0.77	
(3) Overwintering animals 1964-65	-	0.79	

Table 34 . Survival of the different cohorts of Clethrionomys males on grid B. Survival of marked animals only. The rates given are means for the periods indicated.

Cohorts	Mean Monthly Survival Rates.		
	Jun./Oct. 1963	Sep./Jun. 1963 1964	Sep./Nov. 1964
Females Grid A			
(1) Overwintered animals 1962-63	0.62	-	-
(2) Summer-born young 1963	0.63	0.80	-
(3) Autumn-born young 1963	-	0.79	-
(4) Summer-born young 1964	-	-	0.54
(5) Overwintering animals 1964	-	-	0.33
Females Grid B			
	Jun./Mar 1963 1964	Sep./Mar. 1963 1964	Sep./Dec. 1964
(1) Overwintered animals 1962-63	0.77	0.74	-
(2) Summer-born young 1963	0.87	0.95	0.83
(3) Overwintered animals 1963-64	-	0.71	-
(4) Summer-borne young 1964	-	-	-
(5) Overwintering animals 1964	-	-	0.89

Table 35. Survival of the different cohorts of Clethrionomys females on grid A and grid B. Survival of marked animals only. The rates given are means for the periods indicated.

but found that in the field few survived from one winter season to the next. Blair (1948) found that in three species of rodent, Peromyscus maniculatus, Peromyscus leucopus, and Microtus pennsylvanicus, the average life span among individuals that lived until they left the nest was less than five months. That rodents live only a fraction of their potential life-span in the field is amply demonstrated by the fact that many species have lived for some years in captivity. Dice (1933) reported individual Peromyscus maniculatus living up to seven and eight years in captivity. Captive Apodemus sylvaticus and Clethrionomys glareolus have also been reported as having lived for three and a half and three years respectively, (Ashby pers. comm.). There is much evidence in support of the statement made by Burt (1940) to the effect that mice rarely reach 'old age' in the field.

4. Summary and discussion

In the present study the survival of Clethrionomys, when both sexes are considered together, was found to be good just prior to the start of the breeding season, poor during the breeding season, and good in the late autumn and the winter. Also, survival on grid B was consistently better than on grid A. Leslie et al (1953) and Newson (1963) found similar seasonal variation in survival in Clethrionomys populations which they studied. They found also, however, that the survival of the

females was consistently superior to that of the males. No such consistent sexual difference in survival was observed in the present study. Ashby (pers. comm.) also found there to be no significant difference between the survival of the two sexes of Clethrionomys. On grid A the survival of overwintered animals of 1962-63 was superior to that of the spring and summer-born young of that year. The autumn-born young also survived better than the summer-born young. Few of the summer-young successfully overwintered in 1963-64, and none were recorded as being in breeding condition in 1964. Such a survival pattern would seem to be a fairly normal one in natural populations of mice and voles. Leslie and Ranson (1940) in laboratory studies of Microtus agrestis and Chitty (1952) in a field study of the same species, found a pattern of survival similar to that described above for Clethrionomys. There is general acceptance of the fact that mice and voles seldom survive for more than one year in the wild, and rarely breed in two seasons. On grid B, however, in the present study, some voles were observed to be in breeding condition in late-summer 1963 and in spring and summer 1964. The survival pattern on grid B differed from the more usual one described for Clethrionomys on grid A, mainly in that the survival of the summer-born animals of 1963 was very good, being superior to that of the overwintered animals of 1962-63, and being sufficiently on a par with that of autumn-born young of 1963

to ensure that a substantial proportion of the overwintering animals of 1963-64 was composed of summer-born young.

The question of differential survival of the sexes appears to be as yet unresolved. Leslie et al (1953) and Newson (1963) found females to survive better than males in Clethrionomys, and Godfrey (1955) found with Microtus agrestis that young males survived less well than young females. Frank (1957) discovered that in Microtus arvalis there was a heavy mortality in young males as they dispersed from the maternal home range; the mortality did not affect the females as they did not leave the maternal home range. However, Frank found that winter mortality affected the females more than the males, suggesting that the smaller and weaker sex succumbed. Frank (1957) also noted that animals never survived two winters, the markedly old individuals dying in the first winter months. Van Wijngaarden (1960), also working with confined populations of Continental voles, found a high juvenile mortality to exist, but he did not find any evidence of sexual difference in survival rates. He concluded that mortality was not density-dependent, a conclusion also arrived at by Southwick (1958) with reference to house-mice living in corn-ricks. Bendell (1959) could find no statistically significant differences between the survival of males and females of Peromyscus leucopus noveboracensis in the United States. Nor did he find any significant differences between the survival rates of the

various age classes which he examined.

In the present study little can be said of the survival of Apodemus other than to note that it was good in the winter months but apparently became poor after April each year. Hacker and Pearson (1946) considered the survival of Apodemus to be affected by repeated trapping, but Newson (1960) found no evidence that this was so, nor was it found to be so in the present study. Hacker and Pearson (1946) also recorded that no animals survived from one winter to the next, and Brown (1954) indicated that few animals survive for more than ten months in the wild.

V. BREEDING

1. The breeding of Clethrionomys on grid A

The sexual condition of Clethrionomys individuals in the catch each month is given in Table 36. The percentage of males and females in breeding condition each month is given in Table 40, and shown graphically in Fig. 13a. Breeding data, with relation to body weight, are given in Table 43. The proportion of pregnant females in the catch and the proportion of juveniles in the catch are given in Tables 41 and 42 respectively, and shown in Fig. 14.

With the exception of autumn 1963 there was a greater proportion of males in breeding condition than females throughout the study. It is thus probable that all fecund females

MONTH	Males			Females						Esc.	Total
	Fec.	NF.	J.	I.	P.	Pr.	Pr.L.	PL	J.		
1963											
March	4	14	0	8	0	0	0	0	0	3	29
April	15	2	0	7	0	0	0	0	0	1	25
May	12	0	0	1	6	1	0	0	0	1	21
June	18	0	1	8	2	1	2	0	1	1	34
July	21	0	2	5	5	2	17	0	5	6	63
August	24	0	7	0	2	3	15	4	11	0	66
September	19	3	15	8	2	3	11	3	11	1	76
October	5	15	10	10	2	3	6	0	8	2	61
November	4	22	4	20	1	2	2	2	2	0	59
December	5	23	3	21	0	0	2	2	0	0	56
1964											
January	0	18	0	14	0	0	0	0	0	2	34
February	-	-	-	-	-	-	-	-	-	-	-
March	10	19	0	17	0	0	1	0	0	1	48
April	11	1	0	6	1	1	0	0	0	0	20
May	30	0	0	3	9	0	1	0	0	2	45
June	-	-	-	-	-	-	-	-	-	-	-
July	22	4	6	6	6	0	6	2	3	0	55
August	31	4	4	7	3	0	18	0	3	0	70
September	33	6	11	6	1	1	18	2	6	0	84
October	18	30	1	20	1	1	8	1	3	1	84
November	5	33	0	15	0	0	2	0	4	2	61
December	-	-	-	-	-	-	-	-	-	-	-
1965											
January	0	27	0	7	0	0	0	0	0	0	34
TOTALS	287	221	64	189	41	18	109	16	57	23	1025

Table 36 . Sexual condition of Clethrionomys individuals caught on Grid A.

Fec. = Fecund I. = Imperforate Pr.L. = Pregnant, lactating
 NF = Non-fecund P. = Perforate PL = Perforate, lactating
 J. = Juvenile Pr. = Pregnant Esc. = Escaped

- = No trapping

would become pregnant. In March 1963 only 20% of the males were fecund but by April this proportion had increased to 85%, and by May 100% of the males were fecund. From May to August the percentage fecund decreased to 75%, mainly because of the dilution of the population by juveniles and by sub-adults. The percentage fecund had decreased to 50% by September, partly because of the dilution effect noted above, but partly because of old fecund animals dying off. In October, November, and December only 15% of the males captured were fecund, there being three factors operating at this time to reduce the proportion fecund:-

- 1) old animals from 1962 and some from summer 1963 were dying off,
- 2) summer-born young, having bred, were coming out of breeding condition,
- 3) autumn-born young were not becoming fecund.

In January 1964 all the males were quiescent. In 1964 the pattern of 1963 was followed closely, there being 100% of the males fecund in May, followed by gradual dilution throughout the summer, for the reasons already given. In September 1964 over 65% were fecund compared with 50% in September 1963, but after September the proportion in breeding condition declined quickly, and by January 1965 all the males were in a quiescent condition.

No females were in breeding condition in April 1963 but by

May almost 90% were perforate or already pregnant. The percentages quoted here and elsewhere for females in breeding condition may be underestimates because of the difficulties of diagnosing pregnancy in the field. Godfrey (1955), with Microtus agrestis, considered that 50% of pregnancies were missed in the field. After May 1963 the percentage of females in breeding condition never rose above 70% because, as with the males, of dilution by juveniles and immatures, the death of old females, and the regression of the sex organs in the autumn. After August the proportion breeding declined steadily and by January 1964 all were out of breeding condition. In October, November, and December 1963, more females than males were engaged in breeding activities because of the occurrence of late pregnancies and the suckling of young. Some females (6%) were perforate in March 1964, and by April 25% of the females were in breeding condition. The breeding season thus commenced a little earlier in 1964 than in 1963, possibly because of the milder winter in 1963-64. Throughout the summer the pattern was much as in 1963, although the proportion still concerned in breeding after September 1964 fell more rapidly than was the case in 1963. By January 1965 all the females were out of breeding condition.

Juveniles were observed to enter the trappable population in the months from June to December inclusive in 1963, and from July to November inclusive in 1964. In 1964, however, no

trapping was carried out in June or December on the grid and hence no records of juveniles could be made. In some line trapping in June 1964 (see Appendix II. p. 352) some juveniles were present in the catch, so breeding must have been well advanced by May. In no month did juveniles form more than 35% of the catch for that month. It is possible that some juveniles of 7-9 grams were missed because of lack of sensitivity of the traps. In 1963 the largest influx of juveniles was in September, but many were caught in August and October also. In 1964 September again was the month which had most juveniles, but only 5% of the catch in October was composed of juveniles compared with almost 30% for that month in 1963. In the summer and autumn each year many animals were captured which were obviously young judging from appearance and weight, but were without the characteristic juvenile fluffy pelage, and were hence not classed as juveniles. They were in fact probably just small enough to have escaped capture the previous month. Juveniles were less well represented in the catch in 1964 than in 1963, even allowing for the fewer trapings, thus suggesting that a less successful breeding season had occurred.

2. The breeding of *Clethrionomys* on grid B (Table 37, Fig. 13b)

In March 1963 more than 50% of the males captured were fecund, and in April and May this percentage had risen to 100%.

10 SEP 1965

MONTH	Males			Females						Esc.	Total
	Fec.	NF.	J.	I.	P.	Pr.	Pr.L.	PL	J.		
1963											
March	9	8	0	10	6	0	0	0	0	4	37
April	17	0	0	7	2	0	0	0	0	3	29
May	26	0	0	7	5	0	0	0	0	2	40
June	18	0	2	2	4	1	5	0	3	0	35
July	31	4	1	0	3	1	17	0	2	1	60
August	35	1	6	3	1	4	20	2	6	0	78
September	32	5	7	7	0	7	10	0	10	0	78
October	-	-	-	-	-	-	-	-	-	-	-
November	-	-	-	-	-	-	-	-	-	-	-
December	19	33	0	21	1	5	1	0	0	0	80
1964											
January	-	-	-	-	-	-	-	-	-	-	-
February	0	15	0	15	0	0	1	0	0	0	31
March	3	14	0	13	0	2	0	0	0	1	33
April	-	-	-	-	-	-	-	-	-	-	-
May	20	0	0	8	5	0	1	0	0	0	34
June	15	0	0	0	0	2	4	1	0	1	23
July	-	-	-	-	-	-	-	-	-	-	-
August	37	5	2	7	3	0	13	1	5	1	74
September	38	10	1	18	1	0	14	0	2	2	86
October	-	-	-	-	-	-	-	-	-	-	-
November	8	36	0	36	0	0	0	0	0	0	80
December	1	23	0	18	0	0	0	0	0	0	42
1965											
January	-	-	-	-	-	-	-	-	-	-	-
TOTALS	339	154	19	172	31	22	86	4	28	15	840

Table 37. Sexual condition of Clethrionomys individuals caught on Grid B.

Fec. = Fecund I. = Imperforate Pr.L. = Pregnant, lactating
 NF = Non-fecund P. = Perforate PL = Perforate, lactating
 J. = Juvenile Pr. = Pregnant Esc. = Escaped

- = No trapping

The proportion had dropped to just over 70% by September because of the dilution of the population by young animals and the death of some old ones. By December 1963 only 35% were fecund, and this proportion had decreased to zero by February 1964. All the males were fecund in May and June 1964 but the proportion dropped steadily throughout the year for the reasons already noted. In September just under 80% were fecund, but by November the proportion had dropped to 20%, and by December 1964 only 5% were in breeding condition.

Almost 40% of the females were in breeding condition in March 1963, but the value dropped to 20% by April because of the death of some of the precocious individuals. Some 40% were again in breeding condition in May. By July 90% of the females were engaged in breeding activities, but this percentage had decreased to 50% by September 1963. In February 1964 a few females were still lactating (6%), a similar situation to that found on grid A. In March 1964, perforate females were appearing in the catch, and by May over 40% were breeding; the proportion breeding dropped rapidly in late summer and early autumn and by November 1964 none of the females were engaged in breeding activities of any kind.

In 1963 juveniles were represented in the catches from June to September (Fig. 14) but since there was a close similarity between the breeding seasons on the two grids they probably entered the population also in October and November

(a).

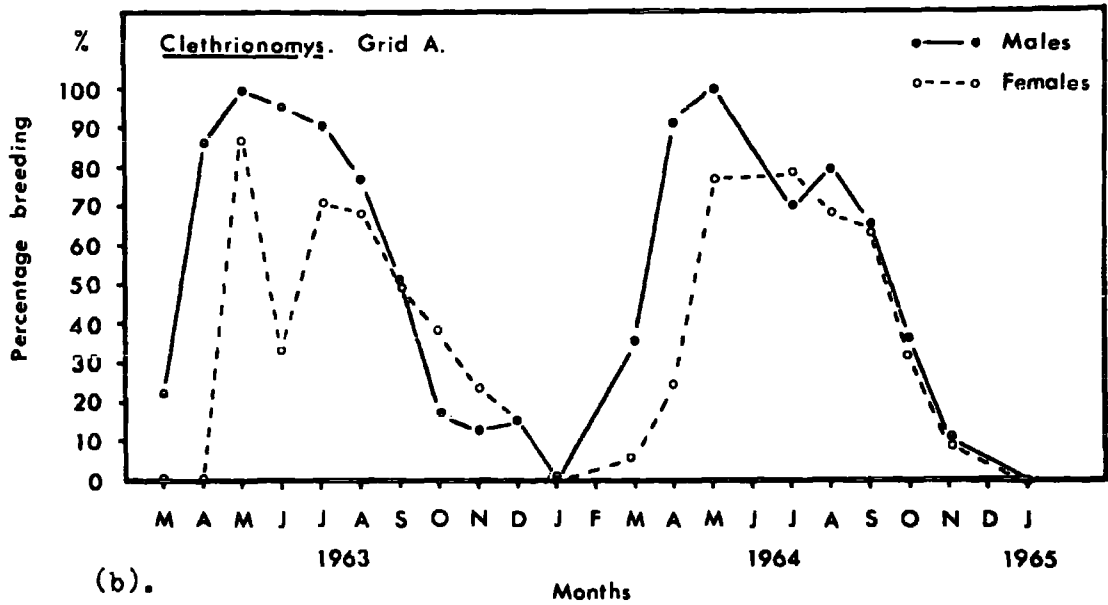

(b).

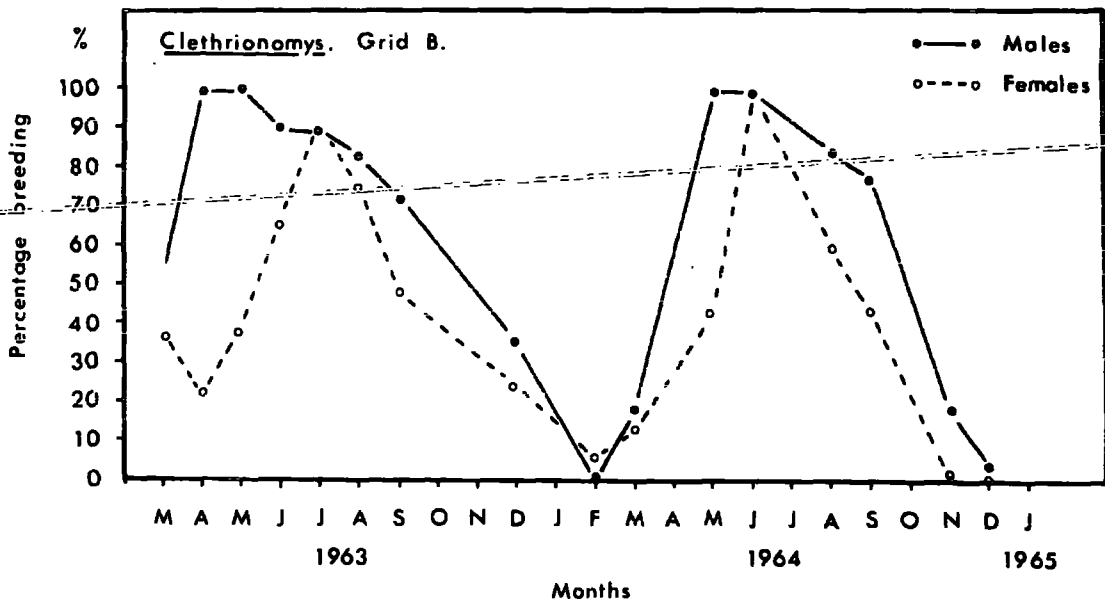

FIGURE 13. Seasonal variation in the percentage of males and females of Clethrionomys in breeding condition on grid A (a) and grid B (b).

as on grid A. In 1964 no trapping was performed in July or October, but even in August and September less than 10% of the catch was composed of juveniles, indicating perhaps that breeding was less successful in that year, as on grid A.

3. Pregnant Females. (Table 41, Fig. 14)

Pregnancies were first diagnosed in May 1963 on grid A, but some females must have littered in late April or early May, in order to allow the capture of juveniles in June. On grid A the highest proportion of pregnant females was found in July and August 1963, and August and September 1964. On grid B a similar situation prevailed, although for the greater part of the study the percentage of females pregnant was higher than on grid A, but this was due to fewer juvenile females being present resulting in there being less of a dilution effect than was present on grid A. In all the months that trapping occurred on grid A an absence of pregnant females was recorded only in April 1963, and January and December 1964. On grid B only in May 1963 and November 1964 were no pregnant females trapped.

4. A comparison of the breeding of *Clethrionomys* on grid A and grid B

The males on grid B appeared to have come into breeding condition earlier than those on grid A in 1963, and they also appeared to stay fecund longer. In 1964 there was little

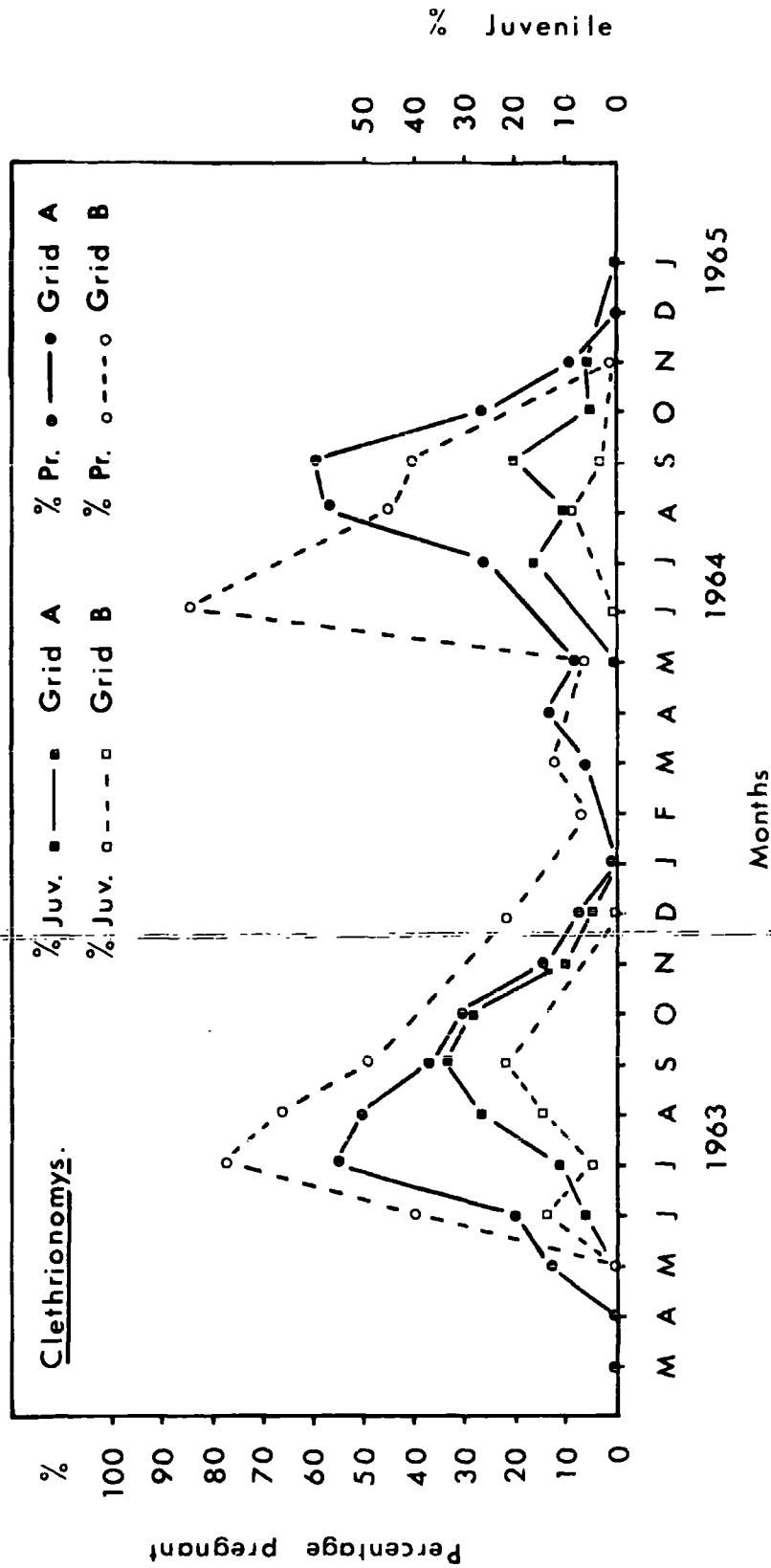

FIGURE 14. The percentage of pregnant females of Clethrionomys in the total catch of female Clethrionomys each month on Grid A and grid B. Also shown is the percentage of juveniles (sexes combined) present in the total catch (of both sexes) each month. See text for further details.

difference in the length of the breeding season so far as the males were concerned. However, the females on grid B were a little later than those on grid A in coming into breeding condition, so it is unlikely that the precocious behaviour of the males resulted in an earlier start to the breeding season.

In both 1963 and 1964 juveniles were better represented in the catches on grid A than on grid B, suggesting possible differences in breeding success (see pp. 103-104). In 1963 juveniles were still entering the population in December on grid A, so the breeding season may have been more prolonged on that grid than on grid B.

5. The breeding of *Apodemus* on grid A and grid B

(Tables 38 and 39)

On grid A, (Table 38), with the exception of March 1963 when 12 animals were caught, all samples up to and including September were of less than 5 animals. However, it is still proposed to discuss the breeding conditions in terms of percentages for convenience of comparison. All the males captured in March, April, May, and June were fecund, but in July and August the few juveniles captured brought the proportion fecund down to 60% and 80% respectively. In September, again all the males caught were fecund. From October 1963 to April 1964 inclusive all samples had more than 20 animals in them and percentages have greater significance. From October to

MONTH	Males			Females						Esc.	Total
	Fec.	NF.	J.	I.	P.	Pr.	Pr.L.	PL	J.		
1963											
March	12	0	0	4	4	0	0	0	0	1	21
April	4	0	0	3	2	0	0	0	0	0	9
May	1	0	0	2	1	0	0	0	0	1	5
June	1	0	0	0	0	0	2	0	0	0	3
July	3	0	2	0	0	0	3	0	0	1	9
August	4	0	1	0	0	0	3	0	0	0	8
September	4	0	0	1	0	0	3	1	1	0	10
October	15	2	0	3	2	0	1	0	3	2	28
November	19	3	0	7	0	0	4	1	0	1	35
December	22	7	0	12	1	1	0	3	1	4	51
1964											
January	10	28	0	28	1	0	0	0	0	3	70
February	-	-	-	-	-	-	-	-	-	-	-
March	36	1	0	24	3	8	3	0	0	2	77
April	24	0	0	16	5	0	1	1	0	0	47
May	8	0	0	6	1	0	7	1	0	0	23
June	-	-	-	-	-	-	-	-	-	-	-
July	2	0	0	0	1	0	2	0	1	0	6
August	2	0	0	0	1	0	2	0	1	0	6
September	13	0	1	0	0	0	9	1	0	1	25
October	13	16	0	12	0	0	6	0	2	2	51
November	12	27	1	23	0	0	1	0	0	0	64
December	-	-	-	-	-	-	-	-	-	-	-
1965											
January	0	18	0	12	0	0	0	0	0	1	31
TOTALS	205	102	5	153	22	9	47	8	9	19	579

Table 38. Sexual condition of Apodemus individuals caught on Grid A.

Fec. = Fecund I. = Imperforate Pr.L. = Pregnant, lactating
 NF = Non-fecund P. = Perforate PL = Perforate, lactating
 J. = Juvenile Pr. = Pregnant Esc. = Escaped

- = No trapping

December 1963 the proportion fecund declined slowly but was still above 70% in December. The animals which caused the dilution were not classed as juvenile but were young animals, (sub-adults). In January 1964 only 26% of the males were fecund, but by March the proportion had risen to 97%. All the males captured from April to August were fecund, but in September one juvenile was captured. In October and November the influx of sub-adults caused a reduction of the proportion fecund to 45% and 30% respectively. In January 1965 all males were out of breeding condition, in contrast to the situation in 1964.

On grid B (Table 39) all samples were composed of less than 5 animals until December 1963. All the males captured until December were fecund, with the exception of one juvenile caught in July. In December one male was non-fecund. In February 1964, 54% of the males were fecund but by March all the males were again fecund. One juvenile was captured in May, but apart from that one exception all males captured until November were fecund. In November and December most of the males captured were non-fecund.

In March and April 1963 on grid A, 50% and 40% respectively of the females captured were perforate. All the females caught were in breeding condition until September 1963. In September and October a few juveniles were captured, and these, along with some other young animals, caused the proportion breeding to

MONTH	Males			Females						Esc.	Total
	Fec.	NF	J.	I.	P.	Pr.	Pr.L.	PL	J.		
1963											
March	2	0	0	1	1	0	0	0	0	2	6
April	2	0	0	0	0	0	0	0	0	0	2
May	1	0	0	0	0	0	0	0	0	0	1
June	-	-	-	-	-	-	-	-	-	-	-
July	4	1	1	0	0	0	1	0	0	0	7
August	1	0	0	0	0	0	0	0	0	0	1
September	2	0	0	0	0	0	0	0	0	0	2
October	-	-	-	-	-	-	-	-	-	-	-
November	-	-	-	-	-	-	-	-	-	-	-
December	13	1	0	11	0	0	0	0	0	0	25
1964											
January	-	-	-	-	-	-	-	-	-	-	-
February	7	6	0	5	0	0	0	0	0	1	19
March	18	0	0	4	0	1	0	0	0	0	23
April	-	-	-	-	-	-	-	-	-	-	-
May	7	0	1	5	1	1	1	1	0	1	18
June	3	0	0	0	0	1	1	0	0	0	5
July	-	-	-	-	-	-	-	-	-	-	-
August	4	0	0	0	0	0	1	1	0	0	6
September	8	0	0	1	0	0	1	0	0	0	10
October	-	-	-	-	-	-	-	-	-	-	-
November	2	14	0	3	0	0	0	0	0	1	20
December	1	8	0	1	0	0	0	0	0	0	10
1965											
January	-	-	-	-	-	-	-	-	-	-	-
TOTALS	75	30	2	31	2	3	5	2	0	5	155

Table 39. Sexual condition of Apodemus individuals caught on Grid B.

Fec. = Fecund I. = Imperforate Pr.L. = Pregnant, Lactating
 NF = Non-fecund P. = Perforate PL = Perforate, Lactating
 J. = Juvenile Pr. = Pregnant Esc. = Escaped

- = No trapping

MONTH	<u>Clethrionomys</u>				<u>Apodemus</u>			
	% males fecund		% females breeding		% males fecund		% females breeding	
	A	B	A	B	A	B	A	B
1963								
March	22	53	0	38	100	100	50	50
April	88	100	0	22	100	100	40	0
May	100	100	88	39	100	100	33	0
June	95	90	33	67	100	0	100	0
July	91	89	71	91	60	67	100	100
August	77	83	69	75	80	100	100	0
September	51	73	50	49	100	100	67	0
October	17	-	38	-	88	-	33	-
November	13	-	24	-	86	-	42	-
December	15	36	16	25	71	93	26	0
1964								
January	0	-	0	-	26	-	3	-
February	-	0	-	6	-	54	-	0
March	35	18	6	13	97	100	37	20
April	92	-	25	-	100	-	32	-
May	100	100	77	43	100	88	64	44
June	-	100	-	100	-	100	-	100
July	69	-	78	-	100	-	75	-
August	80	84	68	59	100	100	75	100
September	66	78	65	43	93	100	100	50
October	36	-	32	-	45	-	30	-
November	11	18	10	0	30	13	42	0
December	-	4	-	0	-	11	-	0
1965								
January	0	-	0	-	0	-	0	-

Table 40 . Percentage of males and females in breeding condition each month. Clethrionomys and Apodemus

- = No trapping

drop to 33% in October. By January 1964 only one perforate female in a catch of 29 animals was recorded. In 1964 the breeding was under way in March, and all animals captured from May to October were in breeding condition with the exception of two juveniles caught in July and August. In October the percentage fecund had decreased to 30%, and by January 1965 all were out of breeding condition.

On grid B only 3 females were captured until December 1963, and in that month all the females caught were out of breeding condition. From May to September 1964 the few females caught were in breeding condition, but from September to December most of the females captured were quiescent.

Despite the appreciable numbers of Apodemus males still fecund over winter there was no winter breeding as the females all came out of breeding condition for at least two months.

6. Summary and Discussion

In 1963 on grid A Clethrionomys males were in breeding condition from April to September (i.e. more than 50% of the males captured were fecund in the period stated). The females were engaged in breeding activity from May 1963 to September 1963 (the criterion above being used), although some pregnant and lactating females were found throughout the winter. The breeding season in 1964 was of similar length, though with some indication that breeding was coming to a stop earlier than in

MONTH	<u>Clethrionomys</u>		<u>Apodemus</u>	
	GRID A	GRID B	GRID A	GRID B
1963				
March	0	0	0	0
April	0	0	0	0
May	14	0	0	0
June	20	40	100	0
July	56	78	100	100
August	51	67	100	0
September	37	49	60	0
October	31	-	11	-
November	14	-	33	-
December	8	21	5	0
1964				
January	0	-	0	-
February	-	6	-	0
March	6	13	29	20
April	14	-	5	-
May	8	7	50	22
June	-	86	-	100
July	26	-	40	-
August	58	45	40	50
September	60	40	90	50
October	26	-	30	-
November	9	0	4	0
December	-	0	-	0
1965				
January	0	-	0	-

Table 41. The proportion of pregnant females each month expressed as a percentage of the catch of females in that month.

- = No trapping

MONTH	<u>Clethrionomys</u>						<u>Apodemus</u>					
	GRID A			GRID B			GRID A			GRID B		
	♂♂	♀♀	♂+♀	♂♂	♀♀	♂+♀	♂♂	♀♀	♂+♀	♂♂	♀♀	♂+♀
1963												
March	0	0	0	0	0	0	0	0	0	0	0	0
April	0	0	0	0	0	0	0	0	0	0	0	0
May	0	0	0	0	0	0	0	0	0	0	0	0
June	5	7	6	10	20	14	0	0	0	0	0	0
July	9	15	11	3	9	5	40	0	22	20	0	14
August	23	31	27	14	17	15	20	0	12	0	0	0
September	40	29	34	16	29	22	0	20	10	0	0	0
October	33	28	29	-	-	-	0	33	11	-	-	-
November	13	7	10	-	-	-	0	0	0	-	-	-
December	9	0	5	0	0	0	0	5	2	0	0	0
1964												
January	0	0	0	-	-	-	0	0	0	-	-	-
February	-	-	-	0	0	0	-	-	-	0	0	0
March	0	0	0	0	0	0	0	0	0	0	0	0
April	0	0	0	-	-	-	0	0	0	-	-	-
May	0	0	0	0	0	0	0	0	0	14	0	5
June	-	-	-	0	0	0	-	-	-	0	0	0
July	19	15	16	-	-	-	0	20	17	-	-	-
August	10	10	10	4	17	9	0	20	17	0	0	0
September	22	18	20	2	6	3	7	0	4	0	0	0
October	2	9	5	-	-	-	2	10	4	-	-	-
November	0	19	6	0	0	0	0	0	2	0	0	0
December	-	-	-	0	0	0	-	-	-	0	0	0
1965												
January	0	0	0	-	-	-	0	0	0	-	-	-

Table 42.

Proportion of juveniles in the catch each month,
a) expressed for each sex as a percentage of the catch of that sex;
b) expressed for both sexes as a percentage of the total catch.

Note:- 'No trapping' is indicated by a dash (-).

1963. On grid B in 1963 the males became fecund a month earlier than on grid A, and remained in a fecund condition longer, but in 1964 no difference in the length of the breeding season of the males on the two grids was detected. The females on grid B appeared to be ahead of those on grid A at first in 1963, but their maturation suffered a set back in April and eventually they started breeding later than on grid A. Breeding ceased at about the same time on the two grids. In 1964 breeding commenced at the same time, but ended a little earlier on grid B.

Brambell and Rowlands (1936) reported that the breeding season began in the middle of April in the Clethrionomys populations that they investigated. Some individuals they observed bred in two seasons, an occurrence reported also in the present study (p. 88). These workers recorded the breeding season as ending in October in the year in which they obtained their material. Barrett-Hamilton (1911) reported the breeding season of Clethrionomys in the south of England as lasting regularly from March to December inclusive, with breeding sometimes occurring in January and February, and Baker (1930) recorded in Oxfordshire that the peak of the breeding season was reached in June, and that breeding ceased entirely, as determined by the percentage of pregnant females, from October to February in 1925-26 and 1926-27, but he recorded winter breeding in 1927-28. Newson (1963) found winter

breeding to occur in both Clethrionomys and Apodemus, and Steven (1957) reported the phenomenon also for Apodemus. Ashby (pers. comm.) reported intensive winter breeding in Clethrionomys in 1959-60, and in Microtus in 1961-62. Apodemus bred well into the winter in 1955-56, and throughout the winter in 1958-59, (Ashby, pers. comm). No winter breeding occurred in either species in the present study, but the breeding season, as determined by the occurrence of pregnant females, extended from May to December inclusive in 1963 on grid A, and from March to November inclusive in 1964, for Clethrionomys. On grid B pregnant females were recorded from June to December 1963, and February to September 1964. In Apodemus on grid A pregnant females were found from June to December inclusive in 1963, and from March to November inclusive in 1964. Evans (1942) recorded that he found fecund males of Apodemus and Clethrionomys in February, but found no pregnant females until April. Delany and Davis (1961) observed that there was no difference in the length of the breeding season of Apodemus and Clethrionomys on Fair Isle from that found in southern England. Coventry (1937) reported that the breeding season in Peromyscus leucopus noveboracensis extended from April to October, with complete dormancy in December to February. Baker and Ranson (1932) found the breeding season of Microtus agrestis to last from February or March to September or October. They suggested that the breeding of the females may

be affected by the hours of sunshine the breeding area receives. In three areas studied, two in Scotland and one in Wales, they found breeding to start earliest in the most northern area, and to finish latest there also. There is thus perhaps some evidence for the idea that the breeding season is longer in the north of the country.

Newson (1963) indicated that winter breeding was restricted to the winter of 1958-59, and did not occur in 1956-57 or 1957-58. He further observed that only the older animals bred all winter on his grassland grid I., but animals on the woodland grid II. bred as soon as they matured. Winter breeding is usually associated with peak population numbers (Pitelka, 1957; Hamilton, 1951), and the highest mean body weights are usually recorded at a peak also (Chitty, 1952; Kalela, 1957). In the populations studied by Newson (1963), however, the phenomenon occurred during the first year after a decline when most accounts of microtine cycles record low body weights and only a slight increase in numbers.

	1963												1964												1965
	M. A.	A. M.	J. J.	A. A.	S. S.	O. O.	N. N.	D. D.	J. F.	M. A.	A. M.	J. J.	A. A.	S. S.	O. O.	N. D.	J.								
No. fecund males	4	15	12	18	21	24	19	5	4	5	0	-	10	11	30	-	22	31	33	18	5	-	0		
No. males over 14 g.	12	17	14	14	22	31	30	21	27	18	14	-	26	11	27	-	30	34	36	37	24	-	15		
No. breeding females	0	0	7	5	24	24	19	11	7	4	0	-	1	2	10	-	14	21	22	11	2	-	0		
No. females over 14 g.	6	1	6	11	31	28	30	25	20	16	10	-	12	5	10	-	20	21	22	24	11	-	3		
No. pregnant females	0	0	1	3	19	18	14	9	4	2	0	-	1	1	1	-	6	18	19	9	2	-	0		
No. juveniles	0	0	0	2	7	18	26	18	6	3	0	-	0	0	0	-	9	7	17	4	4	-	0		
Total examined	29	25	21	34	63	66	76	61	59	56	34	-	48	20	45	-	55	70	84	84	61	-	34		

Table 43. Breeding data of Clethrionomys on Grid A. The number of animals in breeding condition is given, along with the total number of animals over 14 gms. The totals given for females in breeding condition include pregnant females but the numbers of the latter are given separately also. The number of juveniles caught each month is also shown.

- = No trapping.

	1963										1964										1965				
	M.	A.	M.	J.	J.	A.	S.	O.	N.	D.	J.	F.	M.	A.	M.	J.	J.	A.	S.	O.	N.	D.	J.		
No. fecund males	12	4	1	1	3	4	4	4	15	19	22	10	-	36	24	8	-	2	2	13	13	12	-	0	
No. males over 15 g.	12	2	1	1	4	4	4	5	16	19	31	37	-	37	21	7	-	3	3	11	24	30	-	12	
No. breeding females	4	2	1	2	3	3	4	3	4	3	5	5	1	-	14	7	9	-	3	3	10	6	1	-	0
No. females over 15 g.	9	5	3	2	3	3	4	4	6	7	10	26	-	37	23	10	-	4	4	8	11	10	-	8	
No. pregnant females	0	0	0	2	3	3	3	1	4	1	1	0	-	11	1	7	-	2	2	9	6	1	-	0	
No. juveniles	0	0	0	0	2	1	1	3	0	1	1	0	-	0	0	0	-	1	1	1	2	1	-	0	
Total examined	21	9	5	3	9	8	10	28	35	51	70	-	77	47	23	-	6	6	25	51	64	-	31		

Table 44. Breeding data of *Apodemus* on Grid A. The number of animals in breeding condition is given, along with the total number of animals over 15 gms. The totals given for females in breeding condition include pregnant females but the numbers of the latter are given separately also. The number of juveniles caught each month is also shown.

- = No trapping.

	1963						1964						1965									
	M. A.	M. J.	J. A.	S. O.	N. D.		J. F.	M. A.	M. J.	J. A.	S. O.	N. D.	J.									
No. fecund males	9	17	26	18	31	35	32	-	19	-	0	3	-	20	15	-	37	38	-	8	1	-
No. males over 14 g.	9	14	23	17	35	34	39	-	38	-	9	16	-	20	15	-	37	38	-	23	11	-
No. breeding females	6	2	5	10	21	27	17	-	7	-	1	2	-	6	7	-	17	15	-	0	0	-
No. females over 14 g.	7	6	12	13	22	28	29	-	19	-	10	12	-	14	8	-	26	24	-	8	9	-
No. pregnant females	0	0	0	0	6	18	24	17	6	-	1	2	-	1	6	-	13	14	-	0	0	-
No. juveniles	0	0	0	0	5	3	12	17	0	-	0	0	-	0	0	-	7	3	-	0	0	-
Total examined	37	29	40	35	60	78	78	78	80	-	31	33	-	34	23	-	74	86	-	80	42	-

Table 45. Breeding data of Clethrionomys on Grid B. The number of animals in breeding condition is given, along with the total number of animals over 14 gms. The totals given for females in breeding condition include pregnant females but the numbers of the latter are given separately also. The number of juveniles caught each month is also given.

	1963				1964				1965												
	M. A.	M. J.	J. A.	S. O. N. D.	J. F. M. A. M. J. J. A. S. O. N. D.	J.															
No. fecund males	2	2	1	0	4	1	2	-	13	-	7	18	-	4	8	-	2	1	-		
No. males over 15 g.	1	0	1	0	5	0	1	-	9	-	13	9	-	7	3	-	6	8	-	10	6
No. breeding females	1	0	0	0	1	0	0	-	0	-	0	1	-	4	2	-	2	1	-	0	0
No. females over 15 g.	0	0	0	0	1	0	0	-	7	-	0	5	-	9	1	-	2	1	-	1	2
No. pregnant females	0	0	0	0	1	0	0	-	0	-	0	0	-	2	2	-	1	1	-	0	0
No. juveniles	0	0	0	0	1	0	0	-	0	-	0	0	-	1	0	-	0	0	-	0	0
Total examined	6	2	1	0	7	1	2	-	25	-	19	23	-	18	5	-	6	10	-	20	10

Table 46. Breeding data of Apodemus on Grid B. The number of animals in breeding condition is given, along with the total number of animals over 15 gms. The totals given for females in breeding condition include pregnant females but the numbers of the latter are given separately also. The number of juveniles caught each month is also shown.

VI. AGE-STRUCTURE OF THE POPULATIONS

1. Introduction

One of the main difficulties in working with small mammals in the field is the determination of age. Unless the animals are killed and their tooth structure and wear examined (Delany and Davies, 1961) then the determination of age is difficult and imprecise. Of necessity, in live-trapping studies methods of age-determination are required to be simple and able to be rapidly carried out. Two methods are in current use, one entailing the measurement of body-length (head and trunk), (Southern, 1964), Ashby (unpubl.), and the other the measurement of body-weight. In the present study the weight of the animals was recorded and all approximate age determinations were made using body-weight in conjunction with information gained from marked animals. The presence or absence of juvenile pelage and the condition of the sex organs also assisted in the ageing technique. The use of weight records rather than length records was decided upon after the relative usefulness and simplicity of the two methods had been considered. Weight is more easily measured in the field, and is also more accurately measured than is length. Length measurements on living animals are prone to a large error because of the difficulty in regulating the degree of stretching of the animal, but Ashby (pers. comm.) found that errors in measurement of

body length were small when one recorder did all the measuring. A further advantage of weight measurements over length measurements is that weight is directly proportional to volume, and for this reason the range from juvenile to adult size will be greater than it is for length. Hence, size differences are more pronounced when weight is used as a measure. One of the main disadvantages of using weight records is that weight is subject to errors caused by the weight of food in the stomach, or of urine in the bladder. Discussion of the various disadvantages of the use of weight as a measure of age may be found in the work on Apodemus sylvaticus by Hacker and Pearson (1944). The other major deficiency of the weight record is that in females the complicating factor of pregnancy renders the weight a poor guide to age. However, when large numbers of animals are sampled regularly the effect on weight because of pregnancy may often be evaluated. It is probable that if time allows it both weight and length measurements should be taken. In the present study the advantages of using weight as an indicator of age were felt to outweigh the disadvantages, particularly in view of the regularity and intensity of the trapping effort which was employed. The relationships between weight, sexual maturity, and age described by Baker (1930) were utilised in this work. In Clethrionomys no animals of less than 14 grams were considered as sexually mature, and in Apodemus 15 grams was taken as the minimum weight for sexual maturity (Baker, 1930).

2. The Frequency distributions of body-weights

The weight records for each month were analysed and placed in weight classes and the mean weight for each month with its standard error was calculated for comparative purposes. The variance of each distribution was also calculated to give a measure of the spread of records i.e. the degree of heterogeneity of the sample. The mean body weight with its standard error, the variance, and the number of the sample, are given for each month in Tables 47 and 48 for Clethrionomys males and females respectively; and in Tables 49 and 50 for Apodemus males and females respectively. The trends of the mean weights are shown graphically in Figs. 18 and 19, and the frequency distributions of weights in different seasons are shown in Figs. 15-18.

a) The body-weights of Clethrionomys males on grid A (Table 47, Figs. 15 and 18)

There was a gradual increase in mean body weight from a value of 16.25 grams in March 1963, to one of 23.40 grams in July. This increase was due to the overwintered animals of 1962-63 putting on a great deal of weight and coming into breeding condition. The mean weight would have been even greater but for the fact that by July the dilution effect of young entering the population kept the mean weight down a little. All the males were in breeding condition by May (see p. 99), but they continued to put on weight throughout

the summer. The mean weight decreased from July onwards, there being three main contributory factors in this drop:-

- 1) Many of the older, and hence heavier, animals died.
- 2) The breeding males remaining were mainly animals born in late spring and early summer which had matured quickly and were breeding at a lower body weight than the overwintered animals.
- 3) Constant dilution of the population by juveniles and subadults was occurring.

The mean body weight decreased further from a November value of 16.70 grams to a December value of 15.00 grams, this drop being associated with the termination of the breeding season. The majority of the young born in late summer and early autumn did not become fecund and remained at a low body weight. The variances of the frequency distributions decreased in value in December 1963 and January 1964 indicating the more homogeneous nature of the population and the presence of a narrower range of body weights than was present in the summer. In 1964 the males began to increase in weight earlier than in 1963, possibly because of the winter being less severe in 1963-64 than in 1962-63. The mean body weight in March 1964 was consequently substantially higher than in March 1963 (18.10 grams compared with 16.25 grams). The mean weight dropped slightly in April, a drop which corresponded with a suddenly

Month	GRID A				GRID B			
	n	Mean (gms.)	± S.E.	s ²	n	Mean (gms.)	± S.E.	s ²
1963								
Mar.	16	16.25	± 0.45	3.24	16	15.75	± 0.52	4.41
Apr.	18	16.80	± 0.47	4.00	14	19.10	± 0.53	4.00
May	15	18.00	± 1.06	16.81	14	19.40	± 0.43	2.56
June	15	21.70	± 1.08	17.64	18	20.70	± 1.06	20.25
July	23	23.40	± 0.79	14.44	35	20.20	± 0.56	10.89
Aug.	36	18.20	± 0.65	15.21	36	20.00	± 0.68	16.81
Sept.	39	17.00	± 0.74	21.16	42	17.00	± 0.48	8.41
Oct.	29	16.50	± 0.63	11.56	-	-	-	-
Nov.	31	16.70	± 0.59	10.89	-	-	-	-
Dec.	30	15.00	± 0.38	4.41	45	16.10	± 0.27	3.24
1964								
Jan.	18	15.70	± 0.47	4.00	-	-	-	-
Feb.	-	-	-	-	15	14.70	± -	-
Mar.	29	18.10	± 0.71	14.44	16	16.50	± 0.60	5.76
Apr.	12	17.80	± 0.78	7.29	-	-	-	-
May	27	21.00	± 0.54	7.84	20	21.00	± 0.78	12.25
June [‡]	-	-	-	-	15	23.60	± 0.62	5.76
July	34	18.80	± 0.93	29.16	-	-	-	-
Aug.	40	17.10	± 0.62	15.21	43	18.40	± 0.67	19.36
Sept.	45	16.50	± 0.57	14.44	46	17.20	± 0.68	21.16
Oct.	45	15.90	± 0.36	5.76	-	-	-	-
Nov.	40	15.20	± 0.43	7.29	40	14.50	± 0.35	4.84
Dec.	-	-	-	-	19	14.79	± 7.29	7.29
1965								
Jan.	28	14.6	± 0.55	8.41	-	-	-	-

Table 47 . Body weights in grams of Clethrionomys δ on Grid A and Grid B. The number in the sample (n), the mean with its standard error (S.E.), and the variance (s²), are given for each month.

- = No trapping
[‡] = Half-grid only trapped.

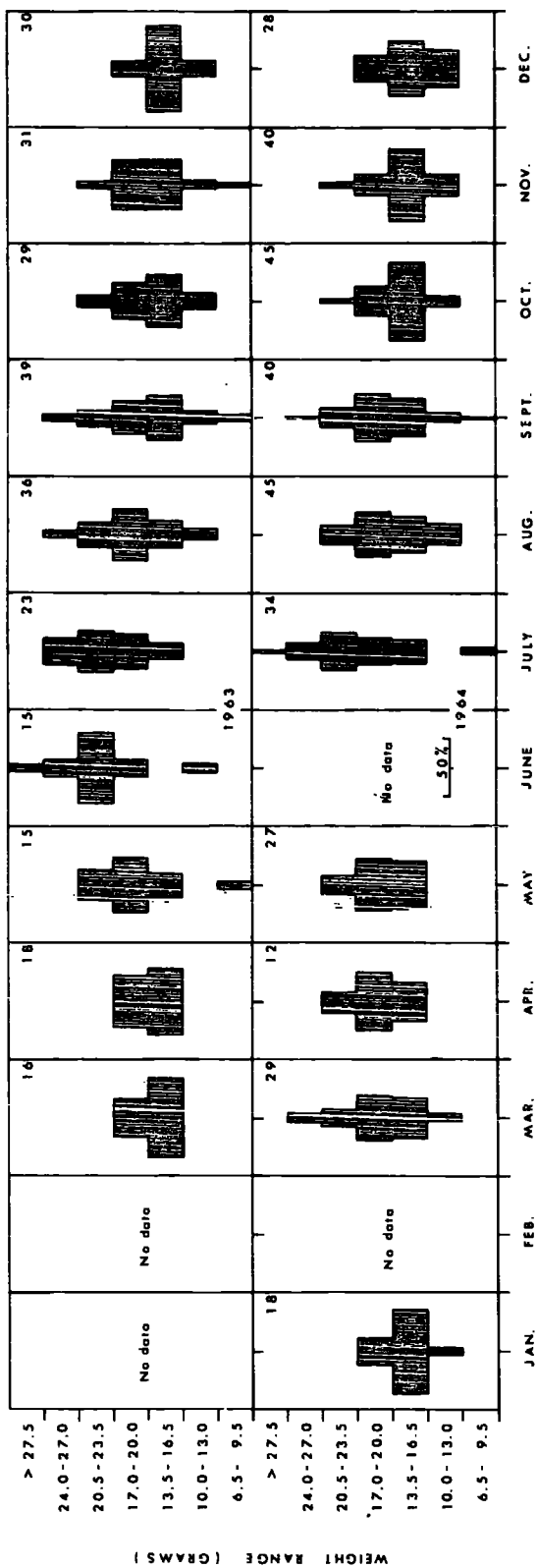

DISTRIBUTION (%)

FIGURE 15. The weight range of Clethrionomys males caught each month on grid A. The sample sizes are given in the top right-hand corner of each compartment.

increased death rate, probably associated with severe weather conditions (see p. 78). The highest mean body-weight of 1964 was attained in May, there being no trapping in June, and from then onwards there was a gradual decline in mean body-weight as the population became more heterogeneous in composition. The surviving males entered the overwintering period at a mean body-weight of 15.00 grams, the same as in 1963. Throughout the study, as would be expected, the variances of the distributions were high during the breeding season, and low during the non-breeding season. In January 1965 the overwintered males had a mean body weight of 14.60 grams compared with 15.70 grams in 1964. This increased loss of weight during the winter may be associated with the rather poorer survival of animals in late autumn-winter of 1964 compared with 1963-64.

b) The body-weights of *Clethrionomys* males on grid B
(Table 47, Figs. 16 and 18)

In 1963 the males put on weight quickly, and a mean body-weight of 15.75 grams in March had risen to one of 19.10 grams in April, when all the males were fecund. This increase in weight was much greater and more rapid than that which occurred on grid A. In April few animals weighed less than 17 grams and some weighed up to 24 grams. The mean body-weight rose steadily to a maximum in June, a month earlier than on grid A, and then gradually decreased from June to August, when

the mean body-weight was 20.00 grams. The mean body-weight dropped sharply from August to September, and had decreased further by December. The steady entry of juveniles into the population from June onwards, allied with the mortality of heavy, older animals, caused the gradual decline in the mean body-weight. By September only 14% of the overwintered animals still survived, and most of these died in the early autumn. The mean body-weight in December was higher on grid B than on grid A, probably because the composition of the population in terms of age groups was different, there being more summer-born young of higher body-weight still surviving on grid B than on grid A. About one-third of the summer-born young survived until February 1964, but only three individuals were recorded in breeding condition in 1964. The mean body-weight in February had decreased to a value of less than 15.00 grams, the population at this time being composed of autumn-born animals which had remained low in body-weight throughout the winter and had not begun to increase in size, and a remnant of the summer-born animals which had lost weight during the winter. About 20% of the animals marked in the autumn survived to breed in 1964. By March 1964 some of the males were fecund (p. 103), and the mean weight had risen to 16.50 grams. In May all the males were fecund, and the mean body-weight was 21.00 grams. The increase in mean body-weight continued until a maximum was reached in June. From June to December the

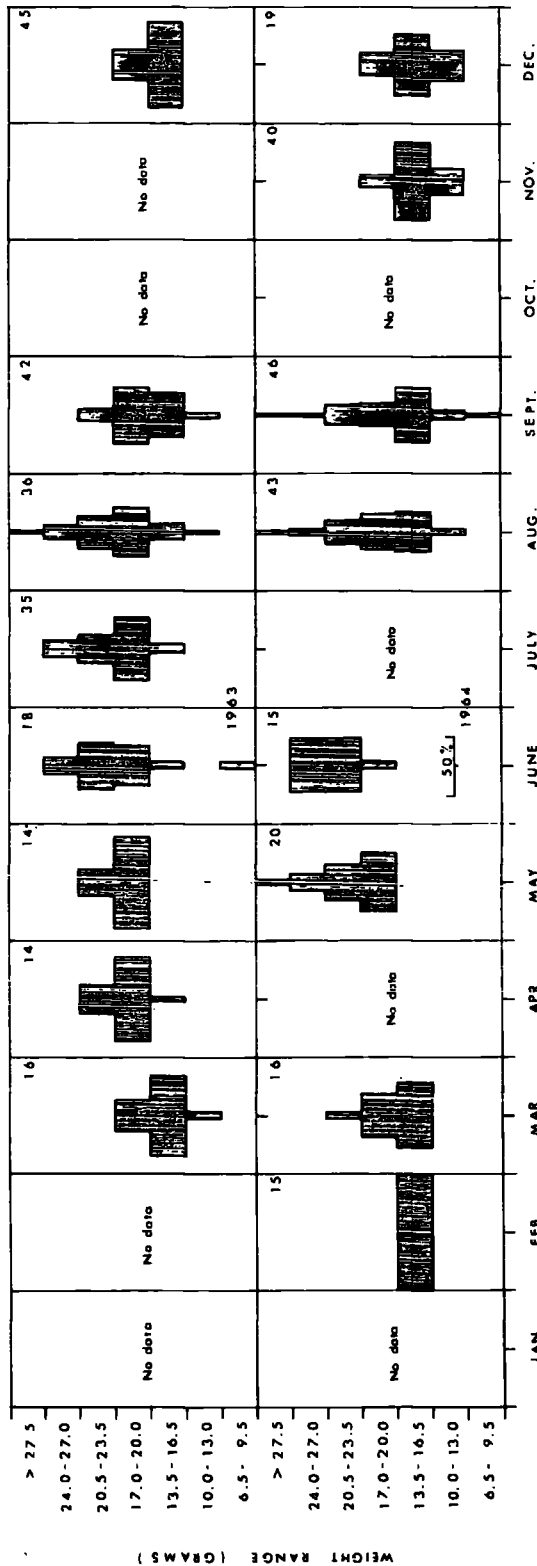

DISTRIBUTION (%)

FIGURE 16. The weight range of Clethrionomys males caught each month on grid B. The sample sizes are given in the top right-hand corner of each compartment.

mean body-weights decreased to reach a value of less than 15.00 grams in December 1964. Approximately 25% of the summer and autumn animals of 1964 were still alive in December. Although there was some difference between the mean body-weights of male Clethrionomys in the populations on the two grids, no significant difference was found between the variances of the distributions when these were tested by the 'F' test. This would indicate that the breeding pattern was similar in form on the two grids, although perhaps different in detail.

c) The body-weights of Clethrionomys females on grid A
(Table 48, Fig. 19)

Although the weight as a measure of age in females means less than in the case of the males, it is of use when used in conjunction with the known survival of marked animals. It is thus possible to construct a picture of the age-structure of the population throughout the period of study. Because of the pregnancy factor the weight distributions were more heterogeneous than was the case in the males, and this was shown by the larger variances calculated.

The mean body-weight was low in March and April 1963 but had risen sharply by May, in which month some 80% of the females were perforate, and some must have been pregnant although they were undetected in the field (p. 100). The mean

Month	GRID A			GRID B				
	n	Mean (gms.)	\pm S.E.	s^2	n	Mean (gms.)	\pm S.E.	s^2
1963								
Mar.	7	15.50	\pm -	-	12	15.00	\pm 0.46	2.56
Apr.	6	14.40	\pm -	-	12	15.30	\pm 0.75	6.76
May	6	19.20	\pm 1.75	18.49	12	18.20	\pm 0.75	6.76
June	15	18.10	\pm 1.39	29.16	15	19.30	\pm 1.21	22.09
July	35	18.80	\pm 1.03	37.21	23	21.50	\pm 0.85	16.81
Aug.	34	20.00	\pm 1.05	37.21	29	21.20	\pm 0.95	26.01
Sept.	35	18.60	\pm 0.88	27.04	36	17.40	\pm 0.77	21.16
Oct.	28	17.60	\pm 0.81	18.49	-	-	-	-
Nov.	29	16.40	\pm 0.85	21.16	-	-	-	-
Dec.	22	16.80	\pm 0.96	20.25	24	17.00	\pm 0.65	10.24
1964								
Jan.	14	14.70	\pm 0.75	7.84	-	-	-	-
Feb.	-	-	-	-	15	15.26	\pm 0.85	10.89
Mar.	17	16.60	\pm 0.82	11.56	14	16.80	\pm 0.67	6.25
Apr.	7	16.70	\pm 1.13	9.00	-	-	-	-
May	11	18.90	\pm 0.78	6.76	14	19.40	\pm 0.61	5.29
June $\frac{1}{2}$	-	-	-	-	8	22.00	\pm 0.71	4.00
July	24	20.30	\pm 1.35	43.56	-	-	-	-
Aug.	27	17.80	\pm 0.96	25.00	29	19.20	\pm 0.93	25.00
Sept.	28	18.40	\pm 0.87	21.16	34	16.50	\pm 0.69	16.00
Oct.	31	15.90	\pm 0.70	15.21	-	-	-	-
Nov.	20	15.20	\pm 0.78	12.25	30	13.10	\pm 0.40	4.84
Dec.	-	-	-	-	17	14.30	\pm 0.60	6.25
1965								
Jan.	6	13.00	\pm 0.82	4.00	-	-	-	-

Table 48 . Body weights in grams of Clethrionomys females on Grid A and Grid B. The number in the sample (n), the mean with its standard error (S.E.), and the variance (s^2), are given for each month.

- = No trapping

$\frac{1}{2}$ = Half-grid only trapped.

body-weight fluctuated a little in June and July because of the combined effect of the entrance of juveniles into the population, the birth of young, and pregnancy factors. In August the mean weight was 20.00 grams, the variance was very large, and the weight range was from 6 grams to 32 grams. The mean body-weight decreased quickly from August to September, probably because of the disappearance of heavier, older animals, and it continued to decrease to an overwintering level of under 15.00 grams. Most of the early generations of 1963 young had disappeared by January 1964 after having, along with older animals, reared the autumn-young. None of the autumn-born young of 1963 bred in that year but they overwintered at low body-weights. About one-third of them survived to breed in 1964. The mean body-weights in March and April 1964 were higher than in those months in 1963 and this is most probably due to there being a slightly earlier start to the breeding season (as was noted for the males). The population was much more heterogeneous in composition in 1964 than in 1963, the weight range in March 1964 being from 10 to 24 grams, compared with a range of from 13 to 16 grams in March 1963. The mean body-weight increased until July, but then decreased from August to October as the main influx of juveniles and immatures occurred. All the summer-born young had disappeared by November and from then on the population was composed entirely of autumn-born young. These latter became clustered together into a narrow

weight range without breeding. The mortality rate was high in the early winter and the survivors lost weight. Only six animals were captured in January 1965, and these had a mean body-weight of only 13.00 grams. The reproductive potential for 1965 on this evidence appears to be low, (see also pp. 86-87).

d) The body-weights of *Clethrionomys* females on grid B
(Table 48, Fig. 19)

The females on grid B came into breeding condition a little earlier in 1963 than did those on grid A, but the breeding season proper did not start until May. The variances of the body-weight distributions were small until June, thus indicating the presence of a narrow range of body-weights with little evidence of pregnancies having occurred. The mean body-weight rose sharply from April to May as the females put on weight, and continued to rise steadily, due mainly to pregnancies, until August. July and August were the months in 1963 with the most pregnancies recorded, but many juveniles and immatures were also present. Between August and September the mean body-weight dropped abruptly, coincident with a number of heavy overwintered animals dying, and a large influx of juveniles occurring. The mean body-weight was still quite high in December, when about 20% of the females were still pregnant. By February 1964 the mean body-weight had dropped considerably, to 15.26 grams. The population at this

time consisted mainly of summer-born animals of 1963 which had lost weight over winter. The mean body-weight rose steadily from February to June, by which time the population consisted almost entirely of summer-born animals of 1963, the remaining autumn-born young having disappeared. In May and June the mean body-weight was high and the variances low. A large percentage of the females were pregnant but no juveniles were yet entering the trappable population, and hence the population was more homogeneous with regard to weight than is usual at this time of the year. The mean body-weight decreased in August as the first juveniles and immatures were trapped, and in September the mean body-weight was down to 16.50 grams due to the disappearance of virtually all the old animals, the population thus consisting entirely of animals marked in August i.e. summer-young of 1964. In November the mean body-weight was very low, 13.10 grams, none of the September young having attained breeding condition. Heavy mortality between November and December affected mainly the smaller animals and the mean body-weight in December 1964 was higher than in November for this reason.

e) The body-weights of *Apodemus* males on grid A

(Table 49, Figs. 17 and 18)

In March 1963 all the *Apodemus* males were fecund, having a high mean body-weight of 26.80 grams. The few individuals

captured in April, May and June, were all fecund and of high body-weight. In July, five animals were captured, all of which were fecund, and they had an average body-weight of 17.90 grams. This low mean body-weight suggests that they were early young which had matured quickly. Similar samples in August and September to those taken in July had larger mean body-weights than did the July sample, indicating that the summer-young were increasing in size. In October an influx of males occurred, and from their body-weights it would appear that they consisted of approximately equal numbers of early and late summer-young. In November, the animals which entered the population were mainly late-summer young of lower average body-weight. Some of the older animals had disappeared, and this factor together with the influx of low-weight young depressed the mean body-weight considerably. The mean rose again in December as the autumn-young put on weight. In January 1964 almost 75% of the males were non-fecund and of a fairly uniform weight. By April the males had put on a great deal of weight and all were fecund. The uniformity of the males with regard to weight at this time was indicated by the low variance. Throughout the summer, the situation closely resembled that outlined above for 1963. In September all the males were fecund but some were of low body-weight and must have been weaned not long before capture and have matured early. From September to November the mean body-weight decreased as heavier animals disappeared and some

Month	GRID A				GRID B			
	n	Mean \pm (gms.)	S.E.	s ²	n	Mean \pm (gms.)	S.E.	s ²
1963								
Mar.	12	26.80 \pm	0.58	4.00	1	NC		NC
Apr.	2	NC		NC	0	NC		NC
May	1	NC		NC	1	NC		NC
June	1	NC		NC	0	NC		NC
July	5	17.90 \pm	1.83	16.81	5	21.90 \pm	2.14	23.04
Aug.	5	19.50 \pm	2.50	31.36	0	NC		NC
Sept.	5	21.10 \pm	1.83	16.81	1	NC		NC
Oct.	17	17.80 \pm	0.73	9.00	-	-		-
Nov.	21	16.80 \pm	0.44	4.00	-	-		-
Dec.	32	18.25 \pm	0.41	5.29	37	20.30 \pm	0.43	6.76
1964								
Jan.	37	20.30 \pm	0.43	6.76	-	-		-
Feb.	-	-		-	13	21.60 \pm	1.03	13.69
Mar.	37	24.40 \pm	0.49	9.00	9	25.20 \pm	0.66	4.00
Apr.	21	25.70 \pm	0.50	5.29	-	-		-
May	6	NC		NC	7	24.10 \pm		7.84
June ¹	-	-		-	3	25.70 \pm	1.10	3.61
July	4	23.50 \pm	3.85	59.29	-	-		-
Aug.	4	23.50 \pm	3.85	59.29	6	25.60 \pm	2.20	29.16
Sept.	10	20.70 \pm	1.33	39.69	8	21.50 \pm	1.20	11.56
Oct.	29	17.50 \pm	0.71	14.44	-	-		-
Nov.	40	17.60 \pm	0.55	12.25	16	16.70 \pm	0.80	10.24
Dec.	-	-		-	8	20.00 \pm	1.10	9.61
1965								
Jan.	12	20.50 \pm	0.69	5.76	-	-		-

Table 49. Body-weights in grams of Apodemus males on Grid A and Grid B. The number in the sample (n), the mean with its standard error (S.E.), and the variance (s²), are given for each month.

- = No trapping
 1 = Half-grid trapped.
 NC = Not calculable.

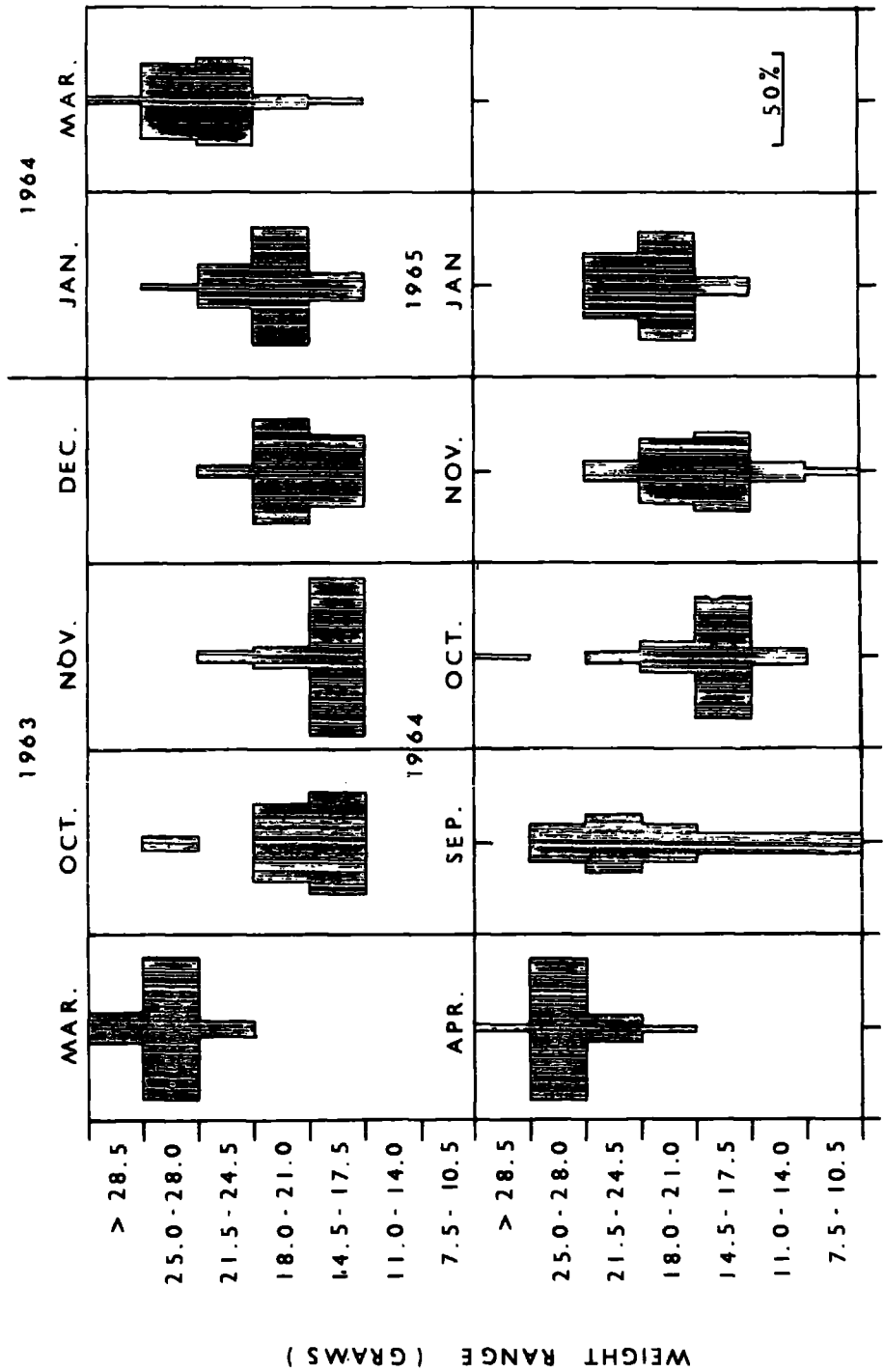

FIGURE 17. The weight range of Apodemus males caught on grid A in the months in which the sample size was more than ten.

individuals lost weight. As in 1963 the first influx of animals contained mainly summer-born young, whereas the second contained mainly autumn-born young not in breeding condition. Of the animals marked in September, October, and November, approximately one-third were alive in January 1965, at this time all were non-fecund but were beginning to put on weight.

f) The body-weights of Apodemus females on grid A
(Table 50, Fig. 19)

The females on grid A showed a similar pattern of age distribution to that described for the males. In November 1963 the body-weight distribution clearly showed pregnant females still to be present, being most probably themselves young of the early summer generation. The mean body-weight dropped in December, at which time most of the females were out of breeding condition. In January 1964 only one female was in breeding condition, but all were starting to put on weight. The mean body-weight continued to rise until May by which time a large percentage were pregnant. In September all of the females captured were pregnant, but had a mean body-weight of less than the average body-weight of pregnant females caught in the summer months, suggesting that they were animals of the year. The mean body-weight decreased in October, but the variance was high, there being a wide range of weights due to young immature

Month	GRID A				GRID B			
	n	Mean \pm S.E. (gms.)	S.E.	s ²	n	Mean \pm S.E. (gms.)	S.E.	s ²
1963								
Mar.	9	21.70 \pm 0.63	0.63	3.61	0	NC		NC
Apr.	5	25.40 \pm 1.43	1.43	10.24	0	NC		NC
May	3	NC		NC	0	NC		NC
June	2	NC		NC	0	NC		NC
July	3	NC		NC	1	NC		NC
Aug.	3	NC		NC	0	NC		NC
Sept.	4	23.00 \pm 1.40	1.40	7.84	0	NC		NC
Oct.	8	17.50 \pm 0.99	0.99	7.84	-	-		-
Nov.	12	19.30 \pm 1.88	1.88	42.25	-	-		-
Dec.	14	17.40 \pm 0.85	0.85	10.24	10	16.40 \pm 0.66	0.66	4.41
1964								
Jan.	27	18.60 \pm 0.52	0.52	7.29	-	17.10 \pm 1.43	1.43	10.24
Feb.	-	-		-	5	17.90 \pm 1.43	1.43	10.24
Mar.	36	19.90 \pm 0.52	0.52	9.61	5	-		-
Apr.	23	19.80 \pm 0.69	0.69	10.89	-	19.10 \pm 1.40	1.40	17.64
May	10	25.00 \pm 1.30	1.30	16.81	9	NC		NC
June $\frac{1}{2}$	-	-		-	1	NC		NC
July	5	22.50 \pm 0.40	0.40	0.81	-	-		-
Aug.	5	22.50 \pm 0.40	0.40	0.81	2	NC		NC
Sept.	8	22.00 \pm 1.26	1.26	15.21	2	NC		NC
Oct.	20	18.20 \pm 1.03	1.03	21.16	-	-		-
Nov.	24	15.80 \pm 0.63	0.63	9.61	2	NC		NC
Dec.	-	-		-	2	NC		NC
1965								
Jan.	8	18.00 \pm 0.71	0.71	4.00	-	-		-

Table 50. Body weights in grams of Apodemus females on Grid A and Grid B. The number in the sample (n), the mean with its standard error (S.E.), and the variance (s²), are given for each month.

- = No trapping
 $\frac{1}{2}$ = Half-grid only trapped.
 NC = Not calculable.

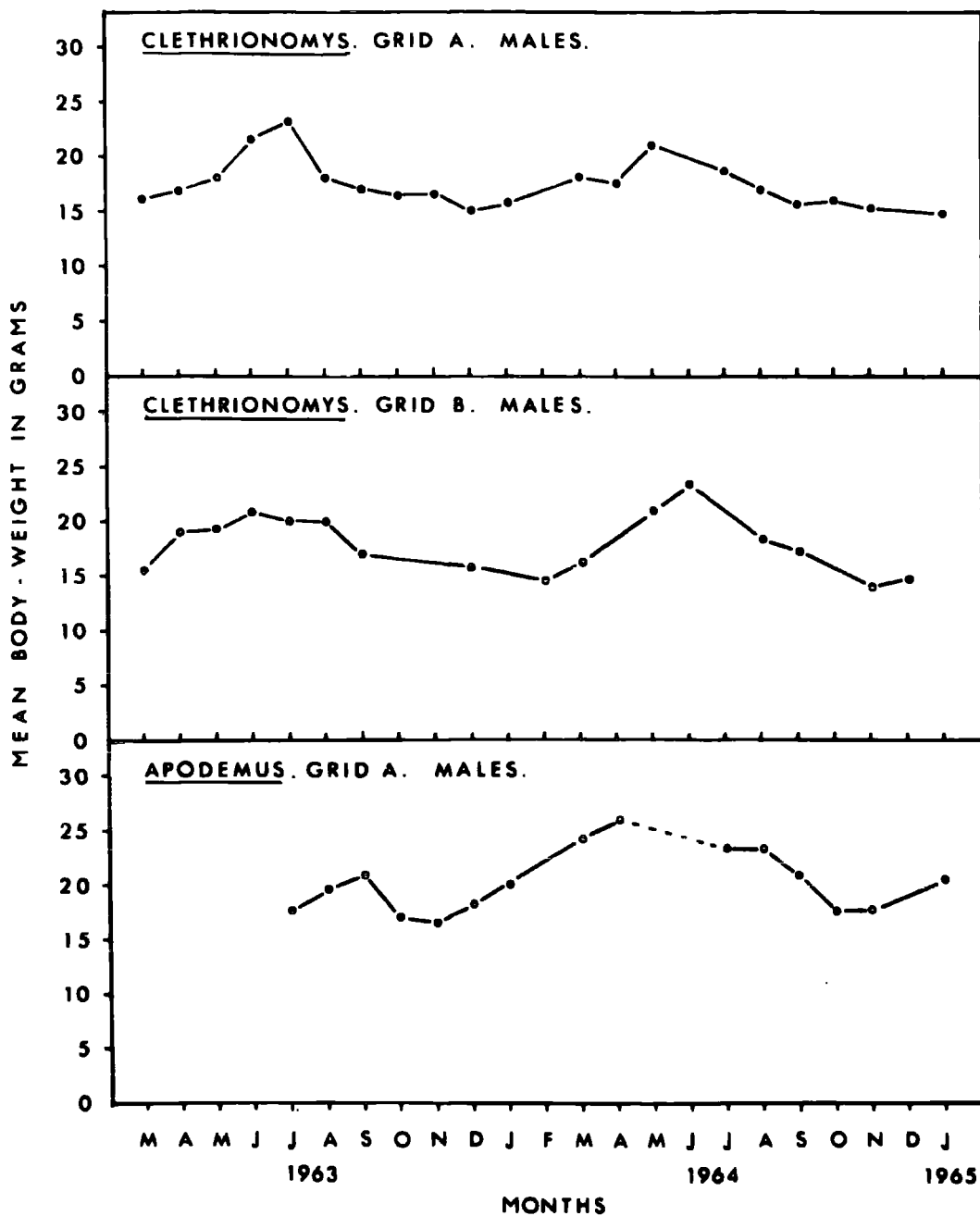

FIGURE 18. Seasonal variation in the mean body weight (grams) of male Clethrionomys on grids A and B, and of male Apodemus on grid A.

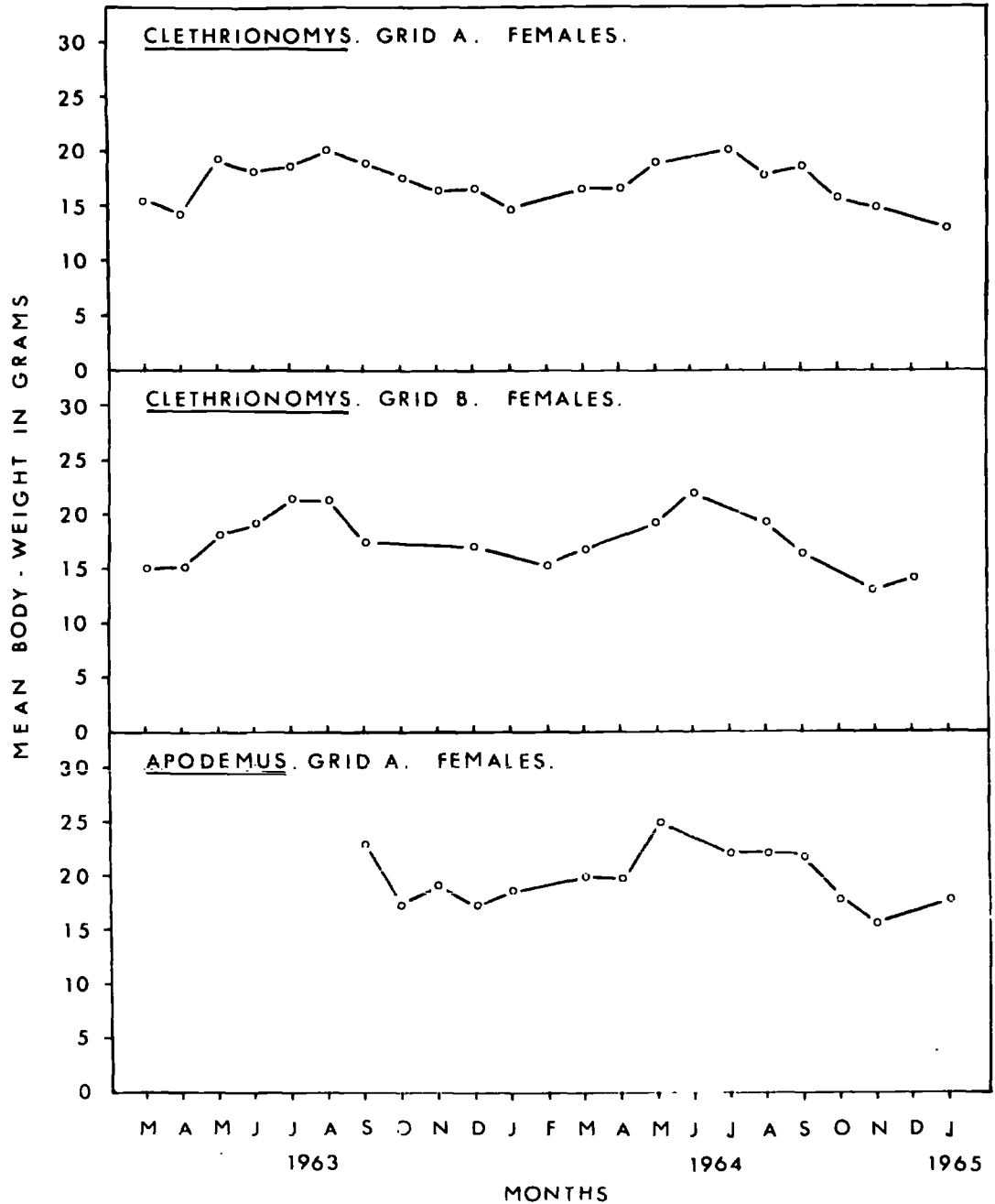

FIGURE 19. Seasonal variation in the mean body weight (grams) of female Clethrionomys on grids A and B, and of female Apodemus on grid A.

animals entering the population. By November all were out of breeding condition and the mean body-weight was low. In January 1965 no females were in breeding condition; about 25% of the autumn-marked animals were alive.

SECTION C

THE EFFECT OF HABITAT ON THE POPULATION
DYNAMICS, AND THE DISTRIBUTION AND
ABUNDANCE OF CLETHRIONOMYS AND APODEMUS

SECTION C. THE EFFECT OF HABITAT ON THE POPULATION DYNAMICS AND
DISTRIBUTION AND ABUNDANCE OF CLETHRIONOMYS AND APODEMUS

I. INTRODUCTION

Several workers who have studied populations of small rodents have made observations on the effects of habitat on the ecology of the animals (Evans, 1942; Brown, 1954; Delany, 1957, 1961; Newson 1960, 1963; Fullager et al 1963; Kikkawa, 1964). In the study of Newson (1960) attention was paid to both the performance of populations of Clethrionomys and Apodemus in different habitats, and to the distribution of the animals within the habitats. In the present study investigations into both of these aspects of the ecology of the two species have been carried out. Most of the other workers mentioned above have supplied information on the distribution of the rodents with relation to the distribution of the vegetation in the study area (Evans, 1942; Delany, 1957), and in some cases with regard also to the cover provided by the vegetation (Newson, 1960; Kikkawa, 1964). As a result of these several studies there has come into general acceptance the view that the distribution of Clethrionomys is associated with that of dense vegetation, and the distribution of Apodemus is associated with that of more open areas. In the present study an attempt was made to examine more closely the relationship between the distribution of Clethrionomys and Apodemus, and

that of the various types of vegetation forming the field layer in the study areas. The relationship was examined in two ways, one being concerned with the nature of the vegetation and the distribution of rodents, the other being more concerned with the degree of protective cover provided by the vegetation regardless of its nature. The precise nature of the procedures employed in this study, and the results obtained, are given below (pp. 138-165) and the interpretations of the results are discussed, with reference to the results of other workers, in the discussion at the end of this section (pp. 166-171).

II. THE POPULATION DYNAMICS OF CLETHRIONOMYS AND APODEMUS IN DIFFERENT HABITATS

1. Changes in population size of Clethrionomys on the two halves of grid A from March 1963 to January 1965

Following the methods of estimation of population size previously described (pp. 37-46) the size of the population on each half-grid throughout the study was calculated. The resulting ' N_t ' curves are shown in Fig. 20, and the results are given in Table 51. From the graph shown in Fig. 20 it can be seen that the Clethrionomys population in the sycamore wood was greater in size on all occasions when calculated with the exceptions of March, April, and December of 1963.

In March and April 1963 the calculated ' N_t ' values for the Clethrionomys population in the sycamore wood were slightly

smaller than those of the larch wood population. From April to September 1963, however, the sycamore wood population was consistently some 30% larger. Between September and October 1963, the population size in the sycamore wood doubled, while that in the larch wood fell by one third. The reason for this remarkable happening is unknown, but its time of occurrence is coincident with the first large influx of Apodemus into the larch wood. From October to December 1963, the population in the sycamore wood declined greatly in numbers, whereas that in the larch wood increased in size to become the larger of the two. Some of this change was almost certainly due to the movement of Clethrionomys into the larch wood from the sycamore wood, coincident with an increase in the numbers of Apodemus captured in the sycamore wood. Between December 1963 and January 1964 the larch wood population decreased in size while the sycamore wood population increased in size, and this time movement from the larch to the sycamore was mainly responsible for the changes. Both populations decreased in size until April 1964, the sycamore wood population losing the most animals. Throughout the summer of 1964 the pattern of 1963 was repeated even to the October rise in the sycamore population and the fall in the larch population. After October the sycamore wood population declined and the larch wood population continued its decline. In January 1965 the population in the sycamore wood was approximately twice as large as that in the larch wood.

Date	1. Larch	2. Sycamore	3. Whole grid	1+2
1963				
Mar.	16.0	14.5	26.0	30.5
Apr.	14.4	11.4	22.0	25.8
May	19.3	32.5	25.0	51.8
June	22.9	31.8	51.5	54.7
July	26.2	36.4	64.1	62.6
Aug.	31.4	34.9	66.3	66.3
Sept.	31.6	46.2	78.8	77.8
Oct.	21.3	94.4	103.3	115.7
Nov.	43.1	54.3	97.9	97.4
Dec.	45.3	28.4	66.8	73.7
1964				
Jan.	16.7	57.7	50.6	74.4
Mar.	13.0	44.0	[⊠] 90.5	57.0
Apr.	10.5	23.8	34.3	34.3
May	25.8	38.0	63.8	63.8
June	32.9	37.8	70.2	70.7
Aug.	36.4	42.4	78.0	78.8
Sept.	41.0	40.7	83.7	81.7
Oct.	30.7	68.9	100.1	99.6
Nov.	19.1	42.7	61.6	61.8
1965				
Jan.	12.0	31.5	33.0	33.5

Table 51. Estimates of populations of Clethrionomys on the half-grids of grid A. In column 3 are shown the estimates calculated for the whole grid, and in column 4 the combined estimates of the two half-grids are given.

⊠ = doubtful estimate.

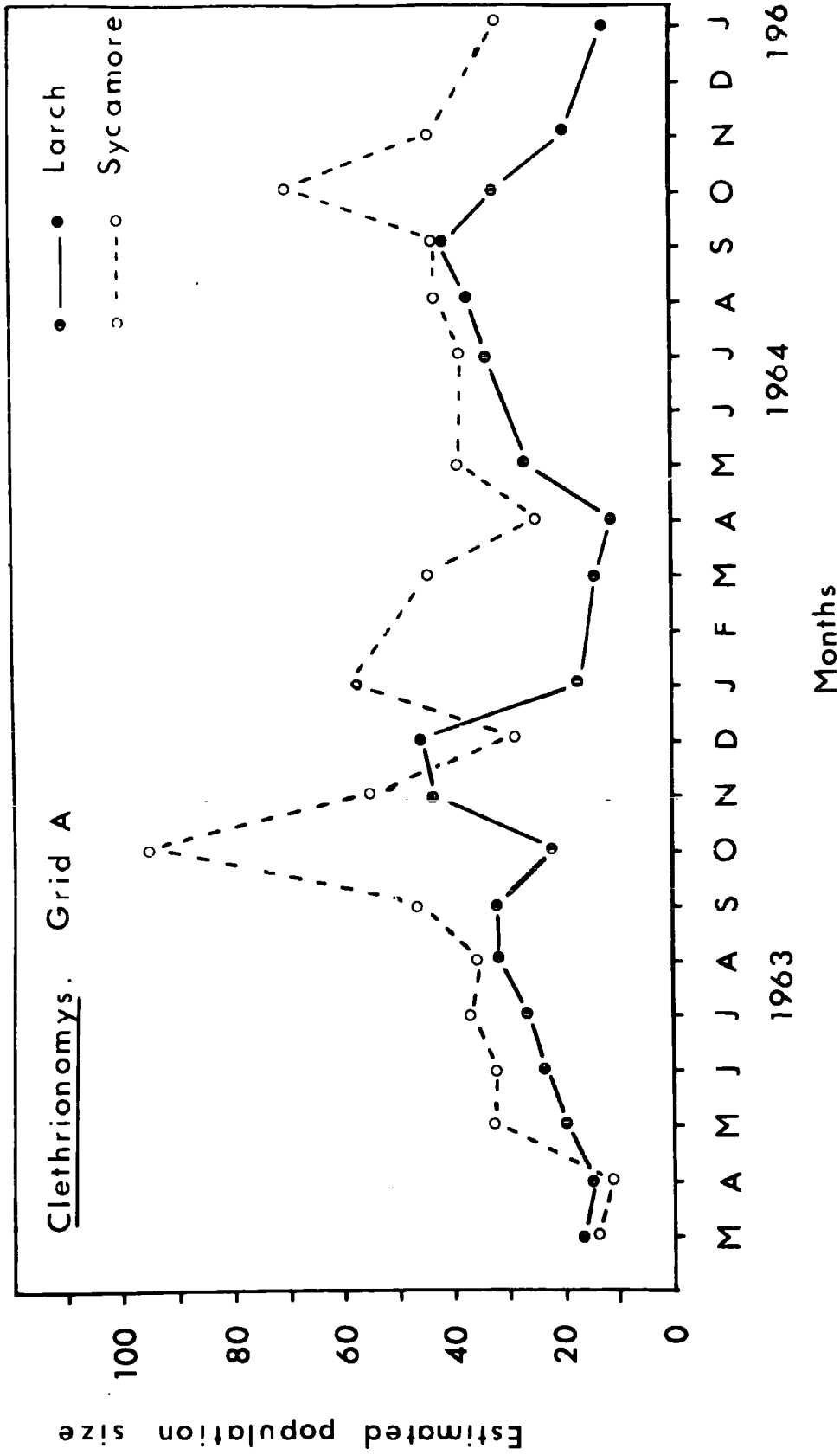

FIGURE 20. Population trends of Clethrionomys in the larch and in the sycamore woods on grid A during the study period, as drawn from the best available estimates of population size (N_t).

2. Changes in population size of Apodemus on the two halves of grid A (Fig. 21, Table 52)

Only in January 1965 was the population of Apodemus in the sycamore wood greater than that in the larch wood, and the margin of difference between them even then was negligible. After March 1963 no Apodemus were captured in the sycamore wood until September, and in the same period only a few individuals were caught in the larch wood. Between September and December 1963, the population size increased greatly in the larch wood, and from October to December 1963 a similar increase took place in the sycamore wood also. Both populations remained at a high level of density until March 1964, and then both declined in parallel throughout the spring and summer. The autumn increase in population size occurred in both the larch and the sycamore as in 1963, with the increase coming earlier in the larch and being of larger dimensions. After October 1964 the population in the larch decreased, while the sycamore wood population continued to increase; the populations were thus equivalent in size in November 1964. From November to January 1965 both populations decreased in size at a similar rate.

3. Changes in population size of Clethrionomys on the two halves of grid B

The ' N_t ' estimates for the populations of Clethrionomys on the half-grids of grid B are given in Table 53 and shown

Date	1. Larch	2. Sycamore	3. Whole grid	1+2
1963				
Mar.	15.0	6.5	24.0	21.5
Apr.	5.7	0	13.9	5.7
May	3.8	0	7.5	3.8
June	-	-	4.5	-
July	-	-	Ⓜ24.7	-
Aug.	-	-	6.7	-
Sept.	17.3	1.2	11.0	18.5
Oct.	34.2	3.7	39.0	37.9
Nov.	39.5	18.9	49.6	58.4
Dec.	49.2	40.8	84.0	90.0
1964				
Jan.	39.5	35.1	71.9	74.6
Mar.	47.8	37.1	83.4	84.9
Apr.	23.1	16.3	39.6	39.4
May	20.0	10.3	31.9	30.3
June	7.2	0	7.2	7.2
Aug.	7.2	0	7.2	7.2
Sept.	-	-	39.4	-
Oct.	54.5	26.4	80.9	80.9
Nov.	34.6	33.3	68.1	67.9
1965				
Jan.	16.5	18.0	25.5	34.5

Table 52. Estimates of populations of Apodemus on the half-grids of grid A. In column 3 are shown the estimates calculated for the whole grid, and in column 4 the combined estimates of the two half-grids are given.

Ⓜ = doubtful estimate.

- = no trapping.

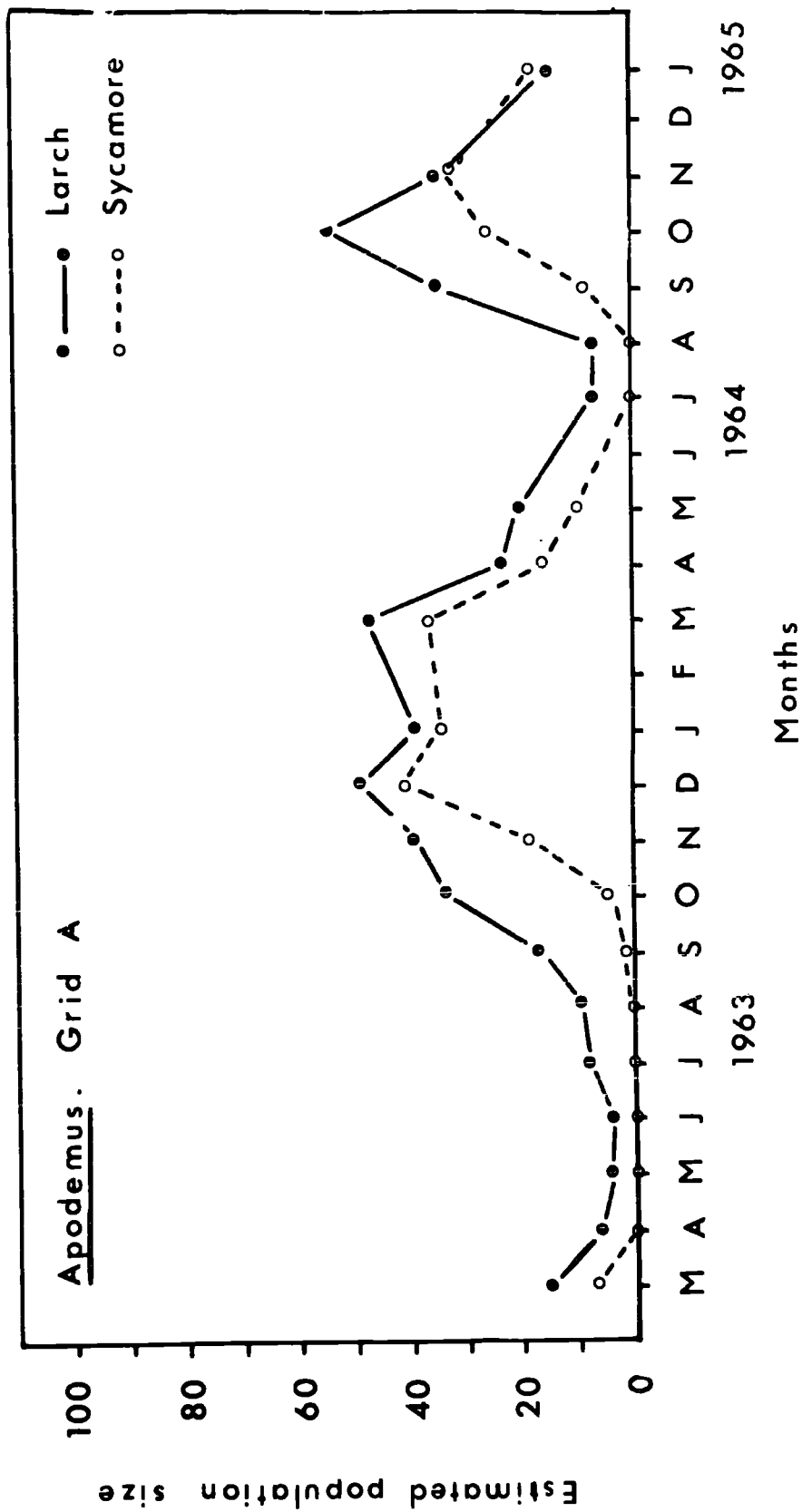

FIGURE 21. Population trends of Apodemus in the larch and in the sycamore woods on grid A during the study period, as drawn from the best available estimates of population size ($'N_t'$).

graphically in Fig. 22. The differences in population size between the larch and ash populations are less marked than those between the larch and sycamore populations on grid A. With only four exceptions (see below) the ' N_t ' values for the population in the ash plantation are greater than those for the population in the larch throughout the study as a whole. In March and April 1963 the populations were similar in size with, perhaps, the population in the larch being a little larger. A sharp population rise in the ash plantation between April and May was not maintained and the population had decreased again in size by June. From June until December 1963 the two populations behaved similarly with the ash plantation population being the larger. From December 1963 to February 1964 the population in the ash plantation continued to dwindle in numbers but the population in the larch remained at a constant size. There was some interchange of animals between the half-grids in the period from February to May causing the ash plantation population to increase in size as the larch wood population decreased in size. During the breeding season of 1964 the population increased greatly in size in the ash plantation but increased only very moderately in the larch wood. From August to December 1964 the ash plantation population declined rapidly, and in December 1964 there was only some 30% difference in size between the two populations.

Over the whole period of study the population in the larch

Date	1. Ash	2. Larch	3. Whole grid	1+2
1963				
March	20.0	24.0	45.0	44.0
April	19.7	20.5	40.6	40.2
May	38.5	20.8	41.0	59.3
June	24.7	32.3	57.0	57.0
July	45.8	33.2	79.5	79.0
Aug.	48.5	30.1	79.4	78.6
Sept.	48.1	37.0	83.9	85.1
Dec.	30.1	23.2	53.6	53.3
1964				
Feb.	14.8	24.1	39.7	38.9
Mar.	21.1	20.6	41.7	41.7
May	22.6	9.6	32.0	32.2
June	-	-	Ⓜ40.0	-
Aug.	64.9	27.7	99.0	92.6
Sept.	58.5	30.8	92.6	89.3
Nov.	31.8	22.1	51.8	53.9
Dec.	24.5	15.0	38.0	39.5

Table 53. Estimates of populations of Clethrionomys on the half-grids of grid B. In column 3 are shown the estimates calculated for the whole grid, and in column 4 the combined estimates of the two half-grids are given.

Ⓜ = doubtful estimate.

- = no trapping.

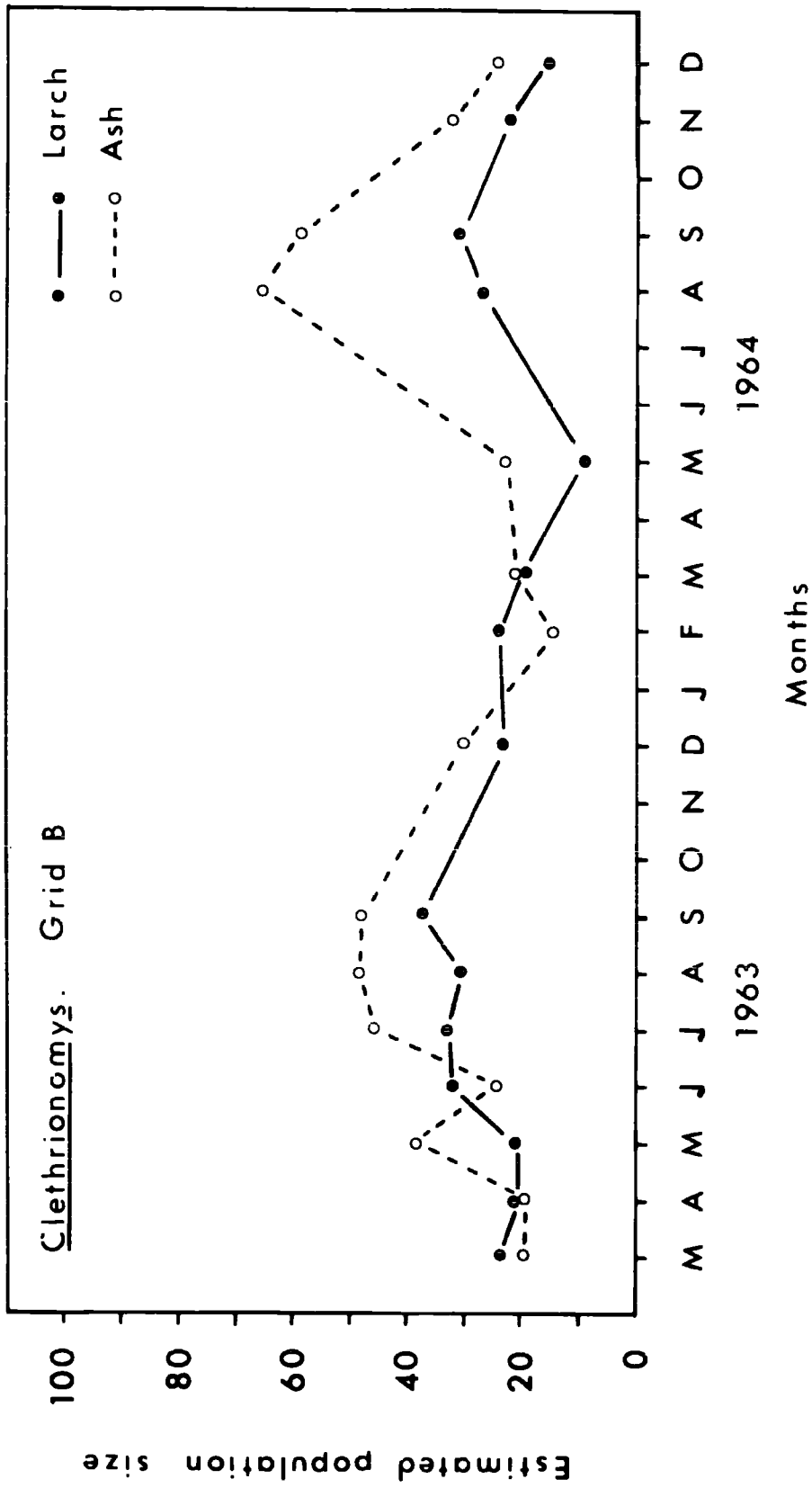

FIGURE 22. Population trends of Clethrionomys in the larch and in the ash plantations on grid B during the study period, as drawn from the best available estimates of population size (N_t).

wood fluctuated far less in size than did that in the ash plantation but the reason for this is not clear.

From the trapping records it seems unlikely that there was a resident population of Apodemus on grid B, but of those animals which were captured the majority frequented areas in the larch wood.

4. The survival, breeding, and age structure of populations of Clethrionomys and Apodemus living in different habitats

From a preliminary analysis of the survival, breeding and age-structure of the two species on the four half-grids of grid A and grid B no significant differences were found between the populations in the different habitats.

III. SEASONAL CHANGES IN THE DISTRIBUTION AND ABUNDANCE
OF CLETHRIONOMYS AND APODEMUS WITH REFERENCE TO
CHANGES IN THE VEGETATION

1. Introduction

Before the start of every trapping period a record was made of the type and density of the vegetation around each trapping point. By consideration of these records throughout the year seasonal changes in the vegetation were recognisable, and notes were made at the time of the details of the changes. Examination of the trapping records allowed the number of captures made of both species of rodent at each trapping point to be

determined for each trapping period. In order to allow for direct comparison of different seasons in terms of the number of captures made in different vegetation types, it was necessary to devise an average capture index per trap-position for each season. Such an index was necessary because each season was not composed of equal numbers of trapping periods. The capture index was calculated by considering all seasons to have three trapping periods, thus by application of the simple equation given below, the average capture index per trap-position per season could be found:-

$$\text{Average capture index} = \frac{\text{No. of captures made at trapping point}}{\text{No. of trapping periods in season}} \times 3$$

In order to facilitate this analysis the average capture indices are considered to portray accurately the distribution of the rodents at the times of the trappings. This assumption may not be far from the truth as there is no indication that animals living in one vegetation type are more liable to recapture than are animals living in any other vegetation type.

2. Seasonal changes in the distribution and abundance of

Clethrionomys and Apodemus on grids A and B

a) Clethrionomys. Grid A

The seasonal changes in distribution of Clethrionomys on grid A are shown diagrammatically for the two years of the study in Figs. 24 and 25. The method of shading used in the

diagrams is directly comparable in all of the seasons and hence shows not only the nature of the distribution of the rodents, but also the comparative numbers present on the area in the different seasons.

The Clethrionomys population was small and was restricted in distribution in the spring of 1963 (Fig. 24). The majority of the captures were made at trap positions situated in areas of bracken or bramble, although a few were made in traps placed in areas where dogs mercury is the dominant in the field layer in the summer (Fig. 23). A few animals were caught in areas where there was little ground vegetation, but where cover was available in the root-systems of up-rooted larch trees. No captures were made in thirty of the fifty trap-sites available, most of the thirty sites being situated in areas with sparse cover in the spring. In summer 1963 the Clethrionomys population was twice as large as it had been in the spring, and the distribution of the animals was much less restricted. In all only five trap-positions were not visited, all of which were in the larch wood. In the sycamore wood many animals were captured in trap-sites situated in areas covered by bracken, bramble, and dense carpets of dogs mercury, the latter plant having grown up since the spring. Fewer captures were made in areas with a diffuse cover of dogs mercury. In the larch wood there appeared to be avoidance of the more open areas but many animals were caught in clumps of bracken or dogs mercury. The population was

very large in autumn 1963, larger than it had been in the summer, but the distribution of the main centres of population was more restricted than it had been in the summer. This change in distribution was due mainly to the far fewer captures made in the areas of dogs mercury in the autumn than had been the case in the summer. The cover provided by the dogs mercury was much less in the autumn as much of it had died back by October-November. The distribution of the rodents in winter 1963 resembled that of autumn in pattern although there were differences in detail. The population was smaller than it had been in the autumn, but again the majority of the captures were made in traps placed at sites surrounded by bracken and bramble, and the trend commenced in autumn of an apparent withdrawal from areas with sparse cover was continued in the winter. No animals were captured at sixteen of the fifty trap-sites.

As the distribution patterns in 1964 were rather different from those described above for 1963 they warrant a separate treatment. In spring 1964 (Fig. 25) the distribution of Clethrionomys was different from what it had been in spring 1963. The population size was larger than it had been at the same time in 1963, and the distribution of the main centres of population resembled that of winter 1963 more than it did that of spring 1963. The main difference in the distribution in spring 1964 from that in winter 1963 is that more captures were made in areas dominated by dogs mercury in the former. The

(a).

VEGETATION. GRID A

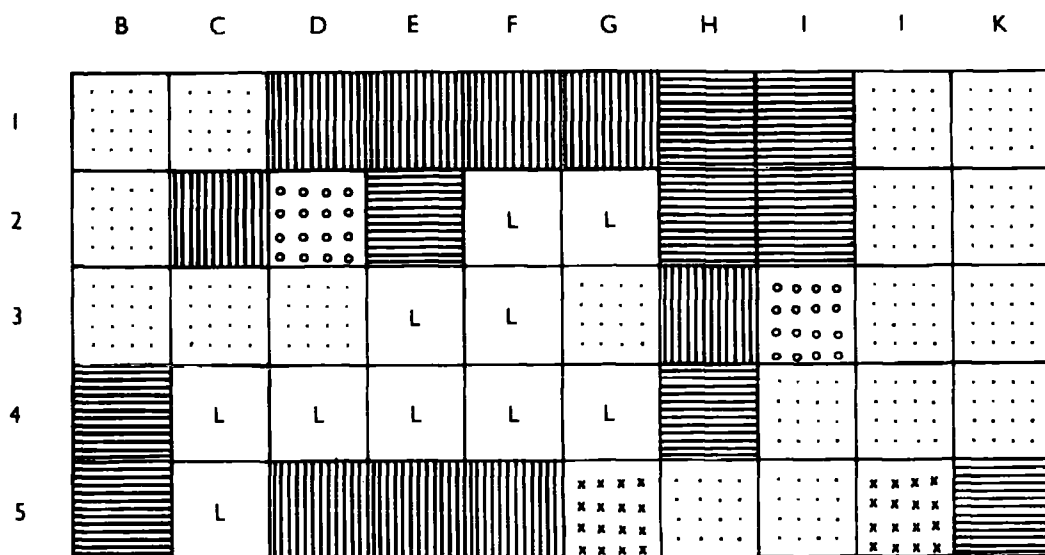

(b).

KEYS TO VEGETATION AND DISTRIBUTION MAPS

VEGETATION

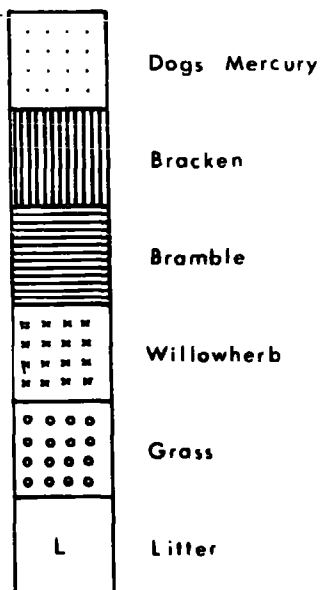

DISTRIBUTION

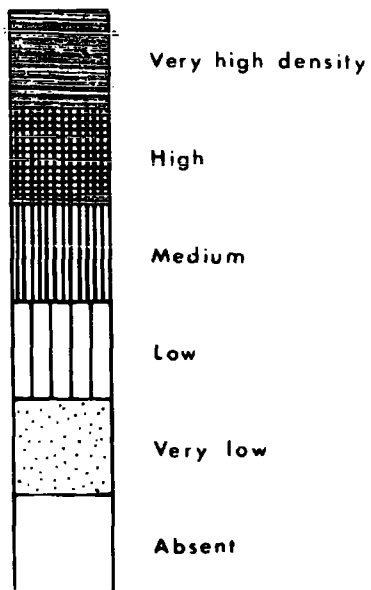

FIGURE 23. (a). Vegetation map of the field layer on grid A.

(b). Keys to the vegetation map and to the distribution maps (Figures 24-26).

DISTRIBUTION OF CLETHRIONOMYS ON GRID A

1963

SPRING

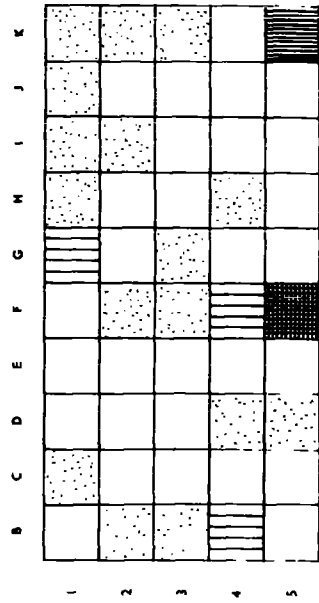

SUMMER

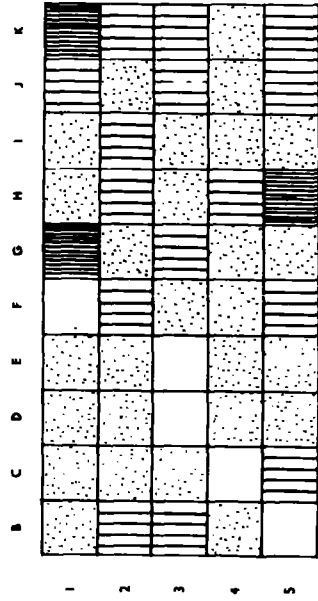

AUTUMN

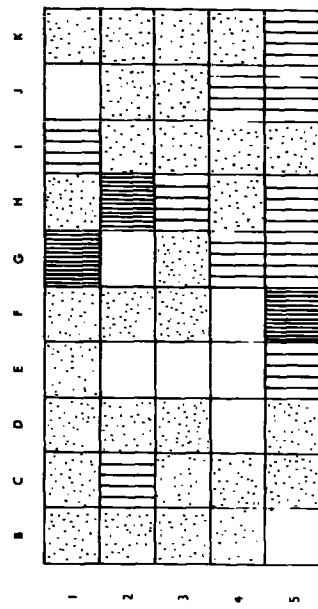

WINTER

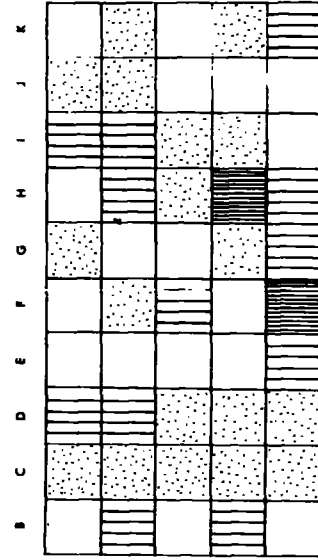
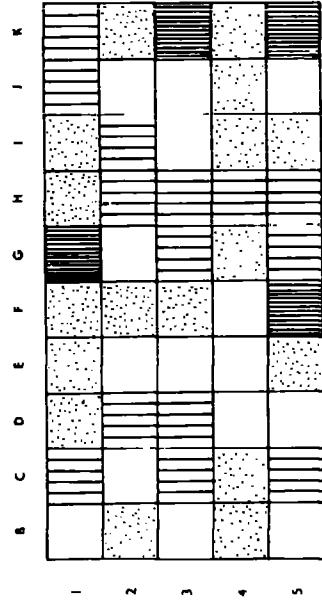

FIGURE 24. Maps showing the distribution and abundance of Clethrionomys on grid A in the four seasons of 1963. Key as in Figure 23b.

DISTRIBUTION OF CLETHRIONOMYS ON GRID A

1964

SPRING



SUMMER

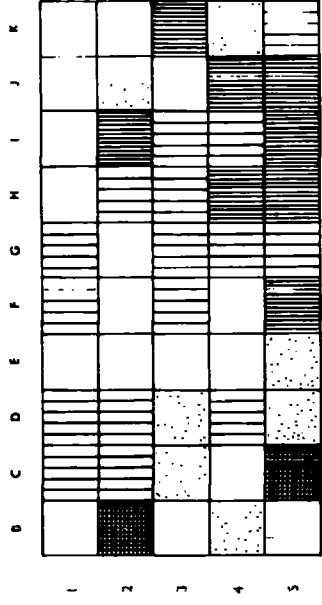

AUTUMN

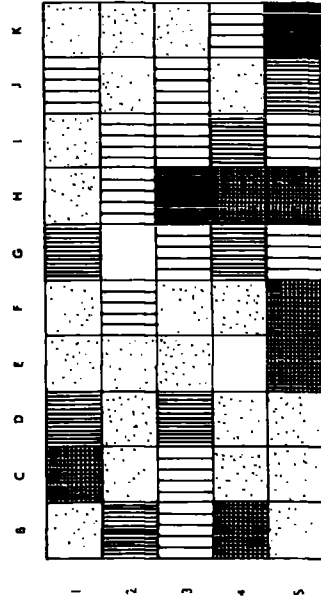

WINTER

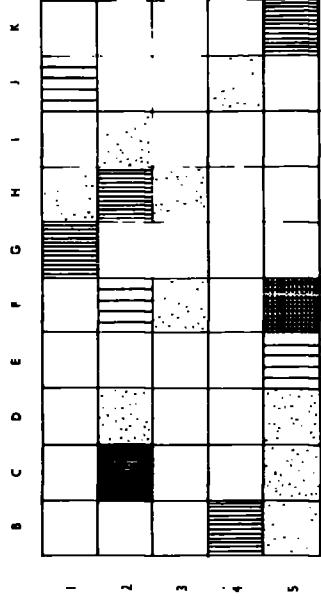

FIGURE 25. Maps showing the distribution and abundance of Clethrionomys on grid A in the four seasons of 1964. Key as in Figure 23b.

dogs mercury plants were, of course, almost in full bloom towards the end of the spring (May) and hence provided much more cover than was present in the same areas in the winter. In the summer of 1964 the population was large and the distribution of animals wide. Many captures were made in the several areas of different vegetation type and only areas with sparse cover of dogs mercury, or with a layer only of larch needles over the soil, were avoided by the voles. The general picture of the distribution in autumn 1964 is similar to that described for summer 1964. The heaviest catches were made in traps sited in bracken and in bramble areas, the lightest catches being made in areas covered only by larch-litter, or by dogs mercury. In winter 1964 the population had decreased greatly in size from what it had been in autumn, and the distribution of animals resembled that of spring 1963. Of the five major concentrations of animals found in spring 1963 four were again represented in winter 1964. However, five other major concentrations were present also in winter 1964. Only one of the main centres was situated other than in a bracken or bramble area, and it was in a dogs mercury region adjacent to some patches of bramble.

b) Clethrionomys. Grid B

The seasonal changes in distribution of Clethrionomys on grid B are shown diagrammatically in Figs. 28 and 29.

In spring 1963 (Fig. 28) the distribution of Clethrionomys

on grid B was fairly wide, but the main centres of population were in the areas of bracken. In the summer animals were captured in areas of different vegetation type all over the grid (Fig. 27), but in the larch wood the main concentrations of animals were found to be in areas of bracken and willowherb, the latter having grown up considerably since the spring. In the ash plantation, most of the animals were captured in bracken and bramble areas, but also many were caught in areas covered by temporary summer vegetation e.g. dogs mercury, hogweed, and thick grass. In autumn 1963 the distribution had changed a little from that in the summer, mainly because of the apparent withdrawal of animals from areas of dogs mercury, hogweed, and thick grass. There was continued avoidance of ground covered only by larch litter. In winter the willowherb areas also were comparatively deserted and the bulk of the admittedly few animals were again restricted in their distribution to the areas of bracken and bramble.

In spring 1964 (Fig. 29) the distribution of animals was restricted in the main to areas of bracken and dead willowherb. In summer the population size was greater and the distribution wider than it had been in the spring. The main concentrations of animals were in the areas of bracken, with considerable numbers being caught also in areas of bramble and willowherb. In the larch wood, areas with litter only, or with a rather diffuse covering of dogs mercury or bracken, were devoid of

animals. In autumn, only the larch-litter areas were avoided; again the main concentrations of animals were in the bracken, bramble, and willowherb regions. In winter the distribution of Clethrionomys was more restricted than it had been in the autumn. The larger concentrations of animals were confined almost entirely to the more dense bracken clumps.

c) Apodemus. Grid A

The diagrams showing the distribution of Apodemus on grid A are given in Fig. 26.

In spring 1963 few Apodemus were captured on grid A. Of those animals that were caught the majority of them were trapped in the larch wood in many different habitats, including open larch-litter areas. The few animals captured in the sycamore wood were trapped in sparsely-covered areas of dog's mercury. Very few animals were captured during the summer, and the few that were captured were taken in the more open areas of the larch wood or the spruce. In autumn 1963 the number of Apodemus caught was greater than in other seasons and the animals were distributed widely. The bulk of the captures was made in the larch wood, with the more open areas apparently being favoured by the animals. The population size had again increased by winter 1963 and the animals were in the larch and spruce zones, but within those zones no preference for any type of vegetation could be detected.

DISTRIBUTION OF APODEMUS ON GRID A

1963

WINTER

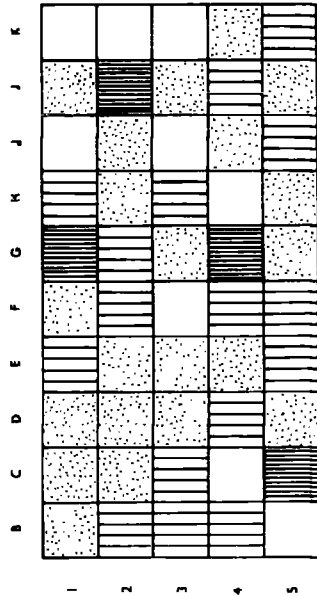

1964

SPRING

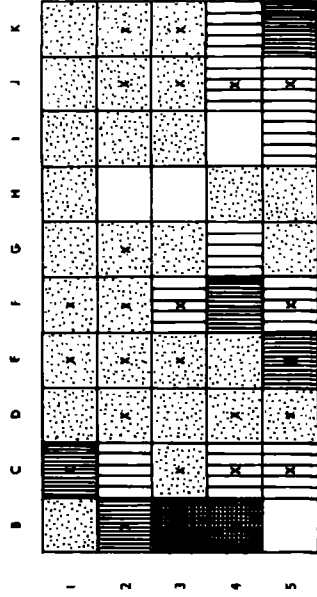

1964

AUTUMN

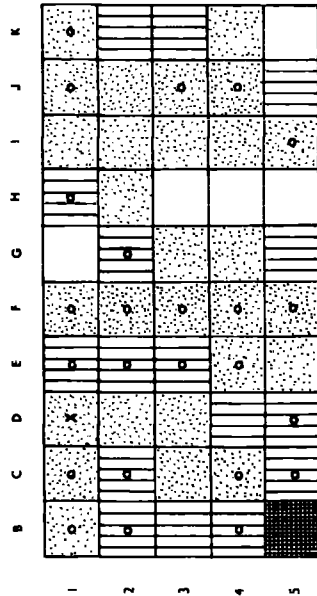

1964

WINTER

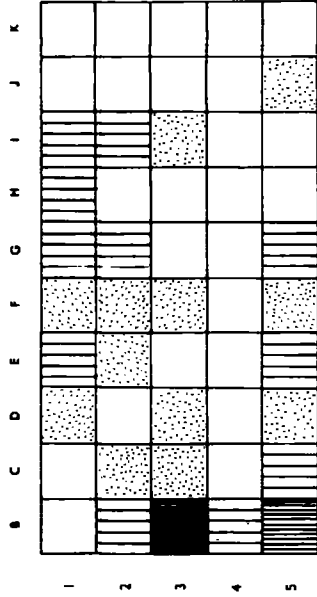

FIGURE 26. Maps showing the distribution and abundance of Apodemus on grid A in winter 1963, and in spring, autumn, and winter 1964. On the distribution map for spring 1964 the crosses (x) mark the sites where Apodemus were caught in spring 1963. On the map for autumn 1964, the circles mark the sites where Apodemus were caught in autumn 1963.

There were three main concentrations of animals in spring 1964. Two of the concentrations were in sparsely-covered areas in the larch wood, and one was in the sycamore wood in an area of dead willowherb and withered dogs mercury plants. The few captures made in summer were all at sites in the larch wood. In autumn 1964 the population of Apodemus was large and as in autumn 1963, the majority of the captures were made in the larch wood, but no one type of vegetation harboured disproportionate numbers of animals. In the winter the distribution of the Apodemus was more restricted than it had been, and the completely open areas seemed to be avoided to a certain extent, although no actual preference for a particular vegetation type was detectable.

d) Apodemus. Grid B

Very few Apodemus were caught on grid B until winter 1963 but the few that were tended to occupy habitats in the larch wood. In the winter more animals were captured, the majority of them being in the larch wood, but no habitat preference was detectable from an examination of their distribution. Throughout 1964 the pattern was very similar to that seen in 1963, with the few animals that were captured being confined mainly to the larch wood.

(a).

VEGETATION GRID B

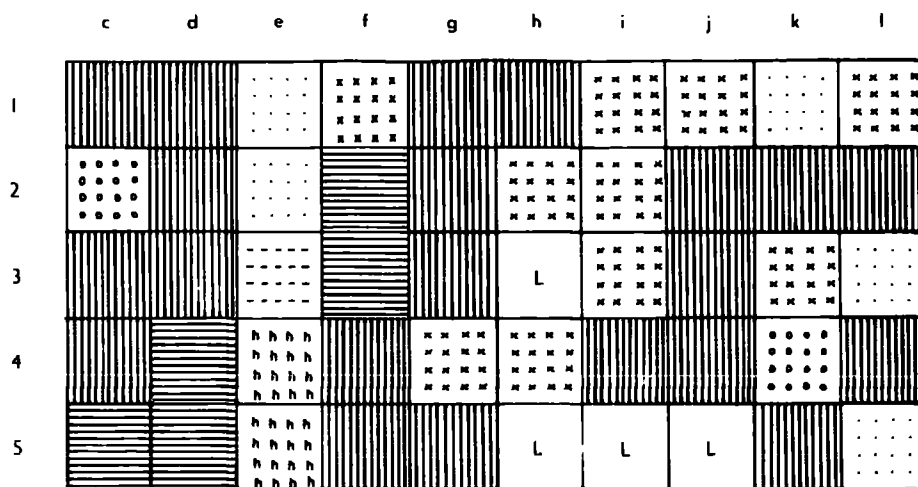

(b).

KEYS TO VEGETATION AND DISTRIBUTION MAPS

VEGETATION



Dogs Mercury

Bracken

Bramble

Willowherb

Grass

Litter

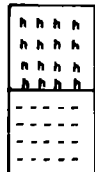

Hogweed

Raspberry

DISTRIBUTION



Very high density

High

Medium

Low

Very low

Absent

FIGURE 27. (a). Vegetation map of the field layer on grid B.

(b). Keys to the vegetation map and to the distribution maps (Figures 28-29).

DISTRIBUTION OF CLETHRIONOMYS ON GRID B

1963

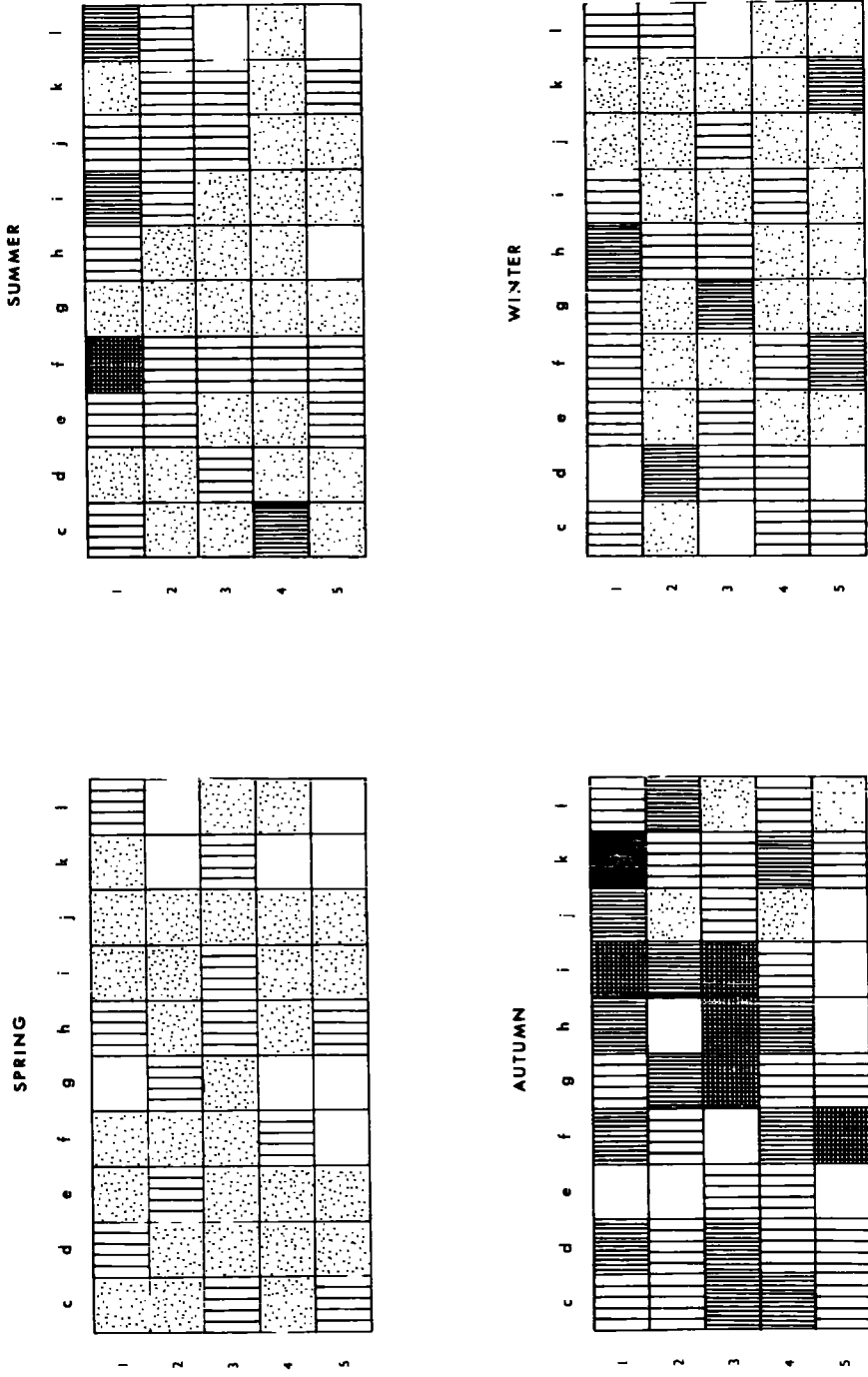

FIGURE 28. Maps showing the distribution and abundance of Clethrionomys on grid B in the four seasons of 1963. Key as in Figure 27b.

DISTRIBUTION OF CLETHRIONOMYS ON GRID B

1964

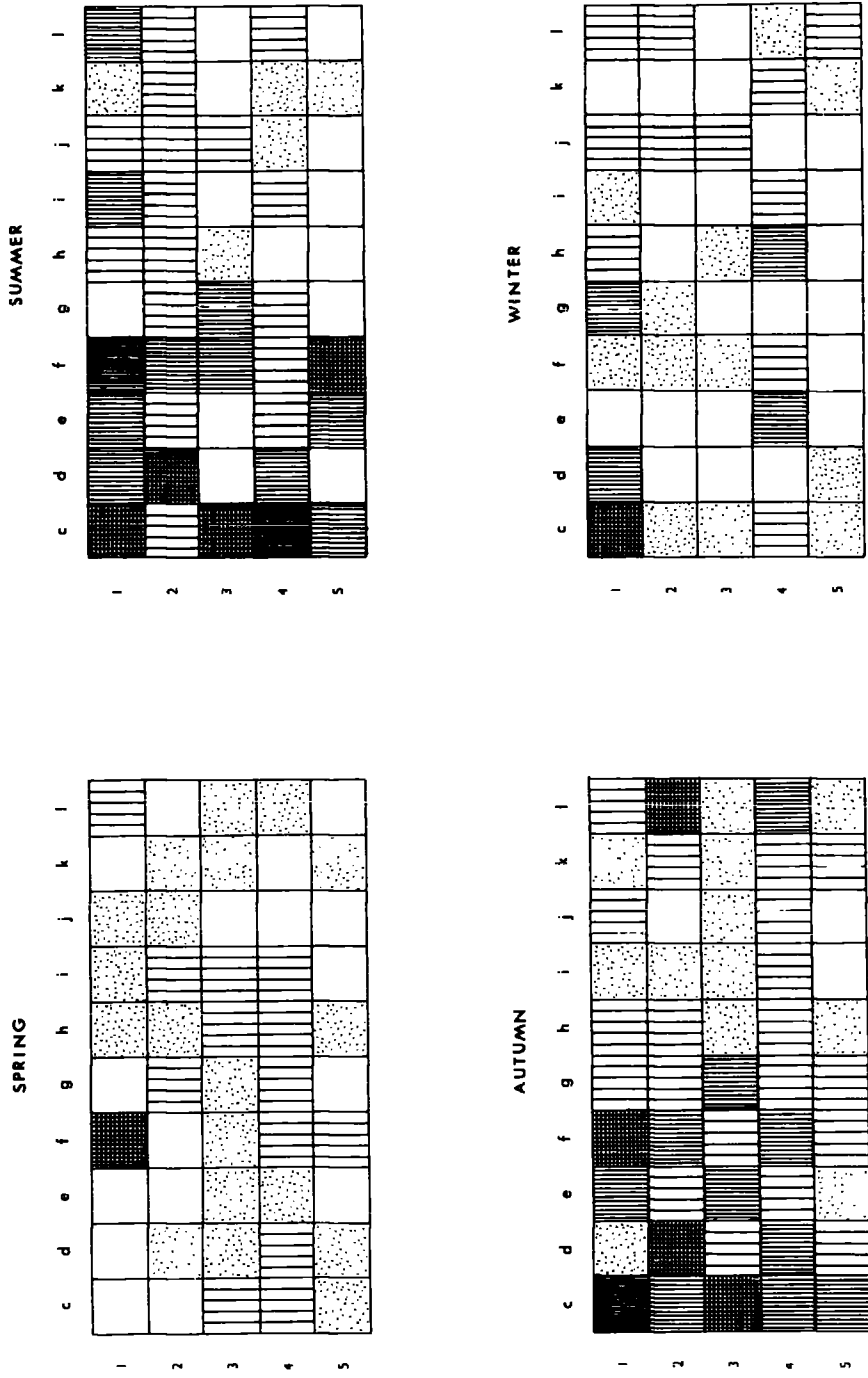

FIGURE 29. Maps showing the distribution and abundance of Clethrionomys on grid B in the four seasons of 1964. Key as in Figure 27b.

3. The influence of vegetation type upon the distribution and abundance of *Clethrionomys* and *Apodemus*

a) *Clethrionomys*

From the accounts given above of the seasonal variation in distribution of *Clethrionomys* on grids A and B it is apparent that the nature and distribution of the vegetation influence the distribution of the rodents. The influence of the vegetation on the distribution of the rodents must be considered in conjunction with the influence of changes in population size also, however. When the population was small as in winter and spring, such animals as were present had a restricted distribution, being confined in the main to areas of bracken, bramble and thick grass. The more open areas were devoid of animals by comparison. In the summer the population size during the summer was coincident with the formation of favourable habitats, as regards cover, of dog's mercury (on both grids), and of other summer vegetation (on grid B). Thus, favourable habitats were available at a time when crowding could reasonably be expected to have been occurring in the original centres of population. However, that population pressure is not solely responsible for the colonisation of areas not previously occupied is suggested by the results obtained from an examination of the patterns of distribution present in the autumn. The population was equally as large in the autumn as it had been in the summer, and

yet the distribution tended to be more limited in the autumn. This comparative restriction was due to the comparative absence in autumn, from the areas with summer vegetation only, of animals present in the summer. Considering these areas with summer-vegetation only, particularly those covered by dogs mercury, the newly-evident avoidance of these areas was seen to coincide with the dying-back of the plants, which thus lessened their value as providers of protective cover. As will be seen in a later section (pp. 158-162) this point about protective cover is very important. It would seem therefore, that the wider distribution of animals in the summer is at least partially due to the exploitation of newly-available favourable habitats, and is hence not due solely to the crowding-out of excess animals into less favourable habitats. The question of the changing use of areas with temporary summer vegetation is examined in more detail in a later section (pp. 162-165).

b) Apodemus

There does not seem to be any sort of positive association with a vegetation type in Apodemus. On the other hand, nor does there seem to be a restrictive effect exerted by sparsely-covered areas, although if anything, there is a slight tendency for open areas to be preferred. The question of whether the distribution of Apodemus is restricted by the presence of Clethrionomys, or vice versa, is difficult to

answer with the information available. However, when large numbers of both Clethrionomys and Apodemus were present together on grid A in the autumn and winter, the Apodemus were more confined to the larch and the Clethrionomys to the sycamore. This preference of Apodemus for the larch wood, and Clethrionomys for the sycamore was present at other times of the year also, so care must be taken not to read too much into this.

IV. THE RELATIONSHIP BETWEEN THE DENSITY OF THE VEGETATION COVER AND THE DISTRIBUTION AND ABUNDANCE OF CLETHRIONOMYS AND APODEMUS

1. Introduction

In part III (pp. 145-155) of this section the distributions of Clethrionomys and Apodemus are described with reference to the nature of the vegetation in the bush and herb-layers. In addition to that method of analysis the distributions of Clethrionomys and Apodemus were examined also with reference to the degree of protective cover provided by the vegetation, regardless of the exact nature of that vegetation. The results of the second analysis are given in this sub-section.

An attempt was made to assess the density of the vegetation around each trapping position in terms of the protective cover afforded by that vegetation to small rodents. The assessments were made prior to each trapping period. Each trapping

position was given a cover estimate of between 0 and 5, where 0 represents bare ground devoid of any herbs, and 5 represents dense cover such as may be provided by thick bramble plots. This method of estimation is a subjective one, but it was made as objective as possible by making the estimations each time without reference to the previous values recorded, and by recording the estimates before the number of captures made at each point was known. From the results of the monthly cover estimates an average estimate of the cover at each trapping point for each season was determined. In a similar manner the average number of captures made per point was calculated for each season. For each season an average capture index of the average number of animals caught at trap-positions with cover of 0, 0.5, 1.0, 1.5 etc. was determined by the use of the following formula:-

$$\text{Average capture index for points with cover value of 'x'} = \frac{\text{Total no. captures made at points with cover value 'x'}}{\text{No. of points with cover value 'x'}}$$

This procedure was followed for each season and the average number of animals captured per point was plotted against the range of cover values recorded for the season.

2. The general relationship between the density of cover and the distribution of rodents.

Throughout the course of the two year study a general impression was gained of an underlying relationship between the

abundance of Clethrionomys and the density of the vegetation cover. Accordingly the number of catches made at areas with "thick" cover and with "thin" cover throughout the study period was calculated. The areas with bramble and bracken were considered to provide "thick" cover, and all other vegetation was considered to provide comparatively "thin" cover. This procedure was carried out for both grids, and the number of animals in each category was adjusted in order to consider there to be 25 points with "thick" and 25 points with "thin" cover on each grid. The results are shown in Table 54.

	Grid A		Grid B	
	Thick	Thin	Thick	Thin
<u>Clethrionomys</u>	912	575	781	531
<u>Apodemus</u>	479	439	102	118

Table 54. The captures of Clethrionomys and Apodemus in areas of "thick" and "thin" cover.

On both grids more Clethrionomys were caught in areas with thick cover than in areas with thin cover. With Apodemus on grid A slightly more captures were made in thick cover than in thin cover, but on grid B the reverse situation was found. In order to see whether such a distribution of captures in thick and thin cover could have occurred by chance the distributions were tested for significance by chi-square. For Clethrionomys on grid A in thick cover $\chi^2 = 38.19$ with 1 degree of freedom ($P < 0.001$), on grid B $\chi^2 = 23.82$ with 1 degree of freedom ($P < 0.001$), there is thus a highly significant difference in

distribution from a random one with thick cover harbouring many more animals than thin cover. With Apodemus, the distribution in thick and thin cover was found to be entirely at random, no preference being shown for either. Having thus established that a marked preference for thick cover exists in Clethrionomys the relationship is considered in more detail in part 3 below.

3. The detailed relationship between the degree of protective cover afforded by the vegetation and the distribution and abundance of Clethrionomys and Apodemus

a) Clethrionomys. Grid A

The relationship between the density of cover of the vegetation and the average number of captures of Clethrionomys made at trap-positions situated in such cover is shown for the four seasons in Figs. 30 and 31. The relationship over the entire period of study is shown in Fig. 32. In the spring the range of cover estimates was from 0 to 3, none of the more dense vegetation types having grown up by then. The association between the number of animals captured and the cover density around the trap points was examined, and a highly significant positive correlation was found to exist between them ($r =$ correlation coefficient $= + 0.89$). A regression line of 'y' upon 'x' was fitted by calculation to the distribution shown in Fig. 30 ($y = 0.20 + 3.98x \pm 2.01$) and a linear relationship was demonstrated to exist between the two sets of values. As

the number of captures made at a point is considered to reflect the actual distribution of the animals over the area then the above reasoning may be stated another way. There is a highly significant positive correlation between the distribution of Clethrionomys and the density of cover of the vegetation, such that more animals occur where the vegetation is more dense. This has been demonstrated so far only for spring, but that it is true for all seasons is now briefly shown. In the summer the cover estimates were within the range 0 to 5, and a positive correlation of high value was found to exist between the density of cover and the number of animals captured. ($r = 0.91$; $y = 2.60 + 1.79x \pm 1.38$). In autumn the maximum cover estimate was 4, and the correlation between cover and abundance of captures was good ($r = 0.96$; $y = 5.26 + 7.22x \pm 2.88$). In the winter there was a narrower range of cover estimates (0-3) as was found in the spring also. The correlation between cover and the abundance of captures was closer than in the other seasons ($r = 0.98$; $y = 0.21 + 2.8x \pm 0.57$). When the results over the whole study were considered the degree of correlation between the two sets of values was seen to be very high, and the scatter of values about the fitted regression line of y upon x was well within the limits of one standard error on each side of the line ($r = 0.99$; $y = 1.18 + 5.24x \pm 0.952$).

(a).

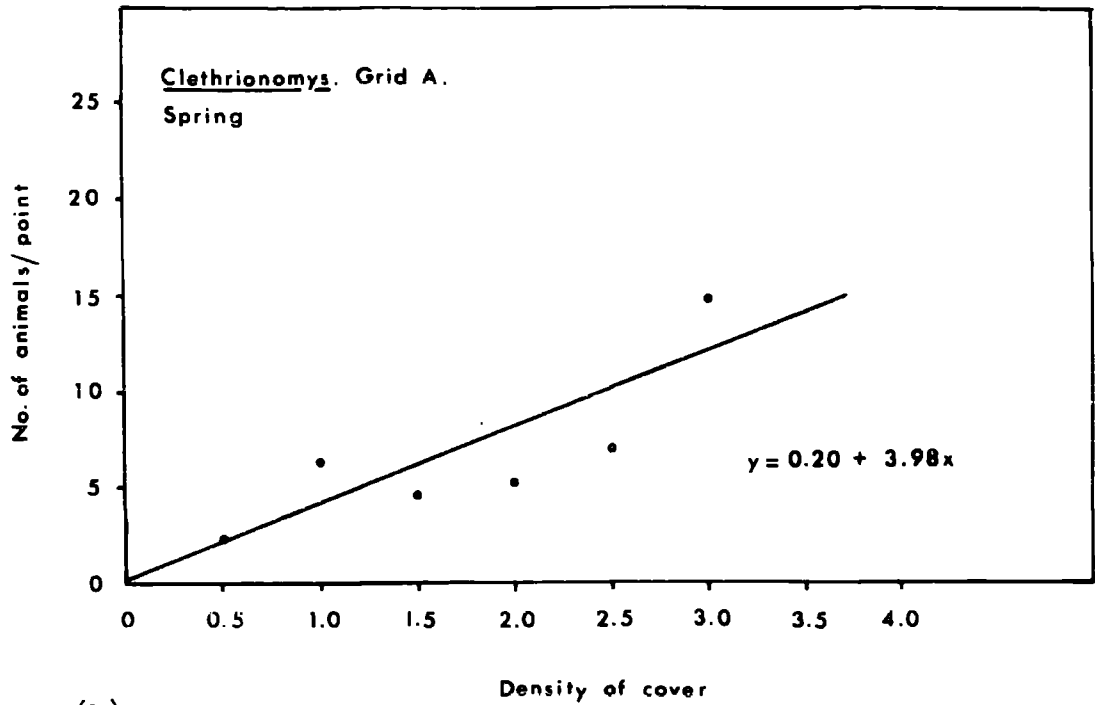

(b).

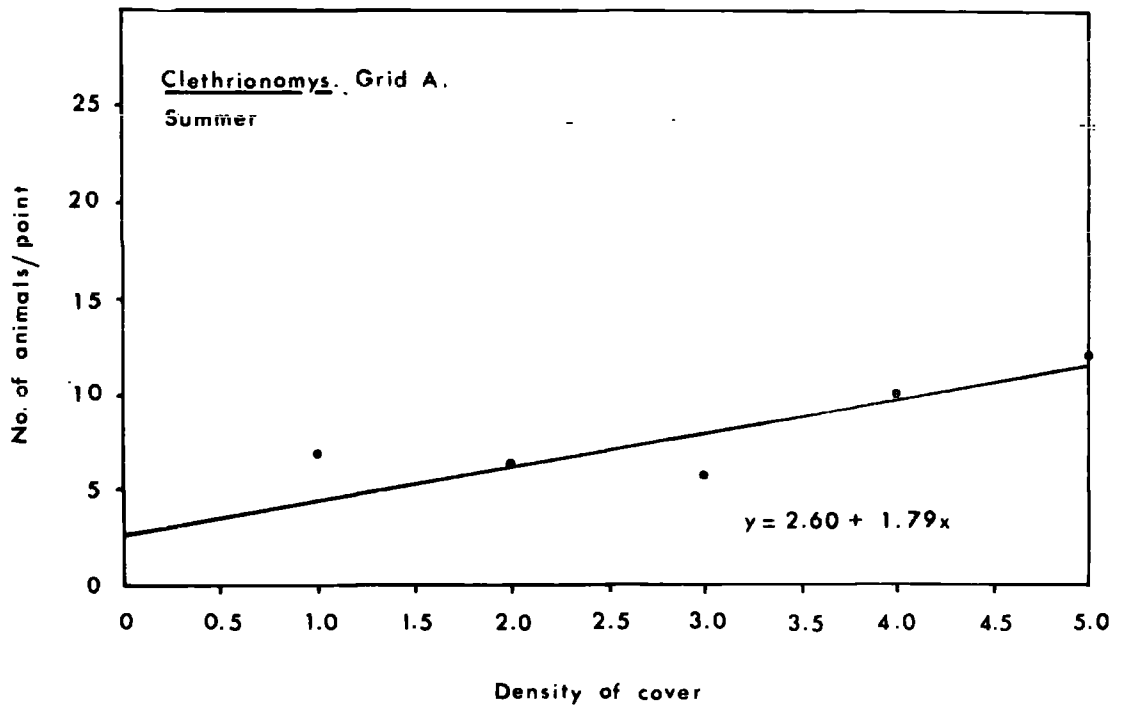
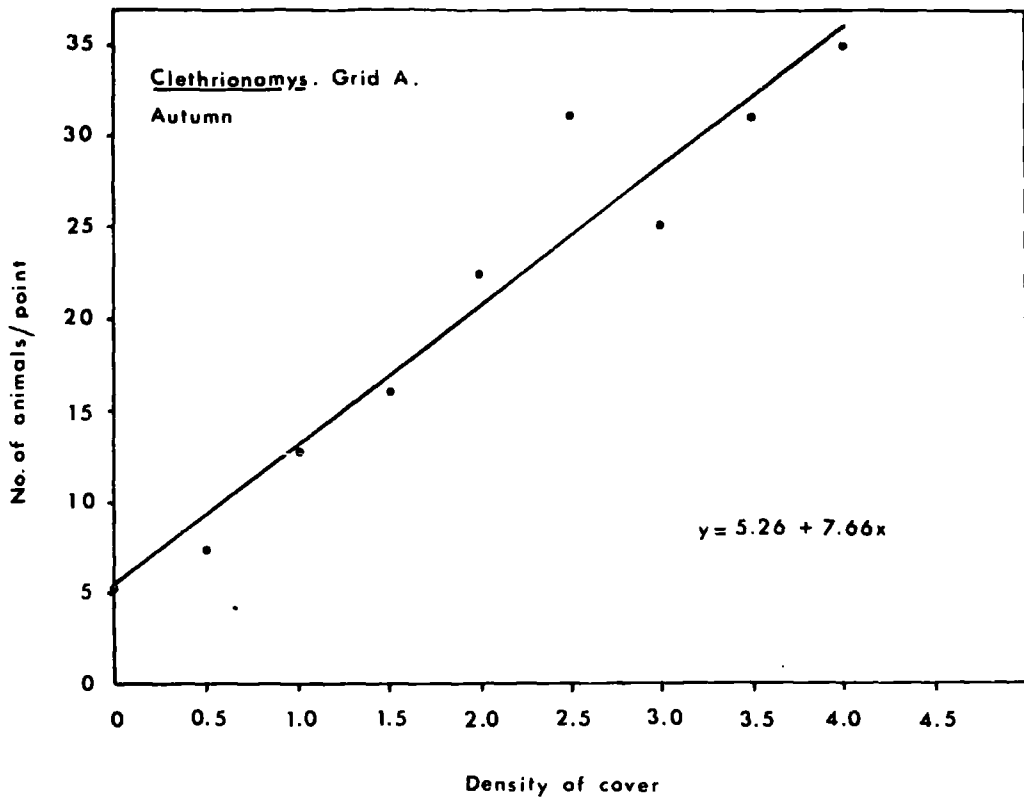

FIGURE 30. Graphs showing the relationship between the mean number of Clethrionomys captured at points with different degrees of vegetation cover on grid A, and the actual density of the cover at the points in spring (a) and summer (b).

(a).



(b).

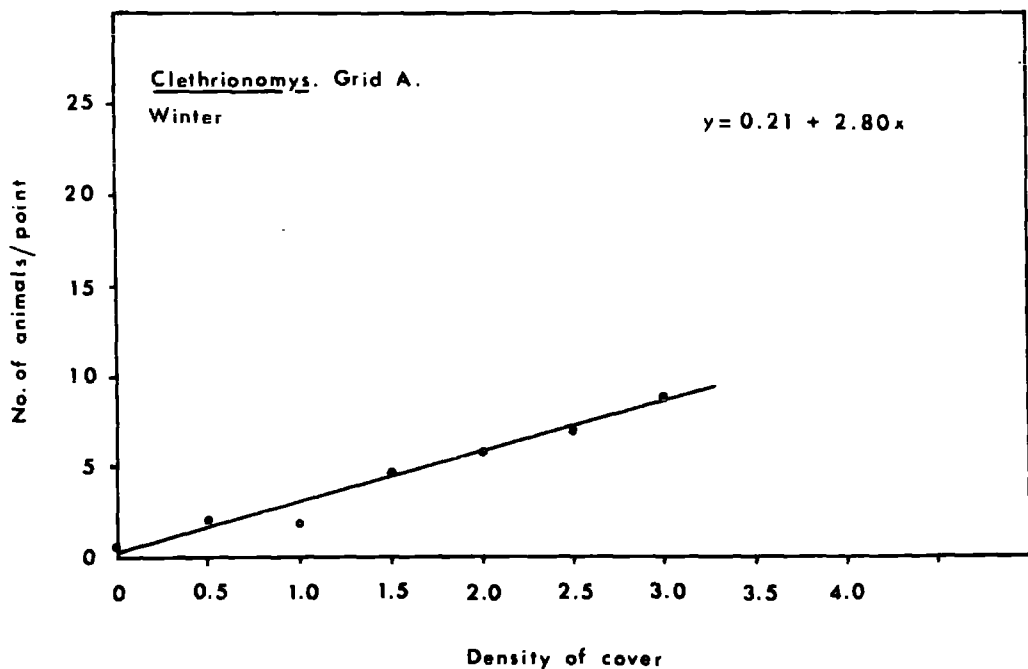

FIGURE 31. Graphs showing the relationship between the mean number of Clethrionomys captured at points with different degrees of vegetation cover on grid A, and the actual density of the cover at the points in autumn (a) and winter (b).

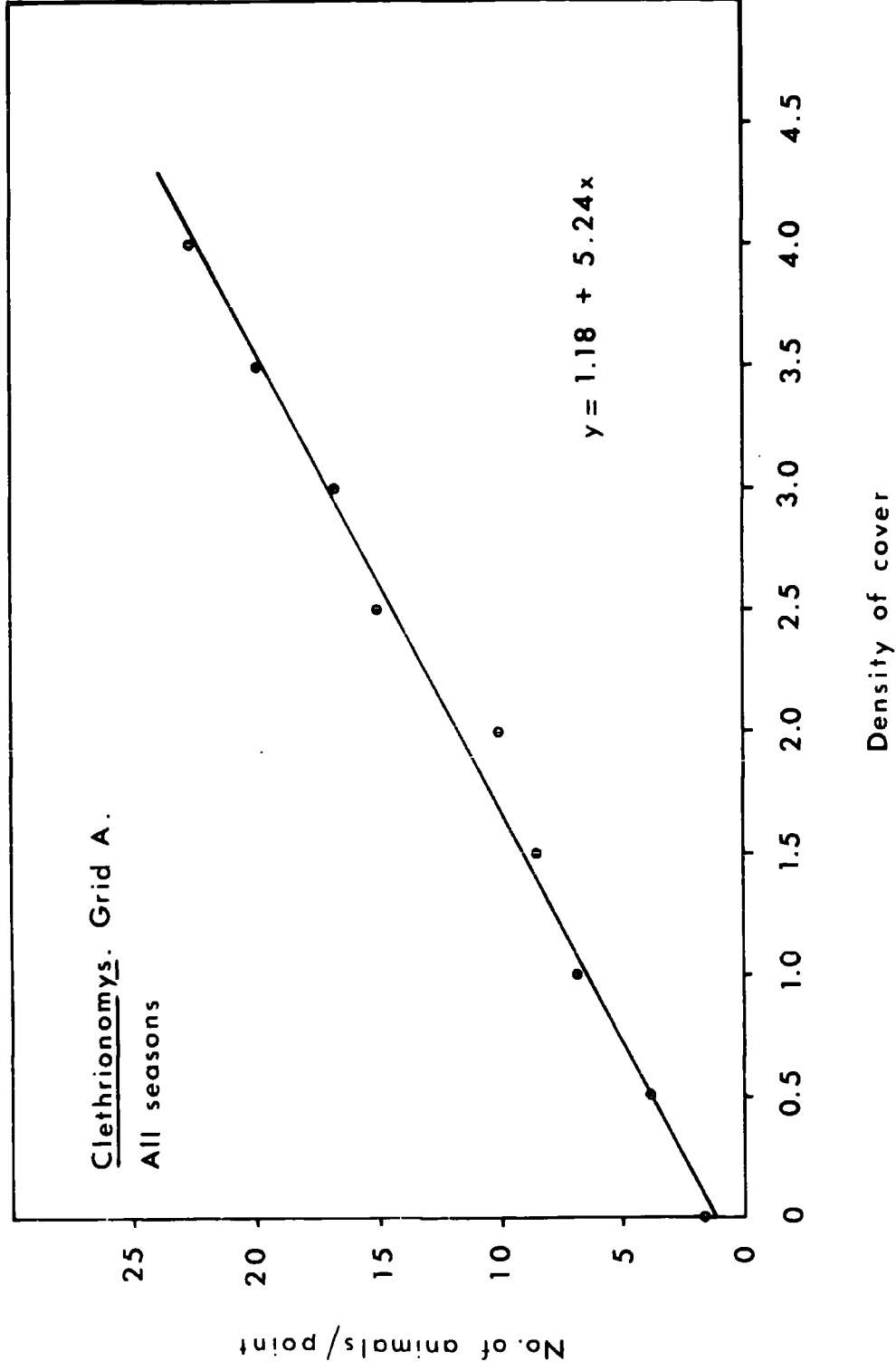

FIGURE 32. Graph showing the relationship between the mean number of Clethrionomys captured at points with different degrees of vegetation cover on grid A, and the actual density of the cover at the points. Data for all seasons are combined.

b) Clethrionomys. Grid B

An identical procedure to that described above for Clethrionomys on grid A was carried out for Clethrionomys on grid B, and the results are presented graphically in Figs. 33-35. As on grid A the maximum cover estimate made for spring was 3. The correlation between the cover density and the number of captures in spring was the same as that for grid A ($r = 0.89$; $y = 4.78 + 1.21x \pm 0.62$). In summer the maximum cover estimate was 4. The correlation between the values was less good for summer than for spring, and was less good than the value for summer on grid A. ($r = 0.88$; $y = 1.77 + 3.95x \pm 2.78$). In the autumn on grid B the cover estimates again ranged only up to 3, but the correlation was better than in spring or summer ($r = 0.92$; $y = 2.45 + 3.39x \pm 1.44$). In winter the cover estimates ranged only from 0 to 2, and the correlation was less close than in the other seasons ($r = 0.88$; $y = 2.39 + 2.67x \pm 1.04$). When the results of the whole study were considered the correlation was good between the two sets of values ($r = 0.89$; $y = 1.74 + 3.98x \pm 2.65$).

c) Apodemus. Grid A

When the results for Apodemus were treated as described above, for the whole study, the resultant picture was as is shown in Fig. 36. From this graph it can be seen that there was no tendency for the average number of catches per point to

(a).

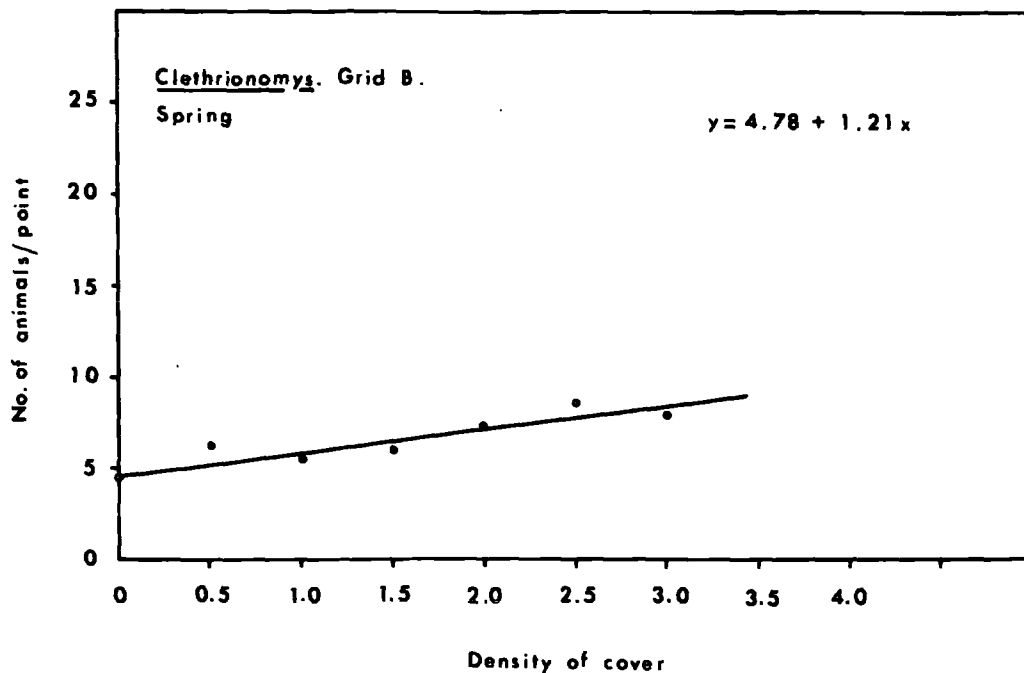

(b).

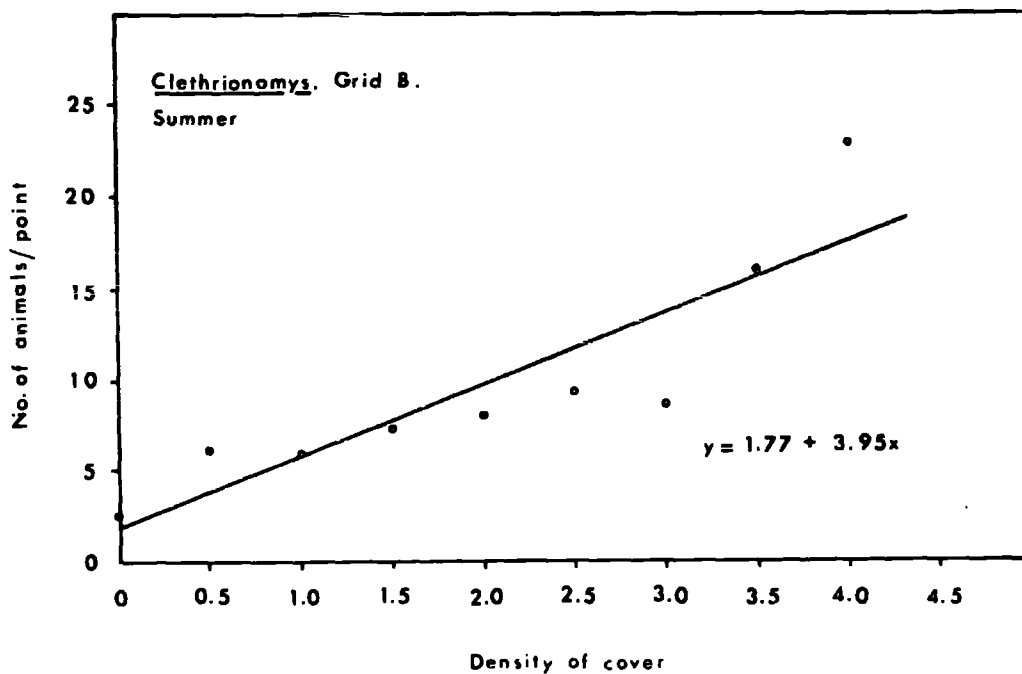
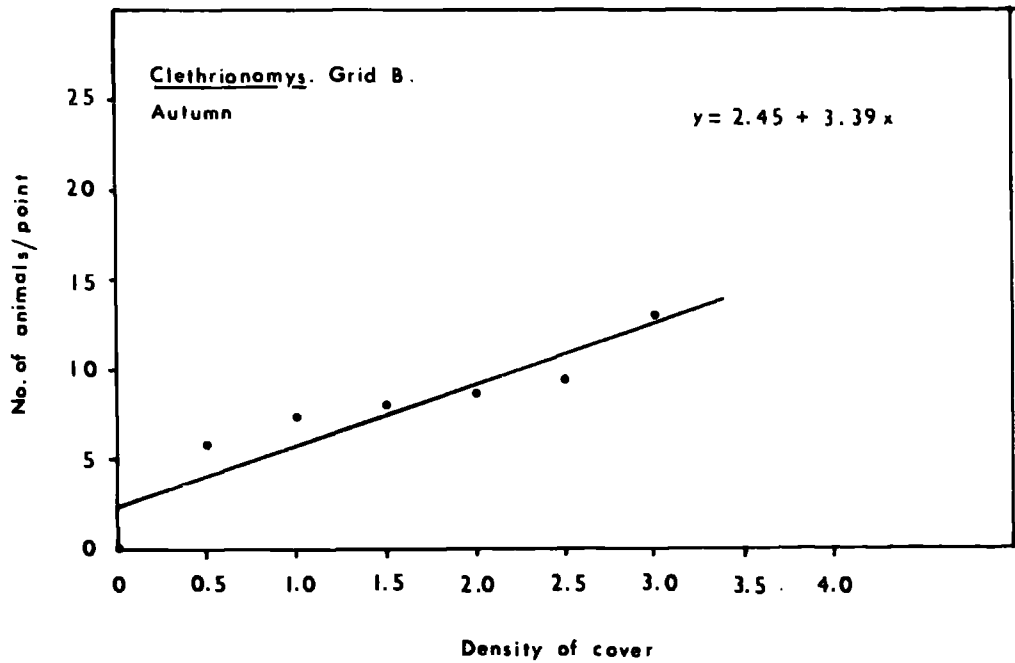

FIGURE 33. Graphs showing the relationship between the mean number of Clethrionomys captured at points with different degrees of vegetation cover on grid B, and the actual density of the cover at the points in spring (a) and summer (b).

(a).



(b).

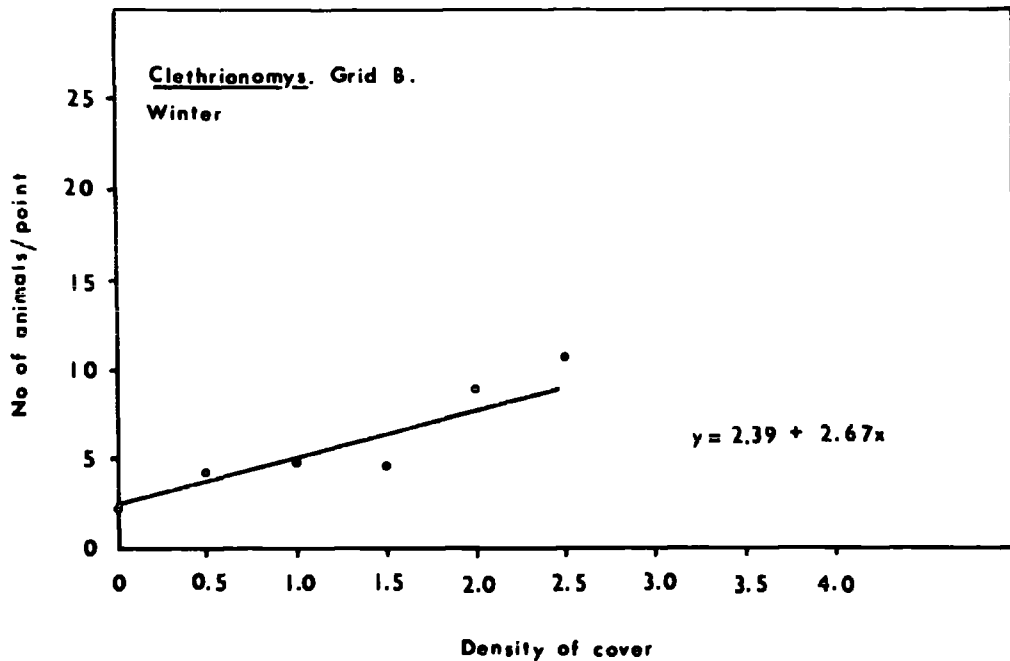

FIGURE 34. Graphs showing the relationship between the mean number of Clethrionomys captured at points with different degrees of vegetation cover on grid B, and the actual density of the cover at the points in autumn (a) and winter (b).

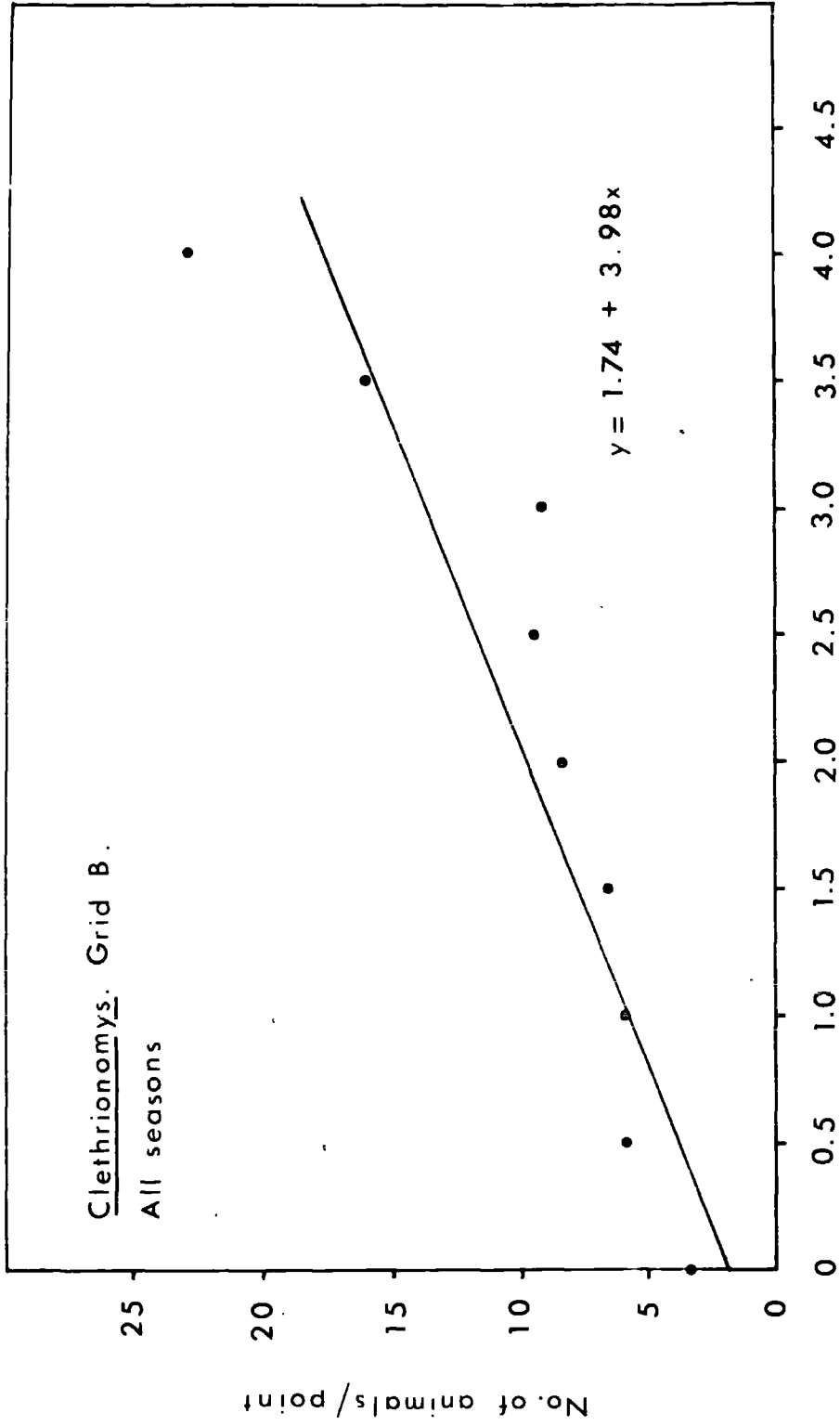

FIGURE 35. Graph showing the relationship between the mean number of Clethrionomys captures at points with different degrees of vegetation cover on grid B, and the actual density of the cover at the points. Data for all seasons are combined.

increase or decrease with increasing cover density. A slightly negative correlation was calculated which was not significant ($r = -0.25$). No seasonal analysis was attempted as the numbers of captures in spring and summer were inadequate for this purpose. On grid B also the number of captures was inadequate for analysis.

d) Conclusions

From the form of the distributions discussed above and presented graphically in Figs. 30-36, certain conclusions may be drawn. For Clethrionomys on both grids there was a high degree of correlation between the density of cover around the trapping point and the number of captures made at that point. The number of captures may be regarded as a measure of the abundance of the animals in the vicinity for the purposes of this investigation, hence a linear relationship between the density of cover and the abundance of animals was found to exist throughout the year. This relationship suggests that it is the density of the cover which is important and not the nature of the vegetation providing that cover. For example, both bracken and bramble provide dense cover, yet no preference appeared to be shown by the animals for either (see pp. 153-154). In short, the distribution of Clethrionomys was markedly associated with the distribution of the vegetation, there being a greater abundance of animals in areas with more dense cover.

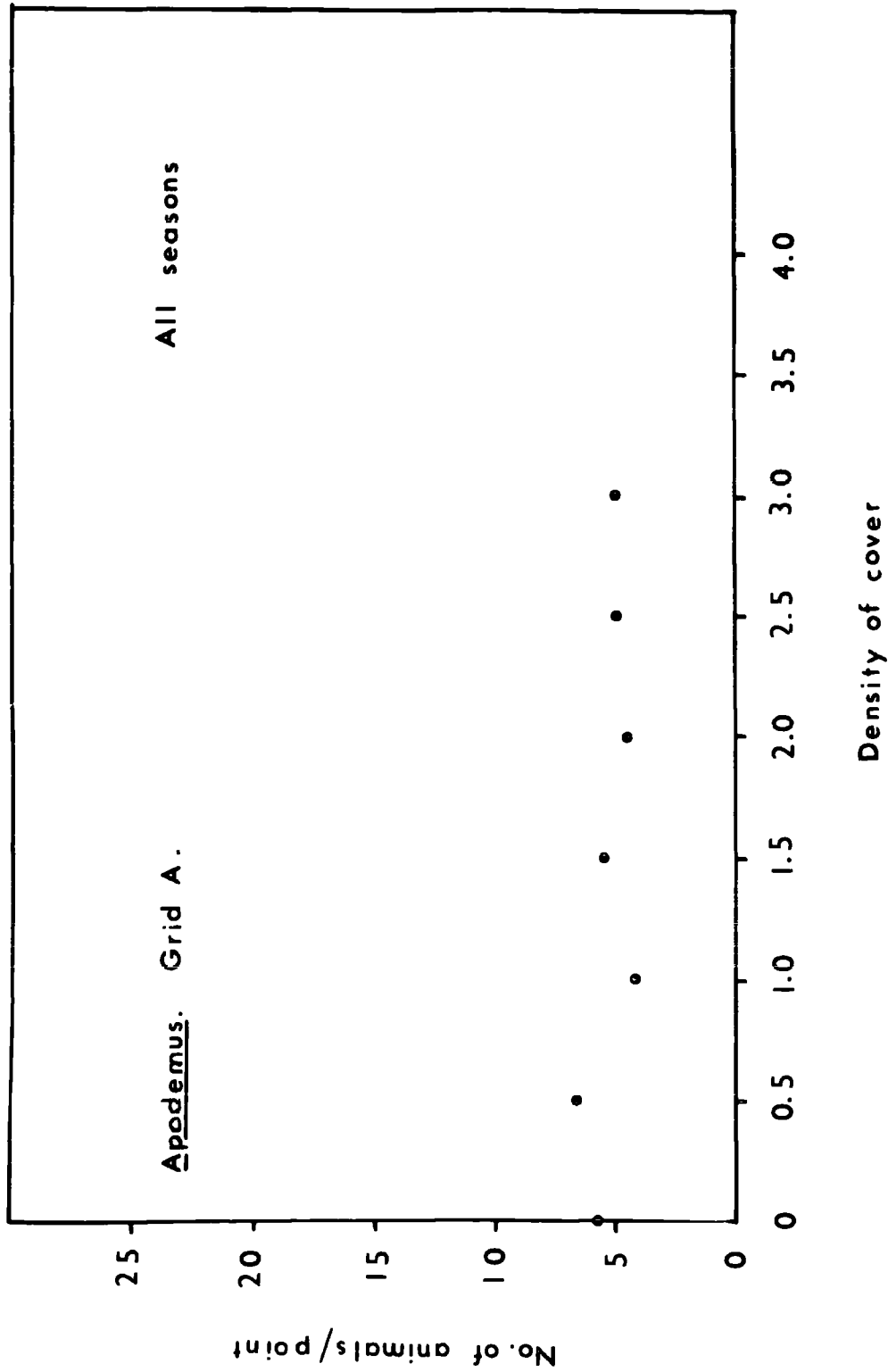

FIGURE 36. Graph showing the relationship between the mean number of Apodemus captured at points with different degrees of vegetation cover on grid A, and the actual density of the cover at the points. Data for all seasons are combined.

Apodemus, from the results noted above, appeared to be distributed at random with regard to cover. This conclusion is supported by the results presented earlier on distribution and vegetation type (pp. 145-155).

4. The utilisation of temporarily-available favourable habitats by Clethrionomys

a) Introduction

From the information presented earlier the close association between the distribution of Clethrionomys and the distribution of the vegetation has been established. It is of interest, therefore, to examine the changes in distribution which occur where the seasonal changes in the vegetation are most evident. On grid A the greatest changes occur where dogs mercury is the dominant plant in the field layer. The dogs mercury dies down between September and October, and is at its most dense from May to August, accordingly the distribution of animals in the winter period (October-April) was compared with that in the summer period (May-September) in order to see what proportion of animals were captured in the dogs mercury areas in the two periods. The two main cover types on grid A are:-

- 1) that dominated by dogs mercury, poor cover in winter,
- 2) that dominated by bracken and bramble, relatively good cover in winter.

On grid B the distinction is made between vegetation providing good cover in summer and poor in winter, and that providing good cover in summer and moderate in winter. In the first category dogs mercury is represented, but so are other plants e.g. hogweed, mixed herbs; bracken and bramble again dominate the second category.

b) Method of analysis

In the analysis, Cochran's (1954) modification of the χ^2 test was used in preference to the more normal χ^2 test for significance. Cochran's method enables all the data for each species, sex, and grid to be tested at once with a system of weighting to compensate for variations in the numbers of individuals in each group. The data were arranged as in Table 55. Column 'd' represents the difference in each case between the proportion of individuals in a 'dogs mercury' area when the cover is well established, in summer, and the proportion in the same area during the winter. Thus in the first row:-

$$d = \frac{135}{135 + 171} - \frac{29}{29 + 117}$$

The weight 'w' is obtained by dividing the product of the two sample sizes by their sum e.g.

$$w = \frac{(135 + 171) (29 + 117)}{135 + 171 + 29 + 117}$$

	Grid	Summer		Winter		d	w	wd	w $\hat{p}\hat{q}$
		DM	OC	DM	OC				
<u>Cleth-</u> <u>rionomys</u>	A	135	171	29	117	+0.242	+98.84	23.92	22.85
	B	181	203	92	134	+0.64	+142.27	9.10	35.17

Table 55. The arrangement of data for analysis by Cochran's χ^2 test.

DM = dogs mercury. OC = other cover.

In the next column, 'wd', the weighted contribution of each row to the test criterion, is the product of the two previous quantities. Finally, w $\hat{p}\hat{q}$, is the weighted contribution of each row to the variance of this criterion. The symbol \hat{p} . represents the marginal proportion of animals present in the dogs mercury areas over the whole period of study.

$$\text{e.g. } \hat{p} = \frac{135 + 29}{135 + 171 + 29 + 117}$$

The marginal proportion in the other area is represented by \hat{q} , which is $1 - \hat{p}$. From 'wd' and 'w $\hat{p}\hat{q}$ ' may be calculated 'u', the deviate from the normal distribution:-

$$u = \frac{wd}{\sqrt{w\hat{p}\hat{q}}}$$

It is necessary to make a null hypothesis (H_0) in order to apply such a test, and also an alternative hypothesis (H_1) to explain the result if H_0 can be disproved. In determining 'd' it must be decided in advance in which order the two proportions are

to be treated in order that they are arranged so that positive values of 'd' would tend to support H_1 .

c) Results

Null Hypothesis

"That the proportion of the total number of individuals on the whole grid that was in the dogs mercury cover was the same in winter and summer.

$$\text{i.e. } \frac{(\text{in dogs mercury})}{(\text{whole grid}) \text{ summer}} = \frac{(\text{in dogs mercury})}{(\text{whole grid}) \text{ winter}}$$

i. Clethrionomys. Grid A

$$u = \frac{wd}{\sqrt{wpq}} = P < 0.001$$

ii. Clethrionomys. Grid B

$$u = 1.535 \quad P < 0.01$$

For Clethrionomys on both grid A and grid B the proportion of animals captured in the dogs mercury areas was lower in the winter than it was in the summer, therefore the Null Hypothesis is disproved.

5. Discussion

Evans (1942) found the distribution of Apodemus and Clethrionomys in mixed woodland not to be at random. He observed that the highest numbers of Apodemus were captured in areas of spruce, larch, and cedar. In this study also the majority of the Apodemus were trapped in larch and spruce areas. Evans further found the distribution of Clethrionomys to be positively associated with that of bracken, with a noticeable tendency for a further association with the relative density of the bracken. The observations of Evans have been confirmed and expanded in the present investigation. Brown (1954) found Apodemus and Clethrionomys to be co-dominant in a mixed woodland of predominantly beech trees. She also noticed, as did Evans (1942), an association between the distribution of the rodents and the presence of undergrowth. Delany (1957) carried out studies on Clethrionomys and Apodemus in a Dunbartonshire oakwood and found that many more captures of mice and voles were made in areas with cover of rhododendrons and bramble than were made in areas with less dense cover. He emphasised, however, that there was no indication of either species displaying a predilection for a particular habitat to the exclusion or significant reduction in numbers of the other species. Southern (1954) in a study of the prey of the Tawny owl (Strix aluco) found there to be a regular seasonal swing between the taking of small rodents

(mainly Clethrionomys and Apodemus) and that of larger prey (moles and rabbits). The small rodents were taken in winter and spring, Southern (1954) related the seasonal swing to the growth of dense vegetation from May onwards thus making the mice and voles more difficult to catch. The role of vegetation in providing protective cover is well demonstrated here. Morris (1955) also emphasised the importance of protective cover in the ecology of Clethrionomys gapperi (the red-backed vole). He noted the dependence of the voles upon cover, particularly that provided by debris such as fallen trees, decaying logs, and slash from cutting and thinning. He noted also that where the forest floor was covered only by bare needle litter there were few captures made of voles, and he found that the cover provided by tall bracken was not so effective as debris in encouraging small mammal populations. Morris considered the protective function of the cover to be probably more important than its role as a food supply, basing his argument on the omnivorous nature of the diet of rodents. Getz (1961) found the nature of the vegetation cover to be the most important factor influencing the local distribution of Synaptomys cooperi (the bog lemming) and Microtus pennsylvanicus.

Newson (1960) examined the distribution of Clethrionomys and Apodemus in relation to vegetation type and the density of cover provided. He found, when he considered areas of 'thick' cover and 'thin' cover, there to be a positive correlation

between the distribution of Clethrionomys and the density of the ground cover. He found the distribution of Apodemus to be at random with respect to cover. The results of Newson's study are confirmed and expanded in the present work. Delany (1961) considered Apodemus to positively prefer habitats with a firm dry substrate and little ground cover, associating this preference with the ability of Apodemus to run quickly over clear areas whilst being slowed down by dense vegetation. Delany did note, however, that Apodemus required some cover for nesting and concealment, but thought that such cover could be provided by logs or tree roots. In the present study also, an indication of a positive association of Apodemus with open areas was noted.

The studies of Fullager et al (1963) on Clethrionomys glareolus skomerensis (the Skomer vole) and Apodemus sylvaticus are of interest, because the area in which the studies were carried out forms a useful contrast with the mixed woodland habitats examined by other workers (Evans, 1942; Brown, 1954; Newson 1960; Delany, 1961) and by the present writer. Fullager et al (1963) found the bank vole to favour areas with some scrub cover, whilst the field mouse could roam over more open country. They found there to be a much more clear cut difference in the distributions of Clethrionomys and Apodemus than had been found in mixed woodland prior to the study of Newson (1960). They found, in fact, that a single species may

be dominant in a particular habitat in areas where extremes of habitat exist e.g. dense bracken and bare rock. They found a close association between bank voles and bracken (as did Evans, 1942) except where a low ground cover of wet grass deterred the voles. It was noted also that areas of high vole density were shunned by the mouse, and they hence put forward the view that abundant voles excluded the mice. Brown (1954) found also that high numbers of Microtus agrestis may restrict the range of Apodemus. Fullager et al (1963) divided the available habitats on Skomer into three main types:-

- 1) Deep bracken in dry, sheltered areas,
- 2) scattered bracken with an understory of grass,
- 3) cliff slopes with rocky outcrops,

and they found that voles were exclusively dominant in habitat 1), both species existed in habitat 2), and mice only were found in habitat 3). They concluded that voles were unable to exploit completely bare areas, while mice could live in dense bracken but avoided it where possible.

From the information so far presented the dependence of voles upon the presence of adequate vegetation cover has been clearly demonstrated. Also the preference of mice for more open areas has been established. In the remainder of this discussion some of the possible reasons for such dependence upon the cover available are considered.

In ecological studies on Peromyscus leucopus noveboracensis

and Peromyscus maniculatus gracilis Klein (1960) found that the actual amount of ground cover did not influence the distribution of either species. A factor which was considered to have importance, however, was the amount of illumination reaching the forest floor at night when the animals are active. Blair (1943) found the desert-dwelling mouse Peromyscus maniculatus blandus to be most active in total darkness, while Mossman (1955) found there to be a significant correlation between the abundance of Microtus, Sorex, Blarina, Peromyscus and Mustela and the degree of light penetration through the herbaceous vegetation. As Apodemus is a nocturnal animal, as are several species of Peromyscus it could well be that the amount of light reaching the woodland floor at night plays an important part in the distribution of the animals. It has been observed in many small mammal studies that Apodemus is less active on moonlit nights (Hacker & Pearson, 1944; Tanton, 1965) so the light factor may well be important. In the present study the Apodemus on grid A were more commonly found in the larch wood than in the sycamore wood. In the autumn and winter there is no tree canopy in the sycamore wood and the area is bright, whereas in the larch wood many of the larch needles are retained, the trees grow closely together, and much of the light is excluded. Hence the preference of Apodemus for the dark, open areas of the larch wood may be a combination of their preference for open areas for free movement, and a

necessity for a cloaking darkness for protection. The point about freedom of movement for mice (Peromyscus maniculatus) in areas with sparse vegetation was made by Rickard (1957).

Clethrionomys is primarily a diurnal animal and hence it is probable that the protective nature of the ground cover is very important to it. As a group voles seem to frequent the areas with the most ground cover (cf. Microtus montanus; Ogilvie & Furman, 1959) and Microtus pennsylvanicus, (Eadie, 1933; Mossman 1955; Pearson 1959).

In conclusion the following factors are considered to influence the distribution of Clethrionomys:-

- 1) the nature of the ground vegetation,
- 2) the degree of protective cover provided by the vegetation,
- 3) the population size.

The distribution of Apodemus is considered to be influenced more by such factors as the necessity for free rapid movement, and the nature of the tree canopy with regard to the exclusion of moonlight and starlight.

SECTION D

MOVEMENTS AND HOME RANGE OF
CLETHRIONOMYS AND APODEMUS

SECTION D. MOVEMENTS AND HOME RANGE OF

CLETHRIONOMYS AND APODEMUS

(A.) GENERAL INTRODUCTION

1. The aims of the study

Although many investigations into the population dynamics, the feeding, and other aspects of the ecology of Apodemus sylvaticus and Clethrionomys glareolus have been carried out in Great Britain few of them have been concerned specifically with the subject of movements and home range. Evans (1942) made some observations on the movements of both species, and Hacker and Pearson (1951, 1952) discussed homing and wandering behaviour in Apodemus, but previous to the start of the present study only Brown (1956a) for both species, and Miller (1958) for Apodemus had dealt with the subject in much detail. Since the present work commenced, publications by Kikkawa (1964) on Clethrionomys and Apodemus, and Tanton (1965) on Apodemus, have added to the knowledge of the movements and home range of the two species.

The part of the present study concerned with movements and home range in Clethrionomys and Apodemus was designed to gain information on the following topics:-

- 1) seasonal variation in activity,
- 2) the characteristic movement patterns of the two species,

- 3) the size of the home range area,
- 4) inter and intra-specific differences in movement patterns,
- 5) the influence of sex, number of recaptures and method of estimation on estimates of home range size.

2. The procedure followed in the examination of movements and home range

The method of examining home range was designed to exclude as far as possible the complicating factor of trap-limitation of movement. The method used was to consider all the recaptures made of each animal, even though these recaptures were made in different trapping periods. In this way, and by the employment of short regular trapping periods, it was hoped that the animals would be sampled in all parts of their home range area as they could move about completely unrestricted by traps between trapping periods. Because of this method of examining home range, with animals being captured in more than one season of the year, it was not possible to examine seasonal activity by comparison of the size of home ranges in different seasons, and hence seasonal activity was studied by the analysis of linear movements (see pp. 174-214). Thus, of the topics listed above (p. 172-173). seasonal variation in activity, characteristic movement

patterns, and inter and intra-specific differences in movement patterns were examined by use of the linear measurement of movements.

(B.) MOVEMENTS

I. INTRODUCTION

As was pointed out by Brown (1956a) the linear measure of movements made by an animal is in many ways superior to the calculation of estimates of home range size when information on daily activity, and possible seasonal variation in such activity is required (see below). Two methods of measuring the movements made are in current usage, these are the measurement of:-

- 1) the distance between successive captures,
- 2) the distance from the point of original capture.

In this study the first measurement was recorded. Other workers who have used one or other of the two methods include Murie and Murie (1931); Chitty (1937); Linsdale (1946); McDougal (1946); Aldous (1947); Fitch (1947); Jordan (1948); Young et al (1950); Brown (1956a); Brant (1962); and Kikkawa (1964).

One of the main advantages in using such measurements of movement is that data from animals recaptured only a few times may be used. This is important, because proportionately few

animals in a population are captured more than once. In the present study, of 733 Clethrionomys 170 were caught once only, and of the remaining 563, only 411 were captured more than three times, 244 more than five times, 149 more than seven times and 72 more than ten times.

Of the aims listed in the General Introduction to this Section (p. 172) it was considered that seasonal variation in activity, and inter and intra-specific differences in movement patterns, could best be examined by analysis of the movements measured in the way described above (p. 174). The maximum movement made by every animal captured during certain specified periods was recorded, and from analysis of such records for both sexes of both species information was obtained on seasonal activity. Another measurement used in this investigation was the Maximum Range Length. This is a measure of the distance between the two most distant points of capture and may be used as an index of the diameter of the home range area (see pp. 225-226). Some information was also collected, from examination of the movement patterns of each animal, on the restriction of movements, wandering and dispersal, and change in areas of activity displayed by the two species.

II. THE NUMBER OF ANIMALS USED IN THE
STUDY OF MOVEMENTS (Table 56)

In the course of the study as a whole 427 male Clethrionomys were marked and released, of which 226 were used in the analysis of movements. All of the 226 animals used had been captured at least three times. Of these, 149 had been captured at least five times, 87 at least seven times, and 39 ten or more times. Of the 306 females handled during the two years, 160 were of use in the analysis of movements, having a minimum of three captures each. Of these, 95 had five or more captures, 62 had seven or more captures, and 33 had at least ten captures. The maximum number of recaptures recorded for a male was 28, and for a female 29.

Of the 212 male Apodemus captured, 108 were suitable for use in the study of movements. Of these, 61 had five or more captures, 31 had seven or more captures, and 9 had been captured at least ten times. 77 female Apodemus, out of a total number of 128 handled, were used in the analysis of movements. Of these, 39 had five or more captures, 24 had seven or more captures, and 12 had been caught at least ten times. The maximum number of recaptures recorded for a male was 14, and for a female 16.

Species and sex	Total No. Individuals	No. ct. once	No. ct. 3+	No. ct. 5+	No. ct. 7+	No. ct. 10+
<u>Clethrionomys</u> Males	427	100	251	149	87	39
<u>Clethrionomys</u> Females	306	70	160	95	62	33
<u>Apodemus</u> Males	212	66	108	61	31	9
<u>Apodemus</u> Females	128	33	77	39	24	12

Table 56 The number of animals out of the total caught which were caught three or more times (3+), five or more times (5+), seven or more times (7+), or ten or more times (10+).

III. MAXIMUM MOVEMENTS

1. Introduction

The maximum movement made in each season in which it was captured was recorded for every animal handled in the course of the study. Frequency distributions of the maximum movements made in each season were then constructed. The seasons were arbitrarily assigned and were made up as shown in Table 56a.

Season	Months in the season
1. Spring	February, March, April, May.
2. Summer	June, July, August, September.
3. Autumn-winter	October, November, December, January.

Table 56a. The 'seasons' for the analysis of maximum movements.

Thirteen categories of movements were designed, with class intervals of 15 metres. The maximum possible movement on each grid was 180 metres, and hence the categories ranged from less than 15 metres up to 180 metres or more. The final movement category of 180 metres or more allowed for the inclusion of movements made by animals which left one grid and were caught on the other grid, or on trap-lines. The maximum movements of an individual were sometimes recorded in three or more seasons.

The data on maximum movements were organised in the form of 2 x 2 Contingency Tables and in order to see if there were any

differences between the different distributions, Chi-squared Tests for significance were performed using Yates' Correction Factor to correct for small sample sizes. The frequency distributions of maximum movements in the different seasons were tested for significant differences in the proportion of movements made of above and below 30 metres. This distance was chosen as the level for the division of the distribution as it had been noticed in the field that most animals seemed to be caught at a few closely adjoining trap sites. The distance between alternate trap sites is approximately 30 metres so this distance was selected as being the most useful for the analysis of possible seasonal differences in movement. Division of the distributions at this level was subsequently found also to result in sample sizes for comparison being roughly equivalent.

2. Seasonal variation in the frequency distributions of maximum movements made by both sexes of *Clethrionomys* and *Apodemus*.

a) *Clethrionomys* males (Table 57, Fig. 37)

The bulk of the maximum movements recorded for *Clethrionomys* males occur in the three movement categories below 45 metres in all seasons of the year.

Statistically significant differences in the proportion of maximum movements made of more than 30 metres were found between the distributions of movements in spring 1963 and

Distance moved metres	1963		1963		1963-64		1964		1964-65			
	Feb.-May	Jun.-Sep.	Feb.-May	Jun.-Sep.	Oct-Jan.	Feb.-May	Jun.-Sep.	Oct.-Jan.	No.	%		
15 : 16.5	11	27.5	22	22.5	42	35.3	14	25.0	24	25.2	62	40.5
16-30 : 17.5-33	9	22.5	22	22.5	41	34.5	15	26.8	32	32.1	38	24.8
31-45 : 34-49.5	6	15.0	17	17.3	15	12.6	11	19.6	11	11.1	23	15.0
46-60 : 50.5-66	2	5.0	11	11.3	1	0.9	6	10.6	6	6.1	12	7.8
61-75 : 67-82.5	2	5.0	8	8.2	3	2.5	2	3.6	6	6.1	6	4.0
76-90 : 83.5-99	0	0	3	3.1	7	5.9	4	7.2	3	3.1	3	2.0
91-105 : 100-115.5	1	2.5	2	2.0	0	0	0	0	1	1	1	0.65
106-120 : 116.5-132	2	5.0	2	2.0	1	0.9	2	3.6	4	4.1	2	1.3
121-135 : 133-148.5	0	0	1	1.0	5	4.2	0	0	5	5.1	1	0.65
136-150 : 149.5-165	1	2.5	2	2.0	1	0.9	0	0	0	0	0	0
151-165 : 166-181.5	1	2.5	1	1.0	0	0	1	1.8	0	0	0	0
166-180 : 182.5-198	0	0	0	0	0	0	0	0	1	1.0	0	0
180 : 198	5	12.5	7	7.1	3	2.5	1	1.8	6	6.1	5	3.3
TOTALS	40	100	98	100	119	100	56	100	99	100	153	100

Table 57. Movements of Clethrionomys males as shown by the greatest distance between any two successive capture points within the periods indicated. The number in each category is given also as a percentage of the total number of movements recorded for that season.

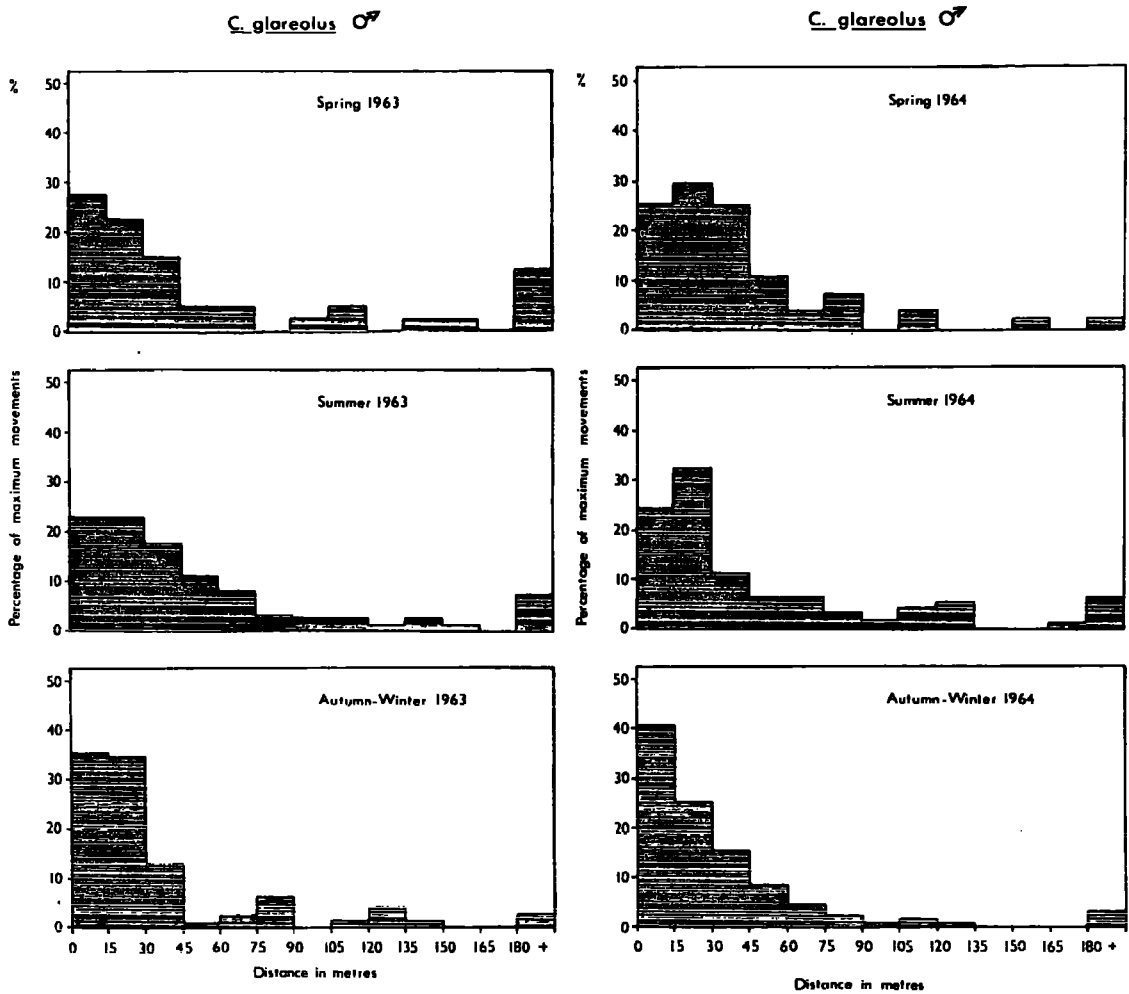

FIGURE 37. The frequency distributions of maximum movements of Clethrionomys males in spring, summer, and autumn-winter of 1963 and 1964.

autumn-winter 1963, ($P < 0.01$). A similar level of significant difference was found between the proportion of movements greater than 30 metres made in summer 1963 and autumn-winter 1963, a greater proportion of larger movements being made in the summer ($P < 0.01$), than in the autumn-winter. The differences between the movement distributions of the seasons in 1964 were not sufficiently great to be statistically significant, but again, as in 1963, proportionally more movements of over 30 metres were made in the spring and summer, than in the autumn-winter. In 1963 movements of more than 30 metres were recorded far more frequently during the breeding season (spring and summer) than during the non-breeding season (autumn-winter). This was apparently so in 1964 also but the tendency was less marked and was not statistically significant.

b) Clethrionomys females (Table 58, Fig. 38)

Seasonal differences in the frequency distributions of maximum movements were found in Clethrionomys females as well as in the males. The greater proportion of movements of over 30 metres in spring 1963 compared with autumn-winter 1963, was highly significant ($P < 0.001$). The same was true of the difference between the distributions of movements in spring 1964 and autumn-winter 1964 ($P < 0.001$). The difference between the maximum movement distributions of summer 1963, and of autumn-winter 1963 was not statistically significant but

Distance moved metres	1963		1963		1963-64		1964		1964		1964-65	
	Feb.-May	Jun.-Sep.	Jun.-Sep.	Oct.-Jan.	Feb.-May	Jun.-Sep.	Jun.-Sep.	Oct.-Jan.	Jun.-Sep.	Oct.-Jan.	No.	%
yards	No.	%	No.	%	No.	%	No.	%	No.	%	No.	%
15 : 16.5	9	37.5	34	43.0	37	41.2	7	18.9	18	28.1	35	37.2
16-30 : 17.5-33	4	16.7	24	30.4	33	36.7	10	27.0	24	37.5	43	45.7
31-45 : 34-49.5	4	16.7	8	10.1	7	7.8	7	18.9	7	10.9	7	7.4
46-60 : 50.5-66	0	0	4	5.0	3	3.3	3	8.1	7	10.9	3	3.2
61-75 : 67-82.5	1	4.2	1	1.3	3	3.3	4	10.8	1	1.6	1	1.1
76-90 : 83.5-99	1	4.2	1	1.3	1	1.1	2	5.4	5	7.8	2	2.1
91-105 : 100-115.5	0	0	1	1.3	0	0	0	0	1	1.6	0	0
106-120 : 116.5-132	0	0	0	0	0	0	0	0	0	0	0	0
121-135 : 133-148.5	0	0	0	0	0	0	0	0	0	0	1	1.1
136-150 : 149.5-165	0	0	0	0	1	1.1	1	2.8	0	0	0	0
151-165 : 166-181.5	0	0	0	0	1	1.1	0	0	0	0	0	0
166-180 : 182.5-198	0	0	0	0	0	0	0	0	0	0	0	0
180 : 198	5	20.7	6	7.6	4	4.4	3	8.1	1	1.6	2	2.1
TOTALS	24	100	79	100	90	100	37	100	64	100	94	100

Table 58. Movements of Clethrionomys females as shown by the greatest distance between any two successive capture points within the periods indicated. The number in each category is given also as a percentage of the total number of movements recorded for that season.

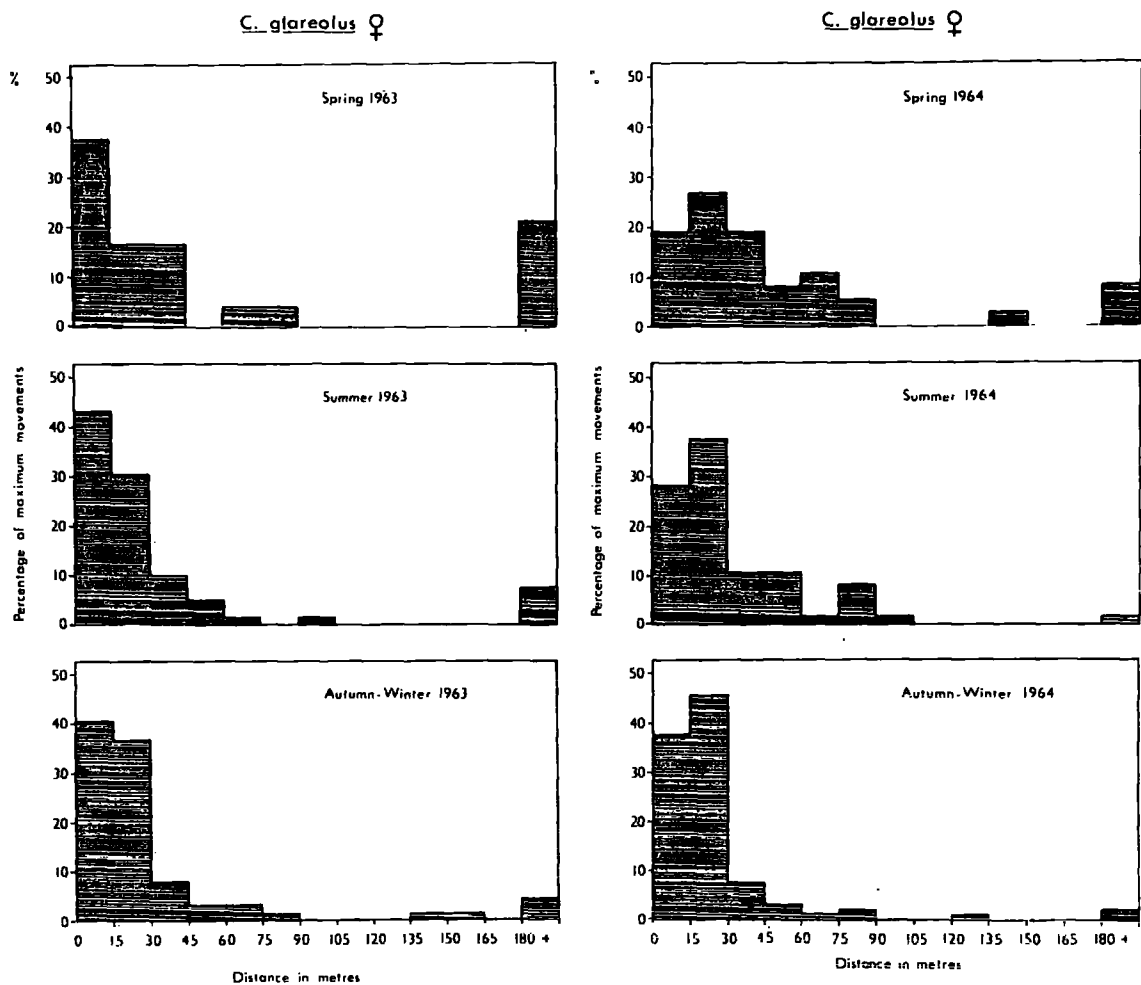

FIGURE 38. The frequency distributions of maximum movements of *Clethrionomys* females in spring, summer, and autumn-winter of 1963 and 1964.

movements of over 30 metres were significantly more common in summer 1964 than in autumn-winter 1964, ($P < 0.01$). In contrast to the situation in the males, differences between the movement distributions of spring and summer were detectable in both years. In spring 1963 the proportion of movements made of over 30 metres was significantly greater than in summer 1963 ($P < 0.01$). In 1964 the difference between the spring and summer distributions was less marked but was still significant ($P < 0.02$).

c) Apodemus males (Table 59, Fig. 39)

For Apodemus males in 1963 no statistically significant differences were found to exist between the seasons with regard to the frequency distribution of movements of above and below 30 metres, but there was a greater proportion of movements made of over 180 metres in the spring than in the other seasons. In 1964 differences between the seasonal distributions of movements were significant, the proportion of movements made of over 30 metres being greater in spring 1964 than in autumn-winter 1964 ($P < 0.01$). Similarly, more movements were of greater length than 30 metres in summer than in autumn-winter ($P < 0.001$). Of lesser significance ($P < 0.05$) was the proportionately greater number of movements of more than 30 metres made in spring 1964 compared with summer 1964.

Significant differences were found to exist between the

Distance moved metres	1963		1963		1963-64		1964		1964-65	
	Feb.-May	Jun.-Sep.	Feb.-May	Jun.-Sep.	Oct.-Jan.	Feb.-May	Jun.-Sep.	Oct.-Jan.	No.	%
15 : 16.5	10	8	17	8	17	17	5	5	31	38.3
16-30 : 17.5-33	2	1	11	1	11	10	1	1	19	23.4
31-45 : 34-49.5	1	2	4	2	4	8	4	4	12	14.8
46-60 : 50.5-66	1	0	3	0	3	7	2	2	7	8.6
61-75 : 67-82.5	1	2	1	2	1	5	2	2	5	6.2
76-90 : 83.5-99	0	0	1	0	1	7	0	0	1	1.2
91-105 : 100-115.5	1	1	1	1	1	1	1	1	0	0
106-120 : 116.5-132	0	0	0	0	0	2	1	1	2	2.5
121-135 : 133-148.5	0	0	0	0	0	2	2	2	0	0
136-150 : 149.5-165	0	0	1	0	1	1	1	1	0	0
151-165 : 166-181.5	0	0	0	0	0	1	1	1	0	0
166-180 : 182.5-198	0	0	0	0	0	0	0	0	0	0
180 : 198	3	0	1	0	1	6	2	2	4	5.0
TOTALS	19	14	40	14	40	67	22	22	81	100

Table 59. Movements of Apodemus males as shown by the greatest distance between any two successive capture points within the periods indicated. The total number of movements recorded for each period is given and the number of animals in each movement category is given as a percentage of that total.

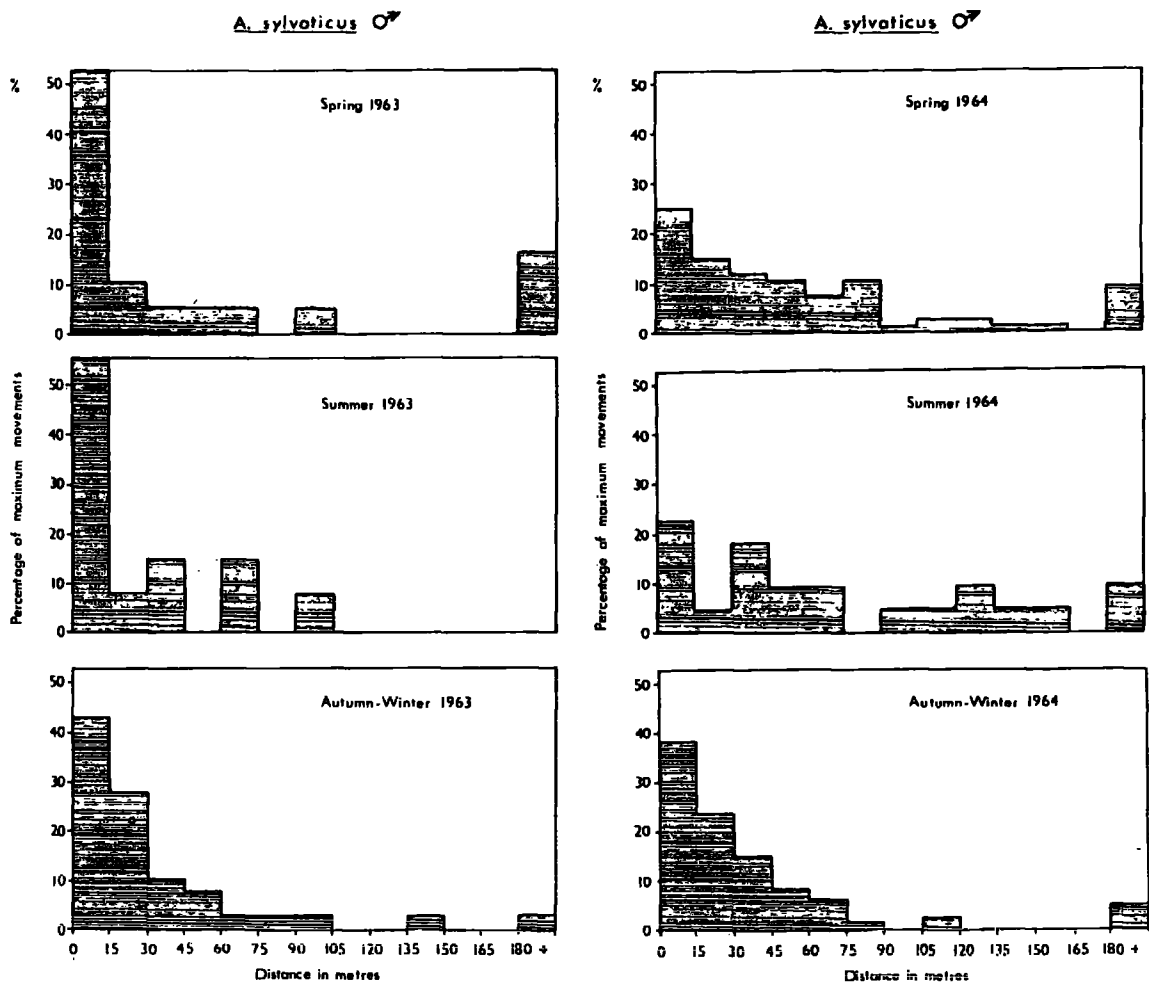

FIGURE 39. The frequency distributions of maximum movements of *Apodemus* males in spring, summer, and autumn-winter of 1963 and 1964.

frequency distributions of movements in the same seasons in the two years. A significantly greater proportion of movements of over 30 metres was made in spring 1964 than in spring 1963 ($P < 0.01$). Similar differences were found between the distributions of summer 1964 and summer 1963 ($P < 0.001$).

d) Apodemus females (Table 60, Fig. 40).

No significant differences were found between the seasonal movement distributions in Apodemus males in 1963 (see above), but a difference between the movement distributions of summer and autumn-winter 1963 was detected in Apodemus females. A significantly greater proportion of movements of over 30 metres was made in summer 1963 than in autumn-winter 1963 ($P < 0.01$). The main difference between the summer and autumn-winter distributions of movements was in the large percentage of movements in the 31-45 metre category in the summer. No movements of more than 45 metres were recorded in autumn-winter. It would seem, therefore, that to conclude that Apodemus females tend to move greater distances in summer than in autumn-winter would be of doubtful validity, if based only on the 1963 results. In 1964 some difference was found between the proportion of movements greater than 30 metres made in summer and in autumn-winter, there being a significantly greater proportion made in the summer ($P < 0.02$). In 1964 four categories of movement above 30 metres were represented in the frequency distribution of summer.

Distance moved metres	1963		1963		1963-64		1964		1964		1964-65	
	No.	%	No.	%	No.	%	No.	%	No.	%	No.	%
15 : 16.5	4	36.4	3	50.0	9	34.6	13	25.0	2	9.1	16	41.0
16-30 : 17.5-33	3	27.2	0	0	10	38.5	14	26.9	8	36.4	9	23.1
31-45 : 34-49.5	0	0	3	50.0	2	7.7	13	25.0	6	27.3	11	28.2
46-60 : 50.5-66	1	9.1	-	-	1	3.85	5	9.6	4	18.2	2	5.1
61-75 : 67-82.5	1	9.1	-	-	3	11.5	4	7.8	-	-	1	2.6
76-90 : 83.5-99	-	-	-	-	-	-	1	1.9	-	-	-	-
91-105 : 100-115.5	1	9.1	-	-	-	-	-	-	1	4.5	-	-
106-120 : 116.5-132	-	-	-	-	1	3.85	1	1.9	-	-	-	-
121-135 : 133-148.5	-	-	-	-	-	-	1	1.9	-	-	-	-
136-150 : 149.5-165	-	-	-	-	-	-	-	-	-	-	-	-
151-165 : 166-181.5	-	-	-	-	-	-	-	-	-	-	-	-
166-180 : 182.5-198	-	-	-	-	-	-	-	-	-	-	-	-
180 : 198	1	9.1	-	-	-	-	-	-	1	4.5	-	-
TOTALS	11	100	6	100	26	100	52	100	22	100	39	100

Table 60. Movements of Apodemus females as shown by the greatest distance between any two successive capture points within the periods indicated. The number in each category is given also as a percentage of the total number of movements recorded for that season.

- = No captures.

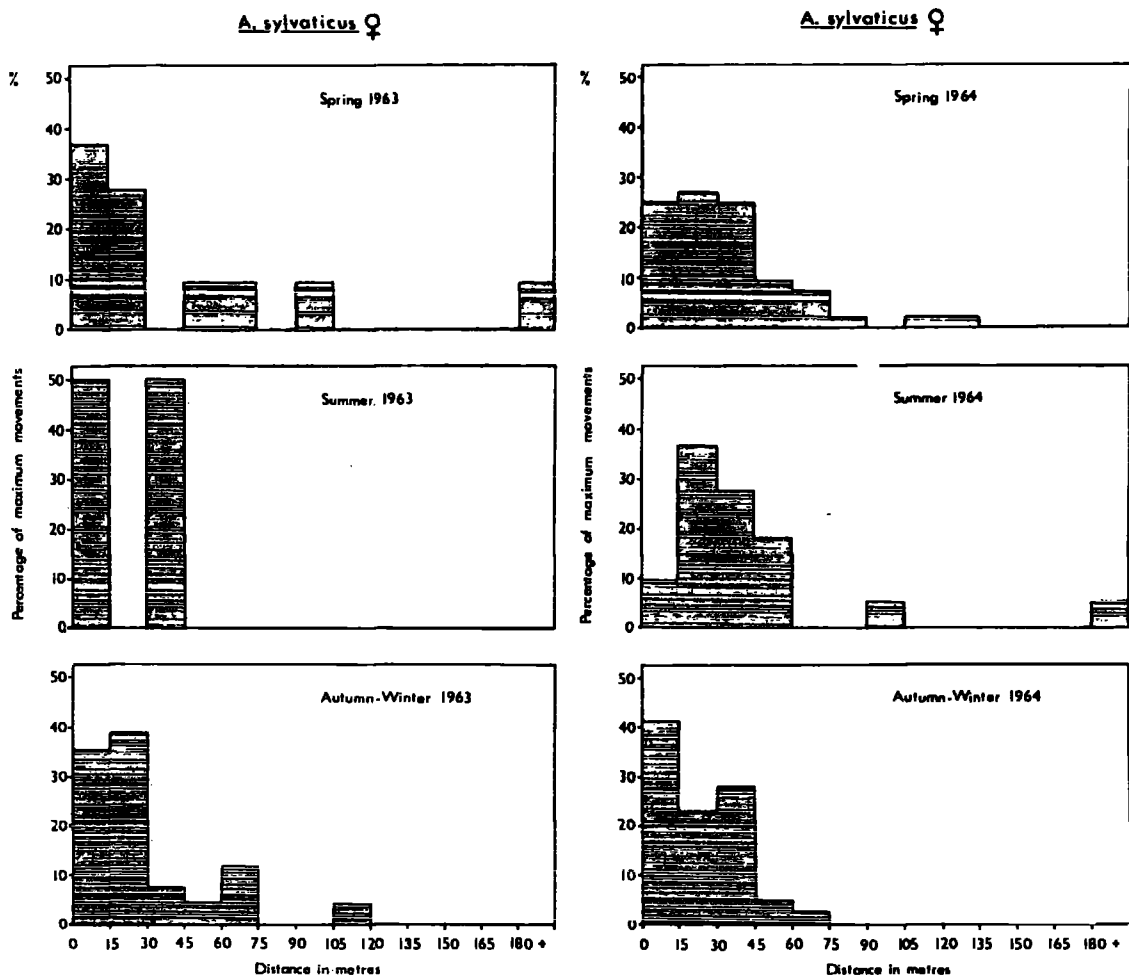

FIGURE 40. The frequency distributions of maximum movements of Apodemus females in spring, summer, and autumn-winter of 1963 and 1964.

2. A comparison of the frequency distributions of maximum movements of Clethrionomys and Apodemus

a) Males

The differences between the frequency distributions of maximum movements of Clethrionomys males and Apodemus males were statistically significant in summer only. In summer 1963 a significantly greater proportion of movements of more than 30 metres was made by Clethrionomys than by Apodemus ($P < 0.05$). In 1964 the situation was reversed and the greater proportion of large movements was made by Apodemus ($P < 0.001$). The difference in 1963 was just significant, in 1964 it was highly significant. Although not tested statistically, other differences appear to be present between the movement distributions of the two species. In 1963, in all seasons but particularly in spring and summer, a much greater proportion of movements of less than 15 metres was made by Apodemus than was the case with Clethrionomys. In both 1963 and 1964 more movements of over 180 metres were recorded for Apodemus males than for Clethrionomys males, in all seasons.

b) Females

Apodemus females had a significantly greater proportion of movements of more than 30 metres than Clethrionomys females in the seasons of summer 1963 ($P < 0.001$), summer 1964 ($P < 0.001$),

and autumn-winter 1964 ($P < 0.001$). Another difference between the movements of the two species was that Clethrionomys females had recorded movements of more than 180 metres in all seasons of both years, whereas in Apodemus this was the case only in spring 1963 and summer 1964.

3. Sexual differences in the frequency distributions of maximum movements.

a) Clethrionomys

With division of the frequency distributions of maximum movements at the 30 metre level significant differences were detected between the movement distributions of the two sexes in summer 1963 and autumn-winter 1964. In both seasons the males had a greater proportion of movements of more than 30 metres than the females, in summer 1963 at the $P < 0.001$ level of significance, and in autumn-winter 1964 at the $P < 0.01$ level of significance. Although differences between the movement distributions of the two species were detected only in summer 1963 and autumn-winter 1964, this was because division of the distributions at the 30 metre level did not reveal other salient differences between the distributions. When movements above and below 90 metres were considered the movements of the males were found to be of more than 90 metres significantly more often than were the movements of the females in summer 1964 ($P < 0.01$). Division at the 15 metre level revealed that the male

distributions in spring 1963 and summer 1963 had proportionately more movements of over 15 metres than did the females, (spring 1963 ($P < 0.05$) summer 1963 ($P < 0.01$)). Similarly when movements below 45 metres, and between 46 and 150 metres were considered, the males had greater proportions of the larger movements than did the females in spring 1963 ($P < 0.05$) and in summer 1963 ($P < 0.001$). The main difference to be revealed between the movement distributions of the two sexes is that fewer categories of movements between 45 metres and 180 metres are represented in the female distributions as compared with the male distributions.

b) Apodemus

The frequency distributions of the maximum movements of Apodemus were tested for significant seasonal differences between the sexes using the procedure described for Clethrionomys. At the 30 metre level of division the males had a greater proportion of larger movements than did the females in summer 1964 ($P < 0.01$). At the 90 metre level of division the males again moved the greater distances proportionately more than did the females in spring 1964 ($P < 0.02$). When division of the movement distributions at the 15 metre level was tested, however, the females had a greater proportion of movements of more than 15 metres in spring 1963 ($P < 0.05$) and summer 1964 ($P < 0.02$). As with Clethrionomys, the main difference between the movement distributions of males and females was in the

in females.
comparative lack, of movements of moderate length i.e. between 45 metres and 150 metres. When the movement distributions were divided at the 45 metre and the 150 metre level, i.e. excluding movements above 150 metres, there were found to be significant differences between the movements of the sexes in summer 1963 ($P < 0.001$), spring 1964 ($P < 0.01$), summer 1964 ($P < 0.001$), and autumn-winter 1964 ($P < 0.05$). In all these seasons the males had a greater proportion of the medium-distance movements than did the females.

4. A comparison of the frequency distributions of maximum movements of both species on grid A and grid B (Tables 61-68)

Only in spring was there a statistically significant difference between the frequency distributions of maximum movements of Clethrionomys on the two grids. In the males movements of more than 30 metres were more common on grid B than on grid A in both 1963 ($P < 0.02$) and 1964 ($P < 0.01$). In the females a difference in the movements on the two grids was detectable only in spring 1963 when more movements of more than 30 metres were made on grid A than on grid B, the reversal of the situation in the males. The poor catches of Apodemus on grid B prevented a comparison of the maximum movement distributions of Apodemus on the two grids.

Distance moved		Feb.-May 1963		June- Sep. 1963		Oct. 1963-Jan. 1964	
metres	yards	Grid A	Grid B	Grid A	Grid B	Grid A	Grid B
15	: 16.5	5	6	12	10	22	20
16-30	: 17.5-33	3	6	11	11	23	18
31-45	: 34-49.5	1	5	3	14	6	9
46-60	: 50.5-66	0	2	6	5	1	0
61-75	: 67-82.5	1	1	4	4	2	1
76-90	: 83.5-99	0	0	2	1	5	2
91-105	: 100-115.5	0	1	1	1	0	0
106-120	: 116.5-132	0	2	1	1	0	1
121-135	: 133-148.5	0	0	1	0	2	3
136-150	: 149.5-165	0	1	0	2	0	1
151-165	: 166-181.5	1	0	1	0	0	0
166-180	: 182.5-198	0	0	0	0	0	0
180	: 198	2	3	5	2	1	2
TOTALS		13	27	47	51	62	57
		100	100	100	100	100	100

Table 61. Movements of *Clethrionomys* males (1963), as shown by the greatest distance between any two successive capture points within the periods indicated. Grid A and Grid B animals considered separately. The number in each category is given also as a percentage of the total number of movements recorded for that season.

Distance moved metres	yards	Feb.-May 1964		June-Sep. 1964		Oct. 1964-Jan. 1965							
		Grid A		Grid B		Grid A		Grid B					
		No.	%	No.	%	No.	%	No.	%				
15	: 16.5	9	22.5	5	31.25	10	22.7	14	25.5	45	46.4	17	30.3
16-30	: 17.5-33	9	22.5	6	37.5	12	27.0	20	36.4	19	19.6	19	33.9
31-45	: 34-49.5	7	17.5	4	25.0	6	13.5	5	9.1	15	15.5	8	14.3
46-60	: 50.5-66	5	12.5	1	6.25	2	4.5	4	7.3	5	5.1	7	12.5
61-75	: 67-82.5	2	5.0	0	0	3	6.9	3	5.5	4	4.1	2	3.6
76-90	: 83.5 - 99	4	10.0	0	0	1	2.3	2	3.6	3	3.1	0	0
91-105	: 100-115.5	0	0	0	0	1	2.3	0	0	0	0	1	1.8
106-120	: 116.5-132	2	5.0	0	0	2	4.6	2	3.6	2	2.1	0	0
121-135	: 133-148.5	0	0	0	0	3	6.9	2	3.6	0	0	1	1.8
136-150	: 149.5-165	0	0	0	0	0	0	0	0	0	0	0	0
151-165	: 166-181.5	1	2.5	0	0	0	0	0	0	0	0	0	0
166-180	: 182.5-198	0	0	0	0	0	0	1	1.8	0	0	0	0
180	: 198	1	2.5	0	0	4	9.3	2	3.6	4	4.1	1	1.8
TOTALS		40	100	16	100	44	100	55	100	97	100	56	100

Table 62 . Movements of Clethrionomys males (1964) as shown by the greatest distance between any two successive capture points within the periods indicated. Grid A and Grid B animals are considered separately. The number in each category is given also as a percentage of the total number of movements recorded for that season.

Distance moved metres	yards	Feb.-May 1963				June-Sep. 1963				Oct. 1963-Jan. 1964			
		Grid A		Grid B		Grid A		Grid B		Grid A		Grid B	
		No.	%	No.	%	No.	%	No.	%	No.	%	No.	%
15	: 16.5	3	30.0	6	42.8	24	57.1	10	27.0	24	43.6	13	37.1
16-30	: 17.5-33	1	10.0	3	21.4	10	23.8	14	37.8	18	32.8	15	42.9
31-45	: 34-49.5	1	10.0	3	21.4	3	7.1	5	13.6	5	9.1	2	5.7
46-60	: 50.5-66	0	0	0	0	3	7.1	1	2.7	2	3.6	1	2.9
61-75	: 67-82.5	1	10.0	0	0	0	0	1	2.7	3	5.5	0	0
76-90	: 83.5-99	1	10.0	0	0	0	0	1	2.7	0	0	1	2.9
91-105	: 100-115.5	0	0	0	0	0	0	1	2.7	0	0	0	0
106-120	: 116.5-132	0	0	0	0	0	0	0	0	0	0	0	0
121-135	: 133-148.5	0	0	0	0	0	0	0	0	0	0	0	0
136-150	: 149.5-165	0	0	0	0	0	0	0	0	1	1.8	0	0
151-165	: 166-181.5	0	0	0	0	0	0	0	0	1	1.8	0	0
166-180	: 182.5-198	0	0	0	0	0	0	0	0	0	0	0	0
180	: 198	3	30.0	2	14.4	2	4.9	4	10.8	1	1.8	3	8.5
TOTALS		10	100	14	100	42	100	37	100	55	100	35	100

Table 63 . Movements of Clethrionomys females (1963) as shown by the greatest distance between any two successive capture points within the periods indicated. Grid A and Grid B animals are considered separately. The number in each category is given also as a percentage of the total number of movements recorded for that season.

Distance moved metres	Feb.-May 1964		June-Sep. 1964		Oct. 1964-Jan. 1965	
	Grid A NO. %	Grid B NO. %	Grid A NO. %	Grid B NO. %	Grid A NO. %	Grid B NO. %
15 : 16.5	5 22.7	2 13.33	10 30.25	8 25.8	25 44.6	10 26.3
16-30 : 17.5-33	5 22.7	5 33.33	12 36.4	12 38.7	22 39.3	21 55.4
31-45 : 34-49.5	3 13.6	4 26.66	3 9.1	4 12.9	3 5.3	4 10.5
46-60 : 50.5-66	3 13.6	0 0	3 9.1	4 12.9	2 3.6	1 2.6
61-75 : 67-82.5	2 9.15	2 13.33	1 3.05	0 0	1 1.8	0 0
76-90 : 83.5-99	2 9.15	0 0	2 6.1	3 9.7	1 1.8	1 2.6
91-105 : 100-115.5	0 0	0 0	1 3.05	0 0	0 0	0 0
106-120 : 116.5-132	0 0	0 0	0 0	0 0	0 0	0 0
121-135 : 133-148.5	0 0	0 0	0 0	0 0	0 0	1 2.6
136-150 : 149.5-165	1 4.55	0 0	0 0	0 0	0 0	0 0
151-165 : 166-181.5	0 0	0 0	0 0	0 0	0 0	0 0
166-180 : 182.5-198	0 0	0 0	0 0	0 0	0 0	0 0
180 : 198	1 4.55	2 33.33	1 3.05	0 0	2 3.6	0 0
TOTALS	22 100	15 100	33 100	31 100	56 100	38 100

Table 64 . Movements of Clethrionomys females (1964) as shown by the greatest distance between any two successive capture points within the periods indicated. Grid A and Grid B animals are considered separately. The number in each category is given also as a percentage of the total number of movements recorded for that season.

5. A summary of the results of the analysis of maximum movements of Clethrionomys and Apodemus

From the analysis of the frequency distributions of maximum movements there is some evidence that seasonal variation in movements occurs. In both sexes of Clethrionomys movements of more than 30 metres were more common in spring and summer than in autumn-winter. This trend was particularly marked in the males and may possibly have been associated with activities of the breeding season, e.g. searching for mates, and dispersal. In the females, differences were found between the movements made in spring and summer, the females being more active in the spring. This could be due to the restriction of the females to the nest site in the summer when they are usually pregnant or suckling young. (Brown, 1956a, for Microtus agrestis). The greater activity of immature and juvenile females may have been the reason for the movement distributions in the summer having had a greater proportion of the longer movements than did the autumn-winter distributions.

The above differences apply also in the case of Apodemus. With Apodemus, however, it may be that the feeding behaviour changes in the spring and summer as insect material becomes available and hence activity may be increased in those seasons. So far as the movement records show there was little difference between the pattern of movements shown by Clethrionomys and Apodemus males. However, at the time when activity is

Distance moved metres	yards	Feb.-May 1963				June-Sep. 1963				Oct. 1963-Jan. 1964			
		GRID A		GRID B		GRID A		GRID B		GRID A		GRID B	
		No.	%	No.	%	No.	%	No.	%	No.	%	No.	%
15	: 16.5	8	47.0	2	100.0	5	62.5	3	50.0	14	42.4	3	42.8
16-30	: 17.5-33	2	11.8	0	0	0	0	1	16.66	9	27.25	2	28.6
31-45	: 34-49.5	1	5.9	0	0	1	12.5	1	16.66	3	9.0	1	14.3
46-60	: 50.5-66	1	5.9	0	0	0	0	0	0	2	6.1	1	14.3
61-75	: 67-82.5	1	5.9	0	0	1	12.5	1	16.66	1	3.05	0	0
76-90	: 83.5-99	0	0	0	0	0	0	0	0	1	3.05	0	0
91-105	: 100-115.5	1	5.9	0	0	1	12.5	0	0	1	3.05	0	0
106-120	: 116.5-132	0	0	0	0	0	0	0	0	0	0	0	0
121-135	: 133-148.5	0	0	0	0	0	0	0	0	0	0	0	0
136-150	: 149.5-165	0	0	0	0	0	0	0	0	1	3.05	0	0
151-165	: 166-181.5	0	0	0	0	0	0	0	0	0	0	0	0
166-180	: 182.5-198	0	0	0	0	0	0	0	0	0	0	0	0
180	: 198	3	17.6	0	0	0	0	0	0	1	3.05	0	0
TOTALS		17	100	2	100	8	100	6	100	33	100	7	100

Table 65. Movements of Apodemus males (1963) as shown by the greatest distance between any two successive capture points within the periods indicated. Grid A and Grid B animals are considered separately. The number in each category is given also as a percentage of the total number of movements recorded for that season.

Distance moved metres	Feb.-May 1964				June-Sep. 1964				Oct. 1964-Jan. 1965			
	GRID A		GRID B		GRID A		GRID B		GRID A		GRID B	
	No.	%	No.	%	No.	%	No.	%	No.	%	No.	%
15 : 16.5	16	26.66	1	14.3	1	7.7	4	44.5	23	35.9	8	47.0
16-30 : 17.5-33	8	13.33	2	28.6	1	7.7	0	0	16	25.0	3	17.6
31-45 : 34-49.5	8	13.33	0	0	2	15.35	2	22.5	11	17.2	1	5.9
46-60 : 50.5-66	6	10.0	1	14.3	1	7.7	1	11.0	5	7.8	2	11.8
61-75 : 67-82.5	5	8.33	0	0	1	7.7	1	11.0	4	6.2	1	5.9
76-90 : 83.5-99	6	10.0	1	14.3	0	0	0	0	1	1.6	0	0
91-105 : 100-115.5	1	1.7	0	0	0	0	0	0	0	0	0	0
106-120 : 116.5-132	2	3.4	0	0	1	7.7	0	0	1	1.6	1	5.9
121-135 : 133-148.5	2	3.4	0	0	2	15.4	0	0	0	0	0	0
136-150 : 149.5-165	1	1.7	0	0	1	7.7	0	0	0	0	0	0
151-165 : 166-181.5	1	1.7	0	0	1	7.7	0	0	0	0	0	0
166-180 : 182.5-198	0	0	0	0	0	0	0	0	0	0	0	0
180	4	6.44	2	28.5	2	15.35	0	0	3	4.7	1	5.9
TOTALS	60	100	7	100	13	100	9	100	64	100	17	100

Table 66 . Movements of Apodemus males (1964) as shown by the greatest distance between any two successive capture points within the periods indicated. Grid A and Grid B animals are considered separately. The number in each category is given also as a percentage of the total number of movements recorded for that season.

Distance moved metres	Feb.-May 1963				June-Sep. 1963				Oct. 1963-Jan. 1964			
	GRID A		GRID B		GRID A		GRID B		GRID A		GRID B	
	No.	%	No.	%	No.	%	No.	%	No.	%	No.	%
15 : 16.5	4	40.0	0	0	2	40.0	1	100.0	8	38.0	1	20.0
16-30 : 17.5-33	2	20.0	1	100.0	0	0	0	0	7	33.3	3	60.0
31-45 : 34-49.5	0	0	0	0	3	60.0	0	0	1	4.8	1	20.0
46-60 : 50.5-66	1	10.0	0	0	0	0	0	0	1	4.8	0	0
61-75 : 67-82.5	1	10.0	0	0	0	0	0	0	3	14.3	0	0
76-90 : 83.5-99	0	0	0	0	0	0	0	0	0	0	0	0
91-105 : 100-115.5	1	10.0	0	0	0	0	0	0	0	0	0	0
106-120 : 116.5-132	0	0	0	0	0	0	0	0	1	4.8	0	0
121-135 : 133-148.5	0	0	0	0	0	0	0	0	0	0	0	0
136-150 : 149.5-165	0	0	0	0	0	0	0	0	0	0	0	0
151-165 : 166-181.5	0	0	0	0	0	0	0	0	0	0	0	0
166-180 : 182.5-198	0	0	0	0	0	0	0	0	0	0	0	0
180 : 198	1	10.0	0	0	0	0	0	0	0	0	0	0
TOTALS	10	100	1	100	5	100	1	100	21	100	5	100

Table 67 . Movements of Apodemus females (1963) as shown by the greatest distance between any two successive capture points within the periods indicated. Grid A and Grid B animals are considered separately. The number in each category is given also as a percentage of the total number of movements recorded for that season.

Distance moved metres	yards	Feb.-May 1964				June-Sep. 1964				Oct. 1964-Jan. 1965			
		GRID A		GRID B		GRID A		GRID B		GRID A		GRID B	
		No.	%	No.	%	No.	%	No.	%	No.	%	No.	%
15	: 16.5	13	28.9	0	0	2	15.4	0	0	14	40.0	2	50.0
16-30	: 17.5-33	9	20.0	5	71.4	6	46.1	2	22.2	9	25.7	0	0
31-45	: 34.49.5	13	28.9	0	0	3	23.1	3	33.3	9	25.7	2	50.0
46-60	: 50.5-66	5	11.2	0	0	2	15.4	2	22.2	2	5.7	0	0
61-75	: 67-82.5	2	4.4	2	28.6	0	0	0	0	1	2.9	0	0
76-90	: 83.5-99	1	2.2	0	0	0	0	0	0	0	0	0	0
91-105	: 100-115.5	0	0	0	0	0	0	1	11.15	0	0	0	0
106-120	: 116.5-132	1	2.2	0	0	0	0	0	0	0	0	0	0
121-135	: 133-148.5	1	2.2	0	0	0	0	0	0	0	0	0	0
136-150	: 149.5-165	0	0	0	0	0	0	0	0	0	0	0	0
151-165	: 166-181.5	0	0	0	0	0	0	0	0	0	0	0	0
166-180	: 182.5-198	0	0	0	0	0	0	0	0	0	0	0	0
180	: 198	0	0	0	0	0	0	1	11.15	0	0	0	0
TOTALS		45	100	7	100	13	100	9	100	35	100	4	100

Table 68 . Movements of Apodemus females (1964) as shown by the greatest distance between any two successive capture points within the periods indicated. Grid A and Grid B animals are considered separately. The number in each category is given also as a percentage of the total number of movements recorded for that season.

apparently greatest the number of Apodemus caught was low (pp. 50-51) and hence the larger movements taking the animals away from the grids were probably not recorded.

No consistent differences between the movement patterns of Clethrionomys on the two grids were detected. A slight tendency for males on grid B to move greater distances than males on grid A in the spring of each year was noted, and this may be associated with the better ground cover of vegetation on grid B in spring. However, the opposite results obtained for the females demonstrate the possible fallibility of such an argument.

IV. MOVEMENT PATTERNS

1. Introduction

A study of the movement charts of the animals revealed the presence of several patterns of movement. The normal pattern was considered to be that of the possession of a stable home range. The other patterns discovered included animals with:-

- 1) two home range areas distinct in space and time,
- 2) an above average movement away from an established home range,
- 3) occasional long movements away from the home range, but with subsequent return,

- 4) long movements from the original capture point, with a subsequently established home range in the new area.

Pattern one was considered to represent a genuine change in home range area. Pattern three was considered to be an example of exploratory behaviour as reported by Burt (1943) and Kendeigh (1944). Pattern four was thought to display wandering and dispersal behaviour. Pattern two probably represents a transitional stage between the normal and the three other patterns. The movement patterns and the animals which are considered to display them, are discussed below, and the number of animals displaying each movement pattern are given in Table 69.

1) Change in home range area

An inherent difficulty in defining a change in home range area is deciding when a home range is definitely changed as opposed merely to a centre of activity within a single home range being moved. Without careful checking of the home sites at regular intervals it is not possible fully to resolve the difficulty. However, for the purposes of the present study, the complete cessation of recorded visits to the previous area of activity has been accepted as the criterion for considering a genuine movement of home range to have occurred. Using this criterion the results below were obtained (Table 69).

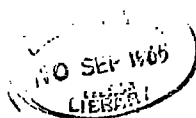

Fifteen Clethrionomys males were considered to have changed their home range area, but only three females displayed a movement of this type. Of the Apodemus only the males had representatives in this category, and four were considered to have changed their area of activity. Of all these animals, only three of the Clethrionomys males had moved less than 100 metres to the new area.

2) Transition stage movements (Table 69)

Eleven Clethrionomys males and six females were placed in this category, and eleven males and two females of Apodemus had patterns of this type. Only three of the Clethrionomys males and one of the Apodemus males had the large movement of less than 100 metres.

3) Exploratory movements (Table 69)

Twenty-two males and eight females of Clethrionomys, and eleven males and four females of Apodemus made these exploratory types of movement. Four of the Clethrionomys females, and three of the Apodemus females had exploratory movements of less than 75 metres. Ten of the Clethrionomys males and eight of the Apodemus males had exploratory movements of less than 100 metres.

4) Dispersal and wandering

The number of animals showing dispersal and wandering behaviour is given in Table 69, and some examples of such behaviour are shown in Figs. 41 and 42. With the exception of movements made by three Clethrionomys males, all of the movements made were of more than 100 metres in the case of males, and 75 metres in that of females. Prior to this study it was well known that Apodemus frequently wandered over large areas (Evans, 1942; Hacker and Pearson 1951, 1952), but very little had been reported concerning wandering and dispersal in Clethrionomys. Kikkawa (1964) found no evidence of dispersal in Clethrionomys, although he found many examples of such behaviour in Apodemus. In the present case, however, many records of movements of more than 100 metres in males and 75 metres in females were obtained for Clethrionomys, (Tables 70 and 71). The proportions of males and females showing dispersal movements were similar. If, as appears likely, only a small proportion of the animals leaving one grid and travelling large distances were captured on the other grid, it would seem that a great deal of such wandering and dispersal could have been occurring in the Clethrionomys population. In Figs. 41 and 42 it can be seen that the stream, some 8-10 feet wide, running down the middle of the Dene did not prevent movements from one grid to the other. The maximum movement possible with the trap arrangement used was 365 metres, and representatives

Species and Sex	Movement Pattern				Total No. of animals
	1	2	3	4	
<u>Clethrionomys</u> Males	15	11	22	18	66
<u>Clethrionomys</u> Females	3	6	8	13	30
<u>Apodemus</u> Males	4	11	11	7	33
<u>Apodemus</u> Females	0	2	4	4	10

Table 69. The number of animals displaying movement pattern 1 to 4 (see text).

Species	100-150 metres	151-200 metres	201-250 metres	251-300 metres	301 + metres	Total
<u>Clethrionomys</u>	29	4	6	14	6	59
<u>Apodemus</u>	14	3	1	5	7	30

Table 70. The number of males of Clethrionomys and Apodemus with recorded movements of the distances shown.

Species	75-100m.	101-150m.	151-200m.	201-250m.	251-300m.	301 + m.	Total
<u>Clethrionomys</u>	12	4	3	4	7	5	35
<u>Apodemus</u>	2	4	0	1	0	1	8

Table 71. The number of females of Clethrionomys and Apodemus with recorded movements of the distances shown.

(a).

DISPERSAL AND WANDERING

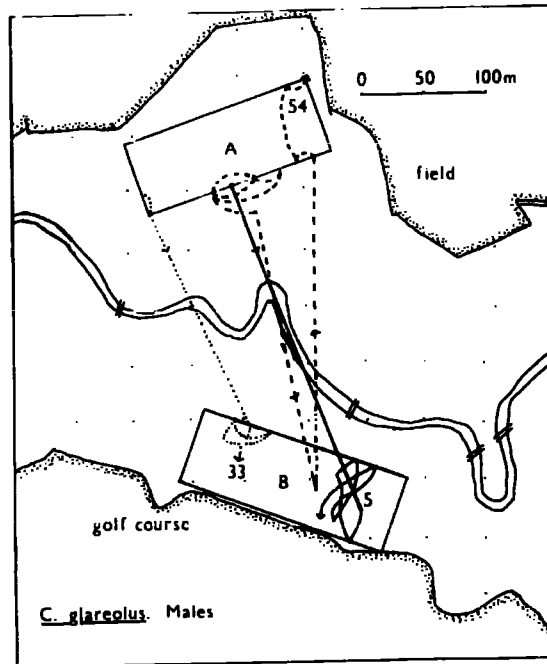

(b).

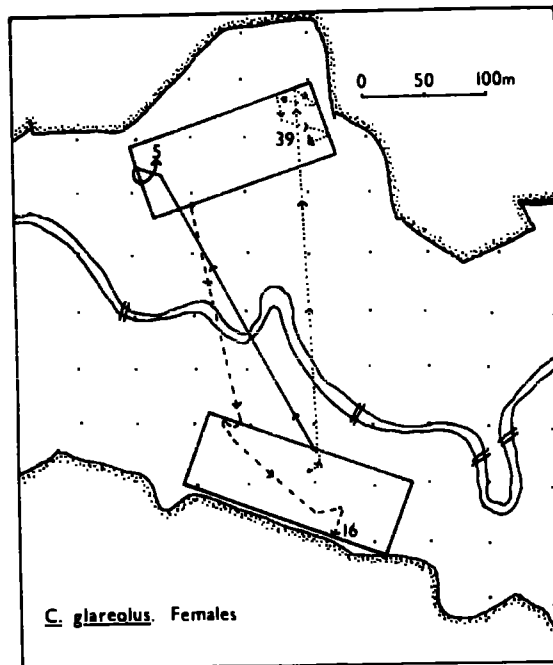
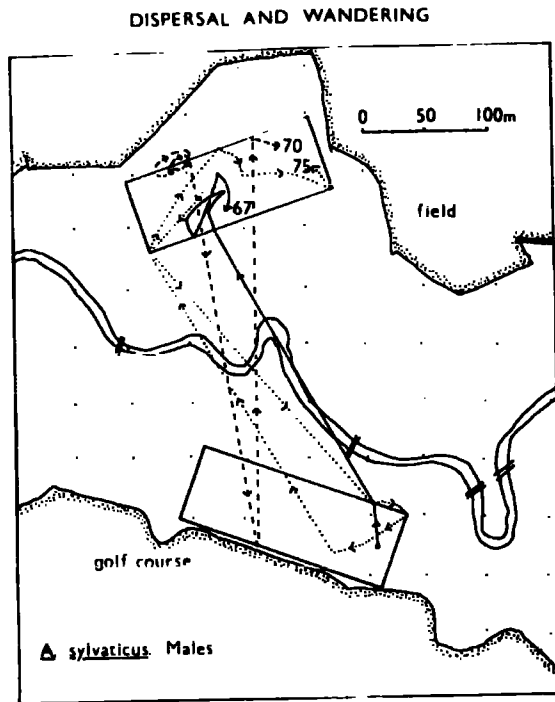

FIGURE 41. Some examples of wandering and dispersal movements made by individual Clethrionomys males (a) and females (b).

(a).



(b).

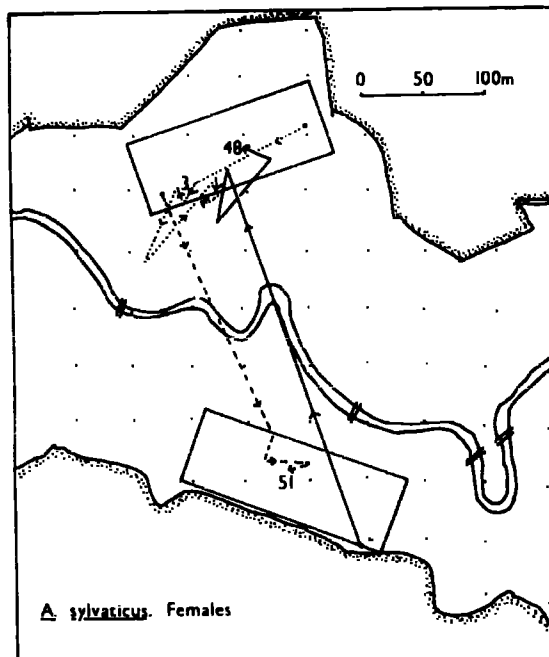

FIGURE 42. Some examples of wandering and dispersal movements made by individual Apodemus males(a) and females (b).

of all but Apodemus females moved that distance.

V. MAXIMUM RANGE LENGTH MEASUREMENTS

1. Introduction

The maximum range length was recorded of all animals caught more than three times (see p. 175). As part of an examination into the possible variability of results obtained from capture-recapture studies of the movements of Clethrionomys and Apodemus, the average range lengths of groups of animals, with different numbers of recaptures per animal for each group, were calculated. The results are shown in Tables 72 to 75.

The main purpose in calculating the average maximum range lengths of the two species was to obtain some idea of the distance from which animals were likely to come to enter the traps. The total area from which the samples of animals caught on the grid were drawn was computed by adding a border strip of half the maximum range length of the species under consideration to the area of the grid proper. The density per acre of Apodemus and Clethrionomys was calculated on the basis of the sampling area as calculated by this means (pp. 58,62). Similar techniques have been used by, among others, Morris (1955), Brant (1962), and Fullager et al (1963).

2. Results

The Observed Range Length (see p. 225) of Clethrionomys males caught three or more times (Table 72) averaged 63 metres

Species & Sex		Observed Range Length		Adjusted Range Length	
		Estimate	Range	Estimate	Range
<u>Clethrionomys</u> Males	m.	63.1	15.6-156.5	78.7	31.2-172.1
	yds.	69.0	17.1-171.1	86.1	34.1-188.2
<u>Clethrionomys</u> Females	m.	47.5	21.7-171.1	63.05	37.3-186.6
	yds.	51.9	23.7-187.0	68.90	40.8-204.0
<u>Apodemus</u> Males	m.	72.2	21.7-165.8	87.8	37.3-181.4
	yds.	78.9	23.7-181.3	96.0	40.8-198.4
<u>Apodemus</u> Females	m.	56.1	21.7-137.9	71.7	37.3-153.5
	yds.	61.3	23.7-150.8	78.4	40.8-167.9

Table 72 . Maximum Range Length measurements for animals caught three or more times.

Species & Sex		Observed Range Length		Adjusted Range Length	
		Estimate	Range	Estimate	Range
<u>Clethrionomys</u> Males	m.	63.0	15.6-156.5	78.6	31.2-172.1
	yds.	68.9	17.1-171.1	85.9	34.1-188.2
<u>Clethrionomys</u> Females	m.	48.9	21.7-110.0	63.5	37.3-125.6
	yds.	53.5	23.7-187.0	69.4	40.8-137.3
<u>Apodemus</u> Males	m.	73.4	21.7-165.8	89.0	37.3-181.4
	yds.	80.3	23.7-181.3	97.3	40.8-198.4
<u>Apodemus</u> Females	m.	61.8	21.7-137.9	77.4	37.3-153.5
	yds.	67.6	23.7-150.8	84.6	40.8-167.9

Table 73 . Maximum Range Length measurements for animals caught five or more times.

Species & Sex		Observed Range Length		Adjusted Range Length	
		Estimate	Range	Estimate	Range
<u>Clethrionomys</u> Males	m.	67.5	21.7-156.5	83.1	37.2-172.1
	yds.	73.8	23.7-171.1	90.9	40.8-188.2
<u>Clethrionomys</u> Females	m.	45.6	21.7-171.1	61.2	37.3-186.6
	yds.	49.9	23.7-187.0	66.9	40.8-204.0
<u>Apodemus</u> Males	m.	76.5	21.7-147.0	92.1	37.3-162.6
	yds.	83.7	23.7-160.75	100.7	40.8-177.8
<u>Apodemus</u> Females	m.	58.8	21.7-137.9	74.4	37.3-153.5
	yds.	64.3	23.7-150.8	81.4	40.8-167.9

Table 74. Maximum Range Length measurements for animals caught seven or more times.

Species & Sex		Observed Range Length		Adjusted Range Length	
		Estimate	Range	Estimate	Range
<u>Clethrionomys</u> Males	m.	79.7	21.7-142.6	95.3	37.3-158.2
	yds.	87.1	23.7-155.9	104.2	40.8-173.0
<u>Clethrionomys</u> Females	m.	50.3	21.7-110.0	65.9	37.3-129.6
	yds.	55.0	23.7-187.0	72.1	40.8-141.7
<u>Apodemus</u> Males	m.	100.9	66.0-147.0	116.5	81.6-162.6
	yds.	110.3	72.2-160.75	127.4	89.2-177.8
<u>Apodemus</u> Females	m.	72.8	21.7-137.9	88.4	37.3-153.5
	yds.	79.6	23.7-150.8	96.7	40.8-167.9

Table 75. Maximum Range Length measurements for animals caught ten or more times.

and that of individuals with ten or more captures (Table 75) averaged 79.5 metres. Range Length measurements based on only a few recaptures per animal hence probably fail to reveal the full range of the animals' movements. The average Observed Range Length of the females was rather smaller than that of the males, averaging from 47.5 metres for all the animals captured three or more times to 50 metres for those captured ten times or more. The difference in these two values, some 7%, is small, and it would seem that the range of movement of females of Clethrionomys may be revealed with fewer captures than for the males.

Apodemus males had the largest average Observed Range Length. The average range length increased steadily with increased number of recaptures per animal to reach a value of 101 metres for animals having ten or more captures. As was indicated in the case of Clethrionomys males (p. 208) the true average range length may not be revealed if the animals used in the estimation have been captured only a few times. The average Observed Range Length calculated for Apodemus females averaged 56 metres when animals caught three or more times were considered, and averaged 73 metres when the few (12) animals captured ten or more times were used.

Although the actual value of the maximum range length varied with the number of times the animal had been captured, the relative values for the range lengths of the sexes of both

species relative to one another remained unaltered, being in ascending order of magnitude, Clethrionomys females, Apodemus females, Clethrionomys males, and Apodemus males.

VI. DISCUSSION

The main points to emerge from the analysis of movements of the two species are discussed here in conjunction with the results of other workers. A large proportion of the animals captured were captured on only one occasion or were caught in only one trapping period. Following the example of Evans (1942), these animals may be considered to be 'transients', although mortality was probably an important factor in causing their non-return. Approximately 39% and 48% of Clethrionomys males and females respectively were found to be 'transients' (in Evans' sense) so far as the trapping record showed. Equivalent figures for Apodemus are 49% for the males, and 40% for the females. Evans (1942) considered the populations of Clethrionomys and Apodemus with which he worked to be composed of residents and transients, using the criterion mentioned above for distinguishing transients. He found 47% of the males and 48% of the females of Clethrionomys to be transients; for Apodemus the figures were 48% and 43% for males and females respectively. There is close agreement here between the results of the present study and those of Evans (1942). Youngman (1946) found there to be up to 40% of transients in populations of

Apodemus agrarius coreae. Getz (1960) with Microtus pennsylvanicus, and Tanton (1965) with Apodemus sylvaticus also recognised considerable numbers of what they termed 'migrants' in the populations they studied. Andrzejewski and Wierzbowska (1961) found that in house-mice also the populations contained residents and transients. Andrzejewski (1963), and Wierzbowska and Petruszewicz (1963), calculated the number of migrants in a house-mouse population from exponential characteristics of their data for duration of residence. They distinguished what they termed 'open-and-shut settled mice' which stayed in the study area for a week or more, and 'ephemeral mice' which were caught on one day only. From their analysis they claimed that the rate of disappearance of ephemeral mice exceeded that of open-and-shut settled mice. Holgate (1964) criticised their work on mathematical grounds indicating that their results could have arisen from the method of recording employed. More recently, work by Trojan and Wojciechowska (1964) on Clethrionomys glareolus, Apodemus agrarius, and Apodemus flavicollis has analysed the residency and disappearance of rodents in a population more thoroughly. These workers found that there were three stages in the average time of occurrence of an animal in an area, these stages being 'settling', 'real residency', and 'disappearance'. They found the 'settling' phase to last, depending on the species, up to nine days. With Clethrionomys they noted that attachment to a small home

range area was firm and was characterised by high trappability. 'Real residency' was discovered to last up to 21 days, depending upon the species. All the species showed high trappability in this phase. Clethrionomys movements were more wide-ranging in the 'real residency' phase than in the 'settling' phase. The 'disappearance' phase occurred after the 'real residency' phase and was characterised by a considerable decrease in residence expectation. In all three species trappability decreased, indicating a less rigid attachment to a home range area. With Clethrionomys and Apodemus flavicollis an enlargement of the area penetrated was observed during this phase.

Despite the precautions taken to avoid trap limitation of movement (p. 173), the majority of the recorded movements in the present study were of less than fifteen metres. Of the maximum movements made in the two years of study 59% of those made by Clethrionomys males were of less than 30 metres, as were 75% of those made by the females. In Apodemus the proportion of restricted movements was a little smaller than in Clethrionomys, being 54% and 60% for males and females respectively. Evans (1942) also found most of the animals he studied to be restricted in movement, 83% of his Clethrionomys moving less than 65 metres, and 75% of his Apodemus moving less than 110 metres. Brown (1956a) found that 65% of Clethrionomys males, and 60% of Clethrionomys females moved less than 30 yards, her equivalent figures for Apodemus being 68% and 71%

for males and females respectively. Kikkawa (1964) for Apodemus and Clethrionomys, and Tanton (1965) for Apodemus only, also noted the preponderance of short movements. The present study has thus confirmed the existence of a transient section of a population (in the terminology of Evans (1942)) and has also shown the preponderance of short movements around the home area in both species.

Seasonal variation in wandering activity has been clearly displayed in the present study (see pp. 178-200), both sexes of both species displaying considerably more activity in the spring and summer than in the autumn and winter. Movements of Apodemus males recorded on the grid were not significantly greater than those of Clethrionomys males, but there is some evidence that many of the Apodemus movements were outside the boundaries of the grid (p. 202). The movements of Apodemus females were consistently of greater dimensions than those of Clethrionomys females, this being particularly so in the summer. The males of both species moved greater distances than the females, particularly in the summer months. The restriction of the females to the nest area in the breeding season is suggested as the primary cause of the small movements made in that season. This was thought to occur also by Howell (1954) for Signodon (the cotton-rat), by Brown (1956a) for Microtus agrestis, and by Brant (1962) for Peromyscus maniculatus gambeli (the white-footed mouse), and Reithrodontomys megalotis longicaudus

(the harvest mouse). Kikkawa (1964) noted that the males of both Apodemus and Clethrionomys tended to move more than the females, and that the movements of both sexes were greater in summer than in winter.

Some evidence of change in home range area was found in both sexes of Clethrionomys, and in males of Apodemus. Brown (1956a) found no evidence in Clethrionomys and Apodemus of change in home range within trapping periods, but she did find that some changes occurred throughout the year between trapping periods. Kikkawa (1964) considered that about 6% of his voles and about 14% of his mice (caught ten or more times) changed their home range area. He also found movements of home-site within a trap-revealed home range to occur.

Dispersal and wandering movements of over 100 metres (males) and 75 metres (females) were found to be more common in Clethrionomys than had been expected from previous reports. It was confirmed that Apodemus males and females could wander considerable distances as has been reported by several workers (Evans 1942; Hacker and Pearson 1951, 1952; Kikkawa 1964). Kikkawa (1964) found wandering and dispersal to be an integral part of the movement pattern of Apodemus, but to be much less so in Clethrionomys. In Peromyscus maniculatus, Dice and Howard (1951) found that 38% of the females and 28% of the males remained within the natal home range. Frank (1957) observed, with Microtus arvalis, that the young males dispersed

from the maternal home range but the young females did not. Peromyscus leucopus noveboracensis does not apparently show a great tendency to disperse from its natal area (Burt, 1940; Nicholson, 1941), so dispersal is not by any means universal among 'mice'. Dice and Howard (1951) found movement generally in Peromyscus to be influenced by sexual factors, hereditary variation, wanderlust, and external factors. Dispersal in the present study was confined almost exclusively to sub-adults, although a few adults (all males) did show dispersal movements. Brant (1962) considered his animals to fall into three age classes, these being juvenile, sub-adult, and adult. He found that most of the largest movements (probably dispersal) were made by the adult animals.

The measurements of Maximum Range Length (pp.205-208) of the two species confirm the impressions gained from the maximum movements and movement patterns analysis. This impression is that Apodemus tends to range more widely than does Clethrionomys, but the latter ranges more widely than has hitherto been described. The actual range lengths recorded in the studies of Brown, (1956a), Miller (1958), and Tanton (1965) were smaller than those obtained in the present study, and it is suggested that the larger values obtained here over long periods of time are the more accurate. Further discussion of differences in inter and intra-specific movement patterns and home-range sizes is to be found in the section dealing with home-range (pp. 215-267).

(C.) HOME RANGE

I. INTRODUCTION

1. The concept of home range in small mammals

That many small mammals, rodents in particular, tend to remain in the same small area of terrain once sexual maturity has been reached has long been recognised as a result of many rodent-population studies. (e.g. those of Elton et al (1931); Chitty (1936); Dice (1941); Evans (1942)). But while the concept of a home range is an old one in vertebrate natural history, the measurement of home range size in small nocturnal mammals was not feasible until the development of live-trapping and marking methods. Seton (1909) used the term home range in the sense that "no wild animal roams at random over the country; each has a home region, even if it has not an actual home." Burt (1940) was the first to define the home range as "that area about its established home which is traversed by the animal in its normal activities of food gathering, mating, and caring for young. Occasional sallies outside the area, perhaps exploratory in nature, should not be considered as in part of the home range." Evans (1942), in the course of a study on Apodemus sylvaticus and Clethrionomys glareolus populations in Bagley Wood, Berkshire found that Apodemus could range widely, but he stated also that "there seems to be a tendency to restrict activity to a certain area (home range)..." The

definition of home range devised by Burt (1940) has since been modified by many workers. Blair (1951) working on Peromyscus polionotus leucocephalus (the beach mouse) in the United States, found that the "established home" of Burt's definition is not always permanent. Blair also noted that the area of activity of an individual may vary with season, age of occupant, and the degree of competition for food etc. Kendeigh (1944) was of Burt's opinion that the sallies outside the home range area were exploratory in nature.

Burt (1943) considered rodents to have either permanent or semi-permanent home ranges, the latter type being established by some females which change their areas of activity between litters. Small defended areas around the nests were considered by Burt (1943) to be "territories", the aggressive defence of which could lead to dispersal of young animals. The permanence of the home range as envisaged by Burt (1943) has since been held in doubt by various workers. Yerger (1953) writes:-

"It is generally agreed that the home range of a wild animal is not a well-defined plot of ground with permanent fixed boundaries, but rather the size and shape changes more or less continually from week to week, season to season, and year to year." Connell (1954) noted seasonal shifts in the home ranges of brush rabbits, and Layne (1954) observed shifting home ranges among red squirrels. However, whether there is a fixed 'home range' or not there seems little doubt that most rodents

have a localised area of activity. In many communities of rodents there does seem to be a substantial proportion of transient animals which do not have a permanent residence (up to 40% in Apodemus agrarius coreae as reported by Youngman, 1956). Within the range of such a community the death of a resident quickly results in transients taking over (Youngman, 1956). The question of how to separate transients from residents when examining data from live-trapping studies may cause difficulty. One way of solving the problem is to consider as residents such animals as are caught four or more times in an area (Blair, 1951).

It seems that few small mammals use all of the home range to the same extent, (Mohr, 1947). Nor do they wander at random over the home range area. Howard (1949) with Peromyscus maniculatus and Blair (1951) with Peromyscus polionotus studied tracks made by the mice. They interpreted their results as suggesting that the mice are purposeful in their movements and do not wander aimlessly. The remarks of Blair (1951) on the question of established homes (p. 216) received support from studies made of Apodemus sylvaticus movements by Curry-Lindahl (1956). He emphasised that the concept of a single established home for each individual is too limited. He indicated that a more probable situation is that many holes are used at different times for homes, refuges, and food stores. Blair (1951) had noted in his studies that new holes were being

utilised and old ones abandoned each year by Peromyscus polionotus leucocephalus. That such changes of home site may occur within the home range (Howard, 1949; Brown, 1956a) or beyond it (Miller, 1958; Kikkawa, 1964) have also been noted for Peromyscus, Apodemus, and Clethrionomys.

Sexual differences in home range size and usage have been recorded. Pregnant females or females with young are restricted to the area near the nest (Howell, 1954 for Sigmodon; Brown, 1956a for Microtus agrestis).

It has been observed that habitat preference is usually limited by the availability of food and shelter (Williams, 1955), and several types of vegetation may be found in one home range (Blair, 1951). The preference for one part of a home range was demonstrated by Curry-Lindahl (1956) for Clethrionomys glareolus. He found that some animals lived in one part of their home range but maintained direct routes to food supplies in other regions. Where more than one species share a region there tends to be a choice of 'microhabitat' between them (Howell, 1954; Findley and Anderson, 1956; Sanderson, 1950). Even when nearly-related species share there is still some habitat preference shown between them (McCabe and Blanchard, 1950 for species of Peromyscus.)

In the present study an attempt was made to examine the home range of Apodemus and Clethrionomys living in varied habitats to see if the results confirmed or refuted the

concept outlined above. The results and conclusions of the study are given in the sections following (pp. 219-267).

2. The validity of trap-revealed home range size

The measurement and precise definition of home range are complicated by the statistical and methodological problems of expressing the sum of an animal's movements in areal units of measure. Estimates of home range size have usually been made from information supplied from the live-trapping of animals. Mohr (1947), Hayne (1949a), and Stickel (1954) have reviewed some of the problems encountered in estimating home range size from such records. The principal difficulties are that the intensity of use of various parts of the home range may vary greatly. There may be intensive use of areas surrounding the home site and decreased use of areas away from the home (Southern, 1940; Blair, 1942; Linsdale, 1946; Fitch 1948a; Brown 1956a; and others). Dice and Clarke (1953) state:- "If an animal has no fixed limits to its wanderings the attempt to ascertain home range boundaries or home range areas is futile." Kikkawa (1964) also holds this opinion with regard to Apodemus.

One of the main difficulties with records obtained from live-trapping studies, with regard to estimating home range size, is the problem of artificial limitation of the movements of the animals by the traps. This is of particular importance

when live-traps placed on a grid are used. Morris (1955) was of the opinion that traps interfered with movements most when the traps were closely spaced, the trapping period brief, and the population level low. The only feasible alternatives to using live-traps to collect information on movements involve the use of either:-

- 1) radio-active rings to mark animals which may be tracked,
- 2) radio active injections in the bait, the faeces then being traced,
- 3) nest-boxes.

The first of these alternatives has been used by Godfrey (1954, 1955) and by Kikkawa (1964). Godfrey (1954) traced the movements of Microtus agrestis marked with radio-active rings using a Geiger-Müller counter. Kikkawa (1964) did the same for Apodemus and Clethrionomys individuals. This method has the disadvantages that only one individual may be traced at a time, in any one area if confusion is to be avoided, and long periods of time may be spent before the animal is located. In addition the presence of an observer only 8-10 feet away may well influence the activity of the animal. The method used by Miller (1957) of injecting bait with radio-active material and then tracing the faeces has certain advantages. One difficulty, however, is that absence of faeces from an area does not necessarily mean that the animal never visited that area. The use of nest boxes in population work was advocated by Nicholson

(1941), who worked on Peromyscus leucopus, and Howard (1949) who studied Peromyscus maniculatus bairdii. Howard (1949) noted, however, that:- "The presence of artificial homesites modified some of the minor movements of the mice. Particularly with regard to the boundaries of their daily home ranges." From this brief survey of possible alternatives to live-trapping methods for the study of movements in rodents and other small mammals it seems that live-trapping may still give the best results.

Stickel (1954) confirmed previously held views that trap spacing may affect the home range estimates of the same animals. She found the home range of some feral housemice to be 17,200 square feet when a 60 feet trapping grid was used, and 33,100 feet when a 120 feet grid was used. However, despite this, she considered that the ranges revealed by grid trapping are significantly related to the natural range of the animal. Blair (1951) also was of the opinion that such a relationship as that advocated by Stickel (1954) existed.

In the present study it was considered that some of the difficulties encountered in the estimation of home range size from trapping records obtained from grids set on a grid pattern could be avoided. As short but regular trapping periods were employed, home ranges could be calculated from recaptures spread over several trappings and by this means it was hoped that the animals would be sampled in a different

part of their range after intervals of four or five weeks. In addition it was hoped to minimise the restriction of movement due to trap spacing by using animals with the maximum number of recaptures to estimate the home range size. The other main difficulty in using grid-based movement records to estimate home range is the so called 'edge-effect' due to the occurrence of animals with only fractional parts of their home-range on the grid area. Their inclusion in samples from which estimates of home-range size are made depresses the estimate calculated. Therefore, in order to avoid this difficulty, animals with captures on the periphery of the grid only were not included in the calculations.

Below are listed the methods of estimation of home range size employed in the present study. Several methods were used in order to allow comparisons to be made of the results of this study and those of other workers.

3. The methods used to estimate home range size

All the methods discussed here were used on the data from the present study for the purpose of comparison. It was hoped to see what was the range of possible estimates of home range size which could be calculated from one set of data, when different methods of analysis and estimation were used.

a) The Minimum Area Method

This method was first used by Dalke and Sime (1938). The capture points of each animal are joined together by straight lines in such a way as to enclose an area which is then measured. The method is a conservative one since only the area in which the animal is known to have been present for the duration of the experiment is included in the estimate. Other users of this method include Schwartz, (1941), Lay, (1942), Dalke (1942), Storer et al, (1944), Mohr, (1947), Yerger, (1953).

b) Boundary Strip Methods

These methods of estimation were designed to compensate for the lack of traps at a boundary, or to allow for movements beyond the traps in which the actual captures were made.

i. The Inclusive Boundary Strip

The reasoning behind the use of this method is that the animal is assumed to have the chance to travel almost to the next set of traps beyond those in which its capture was recorded. Therefore, the area halfway to the next set of traps beyond each capture point is included in the estimate on the assumption that this would be the mean distance moved. This method has been used by Blair, (1940, 1943a), Haugen (1942), and Allen (1943) amongst others. When estimating the home range from recapture points marked on a chart, the external points of capture are

regarded as the centres of squares, the sides of which have a length equal to the trap-spacing used on the grid. The outside corners of the squares when drawn are joined by straight lines, and the area of the polygon so constructed is calculated. Hayne (1949b) criticised this method as being too artificial, and tending to include trap-sites within the estimated home range which were not visited by the animal in the course of the experiment.

ii. The Exclusive Boundary Strip

This method adds additional area to the trap-revealed area but allows also for observed irregularities in the habitat. Workers who have used this method include Burt (1940, 1943); Evans and Holdenreid (1943); Baker (1946); and Stickel (1954). The squares are constructed on the movement charts as described for the Inclusive Boundary Strip Method, but the internal edges of the squares surrounding the external capture points are joined instead of the external edges, thus excluding traps not visited by the animal.

c) Manville's (1949) Method

This method is essentially a modification of the Exclusive Boundary Strip method and was devised by Manville (1949). He based the home range on the area of quadrats which the animal was known to have entered or passed through in

successive captures. Each capture point was considered as the centre of a square with sides equal in length to the trap-spacing employed. The total area of the squares with capture points, and those which the animal must have passed through to reach subsequent capture points was regarded as the home range.

d) Maximum Range Length Methods

The Maximum Range Length is a linear measure of the greatest distance moved within a trapping period. The home range may be calculated from this measure by considering it to be the diameter of a circle the area of which is then calculated, (Lay, 1952; Stuewer, 1943; Stickel, 1946b; Fitch, 1947). Two measures of the Maximum Range Length have been used, one, the Observed Range Length, is the distance between the two most distant capture points; the other, the Adjusted Range Length, is calculated by adding the distance to the next trap point on to the Observed Range Length, to allow for the possibility of the animal having travelled almost to the next trapping point at each end of the range length.

4. The validity of the methods of home range estimation

Stickel (1954) tested the validity of the methods described above by applying them to artificial populations of counters with known circular home ranges. She calculated the home ranges by the various methods and compared the results with the known

mathematically-devised home ranges. She claimed that the Exclusive Boundary Strip and the Adjusted Range Length methods were the most accurate.

II. THE NUMBER OF ANIMALS UNDER CONSIDERATION

Only those animals which were caught three or more times at three or more points, which latter were not all in a straight line or along a boundary, were considered in the main part of the analysis. Thus of the 427 Clethrionomys males captured in the course of the study only 141 were suitable for the analysis in connection with the estimation of the size of their home range areas. The home range estimations were carried out also on 65 female Clethrionomys, 62 male Apodemus, and 40 female Apodemus.

III. THE ESTIMATES OF TRAP-REVEALED HOME-RANGE SIZE

1. The influence of sex, number of recaptures, and method of estimation on home-range size estimates.

a) Clethrionomys males

The estimated average home range sizes of the Clethrionomys males are given in Tables 76-83. The range sizes are given for animals caught three or more times, five or more times, seven or more times, and ten or more times. Because the estimates are average values the range of values is given also.

The average home range size of animals captured three or more times was found to vary from 772m.^2 when the Minimum Area Method was used (Table 76) to 4997m.^2 when the Adjusted Range Length method was used (Table 77). The second estimate is six times as large as the first. Variation within one method of estimation when different classes of animals were concerned was found not to be as great as when different methods of estimation were used on one class of recaptured animals. When the Minimum Area Method was used the values estimated for home range size varied from 772m.^2 for animals captured three or more times (Table 76) to 1497m.^2 for animals captured ten or more times (Table 82). The second estimate here being only twice as large as the first. When the four different classes of animals are considered it may be seen that the ranking of the methods of estimation of home range, in terms of relative magnitude of the estimate, is the same for each class, with only one minor exception, given below. With animals captured three or more times, five or more times, and seven or more times, the ranking of the methods of estimation in ascending order of the size of the estimate is the Minimum Area Method, the Exclusive Boundary Strip Method, Manville's Method, the Inclusive Boundary Strip Method, the Observed Range Length Method, and the Adjusted Range Length Method. When animals caught ten or more times are considered the Exclusive Boundary Strip Method and Manville's Method change

Species & Sex		Minimum Area		Inclusive Boundary Strip		Exclusive Boundary Strip		No. of animals
		Estimate	Range	Estimate	Range	Estimate	Range	
<u>Clethrionomys glareolus</u> . Males	2	772	59-4236	2398	729-7655	1558	608-5711	141
	m.2	923	70-5066	2868	872-9155	1863	727-6830	
	yd. acres	0.19	.01-1.05	0.59	0.18-1.89	0.38	0.15-1.41	
<u>Clethrionomys glareolus</u> . Females	2	409	100-2552	1712	790-8141	1177	608-4982	65
	m.2	489	120-3052	2048	945-9737	1408	727-5958	
	yd. acres	0.10	.02-0.63	0.42	0.20-2.01	0.29	0.15-1.23	
<u>Apodemus sylvaticus</u> . Males	2	974	122-3767	2963	851-6318	1969	729-5346	62
	m.2	1165	146-4505	3544	1018-7847	2355	872-6394	
	yd. acres	0.24	.03-0.93	0.73	0.21-1.56	0.49	0.18-1.32	
<u>Apodemus sylvaticus</u> . Females	2	635	122-2916	2193	851-6561	1494	729-4496	40
	m.2	759	146-3488	2623	1018-7847	1737	872-5337	
	yd. acres	0.16	.03-0.72	0.54	0.21-1.62	0.37	0.18-1.11	

Table 76 .
 Estimates of average home range size for animals caught three or more times.
 The areas are given in square metres (m.2), square yards (yd.2) and acres,
 and the range of estimated sizes is shown. The estimates are calculated
 using the Minimum Area, Inclusive Boundary Strip, and Exclusive Boundary
 Strip methods.

Species & Sex		Manville's Method		Observed Range Length		Adjusted Range Length		No. of animals
		Estimate	Range	Estimate	Range	Estimate	Range	
<u>Clethrionomys glareolus</u> . Males	2 m. yd. acres	1727	486-4860	4332	191-19238	4997	430-21204	141
		2065	581-5813	5181	228-23009	5976	514-25360	
		0.43	0.12-1.20	1.10	0.05-4.75	1.23	0.11-5.24	
<u>Clethrionomys glareolus</u> . Females	2 m. yd. acres	1320	729-4617	2985	370-22728	3708	684-25112	65
		1579	872-5522	3570	443-27183	4435	818-30034	
		0.33	0.18-1.14	0.74	0.09-5.60	0.92	0.17-6.20	
<u>Apodemus sylvaticus</u> . Males	2 m. yd. acres	1979	729-3888	5131	370-21593	6082	684-23672	62
		2367	872-4650	6137	443-25825	7274	818-28312	
		0.49	0.18-0.96	1.27	0.09-5.34	1.50	0.17-5.85	
<u>Apodemus sylvaticus</u> . Females	2 m. yd. acres	1543	729-3645	3272	370-14937	4007	684-16675	40
		1845	872-4359	3913	443-17865	4792	818-19943	
		0.38	0.18-0.90	0.81	0.09-3.69	0.99	0.17-4.12	

Table 77 . Estimates of average home range size for animals caught three or more times. The areas are given in square metres (m.²), square yards (yd.²) and acres, and the range of estimated sizes is shown. The estimates are calculated using Manville's Method, Observed Range Length Method and Adjusted Range Length Method.

Species & Sex		Minimum Area		Inclusive Boundary Strip		Exclusive Boundary Strip		No. of animals
		Estimate	Range	Estimate	Range	Estimate	Range	
<u>Clethrionomys glareolus.</u> Males	2	818	59-4236	2462	729-7655	1667	608-5711	118
	m. 2	978	70-5066	2945	872-9155	1994	727-6830	
	yd. acres	0.20	0.01-1.05	0.61	0.18-1.89	0.40	0.15-1.41	
<u>Clethrionomys glareolus.</u> Females	2	428	122-2552	1760	851-6318	1221	729-4982	54
	m. 2	512	146-3052	2105	1018-7556	1460	872-5958	
	yd. acres	0.11	0.03-0.63	0.43	0.21-1.56	0.30	0.18-1.23	
<u>Apodemus sylvaticus.</u> Males	2	1174	122-3767	3276	851-6318	2283	729-5346	42
	m. 2	1404	146-4505	3918	1018-7556	2730	872-6394	
	yd. acres	0.29	0.03-0.93	0.81	0.21-1.56	0.56	0.18-1.32	
<u>Apodemus sylvaticus.</u> Females	2	925	122-2916	2479	851-6561	1681	729-4496	30
	m. 2	1106	146-3488	2965	1018-7847	2010	872-5377	
	yd. acres	0.23	0.03-0.72	0.61	0.21-1.62	0.42	0.18-1.11	

Table 78 . Estimates of average home range size for animals caught five or more times. The areas are given in square metres (m.2), square yards (yd.2) and acres, and the range of estimated sizes is shown. The estimates are calculated using Minimum Area, Inclusive Boundary Strip, and Exclusive Boundary Strip methods.

		Manville's Method		Observed Range Length		Adjusted Range Length		No. of animals
		Estimates	Range	Estimates	Range	Estimates	Range	
<u>Clethrionomys glareolus.</u> Males	2 m. ² yd. acres	1738	486-4860	4297	191-19238	4930	430-21204	118
		2079	581-5813	5139	228-23009	5896	414-25360	
		0.43	0.12-1.20	1.10	0.05-4.76	1.22	0.11-5.24	
<u>Clethrionomys glareolus.</u> Females	2 m. ² yd. acres	1350	729-4617	3216	370-22728	3897	684-25112	54
		1615	872-5522	3846	443-27183	4661	818-30034	
		0.33	0.18-1.14	0.80	0.09-5.60	0.96	0.17-6.20	
<u>Apodemus sylvaticus.</u> Males	2 m. ² yd. acres	2112	729-3888	5141	370-21593	6118	684-23672	42
		2526	872-4650	6149	443-25825	7317	818-28312	
		0.52	0.18-0.96	1.27	0.09-5.34	1.51	0.17-5.85	
<u>Apodemus sylvaticus.</u> Females	2 m. ² yd. acres	1693	729-3645	3867	370-14937	4672	684-16675	30
		2025	872-4359	4625	443-17865	5588	818-19943	
		0.42	0.18-0.90	0.96	0.09-3.69	1.15	0.17-4.12	

Table 79 . Estimates of average home range size for animals caught five or more times. The areas given in square metres (m.²), square yards (yd.²) and acres, and the range of estimated sizes is shown. The estimates are calculated using Manville's Method, Observed Range Length Method and Adjusted Range Length Method.

places in the ranking. The two Maximum Range Length methods were found always to give the largest estimates, and the Minimum Area Method was found to consistently give the smallest estimates. The most extreme variation in estimated values of home range size was found to be when the Minimum Area Method estimate for animals captured three or more times (772m^2) was compared with that calculated by the Adjusted Range Length Method for animals captured ten or more times (7418m^2). The second estimate is almost ten times the size of the first.

b) Clethrionomys females

The average home range sizes for females were found to be considerably smaller than those of the males. The range of values for animals captured at least three times was found to be from 409m^2 when calculated by the Minimum Area Method (Table 76) to 3708m^2 when calculated by the Adjusted Range Length Method (Table 77). As in the males, the range of values using one method of estimation on animals classified according to the number of recaptures was found to be less wide than when the variation was in the method used. For animals captured three or more times the estimated home range size calculated by the Minimum Area Method was 409m^2 , (Table 76) this estimate increasing to 600m^2 when animals captured ten or more times were used (Table 82). The most extreme values obtained were

409m.² for animals captured at least three times when the Minimum Area Method was used (Table 76) and 4595m.² for animals captured ten or more times when the Adjusted Range Length Method was used (Table 83). As with the males (p. 232) an approximately ten-fold difference in estimate was obtained.

c) Apodemus males

The average home range sizes for Apodemus males were found to be the largest of the four groups of animals considered. For all individuals captured at least three times the estimates varied from 974m.² by the Minimum Area Method (Table 76) to 6082m.² by the Adjusted Range Length Method (Table 72). Again the variation was less within one method of estimation used on the four different classes of recaptured animals, than when different methods of estimation were used on one class of animal. The estimated home range size by the Minimum Area Method was 974m.² when all animals captured three or more times were considered (Table 76) and rose to 1844m.² when the animals caught at least ten times were used (Table 82). The most extreme values obtained were 974m.² for animals captured three or more times using the Minimum Area Method of estimation (Table 76), and 9810m.² for animals captured ten or more times when the Adjusted Range Length Method was used (Table 83). In contrast to the situation with Clethrionomys both males and females, the estimated home range sizes of Apodemus males calculated by Manville's Method were smaller

Species & Sex		Minimum Area		Inclusive Boundary Strip		Exclusive Boundary Strip		No. of animals
		Estimate	Range	Estimate	Range	Estimate	Range	
<u>Clethrionomys glareolus</u> . Males	m. ² yds. acres	1024	122-4236	2853	851-7655	1962	729-5711	76
		1225	146-5066	3412	1018-9155	2347	872-6830	
		0.25	0.03-1.05	0.70	0.21-1.89	0.48	0.18-1.41	
<u>Clethrionomys glareolus</u> . Females	m. ² yds. acres	481	122-2552	1829	851-8141	1306	729-4982	42
		575	146-3052	2187	1018-9237	1562	872-5958	
		0.12	0.03-0.63	0.45	0.21-2.01	0.32	0.18-1.23	
<u>Apodemus sylvaticus</u> . Males	m. ² yds. acres	1423	122-3767	3629	851-6318	2615	729-5346	27
		1702	146-4505	4340	1018-7556	3128	872-6394	
		0.35	0.03-0.93	0.90	0.21-1.56	0.65	0.18-1.32	
<u>Apodemus</u> . Females.	m. ² yds. acres	886	122-2916	2754	851-6561	1957	229-4496	21
		1060	146-3488	3294	1018-7847	2341	872-5377	
		0.22	0.03-0.72	0.68	0.21-1.62	0.48	0.18-1.11	

Table 80 . Estimates of average home range size for animals caught seven or more times. The areas are given in square metres (m.²), square yards (yd.²) and acres, and the range of estimated sizes is shown. The estimates are calculated using Minimum Area, Inclusive Boundary Strip, and Exclusive Boundary Strip methods.

Species & Sex		Manville's Method		Observed Range Length		Adjusted Range Length		No. of animals
		Estimate	Range	Estimate	Range	Estimate	Range	
<u>Clethrionomys glareolus</u> . Males	2 m. 2 yds. acres	1970	729-4860	4989	370-19238	5471	684-21204	76
		2356	872-5813	5967	443-23009	6543	818-25360	
		0.49	0.18-1.20	1.23	0.09-4.75	1.35	0.17-5.24	
<u>Clethrionomys glareolus</u> . Females	2 m. 2 yds. acres	1354	729-4617	2973	370-22728	3636	684-25112	42
		1619	872-5522	3556	443-22183	4349	818-30034	
		0.33	0.18-1.14	0.73	0.09-5.60	0.90	0.17-6.20	
<u>Apodemus sylvaticus</u> . Males	2 m. 2 yds. acres	2250	729-3159	5576	370-16974	6605	684-18823	27
		2691	872-3778	6667	443-20301	7899	818-22512	
		0.56	0.18-0.78	1.38	0.09-4.19	1.63	0.17-4.65	
<u>Apodemus sylvaticus</u> . Females	2 m. 2 yds. acres	1817	729-3645	3876	370-14937	4703	684-16675	21
		2173	872-4359	4636	443-17865	5625	818-19943	
		0.45	0.18-0.90	0.96	0.09-3.69	1.16	0.17-4.12	

Table 81. Estimates of average home range size for animals caught seven or more times. The areas are given in square metres (m.²), square yards (yd.²) and acres, and the range of estimated sizes is shown. The estimates are calculated using Manville's Method, Observed Range Length Method and Adjusted Range Length Method.

than those calculated by the Exclusive Boundary Strip Method, with the sole exception of the category containing those animals captured three or more times.

d) Apodemus females

The estimated home range sizes of Apodemus females were calculated in the same way as for the other groups of animals. With animals caught at least three times the estimates varied from 635m.^2 by the Minimum Area Method (Table 76) to 4007m.^2 by the Adjusted Range Length Method (Table 77). Using the Minimum Area Method of estimation on animals captured three or more times the estimated range size was 635m.^2 (Table 76); when animals captured ten or more times were used the estimate increased to 1072m.^2 (Table 82). The most extreme values of estimated average home range size were obtained for animals captured three or more times calculated by the Minimum Area Method (Table 76) and for animals captured ten or more times calculated by the Adjusted Range Length Method (Table 83) the figures being 635m.^2 and 5906m.^2 respectively. The female Apodemus differ from the males, and from both sexes of Clethrionomys, in that for animals caught three or more times and five or more times, the Exclusive Boundary Strip estimates of range size are smaller than those estimated by Manville's Method. The reverse situation was found to be the case for animals captured seven or more times and ten or more times.

Species & Sex		Minimum Area		Inclusive Boundary Strip		Exclusive Boundary Strip		No. of animals
		Estimate	Range	Estimate	Range	Estimate	Range	
<u>Clethrionomys glareolus.</u> Males	2 m. 2 yds. acres	1497	122-4236	3683	851-7655	2594	729-5711	35
		1790	146-5066	4405	1018-9155	3102	872-6830	
		0.37	0.03-1.05	0.91	0.21-1.89	0.64	0.18-1.41	
<u>Clethrionomys glareolus.</u> Females	2 m. 2 yds. acres	600	122-2552	2124	851-8141	1532	729-4982	27
		718	146-3052	2540	1018-9737	1832	872-5958	
		0.15	0.03-0.63	0.52	0.21-2.01	0.38	0.18-1.23	
<u>Apodemus sylvaticus.</u> Males	2 m. 2 yds. Acres	1844	972-3767	5225	2916-6197	3905	2551-5346	7
		2205	1163-4505	6249	3488-7412	4670	3051-6394	
		0.46	0.20-0.93	1.30	0.72-1.53	0.96	0.63-1.32	
<u>Apodemus sylvaticus.</u> Females	2 m. 2 yds. acres	1072	122-1944	3269	851-6318	2264	729-3523	11
		1282	146-2325	3910	1018-7556	2708	872-4214	
		0.26	0.03-0.48	0.81	0.21-1.56	0.56	0.18-0.87	

Table 82 . Estimates of average home range size for animals caught ten or more times. The areas are given in square metres (m.2), square yards (yd.2) and acres, and the range of estimated sizes is shown. The estimates are calculated using Minimum Area, Inclusive Boundary Strip, and Exclusive Boundary Strip methods.

Species & Sex		Manville's Method		Observed Range Length		Adjusted Range Length		No. of animals
		Estimate	Range	Estimate	Range	Estimate	Range	
<u>Clethrionomys glareolus.</u> Males	2	2430	729-4860	6328	370-15973	7418	684-17768	35
	m. 2 yds. acres	2906	872-5813	7568	443-19104	8872	818-21251	
		0.60	0.18-1.20	1.56	0.09-3.95	1.83	0.17-4.39	
<u>Clethrionomys glareolus.</u> Females	2	1521	729-4617	3767	370-22728	4595	684-25112	27
	m. 2 yds. acres	1819	872-5522	4505	443-27183	5496	818-30034	
		0.38	0.18-1.14	0.93	0.09-5.60	1.14	0.17-6.20	
<u>Apodemus sylvaticus.</u> Males	2	3124	1944-3159	8349	3422-16974	9810	5516-18823	7
	m. 2 yds. acres	3736	2325-3778	9985	4093-20301	11733	6597-22512	
		0.77	0.48-0.78	2.06	0.85-4.19	2.42	1.36-4.65	
<u>Apodemus sylvaticus.</u> Females	2	2143	729-3645	4967	320-14937	5906	684-16675	11
	m. 2 yds. acres	2563	872-4359	5941	443-17865	7064	818-19943	
		0.53	0.18-0.90	1.23	0.09-3.69	1.46	0.17-4.12	

Table 83. Estimates of average home range size for animals caught ten or more times. The areas are given in square metres (m.²), square yards (yd.²) and acres, and the range of estimated sizes is shown. The estimates are calculated using Manville's Method, Observed Range Length Method and Adjusted Range Length Method.

2. A comparison of the size of home range in Clethrionomys and Apodemus

With only three exceptions the ranking of the order of magnitude of the estimated average home range sizes for the two sexes of both species was found to be the same when the methods of estimation used and the class of animals considered (e.g. animals captured three or more times) were the same. The ranking of the four groups of animals in order of ascending range size was found to be as follows:- Clethrionomys females, Apodemus females, Clethrionomys males, Apodemus males. The three exceptions to this ranking were for animals with five or more captures when the estimates were calculated using the Minimum Area Method, the Inclusive Boundary Strip Method, and the Exclusive Boundary Strip Method; in these three cases the estimated range sizes for Apodemus females exceeded those calculated for Clethrionomys males. Thus in both species the males were found to have larger home ranges than the females. The home range size of Apodemus males was considerably larger than that of Clethrionomys males. The range size of Apodemus females was only slightly smaller than that of Clethrionomys males. In the discussion (pp.254-267) the home range sizes calculated by Manville's Method of animals captured ten or more times are compared with the values obtained by Kikkawa (1964) who used the same methods. The close agreement between the two sets of results, despite the different trap-

spacings and trapping periods used, suggests that Manville's Method of estimation may be the most accurate. The estimated average home range sizes for animals captured ten or more times calculated using Manville's Method were as follows:-

Clethrionomys males, 2430m.², Clethrionomys females, 1521m.², Apodemus males, 3124m.², Apodemus females, 2143m.². If these figures are the most accurate possible estimates of the home range size of the two species then it may be seen that even the Clethrionomys females have an average range covering almost one-eighth of the area of the grid. The Apodemus males have an average range covering almost one-third of the grid. From these figures, and from the movement charts, it is clear that there is considerable overlapping of home range areas between individuals of the same and different sexes, and of the same and different species.

3. A comparison of home range size of Clethrionomys and Apodemus on the two grids

a) Clethrionomys (Tables 84-87)

The average range sizes of Clethrionomys males were slightly but consistently smaller on grid A than on grid B when calculated by all but one of the methods of estimation on all the classes of recaptured animals. The exception was with the Observed Range Length Method when used on animals captured three or more times (Table 84) and five or more times

Species & Sex	Units	Minimum Area	Inclusive B.S.	Exclusive B.S.	Manville's Method	Observed R.L.	Adjusted R.L.	No. of animals
<u>Clethrionomys glareolus.</u> Males Grid A	2	722	2295	1461	1711	4380	4902	76
	m.2	864	745	1747	2046	5239	5863	
	yd. acres	0.18	0.57	0.36	0.42	1.10	1.21	
<u>Clethrionomys glareolus.</u> Males Grid B	2	831	2519	1738	1746	4278	5108	65
	m.2	994	3013	2079	2088	5117	6109	
	yd. acres	0.21	0.62	0.43	0.45	1.10	1.26	
<u>Clethrionomys glareolus.</u> Females Grid A	2	421	1766	1179	1352	3214	3853	32
	m.2	504	2112	1410	1617	3844	4608	
	yd. acres	0.10	0.44	0.29	0.33	0.80	0.95	
<u>Clethrionomys glareolus.</u> Females Grid B	2	397	1661	1176	1289	2763	3454	33
	m.2	475	1987	1407	1542	3305	4131	
	yd. acres	0.10	0.41	0.29	0.32	0.68	0.85	

Table 84. Estimates of average home range size for Clethrionomys glareolus caught three or more times. Grid A and Grid B animals are treated separately. The areas are given in square metres (m.2), square yards (yd.2) and acres.

Key to Tables to The following six methods of estimation were used:-

1. Minimum Area
2. Inclusive Boundary Strip (B.S.)
3. Exclusive Boundary Strip (B.S.)
4. Manville's Method
5. Observed Range Length (R.L.)
6. Adjusted Range Length (R.L.)

Species & Sex	Units	Minimum Area	Inclusive B.S.	Exclusive B.S.	Manville's Method	Observed R.L.	Adjusted R.L.	No. of animals
<u>Clethrionomys glareolus</u> Males Grid A	2 m.2 yd. acres	770 921 0.19	2337 2795 0.58	1509 1805 0.37	1697 2030 0.42	4365 5221 1.10	4839 5787 1.20	65
<u>Clethrionomys glareolus</u> Males Grid B	2 m.2 yd. acres	876 1048 0.22	2615 3128 0.65	1862 2227 0.46	1788 2138 0.44	4214 5040 1.00	5042 6030 1.25	53
<u>Clethrionomys glareolus</u> Females Grid A	2 m.2 yd. acres	453 542 0.11	1858 2222 0.46	1248 1493 0.31	1418 1696 0.35	3645 4359 0.90	4299 5142 1.10	24
<u>Clethrionomys glareolus</u> Females Grid B	2 m.2 yd. acres	408 488 0.10	1681 2011 0.42	1200 1435 0.30	1296 1550 0.32	2873 3436 0.71	3575 4276 0.88	30

Table 85. Estimates of average home range size for Clethrionomys glareolus caught five or more times. Grid A and Grid B animals are treated separately. The areas are given in square metres (m.2), square yards (yd.2) and acres.

Species & Sex	Units	Minimum Area	Inclusive B.S.	Exclusive B.S.	Marville's Method	Observed R.L.	Adjusted R.L.	No. of animals
<u>Clethrionomys glareolus.</u> Males Grid A	2 m. 2 yd. acres	942 1127 0.23	2645 3163 0.65	1720 2057 0.43	1920 2296 0.47	4974 5949 1.23	5070 6064 1.25	40
<u>Clethrionomys glareolus.</u> Males Grid B	2 m. 2 yd. acres	1116 1335 0.28	3084 3689 0.76	2231 2668 0.55	2025 2422 0.50	5005 5986 1.24	5917 7077 1.46	36
<u>Clethrionomys glareolus.</u> Females Grid A	2 m. 2 yd. acres	471 563 0.12	1768 2115 0.44	1273 1523 0.31	1276 1526 0.32	2376 2842 0.59	2891 3458 0.71	20
<u>Clethrionomys glareolus.</u> Females Grid B	2 m. 2 yd. acres	491 587 0.12	1883 2252 0.47	1337 1599 0.33	1425 1704 0.35	3517 4206 0.87	4314 5160 1.10	22

Table 86. Estimates of average home range size for Clethrionomys glareolus caught seven or more times. Grid A and Grid B animals are treated separately. The areas are given in square metres (m.2), square yards (yd.2) and acres.

Species & Sex	Units	Minimum Area	Inclusive B.S.	Exclusive B.S.	Manville's Method	Observed R.L.	Adjusted R.L.	No. of animals
<u>Clethrionomys glareolus.</u> Males Grid A	2 m. 2 yd. acres	1386 1658 0.34	3236 3870 0.80	2310 2763 0.57	2284 2732 0.56	5376 6430 1.33	6415 7672 1.59	20
<u>Clethrionomys glareolus.</u> Males Grid B	2 m. 2 yd. acres	1644 1966 0.41	4279 5118 1.10	2973 3556 0.73	2624 3158 0.65	7597 9086 1.88	8756 10472 2.16	15
<u>Clethrionomys glareolus.</u> Females Grid A	2 m. 2 yd. acres	621 743 0.15	2187 2616 0.54	1556 1861 0.38	1533 1834 0.38	3236 3870 0.80	3946 4719 0.98	13
<u>Clethrionomys glareolus.</u> Females Grid B	2 m. 2 yd. acres	579 693 0.14	2066 2471 0.51	1510 1806 0.37	1510 1806 0.37	4260 5095 1.10	5197 6216 1.28	14

Table 87 . Estimates of average home range size for Clethrionomys glareolus caught ten or more times. Grid A and Grid B animals are treated separately. The areas are given in square metres (m.), square yards (yd.²) and acres.

(Table 85). With animals captured seven or more times (Table 86) and ten or more times (Table 87) the estimated average range sizes calculated by the Observed Range Length Method were in agreement with those of the other methods.

No consistent differences were found between the range sizes of the Clethrionomys females on the two grids. When animals captured three or more times and five or more times were considered the average range sizes of the females on grid A were found to be larger than those of the females on grid B. With animals captured seven or more times the reverse applied. The grid A females again had larger estimated average range sizes when animals captured at least ten times were considered, except when the Range Length Methods of estimation were used.

b) Apodemus (Tables 88-91)

The sample size of Apodemus males on grid B was more than ten only when animals captured three or more times were considered, so little reliance can be placed on the comparative average range sizes on the two grids. With animals captured three or more times, however, the average range sizes were larger for the males on grid A than for those on grid B, whatever the method of analysis used (Table 88). The average range sizes of males on grid A were again larger for animals captured five or more times when the Minimum Area Method, the Inclusive Boundary Strip Method, and the Exclusive Boundary Strip Method

Species & Sex	Units	Minimum Area	Inclusive B.S.	Exclusive B.S.	Marville's Method	Observed R.L.	Adjusted R.L.	No. of animals
<u>Apodemus sylvaticus</u> Males Grid A	2	1066	3157	2072	2086	5671	6676	48
	m. 2	1275	3776	2478	2495	6783	7985	
	yd. acres	0.26	0.78	0.51	0.52	1.40	1.65	
<u>Apodemus sylvaticus</u> Males Grid B	2	660	2300	1614	1614	3279	4043	14
	m. 2	789	2751	1930	1930	3922	4835	
	yd. acres	0.16	0.57	0.40	0.40	0.81	1.00	
<u>Apodemus sylvaticus</u> Females Grid A	2	656	2202	1513	1539	3208	3934	33
	m. 2	785	2634	1810	1841	3837	4705	
	yd. acres	0.16	0.54	0.37	0.38	0.79	0.97	
<u>Apodemus sylvaticus</u> Females Grid B	2	538	2153	1406	1562	3575	4350	7
	m. 2	643	2575	1682	1868	4276	5203	
	yd. acres	0.13	0.53	0.35	0.39	0.88	1.10	

Table 88. Estimates of average home range size for Apodemus sylvaticus caught three or more times. Grid A and Grid B animals are treated separately. The areas are given in square metres (m. 2), square yards (yd. 2) and acres.

Species & Sex	Units	Minimum Area	Inclusive B.S.	Exclusive B.S.	Manville's Method	Observed R.L.	Adjusted R.L.	No. of animals
<u>Apodemus sylvaticus</u> Males Grid A	2	1215	3300	2302	2111	5130	6104	35
	m.2	1453	3947	2753	2525	6163	7300	
	yd. acres	0.30	0.82	0.57	0.52	1.27	1.51	
<u>Apodemus sylvaticus</u> Males Grid B	2	972	3159	2187	2118	5195	6189	7
	m.2	1163	3778	2616	2533	6213	7402	
	yd. acres	0.24	0.78	0.54	0.52	1.27	1.53	
<u>Apodemus sylvaticus</u> Females Grid A	2	749	2411	1650	1654	3642	4421	26
	m.2	896	2884	1973	1978	4356	5288	
	yd. acres	0.19	0.60	0.41	0.41	0.90	1.10	
<u>Apodemus sylvaticus</u> Females Grid B	2	820	2916	1884	1944	5325	6302	4
	m.2	981	3488	2253	2325	6369	7537	
	yd. acres	0.20	0.72	0.47	0.48	1.32	1.56	

Table 89 . Estimates of average home range size for Apodemus sylvaticus caught five or more times. Grid A and Grid B animals are treated separately. The areas are given in square metres (m.2), square yards (yd.2) and acres.

Species & Sex	Units	Minimum Area	Inclusive B.S.	Exclusive B.S.	Manville's Method	Observed R.L.	Adjusted R.L.	No. of animals
Apodemus sylvaticus Males Grid A	2 m. 2 yd. acres	1503	3709	2679	2275	5673	6717	22
		1793	4436	3204	2721	6785	8034	
		0.37	0.92	0.66	0.56	1.40	1.66	
Apodemus sylvaticus Males Grid B	2 m. 2 yd. acres	1069	3281	2333	2138	5139	6114	5
		1279	3924	2790	2557	6146	7312	
		0.26	0.81	0.58	0.53	1.27	1.51	
Apodemus sylvaticus Females Grid A	2 m. 2 yd. acres	909	2743	1952	1816	3916	4742	19
		1087	3281	2335	2172	4684	5671	
		0.22	0.68	0.48	0.45	0.97	1.17	
Apodemus sylvaticus Females Grid B	2 m. 2 yd. acres	669	2856	2005	1823	3497	4332	2
		800	3416	2398	2180	4182	5181	
		0.17	0.71	0.50	0.45	0.86	1.07	

Table 90. Estimates of average home range size for Apodemus sylvaticus caught seven or more times. Grid A and Grid B animals are treated separately. The areas are given in square metres (m.²), square yards (yd.²) and acres.

Species & Sex	Units	Minimum Area	Inclusive B.S.	Exclusive B.S.	Manville's Method	Observed R.I.	Adjusted R.I.	No. of animals
<u>Apodemus sylvaticus</u> Males Grid A	2 m.2 yd. acres	1908 2282 0.47	5124 6128 1.27	3868 4626 0.96	3119 3730 0.78	7728 9243 1.91	9171 10969 2.27	6
<u>Apodemus sylvaticus</u> Males Grid B	2 m.2 yd. acres	1458 1744 0.36	5832 6975 1.44	4131 4941 1.02	3159 3778 0.78	12078 14445 3.00	13645 16319 3.37	1
<u>Apodemus sylvaticus</u> Females Grid A	2 m.2 yd. acres	1082 1294 0.27	3183 3807 0.79	2211 2644 0.55	2114 2528 0.52	4934 5901 1.22	5835 6979 1.44	10
<u>Apodemus sylvaticus</u> Females Grid B	2 m.2 yd. acres	972 1163 0.24	4131 4941 1.02	2795 3343 0.69	2430 2906 0.60	5295 6333 1.31	6348 7592 1.57	1

Table 91. Estimates of average home range size for Apodemus sylvaticus caught in ten or more times. Grid A and Grid B animals are treated separately. The areas are given in square metres (m.2), square yards (yd.2) and acres.

were used, but were smaller when calculated by the other three methods (Table 89). The males on grid A again had larger average range sizes than those on grid B when animals captured seven or more times were used (Table 90). As only six animals on grid A and one on grid B were captured ten or more times no comparison is possible between their ranges (Table 91).

None of the samples of Apodemus females on grid B contained more than seven animals, so therefore no valid comparisons may be made between the range sizes of animals on the two grids.

c) Conclusions

There was no significant difference between the average range size of animals on the two grids, despite the differences in vegetation between the grids, and the comparative absence of Apodemus from grid B, although there was some indication that range sizes of Clethrionomys males were a little larger on grid B than on grid A. This may possibly be associated with the more uniform vegetation cover on (and the absence of Apodemus from) grid B. There is no concrete evidence for this, however.

4. Home range size and vegetation type.

In Table 92 are presented the average home range sizes of both sexes of Clethrionomys and Apodemus in the four different vegetation types represented on the two grids. The

Species	Grid A		Grid B	
	Larch	Sycamore	Larch	Ash
<u>Clethrionomys</u> Males	1431m. ²	1397m. ²	1486m. ²	1329m. ²
<u>Clethrionomys</u> Females	1215m. ²	1085m. ²	1177m. ²	1205m. ²
<u>Apodemus</u> Males	2242m. ²	3038m. ²	1701m. ²	-
<u>Apodemus</u> Females	2727m. ²	1677m. ²	1215m. ²	-

Table 92. Estimates of home range size of Clethrionomys and Apodemus males and females in different vegetation types. Estimates calculated using the Exclusive Boundary Strip method on animals captured seven or more times.

range sizes were calculated using the Exclusive Boundary Strip Method on animals captured at least seven times. Because of the small sample sizes the estimated range sizes in the different habitats could not be tested statistically.

No consistent differences in range size could be found for either species between the different habitats. There is some suggestion that range sizes in the larch woods are larger than those in the sycamore and ash plantations for both species but the differences in range size are not great.

IV. THE EFFECT ON ESTIMATES OF HOME RANGE SIZE OF THE NUMBER OF RECAPTURES PER ANIMAL

In the information presented earlier (pp. 215-252) it has been observed that the apparent size of trap-revealed home range increases with increased numbers of recaptures per animal e.g. the home range size calculated for animals captured ten or more times is greater than that for animals captured three or more times. The question of how many recaptures per animal are required before it may be assumed that the whole of the range has been revealed is as yet not satisfactorily answered. The data for all animals captured ten or more times were studied to see if there was any indication that the apparent size of the home range had ceased to increase with increased numbers of recaptures per animal. The home range size was calculated by Manville's Method for each

recapture number for every animal captured ten or more times altogether. For both sexes of each species the average size of home range at each number of recaptures was calculated, and the results were plotted on a graph of home range size against number of recaptures. This procedure was carried out for the 35 male Clethrionomys, the 27 female Clethrionomys, the 7 male Apodemus, and the 11 female Apodemus, which had been captured at least ten times. The graphs showing average home range size per number of recaptures are illustrated in Fig. 43. From these graphs it may be seen that in all cases the curve of increasing range size flattened as the number of recaptures approached nine or ten. It seems, therefore, that the true range size may be revealed by the time the animals have been trapped 10 times over a period of a few weeks or months. In addition to the procedure described above, a record was made, for each individual captured ten or more times, of the numbers of captures that it had had when the range-size ceased to increase, if this in fact did happen. The average of the number of recaptures required was then calculated, thus giving an estimate for each sex of each species of how many recaptures will probably be required before the apparent range-size stops increasing. For Clethrionomys males the average number of recaptures required before the range-size ceased to increase was 9, for Clethrionomys females it was 10, for Apodemus males and females it was 9. From this study, on admittedly rather

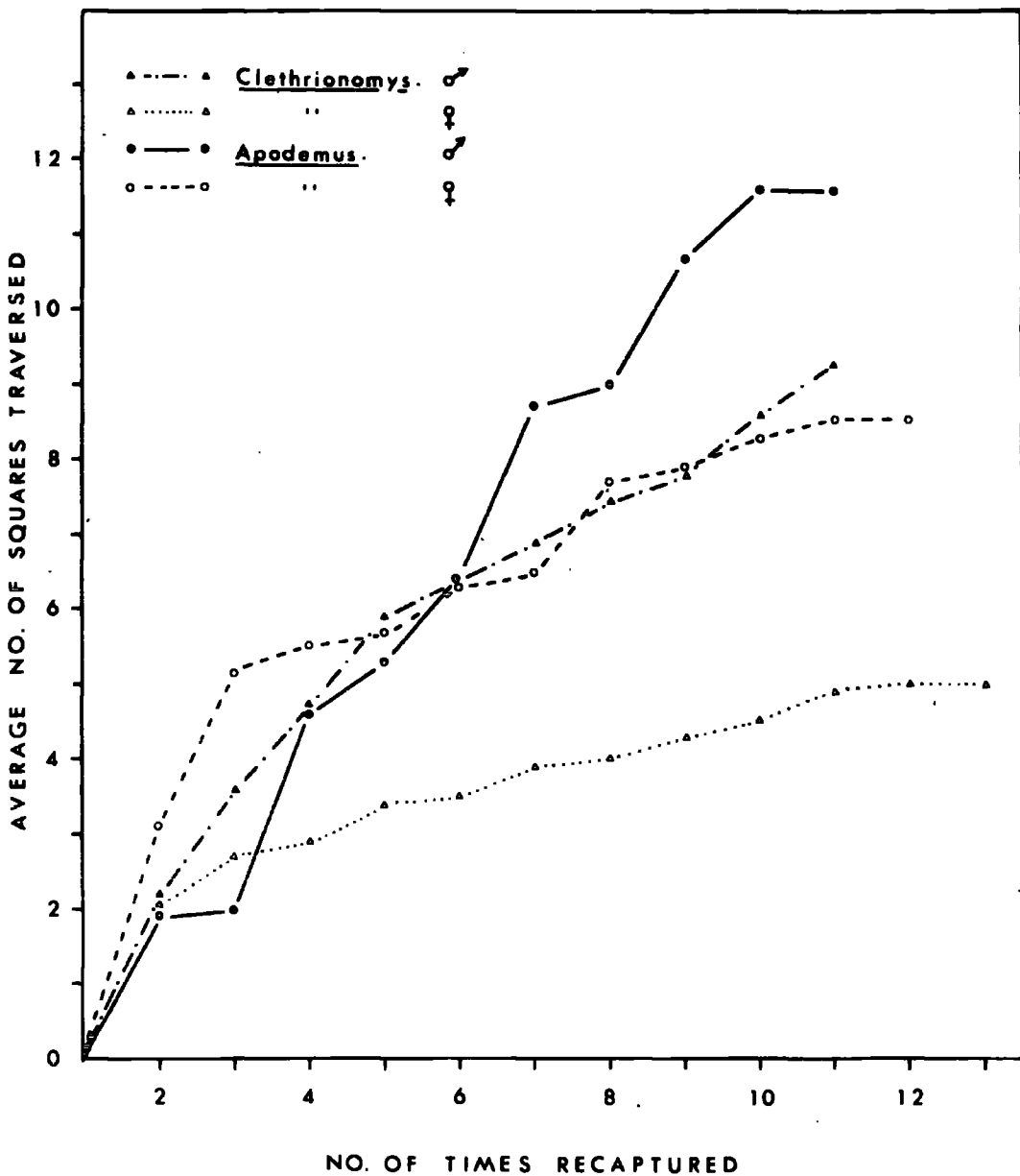

FIGURE 43. Graph showing the increase in apparent home range size with increased number of recaptures per animal, for both sexes of Clethrionomys and Apodemus, in samples of animals which were eventually captured ten or more times.

scanty figures, it would seem that at least ten recaptures are required before it may be assumed that the animal has revealed most of its home range. In the present study some animals appeared to still be increasing their home range size when they were last trapped. Some examples of individual home ranges increasing with increasing numbers of recaptures are given in Fig. 44 for Clethrionomys, and Fig. 45 for Apodemus. The range sizes are calculated using Manville's Method, and the areas are given as the number of squares traversed, for simplicity. The area of each square is approximately 250m.².

V. DISCUSSION

1. Home Range size

Brown (1956a) calculated estimates of home range size for Apodemus and Clethrionomys. In her investigations she trapped in mixed woodland, using Longworth traps in groups of four on a grid with a 30 yard spacing. She calculated the average home range size of animals captured five or more times using the Minimum Area Method, the Exclusive Boundary Strip Method, and Manville's Method. Her results are presented in Table 93, together with the directly comparable results obtained in the present study. When the estimates from the present study, calculated using Manville's Method, are compared with the estimates calculated by Brown using the same method, it is seen that there is close agreement in some respects between the

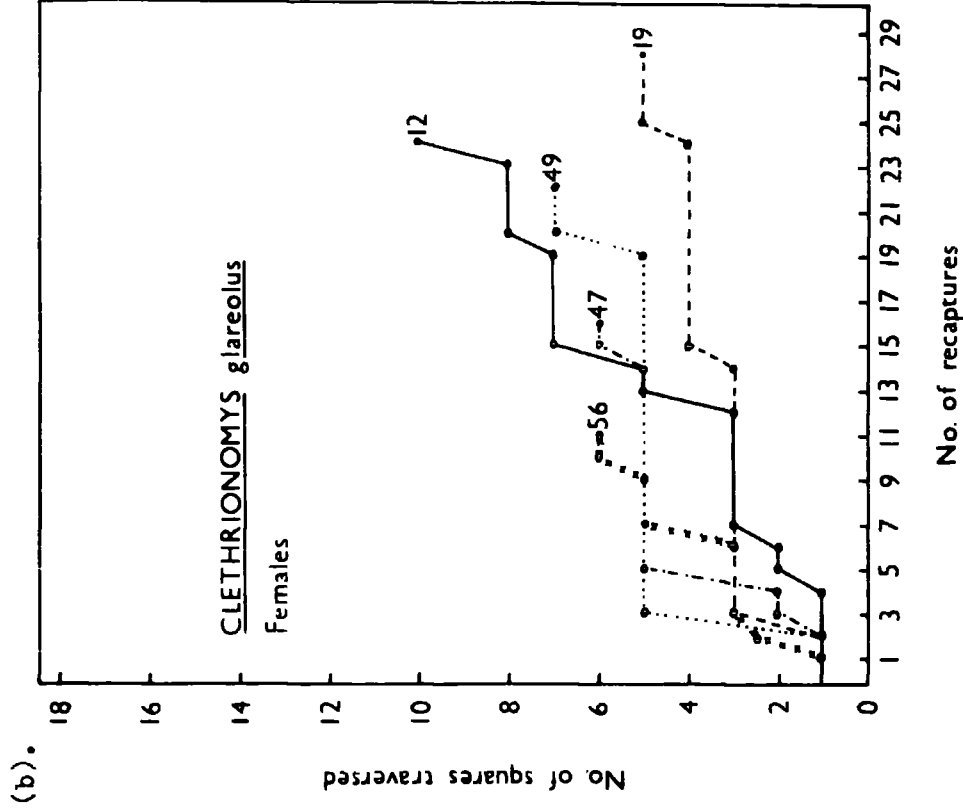
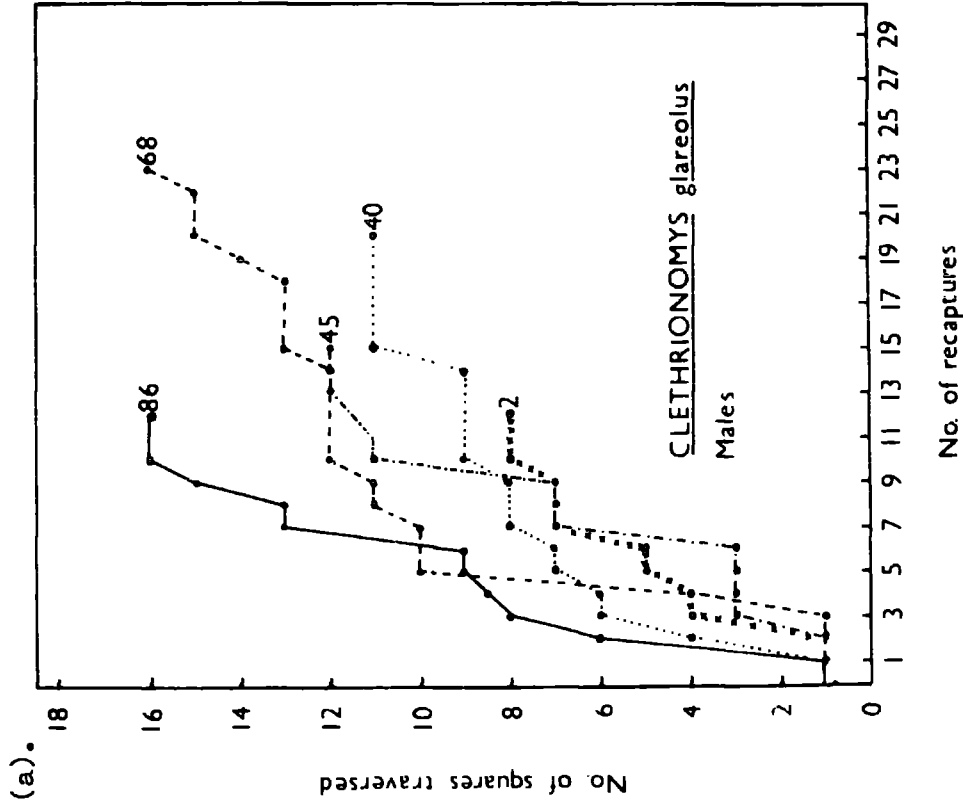

FIGURE 44. Graphs showing the increase in apparent home range size, with increased number of times recaptured, of five males (a) and five females (b) of Clethrionomys. The estimates of home range size were made using Manville's Method.

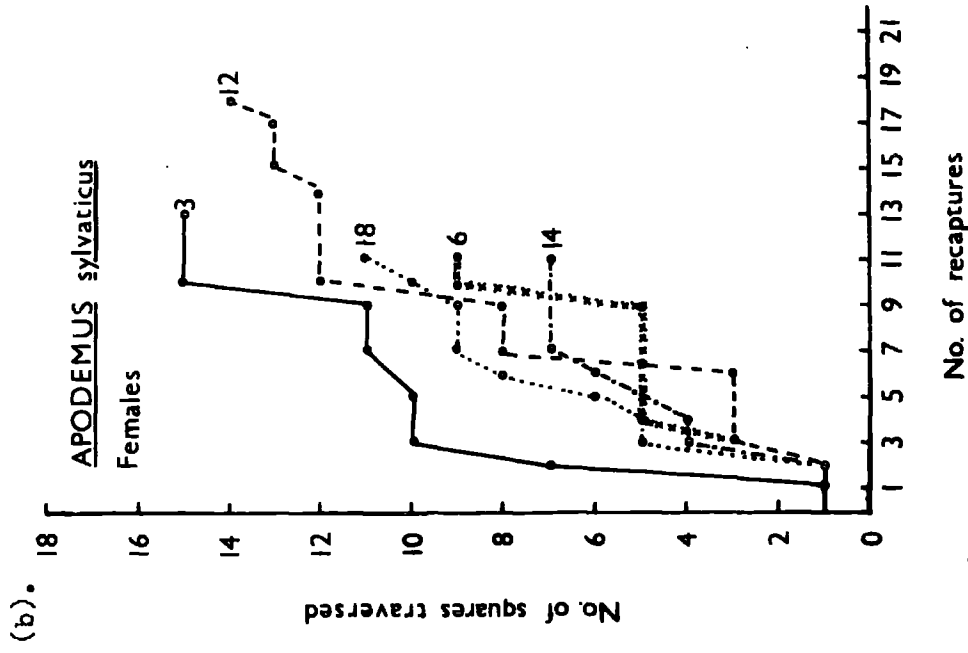
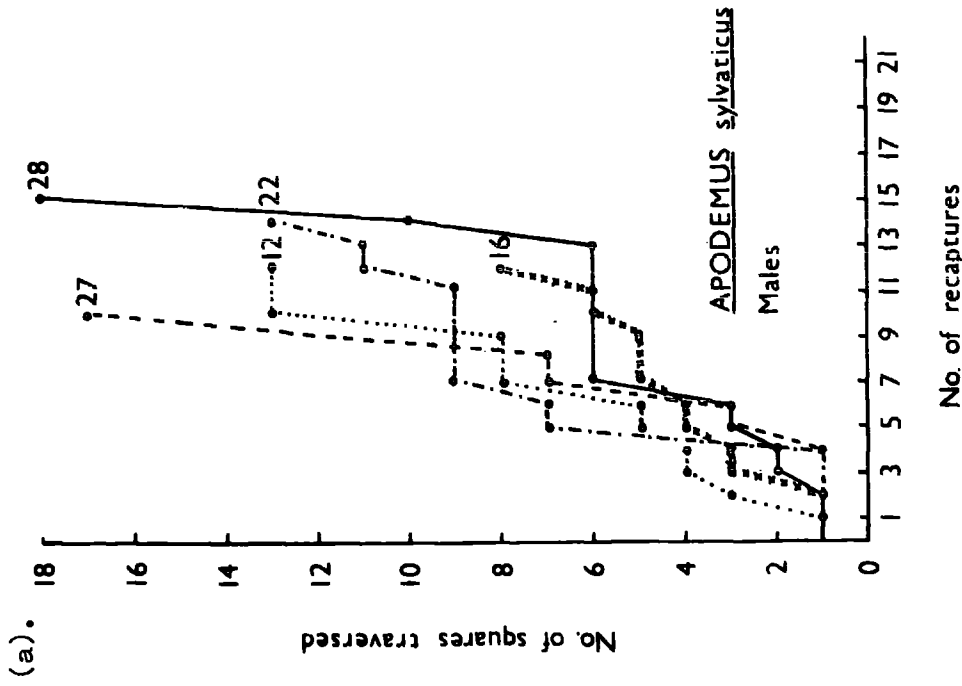

FIGURE 45. Graphs showing the increase in apparent home range size, with increased number of times recaptured, of five males (a) and five females (b) of Apodemus. The estimates of home range size were made using Manville's Method.

results of the two studies. One difference is that Brown found the home range of Apodemus females to be greater than that of Clethrionomys males; this was not so in the present study when Manville's Method was used. The estimates which Brown calculated for Apodemus far exceeded those found in the present study. With the other two methods of estimation the relative range sizes of the sexes of the two species are the same from the two studies, but the actual areas calculated by Brown (1956a) are almost twice as large as those found in the present study. This may be due to the wider trap-spacing used by Brown, but as the results for Clethrionomys with Manville's Method were similar in both studies it may be that the methods of estimation were applied wrongly by Brown. In the present study approximately 60% of the animals were restricted to one quadrat of area 250m.^2 ; Brown (1956a) found 60-70% to be similarly restricted although the area of the quadrat she used was 900 yds.^2 . This would indicate that a large proportion of animals enters the trap nearest to the home site, whether that trap is 18 yds. or 30 yds. distant. The range sizes calculated by Brown for Clethrionomys and Apodemus captured five or more times are more comparable with the range sizes calculated in the present study for animals captured ten or more times. This would suggest that the true home range may be revealed with fewer recaptures of the animal if wider trap-spacings were used. In effect, the trap-limitation factor may be reduced with traps

Species & Sex	Units	Manville's Method		Exclusive Boundary Strip		Minimum Area Method		Observed Range Length	
		Dene	Silwood	Dene	Silwood	Dene	Silwood	Dene	Silwood
<u>Clethrionomys glareolus</u> Males	m. ² yd. ²	1738 2079	1793 2144	1667 1994	3012 3602	818 978	1674 2002	63.0 68.9	54.0 59.1
<u>Clethrionomys glareolus</u> Females	m. ² yd. ²	1350 1615	1419 1697	1221 1460	2150 2571	428 512	1292 1545	48.9 53.5	43.9 48.0
<u>Apodemus sylvaticus</u> Males	m. ² yd. ²	2112 2526	2585 3092	2283 2730	3967 4744	1174 1404	2229 2666	73.4 80.3	59.1 64.6
<u>Apodemus sylvaticus</u> Females	m. ² yd. ²	1693 2025	2197 2628	1681 2010	3579 4280	925 1106	1813 2168	61.8 67.6	52.7 57.6

Table 93 . Estimates of average home range size for animals caught five or more times in the present study (Dene) compared with similar estimates calculated by Brown (Silwood). The areas are given in square metres (m.²) and square yards (yd.²).

spaced more widely. However, there is always the possibility that those animals with small home ranges may not be detected if trap spacings are too wide. Miller (1958) studied Apodemus populations using traps moved at random within 25 yard squares. He calculated home range size using the Observed Range Length Method. Miller's results, on animals captured three or more times, are presented in Table 94, along with the results obtained in the present study using Miller's techniques. The home ranges calculated in the present study are considerably larger than those obtained by Miller, particularly for female Apodemus. The maximum range sizes obtained by Miller were similar to those found in the present study, but the minimum range sizes were much smaller in Miller's work. It would seem that Miller (1958) included in his calculations many animals with home ranges just touching the periphery of the grid i.e. with the main area of the home range away from the grid. Such a procedure could certainly depress the average values he obtained. Kikkawa (1964) worked on both Apodemus and Clethrionomys in the area used by Miller (1958). He trapped a grid with a trap-spacing of 11 x 11 metres and analysed the movements and calculated the range size of both species. Kikkawa used Manville's Method of estimation on animals captured at least ten times in his range size calculations. He omitted from his calculations those animals which he considered to have changed their home range, and those which he regarded as 'wanderers',

Species and sex	Observed Range Length		Home Range Size	
	Pasticks	Dene	Pasticks	Dene
<u>Apodemus</u> Males	60.8m.	72.2m.	2903m. ²	5131m. ²
<u>Apodemus</u> Females	35.1m.	56.1m.	968m. ²	3272m. ²

Table 94. The Observed Range Length measurements, and the average home range size calculated from them, for Apodemus captured three or more times in the present study (Dene), and that of Miller (Pasticks; 1958).

or as having been involved in dispersal activities. His results for all animals captured ten or more times, and the adjusted estimates after omitting the animals mentioned above are given in Table 95, together with the exactly comparable results of the present study. There is close agreement between the adjusted values of Kikkawa's range size estimates and those of the present study. One difference is the larger estimate for Apodemus females obtained in the present study.

Tanton (1965) found Apodemus to have an average range length of 68 metres. This value is in agreement with that found in this study, and is larger than those quoted by Brown (1956a), Miller (1958), and Kikkawa (1964). Miller (1958) thought that his own and Brown's (1956a) estimates of home range may have been too high, but Tanton (1965) thinks they were too low. The results obtained in the present study tend to confirm Tanton's view that the estimated range sizes for Apodemus given by Brown (1956a) and Miller (1958) were too low. It is proposed here that their range size estimates for Clethrionomys were too low also.

The range sizes calculated in the present study for Apodemus and Clethrionomys with ten or more captures, using Manville's Method, are felt to be as accurate a measure of home range area as it is possible to obtain using live-trapping techniques. The average range sizes obtained were:-
2430m.² for Clethrionomys males, 1521m.² for Clethrionomys

Species and Sex	Units	Average Home Range (Original)		Average Home Range (Adjusted)	
		Dene	Pasticks	Dene	Pasticks
<u>Clethrionomys</u> Males	m. ²	2430	2208	1620	1515
	yds. ²	2906	2641	1938	1812
<u>Clethrionomys</u> Females	m. ²	1521	1124	1168	1124
	yds. ²	1819	1344	1397	1344
<u>Apodemus</u> Males	m. ²	3124	1816	1296	1228
	yds. ²	3736	2172	1550	1469
<u>Apodemus</u> Females	m. ²	2143	1124	1750	1006
	yds. ²	2563	1344	2093	1203

Table 95. Estimates of the average home range size of Clethrionomys and Apodemus from the present study (Dene), and estimates from the study of Kikkawa (Pasticks; 1964). In both studies the range sizes were calculated for animals captured ten or more times and Manville's Method of estimation was used. See text for explanation.

females, 3124 m.² for Apodemus males and 2143m.² for Apodemus females.

The ecological counterpart of Apodemus in North America is Peromyscus leucopus, commonly called the wood mouse. Many people have worked on the movements and home range of this species and varied estimates of range size have been quoted. Burt (1940) estimated the home range of males as 0.28 acres, and that of females as 0.21 acres, in animals living in an oak-hickory wood, while Nicholson (1941) found that few individuals were captured more than 200 feet from the point of first capture. Blair (1940b), working in the same area as Burt (1960), found the average range size of males and females to be 0.81 acres; he recognised that the mice foraged in adjoining grassland as well as in the wood. Wood-mice living in brush areas were found to have home ranges of between three and six acres (Blair 1943a). The woodland forms of Peromyscus leucopus had similar range sizes to that found for Apodemus males in the present study (0.77 acres). Various sub-species of Peromyscus maniculatus, the deer mouse, were found by various authors to have home ranges varying in size from 0.10 acres to 2.29 acres. (Blair, 1940a; Mohr, 1947; Manville, 1949; Morris 1955). These estimates are rather larger than those recorded for Apodemus in the present study. Range sizes have also been calculated for various species of Clethrionomys. Tanaka (1951) calculated the home range size of Clethrionomys

smithi as 0.15 acres. The same author (Tanaka, 1953) recorded the range size of Clethrionomys rufocanus as being from 0.19-0.54 acres. Several workers have estimated range size in Clethrionomys gapperi; Blair (1941c) found the range to vary from 0.49-3.56 acres, Manville (1949) estimated the average range as 0.23 acres, while Morris (1955) calculated the range as between 0.37 and 0.98 acres. These estimates are comparable with the values of 0.60 acres for Clethrionomys glareolus males, and 0.38 acres for Clethrionomys glareolus females obtained in the present study.

Although not directly comparable with the present work, it is of interest to note the range size estimates calculated for species of Microtus. Hayne (1950) found Microtus pennsylvanicus to have range sizes of between 0.07 and 0.58 acres. Blair (1941b) found a similar range of values (0.02-0.58 acres). The range size of Microtus montebelli was calculated as between 0.06 and 0.28 acres by Tanaka and Teramura (1953). Finally, for Microtus agrestis, Brown (1956a) found the home range to be between 0.06 and 0.70 acres, while Miller (1957) found an average value of 0.25 acres.

From this review of home range size in various species of Apodemus, Clethrionomys, Peromyscus, and Microtus certain impressions may be gained of the relative degrees of activity of the different species. Although methods of analysis have varied greatly in the works of different authors yet a fairly

consistent set of results for range of home range size has been compiled. The grassland and meadow voles of the genus Microtus tend to have smaller ranges than do woodland voles of the Clethrionomys group. This latter group in turn have smaller ranges than do the mice of Apodemus and Peromyscus species. The various species of Peromyscus have ranges varying greatly in size, but in general terms the range-sizes are comparable with those of Apodemus.

2. Factors affecting home range size

Many factors have been reported as affecting the size and stability of home range areas. Some of the factors are discussed here with reference to the present study.

a) Sex

In the present study the males of both species were observed to have larger home ranges than the females. Such sexual differences in range size have been reported for many species of rodents (Blair, 1942; Storer et al 1944, for Peromyscus maniculatus; Blair, 1940a, for Microtus pennsylvanicus; Chitty, 1937; Evans 1942; Brown 1956a; Miller 1958; and Kikkawa 1964, for Apodemus; and Brown 1956a and Kikkawa 1964 for Clethrionomys.) Many of these workers have suggested or supported the view that the smaller range size of the female is a result of the restriction to the nest-site imposed by the care of the young.

b) Age

The home range sizes of animals in the present study were observed to increase in size with increasing number of recaptures. As some of the recaptures were spread over several months it may be that the size of the home range was increasing as the animals grew older. That young animals do range over smaller areas than the adults has been confirmed by many workers on several different rodent species (Haugen 1942; Blair 1942; Evans and Holdenreid 1943; Fitch 1947; and many others).

c) Food habits

No information on possible variation in home range size according to food habits was obtained in the present study. It is of interest to note, however, that there is some indication that insect-eating species of small mammal range farther afield than do those which eat vegetation. This could well help to explain the greater size of home range in Apodemus compared with Clethrionomys. Blair (1943a) found that insect-eating Onychomys leucogaster, and Onychomys torridus range farther in the same habitat than do the nearly-related Peromyscus species which are primarily vegetation eaters.

d) Food and cover

Several workers have found that the area ranged over by small mammals tends to be larger where the cover is sparse and

smaller where it is dense. Protection and food are difficult to separate as factors influencing the movement, however. Blair (1940a) found that Microtus pennsylvanicus living in sparse bluegrass had larger ranges than those living in dense bluegrass. No significant relationships between cover and home range size were discovered in the present study although it is possible that the larger range sizes found for Clethrionomys and Apodemus in the larch area on grid A were associated with the sparse ground cover found there.

e) Season

Many workers have found range sizes of rodents to be smaller in the non-breeding season (Blair 1943a; 1951a; Brant 1962;). In Apodemus and Clethrionomys in the present study movements were found to be of greater length in the breeding season, particularly in the males, so the range size would be larger then than in the winter.

3. The value of the home range concept.

From the results of the present study, and from an exhaustive study of the literature on home range in rodents, certain opinions have been formed concerning the biological validity of the home range concept and its usefulness as a comparative index of activity. In view of the reported effects on the home range size of season, food supply, age, sex,

population density, habitat etc., it seems that the definition of home range area should have incorporated into it a time factor e.g. "...that area normally traversed by the individual within a specified period of time." The practice of quoting home range area is regarded as of no value unless the following information is also given:-

- 1) the method used to collect the data e.g. live-trapping on a grid,
- 2) the period of time over which the records were made,
- 3) the season, and the habitat, in which the data were recorded,
- 4) the age, sex and breeding condition of the individuals,
- 5) the method of estimation of range size used,
- 6) the population density of the species,
- 7) the importance of territorial behaviour in the species.

Provided that the information listed above is forthcoming then the home range area is to be regarded as a biological reality. In effect, the distinction ought to be made between two types of home range with reference to an individual:-

- i. the total area traversed with some degree of regularity throughout the recorded life-span of the individual,
- ii. that area within the total area which is regularly traversed within short specified periods of time under specified environmental conditions.

Where average home range sizes are required for a population of animals then the distinctions noted above should be taken into consideration, and the range of values quoted as well as the calculated average range size for the population.

SECTION E

**THE BIOCHEMICAL ANALYSIS
OF STOMACH CONTENTS OF
CLETHRIONOMYS AND APODEMUS**

SECTION E. THE BIOCHEMICAL ANALYSIS OF STOMACH CONTENTS
OF CLETHRIONOMYS AND APODEMUS

I. INTRODUCTION

When the present investigation into the ecology of Clethrionomys and Apodemus began in October 1962 one of the original intentions was to carry out studies on the food and feeding behaviour of the two species. One way in which it was planned to examine the food ingested was to carry out biochemical analyses of the stomach contents of randomly selected individuals. It was hoped to determine the proportions of fats, proteins and carbohydrates in the contents, and to see if the average proportions differed between the two species, or differed seasonally in either species. This part of the programme was carried out for one year (1963) but was curtailed when the whole subject of food preference and feeding behaviour was taken over by Mr. N.H. Cleminson. During 1963 samples of animals were obtained by break-back trapping on transects 3-5 (see Fig. 2) in the four seasons of the year, and analyses were performed on the stomach contents. A great deal of time and effort was expended before workable techniques were devised, and suitable apparatus obtained, to carry out biochemical analyses on the micro-scale required. As a consequence of this, and of the many samples wasted through experimental errors, the results are scanty and of doubtful value. However,

as the concept of the whole study was exploratory it is felt to be desirable to describe the methods of analysis which eventually provided satisfactory results, in the hope that future workers may avoid many of the teething troubles. The actual results of the analyses are presented also, although their significance is doubtful for two main reasons:-

- 1) individual variation was found to be great, and hence samples were too small,
- 2) many of the earlier analyses were performed in apparatus which was not sufficiently accurate in view of the small amounts of material available.

Despite the drawbacks freely mentioned above, the study is felt to be of some value in that the techniques have been found to be workable, and could well be used in association with microscopical examination of stomach contents.

II. METHODS OF STUDY

1. The preparation of the samples for analysis

Every animal was weighed and the stomach was removed immediately the animal was brought into the laboratory. After removal the stomach plus contents was weighed and the weight recorded. Each stomach was then slit open and the contents transferred to a clean dry watchglass, every effort being made to remove any contents adhering to the stomach wall. The wet

stomach contents were then weighed, and as a check the stomach wall was also weighed and the weight was subtracted from that of the stomach and contents to give another weight for the wet contents by difference. After the weighings each set of wet stomach contents was dried to Standard Dry Weight in an oven (three hours at 102° c.). After drying the contents were again weighed and the weight of water found by difference from the wet weight previously recorded. The weight of water was then calculated as a percentage value of the wet weight of the contents. After this treatment the samples were ready for analysis by the techniques described below.

2. The quantitative estimation of fat content using the Soxhlet Apparatus

a) The principle of the method

For the purposes of this investigation the term 'fat' is used where a more accurate term would be 'ether-extracted material'. The extraction by ether removes not only true fats but also oils and waxes, but as this is unimportant in the present context the term 'fat' is used in this general way. The extraction is based quite simply on the fact that the fat may be removed from a material by treatment with ether. The apparatus in which this procedure may be carried out is described below.

b) The Micro-Soxhlet Extraction Apparatus

The Micro-Soxhlet apparatus for fat extraction is shown in Plate 7. The apparatus is simple in design and construction, there being only three sections to it. At the top is a reflux condenser, in the middle an extraction chamber with a siphoning device, and at the bottom a flask which contains the ether. In an extraction the material to be extracted is placed in the extraction chamber, the flask is half-filled with ether, and cold-water is circulated through the condenser. The flask is heated in a water-bath and the ether volatilises and rises into the extraction chamber and the condenser. In the latter it liquefies again and the liquid collects in the extraction chamber and covers the material present there. On reaching the level of the siphon the ether siphons off and drains into the flask carrying the extracted fats with it. On re-entering the flask the ether volatilises again but the fat remains in the flask. After several cycles the extraction is complete and the quantity of fat collected in the flask is determined. The exact procedure followed in the present study, together with the details of the weighings made etc. are presented below.

c) The procedure followed in the estimation of fat content in a prepared sample

Each prepared sample was finely ground up and placed in a special quality fat-free filter-paper thimble. The

PLATE VII

THE MICRO-SOXHLET APPARATUS.

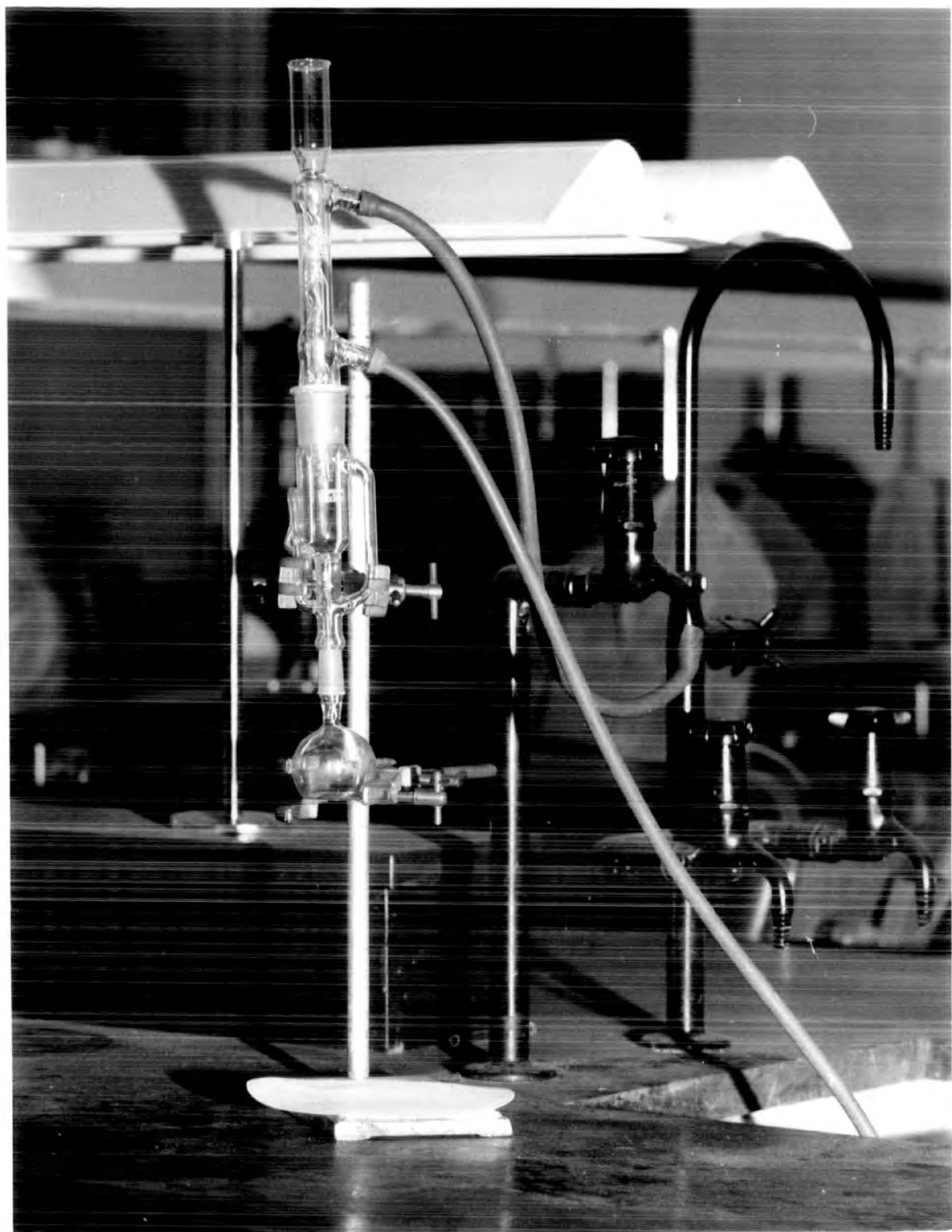

instruments used to grind up the sample were washed in ether and the washings added to the thimble. Chips of porcelain were placed in the flask to prevent 'bumping' and the whole was then weighed. After weighing the flask was half-filled with ether. The thimble plus contents was then placed in the extraction chamber, the whole apparatus connected up, and the flask heated in a water-bath on an electric coil. On warming the ether volatilises as described in b) above and the siphoning procedure commenced. The ether was allowed to siphon off at least 12 times to ensure that all the fat was removed from the sample. When most of the ether was in the extraction chamber the flask was disconnected and the experiment discontinued. The ether in the flask was evaporated off and the flask was placed in a steam-oven for thirty minutes. After removal from the steam-oven the flask was allowed to cool in a dessicator and was then weighed. After the final weighing the percentage of fat contained in the original sample was calculated by use of the formula given below:-

$$\% \text{ fat in sample} = \frac{100 (y-z)}{x} \quad \text{where } x = \text{weight of material,}$$

$$y = \text{weight of flask and chips and fat,}$$

$$z = \text{weight of flask and chips,}$$

$$y-z = \text{weight of fat.} \quad e.$$

This procedure was carried out for all the samples examined in the study.

3. The quantitative estimation of 'crude protein' using the Kjeldahl Method for the determination of Total Nitrogen

a) The principle of the method

A sample of the material is boiled with concentrated sulphuric acid (H_2SO_4) with the addition of potassium sulphate to raise the boiling point, and copper sulphate to catalyse the oxidation of the carbon and hydrogen. The digestion process is prolonged to ensure that all the nitrogen is converted into ammonia. When the digestion is complete the acid digest is made alkaline by the addition of sodium hydroxide and the ammonia thus set free is distilled into a measured amount of boric acid and titrated by hydrochloric acid. The nitrogen value of the sample may be calculated from the titration result (see below) and this is then multiplied by 6.25 to convert into terms of protein. This value of 6.25 is derived from the fact that most proteins contain about 17% of replaceable nitrogen.

b) The Markham Micro-Kjeldahl Apparatus

The Markham Micro-Kjeldahl Apparatus is shown in Fig. 46 and Plate 8. The complete apparatus consists of three main units; there is a large round-bottomed flask for the production of steam, the main reaction vessel or Markham still, and a condenser. The Markham still consists of a funnel, a

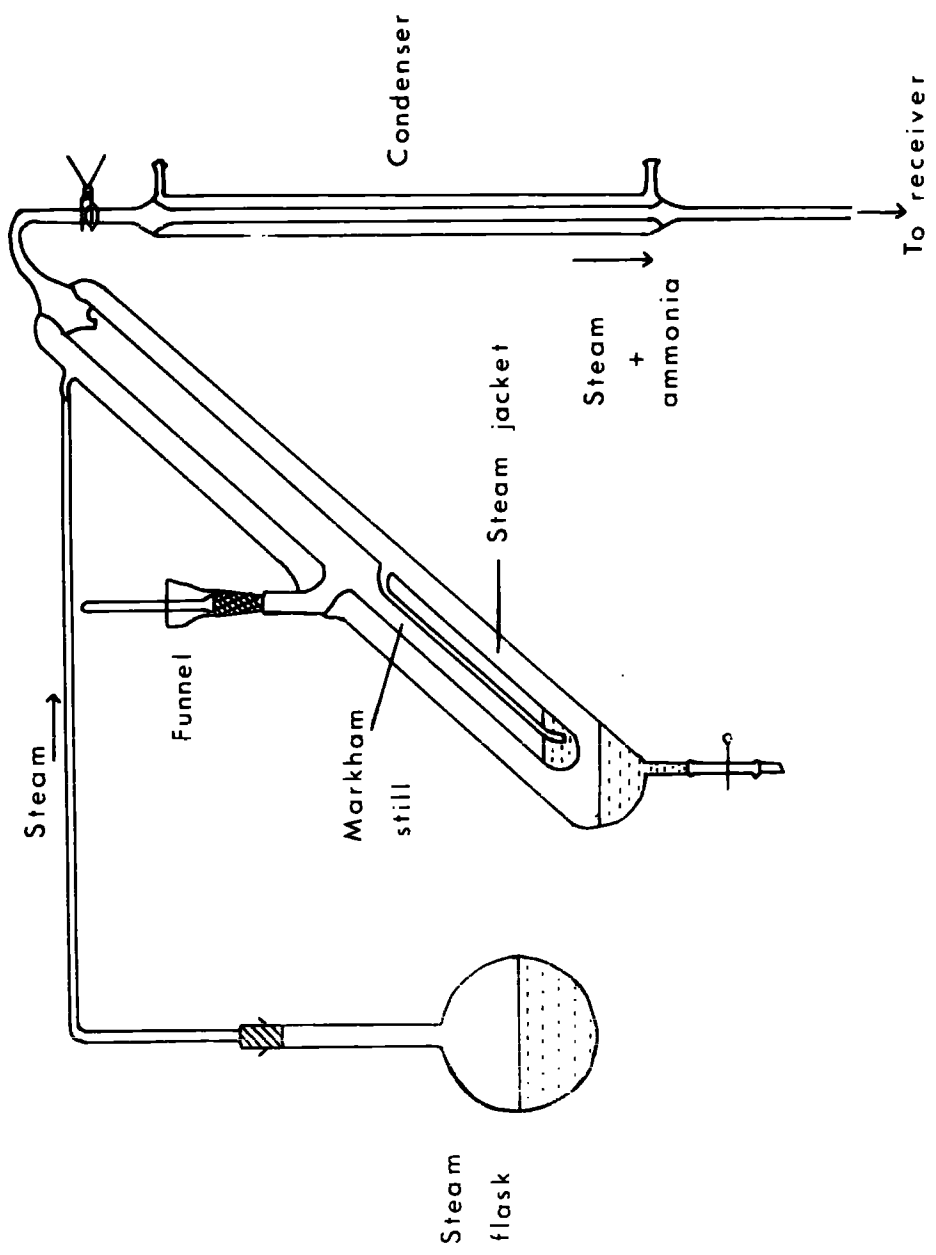

MARKHAM MICRO-KJELDAHL APPARATUS

FIGURE 46. The Markham Micro-Kjeldahl Apparatus used for the estimation of protein content of stomach contents of Clethrionomys and Apodemus.

PLATE VIII

THE MARKHAM MICRO-KJELDAHL APPARATUS.

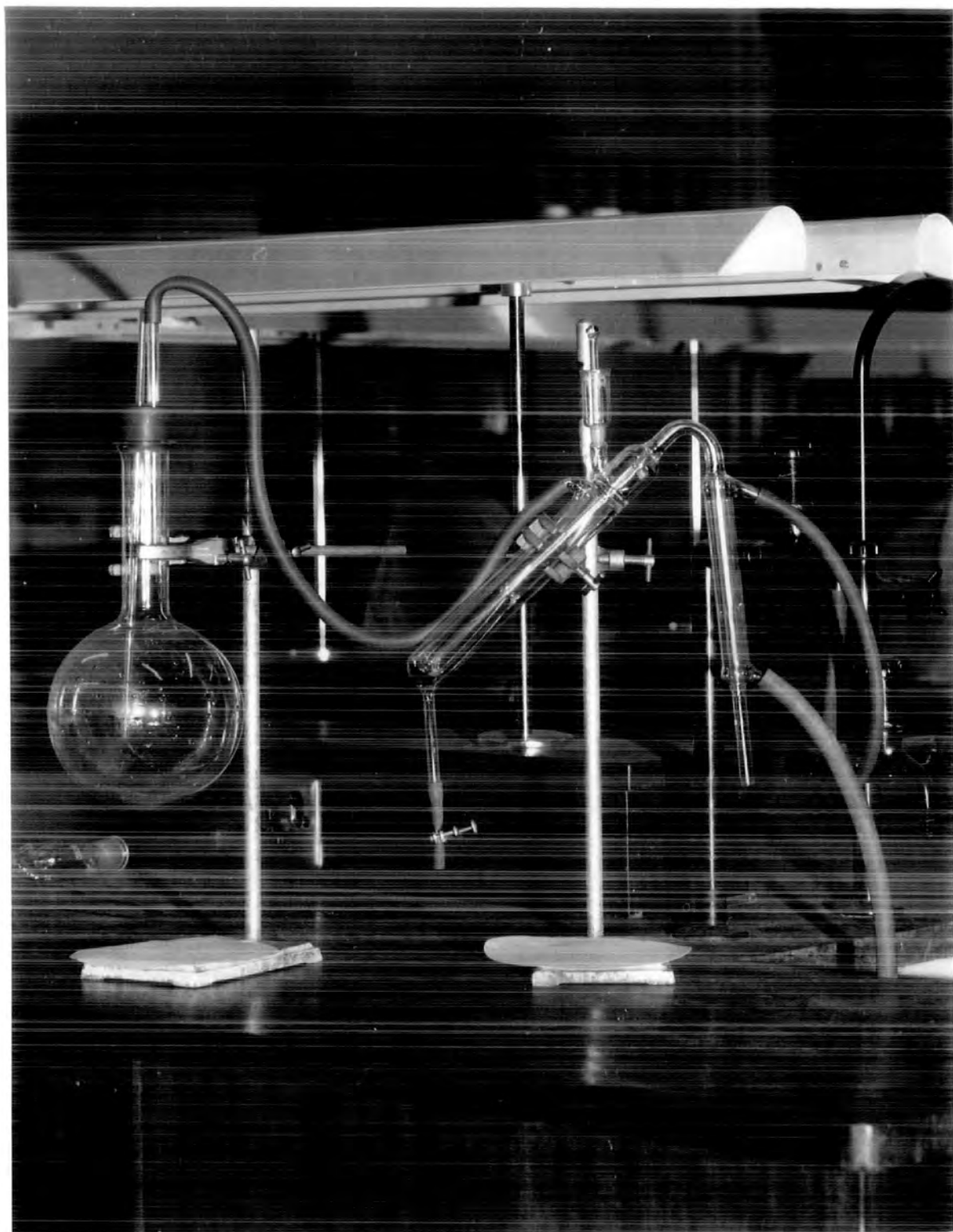

reaction chamber, and a steam-jacket. The still is cleaned by removing the burner from beneath the steam generator so that the contents of the reaction chamber suck back into the steam-jacket. Replacing the burner causes more water to accumulate in the reaction chamber, which is again sucked into the steam-jacket. This is repeated two or three times. Before using, steam is passed through the apparatus for about 20 minutes. When using the apparatus care must be taken to ensure that the delivery tube is arranged below the surface of the boric acid in the receiver.

c) The procedure followed in the estimation of the 'crude protein' content of a prepared sample

Each prepared sample for the protein estimation was fat-free after the fat-extraction procedure had been followed. After all the ether had been evaporated off and the sample was removed from the thimble it was carefully weighed. After weighing, the sample was placed in a micro-Kjeldahl round-bottomed flask and to it was added 0.5 grams of potassium sulphate, three drops of copper sulphate, and 2 mls. of concentrated sulphuric acid. The flask was then placed over a micro-burner in a fume cupboard and gently heated until the mixture was colourless (approximately 4 hours) and then for a further 30 minutes. If, after this time, the liquid was clear and free from any appearance of charring the flask was removed

from the flame and allowed to cool for 5 minutes. Approximately 20 mls. of distilled water were then slowly added to the flask which was rotated all the while to allow the water to rinse the neck of the flask. The flask was then allowed to cool again. The sample was at this stage ready for transference to the micro-Kjeldahl apparatus.

Into a conical flask was measured 10 mls. of 2% boric acid containing a mixed indicator of methyl red and bromcresol green; this flask was placed beneath the main outlet from the condenser in such a way that the outlet was beneath the level of the acid. After ensuring that cold water was passing through the condenser the sample was poured into the reaction chamber of the apparatus and the flask and the neck of the funnel washed with distilled water which was added to the sample. Some 20% NaOH was then added to the sample until the liquid became alkaline (deep blue); when this happened the burner was placed under the flask and the distillation was commenced. The distillation was continued for about fifteen minutes during which time the steam produced in the water flask carried over with it into the receiver all the ammonia formed in the reaction. After the distillation was complete the heat was removed and the reaction-chamber automatically emptied itself. The apparatus was then cleaned out using distilled water.

The liquid in the receiving vessel was titrated with $N/10$ hydrochloric acid to a red endpoint. The 'crude protein'

content of the original sample was then determined by performing the calculation given below:-

$$\begin{aligned}
 1 \text{ ml. of normal (N) acid} & \equiv 14 \text{ mg. nitrogen} \\
 1 \text{ ml. of } N/_{10} \text{ acid} & \equiv 1.4 \text{ mg. nitrogen} \\
 \therefore 'x' \text{ mls. of } N/_{10} \text{ acid} & \equiv 1.4x \text{ mg. nitrogen}
 \end{aligned}$$

1.4x mg. of nitrogen would be formed from $6.25 \times 1.4x$ mg. of 'crude protein', therefore the amount of 'crude protein' in the original sample = $8.75x$ mg.

This value of 'crude protein' was then expressed as a percentage of the dry weight of the original sample.

4. The 'total carbohydrate' portion of the sample

The food of the mice and voles consists essentially of what may be termed 'free water' and 'solids'. The 'free water' is the amount of substance lost in drying the material under specified conditions of analysis (as above, p.270). That which is not moisture constitutes the 'solids' and is made up of protein, fat, carbohydrate, and ash. Apart from moisture, protein, and fat (the methods for determining which have been described) carbohydrate is the only other constituent of food that may occur in large quantities. In the present investigation the 'total carbohydrate by difference' was determined by deducting the dry weight of protein and fat from the dry weight of the sample. In fact this total carbohydrate value

includes also the ash content and any organic acids present in the sample. No attempt was made to estimate the amounts of crude fibre in the samples although techniques for this are usable. The 'total carbohydrate' includes therefore the sugars, dextrans and starches, the crude fibre (mainly cellulose), and the ash (various minerals).

5. The final data recorded for each sample after analysis

When the procedures described above had been carried out the following information on the composition of the food sample was available:-

- i. the moisture content,
- ii. the percentage by weight of fat (ether-extracted material),
- iii. the percentage by weight of 'crude protein',
- iv. the percentage by weight of 'total carbohydrate'.

In the results section which follows these four values are given (as means) for the seasonal samples of both species.

III. RESULTS

1. Clethrionomys

Full analyses were performed on 262 Clethrionomys individuals; no record was made of their sex. The details of the seasonal average weight of the animals, of the stomach contents wet, and of the stomach contents dry are given in

Table 97, together with the average percentage water content of the samples. As may be seen from the size of the standard errors of the mean values given there was a great range of recorded weights of stomach contents.

a) Water content of the samples

The mean water content of the samples never dropped below the value in summer of 73.33%, and the highest moisture content was found in the samples taken in the winter and spring (almost 90%). No significant difference between the seasons was found with regard to water content of the stomach contents samples, but there was an indication that less water was present in the samples in the summer and autumn.

b) The 'crude protein' content of the samples (Table 99, Fig.47)

Very little variation was found in the protein content of the samples taken in different seasons, and such variation as there was in the mean values fell within the standard errors of the means. The protein content was found to be less than 10% in all seasons.

c) The fat (ether-extract) content of the samples
(Table 99, Fig. 47)

There was considerable fluctuation in the seasonal values of the fat content in the samples. In summer the percentage fat

SEASON	<u>APODEMUS</u>			
	Avg. Wt. of animal in sample. (gms.)	Avg. Wt. of contents wet. (gms.)	Avg. Wt. of contents dry (gms.)	% H ₂ O
Spring	24.40 ± 5.3	1.46 ± 0.96	0.36 ± 0.22	79.96 ± 21.3
Summer	26.00 ± 6.2	1.20 ± 0.80	0.36 ± 0.20	73.00 ± 18.4
Autumn	21.7 ± 4.3	1.37 ± 0.91	0.34 ± 0.22	77.42 ± 23.1
Winter	20.5 ± 2.1	1.40 ± 1.00	0.28 ± 0.19	84.40 ± 17.3

Table 96 Details of the average weight of Apodemus in the seasonal samples and the average water content of their stomach contents.

SEASON	<u>CLETHRIONOMYS</u>			
	Avg. Wt. of animal in sample. (gms.)	Avg. Wt. of contents wet. (gms.)	Avg. Wt. of contents dry (gms.)	% H ₂ O
Spring	22.3 ± 3.1	1.21 ± 0.99	0.28 ± 0.20	87.60 ± 14.40
Summer	19.9 ± 5.4	1.09 ± 0.74	0.27 ± 0.14	73.33 ± 22.1
Autumn	21.0 ± 4.0	1.26 ± 1.10	0.13 ± 0.06	80.02 ± 17.6
Winter	17.6 ± 2.3	0.98 ± 0.61	0.19 ± 0.09	88.75 ± 22.3

Table 97 Details of the average weight of Clethrionomys in the seasonal samples and the average water content of their stomach contents.

was 33%, and in spring it was only 11.7%. However, again there was a great deal of variation between individual samples and hence the standard errors of the means were large.

d) The 'total carbohydrate' content of the samples
(Table 99, Fig. 47)

The total 'carbohydrate' fraction of the samples was much the most important quantitatively in all the seasons. There was considerable variation in the seasonal mean values, however, which ranged from 57.7% of the sample dry weight in summer, to 80.4% of the sample dry weight in spring. The 'total carbohydrate' fraction was of course directly dependent upon the amounts of fat and protein found in the samples, as its value was found by difference.

2. Apodemus

Full analyses were performed on 174 Apodemus individuals. The seasonal sample sizes are given in Table 98 along with the mean values of the percentage fat, protein, and carbohydrate found to be present in the samples. The average weight of the animals used in the study, and of the stomach contents may be seen in Table 96 together with the seasonal percentage water content of the samples.

Season	<u>APODEMUS</u>			
	% Crude Protein.	% Fat (ether extract)	% Total Carbohydrate (Fibre & ash)	No. in Sample
Spring	23.4 ± 7.6	46.1 ± 14.7	30.5 ± 10.2	31
Summer	28.5 ± 8.2	43.0 ± 13.2	28.5 ± 9.8	16
Autumn	17.6 ± 4.3	36.4 ± 9.7	46.0 ± 13.0	80
Winter	9.8 ± 3.1	22.0 ± 8.2	68.2 ± 21.4	47

Table 98. The percentage of crude protein, fat, and total carbohydrate in the stomach contents of Apodemus.

Season	<u>CLETHRIONOMYS</u>			
	% Crude Protein	% Fat (ether extract)	% Total Carbohydrate (Fibre & ash)	No. in Sample
Spring	7.9 ± 3.7	11.7 ± 5.6	80.4 ± 17.0	40
Summer	9.3 ± 5.0	33.0 ± 19.0	57.7 ± 23.1	66
Autumn	8.9 ± 4.2	17.4 ± 8.6	73.7 ± 24.2	104
Winter	7.6 ± 3.7	21.4 ± 10.5	71.0 ± 21.0	52

Table 99. The percentage of crude protein, fat, and total carbohydrate in the stomach contents of Clethrionomys.

a) Water content of the samples

The mean water content of the samples varied from 73% in summer to 84.4% in winter. Considerable individual variation was found to be present in the samples collected each season. As in Clethrionomys the mean water content of the samples was lowest in spring and summer.

b) The crude protein content of the samples

(Table 98, Fig. 47).

Considerable proportions of protein were found to be present in spring, summer and autumn. Even the winter value of 9.8% was larger than the largest protein content recorded for Clethrionomys in the summer (9.3%). The highest seasonal average protein content was found to be in summer (28.5%). Individual variation was found to be great, but the difference from the situation in Clethrionomys is evident.

c) The fat (ether-extract) content of the samples

(Table 98, Fig. 47)

The fat content was considerable in all the seasonal samples, ranging from 46.1% in spring to 22% in winter. As with the protein fraction the values are far higher than were recorded for Clethrionomys.

d) The total 'carbohydrate' content of the samples
(Table 98, Fig. 47)

In accordance with the results of the fat and protein estimations the carbohydrate fraction was much lower than was found in Clethrionomys. The highest value was 68.2% in winter, and the lowest was 28.5% in summer.

3. A comparison of the results of the analyses of the stomach contents of Clethrionomys and Apodemus

As has been emphasised throughout this section the results obtained must be considered warily if they are to be regarded as being at all representative of the general situation in Clethrionomys and Apodemus. However, if these doubts are borne in mind then it may be suggested that there is a genuine difference in the composition of the food ingested by Clethrionomys and Apodemus, and that the difference varies seasonally. In all seasons the protein content of the Apodemus stomach contents was higher than that of the Clethrionomys stomach contents, and this was very marked particularly in spring and summer. This situation was found to prevail also with the fat content of the samples in the two species, although to a lesser extent. Conversely, the carbohydrate content of the samples from Clethrionomys was considerably higher than in the samples from Apodemus.

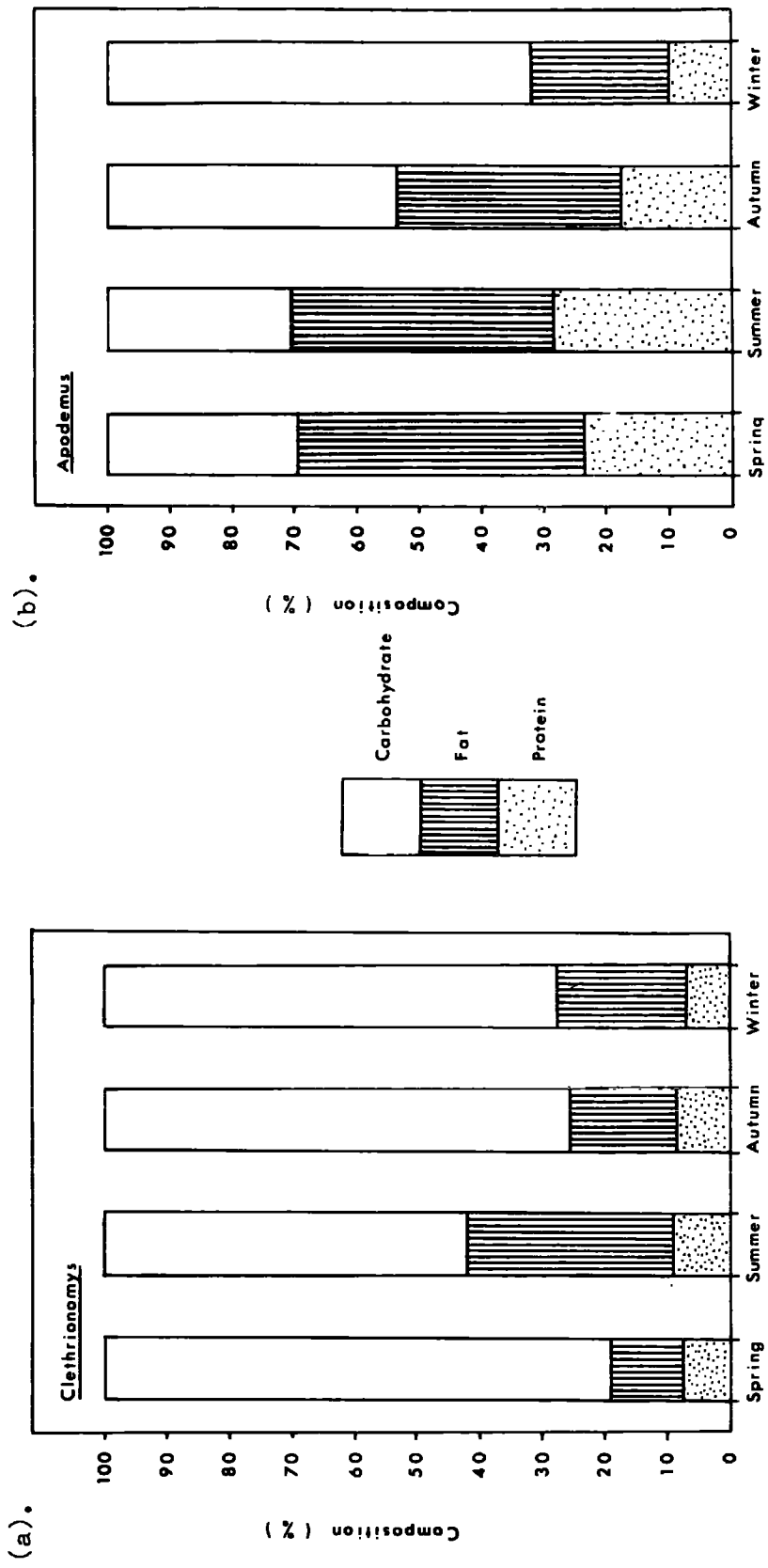

FIGURE 47. The percentage composition, in terms of carbohydrate, fat, and protein, of the stomach contents of Clethrionomys (a) and Apodemus (b) in the four seasons of 1963.

From the extremely limited data available it is dangerous to draw conclusions relating to the diet of the two species. However, the extremely high fat and protein content of the samples of Apodemus stomach contents taken in the spring and summer suggest that a great deal of animal material may be ingested. The higher fat content and fractionally higher protein content of the samples taken from Clethrionomys stomachs in the summer suggest that Clethrionomys also may take animal food at that time. These conjectures are based on the fact that animal material is usually rich in fat and protein, with smaller amounts of carbohydrate, whereas plant material is rich in carbohydrate with greatly varying amounts (but usually small) of fat and protein depending upon the plant concerned. Such theories as those would fit in well with the reported preference of Apodemus for animal (mainly insect) food in the seasons when it is readily available (Miller, 1954; Curry-Lindahl, 1956; Holisövä, 1960; Kikkawa, 1964; Tanton 1965; Gorecki and Gebczyńska 1962).

IV. CONCLUSIONS

The methods described above for the estimation of the amount of fat and protein in a sample of ingested food material have been shown to work. If such studies are to be undertaken, however, it is suggested that they are carried out in association with other work on food including:-

- i. work on food preference by means of food choice experiments,
- ii. analysis of available food material using the same techniques as are used for the analysis of the stomach contents,
- iii. microscopic analysis of the food in the gut,
- iv. microscopic analysis of the faeces,
- v. analysis of the faeces by the described techniques.

If all these procedures are carried out then sufficient information should become available to allow accurate statements about the type of food ingested by the animals to be made. In addition, basic data for possible work on the energetics of the animals may be accumulated.

SECTION F

GENERAL DISCUSSION AND SUMMARY

GENERAL DISCUSSION

Detailed discussions of the population dynamics, the movements and home range, and the spatial distribution of Clethrionomys and Apodemus have been presented in the appropriate sections. In this more general discussion the study as a whole is briefly reviewed and some of the results are considered with relation to wider fields of knowledge.

1. A brief review of the present study

Two annual cycles of two populations of Clethrionomys and one of Apodemus have been described in the present study. With the exception of the realisation that Clethrionomys individuals may travel considerable distances (at least 375 metres) no startling new discoveries have been made about the ecology of the two species, but confirmatory evidence on several points concerning the population dynamics and movements has been obtained, and knowledge of the spatial distribution of Clethrionomys with regard to the vegetation of the field layer (Elton and Miller 1954) has been added to. Of particular interest is the demonstration in the present study of the existence of seasonal variation in the movements and the distribution of Clethrionomys. In addition an attempt has been made to clarify the methods of estimation of home range, and hence to clarify the concept itself. Finally, techniques have been developed for the analysis of the

stomach contents of the two species in the hope that some information of value may be obtained to supplement microscopic studies of the food of the rodents.

2. Factors affecting population size

Affecting any population are a number of factors that serve to regulate its numbers. These factors are discussed in great detail in a number of major works (Allee et al 1949; Andrewartha and Birch 1954; Dice 1952; Elton 1942; Lack 1954; Slobodkin 1962). Briefly, any population at a given time is the result of the interaction of the forces of reproduction, mortality and movement. Reproduction tends to increase the population, mortality tends to decrease it, and movements may increase or decrease it depending upon the net result of immigration and emigration. The factors of physical habitat (environment), predation, and competition affect the action of the three forces mentioned and thus may exert a regulatory effect on the population. The effects of environmental factors e.g. weather, have been generally considered to be density-independent, but Andrewartha and Birch (1954) doubted the existence of density-independent factors, and Chitty (1960) stated that his "...vole work suggests that population densities are indeed governed or regulated but that this is most commonly achieved by the action of the physical factors and since the action of any factor depends upon the properties

of the individual, it seems a priori improbable that the effects of weather are independent of population density." In the present study sudden hard frosts following mild periods of weather were observed to be associated with severe mortality in Clethrionomys, a factor perhaps increased in its effect by artificial interference i.e. trapping, preventing animals from behaving normally. The question of mortality in animals with cyclic fluctuations in numbers has been examined critically in a series of publications by Chitty (1957, 1959, 1960), Christian (1956 etc.), Pitelka (1957), Chitty (1960), Christian (1961), and Frank (1957) consider that stress conditions in high population densities may be responsible for the dramatic declines in numbers which occur in voles and lemmings, but they differ in their views of the exact mechanisms involved. Chitty (1960), and Christian (1961), however, agree that the effect of both 'density-independent' e.g. weather, and density-dependent e.g. predation, factors is increased because of the lowered resistance of individuals to them. Pitelka (1957) supports the view of Lack (1954) that food is one of the causative factors in population declines, but that this is unlikely has been demonstrated by Krebs (1964), Bendell (1959) and Gorecki and Gebczyńska (1962). Clethrionomys glareolus has not been regarded as being subject to cyclic fluctuations in numbers, although Ashby (1962; pers. comm.) as a result of studies made on Clethrionomys populations in Houghall Wood,

Durham, from 1954, suggests that there is a cyclic fluctuation of approximately four years periodicity in that particular locality. The present study, being of less than 3 years duration, has little, if any, relevance to the question of cyclic fluctuations and hence nothing more need be said on this subject, interesting though it may be.

Predation can be a density-dependent factor but in most populations of mammals its effect has been demonstrated to be small at most times, and negligible in the breeding season - particularly of rodents. Lockie, Charles, and East (1962) found that predation on a population of Microtus agrestis by stoats, weasels, and short-eared owls was the most important single mortality factor in winter. They also found, however, that predators could not cope with the rapid production of young voles when breeding got under way, and other checks on population size came into operation. Similar demonstrations of the small effects of predation have been described by Southern (1940, 1954), Jackson (1951), Peters (1948), and Davis (1951c). In the present study it is probable that predation effects by weasels or Tawny owls were negligible as only two weasels were caught on grid A after November 1962, although six were caught on grid B (see Table 112).

Competition, which may be regarded as the direct struggle between individuals for a limited supply of environmental necessities (Solomon, 1949), may affect the reproduction,

mortality, or movements of a population. Calhoun (1952) reported that competition among Norway Rats drove the weaker animals away, and Steiniger (1950a) found the aggressive defence of territories to be responsible for the dispersal of young. Frank (1957) obtained similar results to those above with populations of Microtus arvalis. It seems then that competitive mechanisms such as hierarchy and territorialism serve to keep the population within the limits set by the environmental resources.

In the present study, the recruitment of individuals, as revealed by the capture of juveniles, was sufficient to account for the increases in population size, despite the fact that the calculation of mortality rates revealed that there was a high juvenile mortality throughout most of the breeding season. There is no reason to believe that immigration or emigration were having any untoward effects on estimates of population size, particularly in the non-breeding season. With Apodemus very few individuals were captured in the period from May to September, and those which were captured were adults, so the annual cycle of events is less well known in Apodemus than it is in Clethrionomys. Chitty (1964) considers that adult behaviour towards juveniles in rodents is aggressive to the extreme during the breeding season, this resulting in a heavy juvenile mortality. Chitty is of the opinion that such aggressiveness is at least partially responsible for falls

in numbers in vole populations. Chitty's views have recently been supported by Sadleir (1965) who studied agonistic behaviour in populations of Peromyscus maniculatus, the white-footed mouse. Sadleir suggests that the main factor determining population size in Peromyscus maniculatus is the low recruitment of young into the population compared with the number of embryos carried by pregnant females. He agrees with Chitty that the large juvenile mortality is due to the behaviour of the adults toward them. Peromyscus maniculatus is not territorial but it does have a home-range (McCabe and Blanchard 1950), and during the breeding season the juveniles are driven away from the adult home-range areas. The lack of "a place in which to live" (Andrewartha and Birch 1954) together with the effects of predation and possibly of shock will certainly, in Sadleir's (1965) view, result in the death of the juveniles. Only those juveniles fortunate enough to find a home-range newly-vacated by an adult, or those which survive long enough to deprive a low-aggression adult of its home-range may survive to maturity. Sadleir (1965) reported that the number of juveniles entering the traps rose rapidly at the end of the breeding season, and he suggests that this is due to a newly-evident lack of hostility on the part of the adults, possibly due to the regression of testicular and ovarian activity at the end of breeding, with a consequent lowering of the sexual hormone level and a diminution of

aggressive behaviour. The results of Sadleir's (1965) work are of interest in the present discussion because it is possible that such a mechanism as he describes for Peromyscus maniculatus could apply to Apodemus also. As has been stated elsewhere (pp.105-110) only an occasional juvenile was caught during the breeding season in the present study, yet there was a tremendous influx of sub-adults into the traps in October and November. Full consideration is given to the question of Apodemus population dynamics in another place (pp. 50-77) but it could well be that a mechanism working in the way described by Sadleir (1965) is at least partially responsible for the magnitude of the influx, and particularly for the high proportion of sub-adults in the influx.

3. Habitat and the ecology of Clethrionomys

In Section C the close relationship between the spatial distribution of Clethrionomys and the distribution of the vegetation of the field layer (Elton and Miller 1954) has been demonstrated. It is suggested that this dependence upon vegetation cover is a fundamental and vital one in the life of Clethrionomys. The avoidance of open areas by Clethrionomys has been observed by many workers and was particularly evident in the present study. The high degree of diurnal activity displayed by Clethrionomys has been revealed in many trapping studies (Brown 1954; Miller 1958; Kikkawa 1964) and by

experiments on activity rhythm carried out in the laboratory (Miller 1955; Brown 1956b). Conversely, Apodemus has frequently been captured in areas completely devoid of vegetation (Evans 1942; Miller 1958; Fullager et al 1963) and has been found to have a distinct and exclusive nocturnal activity period (Miller 1955; Brown 1956b). The suggested importance of light as an inhibitor of Apodemus activity (see p. 170) has frequently been remarked upon as various workers have found, as was found in the present study, that poor catches were made after moonlight nights (Gentry and Odum 1957; Tanton 1965). By inference, then, it seems that Apodemus is less tied to cover than is Clethrionomys at least partially because of the protective darkness during activity periods. Cover would seem to be vital to Clethrionomys for protection from predators, and also, as the vole is mainly vegetarian in diet (Gorecki and Gebczyńska 1962), for food supply. Again, particularly in the summer, Apodemus, with its demonstrated preference for insects and seeds (Gorecki and Gebczyńska 1962), would seem to be less dependent upon association with vegetation cover.

The habitats occupied by Clethrionomys in the present study may be divided into superior and marginal areas in terms of the degree of protective cover afforded by the vegetation of the field layer. The superior habitats were occupied during population lows and the marginal areas were occupied in

addition to the superior ones in population highs. The classification of habitat in the present study depended more upon the degree of protective cover afforded by vegetation than upon its nature (although the most dense cover was almost invariably provided by bracken and bramble). Goertz (1964) studied populations of Sigmodon hispidus, the cotton rat, and he found that the percentage of captures of Sigmodon corresponded positively with the density and the height of the grassy cover and herbaceous ground cover. He found that the dense tree canopies were correlated negatively. From the results of the present study and that of Goertz (1964) it would seem that the weather could act as a density-dependent factor in the winter decline of numbers through the preservation of those individuals that occupied superior habitat. This suggestion is in agreement with the remarks of Naumov (1936) to the effect that an animal population will utilise only favourable habitats at low population densities, but will spread to less favourable ones as population density increases, and will finally occupy all available habitats at peak population density. Evans (1942) suggested that marginal habitats may be essential for the survival of a population in the event of an epidemic or similar catastrophe, he based his views on the 'fact' that increased contact in crowded habitats would facilitate the spread of a disease or parasite. This has never been demonstrated to be true, and all the evidence from the present

study is against Evans' views. The decreases in population size affected all habitats, and those animals in marginal habitats either died or moved into more favourable areas, until eventually the only survivors were in superior habitats.

4. The trappability of Clethrionomys and Apodemus

At times when there is no competition for traps, trappability will depend entirely upon the degree of interest in the traps. In order to investigate and analyse possible seasonal variation in such interest the average recapture index for individuals was used as an indicator (see pp. 34-35).

Clethrionomys was found to show more interest than Apodemus in summer and less interest in autumn and winter. In the autumn-winter of 1950-51 Miller (1958) caught very few Clethrionomys in The Pasticks and Brown's (1954) figures showed a low recapture rate at South Lodge Wood for these seasons. The latter author, having caught a large number of individuals, supports Evans (1942) suggestion that the high capture is due to population increase caused by the continuation of breeding rather than to greater interest in the traps. Kikkawa (1964) found similar fluctuations in the degree of interest shown in traps by mice and voles to those found in the present study, and he noted that in winter, despite the severe competition because of increased density, many mice were caught repeatedly. Increased interest in traps towards winter may be, as Kikkawa

(1964) observed, partly due to food-storing habits. In the present study in autumn some mice stored bait by blocking the trap-tunnel with leaves and soil (see also Kikkawa 1964). The day length at the time at which such food-storing occurred was approximately 12.6 hours, a similar day-length to that recorded by Miller (1955) as inducing the food-storing habit in laboratory animals. Elton et al (1931) reported that storing habits of Apodemus began in the late summer and that the stored food was often found in runways.

The question of the availability of food as a factor in causing a loss or gain of interest in traps was considered by Tanton (1965). Tanton (1965) quoted evidence showing that Apodemus tended to take considerably more animal material as food in the summer months, coincident with the period when there was a lack of interest in the traps (Holisövä 1960; Miller 1954; Kikkawa 1959; Gorecki and Gebczyńska 1962). Tanton (1965) found χ^2 tests to be consistent with the hypothesis of changing behaviour towards traps, and he postulated that the increased number of mice which first appeared in traps in the autumn would be trap-prone, and their repeated appearance would cause there to be a high recapture index. As the natural food resources dwindled the more trap-shy individuals would enter the traps also. Tanton (1965) found no evidence of mice learning to avoid or enter traps, and Young et al (1952) with house mice, and Crowcroft and Jeffers (1961)

with feral house-mice, reached similar conclusions.

The possible effects on population estimation, and the invalidity of sampling methods, in populations where the degree of interest in the traps varies greatly with season has been discussed already for Apodemus (pp. 68-77). Alternative methods to live-trapping have been tried by many workers who realised the difficulties of sampling using traps. Southern, Watson and Chitty (1946) used infra-red radiation, and Southern (1955) and Finley (1959) used red light for the observation of nocturnal animals. Movements have been studied by the use of dyes (Chitty and Southern 1954; New 1958), of radioactive tracers (Godfrey 1954; Miller 1957), and of radio-transmitters (Le Munyan et al 1959; Cochran and Lord 1963). Distribution and abundance in different habitats, and activity rhythm have been studied by the use of dropping boards (Emlen et al 1957), of nest-boxes (Howard 1949; Terman 1961), and of automatic photographic recorders (Pearson 1959, 1960). But, as was pointed out by Kikkawa (1964), no-one has yet checked trapping results against such methods.

5. Suggestions for further research

The present work has laid the foundation in a specific locality for a closer investigation into the nature of the relationship between Apodemus and Clethrionomys. Of particular importance is the solving of the problem of what happens to

the Apodemus populations on grid A during the breeding season, and the answer to this question should resolve the whole question of the trappability of Apodemus in the summer. Trapping methods should be supplemented by dropping-board studies (see Emlen et al 1957) and by radio-active tracer work, and the trapping methods themselves should be varied to see whether trap spacings suitable at one time of the year are suitable at another. In addition, an area as similar as possible to that of grid A should be trapped out and the recolonisation carefully followed, in order to determine habitat preference in the absence of competition due to the presence of a lot of animals.

SUMMARY

1. A study of the ecology of Clethrionomys and Apodemus was made in Castle Eden Dene, a local Nature Reserve, from 1962-1965. No previous investigations had been carried out in the Reserve and this was one of the first studies made on the ecology of woodland rodents in the north of England.
2. The methods of sampling the small mammal populations of selected areas of the Dene are described, and the nature, and methods of obtaining information on the animals are presented.
3. The methods of estimation used in ascertaining various population parameters are described and the usefulness of such parameters is discussed.
4. The trapping records are presented and the comparative absence of Apodemus from grid B, and the preponderance of Clethrionomys over Apodemus on grid A, is noted. The male to female ratio of Clethrionomys caught was 1.4 : 1 on grid A, and 1.5 : 1 on grid B. For Apodemus it was 1.5 : 1 on grid A, and 2.5 : 1 on grid B. In Clethrionomys there was seasonal variation in sex-ratio, with females being best represented in summer and autumn. For Apodemus the males predominated in the catches particularly in the winter months.
5. Trap mortality in the course of the study as a whole was found to be of the order of 15% of individuals on grid A and 31% on grid B for Clethrionomys. The greatest mortality occurred in October-December. Trap mortality was negligible in Apodemus.

6. On grid A both sexes of Clethrionomys had equal recapture indices. On grid B females had higher recapture indices than the males. Seasonal variation in the likelihood of recapture was found to exist, with Clethrionomys being more likely to be recaptured in summer, and Apodemus in winter.
7. Changes in population size of Clethrionomys and Apodemus on grids A and B are described for the period from March 1963 to January 1965. Clethrionomys was found to have a low population in spring, which built up to an October peak value and then declined through the winter. Apodemus was found to have a low population in spring and very few captured at all during the breeding season. There was an enormous influx of sub-adults into the traps in autumn, and the peak population for Apodemus was reached in December. After March the population declined sharply. Very few Apodemus were found to be present on grid B, in the study as a whole.
8. The survival rate of the Clethrionomys population on grid A was found to be high in early spring, but it declined throughout the breeding season, finally improving again as autumn and winter continued. The survival of Apodemus appeared to be very low after April, but complicating factors of trapability render the estimates of survival rate in Apodemus unreliable. On grid B the survival rate of Clethrionomys was consistently higher than on grid A, and seasonal variations, although present, were less well marked. There were found to be no consistent differences in the survival rate of the sexes of Clethrionomys. On grid A the survival rate of overwintered

animals of 1962-63 was found to be high, while that of the summer-young of 1963 was found to be low. The survival rate of the autumn-young of 1963 was superior to that of the summer-young. A similar pattern was evident in 1964 also. On grid B the survival of summer-born young of 1963 was found to be superior to that of overwintered animals of 1962-63, and of autumn-young of 1963. Some summer-young of 1963 bred in both 1963 and 1964.

9. The breeding season of Clethrionomys extended from April to December for the males of Clethrionomys and from May to December for the females. That of Apodemus males extended from March to December, and the females from April to December. The breeding success of Clethrionomys was found to be superior on grid A when considered in terms of the number of juveniles produced. 1963 was found to be a better breeding season than 1964. The breeding of Apodemus was apparently excellent, but was poorly documented until October in each year.

10. The age structure of the populations of Clethrionomys and Apodemus was determined by use of the frequency distributions of body weights. The value of body weight as an indicator of age, when used in conjunction with breeding condition and appearance in a population of marked animals is indicated. The mean weight of Clethrionomys and Apodemus males was found to increase rapidly in the spring but to decrease throughout the breeding season because of the dilution effect of the entry

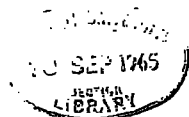

of juveniles and the death of older, heavier animals. The complicating factor of pregnancy in females was found to make body weight records less valuable.

11. The changes in population size in the larch wood and in the sycamore wood on grid A are described for Clethrionomys and for Apodemus. Similar descriptions are given for the Clethrionomys populations in the ash plantations and the larch wood on grid B. The population of Clethrionomys in the sycamore wood was found to be larger than that in the larch wood at all times, but to be particularly so in the autumn. In contrast the population of Apodemus in the larch wood was found to be larger than that in the sycamore wood at all times, although in the winter there was not a great margin of difference between the two areas.

12. The differences in population size between the Clethrionomys in the ash and those in the larch on grid B were found not to be so great as those differences existing between populations of the two woods on grid A. However, the population in the ash plantation was consistently larger than that in the larch wood. The few Apodemus that were caught on grid B were caught in the larch wood.

13. Seasonal changes in the distribution of Clethrionomys on both grids are shown to occur, and the importance of cover, in this case, provided mainly by bramble and bracken, is demonstrated. Also emphasised is the way in which temporarily-

available favourable habitats, with cover provided by summer vegetation only, are utilised. The avoidance by Clethrionomys of areas devoid of cover in the field layer is demonstrated, and the apparent disregard of Apodemus for cover is also shown.

14. It is suggested that it is less the nature of the vegetation which governs the distribution of Clethrionomys, but rather the degree of protective cover afforded by it. It is also suggested that Apodemus may positively prefer open areas which allow freedom of movement, relying upon its nocturnal habit for protection from predators.

15. A record was kept of the density of the vegetation cover of the field layer at each trapping point on both grids, prior to the start of every trapping period, and there was found to be a close correlation between the distribution and abundance of the Clethrionomys population and the density of the vegetation cover on both grids. No such correlation was found between the distribution of Apodemus and that of the vegetation cover. Apodemus distribution was at random with regard to cover.

16. The utilisation of temporarily available favourable habitats was demonstrated to occur in Clethrionomys, without there being of necessity population pressure causing animals to move out of consistently favourable areas.

17. The advantages of using linear measure of movements to reveal daily activity and possible seasonal variation in

such activity are discussed, and the reasons for using frequency distributions of maximum movements to show seasonal variation in activity in both sexes of the two species are given.

18. Seasonal variation in activity was found to exist in both sexes of both species. Greater activity was evident in spring and summer than in autumn and winter, and in Clethrionomys females, greater activity was evident in the spring than in the summer, also. Apodemus males were apparently more active than Clethrionomys males only in summer, but Apodemus females were more active than Clethrionomys females in all seasons. Males of both species were found to be more active than the females, particularly in the summer.

19. Only in spring was there a statistically significant difference between the activity of Clethrionomys males on grid A and those on grid B, with the males on grid B being more active. The situation in the females was the reverse of that in the males.

20. The discovery of four main movement patterns in the two species is described, the three most evident being change in home range area, exploratory movements, and dispersal movements. Males of Clethrionomys were considered to have changed their home range area more than were females. With Apodemus such behaviour was confined to the males. Large numbers of both species and sexes made movements away from, and back to established home range areas, such movements are considered to

be exploratory in nature.

21. Dispersal and wandering movements were detected in both sexes of Clethrionomys and Apodemus. These movements were more common in Clethrionomys than had been expected from reports in the literature. Movements of up to 365 metres were recorded, this being the maximum distance it was possible to record with the trap arrangement used.

22. Range Length measurements of Clethrionomys and Apodemus caught 10 or more times were found to average 79.5 metres for Clethrionomys males, 50 metres for Clethrionomys females, 101 metres for Apodemus males, and 73 metres for Apodemus females.

23. The existence of transient animals in the population is suggested. It is also suggested that trap-limitation of movement is the biggest problem in studying movements of marked animals.

24. The home range concept in small mammals is discussed and the relevant literature is reviewed. The validity of trap-revealed home range size is considered by use of the literature, and the more important methods of estimating home range size are described.

25. The estimates of home range size were found to differ for one class of animal e.g. Clethrionomys males, according to the method of estimation used and the number of times the animals in the sample had been captured. The variation in estimates of range size when one method of estimation was used on the four different groups of recaptured animals was found

to be less than that obtained when different methods of estimation were used on one group of recaptured animals e.g. those captured three or more times.

26. The estimates of average home range size calculated using the Minimum Area Method of estimation were found to always be the smallest, those obtained using the Adjusted Range Length Method of estimation were found always to be the largest. The ranking in order of magnitude of the average home range sizes when standardised methods of estimation were used on comparable groups of animals was:- Clethrionomys females, Apodemus females, Clethrionomys males, Apodemus males. Thus males were found to have larger range sizes than females and Apodemus to have larger range sizes than Clethrionomys.

27. No consistent difference was found between the range sizes of animals in different vegetation types. The estimated average home range size was found to increase with increasing number of recaptures of the animals in the sample. A suggestion of a cessation in the increase in the apparent range size was present when animals had been captured ten times.

28. Manville's Method of estimation of home range size was found to be easy to apply and to give consistent results. The average home range size of both sexes of both species calculated using Manville's Method on animals captured ten or more times was:- Clethrionomys males - 2430 square metres;

Clethrionomys females - 1521 square metres; Apodemus males - 3124 square metres; Apodemus females - 2143 square metres.

29. Close agreement was found between the results of the calculation of average home range size of Clethrionomys and Apodemus in the present study, and the results from the study of Kikkawa (1964).

30. It is suggested that the definition of home range area should have incorporated into it a time factor viz. "...that area normally traversed by the individual within a specified period of time." In addition a list is given of the information which the present author considers ought to be given along with any estimates of range size. It is also suggested that the home range area is a biological reality, but that a distinction ought to be made between two types of home range, where one is that area traversed with some regularity throughout the recorded life-span of the individual; and the other that area within the total area which is regularly traversed within short specified periods of time under specified environmental conditions.

31. Biochemical analyses were performed on the stomach contents of 262 Clethrionomys individuals and 174 Apodemus individuals, samples being taken in the four seasons of 1963.

32. The fat content (ether-extract) was estimated by ether-extraction using a micro-Soxhlet apparatus, and the protein content was estimated by use of the Markham micro-Kjeldahl apparatus. The 'total carbohydrate' fraction of each sample

was found by difference.

33. The protein content of Apodemus stomach contents was higher than that of Clethrionomys stomach contents in all seasons, but was particularly so in spring and summer. Similar results were obtained for the fat contents. Naturally the carbohydrate portion of the Clethrionomys stomach contents was higher in all seasons than it was in Apodemus.

34. It is tentatively suggested that the results of the analyses confirm the conclusions of other workers that Apodemus tends to eat more animal material than does Clethrionomys, particularly during the summer.

35. A brief review of the present study is presented, and the factors affecting population size are discussed in general terms with specific references to the present study where appropriate.

36. It is suggested that predation by weasels and owls was probably negligible throughout the time of the study.

37. The question of agonistic behaviour toward juveniles in the breeding season in Peromyscus maniculatus (Sadleir 1965) is discussed with regard to its relevance to Apodemus.

38. The importance of vegetation cover as protection and food supply for Clethrionomys is discussed, and the situation is compared with that in Apodemus. Superior and marginal habitats are considered with regard to their possible survival value.

39. The trappability of Clethrionomys and Apodemus is

considered. Seasonal variation in interest in traps was found to occur with Clethrionomys showing more interest in the summer, and Apodemus in the winter. The possible role of changing diet in Apodemus is discussed with regard to the trappability of Apodemus. It is thought that the preference of Apodemus for insects and seeds in the summer may cause the lack of interest in the traps.

40. Some alternative methods to live-trapping for the study of small mammal populations, used by other workers, are mentioned, and some suggestions for further research into the relationship between Clethrionomys and Apodemus are put forward.

BIBLIOGRAPHY

- * ADAMCZEWSKA. (1961). Intensity of reproduction of Apodemus flavicollis (Melchior 1834) during the period 1954-59. Acta Theriol. 5 (1): 1-21.
- ALDOUS, S.E. (1947). Muskrat trapping on Sand Lake National Wildlife Refuge, South Dakota. J. Wildl. Mgmt. 11: 77-90.
- ALLEE, W.C., EMERSON, A.E., PARK, O., PARK, T., and SCHMIDT, K.P. (1949). Principles of Animal Ecology. Philadelphia, W.B. Saunders Co. 837 pp.
- ALLEN, D. (1943). Michigan fox squirrel management. Mich. Dept. Conserv. Game Div. Publ. No. 100: 1-404.
- ANDREWARTHA, H.G. and BIRCH, L.C. (1954). The distribution and abundance of animals. Chicago: 782 pp.
- ANDRZEJEWSKI, R., PETRUSEWICZ, K. and WALKOWA, W. (1959). Preliminary report on results obtained with living traps in a confined population of mice. Bull. Acad. pol. Sci. Cl. II Ser. Sci. biol. 7, 367-70.
- ANDRZEJEWSKI, R., PETRUSEWICZ, K. and WALKOWA, W. (1963). Absorption of newcomers by a population of white mice. Ekol. Pol. A. XI: 224-240.
- ANDRZEJEWSKI, R. and WIERZBOWSKA, T. (1961). An attempt at assessing the duration or residence of small rodents in a defined forest area and the rate of interchange between individuals. Acta. Theriol. 5, 153-72.

- ASHBY, K.R. (1959). Prevention of regeneration of woodland by field-mice and voles. *Quart. J. For.*, 53: 228-36.
-(1962). Dinamica di popolazioni dei Topi Campagnoli e suo Significato per la Rinnovazione dei Boschi. *Atti. Ist. veneto Sci.* 120: 319-26.
- BAILEY, N.T.J. (1951). On estimating the size of mobile populations from recapture data. *Biometrika*, 38: 293-306.
- BAKER, J.R. (1930). The breeding-season in British wild mice. *Proc. zool. Soc. Lond.* (1930): 113-26.
- BAKER, J.R. and RANSON, R.M. (1932a). Factors affecting the breeding of the field mouse (Microtus agrestis). Part I. Light. *Proc. roy. Soc. B*, 110: 313-22.
- (1932b). Factors affecting the breeding of the field mouse (Microtus agrestis). Part II. Temperature and food. *Proc. roy. Soc. B*, 112: 39-46.
- (1933). Factors affecting the breeding of the field mouse (Microtus agrestis). Part III. Locality. *Proc. roy. Soc. B*, 113: 486-95.
- BAKER, R.H. (1946). A study of rodent populations on Guam, Mariana Islands. *Ecol. Monogr.* 16: 393-408.

- ¹ BALDWIN, E. and BELL, D.J. (1955). Cole's Practical Physiological Chemistry. 10th Edn. Cambridge. 261 pp.
- * HAMILTON, G.E.H. BARRETT- and HINTON, M.A.C. (1910-21). A History of British Mammals. London, Gurney & Jackson.
- BENDELL, J.F. (1959). Food as a control of a population of white-footed mice, Peromyscus leucopus noveboracensis (Fischer). Can. J. Zool. 37: 173-209.
- (1961). Some factors affecting the habitat selection of the white-footed mouse. Canadian Field Nat. 75(4): 244-55.
- BISHOP, I.R. and DELANY, M.J. (1963a). The ecological distribution of small mammals in the Channel Islands. Mammalia, 27: 99-110.
- BLAIR, W.F. (1940a). Home ranges and populations of the meadow vole in southern Michigan. J. Wildl. Mgmt. 4: 149-161.
- (1940b). A study of prairie deer-mouse populations in southern Michigan. Amer. Midl. Nat. 24: 273-305.
- (1940c). Home ranges and populations of the jumping mouse. Amer. Midl. Nat. 23: 244-250.
- (1941a). Techniques for the study of mammal populations. J. Mammal. 22: 148-157.

- BLAIR, W.F. (1941c). Some data on the home ranges and general life history of the short-tailed shrew, red-backed vole, and woodland jumping mouse in northern Michigan. *Amer. Midl. Nat.* 25: 681-685.
- (1942). Size of home range and notes on the life history of the woodland deer-mouse and eastern chipmunk in northern Michigan. *J. Mammal.* 23: 27-36.
- (1943a). Populations of the deer-mouse and associated small mammals in the mesquite association of southern New Mexico. *Contr. Lab. Vertebr. Biol. Univ. Mich.* 21: 1-40.
- (1951a). Population structure, social behaviour, and environmental relations in a natural population of the beach mouse (*Peromyscus polionotus leucocephalus*). *Contr. Lab. Vertebr. Biol. Univ. Mich.* 48: 1-47.
- (1953). Population Dynamics of Rodents and Other Small Mammals. *Adv. in Genetics.* 5: 2-41.
- BOJALSKA, G. and RYSZKOWSKI, L. (1964). Trappability and daily rhythm of *Clethrionomys glareolus*. Schreb. *Bull. de l'Acad. Polon. des Sciences. Serie des Sciences Biologique.* 12: (1964) No. 12.
- BRAMBELL, F.W.R. and HALL, K. (1939). Reproduction of the field vole *Microtus agrestis hirtus* Bellamy. *Proc. zool. Soc. Lond. A,* 109: 133-8.

- BRAMBELL, F.W.R., and ROWLANDS, I.W. (1936). Reproduction of the bank vole (Evotomys glareolus Schr.). I. The oestrous cycle of the female. Phil. Trans. B, 226: 71-97.
- BRANT, D.H. (1962). Measures of the movements and population densities of small rodents. Univ. Calif. Publ. Zool. 62(2): 105-183.
- ¹ BRAVERMAN, J.B.S. (1963). Introduction to the biochemistry of foods. Elsevier Publ. Comp. 336 pp.
- BROWN, L.E. (1954). Small mammal populations at Silwood Park Field Centre, Berkshire, England. J. Mammal. 35: 161-76.
- (1956a). Movements of some British small mammals. J. Anim. Ecol. 25: 54-71.
- (1956b). Field experiments on the activity of the small mammals, Apodemus, Clethrionomys and Microtus. Proc. zool. Soc. Lond. 126: 549-64.
- (1962). Home range in small mammal communities. Surv. Biol. Progr. 4: 131-179.
- BROWN, R.Z. (1953). Social behaviour, reproduction and population changes in the house mouse. Ecol. Monogr. 23: 217-40.

- BURT, W.H. (1940). Territorial behaviour and populations of some small mammals in southern Michigan. Misc. Publ. Mus. Zool. Univ. Mich. 45: 1-58.
- (1943). Territoriality and home range concepts as applied to mammals. J. Mammal. 24: 346-52.
- CALHOUN, J.B. (1952). The social aspects of population dynamics. J. Mammal. 33: 139-59.
- (1955). A technique for investigating the distance parameter of home range. J. Mammal 36: 45-52.
- (1957). Social welfare as a variable in population dynamics. Cold Spr. Harb. Symp. Quant. Biol. 22: 339-356.
- CHITTY, D. (1937). A ringing technique for small mammals. J. Anim. Ecol. 6: 36-53.
- (1938). Live trapping and transport of voles in Great Britain. J. Mammal. 19: 65-70.
- (1952). Mortality among voles (Microtus agrestis) at Lake Vyrnwy, Montgomeryshire in 1936-9. Phil. Trans. B, 236: 505-52.
- (1958). Self-regulation of numbers through changes in viability. Cold Spr. Harb. Symp. Quant. Biol. (1957), 22: 277-80.
- (1960). Population processes in the vole and their relevance to general theory. Can. J. Zool. 38(1): 99-113.

- CHITTY, D. (1964). Animal numbers and behaviour. Longmans
Canada Limited. 15 pp.
- CHITTY, D. and KEMPSON, D.A. (1949). Prebaiting small mammals
and a new design of live trap. Ecology, 30:
536-42.
- CHITTY, D. and SOUTHERN, H.N.(ed.) (1954). Control of Rats and
Mice. Oxford.
- CHRISTIAN, J.J. (1956). Adrenal and reproductive responses to
population size in mice from freely growing
populations. Ecology, 37: 258-273.
- (1959). The roles of endocrine and behavioural
factors in the growth of mammalian populations.
pp. 71-97 in 'Comparative endocrinology', ed.
by A. Gorbman. New York: 746 pp.
- (1961). Phenomena associated with population
density. Proc. Nat. Acad. Sci. U.S. 47: 428-49.
- CLAPHAM, A.R., TUTIN, T.G., and WARBURG, E.F. (1952). Flora of
the British Isles. Cambridge 2nd Edn. 1269 pp.
- CLARKE, J.R. (1953). The effect of fighting on the adrenals,
thymus, and spleen of the vole (Microtus agrestis).
J. Endocr. 9: 114-26.
- (1955). Influence of numbers on reproduction and
survival in two experimental vole populations.
Proc. Roy. Soc. B. 144: 68-85.

- CLARKE, J.R. (1956b). The aggressive behaviour of the vole.
Behaviour 9: 1-23.
- CLOUGH, G.C. (1965). Viability of wild meadow voles under various conditions of population density, season and reproductive activity. Ecology 46(1): 119-134.
- COCHRAN, W.G. (1954). Some methods of strengthening the common χ^2 test. Biometrics 10: 417-51.
- COCHRAN, W.W. and LORD, R.D. (1963). A radio-tracking system for wild animals. J. Wildl. Mgmt. 27: 9-24.
- ¹ COMBER, N.M., WILLCOX, J.S., and TOWNSEND, W.N. (1953). An introduction to Agricultural Chemistry. London. Edward Arnold (Publ.) Ltd. 348 pp.
- CONNELL, J.M. (1954). Home range and mobility of brush rabbits in California chaparral. J. Mammal. 35: 392-405.
- CROWCROFT, P. and JEFFERS, J.N.R. (1961). Variability in the behaviour of wild house mice (Mus musculus L.) towards live traps. Proc. zool. Soc. Lond. 137: 573-82.
- ² CURRY-LINDAHL, K. (1956). Biotoper revir vandringar och periodicitet hos nagra smadaggdjur. Fauna flora, 51: 193-218.
- DALKE, P.D. (1942). The cottontail rabbits in Connecticut. Bull. Conn. Geol. Nat. Hist. Surv. 65: 1-97.

- DALKE, P.D. and SIME, P.R. (1938). Home and seasonal ranges of the eastern cottontail in Connecticut. Trans. 3rd. N. Amer. Wildlife Conf. 659-669.
- DAVIS, D.E. (1951c). The relation between the level of population and the prevalence of Leptospira, Salmonella and capillaria in Norway rats. Ecology 32: 465-68.
- (1953). The characteristics of rat populations. Quart. Rev. Biol. 28(4): 373-401.
- (1953). Analysis of home range from recapture data. J. Mammal. 34: 352-8.
- (1956). Manual for analysis of rodent populations. Edwards.Bros. 82 pp.
- DAVIS, D.E., EMLEN, J.T., and STOKES, A.W. (1948). Studies on home range in the brown rat. J. Mammal. 29: 207-25.
- DAVIS, D.E., and EMLEN, J.T. (1956). Differential trappability of rats according to size and sex. J. Wildl. Mgmt. 20: 326-7.
- DAVIS, D.H.S. (1933). Rhythmic activity in the short-tailed vole, Microtus. J. Anim. Ecol. 2: 232-8.
- DELANY, M.J. (1957). The small mammals of a Dunbartonshire oakwood. Glasgow Nat. 17: 272-278.
- (1961). The ecological distribution of small mammals in north-west Scotland. Proc. zool. Soc. Lond. 137: 107-26.

- DELANY M.J., and BISHOP, I.R. (1960). The systematics, life-history and evolution of the bank vole (Clethrionomys Tilesius) in north-west Scotland. Proc. zool. Soc. Lond. 135: 409-22
- DELANY, M.J. and DAVIES, P.E. (1961). Observations on the ecology and life-history of the Fair Isle field-mouse. Proc. zool. Soc. Lond. 136: 439-52.
- DELURY, D.B. (1947). On the estimation of biological populations. Biometrics 3: 145-167.
- DICE, L.R. (1931). The occurrence of two subspecies of the same species in the same area. J. Mammal. 12: 210-213
- (1931b). The relation of mammalian distribution of vegetation types. Sci Mon. N.Y. 33: 312-317.
- (1941). Methods of estimating populations of mammals. J. Wildl. Mgmt. 5: 398-407
- (1952). Natural communities. Ann. Arbor.
- DICE, L.R. and CLARK, P.J. (1953). The statistical concept of home range as applied to the recapture radius of the Deer-mouse. Contr. Lab. Vert. Biol. Univ. Mich. 62: 1-15.
- DICE, L.R. and HOWARD, W.D. (1951). Distance of dispersal by Prairie Deer-mice from birth-places to breeding-sites. Contr. Lab. Vert. Biol. Univ. Mich. 50: 1-15.

- EADIE, W.R. (1952). Shrew predation and vole populations in a localised area. J. Mammal. 33: 185.
- ELTON, C. (1942). Voles, mice and lemmings: problems in population dynamics. Oxford. 496 pp.
- (1946). Competition and the structure of ecological communities. J. Anim. Ecol. 15.
- ELTON, C., DAVIS, D.H.S., and FINDLAY, G.M. (1935). An epidemic among voles (Microtus agrestis) on the Scottish border in the spring of 1934. J. Anim. Ecol. 4: 277-88.
- ELTON, C. FORD, E.B., BAKER, J.R., and GARDNER, A.D. (1931). The health and parasites of a wild mouse population. Proc. zool. Soc. Lond. 1931, 657-721.
- ELTON, C., and MILLER, R.S. (1954). The ecological survey of animal communities: with a practical system of classifying habitats by structural characters. J. Ecol. 42: 460-96.
- EMLEN, J.T., HINE, R.L., FULLER, W.A., and ALFONSO, P. (1957). Dropping boards for population studies of small mammals. J. Wildl. Mgmt. 21: 300-14.
- EVANS, F.C. (1942). Studies of a small mammal population in Bagley Wood, Berkshire. J. Anim. Ecol. 11: 182-97.
- EVANS, F.C. and HOLDENRIED, R. (1943). A population study of the Beechey ground squirrel in central California. J. Mammal, 24: 231-260

- FINDLAY, G.M., and MIDDLETON, A.D. (1934). Epidemic disease among voles (Microtus) with special reference to Toxoplasma. J. Anim. Ecol. 3: 150-60
- FINDLEY, J.S., and ANDERSON, S. (1956). Zoogeography of the Montana mammals of Colorado. J. Mammal. 37: 80-82.
- FINLEY, R.B. (1959). Observations of nocturnal animals by red light. J. Mammal. 40: 591-4.
- FITCH, H.S., (1947). Ecology of a cottontail rabbit (Sylvilagus audubonii) population in central California. Calif. Fish Game 33: 159-184.
- (1948). Habits and economic relationships of the Tulare kangaroo rat. J. Mammal. 29: 5-35.
- FRANK, F. (1957). The causality of microtine cycles in Germany. J. Wildl. Mgmt. 21(2): 113-121.
- FULLAGER, P.J., JEWELL, P.A., LOCKLEY, R.M., and ROWLANDS, I.W. (1963). The Skomer Vole (Clethrionomys glareolus skomerensis) and Long-tailed Field Mouse (Apodemus sylvaticus) on Skomer Island, Pembrokeshire in 1960. Proc. zool. Soc. Lond. 140: 295-314
- GENTRY, J.B., and ODUM, E.P. (1957). The effect of weather on the winter activity of old-field rodents. J. Mammal. 38: 72-77.
- GETZ, L.L. (1960). A population study of the vole, Microtus pennsylvanicus. Amer. Midl. Nat. 64: 392-405.

- GETZ, L.L. (1960). An analysis of some of the factors influencing the local distribution of small mammals in southern Michigan. Diss Absts. 21(2): 379.
- GETZ, L.L. (1961a). Factors influencing the local distribution of Microtus and Synaptomys in southern Michigan. Ecology, 42: 110-19.
- (1961b). Home ranges, territoriality, and movement of the meadow vole. J. Mammal. 42: 24-36.
- GODFREY, G.K. (1953). Factors affecting the survival, movements, and intraspecific relationships during early life in populations of small mammals with particular reference to the vole. D. Phil. thesis, Bureau of Animal Population, Oxford. 127 pp.
- (1954). Tracing field voles (Microtus agrestis) with a Geiger-Müller counter. Ecology 35: 5-10
- (1955). Observations on the nature of the decline in numbers of two Microtus populations. J. Mammal. 36: 209-14.
- GOERTZ, J.W. (1964). The influence of habitat quality upon density of cotton rat populations. Ecol. Monogr. 34(4): 359-381.

- GORECKI, A., and GEBczyńska, Z. (1962). Food conditions for small rodents in a deciduous forest. *Acta theriol* 6: 276-95.
- GRODZIŃSKI, W. (1959). The succession of small mammal communities on an overgrown clearing and landslip mountain in the Beskid Sredni (western Carpathians). *Ekologia Polska*, 7: 83-143.
- (1961). Metabolism rate and bioenergetics of small rodents from the deciduous forest. *Bull. Acad. Pol. Sci. Cl. II* 9. 12: 493-499.
- (1962). Influence of food upon the diurnal activity of small rodents. *Symp. Theriol.* 134-140. Publ. House. Gech. Ac. Sci. Praha.
- HACKER, H.P. and PEARSON, H.S. (1944). The growth, survival, wandering and variation of the long-tailed field-mouse Apodemus sylvaticus. I. Growth. *Biometrika*, 33: 136, 162
- (1946). The growth, survival, wandering and variation of the long-tailed field mouse, Apodemus sylvaticus. II. Survival. *Biometrika*, 33: 333.
- (1951). Distribution of the long-tailed field-mouse, Apodemus sylvaticus, on South Haven Peninsula, Dorset, in 1937, with some observations on its wandering and homing powers. *J. Linn. Soc. (Zool.)*, 42: 1-17.

- HACKER, H.P., and PEARSON, H.S. (1952). The growth, survival, wandering and variation of the long-tailed field-mouse, Apodemus sylvaticus. III. Wandering power and distribution. *Biometrika*, 39: 389-413.
- HARRISON, J.L. (1958). Range of movement of some Malayan rats. *J. Mammal.* 39(2): 190-206.
- HAUGEN, A.O. (1942). Home range of the cottontail rabbit. *Ecology*, 23: 354-67.
- HAYNE, D.W. (1949a). Calculation of size of home range. *J. Mammal.* 30, 1-18.
- (1949b). Two methods for estimating populations from trapping records. *J. Mammal.* 30: 399-411.
- (1950). Apparent home range of Microtus in relation to distance between traps. *J. Mammal.* 31: 26-39.
- * HOLGATE, P. (1964). A modified geometric distribution arising in trapping studies. *Acta Theriol.* (In press).
- * HOLISÖVÁ, V. (1960). Potrava myšice krovinne Apodemus sylvaticus L. na Ceskomoravske virchovine (Die Nahrung der Waldmaus Apodemus sylvaticus L. im Bömisch-mährischen Hohenzug). *Zoolog. Listy*, 9: 135-59.
- HOWARD, W.E. (1949). Dispersal, amount of inbreeding, and longevity in local population^s of Prairie Deermice on the George Reserve, Southern Michigan. *Contr. Lab. Vert. Biol. Univ. Mich.* 43: 1-50.

- HOWARD, W.E., (1951). Relation between low temperature and available food to survival of small rodents. *J. Mammal.* 32: 300.
- HOWELL, J.C. (1954). Populations and home ranges of small mammals on an over-grown field. *J. Mammal.* 35: 177-186.
- JACKSON, C.H.N. (1933). On the true density of tsetse flies. *J. Anim. Ecol.* 2: 204-9.
- (1937). Some new methods in the study of Glossina morsitans. *Proc. zool. Soc. Lond.* 1936(4). 811-96.
- (1939). The analysis of an animal population. *J. Anim. Ecol.* 8: 238-46.
- (1940). The analysis of a tsetse fly population. *Ann. Eugen. Lond.* 10: 332-69.
- (1948). The analysis of a tsetse-fly population. III. *Ann. Eugen. Lond.* 14(2): 91-108.
- JACKSON, W.B. (1951). Food habits of Baltimore, Maryland cats in relation to rat population. *J. Mammal.* 32: 458-461.
- JAMESON, E.W., (1955). Food of the deer mice Peromyscus maniculatus and Peromyscus boylei in the northern Sierra Nevada, California. *J. Mammal.* 33: 50-60.
- JORDAN, J.S. (1948). A midsummer study of the southern flying squirrel. *J. Mammal.* 29: 44-48.

- KALELA, O. (1957). Regulation of reproduction rate in sub-arctic populations of the vole Clethrionomys rufocanus (Sund.) Ann. Acad. Sci. Fenn. Ser. A, 4(34): 1-60.
- KENDEIGH, S.C. (1944). Homing of Peromyscus maniculatus gracilis. J. Mammal. 25: 405-407.
- KIKKAWA, J. (1959). Habitats of the field mouse on Fair Isle in spring 1956. Glasgow Nat. 18: 65-77.
- (1964). Movement, activity and distribution of the small rodents Clethrionomys glareolus and Apodemus sylvaticus in woodland. J. Anim. Ecol. 33: 259-99.
- KLEIN, H.G. (1960). Ecological relationships of Peromyscus leucopus noveboracensis and P. maniculatus gracilis in central New York. Ecol. Monogr. 30: 387-407.
- KREBS, C.J. (1964). The Lemming cycle at Baker Lake, Northwest Territories, during 1959-62. Arctic Inst. of North America Technical Paper No. 15. 104 pp.
- LACK, D. (1954). The natural regulation of animal numbers. Oxford. 343 pp.
- LAY, D.W. (1942). Ecology of the opossum in eastern Texas. J. Mammal. 23: 147-159.
- LAYNE, J.N. (1954). The biology of the red squirrel, Tamiasciurus hudsonicus loquax (Bangs.), in central New York. Ecol. Monogr. 24: 227-267.

- LE MUNYAN, C.D., WHITE, W., NYBERG, E., and CHRISTIAN, J.J. (1959).
Design of a miniature radio transmitter for use in
animal studies. J. Wildl. Mgmt. 23: 107-110
- LESLIE, P.H. (1952). The estimation of population parameters
from data obtained by means of the capture-recapture
method. II. The estimation of total numbers.
Biometrika, 39: 363-88.
- LESLIE, P.H., and CHITTY, D. (1951). The estimation of
population parameters from data obtained by means
of the capture-recapture method. I. The maximum
likelihood equations for estimating the death-rate.
Biometrika, 38: 269-92.
- LESLIE, P.H., CHITTY, D., and CHITTY, H. (1953). The estimation
of population parameters from data obtained by
means of capture-recapture method. III. An example
of the practical applications of the method.
Biometrika, 40: 137-69.
- LESLIE, P.H., and RANSON, R.M. (1940). The mortality, fertility,
and rate of natural increase of the vole (Microtus
agrestis) as observed in the laboratory.
J. Anim. Ecol. 9: 27-52.
- LINCOLN, F.C. (1930). Calculating waterfowl abundance on the
basis of banding returns. U.S. Dep. Agric.
Cir. No. 118.
- LINSDALE, J.M. (1946). The California ground squirrel. Univ.
of Calif. Press, Berkeley. 475 pp.

- LOCKIE, J.D., CHARLES, W.N., and EAST, K. (1962). Nature Conservancy Annual Report. 1962.
- MANVILLE, R.H. (1949). A study of small mammal populations in northern Michigan. Misc. Publ. Mus. Zool. Univ. Mich. 73: 1-83
- MCCABE, T.T., and BLANCHARD, B.D., (1950). Three species of Peromyscus. Rood Assoc., Santa Barbara. 136 pp.
- McDOUGALL, W.A., (1946). An investigation of the rat pest problem in Queensland canefields. Queens. J. Agri. Sci. 3: 157-237.
- MILLER, L.S. (1957). Tracing vole movements by radioactive excretory products. Ecology, 38: 132-6
- MILLER, R.S. (1954). Food habits of the wood-mouse, Apodemus sylvaticus (Linne, 1758) and the bank vole Clethrionomys glareolus (Schreber, 1780) in Wytham Woods, Berkshire. Saugetierk. Mitt. 2: 109-14.
- (1955). Activity rhythms in the wood mouse, Apodemus sylvaticus, and the bank vole, Clethrionomys glareolus. Proc. zool. Soc. Lond. 125: 505-19.
- (1958). A study of a wood mouse population in Wytham Woods, Berkshire. J. Mammal. 39: 477-93.
- MOHR, C.O. (1947). Table of equivalent populations of North American small mammals. Amer. Midl. Nat. 37: 223-49.

- MORRIS, R.F. (1955). Population studies on some small forest mammals in eastern Canada. J. Mammal. 36: 21-35.
- MOSSMAN, A.S. (1955). Light penetration in relation to small mammal abundance. J. Mammal. 36: 564-66.
- * MURIE, O.J. and MURIE, A. (1931). Travels of Peromyscus. J. Mammal. 12: 200-209.
- * (1932). Further notes on travels of Peromyscus. J. Mammal. 13: 78-9.
- NAUMOV, N.P. (1936). (On peculiarities of the habitat distribution of mouse-like rodents in the south of the Ukraine.) (English summary). Zool. Zh. 15: 674-96.
- NEW, J.G. (1958). Dyes for studying the movements of small mammals. J. Mammal. 39: 416-29.
- (1959). Additional uses of dyes for studying movements of small mammals. J. Wildl. Mgmt. 23(3): 348-51
- NEWSON, R.M. (1960). The Ecology of Vole and Mouse Populations in Different Habitats. D.Phil. unpubl. thesis, Univ. of Oxford.
- (1963). Differences in numbers, reproduction and survival between two neighbouring populations of bank voles (Clethrionomys glareolus). Ecology, 44: 110-20.

- NICHOLSON, A.J. (1941). The homes and social habits of the wood-mouse (Peromyscus leucopus noveboracensis) in southern Michigan. Amer. Midl. Nat. 25: 196-223.
- OGILVIE, R.T., and FURMAN, (1959). Effect of vegetational cover of fence-rows on small mammal populations. Ecology 40(1): 140-1.
- PEARSON, O.P. (1959). A traffic survey of Microtus-Reithrodontomys runways. J. Mammal. 40: 169-80.
- (1960). Habits of Microtus californicus revealed by automatic photographic recorders. Ecol. Monogr. 30: 231-49.
- [#] PETERS, H. (1948). Ergebnisse der Rattenbekämpfung in Stuttgart 1944-48. Festschrift zur Tagung deutscher Hygieniker und Mikrobiologen, Stuttgart: 1-48.
- PITELKA, F.A. (1957). Some characteristics of microtine cycles in the arctic. pp. 73-88 in 'Arctic biology', ed. by H.P. Hansen, Biology Colloquium, Oregon State College, 1957.
- (1958). Some aspects of population structure in the short-term cycles of the brown lemming in northern Alaska. Cold Spr. Harb. Symp. Quant. Biol. 22: 237-51.
- ¹ ROSENTHALER, L. (1930). The chemical investigation of plants. Lond. G. Bell & Sons. Ltd. 197 pp.

- ROWLANDS, I.W., (1936). Reproduction of the Bank Vole
(Evotomys glareolus, Schreber). II. Seasonal
Changes in the Reproductive Organs of the Male.
Phil. Trans. B 226: 99-121.
- SADLEIR, R.F.M.S., (1965). The relationship between agonistic
behaviour and population changes in the deer mouse,
Peromyscus maniculatus (Wagner). J. Anim. Ecol.
34: 331-352.
- SANDERSON, G.C. (1951). Breeding habits and history of the
Missouri raccoon population from 1941-1948.
Trans. N.A. Wildl. Conf. 16: 445-461.
- SCHWARTZ, C.W., (1941). Home range of the cottontail in central
Missouri. J. Mammal. 22: 386-392.
- * SETON, E.T., (1909). Life histories of northern animals. An
account of the mammals of Manitoba. Vol. 1.
Charles Scribner's Sons, New York. 673 pp.
- SLOBODKIN, L.B. (1962). Growth and regulation of animal
populations. Holt, Rinehart and Winston,
New York. 184 pp.
- SNYDER, D.P. (1956). Survival rates, longevity and population
fluctuations in the white-footed mouse
(Peromyscus leucopus) in southern Michigan.
Misc. Publ. Mus. Zool. 95: 1-32.
- SOLOMON, M.E. (1949). The natural control of animal populations.
J. Anim. Ecol. 18: 1-35.

- SOUTHERN, H.N. (1940). The ecology and population dynamics of the wild rabbit, Oryctolagus cuniculus.
Ann. appl. Biol. 27: 509-26.
- (1954). Tawny owls and their prey. Ibis, 96:
384-410.
- (1955). Nocturnal animals. Sci. Amer. 193(4):
88-98.
- (1959). Mortality and population control.
Ibis, 101: 429-436.
- (1964). (ed.). The Handbook of British Mammals.
Oxford.
- SOUTHERN, H.N., WATSON, J.S., and CHITTY, D. (1946). Watching nocturnal animals by infra-red radiation.
J. Anim. Ecol. 15: 198-202.
- SOUTHWICK, C.H. (1955a). The population dynamics of confined house-mice supplied with unlimited food.
Ecology, 36: 212-24.
- (1955b). Regulatory mechanisms of house-mouse populations; social behaviour affecting litter survival. Ecology, 36: 627-634.
- (1958). Population characteristics of house mice living in English corn ricks: density relationships. Proc. zool. Soc. Lond. 131: 163-75.
- * STEINIGER, F. (1950a). Beitrage zur Soziologie und sonstigen Biologie der Wanderratte. Z. Tierpsychol.,
3: 356-379.

- STEVEN, D.M. (1957). The bank vole in captivity. *Nature*,
179: 33-34.
- STICKEL, L.F. (1946). The source of animals moving into a
 depopulated area. *J. Mammal.* 27: 301-307.
- (1948). The trap line as a measure of small
 mammal populations. *J. Wildl. Mgmt.* 12: 153-61.
- (1954). A comparison of certain methods of
 measuring ranges of small mammals.
J. Mammal. 35: 1-15.
- STORER, T.I., EVANS, F.C., and PALMER, F.G., (1944). Some
 rodent populations in the Sierra Nevada of
 California. *Ecol. Monogr.* 14: 165-192.
- STUEWER, F.W. (1943). Raccoons, their habits and management
 in Michigan. *Ecol. Monogr.* 13: 203-258.
- STRECHER, R.L., and EMLEN, J.T. (1953). Regulatory mechanisms
 in house-mouse populations; the effect of
 limited food supply on a confined population.
Ecology, 34: 375-386.
- * SVIRIDENKO, P.A. (1940). The food habits of mouse-like rodents
 and their effects upon forest regeneration.
Zool. Zh. 19: 680-703. (Translation 144, B.A.P.)
- TANAKA, R. (1952). Theoretical justifications of the mark and
 release index for small-mammals. *Bull. Kochi.*
Wom. Coll. 1: 38-47.

- TANAKA, R. (1953). Home ranges and territories in the Clethrionomys population on a peat bog grassland in Hokkaido. Bull. Kochi. Wom. Coll. 2: 10-20.
- (1956). On differential response to live traps of marked and unmarked small mammals. Annotnes zool. jap. 29: 44-51.
- (1957). An ecological review of small mammal outbreaks with special reference to their association with the flowering of bamboo grasses. Bull. Kichi. Wom. Coll. 5: 1-30.
- TANAKA, R. and TERAMURA, S. (1953). A population of the Japanese field vole infested with tsutsugamushi disease. J. Mammal. 34: 345-52.
- TANTON, M.T. (1965). Problems of live-trapping and population estimation for the wood mouse, Apodemus sylvaticus (L). J. Anim. Ecol. 34: 1-22.
- TERMAN, C.R. (1961). Some dynamics of spatial distribution within semi-natural populations of prairie deer mice. Ecology, 42: 288-302.
- TROJAN, P., and WOJCIECHOWSKA, B. (1964a). Studies on the residency of small forest rodents. Ekol. Polska. Ser. A. XII(3): 33-50.
- (1964b). The distribution of captures of small rodents and its causes. Ekol. Polska. Ser. A XII(21): 369-378.

- TURCEK, F.J. (1958). Quantitative experiments on the consumption of tree-seeds by mice of the species Apodemus flavicollis. Arch. Soc. Zool. Bot. Fennicae "Vanamo", 10(1): 50-59.
- WHITAKER, J.O. (1963). A study of the meadow jumping mouse, Zapus hudsonius (Zimmerman) in central New York. Ecol. Monogr. 33(3): 215-54.
- WIERZBOWSKA, T., and PETRUSEWICZ, K. (1963). Residency and rate of disappearance of two free-living populations of the house mouse (Mus musculus L.). Ekol. Polska. Ser. A. 11: 557-75.
- WIJNGAARDEN, A. VAN (1960). The population dynamics of four confined populations of the continental vole Microtus arvalis (Pallas). Versl. Landbouwk. Onderzoek. No. 66: 22.
- WILLIAMS, O. (1955). Home range of Peromyscus maniculatus rufinus in a Colorado Ponderosa Pine community. J. Mammal. 36: 42-45.
- ¹ WOOD, T.D. (1927). Animal Nutrition. Lond. Univ. Tutorial Press. 2nd edn.
- ¹ WOOTTON, I.D.P. (1964). Micro-analysis in Medical Biochemistry. 4th edn. J. & A. Churchill Ltd. 254 pp.
- YERGER, R.W. (1953). Home range, territoriality and populations of the chipmunk in central New York. J. Mammal. 34: 448-58.

- YOUNG, H., NEESS, J., and EMLLEN, J.T. (1952). Heterogeneity of trap response in a population of house mice.
J. Wildl. Mgmt. 16: 169-80.
- YOUNGMAN, P.M. (1956). A population of the striped field mouse, Apodemus agrarius coreae in central Korea.
J. Mammal. 37: 1-10.
- ZIPPIN, C. (1956). An evaluation of the removal method of estimating animal populations.
Biometrics. 12: 163-89.
- (1958). The removal method of estimation.
J. Wildl. Mgmt. 22: 82-90.

* = Original not consulted.

‡ = Consulted, but not referred to in the text.

APPENDIX I. LIVE-TRAPPING FOR SMALL RODENTS AND WEASELS
IN A 100-ACRE AREA OF CASTLE EDEN DENE

I. INTRODUCTION

In this Appendix to the main thesis it is proposed to describe briefly the results of three trapping experiments carried out in an area of 100 acres of Castle Eden Dene. The three experiments were performed in August-September 1962, May 1963, and September 1963. The first live-trapping experiment was part of a mammal survey of the whole of the Castle Eden Denes which was being carried out by Mr. J.D. Davies, Mr. D.S. Gibbons, and the writer, under the supervision of Dr. K.R. Ashby. The second and third trappings were repeats of the first one; the second being performed by the writer and several students of zoology, and the third by Mr. P.J. Bolton, Mr. C. Malpus, and the writer. Dr. K.R. Ashby supervised all the work. The full results of the three studies, which have been analysed by the writer, are to be presented as a joint publication by Dr. K.R. Ashby and the writer.

II. THE STUDY AREA

The general features of the study area have already been described (see pp. 5-7 and Fig. 2). The nature of the tree cover of the area is shown in Fig. 48, and the dominants in the ground vegetation are shown in Fig. 49. These two figures were

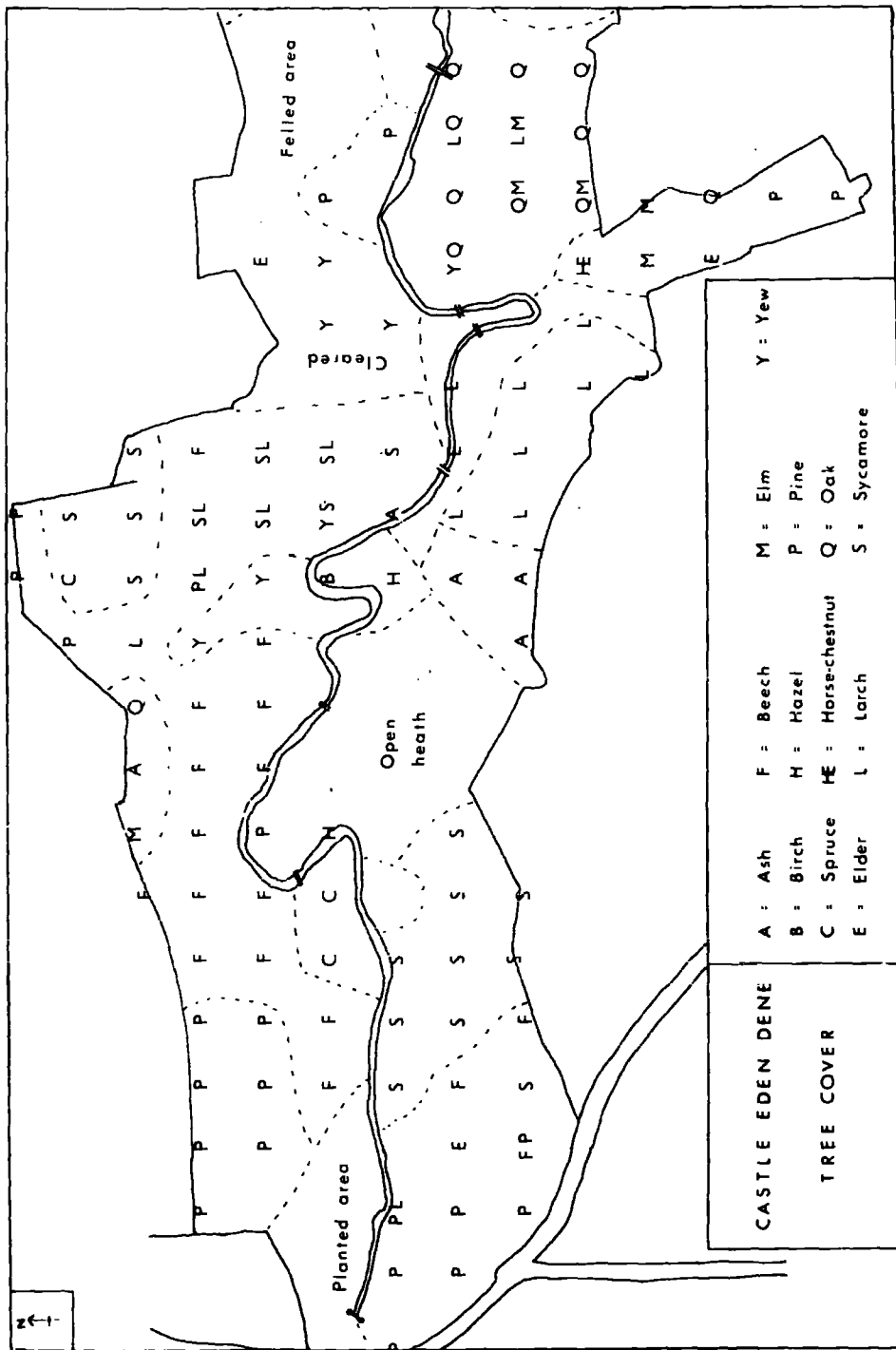

FIGURE 48. The tree cover at the trapping positions used in the surveys of a 100 acre area of Castle Eden Dene.

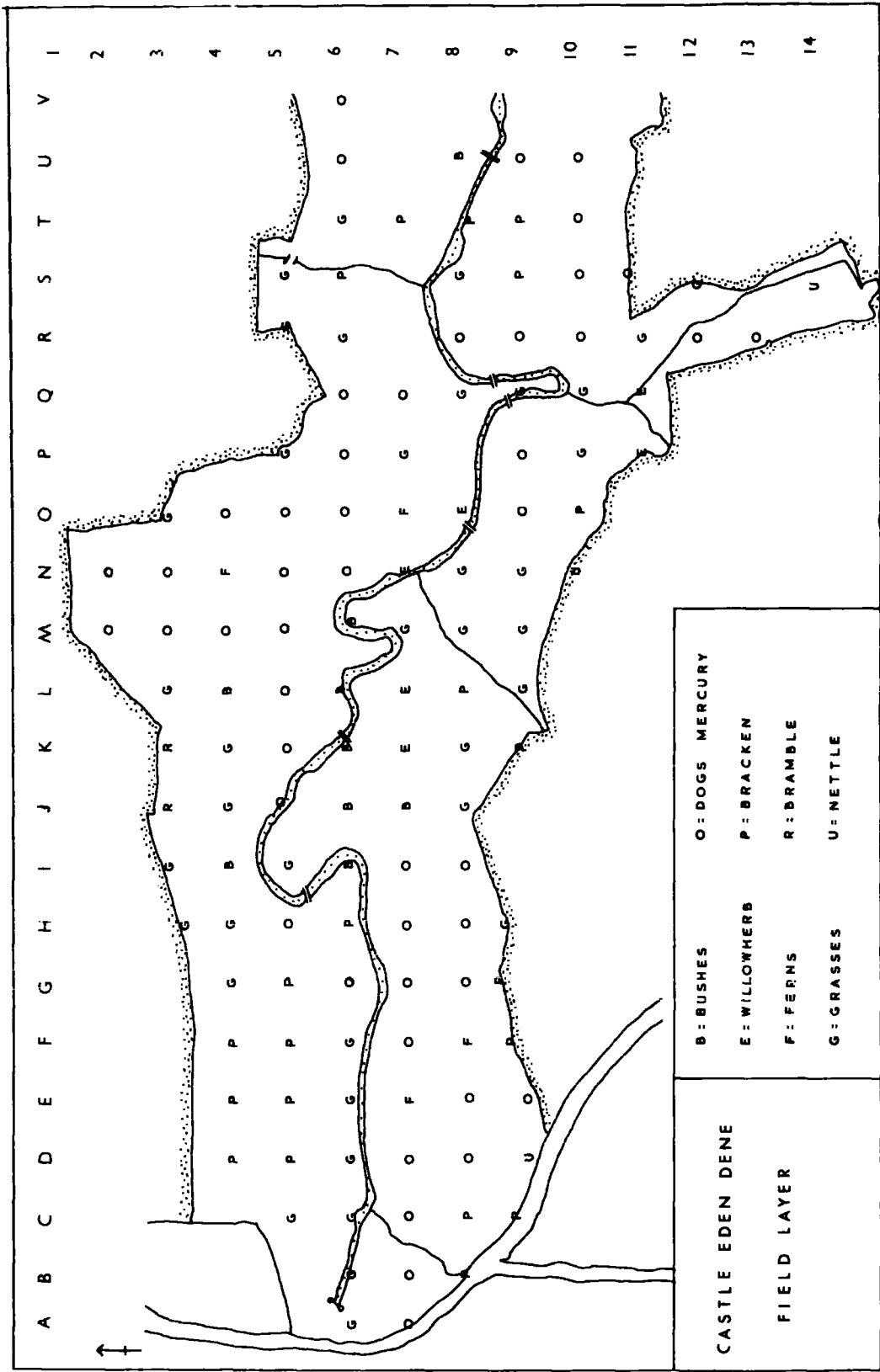

FIGURE 49. The vegetation of the field layer at the trapping positions used in the surveys of a 150 acre area of Castle Eden Dene.

constructed by putting together the vegetation records from individual trap positions and presenting them all together on one map.

II. METHODS OF STUDY

1. Trapping procedure

A 50 metre grid based on the National Ordnance Survey Grid was marked out over the study area in August 1962. Live-trapping for small rodents, using Longworth small mammal traps (Chitty & Kempson, 1949) was carried out with traps placed every 50 metres along the grid lines running in an east-west direction. Trapping was done in two sessions of five days each, because insufficient traps were available for the whole area to be covered in one trapping. Session I was carried out with two traps placed every 50 metres along the oddly-numbered grid lines (Fig. 49), and session II was performed with traps similarly placed only along the evenly-numbered grid lines. No pre-baiting period was used, the traps being set on the first day and checked daily for a further five days. One day was allowed for the traps to be moved to the new positions, then session II was carried out in an identical manner to session I. After session II was completed, weasel traps were placed at intervals of 100 metres along the grid lines. They were pre-baited with liver for two days, and were then set and visited daily for five days.

The procedure described above was carried out in the May 1963 and September 1963 trappings also, but with the following modifications:-

- 1) three Longworth traps were placed at each point instead of two,
- 2) estimates of the density of vegetation cover at the trapping points were made.

2. Methods of marking and the data recorded

Both ear-clipping and toe-clipping methods were used to mark the rodents, but ear-clipping only was used on the weasels. The rodents were given a mark to indicate upon what day they were marked, but the weasels were given individually specific marks.

All of the animals captured were marked and weighed, and information on their place of capture, sex, sexual condition, and approximate age was recorded.

All weasels were anaesthetised with ether before they were removed from the trap on the recommendation of Lockie & Charles, (pers. comm.).

IV. RESULTS

The numbers of Apodemus and Clethrionomys captured, together with their sexual condition, are given in Tables

100-103 for the first survey, and in Tables 104-107, and 108-111 for the second and third surveys respectively. Information on the body-weight frequency distributions is presented in Figures 50-52. The distribution of the captures of Clethrionomys and Apodemus in the three surveys is shown on maps shown in Figs. 53-55. In the sub-sections below the results from the three surveys are treated together in order to compare them.

1. The number of animals captured

In all three surveys the number of Clethrionomys captured exceeded that of Apodemus by a ratio of approximately 8 : 1. Only in the first survey were any Microtus or Mustela captured. Reference to Tables 100-111 shows that the largest captures of Clethrionomys and Apodemus were made in September 1963, and the lowest in May 1963. The trapping in May, at the onset of the normal breeding season, would be expected to provide only low catches. The greater size of the samples in September 1963, as compared with September 1962, is possibly due to the larger number of traps then available rather than to the presence of significantly larger populations of Clethrionomys and Apodemus. The absence of Mustela from the surveys in May and September 1963 may have been due to the severity of the long hard winter of 1962-63 making it difficult for the animals to survive.

Day	Males		Females		Esc.	Total	Dead in trap		
	Fec.	NF	P.	I.			Males	Females	Total
1.	10	3	2	7	1	23	2	4	6
2.	6	10	10	8	0	34	1	4	5
3.	16	8	14	12	3	53	3	3	6
4.	25	9	11	12	1	53	1	2	3
5.	24	8	10	18	3	63	0	0	0
Total	81	38	47	57	8	231	7	13	20

Table 100. The total number of Clethrionomys captured in Session I. September, 1962. Animals dead in traps are included in the total daily catch.

Day	Males		Females		Esc.	Total	Dead in trap		
	Fec.	NF	P.	I.			Males	Females	Total
1.	35	4	10	6	0	55	1	2	3
2.	35	7	10	13	0	65	4	1	5
3.	32	6	15	19	5	77	1	1	2
4.	38	12	18	17	4	89	4	4	8
5.	29	19	8	21	0	77	9	1	10
Total	169	48	61	76	9	363	19	9	28

Table 101 The total number of Clethrionomys captured in Session II. September, 1962. Animals dead in traps are included in the total daily catch.

Fec. = Fecund
 NF = Non-Fecund
 Esc. = Escaped.
 P. = Perforate
 I. = Imperforate

Day	Males		Females		Esc.	Total
	F.	NF	P.	I.		
1.	2	0	1	0	0	3
2.	1	0	3	0	2	6
3.	3	0	1	0	1	5
4.	1	0	2	0	1	4
5.	4	0	2	0	4	10
Total	11	0	9	0	8	28

Table 102. The total number of Apodemus captured in Session I. September, 1962.

Day	Males		Females		Esc.	Total
	F.	NF	P.	I.		
1.	6.	0	3	1	2	12
2.	4	0	0	1	0	5
3.	4	0	2	1	1	8
4.	3	0	4	0	0	7
5.	2	0	1	0	3	6
Total	19	0	10	3	6	38

Table 103. The total number of Apodemus captured in Session II. September, 1962.

F. = Fecund NF = Non-fecund
P. = Perforate I. = Imperforate
Esc. = Escaped

Day	Males		Females		Esc.	Total	Dead in trap		
	Fec.	NF	P.	I.			Males	Females	Total
1.	11	0	3	2	0	16	0	0	0
2.	18	0	3	3	1	25	1	0	1
3.	19	0	0	4	1	24	0	0	0
4.	12	0	2	2	6	22	1	0	1
5.	23	0	3	2	2	30	1	0	1
Total	83	0	11	13	10	117	3	0	3

Table 104. The total number of Clethrionomys captured in Session I. May, 1963. Animals dead in traps are included in the total daily catch.

Day	Males		Females			Esc.	Total	Dead in trap		
	Fec.	NF	P.	I.	Pr.			Males	Females	Total
1.	7	0	1	3	3	0	14	0	0	0
2.	11	0	4	2	3	0	20	0	0	0
3.	10	0	3	2	2	0	17	0	1	1
4.	16	0	2	1	3	1	23	0	0	0
5.	19	0	0	3	5	1	28	0	0	0
Total	63	0	10	11	16	2	102	0	1	1

Table 105. The total number of Clethrionomys captured in Session II. May, 1963. Animals dead in traps are included in the total daily catch.

Fec. = Fecund
 NF = Non-Fecund
 Esc. = Escaped

P. = Perforate
 I. = Imperforate
 Pr. = Pregnant.

Day	Males		Females		Esc.	Total
	Fec.	NF	P.	I.		
1.	0	0	0	0	0	0
2.	1	0	0	0	0	1
3.	0	1	0	2	1	4
4.	3	0	0	3	2	8
5.	1	1	0	2	0	4
Total	5	2	0	7	3	17

Table 106. The total number of Apodemus captured in Session I. May, 1963.

Day	Males		Females			Esc.	Total
	Fec.	NF	P.	I.	Pr.		
1.	2	0	0	0	0	0	2
2.	2	0	0	0	0	0	2
3.	2	0	0	0	1	0	3
4.	2	0	0	1	0	1	4
5.	3	0	0	0	1	0	4
Total	11	0	0	1	2	1	15

Table 107. The total number of Apodemus captured in Session II. May, 1963.

Fec.	=	Fecund	NF	=	Non-fecund
P.	=	Perforate	I.	=	Imperforate
Pr.	=	Pregnant	Esc.	=	Escaped.

2. Breeding

At the time of the trappings in September 1962 and September 1963 breeding was still taking place in both the Clethrionomys and Apodemus populations, and the populations were heterogeneous in age-structure. In May 1963 the breeding appeared to have just commenced, for although all the males were fecund not all the females were in breeding condition, and there was no evidence that any juveniles had been produced.

3. The body-weight frequency distributions

Histograms showing the range of body-weights in the Clethrionomys and Apodemus populations on the three occasions when trapping took place are shown in Figs. 50-52. The distributions confirm the ideas already put forward as a result of examining the breeding data viz. that breeding was actively in progress in the September surveys, and was commencing at the time of the May survey.

4. The distribution of captures over the study area

The mapped distributions of the captures of Clethrionomys and Apodemus are shown in Figs. 53-55. According to the number of individuals captured at each trap site the density of capture was denoted as listed below:-

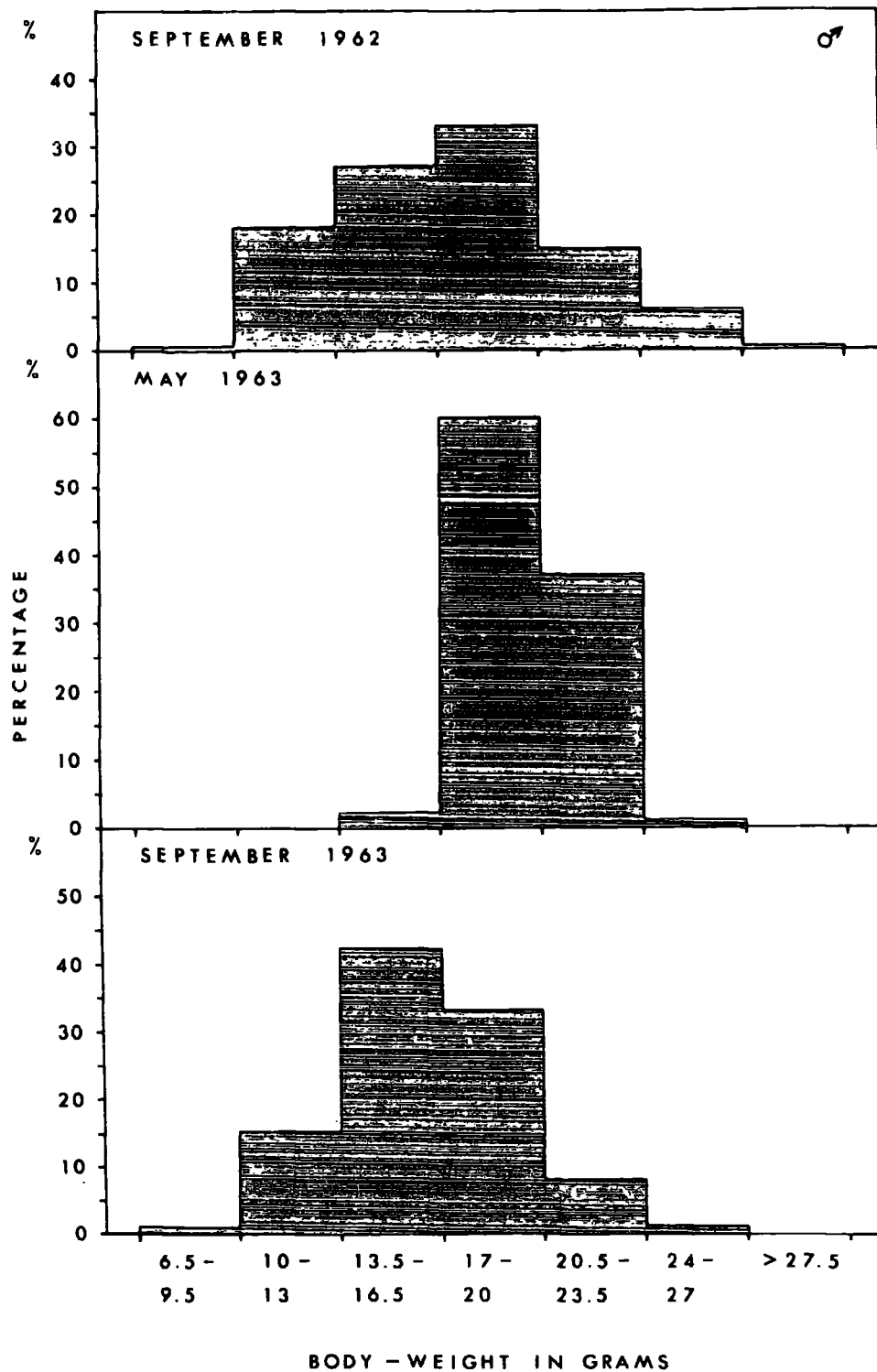

FIGURE 50. The frequency distributions of body weights of Clethrionomys males in the three surveys of Castle Eden Dene.

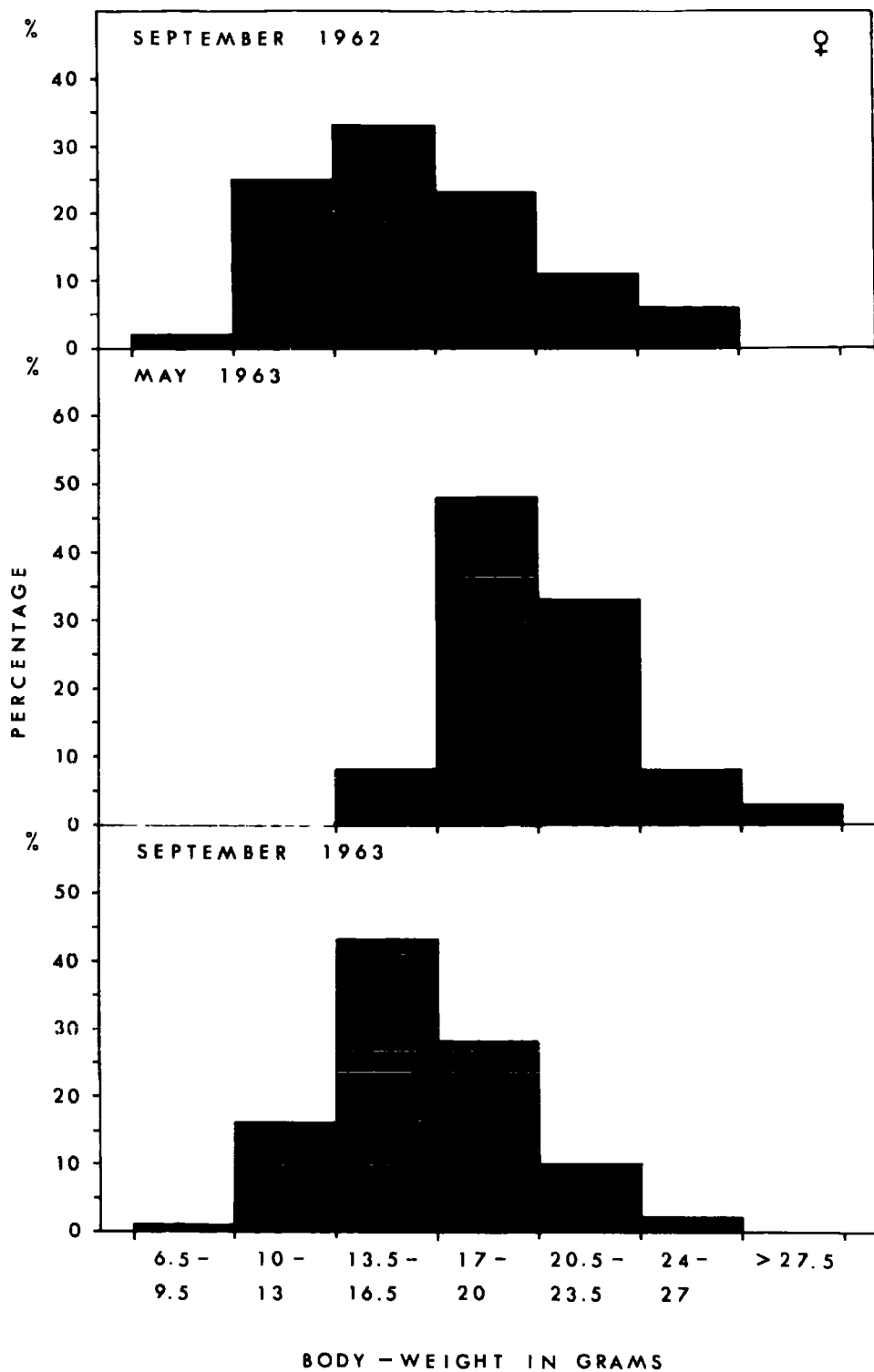

FIGURE 51. The frequency distributions of body weights of Clethrionomys females in the three surveys of Castle Eden Dene.

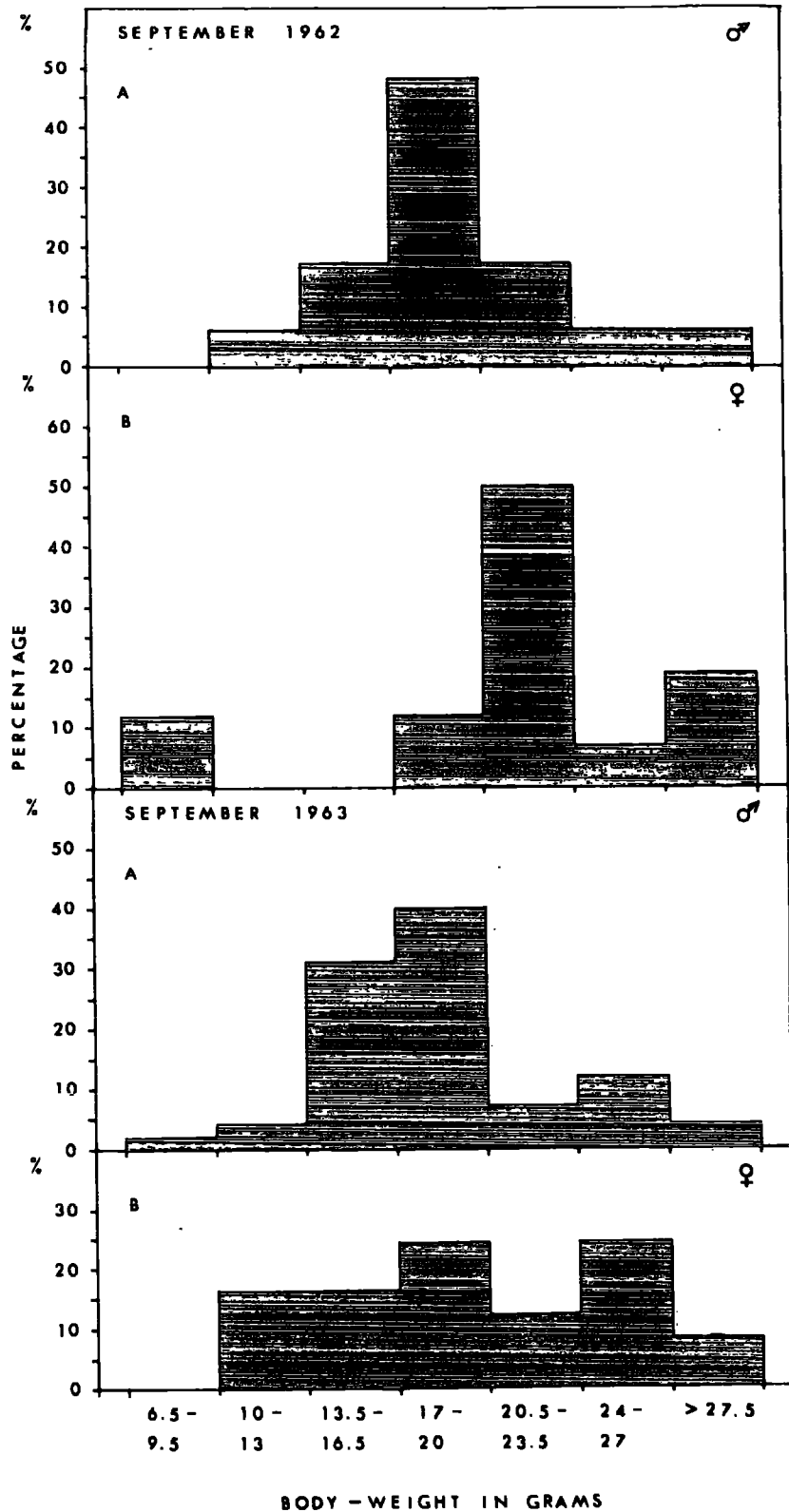

FIGURE 52. The frequency distributions of body weights of Apodemus males and females in surveys I and III.

- 1) no captures absent
- 2) 1-3 captures low density
- 3) 4-6 captures medium density
- 4) 7-10 captures high density

When the mapped distributions of Clethrionomys captures at the three trappings are compared it is seen that whatever the overall number of animals captured may have been, the major centres of abundance were similarly placed on all three occasions. In May 1963 the highest grade of density reached was 'medium' on the above scale, but the areas of medium density corresponded well in position with the areas of high density in September 1962 and 1963. Similarly, the 'low' density areas of May 1963 were incorporated in the medium density areas of the two September samples.

From this admittedly very brief analysis it may be suggested that the results of this investigation tend to support the views of Naumov (1936). Naumov suggested that when a population is at its lowest density it occupies only the most favourable habitats, but that as the density increases the pressure of numbers forces the population into less favourable habitats, until eventually a maximum density is reached when all possible habitats are occupied.

The numbers of Apodemus captured were much fewer than those of Clethrionomys and hence the distribution of the

Day	Males			Females						Esc.	Total
	Fec.	NF	J.	P.	I.	Pr.	ILP	PL	J.		
1.	12	5	1	2	15	4	2	0	9	2	52
2.	15	12	1	1	19	2	4	0	4	4	62
3.	33	8	9	8	30	4	4	0	9	4	109
4.	22	10	9	3	31	7	12	0	5	5	104
5.	14	15	14	1	28	5	9	0	7	0	93
Total	96	50	34	15	123	22	31	0	34	15	420

Table 108. The total number of Clethrionomys captured in Session I. September, 1963.

Day	Males			Females						Esc.	Total
	Fec.	NF	J.	P.	I.	Pr.	ILP	PL	J.		
1.	13	3	10	1	15	4	7	0	5	0	58
2.	12	9	11	1	18	8	15	0	12	1	87
3.	16	12	8	1	26	6	4	0	5	1	79
4.	29	15	6	2	22	6	13	0	6	3	102
5.	18	10	7	4	26	7	13	0	3	5	93
Total	88	49	42	9	107	31	52	0	31	10	419

Table 109. The total number of Clethrionomys captured in Session II. September, 1963.

Fec. = Fecund
 J. = Juvenile
 I. = Imperforate
 ILP = Imperforate, Lactating, Pregnant.
 NF = Non-Fecund
 Pr. = Pregnant
 p. = Perforate
 PL = Perforate, Lactating
 Esc. = Escaped.

Day	Males			Females						Esc.	Total
	Fec.	NF	J.	P.	I.	Pr.	ILP	PL	J.		
1.	5	1	0	1	1	0	0	0	1	0	9
2.	0	0	0	0	0	0	0	0	1	2	3
3.	6	0	0	3	1	0	1	0	0	1	12
4.	8	2	0	0	1	0	1	0	0	5	17
5.	10	0	2	0	1	0	2	0	1	1	17
Total	29	3	2	4	4	0	4	0	3	9	58

Table 110. The total number of Apodemus captured in Session I. September, 1963.

Day	Males			Females						Esc.	Total
	Fec.	NF	J.	P.	I.	Pr.	ILP	PL	J.		
1.	5	1	0	1	0	0	1	0	1	3	12
2.	9	1	1	0	0	1	3	0	1	5	21
3.	8	0	1	1	0	0	0	0	1	2	13
4.	10	0	1	0	1	0	1	0	0	0	13
5.	6	1	0	1	1	1	2	0	1	2	15
Total	38	3	3	3	2	2	7	0	4	12	74

Table 111. The total number of Apodemus captured in Session II. September, 1963.

Fec. = Fecund
 J. = Juvenile
 I. = Imperforate
 ILP = Imperforate,
 Lactating, Pregnant
 Esc. = Escaped.
 NF = Non-fecund
 P. = Perforate
 Pr. = Pregnant
 PL = Perforate,
 Lactating

captures must be considered warily if viewed as being representative of the distribution of the Apodemus population. However, in September 1962 the majority of the Apodemus captures were made in areas where Clethrionomys was less well represented, and this general premise held with the two other surveys also. Whether this apparent distinction between the distributions of the two species is real is not clear, because it could possibly be partially due to the exclusion from the traps of the nocturnal Apodemus by the prior occupation of those traps by the diurnal Clethrionomys. This would have been less likely to happen in September 1963 when there were more traps available.

5. The possible influence of cover density on the distribution of rodents

From the distribution maps in Figs. 53-55 it may be seen that the highest numbers of Clethrionomys captures were made where the densest vegetation was found around the trapping-sites. Conversely, the majority of the Apodemus captures were made in areas where the cover was less dense. The relationship between the cover density of the vegetation and the distribution of Clethrionomys and Apodemus has been examined more closely in Section C (pp. 137-171).

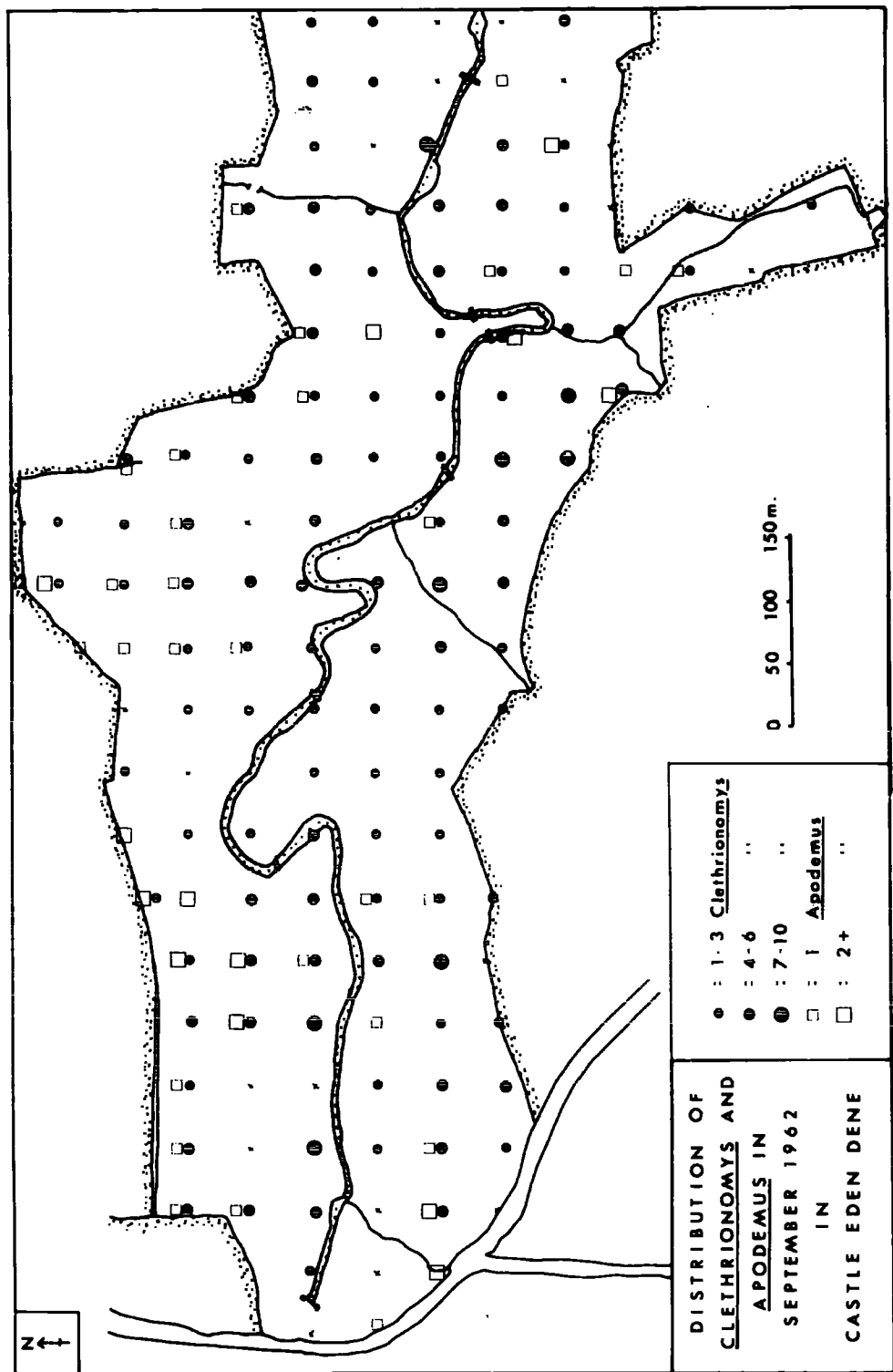

FIGURE 53.

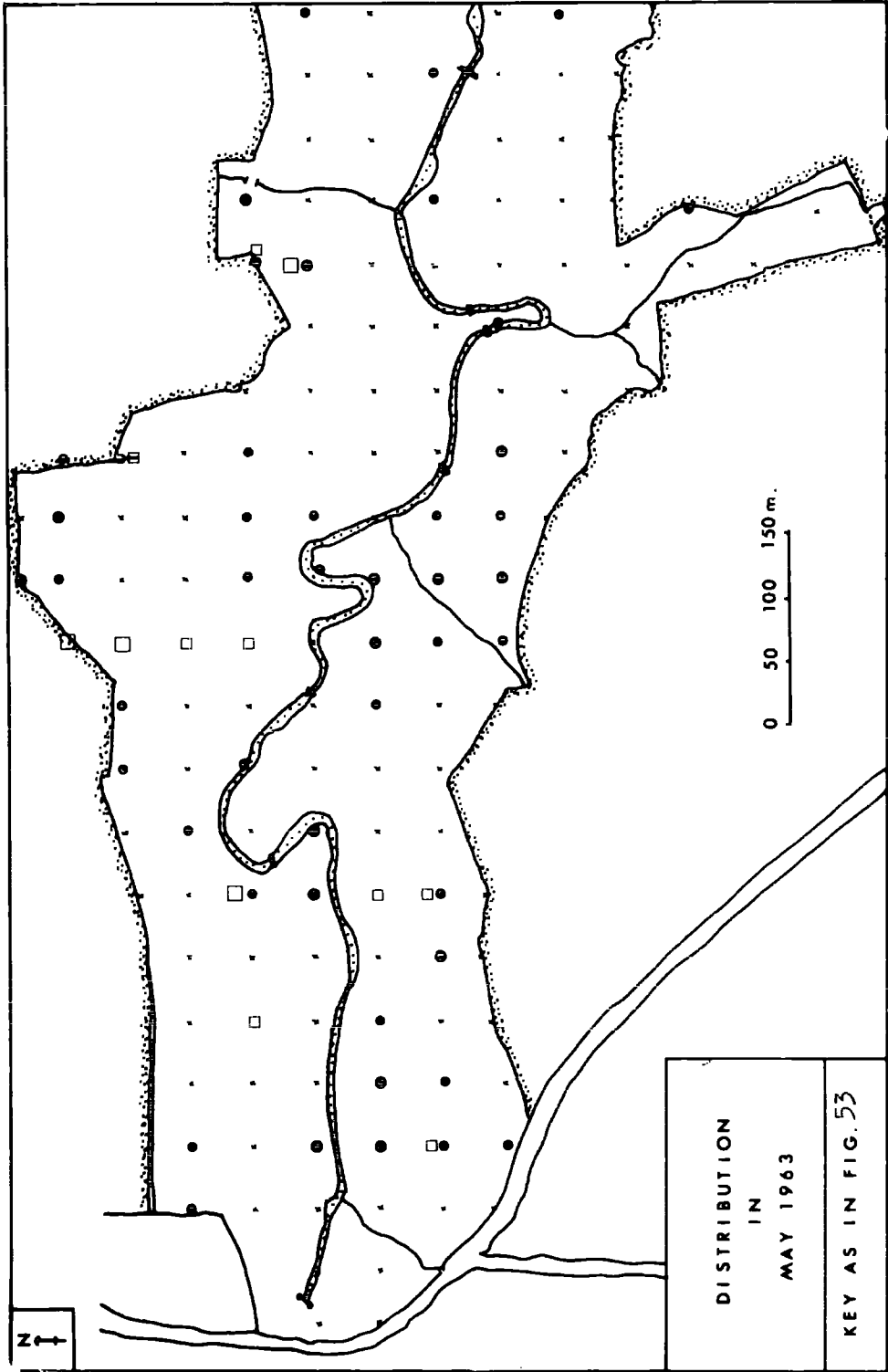

FIGURE 54.

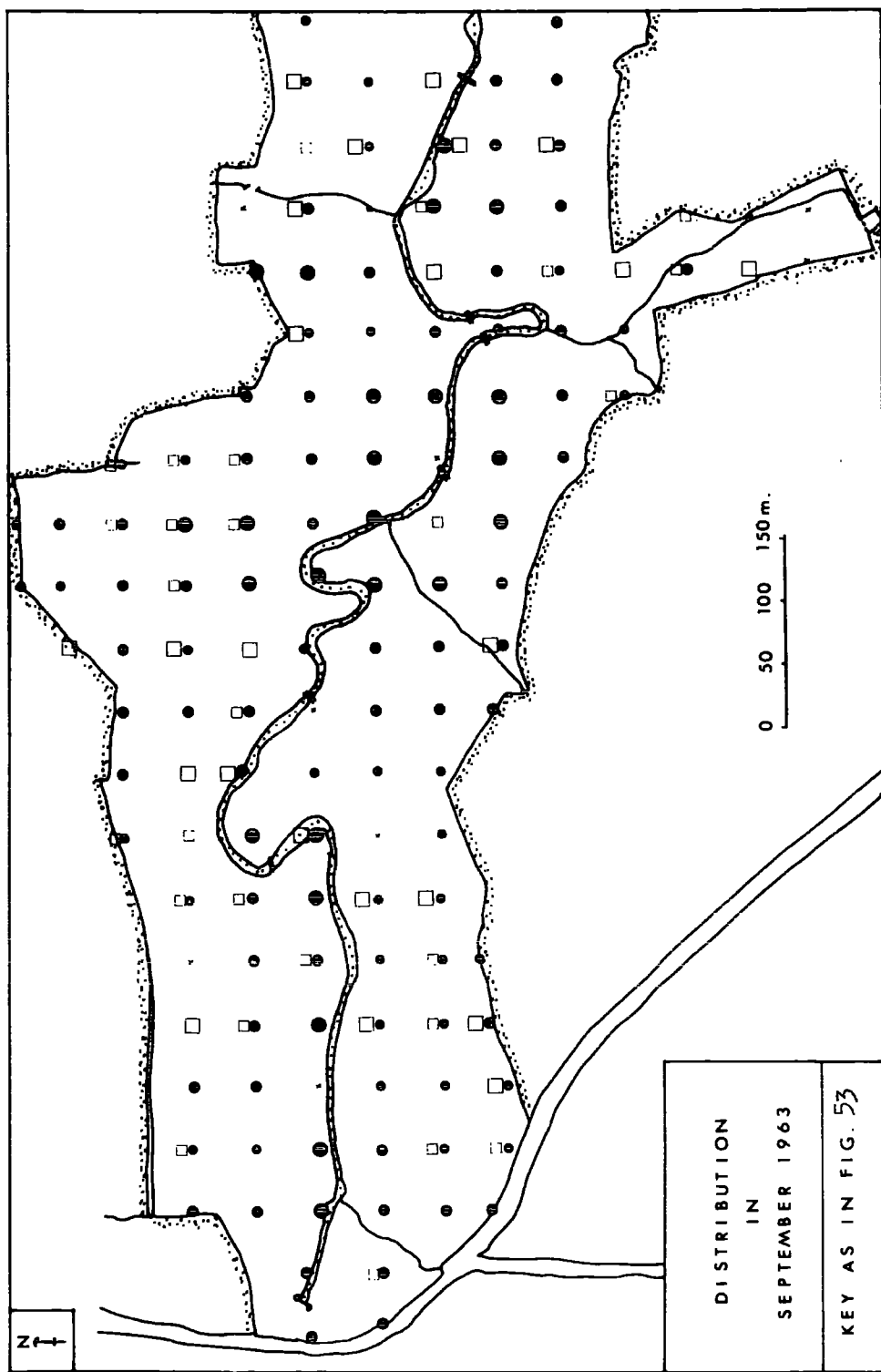

FIGURE 55.

6. The captures of weasels (*Mustela nivalis*)

A complete list of all the weasels captured in Castle Eden Dene from August 1962 to January 1965 is given in Table 112. It can be seen from this table that twice as many weasels were captured in 1962 than in 1963 and 1964 added together. The positions of the captures may be ascertained by reference to Fig. 49 which has the grid references marked.

Date of Capture	Sex	Weight	Type of trap	Locality
31/8/62	♂	-	Longworth	U5
3/9/62	♂	-	"	T5
3/9/62	♂	118 gms.	"	P7
5/9/62	♀	55 gms.	"	U8
8/9/62	♀ ¹	40 gms.	"	S8
18/9/62	♂	134 gms.	Weasel	B7
18/9/62	♂	120 gms.	"	R11
19/9/62	♂	110 gms.	"	P11
19/9/62	♂	123 gms.	"	N5
20/9/62	♂	118 gms.	"	L9
20/9/62	♂	109 gms.	"	N7
21/9/62	♂	118 gms.	"	R11
27/11/62	♂	128 gms.	"	H5
28/11/62	♂	100 gms.	"	P5
28/11/62	♂	118 gms.	"	R9
29/11/62	♂	130 gms.	"	F5
6/3/63	♂ ¹	112 gms.	Longworth	Grid B
20/3/63	♂	102 gms.	"	Grid B
28/4/63	♂	110 gms.	"	Grid B
28/4/63	♀	52 gms.	"	Grid B
6/8/64	♀ ¹	50 gms.	"	Grid A
13/8/64	♂ ¹	80 gms.	"	Grid B
13/8/64	♂ ¹	-	"	Grid A
18/8/64	♂	109 gms.	"	Grid B

Table 112. Records of captures of Mustela nivalis in Castle Eden Dene from 1962-1965. For position of captures see Fig.

¹ = dead.

APPENDIX II. A SPECIES LIST OF FLEAS TAKEN FROM RODENTS AND
SHREWS IN CASTLE EDEN DENE

In June 1964 some work was carried out by Mr. P.J. Bolton and the writer on the fleas of small rodents. Below is given the species list of fleas obtained from rodents and shrews in ten days trapping. The fleas were identified by Mr. P.J. Bolton.

1. Ctenophthalmus nobilis nobilis (Rothschild)
2. Ctenophthalmus nobilis vulgaris (Smit)
3. Malaraeus penicilliger mustelae (Dale)
4. Doratopsylla dasyncnema dasyncnema (Rothschild)
5. Palaeopsylla soricis soricis (Dale)
6. Peromyscopsylla sylvatica spectabilis (Rothschild)
7. Hystrihopsylla talpae talpae (Curtis)

Fleas 4 and 5 are shrew fleas; flea 7 is a mole flea.

