



Durham E-Theses

The electric charges and masses of rain drops

Hutchinson, W. C. A.

How to cite:

Hutchinson, W. C. A. (1949) *The electric charges and masses of rain drops*, Durham theses, Durham University. Available at Durham E-Theses Online: <http://etheses.dur.ac.uk/8961/>

Use policy

The full-text may be used and/or reproduced, and given to third parties in any format or medium, without prior permission or charge, for personal research or study, educational, or not-for-profit purposes provided that:

- a full bibliographic reference is made to the original source
- a [link](#) is made to the metadata record in Durham E-Theses
- the full-text is not changed in any way

The full-text must not be sold in any format or medium without the formal permission of the copyright holders.

Please consult the [full Durham E-Theses policy](#) for further details.

T H E S I S

Presented in candidature for the degree of

DOCTOR OF PHILOSOPHY

of the University of Durham

by

Walter Charles Andrew Hutchinson, B.Sc.

entitled

THE ELECTRIC CHARGES AND MASSES OF RAIN DROPS

Being an account of work carried out at the Science
Laboratories, Durham Colleges in the University
of Durham, during the period, 1946 - 1949 under
the supervision of J. A. CHALMERS, M.A., B.Sc., Ph.D.

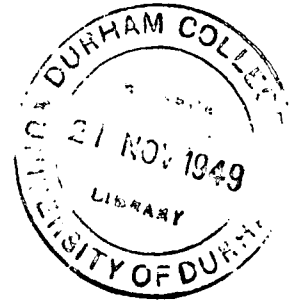

THE ELECTRIC CHARGES AND MASSES

OF RAIN DROPS

C O N T E N T S

<u>CHAPTER I</u>	<u>Introduction</u>	Page
1.	Atmospheric electricity - the part played by precipitation.....	1
	(a) Maintenance of earth's charge.....	1
	(b) The separation of charge.....	2
2.	The origin of rain charges.....	6
3.	General results for rain currents.....	9
4.	Previous work on single drop measurements....	11
	(a) Methods of measuring drop size.....	11
	(b) Methods of measuring drop charge.....	13
	(c) Previous results for single drops.....	14
<u>CHAPTER II</u>	<u>The amplifier for measuring electric charge.</u>	
1.	Advantages and theory of the valve amplifier.	16
2.	The design of the amplifier.....	23
3.	The calibration of the amplifier.	
	(a) The 'Calibrating Condenser'.....	30
	(b) Attempt to standardise the air condenser using a $500\mu\mu\text{F}$ mica condenser.....	32
	(c) Standardisation with a $10\mu\mu\text{F}$ precision condenser.....	33
	(d) An experiment with charged water drops to check the standardisation.....	38
	(e) Sensitivity of the amplifier.....	43
	(f) The effect of terminal velocity of rain drops on amplifier sensitivity.....	45
4.	Further work on amplifier design.....	46

CHAPTER III

The measurement of drop mass.

1. The production of drops of a given size..... 53
 2. Account of two methods investigated but not subsequently employed..... 56
 - (a) The Momentum method..... 56
 - (b) The Drop Velocity Camera method..... 61
 3. The method used - the Absorbent Paper Method. 62
- Table. Stain diameter, drop size and terminal velocity..... 68

CHAPTER IV

The Complete apparatus and experimental procedure.

1. The site..... 72
2. The rain drop receiver..... 73
3. Measurement of the electric field..... 78
4. The measurement of Point Discharge..... 82
5. Recording Technique..... 83
6. Making observations..... 85
7. Interpretation of records..... 87

CHAPTER V

The connexion between point discharge current and field.

92

CHAPTER VI

Results for rain.

1. Extent of the observations. 96
2. Possible errors in the measurements..... 98
3. The sign of charge and field..... 100
4. Rain without point discharge..... 103
 - (a) Drop size and charge..... 103
 - (b) The continuous rain on 2nd June, 1948. 104
5. Rain with point discharge..... 105

CHAPTER VI cont'd:

5. (a) Drop size and charge..... 105
- (b) The continuous rain on 3rd June, 1948. 107
6. Summary of results..... 108

CHAPTER VII

Discussion of results for rain.

1. Comparison with previous results for single drops..... 110
2. Rain without point discharge..... 110
3. Rain with point discharge..... 111
4. Consideration of recent results for rain currents..... 114
5. Dependence of rain charge on instantaneous point discharge current..... 115
6. The primary process - establishing the field, or charging of rain..... 117

CHAPTER VIII

Suggestions, further work on single drops. 120

SUMMARY. 123

BIBLIOGRAPHY. 129

ACKNOWLEDGMENTS. 132

CHAPTER I

INTRODUCTION

I 1. Atmospheric electricity - the part played by precipitation.

The electrification of rain may be studied in connexion with thunderstorm activity, atmospheric ionization, and vertical electric fields and currents in the atmosphere. We will consider these phenomena under headings representing two broadly defined and inevitably overlapping problems.

I 1.a. The maintenance of the earth's charge.

In fine weather there is a vertical electric field in the atmosphere, directed downwards and conventionally positive. The earth, which is a conductor, therefore carries a negative bound charge on that part of its surface which is experiencing fine weather. At the same time the air, which is always to some extent ionized, carries an ionic conduction current which tends to neutralize the bound charge. Chalmers (1949, page 118) calculates from results for Kew that the surface of the earth near Kew would lose its bound charge by means of the conduction current in 48 minutes, were there no means of replenishing it. Over the sea and in country districts where the conduction current is higher the time would be even less. The charge may be replenished by the transfer of positive or negative electricity to or from the earth by ionic conduction current, point discharge current, precipitation current, and lightning, occurring at any part of the earth's surface.

Wormell (1930) and Chalmers (1949, page 120) have made estimates of the balance of charge transferred to 1 sq. Km. of the earth's surface by these processes in the course of a year. Although the estimates are only very approximate, observational data being limited, the results do show that the processes enumerated may together produce no net transfer of charge to or from the earth. The contribution of rain charge in England is estimated at about + 20 coulombs, which should be compared with the greatest contribution, which is about -120 coulombs, by point discharge.

I 1.b. The separation of charge.

The normal fine weather positive field corresponds to a potential difference between the ionosphere and the earth. The fluctuating fields of either sign associated with disturbed weather and particularly with thunderstorms show that there is a separation of electric charge in the atmosphere. There have been several attempts to account for this separation of charge, and we will consider the main ones briefly. In each one water has an essential role, whether in the form of cloud particles (solid or liquid) or as precipitation (again solid or liquid). In general the separation of charge takes place in two stages. First there is some process whereby a precipitation or cloud particle and the surrounding air become oppositely charged. Then there is the relative movement of these two charges, usually by convection, giving the separation of charge in space.

Simpson (1927) based his 'breaking drop theory' of the separation of charge in thunderclouds on the phenomenon observed by Lenard (1892) and further investigated by Simpson (1909) that when water drops are broken in air the water fragments have a positive charge and the air acquires a negative charge. According to Simpson's original theory drops of water carried up in convection currents go through many cycles of breaking and coalescing. The negatively charged air is carried up above the positively charged water drops, giving rise to an upper negative and a lower positive charge accumulation in the cloud. Such a cloud is said to be of negative polarity.

Subsequent investigations by Simpson and Scrase (1937) have shown that this picture is wrong, and that the thundercloud is of positive polarity. Moreover the level of charge separation is above freezing level where cloud particles are solid, or, even if they are supercooled water, will freeze on coalescing. This rules out electrification by breaking drops for producing the main separation of charge giving a cloud of positive polarity. A localized zone of positive charge usually found near the cloud base by Simpson and Scrase (1937) and Simpson and Robinson (1940) may well result from the breaking of drops as in Simpson's original theory. Simpson and Scrase (1937) have therefore put forward a new theory - the 'ice-friction theory' - according to which ice particles in the cloud rub together, the larger particles acquiring a negative charge and slowly sinking, leaving the air above positively charged. This results in a positive cloud as usually found.

According to Wilson's 'ion-capture theory' (1929) drops of water falling in a cloud are polarized by an existing vertical electric field. For a positive field the drops carry an upper negative and a lower positive charge. By the selective capture of the upward-moving negative ions (the air always being to some extent ionized) the drops acquire a net negative charge. The resulting deficiency of negative ions gives the cloud a layer of positive charge at the top and negative charge near its base, that is, the cloud is of positive polarity. Below such a cloud the field is negative (directed downward), and so rain will be mainly positively charged, which is what is usually found. Whipple and Chalmers (1944) have developed Wilson's theory quantitatively, and Chalmers (1947) has shown that on account of dielectric polarization ice crystals should be even more effective in the selective capture of ions than water drops of the same mass. Laboratory experiments by Gott (1933, 1935) on the capture of ions by drops of water falling in a vertical field give results in keeping with Wilson's theory.

Gunn (1935) performed laboratory experiments which supported the theoretical conclusion that a water drop evaporating carries a positive charge, and a negative charge when condensing. From this he elaborated a theory of charge separation in thunderclouds. Later (1947) he measured rain drop charges with apparatus attached to an aircraft flying below a precipitating cloud. Electric field measurements showed that the rain particle charges were largely neutralized by nearby charges. The separation of these opposite charges would immediately produce the high fields associated with thunderstorms.

Chalmers (1943) has criticised the ice-friction theory on the grounds that from the results of Simpson and Scrase (1937) with the alti-electrograph the separation of charge occurs at heights just above the freezing level where there are also supercooled water droplets and not merely ice-crystals. According to Bergeron's theory of rain formation (1933) these droplets freeze on coalescing with ice particles, building up precipitation particles which below the freezing level melt to form rain. On the sudden freezing with the coalescence, it is suggested that positive charge is released, the drop carrying away negative charge, and the separation is effected.

Findeisen (1943) has put forward a theory as a result of his laboratory observation of the shedding of mainly negatively charged ice-splinters by a surface on which ice crystals are being deposited by sublimation. Mostly positively charged splinters are formed in the reverse process. If an electric field exceeding a certain minimum is applied to the surface the splinters formed are mainly opposite in sign to the field. In clouds, particles of ice will give negative or positive splinters according to conditions in the air, resulting in charge separation as the main particles fall. In some circumstances an existing field may be very much increased to values found in thunderstorms.

Frenkel (1946) bases a theory on the fact that water droplets in ionised air take on a negative charge. The sinking of the droplets under gravity produces the separation of charge observed in clouds. This theory is of interest in connexion with negative fields observed in mist and low-lying stratus cloud when there is no

precipitation. Chalmers and Little (1947) have observed such negative fields at Durham during 1939, and I have observed the same phenomenon on several occasions during 1948. In these cases the separation of charge necessary to produce the negative field may well be due to an agency such as Frenkel describes.

I 2. The origin of rain charges.

As precipitation appears to play an essential part in the main separation of charge in 'rain-clouds' the precipitation particles will begin their downward journey to the earth carrying a charge. According to the various theories of charge separation already mentioned we then have the following possibilities for the sign of the initial charge:-

- (a) Ion-capture theory (Wilson): negative (for a positive cloud);
- (b) Ice-friction theory (Simpson and Scrase); negative;
- (c) Breaking drop theory for cloud base localized charge: positive;
- (d) Gunn's theory: negative (because of condensation);
- (e) Chalmers theory: negative;
- (f) Findeisen's theory: positive or negative (according to initial conditions of temperature or field);
- (j) Frenkel's theory: negative.

Superimposed on the initial charge of the precipitation particles will be charges acquired in one or more subsequent processes. These include:-

- (a) selective ion-capture by Wilson's process, both for ice and water, giving charge opposite in sign to the field;

- (b) breaking of drops (Lenard effect), perhaps in the air or at the earth's surface, giving positive charge;
- (c) in the case of snow, ice friction near the earth's surface, for example in a blizzard, giving negative charge;
- (d) evaporation or condensation, giving (according to Gunn) positive or negative charge;
- (e) selective capture of ions (according to Frenkel), the excess of positive ions in the air producing a net gain of positive charge;
- (f) when freezing level is near the earth's surface, ice-splinter formation as described by Findeisen, the field or temperature conditions deciding whether the charge is positive or negative.

Not all the theories have been worked out quantitatively. Whipple and Chalmers (1944) have elaborated Wilson's theory, from which they deduce that the charge acquired by a drop, in some circumstances at least, is proportional to the field in which the drop falls and to the square of the radius. The work of Nolan and Enright (1922 (2)) on the splashing of water drops gives the result that the charge produced by breaking drops is nearly proportional to the area of new surface produced, but this does not lead to any simple connexion between charge and radius of rain drops considered singly. According to Gunn's theory, the drop charge is roughly proportional to its radius. Frenkel in his theory calculates that the positive charge acquired by a drop in

falling is proportional to field strength and the square of drop radius (c.f. Whipple and Chalmers above).

Because there are so many possibilities for charge acquisition, the study of the charges on single drops at the earth's surface is likely to yield information which would be masked in the study of rain currents. Chalmers and Pasquill (1938) report sequences of single drop charges where one sign predominates for a short time. They suggest that this is evidence for the existence of two processes of charging, the sequences corresponding to times when one process is more effective than the other. It appears from their suggestions that a method of measuring a large number of charges in a very short time would enable an observer to 'isolate' samples of rain associated primarily with only one process of charging.

I 3. General results for rain currents.

Most observers estimating the total quantities of positive and negative charge brought to a given area of the earth's surface in a year by rain find an excess of positive charge. The actual ratio of positive to negative charge varies from one observer to another. An inverse connexion between the sign of rain charge and of field has been found to a greater or less extent since the observations of Elster and Geitel in 1888. Reported observations differ widely one from another, and are too few to be truly representative of rain currents for the whole earth. A short account of most of the observations, with bibliographical references, is given by Chalmers (1949).

The results of Simpson (1948) obtained from continuously recorded observations at Kew from 1942 to 1946 are of particular interest as they show certain quantitative relationships. For rain when fields are below 1000 Volts/metre Simpson finds by empirical means that the charge per c.c. of rain (q) is proportional to $-(F - 400)$, where F is the field in Volts/metre, and is independent of the rate of rainfall. The average value of the fine weather field at Kew is 400 V./m., and so q is proportional to the 'displacement' of the field from its fine weather value. Rainfall rarely occurred when the field was between + 400 and + 1000 V/m. For fields greater than 2000 V/m., there being point discharge current (I), Simpson finds that frequently an inverse sign relationship between I and rain current i is so clearly marked that on plotting I and i on the same graph against time the curves rise and fall

together and cross the axis together, but in opposite directions. Simpson calls this the 'mirror image effect'. He finds also that results taken from periods when the mirror image effect was clearly in evidence may be represented by

$$i = -0.80 \times 10^{-5} I R^{0.57}$$

where I is point discharge current as measured and R the rate of rainfall (i and I in e.s.u. and R in cm./sec.) Simpson gives two other equations which represent his results equally well:-

$$i = -\frac{I}{5.5 \times 10^6} \left(1 - e^{-2.1 \times 10^3 R} \right)$$

and

$$i = -\frac{IR}{4 \times 10^6 (R + 5.5 \times 10^{-4})}$$

These two equations show that when R is large the ratio i/I approaches a constant value, and that if the rain drops absorb the point discharge ions then for high rates of rainfall the whole of the ions will be so collected. Simpson offers no solution to the problems of where the rain charge originates, either with or without point discharge.

I 4. Previous work on single drop measurements.

I 4.a. Drop size.

Laws and Parsons (1943), developing a method due to Bentley (1904), caught rain drops on a tray of sifted flour. Each drop produced a pellet of dough which, after an elaborate hardening treatment, was measured. By means of a calibration the drop size was found. They measured drops of radius from 0.6 mm. upwards.

Defant (1905) developed Wiesner's absorbent paper method. Drops falling on homogeneous blotting paper produce a circular stain of which the diameter is related to the drop size. Defant used a mixture of eosin and talc to fix the spots. The smallest drop he measured was 0.5 mm. radius.

Nolan and Enright (1922) used glass microscope slides prepared by spreading on them a layer of thick dark oil of density 0.9. Drops falling on them are suspended as spheres and sink slowly. Drop radius is measured with a microscope and eyepiece scale. This method is suitable for very small drops.

Flower (1928) used a delicate ballistic balance to determine the distance a drop of given size falls from rest before attaining its terminal velocity. He made no measurements of drops less than 1.0 mm. in radius. Such a balance, if calibrated, could be used to measure rain drop size, terminal velocities being known (see Laws, 1941). A serious disadvantage of such a method is that the momentum of rain drops increases very rapidly with drop radius.

For a small drop of radius 0.2 mm. the mass is 0.033 mg., the terminal velocity 160 cm./sec., and hence the momentum 5.4 mg. - cm./sec. For a not unusually large drop of radius 1.0 mm. the mass is 4.2 mg., the terminal velocity 660 cm./sec. and hence the momentum 2,800 mg. -cm./sec. A ballistic balance designed to measure the small drop would probably be put out of action by the 1.0 mm. drop.

Laws (1941) with his 'drop-velocity camera' measured the terminal velocity of drops of water of radius 0.6 mm. and upwards. Using a cine camera he photographed single drops along a line at right angles to their path as they fell through a region of dark field illumination. The light was interrupted 480 times a second so that the drop paths appeared on the photographs as broken lines. A large aperture converging lens was placed at its own focal length away from the camera lens and on the same axis. For drops falling within a few cm. of this 'collimating lens' the magnification was uniform over the whole field. Measurement of the broken line elements gave the drop velocity. The size of a rain drop may be found from its terminal velocity as measured with the drop-velocity camera. Law's method is suitable for drops of any size, limiting factors being sensitivity of film and fogging by stray light.

Gunn (1947) set up two horizontal 'inducing rings' one above the other and 75 cm. apart. A charged rain drop as it falls through each ring gives a signal on a cathode ray oscillograph. From the interval between the two signals the drop velocity is calculated, and from this is found the drop size. The size of the

signal is also a measure of drop charge.

Hooper (1948) describes a 'raindrop impactor', not yet completely developed, for use ultimately on a flying aircraft to measure drop size. A suitably loaded microphone diaphragm is whirled in a horizontal plane at a high speed to simulate that of a flying aircraft. When it strikes a rain drop, the electrical impulse produced in the microphone circuit is a function of the relative momentum of the drop. This impulse, amplified and displayed on a cathode ray oscillograph screen, is recorded photographically on a continuously running film. It is obvious that a method such as this, used in conjunction with a means of recording the drop charges, could provide a large number of observations in a short time, meteorological conditions showing less variation accordingly.

I 4. b. Drop Charge.

Gschwend (1921) used a string electrometer. Above and connected to it was an insulated metal receiving vessel in which he placed a prepared filter paper for measuring drop size by the absorbent paper method (see above). Rain drops were admitted through an opening which was cone-shaped to minimize the effects of splashing, whether by drops outside splashing into the cone or drops having arrived inside the vessel splashing out. Splashing produces charges by Lenard effect, as already described. After each single observation of charge it was necessary to earth the electrometer, and this increased the time taken by the observation.

Gschwend claimed that his apparatus would measure 0.02×10^{-3} e.s.u., but he reports very few observations less than 0.05×10^{-3} e.s.u.

Chalmers and Pasquill (1938) collected drops in an insulated vessel with a cone-shaped opening. The vessel was connected to a valve amplifier, and the charge was measured by observing the deflexions of a galvanometer. After each deflexion the amplifier was automatically ready to receive the next charge, and a high rate of observing was possible. The limit of observation was about 0.2×10^{-3} e.s.u.

Gunn's method of measuring charge and drop size has been described above.

I 4. c. Previous results for single drops

The only results for measurements at the earth's surface are those of Gschwend (1921). He found that there is nearly always a mixture of drops of both sign, and points out that calculations on rain charge per c.c. taken from observations on rain current will therefore give lower values than those for single drops. His observations gave a surplus of positive charge. He found no connexion between field and drop size and charge, but more often than not the sign of the field and that of drop charge were opposite.

No results are available for any measurements made at the earth's surface by Gunn.

Chalmers and Pasquill (1938) measured only drop charge -- 11,094 charges in all. They found an excess of positive electricity in all except storm rain. There was in general a mixture of charges of both signs, but there were conspicuous sequences of drops of only one sign. They drew a distribution curve of charges which was approximately symmetrical and showed a maximum for about $+ 0.3 \times 10^{-3}$ e.s.u. They had no means of detecting the arrival of drops bearing charges less than about 0.2×10^{-3} e.s.u. (This also applies to Gunn's inducing ring method).

II The Amplifier for measuring Electric Charge.

II 1. Advantages and Theory of the Valve Amplifier.

I chose the valve bridge amplifier method because it so readily lends itself to recording. There were other advantages. I was able to use a comparatively insensitive galvanometer, avoiding the tedious adjustments of an electrometer, yet having a small resolving time. Chalmers and Pasquill (1937) have pointed out that it is easy to maintain the necessary degree of insulation, and that the sensitivity of the amplifier is almost independent of the electrical capacity of the drop-collecting system.

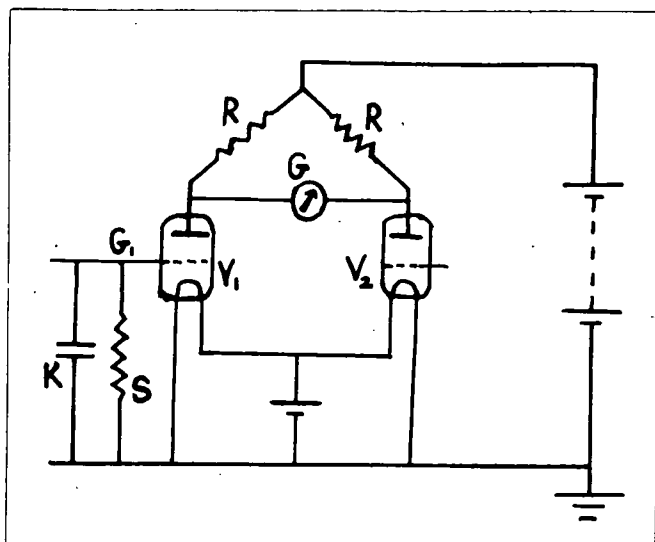

The theory given by Chalmers and Pasquill (1937) is as follows. In the diagram, V_1 and V_2 are triodes of the same type and their grids insulated, or in other words with grids

'floating'. If the valves are identical the galvanometer G will show no deflexion, and any change in low tension or high tension voltages will produce no deflexion. Now let a charge q suddenly arrive on the grid G_1 , of the 'operating valve' V_1 , which is connected to a capacity K . Let the internal leakage of the valve, when running, correspond to a resistance S . Let the mutual conductance be M . The initial potential applied to G_1 is q/K and this leaks away so that after a time t the potential on G_1 is $\frac{q}{K} e^{-\frac{t}{SK}}$, and the anode current of V_1 is altered from its normal value by $\frac{Mq}{K} e^{-\frac{t}{SK}}$. Provided the resistance of G is small compared with R this current must flow through G .

The total charge passing through G is therefore

$$\int_0^{\infty} \frac{Mq}{K} e^{-\frac{t}{SK}} dt = MSq.$$

This is independent of K and proportional to q . Chalmers and Pasquill found that the zero of their galvanometer drifted, in one instance this drift amounting to 16 cm. in eight minutes when the amplifier had been switched on for three hours. To avoid this steady drift they put a condenser, usually $20 \mu F$, in series with their galvanometer. The zero was then steady apart from fluctuations of ± 2 or 3 mm.

The treatment of the amplifier as it appears in the paper published by these authors is open to two criticisms, that they have neglected changes in the anode current of the idle valve, and that

the effect of the condenser in the galvanometer circuit is to alter the nature of the expression for amplification.

We will first consider the amplifier with no condenser in the galvanometer circuit.

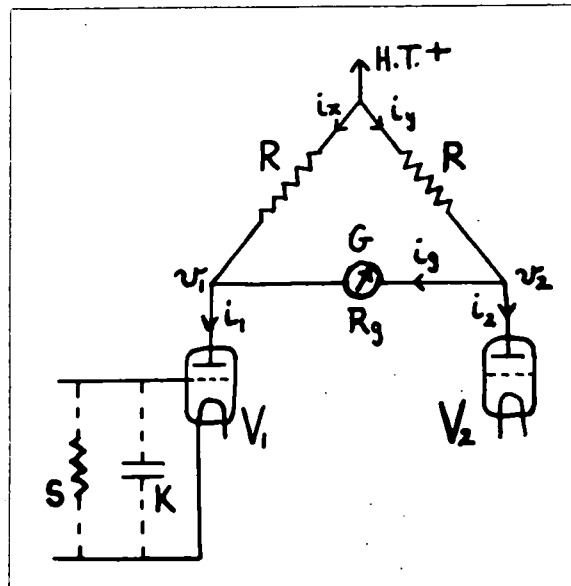

Let the currents i_x , i_y , i_1 , i_2 , i_g and the potentials v_1 , v_2 be increments on the steady values, due to the arrival of the charge.

$$\text{Then } i_g = \frac{v_2 - v_1}{R_g}$$

$$\left. \begin{array}{l} \text{But } v_1 = -R i_x \\ \text{and } v_2 = -R i_y \end{array} \right\}$$

$$\therefore i_g = -\frac{R}{R_g} (i_y - i_x)$$

$$\left. \begin{array}{l} \text{Since } i_x = i_1 - i_g \\ \text{and } i_y = i_2 + i_g \end{array} \right\},$$

$$\therefore i_g = -\frac{R}{R_g} (i_2 - i_1 + 2i_g).$$

Writing $\left(\frac{\partial i}{\partial v}\right)$ with grid floating as $\frac{1}{e}$ we have e is the A.C. resistance of either valve with floating grid.

$$\begin{aligned} \text{Then } i_2 &= v_2 \left(\frac{\partial i}{\partial v}\right)_{\text{grid floating}} \\ &= \frac{v_2}{e}. \end{aligned}$$

$$\begin{aligned} \text{Now } v_2 &= -R i_y \\ &= -R (i_2 + i_g) \\ &= -R \left(\frac{v_2}{e} + i_g\right) \end{aligned}$$

$$\text{or } -\frac{v_2}{R} = \frac{v_2}{e} + i_g$$

$$v_2 \left(-\frac{1}{R} - \frac{1}{e}\right) = i_g$$

$$\text{or } v_2 = \frac{-i_g}{\frac{1}{R} + \frac{1}{e}}$$

$$\begin{aligned} \therefore i_2 &= \frac{v_2}{e} \quad (\text{from above}) \\ &= -\frac{1}{e} \cdot \frac{i_g}{\frac{1}{R} + \frac{1}{e}} \end{aligned}$$

$$\therefore i_g = -\frac{R}{R_g} \left\{ -\frac{1}{e} \cdot \frac{i_g}{\frac{1}{R} + \frac{1}{e}} - i_1 + 2i_g \right\}$$

Rearranging,

$$\frac{R_g}{R} i_g - \frac{\frac{1}{e}}{\frac{1}{R} + \frac{1}{e}} i_g + 2i_g = i_1$$

$$\therefore i_g = \frac{i_1}{2 - \frac{1/e}{1/R + 1/e} + \frac{R_g}{R}}$$

$$\text{or } i_g = \frac{i_1}{2 - \frac{R}{e+R} + \frac{R_g}{R}}$$

Now e will depend on the type of valve and will usually be some thousands of ohms. According to the values of R and e the term $\frac{R}{e+R}$ will lie between 0 and 1, and $\frac{R_g}{R}$ will usually be small. Hence i_g will lie between $\frac{i_1}{2}$ and i_1 and the charge passing through the galvanometer will lie between $\frac{MSq}{2}$ and MSq .

We will now apply a similar treatment to the amplifier when a condenser is placed in series with the galvanometer.

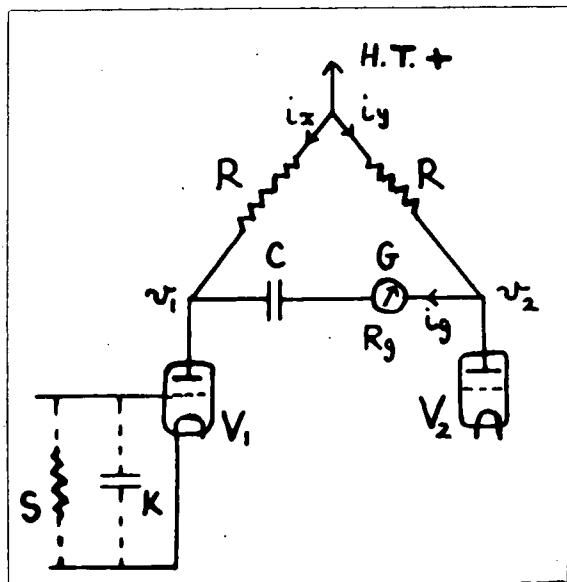

$$i_g = \frac{dQ}{dt}$$

$$= C \frac{d}{dt} (V_2 - V_1 - R_g i_g)$$

Now $V_1 = -R i_x$

and $V_2 = -R i_y$

$$\therefore i_g = C \left\{ R \frac{di_x}{dt} - R \frac{di_y}{dt} - R_g \frac{di_g}{dt} \right\}$$

But $i_x = i_1 - i_g$

and $i_y = i_2 + i_g$

$$\therefore i_g = CR \left\{ \frac{di_1}{dt} - \frac{di_2}{dt} - 2 \frac{di_g}{dt} \right\} - CR_g \frac{di_g}{dt}$$

Now the charge q takes a definite time to arrive on the grid of V_1 .

We will take time $t = 0$ to represent the instant when the grid of V_1 is first affected by the lines of force of the charge q .

At the instant when all these lines of force have just ended on the grid circuit, $t = \psi$. We call ψ the 'time of arrival' of the charge.

We will assume that at $t = \psi$ no appreciable part

of q has leaked away through S , that is, $SK \gg \psi$. Then at $t = 0$ we have $i_2 = 0$ and $i_g = 0$.

$$\begin{aligned} \therefore Q &= \int_0^{\psi} i_g dt \\ &= CR \int_0^{\psi} \frac{di_1}{dt} dt - CR \int_0^{\psi} \frac{di_2}{dt} dt - 2CR \int_0^{\psi} \frac{di_g}{dt} dt - CR_g \int_0^{\psi} \frac{di_g}{dt} dt \end{aligned}$$

and the last three terms vanish.

But $i_1 = M v_g$ where v_g is the increment of grid potential due to the charge q .

$$\therefore i_1 = \frac{M}{K} q$$

$$\begin{aligned} \therefore Q &= CR \int_0^{\psi} \frac{M}{K} \frac{dq}{dt} dt \\ &= \frac{CRM}{K} q. \end{aligned}$$

The amplification is hence no longer independent of K , which is what Chalmers and Pasquill (1937) observed. The expression $\frac{CRM}{K}$ is identical with that deduced by Chalmers (1949) for an amplifier not employing an idle valve, as in the figure below:-

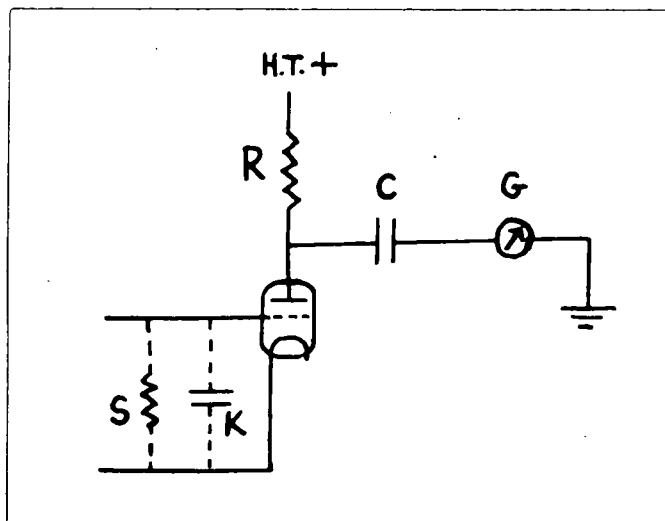

The time constant CR should not be much greater than the resolving time of the galvanometer, normally two or three seconds. The return of the grid potential of V_1 to its normal undisturbed value takes place by the exponential decay process described in the original theory. It is accompanied by a reverse current through the galvanometer. If SK is large, this reverse current will be small, appearing as a slight displacement of the zero. If SK is not large compared with the time of swing of the galvanometer, this reverse current will appear as a 'reverse charge' which partly neutralizes the original charge $Q = \frac{CRM}{K} q$. Hence SK must be as large as possible. S depends mainly on grid current (investigated and discussed later) and is not easily made large. The values of C , R and K cannot therefore be improved indefinitely, and M depends on the valve used. These considerations give some guidance in the design of a suitable amplifier. The principles have become clearer during the course of this work. My first amplifier, next to be described, was built before the expression for amplification $\frac{CRM}{K}$ had been worked out.

II 2. The Design of the Amplifier.

The most difficult task was to make galvanometer zero instability small. Chalmers and Pasquill (1937), observing deflexions by eye, experienced this as 'slight fluctuations,

never amounting to more than 2 or 3 mm. on either side of the zero'. I wished to record deflexions photographically. These deflexions were limited by the size of the recording drum to ± 60 mm. It was therefore of no value to employ a sensitivity (charge/mm.) with which zero fluctuations exceeded ± 1 mm. Wynn-Williams, (1927) and McFarlane (1932) describe ways of eliminating zero instability due to variation of filament supply voltages, for directly heated valves. Changes in high tension supply are considered relatively unimportant, and I found no improvement on changing from a dry battery to a Milne's high tension unit of storage cells. Wynn-Williams keeps the ratio of anode currents constant for the two valves of the bridge. By this means the anode potentials, varying together with battery fluctuations, still remain equal and the galvanometer is undeflected. It is only necessary to adjust the proportion of filament voltage, from a common battery, supplied to each valve, until the desired condition is reached. McFarlane uses a common battery for filament and grid bias supplies. Changes in this battery voltage affect filaments and grid bias in such a way that they produce equal and opposite effects in anode current for the two valves, and the galvanometer is therefore unaffected. I found their methods unsatisfactory for a valve bridge with floating grids, using Ministry of Supply valves, type VR 21 (equivalent to Mullard PM one LF). The methods certainly worked well for

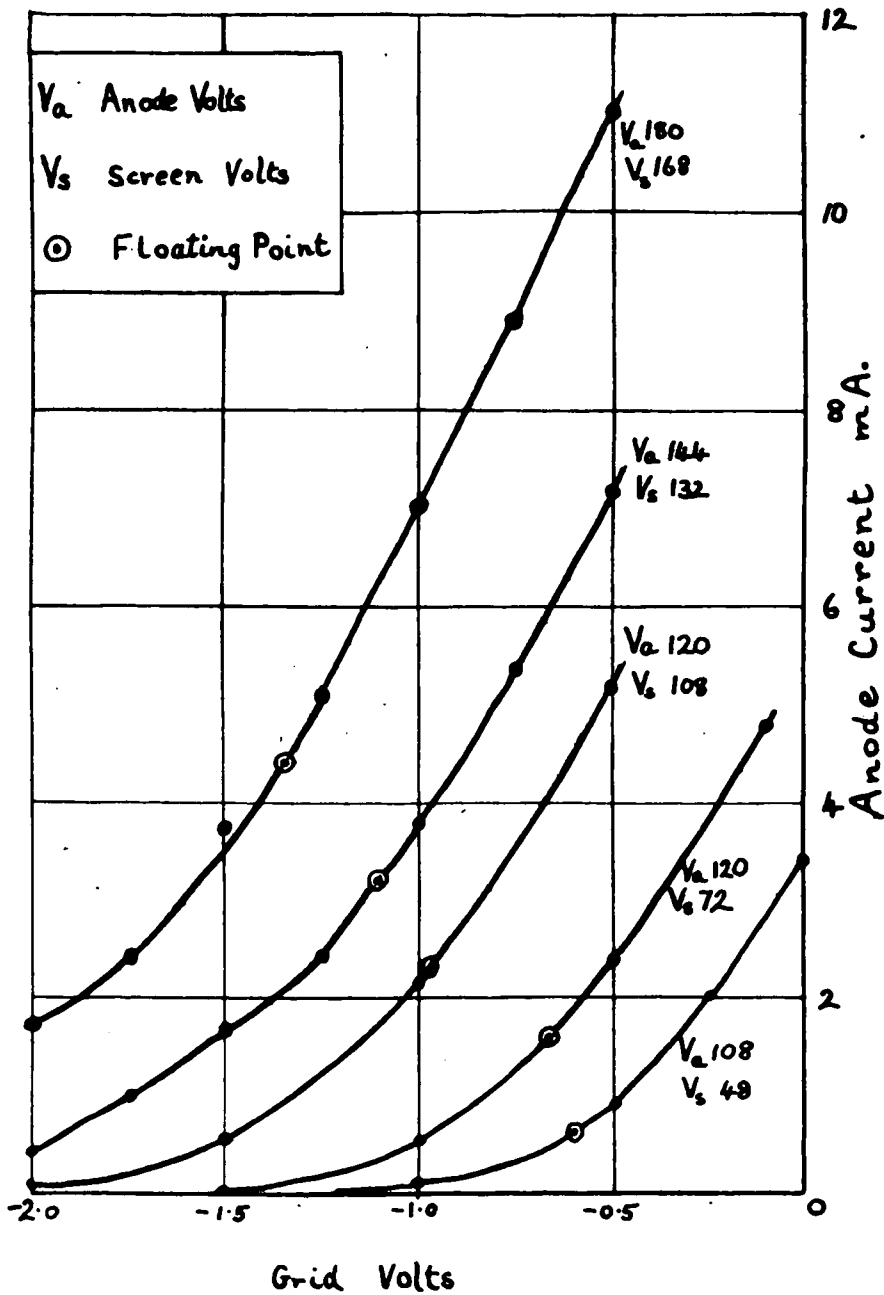

Static characteristics.

VR 65 (SP41)

sudden gross changes in battery voltage, say 10%, but did not reduce fluctuations of the zero of 2 or 3 mm. during ordinary working. I therefore turned to indirectly heated valves, where fluctuations in heater current are in effect smoothed out because of the heat capacity of the cathode.

The valve chosen and actually used in this research was the radio-frequency pentode Ministry of Supply type VR 65 (equivalent to Cosser SP 41). The control grid of this valve is particularly well insulated, being connected to a top cap. This is important, for in the theory just given the amplification is seen to be proportional to the leakage R . Moreover by the construction of the valve the control grid - anode capacity is very low, reducing the chance of feedback.

Some typical static characteristics for various anode and screen voltages are shown opposite for the VR 65. The slope, which is M at the floating point, does not show any great variation with electrode voltages. The amplification is MR (from the theory above). I could therefore use just one ordinary 120 volt high tension battery for anode and screen supplies, without working at too low a value of M . The circuit of my amplifier is shown in the figure.

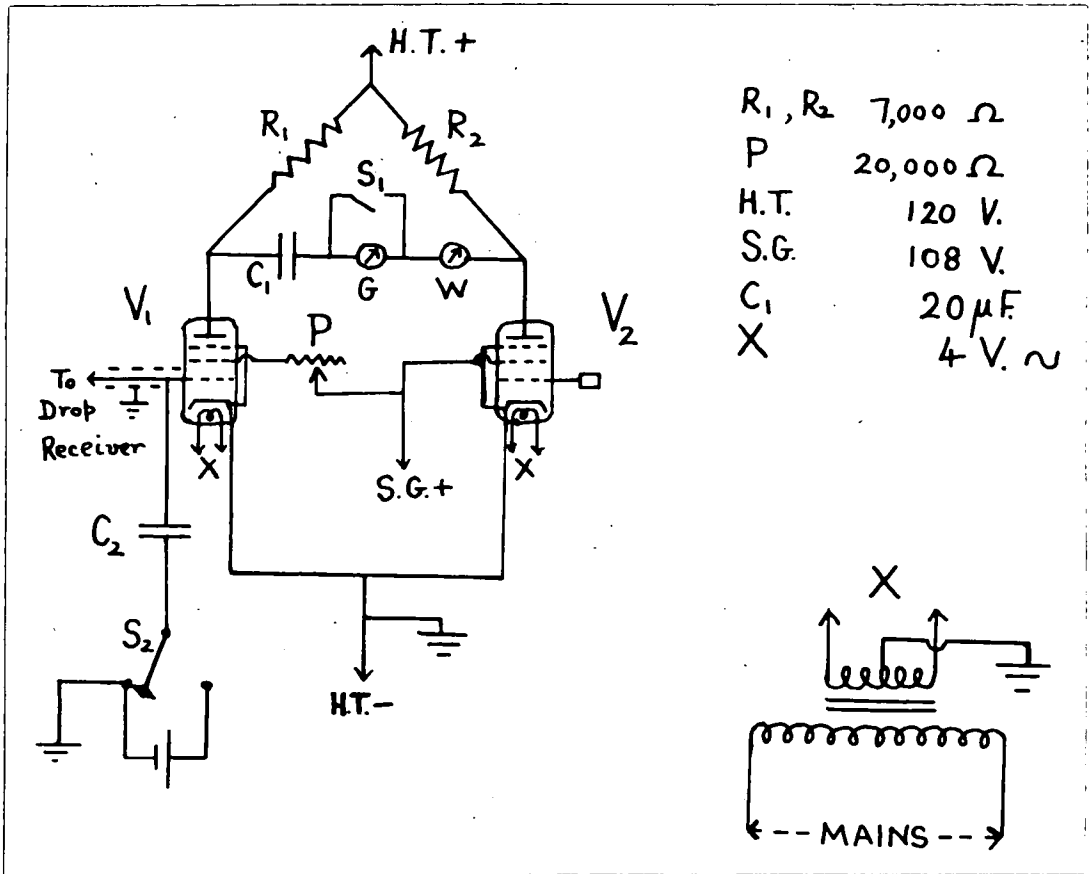

V_1 is the operating valve, and V_2 the 'idle valve' which reduces the effect of battery changes, as explained in the theory. The grid cap of V_2 is disconnected. C_2 is a fixed air condenser of capacity about 2 cm. One plate is connected permanently to the grid of V_1 , the other may be switched by S_2 from earth to any desired potential. The charge then flowing into the grid serves as a reference charge for comparing

the amplification under different conditions. The heater current was at one time obtained from accumulators, but later from the mains. Finding the anode load in accordance with theory was not critical, I used a fairly low value and so avoided a wasteful voltage drop. From a number of VR 65 valves V_1 and V_2 were chosen as having low floating values of anode current, both about 1mA. The potentiometer in the screen supply lead of V_1 serves to balance the bridge, the condenser C_1 (see below) being temporarily short-circuited. G is a dead-beat mirror galvanometer of sensitivity $42 \text{ mm}/\mu\text{C}$. This is put out of circuit by switch S_1 for coarse adjustments, the insensitive pointer type galvanometer W then being used. The condenser C_1 (paper type) is inserted to block steady currents and so prevent zero drift, which would otherwise make recording difficult. The valves and all apparatus and leads connected to the grid of V_1 were screened.

As a guide to the sensitivity of the amplifier I made use of the air condenser C_2 already mentioned, and also an apparatus for delivering single drops with equal electric charges, described by Chalmers and Pasquill, (1937) (2).

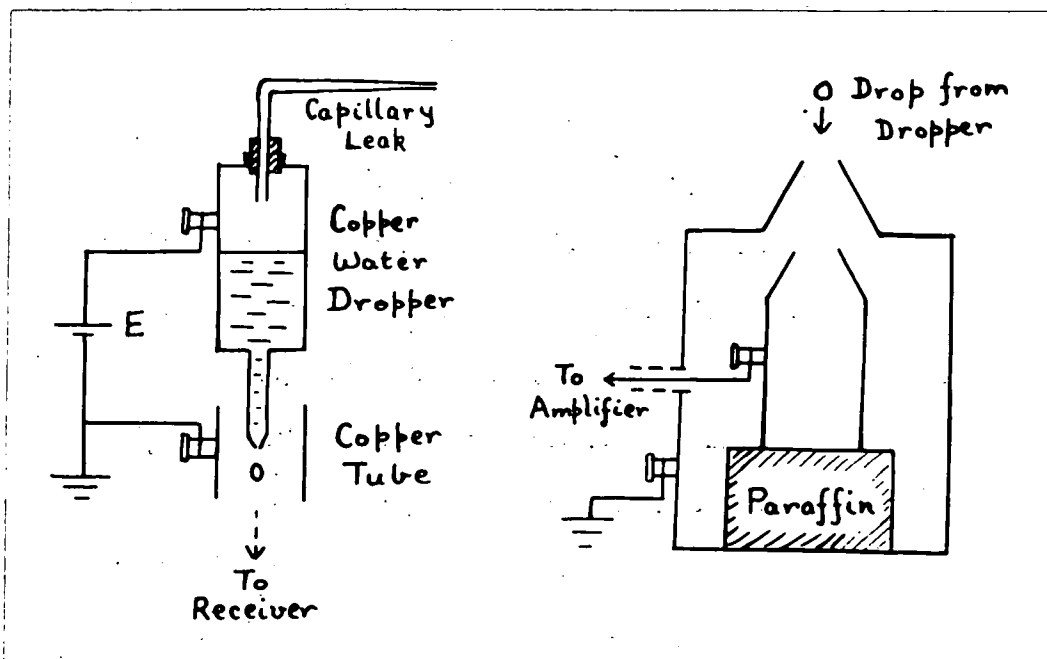

This apparatus is shown in the figure. Water drops form at a steady rate at the nozzle of the dropper, and carry away a charge depending on the electric field set up between the nozzle and the concentric earthed copper cylinder. Drops are produced at a rate controlled by the air leak through the glass capillary tube. The drops are caught in a screened insulated vessel connected to the grid of the amplifier operating valve. The results of Chalmers and Pasquill. (1937)⁽²⁾ show that the charge on the drops is nearly $E \times 10^{-3}$ e.s.u. where E is the potential applied to the dropper, measured in volts. Now for the air condenser C_2 (approximately 2 cm.) the charge for one volt applied is $c. \frac{2}{300}$ e.s.u. or nearly 7×10^{-3} e.s.u.. The

Operating
Valve

Calibrating
Condenser

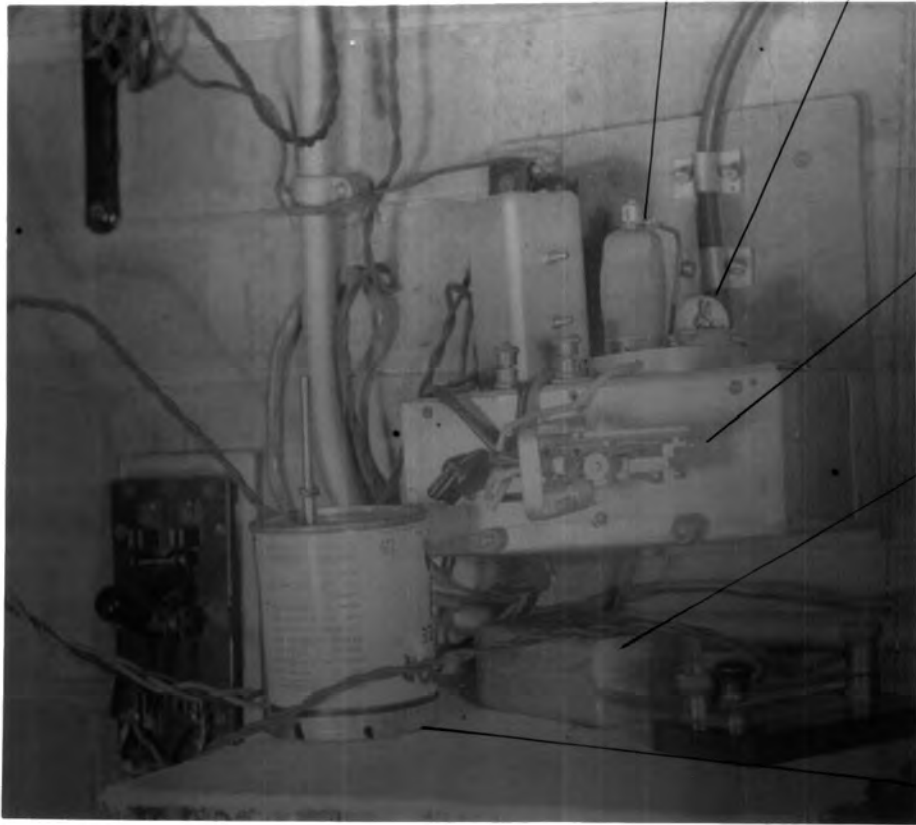

Telegraph relay

Telegraph relay
screening can

Operating valve
screening can

The Amplifier.

- (7) electrostriction effects appeared as 'interference' when the grid cable was stood on or even slightly displaced, so that it was essential to protect it from the wind.
- (8) the amplifier took only about one minute to 'warm up' to its working condition from first switching on, provided that all apparatus connected to the grid of the operating valve was quite dry.

I tried out the amplifier with rain as opportunity arose. The receiver only was exposed, the rest of the apparatus connected by an insulated cable being indoors. Finding that the amplifier behaved satisfactorily under these conditions, I at once began to develop the method for measuring drop size and drop charge together. This was in order to begin measurements on rain without delay and so to obtain results over as long a period as possible. The accurate calibration of the amplifier and other tests, described next in this chapter, were actually performed later during spells of fine weather.

II 3 The Calibration of the Amplifier.

II 3a The 'Calibrating Condenser'.

The use of a small air condenser for providing a 'reference' charge to check the sensitivity of the amplifier was mentioned on page 26 . For this purpose I now made a fixed

air condenser. The plates are brass discs of diameter 20 mm., and are set rigidly about $\frac{1}{4}$ mm. apart. The insulation is polystyrene. The condenser is mounted firmly beside the operating valve and inside the same screening can, and in this position it serves as the 'calibrating condenser'. The 'calibrating voltage' is applied by means of a single-current telegraph relay S_2 (see figure page 26), which is switched 'on' and 'off' by a remote tapping key. In the 'off' position the calibrating condenser is connected between grid and earth. In the 'on' position the earthy plate is connected through the calibrating battery to earth. The advantages of having a relay are:-

- (1) Leads to the calibrating condenser are short.
- (2) The transit time in switching is short and constant.
- (3) The mechanical shock is too small to give the spurious deflexions which occur with an ordinary switch.

The relay is enclosed in an earthed can, and sparking at the tapping key contacts is suppressed by a $0.5 \mu F$ condenser. For day to day calibrating checks it is only necessary to observe the deflexion when the tapping key is operated, 'on' and 'off' giving positive and negative charges respectively if the battery negative is earthed. Given the calibrating condenser capacity,

determination of C_x just described the three condensers in series must have a combined capacity of about 0.7 cm. This seemed ridiculously small, so I determined C_x by two other independent methods, which agreed together. The earlier value, which was much too low, was therefore discarded.

II 3.c Standardisation with a 10 $\mu\mu F$. Precision Condenser

A Sullivan precision fixed air condenser had meanwhile become available. (This is to be referred to as the 'precision condenser'. The small air condenser in the amplifier is the 'calibrating condenser'.) The Calibration Certificate provided by the makers showed that an incremental capacity of 10.0 $\mu\mu F$ was introduced when the brass strip link supplied was inserted between the appropriate screw terminals. I compared the capacity of my calibrating condenser with the incremental 10.0 $\mu\mu F$. I first applied a voltage to the calibrating condenser sufficient to give a convenient 'reference charge' indicated by the amplifier. Then using the precision condenser in the same manner I found the voltage required to produce the same reference charge with and without the 10 $\mu\mu F$ increment.

Let $C_{\mu\mu F}$ be the capacity of the calibrating condenser.

Let $S_{\mu\mu F}$ be that of the precision condenser without increment.

Let $x.E$ volts be applied to the calibrating condenser.

Let $y.E$ volts be applied to the precision condenser without increment.

Let $z.E$ volts be applied to the precision condenser with increment.

Since these three voltages applied separately all give the same reference charge, we have

$$\begin{aligned}
 xE.C &= yE.S = zE(S+10) \\
 S &= \frac{x}{y}C \\
 xC &= z\left(\frac{x}{y}C + 10\right) \\
 C &= \frac{10}{\frac{x}{z} - \frac{x}{y}}
 \end{aligned}$$

The way in which x , y and z were measured will now be described.

The amplifier was switched on and allowed time to become steady. The precision condenser was placed on a slab of ebonite inside an earthed metal box. It was left in the same position throughout the experiment so that stray capacities (and therefore S) should remain constant. The insulated plate of the precision condenser was connected the whole time to the amplifier grid by a screened polystyrene cable - the cable normally used to connect the receiver to the amplifier. The earthy plate could be connected either to earth or to a point at a known potential by means of a relay similar to that used with the calibrating condenser. Potential differences were taken from a potentiometer of two resistance boxes used with an accumulator of E.M.F. $E = 2.08$ V. This value of E remained constant. The precision condenser brass strip was disconnected at first. Later when it was connected a slight correction was necessary

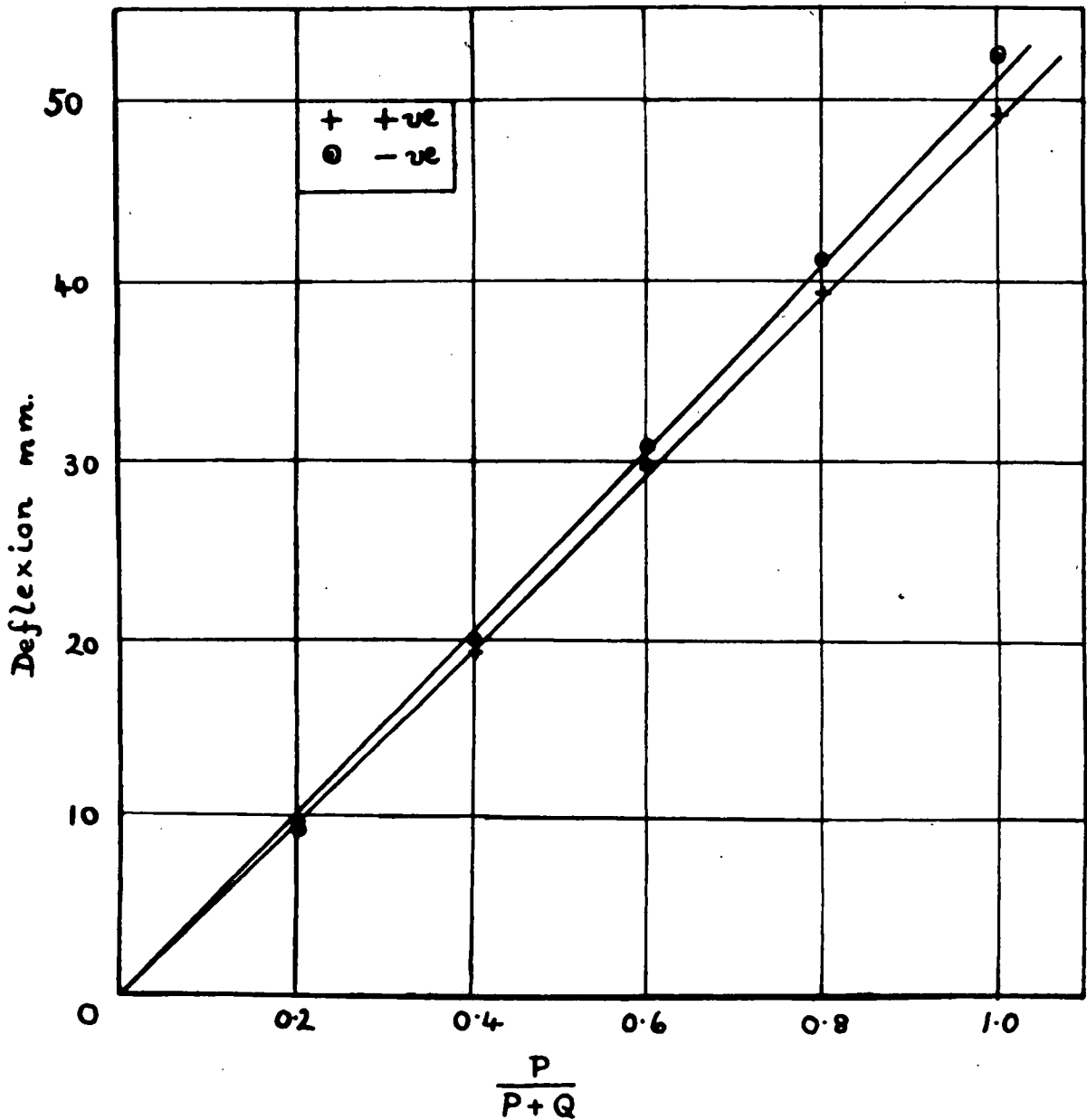

Standardization with Precision Condenser. Fractions
 $\frac{P}{P+Q}$ of voltage E applied to Calibrating Condenser
 (strip disconnected).

to allow for the change in sensitivity of the amplifier due to the extra $10 \mu\text{F}$ in the grid circuit. First, strip disconnected, various fractions of E were applied to the calibrating condenser, for $E = \pm 2.08 \text{ V}$. Switching 'on' a positive potential gave the same effect as switching 'off' a negative potential, that is, the effect of a positive charge placed on the grid. Therefore to each fraction of E four measurements were made, '+ve volts on', '+ve volts off', '-ve volts on' and '-ve volts off', each being made three or four times. The first and fourth were averaged as giving positive charge effects, the second and third as negative charge effects, as in the following table.

FRACTIONS OF E APPLIED TO CALIBRATING CONDENSER (STRIP DISCONNECTED)

Fraction	Galvanometer deflexion mm.					
	+ ve volts on	- ve volts off	Average for + ve charge	- ve volts on	+ ve volts off	Average for - ve charge.
0	0	0	0	0	0	0
0.2	9.5	10.0	9.8	-9.5	-9.5	-9.5
0.4	19.5	19.8	19.6	-20.0	-20.3	-20.2
0.6	29.5	30.0	29.8	-31.0	-30.8	-30.9
0.8	39.3	39.3	39.3	-41.0	-41.2	-41.1
1.0	49.0	49.2	49.1	-52.2	-52.5	-52.4

A straight line graph (opposite) was drawn through the origin for the positive and negative charges. The difference in

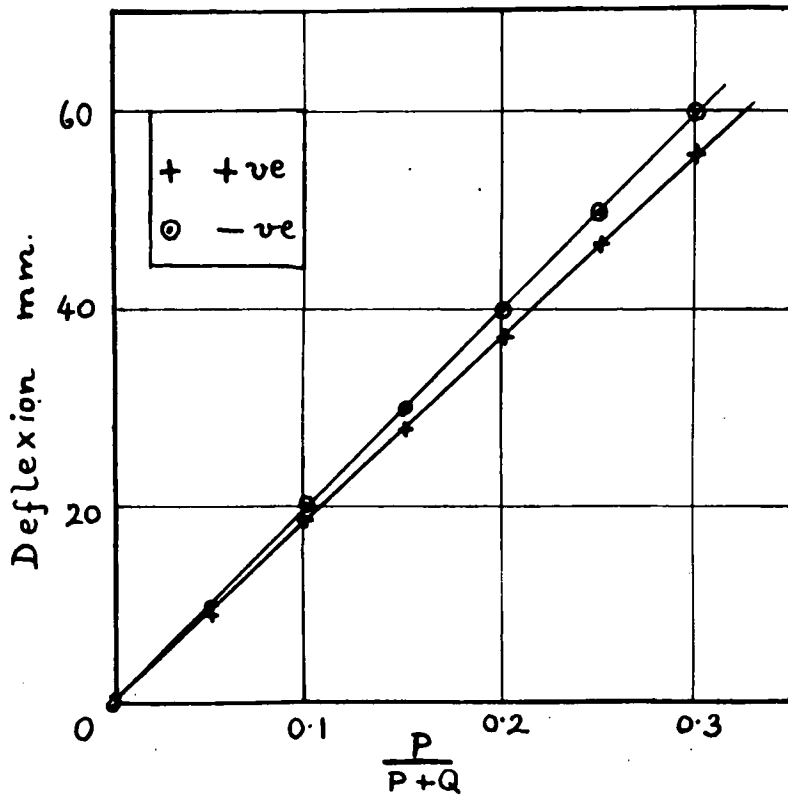

Standardization with Precision Condenser.

Fractions $\frac{P}{P+Q}$ of voltage E applied to precision condenser (strip disconnected).

slope of the two lines represents the slight difference in amplifier sensitivity for positive and negative charges. Both in this and in the two following graphs the observations for positive charge show least deviation from the straight line. The values of x , y and z were therefore read from the positive lines. The reference charge was chosen as that giving a reference deflexion of 50 mm. (brass strip disconnected). For this deflexion we read from the graph the fraction of E , i.e. $x = 1.020$.

Similar measurements were next made by applying fractions of E to the precision condenser (brass strip disconnected), and the following table was prepared and the graph opposite drawn.

FRACTIONS OF E APPLIED TO PRECISION CONDENSER (STRIP DISCONNECTED)

Fraction	Galvanometer Deflexion mm.					
	+ ve volts on	- ve volts off	Average for + ve charge	-ve volts on	+ volts off	Average for -ve charge
0	0.2	0.1	0.2	+ 0.4	+ 0.2	+ 0.3
0.05	9.2	8.8	9.0	- 9.8	- 9.3	- 9.6
0.10	18.2	18.8	18.5	-20.2	-18.8	-20.0
0.15	27.5	28.2	27.8	-30.0	-29.2	-29.6
0.20	36.7	37.5	37.1	-39.8	-39.2	-39.5
0.25	46.2	46.7	46.5	-50.2	-49.2	-49.7
0.30	55.2	55.7	55.5	-60.5	-59.5	-60.0

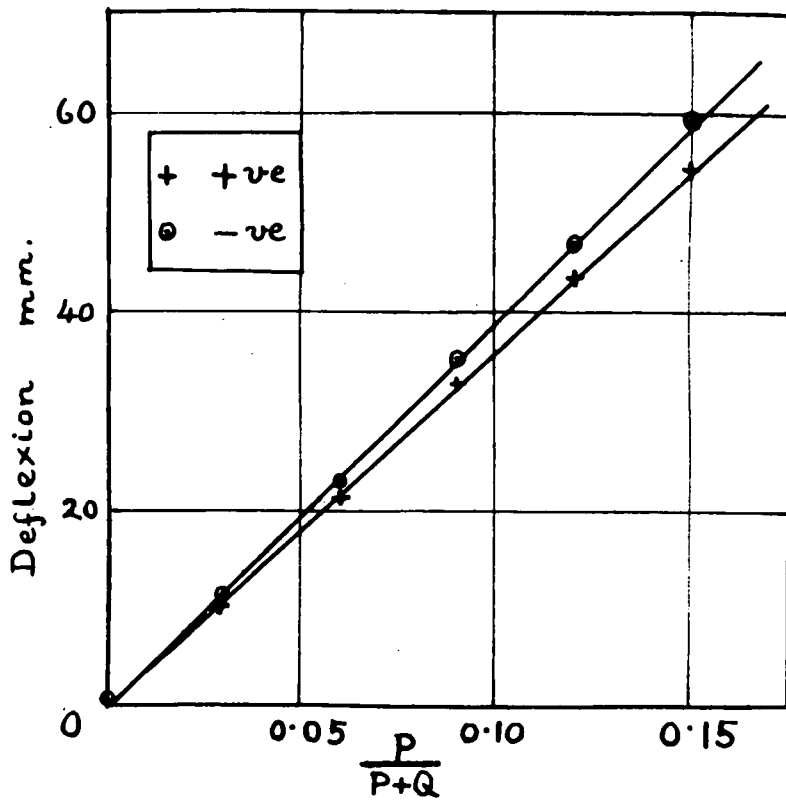

Standardization with Precision Condenser.
 Fractions $\frac{P}{P+Q}$ of voltage E applied to
 precision condenser (strip inserted).

Using the line for positive charge, against reference deflexion 50 mm. we read $y = 0.269$.

The brass strip was now inserted to introduce the $10.0 \mu\mu\text{F}$ and the measurements with the precision condenser were repeated. They are shown in the table following and the graph opposite.

FRACTIONS OF E APPLIED TO PRECISION CONDENSER (BRASS STRIP INSERTED)

Fraction	GALVANOMETER DEFLEXION MM.					
	+ ve volts on	- ve volts off	Average for +ve charge	- ve volts on	+ ve volts off	Average for - ve charge
0	1.0	0.8	0.9	- 0.6	0	- 0.3
0.03	10.5	10.5	10.5	-11.5	-11.7	-11.6
0.06	21.0	21.8	21.4	-23.2	-22.3	-22.8
0.09	31.7	33.0	32.4	-35.7	-35.0	-35.4
0.12	43.8	43.7	43.8	-47.7	-46.8	-47.2
0.15	54.3	54.8	54.6	-59.8	-59.2	-59.5

The value of Z was obtained from this graph after making an adjustment allowing for the extra $10.0 \mu\mu\text{F}$ in the grid circuit. With the brass strip disconnected and + 2.20 volts applied to the calibrating condenser the deflexion averaged 52.3 mm. for switching on. With the brass strip inserted the throw averaged 51.5 mm. The correction factor is therefore $\frac{51.5}{52.3}$, and the reference charge (which before gave 50 mm. deflexion) will now give a

deflexion $\frac{50 \times 51.5}{52.3} = 49.1 \text{ mm.}$, the brass strip being inserted. Against this deflexion on the positive charge line we read $Z = 0.1355$.

$$\text{Thus } C = \frac{10.0}{\frac{x}{Z} - \frac{x}{y}}$$

$$\begin{aligned} \text{and } x &= 1.020 \\ y &= 0.269 \\ Z &= 0.1355 \end{aligned}$$

$$\text{Hence } \underline{C = 2.68 \mu\mu\text{F.} = 2.41 \text{ cm.}}$$

This is the value adopted for the capacity of the calibrating condenser.

II 3. d. An experiment with charged water drops to check the standardisation

As an independent check on the result of the last section I counted a large number of equally charged water drops into an insulated receiver and measured their combined charge with a ballistic galvanometer. I was then in a position to use the charge on a drop to estimate the amplifier sensitivity. I had already found that the charge on drops from the water dropper described on page 28 was seriously altered by vertical electric fields of about 100 V./m. , i.e. 1 V./cm. I therefore

constructed a new dropper completely screened by an earthed container.

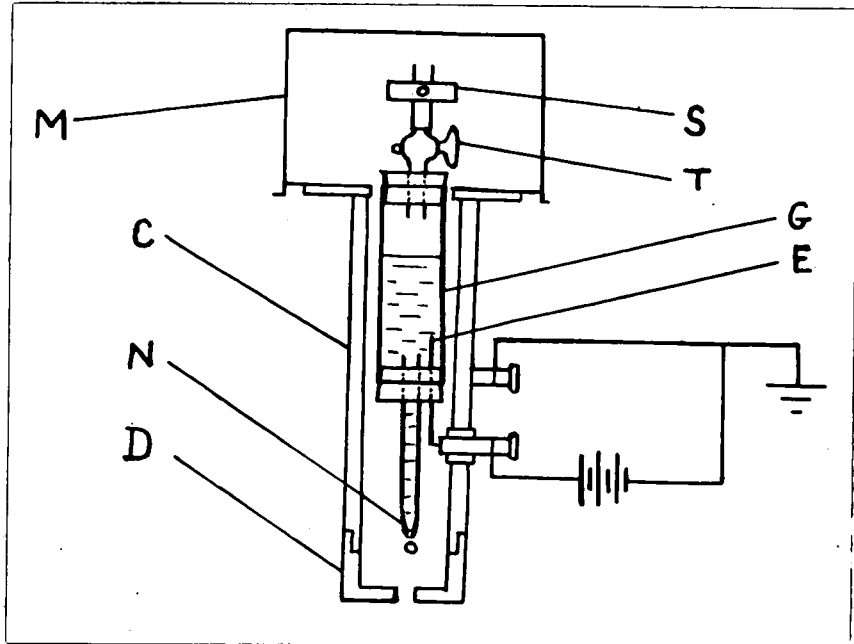

Water contained in the glass reservoir *G* emerges as drops of mass c. 30 mg. at the glass nozzle *N*. The capacity of *G* is 30 cc. or 1000 drops. The rate of dropping is controlled by the air leak through the rubber tube and screw stop clip *S* and the tap *T*. The glass reservoir is surrounded by and insulated from a copper tube *C* which extends 2 mm. below *N*. There is a copper end-piece *D* with a hole just large enough to allow drops to pass without touching. A tightly fitting metal cover *M* completes the electrostatic shielding which is earthed. An electrode *E* set in the lower rubber bung connects the water to an insulated screw terminal. With the battery connected there

putting every piece of apparatus on its own insulating base and standing every base on an earthed metal sheet.

Let C $\mu F.$ be the capacity of the Pye condenser system.

r ohms .. the insulation resistance.

τ secs .. the interval between drops.

Δ .. the charge on each drop.

n .. the total number of drops

Then the charge q on the condenser on the arrival of the 1st, 2nd, 3rd, drops is found as follows:-

$$1^{\text{st}} \text{ drop: } q = \Delta$$

$$2^{\text{nd}} \text{ drop: } q = \Delta + \Delta e^{-\frac{\tau}{rC}} = \Delta \left(1 + e^{-\frac{\tau}{rC}} \right)$$

$$3^{\text{rd}} \text{ drop: } q = \Delta + \Delta \left(1 + e^{-\frac{\tau}{rC}} \right) e^{-\frac{\tau}{rC}} = \Delta \left(1 + e^{-\frac{\tau}{rC}} + e^{-\frac{2\tau}{rC}} \right)$$

$$n^{\text{th}} \text{ drop: } q = \Delta \left(1 + e^{-\frac{\tau}{rC}} + e^{-\frac{2\tau}{rC}} + \dots + e^{-\frac{(n-1)\tau}{rC}} \right)$$

$$= \Delta \frac{1 - e^{-\frac{n\tau}{rC}}}{1 - e^{-\frac{\tau}{rC}}}$$

If q is in $\mu C.$ we have

$$\Delta = q \frac{1 - e^{-\frac{\tau}{rC}}}{1 - e^{-\frac{n\tau}{rC}}} \times 3000 \text{ e.s.u.}$$

The results are given in the following table.

This agrees within 5% with the value 2.41 cm. found by using the precision condenser. The difference is not greater than the error to be expected in observations on rainfall, and may be due to differences in the voltmeters used.

II 3.e. Sensitivity of the amplifier.

The smallest charge I could detect when recording was 0.1×10^{-3} e.s.u. I would usually connect the high tension battery two minutes after switching on the heaters. The amplifier was then ready to work. In the first hour the sensitivity would increase by about 5%, and from day to day it varied by less than 10%. The sensitivity S in 10^{-3} e.s.u./mm. at 1 metre could be varied by galvanometer shunts connected with a paraffin key.

High sensitivity	was	approximately	0.2×10^{-3}	e.s.u./mm.
Medium	"	"	0.4	"
Low	"	"	3	"

For most purposes medium sensitivity was used.

When zero fluctuations were less than $\frac{1}{2}$ mm., "high" could be used. "Low" was rarely employed. The sensitivity for negative charge (S^-) was about 10% higher than that (S^+) for positive charge. Typical values are $S^+ = 0.39 \times 10^{-3}$ and $S^- = 0.37 \times 10^{-3}$ e.s.u./mm. on medium sensitivity.

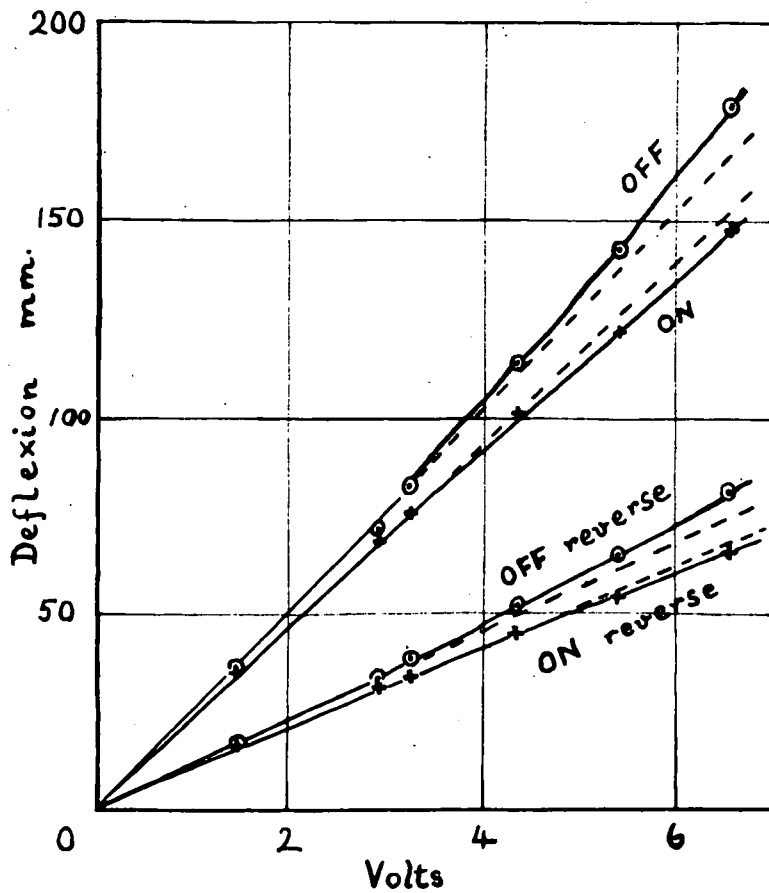

Reverse swings, medium sensitivity, for voltages applied to calibrating condenser.

The rotating drum camera I used would record deflexions of \pm 60 mm. For throws up to twice this value the 'reverse swing' was recorded. This, multiplied by the 'decrement', gives the original throw. The decrement is the ratio of the first swing to the succeeding reverse swing, and remained very nearly constant. The decrement was found by applying positive voltages to the calibrating condenser so as to give reverse swings up to 60 mm. The original throws were also measured, and both plotted against volts applied, for switching on (positive charge) and off (negative charge). (see graph opposite). The dotted lines are extrapolations. For any value of reverse throw, positive or negative, the original deflection is obtained from the corresponding dotted line above. The ratio for the various throws gives the decrement, as follows:-

Reverse Throw	Original Throw		Decrement	
	+ ve	- ve	+ ve	- ve
65	150	135	2.3	2.1
60	138	125	2.3	2.1
55	126	115	2.3	2.1
50	114	106	2.3	2.1
45	100	96	2.2	2.1
40	88	87	2.2	2.2
35	78	77	2.2	2.2
30	67	66	2.2	2.2

The decrement includes the slight correction for non-linearity of amplifier response.

II 3. f. The effect of terminal velocity of Rain Drops on Amplifier Sensitivity.

From the theory on page 21 we would expect amplifier sensitivity to fall off as the time of arrival ψ becomes large compared with the grid circuit time constant SK . This would be the case for rain drops with a very small terminal velocity, that is, very small drops. I investigated the effect using large water drops of a given size falling from various heights and hence arriving at the receiver with various velocities. The drops were produced by the water dropper (page 39) and carried a charge due to an applied p. d. of 23 V. The velocity of these drops after falling 2 metres is $5\frac{1}{2}$ m./sec. which is not much less than the terminal velocity $6\frac{1}{2}$ m./sec. of a drop mass 4 mg. The smallest drops reported by Gschwend were of mass 0.01 mg. and terminal velocity 1.0 m./sec. I varied the height of the water dropper so that the drop velocity on entering the receiver varied between $5\frac{1}{2}$ m./sec. and 0.7 m./sec. The galvanometer deflexion in every case was 46 mm. $\pm \frac{1}{2}$ mm. The drop was considered to "enter" the receiver when it passed through a hole 18 mm. diameter in the apex of an inverted earthed metal cone at the mouth of the

receiver.

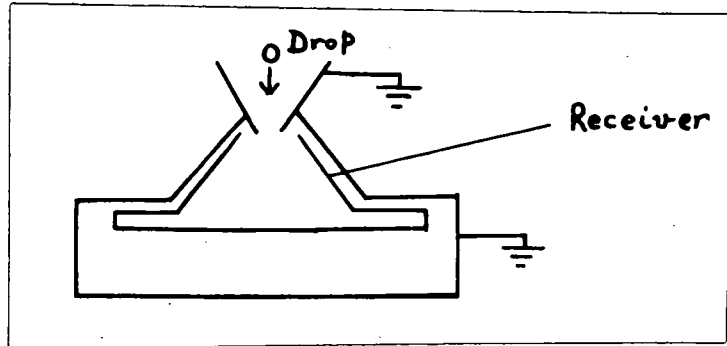

In Chapter III the lower limit of drop size considered in this work is 0.01 mg. The amplifier sensitivity is therefore independent of terminal velocity for the purpose of my present investigations.

II 4 Further work on amplifier design.

Finding that a large proportion of drops in quiet rain carry a charge less than 0.2×10^{-3} e.s.u. I sought to design a more sensitive amplifier. Although this work was not completed (through lack of time), it was carried far enough to show that the methods lead to higher sensitivity. On page 23 it was pointed out that the resistance S , corresponding to the internal grid leakage of the valve when running, must be as large as possible to give the highest amplification of charge. This leakage in the case of receiving valves operated at normal potentials is mainly

due to grid current. To keep S high this current must be as low as possible over the working range of grid potential. At the same time there is a limit to the value of S , set by the grid circuit time constant. The grid capacity K cannot be reduced below the valve interelectrode capacity, about 10×10^{-12} F. If a time constant of 10 seconds can be tolerated, $SK = 10$ and so $S = 10^{12}$ ohms as a maximum. If SK is made too high, a succession of charges of one sign will result in a temporary change of sensitivity by the displacement of the grid operating potential.

The sources of grid current in a valve are given by Metcalf and Thompson (1930). Leakage over the glass or insulation is relatively unimportant. The main source of current is ionization of the residual gas. This is very much lessened by choosing a suitable type of valve and operating it in the dark at reduced potentials. Nielsen (1947) discusses the use of valves for measuring small currents. Ordinary valves working at rated voltages can be used to measure currents down to 10^{-8} or 10^{-9} amp., the limit being set by grid current. Expensive electrometer valves can be used for currents down to about 10^{-16} amp. Nielsen shows that the type 38 pentode, if operated in the dark at reduced voltages, can be used to measure currents as small as 10^{-12} amp. At the same time it has the advantage of functioning as a pentode, which the electrometer valve does not. A valve such as the 38, suitable for the 'intermediate' small currents down to 10^{-12} amp., might be adapted for use in a charge amplifier to measure the small rain drop charges

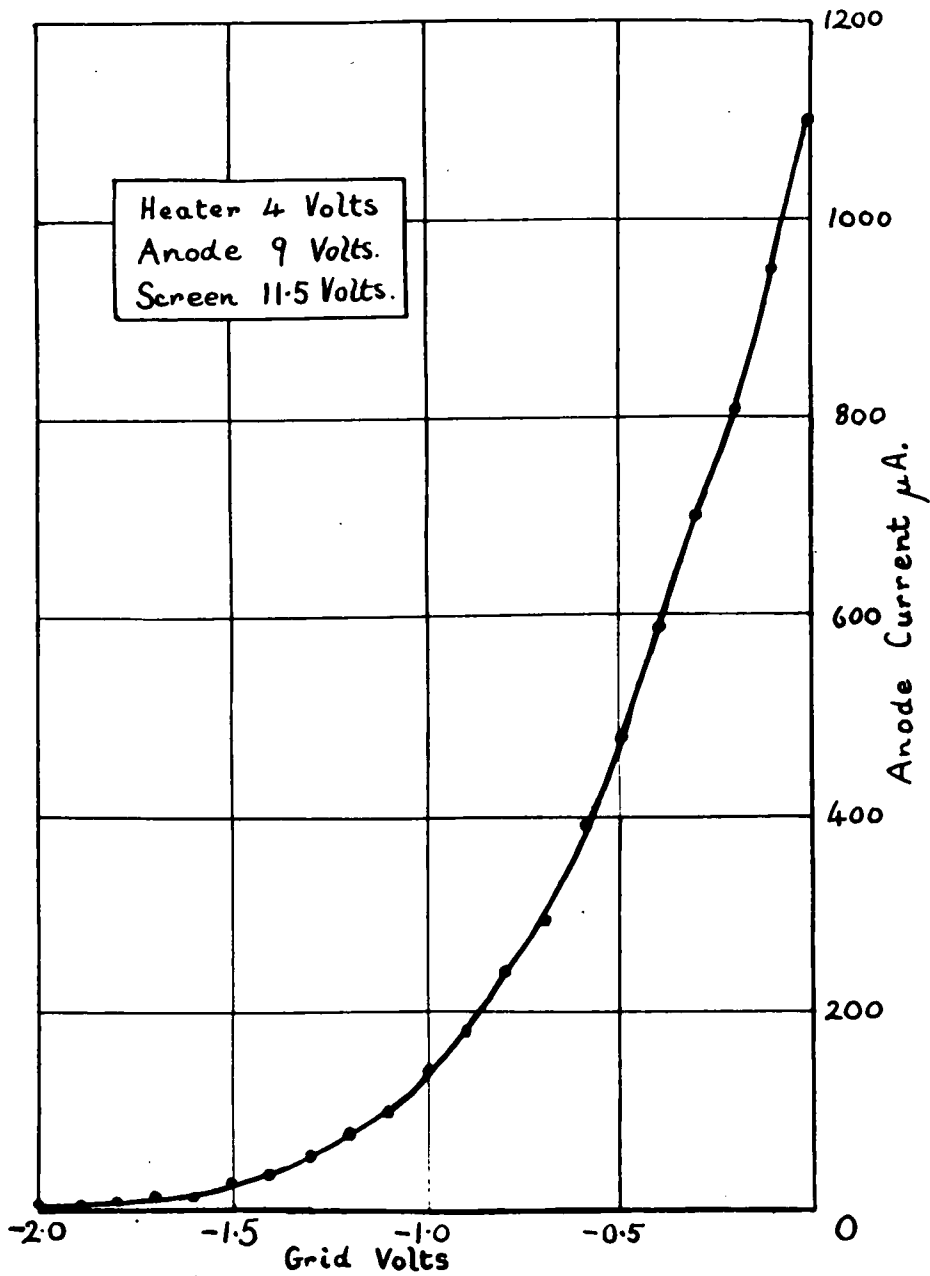

Static Characteristic, 6F6G, at
reduced voltages.

below 0.2×10^{-3} e.s.u. The effect of the mechanical disturbance due to wind would probably outweigh the advantage of extra charge sensitivity obtainable with an electrometer valve. Hence the initial cost of this valve and the considerable labour of building up the necessary circuits would be largely wasted. Nielsen had chosen the type 38 because it has a small ratio of screen to control grid potential (a necessary condition for operating at reduced voltages) and it has a top cap grid, giving good grid insulation.

The type 38 being unobtainable, I chose the 6 F 6 G power pentode. This valve appeared to be the most suitable of those immediately available in stock. It has the grid connected to a pin in the base, but by cutting away part of the moulding I was able to carry out the grid connecting wire without it touching the base. A can with which I screened the valve also served to exclude daylight.

First I drew the mutual characteristic curve for anode potential 9 volts, screen 12 volts, both taken from dry batteries, and heater supply 4 volts taken from accumulators. These voltages are those which gave the least grid current with the 38 valve according to Nielsen. The characteristic is shown opposite page 48. With grid floating the anode current was $143 \mu\text{A}$ and so from the characteristic we find that the floating grid potential was -0.99 volts.

Grid current near the floating point was next measured.

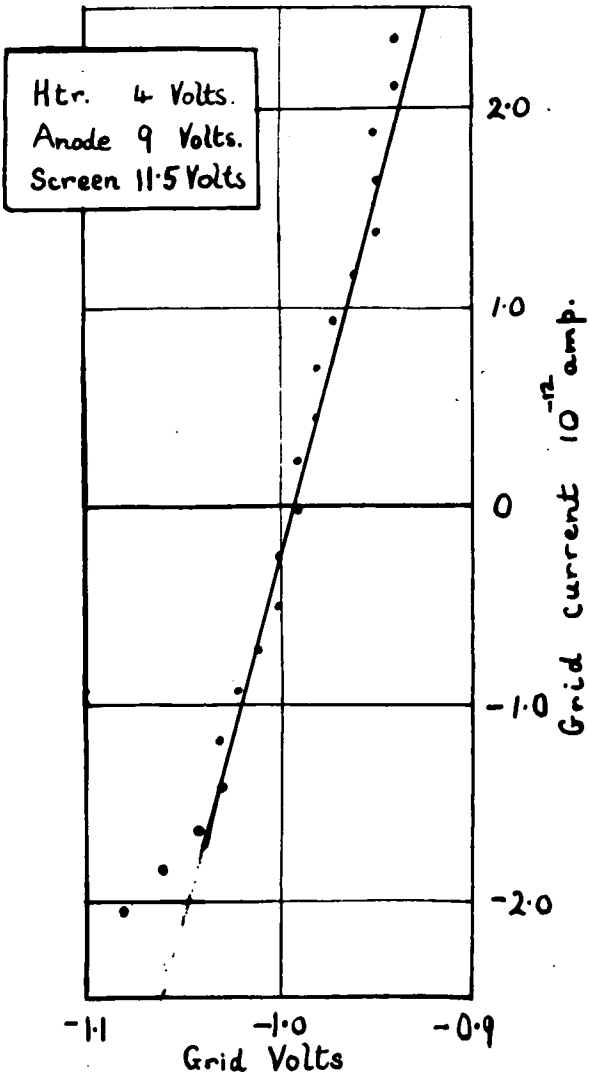

Grid current, 6F6G at reduced voltages.

A resistor of 4×10^{11} ohms (as supplied commercially) was connected between the biasing battery and grid, and for each of a series of values of bias applied the anode current was read. The mutual characteristic shows the grid potential V_g corresponding to each value of anode current. From this the change in grid potential ΔV_g due to the high resistance in the grid lead was found. If the grid current is I_g we have $I_g = \frac{\Delta V_g}{4 \times 10^{11}}$. When the grid potential is slightly positive the grid current will be mainly due to electrons emitted from the cathode and therefore positive. When the grid potential is about -2 volts the grid current will be mainly due to ionization of the residual gas and therefore negative. Somewhere between these values of grid potential the currents due to ionization and the cathode electron stream just cancel out and I_g is zero. This is at the floating potential, in this case -0.99 V. This is a stable condition, any small displacement of grid potential from the floating value being accompanied by a change in grid current which tends to restore the former floating condition. A graph relating grid current and grid potential near the floating point is shown opposite page 49. Over a range of 0.1 volt the relationship is linear.

Now if we place a charge q on the floating grid, the leakage resistance over the glass being S' , the grid current is given by

$$I_g = V_g \left\{ \frac{1}{\left(\frac{dV_g}{dI_g}\right)} + \frac{1}{S'} \right\}$$

where for convenience V_g is considered to be zero at the

floating potential. The expression

$$\frac{I}{\left(\frac{dV_g}{dI_g}\right)} + \frac{I}{S'}$$

is the resistance S already referred to earlier in this section. Obviously S is constant over the range for which $\left(\frac{dV_g}{dI_g}\right)$ is constant. From the graph $\left(\frac{dV_g}{dI_g}\right)$ over this range is 2.7×10^{10} ohms. Both this and the floating potential -0.99 volts are almost exactly those found by Nielsen for the type 38. The value of S' was found by the method of leakage to be not less than 10^{12} ohms. and so S is 2.7×10^{10} ohms.

An amplifier was built, using the 6 F 6 G in the circuit shown (c.f. Chalmers' amplifier on page 22):

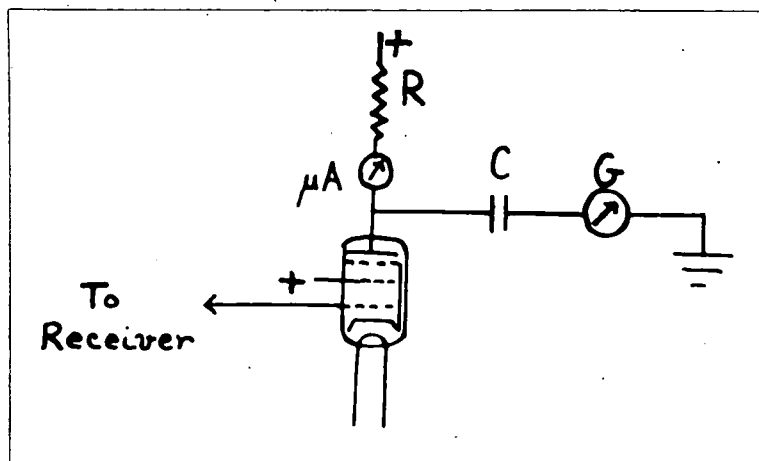

Again screen and anode were at the reduced voltages, and heater supply was 4 volts. R was $200,000 \Omega$ corresponding to the valve A. C. resistance measured under the modified operating

conditions. C was usually $\frac{1}{2} \mu F$. The microammeter was used in conjunction with the mutual characteristic curve to adjust the anode voltage to the correct value. A calibrating condenser (see page 26) was made, consisting of three commercially made $5 \mu\mu F$. condensers in series. With this amplifier temporarily connected to the receiver and galvanometer (which were used for the main measurements with the original amplifier) the sensitivity limit set by zero stability was not greater than $0.05 \times 10^{-3} e.s.u.$ and probably less. This is an improvement by a factor of 2 on that obtained with the amplifier used for the main research. On using A.C. instead of D.C. for the heater no extra fluctuations were observed. The amplification was found to be proportional to C for values between $6.5 \mu F$. and $8.5 \mu F$. (see page 22), but the size of fluctuations increased at roughly the same rate. The galvanometer deflexion was almost unidirectional, the reverse swing (discussed on page 23) appearing as a small steady displacement of the zero lasting a few seconds. This is due to the higher value of S . The amplifier was tried out for rain charges and worked satisfactorily.

The immediate advantages of this amplifier over the one actually used are:-

- (1) the charge sensitivity is higher (factor of 2);
- (2) there is negligible reverse swing, reducing the resolving time;
- (3) lower voltage batteries are used;
- (4) it employs only one valve and has a simpler circuit;
- (5) the galvanometer is at earth potential.

It is important to realise that this work is of the nature of a preliminary test. There are almost certainly better operating conditions for this valve, and probably there are valves more suitable for the purpose.

III 1. The Production of Drops of a given size.

This chapter would be incomplete without some account of the ways in which drops of a given size may be obtained. Although drops of mass 10 mg. or more are easily obtained by allowing water from a reservoir to drip through a coarse capillary tube drawn out to a tip, the reliable production of drops with masses between 0.01 and 1 mg., such as are found in most falls of rain, calls for considerable experimental ingenuity. Defant (1905), using tubes tipped with paraffin wax, obtained drops as small as 0.63 mg., and Laws (1941) 0.82 mg. Nolan (1914) produced small drops down to 0.001 mg. in the form of a spray by using a scent spray arranged as shown in the figure:-

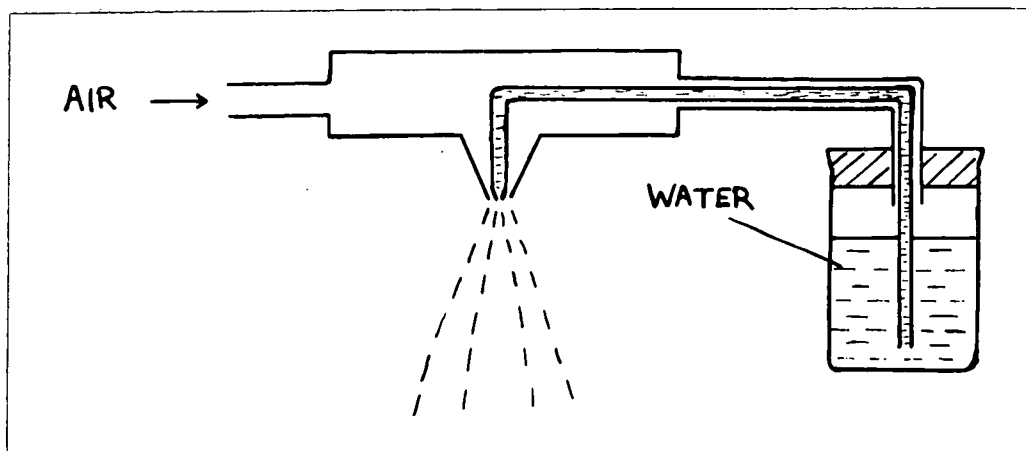

The size of drop depends on the air pressure.

The Microburette

An apparatus for producing single small drops of a given size has been described by Lane (1947)

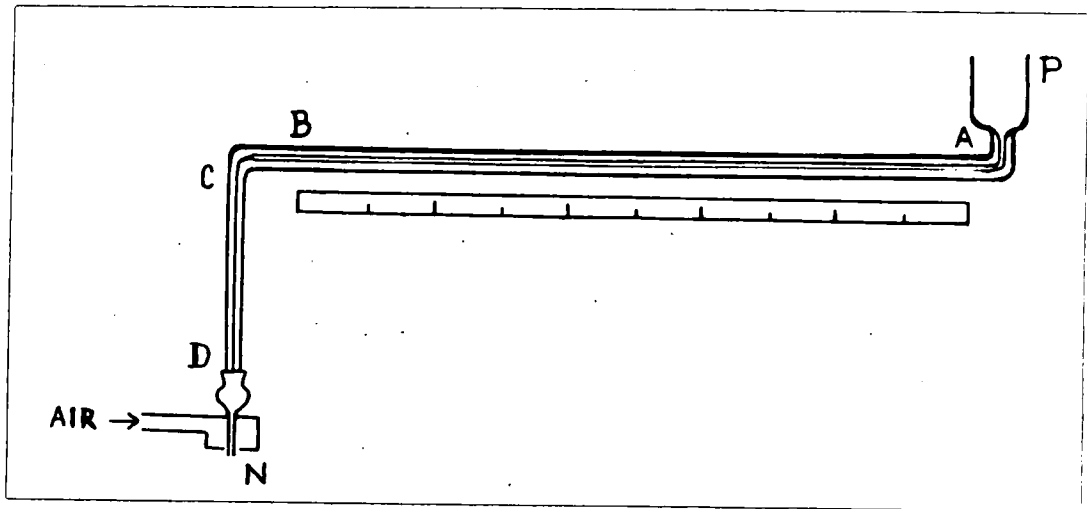

In his Microburette, water introduced into the cup P passes through the capillary tube AB, of regular bore, through the finer capillary CD, and forms drops at the hypodermic needle tip N. A steady air stream passing through an annular opening around the needle and concentric with it plays on the drop which is consequently released from the needle tip sooner than if there were no air current, and the drop is accordingly smaller. The drop size is regulated by adjusting the air pressure. If the liquid in P is allowed to drain out, a meniscus forms in AB and the distance it recedes along AB may be measured by the attached scale. If the bore of AB is known, the movement of the meniscus measured and the number of drops delivered at the same time from the needle tip counted, the drop size may be calculated.

For my work I had a microburette made with AB 50 cm. long. The diameter of the bore was $0.99 \text{ mm} \pm 0.01 \text{ mm}$. The capillary CD was 14 cm. long and of bore diameter 0.28 mm . The hypodermic needle was of the type used in medical work, size No. 20. Air under pressure was supplied either by an electrically driven pump with an intermediate reservoir, or from a cylinder. This apparatus delivered single drops satisfactorily down to about 0.1 mg . Drops smaller than this came too fast to be counted, but they were sufficiently uniform in size for the calibration purposes described later in this chapter. The scale on AB was little used except for rough setting of drop size. Instead the cup P was kept well supplied with filtered distilled water and drop size was measured by a separate method. I considered that this would involve less labour than the construction of microburettes fine enough to measure very small drops. Indeed the selection and calibrating of the tube AB was laborious, and capillary tubes much finer than that used for CD would be tedious to select, instal and use. The microburette thus served to deliver, but not measure, my drops of a given size. It will be shown later in this chapter that the drops in any batch differed amongst themselves by only 1% or 2%.

III 2. Account of two methods investigated but not subsequently employed.

III 2a The Momentum method

I examined this method, suggested by Dr. J. A. Chalmers, with a view to adapting it to continuous recording. Although the method was not used, some of its advantages and disadvantages may well be put on record.

Theoretical Introduction

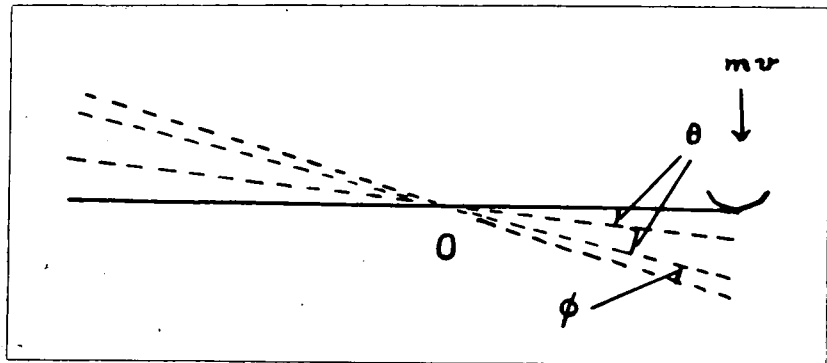

Consider a beam carrying a scale-pan at one end. If a drop of water falls into the pan the beam turns about a horizontal axis O. We will assume there is no splashing.

Let the mass of the drop be m and its velocity v . If the beam turns through an angle θ the restoring couple, gravitational or torsional, is $c\theta$. For an added mass m the steady deflexion is given by

$$mgr = c\theta$$

If there is no damping, and if the mass m is suddenly added, with no additional momentum, the beam will oscillate about a new zero, distant

θ from the old, and the amplitude is 2θ .

If in addition a momentum mv is given to the beam it starts moving with a kinetic energy $\frac{1}{2} \frac{(mvr)^2}{I}$, where I is the moment of inertia. If there is no damping it will get to the corresponding position on the other side of the new zero with this same kinetic energy, which will then be lost in going a further angle ϕ where

$$\frac{1}{2} c [(\phi + \theta)^2 - \theta^2] = \frac{1}{2} \frac{(mvr)^2}{I}$$

$$\therefore \phi(2\theta + \phi) = \frac{(mvr)^2}{cI}$$

The total 'kick' is $2\theta + \phi = \psi$ (say)

$$\therefore \phi = \psi - 2\theta$$

$$\begin{aligned} \therefore \phi(2\theta + \phi) &= (\psi - 2\theta)\psi \\ &= \psi^2 - 2\psi\theta \end{aligned}$$

$$\begin{aligned} \therefore \psi^2 - 2\psi\theta - \frac{(mvr)^2}{cI} &= 0 \\ \therefore \psi &= \frac{2\theta + \sqrt{4\theta^2 + 4 \frac{(mvr)^2}{cI}}}{2} \\ &= \theta + \sqrt{\theta^2 + \frac{(mvr)^2}{cI}} \end{aligned}$$

If the instrument is to be self-recording it is essential that the 'zero' should remain unchanged or very little changed, even after the arrival of a number of drops in succession.

That is, $\frac{\psi}{\theta}$ must be small.

$$\frac{\psi}{\theta} = 1 + \sqrt{1 + \frac{v^2 c}{g^2 I}} \dots \text{(since } mgr \neq c\theta)$$

If the time of oscillation is $t = 2\pi\sqrt{\frac{I}{c}}$,

$$\frac{\psi}{\theta} = 1 + \sqrt{1 + \frac{4\pi^2 v^2}{t^2 g^2}}$$

For a given value of v i.e. a given size of drop this can only become large if t is small (i.e. if I is small) or c large. If c is large the actual values for ψ and θ will be small.

The effect of damping, is to reduce ψ , though θ is not affected. The terminal velocities of raindrops of the size dealt with in this work vary between 1 and 9 m./sec. according to the size. The maximum possible values of $\frac{\psi}{\theta}$ for $t = 1$ sec. are, from the equation above:-

v m./sec.	1	2	3	4	5	6	7	8	9
$\frac{\psi}{\theta}$	2.2	2.6	3.1	3.7	4.3	4.9	5.6	6.2	6.7

Design and Performance of ballistic balance.

The effective length $2a$ of the pan should be small compared with the length of the arm supporting it.

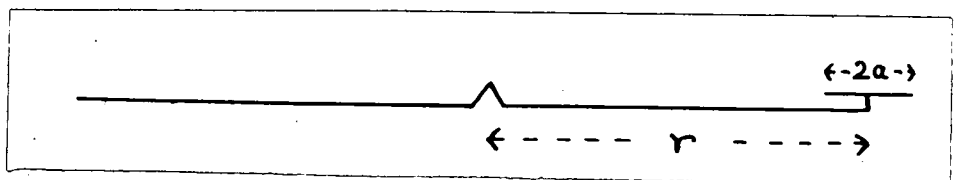

The effective value of r depends on where the drop strikes the pan. This introduces a maximum error $\pm \frac{a}{r}$. If $2a$ is 3 cm. (after Chalmers and Pasquill (1938)) and r is 20 cm., this error may take all values between 0 and $\pm \frac{1.5}{20}$ (or $7\frac{1}{2}\%$).

I first made a series of rough trial balances and studied their behaviour for drops of water falling on to the scale pan. When drops arrived in succession a considerable amount of water clung

to the pan, producing a permanent deflection of the balance. An instrument suitable for small drops would remain deflected to the limit of its range on the arrival of one large drop. Coating the pan with paraffin wax did not remove this difficulty. Heating could not be used to remove this accumulated water because of the attendant convection currents. Draughts were a constant cause of zero fluctuation.

I next constructed a working model. In order to make it more robust and simpler to handle than the trial models, I made it a horizontal torsion suspension of phosphor-bronze. Then, as in the theory above.

$$c = Mgh + c'$$

where M is the mass of the balance beam and attachments, h the depth of the centre of gravity below the axis of suspension and c' the torsion couple per unit angle of twist.

The arms of total mass 0.75 g. were of drawn-out glass tube. The pan, mass 0.25 g, was a square of filter paper waxed on to a glass framework. The filter paper reduced splashing considerably. The counterpoise, of sheet aluminium, moved through the field between the polepieces of two permanent magnets. The damping so produced was adjusted 'till the balance was 'dead beat'. A light mirror was attached to the balance to measure deflexions. The total mass was 8 g.

Using this balance and drops of water representing a

large raindrop ($v = 7\frac{1}{2}$ m./sec.) a ratio $\frac{\psi}{\theta} = 2.1$ was observed. The theory suggests that a larger ratio is obtainable.

$$\text{In the expression } \frac{\psi}{\theta} = 1 + \sqrt{1 + \frac{v^2 c}{g^2 I}},$$

writing $Mgh+c'$ for c we have

$$\frac{\psi}{\theta} = 1 + \sqrt{1 + \frac{v^2 (Mgh+c')}{g^2 I}}$$

Clearly this will increase if h is increased, provided I remains not much changed. Increasing M will increase Mgh and I in the same proportion, and if c' is small compared with Mgh the net effect of increased M on $\frac{\psi}{\theta}$ will be small. c' was found by noting the steady deflection for a small mass added to the scale pan, first using the torsion suspension, and then a knife edge support. c' was about $\frac{1}{4} Mgh$. h was therefore increased by loading the balance arms with masses at a level well below the former centre of gravity. $\frac{\psi}{\theta}$ was found on an average now to be roughly 6.

However, the results were very variable, probably due to splashing and dripping off. An increase in c' might improve the $\frac{\psi}{\theta}$ ratio further, but the deflexions would then be so small their amplification would be difficult. Moreover t then being very small, photographic recording would be difficult. Even so, $\frac{\psi}{\theta}$ would be nearly proportional to v , which ranges from 1 to 9 m./sec. In view of these factors, and because observations on actual precipitation over a long period were desirable, I could not devote more time to this method.

III 2b The Drop Velocity Camera method. (investigated but not employed subsequently.)

I investigated this method with the measurement of drops below 0.5 mg. in view, i.e. below the smallest in the measurements by Laws (1941). As stated in Chapter One this arrangement is suitable for measuring dropsizes over the complete range, limited only by the sensitivity of the photographic plates (and the stray light) in the case of very small drops. In my experiment drops of mass 5 mg., formed at the needle tip of the micro burette, fell through the horizontal beam of a 'pointolite' source of illumination, having fallen $\frac{1}{2}$ m. These drops were photographed in a line at right angles to the beam. The camera aperture was $f/3.5$, the plates were Ilford 34^o Hand D 6000. The drop path was clear on the negative. When drop size was reduced to 0.8 mg. the drop path was still distinct enough for measurement.

A collimating lens (as described in Chapter One) was next set up. Using aperture $f/9$ (giving depth of focus 2 cm.) and oblique illumination (45^o) a 0.8 mg. drop still showed up clearly, but 0.2 mg. drops were very faint on the negative. Exposures had been for two seconds only. Laws (1941) had found this to be about the maximum exposure possible without undue blurring by stray light. To develop this method to be suitable for my measurements would have taken more time than I could afford to give to it, and so I turned to a method, described next, which could be put into use almost at once.

III 3. The Method Used - the Absorbent Paper Method

I finally adopted Wiesner's Absorbent Paper method (1895) for measuring rain drop size. As stated in Chapter One, this was developed by Defant (1905) and is the method which was used by Gschwend (1921). The absorbent paper I used was in the form of filter papers of diameter 11 cm. These were the kind commonly used in this Department, and known as 'English Postlip Milled' Quality No. 633 (White). No special care was found necessary in preparing these papers for use, other than keeping them moderately dry by storing in a cardboard box over an ordinary central heating radiator. To render permanent the stains formed by water I used the red dye Rhodamine B.S. (supplied by Messrs. Imperial Chemical Industries, Limited). Rhodamine has been used for similar purposes by the Meteorological Office. I applied it lightly as a dry powder, using a small camel hair brush. Care was needed to avoid breathing in more particles of the dye than absolutely necessary, for this causes irritation of the lungs, with coughing, and also streaming of the nose, the dye dissolving in the fluid so formed. The advantages of using this dye are that its vivid red colour appears immediately when a spot of water falls on a prepared paper, and the stain is semi-permanent. Stains could still be easily measured twelve-months after they were first formed, and no special storage precautions were necessary. It is important that the stain should remain 'fixed' for at least a few days as a delay of this duration is sometimes inevitable before an opportunity to measure them arises.

I performed a calibration of this variety of filter paper for drops of water in the mass range 0.01 to 66 mg., covering the complete range in Gschwend's work (1921). The size of drops above 9 mg. was measured by counting a number of drops into a bottle and weighing. The drops were formed by allowing water supplied from a constant head reservoir to drip from the waxed tip of drawn-out glass capillary tube of approximately 1 mm. bore. The tip needed for the particular size required at any time was obtained by trial and error. This was simplified after one or two drop sizes had been investigated because it was then possible to estimate the size roughly from the stain on a prepared filter paper. For each size of drop examined, the capillary tube was drawn out and waxed so as to deliver drops steadily at a comfortable rate for counting. A prepared paper was divided by a pencil line and the two halves labelled 'before' and 'after' respectively. When drops were falling steadily four or five were caught on the half labelled 'before', the next ten or twenty drops were caught in a weighing bottle and the stopper inserted, and four or five drops were then caught on the 'after' half. The paper was guided so that each drop formed a separate stain. It was necessary to keep the paper horizontal for a few seconds to allow the stain to spread uniformly. The paper, serially numbered, was left protected from accidental splashes whilst the drops in the bottle were weighed. The stains on the paper were then measured. These were all nearly circular. All measurements were in millimetres, and were made by placing a transparent ruled grid over the stain. The grid was a lantern slide made by

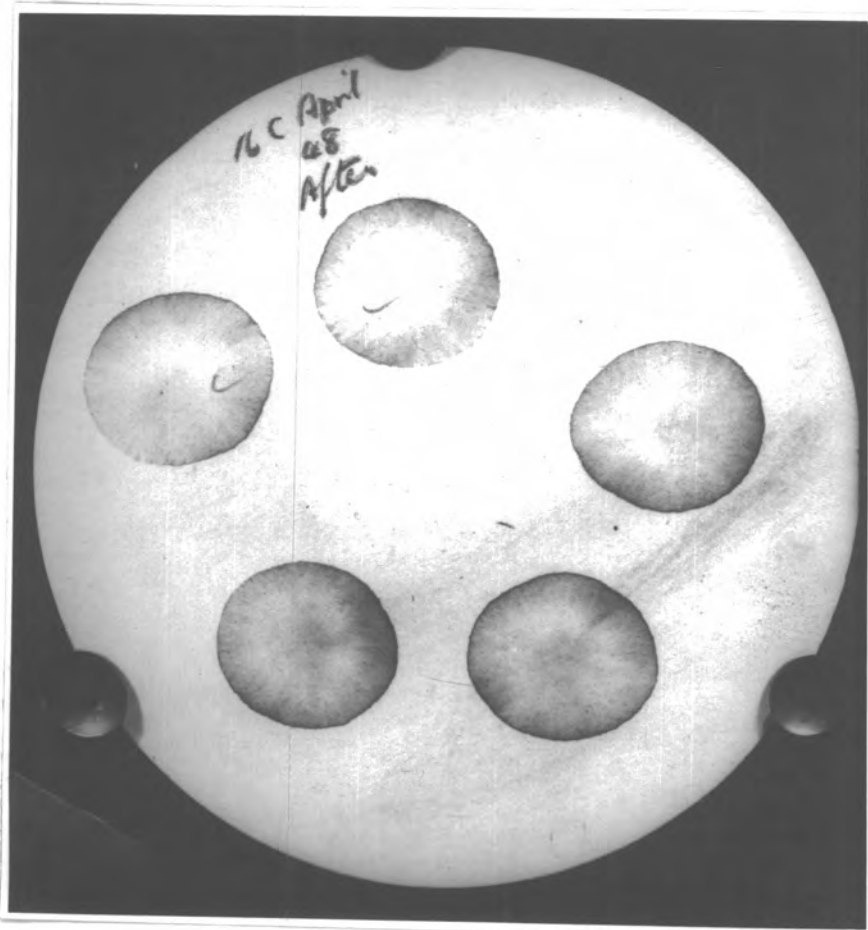
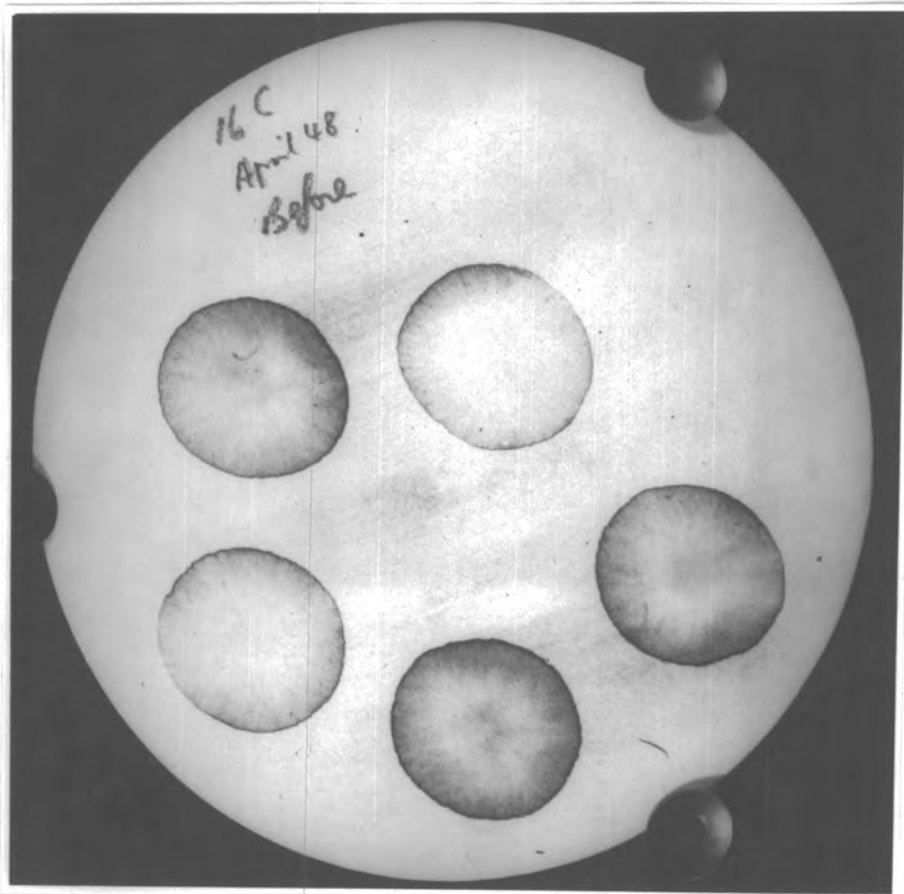

photographing graph paper, and was accurate to within 1%. I would place it so as to give the maximum diameter, and record this and the diameter at right angles. Hence I got the average stain-diameter of the 'before' series of drops and of the 'after' series. Here is an example taken from the records:-

Weight of bottle	28.0821	gm.
do. + twenty (20) drops	<u>28.5440</u>	gm.
Weight of twenty (20) drops	0.4619	gm.
Average drop weight	23.10	mg.
Average drop radius	1.77	mm.

Stain Diameter

<u>Before</u>	(Max. 25.0 24.4 24.0 25.2 25.4 Av. 24.8)	Av. 23.3	}	Av.
	(Min. 21.6 21.8 21.2 21.6 21.8 Av. 21.8)			
<u>After</u>	(Max. 25.0 24.6 24.6 25.0 25.2 Av. 24.9)	Av. 23.5	}	Av.
	(Min. 22.2 21.8 22.2 22.4 22.6 Av. 22.2)			

(Drop radius 1.77 mm.
 (Stain diameter 23.4 mm.

(See photographs opposite)

19C
April 48
After

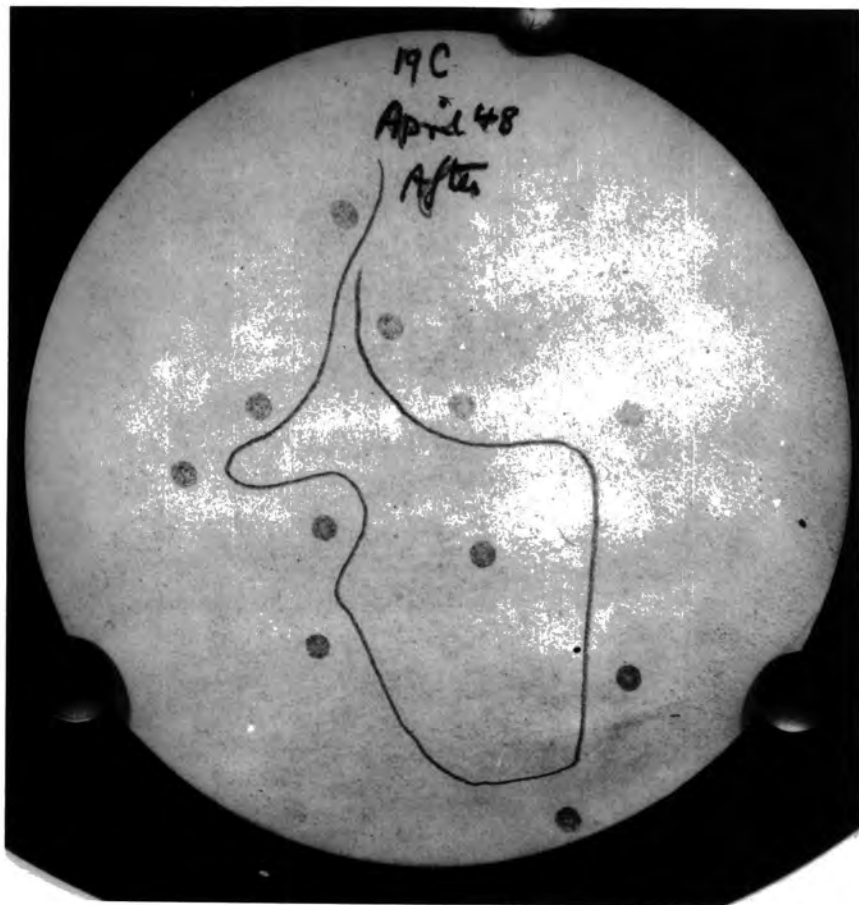

For measuring drops smaller than 9 mg. I used a method due to Nolan and Enright (1922). Thick dark lubricating oil of density 0.88 was poured into a flat-bottomed glass dish to a depth greater than the diameter of the drops to be measured. The drops, formed by the method described above, or with the microburette, were allowed to fall into this oil, where they lay submerged as spheres. It was found necessary to smear the bottom of the dish with vaseline to prevent the drops from becoming distorted by sticking to the glass. The diameters were then measured with a microscope and eyepiece scale. The image of the drop appeared to include a number of concentric rings and at first I was uncertain which ring to measure for the drop diameter. However when I moved a nearby table lamp from side to side the outer ring remained stationary while the others appeared to move. The outer ring was therefore chosen and measurements made in this way on the larger drops (below 9 mg.) agreed well with diameters obtained by weighing.

Drops between 3 and 9 mg. were measured both by weighing and by the microscope method. In this case the sequence of operations was:-

- (1) Drops were caught on a prepared paper.
- (2) Drops were caught in bottle.
- (3) Drops were caught in thick oil.
- (4) Drops were caught on prepared paper.

Drops below 3 mg. were measured by the microscope method only. As the smallest drops did not sink into the oil immediately a

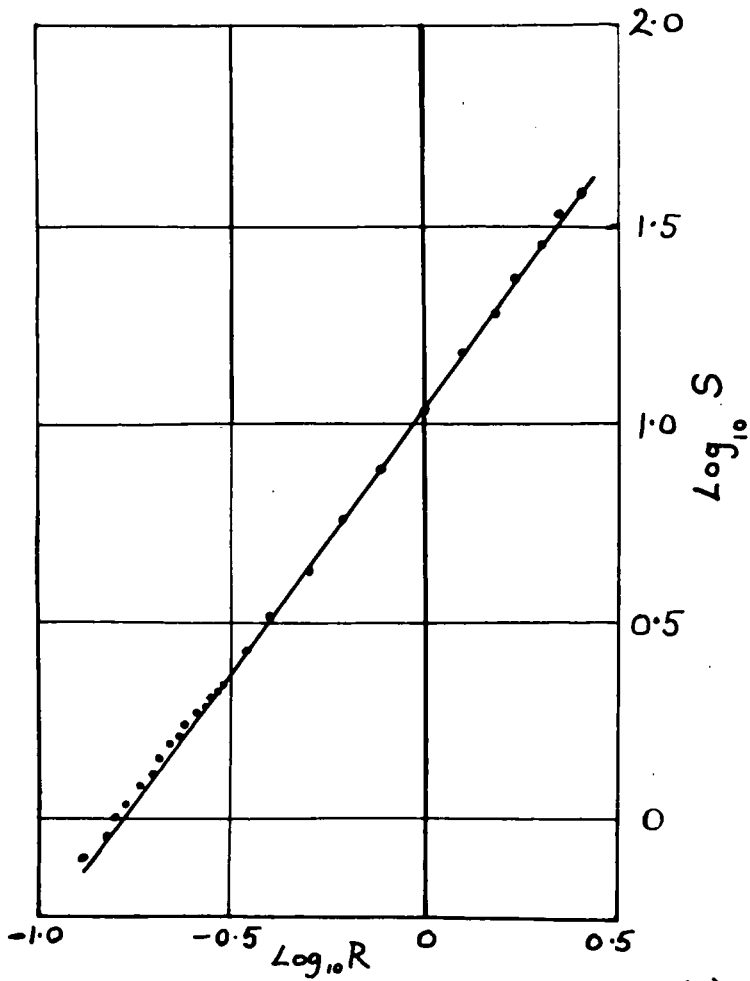

Relationship between Stain Diameter (S)
and Drop Radius (R).

layer of oil was poured over them to prevent evaporation. Two sets of measurements on very small drops were made with a lighter oil known commercially as 'Three-in-One'. (See opposite page 65).

The calibration figures as observed are given in the table overleaf, the method of measurement being indicated. These values were plotted on a graph (page 68), from which 'smoothed' values were read and used in constructing Table (page 68). The table does not extend outside the range covered by the calibration experiments.

I found no appreciable variation of stain size with height of fall, although Laws (1941) observes that such a variation was apparently overlooked by Schmidt (1909).

From the calibration curve it is seen that only about one tenth of the values of drop radius plotted differ by as much as 5% from the value on the curve against the stain diameter concerned. Only one point shows a difference of 10%. On any particular calibration filter paper the deviation from the mean stain diameter was not more than 2% when calculated as a probable error. The main source of inaccuracy therefore lies in the variation of thickness from one paper to another.

No simple relationship was found between drop radius and stain diameter, though on plotting their logarithms (see opposite) I obtained a good straight line for values of stain diameter above 2 mm., from which I deduced

$$R = 0.17 S^{0.74}$$

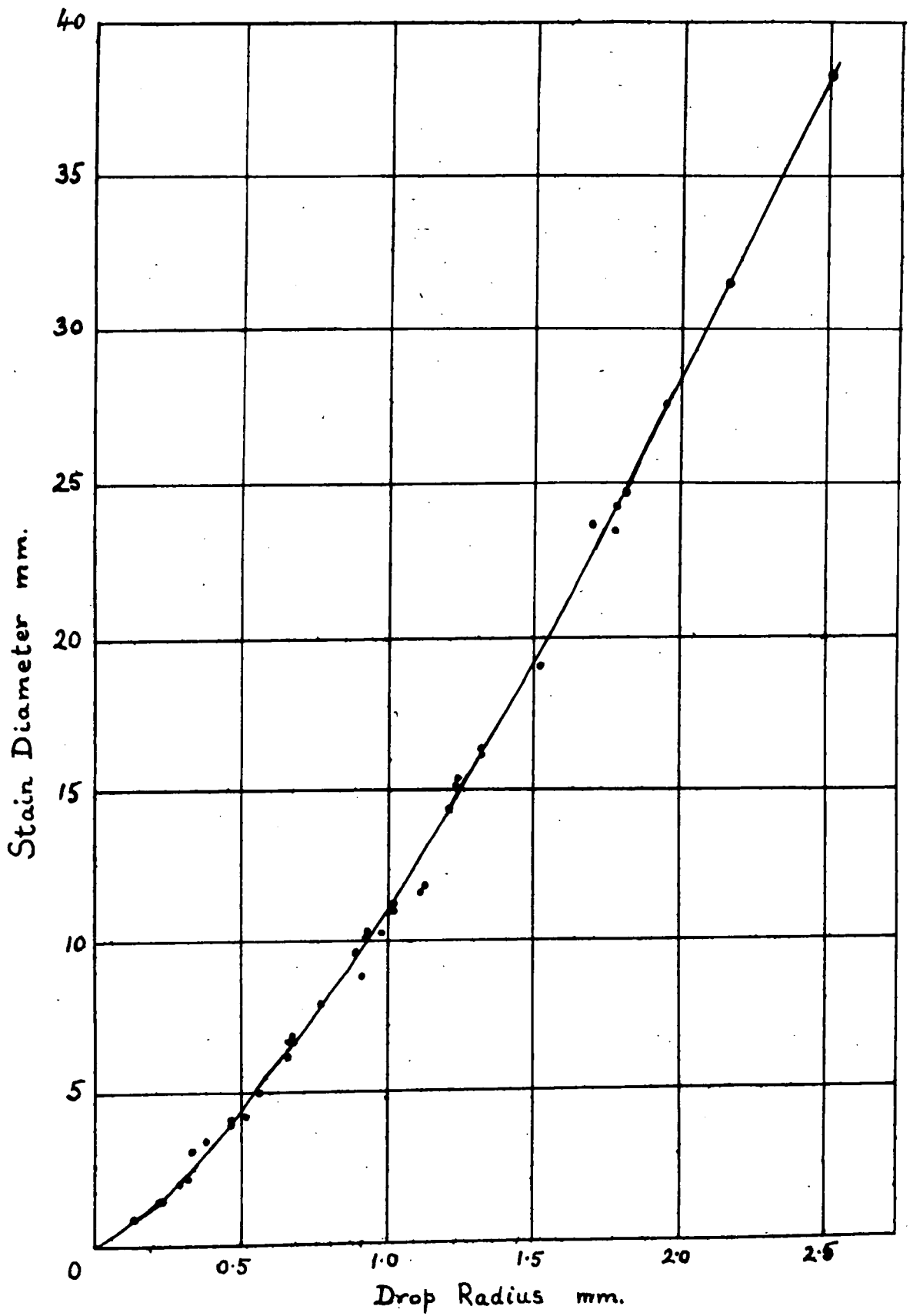

Relationship between Stain Diameter and
Drop Radius.

Stain Diameter	Drop Radius	Drop Diameter	Drop Mass	Terminal Velocity see Laws (1941)
0.8 mm	.13 mm	.26 mm	.0092 mg	1.0 m/sec.
0.9	.15	.30	.014	
1.0	.16	.32	.017	
1.1	.17	.34	.020	
1.2	.18	.36	.024	1.5 m/sec.
1.3	.20	.40	.033	
1.4	.21	.42	.039	
1.5	.22	.44	.045	
1.6	.23	.46	.052	
1.7	.24	.48	.058	2.0 m/sec.
1.8	.26	.52	.074	
1.9	.27	.54	.082	
2.0	0.28	0.56	0.092	
2.1	.29	.58	.10	2.5 m/sec.
2.2	.30	.60	.11	
2.3	.31	.62	.12	
2.4	.32	.64	.14	
2.5	.33	.66	.15	
2.6	.34	.68	.16	
2.7	.35	.70	.18	3.0 m/sec.
2.8	.36	.72	.19	
2.9	.37	.74	.21	
3.0	.38	.76	.23	
3.1	.39	.78	.25	3.5 m/sec.

Stain Diameter	Drop Radius	Drop Diameter	Drop Mass	Terminal Velocity see Laws (1941)
3.2 mm	.40 mm	.80 mm	.27 mg	
3.3	.41	.82	.29	
3.4	.42	.84	.31	
3.5	.43	.86	.33	3.75 m/sec.
3.6	.43	.87	.34	
3.7	.44	.88	.36	
3.8	0.45	0.90	0.38	
3.9	.46	.92	.41	
4.0	.47	.94	.43	4.0 m/sec.
4.1	.48	.96	.46	
4.2	.49	.98	.48	
4.3	.49	.99	.50	
4.4	.50	1.00	.52	4.25 m/sec.
4.5	.51	1.02	.55	
4.6	.52	1.04	.58	
4.7	.53	1.06	.61	
4.8	.53	1.07	.63	
4.9	.54	1.08	.66	4.5 m/sec.
5.0	.55	1.10	.69	
5.1	.56	1.12	.73	
5.2	.57	1.14	.77	
5.3	.57	1.15	.79	
5.4	.58	1.16	.82	
5.5	.59	1.18	.86	
5.6	.60	1.20	.90	4.75 m/sec.

Stain Diameter	Drop Radius	Drop Diameter	Drop Mass	Terminal Velocity see Laws (1941)
5.7 mm.	.61 mm.	1.22 mm	.95 mg	
5.8	.61	1.23	.97	
5.9	.62	1.24	1.00	
6.0	.63	1.26	1.05	
6.1	.64	1.28	1.10	5.0 m/sec.
6.2	.65	1.30	1.13	
6.3	.65	1.31	1.16	
6.4	.66	1.32	1.20	
6.5	.67	1.34	1.26	
6.6	.68	1.36	1.31	5.25 m/sec.
6.7	.69	1.38	1.35	
6.8	.69	1.38	1.38	
6.9	.70	1.40	1.44	
7.0	.71	1.42	1.50	
7.1	.72	1.44	1.55	
7.2	.72	1.45	1.58	
7.3	.73	1.46	1.63	5.5 m/sec.
7.4	.74	1.48	1.68	
7.5	.74	1.49	1.72	
7.6	.75	1.50	1.76	
7.7	.76	1.52	1.82	
7.8	.77	1.54	1.88	
7.9	.77	1.55	1.92	
8.0	.78	1.56	1.98	5.7 m/sec.

Stain Diameter	Drop Radius	Drop Diameter	Drop Mass	Terminal Velocity see Laws (1941)
8.5 mm	.82 mm	1.64 mm	2.30 mg	5.75 m/sec.
9.0	.86	1.72	2.66	
9.5	.90	1.80	3.05	6.3
10.0	.94	1.88	3.48	
10.5	.97	1.94	3.83	6.5
11.0	1.00	2.00	4.19	
11.5	1.04	2.08	4.71	6.7
12.0	1.07	2.14	5.13	
12.5	1.10	2.20	5.57	7.0
13.0	1.13	2.26	6.05	
13.5	1.17	2.34	6.71	7.2
14.0	1.19	2.38	7.05	
14.5	1.22	2.44	7.60	
15.0	1.25	2.50	8.17	7.5 m/sec.
16.0	1.32	2.64	9.61	
17	1.38	2.76	11.0	
18	1.44	2.88	12.5	
19	1.50	3.00	14.1	8.0 m/sec.
20	1.56	3.12	15.9	
25	1.83	3.66	25.6	
30	2.08	4.16	37.7	9.0 m/sec.
35	2.34	4.68	53.7	9.2 m/sec.

IV THE COMPLETE APPARATUS AND EXPERIMENTAL PROCEDURE

IV 1. The Site

I built the apparatus partly inside and partly on the flat roof of a hut, 10 ft. x 10 ft. x 7 ft. high. The surroundings of the hut were as follows:-

to the east:	distant 40 ft.,	a building 10 ft. high;
to the S.E.	" 160 ft.,	" tree 50 ft. " ;
to the S.W.	" 65 ft.,	" building 10 ft. " ;
to the west.	" 55 ft.,	" building 30 ft. " ;
to the N.W.	" 35 ft.,	" building 12 ft. " .

The rain drop receiver was on the roof of the hut. Considering the excess height of any building or the tree over that of the hut, it is seen that no obstacle to driving rain is nearer to the hut than twice the value of that excess height.

The rain drop receiver was connected by a cable to the amplifier inside the hut, which was kept dry by means of an electric radiator always on. This was essential for the proper working of the amplifier. The hut could be blacked out for photographic work.

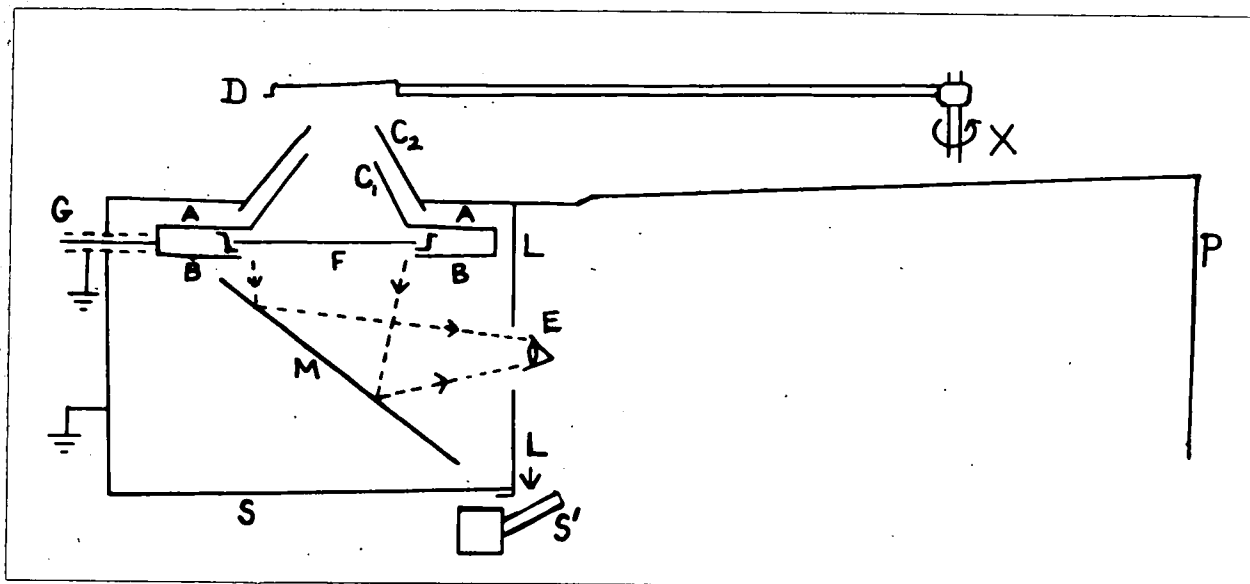
IV 2. The Rain Drop receiver.

The receiving vessel consists of two parallel metal plates AA, BB, 16 cm. square, 4 mm. apart, and connected electrically. A circular hole, diameter 11 cm., is cut in the centre of each plate. To AA is soldered an open copper cone C_1 . This is the opening through which rain drops were admitted. It is cone-shaped to prevent drops arriving inside from splashing out, and drops outside from splashing in. A moveable circular tin tray F with a peripheral lip 12.4 cm. in diameter fits easily between the plates, just under C_1 . This tray has a circular hole cut centrally 10.5 cm. in diameter, and an 11 cm. diameter filter paper lies in the tray, over the

hole, being held in position by four clips which lie below the level of the tray lip. The tray and paper form part of the receiver electrically. S is a metal box - a 22 cm. cube (a biscuit tin) with a conical opening C_2 at the top. It has a sliding lid LL. Both S and LL are earthed to form an electrostatic screen for the receiver. By means of the inclined plane mirror M inside S an observer looking through a hole at E in LL sees an image of the filter paper F and the stains as they are formed by rain drops. The screened cable G connects the receiver to the amplifier. The observer stands on a platform built close up to the wall of the hut at such a height that his eyes are at the correct level to watch the image of F without great discomfort. A waterproof shelter P protects him and his supply of filter papers from wind and rain. The cone C_2 is covered by an earthed metal disc D 12 cm. in diameter. This moves horizontally 30 cm. clear of the cone by a rotation of the vertical rod X. It is operated by depressing a pedal at the foot of the operator under the shelter, or by pulling a cord inside the hut, and is fitted with a return spring. The whole structure is fixed firmly to the roof and walls of the hut to reduce electrical disturbances due to movement in the wind. The cable is carried in an iron pipe to avoid electrostriction effects. As an added protection against wind a number of heavy concrete slabs and bricks are stacked round and partly on the structure.

The receiver is shown in greater detail in the following diagram.

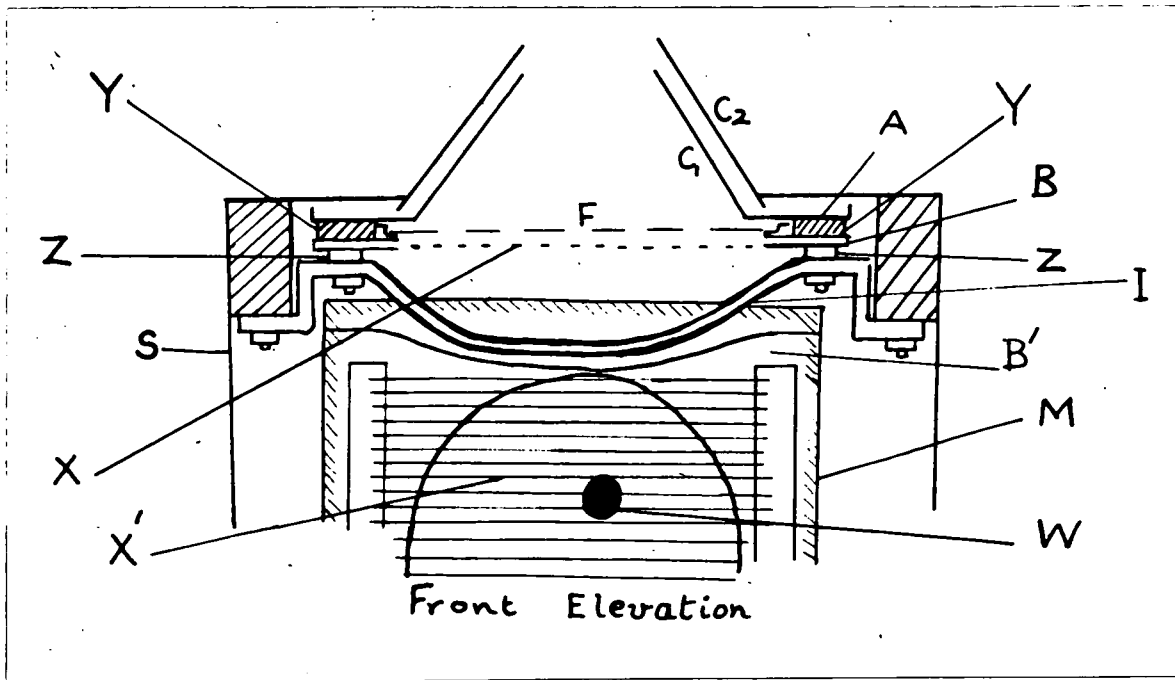

The plate A is turned up 1 cm. round its edge to form a trap for any drops which fall between the cones C_1 and C_2 . It is thus impossible for this water to spoil the insulation of the receiver. YY are two parallel rails which serve to locate the tray carrying the filter paper F. The plate B is partly cut away to facilitate inserting the tray, and its image B' is seen in the mirror M. Across the circular hole in B are soldered very fine parallel wires to form a grid X, seen as X' in the mirror M. This grid behaves as a transparent conductor through which the stain W is clearly

visible. The receiver is rigidly mounted inside the box S by means of two shaped iron strips I, and well insulated with the polystyrene bushes ZZ. A 25-watt electric heater in a screening can lies behind M and keeps the assembly dry. A small battery fed lamp inside S illuminates the filter paper by night. At other times sufficient light enters through the cones. The aperture of C_1 (and C_2) is 3.8 cm. in diameter. This was chosen as that found satisfactory by Chalmers and Pasquill (1938). The height was chosen by the following method. When a charged drop enters the cone the lines of force from it will mostly terminate on the metal-work of the receiver, the dry filter paper being an insulator. Some of these lines of force however will pass through the cone mouth and terminate on the outer earthed cone. The charge measured will therefore be too low, by an amount corresponding to the lines of force 'lost' through the aperture.

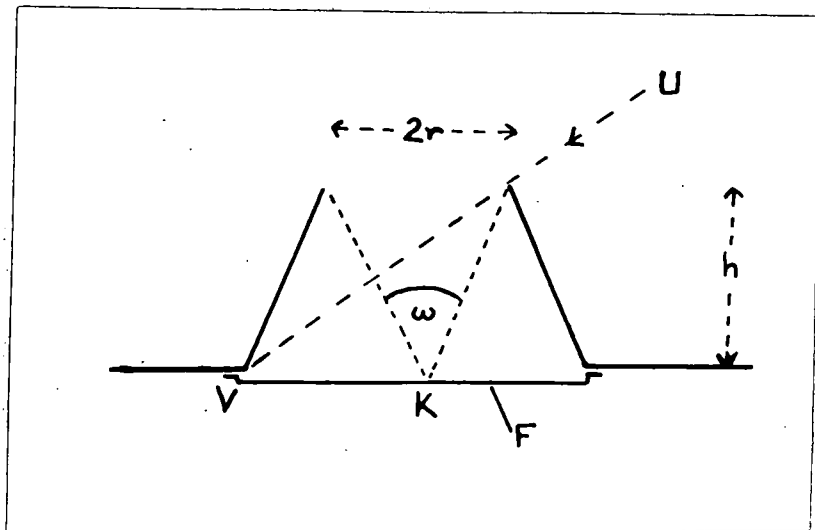

For a diameter of aperture $2r$ and height h the proportion of lines of force 'lost' will be approximately $\frac{\omega}{4\pi}$ where ω is the solid angle subtended at K by the aperture, and $\omega = \frac{\pi r^2}{h^2}$. For this loss to be 1%, $h = 10$ cm., giving a cone with sides at 64° to the horizontal. This would exclude from the filter paper F rain driving at less than 50° to the horizontal (UV). On the other hand, to include rain driving at a low angle the loss will be high. Three values of h are shown in the following table

h	% 'loss'	Minimum driving angle of rain
10 cm.	1	50°
5.8 cm.	3	35°
4 cm.	6	26°

The value $h = 5.8$ cm. was chosen, 3% being considered not excessive for the loss, and 35° a fair angle for driving rain. For most rainfalls the 3.8 cm. aperture was too large to take drops singly, and an extra earthed cone could be clipped over C_1 with an aperture 1.8 cm. in diameter. With this the least driving angle is 45° . However, with the small cone, rain drops driving at angles above 33° will fall inside the receiver and their charge be registered, though they may not reach the filter paper.



Inside the Shelter.

The grid (mentioned above) was found necessary because for a charged drop from the water dropper the amplifier gave a higher reading when a tray without a circular hole in the bottom was used. There had evidently been a 'loss' due to lines of force 'escaping' through the filter paper. The grid was adjusted until with a spacing of 5 mm. between wires the "loss" as shown from the amplifier deflexions was only 1%, using a tray with the hole cut.

For measurements, a large number of trays with prepared filter papers inserted are kept near at hand. The trays are changed by hand, this operation proving to be no longer than using a mechanical system with a sliding piston. The manual method is simpler and more reliable. As the method involves earthing the receiver with my hand, I arranged a relay to short-circuit the galvanometer during the changing of trays. The amplifier recovers from this rough handling in three seconds, and it is then quite safe to continue recording. The relay is controlled by the spring-loaded switch S' (see diagram page 73) the leads being screened, and sparking suppressed with a $0.1 \mu F$. condenser. The amplifier and screening all use a common earth - an iron pipe driven into the ground - and all connexions are soldered.

IV 3. Measurement of the Electric Field

As the receiver was not completely shielded by the

outer earthed cone C_2 a bound charge of the same sign as the field was indicated by the galvanometer when the cover D was moved from over the cone. On the return of the cover a charge of opposite sign was indicated. This bound charge was easily identified on the records, as will be seen later. In almost all the observations the deflexion due to this charge was of a convenient size for recording. On the rare occasions when the 'large cone' (3.8 cm. diameter) was used without the 'small cone' (1.8 cm.) the field was smaller than in heavier rain and so the bound charge deflexion was not off the scale. I therefore made use of this effect to obtain the value of the field at frequent intervals, usually every 20 seconds. The instantaneous value of field is given by this method.

A field calibration was necessary. I performed this by using a horizontal wire one metre high with a glowing fuse of twisted paper 'string' impregnated with lead nitrate. The wire was stretched between two posts 10 metres apart, near the hut. The fuse was at the centre of the wire. One end of the wire was connected to a double tilted electroscope inside the hut. Every ten seconds, using the receiver 'large cone', I operated the cover D and at the same instant noted the electroscope eye piece scale reading. The bound charge due to the field was recorded photographically, and for each operation of the

cover it was afterwards compared with the field, which is given directly by the electroscope in Volts/metre at the earth's surface. This field calibration was performed on three separate occasions. Later another calibration was performed, this time with the stretched wire in a nearby open field of trampled stubble. The nearest objects which might disturb the electric field were a building 12 ft. high, distant 160 ft.; a tree 30 ft. high at 160 ft.; and a building 30 ft. high, distant 200 ft. Two operators were necessary, one to read the electroscope, the other to operate the cover D over the rain drop receiver. A whistle was used for co-ordination. The results of these calibrations are shown on the graph opposite. The first three calibrations agree together. The last shows higher values of field, as to be expected with the more open site. The values from the last calibration were adopted for this work. They show that a bound charge of 10^{-3} e.s.u. represents a field of 19.3 Volts/metre at the earth's surface on the open site. The scatter of points on the graph is to be expected on account of local variations in field. It is greater for the open site calibration, the stretched wire being then 200 feet from the hut. That the scatter is not due to peculiarities of the bound charge measurement system is clear from the fact that when the field is steady the bound charge deflexions show practically no scatter at all.

A comparison of the bound charge for the 'large cone'

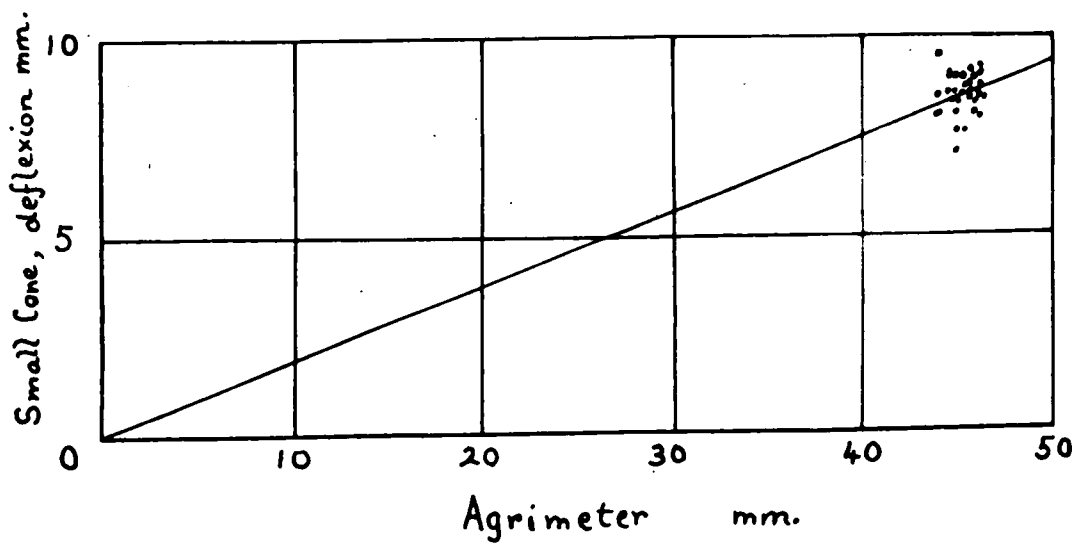
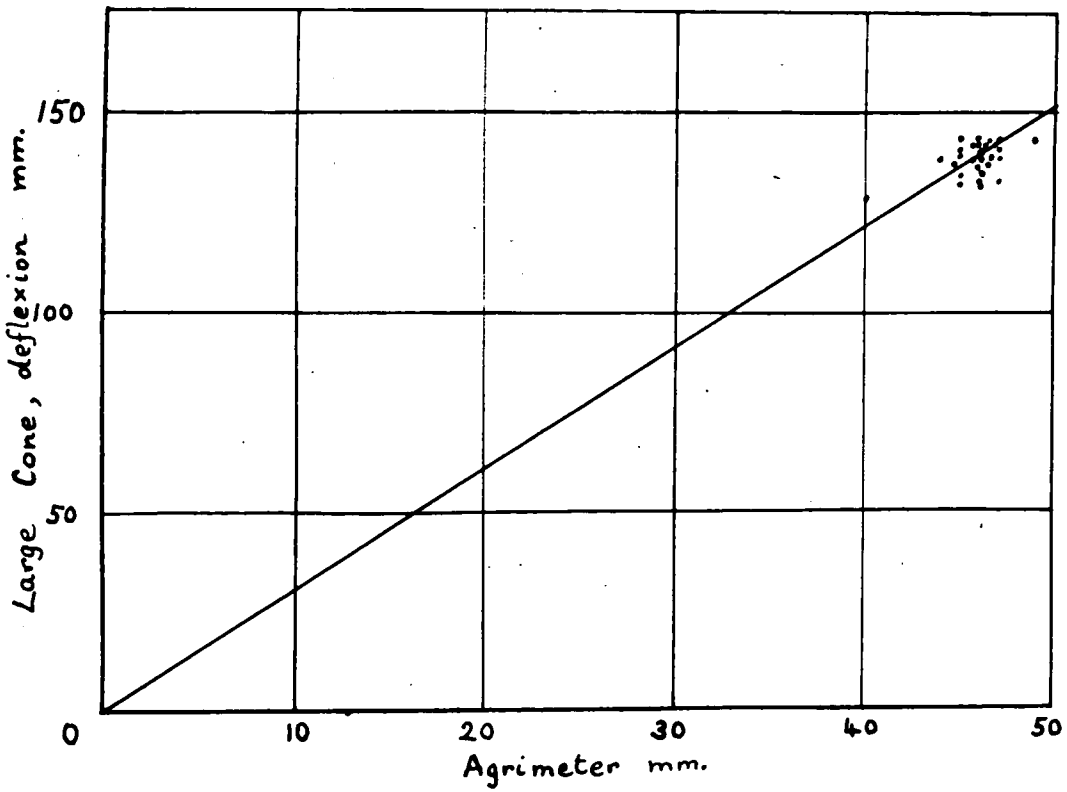

Comparison of bound charge for large and small cones.

and the 'small cone' was made. For this the 'Agrimeter', an instrument by which the instantaneous field is continuously recorded, was made available and operated by Dr. J. A. Chalmers (not yet published). The agrimeter deflexion, which is proportional to the field at ground level near the hut, was noted each time the rain drop receiver cover D was operated for a few minutes using the large cone, then a few minutes with the small cone, and so on. The large and small cone deflexions were expressed in terms of agrimeter deflexions, and plotted on the graph opposite. From this, 50 mm. on the agrimeter corresponds to 152 mm. with the large cone, medium sensitivity, and 9.3 mm. with the small cone, high sensitivity. The factor for converting high sensitivity to medium is $\frac{1}{1.95}$. Hence the small cone deflexion is equivalent to $\frac{9.3}{1.95}$ mm., Medium sensitivity, i.e. 4.77 mm. The ratio of bound charges for the two cones is thus $\frac{152}{4.77} = 32$ and the field corresponding to a small cone bound charge of 10^{-3} e.s.u. is obtained from the large cone value of 19.3 V/m. and is $19.3 \times 32 = 620$ V/m.

From the expression $F = -4\pi\sigma$ for a surface level with the ground, where F is the field and σ the bound charge per unit area, we can calculate the 'effective area' of the two cones used with the receiver. This is $\frac{3}{2}A$ for the large cone and $\frac{a}{4}$ for the small cone where A , a are the areas of the cone mouths. These figures indicate that the field is considerably distorted by the presence of the cones and their

height above the earth's surface.

IV 4. The Measurement of Point Discharge

A discharging point having already been erected by Dr. J. A. Chalmers, I found it convenient to pass the point discharge current through a galvanometer and record it simultaneously with the rain drop charges. The point consisted of 1 cm. of platinum wire at the upper end of a heavy gauge copper wire. This was fixed on a post on the corner of the 30 ft. building 55 ft. from the hut, the point being about 36 ft. above ground. An insulated cable carried the current via the galvanometer inside the hut to earth. The empirical formula found by Whipple and Scrase (1936) relating point discharge current I and Field F at Kew is

$$I = a(F^2 - M^2)$$

where a is a constant and M a minimum field. The value of I is thus an indication of the field F , and I recorded it in order to confirm or contradict any measurements of field which I considered questionable. The above relationship is not exact at all times, probably because of local variations in field and ionization. The constants a and M depend on the sign of the current, and may well vary from place to place.

By means of shunts two sensitivities of the galvanometer

were available. At first a nearly dead-beat galvanometer was used, but later one completely dead-beat, the latter giving a steadier trace.

The platinum tip mentioned above was often found turned horizontal, even when there had been only light winds. It has been suggested that birds are responsible. I finally replaced the point by a stout brass rod tipped with platinum, and brought to a point rather larger than a gramophone needle. This remained quite firm.

IV 5. Recording Technique.

A rotating drum camera was used. The drum diameter was 14 cm., and it carried a strip of bromide paper 12 cm. wide. A galvanometer lamp with a fine slit produced a beam of light which was brought to a point focus by the galvanometer concave mirror and the camera cylindrical lens. A synchronous electric motor turned the drum one revolution in 20 minutes, and for my purposes the rate of travel of the paper surface was taken to be 1 mm. in 3 seconds. The camera was located by a fixed metal strip, and a scale could be placed in front for eye observations. The intensity of the 'zero' trace was reduced by placing a strip of plane blue glass 1 cm. wide centrally in front of the cylindrical lens.

Point discharge current was recorded on the same paper.

The point discharge galvanometer lamp beam was divided by a thin plate of glass into a transmitted and a reflected beam. The latter was directed to the galvanometer by a further reflection at a glass plate (see figure).

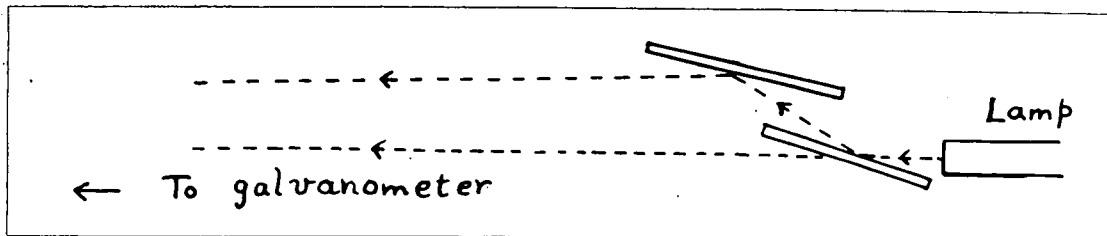

After reflection at the galvanometer mirror the beams were focussed to two separate points on the bromide paper 10 cm. apart. The zero traces thus did not foul the drop charge zero trace. At the same time a maximum point discharge deflexion of ± 11 cm. could be recorded, using one beam for high positive values and the other for high negative.

In order to be able to identify any part of the record with any filter paper used in the receiver the charge galvanometer lamp beam was normally obscured by a light Aluminium screen fixed to the armature of a relay. When the relay was operated the beam fell on the bromide paper. The relay was operated by the same switch as the relay used to short-circuit the galvanometer. The charge record thus consisted of a series of trace-lengths

corresponding with filter paper exposures. A duplicate paralleled switch inside the hut was used for eye observations.

IV 6. Making Observations.

It was essential to have the apparatus ready to work at all times. Weather forecasts were of too general a nature to be of much help, except to warn of a fairly long spell of fine weather. Showers might occur at any time. I therefore checked the apparatus daily, keeping a supply of filter papers prepared and ready in trays, photographic paper to hand, the drum loaded and in position, galvanometer zeros properly adjusted, and the stop clock set at zero ready to time the 20 minutes run. When rain seemed imminent the amplifier was switched on, filter paper trays placed ready in the shelter, and the small cone put on. When rain began the camera shutter was opened, motor and clock were started, and galvanometer lamps switched on. I mounted the platform, inserted the first tray, closed the screening box lid, and looking in the mirror began to count seconds at an estimated rate. At '0' I pressed the switch S' (see figure page 73). At '3' I operated the pedal to expose the filter paper and record the field. When a rain drop stain appeared I made a mental note of the particular second. After three more seconds I released the pedal (closing the cover and again recording the field) and made a mental note of the particular second. After a further three seconds I released the switch.

Extracting the tray, I at once drew a pencil ring round the stain and wrote by it the number of the second at which I saw it. I also wrote down the second at which I released the pedal, and any outstanding weather features. The tray was then placed in the box provided. This was the first exposure. The process was repeated until 19 minutes had elapsed, or the rain ceased. I then went into the hut, and using the duplicate switch for recording I operated the calibrating condenser switch so as to record the amplifier calibration. Lights, motor and clock were now switched off, and notes made on the weather. The trays were serially numbered and stored, and the drum reloaded for the next run. At leisure the stains were measured and the record developed and examined. Sometimes in one exposure two or even three drops could be 'memorized', especially after some experience had been gained. At times spots appeared too quickly. At other times they came at long intervals and in this case the cover pedal was operated at 3; 20; 23; 40; 43; secs. as seemed fitting at the time.

Visual observations were usually made with the large cone. I would frequently observe by eye at first to see if these were sufficient charges to justify recording. If charges appeared very infrequently I did not usually record.

Certain difficulties arose from time to time. Sometimes when a nearby inductive circuit was switched on or off the

Mon 31st May 48
1641 hrs

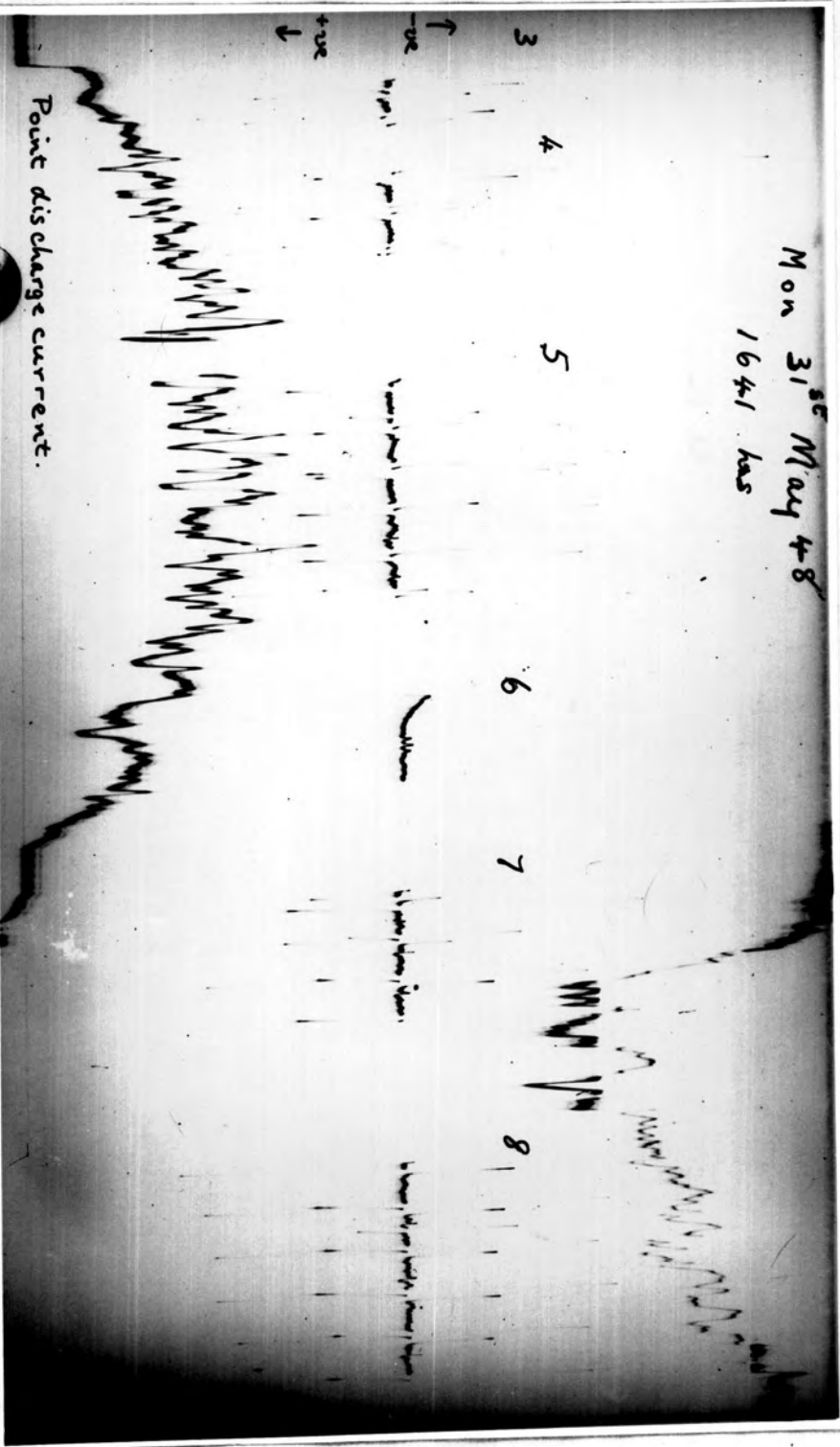

Point discharge current.

amplifier became quite insensitive, recovering after a shorter or longer time with a violent galvanometer deflexion. This was caused by the operating valve becoming cut off and finally once more conducting. Touching the grid with the hand was normally sufficient to restore the conducting state. When I was in the hut I used a special plunger on the operating valve screening can to earth the grid momentarily. It was easy to see from the record if the valve was in that non-conducting state by the complete absence of slight fluctuations. The condition never lasted for more than one exposure.

Occasionally unaccountable fluctuations appeared. A spider between the outer and inner cones seemed to be responsible for this. Spiders seemed to be repelled by putting a little naphthalene on the plate A (figure, page 75).

If, after inserting a tray I switched on too soon, a large galvanometer deflexion appeared at the beginning of the exposure trace. This was due to the disturbance following the earthing of the grid circuit with my fingers. The trouble was eliminated by waiting 3 seconds from inserting the tray to switching on.

IV 7 Interpretation of records.

Part of a typical record is reproduced opposite, actual size. It has not been retouched. The separate exposures are

↑
-ve

Sat. 22 May 1948

1741 hrs.

4

5

6

7

8

9

10

+ve
↓

Point discharge current.

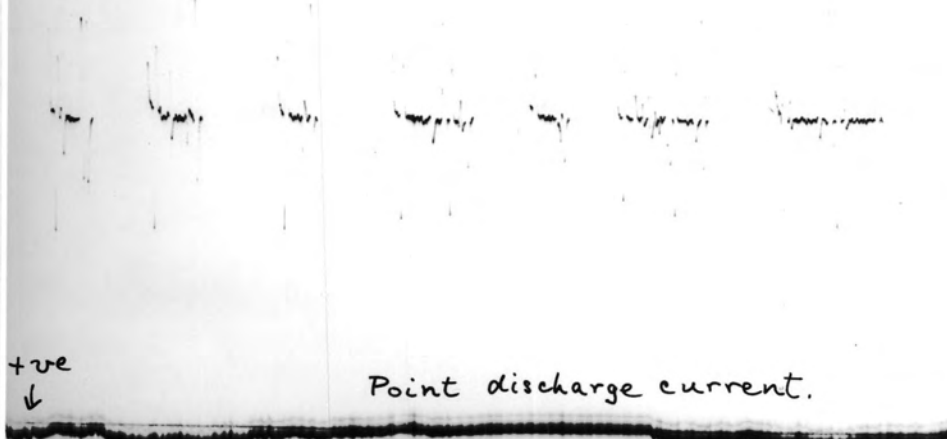

clearly seen, and the numbers (3 to 8) are the serial numbers which were given to the filter papers immediately at the end of this run of observations on 31st May, 1948. The galvanometer reverse swing gives a heavier trace than the main throw. A horizontal distance of 1 mm. is equivalent to 3 seconds very nearly. It is possible to measure to $\frac{1}{3}$ mm. and hence to locate deflexions for any exposure to within one second, counting from the beginning of the exposure. The regularly recurring deflexions conspicuous in Nos. 5, 7 and 8 result from operating the cover pedal as explained in the last section, and give the value of the field. In No. 6 the trace does not show the usual small fluctuations, a clear sign that the operating valve was not conducting at the time.

Point discharge current was negative, recorded on the lower trace, for Nos. 3 - 6, and positive, recorded on the upper trace, for Nos. 7 - 8.

The photograph opposite shows part of a typical record,  actual size. Apart from the lettering it is untouched. The point discharge trace below shows positive current for most of the time. The other point discharge trace was just off the top edge of the record but would appear for slightly larger currents. On this scale 1 mm. measured horizontally represents 3 seconds. The exposure No. 7 will now be analysed in detail as an example of the usual procedure in record interpretation.

The filter paper used for No. 7, and an enlarged drawing of the record trace, are reproduced overleaf. The stains, labelled '15' and '22', are untouched, and were photographed ten-months after being formed. 'F 29' indicates that the cone cover pedal was released at second 29 to give a field measurement, and 'Off 32' that the galvanometer lamp was obscured at second 32. The identification mark '22/7' (added at the end of the run of observations) refers to the 7th exposure of the 22nd day (May, 1948). The events of the exposure are lettered a - h. Measuring time $t = 0$ from a when the galvanometer lamp switch was operated, the events are as follows.

Event	Time t	
a	0	Vertical line due to initial momentary zero drift, later eliminated.
b	3	Pedal to uncover cone, giving field deflexion + 20 mm.
c	15	Throw - 12 mm. Charge associated with stain '15'
d	20	Reverse of b. The deflexion d' of - 6 mm. is probably due to a drop blown in under the cover but not reaching the filter paper. The return swing of d' is interrupted and the field deflexion d measured from that point is 13 mm. This is too low because the galvanometer coil was already moving in the positive direction. <u>The Reverse swing</u> of d is available however, and as explained on page 23 this is due to a current passing in the reverse direction. The reverse swing of d' being almost if not quite completed will have little or no effect on the reverse swing of d. This latter is 11 mm. Hence the original throw would be 22 mm. approximately. As this is for <u>returning</u> the cover to over the cone it represents a <u>positive</u> field, i.e. +22 mm.

22/7

26 

15 

Fed 29
off 32

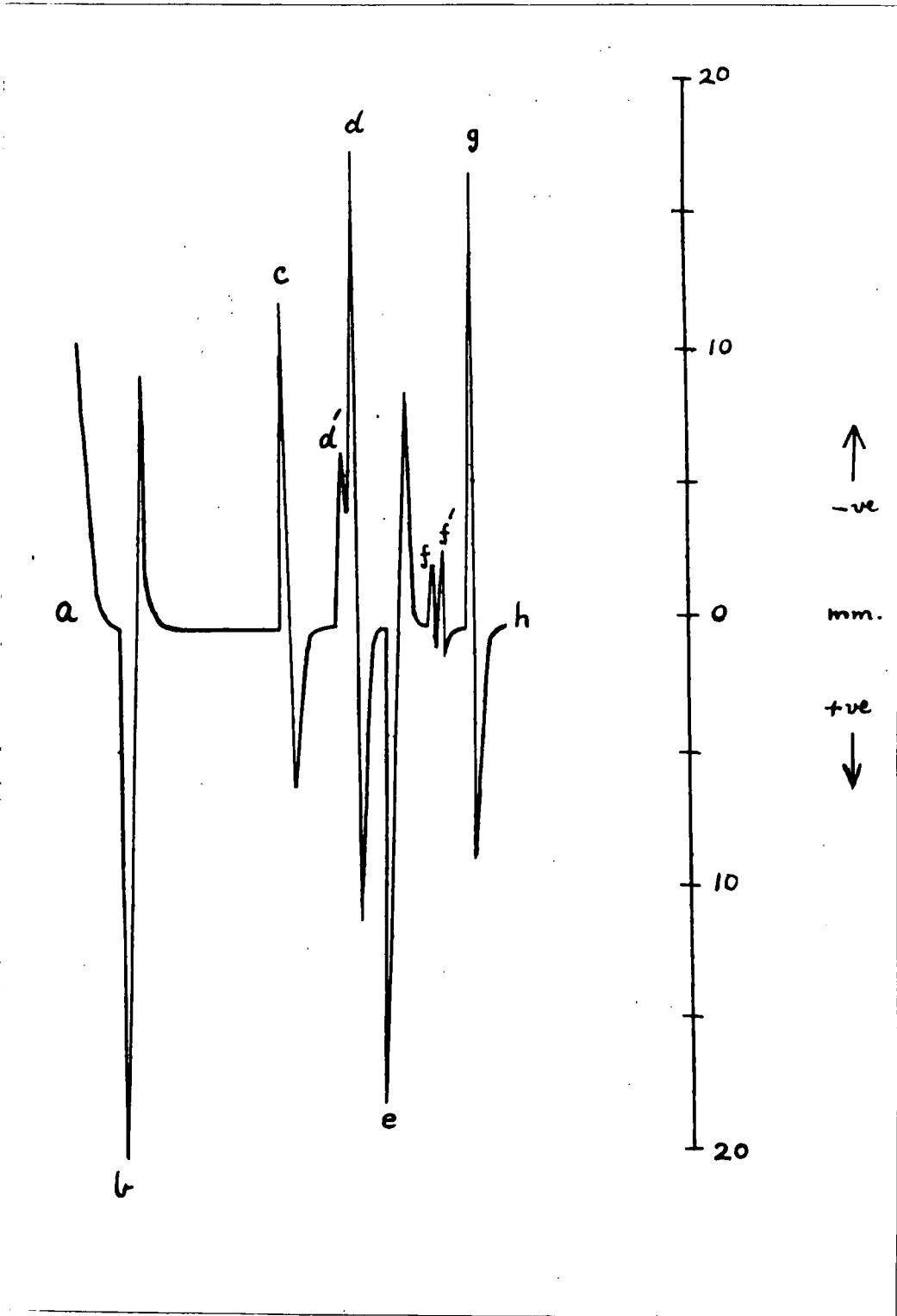

Event	Time t	
e	23	As b. Field deflexion + 18 mm., confirming estimate in d.
f	26	Throw of - 2 mm. Charge associated with stain '26'. Followed by a charge f' 1 second later, throw - 3 mm., though no stain obtained.
g	29	As d. Throw is - 17 mm. indicating a positive field + 17 mm. g serves as a time mark to distinguish the charges at f and f'.
h	32	End of exposure trace, galvanometer lamp obscured.

The point discharge galvanometer deflexion is measured for each charge and field throw. Stain diameters are measured. By means of the calibrations already described the values of drop size, charge, field and point discharge current are found. The exposure No. 7 then provides the following information:-

Time (secs.)	Radius (mm.)	Charge (10^{-3} e.s.u.)	Field (V/m.)	Point Discharge (μ A.)
3	-	-	1700	0
15	0.57	- 1.6	-	+ 0.4
19	-	- 0.8	-	+ 0.4
.....				
20	-	-	c. + 1900	+ 0.4
23	-	-	+ 1550	+ 0.4
.....				
26	0.71	- 0.4	-	+ 0.4
27	-	- 0.6	-	+ 0.4
29	-	-	+ 1450	+ 0.4

The range of charges measured for various values of field, and the proportions of positive and negative charges, are summarized in the following table:-

	<u>Field V/m</u>		
	<u>< 400</u>	<u>400 to 1000</u>	<u>> 1000</u>
Largest positive charge, 10^{-3} e.s.u.	+ 1.3	+ 8.1	+ 50.0
Largest negative charge, 10^{-3} e.s.u.	-22.0	-40.0	- 68.0
Ratio of numbers of positive to negative:-			
(a) radius < 0.5 mm.	1.4	5.4	0.7
(b) radius \geq 0.5 mm.	0.4	0.6	0.7

Point discharge current μA

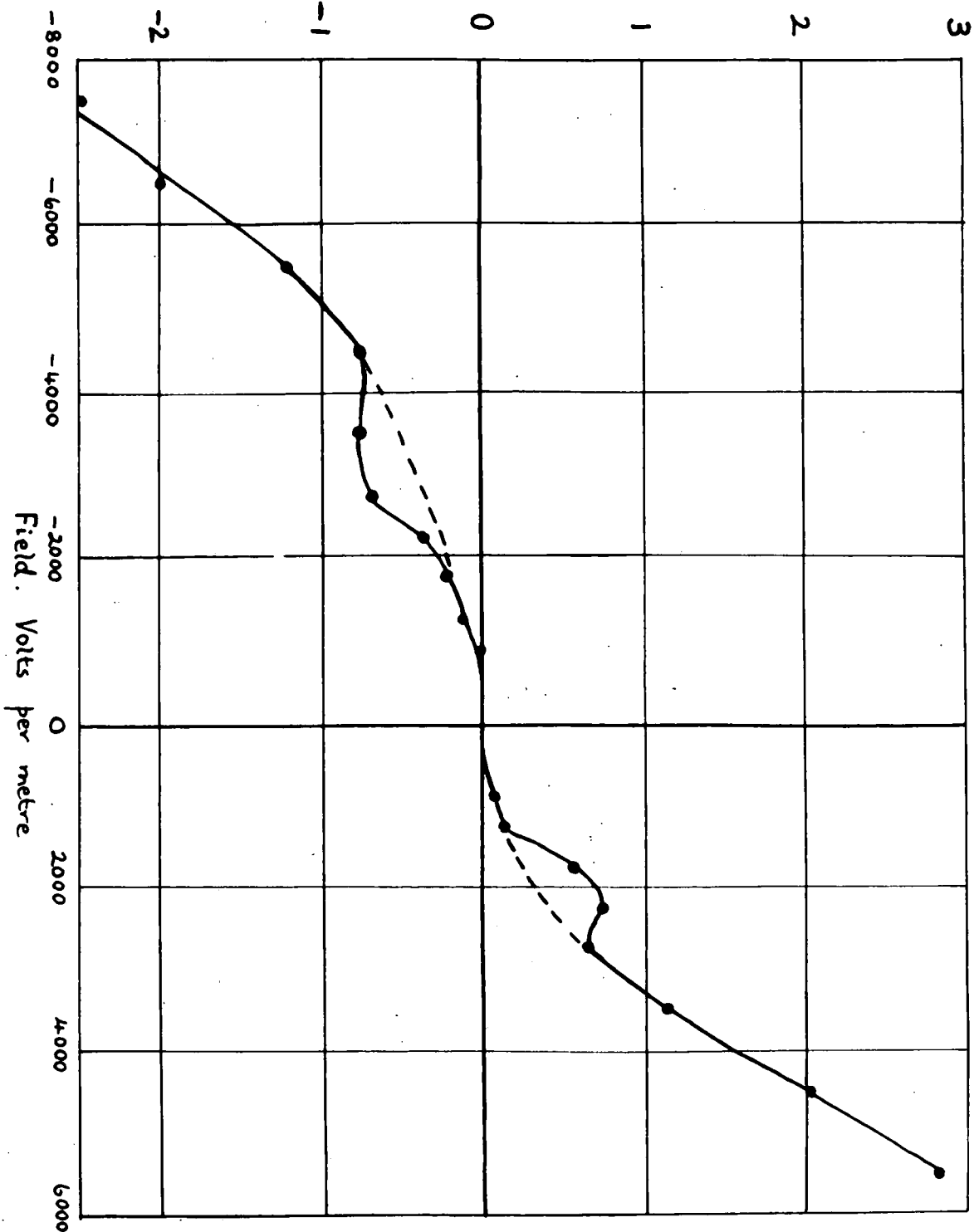

Connexion between point discharge current and the earth's field.

CHAPTER VThe Connexion between point discharge, current and field

During the period of observations on rain more than 1,000 observations of point discharge current were made, with the simultaneous field. A summary and discussion of the results are given here, the connexion with rain charge being considered in the next chapter.

First the values of field were divided into convenient groups and the average current in each group calculated. The few observations outside the range - 8000 to + 6000 Volts/metre were not included. The highest current observed was + 20.0 μ amp. during snow, with a field not less than + 9000 V/m. The average values obtained are plotted on the graph opposite. Apart from the humps at + 2000 and - 3000V/m. the curve is similar in form to that drawn by Whipple and Serase (1936). These authors chose 200 periods of fairly steady point discharge from six thunderstorms at Kew and drew a smooth curve through the points so obtained. Their curves for positive and negative currents, gave an empirical relationship.

$$I = a (F^2 - M^2)$$

where I is point discharge current, F the field and M a minimum field at which point discharge begins. The Kew results gave a = 0.0008 and M = 7.8 for positive currents entering the point, and a = 0.0010 and M. = 8.6 for negative currents, fields being

'lag' behind a changing field, often persisting at a high value when the field had fallen far below the corresponding point on the average value curve. This effect was pronounced on four occasions when the field changed sign well in advance of the point discharge current. The extent of the lag is shown in this table:-

Field Change	I at F = 0	Approximate Interval F = 0 to I = 0	F at I = 0	F when I begins with opposite sign
+ to -	+ 0.7 μ A.	20 secs.	- 1500 V/m.	---
- to +	- 0.1 μ A.	15 secs.	+ 2000 V/m.	+ 2000 V/m.
+ to -	+ 0.2 μ A.	20 secs.	- 1500 V/m.	- 3000 V/m.
+ to -	+ 1.4 μ A.	15 secs.	c. - 500 V/m.	----

Simultaneous values of wind speed and direction near the hut and discharging point are not available. However the lag seems much too great to be accounted for by wind velocity gradient.

It is necessary to take into account the fact that the field measured is that within two or three metres of the earth's surface. Let us refer to the field above the point as the 'main field'. Consider a time when point discharge has been established for at least a minute. Between the point and the ground there will be a layer of space charge opposite in sign to the main field, due either to lower discharging objects or to the downward convection of ions by turbulence. If the main field starts to

diminish, prior to reversing in sign, the field as measured within two or three metres of the ground will be reduced or even reversed by the space charge layer, even though the point discharge current persists. A consideration of lines of force shows that the main field will differ from the field near the ground until the intermediate space charge layer is dispersed. Since the space charge ion mobility is 1 or 2 cm./sec. per Volt/cm. and the ions are moving in a field of the order of 10 V/cm. it is seen that the 'lag' described above may perhaps be accounted for by the time taken for the space charge layer to rise above the discharging point.

There does not seem to be any reference in published work to this 'lag' effect, although Dr. Leckie of Bandoeng mentioned to me in conversation that he had noticed something similar in Java.

CHAPTER VIRESULTS FOR RAINVI 1. Extent of the observations.

Between December, 1947 and October, 1948 a total of 54 periods of rainfall yielded values of electric charge and mass for 1128 single drops. There were many other periods, usually of quiet continuous rain, when charges were too small to be recorded, that is, in general less than 0.1×10^{-3} e.s.u. The periods of rain may be classified simply as follows:-

Continuous rain: when the rate of rainfall remains practically constant for at least one hour;

Thunderstorms: when thunder is heard;

Showers: all other kinds of rain.

Of the 54 periods mentioned, 27 were of continuous rain, 23 showers and 4 thunderstorms.

Provided the rate of rainfall was not too small, say not below 0.01 inches per hour, it was often possible to collect and measure the mass and charge of two or three drops in an exposure of up to 30 seconds. The rate averaged over any period of rainfall will be less than this. My highest rates were 70 drops in 43 minutes (average 1 in 37 seconds) and 45 drops in 14 minutes (average 1 in 19 seconds). To obtain these figures any drops arriving together

and which might be fragments of a larger broken drop have not been counted, nor have those drops for which the stains were discovered only after the filter paper tray was withdrawn from the apparatus. The highest rate of observing indicated by Gschwend (1921) is 18 drops in 50 minutes, or 1 drop in 167 seconds. The present work thus shows a speeding up of the measuring processes by a factor between 5 and 10. This is important when observational conditions, obviously connected with the weather, are continually changing.

VI 2. Possible errors in the measurements.

The rejection of some drops suspected of breaking was mentioned above. A certain proportion of drops will strike the outer cone edge. This has been discussed by Gschwend (1921). If the cone mouth is of radius r and the drops are all of diameter d , the proportion of drops which touch the rim of the cone is found by drawing two circles concentric with the cone mouth and of radii $r+d$ and $r-d$ respectively. Drops which fall between the two circles will foul the cone edge. The proportion is

$$\frac{(r+d)^2 - (r-d)^2}{(r+d)^2} = \frac{4rd}{(r+d)^2}$$

For the small cone and drops of diameter 1 mm. this proportion is one in five, and for drops of 0.5 mm. diameter one in ten. The proportion would be less if r were larger, but then drops would arrive too rapidly to be recorded. A drop striking the cone edge may be split up and discharged, and may also take on an influence charge. Gschwend has shown that the influence charge acquired by a drop of radius 1.2 mm. for any field is much less than the rain charges mostly observed for that field. In considering size and charge of single drops, only those appearing as single stains have been included. The proportion of drops remaining which have fouled the cone edge is probably one in eight or nine for most rains.

Of the 1128 measurements for which drop size and charge were both found, a small number of charges were outstandingly high. Taking the normal limits as $\pm 10.0 \times 10^{-3}$ e.s.u., 74 charges (26 positive and 48 negative) were outside this range. A laboratory

test showed that when drops of radius 2.0 mm. fall on to the edge of the inner cone and shatter, - the fragments falling out of the receiver, - charges of $- 10.0 \times 10^{-3}$ e.s.u. or more are shown by the galvanometer. This is undoubtedly an example of Lenard effect (see page 3), the positively charged water being lost leaving a negative charge. When the drops shatter above the cone and the fragments are collected, a positive charge is observed, the negatively charged spray being lost in this case. Lenard effect at cone edges might account for some of the high charges observed in rain. However, of the 74 exceeding $\pm 10.0 \times 10^{-3}$ e.s.u., 66 appear as single drops, and 7 of these are so small that they may each be a single fragment of a breaking drop. It appears then that 59 of the 74 high charges are probably not in error on account of Lenard effect, there being no sign of shattering.

Chalmers and Pasquill (1938) speak of drops passing between the inner and outer cones and so causing a short circuit. With my apparatus this was possible only for a drop radius exceeding 1.5 mm. I observed only one drop as large as this, so the effect is negligible here.

VI 3. The sign of charge and field.

There were 1456 charges altogether on the records of the 54 periods concerned, though the mass was not known definitely for them all. The numbers of either sign, and the number of drops with zero charge (or rather a charge too small to measure) are given in the table below for either sign of field:-

Sign of charge	<u>Field Positive</u>			<u>Field Negative</u>		
	+	-	zero	+	-	zero
Continuous rain	22	127	65	230	134	348
Thunderstorms	7	38	2	28	19	4
Showers	35	82	57	124	69	85
<hr/> TOTAL <hr/>	<hr/> 64 <hr/>	<hr/> 247 <hr/>	<hr/> 124 <hr/>	<hr/> 382 <hr/>	<hr/> 222 <hr/>	<hr/> 437 <hr/>

The totals for each kind of rain show the sign of drop charge most often opposed to the sign of the field. This agrees with what Gschwend (1921) found.

The figures for continuous rain have been examined in more detail to see if they show any agreement with Simpson's result for rain current at Kew. Simpson (1948) found that with field F less than 1000 V./m. the charge per c.c. is proportional to $-(F - 400)$. The following tables show the figures for three ranges of field. Percentage values are also given for comparison purposes.

		<u>POSITIVE FIELDS</u>											
		<u>0 to 399</u>			<u>400 to 1000</u>			<u>> 1000</u>			<u>Total</u>		
Sign		+	-	Zero	+	-	Zero	+	-	Zero	+	-	Zero
Number		1	13	8	8	26	23	13	88	34	22	127	65
%		5	59	36	14	46	40	10	65	25	10	60	30

NEGATIVE FIELDS

		<u>0 to 399</u>			<u>400 to 1000</u>			<u>> 1000</u>			<u>Total</u>		
Sign		+	-	Zero	+	-	Zero	+	-	Zero	+	-	Zero
Number		40	49	131	108	54	167	82	31	50	230	134	348
%		18	22	60	33	16	51	50	19	31	32	19	49

For the higher fields the proportions of positive, negative and zero charges are not much different for positive and negative fields. In the range - 400 to + 400 V./m. however there are more negative than positive charges. Between zero field and - 400 V./m. there are nearly equal numbers of positive and negative charges.

The mixture of positive and negative charges is also apparent for anyone of the periods. Still there were often occasions when several charges of only one sign were received in succession, usually when the field was of opposite sign, but sometimes when the field had the same sign as the charges. At one time with a field of -3000 V./m. 10 positive charges were recorded in quick succession between 0.8×10^{-3} and 2.7×10^{-3} e.s.u. On another occasion in light continuous rain with little wind and

a field of -300 V./m. the galvanometer deflexions were observed visually. All charges were negative, between 0.5×10^{-3} and 1.0×10^{-3} e.s.u. The large cone was used so that drops arrived fairly frequently. During a period of quiet snow with practically no wind, and using the large cone with visual observing, 36 negative and only 2 positive charges were noted in 16 minutes. The field was between $+50$ and $+150$ V./m. Again, in a heavy shower of snow and soft hail when the field was about $+3000$ V./m. there were 30 negative charges ranging up to 60×10^{-3} e.s.u., all observed within two minutes, using the large cone.

VI 4.a. Drop size and charge for rain without point discharge.

Of the 54 periods of rainfall investigated, there were 21 when the field was less than 1000 V./m. and therefore without appreciable point discharge. Of these 15 have been classed as continuous rain and 6 as showers. The preceding tables show that in continuous rain without point discharge a very high proportion of the drops have no measurable charge. This applies also to the 6 showers. Sometimes 20 or 30 drops of radius between 0.2 and 0.5mm. would be collected with no detectable charge. Except for rain on 2nd June, 1948, which will be discussed later, no general relationship was found between mass and charge for rain without point discharge, though usually the larger charges were carried by the larger drops. During one period of light rain when charges were too small to justify making a photographic record, the field being - 100 to - 300 V./m., I made an estimate of the number of drops arriving. Using the large cone and exposing filter papers for 10 seconds each I observed stains corresponding on an average to 7 drops of at least 0.5 mm. radius and several smaller drops, or roughly 1 drop per second. Charges were detected at an average rate of one in 100 seconds. Hence in this particular rain only about one drop in 100 carried a charge which could be measured.

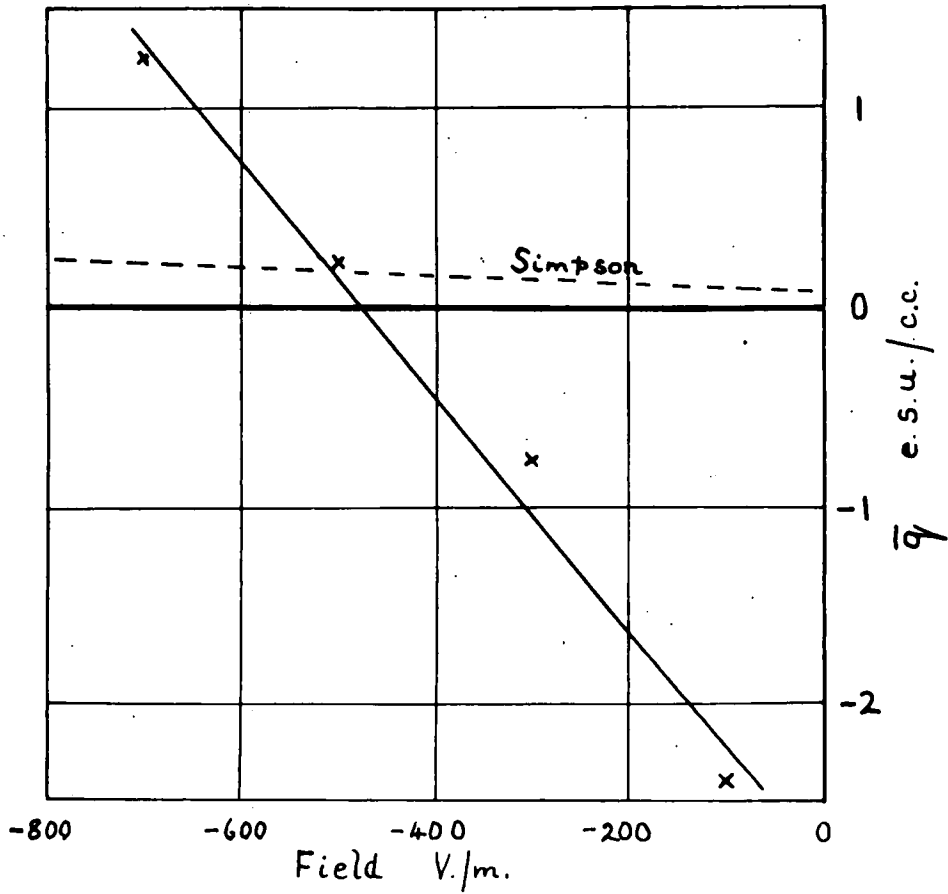

Connexion between charge per cc. (\bar{q}) and field for rain without point discharge on 2nd. June, 1948.

VI 4.b. The continuous rain without point discharge on 2nd June, 1948.

Rain from early morning was practically continuous throughout this day, and 231 drop charges were measured. In some cases the drop radius was not obtained. In others it was not possible to say at what instant a particular stain appeared, and so a charge could not be associated with it. However, the observations were grouped according to the field strength, using an interval of 200 V./m. All fields were negative. In each group the algebraic sum of all the charges observed was divided by the total volume of water measured to give \bar{q} , the average charge per c.c. No charges or masses were rejected in forming this average. When \bar{q} is plotted against field F (opposite page 104) the points fall very nearly on a straight line for which \bar{q} is proportional to $-(F + 500)$ where F is in volts/metre. For comparison purposes the line $q \propto -(F - 400)$ representing Simpson's observations for rain currents (1948) is shown dotted.

The observations on 2nd June, 1948 included one period, beginning at 1626 hrs. and lasting 19 minutes when the charges were mostly above the average for the field at the time. The charge Q for each drop is plotted against field F on the left hand graph (opposite page 105), and on the right hand graph for the same drops the charge per c.c. q is plotted against F . Drops with zero charge and any suspected of breaking have been omitted, leaving 24 points for the graph. Masses ranged from 0.02 to 4.2 mg. The orderly arrangement of points on the graph of q and F shows that for this period a relationship similar to that for the average values \bar{q} may hold approximately even for individual drops.

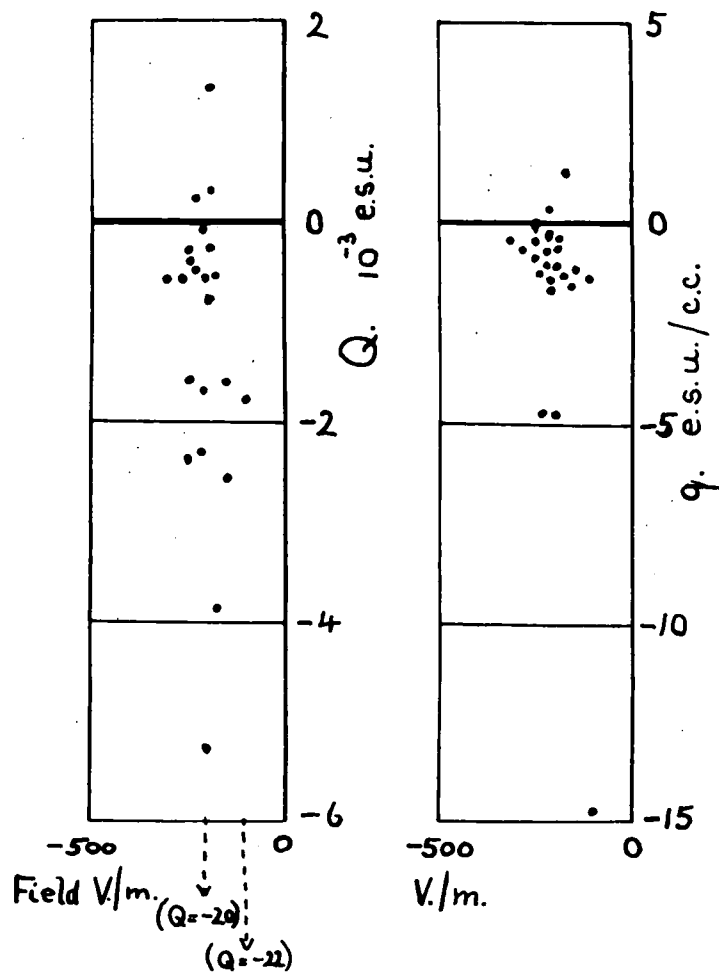

Drop charge (Q) and charge per c.c. (q) for
single drops for the rainfall period
beginning at 1626 hrs. 2nd. June, 1948.

VI 5.a. Drop size and charge for rain with point discharge.

In general, drop charges were much higher for the periods when there was point discharge either all or most of the time. The proportion of drops with charge too small to be measured was only one in four. No general relationship between size and charge was found for individual drops, though we will consider later the results for one particular day when conditions were steadier than usual.

Taken from all the periods of rainfall examined there were 170 drops, for each of which both radius a and charge Q were known and the simultaneous value of point discharge current I was not zero. These drops were arranged in groups according to their radius, using an interval of 0.2 mm. The average value of $\frac{Q}{I}$ for each group was plotted against radius (see upper graph opposite page 106). Apart from the point for $a = 1.2$ mm. which is based on ¹⁰ observations for $a > 1.0$ mm., the points lie close to a straight line through the origin and of slope 12×10^{-3} e.s.u./ μ A. per mm.

In order to see if a better line could be obtained for only steady point discharge currents I selected from the 170 drops those for which the current had persisted at least 1 minute without change of sign. A graph similar to that just mentioned was drawn, but using the estimated average value of I for the previous minute. This graph showed no improvement on the other, bearing out that it is the instantaneous value of I which is connected with drop charge.

For reasons discussed in the next chapter the average

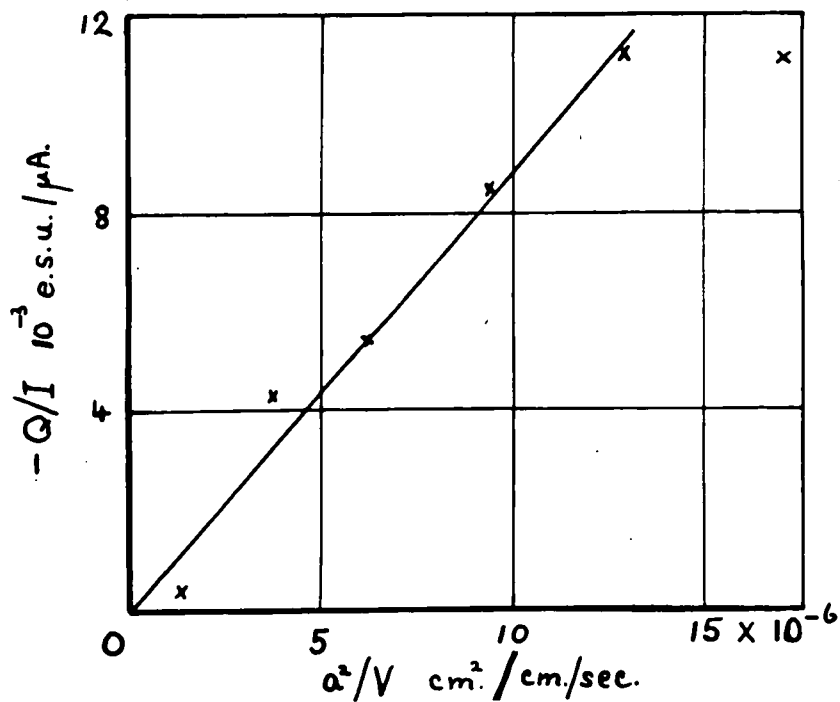
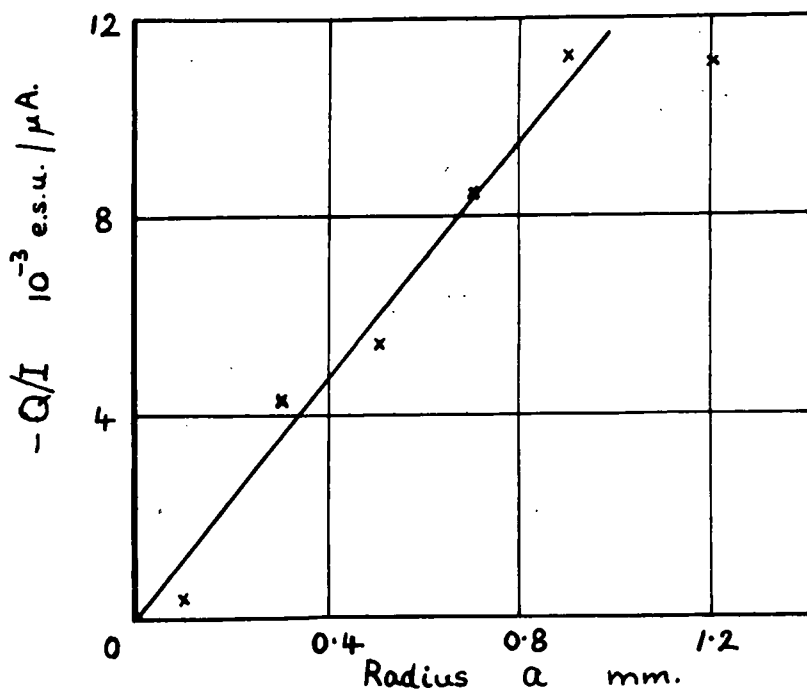

Connexion between drop charge and point discharge current, taking average values of Q/I .

values of $\frac{Q}{I}$ for the 170 drops were plotted on a graph against $\frac{a^2}{V}$ where V is the terminal velocity of a drop of radius a . (see lower graph opposite page 106). The points lie near a straight line through the origin and of slope 0.9×10^{-3} e.s.u./ μA . per $\text{cm}^2/\text{cm./sec.}$, and the fit is better than it was for $\frac{Q}{I}$ and a .

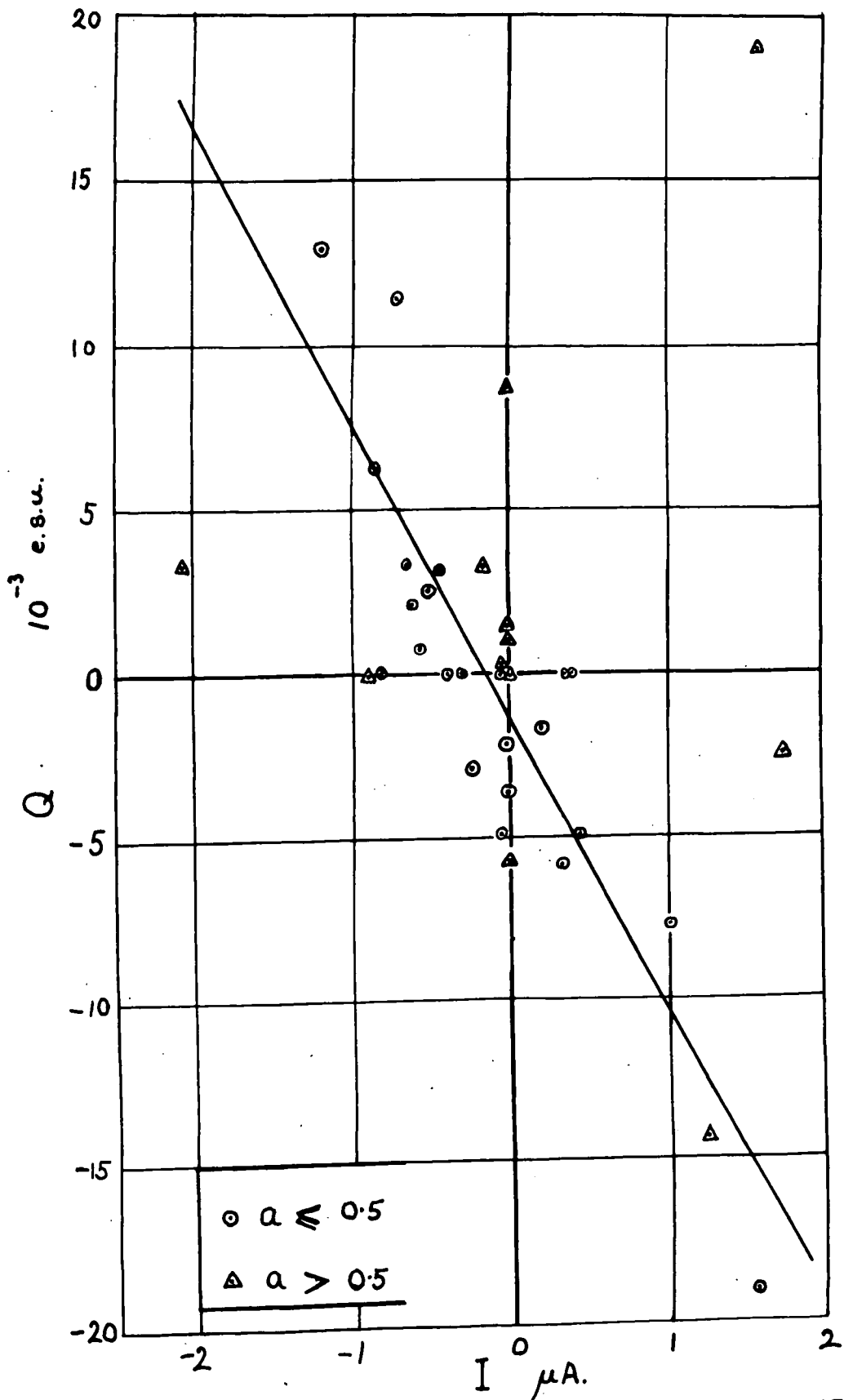

Drop charge (Q) and point discharge current (I)
for the period beginning 1106 hrs., 3rd. June, 1948.

VI 5.b. The continuous rain with point discharge on 3rd June, 1948.

During this particular day an occluded front passed slowly over northern England and it rained steadily throughout the morning and afternoon at rates between 0.04 and 0.16 inches per hour. There were no sudden changes in temperature greater than 1° F. Wind veered steadily throughout the day from 310° to 350° , and showed no violent changes in speed. Cloud base height remained practically constant at some 2000 ft. at Leeming and some 1300 ft. at Tynemouth (nearest reporting stations). At times there was sustained point discharge of both signs. In one particular period from 1106 hrs. to 1130 hrs. the radius of drops collected was nearly constant (average 0.48 mm.) and the drop charge Q was usually high compared with errors due to zero fluctuation of the charge galvanometer. The period yielded 37 measurements of single drops, any suspected of breaking having already been rejected. The 37 drops are represented on a graph, plotting Q and I (opposite page 107), where Q is the observed charge of a single drop. Circles indicate radius ≤ 0.5 mm., triangles indicate radius > 0.5 mm. The circles lie roughly on a straight line of slope -9×10^{-3} e.s.u./ μA . Because of the scatter no estimate of the intercepts has been made, though there appears to be a small negative value of Q when $I = 0$. The values of charge per c.c. q of a single drop are plotted against I for the 37 points on the graph opposite page 108. Again the points lie roughly on a straight line of slope -28 e.s.u./e.c. per μA .

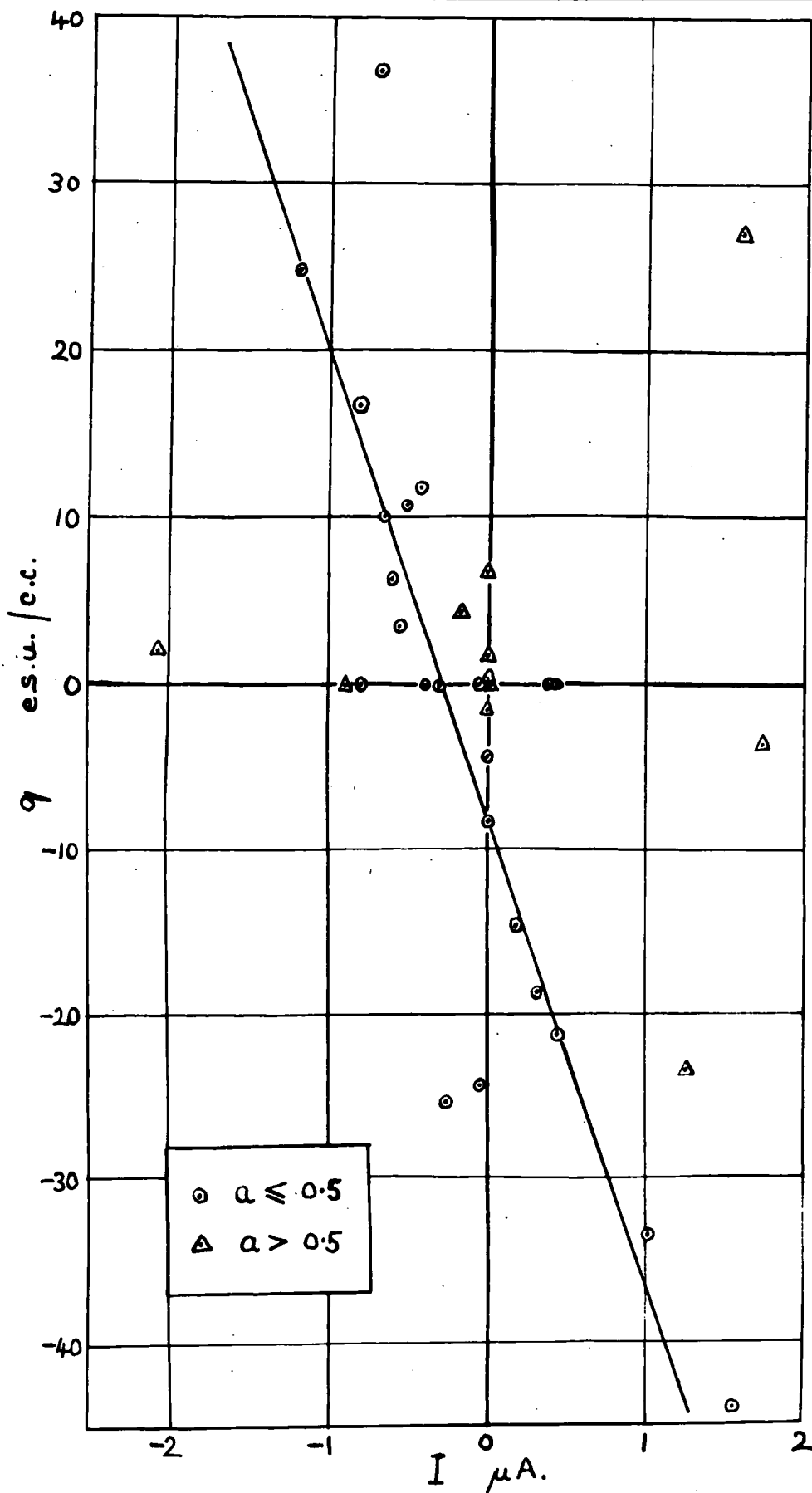

Charge per cc. (q) for single drops and point discharge current (I) for the period 1106 hrs, 3rd. June, 1948.

VI 6. Summary of Results.Sign of charge and field.

In the case of fields greater than 400 V./m. an inverse connexion between sign of drop charge and field is nearly always indicated, but there are usually some drops carrying a charge of the same sign as the field.

Size and charge of drops in the absence of point dis charge.

On one day of continuous rain (June 2nd, 1948), when conditions were steadier than usual, measurements on drops with charges not less than 0.1×10^{-3} e.s.u. could be represented by

$$\bar{q} \propto -(F + 500)$$

where \bar{q} is the average charge per c.c. and F the field in volts per metre. The field was negative throughout.

For one period of 19 minutes on the same day there were 24 drops for which measurements were not in appreciable doubt. For these taken singly charge and field seemed quite independent, but there is some evidence for a connexion between charge per c.c. and field similar in form to that given above for average values.

Size and charge of drops during point discharge.

There were altogether 170 drops for which both radius a and charge Q were measured and the instantaneous point discharge current I was not zero. The measurements may be represented by

$$\frac{Q}{I} \propto a$$

Agreement is rather better if they are expressed by

$$\frac{Q}{I} \propto \frac{a^2}{V} ,$$

where V is the terminal velocity of a drop of radius a .

During a period of 24 minutes on 3rd June, 1948, the 37 drops collected were of nearly constant radius, and without taking averages gave the connexion

$$Q \propto I .$$

VII 1. Comparison with previous results for single drops

The present results agree with those of Gschwend (1921) and Chalmers and Pasquill (1938) in showing that there is in nearly all rain a mixture of drops with charges of either sign. With Gschwend, I have observed that the sign of drop charge is, more frequently than not, opposed to the sign of the field. I do not consider my observations to be extensive enough to supply data for calculating either average charge per c.c. of rain or to discuss the excess of positive or negative electricity.

VII 2. Rain without point discharge

The results for 2nd June, 1948 (see page 104) give a linear connexion between average charge per c.c. \bar{q} and field F (see graph opposite page 104). My line has a steeper slope than that for Simpson's results (1948) for rain currents, and the intercept on the field axis gives $F = -500$ for $\bar{q} = 0$ against Simpson's $F = +400$ for $q = 0$. Little agreement can be expected between my results for one day and Simpson's results averaged over four years. The steep slope for the values taken from single drops will be high partly because of the neglect of small drops, the lower limit of charge sensitivity being 0.1×10^{-3} e.s.u. Considering the 1626 hours period on the same day (see page 104), there are signs of a connexion, similar to Simpson's, between field and the value of charge per c.c. even for single drops. The results for the day in general suggest that, given steady

conditions and a more sensitive means of measuring charges in quick succession, a definite relationship between field, drop size and drop charge may be found. A theoretical discussion must be postponed until the results of more extensive observations are available.

VII 3. Rain with point discharge

If at first we ignore the connexion $\frac{Q}{I} \propto \frac{a^2}{V}$ the results for rain with point discharge are summarised in the relationship

$$\frac{Q}{I} \propto a .$$

The values of $\frac{Q}{I}$ were obtained from values of Q (and I) of both sign, in roughly equal proportions. Therefore any theory to account for the observed relationship must have provision for drops to acquire a charge of either sign. We will consider two simple classes of possibilities. In the first class (a) the drop charge as measured at the earth's surface is principally the initial charge acquired by one single process of charge separation to form the cloud. In the second class (b) the drop charge as measured has been acquired after the original separation of charge, or 'on the way down', the new charge being much greater than the initial charge. (I consider that many more observations are necessary before there can be any discussion of charging by two processes jointly.)

In class (a) there are two possibilities, the theory of Wilson and that of Findeisen. All others give a charge of one sign only. We can reasonably rule out Wilson's process of charge separation in clouds because it has only a limited application (see

Chalmers (1949, page 158)), namely when there is an upward convection current with velocity between that of the falling drops and that of the downward moving ions. Without this condition a separation is not effected. Findeisen's splinter-formation theory has not yet been fully developed, but it does seem that the ice particle, carrying a charge opposite to that of the splinters it has shed, will be of the same sign as the field it produces between cloud and earth. As at the earth's surface the sign of the drop charge is generally opposite to that of the field, an initial charge acquired by Findeisen's process must be reversed in sign before reaching the ground. This for initial charging cannot then account for the observed charges.

In class (b) we will not discuss the possibilities associated with a very low freezing level because none of the point discharge results were obtained during winter. At the same time we will not consider the breaking of drops, nor Frenkel's mechanism of positive ion capture, as single principal means of charging, since they give drop charges of one sign only. Gunn's theory predicts that the charge of drops in electrical equilibrium will be positive if they are evaporating, negative if condensing, and that the drops will all have the same potential, i.e. $Q \propto a$. There seems to be no obvious connexion with point discharge however.

Dr. J. A. Chalmers suggested to me that a linear (or nearly linear) relationship between $\frac{Q}{I}$ and a might be accounted for by Wilson's theory of the capture of ions by falling drops, as developed by Whipple and Chalmers (1944). According to the theory,

an uncharged drop of radius a and velocity V falling a distance x through a region where the average vertical ionic conduction current density is \bar{i}_2 will acquire a charge Q where

$$Q = - \frac{3\pi\bar{i}_2 a^2 x}{V}$$

This is a simplified expression obtained when ions of only one sign are present. Considering the ions as originating in point discharge and assuming that \bar{i}_2 is proportional to the point discharge current I as measured, it follows that $Q \propto -\frac{I a^2}{V}$ for x constant. The average values of $\frac{Q}{I}$ for the 170 drops when $I \neq 0$ (see page 105) were for this reason plotted against $\frac{a^2}{V}$ (see lower graph opposite page 106). The points fit the line rather better than was the case for $\frac{Q}{I}$ and a (upper graph opposite page 106). Assuming that variations in x are smoothed out by taking averages, this is evidence for Wilson's process as the principal means by which these rain drops have acquired their charge. Incidentally for values of a up to 1.0 mm. Laws' results (1941) show that $a \propto V$ nearly. Then $\frac{a^2}{V}$ is nearly proportional to a accounting for the straight line obtained by plotting $\frac{Q}{I}$ and a .

For the 1106 hours period on 3rd June, 1948 there is a clear connexion between Q and I for individual drops. It is hoped later to account for the results of this period in terms of Wilson's theory.

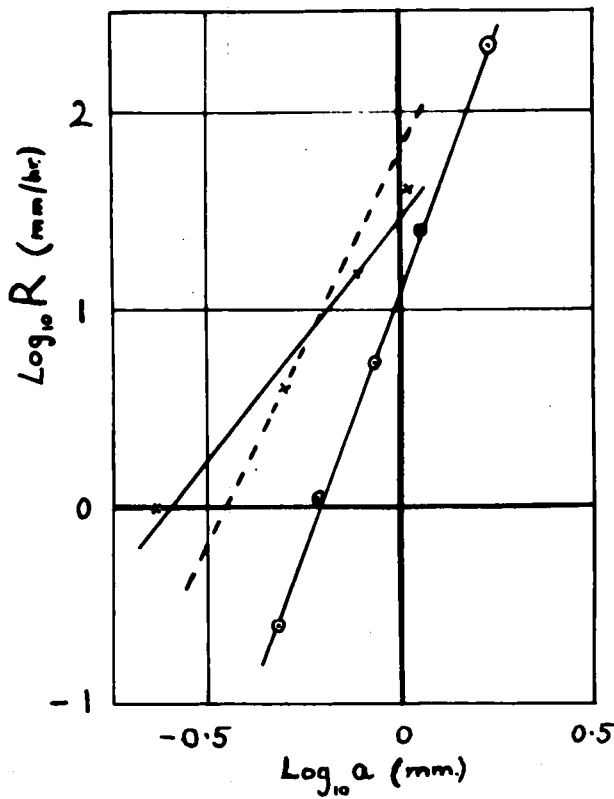

Connexion between rate of rainfall (R) and drop radius (a) from data given by Humphreys (x) and Laws and Parsons (○).

The dotted line shows the results of Best.

VII 4. Consideration of recent results for rain currents.

Simpson (1948) found that his results for rain current and point discharge could be expressed by the empirical relationship (given on page 10):-

$$i = -0.80 \times 10^{-5} I R^{0.57}$$

where i is the measured rain current density and R the rate of rainfall. Now $i = q R$ where q is the charge per c.c. of rain. Simpson's equation then gives $q R \propto I R^{0.57}$ or $q \propto \frac{I}{R^{0.43}}$ and for a given rate of rainfall $\frac{Q}{I} \propto a^3$. For $\frac{Q}{I}$ to be proportional to a the necessary condition is that a^2 is proportional to $R^{0.43}$ or R proportional to $a^{4.6}$. 'Roughly average values' (as he describes them) of rate of rainfall and drop diameter are given by Humphreys (1940, page 280), and if from his values $\log R$ is plotted against \log (radius) on a graph a straight line is obtained, of slope 2.4. Laws and Parsons (1943) give corresponding values of R and median drop diameter. (In any sample of rain the volume of water occupied by drops larger than the median is equal to the volume occupied by drops smaller than the median). If $\log R$ is plotted against \log (median drop radius) the slope of the straight line obtained is 5.2. Palmer (1949) refers to a relationship given by A. C. Best that the rate of rainfall is proportional to the fourth power of the radius of the drop whose volume is the mean volume of the drops counted. (The graphs are opposite page 114). The slopes show that it is within the bounds of possibility that R varies approximately with a power of a such as 4.6, and hence that the connexion $-\frac{Q}{I} \propto a$ or $-\frac{Q}{I} \propto \frac{a^2}{V}$ is not necessarily at variance with Simpson's results

for rain currents.

VII 5. Dependence of rain charge on instantaneous point discharge current

Wherever there appeared to be any connexion between drop charge and point discharge current, whether for particular periods or for the average of many periods, it was the instantaneous value of \bar{I} which fitted best. If \bar{I} included only those drops for which \bar{I} had remained without change of sign for one minute, there was no improvement. Using the average value of \bar{I} for that minute gave no better fit. If the value of \bar{I} was taken from the average point discharge current curve (see Chapter V) for the instantaneous field there was no improvement. Simpson's results (1948) show that the rain current is related to the instantaneous value of \bar{I} . Now a drop of radius 0.42 m.m. has a terminal velocity of 3.6 metres/sec. To fall 500 metres from the cloud base (as on 3rd June, 1948) would therefore take some $2\frac{1}{2}$ minutes at least. To this must be added increments to allow for (a) the distance the drop was falling before it left the cloud base (usually some hundreds of metres), and (b) the relative slowing down of the drop below the cloud due to convection. The time of fall of such a drop is thus probably not less than 5 minutes for most rainfalls. In the theory, Whipple and Chalmers (1944) predict that the drop charge will be either (a) the charge the drop had before it fell through the region of ions, or (b) a maximum of $|3 \chi a^2|$ where χ is the field. For $\chi = 3,000 \text{ V./m.}$ and $a = 0.042 \text{ cm.}$ the product $3\chi a^2$ gives only 0.5×10^{-3} e.s.u. We see that for case (a) there can be no connexion with the instantaneous measured value

of I and for (b) the predicted charge is far below the observed values. Hence we cannot consider the charging of the drop to have taken place by Wilson's process in the field near the earth's surface, and so again the instantaneous value of I would not be related to the drop charge.

The value of X in the expression $3 X \alpha^2$ to give a charge as great as those observed must be much higher than 3,000 V/m. Wilson (1925) and Whipple and Scrase (1936) have shown theoretically that the value of X between cloud and earth will be much higher than its value near the earth's surface as a result of the production of a space charge, positive for negative point discharge and vice versa. The only estimates of field strength below clouds based on observation are those made by Simpson and Scrase (1937) and Simpson and Robinson, (1940). They used the alti-electrograph - an instrument by means of which is recorded the direction of the ~~current~~ flowing between points attached to a free balloon and a point on a trailing wire. The direction of the current is indicated by pole-finding paper and the width of the trace enables an estimate to be made of the current flowing. Simpson and Scrase assumed that this current was related to the field by the expression $I = \alpha (F^2 - M^2)$ as for discharge from an earthed point (see Chapter V). The alti-electrograph results show no increase in field with height above the earth's surface sufficient to account for the magnitude of rain charges observed. The estimates of field from the alti-electrograph observations are not everywhere accepted unconditionally. Chalmers (1949, page 103) suggests that as in steady conditions the total vertical current density is constant, perhaps it is this current density which is

measured by the alti-electrograph, and not the field. The width of the trace on the instrument would then be approximately constant, as it appears to be from the published results. Moreover Gunn (1948) reports fields between 130,000 and 340,000 Volts/metre when flying an aircraft through thunderclouds. Although no definite conclusion on the field strength below clouds can yet be reached, Whipple and Scrase (1936) have pointed out that Schonland's results for point discharge lead to a field below the clouds of some 6×10^5 V/m. With values such as this for X it is clear that drop charges of the magnitude observed can be accounted for by Wilson's theory.

If Wilson's is the main process at work it still remains to show why it is the instantaneous value of I which is related to rain drop charge. Dr. J. A. Chalmers has suggested that the difficulty will be overcome if we consider cloud, rain, and region containing point discharge ions to move together horizontally past the place of observation. Then the effective ionic current density below the cloud will be proportional to the observed value of I . Incidentally Humphreys (1940, page 265), discussing vertical convection of moist air, also emphasises the need to consider the horizontal movement of the air.

VII 6. The primary process - establishing the field or charging of rain

If Wilson's process is the principal means of acquiring charge, then the primary process is the establishing of a potential gradient. The charging of rain is a secondary process. We will now consider this, and its alternative. It was seen in Chapter I

(page 10) that Simpson's observations (1948) on rain currents with point discharge showed that $\frac{i}{I}$ approaches a constant value for high rates of rainfall. Simpson attributes this to the sweeping down by rain of all the point discharge ions. The suggestion is that the rain current is limited by the supply of point discharge ions. The primary process is then the setting up of an electric field. I have worked out equivalent rain currents from the results for drops with point discharge given in section VI 5. a. Rain current i is equal to qR where q is charge/cc and R the rate of rainfall. The value of $\frac{qR}{I}$ was averaged for drops taken from each period of rainfall. The averages, which are equivalent to $\frac{i}{I}$, increase with R , but no maximum value of $\frac{i}{I}$ is evident. Values of R ranged up to 0.2 inches/hour. The highest value of $\frac{qR}{I}$ is 9.5 e.s.u./c.c. - inches/hr. per μA . Expressing this in c.g.s. units and e.s.u. we have

$$\begin{aligned} \frac{qR}{I} = \frac{i}{I} &= 9.5 \times \frac{2.54}{60 \times 60} \times \frac{1}{3 \times 10^3} \\ &= 2.2 \times 10^{-6} \text{ cm.}^{-2} \end{aligned}$$

It is customary to refer to the density of ionic current due to point discharge as the 'natural point discharge current density' J , assumed to be uniformly distributed. If the natural current is due to a number of equally spaced points in rectangular array identical with that used for measurements, each can be considered to occupy an area A and the distance between points is \sqrt{A} . Then $I = JA$ for one point and we have

$$\frac{i}{JA} = 2.2 \times 10^{-6} \text{ cm.}^{-2}$$

If the value of $\frac{qR}{I}$ were limiting, which it does not appear to

be, we should have $i = J$, and so

$$A = \frac{10^6}{2.2} \text{ sq. cm.}$$

$$= 45 \text{ sq. m.}$$

Hence the effective separation of points similar to that used would be $\sqrt{45}$ i.e. 6.7 metres. If the value of $\frac{qR}{I}$, (9.5) is not a maximum the separation will be less than 6.7 metres.

Judging from the exposure of the point used, this estimate is perhaps low. It is certainly much lower than the value 25 metres assumed by Chalmers and Little (1947) for a point erected in the same vicinity, but when the main building was only about half its present size. If 6.7 metres is much less than the true value, it is clear that the rain current exceeds the natural point discharge current, - that is, if the results for drop charge considered here are at all representative of rain at Durham in general. If so, the rain is acquiring charge by some process other than Wilson's. This other process, giving charge connected with instantaneous point discharge current, may operate near the earth's surface. It must be effective for either sign of charge, and is therefore not merely the breaking drop process. The rain drops leave an opposite charge in the air, setting up the observed potential gradient as a secondary process.

Further discussion of these possibilities must await a more satisfactory estimate of discharging point separation and more numerous observations on single drops.

VIII SUGGESTIONS FOR FURTHER WORK ON SINGLE DROPS

The results of my work show that measuring technique must be developed to meet with two different kinds of circumstances. On the one hand in more disturbed weather, drop charges are usually high but atmospheric conditions are changing rapidly. On the other hand, in quiet rainfalls, drop charges are usually low, but conditions remain steady often for an hour or more. For lively weather then the main need is to be able to measure charge and size of 100 or more drops in as many seconds or less, the charge sensitivity of the apparatus not necessarily exceeding that of the amplifier described in Chapter II. On the other hand, in quiet steady conditions, drops need not be collected in nearly so short a time, but it must be possible to measure charges as small as 10^{-5} e.s.u. or even less.

Let us consider the lively weather first. For measuring charge, electronic methods are probably best. The important requirement is a short resolving time, less than 1 second, and so the cathode ray oscillograph is probably the best indicating device. For measuring drop size the raindrop impactor (see page 13) has the advantage of a high rate of working and independence of drop terminal velocity. A combination of Gunn's 'inducing ring' (to measure charge) (see page 12) moving just ahead of the raindrop impactor should give a high rate for observations. Both charge and size could be represented simultaneously on a cathode ray oscillograph screen and a continuous photographic record made.

Such an arrangement would include all rain falling obliquely, thus ensuring a fair sample. By using a large reception aperture, effects due to touching the edge would be much reduced. By visually observing the oscillograph screen the best moment for photographic exposures could be judged, thus avoiding waste of film. An attractive variation would be to devise an apparatus with which two variables such as charge and radius are automatically plotted with rectangular co-ordinates on the oscillograph screen. The operator could then select for his records those periods when the best correlation was apparent. This is not outside the bounds of electronic technique, and the labour saved in computation would probably justify building the apparatus.

In the case of quiet weather when charges are small the first requirement is a device for measuring charges at least as small as 10^{-5} e.s.u. A low rate of observation is permissible since conditions are usually steady. Therefore if a valve amplifier is developed on the lines of that mentioned in section II 4 the grid circuit time constant may be accordingly higher. This means that the use of electrometer valves is not out of the question, particularly if there is adequate protection from the wind. For the measurement of drop size the rather tedious absorbent paper method is available for drops of radius more than 0.2 mm. A method involving terminal velocity is available, on the principle of that used by Gunn (page 12). If the receiving vessel is a long vertical cylinder a charged drop will give a signal both on entering the top and on leaving the bottom. The time interval between these

signals is inversely proportional to the drop velocity, which depends on drop size. Of course an uncharged drop will pass unnoticed.

In these suggestions I have considered two classes of rainfall, according as the weather is more or less disturbed. Further classifications could obviously be made, particularly to include other forms of precipitation, not forgetting mist and fog. It is unlikely that any one set of apparatus will be satisfactory for all types of precipitation. There is also a need for observations at varying altitudes. These can be made either on high buildings and mountains, or from flying aircraft. Chauveau (1922) observed that often during rainfall when the sign of the field at ground level was reversed, the normal positive field at the top of the Eiffel Tower was only diminished. He did not measure rain charges. The reversal of the field at the foot of the tower implies a negative space charge between the level of the top and the ground. Measurements made at the two levels might reveal what part the rain plays in this phenomenon. Gunn's pioneer measurements from an aircraft were mentioned on page 4. Chalmers (1949, p.163) points out that measurements should be made in other parts of the world, both on land and sea, particularly in the tropics and polar regions. Until these extensive observations in varying conditions are made, our knowledge of precipitation electricity, and atmospheric electricity in general, will be both uncertain and incomplete.

SUMMARY

Precipitation has an essential role in all theories of the 'separation of charge' in clouds. The precipitation particles first acquire a charge opposite in sign to that of the surrounding air. Convection then brings about the separation in space. On reaching the ground a precipitation particle carries a charge made up of the charge it had in the cloud and, superimposed, any charge acquired whilst falling. The various theories of separation of charge and of the charging of precipitation are based on electrification associated with one or more of the following processes:-

- (a) selective capture of ions by water drops or ice particles;
- (b) friction of ice particles;
- (c) breaking of water drops;
- (d) evaporation and condensation;
- (e) freezing of supercooled water drops;
- (f) formation of ice-splinters during vaporization or sublimation;
- (g) assumption of negative charge by water droplets in ionized air.

Most observers measuring rain currents have found the sign of the rain, more often than not, opposed to that of the field. Certain quantitative relationships are shown by measurements made at the earth's surface by Simpson (1948). For rain without point discharge he obtains a linear connexion between the charge per c.c. of rain and the earth's electric field. For rain with point discharge Simpson's results lead him to conclude that the rain collects the point discharge ions in the air. Earlier work on single drops shows that field and charge are, more often than not,

of opposite sign, but no quantitative relationships had been found for drop charge and mass and the field.

In the present work both mass and charge of single drops have been measured. A drop admitted through a cone-shaped opening falls on to a prepared filter paper placed in an insulated metal receiver. The stain on the paper gives a measure of the drop size - following Wiesner's absorbent paper method. The charge is amplified by electronic means and recorded photographically on a rotating drum. In the amplifier two S P 41 pentode valves operate in a balanced bridge circuit with floating grids. A galvanometer connected between the anodes gives a ballistic deflexion proportional to the charge arriving in the receiver. The sensitivity limit when recording is 0.1×10^{-3} e.s.u. The amplifier automatically re-adjusts itself to measure the next charge, the resolving time being 2 seconds. The recorded deflexion and the stain on the filter paper for any particular drop are associated by a special technique. The records are later interpreted at leisure. Over periods of 20 minutes records of charges and sizes have been made corresponding to 2 or 3 drops per minute, a rate some 5 or 10 times higher than that in the earlier work by Gschwend (1921). The entry of drops into the cone was controlled by an earthed metal cover. When this cover was moved away from over the cone the bound charge due to the earth's field was recorded. The deflexion due to this charge could always be identified, providing a convenient method of measuring the field. The point discharge current from an exposed point was recorded on the same drum.

For more than 1000 observations of point discharge current the values of the simultaneous field were divided into groups and the average current for each group calculated. The results give a relationship similar to that of Whipple and Scrase (1936):-

$$I = a (F^2 - M^2)$$

where I is current in μ amp., F the field in V./cm., M a minimum field, and a is a constant. M was 4V/cm. and $a = 0.0009$ for positive currents entering the point and $a = 0.0005$ for negative currents. There are two unaccountable humps in the curve giving high values of I at ± 20 V./cm. On several occasions the current showed a lag behind a changing field. It is suggested that this lag really indicates that the field near the ground changes sign in advance of the field higher up, on account of a layer of space charge near the ground.

An inverse connexion between sign of drop charge and of field was nearly always found during this work for fields greater than 400 V./m., though there were usually some drops with the same sign as the field. In the case of rain without point discharge there was in general no connexion found between charge and field, perhaps because drop charges were smaller than the limit of measurement very often. On one particular day however (2nd June, 1948), when conditions were quiet and steady, the average charge per c.c. \bar{q} showed a roughly linear relationship with field F expressed in volts per metre:-

$$\bar{q} \propto -(F + 500)$$

For one period of 19 minutes on that same day the 24 drops observed appear to have a similar relationship with field, without taking averages.

The observations on rain with point discharge included 170 drops for which radius a and charge Q were measured and the point discharge current I was not zero. On taking average values of $-\frac{Q}{I}$ for groups of drops with radius a in definite ranges the results are expressed by

$$-\frac{Q}{I} \propto a$$

or rather better by

$$-\frac{Q}{I} \propto \frac{a^2}{V}$$

Where V is the drop terminal velocity. For one particular day, (3rd June, 1948) when conditions were steady a period of 24 minutes included 37 drops, of nearly equal radius, for which, without taking averages,

$$Q \propto I$$

It appears to be the instantaneous value of I which best fits the relationships given in this paragraph.

For Q , a , I and V to be so related, the theory which seems to give the best explanation is Wilson's theory of selective ion capture by falling drops as developed by Whipple and Chalmers (1944). In this connexion it is interesting to examine Simpson's result

$$i \propto IR^{0.57}$$

where i is the rain current density, R the rate of rainfall and I

the instantaneous value of point discharge current. Writing qR for qI where q is the charge per c.c. of rain, it follows that:-

$$q \propto \frac{I}{R^{0.43}}$$

or

$$\frac{Q}{I} \propto a \cdot \frac{a^2}{R^{0.43}}$$

The data available for corresponding values of R and a suggest that $R \propto a^4$ very approximately. In this case

$$\frac{a^2}{R^{0.43}} = 1 \quad \text{roughly.}$$

Simpson's results thus are not necessarily at variance with those for single drops obtained during the present work. The dependence of rain charge on the instantaneous value of I rather than on the average value whilst the drops are falling is explained if clouds, rain and point discharge ions move horizontally at the same speed. Simpson found that $\frac{c}{I}$ tended towards a maximum value for high rates of rainfall, and suggested that at this maximum all the ions are swept up by the rain. If this is so, the results of the present work require the effective separation of discharging points to be appreciably less than 6.7 metres. Judging from the exposure of the point used this value is low. If so, Wilson's process cannot account for the observed rain charges, which must therefore be due to some other process operating near the earth's surface, effective for both signs of charge, and setting up the observed field as a secondary process.

In further investigation of rain drop charges one should

aim at making a large number of measurements while atmospheric conditions are nearly steady. For rain without point discharge, especially in quiet weather, a much more sensitive amplifier is required but a high rate of measurement is not necessary. In very disturbed conditions and when there is point discharge a high rate of measuring drops is desirable, though the charge sensitivity limit of the apparatus may not need to be better than 0.1×10^{-3} e.s.u.

B I B L I O G R A P H Y

- Belin, R.E. Proc. Phys. Soc. 61, 381, 1948.
- Bentley, W.A. Mon. Weath. Rev. p. 450, October, 1904.
- Bergeron, T. Union Géod. et. Géophys. Intern.,
(Lisbon), p. 156, 1933.
- Best, A.C. Met. Res. Coun. (London), M.R.P. No.
352 (unpublished) (quoted by Palmer
H.P. Q.J.R. Met. Soc. January,
1949).
- Chalmers, J.A. Phil. Mag. 34, 63, 1943.
- Chalmers, J.A. Q.J.R. Met. Soc. 73, 324, 1947.
- Chalmers, J.A. Atmospheric Electricity, (Oxford),
1949.
- Chalmers, J.A. Not yet published. 1949 (2).
- Chalmers, J.A. and Little, E.W.R. Terr. Mag. and Atmos. Elec. 52,
239, 1947.
- Chalmers, J.A. and Pasquill, F. Jour. Sci. Inst. 14, 127, 1937.
- Chalmers, J.A. and Pasquill, F. Phil. Mag. 23, 88, 1937 (2).
- Chalmers, J.A. and Pasquill, F. Proc. Phys. Soc. 50, 1, 1938.
- Chauveau, B. Electricité Atmosphérique, (Paris),
Pt. II, p. 6, 1922.
- Defant, A. Akad. Wiss, Wien. Sitz. Ber. 114, 2 a
May, 1905.
- Findeisen, W. and E. Met. Zeit. 60, 145, 1943.
- Flower, W.D. Proc. Phys. Soc. 40, 167, 1928.
- Frenkel, J. Elektrichestvo 10, 5, 1946 (See also
Jour. Frank. Inst. 243, 287, 1947).
- Gott, J.P. Proc. Roy. Soc. A. 142, 248, 1933.
- Gott, J.P. ibid. 151, 665, 1935.
- Gschwend, P.P. Beilage zum Jahresber. der Kant.
Lehranstalt in Sarnen. 1921/22.
- Gunn, R. Terr. Mag. and Atmos. Elec. 40, 79,
1935.

- Gunn, R. Phys. Rev. 71, 181, 1947.
- Gunn, R. J. Appl. Phys. 19, 481, 1948.
- Hooper, J.E.N. Private communication from T.R.E. Malvern. (See also Science News 10 (Penguin Books, London) p. 129, 1949.)
- Humphreys, W.J. Physics of the Air. Third Edition. (New York). 1940.
- Lane, W.R. Jour. Sci. Inst. 24, 98, 1947.
- Laws, J.O. Trans. Amer. Geoph. Union, Pt. III. Sec. of Hydrology, p. 709. 1941.
- Laws, J.O. and Parsons, D.A. Trans. Amer. Geoph. Union. p. 452 1943.
- Lenard, P. Ann. d. Phys. 46, 584, 1892.
- McFarlane, A.S. Phil. Mag. 14, 1, 1932.
- Metcalf, G.F. and Thompson, B.J. Phys. Rev. 36, 1489, 1930.
- Nielsen, C.E. Rev. Sci. Inst. 18, 18, 1947.
- Nolan, J.J. Proc. Roy. Soc. A 90, 531, 1914.
- Nolan, J.J. and Enright, J. P.R.S. Dublin, 17, 3, 1922 (1).
- Nolan, J.J. and Enright, J. ibid, 18, 1, 1922 (2).
- Palmer, H.P. See Best, A.C. above.
- Schmidt, W. Akad. Wiss. Wien. Sitz. Ber. 118, 2 a, 71, 1909.
- Scrase, F.J. Met. Off. Geophys. Mem. 58, 1933.
- Simpson, G.C. Phil. Trans. Roy. Soc. A. 209, 379, 1909.
- Simpson, G.C. Proc. Roy. Soc. A. 114, 376, 1927.
- Simpson, G.C. Terr. Mag. and Atmos. Elec. p. 27, March, 1948.
- Simpson, G.C. and Robinson G.D. Proc. Roy. Soc. A 117, 281, 1940.
- Simpson, G.C. and Scrase, F.J. ibid. 161, 309, 1937.
- Whipple, F.J.W. and Chalmers, J.A. Q.J.R. Met. Soc. 70, 103, 1944.
- Whipple, F.J.W. and Scrase, F.J. Met. Off. Geophys. Mem. 68, 1936.

Wilson, C.T.R.

Proc. Phys. Soc. 37, 32D, 1925.

Wilson, C.T.R.

Jour. Frank. Inst. 208, 1, 1929.

Wiesner, J.

Wien. Ber. 14, Abh. 1, 1895.

Wormell, T.W.

Proc. Roy. Soc. A. 127, 567, 1930.

Wynn-Williams, C.E.

Proc. Camb. Phil. Soc. 23, 810,
1927.

ACKNOWLEDGMENTS

My thanks are offered to Professor J. E. P. Wagstaff and to the various members of the teaching and laboratory staff of the Science Department, Durham, for so willingly giving me their assistance and advice during this course of study; and especially to Mr. E. Hugill for valuable help in the construction of apparatus and with the photographic work.

I am particularly indebted to Dr. J. A. Chalmers. He suggested the problem, and has shown the keenest interest in every stage of the work. The friendly criticism, unstinted help and constant encouragement I have received from him have both inspired confidence and made the work a pleasure.

I wish to acknowledge the award by the Ministry of Education of a Further Education and Training Grant following my service with His Majesty's Forces.

W. C. A. Hutchinson