



Durham E-Theses

An investigation into the factors involved in acclimatization to temperature and death at high temperature in calliphora erythrocephala (meig)

Davison, T. F.

How to cite:

Davison, T. F. (1970) *An investigation into the factors involved in acclimatization to temperature and death at high temperature in calliphora erythrocephala (meig)*, Durham theses, Durham University. Available at Durham E-Theses Online: <http://etheses.dur.ac.uk/8683/>

Use policy

The full-text may be used and/or reproduced, and given to third parties in any format or medium, without prior permission or charge, for personal research or study, educational, or not-for-profit purposes provided that:

- a full bibliographic reference is made to the original source
- a [link](#) is made to the metadata record in Durham E-Theses
- the full-text is not changed in any way

The full-text must not be sold in any format or medium without the formal permission of the copyright holders.

Please consult the [full Durham E-Theses policy](#) for further details.

Academic Support Office, Durham University, University Office, Old Elvet, Durham DH1 3HP
e-mail: e-theses.admin@dur.ac.uk Tel: +44 0191 334 6107
<http://etheses.dur.ac.uk>

AN INVESTIGATION INTO THE FACTORS INVOLVED
IN ACCLIMATIZATION TO TEMPERATURE AND DEATH
AT HIGH TEMPERATURE IN CALLIPHORA
ERYTHROCEPHALA (MEIG).

by

T.F. Davison, B.Sc.

Being a thesis submitted for examination for
the degree of Doctor of Philosophy of the
University of Durham, February, 1970.

Grey College,
Durham.



ACKNOWLEDGEMENTS

I am very grateful to Dr. K. Bowler for his advice and encouragement throughout this work, and for his critical reading of the manuscript. I should also like to thank the following; Dr. M. Stones (Department of Mathematics) for his advice on statistics; Dr. M.A. Tribe (Department of Biological Sciences, University of Sussex) for his technical advice in the biochemical aspects of this work; Professor D. Boulter for his permission to use the electron microscope in the Botany Department; the members of the E.M. Unit for their advice and assistance; Miss K. Flower for her skilful technical assistance; the technical staff of the Zoology Department for their help on many occasions. I am indebted to the Scientific Research Council for providing me with a Research Studentship and to Professor D. Barker for use of laboratory facilities.

I should like to thank Mr. E. Henderson for his photographic assistance and Mrs. J. Orr for her skilful typing in the production of this thesis.

Finally, I am particularly indebted to my wife for her encouragement throughout this work and during the writing of this thesis.

GLOSSARY

ADP	Adenosine-5'-diphosphate
ADP:O	ADP:O ratio (number of molecules of ADP esterified per atom of oxygen consumed)
ATP	Adenosine-5'-triphosphate
ATPase	Adenosine-5'-triphosphatase EC 3.6.1.3.
BSA	bovine serum albumin (fraction V)
pp'DDT	1,1,1-trichloro-2,2 bis(p-chlorophenyl) ethane
DNP	2:4 dinitrophenol
DNP factor	the ratio of Mg^{2+} activated ATPase activity in the presence and in the absence of DNP
EDTA	ethylenediamine tetra-acetate (sodium salt)
α -GP	α -glycerophosphate (sodium salt)
LD ₅₀ etc	experimental treatment causing 50 per cent mortality in a sample of animals
NAD ⁺	Nicotinamide-adenine dinucleotide (oxidized form)
NADH	Nicotinamide-adenine dinucleotide (reduced form)
Pi	inorganic phosphate
QO ₂	oxygen uptake expressed as μ g atoms oxygen per mg protein per hour
RCI	respiratory control index (the ratio of oxidation in the presence and in the absence of ADP)
Tris	tris (hydroxymethyl) aminomethane

TABLE OF CONTENTS

	Page
ACKNOWLEDGEMENTS	i
GLOSSARY	ii
TABLE OF CONTENTS	iii
ABSTRACT	vii
Chapter 1. GENERAL INTRODUCTION	1
Chapter 2. GENERAL MATERIALS AND METHODS	12
Culture of stocks.	12
Breeding experimental and stock cultures.	13
Mean expectation of imaginal life.	14
Chemical reagents.	14
Chapter 3. CHANGES IN TEMPERATURE TOLERANCE DURING THE LIFE HISTORY OF <u>CALLIPHORA ERYTHROCEPHALA</u>	15
Introduction.	15
Materials and methods.	16
Rearing of experimental animals.	16
The heat death point.	16
Method of heat treatment.	18
Results.	26
Discussion.	37
Chapter 4. CHANGES IN RESISTANCE TO CHEMICAL STRESS IN YOUNG ADULT <u>CALLIPHORA ERYTHROCEPHALA</u>	43
Introduction.	43
Materials and methods.	44
Choice of method.	44
Preparation of toxin.	45
Microsyringe applicator.	46
Dosage of flies.	46
Treatment of results.	47
Results.	48
Discussion.	50

Chapter 5.	THE RELATIONSHIP BETWEEN AGE, ACCLIMATIZATION TEMPERATURE AND HEAT DEATH POINT IN ADULT <u>CALLIPHORA</u> <u>ERYTHROCEPHALA</u> .	52
	Introduction.	52
	Materials and methods.	53
	Acclimatization of stocks.	53
	Determination of the heat death point.	54
	Lifetables at 34°C.	54
	Results.	55
	Adults developmentally acclimatized to 24°C.	55
	Flies developmentally acclimatized to 15°C.	61
	Physiological acclimatization to 34°C.	66
	Discussion.	69
Chapter 6.	INVESTIGATIONS INTO THE CAUSES OF HEAT DEATH. I. THE EFFECT OF LETHAL HIGH TEMPERATURES ON BODY WATER CONTENT AND THE DISTRIBUTION OF IONS IN THE HAEMOLYMPH AND MUSCLE	76
	Introduction.	76
	Materials and methods.	78
	Water content.	78
	Analysis of ions in the haemolymph of larvae.	78
	Analysis of haemolymph and muscle ions.	79
	Results.	81
	Discussion.	88
Chapter 7.	INVESTIGATIONS INTO THE CAUSES OF DEATH AT HIGH TEMPERATURE. II. AFFECT OF LETHAL AND SUBLETHAL HIGH TEMPERATURES UPON THE EFFICIENCY OF OXIDATIVE PHOSPHORYLATION IN FLIGHT MUSCLE SARCOSOMES	92
	Introduction.	92
	Materials and methods.	95
	Isolation of sarcosomes.	95
	Measurement of oxidative phosphorylation.	97
	Estimation of ADP using an enzyme method.	101
	Determination of sarcosomal protein.	103
	Measurement of sarcosomal Mg ²⁺ stimulated ATPase activity.	107
	Determination of inorganic phosphate.	108

	Page
Chapter 7. Chemicals.	108
contd. Results.	110
Recovery from sublethal heat treatment.	131
Discussion.	131
Chapter 8. ULTRASTRUCTURAL CHANGES IN SARCOSOMES AFTER EXPOSURE OF ADULT <u>CALLIPHORA</u> <u>ERYTHROCEPHALA</u> TO LETHAL AND SUBLETHAL HIGH TEMPERATURES	140
Introduction.	140
Materials and methods.	142
Experimental animals.	142
Fixation and electron microscopy.	142
Observations.	143
Discussion.	157
Chapter 9. THE EFFECT OF TEMPERATURE ON OXIDATIVE PHOSPHORYLATION IN ISOLATED FLIGHT MUSCLE SARCOSOMES	161
Introduction.	161
Materials and methods.	163
Method of isolating flight muscle sarcosomes and determining oxidative phosphorylation.	163
Results.	164
Temperature dependence of substrate respiration.	165
Temperature dependence of ADP-stimulated respiration.	165
The effect of temperature on ADP;O and RCI values.	173
Oxidative phosphorylation of sarcosomes from 1 day old flies.	174
Discussion.	179
Chapter 10. GENERAL DISCUSSION	189
Appendix 1. METHOD OF CONSTRUCTION OF THE "DOSE EFFECT" CURVES DETERMINATION OF LD ₅₀ AND USE OF THE FIELLER THEOREM FOR PLACING CONFIDENCE LIMITS ON THE LD ₅₀	204
Conversion of the dosage/effect curve to a straight line.	204
Fitting the best straight line to the data.	205
Fitting the confidence limits to the LD ₅₀ .	207
Computing the data.	209

	Page
Appendix 2. DESCRIPTION AND CALIBRATION OF THE OXYGEN ELECTRODE.	210
Calibration of the oxygen electrode.	213
REFERENCES	218

ABSTRACT

The heat resistance of Calliphora erythrocephala varies during the life history. The egg is most sensitive to high temperature and the puparium most resistant. Puparial resistance develops in the larval stage and declines in the young adult. This adult decline is temperature dependent and seems to be related to changes taking place during maturation.

Evidence for the existence of development acclimatization was found to be contradictory, however, physiological acclimatization did occur in the adult. This latter form of acclimatization differs from the typical pattern observed with other species, for the increase in heat resistance with increasing temperature of acclimatization is not proportionate and it declines with adult age. The interaction of these factors makes resistance adaptation in Calliphora erythrocephala a complex phenomena.

It is concluded that the primary lesion of heat death in adults is the uncoupling of the sarcosomal enzymes associated with oxidative phosphorylation of α -glycerophosphate. The heat sensitivity of this enzyme pathway is correlated with the heat death point of the

whole animal and death is probably the result of a breakdown in ATP synthesis, which leads to the interruption of other energy dependent processes.

The biochemical lesions during heat death are correlated with dramatic changes in the ultrastructure of sarcosomal cristae, which house the respiratory assemblies. This suggests that the structural and functional integrity of membrane-enzyme complexes are important factors in cellular metabolism.

Studies on isolated sarcosomes have shown that the coupling of oxidative phosphorylation is influenced by both age and acclimatized state of the fly. The coupling enzymes are implicated in both the age dependent changes in heat resistance and also capacity adaptation. They are likely to be key factors in the temperature physiology of adult Calliphora.

Chapter 1.

GENERAL INTRODUCTION

Adaptation has been defined by Prosser (1958) as "any alteration or response of an organism which favours its survival in a changed environment." Thus an adaptation can be morphological or physiological. When applied to a population of organisms it may be genetically determined; when applied to an individual it may be environmentally induced. The work presented in this thesis is primarily concerned with the physiological aspects of adaptation in individuals of a population of inbred Calliphora erythrocephala. It is presumed that the genotype of each individual will set the limits within which physiological adaptation is possible. Furthermore, it is assumed that under consistent culture conditions this inbred population has remained genetically unchanged throughout the study.

With respect to changes in environmental temperature the terms adaptation and acclimatization are frequently used synonymously and throughout this study the above definition will be used to embrace both terms. Several workers prefer to use the term acclimation when referring to thermal adaptations under laboratory conditions. They reserve acclimatization for adaptations under natural

conditions, where several environmental variables may be interacting (see Fry, 1958; Prosser, 1958; Read, 1964 and Hoar, 1967). However, as acclimatization and acclimation seem to be fundamentally the same, see definition by Prosser and Brown (1961), the term acclimatization will be used exclusively throughout this study.

The influence of environmental temperature on animals has been the subject of many reviews and symposia (see Precht, Christophersen and Hensel, 1955; Prosser, 1958; Hoar, 1967 and Prosser, 1967). Generally speaking the responses of homeotherms and poikilotherms can be summarised schematically in Figure 1 after Hoar (1967). Poikilotherms, with which this work is concerned, conform to environmental temperature and within the viable temperature range (solid line Figure 1), their metabolic rate approximately doubles for each 10°C rise in temperature. At temperatures outside the viable range (broken lines Figure 1) they experience varying intensities of metabolic stress which eventually results in death. Precht (1958) has drawn attention to two types of acclimatization in poikilotherms which are associated with the viable and non-viable ranges; they are capacity adaptation and resistance adaptation.

Figure 1

Diagram showing the physiological responses of homeotherms (regulators) and poikilotherms (conformers) to changes in environmental temperature (after Hoar, 1967).

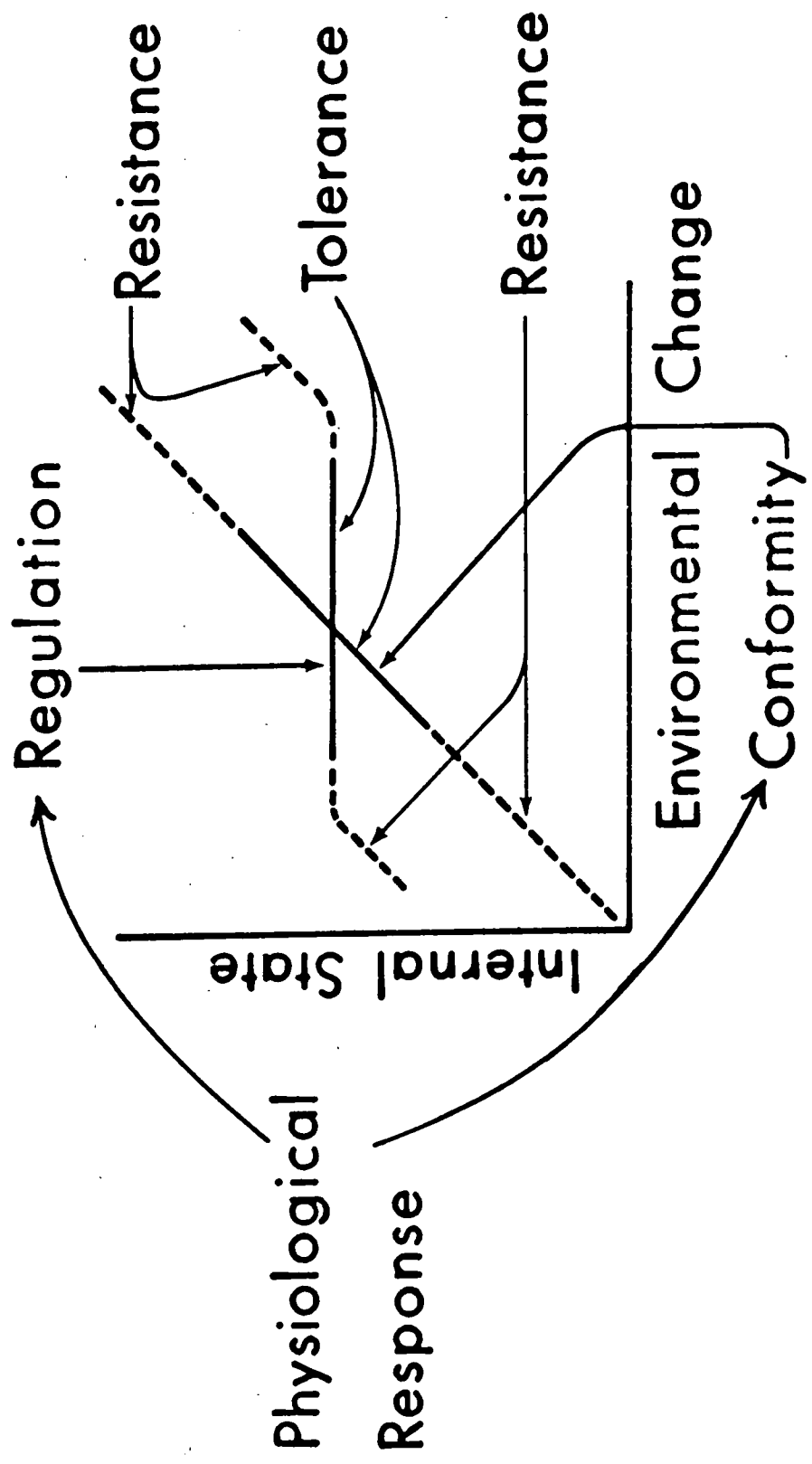

Capacity adaptation is a "temperature adaptation in the normal range" (Precht, 1958). Such adaptations are usually measured as the rate change of some activity or process. Individuals adapted to low temperatures generally have a higher metabolic rate, at a given temperature, than those adapted to high temperatures. The rate/temperature curves may be translated during acclimatization and frequently they are rotated showing that temperature coefficients also may change during acclimatization (Prosser and Brown, 1961).

Resistance adaptations are defined by Precht (1958) as "adaptations to extremes of temperature", and are usually demonstrated by the ability of an individual to withstand an increased exposure to a lethal temperature. Resistance is measured as the time/temperature relationship causing 50 per cent mortality in a group of animals (LD_{50}). At high and low lethal temperatures the LD_{50} 's are referred to as the heat and cold death points respectively. An individual from a higher acclimatization temperature usually possesses a higher heat death point than an individual from a lower acclimatization temperature. The reverse applies to the cold death point.

On defining these two types of acclimatization Precht

(1958) suggested that the coupling of capacity and resistance adaptation may not necessarily occur. However, the relationship between these two types remains to be fully elucidated, for most workers have studied them independently (see reviews by Prosser and Brown, 1961 and Prosser, 1967). A study of the two processes in the same individual would be useful for it is possible that resistance and capacity adaptations are in fact integrally related, but recognised independently as different parameters of the process of physiological adaptation.

Compared to other poikilotherms, insects appear to be relatively poor in their ability to acclimatize. Bursell (1964) in his review of the literature on temperature physiology of insects was led to conclude, "Insects are considered to be relatively poor in their ability to compensate for differences in temperature." However, this observation may not be entirely valid, for recent evidence from endopterygote insects has shown that the heat death point is not standard throughout the life history (Baldwin, 1954; Hollingsworth and Bowler, 1966; Bowler, 1967). These workers have observed a dramatic decline in LD₅₀ in the young imago. Such a decline is likely to complicate the study of

resistance adaptation in this stage and since much of the earlier work on heat death did not take adult age into account, the results must now be questioned.

Another complicating factor in insects is the occurrence of two types of resistance adaptation. Maynard Smith (1957) has suggested that developmental and physiological acclimatization occur in Drosophila subobscura. Developmental acclimatization is dependent upon the acclimatization temperature of the pre-adult stages and it is carried over to the adult stage. It appears to be developmentally fixed (canalization) for it is long lasting. Physiological acclimatization is attained in the adult stage, it is transitory and appears to be reversible. Both forms of acclimatization contribute to the heat resistance of the adult stage.

Thus it is important to determine how these interacting and possibly antagonistic factors influence resistance adaptation; so that an assessment of the role of acclimatization can be made. Furthermore, to determine the physiological processes involved in the change of the heat death point, it is important to determine the factors causing death at high temperatures.

There have been a variety of theories concerning heat death. The earliest was that protein coagulation or

denaturation occurs at high temperatures. However, Mayer (1914) has demonstrated that although most marine animals die when exposed to temperatures of 46°C , the most readily denatured protein does not coagulate until 10°C above that temperature. Mayer suggested that oxygen supply becomes inadequate at high temperatures and anoxia may be a cause of death. Fränkel and Herford (1940) have shown that heat death in Calliphora erythrocephala larvae is not to be ascribed to a deficiency of oxygen and Bowler (1963) has pointed out that this is also the case in Astacus pallipes.

Heilbrunn (1924) drew attention to the correlation between the heat resistance and the melting point of cellular lipids. Later Belehrádek (1931) enlarged on this and formulated the "lipoid liberation theory" postulating that heat injury is caused by the melting of lipid constituents in the cell membranes and hence death ensues. This theory links the heat resistance of an animal with the melting of its cellular lipids, which are correlated with the degree of unsaturation of their constituent fatty acids and also the temperature of their formation. Fraenkel and Hopf (1940) have shown that this correlation occurs in Calliphora erythrocephala larvae, although the theory could not explain the

different heat resistances of related species possessing the same lipid constituents.

Ushakov (1964) in his review of the literature on heat resistance in poikilotherms points out that all the evidence indicates no definite correlation exists between irreversible cell damage and the melting point of lipid constituents. He suggests that although lipids affect the thermostability of proteins by forming complexes with them, this function is not correlated with their melting points. In conclusion Ushakov suggests that the data relating the saturation of lipids to acclimatization temperature should be associated, not with the melting point of lipids, but with an increase in chemical activity resulting in the replacement of double bonds.

House, Riordin and Barlow (1958) in support of the lipid theory have shown that at standard acclimatization temperatures, a definite correlation exists between the changes in heat death point and the increase in saturation of dietary lipids. Thus, although Ushakov (1964) has contradicted the view that the saturation of lipids is implicated in heat resistance, it cannot be completely rejected.

The most widely accepted view of the causes of heat

death is protein denaturation. The classical interpretation has already been referred to as protein coagulation. The modern concept (Sizer, 1943; Stearn, 1949 and Johnson, Eyring^{and} / Polissar, 1954) regards protein denaturation as any process by which one or more properties of the protein, in the case of an enzyme its catalytic activity, are reversibly or irreversibly lost. Protein denaturation usually takes the form of changes in the tertiary and quaternary structure of the protein molecule due to the breaking of hydrogen bonds and large entropy changes are involved. It is not necessarily accompanied by the fragmentation or aggregation of protein molecules.

Ushakov (1964) noted that the heat resistance of proteins and protein complexes can be correlated with the heat resistance of the cells from which they were obtained, for the temperature coefficients are characteristically high in both cases, indicating large entropy changes are involved. However, according to Ushakov (1964) most protein preparations tested up to 1964 possessed a greater degree of heat resistance than the cells from which they originated. Thus he suggests that the heat resistance of a cell is limited by the thermostability of its least resistant protein systems, although what these are remains obscure.

Read (1964) has pointed out that caution must be observed when relating heat resistance of animals to the thermostability of constituent proteins, unless the temperature, at which the protein activity or function is lost, coincides closely with those at which metabolism fails.

Bowler (1963b) has shown that changes in the level of Na^+ and K^+ ions take place in the haemolymph of the crayfish Astacus pallipes during heat death and Grainger (1969) has observed similar changes in a mollusc Arianta arbustorum. Bowler and Duncan (1967) have correlated the changes in Na^+ and K^+ levels in Astacus haemolymph with the inactivation of a magnesium stimulated ATPase located in the muscle membrane. They have suggested that this ATPase is involved in the control of passive permeability and its inactivation may be one of the primary and most important events in heat death in this species.

The main components of cellular membranes are lipids and proteins and all three have been implicated as factors in heat death. Moreover, many enzyme pathways seem to be orientated on cell membranes and the membrane-enzyme complex is considered to be important in coupling and co-ordinating the activity of the component enzymes. It is conceivable that such a

"complex" as this may be disrupted during exposure to lethal temperatures with a resultant inactivation of enzyme activity and imbalance in cellular metabolism. Thus it was considered important to study a membrane enzyme complex paying particular attention to its lability to lethal temperatures. The mitochondrion is convenient for such a study for it is a discrete multi-enzyme system, which can easily be isolated in an intact condition. Furthermore, its efficiency can be readily measured.

The main objects in this study have been :

1. To determine the changes in heat death point throughout the life history of the endopterygote insect Calliphora erythrocephala.
2. To investigate the interaction of such changes with the development of resistance adaptation in the adult stage.
3. To investigate the causes and events in death at high temperatures paying particular attention to membranes.
4. To determine the factors which change during acclimatization in the viable temperature range and thereby influence the heat resistance of the animal.

Chapter 2

GENERAL MATERIALS AND METHODS

The animals used in this study were male and female Calliphora erythrocephala (Meig.). This stock has been maintained in our laboratory for five years and was originally obtained from a mass-mated culture (12 years old) bred at the Pest Infestation Laboratory, Slough.

Culture of stocks.

The stock cultures^s used for breeding were kept in muslin covered cages, approximately 70 cm x 50 cm x 35 cm with corrugated cardboard placed in the bottom to allow the flies to right themselves. These cages were kept at room temperature and the stocks were replaced at two monthly intervals. The flies were fed sugar and water ad libidum and ox liver was provided regularly as a source of protein and to allow oviposition.

The influence of the degree of saturation of dietary lipids has been discussed in Chapter 1. English ox liver has been used throughout this study; although no attempts have been made to assess any changes in the constituent lipids; the results over a period of several months suggest that any change in the lipid constitution was not causing significant differences in temperature tolerance.

Breeding experimental and stock cultures.

Liver covered with eggs was removed from the stock cage and placed in a crystallizing dish (15 cm diameter) for incubation. The liver was covered with a wet filter paper to provide a high relative humidity (R.H.), Davies (1949). The crystallizing dish was covered with muslin and transferred to an incubator maintained at $24 \pm 0.5^{\circ}\text{C}$ to ensure larval emergence during the next 12 hours. Newly hatched larvae were placed on fresh liver in a crystallizing dish filled with sawdust and the previous incubation process was repeated. Larvae were fed for 4-5 days on liver, which was replenished as required. Pupation took place in the sawdust 8-9 days after oviposition. When puparia were required for heat death studies they were collected within 12 hours of pupation, otherwise the puparia were left for 24 hours before being placed on fresh dry sawdust in a 750 ml conical flask, plugged with cotton wool, and incubated at $24 \pm 0.5^{\circ}\text{C}$. The puparium stage was 9 days long.

Acclimatization of experimental flies.

Male and female adults were separated on the day of eclosion and large numbers were placed in wooden cages 45 cm x 45 cm x 45 cm similar to the design of Parkin and Green (1958). The cages were housed in constant

temperature cabinets, maintained at $24 \pm 0.5^{\circ}\text{C}$. The air was circulated by two small fans and heated with two 100 watt electric bulbs controlled by a Sunvic thermoregulator (Type T.S.7.) and a Sunvic relay (Type F102/3). Continual illumination was provided by miniature fluorescent lights. R.H. was $50 \pm 10\%$. Where groups of 100 or less animals were used, they were housed in smaller cages 22 cm x 22 cm x 22 cm constructed from commercial biscuit tins with three sides removed. Two sides were covered with polyglaze and a third had a muslin sleeve attached.

Mean expectation of imaginal life.

Lifetables for 100 male and 100 female adults, housed in the smaller cages at $24 \pm 0.5^{\circ}\text{C}$, gave a mean expectation of life of 55.4 ± 2.41 and 44.75 ± 1.8 days respectively. This agrees with the data of Tribe (1966a) who constructed life tables for this stock.

Chemical Reagents.

All chemical reagents used in this work were of the highest purity which can be obtained commercially. Solutions were made up in glass distilled, deionised water.

Chapter 3

CHANGES IN TEMPERATURE TOLERANCE DURING THE
LIFE HISTORY OF CALLIPHORA ERYTHROCEPHALA

INTRODUCTION

There is a large literature on heat death in insects reviewed by Uvarov (1931), Heilbrunn (1952), Prosser and Brown (1961) and Wigglesworth (1965). However, few workers have studied the changes in heat death point, which take place during the life history.

Baldwin (1954) presented evidence which indicated that the heat death point of the chalcid wasp Dahlbominus fuscipennis is related to the age of the emerged adult. Bowler and Hollingsworth (1965), during work on the affect of inbreeding on the ability to acclimatize to temperature in adult Drosophila subobscura, observed a decline in resistance to 34°C after 7 days of age in the inbred lines B and K. They suggested at the time that this may have been due to an ageing phenomenon. However, later work (Hollingsworth and Bowler, 1966) on these inbred insects showed a rapid decline in resistance to 34°C occurred in the young adult. Bowler (1967) has shown similar, but more dramatic changes in the temperature tolerance of Tenebrio molitor. This suggests that these changes may

well be a widespread phenomenon in endopterygote insects. It is important to determine if the phenomenon is general, for if this is so, future work on heat death in endopterygote insects must take careful note of adult age.

Hollingsworth and Bowler (1966) have suggested that these changes in temperature tolerance, occurring in the adult, may be carried over from the pupal stage. A high tolerance would be an advantage to an immobile stage unable to move away from adverse conditions.

The aim of the work presented in this chapter is to determine whether the pattern of change in resistance to high temperature follows the pattern predicted for endopterygote insects by earlier workers.

MATERIALS AND METHODS

Rearing of experimental animals

Throughout this part of the study animals were reared as described in Chapter 2, at a constant temperature of $24 \pm 0.5^{\circ}\text{C}$ in a R.H. of $50 \pm 10\%$.

The heat death point

The usual method of measuring the heat death point, or LD_{50} , is to determine the time taken for 50 per cent of the experimental animals to die at a stated lethal

temperature. A prerequisite of this method is that the animals show some symptom of death e.g. cessation of leg movement. However, this method cannot be used with an immobile stage. Thus the following method has been adopted to allow comparison of active and immobile stages. Moreover, the method removes the need for a subjective evaluation of the time of death.

Groups of 100 larvae, puparia and adults were each given a standard 40 minute exposure at a series of temperatures at 0.2°C intervals within the range of 39.6° to 43.2°C . With eggs approximately 100 were used at each exposure and the intervals were 0.5°C within the range 34.0°C to 39.5°C . Temperature/mortality curves were drawn and the LD_{50} was defined as that temperature which caused 50 per cent mortality.

In the egg, larval and puparial stages mortality was recorded from the number of animals failing to reach the subsequent stage of the life cycle, e.g. egg to larva. Control mortalities were recorded for each stage using groups of 200 - 300 adults, 900 puparia and 900 larvae held under the same conditions, but without heat treatment. Evidence from preliminary experiments showed that deaths in adults caused by the heat treatments occurred in the 2 days following exposure. Survivors

were then fully active and behaving normally. A life-table drawn from the survivors of 1 day male adults treated to 42.2°C gave a mean expectation of life of 53.69 ± 3.88 days ($n = 49$). This is not significantly different from the control life-table where the mean expectation of life was 55.4 ± 2.41 days ($n = 100$). Consequently in the heat treatment of adults mortality was recorded after 2 days.

Method of heat treatment

The animals were placed in a series of 7.5 cm x 2.5 cm glass vials, which were completely immersed in a water bath at the required temperature. Racks were constructed to hold 50 vials. Each vial was fitted to a rubber bung, connected to the rack by a Terry clip. The vials were connected by glass and rubber tubing as shown in Figure 2. Air was circulated through the vials at 600 ml per minute and brought to a R.H. of 47.5 - 50.5 per cent by bubbling through a saturated solution of $\text{Mg}(\text{NO}_3)_2 \cdot 6\text{H}_2\text{O}$ (Winston and Bates, 1960).

The temperature of the water bath was maintained at $\pm 0.05^{\circ}\text{C}$ using two 500 watt immersion heaters controlled by a Jumo thermoregulator and Sunvic relay (Type F103/4). The water was continuously stirred. Air temperature in the vials was also determined. In the temperature range

Figure 2

Diagram showing the arrangement of the vials on the heat death rack.

a, rubber stopper; b, glass vial;
c, rubber tubing; d, glass tubing.

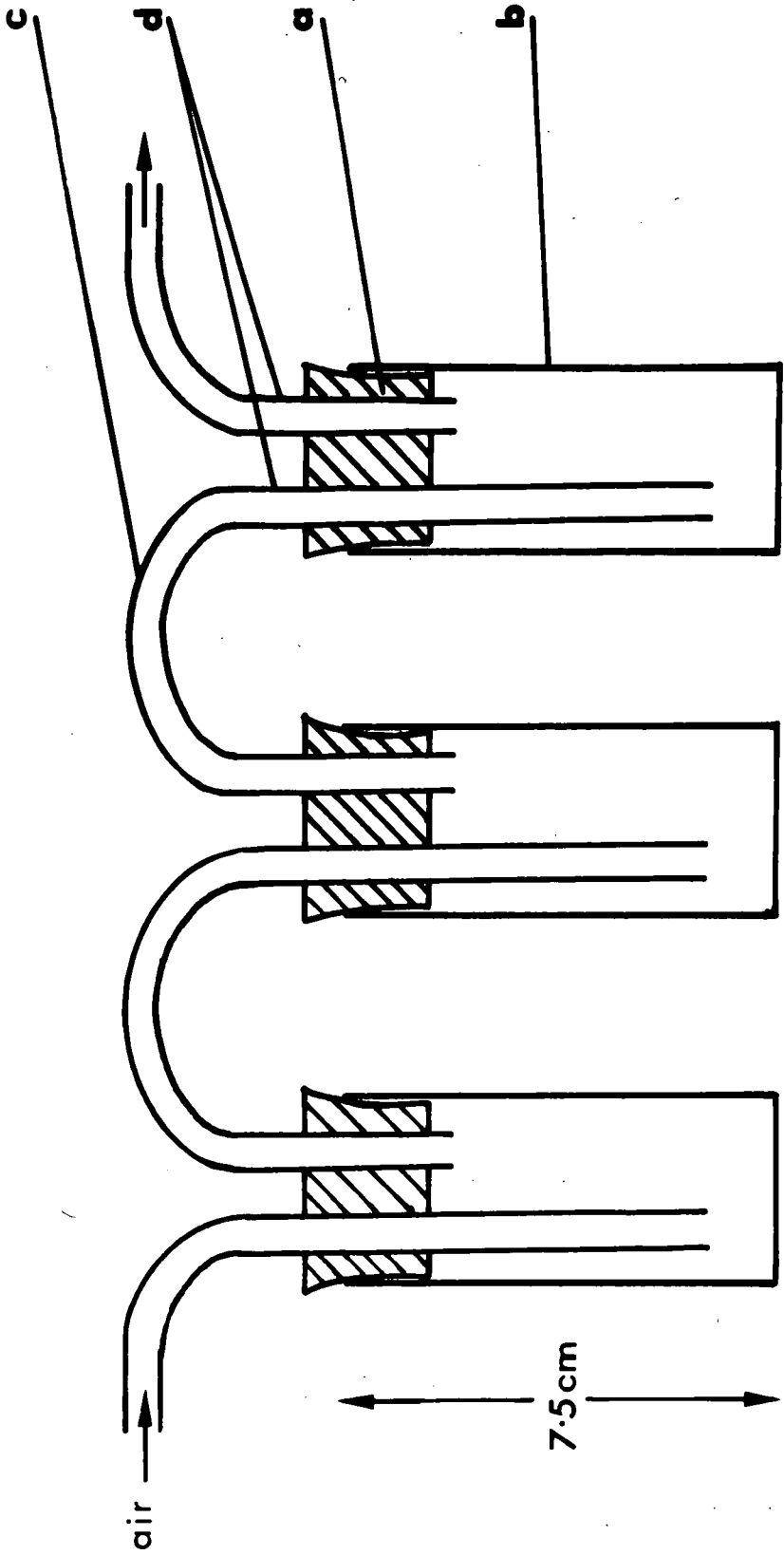

studied, 15 minutes was required for equilibration of the air and water bath temperatures. This 15 minute period was included in the 40 minute exposure. During the remainder of the exposure the air temperature was maintained at the temperature of the water bath $\pm 0.05^{\circ}\text{C}$.

Heat treatment of eggs

Within 1 hour of the time of oviposition, eggs were washed from the liver with 2% NaOH onto filter paper. The filter paper was carefully rinsed with tap water to remove the NaOH and to spread the eggs. Approximately 100 eggs were used in each experiment. Great care was taken to avoid damage to the chorion and damaged eggs were rejected. During the heat treatment the egg-covered filter paper was suspended in one of the glass vials on the heat death rack. After exposure the filter paper was suspended in a covered dish in a saturated atmosphere and replaced in the incubator, unhatched eggs were counted after two days.

Heat treatment of larvae and puparia

Sexually unsegregated 4, 6 and 7 day old larvae and 1, 4, 6 and 8 day old puparia were used. Larvae younger than 4 days did not give consistent results and these experiments were abandoned. After heat treatment larvae were placed in damp sawdust in 250 ml conical flasks plugged with cotton wool and put in the incubator

Figure 3

Dosage/mortality curves for eggs.

- Sigmoid curve, mortality H' against temperature $^{\circ}\text{C}$ for a 40 minute exposure;
- linear conversion of the sigmoid curve, $\text{Log } z$ against temperature $^{\circ}\text{C}$.
- ┌─ 0.95 confidence interval for the LD_{50}

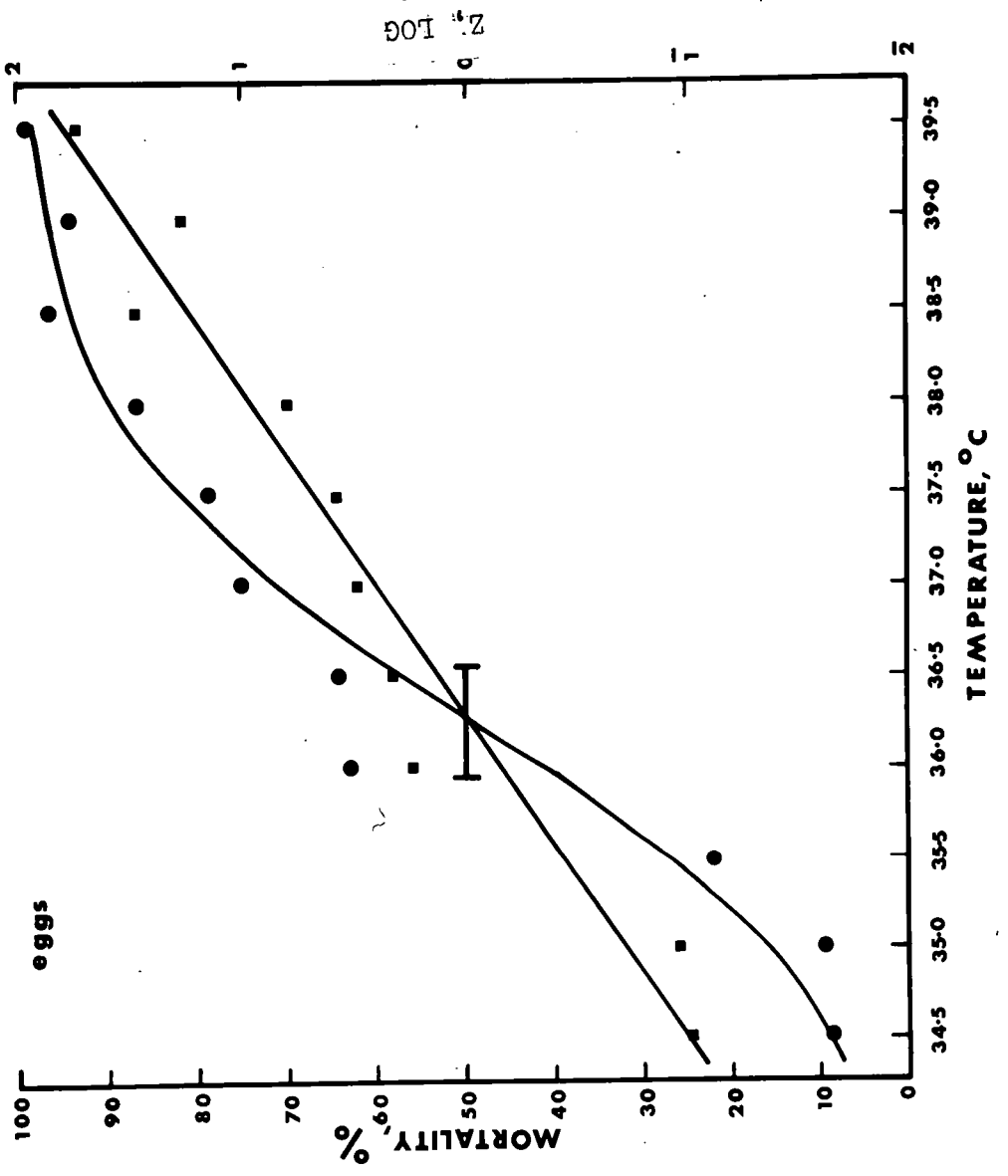

Z, LOG

eggs

Figure 4

Dosage/mortality curves for 4 day larvae
(mortality recorded at pupation)

- Sigmoid curve, mortality H' against temperature $^{\circ}\text{C}$ for a 40 minute exposure;
- linear conversion of the sigmoid curve, $\text{Log } z$ against temperature $^{\circ}\text{C}$.
- 0.95 confidence interval for the LD_{50}

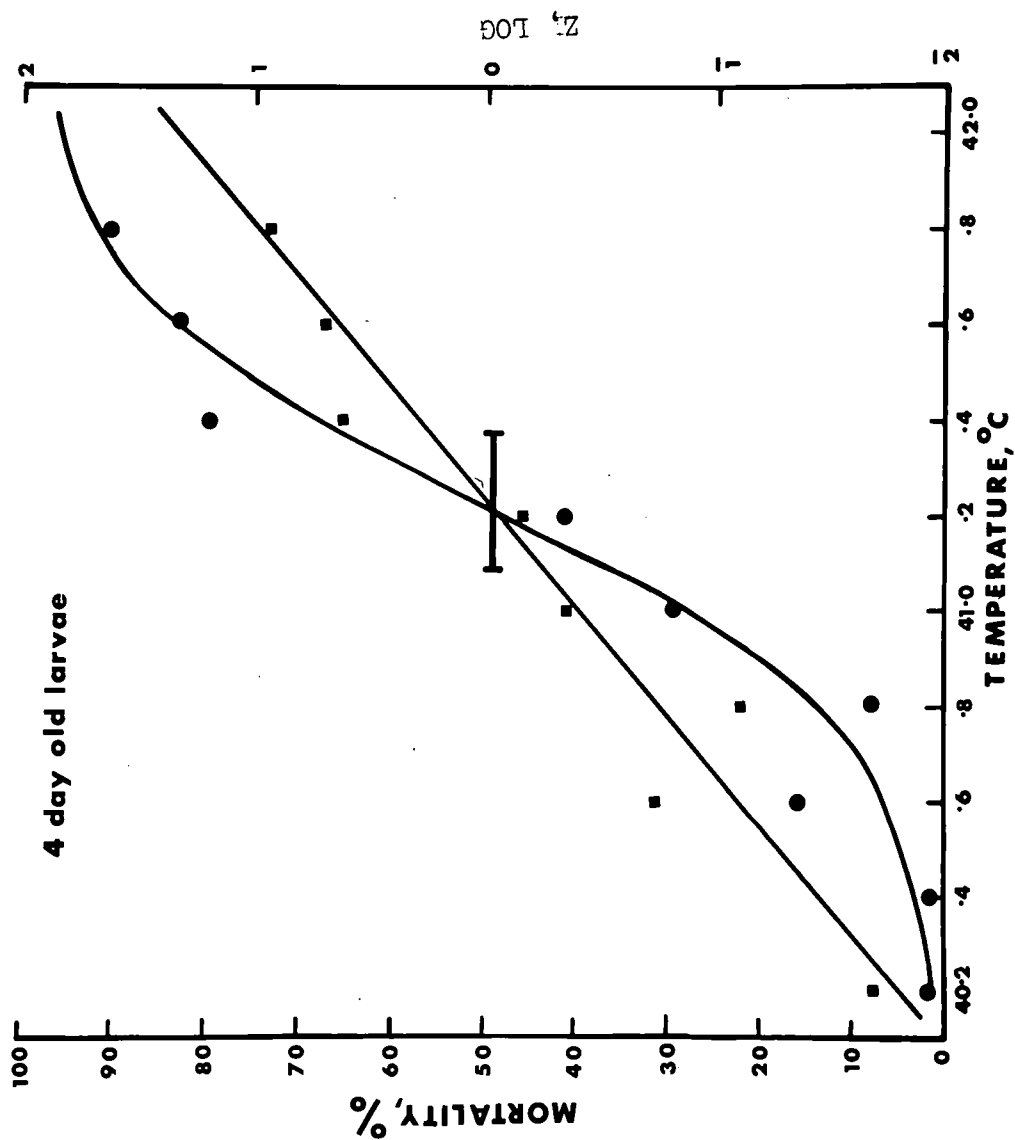

Figure 5

Dosage/mortality curves for 8 day puparia.

- Sigmoid curve, mortality H' against temperature $^{\circ}\text{C}$ for a 40 minute exposure;
- linear conversion of the sigmoid curve, $\text{Log } z$ against temperature $^{\circ}\text{C}$.
- 0.95 confidence interval for the LD_{50}

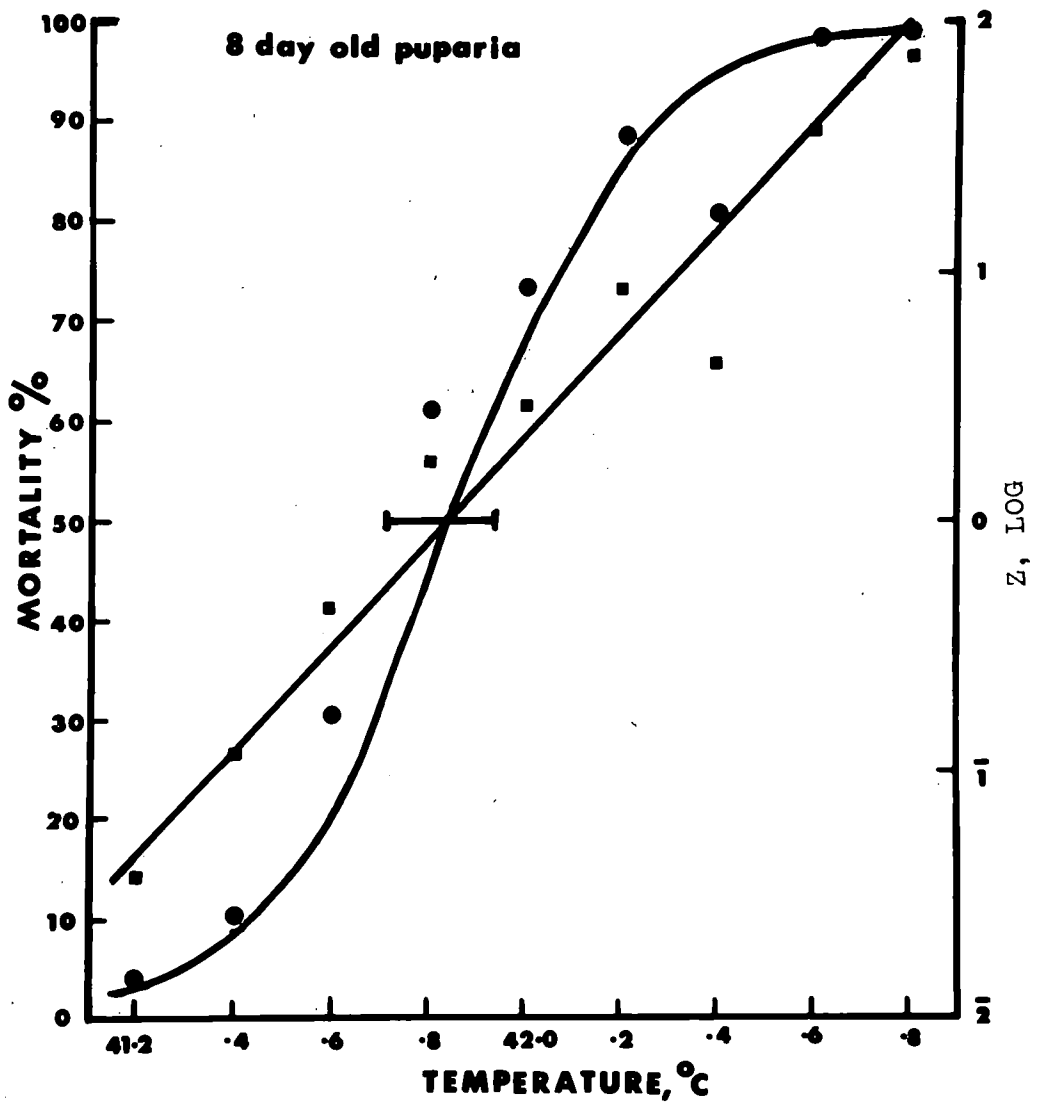

Figure 6

Dosage/mortality curves for 10 day
male adults.

- Sigmoid curve, mortality H' against
temperature $^{\circ}\text{C}$ for a 40 minute exposure;
 - linear conversion of the sigmoid curve,
Log z against temperature $^{\circ}\text{C}$.
- 0.95 confidence interval for the LD_{50}

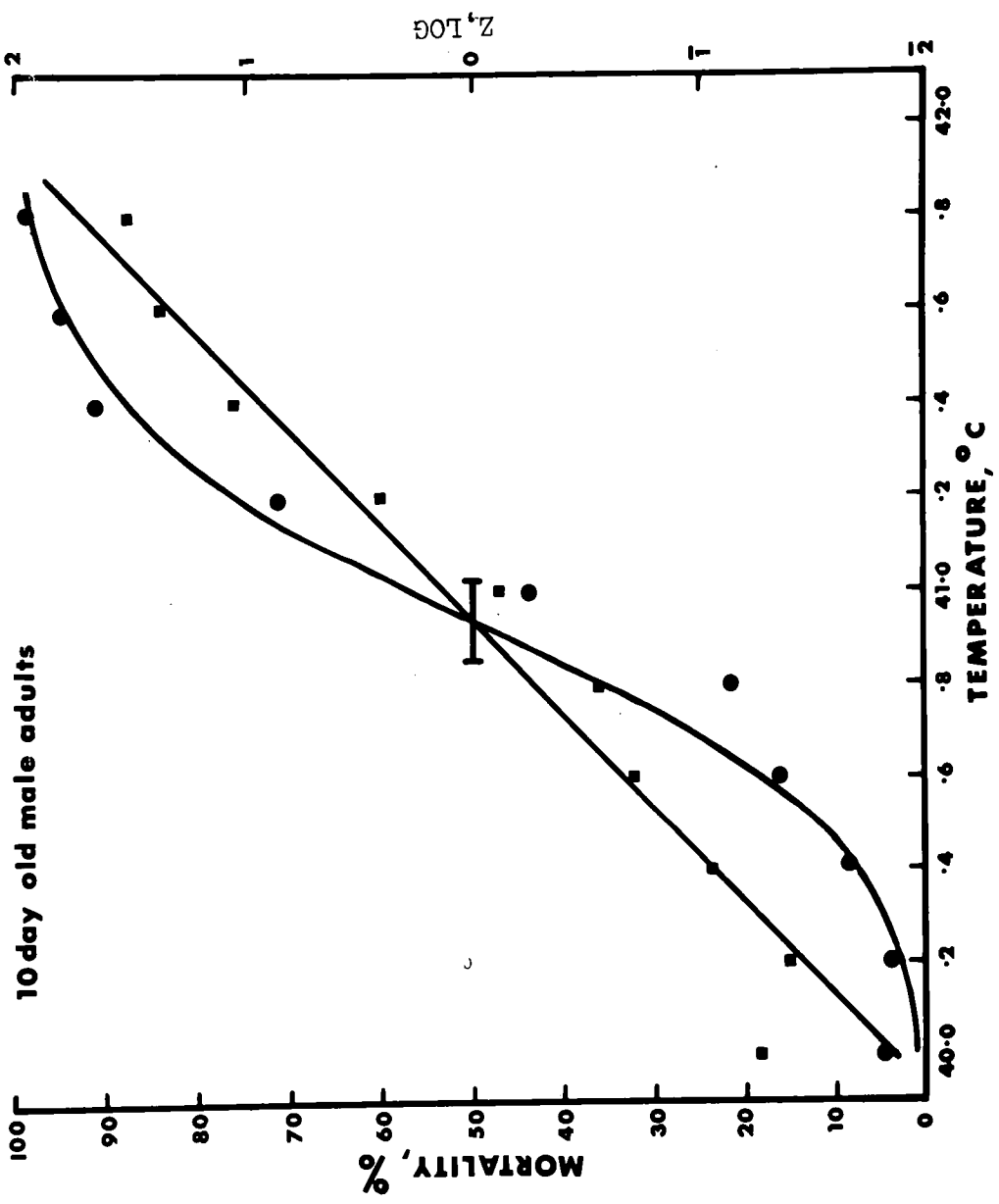
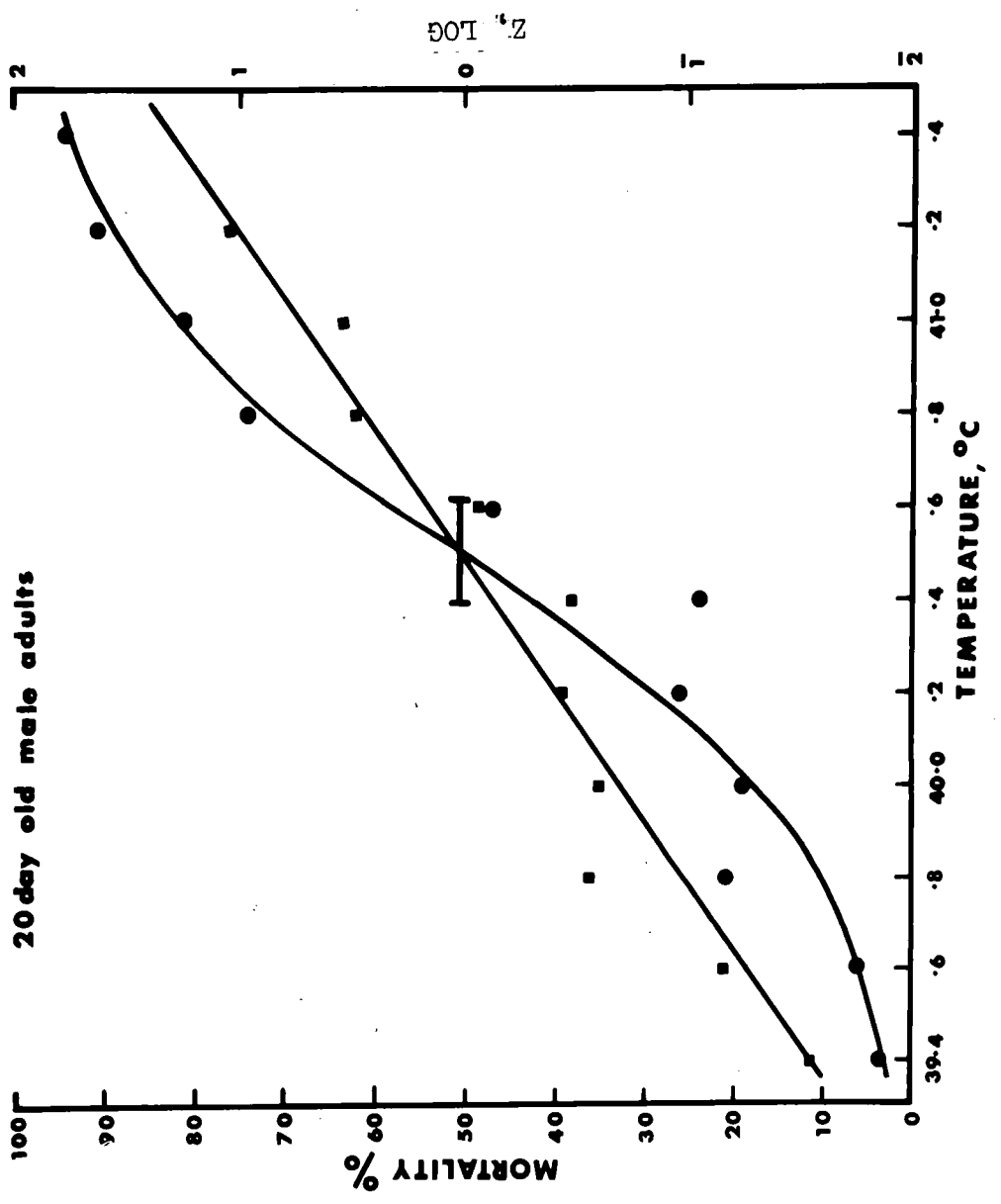

Figure 7

Dosage/mortality curves for 20 day
male adults.

- Sigmoid curve, mortality H' against
temperature $^{\circ}\text{C}$ for a 40 minute exposure;
- linear conversion of the sigmoid curve,
Log z against temperature $^{\circ}\text{C}$.
- 0.95 confidence interval for the LD_{50}



to pupate. Heat treated puparia were placed in dry sawdust in 250 ml conical flasks, plugged with cotton wool, and put in the incubator to eclose. Larvae and puparia were allowed to develop to the adult stage. Any deformities in the emerged adults were recorded.

Heat treatment of emerged adults

Males and females were used separately in the heat treatments. For heat treatment 100 adults were placed in pairs in each vial. In the case of 30 day old adults only 50 animals were used. After heat treatment the adults were transferred to the 22 cm x 22 cm x 22 cm cages and placed in the acclimatization cabinet. They were fed on sugar and water ad libidum.

RESULTS

The data on heat death was compiled and computed using the method described in Appendix 1. Examples of temperature/mortality curves are shown in Figures 3, 4, 5, 6 and 7. Heat death points at various stages in the life history are recorded in Table 1 and Figure 8. It is clear that these stages have different patterns of response to high temperature. The 0.95 confidence intervals, given in Table 1 and plotted as the vertical line in Figure 8, show that the egg is significantly the

TABLE 1

Temperatures causing 50% mortality for a 40 minute exposure at different stages in the life history of C. erythrocephala.

Stage of Life History	LD ₅₀ (°C)	0.95 Confidence Limits	n
Egg	36.29	35.96 - 36.57	11
4 day larva	41.23	41.09 - 41.39	9
6 day larva	41.04	40.88 - 41.19	13
7 day larva	41.53	41.31 - 41.71	12
1 day puparia	42.38	42.19 - 42.65	6
4 day puparia	42.09	41.97 - 42.22	6
6 day puparia	41.94	41.72 - 42.14	9
8 day puparia	41.83	41.71 - 41.94	9
1 day adults ♂	42.23	42.11 - 42.37	11
1 day adults ♀	42.08	41.89 - 42.35	10
5 day adults ♂	41.25	41.13 - 41.38	11
5 day adults ♀	41.43	41.26 - 41.63	11
10 day adults ♂	40.94	40.86 - 41.03	10
10 day adults ♀	41.13	40.86 - 41.48	9
20 day adults ♂	40.50	40.39 - 40.63	10
20 day adults ♀	41.01	40.81 - 41.23	10
30 day adults ♂	40.38	40.28 - 40.48	11
30 day adults ♀	40.69	40.58 - 40.80	11

n is the number of temperatures used in the determination of the LD₅₀

Figure 8

Changes in the LD₅₀ temperature of eggs, larvae, puparia, and adult C. erythrocephala at different ages when given exposures of 40 min duration. The three arrows from left to right represent hatching, puparium formation and adult emergence respectively. The vertical lines on the graph represent the 0.95 confidence limits.

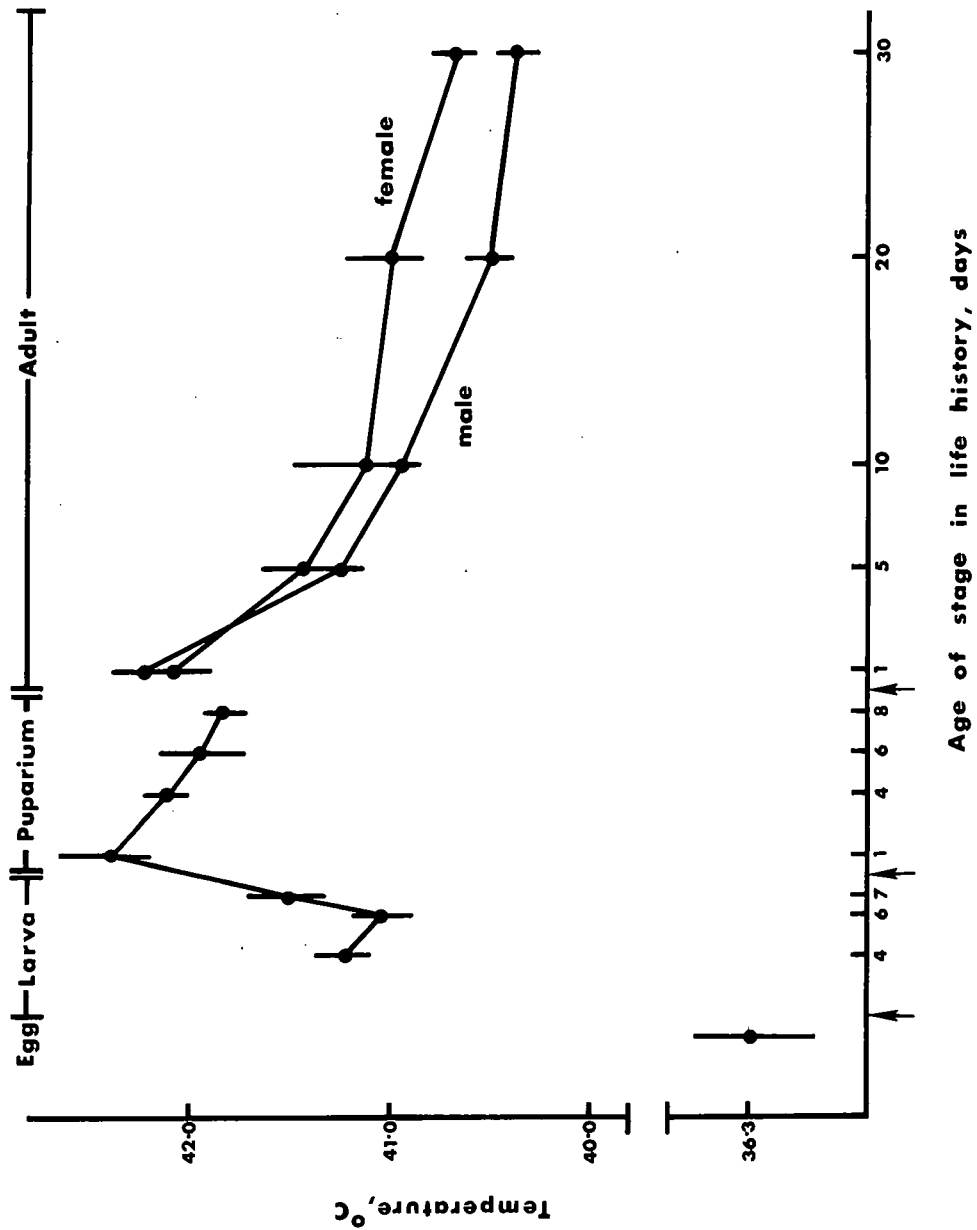

most sensitive stage with an LD_{50} of $36.29^{\circ}C$.

The heat death points of 4, 6 and 7 day old larvae were 41.23° , 41.04° and $41.53^{\circ}C$, see Table 1 when mortalities were recorded at pupation. However, when mortality was recorded at eclosion, heat death points were slightly lower, see Table 2, only in the case of the 7 day old larvae were the differences in heat death point significant ($p = 0.05$). This suggests that further deaths were taking place during the puparium stage.

Heat death points in the puparium stage are significantly greater than in all other stages, excepting 1 day old emerged adults. The 1 day old puparium is most tolerant with an LD_{50} of $42.38^{\circ}C$. The temperature tolerances decline with puparium age. The 6 day and 8 day old puparia, which are pharate adults, are significantly ($p = 0.05$) less tolerant than 1 day old puparia.

On the day of emergence adult males and females have an LD_{50} of 42.23° and $42.08^{\circ}C$ respectively. These are not significantly different from the high heat death point observed in 1 day old puparia. Moreover, 1 day old male emerged adults are more tolerant ($p = 0.05$) than 8 day pharate adults. The heat death point of

TABLE 2

Temperatures causing 50% mortality for a 40 minute exposure at different ages in the larval stage.

Deaths were compiled at eclosion.

Age of larva	LD ₅₀ (°C)	0.95 confidence interval
4 day	41.08	40.90 - 41.27
6 day	40.78	40.65 - 40.9
7 day	41.08	40.84 - 41.24

TABLE 3

Linear regression lines with 0.95 confidence intervals obtained in the heat death point determinations recorded in Table 1.

Stage of life history	Slope	\pm 0.95 confidence limits
Egg	0.53	0.09
4 day larva	1.85	0.47
6 day larva	1.06	0.21
7 day larva	1.14	0.28
1 day puparia	1.07	0.3
4 day puparia	2.59	0.92
6 day puparia	1.48	0.56
8 day puparia	1.94	0.39
1 day male	1.59	0.3
adult female	1.31	0.4
5 day male	1.55	0.28
adult female	1.58	0.42
10 day male	1.79	0.27
adult female	2.02	1.01
20 day male	1.31	2.56
adult female	1.26	0.42
30 day male	1.57	2.53
adult female	1.18	0.21

males and females declines respectively by 1° and 0.6°C in the first five days after emergence. During the following five days, the decline is only 0.3°C for both males and females. The decline becomes progressively smaller during the next 20 days and at 30 days old the LD_{50} is 40.38°C for male and 40.69°C for female.

Thus during the first 30 days of the adult stage, the LD_{50} of the male declines by 1.8°C and at all the ages tested the heat death points are significantly different ($p < 0.05$), except 20 day old males are not different from 30 day old males. A similar, but not such a significant, decline is observed for the female. 20 and 30 day old females are significantly more tolerant than males of the same age ($p = 0.05$).

The slopes of the linear regression lines obtained from the data are given in Table 3. The slopes represent the relative potency of the dose, since they are obtained from the increase in number of deaths occurring for each degree rise in lethal temperature. No consistent pattern can be obtained from these results except that the eggs are significantly different from all other stages. Mean slopes for the dosage of larvae, pupae and adults varied between 1.06 and 2.59. They may

reflect differences in the causes of heat death in particular stages. However, as little is known of the specific causes of heat death in each stage, little can be concluded at present.

To try to account for the decline in temperature tolerance with older puparia, 100 six day pharate adults were treated to 42.4°C for 40 minutes and allowed to complete metamorphosis. 29 adults emerged at eclosion and the 71 unhatched adults were dissected to determine whether the pharate adults were living. After dissection it was found that 61 had completed development and 52 were living. These dissected animals showed walking movements or twitching of legs, arista and proboscis. None inflated their wings or abdomens to become normal adults like control adults similarly dissected prior to eclosion. Figure 9 shows the condition of the heat treated pharate adults.

The number of deformities in emerged adults after heat treatments in the larval and puparial stages are recorded in Table 4. Deformities consisted of twisted and uninflated wings and abdomens. There were no changes in wing venation as reported by Milkman (1967) for Drosophila melanogaster. All the deformities were compiled together and the occurrence of any one deformity

Figure 9

Photograph of deformed adults dissected
from puparia on the day of eclosion.

The puparia were treated to $42.4^{\circ}\text{C}/40$ mins
on the sixth day after pupation.



5MM

TABLE 4

Percentage deformities in adults, and occurrence of partially eclosed adults, after heat treatments given at various stages in the life cycle.

Stage at which treatments given	% age deformity in adults	No. of adults eclosed after heat treatment	% age adults partially eclosed
Control	7.16	852	2.58
4 day larvae	5.71	420	0
6 day larvae	4.11	389	3.03
7 day larvae	2.15	186	5.08
1 day puparia	16.0	340	5.33
4 day puparia	14.7	279	6.25
6 day puparia	21.85	444	8.54
8 day puparia	18.54	302	9.1

classified an adult as deformed. It was not possible to determine if the data was significant at each stage, neither was it possible to show increased deformities with increase in exposure temperature, for higher temperatures caused increased mortality and therefore reduced the sample of survivors.

Heat treatments in the larval stage caused a slight reduction in the number of deformed adults, particularly when 6 and 7 day old larvae were tested, see Table 4. Whereas heat treatments given to puparia caused an increased number of adult deformities. The number of deformities was larger when older puparia were heat treated. This agrees with Mellanby (1954) who has reported that in T. molitor the older the pupa at heat treatment, the greater the number of deformities in the adult stage.

The numbers of adults partially emerging, that is not completely escaping from the puparium, is also recorded in Table 4. Heat treated older larvae produced a greater number of partially emerged adults than heat treated younger larvae. Likewise older puparia, given heat treatments, produced greater numbers of partially emerged forms than younger puparia.

DISCUSSION

Considering the pattern of changes in heat death point during the life history it is obvious that the egg is the most sensitive stage. It possesses an LD₅₀ of at least 4°C below the LD₅₀'s of all other stages. Three factors may be involved. First, the egg stage requires a high humidity for successful hatching (Davies, 1949) and so the removal to a R.H. of 50 per cent at a high temperature for as little as 40 minutes may cause considerable dehydration. Although R.H. was maintained at 50 per cent during lethal exposures, the saturation deficit will be considerably larger than at 24°C. Davies (1949) has shown that water loss of C. erythrocephala eggs was almost three times greater at 40°C than at 30°C. Thus with the egg stage dehydration may play an important part in death at high temperatures.

Second, the egg stage has a much smaller mass than the other stages of the life history and on exposure to a high temperature it is likely to heat up more quickly. Thus the time the egg is held at the lethal temperature may be slightly longer and so it effectively receives a longer exposure.

Third, the hatching of the larva takes place within 12 - 24 hours of the egg being laid and therefore there

are likely to be rapid, tightly integrated developmental changes taking place during this stage. Moreover, it is probable that the major developmental systems involved in histogenesis and organogenesis will require a high rate of metabolism. Heat damage to any of these integrated and phased systems will impair larval development and lead to the failure of the egg to hatch. It is significant that Grainger (1959) has shown that eggs of Rana temporaria are most sensitive to high temperature during gastrulation.

Heat death points in the larval stage are significantly higher than the egg ($p < 0.05$) and significantly lower than the puparium ($p < 0.05$). When mortalities of heat treated larvae were compiled at eclosion, the LD_{50} was lower than when deaths were compiled at pupation. This suggests that the processes impaired in the larval stage may only become apparent during metamorphosis.

The puparium is the most resistant stage, but a decline in tolerance occurs with increase in puparial age. These changes in tolerance probably reflect developmental changes taking place during metamorphosis. Agrell (1964) has reported that histolysis of larval tissue is dominant during the early pupal stage. In the middle and latter part of this stage histogenesis and differentiation

become progressively more important. The breakdown of tissue and relative lack of tissue organisation in the 1 day old puparium may account for the higher level of tolerance.

Three further factors must be taken into account when discussing the decline in heat death point in the puparial stage and the inability of heat treated pharate adults to emerge. First, in the later stages of metamorphosis, the endocrine system which initiates and controls eclosion will be almost fully developed. This system may be impaired by high temperatures and consequently eclosion will be affected. Secondly, the heat treatment may cause the puparium case to become super-hardened; so preventing the pharate adult from forcing it open completely in order to escape. Younger puparia have a higher LD₅₀ and produce fewer partially emerged adults than older puparia, and so changes in the nature of the cuticle during metamorphosis would be required to account for different degrees of super-hardening. Thirdly, high temperatures may uncouple the mitochondria of the pharate adult (for full discussion of uncoupling see Chapter 7.) This could account for the fact that the adults dissected from heat treated puparia were unable to inflate their wings and abdomens.

The fall in tolerance in male and female adults agrees with the work of Hollingsworth and Bowler (1966). They found a fall in heat death point between the 3rd and 10th day after emergence in adult D. subobscura followed by a progressively smaller decline with increasing age, similar to the pattern observed in this study. However, the changes which Bowler (1967) observed in T. molitor in the first 5 days of the adult stage were far more dramatic. At 42.5°C he obtained an LD₅₀ of 190.1 mins for 1 day old adults and 126.7 mins for 5 day old adults. The heat death point then remained at approximately 120 mins until 75 days old.

The reason for the decline in temperature tolerance in the young adult is difficult to account for. Baldwin (1954) suggested that the decline in tolerance in young adult D. fuscipennis is related to changes in tissue water content. Alternatively young adults may be capable of better evaporative cooling. These two suggestions will be discussed in Chapter 6.

Recent evidence has implicated the importance of enzymes as a factor involved in temperature acclimatization and heat death (Strangenberg, 1955; Precht, 1958; Kanungo and Prosser, 1959; Bowler, 1963b; Ushakov, 1964; Bowler and Duncan, 1967; Hochachka, 1967). It is likely

that the changes in temperature tolerance observed here are caused by enzyme changes which are part of the sequence of development. Agrell (1964) has reviewed the various biochemical changes taking place during metamorphosis. These changes do not occur abruptly and are continuous into the next stage.

For instance, Jones (1964) has observed changes in the activity of respiratory enzymes in T. molitor during metamorphosis. He found the pattern of these changes followed a U-shaped curve, the lowest activity occurring in the middle of the pupal stage. Chaudhary, Srivastava and Lemonde (1966) have shown changes in aldolase activity, during metamorphosis of Tribolium confusum, followed an inverted U-shaped pattern. The decrease in activity in the late pupa continues in the adult stage. Whereas, Bauer and Levenbook (1969) have shown that total aldolase activity in Phormia regina increases during larval growth, follows a U-shaped pattern during metamorphosis and increases rapidly in the first five days of adult life. Thus a study of the changes in enzymes, particularly the respiratory enzymes, may indicate the reason for the changes in heat death point. Tribe (1967a) has shown that there are changes in the size and distribution of flight muscle sarcosomes

in young adult C. erythrocephala from this stock. Changes in respiratory enzymes of these mitochondria may be associated with the changes in the heat death point of the adult.

The results, presented in this chapter, substantiate the suggestion that the pupa is more resistant to high temperature than the adult (Hollingsworth and Bowler, 1966). The elevated level of heat resistance in young adult C. erythrocephala probably represents an extension of the puparial resistance. Moreover, Burnett (1957) reported that in general Glossina mortisans tolerance to low temperature decreased with increasing age. Thus an age dependent decline in cold death point may reflect the changes in heat death point in adult endopterygote insects. The changes in heat resistance throughout the life history of endopterygote insects may be part of a more general change in physiological resistance to physical stress.

Chapter 4

CHANGES IN RESISTANCE TO CHEMICAL STRESS
IN YOUNG ADULT CALLIPHORA ERYTHROCEPHALA

INTRODUCTION

The results presented in the previous chapter have indicated there are significant changes in tolerance to high temperatures throughout the life history of Calliphora erythrocephala. The decline in tolerance observed in the young imago is in agreement with the results of other workers (Baldwin, 1954; Hollingsworth and Bowler, 1966; Bowler, 1967) and it appears to be a widespread phenomenon in adult endopterygote insects.

Previous workers have shown that there are also changes in tolerance to toxic chemicals throughout the life history of several species of endopterygote insects. Gough (1939) working with Tribolium confusum has measured the median lethal dosage (LD_{50}) of hydrogen cyanide at different stages in the life history. He reported that the egg was most sensitive to hydrogen cyanide and the pupa most resistant. The LD_{50} increased during the larval stage and the changes observed during metamorphosis followed a U-shaped pattern. The decline in LD_{50} in the late pupal stage continued in the adult.

Sun (1947) observed similar changes in tolerance to carbon disulphide throughout the life histories of T. confusum, Sitophilus granarius and Sitophilus oryzae. Cotton (1932) has also studied the effect of carbon-disulphide on T. confusum and suggested that changes in resistance to this gas may be associated with changes in metabolic rate.

Bowler (1967) has pointed out that the decline in tolerance to high and low temperature extremes in the early adult stage of endopterygote insects may reflect a general change in resistance to physical and chemical stress. Moreover, increased resistance to such forms of stress in the immobile pupal stage will have an obvious survival advantage. To determine whether the changes in resistance to high temperature in young adult C. erythrocephala are accompanied by changes in resistance to chemical stress, a study of the effect of 1,1,1-trichloro-2,2-bis(p-chlorophenyl) ethane (p,p' DDT) on young adults has been made.

MATERIALS AND METHODS

Choice of method

In previous studies by Cotton (1932), Gough (1939) and Sun (1947) applications of hydrogen cyanide or carbon disulphide have been made by fumigation. This allows

the treatment of different stages in the life history with known concentrations of the toxin, however, as contact is via the respiratory system, any changes in respiratory rate will influence the dosage contacted.

Tribe (1966b) has shown that the respiratory rate of resting and active adult C. erythrocephala changes significantly during the first few days after eclosion. He also reported that there are changes in activity over this same period. Thus the use of poison sprays, where contact is dependent on activity of the animal, is likewise limited. Therefore in this study, the technique suggested by Busvine (1962) has been adopted, as it allows the dosage of adults with consistent, known quantities of toxin.

Preparation of toxin

The toxin selected as a form of chemical stress was refined 1,1,1-trichloro-2, 2-bis(p-chlorophenyl) ethane (p,p' DDT) melting point 107°C. The p,p' DDT was dissolved in Risella 17 a high boiling, refined, mineral oil and solutions were made up in the range 16 - 32 mg p,p' DDT per 10 ml Risella. Crystals of p,p' DDT were dissolved by shaking at intervals over a period of 24 hours. All solutions were stored in a refrigerator at 4°C.

Microsyringe applicator:

The microsyringe applicator used here was of a similar design to the model described by Busvine (1962). An Agla micrometer syringe was mounted on a frame and a 5 cm tufnol wheel, with 25 notches equally spaced around the circumference, was attached to the micrometer head. A spring loaded rod, also attached to the frame, fitted into one of these notches, so that as the wheel turned the rod was depressed and moved into the adjacent notch. Thus the micrometer turned through 14.4° between notches.

An Agla syringe was mounted in the micrometer and fitted with a blunt 26 G hypodermic needle. The tip of the needle was bent down to aid oil droplet formation. The applicator was calibrated by loading the syringe with mercury and weighing 50 droplets separately. Average droplet volume was $0.41 \mu\text{l}$ and the coefficient of variation 16.22 per cent.

Dosage of flies

In these experiments 1, 5, 10, 20 and 30 day old adult blowfly were used. Each fly was anaesthetized with carbon dioxide and weighed on a torsion balance. A droplet of oil was applied to the surface by touching the dorsal part of the thorax against a drop expelled from the hypodermic needle. Control experiments with

Risella oil, in the absence of p,p'DDT, showed there was no interference with the spiracles when an oil droplet was applied to the thorax in this way.

After treatment, the adults were placed in small disposable cages, constructed from 1 pint milk cartons. Each carton had a hole cut out of the front and back. One hole was covered with polyglaze to allow the animals to be seen and the access hole was plugged with cotton wool. Flies were fed on sugar and provided with cotton wool soaked in water. Mortalities were recorded 2 days after treatment.

15 animals were used in each experiment and experiments were usually repeated three times to give a sample of over 40 animals for each dosage level.

Treatment of results

The average weight of the animals was determined at each dosage level and the average dose in μg p,p'DDT per gram wet weight was calculated. Dosage/mortality curves were drawn and the data compiled and computed using the method described in Appendix 1. The dosage of p,p'DDT producing 50 per cent mortality is referred to as the LD_{50} .

Chemicals

The p,p'DDT used in this study was supplied by

Geigy (U.K.) Ltd., and the Risella 17 by Shell Petroleum Ltd.

RESULTS

The results presented in Table 5 show that the LD_{50} of young adult C. erythrocephala ranges from 20.9 to 24.37 μg p,p'DDT per g wet weight. The one day old adult is most sensitive ($LD_{50} = 20.9 \mu\text{g}$ p,p'DDT/g wet wt). The LD_{50} increased to 23.52 μg p,p'DDT/g wet wt by 5 days old and remained approximately at this level until 30 days old. The LD_{50} 's obtained in these experiments agree with those reported by Busvine (1962) who has reported an LD_{50} of 25 μg DDT/g wet weight for this species.

The 0.95 confidence intervals given in Table 5 show that none of the results are significantly different. The larger confidence intervals with 1 day and 5 day old adults are the result of a smaller number of dosage levels used in plotting the dosage/mortality curves and not to increased variability in the data. The large upper confidence interval with 5 day old adults is due to the fact that there were fewer dosages above the LD_{50} than below it. The slopes of the linear regressions were not significantly different at any of the ages tested.

TABLE 5

Doses of p, p' D.D.T. causing 50% mortality
at different ages in male adult C. erythrocephala.

Age of adult days	LD ₅₀ µg p,p' DDT. /g wet wt.	.95 confidence interval	Regression slope ± 0.95 confidence interval	n
1	20.9	18.23-23.67	0.19±0.12	5
5	23.52	21.93-28.34	0.16±0.09	6
10	24.37	23.64-25.17	0.16±0.03	7
20	23.63	22.66-24.66	0.13±0.03	7
30	24.04	23.19-25.07	0.2 ±0.04	8

DISCUSSION

The results presented in Table 5 suggest that there are no major changes in resistance to p,p'DDT in young adult C. erythrocephala. A small, but not significant, rise in LD₅₀ was observed between the first day and the fifth day of the adult stage and LD₅₀ then remained at almost the same level until the 30 day old adult. The fact that 1 day old adults are slightly less resistant than the older ages tested may be due to an increased absorption of insecticide through the unhardened cuticle and not to lower tolerance of the tissues.

Thus a decline in resistance to chemical stress does not accompany the decline in resistance to high temperature, observed in the adult stage in Chapter 3. The results indicate that the puparium tissues are not likely to possess a higher level of tolerance to p,p'DDT than the adult, but puparium has not been tested in this study for a standard method of dosage was adopted. Two factors are likely to be involved in a higher level of tolerance to chemical stress in the puparium. Firstly, it may be more resistant to superficial dosages of toxin than the adult stage, because it possesses two cuticles which will act as absorption barriers. This would not apply to a true pupa.

Secondly, the pupal or puparial stage of endopterygote insects is more resistant to gaseous toxins because it possesses a lower respiratory rate than the adult stage (Bodine and Evans, 1932; Cotton, 1932).

To show that the pupal tissues are no different in tolerance to toxins than the tissues of the larval and adult stages would require microinjection of toxin directly into the animal.

Chapter 5

THE RELATIONSHIP BETWEEN AGE, ACCLIMATIZATION
TEMPERATURE AND HEAT DEATH POINT IN ADULT
CALLIPHORA ERYTHROCEPHALA.

INTRODUCTION

In Chapter 3, a dramatic fall in the heat death point was observed during the first 10 days of the adult stage of Calliphora erythrocephala. This observation agrees with those of other workers for different species of endopterygote insects. However, previous workers have not considered how this fall in LD₅₀ is affected by acclimatization to other temperatures.

It is well known that the heat death point of insects is dependent upon the previous thermal history of the animals (see Maynard Smith, 1957; Bowler and Hollingsworth, 1965; Bursell, 1967). In addition to this Maynard Smith (1957) has proposed two types of resistance adaptation in adult Drosophila subobscura. Firstly, developmental acclimatization, which is dependent upon the temperature at which the pre-adult stages have been maintained. It is carried over to the adult and seems to be developmentally fixed, for it is long lasting. Secondly, physiological acclimatization,

which is attained in the adult stage as a result of being placed in a new temperature regime. It is transitory and seems to be reversible. Both forms of acclimatization contribute to the heat resistance of the adult.

In previous studies of heat death, few workers have taken the role of developmental acclimatization into account. Moreover, the earlier work of Maynard Smith (1957) on D. subobscura did not take into account the changes in heat death point, which Hollingsworth and Bowler (1966) described for the same inbred lines.

The object of the work, presented in this Chapter, is to determine the influence of physiological and developmental acclimatization upon the age-dependent changes in heat resistance in adult C. erythrocephala.

MATERIALS AND METHODS.

Acclimatization of stocks

The methods of rearing stocks have been described in Chapter 2. The pre-adult stages were reared at either $15 \pm 1.0^{\circ}\text{C}$ or $24 \pm 0.5^{\circ}\text{C}$ and will be referred to as being 'developmentally acclimatized', Maynard Smith (1957). Adults were sexed on the day of emergence and only males were used. They were maintained on a sugar, liver and water diet in the 22 cm x 22 cm x 22 cm

cages at the following temperatures : 5° , 10° , $15 \pm 1^{\circ}\text{C}$ and 19° , 24° , 29° , 30° , 31° , 32° and $34 \pm 0.5^{\circ}\text{C}$. R.H. varied from 40 per cent at the higher temperatures to 90 per cent at the lower temperatures. Continuous illumination was provided at all temperatures except 19° , 30° , 31° , 32° and 34°C , where an electric light bulb acted as both a source of heating and illumination. At 5°C flies were kept in the dark.

Determination of the heat death point

In one series of experiments the heat death points of 1 day and 10 day old adults, developmentally and physiologically acclimatized to 15°C , were determined for a fixed exposure of 40 mins, after the method in Chapter 3 and Appendix 1. In the other experiments heat death point was measured as the time required for 50 per cent of a group of flies to die at $41.2 \pm 0.05^{\circ}\text{C}$. They were exposed to 41.2°C after the method described in Chapter 3 and the time to death was measured using the method described by Bowler and Hollingsworth (1965).

Lifetables at 34°C

Lifetables were constructed for two groups of 100 flies developmentally acclimatized to $15 \pm 1.0^{\circ}\text{C}$ and $24 \pm 0.5^{\circ}\text{C}$ respectively. They were maintained at $34 \pm 0.5^{\circ}\text{C}$ at an R.H. of 40 per cent. Deaths were

recorded daily. The mean expectation of life for the 15°C developed adults was 21.29 ± 0.19 days and for the 24°C developed adults 21.20 ± 0.23 days.

RESULTS

Adults developmentally acclimatized to 24°C

The heat death points of male adults developmentally acclimatized to $24 \pm 0.5^\circ\text{C}$ and placed at various temperatures on the day of emergence are recorded in Table 6 and Figure 10. On the day after emergence, the LD_{50} at 41.2°C was 97.35 mins for adults maintained at 24°C and, as adults were aged at this temperature, LD_{50} declined significantly to 37.22 mins by 10 days old ($p > 0.001$). No further change in LD_{50} was observed in these adults when tested at ages between 15 and 30 days old.

When adults were placed at 5°C on the day of emergence no decline in LD_{50} was observed at 5 or 10 days old and, by 30 days, LD_{50} had only declined to 85.75 mins ($p = 0.1$). Moreover, when tested at 73 days old, the LD_{50} was 72.5 ± 4.48 mins ($n = 29$) which is the same as the LD_{50} of 5 day old adults at 24°C . Flies maintained at 10°C showed a slow decline in LD_{50} , which fell to 42.5 mins by 30 days old. Thus, at this temperature, 30 days were required for the LD_{50} to reach the same level

TABLE 6

Age dependent changes in LD₅₀ (mins) at $41.2 \pm 0.05^\circ\text{C}$ for male adult C. erythrocephala developmentally acclimatized to $24 \pm 0.5^\circ\text{C}$ and placed at either 5° , 10° , 15° , 19° , 24° , 29° or 34°C on the day of eclosion. Standard errors are recorded and the number in the sample indicated in brackets.

Temp °C	1 day	3 days	5 days	10 days	15 days	20 days	30 days
5			95.0 \pm 2.28 (18)	97.33 \pm 5.03 (30)		84.44 \pm 6.34 (18)	85.75 \pm 5.74 (20)
10			86.94 \pm 6.62 (18)	69.75 \pm 6.43 (18)		68.74 \pm 4.46 (20)	42.5 \pm 3.08 (18)
15		83.75 \pm 5.89 (20)	80.61 \pm 3.43 (20)	49.72 \pm 4.38 (18)	52.25 \pm 4.34 (20)	48.29 \pm 2.49 (38)	42.5 \pm 1.98 (31)
19		92.16 \pm 4.71 (29)	76.5 \pm 5.7 (20)	43.19 \pm 2.85 (36)	39.26 \pm 2.2 (37)	43.06 \pm 3.52 (18)	39.81 \pm 4.17 (13)
24	97.35 \pm 2.65 (52)	87.08 \pm 4.12 (18)	72.25 \pm 5.05 (20)	37.22 \pm 2.86 (18)	39.34 \pm 2.2 (38)	39.75 \pm 2.76 (20)	38.75 \pm 2.71 (20)
29		85.28 \pm 6.75 (18)	52.85 \pm 6.04 (33)	44.72 \pm 3.5 (18)	48.0 \pm 2.74 (18)	43.28 \pm 2.86 (18)	34.74 \pm 2.95 (29)
34		104.15 \pm 8.67 (20)	117.2 \pm 2.12 (30)	86.39 \pm 7.65 (18)	79.0 \pm 6.18 (20)	71.0 \pm 6.81 (20)	64.38 \pm 6.42 (8)

* 25 days

Figure 10

Age-dependent changes in LD_{50} mins at 41.2°C for male adult C. erythrocephala developmentally acclimatized to 24°C . Adults were placed on the day of emergence at

▲, 5°C ; ■, 10°C ; ▼, 15°C ; □, 19°C ;
●, 24°C ; ○, 29°C ; ◆, 34°C .

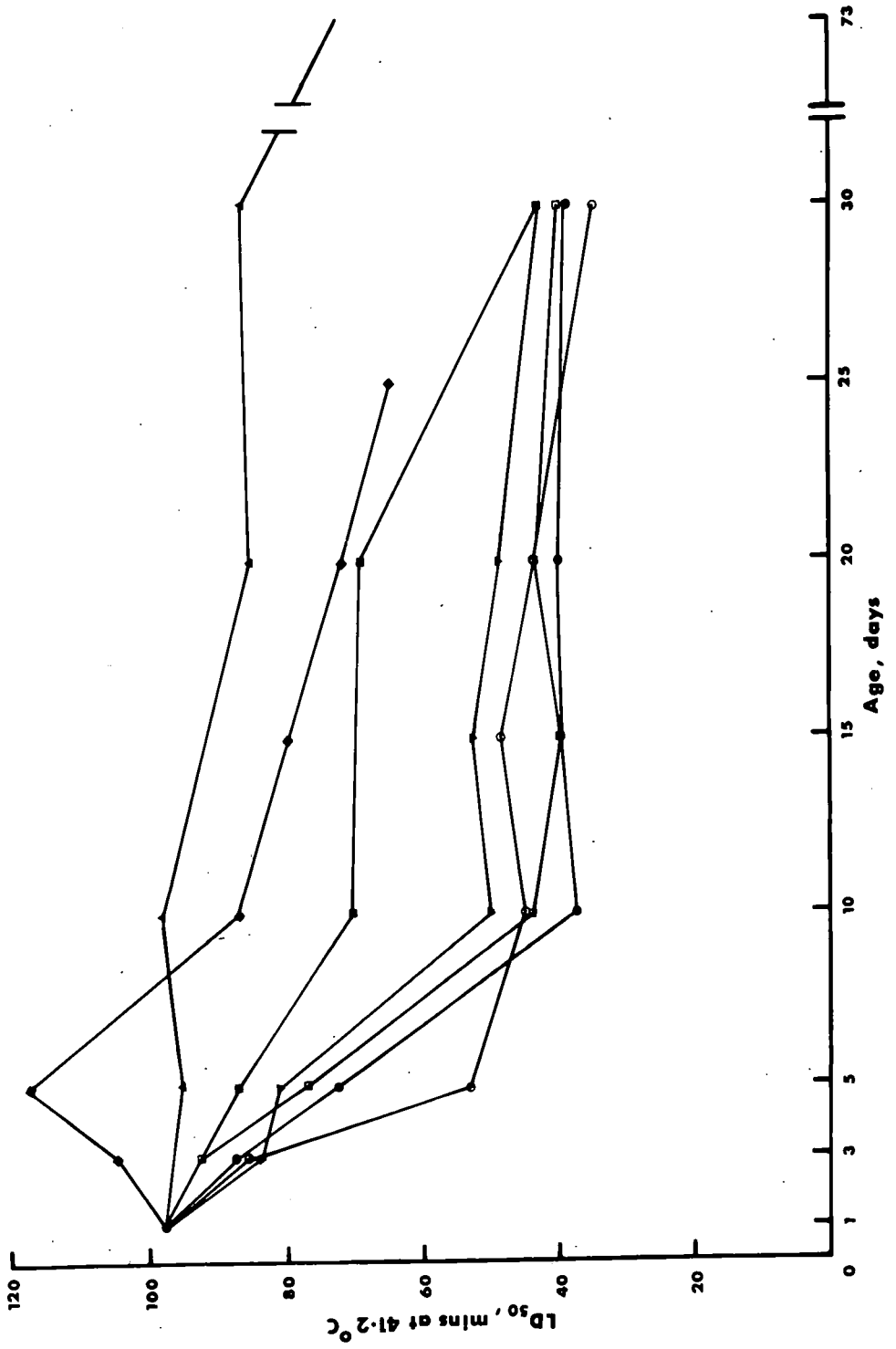

as the 10 day old flies maintained at 24°C.

Flies maintained at 15°C showed the same changes in LD₅₀ as those maintained at 24°C. LD₅₀ fell to 80.61 mins by 5 days old and 49.72 mins by 10 days old. It remained at this level until 20 days old, but fell to 42.5 mins by 30 days old. Between 10 and 20 days old, the LD₅₀ of these flies was significantly higher ($p = 0.05$) than adults, of the same age, maintained at 24°C. Flies placed at 19°C on the day of emergence also produced the same pattern of change in LD₅₀. However, these LD₅₀'s were not significantly different from those of adults, of a similar age, maintained at 24°C.

The LD₅₀ of adults maintained at 29°C declined sharply reaching 52.85 mins by 5 days old; significantly lower than 5 day old adults at 24°C ($p = 0.01$). The decline continued to 10 days old and between 10 and 20 days old the LD₅₀ was slightly higher than for adults, of the same age, at 24°C ($p = 0.1$ at 10 days and $p = 0.02$ at 15 days), suggesting that physiological acclimatization is present at these ages. However, at 30 days old the LD₅₀ of 29°C adults was slightly lower than that of 24°C flies ($p = 0.3$).

A completely different pattern of change was observed in flies maintained at 34°C. The heat death

TABLE 7

Age dependent changes in LD_{50} (mins) at $41.2 \pm 0.05^{\circ}C$ for male adult C.erythrocephala developmentally acclimatized to $24 \pm 0.5^{\circ}C$ and maintained at either 24, 29, 30, 31, 32 or $34^{\circ}C$ from the day of eclosion. Standard errors are given and the number in the sample indicated in brackets.

Temp. $^{\circ}C$	5 days	10 days
24	72.25 ± 5.05 (20)	37.22 ± 2.86 (18)
29	52.8 ± 6.04 (33)	44.72 ± 3.5 (18)
30	78.33 ± 7.42 (18)	45.0 ± 3.12 (16)
31	76.91 ± 6.53 (17)	54.0 ± 5.32 (20)
32	108.5 ± 6.91 (20)	93.97 ± 8.21 (17)
34	117.2 ± 2.12 (30)	86.39 ± 7.65 (18)

Figure 11

Age-dependent changes in LD_{50} (mins) at 41.2°C for male adult C. erythrocephala developmentally acclimatized to 24° .

Adults were placed on the day of emergence at

□, 29°C ; ○, 30°C ; ▼, 31°C ;
■, 32°C ; ●, 34°C .

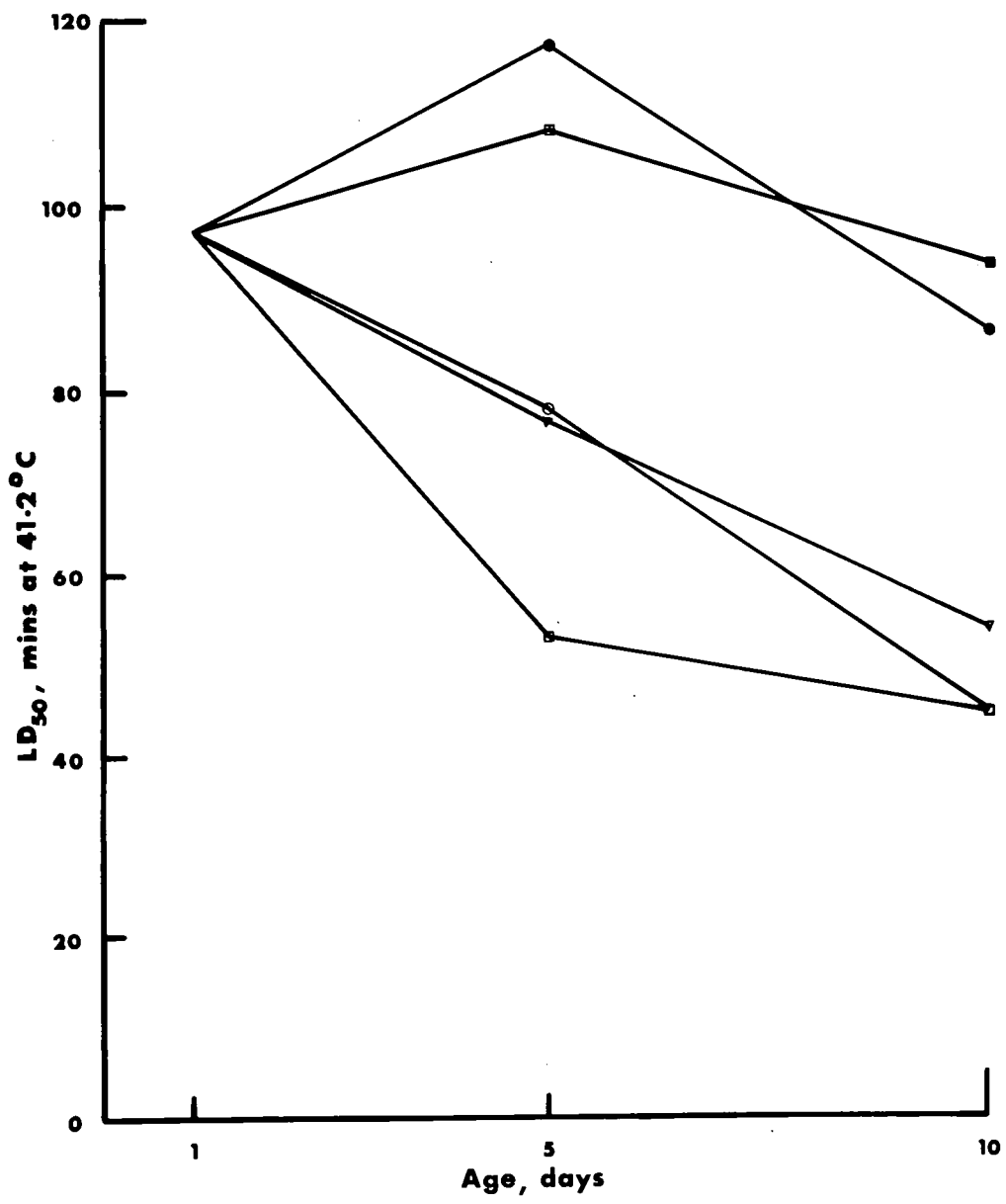

point increased after emergence, reaching 117.2 mins by 5 days old. It declined to 86.39 mins by 10 days and to 64.38 mins by 25 days old. Between 3 and 20 days old, the heat death points of the 34°C flies were significantly higher than for flies of the same age at either 24°C or 29°C ($p > 0.01$).

To determine whether there is a critical temperature when physiological acclimatization becomes superimposed upon the age-dependent decline, flies were placed at 30°, 31° and 32°C on the day of eclosion and the LD₅₀'s determined at 5 days and 10 days old. The results are recorded in Table 7 and Figure 11. At 30°C and 31°C, the LD₅₀'s of 5 day old adults were the same as 24°C acclimatized flies and thus significantly higher ($p = 0.02$) than 29°C flies. At 10 days old the LD₅₀'s of flies held at 30°C and 29°C were the same, but 10 day old adults held at 31°C were slightly higher ($p = 0.2$).

The pattern changed at 32°C and 5 day old flies were significantly more resistant than those at 31°C ($p = 0.01$), but slightly less resistant than those at 34°C ($p = 0.3$). However, the LD₅₀ of 10 day old adults at 32°C was slightly higher ($p = 0.6$) than those at 34°C.

Flies developmentally acclimatized to 15°C

The experiments reported in Table 6 were repeated using flies developmentally acclimatized to 15°C. On

the day of emergence adults were transferred to either 15°, 24°, 29° or 34°C. The LD₅₀'s at various ages are recorded in Table 8 and Figure 12.

The patterns of change in LD₅₀ with increasing age were essentially the same as those for 24°C developed adults. The LD₅₀ of 1 day old flies was 104.4 mins. When maintained at 15°C and 24°C, it fell to 38.0 mins and 33.33 mins respectively in the first 10 days of the adult stage and remained at these levels until 20 days old. However at 29°C, LD₅₀ fell to 40.88 mins by 5 days old and it remained at this level until 20 days old. At 34°C, LD₅₀ declined to 91.0 mins by 10 days old and to 65.0 mins by 20 days old.

The differences between LD₅₀ of animals developmentally acclimatized to 24°C and 15°C and placed at different temperatures in the adult stage were not consistent. Differences were analyzed using the standard error of the mean and the level of significance obtained from the 'distribution of t'; results are recorded in Table 9.

In a further series of experiments adults were developmentally acclimatized to 15°C and maintained at that temperature. LD₅₀'s were measured at 1 day old and 10 days old, using the method described in Chapter 3. The LD₅₀ of 1 day old flies was 42.24°C (0.95

TABLE 8

Age-dependent changes in LD₅₀ (mins) at 41.2 ± 0.05°C for male adult C. erythrocephala developmentally acclimatized to 15 ± 1.0°C and placed at various temperatures on the day of emergence. Standard errors are given and the number in the sample is indicated in brackets.

Temp °C	1 day	5 days	10 days	20 days
15	104.44±6.96 (18)	73.0 ±5.74 (20)	38.0 ±2.94 (20)	39.75±2.57 (20)
24		67.5 ±5.1 (18)	33.33±2.6 (18)	39.44±3.06 (18)
29		40.88±3.29 (18)	45.56±2.82 (18)	38.33±2.91 (18)
34		98.75±6.17 (20)	91.0 ±7.11 (20)	65.0 ±5.45 (20)

Figure 12

Age-dependent changes in LD_{50} (mins) at 41.2°C for male adult C. erythrocephala developmentally acclimatized to 15°C .

Adults were placed on the day of emergence at

●, 15°C ; ▲, 24°C ; ○, 29°C ; ◆, 34°C .

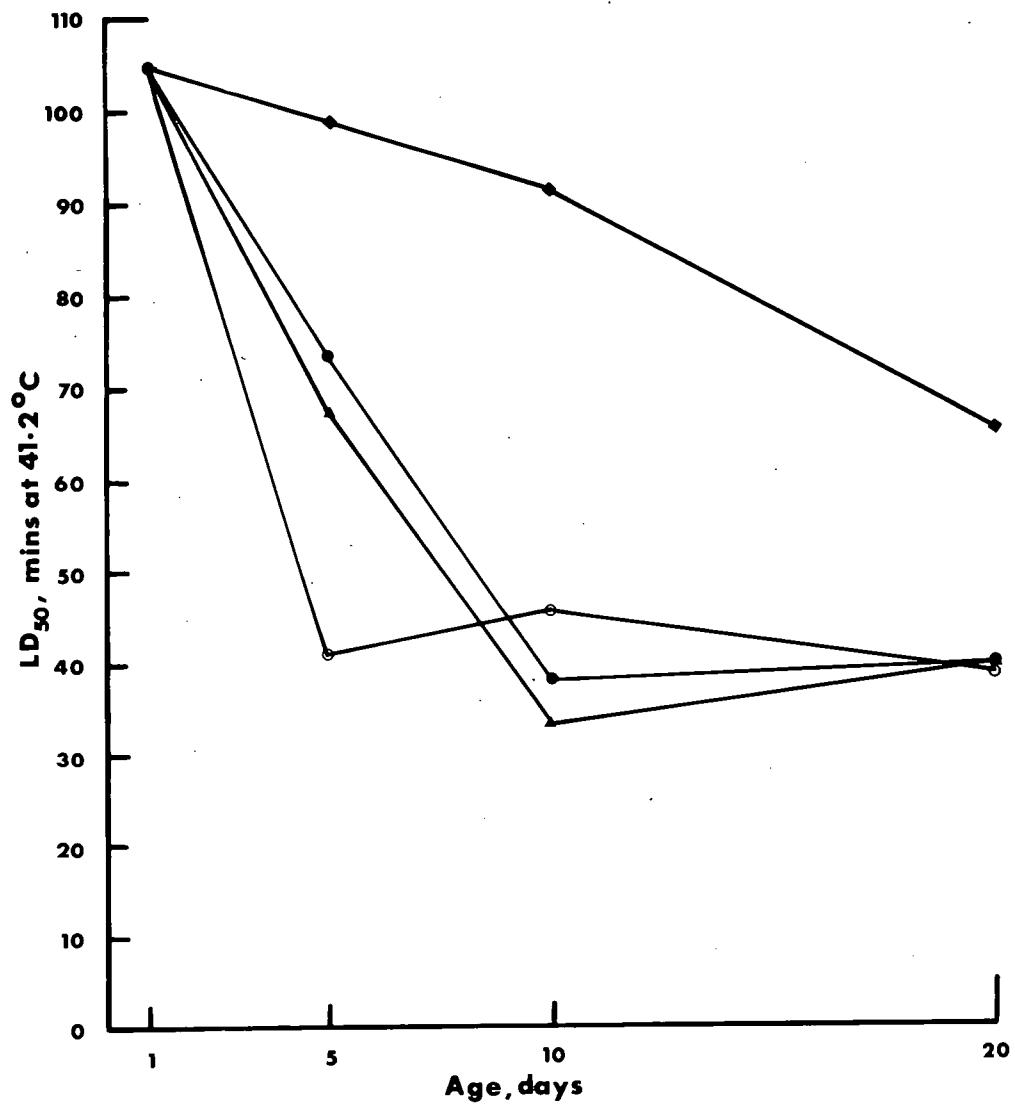

TABLE 9

The significance of the differences in heat resistance of male adult C.erythrocephala developmentally acclimatized to 24°C compared with those developmentally acclimatized to 15°C. Adults were maintained at either 15, 24, 29 or 34°C until 5, 10 or 20 days old. The levels of significance were obtained from the standard errors of the means of the data recorded in Tables 6 and 8.

Adult acclimatization temperature °C	level of significance (p)		
	Age of adults		
	5 days	10 days	20 days
15	0.3	0.05	<<0.02
24	0.5	<0.3	not different
29	0.1	not different	0.3
34	0.01	0.7	0.6

confidence interval was $42.59^{\circ} - 41.97^{\circ}\text{C}$) and at 10 days it was 40.94°C (0.95 confidence interval $41.18^{\circ} - 40.73^{\circ}\text{C}$). The LD_{50} 's were the same as those obtained with adults developmentally acclimatized and maintained at 24°C , see Table 1. Moreover, these results agree with those reported for adults reared and maintained at 15°C and 24°C and recorded in Tables 6 and 8. One day old flies at 15°C were slightly more resistant ($p = 0.4$) than those at 24°C but at all other ages tested the LD_{50} 's in the two groups were the same.

Physiological acclimatization to 34°C

Physiological acclimatization to 34°C has already been demonstrated, see Table 6, and therefore this temperature was chosen to investigate the effect of age on ability to acclimatize. Adults were developmentally acclimatized and maintained at 24°C and, at either 5, 10 or 20 days of age, groups of adults were transferred to 34°C . They were allowed 2, 5 or 10 days for acclimatization and then LD_{50} 's at 41.2°C were determined. The results are presented in Table 10 and Figure 13. The data in Table 6 shows that the LD_{50} of adults was 97.35 mins on the day after emergence and, when transferred to 34°C , it increased to 104.15 mins after 3 days

TABLE 10

Age-dependent changes in LD₅₀ (mins) at 41.2°C of male adult C. erythrocephala maintained at 24°C and placed at 34°C at either 5, 10 or 20 days of age.

Standard errors are given and the number in the sample is indicated in brackets.

Age at transfer to 34°C (days)	LD ₅₀ at transfer	LD ₅₀ 2 days after transfer to 34°C	LD ₅₀ 5 days after transfer to 34°C	LD ₅₀ 10 days after transfer to 34°C
5	72.25 [±] 5.05 (20)	45.43 [±] 3.43 (29)	68.93 [±] 4.29 (28)	73.5 ±6.46 (20)
10	37.22 [±] 2.86 (18)	39.17 [±] 3.03 (30)	53.17 [±] 3.71 (30)	53.17 [±] 3.36 (30)
20	39.75 [±] 2.76 (20)		42.26 [±] 3.23 (21)	42.5 ±2.82 (30)

Figure 13

Age-dependent changes in LD₅₀ (mins) at 41.2°C for male adult C. erythrocephala reared and maintained at 24°C and placed at 34°C when

■, 5 days; ●, 10 days; ▲, 20 days old.

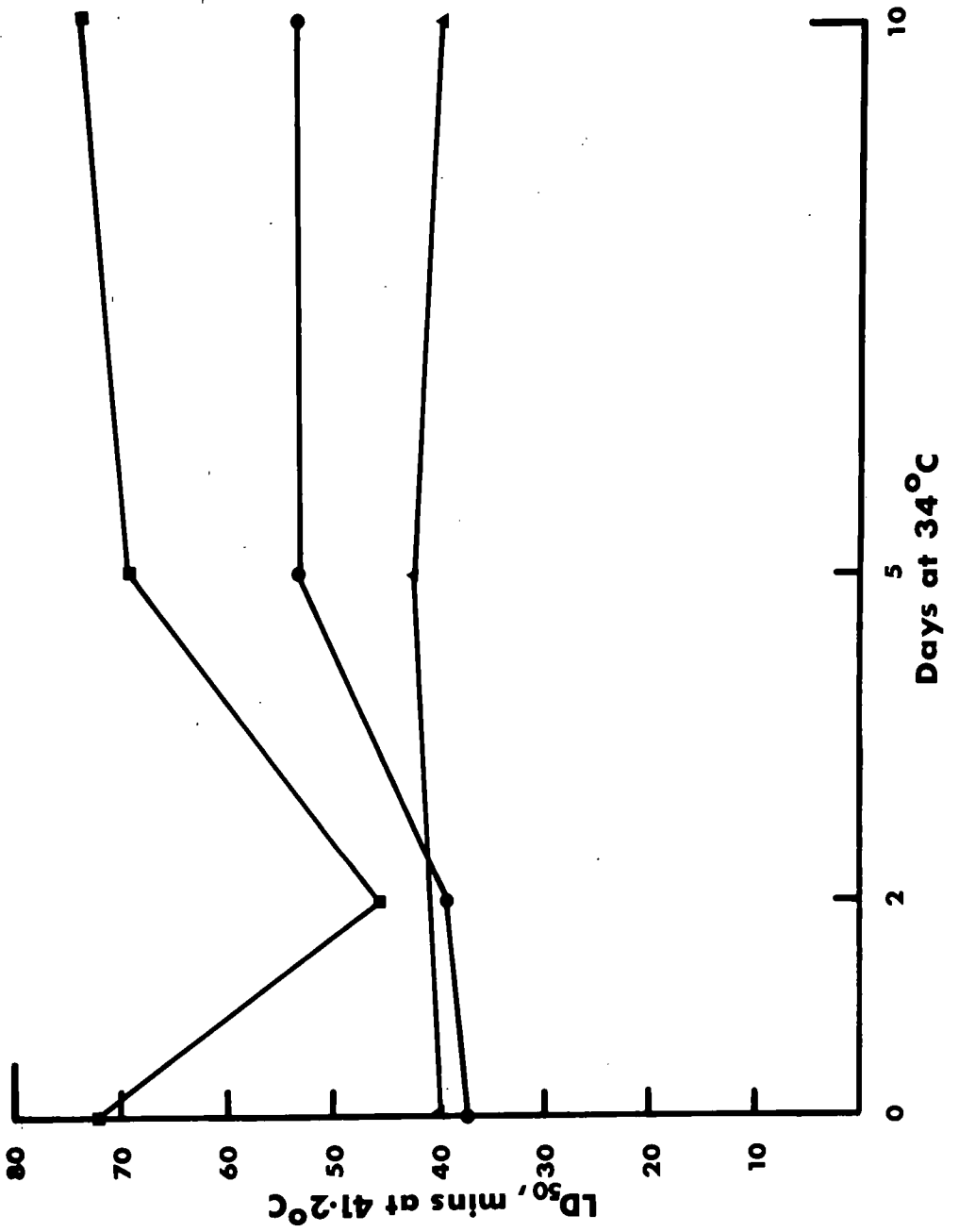

and to 117.2 mins after 5 days. It subsequently fell to 86.39 mins when flies were 10 days old.

Five day old flies had an LD_{50} of 72.25 mins when transferred to 34°C . LD_{50} fell to 45.43 mins after 2 days at 34°C and rose after a further 3 days to 68.93 mins. It was 73.5 mins after 10 days at 34°C . When transferred at 10 days old, LD_{50} increased to 39.17 mins 2 days later, and to 53.17 mins after a further 3 days, it remained at the same level after 10 days. The LD_{50} of 20 day old adults showed an insignificant rise from 39.75 mins at transfer to 42.26 mins after 5 days. It was also 39.75 mins after 10 days at 34°C .

The results in Table 10 and Figure 13, together with those in Table 6, suggest that full acclimatization to 34°C was attained in about 5 days after transfer to that temperature. Moreover, the results of adults transferred at 5 days of age demonstrate that the age-dependent fall in resistance continues before physiological acclimatization is affected. Flies transferred at 20 days old did not show physiological acclimatization at 34°C .

DISCUSSION

The results reported in Table 6 for flies developed and maintained at 24°C show the same pattern of decline in heat death point as that observed in Chapter 3. The

fact, that the small decline in LD_{50} was not observed between 10 days and 30 days old in this part of the study, may be due to the different method employed in determining LD_{50} . In the experiments reported in Chapter 3 two days were allowed from an exposure before mortality was recorded.

When flies were maintained at $5^{\circ}C$ and $10^{\circ}C$ the age dependent decline in LD_{50} was distinctly slower than at $24^{\circ}C$. The pattern at $15^{\circ}C$ and $19^{\circ}C$ were essentially the same as at $24^{\circ}C$ and at $29^{\circ}C$ the fall in resistance was almost complete by 5 days old. The temperature dependence of this loss in resistance indicates that it is metabolically dependent. Indeed, in Chapter 3, it was suggested that the decline in heat resistance is associated with changes taking place in enzymes during maturation of the young imago. Presumably, at 5° and $10^{\circ}C$, these processes are slowed down; whereas at $29^{\circ}C$ they are accelerated.

The results presented in Table 7 indicate that, although physiological acclimatization occurs at temperatures above $29^{\circ}C$, the increases in LD_{50} do not form a consistent pattern. It seems that physiological acclimatization is complicated by a concomitant age-dependent decline in LD_{50} , which is also accelerated

by increasing acclimatization temperatures. Physiological acclimatization does not become superimposed upon this decline until 32°C. Moreover, the increase in resistance between 31° and 32°C is so great as to suggest that this temperature range may be critical for the development of physiological acclimatization. The cause of the abrupt increase in resistance in this temperature range remains obscure.

Most work on the changes in heat death point with increasing acclimatization temperature have been carried out on fish (Fry, 1947; Brett, 1952), and have shown that heat resistance increases proportionately with increasing temperature of acclimatization, until an upper thermal limit is reached. Above this upper limit there is no further increase in heat resistance. Grant (1953) has also reported that the heat death point in the earthworm Pheretima hupeiensis increases by 0.3°C for every 1°C rise in acclimatization temperature.

Baldwin (1954) has demonstrated that heat death point in the chalcid wasp Dahlbominus fuscipennis is not simply related to acclimatization temperature; for adults acclimatized to 17°C were more resistant to 43° C than those acclimatized to 23°C and although the flies acclimatized to 29°C were most resistant, this was lost

in the first 4 days of adult life. The pattern which Baldwin (1954) obtained was not the same as that observed in this study. However, his results can be best explained in the terms of the work presented in Tables 6 to 10 and suggest that resistance adaptation in adult endopterygote insects is more complex than that described for other groups.

The existence of developmental acclimatization in this species remains in some doubt. There seems to be a small increase in heat resistance when adults are developmentally acclimatized to 24°C, but the differences are not consistent, although they are significant at some ages, see Table 9. Thus developmental acclimatization cannot be discounted. When the heat resistance of adults reared and maintained at 24°C are compared to those reared and maintained at 15°C, see Tables 6 and 8, there are no differences. Moreover, lifetables from stocks of animals, developmentally acclimatized to either 15°C or 24°C and transferred to 34°C at eclosion, gave exactly the same LD₅₀'s. The mean expectation of life at 34°C is relatively short, but this temperature can be considered^a viable one. Developmental acclimatization, therefore, seems to have no affect upon the adult life span. The evidence for the

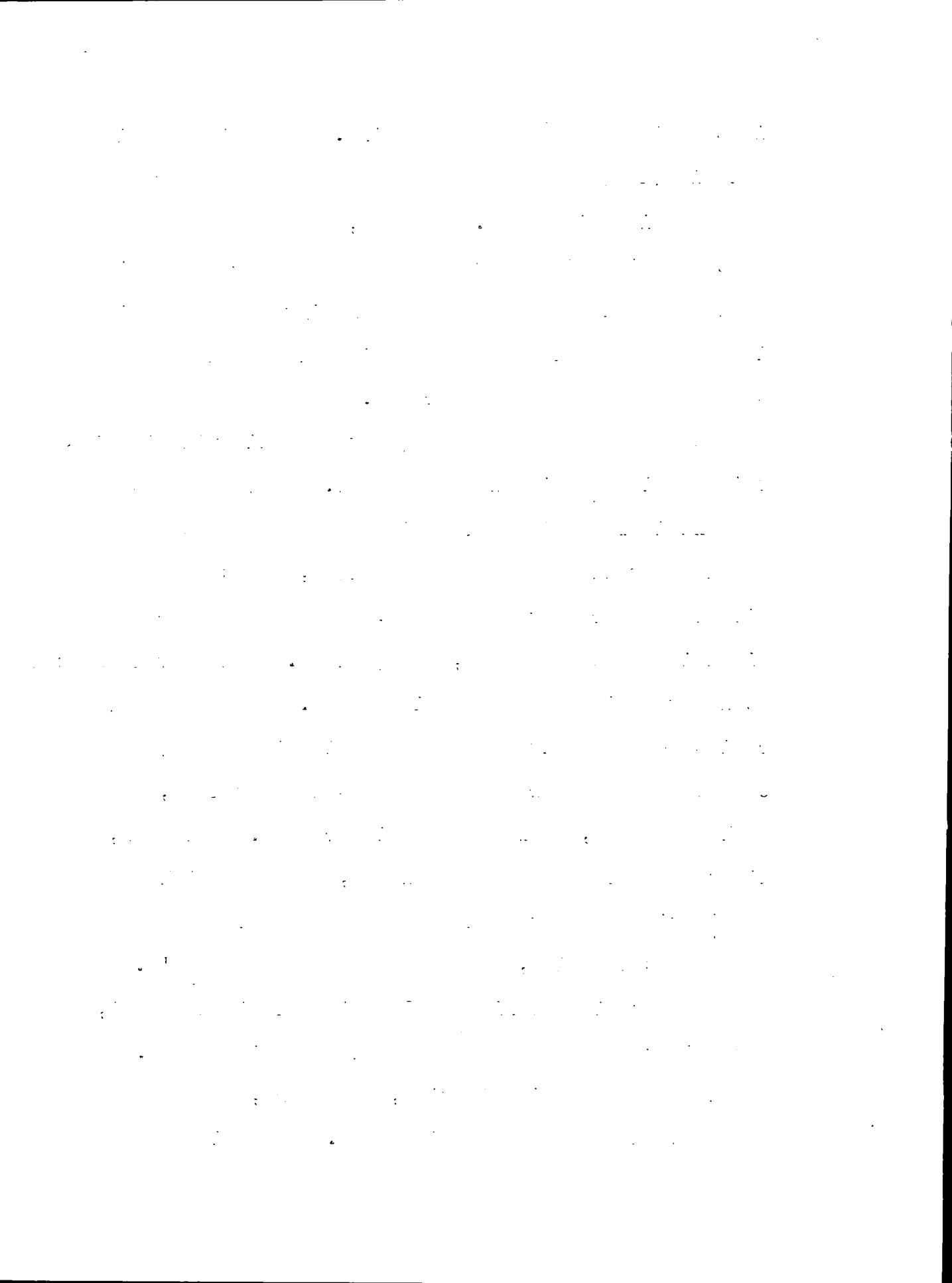

existence of developmental acclimatization in this species appears to be contradictory.

The loss in temperature tolerance in the young adult, which continues over the first 10 days, makes it difficult to determine the real effect of physiological acclimatization. Two interacting and antagonistic factors could be contributing to the changes observed in the LD₅₀. These are (1) the age dependent loss of resistance which is temperature dependent, see Table 6, and (2) the gain of resistance due to physiological acclimatization to higher temperatures in the adult stage. With adults developed and maintained at 24°C (see Table 6) the second factor presumably can be ignored; for adults remain physiologically acclimatized to 24°C and the loss in tolerance is not complicated by physiological acclimatization. When adults are placed at temperatures above 24°C after eclosion, the second factor becomes more important, but it is difficult to determine how much it contributes to the observed LD₅₀.

An estimate of the degree of attainment of physiological acclimatization to 34°C has been made in Table 11. The actual rate of loss of resistance in the young adult at 34°C cannot be determined and so it has been assumed to be the same as at 24°C, although it is almost

TABLE 11

The age dependence of the extent of acclimatization of male adult C. erythrocephala. Adults were transferred from 24°C to 34°C at either 1, 5, 10 or 20 days old and the increase in heat resistance measured by the increase in LD₅₀ (mins at 41.2°C) after 5 days.

Age at transfer	Acclimatization temperature °C	LD ₅₀ at transfer mins	LD ₅₀ after 5 days mins	Change in LD ₅₀ from day of transfer mins	Extent of acclimatization. mins
1 day	24	97.35	72.25 117.2	- 25.1	+ 44.95
	34			+ 19.85	
5 days	24	72.25	37.22 69.00	- 35.03	+ 31.78
	34			- 3.25	
10 days	24	37.22	39.34 53.2	+ 2.12	+ 13.86
	34			+ 15.98	
20 days	24	43.28	38.75 42.26 *	- 4.53	+ 3.51
	34			- 1.02	

* after 10 days

certainly greater (see Table 6, data for 29°C). The results in Table 10 indicate that about 5 days were required for full acclimatization to 34°C, and therefore that data was used. The extent of acclimatization has been defined as the increase in resistance at this temperature i.e. the difference between LD₅₀ at 34°C and the LD₅₀ of adults of the same age at 24°C. In Table 11 the LD₅₀ at the age of transfer is given in column 3 and the observed LD₅₀'s after 5 days at 34°C or 24°C are recorded in column 4. The differences between these values are given in column 5 and the extent of acclimatization in column 6.

The results suggest that young adults are better able to become physiologically acclimatized than older flies, and 20 day old flies seem to be unable to show any physiological acclimatization. Thus physiological acclimatization in C. erythrocephala seems to be an age-dependent phenomenon. Bowler and Hollingsworth (1966) have shown that the extent of acclimatization in D. subobscura declines with adult age and the ability to acclimatize to a higher temperature is lost in this species at 56 days old.

Chapter 6

INVESTIGATIONS INTO THE CAUSES OF HEAT DEATH.

I. THE EFFECT OF LETHAL HIGH TEMPERATURES ON BODY WATER CONTENT AND THE DISTRIBUTION OF IONS IN THE HAEMOLYMPH AND MUSCLE.

INTRODUCTION

Several of the factors implicated in heat death have already been reviewed in Chapter 1. In addition to these, changes in water relations are known to influence the heat point of an animal. Heilbrunn (1952) pointed out that the water content of an organism can affect its heat resistance. Generally, an increase in water is associated with a reduction in the heat death point; while a decrease is associated with a rise in heat death point. Baldwin (1954) has suggested that such changes in adult Dahlbominus fuscipennis may account for the age-dependent changes observed in the heat death point.

Furthermore, the water content of the atmosphere at high temperatures can also modify the LD_{50} of insects. Maynard Smith (1957) has shown that adult Drosophila subobscura die at lower temperatures in dry air than in wet air and the Q_{10} 's of heat death under these two

conditions are 350 and 10,000 respectively. He suggests that the causes of heat death are therefore different at different humidities, but concludes that diffusion of water through the cuticle, or loss through the spiracles, cannot be solely responsible for heat death in D. subobscura, although it is likely to be a contributory cause.

To determine whether the changes in heat death point, which occur during the life history of Calliphora, are related to, or caused by, changes in water content the percentage body water has been determined. Water content has also been measured after lethal and sublethal heat treatments to determine whether dessication is a factor in heat death.

Bowler (1963b) in a study of the causes of heat death in Astacus pallipes observed changes in the distribution of Na^+ and K^+ ions in the haemolymph during exposure to lethal temperatures. He suggested that such changes may be the primary cause of heat death in this species; for an ionic imbalance will affect bioelectric potentials of nerve and muscle, disrupting co-ordination. Later, Bowler and Duncan (1967) correlated these ionic changes with the inactivation of a Mg^{2+} stimulated ATPase in a preparation from crayfish muscle. They

postulated that this ATPase controls the passive permeability of the muscle cells.

Grainger (1969) has observed similar changes in the distribution of Na^+ and K^+ ions during heat death in Arianta arbustorum. He pointed out that it is remarkable for a mollusc and a crustacean to show such similarities in their reactions to lethal temperatures. It was therefore considered a study of the distribution of the important cations in the haemolymph and muscle of C. erythrocephala should be made, to determine whether an ionic imbalance occurs during heat death in this insect.

MATERIALS AND METHODS

Water Content

The water content of larvae, puparia and adults of various ages was obtained by first determining the wet weight and then the dry weight of each of 30 individuals. Dry weights were measured after the animals had been vacuum dried for 48 hrs at 60°C .

Analysis of ions in the haemolymph of larvae

Preliminary experiments with adults were found to be unsatisfactory, as only small quantities (less than $2\ \mu\text{l}$) of haemolymph could be obtained from 1 day old adults

and almost none from older adults. Consequently in these experiments 6 day old larvae (prepupae) were used to obtain haemolymph.

Each larva was quickly rinsed in distilled water and dried on tissue paper, before haemolymph was taken. The hind part of the larva was squeezed and a small cut with a clean scalpel was made in the second or third segment. In this way approximately 10 μ l of haemolymph could be collected on a clean plastic tile. A 5 μ l sample of haemolymph was drawn into a micropipette (Emil Lil) and injected into 2 ml of distilled-deionised water, made slightly acid by the addition of HCl (1-2 drops HCl/1 distilled-deionised water). The pipetting was performed quickly to avoid the haemolymph clotting or becoming discoloured by tyrosinase activity. Na^+ and K^+ concentrations were determined using an Eel flamephotometer. Standard solutions of NaCl and KCl were made up by dissolving the dried Analar salts in distilled-deionised water and these were used to calibrate the instrument.

Analysis of haemolymph and muscle ions

After samples of haemolymph were collected, each larva was dissected and the fat gland, gut and trachea were removed. The carcass was quickly rinsed in

distilled-deionised water, to remove haemolymph, and dried by blotting on a filter paper. Muscle was scraped from the body wall with a clean stainless steel spatula and the sample of muscle placed on a small piece of pre-weighed aluminium foil (previously washed in distilled-deionised water). The muscle and foil were weighed on a torsion balance immediately after the collection of the sample, in order to avoid water loss. Samples of muscle and haemolymph were collected in batches of 10 and the whole operation completed in approximately 30 minutes. The muscle tissue was dried in a vacuum oven at 60°C for 24 hours and then re-weighed. The dried muscle was subsequently ashed for 24 hours in a muffle furnace at 600°C and the ash then dissolved in 2 ml of distilled-deionised water (made slightly acid with HCl).

Sodium and potassium ion concentrations were determined as described above. Mg^{2+} and Ca^{2+} ions were analysed on an Eel atomic absorption spectrophotometer. Standard solutions of MgCl_2 and CaCl_2 were made up by dissolving the dried Analar salts in distilled-deionised water and calibration curves were produced for the spectrophotometer. 2 ml samples, prepared as described above, were sufficient to assay Na^+ , K^+ and Mg^{2+} ions.

However, solutions of Ca^{2+} ions prepared in this way had a concentration too low to be analysed satisfactorily. Consequently 5 samples of haemolymph or muscle were combined and dissolved in 2 ml of distilled-deionised water, to give a sufficiently high concentration of Ca^{2+} ions. In the assay of Ca^{2+} ions, LaCl_3 (5 g/l) was added to the distilled-deionised water to mask interference from phosphate.

The concentration of ions in the haemolymph was expressed as m moles per litre (mM) and the ions in the muscle were expressed as m moles per Kg muscle water.

RESULTS

The water contents of the larval, puparial and adult stages are recorded in Table 12. The water content is highest in the 4 day old larva and it declined to its lowest value in the adult. However, this decline was small and difference between the water content of 4 day larvae old and the 30 day old adult is not significant ($p = 0.3$). Heat treatments were given to groups of animals at various stages in the life history and water content determined directly after heat treatment. When 6 day old larvae were treated to 41.0°C for 40 mins water content fell by only 1 per cent. Similarly, when 7 day

TABLE 12

Percentage water content of control animals and of animals after 40 minute exposure to various temperatures

	No heat treatment	Directly after 40.4°C	Directly after 41.0°C	Directly after 42.0°C	18 hrs. after 42.0°C	Directly after 43.0°C
4 day larvae	74.68±2.64					
6 day larvae	75.23±2.79					
7 day larvae	73.75±2.51			* 72.31±2.46		72.44±2.42
4 day puparia	72.17±2.74					
6 day puparia	71.03±2.51					
1 day adult ♂	70.47±2.35		71.57±2.43			72.41±2.46
5 day adult ♂	70.55±2.41		65.75±3.35		71.59±3.36	61.41±2.52
10 day adult ♂	69.71±2.27					
20 day adult ♂	69.23±2.31					
30 day adult ♂	70.57±2.25	69.44±2.26	67.79±2.4	* 66.99±3.64		64.62±2.23

* Temperature 41.6°C

larvae were treated to 41.6°C and 43.0°C, the water content only declined by 1 per cent, see Table 12. When 6 day puparia were exposed to 41.0°C and 43.0°C (approximate LD₁₀₀) water content did not change from the control value. Thus water loss does not seem to be important at lethal temperatures in this stadia.

With 1 day old adults the water content fell from 70.47 to 65.75 per cent after treatment to 41.0°C and it fell similarly after treatment to 42.0°C (approximate LD₅₀). It fell to 61.41 per cent after treatment to 43.0°C (approximate LD₁₀₀) an overall fall of 9 per cent. Whereas with 30 day old adults, water content fell from 70.57 per cent to 69.44 per cent after treatment to 40.4°C (LD₅₀) and to 66.99 per cent after treatment to 41.6°C (LD₁₀₀). The percentage water loss was less than in 1 day old adults and at 43.0°C (above the LD₁₀₀) it was 64.62 per cent, approximately 3 per cent higher than in 1 day old adults treated to the same temperature. Although 1 day old adults lose slightly more water than 30 day old adults during heat stress, these differences were not significant ($p < 0.3$).

The 1 day old adults that survived 40 mins exposure to 42.0°C replaced their lost water within 18 hours of treatment, see Table 12.

Changes in ions in haemolymph and muscle water during heat stress

The concentrations of Na^+ and K^+ ions in the haemolymph of control larvae were 135.9 mM and 15.1 mM respectively, see Table 13. Boné (1944) has reported Na^+ and K^+ ion concentrations of 148.0 meqiv/l and 37.0 meqiv/l for C. erythrocephala larvae and Duchâteau, Florquin and Leclercq (1953) quote values of 139.6 meqiv/l for Na^+ ions and 26.1 meqiv/l for K^+ ions, for the puparium stage. The values obtained in the present study are in fairly good agreement with those quoted in the literature.

Preliminary experiments suggested that there were no changes occurring in the haemolymph ions at lethal temperatures. Therefore 45°C was chosen as the temperature for heat treatment. Larvae were given this treatment for : 5, 10, 20, 30 and 40 minute periods. The results are recorded in Table 12. After 10 mins at 45°C , when larvae were replaced in sawdust, they were active and 76 per cent pupated successfully. After 20 mins at 45°C larvae were torpid, none responded to stimuli and none pupated. Thus both the 30 and 40 minute treatments at 45°C are above the LD_{100} .

After 5 mins at 45°C the Na^+ ion concentration of

TABLE 13

Concentrations of Na^+ and K^+ ions (mM) in the haemolymph of C. erythrocephala larvae after various heat treatments.

Time at 45°C	Na ⁺ mM	K ⁺ mM	n
0 mins	135.9±13.8	15.1 ±1.6	11
5 mins	138.9±13.0	13 ±1.3	12
10 mins	138.3±15.3	9.3 ±1.3	10
20 mins	135.6±22.9	14.7 ±2.1	8
30 mins	119.5±13.5	18.5 ±2.3	10
40 mins	119.8±11.3	29.2 ±1.1	12

the haemolymph increased slightly and the K^+ ion concentration decreased. After 10 mins the Na^+ level was the same as that after 5 mins but the K^+ ion concentration had fallen to 9.3 mM, significantly lower than in controls ($p = 0.01$). After 20 mins the Na^+ and K^+ ion levels were the same as in controls, whereas after 30 mins Na^+ ion concentration fell to 119.5 mM and K^+ ion concentration increased to 18.5 mM. After 40 mins at $45^{\circ}C$ the Na^+ level remained at 119.8 mM and the K^+ level was raised to 29.2 mM, approximately twice the value found in control larvae.

To determine if a net movement of Mg^{2+} and Ca^{2+} occurred during heat treatment, larvae were heated at $45^{\circ}C$ for 40 mins, as this treatment caused the greatest change in Na^+ and K^+ ion concentrations. Na^+ , K^+ and Ca^{2+} and Mg^{2+} were assayed in haemolymph and muscle water, the results are recorded in Table 14. After this treatment the Na^+ level in the haemolymph fell to 121.6 mM, not significantly different from the control level ($p < 0.2$), but Na^+ level in the muscle did not change. The K^+ concentration increased significantly ($p > 0.01$) in the haemolymph and decreased significantly in the muscle. There were no changes in the concentrations of Ca^{2+} and Mg^{2+} in the haemolymph following this

TABLE 14

Concentrations of ions in haemolymph and muscle water of C. erythrocephala larvae after treatment to 45°C for 40 mins.

Ion	Control		Heated		Significance of the difference P	
	haemolymph mM	muscle water m moles/kg	haemolymph mM	muscle water m moles/kg	haemolymph	muscle
Na ⁺	133.2 [±] 7.5 (19)	15.41 [±] 1.14 (18)	121.6 [±] 4.2 (19)	15.7 [±] 1.3 (18)	≪0.2	no diff.
K ⁺	14.1 [±] 1.4 (17)	81.6 [±] 7.7 (12)	26.8 [±] 1.8 (19)	57.8 [±] 5.5 (13)	>0.01	>0.02
Mg ²⁺	21.5 [±] 1.2 (20)	13.8 [±] 0.8 (18)	20.7 [±] 1.2 (19)	10.5 [±] 0.6 (19)	no diff.	≪0.01
Ca ²⁺	12.8 [±] 0.6 (19)	28.8 [±] 2.0 (20)	12.2 [±] 0.8 (18)	33.1 [±] 3.0 (17)	no diff.	≪0.4
per cent water in animal		84.1 [±] 4.5% (20)		85.5 [±] 4.6% (17)		no diff.

treatment. However, in the muscle the Mg^{2+} level decreased ($p \ll 0.01$) and Ca^{2+} increased ($p = 0.4$). There were no changes in the proportion of muscle water after heat treatment.

DISCUSSION

Baldwin (1954) suggested that the decline in temperature in young adult D. fuscipennis was related to changes in water content, although he did not determine if this was the case. A similar decline in heat death point has been observed in C. erythrocephala adults in this study but there are no significant changes in water content over this period of the life history, see Table 12. The body water content remains fairly constant throughout the larval, puparial and adult stages. It is clear that the age-dependent changes in heat death point, see Figure 8, are not correlated with changes in the water content.

In larvae and puparia there was no appreciable water loss during heat treatment and it does not seem to be a factor involved in heat death in these stages. However, water loss does occur when adults are heat treated, see Table 12. 30 day old adults lost 3.5 per cent of their body water at $41.6^{\circ}C$ for 40 mins (LD_{100})

whereas 1 day old lost 9 per cent of their body water at 43.0°C for 40 mins (approximate LD_{100}). When 30 day old adults were treated 43.0°C for 40 mins, they lost 3 per cent less water than 1 day old adults. The additional water loss in the 1 day old adults may be due to relatively poorer water proofing of the cuticle or poorer spiracular control. Alternatively, it may represent a more efficient method of evaporative cooling. Edney and Barrass (1962) reported that the spiracles of teneral Glossina mortisans open at temperatures above 40°C , and at 45°C these flies were able to cool their bodies by 1.66°C when the surrounding air was completely dry. Although in moist air there was no difference between body and ambient temperature. Thus the additional water loss observed with 1 day C. erythrocephala at 43°C in a RH of 50 per cent may produce a small amount of evaporative cooling.

The differences in water loss by 1 day old adults and 8 day old puparia may account for the differences in LD_{50} . However, it is not considered to be sufficient to account for the differences between 1 day old and 30 day old adults. What must be considered is that changes take place in the LD_{50} of larvae and puparia, and these are not associated with differences in water loss.

The higher water loss of 1 day old adults is almost certainly due to a different permeability of the cuticle, c.f. Chapter 4, where it was suggested that the cuticle of the 1 day old adult was more permeable to insecticides.

The changes in the distribution of Na^+ and K^+ ions in the haemolymph of larvae after heat treatment of 5 mins and 10 mins at 45°C (see Table 13) suggest that the nerve and muscle cells were hyperpolarised. The fall in the level of K^+ ions in the haemolymph is probably due to the active uptake of this ion by the cells. However, after 20 mins the Na^+/K^+ ratios in the haemolymph were the same as in controls. After 30 mins the rise in haemolymph K^+ and fall in Na^+ suggested that there is a breakdown in cell permeability and analysis of these ions in the muscle (see Table 14) show that this is so. However, there were no major changes in Mg^{2+} and Ca^{2+} ions.

Bowler (1963b) demonstrated that changes in the distribution of Na^+ and K^+ ions occurred at the onset of heat death in A. pallipes, and he therefore suggested that these were likely to be the cause of heat death in this species. In C. erythrocephala larvae the temperature/time treatment required to cause such changes

was much greater than those necessary to cause death,
and they cannot be implicated as a lesion in heat death
in the larval stage.

Chapter 7

INVESTIGATIONS INTO THE CAUSES OF DEATH AT
HIGH TEMPERATURE II. AFFECT OF LETHAL AND
SUBLETHAL HIGH TEMPERATURES UPON THE EFFICIENCY
OF OXIDATIVE PHOSPHORYLATION IN FLIGHT MUSCLE
SARCOSOMES.

INTRODUCTION

Evidence suggesting that changes in lipids and proteins, particularly enzymes, are involved in temperature acclimatization and heat death has already been reviewed in Chapter 1. Proteins and phospholipids form the main structural components of cell membranes and in the 'lipoid liberation theory' formulated by Belehrádek (1931) heat death was attributed to the melting of lipid constituents in cell membranes. Ushakov (1964) has rejected this theory and emphasized the denaturation of protein as a cause of heat death. However, the role of lipids and membranes in heat death remains to be clarified. Iandola and Ordal (1966) have shown that heat damage in Staphylococcus aureus is caused by an increase in the permeability of the cytoplasmic membrane and the consequent leakage of solutes. Later, Bluhm and Ordal (1969) reported a reduction in the activities

of several respiratory enzymes directly after sublethal heat treatment of S. aureus, and that these activities recovered in a few hours after such treatment.

Many enzyme pathways are structurally associated with cellular membranes and the integrity of the membrane enzyme complex is known to be important in conferring orientation upon the constituent enzymes of a pathway. The mitochondrion represents such a highly organised membrane-enzyme system, whose functional efficiency is dependent upon the structural integrity and juxtaposition of the component enzymes (Lehninger, 1964). In order to establish the role of the membrane-enzyme complex in heat death, a study has been made of the effects of lethal temperatures upon mitochondria.

Mitochondria have been chosen for they are discrete cell organelles and can be isolated fairly easily in a functional state. Furthermore mitochondrial efficiency, as measured by the tightness of coupling of oxidation and phosphorylation, can be readily determined. When isolated mitochondria are provided with a substrate and phosphate in an oxygenated medium, the esterification of ADP to ATP is coupled to oxygen consumption, and the ADP:O ratio gives a direct measurement of coupling efficiency. Mitochondria are the most important sites of energy production in aerobic cells,

and any damage to this system is likely to have a serious effect upon the levels of ATP and other high energy molecules, which may lead to the impairment of energy requiring cell processes and the consequent breakdown of cellular metabolism.

In this study the giant mitochondria (sarcosomes) of the flight muscle of Calliphora erythrocephala have been used. These sarcosomes are easily accessible and isolation time is relatively short. However, in some respects sarcosomes are unsatisfactory for their morphological integrity and functional behaviour can be altered during isolation (Balboni, 1965; Carney, 1966); structural damage occurring during isolation will markedly affect coupling (van den Bergh, 1962). Sarcosomes can be 'aged' by grinding during isolation or by leaving them for long periods of time after isolation (Lewis and Slater, 1954; van den Bergh, 1962). However, paying careful attention to these facts and using gentle isolation procedures, good sarcosomes whose coupling capacities approach theoretical values can be isolated (van den Bergh, 1962). Furthermore, ensuring standardization of isolation procedure, intact sarcosomes can be obtained, which are satisfactory for use in comparative physiological studies.

The efficiency of sarcosomes isolated from variously heat treated adults are compared with those of untreated control flies. The severity of damage is discussed in relation to the effect of heat treatment on the whole animal, which has been described in Chapter 3.

MATERIALS AND METHODS.

The male adults used in this study were developmentally acclimatized to $24 \pm 0.5^{\circ}\text{C}$ and aged at the same temperature, see Chapter 3. Flies were selected at various ages and heat treatments were given using the method described in Chapter 3.

Isolation of Sarcosomes

Flight muscle sarcosomes were isolated after the procedure used by Lewis and Slater (1954); Lewis and Fowler (1960) and Tribe (1967b). 30 adults were immobilized with carbon dioxide, heads and abdomens were removed as quickly as possible, and the thoraces transferred to a small glass cylinder, similar to the one used by Greville, Munn and Smith (1965). The cylinder was cooled by surrounding it with crushed ice and contained 2 ml of ice-cold sucrose medium I. The thoraces were gently crushed for 2 minutes with a cold, loosely fitting, flat-bottomed glass rod. Care was

taken to avoid twisting or grinding the rod and so damaging the sarcosomes. The resulting pulp was transferred with a further 1 ml of sucrose medium I to a cooled glass funnel lined with 4 layers of fairly coarse muslin, previously boiled in distilled water and soaked in ice cold sucrose medium I. The muscle pulp was forcibly squeezed through the muslin by hand and the filtrate collected in a centrifuge tube, also surrounded with crushed ice.

The filtrate was centrifuged at 100 g for 4 minutes at 4°C in a Mistral 2L centrifuge (M.S.E.) to remove chitin and any flight muscle fibres, which had passed through the muslin. The supernatant was collected and centrifuged at 2,200 g for 10 mins at 4°C in a Mistral 2L centrifuge (M.S.E.) and the resulting pellet suspended in 2 ml of ice cold sucrose medium II. It was recentrifuged at 2,200 g for 10 mins and the final pellet of washed sarcosomes suspended in 0.75 ml of KCl medium III. The average time for the preparation period was approximately 50 mins.

Isolation media used :

- I 0.32 M sucrose, 10 mM EDTA, 2% BSA and 10 mM tris/HCL buffer at pH 7.3
- II As above without 2% BSA.
- III 0.15 M KCl, 1 mM EDTA and 10 mM tris/HCl at pH 7.3

Measurement of oxidative phosphorylation.

Oxidative phosphorylation was measured at 24°C using the oxygen electrode described in Appendix 2. The reaction medium was similar to that used by Tribe (1967b), except the hexokinase-glucose trap was omitted. The basic medium was as follows :-

50 mM KCL

30 mM phosphate buffer (Sørensen) at pH 7.3

5 mM $MgCl_2 \cdot 6H_2O$

1 mM EDTA

20 mM tris/HCl at pH 7.3

The medium was thoroughly equilibrated to 24°C for several hours to saturate it with atmospheric oxygen.

Choice of substrates.

The substrates used were one of the following :-

2M D L α -glycerophosphate (α -GP)

2M sodium succinate

1.5 M sodium pyruvate + 0.5 M L sodium malate

A 50 μ l aliquot of substrate was added to 3.0 ml of reaction medium to give a final concentration of 33 mM. Insect flight muscle is known to be^a highly aerobic tissue and possesses an efficient tracheal supply. Zebe and McShan (1957) have shown that flight muscle contains an extraordinarily active extra-sarcosomal α -glycerophosphate dehydrogenase. This enzyme reduces dihydroxyacetone phosphate produced in glycolysis, to

α -glycerophosphate with the concomitant oxidation of NADH to NAD^+ . The α -GP produced is oxidized intramitochondrially by a flavine-linked α -glycerophosphate dehydrogenase (oxidase); electrons are transferred directly to the cytochrome system, accompanied by two phosphorylations (ADP to ATP). The mitochondrial membrane is permeable to both α -GP and dihydroxyacetone phosphate but not to NADH. Dihydroxyacetone phosphate leaves the mitochondrion and can be reduced again by the extra-mitochondrial α -glycerophosphate dehydrogenase and the cycle repeated.

The α -glycerophosphate cycle acts as a shuttle carrying electrons from cytoplasmic NADH to the respiratory chain and can be summarized schematically as follows:-

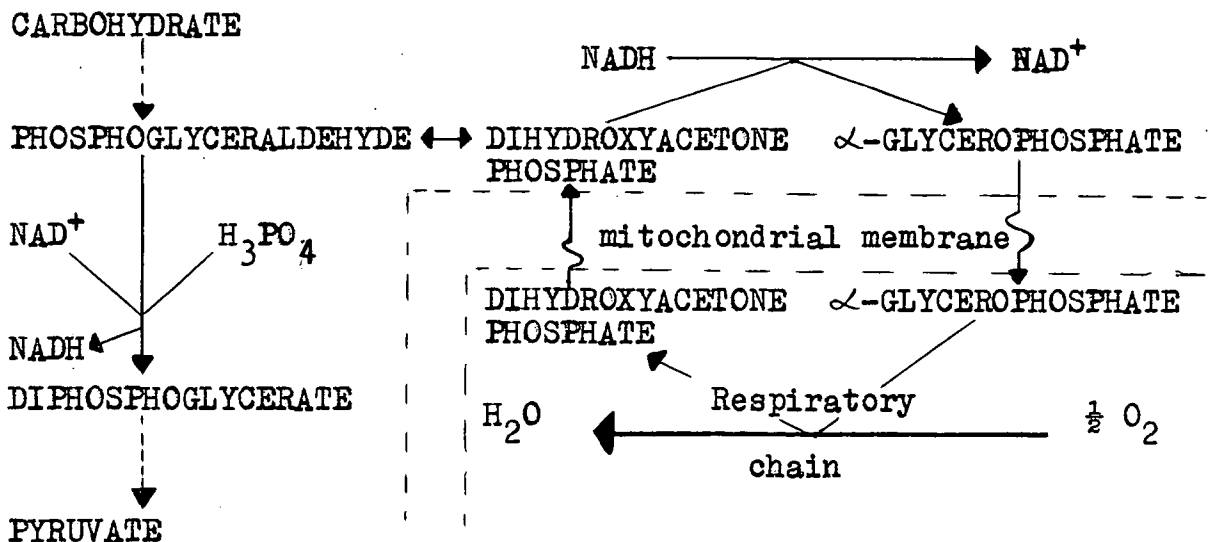

Schematic representation of α -glycerophosphate cycle after

van den Bergh (1962).

Sacktor (1958) has suggested that α -GP is the most important substrate of flight muscle sarcosomes. However, van den Bergh and Slater (1962) have postulated that pyruvate and α -GP are oxidized at high rates for they are produced in equimolar proportions during glycolysis.

Polarographic measurement of oxygen consumption.

3 ml of reaction medium was pipetted into the reaction vessel of the oxygen electrode and after 1-2 mins the recorder was adjusted to give a full scale deflection. Oxygen uptake from this solution was followed by the rate of change of deflection of the pen recorder. Additions to the reaction vessel of the electrode were made with microcap pipettes (Drummond Scientific Co., U.S.A.). 50 μ l of sarcosomal suspension was injected into the reaction vessel and the endogenous rate recorded. Respiration in the presence of substrate alone, called substrate respiration, was measured after the addition of 50 μ l α -GP. Additions of 10 μ l 50 mM ADP (in 30 mM phosphate buffer at pH 6.8) were made and the ADP-stimulated respiration observed. Measurements of oxidative phosphorylation were repeated several times, but not later than 1 hour after isolation, for results after this time became inconsistent, indicating

sarcosomal 'ageing'.

Calculation of QO_2

Sarcosomal oxygen consumption, expressed as μg atoms oxygen/mg protein/hr, is referred to as QO_2 .

Respiration rates were determined as follows :

Let R represent the full scale deflection for the oxygen saturated medium and r the deflection obtained at anaerobiosis; then R-r are the number of scale divisions equivalent to the oxygen content of the medium. For the method of calibration see Appendix 2. Where C (μg atoms) is the oxygen content, S is the rate of chart flow (cm/hr), P is the rate of change of deflection (scale divisions/cm chart) then :-

$$QO_2 = \frac{P \times S \times C}{R-r \times \text{protein conc.}} \quad (\mu\text{g AO/mg protein/hr})$$

Respiratory Control Index.

For polarographic studies Chance and Williams (1956) have defined the respiratory control index (RCI) as the ratio of the respiratory rate in the presence of added ADP to the rate following its expenditure. For reasons given later, RCI has been measured using the ratio of QO_2 in the presence of 0.5 μ moles of ADP to the QO_2 before the addition of ADP i.e. the substrate respiration.

ADP:O ratio.

The ADP:O ratio is the number of moles of ADP esterified to ATP for each gram atom of oxygen consumed. When pyruvate is substrate electrons are donated to the electron transport chain before the flavine nucleotides and consequently there are 3 phosphorylations before the reduction of oxygen (ADP:O = 3). Succinate and α -GP donate electrons via their specific dehydrogenases and electrons enter the electron transport chain after the flavine nucleotides so that only two phosphorylations occur with these substrates (ADP:O = 2).

The ADP:O ratios have been calculated using the method described by Chance and Williams (1955a). When a known amount of ADP is added to a mitochondrial suspension in the presence of substrate, QO_2 increases (see Figure 17) and a quantity of oxygen is consumed. The uptake of oxygen can be measured from the trace by extrapolating the ADP-stimulated rate and the rate after its expenditure, see Figure 17. The distance between the point of addition of ADP and the extrapolated point of its extinction, represents the quantity of oxygen required by respiration when 0.5 μ moles of ADP are converted to ATP.

The estimation of ADP using an enzyme method.

ADP was purchased from Sigma (Grade 1 : disodium salt)

and made up as a 50 mM solution in 30 mM phosphate buffer at pH 6.8. When stored frozen (-20°C) in this state it remains stable for a few months. Samples of ADP solution were assayed by a spectrophotometric method at monthly intervals using a "test kit" supplied by Boehringer (London).

The sequence of the reactions is outlined below :-

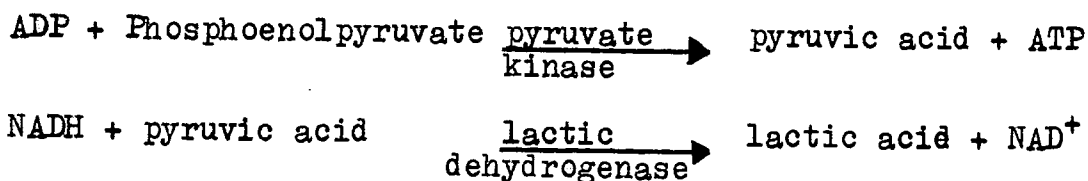

Thus each mole of ADP oxidizes 1 mole of NADH; and therefore the concentration of ADP can be measured by the absorbance change for NADH. This reaction with ADP only goes to 72% completion (personal communication, Boehringer, London) and an appropriate factor must be applied.

Experimental procedure

50 mM ADP was serially diluted to give four concentrations of 0.1, 0.2, 0.3 and 0.4 μ moles ADP per 2 ml tris/HCl buffer at pH 7.4.



Reagents :-

- (1) 10 mM phosphoenolpyruvate, 1.3M KCl, 0.4M MgCl₂
- (2) 6 mM NADH
- (3) 1 mg lactic dehydrogenase/ml
- (4) 1 mg pyruvate kinase/ml

2 ml of the diluted ADP solution was pipetted into a silica cuvette (10 mm light path) together with 0.15 ml of reagent (1), 0.1 ml of reagent (2) and 20 μ l of reagent (3). The contents were stirred and the optical density at 340 m μ measured after 5 minutes, with a Hilger-Watt spectrophotometer. 20 μ l of reagent (4) was added and the contents stirred. The optical density was read at 340 m μ after a further 10 minutes. The change in absorbance for the 4 concentrations of ADP is plotted in Figure 14. The number of moles of NADH oxidized was determined using the Beer-Lombard rule and the extinction coefficient for NADH at 340 m μ (Horecker and Kornberg, 1948).

Determination of sarcosomal protein.

The concentration of sarcosomal protein was determined using the Folin-phenol method of Lowry, Rosebrough, Farr and Randall (1951) and using BSA fraction V as standard.

Figure 14

Spectrophotometric determination of ADP concentration using lactic dehydrogenase, pyruvate kinase, NADH and phosphoenolpyruvate. Details see text.

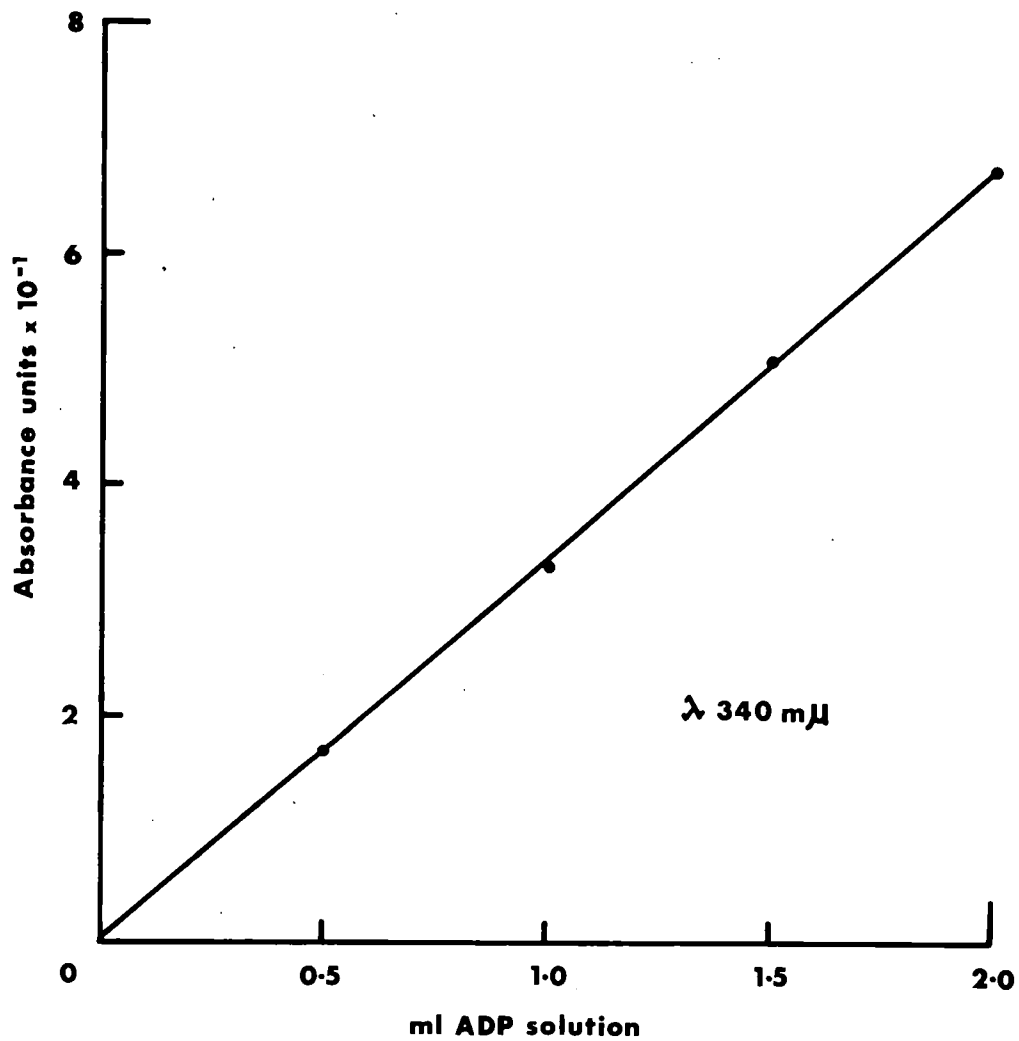

Reagents :

Solution 1 2% (w/v) sodium carbonate in
0.1N sodium hydroxide

Solution 2 0.5% copper sulphate

Solution 3 1% sodium potassium tartrate

Folin mixture A is made up by mixing equal volumes of Solutions 2 and 3 and to each volume of this mixture is added 50 volumes of Solution 1.

Folin mixture B is made up by diluting 4 volumes Folin - Ciocalteau phenol reagent with 6 volumes of distilled water.

Procedure :-

The sarcosomal protein was dissolved in N sodium hydroxide and diluted to give a concentration less than 400 $\mu\text{g}/\text{ml}$. Standard protein solutions were made up of 0, 50, 100, 150, 200, 300 and 400 μg BSA/ml. Duplicates of standards and unknowns were prepared. 0.2 ml of diluted protein was added to 3 ml of Folin mixture (A) in a boiling tube and allowed to stand at room temperature for 30 mins. 0.3 ml of Folin mixture (B) was then added and the resulting mixture allowed to stand at room temperature for a further 60 mins. The solutions were poured into glass cuvettes (10 mm light path) and optical density measured at 500 m μ in a Hilger-Watt spectrophotometer.

Figure 15

Standard curve for protein using
Folin-Ciocalteu phenol reagent.
(BSA as standard protein).

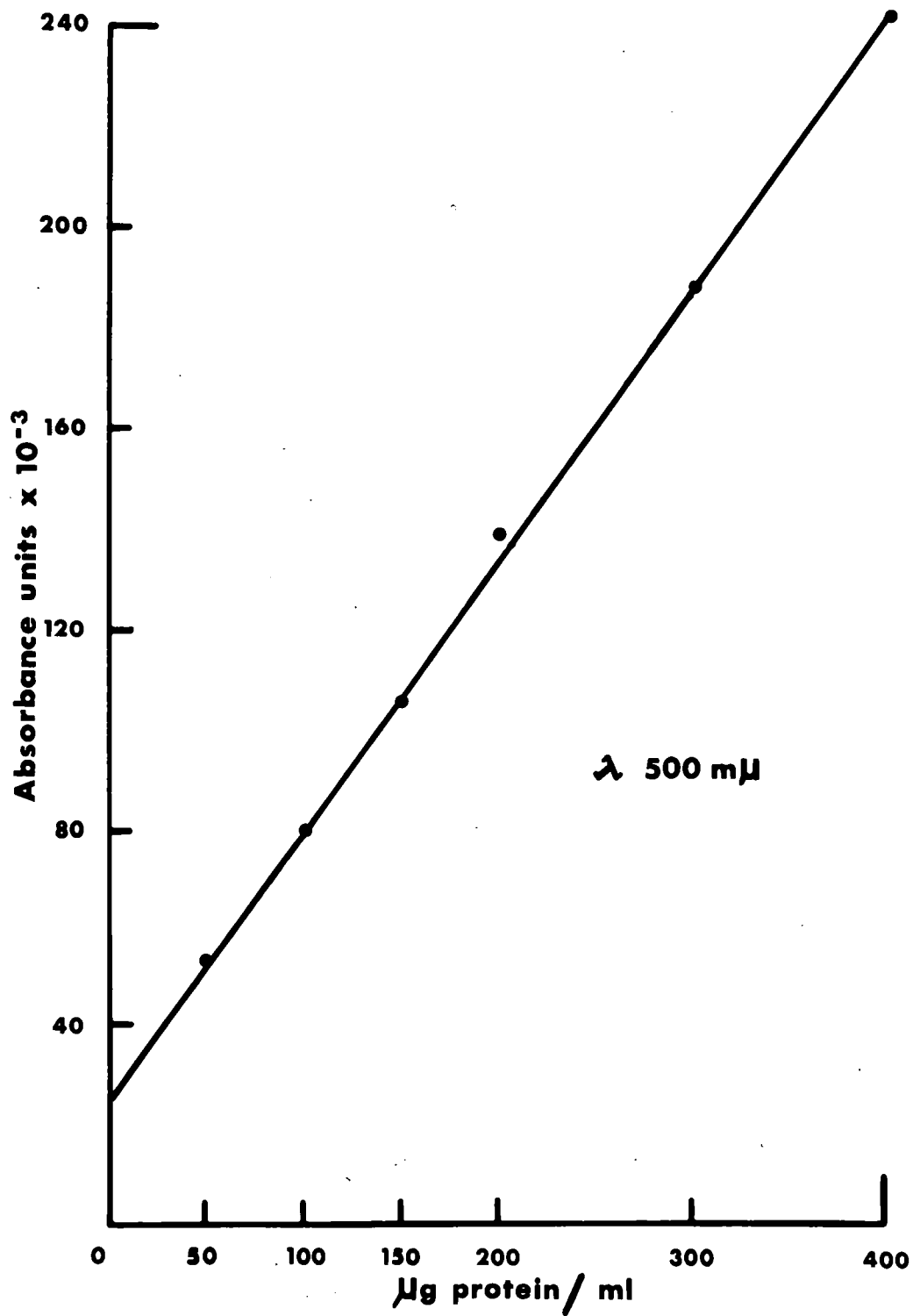

From the standard protein solutions a calibration curve of absorbance against protein concentration was plotted, see Figure 15, and unknowns were determined from this curve.

Measurement of Sarcosomal Mg^{2+} stimulated ATPase activity.

The sarcosomes from 12 thoraces were used in each experiment. Sarcosomes were isolated as described previously and the Mg^{2+} stimulated ATPase and DNP stimulated Mg^{2+} ATPase activities were measured, after Myers and Slater (1957).

Reaction medium :-

75	mM KCl
0.5	mM EDTA
50	mM sucrose
1.5	mM $MgCl_2 \cdot 6H_2O$
2	mM ATP
50	mM tris/HCl at pH 7.3
0.1	mM 2:4 DNP where applicable

Boiling tubes containing 3.0 ml of reaction medium were equilibrated to 24°C in a water bath and the Mg^{2+} stimulated ATPase and DNP stimulated Mg^{2+} ATPase were measured concurrently. The reaction was begun by the addition of 50 μ l of sarcosomal suspension and terminated after 10 mins by the addition of 1 ml of ice-cold 12% TCA. The contents were centrifuged at 4°C for 10 mins at 3,000 g and the amount of inorganic phosphate (P_i) liberated was measured by the method of Fiske and Subbarow (1925).

The DNP factor is the ratio of the Mg^{2+} stimulated ATPase activity in the presence and absence of DNP.

Determination of Inorganic Phosphate.

Boiling tubes were set up to accommodate reagent blanks, standards and unknowns. Standards were prepared by the serial dilution 20 $\mu\text{g}/\text{ml}$ KH_2PO_4 solution.

Reagents : 5N sulphuric acid
 2.5% (w/v) ammonium molybdate

0.5 ml sulphuric acid and 0.5 ml of molybdate were pipetted into each boiling tube together with 1 ml of phosphate test solution. The reaction was allowed to stand for 10 mins when 0.25 ml of diluted Fiske and Subbarow reducer (Sigma) was added. After 15 mins the optical density at 660 $\text{m}\mu$ was measured in a Hilger-Watt spectrophotometer. A standard phosphate curve was drawn, see Figure 16, and the phosphate concentrations of the unknowns were obtained from this curve.

Chemicals

Adenosine-5'-diphosphate (disodium salt), adenosine-5'-triphosphate (disodium salt), DL α -glycerophosphate (sodium salt), sodium pyruvate, D malic acid, bovine serum albumin (Fraction V), tris (hydroxymethyl) aminomethane (Trizma base) and Fiske and Subbarow reducer were obtained from Sigma Chemical Co., Ltd., ATP and BSA

Figure 16

Calibration curve for phosphate using
the method of Fiske and Subbarow.

(20 $\mu\text{g/ml}$ KH_2PO_4 solution as standard)

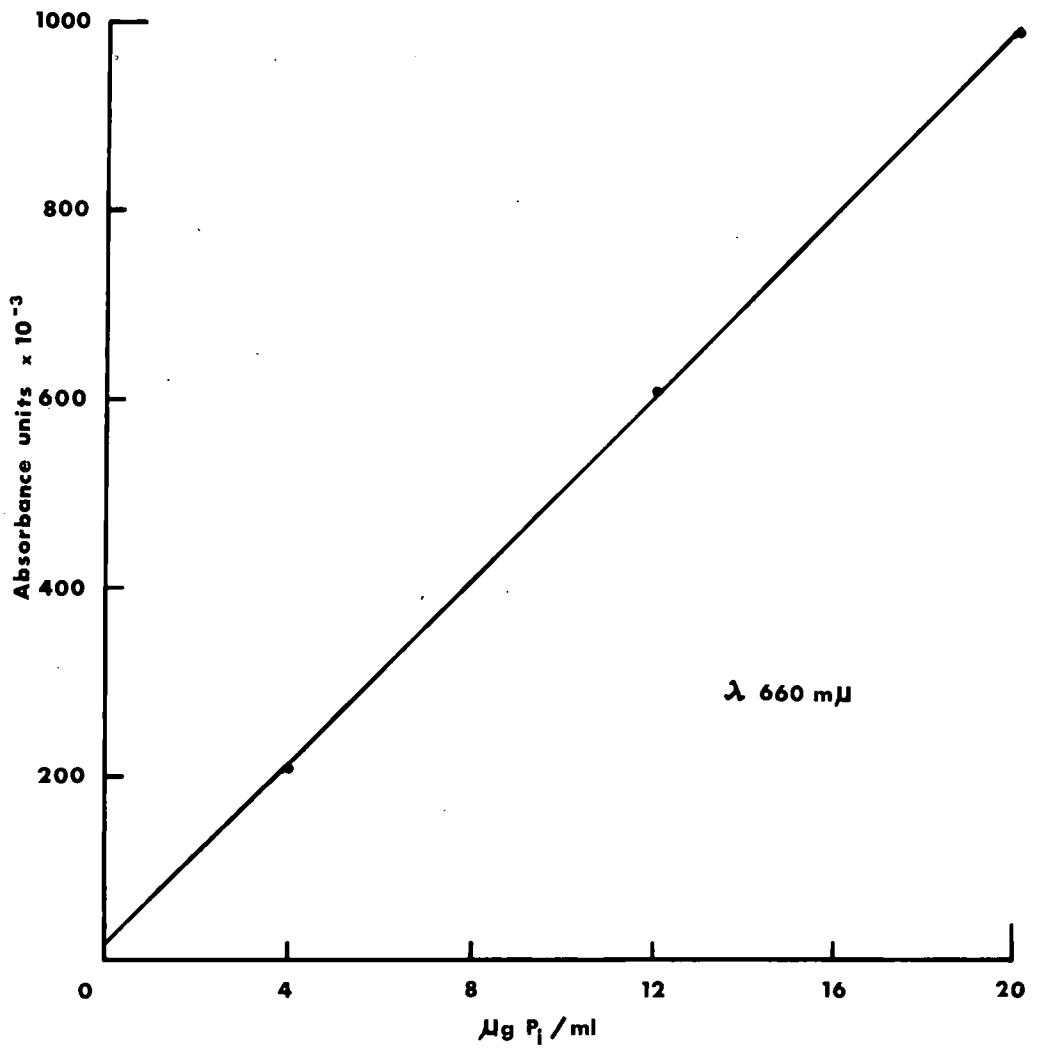

were stored desiccated at -20°C . ADP was stored in a frozen solution buffered at pH 6.8. The chemicals used to assay ADP were obtained in a kit supplied by C.F.Boehringer und Soehne and stored at 4°C .

Ethylenediamine tetra-acetic acid (disodium salt), sodium succinate, 2:4 dinitrophenol and other standard chemicals were obtained from British Drug Houses. AnalaR grade was used wherever possible, otherwise laboratory reagent grade was used.

RESULTS

A typical oxygen electrode recording for untreated, control sarcosomes is presented in Figure 17. Four of the respiratory states recognised by Chance and Williams (1956) have been observed in this study. The endogenous rate in the absence of added substrate corresponds with State 1 (Chance and Williams, 1956); the ADP stimulated respiration in the presence of substrate and ADP corresponds with State 3; the substrate respiration after the expenditure of ADP with State 4 and the anaerobic rate with State 5. State 2, which corresponds to the ADP-stimulated-endogenous rate has not been observed, for as the endogenous rate was very low, there was no necessity to exhaust the endogenous substrate by adding ADP, see Chance and Williams (1955b). Substrate was

Figure 17

Oxygen electrode recordings

Trace 1 Oxygen consumption of sarcosomes isolated from untreated 10 day old male flies.

Trace 2 Oxygen consumption of sarcosomes isolated from 10 day old male flies treated to 42.0°C/40 mins (LD₁₀₀)

The following additions were made to 3.0 ml of reaction medium :

M	50 μ l sarcosomal suspension
α -GP	50 μ l 2M α -GP
ADP	10 μ l 50 mM ADP
S	sodium dithionite (reducing agent)

The ADP:O ratios were calculated using the method of Chance and Williams (1955a). The oxygen consumption in the presence of ADP was calculated from the point of addition of ADP to the extrapolated point, where the ADP-stimulated rate returned to substrate rate.

The vertical bar represents 0.3 μ g atoms oxygen.

The horizontal bar represents 1 minute.

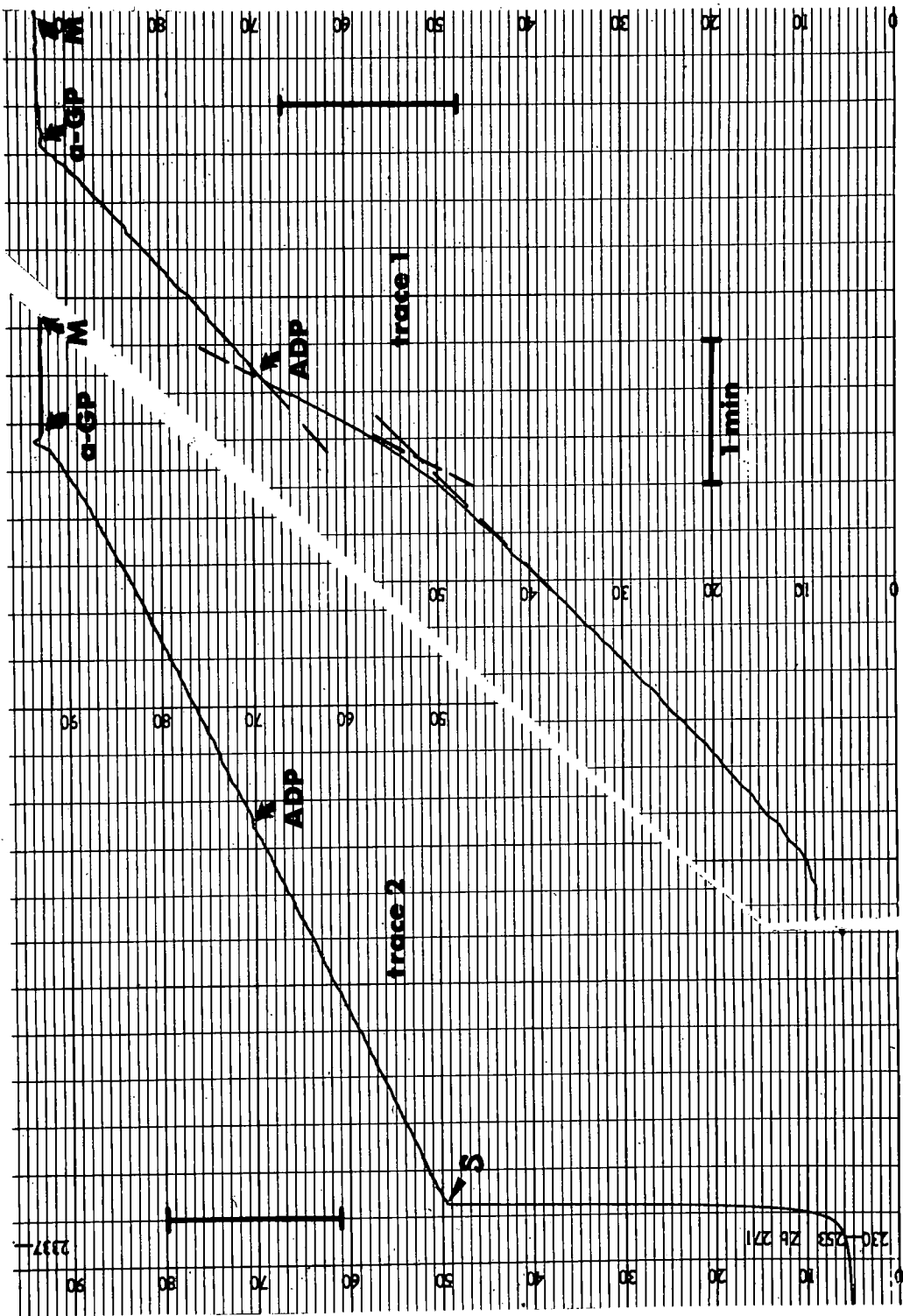

added to the mitochondrial suspension immediately after the endogenous rate was measured, the resulting rate will be referred to as the substrate rate.

The respiratory rates observed with untreated sarcosomes are recorded in Table 15. The endogenous rate is extremely low ($QO_2 = 0.69$) in agreement with the low rates observed for housefly sarcosomes by van den Bergh (1962), who suggested that endogenous substrate is almost absent in those sarcosomes. The addition of substrate, α -GP, caused an immediate rise in respiratory rate, see Figure 17 ($QO_2 = 34.74$), and this rate was further stimulated by the addition of 0.5 μ moles ADP. After the utilization of ADP the respiratory rate almost returned to the substrate rate. Further additions of ADP produced the same effect until the oxygen in the reaction medium was exhausted.

The substrate rate prior to the addition of ADP was slightly lower than the rate observed after the expiration of ADP. Consequently, when these rates were used in the calculation of respiratory control, the 'prior' substrate rate gave a higher RCI, see Table 15. This rate has been used to calculate RCI consistently throughout this study. Firstly because the substrate rate after the expenditure of ADP was not obtainable when sarcosomes were

TABLE 15

Mean QO_2 , ADP : O and RCI values for control sarcosomes from untreated 10 day male flies at 24°C (n = 5)

Respiratory state	$Q O_2$	
	Mean	Range
Endogenous rate	0.69	0.59 - 0.81
Substrate rate with 33 mM L- glycerophosphate	34.74	33.0 - 36.56
ADP stimulated rate 0.5 μ moles ADP	90.68	80.66 - 102.37
Substrate rate after expiration of ADP	39.55	37.16 - 43.87
RCI prior to ADP addition	2.61	2.4 - 2.8
RCI after ADP addition	2.33	2.17 - 2.45
ADP : O ratio	1.65	1.46 - 1.81

inhibited or uncoupled, see Figure 17, secondly the QO_2 measurements in the complete absence of added ADP are directly comparable with the measurement of substrate respiration in manometric studies.

The substrate rates observed in this study agree with those reported by Tribe (1967b) for this stock of flies. Using manometric techniques Tribe recorded values of $365 \mu\text{l } O_2/\text{mg protein/hr}$ ($32.3 \mu\text{g A O}/\text{mg protein/hr}$). However, the ADP-stimulated rates observed in this study were higher than those of Tribe (1967b), who reported values of between 573 and 810 $\mu\text{l}/\text{mg protein/hr}$ for 10 day old adults, which represents 51.1 and 73.2 $\mu\text{g A O}/\text{mg protein/hr}$. The higher values are likely to be due to the better respiratory control obtained with polarographic techniques. ADP:O ratios are similar to Tribe's P/O ratios.

Heat treatments were given to either 1, 10 or 30 day old adults; their sarcosomes extracted directly after exposure and oxidative phosphorylation measured. The LD_0 , LD_{50} and LD_{100} exposures recorded in Chapter 3 are presented in Table 16.

Measurements of oxidative phosphorylation of sarcosomes from heat treated 10 day old flies are recorded in Table 17. After 42.0°C for 40 mins (LD_{100} treatment) substrate rate was approximately two thirds the value obtained with control sarcosomes from untreated adults.

TABLE 16

Approximate LD₀, LD₅₀ and LD₁₀₀ heat treatments for 40 minute exposures obtained from the data used in calculating the heat death points in Chapter 3.

Age days	LD ₀ °C	LD ₅₀ °C	LD ₁₀₀ °C
1	41.0	42.2	43.2
10	39.8	40.9	42.0
30	39.2	40.4	41.6

TABLE 17

Mean $\dot{Q}O_2$, RCI and ADP : O values after various heat treatments to 10 day male flies. Range of values are given in brackets.

Temp. exposure of adults	Sarcosome Respiratory Performance						n
	$\dot{Q}O_2$			RCI	ADP:O	Protein conc. mg/50 μ l	
	Endogenous rate	Substrate rate	ADP stimulated rate				
Control	0.69 (0.59-0.81)	34.74 (33.0 - 36.56)	90.68 (80.66-102.37)	2.61 (2.4-2.8)	1.65 (1.46-1.81)	0.38	5
42.0°C/ 40 mins c. LD ₁₀₀	0.49 (0 - 1.26)	23.52 (18.42-27.03)	20.67 (18.42-24.46)	0.95 (0.81-1.05)	—	0.25	13
41.0°C/ 40 mins c. LD ₅₀	1.26 (0.75-2.55)	18.43 (13.13-24.01)	18.86 (14.61-25.38)	1.03 (0.9-1.11)	—	0.32	11
40.0°C/ 40 mins c. LD ₀	1.42 (1.04-1.65)	32.37 (28.41-37.53)	55.82 (47.44-67.78)	1.73 (1.5-2.17)	1.38 (1.22-1.51)	0.53	6

Moreover, this rate could not be stimulated by the addition of ADP, see Figure 17, in fact it declined slightly after the addition of ADP giving a RCI of less than 1. Observations showed that this decline occurred in the presence and absence of ADP, and the curvilinear electrode trace indicated that a decline in the respiratory rate was occurring during the experiment. ADP:O ratios could not be measured in the absence of respiratory control using the Chance and Williams (1955a) method of calculation.

After treatment of 41.0°C for 40 mins (LD₅₀), the substrate rate was almost half the value of that for control sarcosomes, RCI was approximately 1 and ADP:O was not measurable. However, treatment of flies to 40.0°C for 40 mins (LD₀) caused little change in the respiratory rate of sarcosomes subsequently isolated from them, although RCI had fallen to 1.73 and ADP:O to 1.38 suggesting that sarcosomes were partially uncoupled.

The effects of various heat treatments on the oxidative phosphorylation of sarcosomes from 1 day old flies are recorded in Table 18. The substrate rate in the control sarcosomes from untreated flies was lower than for 10 day old flies, see Tables 15 and 17. After treatment of 1 day old flies to 43.2°C for 40 mins (LD₁₀₀) substrate rate was reduced, RCI was only 1.21 and ADP:O not measurable. After a treatment of 42.0°C/40 mins (approximate LD₅₀)

TABLE 18

QO₂, RCI and ADP : O values of sarcosomes after various heat treatments to 1 day male adults

Temp. exposure of adults	Sarcosome Respiratory Performance						n
	Q O ₂			RCI	ADP:O	Protein conc. mg/50μl	
	Endogenous rate	Substrate rate	ADP stimulated rate				
Control	0.47 (0-0.98)	24.3 (23.28-26.98)	53.52 (41.82-64.1)	2.23 (1.67-2.71)	1.62 (1.28-1.96)	0.20	11
43.2°C/ 40 mins c. LD ₁₀₀	0.39 (0-1.2)	9.18 (5.01-14.21)	10.57 (7.0-14.21)	1.21 (1.0 - 1.41)	—	0.43	7
42.0°C/ 40 mins c. LD ₅₀	1.28 (0-3.64)	10.82 (7.15-16.38)	20.2 (15.51-28.57)	2.04 (1.74-2.5)	1.54 (1.11-1.88)	0.45	9
40.0°C/ 40 mins	1.19 (0-2.7)	26.56 (23.13-28.57)	57.86 (51.95-62.58)	2.22 (1.95-2.71)	1.78 (1.5-2.0)	0.11	4

substrate rate was again reduced, but the RCI was 2.04 and ADP:O almost normal at 1.54. A treatment of 40.0°C for 40 mins caused no change in QO_2 and RCI, in fact the ADP:O was slightly higher than in untreated control sarcosomes. The experiments with 1 day old and 10 day old flies suggest that LD₁₀₀ and LD₅₀ treatments markedly affect oxidative phosphorylation. LD₀ treatment does not have as severe an effect as the treatments which are lethal.

The pattern observed with 30 day old flies was slightly different. 41.0°C for 40 mins (approx. LD₉₀) uncoupled phosphorylation but did not change substrate rate, see Table 19. The QO_2 values observed with the control sarcosomes were slightly lower than the values obtained after treatment of 40.0°C for 40 mins. Uncoupling was observed after sublethal heat treatments.

A series of experiments was performed with BSA omitted from the reaction medium, see Table 20. RCI and ADP:O values for control sarcosomes from 10 day old flies were lower when BSA was omitted, in agreement with van den Bergh (1962) and Tribe (1967b). Substrate rate was slightly higher after a 41.0°C for 40 mins treatment (LD₅₀) and the RCI was 1. After a treatment of 40°C for 40 mins (LD₀) the substrate and ADP-stimulated rates were

TABLE 19

Mean QO_2 , RCI and ADP : O values of sarcosomes after various heat treatments to 30 day male adults.

Temp. exposure of adults	Sarcosome Respiratory Performance					n	
	QO_2			RCI	ADP:O		Protein conc. mg/50 μ l
	Endogenous rate	Substrate rate	ADP stimulated rate				
Control	0.61 (0 - 0.95)	23.73 (22.75-24.89)	53.63 (47.11-62.66)	2.26 (2.05-2.71)	1.66 (1.51-1.71)	0.58	6
41.0°C/ 40 mins c. LD ₉₀	0	23.57 (18.94-28.11)	22.62 (18.94-28.73)	0.96 (0.88-1.02)	—	0.44	4
40.0°C/ 40 mins c. LD ₅₀	1.02	31.51 (27.01-34.63)	50.83 (40.99-62.05)	1.61 (1.38-1.9)	1.22 (1.04-1.45)	0.62	11

TABLE 20

Mean QO_2 , RCI and ADP : O values for sarcosomes after various heat treatments given to 10 day male adults. BSA was not included in the isolation medium

Temp. exposure of adults	Sarcosome Respiratory Performance						n
	QO_2			RCI	ADP:O	Protein conc. mg/50 μ l	
	Endogenous rate	Substrate rate	ADP stimulated rate				
Control	1.23 (0.71-1.9)	35.21 (32.24-38.15)	71.8 (64.47-76.3)	2.04 (2.0 -2.14)	1.25 (1.15-1.36)	0.39	6
41.0°C/ 40 mins c. LD ₅₀	0	24.95 (21.44-29.59)	24.95 (22.47-26.67)	1.01 (0.9 -1.14)	—	0.22	6
40.0°C/ 40 mins c. LD ₀	1.71 (0.94-2.86)	53.54 (51.18-56.92)	95.67 (85.89-106.85)	1.79 (1.69-2.0)	1.31 (1.15-1.43)	0.31	6

significantly higher than when BSA was present in the isolation medium, although RCI and ADP:O values were almost the same. The significance of BSA inclusion will be discussed later.

The data in Table 21 and Figure 18 shows the affect of various concentrations of 2:4 DNP on oxidative phosphorylation of control and 42.0°C/40 mins (LD₁₀₀) treated sarcosomes. DNP uncoupled the control sarcosomes and stimulated oxygen consumption (maximum QO₂ values were observed in the presence of 0.49 - 0.81 mM DNP, see Figure 18) and high concentrations of DNP inhibited QO₂, see van den Bergh (1962). With sarcosomes from heat treated flies no stimulation was observed with DNP. The apparent decline in QO₂ after the addition of DNP to these sarcosomes may be similar to the inhibition previously reported for addition of ADP.

A useful indication of the degree of tightness of coupling in mitochondria can be obtained by measuring the level of ATPase activity (van den Bergh, 1962). The Mg²⁺ stimulated ATPase activity (latent ATPase) is low in tightly coupled mitochondria and the level of activity can be raised (released) by the addition of DNP. The DNP factor, the ratio of the DNP, Mg²⁺ stimulated ATPase to the latent ATPase, reflects the tightness of coupling,

TABLE 21

QO_2 values for sarcosomes from untreated and $42.0^\circ C/40$ mins (LD_{100}) treated 10 day male adults after additions of 2 : 4 DNP. The ADP : O ratio of the untreated sarcosomes was 1.6 before the addition of DNP and the protein concentration 0.34 mg/50 μ l. The protein concentration of the treated sarcosomes was 0.48 mg/50 μ l.

Concentration of 2:4 DNP (mM)	QO_2 of control sarcosomes	QO_2 of LD_{100} treated sarcosomes
0	25.21	18.2
0.003	29.17	
0.0065	30.82	
0.013	35.98	
0.016	39.77	16.54
0.02	36.59	
0.026	46.22	
0.033	52.16	15.44
0.049	66.88	13.79
0.065	66.88	15.33
0.081	68.45	
0.098	62.94	14.88
0.115	55.07	

Figure 18

The effect of DNP on QO_2 of sarcosomes from untreated 10 day old male flies (upper curve) and from 10 day old flies treated to $42.0^{\circ}\text{C}/40$ mins (LD_{100}) (lower curve). The arrows represent the ADP-stimulated rates of respiration.

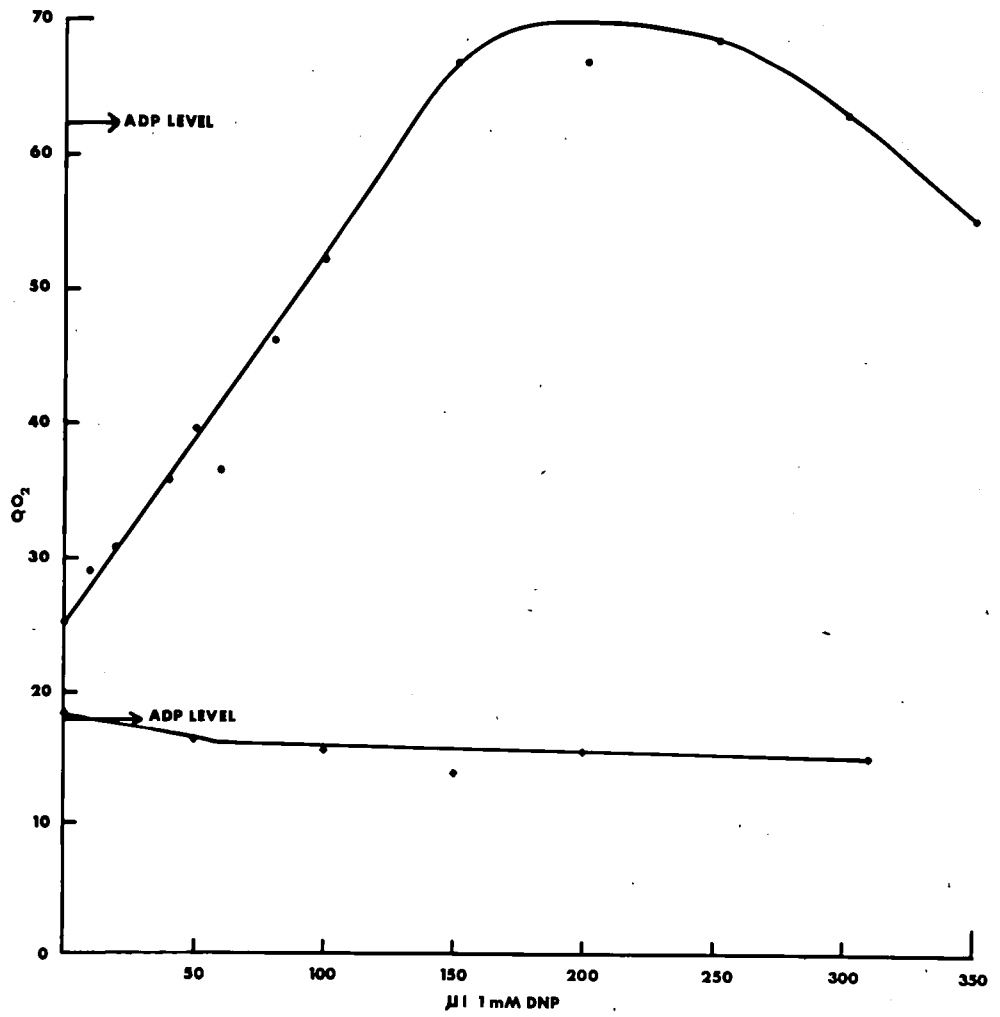

for the DNP factor is large in coupled mitochondria and approaches 1 in uncoupled preparations.

Measurements of ATPase activity and the DNP factor after various heat treatments are recorded in Table 22. Control sarcosomes from untreated 10 day flies had a DNP factor of 4.13, larger than the value reported by Tribe (1967b). After exposure to 42.0°C/40 mins (LD₁₀₀) the DNP factor was only 3.02 and after exposure to 40.0°C/40 mins it was 3.72. The fall in the DNP factor after heat treatment indicates that uncoupling has occurred. However, the extent of uncoupling is not complete for a DNP factor of 3 was obtained, see Table 22.

The results of measurements of oxidative phosphorylation using succinate and pyruvate as substrates are presented in Table 23. Both of these substrates gave low QO_2 values compared to α -GP. After heat treatment to 42.0°C for 40 mins (LD₁₀₀) ADP stimulation was observed with both substrates and respiratory control indices were 1.77 for succinate and 1.5 for pyruvate, the ADP:O ratios were 1.47 and 2.4 respectively. Coupling appeared to be tighter after heat treatment when succinate was used as substrate, it was abolished by freezing and then thawing the preparations.

The coupling observed with these substrates is in agreement with the high DNP factors of the ATPase

TABLE 22

Mg²⁺ stimulated ATPase and DNP stimulated Mg²⁺ ATPase activities of sarcosomes of 10 day male adults after various heat treatments

Treatment	- DNP μ moles Pi released/ mg protein/ min	+ DNP μ moles Pi released/ mg protein/ min	DNP factor	Protein conc. mg/50 μl	n
No treatment	0.42 (0.38-0.46)	1.74 (1.45-2.28)	4.13 (3.52-4.93)	0.073	3
42.0°C/40 mins C. LD ₁₀₀	0.69 (0.65-0.72)	2.08 (1.93-2.16)	3.02 (2.75-3.31)	0.076	3
40.0°C/40 mins C. LD ₀	0.55 (0.52-0.61)	2.04 (1.47-2.41)	3.72 (2.68-3.9)	0.094	6

TABLE 23

QO₂, RCI and ADP : O values for sarcosomes from 10 day male adults using the following substrate : α -GP 33 mM, succinate 33 mM and pyruvate 24.75 + malate 8.25 mM.

	Sarcosome Respiratory Performance						n
	Q O 2			RCI	ADP:O	Protein conc. mg/50 μ l	
	Endogenous rate	Substrate rate	ADP stimulated rate				
Control Substrate α - GP	0.69 (0.59-0.81)	34.74 (33.0-36.56)	90.68 (80.66-102.37)	2.61 (2.4-2.8)	1.65 (1.46-1.81)	0.38	5
42.0°C/ 40 mins Substrate α - GP	0.49 (0 -1.26)	23.52 (18.42-27.03)	20.67 (18.42-24.46)	0.95 (0.81-1.05)	-	0.25	13
Control Substrate pyruvate	1.09	4.35	16.69	3.84	3.19	0.6	1
42.0°C/ 40 mins Substrate pyruvate	0	3.73	5.59	1.5	2.4	0.2	1

TABLE 23 continued.

Sarcosome Respiratory Performance							
	Q O 2			RCI	ADP:O	Protein conc. mg/50μl	n
	Endogenous rate	Substrate rate	ADP stimulated rate				
Control Substrate succinate	1.0 (0 - 2.24)	5.79 (3.57-8.76)	6.97 (4.56-9.22)	1.26 (1.05-1.6)	1.57	0.55	5
42.0°C/ 40 mins Substrate succinate	0.7 (0 - 2.6)	6.79 (5.5-8.67)	11.0 (8.7-11.51)	1.77 (1.31-3.69)	1.47 (1.01-1.95)	0.23	7
42.0°C/40 mins. Preparation frozen and thawed Substrate succinate	-	7.37	7.37	1.0	-	0.23	1

TABLE 24

The affect of recovery on mean $\dot{Q}O_2$, RCI and ADP:O values, after sublethal heat treatment of 10 day old male flies to 40.0°C/40 mins (LD_{50}).

Interval between treatment and isolation	Sarcosomal Respiratory Performance						Protein conc. mg/50 μ l	n
	$\dot{Q}O_2$			RCI	ADP:O			
	Endogenous rate	Substrate rate	ADP stimulated rate					
Control no treatment	1.77 (0.81-2.99)	37.35 (28.23-50.8)	97.55 (52.68-160.11)	2.56 (2.0-3.57)	1.67 (1.41-1.91)		0.47	11
Immediately	1.42 (1.04-1.65)	32.37 (28.41-37.53)	55.82 (47.44-67.78)	1.73 (1.5-2.17)	1.38 (1.22-1.49)		0.53	6
1 day	1.07 (0.58-1.43)	32.68 (30.72-35.52)	58.51 (53.58-64.29)	1.79 (1.7-1.86)	1.45 (1.22-1.59)		0.4	5
2 days	1.41 (0.88-2.13)	32.42 (24.8-37.02)	71.9 (58.22-80.88)	2.27 (1.7-2.73)	1.61 (1.43-1.79)		0.35	9
3 days	1.63 (0.97-3.16)	45.54 (43.18-50.58)	110.3 (89.23-126.44)	2.3 (1.94-2.8)	1.7 (1.47-1.9)		0.46	11

TABLE 25

The affect of recovery on mean QO_2 , RCI and ADP:O values, after sublethal heat treatment of 10 day old male flies to 41.0°C/40 mins (LD₅₀).

Interval between treatment and isolation	Sarcosomal Respiratory Performance						n
	QO_2			RCI	ADP:O	Protein conc. mg/50 μ l	
	Endogenous rate	Substrate rate	ADP stimulated rate				
Control no treatment	1.77 (0.81-2.99)	37.35 (28.23-50.8)	97.55 (52.68-160.11)	2.56 (2.0-3.57)	1.67 (1.41-1.91)	0.47	11
Immediately	1.26 (0.75-2.55)	18.43 (13.13-24.01)	18.86 (14.61-25.38)	1.03 (0.9-1.11)	-	0.32	11
2 days	1.23 (0 - 3.71)	26.93 (25.98-27.54)	45.25 (41.09-52.32)	1.68 (1.55-1.9)	1.38 (1.28-1.48)	0.29	5
3 days	0.88 (0.52-1.28)	31.09 (30.51-32.22)	75.79 (70.64-81.8)	2.44 (2.32-2.61)	1.49 (1.36-1.55)	0.41	4

estimations and indicates that the sarcosomes are not completely uncoupled for all substrates, after LD₁₀₀ treatment.

Recovery from sublethal heat treatment.

Sublethal heat treatments seem to partially uncouple sarcosomes and also affect QO_2 values; but after exposure flies can recover; and those recovering have a normal expectation of life, see Chapter 3. To determine whether sarcosomal damage is repaired after sublethal heat treatment, 10 day old flies were exposed to 40°C for 40 mins (LD₀) and oxidative phosphorylation measured 1, 2 and 3 days later, see Table 24. Directly after such treatment RCI and ADP:O values were low and in the subsequent 2 days both increased; so that by 3 days coupling was as tight as in control sarcosomes. Directly after exposure of flies to 41.0°C for 40 mins (see Table 25) the substrate rate of their sarcosomes was almost half the value observed with control sarcosomes and respiratory control was absent. However, within 2 days QO_2 values had increased and the RCI was significantly higher. 3 days after exposure the performance of these sarcosomes was almost the same as the controls.

DISCUSSION

The results of respiratory studies carried out on sarcosomes isolated from flies treated to lethal

temperatures show quite conclusively that oxidative phosphorylation is drastically impaired. The sarcosomes were isolated directly after exposure and therefore two factors must be taken into account. First, heat death may render the sarcosomes more susceptible to damage during subsequent isolation. However, the changes in oxidative phosphorylation after heat treatment are considered to be too massive to be due to isolation procedure alone. Secondly, lethal temperatures directly affect the sarcosomes in vivo; thereby causing uncoupling and inhibition of oxidation of α -GP and pyruvate.

Fraenkel and Herford (1940) reported a decline in oxygen consumption of blowfly larvae at lethal temperatures above 40°C but suggested that oxygen does not become rate limiting under these conditions. Grainger (1969) has observed similar changes when Arianta arbustorum is exposed to lethal temperatures. Furthermore, Bowler (1963b) reported changes in oxygen consumption of various tissues from heat dead Astacus pallipes, and Grainger (1969) reported the same for heat dead tissues of A. arbustorum. The observations of these workers are in agreement with those reported here for the fall in oxygen consumption of sarcosomes from LD₅₀ and LD₁₀₀ treated flies. Moreover, it is likely that heat death in

Calliphora is primarily due to the breakdown in oxidative phosphorylation and inability to synthesise adequate amounts of ATP. The resultant impairment of energy production could account for the paralysed or sluggish appearance of flies. Naguib and Christophersen (1965) reported a decrease in the ATP level of yeast cells at high temperature. A decline in ATP levels at lethal temperature in flight muscle cells may lead to the breakdown of other important energy dependent cell functions. Presumably after LD₁₀₀ exposures, the damage is so severe that death occurs before repair mechanisms become effective.

The age-dependent changes in heat death point reported in Chapter 3 correlate well with the changes in the heat sensitivity of sarcosomes. For instance, 42.0°C for 40 mins will uncouple and inhibit α -GP oxidation in sarcosomes from 10 day old flies, but it has a much less severe effect upon the coupling and oxidation of 1 day old adult sarcosomes, see Tables 17 and 18. Since the changes in oxidative phosphorylation were most pronounced with α -GP as substrate, see Table 17, it is suggested that impairment of the utilization of this substrate is^a most important cause of death, for it has already been pointed out that it is a major substrate for energy metabolism in sarcosomes.

Furthermore, the results in Table 24 show that damage to the coupling and oxidation of this substrate, caused by LD₀ and LD₅₀ exposures, is completely repaired during the recovery period.

When succinate was used as substrate an increase in QO₂ values and respiratory control was observed after LD₁₀₀ heat treatments, but the ADP:O decreased slightly, see Table 23. Van den Bergh and Slater (1962) have demonstrated that sarcosomes possess a permeability barrier to the intermediates of the Krebs Cycle, which results in very low oxidation rates with these substrates. Thus, the increased QO₂ and RCI values after LD₁₀₀ heat treatment may be accounted for by an increase in sarcosomal permeability and the increased accessibility of succinate to the respiratory assemblies.

The very low QO₂ values, observed when pyruvate was substrate, may be due to the use of sucrose in the isolation medium. Van den Bergh and Slater (1962) have also observed low values when sarcosomes were isolated in sucrose and they were able to increase pyruvate oxidation to the same level as the α -GP oxidation by replacing sucrose with a KCl isolation medium. However, Carney (1966) has reported low QO₂ values for pyruvate with either KCl or sucrose isolation media.

In discussing the causes of the changes in oxidative phosphorylation after sublethal and lethal heat treatments, four factors must be taken into account :-

1. The permeability of the sarcosomal membranes may change.
2. The distribution of divalent cations may change.
3. The release of endogenous uncoupling agents may occur.
4. Damage to the enzymes of the respiratory assemblies may take place.

Taking these points in order. First, the increased oxidation of succinate after LD₁₀₀ heat treatments suggests that the sarcosomal membrane becomes more permeable to substrate molecules, which cannot account for the fall in QO₂ values using pyruvate and α -GP as substrates.

Second, divalent cations are known to cause changes in the performance of sarcosomes; and therefore any changes in the balance of these cations during heat treatment may influence oxidative phosphorylation. Hansford and Chappell (1967) and Donnellan and Beechey (1969) have shown that Ca²⁺ ions act as co-operative allosteric effectors to α -glycerophosphate dehydrogenase when the concentration of α -GP is less than 8 mM. The absence of Ca²⁺ ions after heat treatment should not interfere with the results observed here, for excess concentrations of

L-GP (33 mM) have been used throughout.

Mg²⁺ ions have been provided in the reaction medium and are not therefore considered to be important in these invitro studies.

Third, it is possible that heat treatments cause uncoupling in sarcosomes by stimulating the release of endogenous uncoupling agents. Lewis and Fowler (1960) and Wojtczak and Wojtczak (1960) have isolated these agents and identified them as long chain fatty acids, which can be released from sarcosomes by ageing during isolation. BSA will effectively bind them and stimulate oxidative phosphorylation as demonstrated by Sacktor, O'Neill and Cochran (1958) and many other authors. BSA has been included in the reaction medium throughout this study, however, in one set of experiments it was omitted, see Table 20. In the absence of BSA the ADP:O and RCI values were slightly lower in control sarcosomes but in heat treated sarcosomes these values were not different from those where BSA was included. Although increased QO₂ values, which usually accompany uncoupling, were obtained after LD₀ exposure. The results indicate that endogenous uncoupling agents are not important at lethal temperatures.

Four, lethal and sublethal exposures may damage the enzymes of the respiratory assemblies. The measurements of oxidative phosphorylation with L-GP as substrate,

recorded in Tables 17, 18 and 19, indicate that partial uncoupling occurs at LD_0 exposures. However, as previously pointed out, ADP:O ratios cannot be estimated polarographically in the absence of respiratory control. As ADP:O ratios are the only accurate guide to coupling - the RCI merely represents the ADP stimulation - then the extent of uncoupling after LD_{50} and LD_{100} exposure remains to be determined.

Moreover, uncoupling cannot account for all the changes observed after heat treatment, particularly the decline in QO_2 values with α -GP. Uncoupling is usually accompanied by increased oxygen consumption, e.g. the effect of DNP upon control sarcosomes, see Table 21. Yet DNP does not stimulate QO_2 values of sarcosomes from LD_{100} treated flies suggesting that the oxidative, as well as the coupling enzymes, may be impaired during the exposure.

Estimations of latent ATPase activity, see Table 22, indicated that there is a residual coupling capacity even after LD_{100} exposures, and further investigations showed the coupling of both succinate and pyruvate oxidation with phosphorylation can account for this. Thus the results suggest that the oxidative activity and coupling associated with α -GP are more temperature sensitive than those associated with other substrates.

Most workers have suggested that the various mitochondrial substrates contribute electrons to a common respiratory chain and its associated phosphorylating systems via their specific dehydrogenases (see reviews by Lehninger, 1964; Pullman and Schatz, 1967; Lardy and Ferguson, 1969). A differential sensitivity of both the coupling and oxidative enzymes associated with α -GP oxidation would suggest that oxidative phosphorylation of this substrate is carried out by different respiratory assemblies to those associated with other substrates. However, further investigations are required to confirm this and, in particular, measurements of ADP:O ratios with α -GP after LD₁₀₀ exposure are necessary to determine whether uncoupling is complete with this substrate.

The difference in thermolability of sarcosomes from 1 day old and 10 day old flies correlated well with the differences in their heat death points. These differences are probably related to the development of sarcosomes during this period. Tribe (1967a) reported changes taking place in the size and distribution of sarcosomes in adults in this age group. Lennie, Gregory and Birt (1967) and Gregory, Lennie and Birt (1968) have also shown an increase in the size of sarcosomes and the distribution and organisation of cristae in young adult Lucilia cuprina.

These agree with other observations of changes in the distribution of sarcosomal DNA and RNA (Lennie, Gregory and Birt, 1967); increase in enzymic and structural protein over the period of emergence and post emergence (Walker and Birt, 1969a); the accumulation of phospholipids by sarcosomes (D'Costa and Birt, 1966). In particular, Walker and Birt (1969a) have shown changes in the activities of α -glycerophosphate oxidase and dehydrogenase in young L. cuprina, as well as an increase in the distribution of elementary particles (Walker and Birt, 1969b). These elementary particles are believed to be associated with the Mg^{2+} stimulated ATPase activity (see Pullman and Schatz, 1967; Green and MacLennan, 1969) and are therefore implicated in the coupling of oxidative phosphorylation. Thus the changes in heat sensitivity of sarcosomes may be the result of these changes taking place in sarcosomal organisation. This will be investigated further in Chapters 8 and 9.

Chapter 8

ULTRASTRUCTURAL CHANGES IN SARCOSOMES
AFTER EXPOSURE OF ADULT CALLIPHORA ERYTHROCEPHALA
TO LETHAL AND SUB-LETHAL HIGH TEMPERATURES.

INTRODUCTION

In Chapter 7 the measurements of oxidative phosphorylation made on isolated flight muscle sarcosomes, directly after exposure of intact flies to lethal or sub-lethal high temperatures, indicated that the functional behaviour of these organelles had been drastically impaired. It was suggested that damage to the ordered sequence of enzymes in the respiratory assemblies of sarcosomes and the consequent breakdown in their function may constitute one of the primary and most important lesions in heat death of adult Calliphora.

It is well known that the coupling of oxidative phosphorylation in the mitochondrion is dependent upon the morphological integrity and spatial ordering of the component enzymes (Lehninger, 1964). Carney (1966) has shown that changes in the activity of isolated housefly sarcosomes were linked with gross morphological changes and Balboni (1965) and van den Bergh (1962) have pointed

out that structural damage occurring during isolation markedly affects coupling. Furthermore, Weinbach, Garbus and Sheffield (1967) demonstrated that uncoupling of isolated rat liver mitochondria by 2:4 DNP or other substituted phenols was accompanied by marked morphological changes. In order to determine whether the changes in functional behaviour of sarcosomes after heat damage are linked to changes in their structural organisation, a study has been made of the effect of lethal temperatures upon the morphology of intact sarcosomes.

The ultrastructure of fibrillar flight muscle in C. erythrocephala has been described by Smith (1963) and in a number of other insects by Gregory, Lennie and Birt (1968) and Smith (1961, 1962, 1965 and 1966). These observations show that sarcosomes are relatively large mitochondria (2-3 μ in length), which pack the inter-fibrillar sarcoplasm. They have the typical double membrane structure of mitochondria and the inner membrane is folded into complex and unique lamellate cristae, which are compactly arranged into parallel arrays. Moreover, work on other mitochondria has shown that the enzymes of the respiratory chain and its associated phosphorylating systems are intimately organised into replicated units or assemblies, which appear to represent a substantial

portion of the organised structural elements of the inner mitochondrial membrane (see reviews by Pullman and Schatz, 1967; Green and Maclellan, 1969; Lardy and Ferguson, 1969).

The organisation of the cristae is best observed in longitudinal profile and throughout this study longitudinal sections of flight muscle have been used in the preparation of electron micrographs. Observations on the affect of lethal temperatures upon the morphology of sarcosomes from flies of different ages will be discussed in relation to the results obtained in the heat death studies presented in Chapter 3 and the physiological studies on sarcosomes presented in Chapter 7.

MATERIALS AND METHODS.

Experimental animals

1 day old and 10 day old male flies, acclimatized to 24°C, were used in this study. The experimental animals were given LD₅₀ and LD₁₀₀ heat treatments, see Table 16, using the method described in Chapter 3.

Fixation and electron microscopy

Directly before fixation insects were killed by decapitation and the abdomen and legs removed. Each thorax was carefully bisected dorsoventrally and the two halves dropped into ice-cold fixative. Two methods of

fixation were used. In the first method the half-thoraces were fixed at 4°C, for 3 hours in 1% osmic acid in isotonic buffer (pH 7.3). This buffer consisted of 120 mM sodium dihydrogen phosphate, brought to pH 7.3 with sodium hydroxide and made isotonic with 30 mM glucose. In the second method, fixation was for 1½ hours in 2.5% glutaraldehyde in isotonic phosphate buffer (pH 7.3) and then for 1½ hours in 1% osmic acid in the same buffer. The half-thoraces were then washed in ice-cold buffer and the dorsal longitudinal flight muscles carefully dissected out. After two further washings in buffer the fixed tissue was dehydrated through a graded series of ethanol solutions and finally placed in epoxypropane.

The muscles were embedded in Epon after the method described by Mercer and Birkbeck (1961). The embedded tissue was orientated and sectioned longitudinally on a L.K.B. Ultratome. Thin sections, approximately 300 Å in thickness, were collected on copper grids coated with formvar and the sections were stained with uranyl acetate, after the method described by Watson (1958), and lead citrate (Reynolds, 1963). Electron micrographs were taken on an A.E.I. EM.6B electron microscope.

OBSERVATIONS

Electron micrographs of longitudinal sections of

the dorsal longitudinal flight muscle of 10 day old untreated flies, shown in Figures 19a and 19b are similar to those obtained by Smith (1963). In these sections the A, I, M and Z bands of the myofibrils are visible and measurements showed that the average sarcomere length was approximately 4 μ . The interfibrillar sarcoplasm is packed with sarcosomes, which are orientated singly or in twos apposite each sarcomere. However, the sarcosomes do not appear to be precisely aligned with respect to the myofibrillar striations (see Smith, 1963). The profiles of the sarcosomes are ovoid and slightly irregular, some sarcosomes are almost 5 μ in length, see Figure 19a, although average length appeared to be 2-3 μ . The majority of the cristae are orientated at right angles, or obliquely to the long axis of the fibrils in sub-parallel arrays. The outline of these lamellate cristae is frequently broken by fenestrations (Smith, 1963), see Figure 19a, and in some sarcosomes the fenestrations in successive cristae appear to be aligned, see Figure 19b. The remainder of the sarcoplasm is filled with glycogen which has the appearance of a dense granular material when stained with lead citrate. Tracheoles are frequently observed in these sections; they have a circular appearance when cut in transverse

Figure 

An electron micrograph of the dorsal longitudinal flight muscle from an untreated 10 day old male fly (osmium fixation).

The sarcosomes (s) are closely juxtaposed to the myofibrils (my). The sarcomere length is approximately 4 μ and the striations of the myofibrils are indicated (a, i, m and z). The sarcosomes are packed with lamellate cristae (c) and fenestrations break up the cristal plates (p). Tracheoles (t) in transverse profile are visible in the granular sarcoplasm.

Magnification x 30,000.

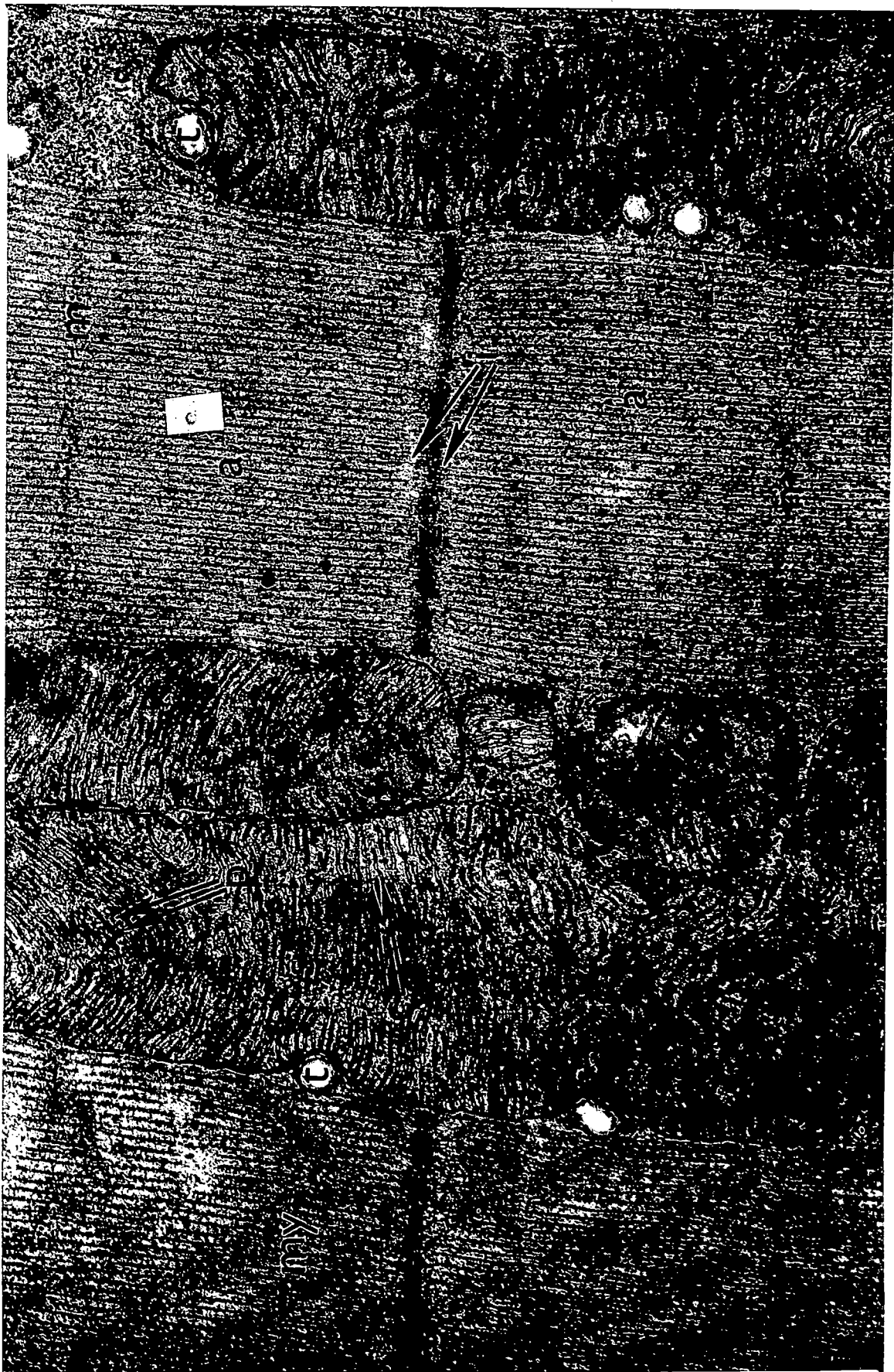

Figure 19b

An electron micrograph of the dorsal longitudinal flight muscle from an untreated 10 day old male fly (osmium fixation). Labelling as in Figure 19a.

Magnification x 34,300



section and an irregular appearance in longitudinal section (see Figure 22). Elements of the sarcoplasmic reticulum do not appear in the electron micrographs presented in Figures 19a and 19b, but 2 membered dyad structures are visible in Figure 26.

The longitudinal sections of flight muscle from untreated adults can be compared with the appearance of sections of muscle from flies of the same age, directly after exposure to 42.0°C for 40 mins, the LD₁₀₀ treatment, see Figures 20 and 21. The electron micrographs are representative of many similar sections of tissue, prepared on different occasions from flies several generations apart. The organisation of the myofibrils, tracheoles and sarcoplasm in this tissue does not differ from the untreated tissue, except that the myofibrils in Figure 20 appear to be slightly contorted, perhaps due to muscular spasm during heat death. The ultrastructure of sarcosomes differ considerably from their untreated counterparts and the parallel arrays of cristae are almost completely lost. Also, the lamellate appearance of the cristae is grossly distorted in some areas of the sarcosomes. The small, discrete dark areas in electron micrographs of these sarcosomes suggest that electron opaque granules have

Figure 20

An electron micrograph of the dorsal longitudinal flight muscle from a 10 day old fly treated to 42°C/40 mins, LD₁₀₀ treatment (osmium fixation). Note the disorganised appearance of the parallel arrays of cristae and the distortion of the cristae plates. The dark granules (g) in the sarcosomes are probably accumulations of precipitated inorganic ions.

Magnification x 22,500



Figure 21

An electron micrograph of the dorsal longitudinal flight muscle from a 10 day old fly treated to 42°C/40 mins, LD₁₀₀ treatment (glutaraldehyde + osmium fixation). Note the disorganisation of the lamellate cristae and the dark granules (g) which are probably accumulations of precipitated inorganic ions.

Magnification x 48,150

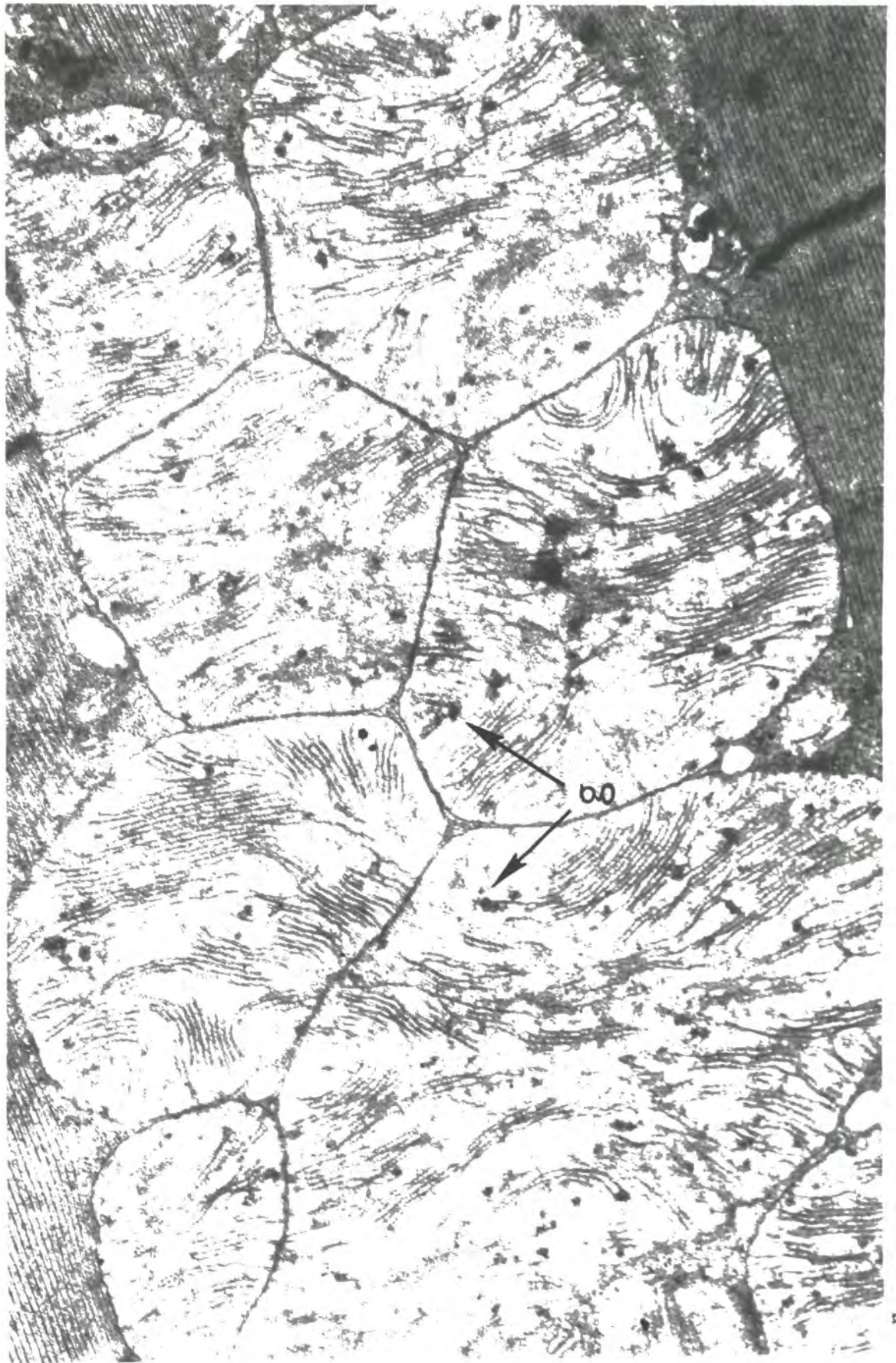

been precipitated and coalesced during heat treatment. The origin of these granules will be discussed more fully in the description of 1 day old sarcosomes treated to LD₁₀₀ temperatures.

After the treatment of 10 day old flies to 41.0°C for 40 mins, the LD₅₀ heat treatment, profiles of sarcosomes are the same as observed with the untreated specimens, see Figure 22. The cristae do not appear disorganised and are orientated in parallel arrays with the fenestrations clearly visible. However, the granular sarcoplasm appears to be less dense than in control tissue, see Figure 19a. Similar results to those presented in this figure were obtained with the flight muscle of flies treated to 40°C for 40 minutes, the LD₀ heat treatment (not shown).

Figure 23 is an electron micrograph of the flight muscle of one fly, 24 hours after treatment to 41.0°C for 40 mins. This animal was only capable of sluggish crawling movements and appeared to be in a dying condition. The profiles of its sarcosomes are quite unlike those in Figures 20 and 21. The lamellate cristae are discernible but appear to be coalesced in places giving rise to dark areas in the sarcosomes. These organelles are possibly in the first stages of autolysis.

Figure 22

An electron micrograph of the dorsal longitudinal flight muscle from a 10 day old male fly directly after treatment to 41°C/40 mins, LD₅₀ treatment (osmium fixation). The organisation of the lamellate cristae appears to be the same as that observed with sarcosomes from untreated flies. A tracheole (t) is visible in longitudinal section.

Magnification x 30,000

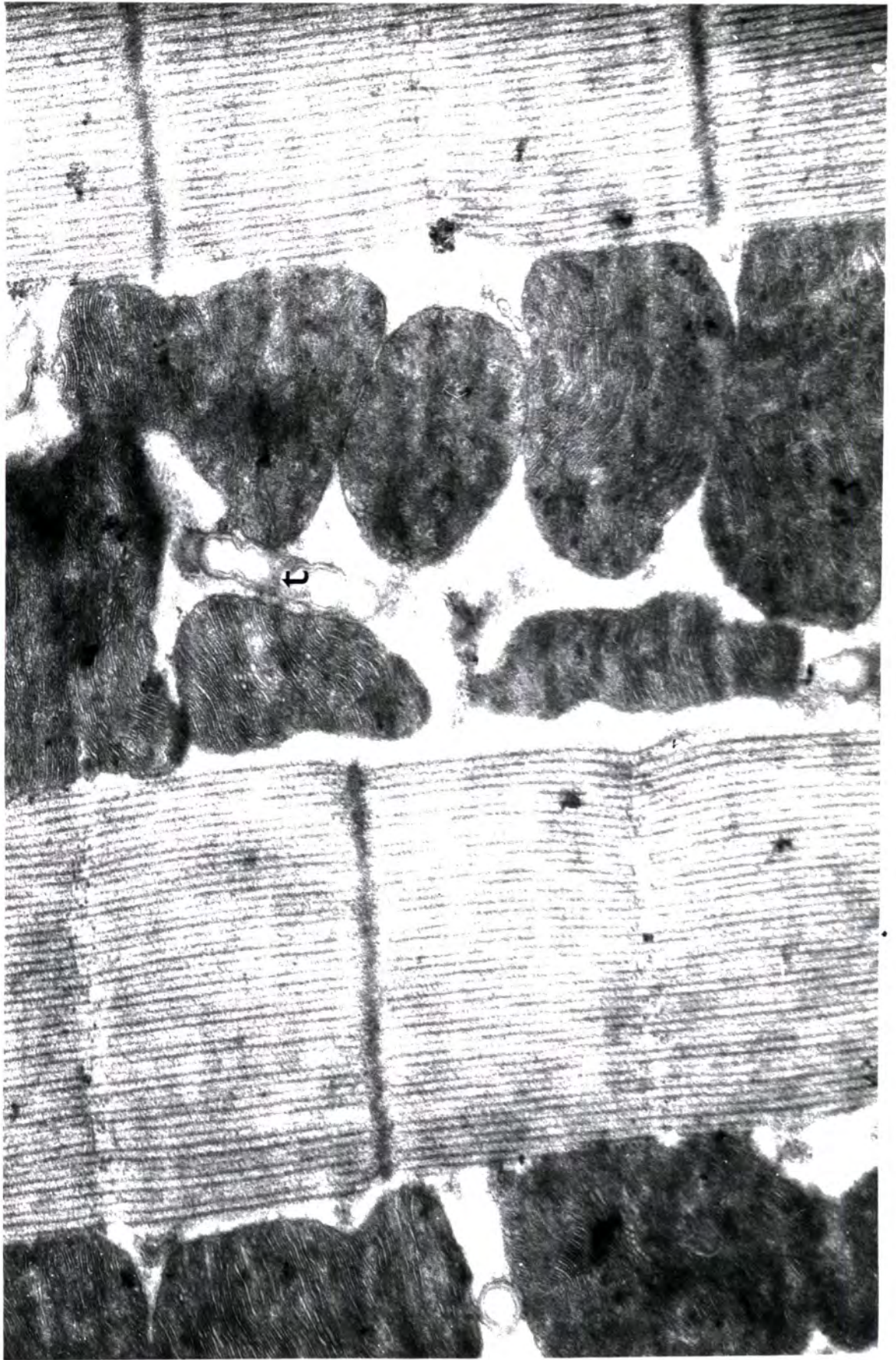

Figure 23

An electron micrograph of the dorsal longitudinal flight muscle from 10 day old male flies 24 hours after treatment to 41°C/40 mins, LD₅₀ treatment (osmium fixation). The profiles of the sarcosomes are unlike those from untreated flies, the cristae are not disorganised, but appear to have coalesced.

Magnification x 15,750.



The series of experiments was performed with one day old adults as a comparison to those with 10 day old adults. In each case 3 adults were used in the preparation of fixed material. An electron micrograph of a longitudinal section of flight muscle from an untreated 1 day old fly is presented in Figure 24. The appearance is the same as for 10 day old flies, although the sarcosomes are slightly smaller, length 1 - 2 μ in agreement with the observations of Tribe (1967a) on isolated sarcosomes for this stock of Calliphora. 'Type a' sarcosomes (Gregory et al, 1968) with few lamellate cristae were not observed in this study, all the sarcosomes observed in 1 day old Calliphora were 'Type b', which have the highly organised lamellate cristae shown in Figure 24. After treatment of flies to 42.0°C for 40 mins (approximate LD₅₀ heat treatment) no changes were observed in the lamellate structure of the cristae, see Figure 25. However, after exposure to 43.2°C for 40 mins, the LD₁₀₀ heat treatment, the cristae structure in Figure 26 appears to be almost completely distorted, similar to that observed with 10 day old flies treated to 42.0°C (LD₁₀₀). In these sarcosomes the discrete dark patches, which have also been observed in 10 day old sarcosomes, see Figures 20

Figure 24

An electron micrograph of the dorsal longitudinal flight muscle from an untreated 1 day old male fly (osmium fixation).

Magnification x 32,000.

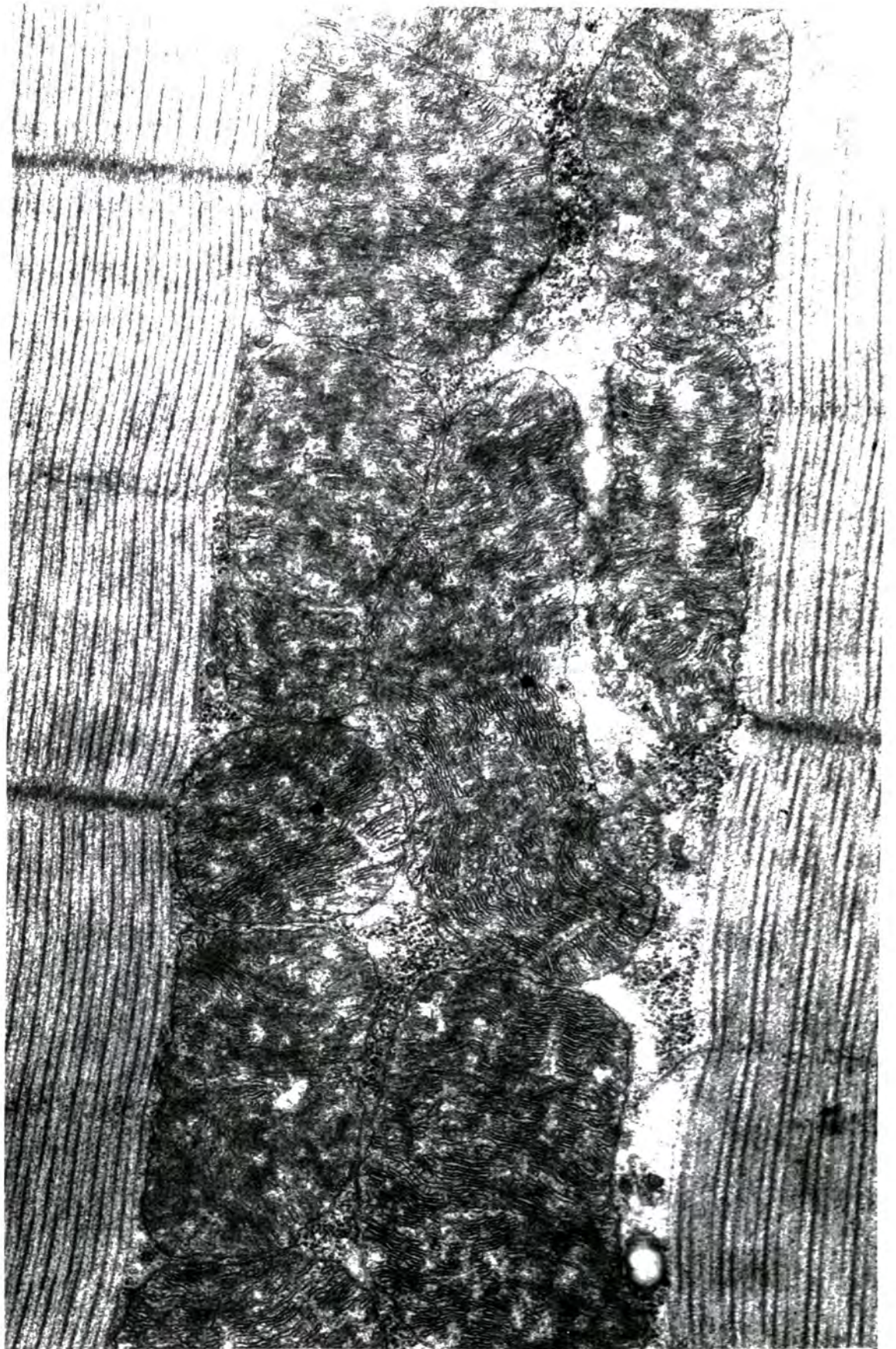

Figure 25

An electron micrograph of the dorsal longitudinal flight muscle from a 1 day old male fly treated to 42° C/40 mins, LD₅₀ treatment (osmium fixation).

Magnification x 23,550.

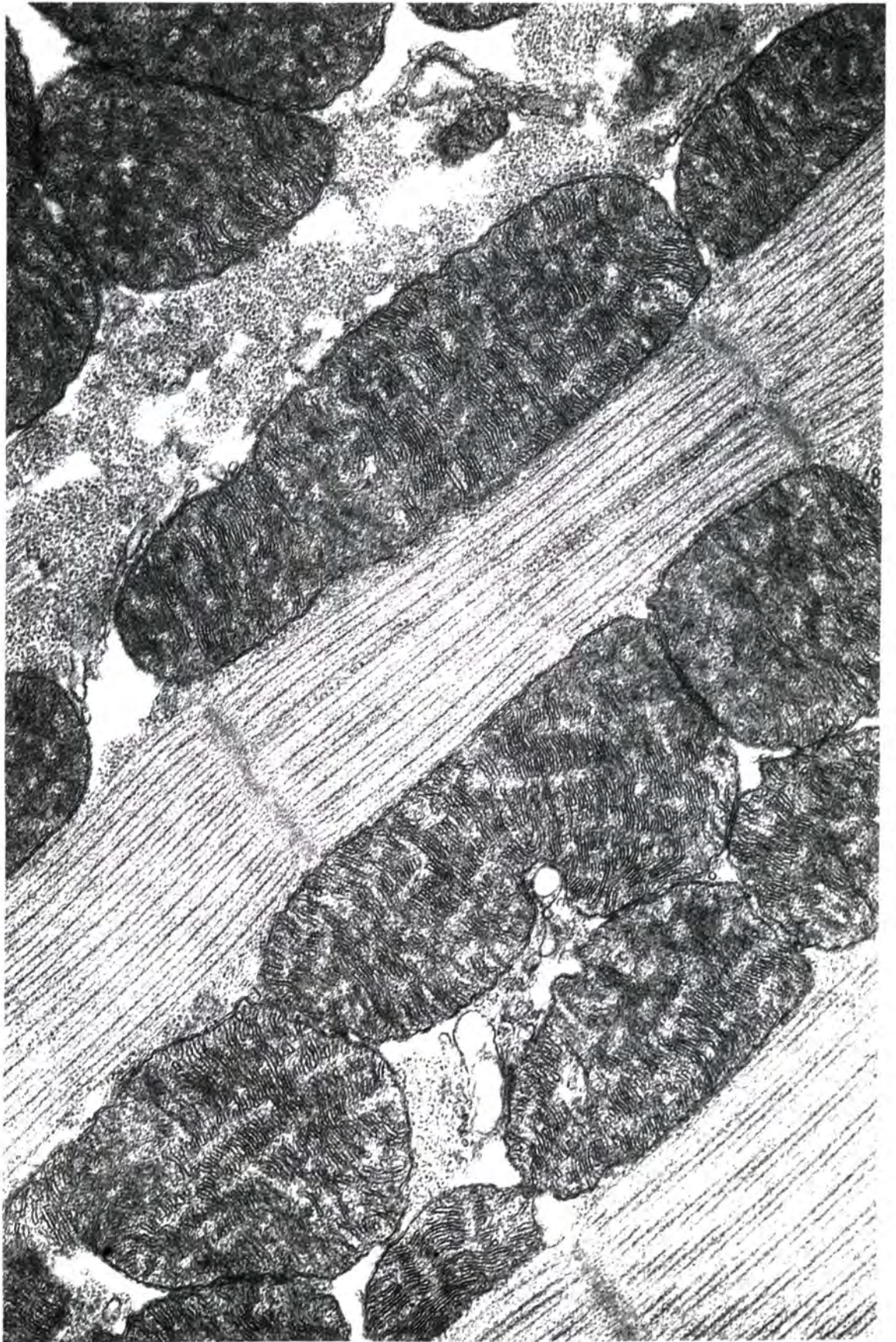

Figure 26

An electron micrograph of the dorsal longitudinal flight muscle from a 1 day old male fly treated to 43.2°C/40 mins, LD₁₀₀ treatment (osmium fixation). Dyad of the sarcoplasmic reticulum (d).

Magnification x 22,500



and 21, were present. These discrete areas of electron opaque material are probably the result of precipitation of cations or anions during heat treatment and they can be divided into two distinct types. The less dense granules are likely to be due to the precipitation and accretion of divalent cations, such as Mg^{2+} and Ca^{2+} . These accretions appear to be widely distributed in these sarcosomes. Whereas, the larger and more opaque granules, which are fewer in number, may be due to the precipitation of phosphate, which has reacted with the lead of the stain to form lead phosphate.

DISCUSSION

The results presented in this chapter confirm that intact flight muscle sarcosomes are damaged after exposure to LD_{100} temperatures. The damage in 1 day old and 10 day old flies consisted of the disorganisation of the cristae lamellae and the precipitation and accumulation of inorganic ions. These profiles of heat damaged sarcosomes resemble the degenerating sarcosomes of mature C. erythrocephala reported by Smith (1963), although tubular elements of fragmented cristae were not as widely distributed. Gregory et al (1968) have also reported degenerating sarcosomes of similar appearance to these ones in ageing L. cuprina, but swollen and

vacuolated sarcosomes similar to those reported by Simon, Bhatnagar and Milburn (1969) have not been observed.

Green and MacLennan (1969) have suggested that the cristal membrane is made up of repeating units, one unit thick, which are lipoprotein complexes containing phospholipid, structural protein and the enzymes associated with oxidative phosphorylation. It is possible that both the protein and the phospholipid components are involved in the heat induced changes in cristal structure. The brief liquefaction of part of the lipid component may account for the distortion of the cristae. However, changes in the lipid structure during heat treatment would probably be accompanied by the release of fatty acids, and the measurements of oxidative phosphorylation presented in Chapter 7 do not clearly indicate this.

Alternatively, the gross changes in the morphology of the cristae may be due to a summation of a variety of heat induced changes in the configuration of individual constituent protein molecules. Stearn (1949) has suggested that protein denaturation is caused by the progressive destruction of hydrogen bonds. In the initial stages of denaturation induced by heat, the breakage of a few hydrogen bonds will cause little change

in the tertiary structure of proteins, and presumably at this stage the bonds can be reformed on cooling. However, as denaturation proceeds more bonds are broken until eventually a state is reached, when the breaking of one or two additional bonds results in major changes in the tertiary structure of the molecule accompanied by a large increase in entropy and the irreversible loss of enzyme activity.

It is envisaged that exposure to LD₅₀ temperatures cause only the reversible loss of enzyme activity without major configurational changes in protein structure. In fact, the results in Chapter 7 show that complete enzyme activity can be recovered in survivors in the 2-3 days following exposure. Whereas LD₁₀₀ temperatures cause the irreversible loss of activity of some enzymes and represent a stage when the native structure of the proteins are changed with the resultant gross changes in crystal membrane morphology.

The observations are in good agreement with the heat death studies presented in Chapter 3 and the physiological studies in Chapter 7. The differences in temperature treatment required to cause structural changes in 1 day and 10 day old adult sarcosomes are correlated exactly with changes in LD₁₀₀ temperatures, see Table 16. The reason for this difference remains

difficult to account for. D'Costa and Birt (1966) reported the incorporation of phospholipid in sarcosomes of L. cuprina during the early adult stage, but although the bulk phospholipid content of sarcosomes became richer in the early adult stage, there were no marked differences in the classes of lipids. Thus the changes in the sensitivity of sarcosomes are likely to be caused by the developmental changes in enzymic and structural protein already outlined in Chapter 7.

Chapter 9

THE EFFECT OF TEMPERATURE ON OXIDATIVE
PHOSPHORYLATION IN ISOLATED FLIGHT MUSCLE SARCOSONES

INTRODUCTION

The temperature dependence of metabolic rate in poikilotherms has been demonstrated in a wide variety of different species. The subject has been reviewed by Bullock (1955), Precht, Christophersen and Hensel (1955) and Prosser (1955).

Recent work, however, claims that in many species of poikilotherms basal or resting metabolism is effectively independent of temperature, whereas active metabolism is temperature dependent in the classical way (Newell and Northcroft, 1967). This work was supported by a study of the respiration of mitochondria isolated from poikilotherms (Newell, 1966; Newell, 1967) and homeotherms (Newell and Walkey, 1966). Q_{10} values of 1 - 1.3 were reported for mitochondrial oxygen consumption over the temperature range 5°C to the maximum normal environment temperature experienced by each species of poikilotherm, and from 5°C to the normal body temperatures in homeotherms. Above the normal temperature range, large Q_{10} values were observed and

Newell (1966) has suggested that this may be due to uncoupling of oxidative phosphorylation. The low Q_{10} values observed for oxidative phosphorylation in the normal range of temperatures has led Newell (1966, 1967) to suggest that oxidative phosphorylation is relatively temperature independent. Furthermore, Newell and Walkey (1966) have suggested that the rate of mitochondrial metabolism may be determined by physical phenomena, such as the supply of substrates, rather than chemical phenomena.

In support of the classical interpretation referred to previously, Tribe and Bowler (1968) have demonstrated that basal metabolic rate in this stock of Calliphora erythrocephala is dependent upon temperature and previous thermal history. The basal metabolic rate of adult blowflies showed 'type 3' adaptation. (Precht, 1958).

Recently, Spencer Davies and Tribe (1969) have investigated the effect of temperature upon the oxygen consumption of intact poikilotherms and their tissues, and also of isolated mitochondria from poikilotherms and a homeotherm. Their investigations also included preparations of flight muscle tissue and sarcosomes from C. erythrocephala. They concluded that in neither the

intact animal at rest nor in endogenous oxygen uptake by isolated cells and tissues was there any evidence of a plateau of temperature independent respiration. Furthermore, the oxygen consumption of mitochondria isolated from rat liver and blowfly flight muscle was also temperature dependent.

The present investigation on the effect of temperature on isolated flight muscle sarcosomes considers the aspect of the changes in oxidative phosphorylation in relation to age and previous thermal history of the animal. The results of this work are discussed in relation to the previous work of Newell (1966, 1967) and Spencer Davies and Tribe (1969).

MATERIALS AND METHODS

The blowflies used in this study were male adults developmentally acclimatized to $24 \pm 0.5^{\circ}\text{C}$. The rearing methods were the same as described in Chapter 2 and flies were acclimatized to either $15 \pm 1.0^{\circ}\text{C}$, $24 \pm 0.5^{\circ}\text{C}$ or $34 \pm 0.5^{\circ}\text{C}$ as described in Chapter 5.

Method of isolating flight muscle sarcosomes and determining oxidative phosphorylation.

The method of isolation and measurement of QO_2 , RCI and ADP:O values of sarcosomes have been fully described in Chapter 7. Oxidative phosphorylation with

33 mM α -glycerophosphate (α -GP) as substrate was measured in the presence of 0.5 μ moles ADP at a series of temperatures in the range 14^o - 39^oC. The reaction vessel of the oxygen electrode was held at a selected temperature by pumping water from a constant temperature bath through the outer jacket. The bath was maintained at the selected temperature (\pm 0.1^oC) as described in Chapter 3. Experiments at 14^oC and 19^oC were carried out in a cold room.

The solubility of oxygen in the reaction medium at various temperatures is recorded in Table 31 and the determination of oxygen solubility is described in Appendix 2.

RESULTS

The measurements of QO_2 and ADP:O values of sarcosomes extracted from 10 day old flies acclimatized to 15^o, 24^o and 34^oC are recorded in Tables 26, 27 and 28 respectively. In these experiments the endogenous respiration of sarcosomes was not influenced by experimental temperature and the QO_2 were very small, in agreement with the results presented in Chapter 7. However, the substrate respiration and ADP-stimulated respiration of sarcosomes, from the various acclimatized flies, increased markedly with experimental temperature,

the rate-temperature (R/T) curves are presented in Figures 27, 28 and 29.

Temperature dependence of substrate respiration.

The R/T curves for substrate respiration followed similar patterns in all three acclimatization groups. A pronounced rise in substrate rate occurred between the experimental temperatures 14° - 24°C giving a large Q_{10} see Table 30. In the range of experimental temperatures 24° to 34°C , however, the increase was much smaller and the Q_{10} values for sarcosomes from 15°C and 24°C acclimatized flies were 1.18 and 1.23 respectively; sarcosomes isolated from 34°C acclimatized flies gave a Q_{10} of 1.97 over this temperature range. A dramatic rise in substrate respiration was observed between experimental temperatures 34° - 39°C in sarcosomes from 15°C and 24°C acclimatized animals (Q_{10} values of 16.47 and 12.31 respectively). Sarcosomes from 34°C acclimatized flies responded quite differently in the range of experimental temperature 34° to 39°C and gave Q_{10} values of 2.91.

Temperature dependence at ADP-stimulated respiration.

The patterns of change in the ADP-stimulated respiration rates of sarcosomes isolated from the variously acclimatized flies are compared in Figure 31.

TABLE 26

Oxidative phosphorylation of sarcosomes isolated from 10 day old male adults acclimatized to 15°C.

Experi- mental temp. °C.	Sarcosomal respiratory performance						Protein conc. mg /50 μ l	n
	Q O ₂			RCI	ADP:O	ADP stimulated rate		
	Endogenous rate	Substrate rate	ADP stimulated rate					
14	1.8 (0.82-2.29)	5.97 (4.29-8.0)	10.64 (6.52-12.64)	1.79 (1.52-2.11)	1.5 (1.36-1.64)		0.2	4
19	0.51 (0 - 1.45)	18.61 (16.12-20.21)	53.96 (51.58-56.58)	2.91 (2.75-3.05)	1.65 (1.56-1.69)		0.19	5
24	1.22 (0 - 2.35)	24.86 (23.89-25.4)	67.51 (62.76-70.21)	2.72 (2.6 - 2.89)	1.74 (1.71-1.82)		0.24	5
29	0.41 (0 - 1.04)	29.73 (27.56-31.21)	67.96 (61.68-74.77)	2.29 (1.98-2.43)	1.63 (1.54-1.7)		0.34	5
34	1.36 (0 - 2.23)	29.32 * (15.91-47.37)	27.05 * (17.82-42.47)	0.94 (0.89-1.12)	n.m.		0.14	5
39	n.m.	118.98 * (112.79-143.44)	115.89 * (109.61-122.16)	0.99 (0.97-1.0)	n.m.		0.23	5

* curvilinear trace

nm. not measurable

Figure 27

Rate/temperature curves, QO_2 ($\mu\text{g A O}/\text{mg protein/hr}$) against experimental temperature ($^{\circ}\text{C}$), for isolated sarcosomes from 10 day old flies physiologically acclimatized to 15°C .

- , substrate respiration;
- ▲ , ADP-stimulated respiration;
- ▼ , ADP:O; ■ , RCI.

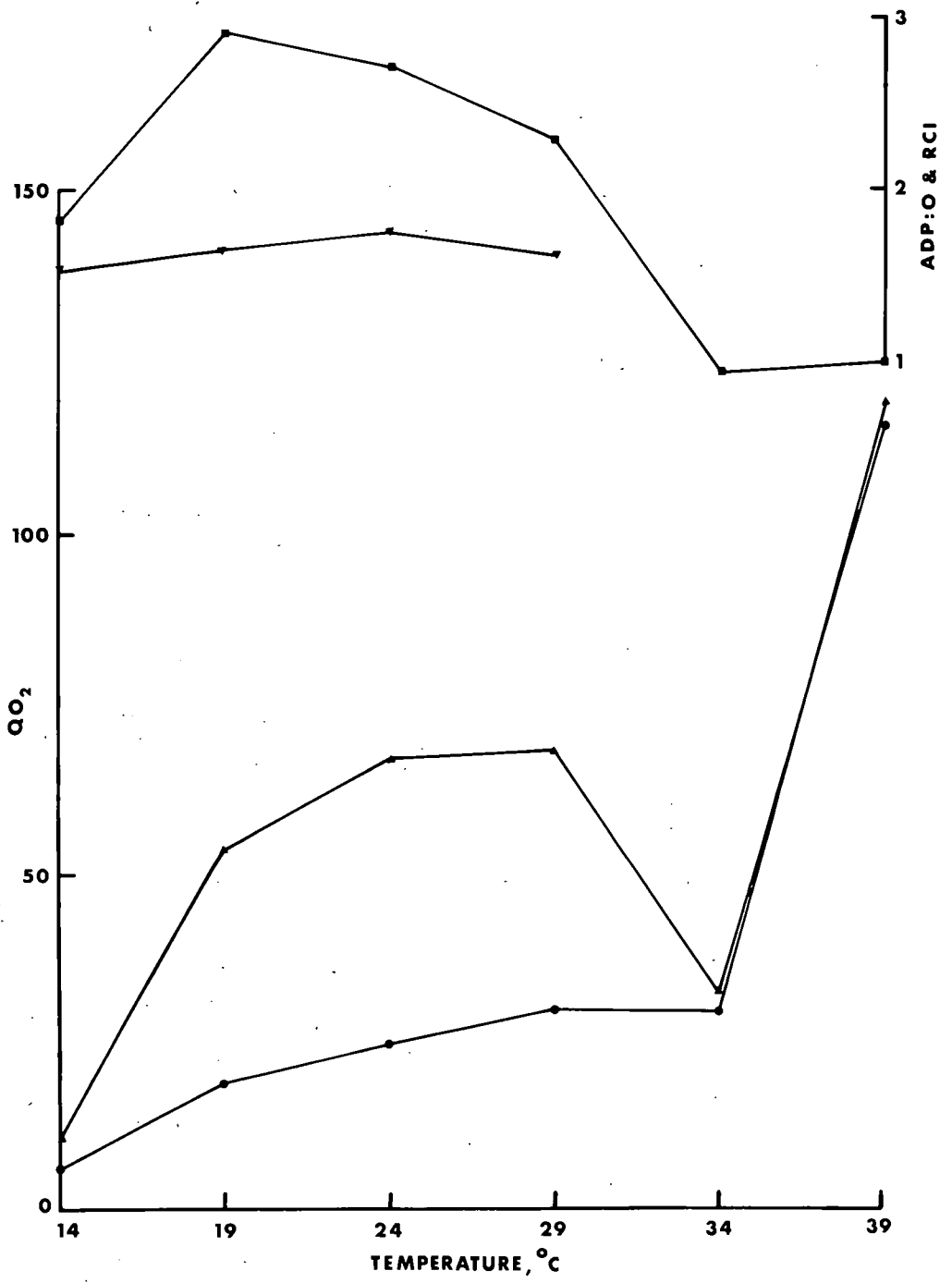

TABLE 27

Oxidative phosphorylation of sarcosomes isolated from 10 day male adults acclimatized to 24°C.

Temp. °C	Sarcosomal Respiratory performance							Protein conc. mg/ 50 μ l	n
	Q O 2			RCI	ADP:O	ADP stimulated rate	ADP		
	Endogenous rate	Substrate rate	ADP rate						
14	0.7 (0.21-2.38)	6.18 (5.33-6.84)	6.42 (5.33-6.84)	1.04 (1.0 - 1.16)	n.m.			0.45	5
19	1.34 (0.93-1.90)	18.73 (15.69-21.28)	49.62 (40.37-55.86)	2.71 (2.02-2.93)	1.49 (1.31-1.64)			0.21	4
24	0.69 (0.59-0.81)	34.74 (33.0 - 36.56)	90.68 (80.66-102.37)	2.61 (2.4 - 2.8)	1.65 (1.46-1.81)			0.38	5
29	n.m.	38.44 (36.24-39.86)	96.74 (83.35-108.42)	2.52 (2.09-2.86)	1.67 (1.58-1.76)			0.55	6
32	n.m.	40.39 (39.32-40.84)	87.71 (86.19-92.07)	2.18 (2.08-2.27)	1.58 (1.39-1.80)			0.45	6
34	n.m.	42.57 * (35.44-47.75)	43.42 * (35.63-59.69)	1.16 (1.0 -1.56)	1.14 (0.99-1.31)			0.39	6
36	n.m.	65.19 * (58.54-78.64)	53.35 * (41.72-67.46)	0.98 (0.92-1.09)	n.m.			0.26	6
39	0.93 (0-1.97)	149.38 * (135.65-155.41)	127.86 * (113.45-140.99)	0.89 (0.84-0.97)	n.m.			0.36	5

* Recorder trace curvilinear
n.m. not measurable

Figure 28

Rate/temperature curves QO_2
($\mu\text{g A O/mg protein/hr}$) against
experimental temperature ($^{\circ}\text{C}$), for
isolated sarcosomes from 10 day old
flies acclimatized to 24°C .

- , substrate respiration;
- ▲ , ADP-stimulated respiration;
- ▼ , ADP:O; ■ , RCI.

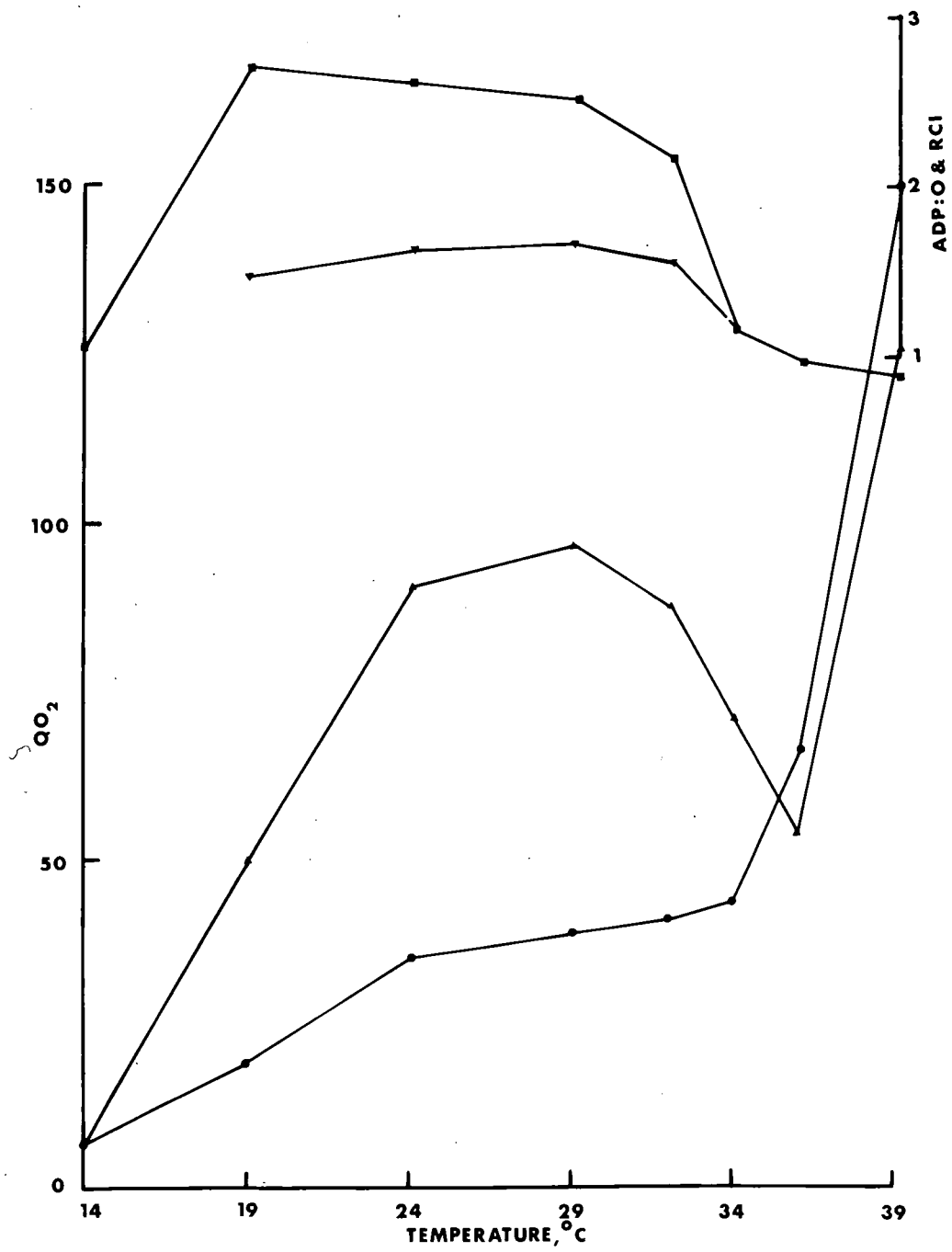

TABLE 28

Oxidative phosphorylation of sarcosomes isolated from 10 day old male adults acclimatized to 34°C.

Experi- mental temp. °C	Sarcosomal respiratory performance						n
	Q O 2			RCI	ADP:O	Protein conc. mg. protein/ 50µl	
	Endogenous rate	Substrate rate	ADP stimulated rate				
14	0.43 (0 - 0.59)	7.8 (7.09-8.46)	7.85 (7.16-8.46)	1.03 (1.0-1.13)	n.m	0.5	4
19	0.99 (0.84-1.07)	15.5 (14.63-16.1)	32.56 (27.17-35.41)	2.1 (1.86-2.23)	1.4 (1.29-1.54)	0.48	5
24	1.56 (0.95-2.38)	27.32 (23.76-28.74)	78.92 (76.03-89.34)	2.87 (2.67-3.13)	1.64 (1.5-1.85)	0.28	5
29	1.28 (0.35-1.73)	42.29 (41.2-43.72)	112.32 (107.8-111.02)	2.66 (2.46-2.78)	1.6 (1.5-1.74)	0.36	6
34	1.26 (0 - 1.57)	53.76 (50.96-58.5)	116.87 (98.0-131.63)	2.19 (1.85-2.33)	1.62 (1.5-1.77)	0.48	6
39	2.31 (1.29-5.08)	91.71 (87.39-105.89)	119.36 (103.26-168.68)	1.31 (0.98-1.8)	1.45 (1.35-1.57)	0.43	6

n.m. not measurable

Figure 29

Rate/temperature curves QO_2
($\mu\text{g A O}/\text{mg protein/hr}$) against
experimental temperature ($^{\circ}\text{C}$), for
isolated sarcosomes from 10 day old
flies physiologically acclimatized
to 34°C .

- , substrate respiration;
- ▲ , ADP-stimulated respiration
- ▼ , ADP:O; ■ , RCI.

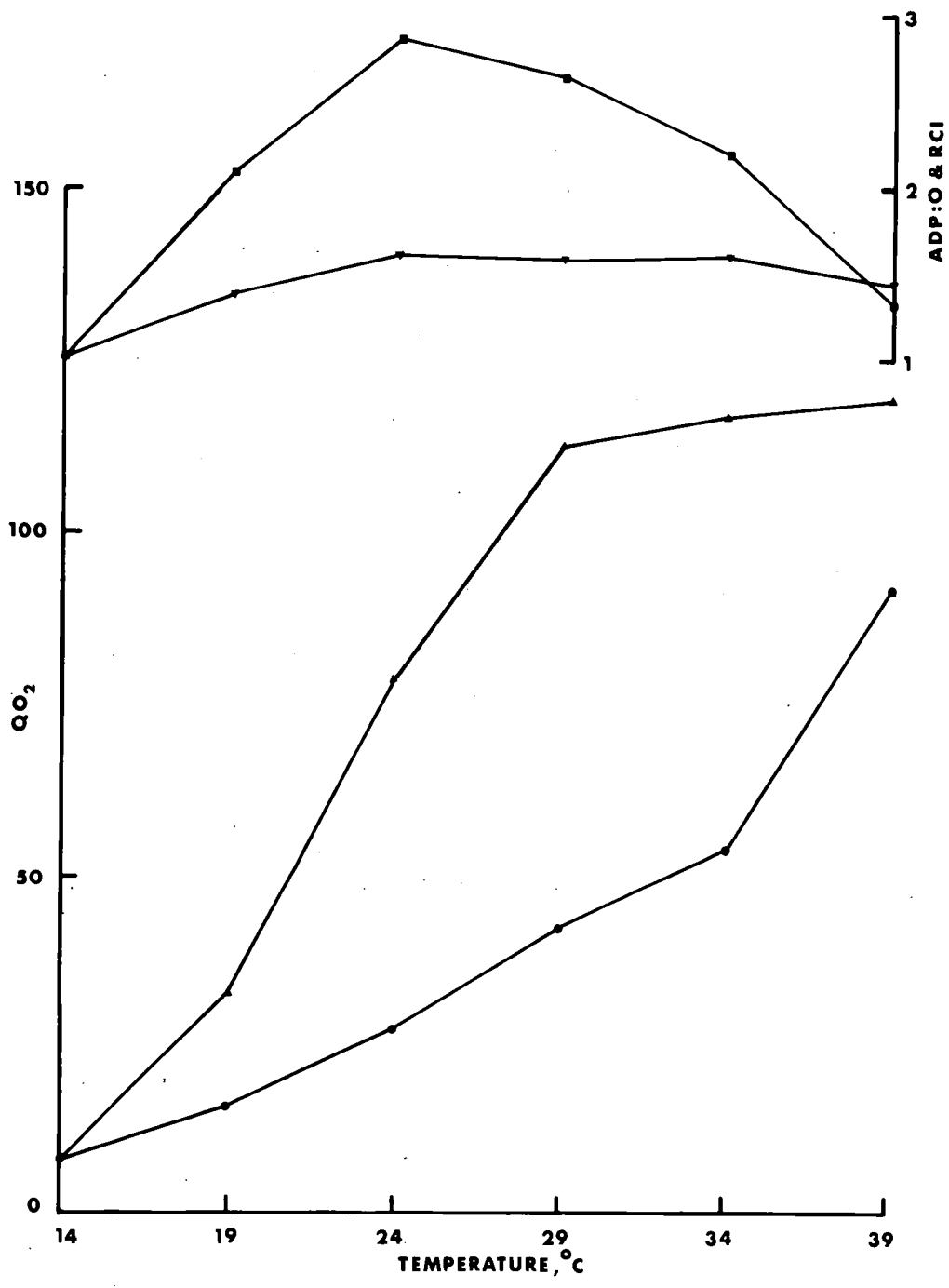

For 15°C and 24°C acclimatized animals the R/T curves obtained can be divided into 4 fairly distinct phases. Only two of these phases were observed with sarcosomes from 34°C acclimatized flies.

Phase 1 : This was observed over the lower temperature range and consisted of a large increase in oxygen consumption with increasing temperature and so resulted in a large Q_{10} value, see Table 30. The actual range of temperature over which the large increase in respiration occurred depended upon the temperature at which the flies were acclimatized. For the 15°, 24° and 34°C acclimatized flies the upper temperature limits of Phase 1 were 19°, 24° and 29°C respectively. Moreover, the Q_{10} values for the ADP-stimulated respiration were larger than those observed for the corresponding substrate respiration, see Table 30. The difference is due to the increase in respiratory control with increasing temperature in Phase 1.

Phase 2 : Virtually no increase in ADP-stimulated respiration was observed in this phase and Q_{10} values ranged from 1.01 to 1.07, see Table 30, suggesting that oxidative phosphorylation was essentially independent of temperature. Phase 2 extended from 24° to 29°C for sarcosomes from 15°C acclimatized flies, although Q_{10} ^{was} also low (1.6) between 19° - 24°C, suggesting that the lower

limit of Phase 2 was within this range. Phase 2 was from 24° to 29°C and 29° to 39°C for sarcosomes from 24° and 34° acclimatized flies respectively. Sarcosomal QO_2 values for ADP-stimulated respiration were 112 - 119 $\mu\text{g A O/mg prot/hr}$ for 34°C acclimatized flies, 87 - 90 for 24°C acclimatized flies and 53 - 68 for 15°C acclimatized flies.

Phase 3 : The decline in ADP-stimulated rate above 29°C was only observed with sarcosomes isolated from 15° and 24°C acclimatized flies. As substrate respiration was unaffected by temperatures in this range, the decline in ADP-stimulated rates resulted in a loss in respiratory control, see Tables 26 and 27. Respiratory control was completely absent in Phase 4 and ADP-stimulated respiration and substrate respiration were almost the same at 34° and 39°C. The RCI values of less than 1 are due to the decline in ADP-stimulated rate during the course of the experiments. A similar decline has been described in the results in Chapter 7.

The effect of temperature on ADP:O and RCI values.

The RCI and ADP:O values of sarcosomes have been plotted in Figures 27, 28 and 29. Low values were obtained at the extremes of the experimental temperature range. Sarcosomes from 24°C and 34°C acclimatized animals gave

RCI values of about 1 at 14°C, however, sarcosomes from 15°C acclimatized flies had a RCI of 1.79 at this temperature. At 34°C only sarcosomes from 34°C acclimatized animals had RCI values above 1, being 2.19. Indeed, these sarcosomes still showed partial coupling of oxidative phosphorylation at 39°C and gave an ADP:O ratio of 1.4 and RCI of 1.31.

Oxidative phosphorylation of sarcosomes from 1 day old flies.

Measurements of oxidative phosphorylation made on sarcosomes extracted from 1 day old flies reared and thus acclimatized to 24°C, are recorded in Table 29 and Figure 30. The endogenous rate was low at all temperatures. Changes in substrate respiration followed the pattern observed with sarcosomes extracted from 10 day old flies and Q_{10} values are recorded in Table 30. However, the R/T curve for the ADP-stimulated respiration was different to the curves obtained with 10 day old adults' sarcosomes, see Figure 31. ADP-stimulated respiration increased between the experimental temperatures 14°C - 24°C giving a large Q_{10} value of 6.64, see Table 30, but between 24°C - 34°C Q_{10} was only 1.4 and between 34°C and 39°C the ADP-stimulated respiration did not change ($Q_{10} = 0.97$).

TABLE 29

Oxidative phosphorylation of sarcosomes isolated from 1 day old male
adults acclimatized to 24°C

Experi- mental Temp. °C	Sarcosomal respiratory performance						Protein conc. mg/ 50 μ l	n
	Q O 2			ADP stimulated rate	RCI	ADP:O		
	Endogenous rate	Substrate rate	ADP stimulated rate					
14	1.30 (0.91-2.07)	5.02 (3.75-6.23)	8.06 (6.11-10.65)	1.6 (1.2-1.88)	1.52 (1.41-1.62)	0.23	4	
24	0.47 (0 - 0.98)	24.3 (23.28-26.98)	53.52 (41.82-64.1)	2.23 (1.67-2.71)	1.62 (1.28-1.96)	0.2	11	
29	1.91 (0.67-3.87)	31.52 (31.45-31.7)	54.91 (50.5 -58.12)	1.75 (1.61-1.85)	1.46 (1.33-1.54)	0.27	4	
34	0.81 (0 - 3.25)	36.34 (34.06-38.15)	74.88 (57.22-89.96)	2.07 (1.5 - 2.55)	1.64 (1.46-1.89)	0.37	6	
39	1.58 (1.4-1.76)	76.66 * (64.39-102.08)	73.84 (63.69-98.03)	0.97 (0.9 - 1.0)	n.m.	0.31	5	

* trace curvilinear
n.m. not measurable

Figure 30

Rate/temperature curves QO_2
($\mu\text{g A O}/\text{mg protein/hr}$) against
experimental temperature ($^{\circ}\text{C}$), for
isolated sarcosomes from 1 day old
flies acclimatized to 24°C .

- , substrate respiration;
- ▲ , ADP-stimulated respiration;
- ▼ , ADP:O; ■ , RCI.

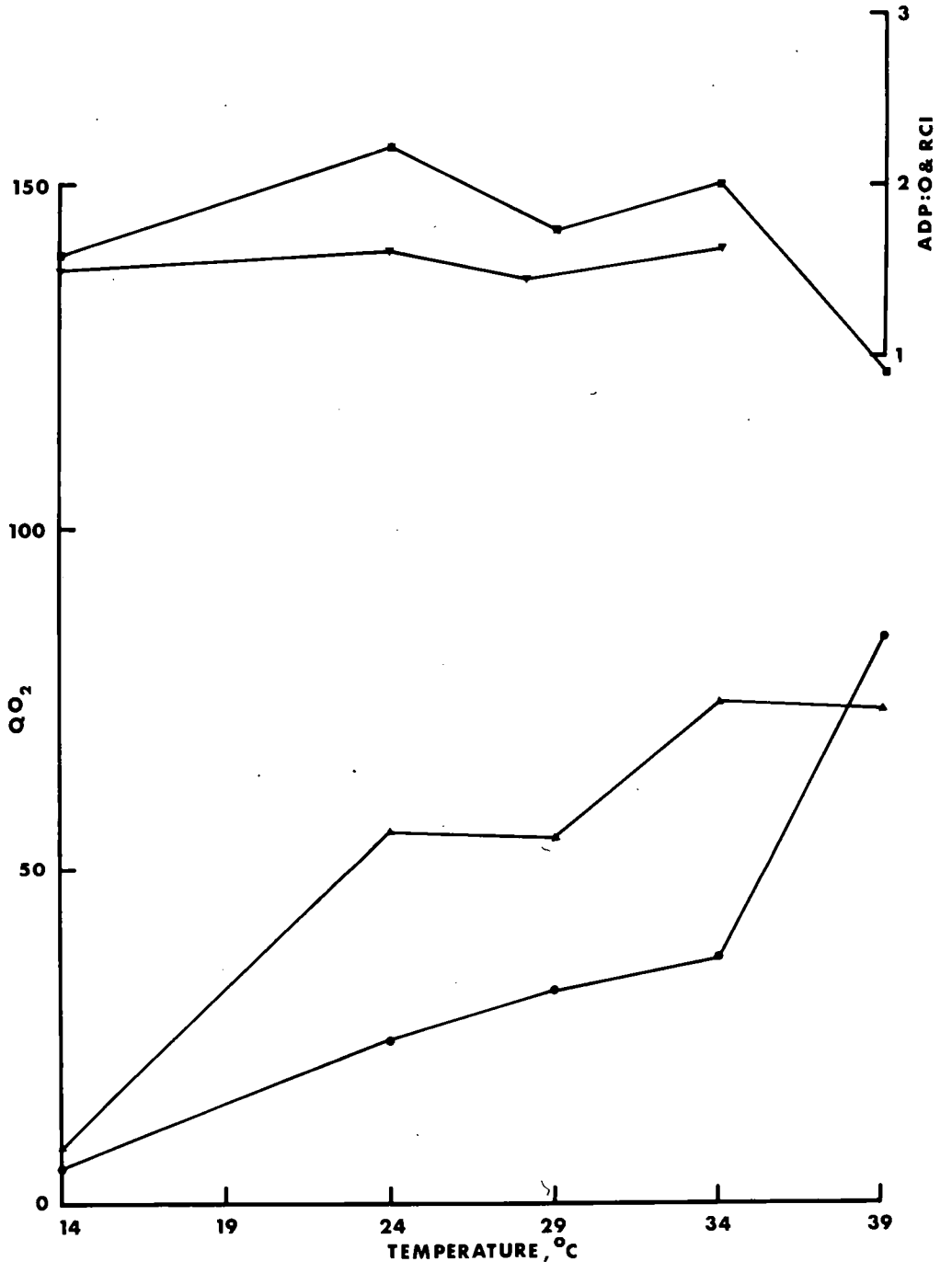

Figure 31

Rate/temperature curves for ADP-stimulated respiration, QO_2 ($\mu\text{g A O/mg protein/hr}$) against temperature ($^{\circ}\text{C}$), of isolated sarcosomes from 10 day old flies acclimatized to \diamond , 15°C ; \circ , 24°C ; \blacksquare , 34°C ; and 1 day old flies acclimatized to 24°C \bullet .

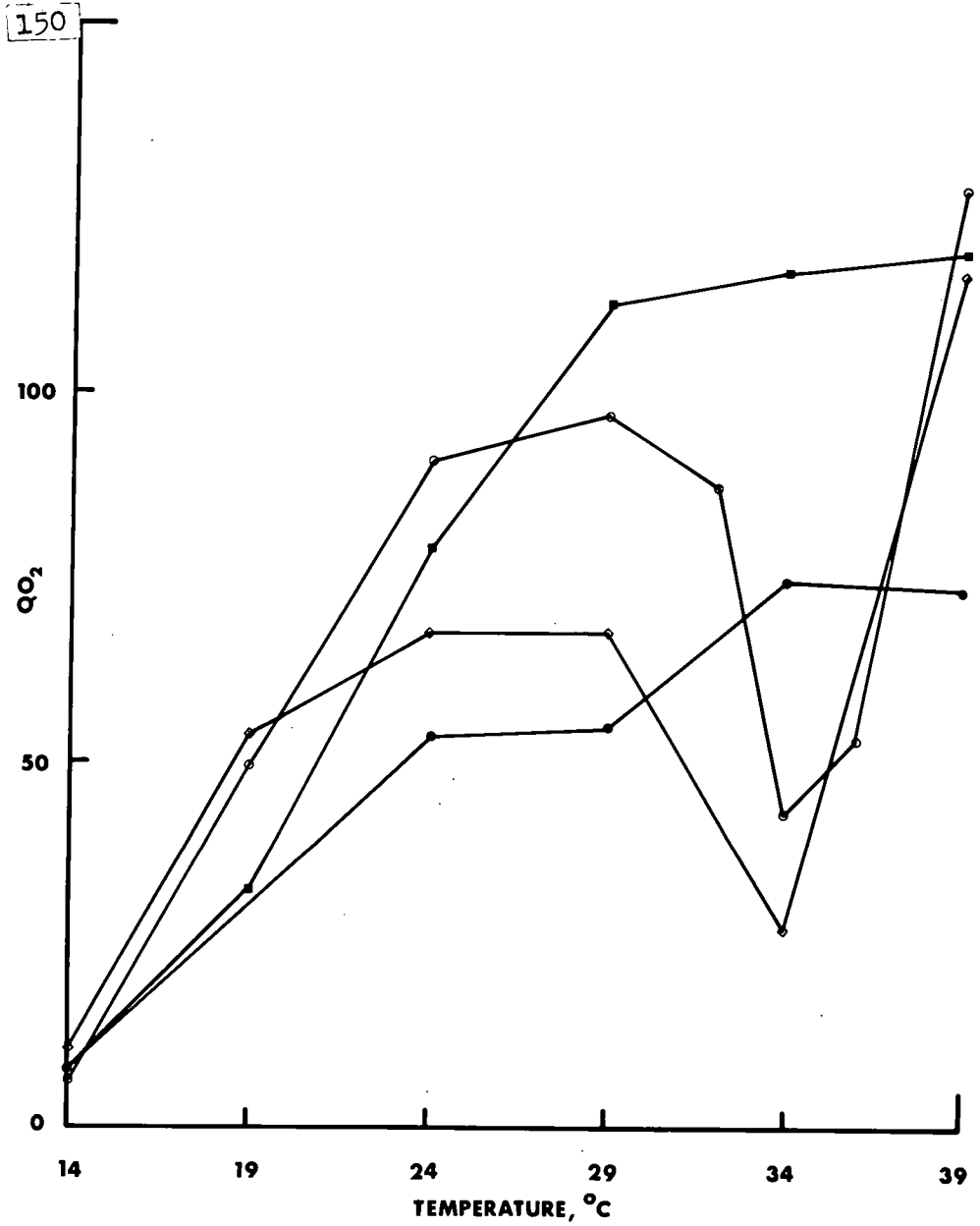

TABLE 30

Changes in the Q_{10} of the substrate rate (-ADP) and ADP stimulated rate (+ADP) of isolated sarcosomes. QO_2 values are obtained from Tables 25-28

Experi- mental temp. range °C		+ / -	ADP	10 day flies acclimatized 15°C	10 day flies acclimatized 24°C	10 day flies acclimatized 34°C	1 day flies acclimatized 24°C
14 - 24	14 - 19	-	ADP	4.16	5.62	3.5	4.84
	19 - 24						
	14 - 19	+	ADP	25.71 1.56	14.12	10.05	6.64
	19 - 24						
24 - 34	24 - 29	-	ADP	1.18	1.23	1.97	1.5
	29 - 34						
	24 - 29	+	ADP	1.01 0.16	1.07 0.2	2.02 1.04	1.4
	29 - 34						
34 - 39		-	ADP	16.47	12.31	2.91	5.4
		+	ADP	18.35	8.67	1.04	0.97

The ADP:O and RCI values were comparatively high at the experimental temperatures 14° and 34°C, see Table 29. At 14°C these values were as good as those obtained with sarcosomes from 10 day old flies acclimatized to 15°C, see Table 26, and at 34°C they were as good as those obtained from 10 day old flies acclimatized to 34°C, see Table 28.

DISCUSSION

A comparison of the effect of temperature on oxidative phosphorylation of isolated sarcosomes suggests that these organelles are more sensitive to exposure to moderately high temperatures in vitro than in vivo. Sarcosomes isolated from 10 day old flies acclimatized to 24°C showed almost complete loss of respiratory control at 34°C (see table 27), whereas sarcosomes isolated after the heat treatment of intact flies were uncoupled and respiratory control lost after only 40 mins at 41°C, see Table 17. This marked temperature sensitivity of isolated sarcosomes might be expected for other workers have demonstrated the acute sensitivity of these isolated organelles to physical damaging agents, see van den Bergh (1962). Furthermore, the results presented in Table 29 suggest that sarcosomes from 1 day flies acclimatized to 24°C were more resistant, at both the high

and low experimental temperatures, than the sarcosomes isolated from 10 day old adults acclimatized to 24°C, (see Table 27). This increased resistance to high temperatures in sarcosomes from 1 day old flies agrees with the results presented in Chapter 7, where higher temperatures were required to impair such sarcosomes in situ, see Tables 17 and 18. Indeed the pattern follows the age dependent differences in heat death point observed in Chapter 3.

The results presented in Tables 26, 27 and 28 show that sarcosomes isolated from 10 day old flies acclimatized to 15°, 24° and 34°C were partially or wholly uncoupled at the high experimental temperatures. At 34°C ADP:O and RCI values for the sarcosomes from 34°C acclimatized flies indicated that these sarcosomes were more tightly coupled than the sarcosomes from either the 24°C or 15°C acclimatized flies. Conversely at 14°C respiratory control was still in evidence in sarcosomes isolated from 15°C acclimatized flies but not in those from 24°C or 34°C acclimatized animals. These results suggest that acclimatization temperature markedly affects the temperature sensitivity of the coupling enzymes in vitro. It is not possible to extrapolate the results of the in vitro work directly to the in vivo

state, for both 14°C and 34°C are viable temperatures (see Chapter 5). However, such changes in the temperature sensitivity of coupling in vitro probably reflect the effect of acclimatization on the efficiency of oxidative phosphorylation in vivo.

The results presented in Figures 26, 27 and 28 show that both substrate respiration and also ADP-stimulated respiration of sarcosomes isolated from 10 day old flies acclimatized to 15°, 24° and 34°C are markedly temperature dependent. The Q_{10} values presented in Table 30 can be divided into 2 fairly distinct categories of values of approximately 1 and values of 1.5 or more.

The large Q_{10} values were obtained at the upper and lower experimental temperature ranges, except in the case of the sarcosomes from 34°C acclimatized flies. Whereas the values approximating 1 were observed in the intermediate range of temperatures.

The sharp break in the R/T curves showing that QO_2 was relatively temperature independent over part of the experimental temperature range is rather surprising. Spencer Davies and Tribe (1969) were unable to observe a plateau of temperature independence for QO_2 of blowfly sarcosomes in the range 10° - 30°C. Using sarcosomes isolated from flies acclimatized to 10°C and 30°C, they

observed Q_{10} values in the range 1.5 - 2.0. However, since they measured QO_2 at 10°C intervals, this may account for their inability to observe a change in Q_{10} values. The break in the R/T curve at the lower temperatures, from a large Q_{10} to a very small Q_{10} , is difficult to account for, for it occurs when the sarcosomes are tightly coupled. Kemp, Groot and Reitsma (1969) have reported a similar discontinuous μ plot for coupled and uncoupled succinate oxidation of isolated rat-liver mitochondria. They observed a temperature coefficient below 17°C more than twice that above 17°C . Moreover, the same pattern was obtained with P_i -ATP exchange, ADP-ATP exchange reactions and also DNP stimulated Mg^{2+} ATPase activity in the same mitochondria. Heldt and Klingenberg (1968) suggested that a break in the R/T curve for state 3 respiration of mitochondria was due to adenine dinucleotide translocation becoming no longer rate limiting above 17°C . However, Groot et al (1969) have shown that adenine dinucleotide translocation is rate limiting at all the temperatures tested. They suggest that the break in the R/T curve is not diagnostic of any particular mitochondrial enzyme system.

No attempt has been made in the present study to determine the critical temperatures at which Q_{10} values of

substrate and ADP-stimulated respiration change. However, the results presented in Figure 31 indicate that the critical temperatures for ADP-stimulated respiration are directly related to the acclimatization temperature of the intact animal.

Low Q_{10} values for substrate respiration of sarcosomes from 15°C and 24°C acclimatized flies were observed in the intermediate range of experimental temperature. No such low substrate rates were observed with sarcosomes from 34°C acclimatized flies.

The effect of experimental temperature on ADP-stimulated respiration of sarcosomes from 15°, 24° and 34°C acclimatized flies is shown in Figure 31. It can be clearly seen that the position of the plateau of temperature independence (phase 2) is dependent upon the previous acclimatization temperature. The very low Q_{10} values for ADP-stimulated respiration in phase 2 may be partly due to the small decline in RCI in this phase. However, the ADP:O ratios in phase 2 did not suggest that extensive uncoupling was occurring.

The ADP:O and RCI values in phase 2 indicate that sarcosomes were more tightly coupled than in the other phases. Therefore this phase must represent the temperature range over which mitochondria are able to

undertake oxidative phosphorylation most efficiently. More important, the temperature range of phase 2 corresponds predictably with the acclimatization temperature.

The R/T curves for ADP-stimulated respiration presented in Figure 31 suggest that the levels of coupled oxidative phosphorylation in phase 2 are directly related to the acclimatization temperature. Sarcosomes from 34°C acclimatized flies were capable of much higher rates of ADP-stimulated respiration than those from the lower acclimatization temperatures. This may be an important adaptation for animals living under a rigorous high temperature regime where metabolic rate is necessarily high. However, this situation is the converse of that normally observed in acclimatized animals. Generally cold adapted animals have a higher metabolic rate than warm adapted animals. This apparent anomaly may be explained by the fact that isolated mitochondria are completely devoid of cellular restraints; this will be discussed more fully later.

The controlling influence of acclimatization upon the level of oxidative phosphorylation in phase 2 could be imposed either by way of the respiratory chain enzymes, or via the enzymes coupling oxidation and phosphorylation, or by a combination of both of these.

In phase 4, large increases in QO_2 were observed in the uncoupled sarcosomes from 15^o and 24^oC acclimatized flies. At 39^o C the rates of oxidation were almost the same as those observed with the partially uncoupled sarcosomes from 34^oC (see Tables 26 - 28) indicating that the sarcosomal respiration was being "held in check" by the coupling enzymes. Thus the coupling enzyme(s) of the phosphorylating sites may be the rate limiting factor(s) in oxidative phosphorylation.

At present, the enzyme mechanism coupling phosphorylation to oxidation is not clearly understood (see reviews by Pullman and Schatz, 1967; Lardy and Ferguson, 1969) and suggestions relating to changes in coupling enzyme(s) can only be conjecture. Nevertheless, it is suggested that acclimatization to various temperatures in adult blowfly may cause the induction of different forms of the coupling enzyme(s) with different activities. Iso-enzyme forms of several respiratory enzymes are known to occur (see review by Wilkinson, 1965) and there is an increasing body of evidence implicating changes from one isoenzyme form to another, during thermal acclimatization. (Hochachka, 1965; 1967 and Hochachka and Somero, 1968). Changes in coupling enzymes could play an important role in the control of oxidative phosphorylation under different temperature regimes. Furthermore, the

change in thermolability of coupling with acclimatization to different temperatures may be additionally indicative of changes in the coupling enzymes.

The pattern of change observed by Newell (1967) for oxygen consumption of isolated mitochondria can be compared to substrate respiration rate obtained in this study for Newell did not provide ADP in his reaction medium. Newell (1967) has reported a different pattern for QO_2 of locust (Schistocerca gregaria) mitochondria to that obtained in this study. He obtained low Q_{10} values (Q_{10} between $10^\circ - 20^\circ\text{C}$ of 1.3) at temperatures from $5^\circ - 35^\circ\text{C}$ and large Q_{10} values above 35°C . The significance of his results is difficult to determine because both the method of isolation and the reaction medium are atypical of work with insect mitochondria. The very low rate of oxygen consumption (between $5^\circ - 35^\circ\text{C}$ QO_2 values were less than $4 \mu\text{l/hr}$) may well have been because insect mitochondria are notoriously impermeable to succinate and pyruvate without a primer substance present (see van den Bergh, 1962). Newell (1967) does not quote QO_2 values in terms of mitochondrial protein, nor has he determined whether the mitochondria which he extracted were coupled and therefore his results are difficult to compare with those of other workers.

The low Q_{10} values (approximating 1) observed in

this study in the intermediate temperature range, together with those reported by Newell (1967) suggest that oxidative phosphorylation may be temperature independent in vitro, in a system devoid of the restraints of cellular metabolism over a rather limited temperature range. Newell (1967) has correlated this with the temperature independence of basal metabolic rate reported by Newell (1966) and Newell and Northcroft (1967). This correlation does not occur in Calliphora for the temperature dependence of basal metabolic rate has been demonstrated by Tribe and Bowler (1968).

It is doubtful whether substrate and ADP-stimulated respiration of mitochondria can be directly compared to either basal or active metabolic rates in the intact animal. In intact mitochondria the link between oxidation and phosphorylation is known to be compulsory (Lardy and Wellman, 1952) and the rate of oxidation is controlled by the rate at which ADP is made available by the ATP utilizing reactions of the cell. There is of course a reciprocal relationship between the concentrations of ATP and ADP in the cell. Moreover, the glycolytic pathway is dependent upon the relative abundance of these nucleotides in the cell. High ATP levels allosterically inhibit some glycolytic enzymes

and so reduce the supply of pyruvate to the mitochondria. ADP and AMP on the other hand stimulate glycolysis (see Atkinson, 1966). The oxygen consumption of isolated mitochondria will only approach the levels of basal and active metabolic rates, when ADP is made available in the same levels that occur in intact cells. Thus, the rate of oxygen consumption of sarcosomes in situ may be temperature-dependent by virtue of the temperature dependence of the ATP utilizing exergonic cellular processes, which would of course, make the supply of ADP to the mitochondria temperature dependent.

Chapter 10

GENERAL DISCUSSION

The heat resistance of Calliphora erythrocephala is not standard throughout the life history. When the heat death point was measured using the standard exposure technique described in Chapter 3, the egg was found to be the most sensitive (see Table 1). The LD₅₀ of the 4 day old larva was 5°C higher than that of the egg and the heat death point increased during the remainder of the larval stage. The puparium was found to be the most resistant stage, although the LD₅₀ declined slightly with puparial age. The 1 day old adult and the 1 day old puparium had almost the same LD₅₀, significantly greater than the 8 day old puparium. In the first 10 days of the adult stage the LD₅₀ declined by approximately 1.3°C in males and 1.0°C in females. This decline continued at a slower rate over the following 20 days.

In a study of the decline in heat death point in adult Drosophila subobscura, Hollingsworth and Bowler (1966) suggested that the pre-adult of the endopterygote insects may be more resistant to high temperatures than the adult. These workers pointed out that a higher level of resistance in a non-motile developmental stage such as

the puparium would have a survival advantage. The results reported for puparial resistance of C. erythrocephala in this present study support this suggestion. However contrary to this suggestion, the egg stage, which is also non-motile and developmental, is the least resistant stadium in the life history of C. erythrocephala. This low tolerance may be due to experimental conditions, other than temperature, influencing the degree of damage caused to the eggs. Alternatively, the egg, a rapidly developing and differentiating stage, may be more sensitive. Further experimental work will be necessary to elucidate these two conflicting suggestions.

The pattern of change in the heat resistance throughout the life history demonstrates that the puparial resistance is developed in the larval stage and lost in the young adult. The decline in heat death point in the adult has now been observed in Diptera, Coleoptera and Hymenoptera and it seems to be a common phenomenon in the endopterygote insects. Moreover, Burnett (1957) has reported the age-dependent decline of cold tolerance in teneral Glossina mortisans. Thus a fall in cold resistance may parallel the decline in heat resistance in the adult.

Bowler (1967) suggested that changes in temperature tolerance in insects may be part of a more general change in physiological resistance to both physical and chemical stress. This suggestion prompted a study of the resistance to p,p',DDT applied superficially to the cuticle of adult C. erythrocephala. Contrary to the above suggestion it was found that there are no changes in resistance. However, a slight but not significant rise in resistance occurred during the first few days of adult life, probably associated with the hardening of the cuticle after eclosion.

Further investigations on the decline of adult tolerance to high temperature with increasing age have shown that it is temperature dependent and therefore likely to be metabolically dependent. This decline interacts with the temperature dependent process of physiological acclimatization (Maynard Smith, 1957) making the pattern of adaptation complicated in the adult. Physiological acclimatization does not increase linearly with temperature and is therefore a more complex type than that observed in other species. The increase in heat resistance (Table 7) in animals adapted to 32°C suggests that a critical temperature may be involved in the stimulation of resistance adaptation.

Little is known about critical temperatures in insect metabolism. However, Hollingsworth (1969) has recently shown that a critical temperature is involved in the Arrhenius μ plot for life span of D. subobscura. This plot is linear but has a sharp break at 28°C; temperature coefficients being 22,390 cal/mole at the lower temperatures and 181,700 cal/mole at the higher temperatures. The higher μ values, correlated with those reported for heat death in the same species (Maynard Smith, 1957; Bowler and Hollingsworth, 1965) and also for protein denaturation (Sizer, 1943; Stearn, 1949), led Hollingsworth (1969) to suggest that changes in the configuration of enzyme molecules at temperatures above 28°C could cause changes in metabolism which result in the accelerated rate of death. There is a similarity in the critical temperature observed by Hollingsworth (1969) and that observed in the present study. Changes in the configuration of enzyme molecules could account for an increased resistance to denaturation at high temperatures thereby conferring on an animal a greater heat tolerance. Further work is necessary to validate this suggestion.

The ability to attain heat resistance declines after eclosion and is lost completely by 20 days old (see Table 11), indicating that physiological acclimatization

is age and temperature dependent. Bowler and Hollingsworth (1966) have also reported an age-dependent/physiological acclimatization in D. subobscura, although in this species it was attributed to senescence for it was lost at 56 days of age.

It was suggested in Chapter 3 that the changes in heat death point in the early adult stage were due to the replacement of heat resistant puparial enzymes during maturation by more sensitive adult enzymes. As the age dependent decline in the ability to attain physiological acclimatization is lost soon after the completion of the fall in heat death point, could it be that the two processes are related? Enzyme changes taking place during maturation may permit the fly to acclimatize to 34°C by retaining heat resistant puparial enzymes. Alternatively they may be able to selectively synthesise more resistant enzymes, thereby raising the heat death point. After the completion of maturation at 24°C puparial enzymes may have been replaced, and the ability to synthesise the resistant enzymes for acclimatization to 34°C lost.

Developmental acclimatization (Maynard Smith, 1957) has not been conclusively demonstrated. When the heat death points of adults reared at either 15°C or 24°C were compared after physiological acclimatization to various

temperatures, adults from the 24°C developmentally acclimatized group were found to be more resistant than their 15°C counterparts, (see Tables 5 and 8) although these differences were not consistently significant (see Table 9). When the heat death points of flies reared and maintained at 15°C were compared with those of flies reared and maintained at 24°C, no differences in resistance were observed (see Tables 6 and 8). Thus the evidence for developmental acclimatization seems to be inconclusive.

In his review of the literature on the effects of temperature on insects Bursell (1964) concluded that insects are relatively poor in their ability to acclimatize. The results reported in this thesis support this conclusion. However, resistance adaptation in C. erythrocephala, and presumably in other species of endopterygote insects, is a complex phenomenon. Several factors must be taken into account when evaluating its importance. This study shows that age is a particularly important factor, which has not been taken into account by earlier workers rendering their conclusions questionable.

The latter part of this thesis has been concerned with the factors involved in heat death, considering the suggested causes made by other workers. Heilbrunn (1952)

pointed out that changes in tissue water content influence the heat death point of organisms and Baldwin (1954) has suggested that such changes may account for the changes in heat resistance in adult D. fuscipennis. Measurements of the water content of larvae, puparia and adult C. erythrocephala have shown that the small differences which occur are not correlated with changes in heat death point. Furthermore, water loss during the heat treatment of larvae and puparia is negligible and dessication does not account for heat death in these stadia. Water loss does take place during heat death in the adult and it is greatest in 1 day old adults. This may be expected, for it has already been pointed out, with reference to the studies on DDT, that the cuticle will not be completely hardened after eclosion and is likely to be more permeable. Water loss and the resulting evaporative cooling in 1 day old adults may account for the elevated heat death point (see Figure 8). However, the effect of evaporative cooling on the pattern of change in heat death point is considered to be secondary, for it only acts in the early adult stage. The remainder of the thesis is concerned with a consideration of the evidence to determine the primary cause of heat death. It has been suggested that a breakdown in cell

permeability resulting in a change in the distribution of cations and the impairment of bioelectric potentials may be one of the events in heat death in crayfish Astacus pallipes (Bowler, 1963b; Bowler and Duncan, 1967) and the mollusc Arianta arbustorum (Grainger, 1969). A study of the distribution of important cations in C. erythrocephala larvae, after exposure to lethal temperatures, suggests that major permeability changes are not involved in heat death in this stadium. Further work is necessary to determine the importance of permeability changes in heat death of other stadia. However, the above work indicates that the change in permeability of membranes is not likely to be the primary cause of heat death in all stadia.

Proteins and lipids have been implicated in heat death but their individual roles have been impossible to elucidate completely. Could this difficulty be caused by the fact that it is ^{their} co-operative role which is involved in heat death? Oxidative phosphorylation is of fundamental importance to the aerobic cell and is mediated by a multi-enzyme membrane complex whose efficiency is dependent on its morphological integrity. A consideration of the above facts led to a study of the sarcosomes of adult flight muscle.

Measurement of the respiration of α -glycerophosphate after sublethal (LD_0) heat treatment showed that phosphorylation was partially uncoupled from oxidation. After LD_{50} and LD_{100} treatments respiratory control was lost; coupling was not measurable and oxidation was reduced to approximately two-thirds of the value found in control sarcosomes. Respiration with pyruvate + malate and succinate were not so drastically affected, and partially coupled respiration with these substrates was observed even after LD_{100} treatment. The rate of oxidation of succinate increased after LD_{100} treatment. This is attributed to the breakdown of the sarcosomal permeability barrier to this substrate, previously reported by van den Bergh and Slater (1962).

α -glycerophosphate is one of the major substrates of respiration of flight muscle sarcosomes (Sacktor, 1958; van den Bergh, 1962) and uncoupling of this substrate is probably one of the primary lesions in heat death. The breakdown in ATP synthesis may lead to the inactivation of ATP dependent processes. Naguib and Christophersen (1965) have reported a fall in the ATP levels of yeast cells at high temperature. Bluhm and Ordal (1969) have reported the reversible inactivation of several respiratory enzymes directly after sublethal

heat treatment of Staphylococcus aureus. Thus the imbalance of supply and demand of ATP may be an important factor in heat death of several species.

The physiological lesions observed with flies treated to LD₁₀₀ heat treatment are correlated with morphological impairment of the sarcosomes. This damage consisted of the disruption of the lamellate cristae and the precipitation of inorganic ions. LD₅₀ treatment caused the same physiological lesions but did not cause the same gross structural damage. Two reasons are offered as the cause of this difference.

Firstly, LD₅₀ temperature treatment is less severe than LD₁₀₀ and it may therefore be less structurally damaging, although sufficient to cause reversible damage to enzyme function. Secondly, the change in sarcosomal ultrastructure and enzyme function after LD₅₀ may be similar to that caused by LD₁₀₀ temperatures, except that the structural as well as the functional changes may be reversible.

The change in structure may be caused by the melting of phospholipids in the cristal membrane resulting in the disorganisation, but not the complete fragmentation of the cristae. This is questionable for a release of long chain fatty acids would be expected, which would uncouple oxidative phosphorylation and also stimulate oxygen consumption, this has not been conclusively demonstrated. Alternatively the structural changes in

sarcosomes may be caused by the denaturation of protein molecules. It is known that configuration change in protein molecules are caused by the breaking of hydrogen bonds (Sizer, 1943; Stearn, 1949). In the early stages of denaturation after few hydrogen bonds have been broken the changes are reversible on cooling, whereas in the later stages of denaturation after more hydrogen bonds have been broken these are irreversible. Weinbach and Garbus (1969) have suggested that conformational changes in mitochondrial proteins are the cause of the uncoupling phenomenon. Thus the configurational changes in protein molecules could account for the structural and functional changes observed.

However, further work is necessary to determine the extent of the interaction of the structural and functional changes at lethal high temperatures. In particular, it would be useful to know whether there are reversible structural changes occurring in the cristae during LD₅₀ heat treatment. Furthermore, it is important to determine how the recovery of enzyme activity takes place after sublethal heat treatment. The return to normal function could occur in one of two ways. If the mitochondrial enzymes are not irreversibly damaged then the removal of the heat stress might allow gradual

return to normal conformation and thus normal activity. Alternatively, if irreversible damage does take place, then recovery can only occur when protein synthesis has replaced the damaged enzymes.

Bluhm and Ordal (1969) have shown that the re-activation of several respiratory enzymes after sub-lethal heat treatment of Staphylococcus aureus takes place in the presence of inhibitors of protein synthesis. Dingley and Smith (1968) have similarly suggested that recovery from sublethal heat treatment in D. subobscura takes place in the absence of protein synthesis. Therefore the measurement of protein synthesis in C. erythrocephala sarcosomes during recovery from sub-lethal heat treatment may prove usefulⁱⁿ determining the nature of the damage.

The age-dependent changes in heat death point are paralleled by the changes in the sensitivity and also the size and distribution of sarcosomes during the maturation of young flies (Tribe, 1967a). Changes in the activity of sarcosomes in maturing flies are recorded in this present study. Walker and Birt, (1969a; 1969b) have reported changes in sarcosomes of L. cuprina over the eclosion period. These include an increase in α -glycerophosphate dehydrogenase and oxidase activities

and also an increase in elementary particles (Kagawa and Racker, 1966) which are possibly the coupling sites. These changes are paralleled by the incorporation of structural protein (Walker and Birt, 1969) and the incorporation of phospholipids (D'Costa and Birt, 1966).

The incorporation of additional components into sarcosomes and the consequent increase in their organisation may account for the increased heat sensitivity. The change in lipid is not significant for D'Costa and Birt (1966) have shown that in L. cuprina, although there is a bulk increase in lipid in sarcosomes, there are no changes in the distribution of the individual species of lipid molecules. It therefore seems that the most important changes affecting sarcosomes are likely to be enzymic.

In vitro studies on the effect of temperature on oxidative phosphorylation of isolated sarcosomes, in Chapter 9, have shown that an increase in the sensitivity of coupling takes place with increase in age. Also an increase in the resistance of coupling takes place with increase in acclimatization temperature. These latter changes in resistance were paralleled by an increase in the level of oxidative phosphorylation, an important adaptation for an animal which is active at high temperatures.

These results suggest that the coupling enzymes may be directly implicated in both acclimatization and also the age-dependent changes in resistance. As little is known of the coupling enzymes, their importance is speculated at present. However, the changes in activity and resistance after acclimatization to high temperature, suggest that these enzymes may exist in different forms (isoenzymes) with the different properties. Since they occupy important positions in the control of cellular energy production they are an obvious candidate for a regulatory role. Therefore, it is suggested that changes in these enzymes may take place as a result of age and also acclimatization.

Furthermore, these changes in activity and the changes in the temperature resistance of coupling suggest that capacity and resistance adaptations are occurring together in the same enzyme system. Thus in this case capacity and resistance adaptations may be different parameters of the same process.

The results presented here are incomplete and a great deal of work will be required to elucidate the intractable problems concerning acclimatization. Changes in sarcosomal sensitivity, although correlated with the change in heat death point, are not likely to be the only factors involved in heat death in adult insects, but may

be one of the primary causes. The latter part of this study has been concerned with heat death in the adult stage. It is possible that heat death in other stages takes place for different reasons.

Nevertheless the work presented in this thesis indicates the importance of studying intact membrane-enzyme complexes in heat death. It is also important to use the criterion of Read (1964) and measure changes in activity of cellular systems under temperature conditions which cause heat death. In this way it is possible to correlate directly the relationship of the lability of the cellular organelles or enzymes to the observed sensitivity of the animal.

Appendix 1

METHOD OF CONSTRUCTION OF THE "DOSE EFFECT"
 CURVES DETERMINATION OF LD₅₀ AND USE OF THE
 FIELLER THEOREM FOR PLACING CONFIDENCE LIMITS
 ON THE LD₅₀.

Mortalities were recorded after each treatment as described in Chapters 3 and 4. From the heat treatments given over a range of dosages, the relationship between mortality and dosage was obtained. In all cases this was found to be sigmoidal, see Figures 3 - 7.

The dosage-mortality relationship is therefore similar to a typical dosage-effect curve obtained with toxicological and pharmacological data.

Conversion of the dosage/effect curve to a straight line.

The mortality of controls was small in all stages of the life history except in the pupa^{ria} (11.5%) and the egg (36.7%). This control mortality was deducted from the mortality recorded after treatment.

Where M is the mortality after treatment of 100 animals, C is the mortality observed in a control group of 100 animals, then H is the mortality caused by the treatment :-

$$H = M - C$$

H expressed as a percentage H'

$$H' = \frac{H \times 100}{100 - C}$$

Mortalities below 1% and above 99% were not considered in order to allow the slope of the sigmoid to be converted to a straight line.

Thus the data between 1% and 99% were used in the following conversion :

$$\log Z = \log_{10} \frac{H'}{100 - H'}$$

Where $Z = 0$ then H' is 50, the LD_{50} point.

Fitting the best straight line to the data.

The best straight line was fitted to the points, based on the assumption of their independence and a constant error of variance, by using the technique of least squares (see Snedecor, 1956).

The number of degrees of freedom was obtained from the number of points used in fitting the straight line. No attempt has been made to weight the line according to the number of animals used in each test, for this was nearly always the same.

Where dosage is plotted along the x axis and $\log Z$

is plotted on the y axis and n is the number of points
(see Figures 3 - 7)

$$\text{Then if } \sum x = S_x$$

$$\sum (x - \bar{x})^2 = SS_x$$

$$\sum y = S_y$$

$$\sum (y - \bar{y})^2 = SS_y$$

$$\sum (y - \bar{y})(x - \bar{x}) = SP$$

$$\text{Then the slope } b = \frac{SP}{SS_x}$$

The mean square deviation from the regression

$$V = \frac{SS_y - \frac{SP^2}{SS_x}}{n - 2}$$

The Student's 't' value for 0.95 confidence interval for (n - 2) degrees of freedom is obtained from the distribution of 't' (Fisher & Yates, 1953).

The confidence interval for the slope will be

$$\pm t \cdot \frac{V}{SS_x}$$

Fitting the LD₅₀ point.

If the true straight line is :

$$y = \beta x + \alpha$$

and the best estimate is :

$$y = b x + a$$

Where $y = 0$, the LD₅₀, then x will be $-\frac{a}{b}$

the true LD₅₀ would be $-\frac{\alpha}{\beta}$

From the line drawn from the data; by using the equation $\bar{y} = b\bar{x} + a$ and deducting it from the LD₅₀ points for Y and X ; then a need not be calculated

$$Y - \bar{y} = b (X - \bar{x}) + a - a$$

Where $Y = 0$ then X is the LD₅₀ point

$$- \bar{y} = b (X_{LD50} - \bar{x})$$

Thus $X_{LD50} = \bar{x} - \bar{y}/b$

Fitting the confidence limits to the LD₅₀

The 95% confidence interval was fitted to the LD₅₀ point using the Fieller theorem (Finney, 1952) and the confidence intervals Θ_1 and Θ_2 were calculated as follows :-

$$\text{where } Y - \bar{y} = b (x - \bar{x})$$

$$Y = \bar{y} + b (x - \bar{x})$$

The confidence intervals Θ_1 and Θ_2 for $(X - \bar{x})$ are obtained from the solution of the equation of the Fieller theorem.

To quote Finney : "The equation is a particular case of a very useful theorem stated by Fieller. If a and b are sample estimates of α and β subject to normal distributed random errors, and if v_{11} , v_{12} and v_{22} are joint estimates from the same sample and based on f degrees of freedom, of the variance and co-variances of a and b , then the fiducial limits of the ratio $\mu - \alpha/\beta$ are the roots of :

$$\Theta^2 (b^2 - t^2 v_{22}) - 2\Theta (ab - t^2 v_{12}) + (a^2 - t^2 v_{11}) = 0$$

where t is the appropriate deviate with f degrees of freedom for the chosen probability level."

Thus where Θ gives the confidence interval for fitting the straight lines from $Y = \bar{y} + b (X - \bar{x})$

Then the variance and covariance can be substituted into Fieller's equation :

$$\text{if } V_{22} = \frac{V}{SS_x}$$

$$- \bar{y} = a$$

$$V_{11} = \frac{V}{n}$$

$$V_{12} = 0 \quad (\text{see Finney, 1952})$$

$$\text{then } \theta^2 \left(b^2 - \frac{t^2 V}{SS_x} \right) + 2\theta \bar{y} b + \left(y^2 - \frac{t^2 V}{n} \right) = 0$$

Solving the roots of the quadratic equation will give the 2 confidence intervals θ_1 and θ_2 which are equal to $(x - \bar{x})$ from the previous equation

$$Y = \bar{y} + b(x - \bar{x})$$

Thus if θ_1 and θ_2 are added to \bar{x} the 2 confidence limits are obtained for the LD₅₀.

Computing the data.

The best straight line, the LD₅₀ and the confidence intervals were fitted using an I.B.M. 360 multi-access computer programmed for PL/1.

Appendix 2

DESCRIPTION AND CALIBRATION OF THE OXYGEN
ELECTRODE.

Measurements of oxidative phosphorylation reported in Chapters 7 and 9 were made using a Rank oxygen electrode (Rank Bros., Cambridge). This electrode is of a similar design to the Clark oxygen electrode (Clark, 1956). A cross section through the electrode is shown in Figure 32.

The electrode has a perspex reaction vessel surrounded by a water jacket and this unit screws on to a perspex base where a platinum cathode and silver anode are situated. The electrodes are bathed in M KCl and this electrolyte is separated from the reaction vessel by a teflon membrane. The perspex screw cap fitted to the top of the reaction vessel has a small hole bored through the centre to allow additions to be made to the reaction chamber. The medium of the reaction vessel is stirred continuously using a small magnetic stirrer and 'flea' (Rank Bros., Cambridge).

The principle of the oxygen electrode has been described by Davies and Brink (1942). When a polarising voltage of - 0.6 volts is imposed across the two electrodes, the platinum negative to the silver,

Figure 32

Diagram showing a vertical section through a Rank oxygen electrode.

a, teflon membrane separating the reaction medium from the KCL electrolyte; b, platinum electrode; c, circular silver electrode; d, reaction chamber; e, water jacket; f, perspex screw top; g, orifice for additions to the reaction chamber; h, locking nut connecting water bath to perspex base; i, stirrer motor (magnetic 'flea' in the reaction chamber is not shown).

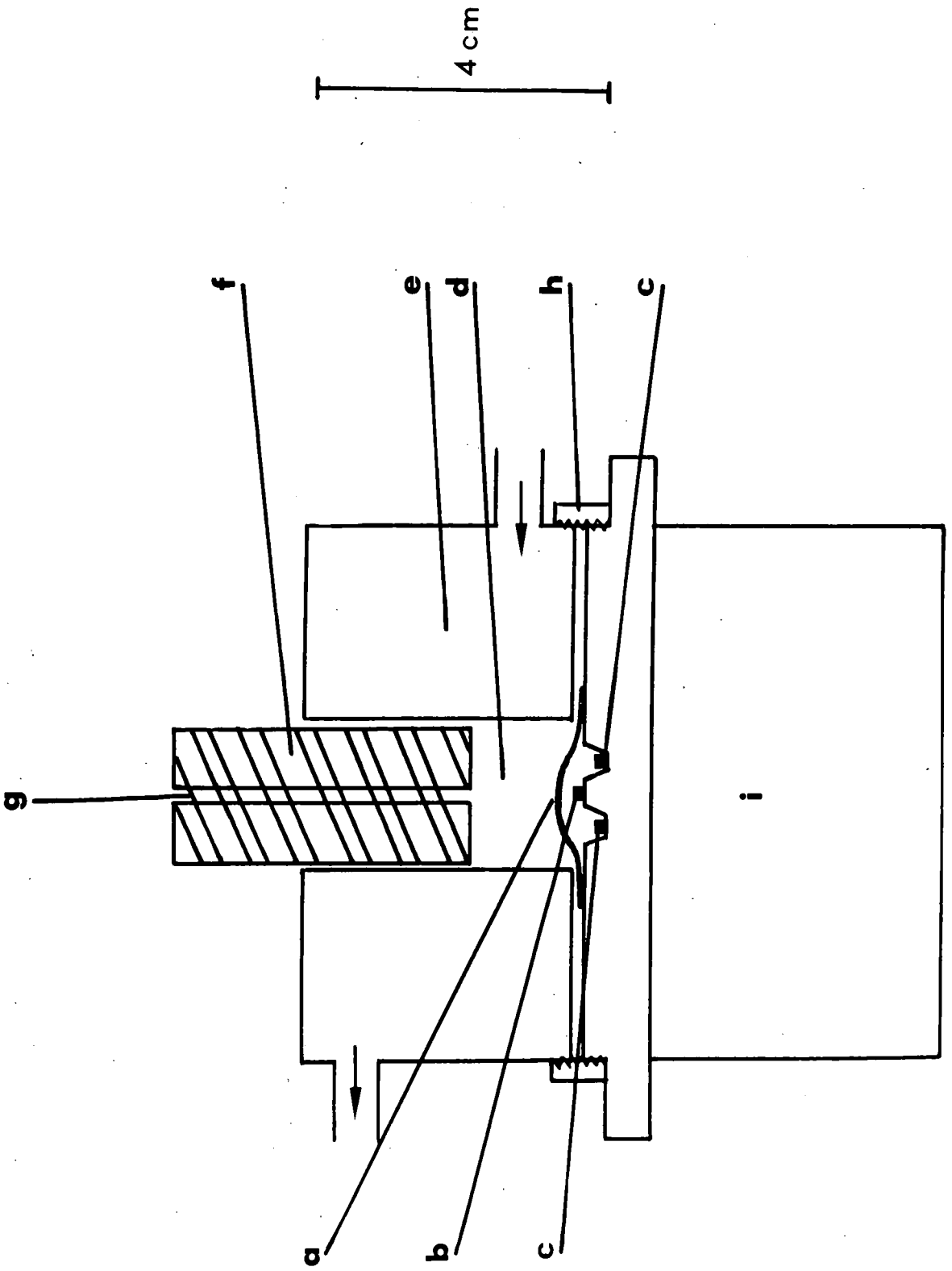

oxygen undergoes an electrolytic reduction

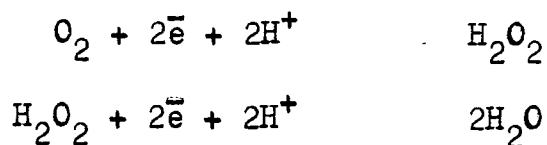

and the current flowing is directly proportional to the oxygen content of the electrolyte. Chappell (1964) has pointed out that the Clark electrode measures activity and not the concentration of the oxygen present. Therefore in this study the oxygen electrode has been calibrated by determining the oxygen content of the reaction medium.

The current flowing through the electrode system was passed through a helical potentiometer in series with the platinum electrode and the voltage developed across this resistance was fed into a Servoscribe recorder (Goerz Electro) set at 2 mV sensitivity. The recorder baseline was set by reducing the medium in the reaction vessel of the oxygen electrode with sodium dithionite. This effectively reduced the current across the electrodes to zero. Reaction medium saturated with oxygen was pipetted into the reaction vessel and the potential adjusted with the helical potentiometer to give a full scale deflexion on the recorder.

Calibration of the oxygen electrode.

The oxygen content of the reaction medium (see Chapter 7) was determined over the range of temperatures used in this study by the method of Chappell (1964).

NADH is oxidized both rapidly and quantitatively by inorganic phosphate-treated, saline-washed, liver mitochondria, Estabrook (1957). NADH is readily assayed spectrophotometrically with alcohol dehydrogenase and acetaldehyde so it is possible to determine the oxygen content of the reaction medium by its reduction with known quantities of NADH.

Lysed P_i -treated, saline-washed, rat liver mitochondria were obtained by the method of Estabrook (1957). The reaction medium (see Chapter 7), containing 1 μ M cytochrome C, was equilibrated to the temperature of the oxygen electrode. 3.9 ml of medium was pipetted into the reaction vessel and the screw top replaced. 1-2 minutes were allowed for the electrode to stabilize and then 0.1 ml of lysed mitochondria were introduced. 20 μ l additions of NADH (Sigma) were made using microcap pipettes (Drummond Scientific Co.). The NADH was made up in a concentration of 30 mg NADH per 2 ml 0.1 M phosphate buffer at pH 7.5. 20 μ l additions of NADH were repeated until all the oxygen in the reaction medium was reduced.

The NADH solution was assayed simultaneously using the spectrophotometric method of Ciotti and Kaplan (1957):

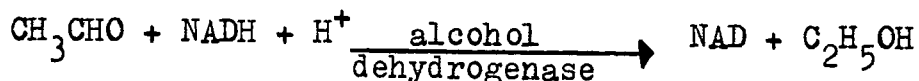

The reagents were as follows :

0.1 M phosphate buffer at ph 7.5 (Sørensen).
alcohol dehydrogenase (Sigma) 10 µl ammonium sulphate suspension per ml 0.1 MK₂HPO₄

0.5 M acetaldehyde

20 µl of NADH solution was pipetted into a silica cuvette with 2.9 ml phosphate buffer and 0.1 ml alcohol dehydrogenase solution. The optical density of 340 mµ was read in a Hilger-Watt spectrophotometer. 20 µl of acetaldehyde was then added and the optical density at 340 mµ read again, after the reaction was completed. The molar concentration of NADH was calculated using the Beer-Lombard Rule and the extinction coefficient for NADH at 340 mµ (6.22×10^{-6} cm²/mole, Horecker and Kornberg, 1948).

$$\text{molar conc.} = \frac{l \times v \times a}{\epsilon}$$

where l = length of light path (cm)
 v = volume of medium (ml)
 a = absorbance (absorbance units)
 ϵ = extinction coefficient (cm²/mole)

The oxygen concentration was extrapolated as follows :

where R is the reading of the recorder for the
O₂ saturated medium

r is the reading of the recorder for the
anaerobic medium.

R - r is the number of chart units proportional
to the oxygen content

V is the volume of the reaction medium (ml)

d is the deflexion caused by the reduction
of N moles NADH

Then since

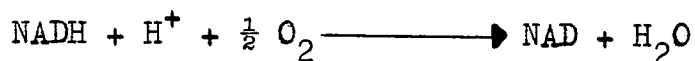

$$\text{O}_2 \text{ conc. ug Atoms O/ml medium} = \frac{N}{V} \times \frac{R - r}{d}$$

The results for oxygen concentration of the reaction medium at various temperatures are recorded in Table 30 and Figure 33. These results agree with those reported by Chappell (1964).

TABLE 31

Concentration of O_2 (μg Atoms O/ml reaction medium)
after equilibration to various temperatures

Temperature $^{\circ}C$	μg A O/ml medium
14	0.606
19	0.523
24	0.458
34	0.405
44	0.350

Figure 33

Graph showing the oxygen content of the reaction medium ($\mu\text{g A O/ml}$) after equilibration to various temperatures.

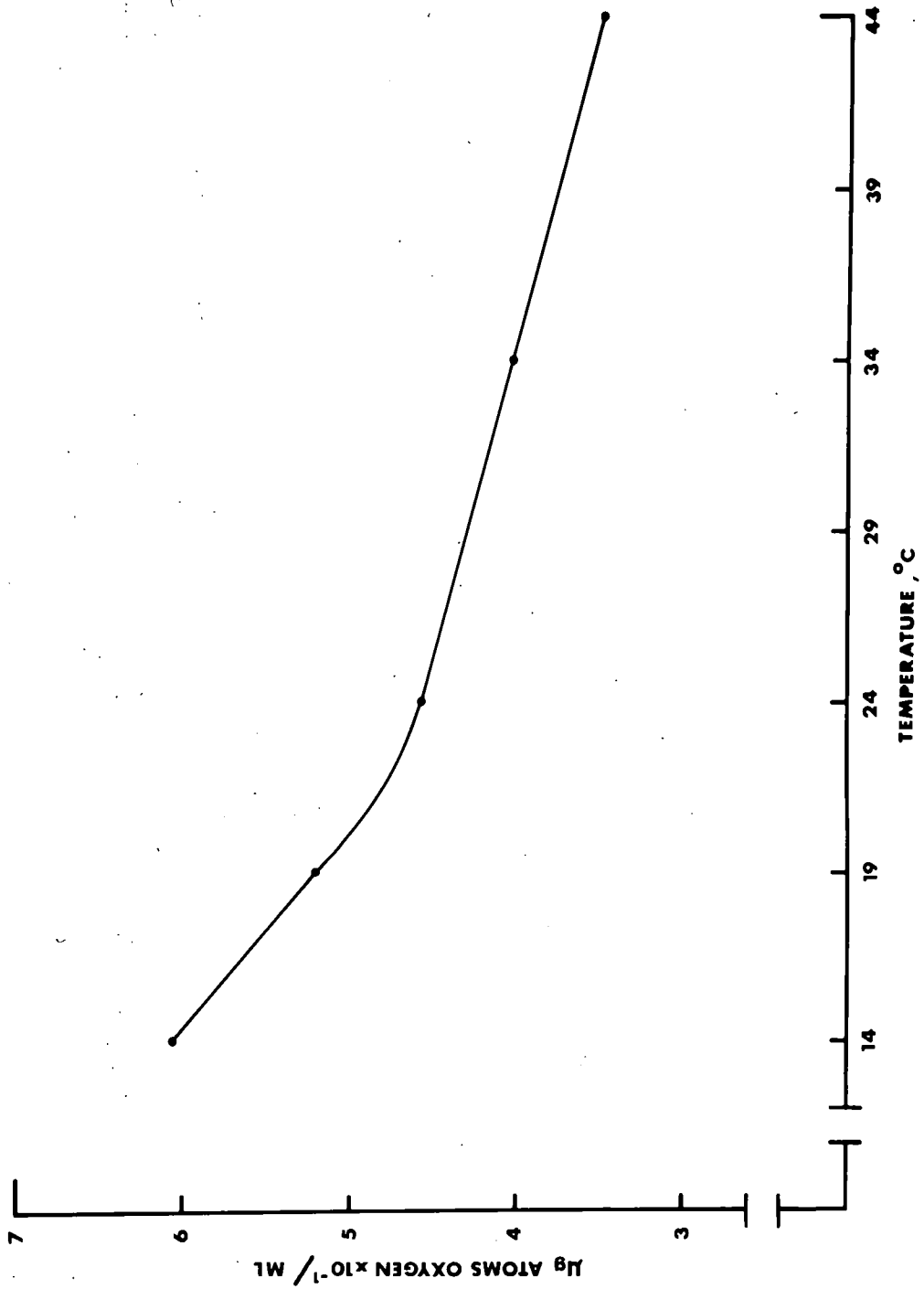

REFERENCES

- AGRELL I. (1964). Physiological and biochemical changes during insect development. In Physiology of Insecta. (Ed. by Rockstein M.) 1. Academic Press, New York.
- ATKINSON D.E. (1966). Regulation of enzyme activity. A. Rev. Biochem 35, 85 - 124.
- BALBONI E.R. (1965). Influence of preparative procedure on oxidative activity of honey bee flight muscle sarcosomes. J. Insect Physiol. 11, 1559 - 1572.
- *BALDWIN W.F. (1954). Acclimatization and lethal high temperature for a parasitic insect. Can. J. Zool. 32, 157 - 171.
- BAUER A.C. and LEVENBOOK L. (1969). Fructose diphosphate aldolase during growth and development of the blowfly, Phormia regina (Meigen). Comp. Biochem. Physiol. 28, 619 - 632.
- BELEHRÁDEK J. (1931). Le mechanisme physicochronique de l'adaptation thermique. Protoplasma 12, 406 - 434.
- BLUHM L. and ORDAL Z.J. (1969). Effect of sublethal heat on the metabolic activity of Staphylococcus aureus. J. Bact. 97, 140 - 150.

- BODINE J.H. and EVANS T.C. (1932). Hibernation and diapause. Physiological changes during hibernation and diapause in the mud-dauber wasp Sceliphron caenentarium. Biol. Bull. 63, 235 - 245.
- BONE G.J. (1944). La rapport sodium/potassium dans le liquide coelomique des insectes. Ann. Soc. r. zool. Belg. 75, 123 - 132.
- BOWLER K. (1963a). A study of the factors involved in acclimatization to temperature and death at high temperatures in Astacus pallipes. I Experiments on intact animals. J. cell. comp. Physiol. 62, 119 - 132.
- BOWLER K. (1963b). A study of the factors involved in acclimatization to temperature and death at high temperatures in Astacus pallipes. II Experiments at the tissue level. J. cell. comp. Physiol. 62, 133 - 146.
- BOWLER K. (1967). Changes in temperature tolerance with adult age in Tenebrio molitor. Entomologia. exp. appl. 10, 16 - 22.
- BOWLER K. and DUNCAN C.J. (1967). Evidence implicating a membrane ATPase in the control of passive permeability of excitable cells. J. cell. Physiol. 70, 121 - 125.

- BOWLER K. and HOLLINGSWORTH M.J. (1965). The effect of inbreeding on temperature acclimatization in Drosophila subobscura. Genet. Res. 6, 1 - 12.
- BOWLER K. and HOLLINGSWORTH M.J. (1966). A study of some aspects of the physiology of ageing in Drosophila subobscura. Exp. Geront. 2, 1 - 8.
- BRETT J.R. (1952). Temperature tolerance in young Pacific salmon genus Oncorhynchus. J. Fish. Res. Bd. Can. 9, 265 - 323.
- BULLOCK T.H. (1955). Temperature adaptation in poikilothermic animals. Biol. Rev. 30, 311 - 342.
- BURNETT G.C. (1957). The relation between age and cold resistance of tsetse flies and the value of chilling when transporting tsetse for experiments. Proc. R. ent. Soc. Lond. 32, 53 - 58.
- BURSELL E. (1964). Environmental aspects : Temperature. In Physiology of Insecta. (Ed. by Rockstein M.) 1. Academic Press, New York.
- BUSVINE J.R. (1962). A laboratory technique for measuring the susceptibility of houseflies to insecticides. Lab. Pract. 11, 464 - 468.
- CARNEY G.C. (1966). The effect of different isolation media on the respiration and morphology of housefly sarcosomes. J. Insect Physiol. 12, 1093 - 1103.

- CHANCE B. and WILLIAMS G.R. (1955a). Respiratory enzymes in oxidative phosphorylation. I Kinetics of oxygen utilization. J. biol. Chem. 217, 383 - 393.
- CHANCE B. WILLIAMS G.R. (1955b). A simple and rapid assay of oxidative phosphorylation. Nature 175, 1120 - 1121.
- CHANCE B. and WILLIAMS G.R. (1956). The respiratory chain and oxidative phosphorylation. Adv. Enzymol. 17, 65 - 134.
- CHAPPELL J.B. (1964). The oxidation of citrate, isocitrate and cis-aconitate by isolated mitochondria. Biochem. J. 225 - 237.
- CHAUDHARY K.D., SRIVASTAVA U. and LEMONDE A. (1966). Aldolase activity in the confused flour beetle, Tribolium confusum Duval. Can. J. Biochem. 44, 155 - 159.
- CIOTTI M.M. and KAPLAN N.O. (1957). Procedures for the determination of pyridine nucleotides. In Methods in Enzymology. (Ed. by Colowick S.P. and Kaplan N.O.) 3, Academic Press, New York.
- CLARK L.C. Junr. (1956). Monitor and control of blood and tissue oxygen tension. Trans. Am. Soc. artif. internal organs 2, 41 - 65.

- COTTON R.T. (1932). The relation of respiratory metabolism of insects to their susceptibility to fumigants. *J. econ. Ent.* 25, 1088 - 1103.
- DAVIES L. (1949). The temperature and humidity relations of various stages in the life history of some calliphorine flies. Ph.D. Thesis, University of Durham.
- DAVIES P.W. and BRINK F. Jun. (1942). Microelectrodes for measuring local oxygen tension in animal tissues. *Rev. scient. Instrum.* 13, 524 - 533.
- D' COSTA M.A. and BIRT L.M. (1966). Changes in lipid content during metamorphosis of the blowfly, Lucilia. *J. Insect Physiol.* 12, 1377 - 1394.
- DINGLEY F. and MAYNARD SMITH J. (1968). Temperature acclimatization in the absence of protein synthesis in Drosophila subobscura. *J. Insect Physiol.* 14, 1185 - 1194.
- DONNELLAN J.F. and BEECHEY R.B. (1969). Factors affecting the oxidation of glycerol - 1 - phosphate by insect flight muscle mitochondria. *J. Insect Physiol.* 15, 367 - 372.
- DUCHÂTEAU G.L., FLORKIN M. and LECLERCQ J. (1953). Concentrations des bases fixes et types de composition de la base totale de l'haemolymphe des insectes. *Arch Intern. Physiol. Biochem.* 61, 518 - 549.

- EDNEY E.B. and BARRASS R. (1962). The body temperature of the tsetse fly, Glossina mortisans Westwood. J. Insect Physiol. 8, 469 - 481.
- ESTABROOK R.W. (1957). The spectral and enzymic characterization of cytochrome C₁ of liver mitochondria. J. biol. Chem. 230, 735 - 750.
- FINNEY D.J. (1952). Probit Analysis. Cambridge University Press, Cambridge.
- FISHER R.A. and YATES F. (1953). Statistical tables for biological, agricultural and medical research. Oliver and Boyd, Edinburgh.
- FISKE C.H. and SUBBAROW Y. (1925). The colorimetric determination of phosphorus. J. biol. chem. 66, 375 - 400.
- FRAENKEL G.S. and HERFORD G.V.B. (1940). The physiological action of abnormally high temperatures on poikilotherm animals. II The respiration at high sublethal and lethal temperatures. J. exp. Biol. 17, 386 - 395.
- FRAENKEL G. and HOPF H.S. (1940). The physiological action of abnormally high temperatures on poikilothermic animals. I Temperature adaptation and the degree of saturation of the phosphatides. Biochem J. 34, 1085 - 1092.

- FRY F.E.J. (1947). Effects of the environment on animal activity. Univ. Toronto Stud. Biol. 55. Publs. Ont. Fish. Res. Lab. 68, 1 - 62.
- FRY F.E.J. (1958). Temperature compensation. A. Rev. Physiol. 20, 207 - 224.
- GOUGH H.C. (1939). Factors affecting the resistance of the flour beetle, Tribolium confusum Duv., to hydrogen cyanide. Ann. appl. Biol. 26, 533 - 571.
- GRAINGER J.N.R. (1959). The effect of constant and varying temperatures on the developing eggs of Rana temporaria. Zool. Anz. 163, 267 - 277.
- GRAINGER J.N.R. (1969). Heat death in Arianta arbustorum. Comp. Biochem. Physiol. 29, 665 - 670.
- GRANT W.C. (1953). Temperature relationships in the peregrine megascolecid earthworm Peretima hupeiensis. Anat. Rec. 117, 561.
- GREEN D.E. and MACLENNAN D.H. (1969). Structure and function of the mitochondrial cristael membrane. Bioscience 19, 213 - 222.
- GREGORY D.W., LENNIE R.W. and BIRT L.M. (1968). An electron microscopic study of flight muscle development in the blowfly Lucilia cuprina. Jl. R. microsc. Soc. 88, 151 - 175.
- GREVILLE G.D., MUNN E.A. and SMITH D.S. (1965). Observations on the fragmentation of isolated flight

- muscle mitochondria from Calliphora erythrocephala (Diptera). Proc. R. Soc. B. 161, 403 - 420.
- HANSFORD R.G. and CHAPPEL J.B. (1967). The effect of Ca^{2+} on the oxidation of glycerol phosphate by blowfly flight-muscle mitochondria. Biochem. biophys. Res. Commun. 27, 686 - 692.
- HEILBRUNN L.V. (1924). The colloid chemistry of protoplasm. Am. J. Physiol. 69, 190 - 199.
- HEILBRUNN L.V. (1952). An outline of general physiology. W.B. Saunders and Co., Philadelphia.
- HELDT H.W. and KLINGENBERG M. (1968). Differences between the reactivity of endogenous and exogenous adenine nucleotides in mitochondria as studied at low temperatures. Eur. J. Biochem. 4, 1 - 8.
- HOAR W.S. (1967). Environmental physiology of animals. Trans. R. Soc. Can. 5, 127 - 153.
- HOCHACHKA P.W. (1965). Isoenzymes in metabolic adaptation of a poikilotherm : subunit relationships in lactic dehydrogenases of goldfish. Arch. Biochem. Biophys. 111, 96 - 103.
- HOCHACHKA P.W. (1967). The organisation of metabolism during temperature compensation. In Molecular mechanisms of temperature adaptation (Ed. by Prosser C.L.). American Association for the Advancement of Science, Washington D.C.

- HOCHACHKA P.W. and SOMERO G.N. (1968). The adaptation of enzymes to temperature. *Comp. Biochem. Physiol.* 27, 659 - 668.
- X HOLLINGSWORTH M.J. and BOWLER K. (1966). The decline in ability to withstand high temperature with increase in age in *Drosophila subobscura*. *Exp. Geront.* 1, 251 - 257.
- HOLLINGSWORTH M.J. (1969). Temperature and length of life in *Drosophila*. *Exp. Geront.* 4, 49 - 55.
- HORECKER B.L. and KORNBERG A. (1948). The extinction coefficients of the reduced band of pyridine nucleotides. *J. biol. Chem.* 175, 385 - 390.
- HOUSE H.L., RIORDIN D.F. and BARLOW J.S. (1958). Effects of thermal conditioning and of the degree of saturation of dietary lipids on resistance of an insect to a high temperature. *Can. J. Zool.* 36, 629 - 632.
- IANDOLA J.J. and ORDAL Z.J. (1966). Repair of thermal injury in *Staphylococcus aureus*. *J. Bact.* 91, 134 - 142.
- JOHNSON F.J., EYRING H. and POLISSAR M. (1954). The kinetic basis of molecular biology. J. Wiley and sons, New York.
- JONES C.R. (1964). Changes in the activity of respiratory enzymes during metamorphosis of the mealworm

- Tenebrio molitor. L. J. cell. comp. Physiol. 63, 65 - 69.
- KAGAWA Y. and RACKER E. (1966). Partial resolution of the enzymes catalyzing oxidative phosphorylation. Correlation of morphology and function in sub-mitochondrial particles. J. biol. Chem. 241, 2475 - 2482.
- KANUNGO M.S. and PROSSER C.L. (1959). Physiological adaptation of goldfish to cold and warm water. II Oxygen consumption of liver homogenates, oxygen consumption and oxidative phosphorylation of liver mitochondria. J. cell. comp. Physiol. 54, 265 - 274.
- KEMP A. Jun., GROOT G.S.P. and REITSMA H.J. (1969). Oxidative phosphorylation as a function of temperature. Biochem. biophys. Acta 180, 28 - 34.
- LARDY H.A. and FERGUSON S.M. (1969). Oxidative phosphorylation in mitochondria. A. Rev. Biochem. 38, 991 - 1034.
- LARDY H.A. and WELLMAN H.J. (1952). Oxidative phosphorylation role of inorganic phosphate and acceptor systems in control of metabolic rates. J. biol. Chem. 195, 215 - 224.
- LEHNINGER A.L. (1964). The mitochondrion. Benjamin Inc. Press, New York.

- LENNIE R.W., GREGORY D.W. and BIRT L.M. (1967). Changes in the nucleic acid content and structure of thoracic mitochondria during development of the blowfly. *J. Insect. Physiol.* 13, 1745 - 1756.
- LEWIS S.E. and FOWLER K.S. (1960). Nature and origin of an inhibitor of oxidative phosphorylation present in freshly isolated sarcosomes from blowfly thoraces. *Biochem. biophys. Acta* 38, 564 - 565.
- LEWIS S.E. and SLATER E.C. (1954). Oxidative phosphorylation in insect sarcosomes. *Biochem. J.* 58, 207 - 217.
- LOWRY O.H., ROSEBROUGH N.J., FARR A.L. and RANDALL R.J. (1951). Protein measurement with Folin-phenol reagent. *J. biol. Chem.* 193, 265 - 275.
- MAYER A.G. (1914). The effects of temperature on tropical marine animals. *Pap. Tortugas Lab.* 6, 1 - 24.
- MAYNARD SMITH J. (1957). Temperature tolerance and acclimatization in Drosophila subobscura. *J. exp. Biol.* 34, 85 - 96.
- MELLANBY K. (1954). The affect of sub-lethal high temperatures on the pupa of the meal worm, Tenebrio molitor L. *Proc. R. ent. Soc. Lond. (C)* 9, 10.

- MERCER E.H. and BIRKBECK M.S.C. (1961). Electron microscopy. A handbook for biologists. Blackwell Scientific Publications, Oxford.
- MILKMAN R.D. (1967). Kinetic analysis of temperature adaptation in Drosophila pupae. In Molecular mechanisms of temperature adaptation. (Ed. by Prosser C.L.) American Association for the Advancement of Science, Washington D.C.
- MYERS D.K. and SLATER E.C. (1957). The enzymic hydrolysis of adenosine triphosphate by liver mitochondria. *Biochem. J.* 67, 559 - 572.
- NAGUIB M. and CHRISTOPHERSEN J. (1965). Über die Beteiligung von ATP bei der Regelung temperaturbedingter leistungsänderungen von Hefezellen. *Naturwissenschaften* 52, 193 - 194.
- NEWELL R.C. (1966). Effect of temperature on the metabolism of poikilotherms. *Nature.* 212, 426 - 428.
- NEWELL R.C. (1967). Oxidative activity of poikilotherm mitochondria as a function of temperature. *J. Zool.* 151, 299 - 311.
- NEWELL R.C. and NORTHCROFT H.R. (1967). A re-interpretation of the effect of temperature on the metabolism of certain marine invertebrates. *J. Zool.* 151, 277 - 298.

- NEWELL R.C. and WALKEY M. (1966). Oxidative activity of mammalian liver mitochondria as a function of temperature. *Nature* 212, 428 - 429.
- PARKIN E.A. and GREEN A.A. (1958). Chapter 69 in Handbook of laboratory animals. Universities Federation for Animal Welfare, London.
- PRECHT H. (1958). Concepts of temperature adaptation of unchanging reaction systems of cold blooded animals. In Physiological adaptation. (Ed. by Prosser C.L.) American Physiological Society, Washington D.C.
- PRECHT H., CHRISTOPHERSEN J. and HENSEL H. (1955). Temperatur und Leben. Springer-Verlag, Berlin.
- PROSSER C.L. (1955). Physiological variation in animals. *Biol. Rev.* 30, 229 - 262.
- PROSSER C.L. (1958). General Summary : The nature of physiological adaptation. In Physiological adaptation. (Ed. by Prosser C.L.) American Physiological Society, Washington D.C.
- PROSSER C.L. (1967). Molecular mechanisms of temperature adaptation in relation to speciation. In Molecular mechanisms of temperature adaptation. (Ed. by Prosser C.L.) American Association for the Advancement of Science, Washington D.C.

- PROSSER C.L. and BROWN F.A. Jun. (1961). Comparative animal physiology. W.B. Saunders and Co., Philadelphia.
- PULLMAN M.E. and SCHATZ G. (1967). Mitochondrial oxidations and energy coupling. A. Rev. Biochem. 36, 539 - 610.
- READ K.R.H. (1964). Comparative biochemistry of adaptations of poikilotherms to the thermal environment. Proc. Symp. Exptl. Marine Ecol. Occasional paper. Graduate School of Oceanography University of Rhode Island No. 2, 39 - 47.
- REYNOLDS E.S. (1963). Staining of tissue sections for electron microscopy with heavy metals. J. cell. Biol. 17, 208 - 212.
- SACKTOR B. (1958). A biochemical basis of flight muscle activity. 4th Int. Conference of Biochemistry (Vienna) Pergamon Press, Oxford.
- SACKTOR B., O'NEILL J.J. and COCHRAN D.G. (1958). The requirement of serum albumin in oxidative phosphorylation of flight muscle mitochondria. J. biol. Chem. 233, 1233 - 1235.
- SIMON J., BHATNAGAR P.L. and MILBURN N.S. (1969). An electron microscope study of the changes in mitochondria of flight muscle of ageing houseflies (Musca domestica). J. Insect Physiol. 15, 135 - 140.

- SIZER I.W. (1943). Effects of temperature on enzyme kinetics. *Adv. Enzymol.* 3, 35 - 62.
- SMITH D.S. (1961). The structure of insect fibrillar flight muscle. *J. biophys. biochem. Cytol.* 10, Suppl. 123 - 158.
- SMITH D.S. (1962). The sarcoplasmic reticulum of insect muscles. Proc. Fifth Int. Cong. Electr. Micr. Philadelphia TT3. Academic Press, New York.
- SMITH D.S. (1963). The structure of flight muscle sarcosomes in the blowfly Calliphora erythrocephala (Diptera). *J. cell. Biol.* 19, 115 - 138.
- SMITH D.S. (1965). The organisation of flight muscle in an aphid Megowan viciae (Homoptera) with a discussion on the structure of synchronous and asynchronous striated muscle fibres. *J. cell. Biol.* 27, 379 - 393.
- SMITH D.S. (1966). The organisation of flight muscle fibres in the Odonata. *J. cell. Biol.* 28, 109 - 126.
- SNEDECOR G.W. (1956). Statistical methods (5th Edition). Iowa State College Press, Ames.
- SPENCER DAVIES P. and TRIBE M.A. (1969). Temperature dependence of metabolic rate in animals. *Nature* 224, 723 - 724.
- STEARNS A.E. (1949). Kinetics of biological reactions with special reference to enzymic processes. *Adv.*

- Enzymol. 9, 25 - 74.
- STRANGENBERG G. (1955). Der Temperatur einfluss auf Lebensprozesse und den Cytochrom c-Gehalt beim Wasserfrosch. Pflügers Arch. ges. Physiol. 260, 320 - 332.
- SUN Y.P. (1947). An analysis of some important factors affecting results of fumigation tests on insects. Tech. Bull. Minn. agric. Exp. Stn. 177, 1 - 104.
- TRIBE M.A. (1966a). The effect of diet on longevity in Calliphora erythrocephala. Meig. Exp. Geront. 1, 269 - 284.
- TRIBE M.A. (1966b). Some physiological studies in relation to age in the blowfly Calliphora erythrocephala Meig. J. Insect Physiol. 12, 1577 - 1593.
- TRIBE M.A. (1967a). Some aspects of the physiology of ageing in the blowfly Calliphora erythrocephala Meig. Ph.D. Thesis, University of Durham.
- TRIBE M.A. (1967b). Changes taking place in the respiratory efficiency of isolated flight muscle sarcosomes, associated with the age of the blowfly, Calliphora erythrocephala. Comp. Biochem. Physiol. 23, 607 - 620.
- TRIBE M.A. and BOWLER K. (1968). Temperature dependence of "standard metabolic rate" in a poikilotherm. Comp. Biochem. Physiol. 25, 427 - 436.

- UMAROV B.P. (1931). Insects and climate. Trans. ent. Soc. Lond. 79, 1 - 247.
- USHAKOV B.P. (1964). Thermostability of cells and proteins of poikilotherms and its significance in speciation. Physiol. Rev. 44, 518 - 560.
- VAN DEN BERGH S.G. (1962). Respiration and energy production in the flight muscle of the housefly Musca domestica. Ph.D. Thesis, University of Amsterdam.
- VAN DEN BERGH S.G. and SLATER E.C. (1962). The respiratory activity and permeability of housefly sarcosomes. Biochem. J. 93, 128 - 136.
- WALKER A.C. and BIRT L.M. (1969a). Development of respiratory activity and oxidative phosphorylation in flight muscle mitochondria of the blowfly, Lucilia cuprina. J. Insect Physiol. 15, 305 - 317.
- WALKER A.C. and BIRT L.M. (1969b). An electron microscope study of thoracic mitochondrial membranes in developing adults of the blowfly Lucilia cuprina. J. Insect Physiol. 15, 519 - 529.
- WATSON M.L. (1958). Staining of tissue sections for electron microscopy with heavy metals. J. biophys. biochem. Cytol. 4, 475 - 478.
- WEINBACH E.C., GARBUS J. and SHEFFIELD H.G. (1967). Morphology of mitochondria in the coupled,

- uncoupled and recoupled states. Exptl. cell. Res. 46, 129 - 143.
- WEINBACH E.C. and GARBUS J. (1969). Mechanism of action of reagents that uncouple oxidative phosphorylation. Nature 221, 1016 - 1019.
- WIGGLESWORTH V.B. (1965). Principles of insect physiology. Methuen and Co.Ltd., London.
- WILKINSON J.H. (1965). Isoenzymes. Spen's Biochemical Monographs, London.
- WINSTON P.W. and BATES D.H. (1960). Saturated solutions for control of humidity in biological research. Ecology 41, 232 - 246.
- WOJTCZAK L. and WOJTCZAK A.B. (1960). Uncoupling of oxidative phosphorylation and inhibition of ATP - Pi exchange by a substance from insect mitochondria. Biochem. biophys. Acta 39, 277 - 286.
- ZEBE E.C. and MCSHAN W.H. (1957). Lactic and α -glycerophosphate dehydrogenases in insects. J. gen. Physiol. 40, 779 - 790.

