



## Durham E-Theses

---

### *Measurements of natural and artificial point discharge*

Jhawar, D. S.

#### How to cite:

---

Jhawar, D. S. (1967) *Measurements of natural and artificial point discharge*, Durham theses, Durham University. Available at Durham E-Theses Online: <http://etheses.dur.ac.uk/8557/>

#### Use policy

---

The full-text may be used and/or reproduced, and given to third parties in any format or medium, without prior permission or charge, for personal research or study, educational, or not-for-profit purposes provided that:

- a full bibliographic reference is made to the original source
- a [link](#) is made to the metadata record in Durham E-Theses
- the full-text is not changed in any way

The full-text must not be sold in any format or medium without the formal permission of the copyright holders.

Please consult the [full Durham E-Theses policy](#) for further details.

The copyright of this thesis rests with the author.  
No quotation from it should be published without  
his prior written consent and information derived  
from it should be acknowledged.

**MEASUREMENTS OF NATURAL AND ARTIFICIAL**

**POINT DISCHARGE**

by

**D. S. Jhavar  
(St. Cuthbert's)  
M.Sc., F.R.Met.S.**

**Presented in candidature for the degree of Doctor  
of Philosophy of the University of Durham.**

*D. S. Jhavar*  
**March 1967**



CONTENTS

	Page
Table of Contents	i
Abstract	iv
<b>CHAPTER I</b>	
1.1 The Importance of Point-Discharge in Atmospheric Electricity	1
1.2 The Nature of Point-Discharge	4
1.3 Point-Discharge Current Down Trees	5
1.4 Point-Discharge Current and the Number and Separation of Points	9
1.5 Conclusion	10
<b>CHAPTER II</b>	
Measurements with a Single Point	12
2.1 Introduction	12
2.2 Mathematical Derivation of $I=AV(V-V_0)$	14
2.3 Experimental Verification of $I=AV(V-V_0)$	18
2.4 Conclusion	23
<b>CHAPTER III</b>	
Measurements with Multiple Points	26
3.1 Introduction	26
3.2 Apparatus	28
3.3 Results	29
3.4 Discussion of Results	32
3.5 Results with Five Points	36
3.6 Conclusion	38

	Page
<b>CHAPTER IV</b>	
<b>Measurements of Point-Discharge Current through Trees and Plants</b>	
4.1 Introduction	40
4.2 Results with a Single Wooden Point	41
4.3 Results with a small Spruce Plant	44
4.4 Results with Trees	47
4.5 Derivation of Cube Law for Tree	49
4.6 Conclusion	51
<b>CHAPTER V</b>	
<b>Measurements of Electrode By-Passing Efficiency</b>	
5.1 Introduction	53
5.2 Experimental Arrangement	55
5.3 The Tree Electrodes	57
5.4 Results with Artificial Fields	59
5.5 Results with Constant D.C. Voltage	62
5.6 Measurement of the Impedance of the Tree	65
5.7 Conclusion	67
<b>CHAPTER VI</b>	
<b>Anomalous Properties of the Tree</b>	
6.1 Introduction	70
6.2 Residual Current of E.M.F. in the Tree	71
6.3 Effect of Current on the Distribution of Resistance in the Tree	74

	Page
6.4 Variation of the Resistance of the Tree with Applied E.M.F.	77
6.5 Conclusion	83
 <b>CHAPTER VII</b>	
Point-Discharge Current and its Relation to Potential Gradient and Wind Speed.	
7.1 Introduction	84
7.2 Experimental Arrangement	88
7.3 Measurement of Wind Speed	89
7.4 Results	90
7.5 Preliminary Analysis of Results	91
7.6 Analysis of Results by Computer	101
7.7 Conclusion	107
 <b>CHAPTER VIII</b>	
Measurements of Point-Discharge Pulses	
8.1 Introduction	109
8.2 Apparatus	110
8.3 Results	111
8.4 Analysis of Results	112
8.5 Conclusion	116
 <b>CHAPTER IX</b>	
Suggestions for further work	118
Acknowledgements	120
References	121

ABSTRACT

Assuming spherical symmetry, an approximate form of the current-voltage relationship has been derived for a single point and the constants involved verified experimentally in the laboratory, under controlled conditions.

When a single point was replaced by a multiple-point system the total point-discharge current through the latter was found to be a function of the point separation and the clearance of the points from the H.F. plate. The current through a system of multiple-points of different starting voltages obeyed an approximate cube law, later derived theoretically, similar to the case of trees and small plants.

The fraction of the point - discharge current in a living tree bypassed through a low resistance galvanometer has been found to increase with total point-discharge current, because the impedance of the tree in between the two electrodes increases and the reactance of the bypassing circuit decreases.

The resistance of the tree was found to increase with time after application of the voltage and also to increase with decreasing voltage when measurements were made of steady currents; no such effect was observed with instantaneous currents.

The effect of the wind on the point-discharge current through a single as well as multiple-point system has been studied. The relation between the point-discharge current, point voltage and wind speed has been derived empirically, using a method of multiple regression analysis.

The quantity of charge per pulse, as calculated from the

ratio of the average current and frequency of the pulses, was always found to be greater than that calculated by integrating the pulse over the time of decay. When a wind was applied parallel to the electron current, the quantity of charge per pulse increased linearly at first and then reached a saturation stage; a very high wind was however needed to get any noticeable effect.

## CHAPTER 1

### 1.1 The Importance of Point-Discharge in Atmospheric Electricity

Atmospheric Electricity is concerned with the study of the electrical phenomenon of the atmosphere between two concentric conducting surfaces, the negatively charged earth and the positively charged ionosphere, which form the two plates of a spherical condenser, having as dielectric the poorly conducting atmosphere.

During fine weather, there is current of positive electricity coming to earth, tending to neutralize its negative bound charge; calculations show that this conduction current would neutralize the bound charge in a matter of a few minutes. On the other hand there is no such loss of charge. So there must be other processes bringing negative charge to earth.

WILSON (1920) was the first to realize that the negative charge arriving at the earth's surface, in regions experiencing stormy weather, would compensate the positive charge arriving in regions experiencing fine weather.

There are four main processes by which charge can reach





the earth.

- (a) Conduction Currents
- (b) Point-discharge Currents
- (c) Precipitation Currents
- (d) Lightning Currents

In order that the charge on the earth should remain constant, it is essential that the effects of these four processes must cancel one another out. Several workers who made an estimate for the whole of the earth's surface, found an excess of negative charge brought to earth, and they were of the opinion that this neutralized the excess of positive charge in non-stormy regions and deserts.

WORMELL (1927) was the first to point out that the point-discharge is an important factor in the transfer of charge from clouds to earth in disturbed weather. Several other people like WHIPPLE and SCRASE (1936), CHIPLONKAR (1940) and CHALMERS and LITTLE (1947) all raised artificial metal points in the atmosphere to heights of 8-12 metres, and measured the total charge brought to earth over considerable periods of time. All results show an excess of negative charge to positive charge in the ratio approximately 2 : 1. From the total excess of charge and an estimate of the number of equivalent points per

square kilometer, the total charge brought to earth was computed. It is in this extrapolation from a single artificial point to the number of similar points per square kilometer that the difficulties and variations in the assessments occur, as it is now confirmed in the present work that there is a great deal of difference between a single point and multiple artificial points and that there is a great deal of difference between these and a single tree or groups of trees. Estimates, therefore, based on measurements made with single points will not be very reliable.

SCHONLAND (1928) in South Africa, circumvented the difficulties of working with artificial points by mounting a small tree, typical of those in the neighbourhood, on insulators and measuring the flow of charge to earth. His results gave a maximum point-discharge current density of  $0.16\text{A/m}^2$ , under the centre of an active cloud, which is considerably higher than the  $0.18\text{A/m}^2$  obtained at Cambridge and the  $0.012\text{A/m}^2$  at Kev, because the tree used by him was more exposed and consequently a more effective discharging element than the average tree in the neighbourhood.

Several workers have made indirect determinations of effective separation of the discharging points, as an example,

SIMPSON (1949) from the measurements of rain current and SMITH (1951) from the potential gradient changes due to near lightning flashes. CHALMERS (1953) used a simple dipole form for the thundercloud to account for the potential gradients at the earth's surface and was able to deduce the effective separation of points.

### 1.2 The Nature of Point-Discharge

Consider an earthed pointed conductor, situated in a positive electric field. When the field is low, there is a conduction current, carried by ions produced mainly by radioactive substances and by cosmic rays. If the field is sufficiently strong, the lines of force become concentrated at the point and the field is strong enough for an electron to gain sufficient energy to disrupt the molecules with which it collides, and this will produce a fresh ion and electron. The same process may occur in the next mean free path and it will be seen that the number of ions present can be considerably multiplied, and it is even more so if the ions of both signs can produce ionisation by collisions.

In a positive potential gradient the positive ions move into the point, forming the point-discharge current while the

negative ions move away from the point and form a space charge, which has the effect of reducing the potential gradient near the point, since the lines of force end on these ions instead of on the point. This may continue until the potential gradient is so much reduced that ionisation by collisions no longer occurs and the discharge ceases. As the last ions are moving off, the field again rises to its original high value and the whole process now repeating itself. This shows that under suitable conditions, the point-discharge occurs in a series of pulses. These were first studied by TRICHEL (1938) who found that they occur very regularly when the point is the negative electrode.

The process is similar when the point is positive with respect to its surroundings, except that when the potential gradient is near onset potential there are 'inductive kicks' with sometimes small and irregular pulses; for higher potential gradients the current becomes more steady.

### 1.3 Point Discharge Current Down Trees

Most of the research work which has been carried out on point discharge currents in Atmospheric Electricity has been concerned with currents flowing down elevated artificial points.

Relatively very little work seems to have been carried out in the investigation of point discharge currents down natural objects, especially trees.

SCHONLAND (1928), mounted a small tree, a thornbush about 12ft. high, on insulators and measured the flow of currents to earth by means of a galvanometer. His results suggest that the current is more nearly proportional to the cube of the field than to the square law usually found for an artificial point.

KIRKMAN (1956) attempted, largely unsuccessfully, to measure currents down a lime tree, by using two conducting bands and shorting out the section of the trunk between them with a low resistance galvanometer.

When point discharge occurs, equal numbers of ions of both signs are produced close to the point, those of the same sign as the potential gradient move into the point, while those of the opposite sign move with the wind and decrease the potential gradient to leeward of the point. MAUND & CHALMERS (1960) attempted to use this method to measure, indirectly, the point-discharge current down a tree. The results obtained showed that

a sycamore tree in full leaves gives no measurable effect, even when the potential gradient reaches 5000V/m. But on the other hand for ash and poplar trees, not in leaf, the discharge appears to commence at about the same value of potential gradient as for a single point of the same height.

MILNER & CHALMERS (1961) bypassed through a low resistance galvanometer, most of the current down a tree, by using leads into it at two different heights. They also made measurements on an artificial point nearly of about the same height as the tree and showed that the current through a lime tree is comparable with that through the point but starts at a higher potential gradient. Using the same sort of electrode system ETTE (1966(b)) found that the bypassed current is only a fraction of the whole current through the tree, though this fraction was constant over a period sufficiently long for the arrangements to provide a useful measure for the point-discharge current in it.

CHALMERS (1962(b)) found that when the potential gradient is varying very rapidly, such as after a close lightning stroke, the currents through a tree and through a metal point do not correspond, instead the tree appears to behave as a resistance capacitance element of time constant about 90 sec.

CHALMERS (1964) and ETTE (1966a) found that the tree is not a single resistance - capacitance element of one time - constant but in fact behaves similar to that of an anomalous dielectric having a series of time - constants, initially of the order of seconds and then of the order of days.

Ions produced at trees from point discharge have been detected as space charge by BENT, COLLIN, HUTCHINSON and CHALMERS (1965).

In all the measurements made so far, (except that of MAUND & CHALMERS) where no complication arises due to displacement currents, no account was taken of the displacement currents which can be quite appreciable, during periods of rapidly changing potential gradients such as accompany lightning discharges, on account of the large surface area of a tree, especially when in leaf. ETTE (1966d) derived theoretically the 'effective area', of trees of simple shapes and hence found the magnitude of the displacement currents picked up by them during known potential gradient changes. He suggested that the magnitude of the displacement currents could be as large as the pure point-discharge current and could cause large errors in the measurements of point-discharge currents in large trees through neglecting the displacement currents.

#### 1.4 Point-Discharge Current and the Number and Separation of Points

It has long been recognised that the phenomenon of point-discharge from trees and other natural and artificial pointed objects must form an important item in the transfer of electricity from clouds to earth.

The idea of obtaining the point-discharge current density from the current through a single point and the estimated number of like points in a given area, gave rise to a number of experiments with multiple point dischargers.

Several workers, who tried to compare the point-discharge currents from multiple-point systems with those from isolated points of heights and dimensions similar to those of the individual points in the systems, found altogether contradictory results.

The apparent discrepancies in the various measurements both in the atmosphere and in the laboratory have been largely resolved through the recent investigations which have shown that there in general exists a 'critical' voltage at which the total point-discharge current from the multiple points equals that from an isolated point of similar height and dimensions.



Below this voltage the multiple point system gives less current than the isolated point; while above it the situation is reversed. Moreover the starting voltages of points in a multiple point discharger depend upon the relative separation between the points to the clearance of the tips from the upper H.T. plate.

### 1.5 Conclusion

Previous investigators have shown that the atmospheric point discharge current, especially through natural points i.e. trees, is a major contributor to the maintenance of the earth's negative charge.

When multiple points are substituted for a single artificial point, the current through the former depends upon the separation between the points. Moreover the starting voltages of points in a multiple-point system is a function of both the clearance for each point as well as the separation between the points.

For a tree, it is possible to short circuit a fraction of the current flowing down it by leads into it at two different levels but in this case an account should be taken of the displacement currents especially for trees of large surface areas, during periods of rapidly changing potential gradients.

In spite of the various contributions by several workers, especially the recent ones by ETE, very little is known about the complex phenomenon of point-discharge currents down trees. So the present investigations are intended as a further contribution to that study.

## CHAPTER II

### Measurements with a Single Point

#### 2.1 Introduction

As the potential is increased between a point and a plane gap, the lines of force become concentrated at the point and ionization by collision takes place. This gives rise to point-discharge currents, lying in the order of a microampere at relatively low potentials, frequently unsteady or fluctuating near onset or threshold potential. For small potential increases above threshold, the point-discharge current increases linearly with potential. This is called the Ohms Law regime. With increase in potential, the discharge also generally becomes more stable and steady. At this stage, depending upon pressure and the nature of the gas, luminosity of some form or other appears near the point. Thereafter the current increases somewhat faster than linearly, approaching a parabolic increase with potential. Depending on the gap, the current and potential can be increased by considerable margins until a point is reached yielding a complete breakdown of the gap, to a transient arc through the medium of a spark with a brilliantly luminous channel at the higher pressure. The breakdown to a spark usually occurs at voltages from two to six times that for onset of the first glow and current.

Except at relatively low pressures, the luminous manifestations at the point near threshold for low currents take on various characteristic shapes such as glows, multiple spots, haloes, coronas, brushes, streamers etc. In consequence, these luminous manifestations give to the phenomenon the general name coronas. It comes from the French word COURONNE, literally crown, which typifies one of the various forms observed.

In the laboratory measurements of point-discharge, it is generally accepted (see LOEB 1965) that the current from a point to a plane gap obey a relationship of the form:-

$$I = AV (V-V_0)$$

where  $A$  = a constant characteristic of the geometry of the point, its position in the field and the ionic mobility.

$V_0$  = voltage at which the discharge starts, which is primarily governed by the distribution of electric field in the immediate vicinity of the point, so is dependent upon the radius and condition of the point.

The investigations described in this chapter mainly deal with an approximate theoretical derivation of the above relation and its experimental verification.

## 2.2 Mathematical Derivation of $I = AV(V-V_0)$

For co-axial cylindrical geometry TOWNSEND (1914) derived mathematically, a current-voltage relation of the form  $I = AV(V-V_0)$  where the symbols have the usual meanings.

For a point-plane gap, the solution of this problem is exceedingly tedious mathematically. LOEB et al (1950) carried out the solution numerically for different ratios of the length of the gap along the axis to the radius of the point.

On certain assumptions, CHALMERS (1962a) has derived an approximate relation of the above form in the following way:-

We consider a region of constant potential, into which is inserted a point maintained at earth potential (without the inconvenience of conducting leads). The picture obviously has spherical symmetry once the leads are neglected. In addition, any recombination effects<sup>by</sup> which these ions become large ions with a consequent reduction in mobility, are ignored.

Let the surroundings be at a negative potential with respect to the point and a steady state is reached, in which sufficient ions leave the neighbourhood of the point to carry the current.

The times concerned are large compared with the lengths of Trichal pulses.

Let us suppose that the field strength  $X_0$  needed for ionisation by collisions is reached everywhere within a distance 'a' from the point, so that the whole sphere of radius 'a' around the point is plentifully supplied with ions and can be considered to be at the same potential as the point i.e. at zero potential.

Consider a sphere of radius  $r$  with centre at the point.

Let  $X$  be field strength at its periphery. If there are  $n$  positive ions per unit volume each carrying a charge  $e$ , the current outward through the sphere is (using M.K.S. units)

$$I = 4\pi r^2 n e w X \quad (1)$$

where  $w$  = mobility of positive ions.

In a steady state  $I$  is the same for all such spheres.

From Poisson's Law

$$4\pi r^2 n e = \epsilon \frac{d}{dr} (4\pi r^2 X) \quad (2)$$

Eliminating  $n e$  between (1) and (2) we get

$$\frac{I}{wX} = 4\pi \epsilon \frac{d}{dr} (r^2 X)$$

Putting

$$r^2 \cdot X = Y \text{ we get}$$

$$I/Y = \frac{4\pi w \epsilon}{r^2} \frac{dY}{dr}$$

Upon integration,

$$\frac{I r^3}{12 \pi w \epsilon} = \frac{X^2}{2}$$

Putting the value of  $y = r^2 X$ , we get

$$\frac{I}{6 \pi w \epsilon r} = X^2$$

$$\text{Let } K^2 = \frac{I}{6 \pi w \epsilon}$$

$$\therefore X^2 = \frac{K^2}{r}$$

$$\text{or } X = K \cdot (r)^{-\frac{1}{2}} \quad (3)$$

$$\begin{aligned} \text{Therefore } X_b &= K (b)^{-\frac{1}{2}} \\ &= \text{Field at distance } b \text{ from the point} \\ &= F \end{aligned}$$

The theory applies only to concentric spheres but by making certain approximations we can extrapolate the theory to apply to a point-plane system, having the point tip situated at a distance  $b$  from the plane,

$\therefore$  we can write

$$F = K (b)^{-\frac{1}{2}} \quad (4)$$

Now from (3) by integrating we get

$$\int -X dr = -K \int_a^b (r)^{-\frac{1}{2}} dr$$

$$\text{or } V_p = -2K (b^{\frac{1}{2}} - a^{\frac{1}{2}})$$

Where  $V_p$  is the voltage of the surroundings with respect to the point, which we shall call as the point voltage, to distinguish

it from the plate voltage denoted by  $V$ .

If we neglect 'a' with respect to 'b', we get

$$V_p = -2K b^{\frac{1}{2}} \quad (5)$$

Eliminating 'b' between (4) and (5), we get

$$V_p = \frac{-2K^2}{F} = \frac{-2I}{6\pi w \epsilon F}$$

$$\text{or } I = -3\pi w \epsilon F V_p$$

By assuming  $a \ll b$ , we have neglected the fact that there is a minimum value of  $V_p$  below which no point-discharge occurs. Therefore, approximately, we can rectify this by replacing  $V_p$  by  $(V_p - V_{op})$ . The negative sign signify merely that there is a positive current outward for negative potential difference outward.

$$\therefore I = 3\pi w \epsilon F (V_p - V_{op})$$

$$\text{Now } V_p = V \cdot \frac{H}{D} \quad , \quad F = \frac{V}{D}$$

where  $V$  = Plate voltage in volts

$H$  = Height of the point in metres

$D$  = Distance between the H.T. and earth plates in metres.

$$\text{Therefore, } I = 3\pi w \epsilon \left(\frac{H}{D^2}\right) \cdot V (V - V_o)$$

$$= A \cdot V \cdot (V - V_o) \quad (6)$$

$$\begin{aligned} \text{where } A &= 3\pi w \epsilon \left(\frac{H}{D^2}\right) \\ &= 1.25 \times 10^{-14} \left(\frac{H}{D^2}\right) \end{aligned}$$



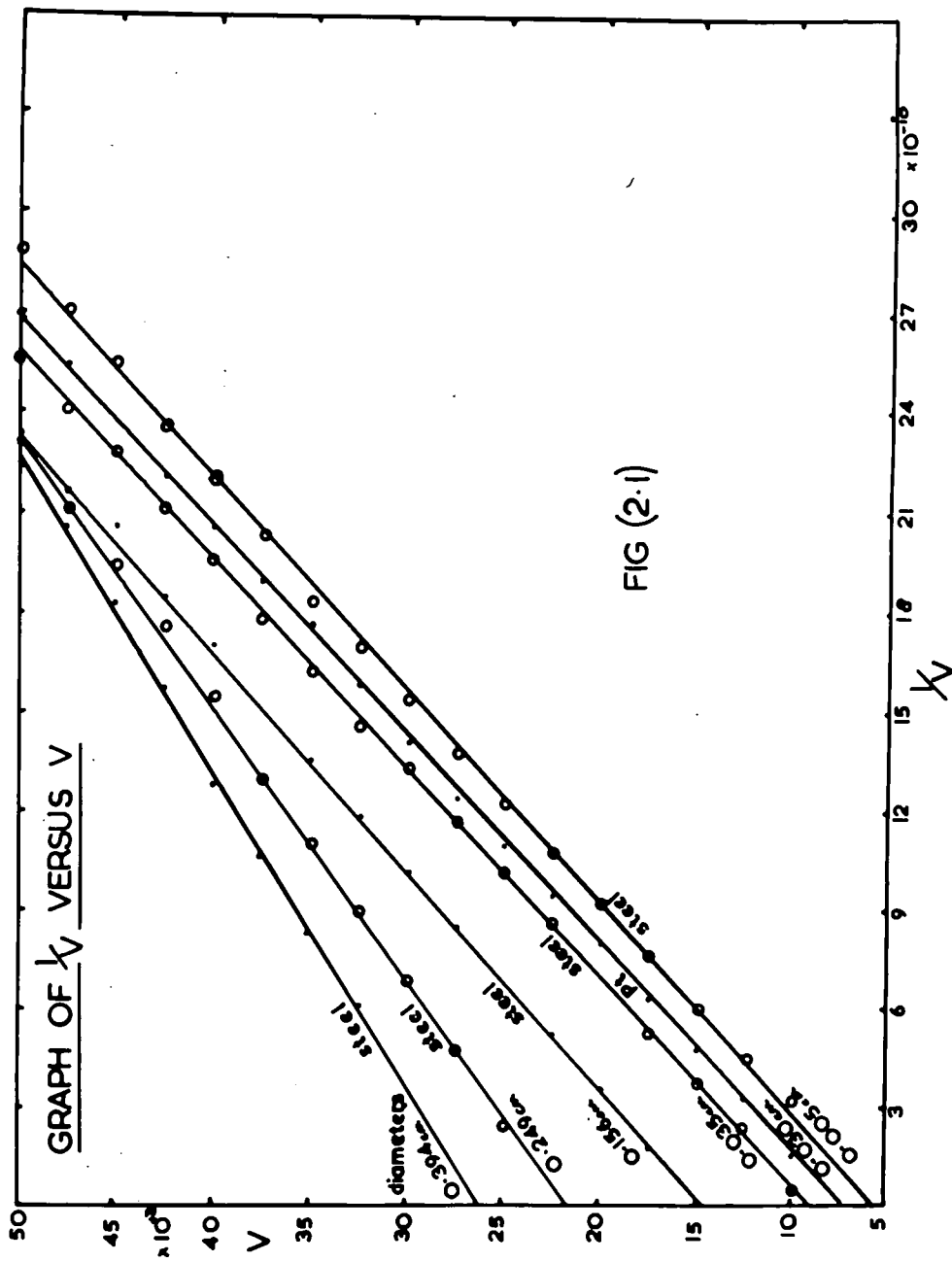

Because  $\epsilon = 8.85 \times 10^{-12} \frac{\text{F}}{\text{m}}$ ,  $W = 1.5 \times 10^{-4} \text{ M.K.S. units}$

If  $H = 5 \times 10^{-2} \text{ m}$ ,  $D = 10 \times 10^{-2} \text{ m}$

then  $A = 6.25 \times 10^{-14}$

### 2.3 Experimental Verification of $I = AV(V-V_0)$

To verify the above relation, a very simple form of apparatus was used. Various points of different diameters from 0.005 cm to 0.40 cm were used. The point-discharge was induced in the point, by mounting it in an artificial field between two parallel plates, each about 65 cm in diameter, spaced about 10 cm apart. The point-discharge current was measured with a galvanometer, as the potential of the upper plate was increased in steps upto a maximum of about  $\pm 50 \text{ KV}$  and then decreased in the same steps to zero. In each case, the distance between the parallel plates i.e.  $D = 10 \text{ cm}$  and the height of the point i.e.  $H = 5.0 \text{ cm}$ . Some of the results for positive potentials on the upper plate (negative points) are shown in table (2.1). The results for the negative potentials are similar but the value of  $A$  is always smaller and  $V_0$  greater.

The fig. (2.1) shows the graphs of  $I/V$  versus  $V$  and the table 2.2 shows the experimental values of  $A$  and  $V_0$  for different points.

Table (2.1)

V (KV)	Point-Discharge Current in $\mu$ A for Different Points					
	I (0.005)	I (0.030)	I (0.035)	I (0.156)	I (0.249)	I (0.394)
50	143.92	134.93	128.50	118.22	115.65	113.08
47.5	128.50	120.79	114.37	102.80	100.23	97.66
45	114.37	106.66	102.80	92.52	87.38	82.24
42.5	100.23	93.81	89.95	78.39	74.53	66.82
40	87.38	82.24	78.39	68.11	61.68	51.40
37.5	75.82	70.68	66.82	56.54	48.83	40.09
35	64.25	61.68	56.54	47.55	38.55	29.30
32.5	55.26	51.40	47.55	38.55	29.04	20.05
30	46.26	42.41	40.09	30.58	20.56	9.25
27.5	37.78	34.18	32.25	23.39	13.11	
25	30.84	27.50	25.57	17.22	6.17	
22.5	24.16	21.33	19.53	11.82		
20	18.50	16.06	14.14	7.20		
17.5	13.36	11.05	9.38	3.19		
15	9.00	7.20	5.65			
12.5	5.65	4.11	2.98			
10	3.19	1.54	0.51			
7	1.03					

**Table (2.2)**  
 Theoretical  $\Lambda = 6.25 \times 10^{-14}$

Point	Diameter (cm)	$\Lambda \times 10^{14}$	$V_0 \times 10^{-5}$
Steel needle	0.005	6.43	5.6
Platinum wire	0.030	6.21	7.25
Rough Steel Point	0.035	6.32	9.0
"	0.156	6.67	14.5
Hemispherical steel point	0.249	8.18	21.7
"	0.394	9.60	26.25

The comparison of the results show quite clearly that the experimental values of  $\Lambda$  agree fairly well with the corresponding theoretical value ( $= 6.25 \times 10^{-14}$ ) with some slight increase for very thick points.

The experiments were repeated, using the same set of different diameter points, to find out the variation of  $\Lambda$  with the height  $H$  of the point. As a typical case, the results for the steel needle of diameter 0.005 cm are shown in the table (2.3). The height of the point was varied from 2 cm to 18cm, keeping  $D$  constant equal to 20 cm.

Table (2.3)

Point-discharge Currents in  $\mu\text{A}$ . for different heights (cm)

V (KV)	I (2cm)	I (3)	I (4)	I (5)	I (7)	I (10)	I (12.5)	I (15)	I (18)
50	6.17	10.54	16.83	20.69	34.44	64.25			
47.5	5.40	9.38	15.03	18.50	30.84	57.83			
45	4.75	8.35	13.36	16.58	27.50	51.40			
42.5	4.11	7.32	11.82	14.65	24.42	46.26			
40	3.57	6.43	10.28	12.85	21.46	40.09			
37.5	3.03	5.53	8.90	11.05	18.63	34.44	51.40		
35	2.51	4.63	7.71	9.38	15.93	29.43	44.98		
32.5	2.02	3.86	6.55	7.97	13.36	25.06	37.01	74.53	
30	1.62	3.14	5.40	6.68	11.31	21.07	30.33	61.68	
27.5	1.23	2.51	4.12	5.53	9.25	17.48	24.80	51.40	
25	0.89	1.93	3.35	4.37	7.45	14.14	19.53	40.09	
22.5	0.59	1.41	2.57	3.42	5.91	11.05	14.91	30.07	
20	0.26	1.00	1.88	2.54	4.50	8.61	11.05	21.85	
17.5		0.62	1.23	1.75	3.14	6.17	7.58	14.91	53.97
15		0.27	0.77	1.03	2.11	4.24			46.26
14									39.06
13					1.23	2.62	4.88	9.77	
12.5									
12									
11									
10					0.54	1.39	2.62	5.65	
9									
8									
7.5									
7						0.39	1.18	3.06	
6									8.35
5									5.40
4									2.98
3							0.2	1.23	1.32
									0.15

GRAPH OF A VERSUS H

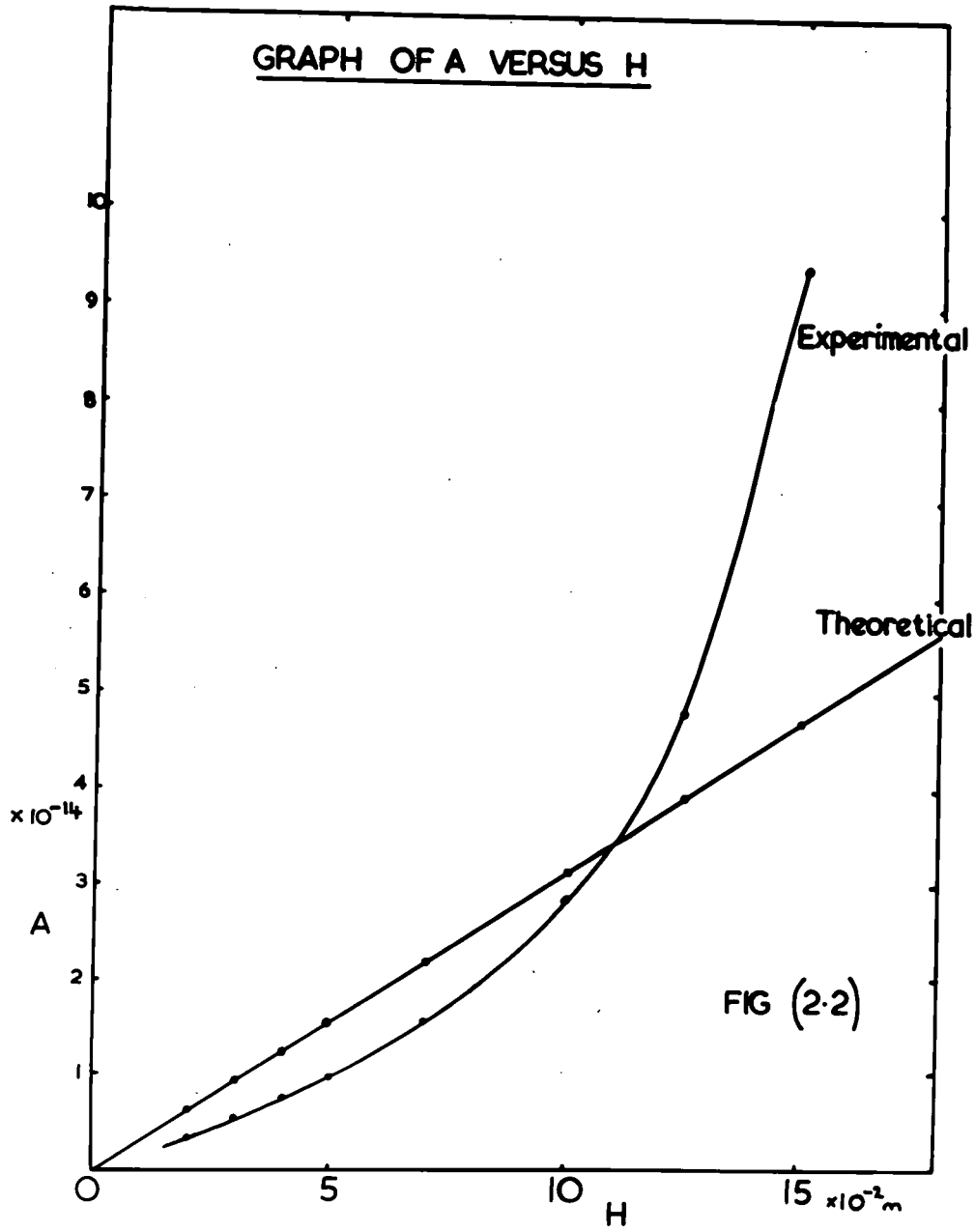

FIG (2.2)

The values of A and  $V_0$  were evaluated (as described above) for each height, from the graphs of  $\frac{I}{V}$  versus V and are shown in the table (2.4). Fig. (2.2) compares the graphs of experimental and theoretical values of A for different heights of the point.

Table (2.4)

H (cm)	$V_0$ (KV)	Values of A	
		Experimental	Theoretical
2.0	15.00	$0.35 \times 10^{-14}$	$0.63 \times 10^{-14}$
3.0	10.75	0.55	0.94
4.0	8.75	0.78	1.25
5.0	7.00	0.97	1.56
7.0	6.25	1.57	2.19
10.0	5.50	2.86	3.12
12.5	4.25	4.80	3.91
15.0	4.00	9.41	4.69
18.0	2.80	29.00	5.63

For smaller heights, the experimental values of A are smaller than the corresponding theoretical values, but as H becomes roughly equal to  $\frac{D}{2}$ , both the values are equal. On the other hand, for very large values of H, the experimental values are very much greater than the corresponding theoretical

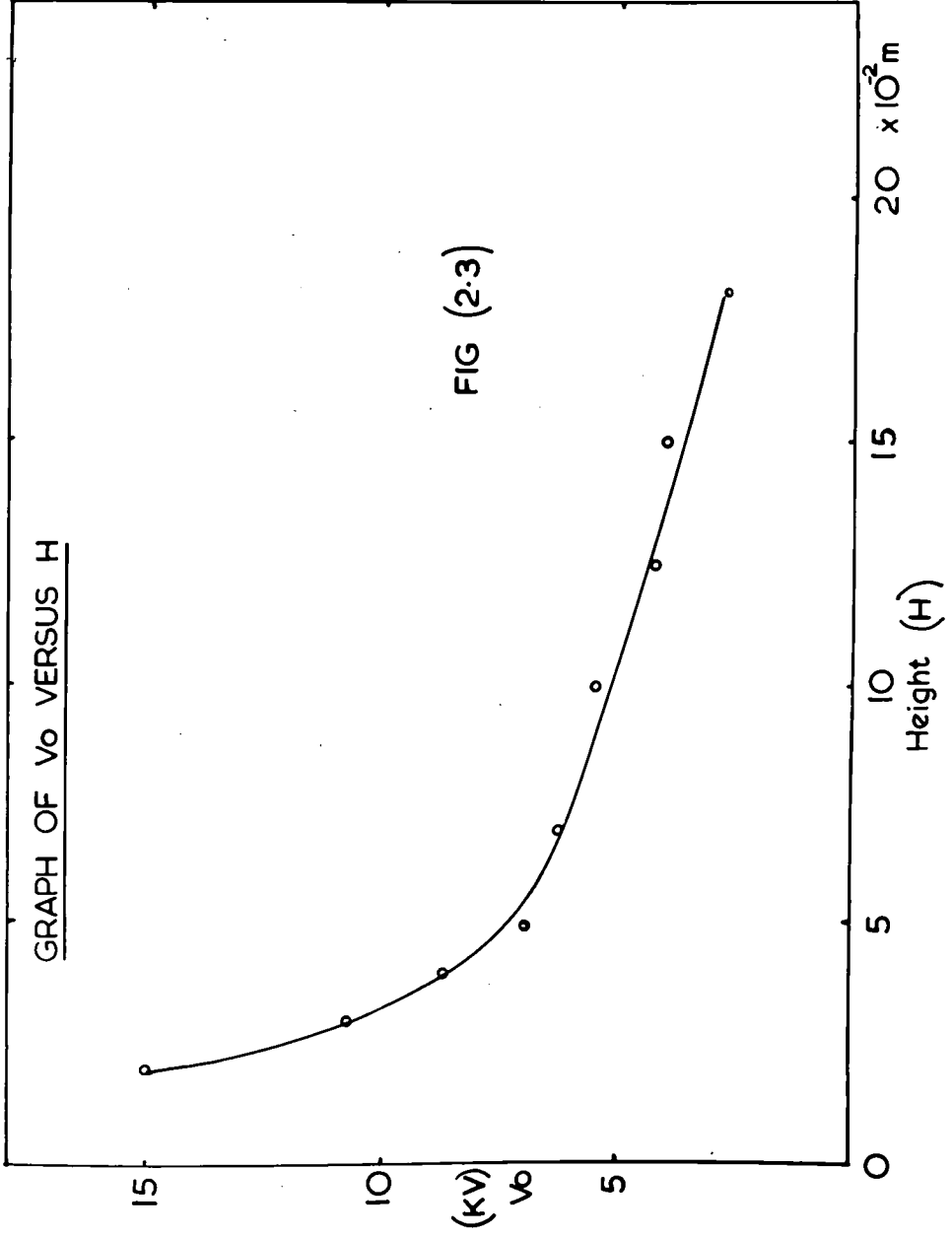



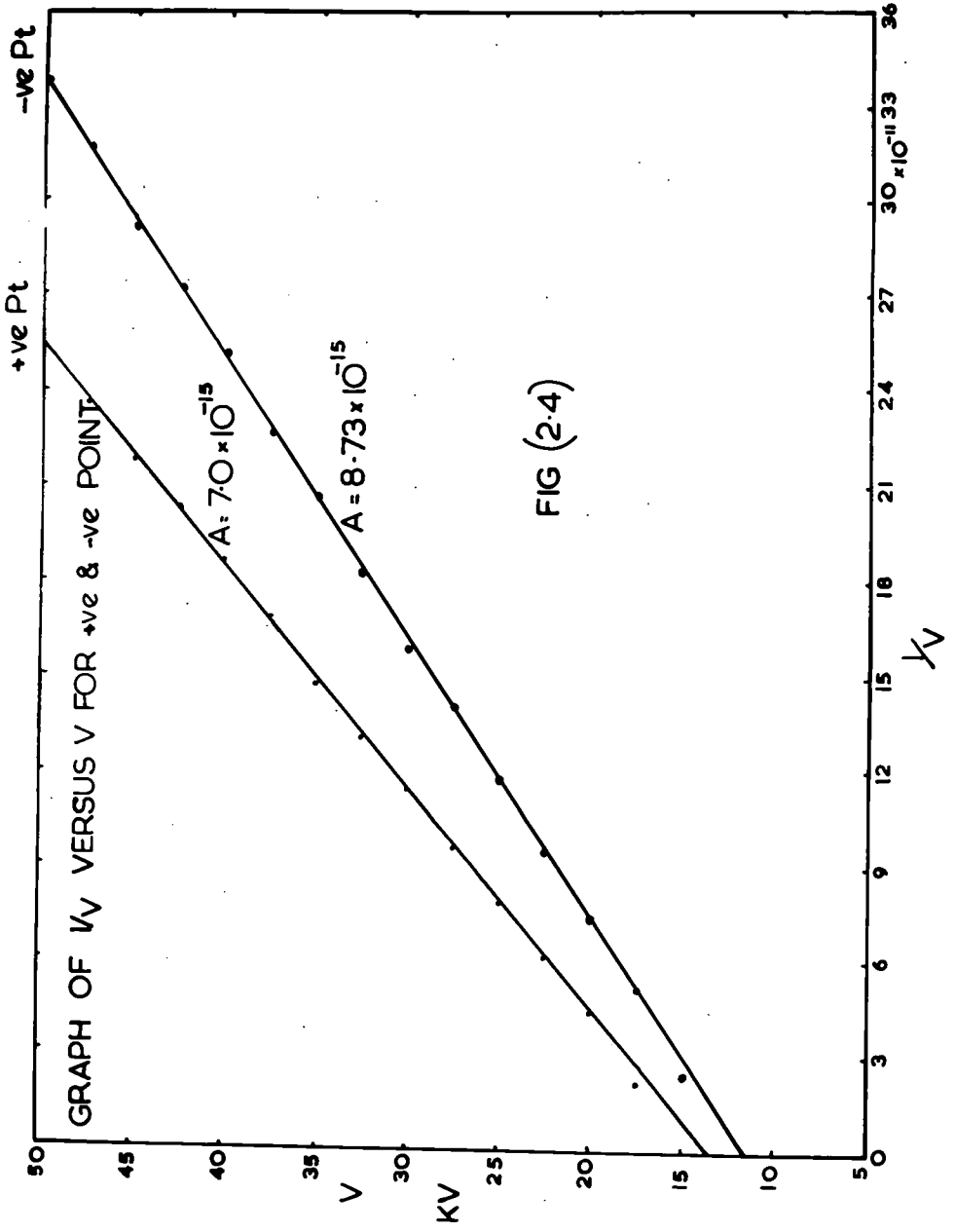

values. The reason for these deviations may be due to the fact that the assumption of spherical symmetry is not valid, as we move to either extreme.

Fig.(2.3) shows the variation of  $V_0$  versus  $H$  which is quite in agreement with the previous workers.

Finally the experiment was repeated, to compare the value of  $A$  for positive and negative fields. Table (2.5) shows some of the results for a platinum point of diameter equal to 0.03 cm for  $H = 5$  cm and  $D = 20$  cm. The fig. (2.4) shows the graph of  $\frac{I}{V}$  versus  $V$  for both positive and negative fields. The value of  $A$  is greater for positive fields than for negative fields, in agreement with the theory because the mobility of the negative ions is greater than that of the positive ions.

#### 2.4 Conclusion

Assuming the spherical symmetry, an approximate form of the current-voltage relationship is derived. For  $H \ll \frac{D}{2}$ , there seems to be a fairly good agreement between the theoretical and experimental results; the value of  $A$  is approximately independent of the diameter of the point (except for very large diameters)

Table (2.5)

V(KV)	Point Discharge Current ( $\mu$ A)	
	+ $V_0$ point	- $V_0$ point
50	-	16.83
47.5	11.18	15.03
45	9.77	13.11
42.5	8.61	11.57
40	7.45	10.02
37.5	6.30	8.48
35	5.14	7.20
32.5	4.24	5.91
30	3.42	4.75
27.5	2.62	3.86
25	1.95	2.93
22.5	1.37	2.13
20	0.85	1.46
17.5	0.37	0.89
15		0.36

and increases rapidly for larger values of H, this may be due to the divergence from the assumption of spherical symmetry. Moreover  $V_0$  increases as H decreases, in agreement with the previous workers.

Finally the comparison of the values of  $A$  for +ve and -ve fields shows that it is greater for the former because the mobility of negative ions is more than that of the positive ions; the value of  $V_0$  is smaller for positive fields than for negative fields.

## CHAPTER III

### 3.1 Measurements with Multiple Points

#### Introduction

It has been pointed out in Chapter I that the comparison of point-discharge currents from isolated points with those from multiple points of similar or arbitrary configurations have in the past led to apparently contradictory conclusions.

CHIPLONKAR (1940) used a group of four points, arranged in a square, each about eight inches long and measured the point discharge currents and simultaneous potential gradients. He found that the total current through the four points was noticeably less than through the single point in the same potential gradient. On the other hand, SIVARAMAKRISHNAN (1957) found, under somewhat similar conditions, a greater current from four points than from one.

CHALMERS & MAPLESON (1955) set up points above a captive balloon and found that eight points, arranged with seven in a regular heptagon of side 15cm and the eighth at the centre, gave about half the current given by a single point, in the same potential gradient and wind speed. However, BELIN (1948) in the laboratory experiments used groups of seven and thirteen similar points in an artificial electric field

between two parallel plates and found that, in the same electric field, the multiple point system gave more current than an isolated point of the same height.

ETTE (1966e) used a multiple point system of arbitrary configuration where the starting voltage has different values for different points and found that the starting voltage increases, as the points become closer, and that, for any one separation of points, there in general exists a 'cross-over' or 'critical' voltage, at which the total point-discharge current from the multiple-points equals that from an isolated point. Below this voltage the multiple-point system gives less current than the isolated point; while above it the situation is reversed. He extended this concept of cross-over voltage to the trees to discuss their discharge efficiency in the atmosphere, in relation of metal points of comparable heights.

ETTE (1966f) found both theoretically and experimentally that the starting voltages of points in a two-point discharger increase linearly with clearance for each point at fixed separations; while at fixed clearance an inverse relation exists between the starting voltages and the separation for separations greater than

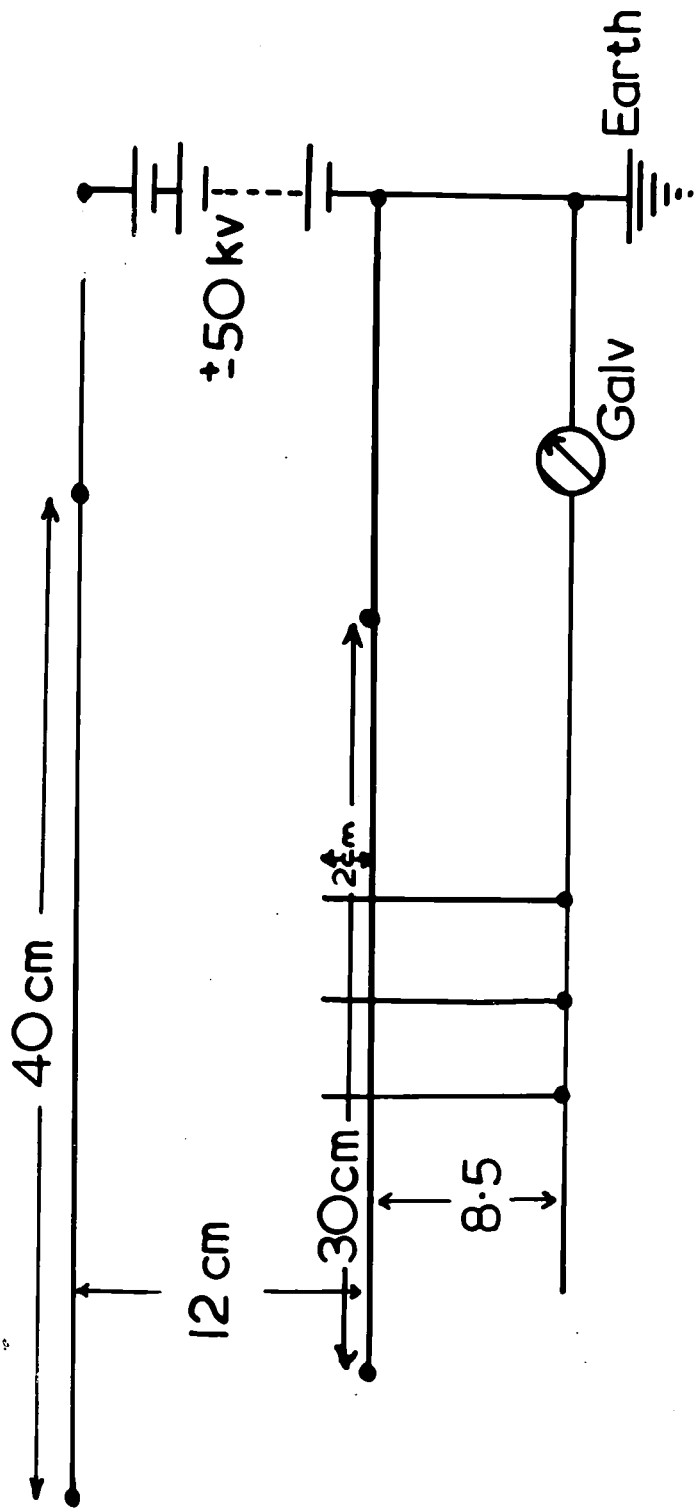

FIG (3.1)

about 1cm. On the other hand for separations below some critical value, determined by the clearance and the dimensions of the points, he found a general decrease in starting voltage with decrease in separation. Finally ETTE (1966c) studied the point-discharge pulses in individual points in a multiple point-discharger and found that each point preserves the magnitude of charge in each Trichel pulse for various point separations; except at separations of the order of 0.1cm an increase in charge per pulse was observed, which he attributed to the mutual interaction between the points.

So the aim of the present investigations is to resolve some of the discrepancies in the various measurements both in the atmosphere and in the laboratory and also to investigate the behaviour of the total point-discharge current in a multiple point system where each point has different starting voltage.

### 3.2 Apparatus

The apparatus used was quite simple of the form shown in the fig. (3.1). From a 'Brandenberg (Type MR 50/R)' power supply a voltage upto about  $\pm$  50 KV could be obtained. This was applied to a horizontal plate X, while a parallel plate



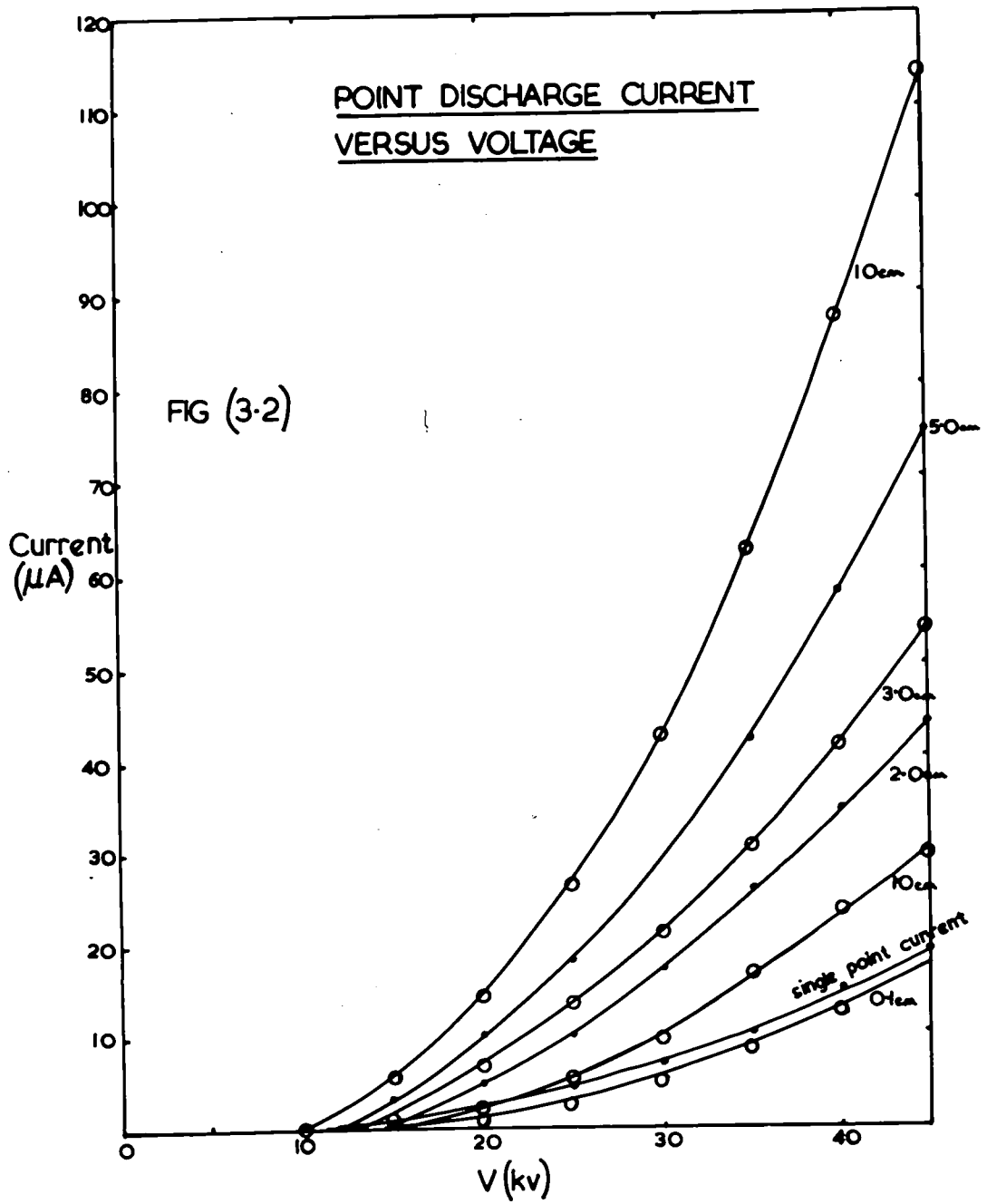

Y, 12 cm away was connected to earth. Holes were drilled in Y, so that the points could project through it. These points were arranged in form of a hexagon, with one point at the centre and the holes were drilled so that hexagonal arrangements of different sizes could be used. This hexagonal arrangement was used because the distances between any two adjacent points are always equal whatever be the size of the hexagon.

The points used were all steel needles with sharp points of minimum radius 0.0035cm and they projected 2cm above Y. These needles were soldered to metallic rods, bent twice at right angles, in opposite directions, the other ends of which were connected to the plate Z, and through a galvanometer to earth. By rotating these rods along their fixed ends, the distance between the points was varied from about 0.1 cm to 10cm. To reduce the corona discharge from the sharp edges of the plates X and Y, they were covered with a thin layer of plasticine, along their peripheries.

### 5.3. Results

First the point-discharge current was measured through a single point, as the potential on the upper plate was increased

MAGNIFIED VIEW OF FIG (3.2)

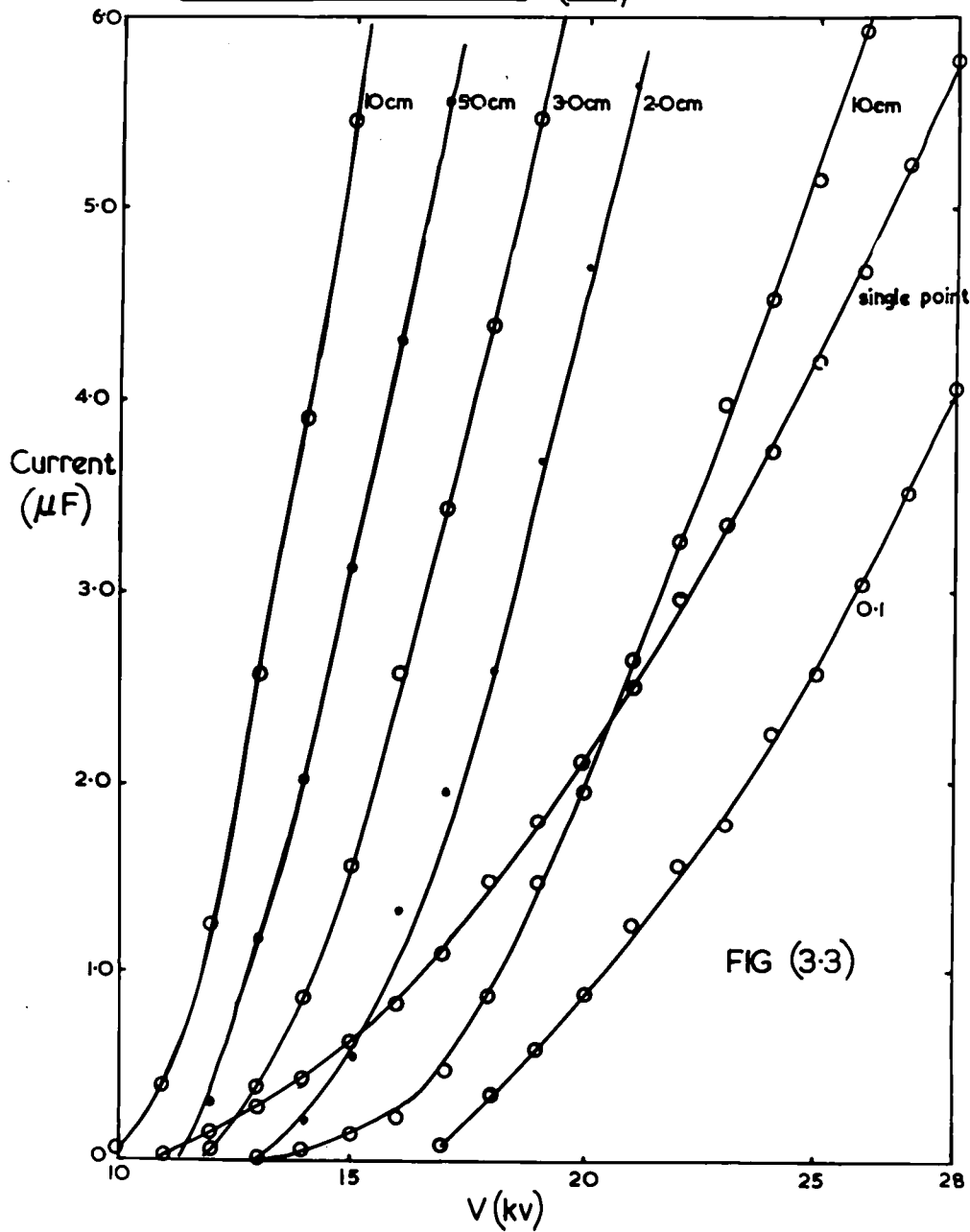
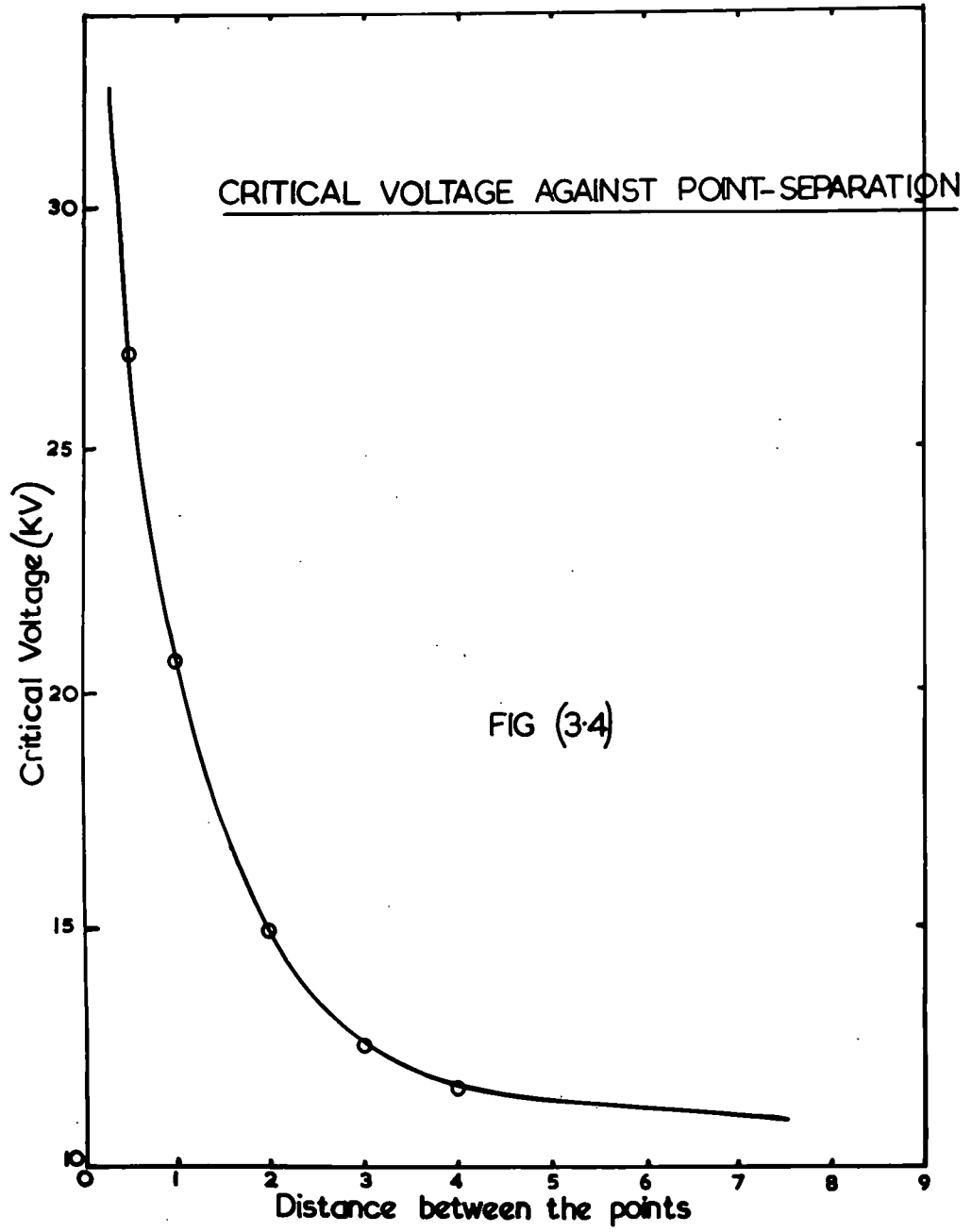

FIG (3.3)

in steps upto a maximum and then decreased in the same steps to zero. The experiment was then repeated using seven points, arranged in the form of a regular hexagon, with one point at the centre and the discharge currents were measured, as the size of the hexagon was varied from 0.1 cm to 10 cm. Some of the results for positive potentials on the plate X (-ve points) are shown in table (3.1) and figs (3.2, 3.3). The results for the negative potentials are the same but the currents are always smaller.

The most striking feature of these results is that the ratio of the current through a single point to that through a group of seven points at a fixed separation is not constant, but depends upon the applied field. Moreover for any one value of the separation between the points, it is possible to define a 'critical voltage' such that for this applied voltage the current through the set of points is the same as that through a single point and this critical voltage decreases as the separation between the points is increased (see Fig.3.4). In other words for smaller distances between the points, even for higher fields (below the critical voltage), the total current through the set of seven points is always less than through an isolated single point, which agrees with what was





observed by CHIPLONKAR (1940) and CHALMERS and MAPLESON (1955). On the other hand for greater distances between the points, the critical voltage is very low, so even for lower fields (above the critical voltage), the multiple point-discharge current is always more than through a single point and agrees with what was observed by SIVARAMAKRISHNAN (1957) and BELIN (1948).

#### 3.4 Discussion of Results

In the laboratory investigations of point-discharge, it has long been recognised that the current - voltage relation is of the form

$$I = AV (V - V_0) \quad (1)$$

where the symbols have the usual meanings.

However, WHIPPLE and SCRASE (1936), while making measurements in the natural conditions found a relation of the form  $I = a (V^2 - V_0^2)$  which can be re-written as follows:-

$$I = B (V^2 - V_0^2) \quad (2)$$

On the other hand PEEK (1929), who measured corona discharge from high tension lines, found the current to be proportional to  $(e - e_0)^2$ , where  $e$  is the voltage on the line. This can be

expressed as:-

$$I = C (V - V_0)^2 \quad (3)$$

Now the equations (1), (2) and (3) are the same when  $V \gg V_0$  but the difference arises when the above condition is not satisfied. However a simple test was performed to find out which of these three equations is the best fit. They can be written in the following forms.

$$V = \frac{1}{A} \left( \frac{I}{V - V_0} \right)$$

$$V = \frac{1}{B} \left( \frac{I}{V - V_0} \right) - V_0$$

$$V = \frac{1}{C} \left( \frac{I}{V - V_0} \right) + V_0$$

It is quite clear the three equations have different intercepts but in the present case it is found that the graph of  $V$  versus  $\left( \frac{I}{V - V_0} \right)$  gives a straight line, which passes through the origin. So the relation (1) seems to be the best fit, which will be used as the fundamental relation for further analysis.

Now if we plot  $\frac{I}{V}$  against  $V$  for the single as well as the multiple points we get fairly good straight lines. It seems that the multiple points also obey the relationship (1). From the graphs, one can find the values of  $A$  and  $V_0$ . (See Table 3.2).



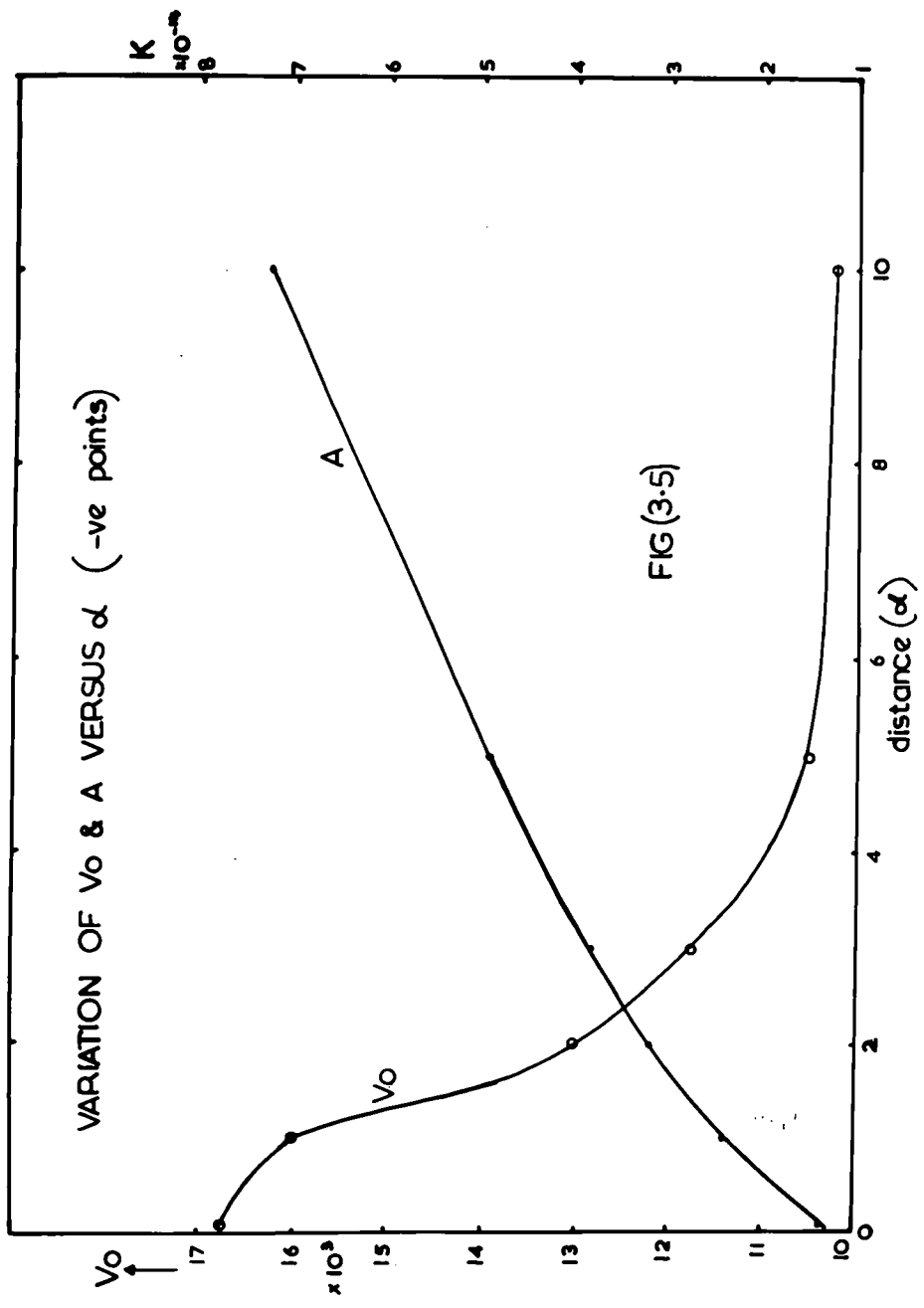

Table (3.2)

Theoretical  $A = 1.74 \times 10^{-14}$  M.K.S. units

EXPERIMENTAL VALUES OF A AND  $V_0$  SINGLE POINT

$A = 1.25 \times 10^{-14}$  M.K.S. units  $V_0 = 11.75 \times 10^3$  volts

MULTIPLE POINTS

Separation (cm)	$V_0 \times 10^{-3}$	$A \times 10^{+14}$
10	10.25	7.27
5.0	10.50	4.90
3.0	11.75	3.80
2.0	13.0	3.20
1.0	16.0	2.40
0.1	16.75	1.33

The most interesting feature is that both the constants  $A$  and  $V_0$  depend upon the number and the separation between the points. As the separation between the points decreases, ' $A$ ' decreases while  $V_0$  increases (see Fig.3.5).

The results show quite clearly that the effect on the total point-discharge current of having a number of points rather than a single point depends mainly on the separation of the points. If the points are widely separated, they behave very much as

independent points as can be seen from the fact that seven points at separations of 10 cm give, together, about six times the current for a single point and the value of 'A' is also about six times that for a single point; the value of  $V_0$  is roughly equal to that for a single point. On the other hand, when the points are close together, they give much less current and tend to behave as a single point of greater diameter. The value of  $V_0$  is more while the value of A is roughly equal to that for a single point.

The fact that the starting voltage is greater when the points are close together is quite easily explained. For point discharge to start, there must be ionisation by collisions close to the point, and this requires a certain value of the field strength i.e. a certain concentration of the lines of force near the point. For a single point, this condition is reached for a certain voltage on the plate X. If other points are placed near it, then some of the lines of force no longer reach the point in question, and the condition for the starting of the point-discharge is not reached until the voltage on the plate is increased.

### 3.5 Results with Five Points

Finally the experiment was repeated using five steel points of diameters equal to 0.005, 0.089, 0.152, 0.249 and 0.394 cm respectively. All the points had the same height equal to 10 cm and they were fixed at the corners of a square of side equal to 18.0 cm with the fifth point at the centre.

The point-discharge was induced, by mounting them in the same way, as mentioned before, in the artificial field between two parallel plates, spaced about 27.5 cm apart; each about 65 cm in diameter. All the points were connected to earth through a galvanometer to measure the total point discharge current and at the same time they were arranged such that the current through any one point could be measured at any time through another galvanometer. The idea of this was just to note the starting potentials for the points individually.

The point discharge current was measured for various values of the potential at the upper plate. Some of the results for positive potentials are shown in the table (3.3).

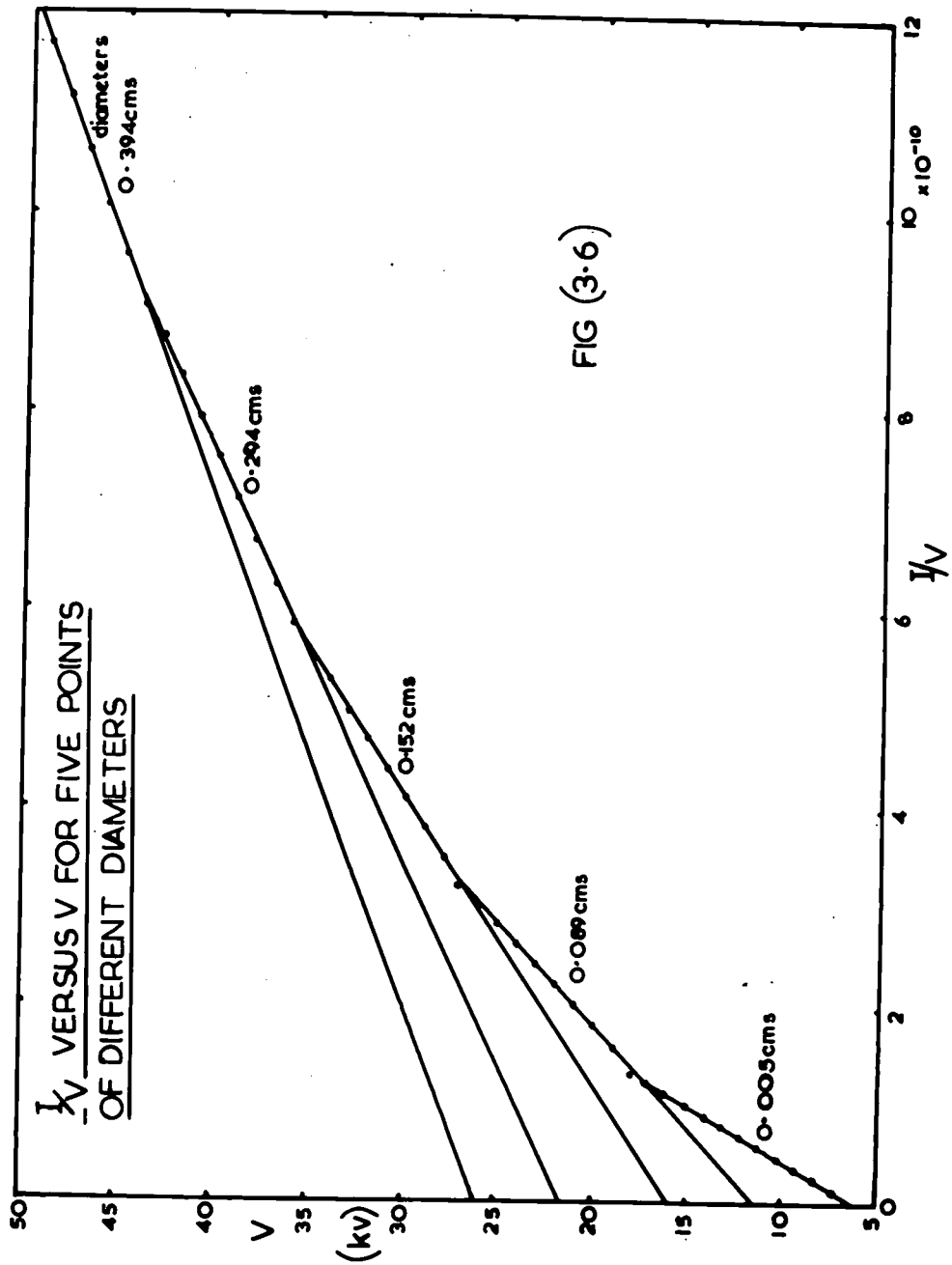

Table (3.3)

V (KV)	I ( $\mu$ A)	V (KV)	I ( $\mu$ A)	V(KV)	I ( $\mu$ A)
50	60.65	36	21.07	20	3.60
48	53.46	34	17.99	19	2.96
46	46.26	32	15.03	17	1.98
45	42.92	30	12.34	16	1.67
44	39.84	28	9.77	14	1.18
43	37.52	26	7.71	12	0.75
42	34.95	25	7.04	10	0.42
40	30.07	24	6.27	9	0.28
38	25.44	22	4.88	7	0.06

The application of the same fundamental square law gives

$$\frac{I_1 + I_2 + I_3 + I_4 + I_5}{V} = \{A_1 + A_2 + A_3 + A_4 + A_5\} \cdot V - \{R_1 V_1 + R_2 V_2 + R_3 V_3 + R_4 V_4 + R_5 V_5\}$$

or

$$\frac{\sum_1^5 (I)}{V} = \sum_1^5 (A) \cdot V - \sum_1^5 (AV)$$

Now the graph of  $\frac{\sum_1^5 (I)}{V}$  versus V gives :

five segments (see fig.3.6). The point where the segment starts, gives the starting potential for the next discharging point coming into action. These values agree fairly well with the corresponding experimental values.

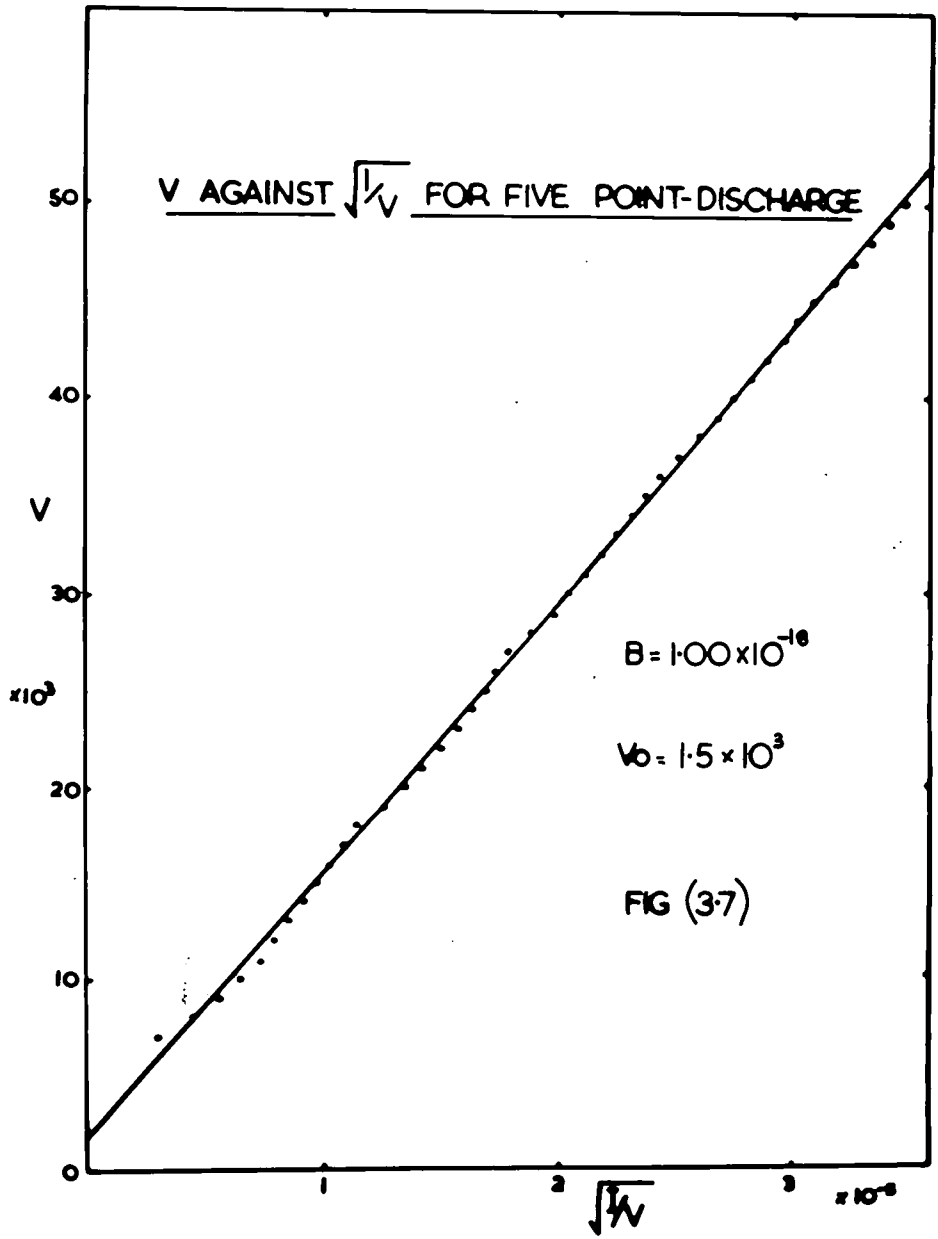

Finally the fig. (3.7) shows that the total point-discharge current through these five points, having different starting voltages, obey a cube law of the form:

$$I = \frac{B}{2} V(V - V_0)^2$$

(For explanation of this cube law, see Chapter IV.5).

From the graph of  $V$  versus  $\sqrt{\frac{I}{V}}$ , one can find the values of  $B$  and  $V_0$  e.g.

$$B = 1.00 \times 10^{-18} \quad V_0 = 1.5 \times 10^3 \text{ volts}$$

This graphical value of  $V_0$  is much smaller than the measured experimental value i.e.  $6.25 \times 10^3$  volts, may be because the number of points taking part in the discharge are smaller than the ones usually found in a tree and also the rate of increase of starting voltage of the individual points is discrete rather than continuous.

### 3.6 Conclusion

Measurements made of the point-discharge current when a single point is replaced by a set of multiple points of similar configuration, showed that there in general exists a critical voltage, such that for this applied voltage the total point-



discharge current through the set of points is the same as that through a single point and this critical voltage decreases as the separation between the points is increased. In other words, the total point-discharge current through multiple-points depends upon the relative separation between the points to the clearance of the tips from the upper plate.

The analysis of the results showed that the current through a multiple-point system of similar configuration obeys the relation:

$$I = AV (V - V_0)$$

The constants  $A$  and  $V_0$  depend upon the number and separation between the points because of the relative change in the concentration of the lines of force.

The point-discharge current through a set of multiple points of different diameters, at any time, depends upon the starting voltage of the individual points and it obeys an approximate cubic law.

## CHAPTER IV

### Measurements of Point-Discharge Current through Trees and Plants

#### 4.1 Introduction

Point discharge, or corona, currents probably play an important part in the atmospheric electricity, since it is believed that the major part of the transfer of charge between thunderclouds and ground occurs by the agency of point-discharge currents through trees and other natural objects. However, very little work has been carried out in the investigation of point-discharge currents down natural objects especially trees and the most of the research work was carried out on currents flowing down elevated artificial points.

There have been many attempts, since the pioneer work of WORNELL (1927), who measured the discharge currents through an artificial point which he hoped would be about equivalent to a tree, and then counted the trees higher than his point in a given area.

SCHONLAND (1928) in an attempt to determine the charge brought down by a collection of trees, mounted a small tree, a thornbush about 12 ft high, on insulators and succeeded in measuring the point-discharge current through it during a

thunderstorm. His results suggest that the current is more nearly proportional to the cube of the field than to square law, usually found for an artificial point. This method of isolation may yield valuable results for freshly cut trees but it is totally unsuitable for measurements on a continuing basis; and in any case cannot easily be employed for large trees which constitute the main discharges in the atmosphere.

The aim of the experiments described in this chapter is to investigate the behaviour of point-discharge current down trees and small plants, and if possible to establish some relationship between the current and the field.

#### 4.2 Results with a Single Wooden Point

The apparatus used here was of the similar type as described before. Various wooden points (both dry as well as those made from a freshly cut branch of a tree) of different diameters were tried.

The point was supported vertically in an artificial field between two parallel plates, spaced about 10 cm apart and the height of the point was 5.0 cm. The point-discharge current

was measured with a galvanometer, as the potential of the upper plate was varied in steps as described before.

Firstly a point was made from a piece of dry wood by sharpening one of its ends to a diameter of about 0.005 cm. No measurable current could be detected when the point was dry but as soon as this point was put in water for a few minutes a current of several micro-amperes was measured which started decaying and became almost zero after about 24 hours. Perhaps this may be due to the fact that the point went dry after such a long time.

Another point was made from a freshly cut branch of a tree of diameter of about 0.6 cm at the tip, by sharpening one of its ends in such a way that only the central core was left behind. All except the tip of this point was covered with an insulating tape, so that the discharge should take place only at the tip, not any where else. In this case again, no point discharge current was detected. This shows that the central core of the point is not a conductor.

Finally the point-discharge current was measured through cylindrical points, made out of a freshly cut branch of a tree.

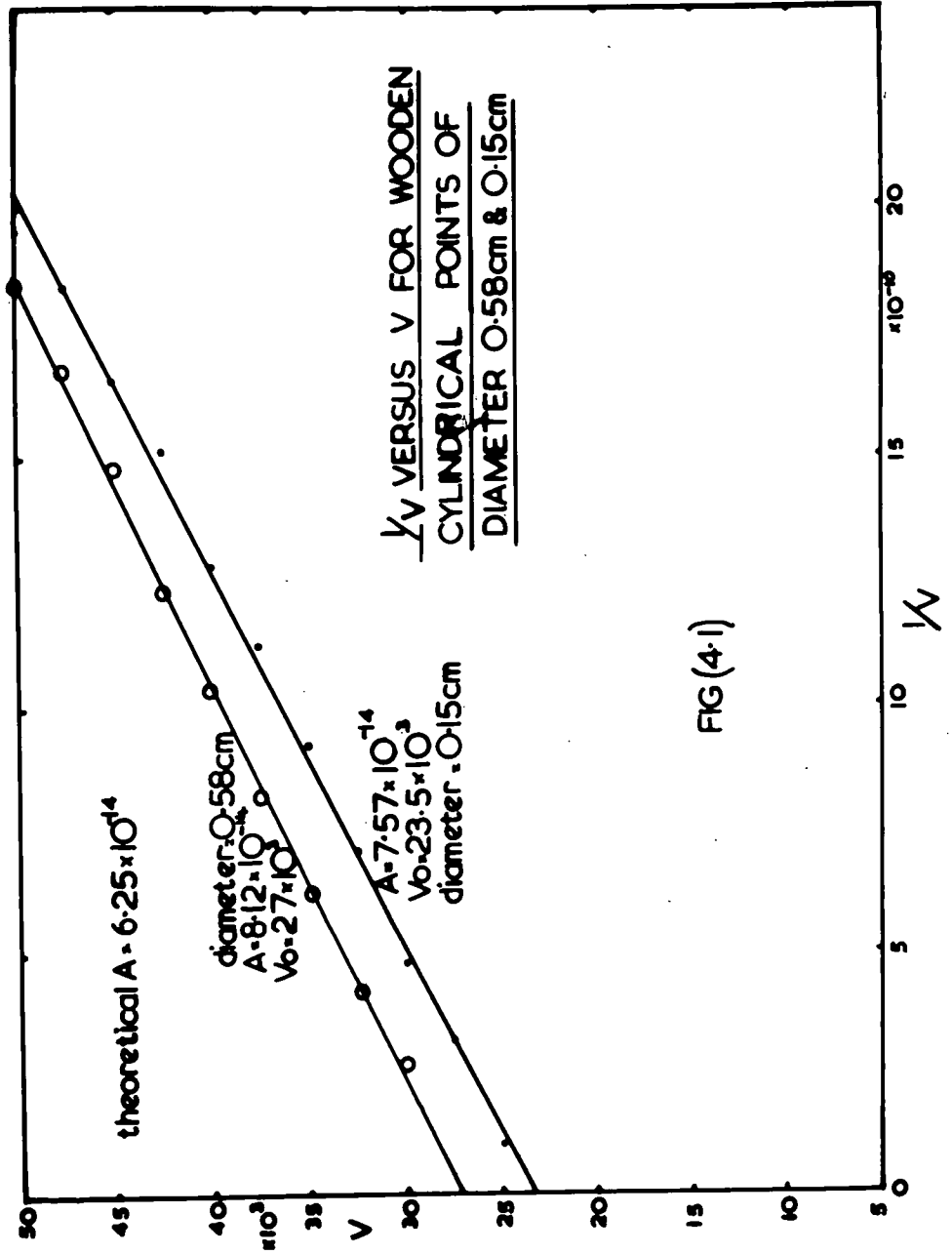

FIG (4-1)

The discharging end of the point was made as smooth as possible. On increasing the voltage to a new value, the point discharge current increased and then began to decay; it settled down to a fairly steady value after about a few minutes. The readings of the point-discharge current were taken on the average of about quarter of an hour intervals, as the voltage on the upper plate was increased in steps. Some of the results for positive potentials on the upper plate for two points of diameters respectively equal to 0.58 cm and 0.15 cm are shown in the table (4.1). The results for negative potentials are similar but the currents were always smaller.

Table (4.1)

V (KV)	Point Discharge Current in $\mu$ A for Diameter	
	0.58 cm	0.15 cm
50	92.52	97.66
47.5	79.67	87.38
45	66.82	74.53
42.5	52.43	64.25
40	41.63	51.40
37.5	30.84	42.15
35	22.10	32.38
32.5	15.88	23.13
30	8.22	14.39
27.5		8.74
25		2.57



FIGURE (4.2 )

Now if we try to fit the square law to these results i.e.

$$I = AV (V-V_0)$$

we get fairly good straight lines by plotting  $I/V$  versus  $V$  (see Fig.4.1). The experimental value of  $A$ , as calculated from the graphs, are of the same order of magnitude as evaluated theoretically i.e.  $6.25 \times 10^{-14}$  (see Chapter II).

So the results can be summarized by saying that a wooden point of this kind behaves more or less like a metallic point.

#### 4.3 Results with a Small Spruce Plant (Picea Pungens)

A small spruce plant of height about 60 cm was grown in a pot. It was mounted on tufnol insulators, in an artificial field between two horizontal metal plates, spaced about 35 cm apart, in such a way that all of its branches could project about 17 cm above the earthed plate, without touching it. (see Fig.4.2). The pot was earthed through a galvanometer and the point-discharge current was measured, as the voltage of the upper plate was increased in steps up to a maximum of about 50 KV and then decreased in the same steps to zero.

As observed in the case of a wooden point, the increase of the voltage to a new value increased the point discharge current,



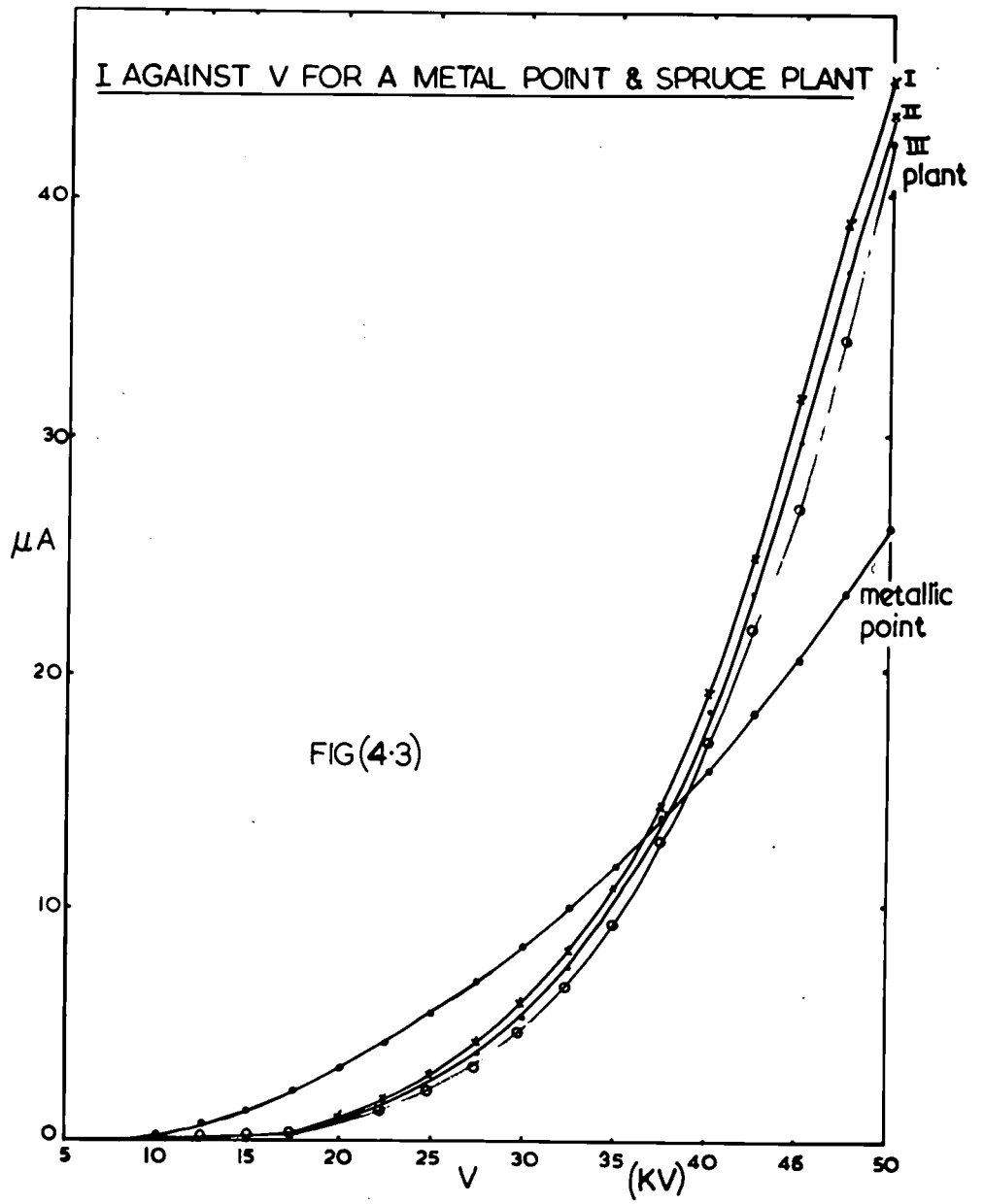

the latter began to decay and settled down to a fairly steady value after a few minutes. So the readings of the mean point discharge current were taken on the average of about quarter of an hour intervals, as the voltage on the upper plate was increased in steps.

The experiment was done on a number of days, in order to see whether the results were reproducible or not. Three sets of results with an average interval of about a week between them, for the positive potentials on the upper plate, are shown in the table (4.2). Fig. (4.3) shows that the general trend of the curves is the same, with some slight variations in currents.

The measurements were also made of the point discharge currents through a metal point (steel needle of diameter equal to about 0.005 cm) of the same height (i.e. 17.0 cm) as that of the plant, in order to find out any correlation between the discharge currents through them. Fig.(4.3) shows that a 'critical voltage' occurs at about 37 or 38KV, similar to the type observed for a multiple point system (see Chapter III), above which the plant discharges more efficiently than the point.

Now if we plot  $I/V$  versus  $V$  for any set of the results,

Table (4.2)

V (KV)	Point-Discharge current in $\mu$ A			
	SPRUCE PLANT			Metal Point Diameter = 0.005 cm
	Set I	Set II	Set III	
50	44.98	43.69	42.41	26.09
47.5	39.06	37.01	34.18	25.26
45	31.61	29.81	26.99	20.56
42.5	24.93	23.39	21.85	18.25
40	19.28	18.50	17.22	15.93
37.5	14.39	14.14	12.85	13.88
35	10.79	10.28	9.25	11.82
32.5	8.22	7.45	6.73	10.02
30	5.91	5.29	4.68	8.35
27.5	4.21	3.75	3.24	6.81
25	2.83	2.31	2.18	5.47
22.5	1.80	1.59	1.34	4.21
20	1.00	0.90	0.70	3.11
17.5	0.36	0.38	0.26	2.11
15	0.12	0.10	0.09	1.31
12.5	0.05	0.05	0.04	0.69
10	0.04	0.02	0.03	0.23

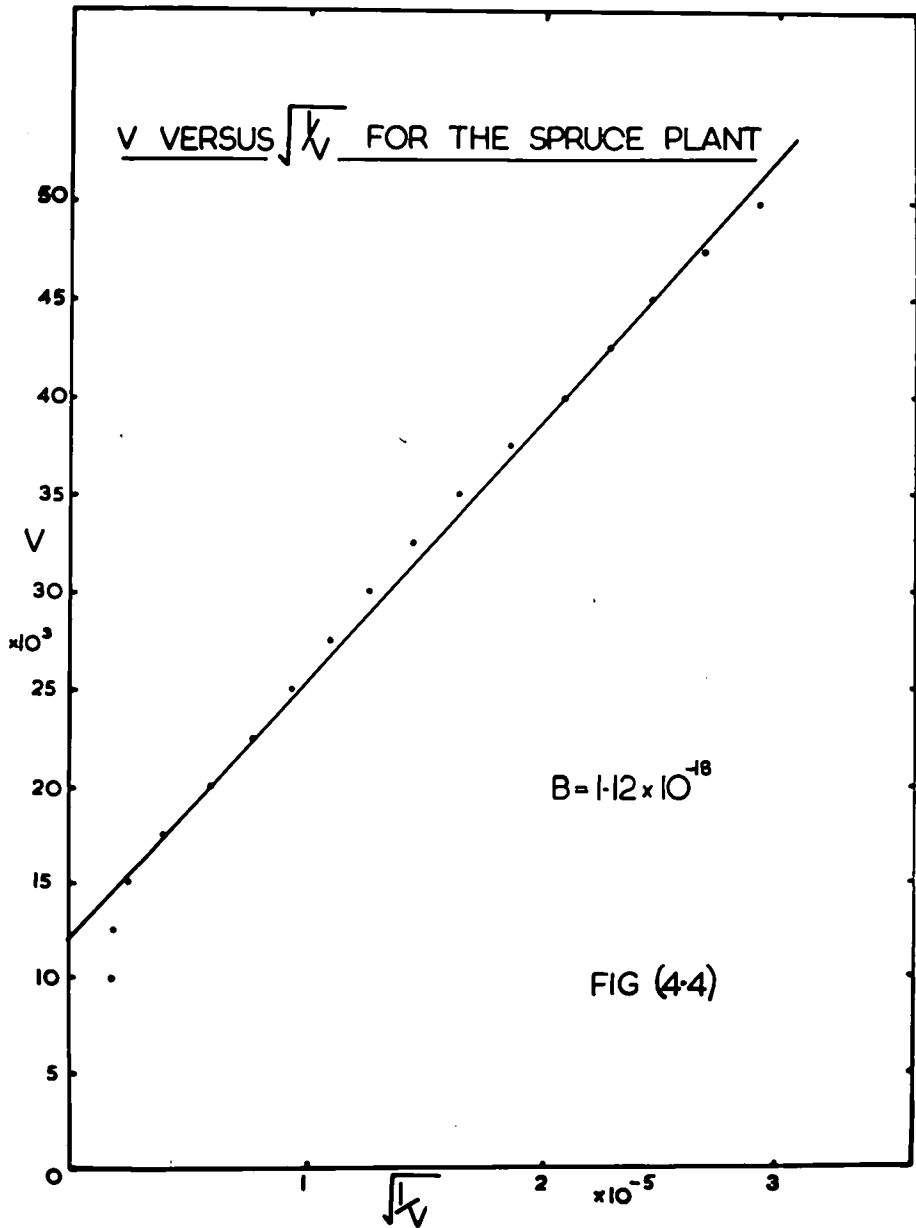

we get a number of segments of the same form as described in Chapter III, meaning thereby more and more points start discharging, as the voltage on the upper plate is increased.

Now let us assume that the plant is discharging to obey a cubic law rather than a square law i.e.

$$I = \frac{B}{2} V (V - V_0)^2$$

Fig. (4.4) shows the graph of  $\sqrt{I/V}$  versus  $V$  which seems to be a fairly good straight line giving  $B = 1.12 \times 10^{-18}$ .

#### 4.4. Results with Trees

An aluminium plate of size about 5 ft. x 10 ft. and thickness of about 0.12 cm was cut into the form of an oval shape. After smoothening its sharp edges, a thin layer of plasticine was stuck along its periphery, to minimize the corona discharge. It was then fixed to a wooden frame through a set of polystyrene insulators, each of length about 6 inches (see Fig.4.5). The whole arrangement could be raised to any height upto about 4.5 m with the help of a block and tackle arrangement along a set of poles about 6.0 m high (see fig.5.1).



FIGURE(4.5)

The potential was applied to the plate with the help of an insulated cable about 50ft long, by running it from the recording room. This insulated cable was such that it could stand 50 KV and so it was made from a heavily polythene insulated plain copper core, covered by a substantial outer sheath of red P.V.C. safe upto 18 KV and was further passed through a polythene tube of diameter about 0.95 cm for extra insulations.

Three species of trees were grown in plastic dustbins i.e. a Sycamore tree (*Acer Pseudo-Platanus*) of height about 4m, a Scots Pine (*Pinus Sylvestris*) of height about 2.6 m and a *Cryptomeria Japonica* of height about 2.5 m.

The Al plate was first raised to a height of about 2.8m and the Scots Pine tree was placed underneath it. The point-discharge current induced in the tree was measured, on the average of about quarter of an hour intervals, by a galvanometer connected between the stainless steel electrode (fixed to the root of the tree) and earth. No marked difference was observed when the steel root electrode was replaced either by a similar electrode stuck into the trunk of the tree or just dug into the soil.

CURRENT VERSUS  
VOLTAGE FOR A SCOTS  
PINE TREE

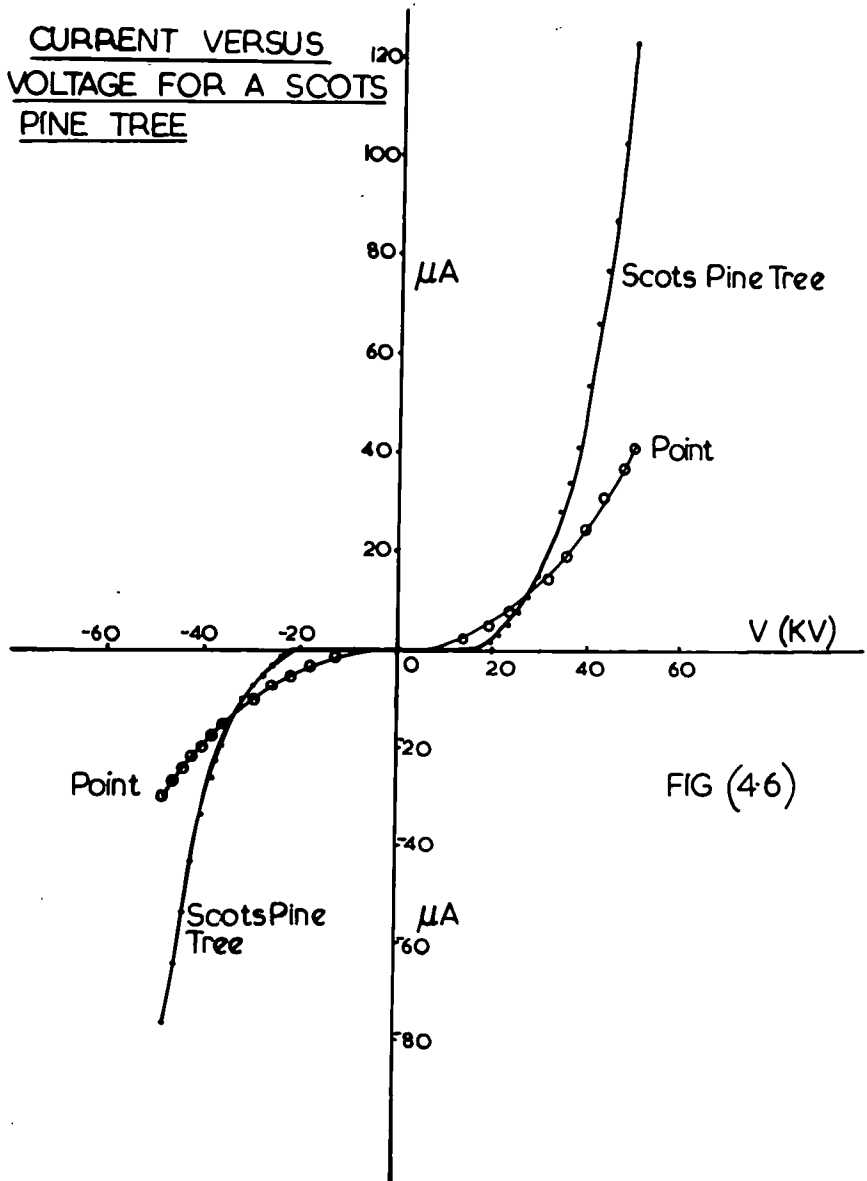

FIG (4-6)



The measurements were also made of the point discharge current through a metal point of the same height as that of the tree. The experiments were finally repeated for the other two trees i.e. the Sycamore and Cryptomeria Japonica. Some of the results for the Scots Pine tree, with the positive and negative potentials on the plate, are shown in fig. (4.6). The results are similar for the other two trees.

Finally the graph between  $\sqrt{I/V}$  versus  $V$  gives the similar type of segments, as found for the plant and the cube law

$$I = \frac{B}{2} V (V - V_0)^2$$

gives a fairly good fit to the results.

#### 4.5. Derivation of Cube Law for Tree

CHALMERS (private communications) has derived the cube law for tree in the following way:

Suppose that the tree consists of a large number of points, each of which gives a current

$$i_k = A_k V (V - V_k)$$

Suppose that for each range of  $\Delta V_k$  of  $V_k$ , there are  $n_k$  points

Then the total current will be

$$I = \int A_k n_k V (V - V_k) dV_k$$

The limits for the integration must be

(1) the point for which  $V_k$  is least,

Say  $V_0$

and (2) The value of  $V_k = V$ , since there is no discharge for points with greater  $V_k$

Putting  $V_k = x$

$$I = \int_{V_0}^V A_k n_k V (V - x) dx$$

Now suppose that  $A_k n_k$  depends upon  $x$ , according to a simple law:

$$\begin{aligned} A_k n_k &= B x^p \\ \therefore I &= \int_{V_0}^V BV x^p (V - x) dx \\ &= BV \int_{V_0}^V (Vx^p - x^{p+1}) dx \\ &= BV \left\{ \frac{Vx^{p+1}}{p+1} - \frac{x^{p+2}}{p+2} \right\}_{V_0}^V \\ &= BV \left\{ \frac{V^{p+2}}{p+1} - \frac{V V_0^{p+1}}{p+1} - \frac{V^{p+2}}{p+2} + \frac{V_0^{p+2}}{p+2} \right\} \\ &= \frac{BV}{(p+1)(p+2)} (V^{p+2} - V V_0^{p+1} (p+2) + V_0^{p+2} (p+1)) \end{aligned}$$

If we take the special case of  $p = 0$

$$\begin{aligned} I &= \frac{BV}{2} (V^2 - 2VV_0 + V_0^2) \\ &= \frac{B}{2} V (V - V_0)^2 \end{aligned}$$

giving the cube law.

The condition  $p = 0$ , means that  $\Lambda_k n_k$  is same for all values of  $V_k$ , i.e. the extra number of points at a given level is just balanced by the smaller current (A) per point.

#### 4.6. Conclusion

The measurements done on points made from a freshly cut branch of a tree show that the point discharge current obeys a square law, similar to the metal points; the points made from dry wood exhibits no corona discharge and discharge only when moisture is present.

The measurement made on metal points of the same height as the trees and plants shows that there in general exists a critical voltage, similar to the form found for multiple points, which is subject to unpredictable variations on account of the variations in the foliage due to physiological factors and atmospheric turbulence.

Finally the point-discharge current through trees and plants obeys a cube law of the form:

$$I = \frac{B}{2} V(V - V_0)^2$$

The measurements made on a number of days show that the

results are fairly reproducible. Moreover, an approximate theoretical derivation of the cube law shows that it can be used as a standard law for making measurements in the natural conditions, on a continuing basis, and hence to estimate the world-wide contribution of the total point-discharge current brought to earth in a given period by trees and other natural and earth connected objects which cannot be conveniently separated from the earth.

## CHAPTER V

### Measurements of Electrode By-Passing Efficiency

#### 5.1 Introduction

It is generally believed that point-discharge currents from trees and other natural and artificial pointed objects play a dominant role in the maintenance of the global fair-weather atmospheric electricity.

It is a comparatively simple matter to set up an artificial point and to measure the point-discharge current through it in disturbed weather. But it is much less simple to measure the point-discharge currents through living trees owing to the technical problems involved in isolating them from the earth without killing them. It is not possible either to attempt to deduce the point-discharge current through a tree from that through an artificial point, since it is impossible to take into account the effects of there being a large number of points close together.

KIRKMAN (1956) attempted, largely unsuccessfully, to measure the point-discharge current flowing down a tree, by inserting brass screws at two different levels and connecting them to each other through a low resistance galvanometer.

MILNER & CHALMERS (1961) replaced the brass screws by mercury contacts; two small holes were drilled through the bark of a lime tree and glass tubes were inserted containing mercury so as to make the contact into the sap-wood. This method should in fact short-circuit most of the current through a low resistance galvanometer if the electrical behaviour between the electrodes is that of a resistance in parallel with the capacitance between the electrodes.

ETTS (1966b) measured the fraction of the point-discharge current in a living tree bypassed through a low resistance galvanometer by using the same sort of experimental arrangement as described by MILNER & CHALMERS (1961) and found that this fraction is small and independent of the total point-discharge current, though constant over a period sufficiently long for the arrangement to provide a useful measure for the point-discharge current in the tree.

CHALMERS' (1962b) results seem to point to the fact that the bypassing arrangement does not provide a valid measure of the point-discharge current in trees under conditions of intense atmospheric electrical activity, such as prevail, during periods of close lightning discharges to earth.

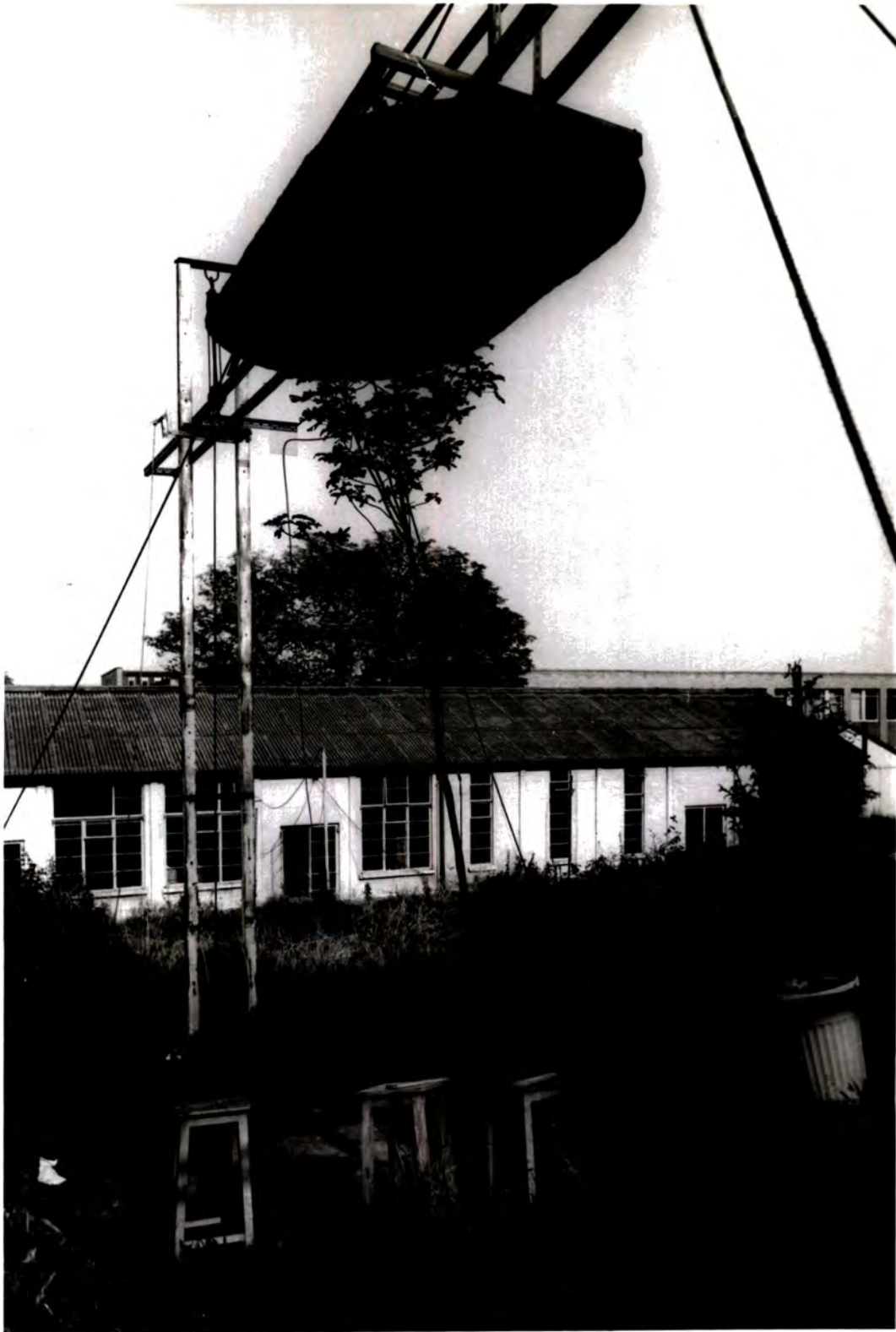

FIGURE ( 5.1 )

## 5.2 Experimental Arrangement

The experimental arrangement was of the same form as described in Chapter IV. From a 'Brandenburg' power supply a voltage upto about  $\pm$  50 KV could be applied to an insulated plate 5ft. x 10ft, which was raised to a height of about 415 cm above the ground. A Sycamore tree of height of about 4m, grown in an insulated dustbin, was placed underneath it (see fig.5.1). The total point-discharge current induced in the tree was measured with a sensitive galvanometer, connected between a stainless steel electrode (fixed to the root of the tree) and the earth. Two more electrodes x and y were fixed in the trunk of the tree at a distance of about 145 cm apart and were connected to each other through another galvanometer in series with a variable resistance (1000 Ohms to 2 Meg Ohms); R represents the total bypassing resistance including that of the galvanometer.

The total point-discharge current I and the bypassed current i were noted, as the voltage on the insulated plate was increased in steps upto the maximum and then decreased in similar step to zero. At first both I and i were recorded photographically on a slow spiral drum camera. The time scale on the recording was provided by switching off the galvanometer lamp and switching



on a fogging lamp for two seconds every half minute with a timing circuit, the latter was simply a series of relays operated every half minute by pulses derived from an electric clock. This method was very useful for recording the instantaneous values of  $I$  and  $i$ , just after the change of voltage to a new value.

On increasing the voltage to a new value, both  $I$  and  $i$  increased and then began to decay,  $I$  settled down to a fairly steady new value after about a couple of minutes but  $i$  took about 20 to 30 minutes to reach that stage. This time was found to be less when the bypassing resistance  $R$  was increased. On the other hand when the voltage was decreased from a higher value to some lower value, both  $I$  and  $i$  decreased and then began to increase,  $I$  settled down again after a couple of minutes but  $i$  took about 20 to 30 minutes to do so.

Finally to record the steady values of current, this method of recording photographically was replaced by a visual method of recording because it was found that each observation took about half an hour to reach a fairly steady value, meaning thereby a large wastage of recording paper. Two sensitive galvanometers  $G$  and  $g$ , each of sensitivity equal to 0.0514

microampere per cm were used. It was found very useful to apply the maximum voltage say 50 KV for about an hour or so to start with and then decrease it in steps. Readings of  $I$  and  $i$  were, therefore, taken on the average at about half an hour intervals.

### 5.3 The Tree Electrodes

Two types of electrodes were used.

#### (1) Mercury Electrodes

These were of the same type as used by MILNER & CHALMERS (1961). A hole was drilled into the tree trunk to a depth of about 2cm. A glass tube was inserted into the hole and filled with mercury. A platinum wire dipped into the mercury completed the contact. The glass tube was sealed off with putty to prevent the mercury from flowing away and being wasted. Two of these electrodes, one about 1.5 m above the other were inserted into the Sycamore tree of height about 4m and diameter at the trunk about 4.5 cm.

#### (2) Stainless Steel Electrodes

A stainless steel strip of about 2cm wide was wrapped around the trunk of the Sycamore tree. Four stainless steel wood screws were driven through this strip into the bark until

they made the electrical contact with the outer conducting layer of the sap-wood. A similar arrangement about 145 cm above this provided the other electrode, y. Two co-axial leads connected these bands x and y to the galvanometer g in the recording room.

As a subsidiary experiment a third similar electrode z was fixed 155 cm above the second band.

The observations were taken with both the electrode systems, after they had been inserted into the tree for about a week or so.

Moreover the contact potential difference or the residual current was found to depend upon the atmospheric conditions and the state of the soil. On rainy days, it was found to be the maximum of the order of 4 or 5  $\mu$ A, sometimes positive and at other times negative. On fairly dry days, it was found to be the minimum, sometimes practically zero. This contact potential difference was found to increase even after watering the tree.

The resistance of the section of the tree between the

bypassing electrodes X and Y was of the order of 0.1 MegOhms and was found to be dependent again on the season and other atmospheric conditions. As described by KILKMAN (1956), the resistance was found to decrease after rainfall, an effect which was attributed to the increased dissociation of the electrolyte (Sap etc.) with increase of dilution.

#### 5.4 Results with Artificial Fields (Direct Method)

As described before, on wet days the contact potential difference or the residual current was found to be as large as 4 or 5 microamperes between the root electrode and the earth (registered by G) and even more than this between the bypassing electrodes X and Y (registered by g). Typical dry and quiet days were chosen to do the experiment when the residual current shown by G was the minimum of the order of 0.05 mA but the residual current registered by g was still large of the order of 4 microamperes in some cases. Both the currents registered by the galvanometers G and g during point-discharge included the residual currents. So to find out the actual values of I and i, the residual currents were subtracted from the galvanometer readings.

First of all in order to make measurements of the steady values of current, readings of I and i were taken on the average

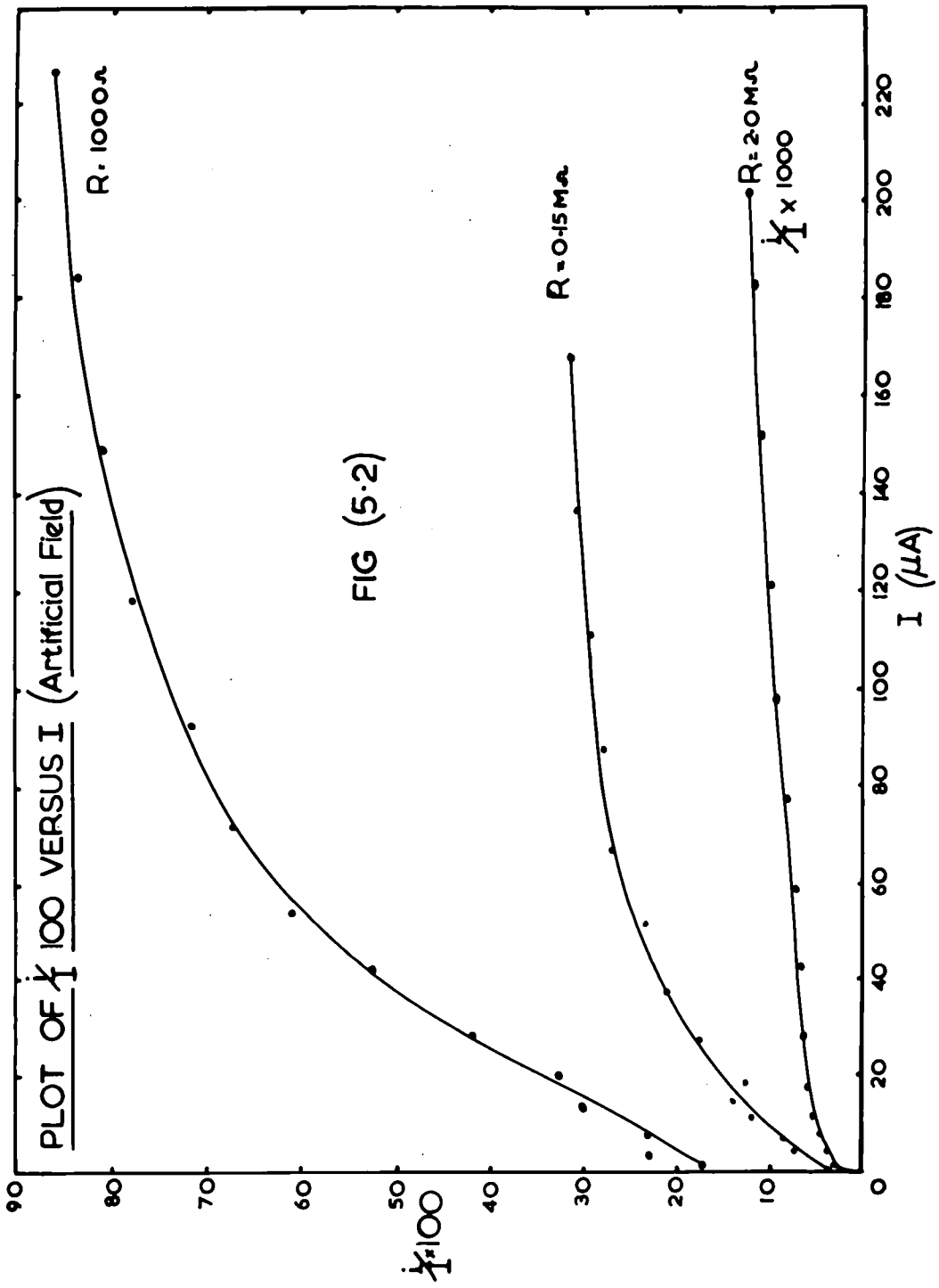

of about half an hour intervals, as the voltage on the insulated plate was decreased in steps for both the sets of electrode system i.e. the mercury as well as the stainless steel. The results were similar in both cases except that the residual currents were different. Various sets of results were taken, as the resistance R of the bypassing circuit was increased from about 1000 Ohms to about 2 MegOhms. Some of the results for the positive potentials on the insulated plate, with stainless steel electrodes, are shown in the table (5.1). The results for the negative potentials were similar but the currents were always smaller.

Now let  $\frac{i}{I} \times 100$  is equal to the percentage efficiency of the electrodes. Fig. (5.2) shows the curves of the percentage efficiency versus I, for various values of R. It clearly shows that as the total point-discharge current I increases, the percentage efficiency increases linearly at first and then reaches a saturation value at larger values of I, in contradiction to EFTE's (1966b) results, who found the efficiency to be constant over a wide range of I. This discrepancy may be due to the fact that he made measurements only upto about 15 - 20  $\mu$ A.

Table (5.1)

V (KV)	Point-discharge currents in $\mu A$ for R					
	1000 Ohms		0.15 Megohms		2 Megohms	
	I	i	I	i	I	i
50	275.04	243.64	167.12	52.43	215.94	2.74
47.5	226.21	194.91	136.28	42.15	182.53	2.17
45	183.81	153.69	110.58	32.64	151.69	1.69
42.5	149.11	120.28	87.45	24.42	120.85	1.22
40	118.27	92.01	66.89	17.99	97.72	0.92
37.5	92.57	66.31	51.47	12.08	77.16	0.63
35	72.01	48.32	37.34	7.97	59.17	0.43
32.5	54.02	32.90	26.80	4.75	42.17	0.29
30	41.17	21.59	18.58	2.36	27.82	0.18
27.5	28.32	11.82	14.72	2.06	17.54	0.10
25	20.10	6.58	10.87	1.31	11.63	0.06
22.5	13.16	5.96	7.52	0.64	7.51	0.04
20	7.76	1.80	4.18	0.31	4.43	0.02
17.5	3.34	0.77			1.60	0.005
15	1.49	0.26	0.53			
12	0.35	0				
Residual Current ( $\mu A$ )	-0.05	-4.63	-0.07	0.10	-0.06	-0.01

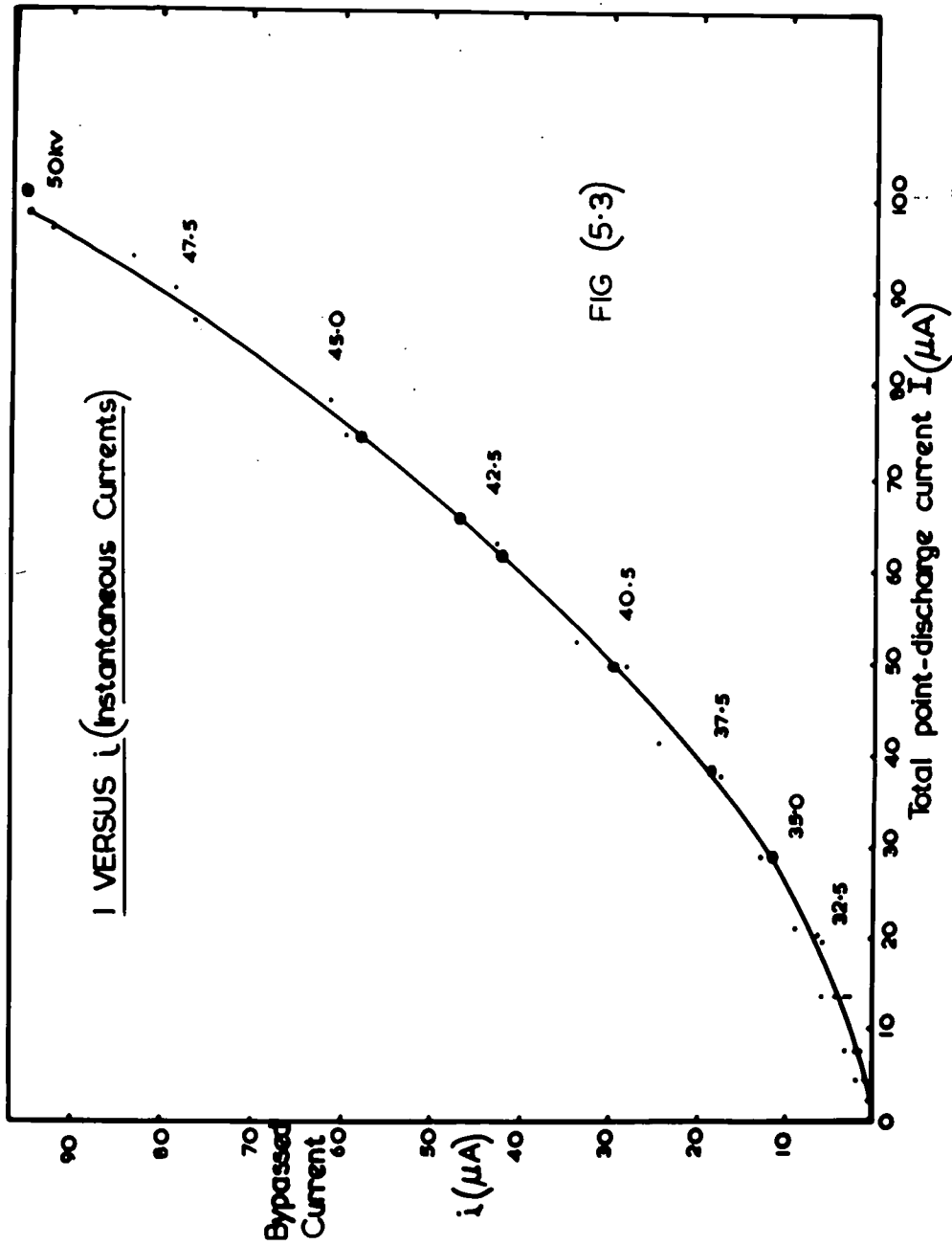



Finally to measure the instantaneous values of  $I$  and  $i$ , the method of photographic recording was used. Each observation was taken on the average for about a couple of minutes, as the voltage on the insulated plate was increased in steps and then decreased in similar steps to zero. Some of the results for the positive potentials on the plate, with stainless steel electrodes, are shown in the fig. (5.3). The results are similar for the negative potentials as well as for the mercury electrodes.

A close examination of the fig. (5.3) shows that the efficiency is more or less constant upto about 20 microamperes in agreement with ETTE's (1966b) results, who made measurements only upto about 15 microampere but it certainly increases at higher values of  $I$ , in the same way as for the steady current.

#### 5.5. Results with Constant D.C. Voltage (Indirect Method)

A constant D.C. voltage was applied between the root electrode and the electrode Z, which was fixed in the top most branch of the sycamore tree - a seat of point-discharge current in the tree. The current distribution in the tree in the neighbourhood of the bypassing electrodes should not differ vastly from that of the actual point-discharge current except that

in the latter case, it consists of random pulses. The constant D.C. voltage upto about 200 volts could be obtained from a FARNELL power supply. The rest of the apparatus was of the same form as described before.

In this case again, as the voltage was increased to a new value, both  $I$  and  $i$  increased, and then began to decay rapidly at first and more slowly afterwards, settling down to a reasonable steady new value after about half an hour, though a further decrease was noticed which was comparatively small and could be neglected for the present experiment. The time to reach the steady value for higher voltages was much smaller than that for low voltages.

So it was reasonably accurate to take readings of  $I$  and  $i$ , on the average of about half an hour intervals, as the applied voltage was increased in steps to the maximum and then decreased in similar steps to zero. The results were again similar for both the sets of electrodes i.e. mercury as well as stainless steel; no marked difference was found when the direction of the applied voltage was reversed. Sometimes fairly high values of residual currents were noticed in both  $G$  and  $g$ , so the final values of  $I$  and  $i$ , were found by subtracting the residual currents from the galvanometer readings.

Table (5.2)

Volts	I ( $\mu$ A)	i ( $\mu$ A)	$\frac{i}{I} \times 100$
1.0	0.81	0.11	13.58
2.0	1.73	0.34	19.65
3.0	2.79	0.59	21.15
4.0	4.15	1.05	25.30
5.0	5.18	1.59	30.69
7.5	8.77	3.57	40.71
10	12.63	6.09	48.22
12.5	16.48	8.91	54.07
15.0	20.34	12.00	59.00
20	28.82	19.45	67.49
25	36.79	26.90	73.12
30	46.04	35.90	77.98
50	79.45	66.74	84.00
100	161.69	145.12	89.75
150	243.93	223.51	91.63
200	318.46	298.04	93.59
Residual Current	+ 0.22	+0.08	

Some of the results for the stainless steel electrodes are shown in the table (5.2) Typical curve of the percentage efficiency versus I is more or less similar to the one found for the point-discharge in an artificial field.



FIGURE(5.4)

### 5.6. Measurement of the Impedance of the Tree

An earthed plate B of about 3ft. x 3ft. was fixed with the help of insulated strings about 37.5 cm below the insulated plate A. A stainless steel wire of diameter equal to 0.35 cm was fixed into the tree top in place of the electrode Z, the other end of which was soldered to a platinum wire of diameter equal to 0.12 cm which projected about 23.5 cm above the earthed plate B without touching it (see fig. 5.4). The height of the plates above the ground was adjusted, so as not to touch any of the branches of the tree.

The point-discharge was induced in the platinum wire, instead of the tree, in the form of fairly regular pulses and was measured with the galvanometers G and g, as described before.

Let P = Impedance of the tree in between the bypassing electrodes X and Y.

R = Resistance of the bypassing circuit

Q = Reactance due to the capacitances of the bypassing electrodes.

Therefore we can write

$$P (I - i) = (Q + R) i$$

or 
$$R = P \left( \frac{I}{i} - 1 \right) - Q$$

A certain constant voltage is applied to the plate 'A' for

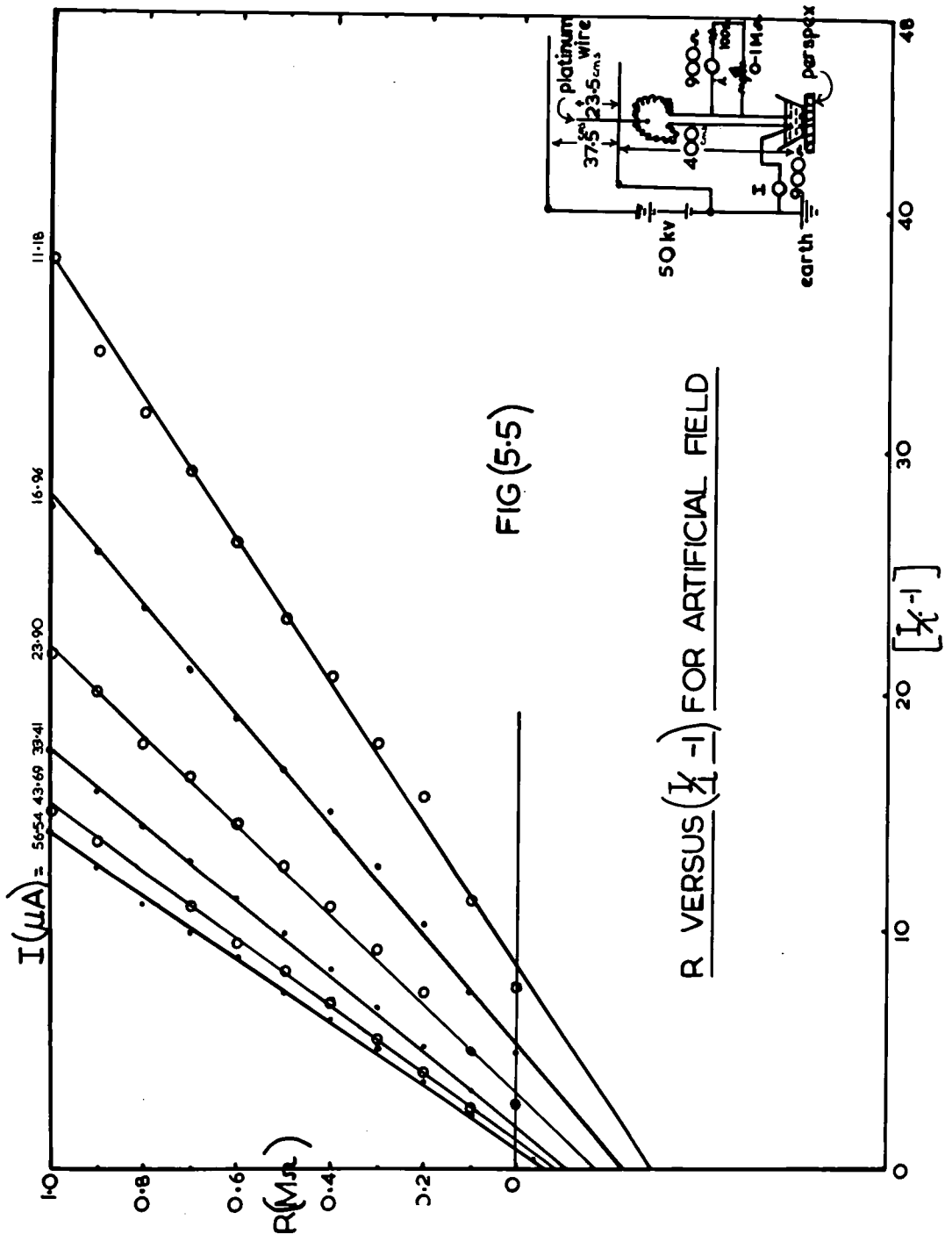

FIG (5.5)

$R$  VERSUS  $\left(\frac{I}{I_0} - 1\right)$  FOR ARTIFICIAL FIELD

about an hour or so till both  $I$  and  $i$  become fairly constant.

Now increase  $R$ , note the value of  $i$ , keeping  $I$  constant.

Various values of  $i$  were taken, as  $R$  varied in steps from

100 Ohms to 1 megohm. The experiment was repeated for

different voltages on the plate A. Some of the results for

positive potentials on the plate A are shown in table (5.3).

Table (5.3)

R (H. Ohms)	By-pass current $i$ in $\mu$ A for					
	$I = 11.18$	16.96	23.90	33.41	43.69	56.54
$10^{-4}$	1.29	2.88	6.43	18.62	22.62	33.92
0.1	0.90	2.00	4.01	7.71	12.08	17.73
0.2	0.67	1.49	2.83	5.40	8.48	12.08
0.3	0.59	1.23	2.31	4.24	6.68	9.25
0.4	0.52	1.05	1.95	3.52	5.40	7.71
0.5	0.46	0.95	1.72	3.03	4.63	6.68
0.6	0.41	0.85	1.54	2.67	4.11	5.65
0.7	0.38	0.77	1.36	2.59	3.60	5.14
0.8	0.34	0.69	1.26	2.16	3.21	4.63
0.9	0.32	0.63	1.13	1.98	2.93	4.11
1.0	0.29	0.59	1.05	1.80	2.72	3.73

Now the graphs of  $R$  versus  $\left(\frac{R}{i} - 1\right)$  are shown fig (5.5)

for various values of  $I$ , which are fairly good straight lines.

The slope of the graph gives the value of  $P$  while the intercept gives  $Q$ .

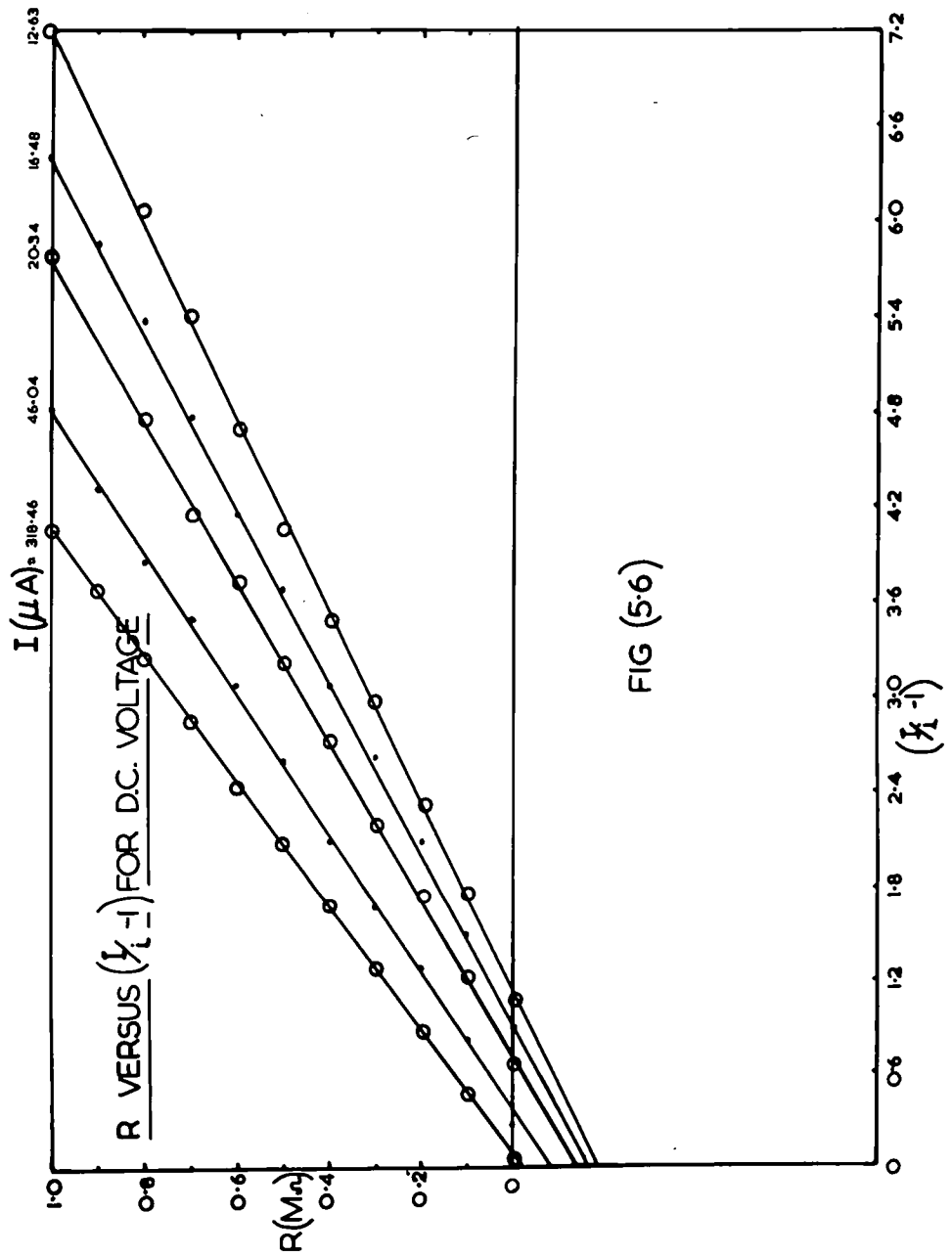

FIG (5.6)



It is quite clear that the increase of the voltage (or  $I$ ) increases  $P$  and decreases  $Q$  or in other words more of the current will be bypassed at higher point-discharge currents.

Finally if we plot the percentage efficiency i.e.  $(\frac{P}{I} \times 100)$  versus  $I$ , we get a graph of the same form as described before i.e. as  $I$  increases, the efficiency increases linearly at first and then reaches a saturation value at larger values of  $I$ .

Last of all the experiment was repeated by applying a constant D.C. voltage, from a Farnell Power Supply, between the electrode  $Z$  and the root electrode, in place of the artificial field. Keeping  $I$  constant, the measurements of  $i$  were taken for various values of  $R$  as described before (see Table 5.4).

Fig. (5.6) shows the graphs of  $(\frac{P}{I} - 1)$  versus  $R$  for various values of  $I$ , from which one can again find the values of  $P$  and  $Q$ . The results are more or less similar to those obtained for an artificial field i.e. the increase of  $I$  increases  $P$  and decreases  $Q$ .

### 5.7. Conclusions

The fraction of the point discharge current in a living tree bypassed through a low resistance galvanometer seems to

Table (5.4)

R (M. Ohms)	By-pass Current $i$ in $\mu$ A for				
	I = 12.63	16.48	20.34	26.04	318.46
$10^{-4}$	6.09	8.66	12.25	35.90	298.04
0.1	4.54	6.60	9.17	25.62	213.23
0.2	3.77	5.31	7.37	20.22	166.97
0.3	3.16	4.54	6.34	17.14	138.40
0.4	2.80	4.03	5.42	14.82	118.14
0.5	2.49	3.52	4.80	12.77	102.72
0.6	2.21	3.18	4.29	11.23	92.44
0.7	1.97	2.85	3.93	10.20	82.16
0.8	1.79	2.59	3.52	9.43	74.45
0.9	1.67	2.41	3.26	8.66	68.11
1.0	1.54	2.23	3.00	7.88	62.88

increase with the total point-discharge current, quite in contradiction to ETTE'S (1966b) results who found this fraction to be independent and fairly constant over a sufficiently long period; no marked difference is observed whether the measurements are made of the instantaneous values of current or the steady current in an artificial field (Direct Method). The same sort of results are observed with a constant D.C. voltage (indirect method). This divergence from ETTE'S results seems to be perhaps

due to the fact that he made measurements only upto about 15-20  $\mu$ A.

One of the main drawbacks with the above calibration using either the direct or the indirect method is due to residual current which not only depends upon the atmospheric conditions but also on the total current passing through the tree.

This increase in efficiency with the increase in the total current is explained due to the fact that the impedance of the tree in between the two electrodes increases while the reactance of the capacitances of the bypassing circuit decreases, as the total current is increased.

## CHAPTER VI

### Anomalous Properties of the Tree

#### 6.1 Introduction

It is known that dry wood exhibits electrical phenomena associated with dielectric materials. In the living state, however, wood contains a very large percentage of water in various fibres running through it. This water content affects the electrical properties considerably and so does the electrolytic action of the other mineral compounds found in wood. As a result of the complex electrical phenomena found in wood little quantitative information is available. Dry wood is essentially a non-conductor of direct current electricity and conducts only when moisture is present.

MURPHY (1929), DAVIDSON (1958) and several other investigators have found that in wood, ice and some textiles, the electrical conductivity decreases as temperature (or humidity) decreases and it is an ionic process rather than the electronic one it is in the metals. MURPHY (1929), while making measurements with cotton found that as the voltage decreases, the resistance increases; this effect was first demonstrated by EVERSHED (1914) for moisture absorbing dielectrics.

More recently CHALMERS (1964) found that when a potential is applied across two electrodes in a tree, a current flows and this decreases with time, rapidly at first and more slowly afterwards.

ETTE (1966a) studied the discharge curves, after a tree had been charged upto a steady state and found that the tree exhibits the behaviour of an anomalous dielectric and has at least three measurable relaxation times of the order of 100, 500 and 1000 sec.

The experimental investigations reported here consisted in measuring the resistance of the tree as a function of the applied voltage and see how it is affected by the passage of current through the tree.

### 6.2 Residual Current or E.M.F. in the Tree

In common with other imperfect dielectrics the tree has the property of absorbing a residual charge, which causes a residual current or e.m.f. This causes a galvanometer deflection in the opposite direction to that which the applied voltage would produce. By adjusting the applied e.m.f. the deflection

can be brought to zero and the applied e.m.f. as read from the voltmeter is then equal to the residual e.m.f., the initial value of which is called here as the e.m.f. of polarization.

If a voltage which has been applied to the tree, is removed, and the tree is connected to a galvanometer, it is found that a current flows, the initial value of which depends upon the applied voltage. The current starts decreasing rapidly at first and more slowly afterwards and eventually the rate of decrease becomes so slow and even after several hours a current due to the residual e.m.f. can be detected.

The chemical changes produced at the electrodes by electrolysis cause a difference of potential which oppose the applied e.m.f. These changes are of such a nature that in general they tend to remain after the applied e.m.f. is removed, producing a residual e.m.f.

If the direction of the current through the tree is reversed, the residual e.m.f. produced by it reverses its sign during the discharging process, the first part of the discharge corresponding to the last current and the last part to the first current. For example an e.m.f. of 200 volts was applied for 4 minutes to the tree, this was followed by 100 volts applied for 2 minutes and finally by - 100 volts applied for

2 minutes. The applied e.m.f. was then removed and the resultant residual e.m.f. varied with time in the following way:

Time (sec)	0	15	30	45	60	120	
Residual e.m.f.	42	12	0.7	-4.4	-7.0	-11.0	arbitrary units of deflection.

The galvanometer deflections for the first 30 sec. correspond to the predominance of the residual e.m.f. produced by -100 volts and those for 45, 60, 120 sec to predominance of that produced by +100 and +200 volts.

The following is a possible explanation for the above: Since the products of electrolysis presumably first make their appearance at the electrode surfaces, it is probable that, when the current direction is reversed, the new products push the products of the first current away from the electrode as a layer and that there are then at each electrode two layers of electrolyte of different chemical composition, the one layer being composed of anode products and the other of cathode products. The reason for the reversal of the sign is evident if the residual e.m.f. is chiefly due to the difference in the chemical composition of the products formed at the anode and the

cathode respectively; if the process of the discharge is the inverse of that of charging; the layers move upto the electrode surfaces and become discharged (in the sense of being made incapable on producing further current) in the inverse order to that in which they are formed.

### 6.3 Effect of Current on the Distribution of Resistance in the Tree

It is a well known fact that the resistance of a moisture absorbing dielectric changes with time while the direct current is flowing through it. This is of considerable importance in the measurement of point-discharge through trees, for their resistances may be changed by an appreciable amount during the measurements.

If we apply a certain constant D.C. voltage across the two electrodes of a tree, the current flow  $I(t)$  decreases with time  $t$  (reckoned from the instant when the circuit is closed). This current consists of three kinds namely the charging current  $i_1(t)$ , absorption current  $i_2(t)$  and leakage current  $i_3$ . The equation for these is:

$$I(t) = i_1(t) + i_2(t) + i_3$$

where  $I(t)$ ,  $i_1(t)$  and  $i_2(t)$  varies with time  $t$  and  $i_3$  is independent of time.



RESISTANCE VERSUS TIME OF CHARGING

FIG (6.1)

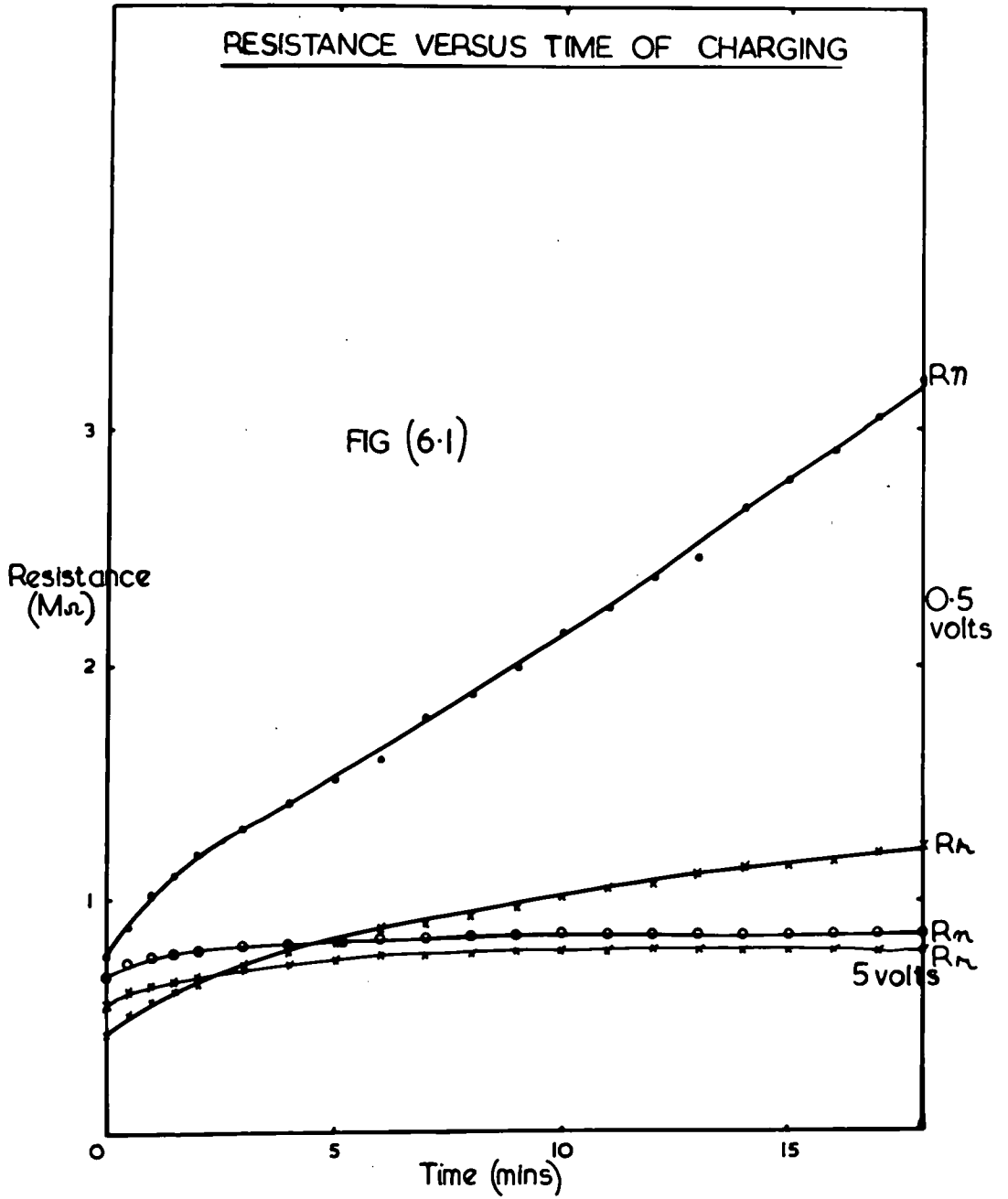

When  $V$ ,  $C$  and  $R$  are respectively the impressed voltage, the capacitance and resistance of the tree between the electrodes the current  $i_1(t)$  is given as a function of time  $t$  in the following equation:

$$i_1(t) = \frac{V}{R} \cdot e^{-t/RC}$$

The capacitance  $C$  and accordingly the product  $R$  and  $C$  are so small that the current  $i_1(t)$  vanishes in a short time.

Therefore,  $I(t) = i_2(t) + i_3$

After closing a direct current circuit containing a Sycamore tree and constant voltage (0.5 volts or 5 volts), the current flow  $I(t)$  was measured every one minute (see the table 6.1). The results are shown in the fig. (6.1) in which the change in resistance instead of the current  $I(t)$  is shown with the symbol  $\Theta$ . In general,  $i_2(t)$  decreases with time, i.e. the resistance increases;  $i_2(t)$  disappears in a relatively short time (i.e. the current  $I(t)$  becomes equal to the constant current  $i_3$ ) when the charging voltage is higher (5 volts). On the contrary, in the case of low charging voltage (0.5 volts), the current  $i_2(t)$  does continuously decrease during the observing time namely 20 minutes.

After the current flowed through the tree during 15 minutes,

Table (6.1)

Time (Min).	0.5 volts		5.0 volts	
	Normal ( $\mu$ A)	Reverse ( $\mu$ A)	Normal ( $\mu$ A)	Reverse ( $\mu$ A)
0	0.67	1.17	7.49	9.05
1.0	0.48	0.87	6.63	7.96
2.0	0.42	0.77	6.40	7.49
3.0	0.38	0.69	6.24	7.18
4.0	0.35	0.64	6.16	6.94
5.0	0.33	0.61	6.08	6.71
6.0	0.31	0.57	6.01	6.59
7.0	0.28	0.55	5.97	6.55
8.0	0.27	0.54	5.93	6.47
9.0	0.25	0.51	5.93	6.44
10.0	0.23	0.49	5.89	6.40
11.0	0.22	0.48	5.85	6.40
13.0	0.20	0.45	5.85	6.32
14.0	0.19	0.44	5.85	6.32
15.0	0.18	0.43	5.85	6.32

the circuit was opened for two minutes, then the direction of the current was reversed and immediately the circuit was closed. The changes of the reverse current are shown in the fig. (6.1) with symbol X.

Finally the experiment was repeated by using a constant current, instead of a constant voltage and the changes of the voltage drop were measured every one minute. The circuit was opened for two minutes, the direction of the current was reversed and immediately the circuit was closed. The same constant current as in the previous normal direction was made to flow in the opposite direction. The results thus obtained were similar to those for a constant voltage.

The increase of resistance can be attributed to one or more of the following phenomena:

- (1) The formation of a high contact resistance between the electrode and the tree
- (2) The drying of the anode region by electroosmotic movement of water away from it
- (3) The drying of the tree by Joule's heating
- (4) The formation of a back e.m.f.

#### 6.4 Variation of the Resistance of the Tree with Applied E.M.F.

EVANS (1914) demonstrated that the insulation resistance of moisture absorbing dielectrics is a function of the applied voltage. He proposed a theory to account for it based upon the

redistribution of the absorbed moisture by the electric field. The present investigation was undertaken chiefly to determine whether or not the resistance of a living tree is affected by the applied voltage.

The resistance of the tree in direct current circuit was measured in two ways:

(1) Instantaneous Current Method

If we close a circuit containing a battery and a galvanometer in series with the tree, the needle will swing and stand still for a while. After noting the reading of the galvanometer, the circuit is opened at once, the time required to take this reading is about 5 sec. within which the charging current would have already vanished, and this current flow thus measured is named here 'Instantaneous Current'.

When the instantaneous current was measured about 10 times at intervals of one minute, the reading remained practically the same each time.

After the current had flowed for one minute, the circuit was opened and then the instantaneous current was measured every one minute. The readings were little or not different. When

RESISTANCE OF THE TREE AGAINST APPLIED VOLTAGE

- (1) Steady current method
- (2) Instantaneous current method

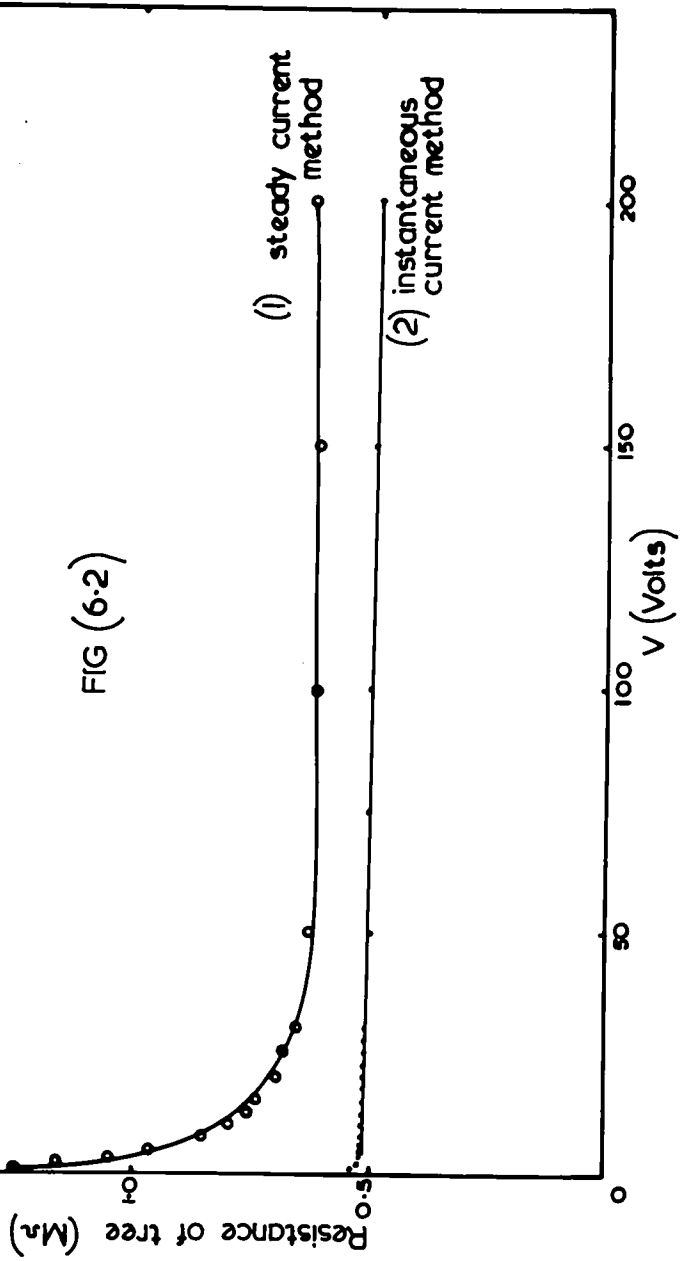

FIG (6.2)

similar process was carried on with current flow for a longer time say 10 minutes, the value while the current passing for 10 minutes decreased considerably. The instantaneous current after the circuit was opened, gradually increased with time and after about several hours, it became almost equal to its initial value.

Consequently the measurements of the resistance of the tree in direct circuit were performed by means of the instantaneous current. The tree, when affected by the current flow, was left un-used until the influence perfectly vanished. The instantaneous currents were measured as the applied e.m.f. was increased in steps from 1 to 200 volts (see table 6.2). Fig. (6.2) shows the variation of the resistance versus the applied e.m.f. and seems to be practically constant over a wide range of voltage.

Now it is evident that the current flow immediately after voltage application has two components

- (1) A true direct current
- (2) A polarization current which is time dependent.

If the assumption is made that the polarization component is small in comparison to true direct current component, fluctuations

Table (6.2)

Volts	Instantaneous Current ( $\mu\text{A}$ )	Steady Current ( $\mu\text{A}$ )
1.0	1.85	0.81
2.0	3.80	1.73
3.0	5.76	2.79
4.0	7.66	4.15
5.0	9.61	5.18
7.5	14.49	8.77
10	19.38	12.63
12.5	24.26	16.48
15	29.14	20.34
20	39.04	28.82
25	49.19	36.79
30	58.60	46.04
50	100.08	79.45
100	200.51	161.69
150	305.11	243.93
200	408.48	318.46
300	614.08	

in the polarization current with time do not appreciably change the total current flow. Thus measurements made immediately after voltage application give a good approximation of the direct current conductivity because this component predominates.



Furthermore a minimum of electrolytic products have accumulated near the electrodes.

## (2) Steady Current Method

As described in Chapter (V-5) a certain constant D.C. voltage was applied across the two electrodes of the Sycamore tree, for about half an hour or so till the current became constant. The time required to reach this constant value was much smaller when the applied voltage was higher. The reading of this steady value of current was taken, as the applied e.m.f. was increased in steps from about 1-200 volts. (see table 6.2).

In this case the relationship between voltage and current is not only governed by the resistance of the circuit i.e. the tree, but also by the resistances such as counter electromotive force due to polarization.

The characteristic form of the resistance versus applied voltage curve is illustrated by the fig. (6.2). The resistance of the tree at lower voltages is not independent of the applied e.m.f. but generally falls with increasing voltage. At higher e.m.f. than 50 volts, the resistance of the tree shows a constant value i.e. the polarization effect becomes negligible.

For applied e.m.f. of about less than 1 or 2 volts, the resistance is abnormally high as compared with its value at higher voltages. This characteristic would be expected if the tree conducts by the electrolysis of the aqueous solutions which it contains, for the resistance of an electrolytic cell is abnormally high for voltages of this order i.e. less than the decomposition potentials and over-voltages. When an e.m.f. of about 1 volt or less is applied to the tree, there is relatively a large initial current which rapidly falls to a small residual current; and when the applied e.m.f. is increased, this process is repeated but the residual current is larger.

This behaviour is qualitatively the same as that of an electrolytic cell in the same range of voltage. The form of the curve shown in the fig. (6.2) could be predicted for voltages less than 50 volts, on the assumption that a tree in between the two electrodes acts as an electrolytic cell which develops a back e.m.f. of polarization, so the enormously high value of resistance at low voltages may be due to the back e.m.f. of electrolytic polarization which becomes negligible at high voltages.

### 6.5 Conclusion

In general the resistance of the tree increases with the time of application of the voltage and reaches a saturation value rapidly for higher charging voltages. The behaviour of the resistance in the reverse direction is similar but here the values are slightly smaller; the resistances in the normal and reverse directions become almost equal for very large charging voltages.

The measurements of the resistance of the tree by instantaneous current method shows that there is no reversed Effect and so the measurements made immediately after the application of the voltage should give a good approximation of the direct current conductivity of the tree.

Finally the measurements made with the steady current method show that the insulation resistance of the tree is a decreasing function of the applied voltage. At low voltages the current-voltage curve for the tree closely resembles that of an electrolytic cell and it is concluded that for voltages lower than about 50 volts the decrease of resistance with increasing voltage is caused by the presence of a back e.m.f. of electrolytic polarization in the tree.

## CHAPTER VII

### Point-Discharge Current and its Relation to Potential Gradient and Wind Speed

#### 7.1 Introduction

It is well known that the phenomenon of point-discharge in atmospheric electricity, occurs at trees and other exposed points when the atmospheric potential gradient becomes sufficiently great and this plays an important part in the transfer of negative charge to the earth during storms, to balance the arrival of positive charge during fine weather.

WHIPPLE and SCRASE (1936) compared the point-discharge current through a single point with the simultaneous potential gradient at the earth's surface without taking into account the wind speed and found empirically a square law. CHIPLONKAR (1940), YRIBERRY (1954) and HUTCHINSON (1951) have found a general agreement with the above square law except the latter found 'humps' and also a tendency towards first power law for high values of potential gradients.

DAVIS & STANDRING (1947) were the first to show that the point-discharge current increases with wind speed but they did not give any general formula.

CHALMERS & MAPLESON (1955) used a captive balloon and made measurements of current  $I$ , wind speed  $W$  and field  $F$  and obtained the following relationship empirically:

$$I = A (Fh)^{7/4} \cdot W^{\frac{1}{2}} \quad (1)$$

where  $h$  = height of the point,  $F$  = pot. grad, at the ground.

For an isolated point, they showed theoretically that

$$I = A_1 (V)^{Q-1} \cdot (W)^{3-Q} \quad (2)$$

where  $V$  is the potential difference between the point and its surroundings,  $W$  is the wind speed,  $I$  is the point discharge current,  $A$  is a constant and  $Q$  a number, not determined by the theory.

For an earthed point at a height  $h$  in a potential gradient  $F$ ,  $V = Fh$ , if the space charge in the height  $h$  is neglected. The relations (1) and (2) are the same if  $Q$  is chosen to be equal to 2.75.

-----

\* In order to distinguish between the different constants involved, they are here given different symbols from those used in the original papers.

KIRKMAN & CHALMERS (1957) using an isolated point on a mast 27m and 34m high found a relationship of the form

$$I = B (P - M) (W + k) \quad (3)$$

where B, M & k are constants.

CHAPMAN (1956), has suggested, on theoretical grounds that the relationship between point discharge current, potential gradient and wind speed should be of the form:

$$I = C (V - V_0) v \quad (4)$$

where V is the potential of the point, relative to its surroundings,  $V_0$  is the minimum value of the potential for starting the discharge, v is the velocity with which the ions are removed from the neighbourhood of the point and C is a constant.

For no wind, v is proportional to V, since the ions are moved away only by the field, so  $I = C V (V - V_0)$ . This is quite similar to the formula of WHIPPLE & SCRASE (1956) at high values of field.

On the other hand for high wind, v is proportional to W, so

$$I = C (V - V_0) W = C_h (P - F_0) W$$

which is not far from relation (3).

Chapman tested his formula by point to plane discharge in still air, by point discharge in a wind tunnel and by measurements with a point on an aircraft, and found good agreement.

CHALMERS (1957) re-analysed the results of HAPLESON & KIRKMAN and found that by suitably choosing the constants, their results could be presented in a relationship very similar to that of CHAPMAN. In fact he suggested that  $v$  should be expressed as a vector sum of  $W$  and  $av$ , giving

$$I = K(V-V_0)(W^2 + a^2V^2)^{\frac{1}{2}} \quad (5)$$

so that  $av$  represents the ion velocity in the field at right angle to wind speed  $W$ .

LARGE & PIERCE (1957) applied a high potential to a point in natural winds and found agreement with the expression (5).

CHALMERS (1962a) derived theoretically an approximate formula, on certain assumptions, between point discharge current, field and wind speed of the form

$$I = 2\pi\epsilon (V-V_0) (W^2 + W^2F^2)^{\frac{1}{2}} \quad (6)$$

where the symbols have the usual meanings.

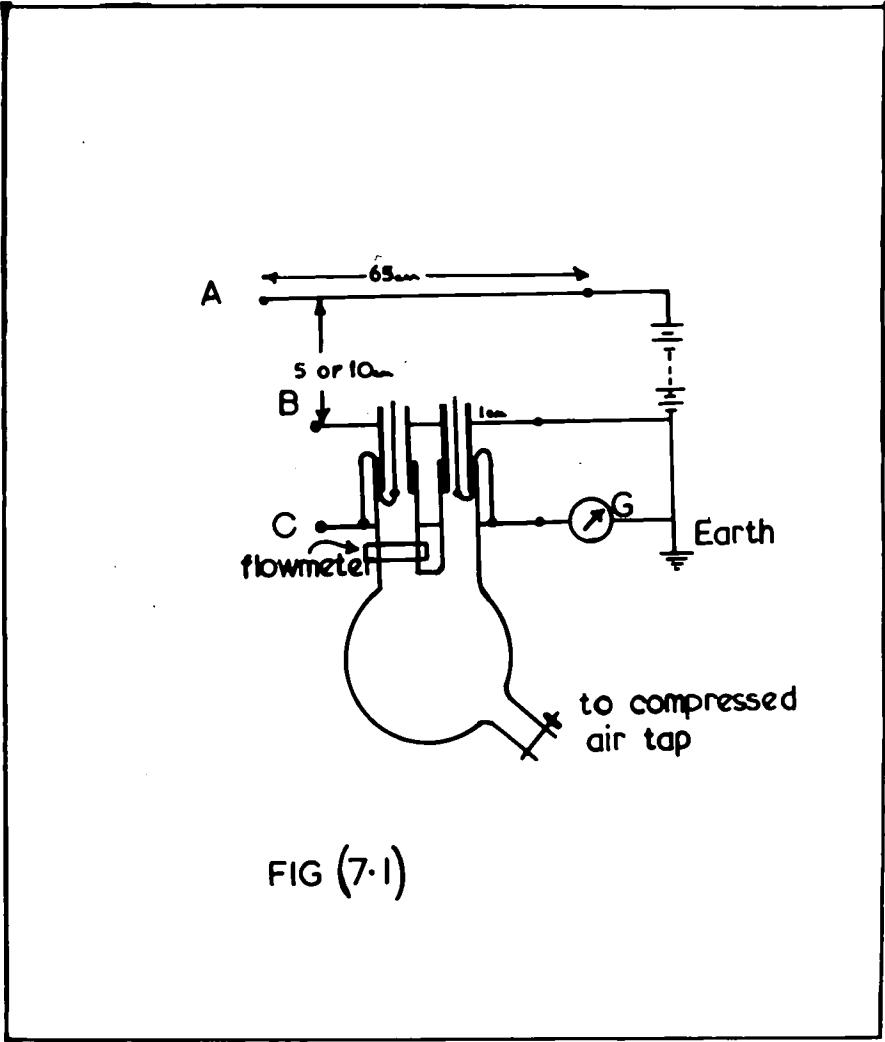

FIG (7.1)



MILNER & CHALMERS (1961) found that the current from a point at tree-top height, agrees with the relation (3), so that the formula of WHIPPLE & SCRASE (1936) is not correct, even for points at such heights, when the wind is taken into account.

## 7.2 Experimental Arrangement

The apparatus used was of the same form as described in Chapter III. A voltage upto about  $\pm 50\text{KV}$  was applied to a horizontal plate A from a Brandenburg power supply while a plate B, 5.0cm or 10cm away, was connected to earth (see fig.7.1). The points used were all steel needles with sharp points of minimum radius 0.025cm. These needles were passed through glass tubes of radius 0.164cm, the lower ends of which were connected to rubber tubes from the compressed air tap, while the needles were soldered to wires, which were further connected to another plate C. The tips of the needles should be in flush with the upper ends of the glass tubes, since the speed of the wind decreases rapidly above them.

Holes were drilled in B, so that the points along with the glass tubes should project through B. (see fig.7.2). These points were arranged in the form of a hexagon, with one point in the centre and the holes were drilled so that the hexagonal

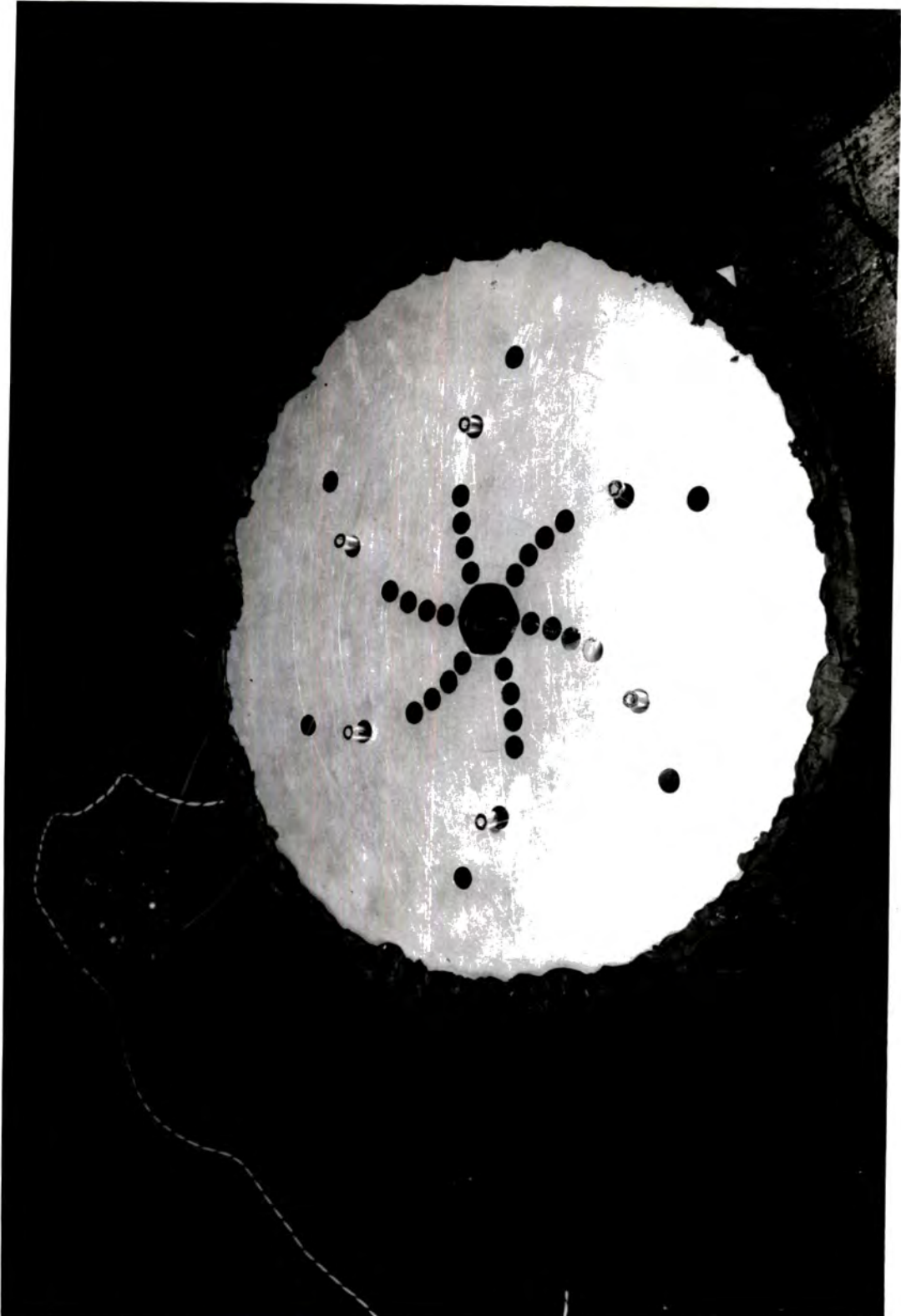

FIGURE(7-2)

arrangements of different sizes could be used. The points projected 1cm above B and were all connected to the plate C and through a galvanometer to earth.

### 7.3 Measurement of Wind Speed:

Various methods were tried to measure the flow of air. The disadvantage of an ordinary Gas Meter is that it can stand pressure difference only equal to about a few inches of water, so it was quite unsuitable for the present purpose. The pressure drop along a Pitot tube can be used to measure the flow of air but it was not found to be very successful because of its inaccuracy.

Finally a series 3000 Flowmeter Model 10A3567S was used. It could measure a flow of 20-260 Litres per minute, as detailed below:-

Temperature - 60°F

Safe working pressure of the instrument 600 P.S.I.G.  
The flow was measured by the visual indication of a stainless steel float (IGSVT - 69) on a calibrated linear scale. It had an accuracy of  $\pm 2\%$ .



FIGURE(7·3)

The diameter of the outlet of each glass tube was 0.328 cm (area of cross-section 0.085 sq.cm.) So with only a single point, a flow of about 25 litres/minute is equivalent to a speed of 49 metres per sec. In the present investigation, a flow upto about 125 litres per minute (i.e. 245 m/sec) was used.

Moreover for a single point, the pressure from the laboratory compressed air tap was high enough to give the required flow. But for the seven points, a compressed air cylinder was used, in which case, the working pressure was adjusted to the required range by a regulator. The air flow was measured only in one tube, on the assumption that equal amounts of air flow in all the seven tubes. The detailed experimental arrangement is shown in the fig. (7.3).

#### 7.4 Results

First of all, the observations were taken with an arrangement of parallel plates, spaced about 10cm apart, with the height of the point equal to 1cm. For a certain positive (or negative) voltage on the plate A, the point discharge currents induced in the point were measured for various values of wind speeds. The process was repeated, as the potential on the upper plate A was increased in steps upto a maximum of about  $\pm$  50KV. With the same set of experimental arrangement, the results were taken with seven points, as the distance  $d$  between them was varied from about 0.6 cm to 10 cm.

(see table 7.3 to 7.9).

Finally the distance between the parallel plates A and B was decreased from about 10cm to 5cm, keeping the rest of the apparatus undisturbed and the observations were again taken in the same way as described above (see table 7.1 and 7.2). Before taking any set of observations the points were polished with a piece of paper because after blowing a high wind across it, the condition of the point changes.

#### 7.5 Preliminary Analysis of Results

If we assume that the relation (5) is the best fit to the results, we can write it in the following form:-

$$I = K(V - V_0) (W + aV) \quad (7)$$

because in the present case, the wind and the field are <sup>in</sup> the same direction.

For zero wind speed, the above relation becomes

$$I = K_a V (V - V_0) \quad (8)$$

Now the graph of  $I/V$  versus  $V$  should give values of  $K_a$  and  $V_0$ . It was found in some cases that the calculated values of  $V_0$  was somewhat lower than the corresponding measured experimental value; which is due to the fact that the condition of the point

Table (7.1)

Single Point Observations

Distance between the plates A and B = 5cm

V	$V_m$	$\sigma$ m/s	49	98	147	196	245
$35 \times 10^3$		$49.6 \times 10^{-6}$	$50.37 \times 10^{-6}$	$51.14 \times 10^{-6}$	$52.17 \times 10^{-6}$	$52.94 \times 10^{-6}$	$53.71 \times 10^{-6}$
32.5		40.86	42.41	43.18	43.95	44.72	45.49
30		33.61	34.44	35.47	36.24	36.75	37.52
27.5		26.99	27.88	28.53	29.30	30.07	31.10
25		21.07	21.85	22.62	23.13	23.64	24.42
22.5		16.19	17.22	17.86	18.25	18.76	19.15
20		11.82	12.59	13.11	13.49	14.01	14.65
17.5		7.97	8.74	9.12	9.51	10.02	10.54
15		4.78	5.29	5.71	6.01	6.35	6.94

Table (7.2)

Simple Point Observations

Distance between the plates A and B = 5 cm

Negative voltage (or + ve Point),  $V_0 = 9.5 \times 10^3$

V	$V_m$	$\sigma$ m/s	49	98	147	196	245
$27.5 \times 10^3$	$15.16 \times 10^{-6}$	$16.19 \times 10^{-6}$	$16.58 \times 10^{-6}$	$17.22 \times 10^{-6}$	$17.73 \times 10^{-6}$	$18.76 \times 10^{-6}$	
25	11.82	12.59	13.11	13.62	14.14	15.16	
22.5	9.00	9.51	10.02	10.54	11.05	11.82	
20	6.43	6.94	7.45	7.84	8.22	9.00	
17.5	4.37	4.73	5.06	5.47	5.94	6.66	
15	2.47	2.70	3.14	3.39	3.70	4.11	



Table (7.3)

Single Point Observations

Distance between the Plates A and B - 10cm

Positive Voltage (or Negative Point),  $V = 18 \times 10^3$

$\frac{V_0}{V}$	$\frac{e}{m} \times 10^{-6}$	69	978	167	196	263
$90 \times 10^3$	$12.34 \times 10^{-6}$	$12.89 \times 10^{-6}$	$13.56 \times 10^{-6}$	$13.62 \times 10^{-6}$	$14.01 \times 10^{-6}$	$14.65 \times 10^{-6}$
68	11.31	11.69	12.08	12.46	12.85	13.69
66	10.02	10.41	10.79	11.18	11.57	12.21
64	8.76	9.25	9.64	10.02	10.28	10.92
62	7.71	8.10	8.35	8.76	9.12	9.77
60	6.96	7.20	7.38	7.97	8.35	8.87
58	5.96	6.30	6.60	6.99	7.30	7.71
56	5.01	5.37	5.65	5.96	6.22	6.70
54	4.21	4.52	4.81	5.06	5.37	5.91
52	3.47	3.78	4.06	4.34	4.65	5.06
50	2.78	3.08	3.37	3.62	3.88	4.34

Table (7.6)

Single Point Observations

Distance between the Plates A and B = 10 cm

Negative Voltage (or + vs Point),  $V_0 = 22.5 \times 10^3$

$V$	$V_0$	$\theta$ m/s	49	98	147	196	245
$48 \times 10^3$	$6.84 \times 10^{-6}$	$7.20 \times 10^{-6}$	$7.45 \times 10^{-6}$	$7.97 \times 10^{-6}$	$8.22 \times 10^{-6}$	$8.74 \times 10^{-6}$	
46	6.07	6.45	6.81	7.20	7.45	7.97	
42	4.65	5.14	5.45	5.78	6.09	6.45	
40	3.96	4.32	4.57	4.91	5.27	5.55	
38	3.34	3.70	3.98	4.27	4.52	4.85	
32	1.67	1.88	2.13	2.34	2.52	2.72	

Table (7.5)

Seven Points Observations

Separation Between the Points = 0.6cm,  $V=22.4 \times 10^3$

$V$	$\sigma$ m/s	69	98	147	196	243
$50 \times 10^3$	$21.53 \times 10^{-6}$	$25.13 \times 10^{-6}$	$24.16 \times 10^{-6}$	$25.19 \times 10^{-6}$	$26.21 \times 10^{-6}$	$27.26 \times 10^{-6}$
47.5	18.25	20.20	21.07	22.10	23.13	24.16
65	15.42	17.48	18.50	19.53	20.56	21.59
42.5	13.36	15.16	15.93	16.71	17.73	18.50
40	10.79	12.34	13.36	14.59	15.16	15.93
37.5	9.00	9.77	10.79	12.08	12.83	13.62
35	6.94	7.97	8.74	9.77	10.54	11.31

**Table (7.6)**

**Seven Points Observations**

Separation Between the Points = 2.0cm,  $V_0 = 25.0 \times 10^3$

V	$\sigma$ m/e	49	98	147	196	245
$30 \times 10^3$	$25.96 \times 10^{-6}$	$29.81 \times 10^{-6}$	$31.53 \times 10^{-6}$	$32.90 \times 10^{-6}$	$34.52 \times 10^{-6}$	$35.21 \times 10^{-6}$
47.5	22.36	26.21	27.76	29.04	30.07	31.10
65	19.28	23.13	24.67	25.96	26.73	27.76
82.5	15.93	20.05	21.59	22.87	23.64	24.67
100	13.11	16.96	17.99	19.02	19.79	20.56
117.5	9.77	12.85	14.14	15.43	15.93	16.45
135	5.65	6.94	8.22	9.00	9.51	10.02

Table (7.7)

Seven Points Observations

Separation Between the Points = 5.0cm,  $V_0 = 18.7 \times 10^3$

$V$	$V_0 \times 10^3$	$\sigma$ m/s	69	98	167	196	945
		$72.99 \times 10^{-6}$	$62.25 \times 10^{-6}$	$84.81 \times 10^{-6}$	$87.38 \times 10^{-6}$	$88.67 \times 10^{-6}$	$91.26 \times 10^{-6}$
47.5		63.99	71.96	74.53	77.10	78.39	80.96
45		56.03	61.68	64.76	67.33	69.39	71.45
42.5		47.03	52.94	55.00	57.31	59.11	61.68
40		40.09	44.72	47.03	49.34	51.40	53.97
37.5		33.15	37.52	39.84	42.13	43.93	46.26
35		26.21	30.84	32.90	34.95	36.96	38.04
30		13.11	15.93	17.48	19.02	19.79	21.33

Table (7.8)

Seven Points Observations

Separation Between the Points = 7.5cm,  $V_0 = 16.6 \times 10^3$

$V$	$V_0$	$\sigma$ m/s	69	98	147	196	245
$50 \times 10^3$		$89.95 \times 10^{-6}$	$93.81 \times 10^{-6}$	$93.09 \times 10^{-6}$	$97.66 \times 10^{-6}$	$100.53 \times 10^{-6}$	$103.57 \times 10^{-6}$
45		66.82	71.96	74.53	75.82	77.10	79.67
40		51.60	53.31	56.80	58.60	61.42	62.71
35		34.70	38.04	40.09	41.12	42.66	44.20
30		21.85	24.67	25.70	27.24	28.78	30.33
25		6.94	10.79	11.31	12.34	13.36	14.39

Table (7.2)

Seven Points Observations

Separation Between the Points = 10cm,  $V=17.8 \times 10^3$

$N \times 10^3$	$\sigma_{m/s}$	49	98	147	196	245
$50 \times 10^3$	$104.09 \times 10^{-6}$	$113.08 \times 10^{-6}$	$115.65 \times 10^{-6}$	$118.22 \times 10^{-6}$	$120.79 \times 10^{-6}$	$123.36 \times 10^{-6}$
47.5	89.95	97.66	102.80	105.57	107.94	109.23
45	78.39	87.58	89.95	95.52	93.81	95.09
42.5	66.82	71.96	77.10	78.39	79.67	85.53
40	58.54	64.25	66.56	68.62	70.93	73.50
37.5	48.32	53.46	56.03	59.08	60.14	62.45
35	39.58	44.20	46.26	48.32	50.57	52.69
30	23.90	28.78	30.33	31.67	33.92	35.47

changes after blowing the high wind or after inducing a high point-discharge current. This was later confirmed by taking measurements on a point without any wind, in which case both the experimental and graphical values of  $V_0$  were nearly equal. So in the final analysis of results, this graphical value of  $V_0$  was used i.e. in the absence of wind, equation (8) was assumed to be the basic relation between point-discharge current and field.

Now from the relation (7), the graph of  $\frac{I}{(V-V_0)}$  versus  $V$  is a straight line, from which one can find the value of  $K$  and  $a$ . It is found that both  $K$  and  $a$  are not constant but depend upon the voltage; as the voltage increases,  $K$  decreases while  $a$  increases, keeping the product  $Ka$  to be constant.

Moreover the values of  $K$  and  $a$  are slightly greater for 5cm than 10cm separation between the parallel plates A and B. Finally the value of  $K$  is greater for multiple points than a single point and increases as the separation between the points increases.

#### 7.6 Analysis of Results by Computer

To derive a relation empirically, between the point-discharge current  $I$ , the voltage  $V$  between the point and its surroundings and the wind speed  $V$ , a method of multiple regression analysis





is used, the aim of which is to obtain from the recorded data an equation of the form.

$$y = b_0 + b_1x_1 + b_2x_2 + \dots + b_nx_n$$

where  $y$  is the dependent variable,  $x_1, x_2, \dots, x_n$  are the independent variables and  $b_1, b_2, \dots, b_n$  are the regression coefficients,  $b_0$  is that part of  $y$  which is not explained by  $x$ 's in the equation.

A programme LS 17 written by R.E.Day of the United Steel Companies Ltd., Rotherham, was used. The method of analysis employed in this programme is that of BARNETT WOOLF (1951).

This programme is designed to enable multiple regression analysis to be carried out on any number of variables upto 49 on an Elliott 803B Computer with automatic floating point unit and 4096 words of storage: (79 variables is the limit on a similar machine with 8192 words of storage). This binary tape can be entered at 4 0 0.

In the present case, there were three variables, i.e.  $U, V$  and  $I$ . By writing a small preliminary programme, variables  $V^2, V_0V, I/(V-V_0)$  and  $IV/(V-V_0)$  were compiled. When this data tape has been entered at 405, there is automatically an output of mean, minimum, maximum and sigma for each variable.

The matrix of correlation coefficients may be obtained by either the key board i.e. enter 446 or the steering tape.

Regression may be performed under complete control of the key board or by the steering tape. It is also possible to allow the analysis to be performed automatically, but in the present case it was undertaken by adding and removing independent variables as desired from the key board.

The dependent variable must be added first i.e. enter 406 with variable number (no.1 in the present case for  $W$ ) on  $N_2$  buttons of the keyboard. The residual mean square and residual sum of squares will be the output together with the degrees of freedom. Independent variables may be added (i.e. enter 407 with  $N_2 =$  variable number) or removed (i.e. enter 407 with  $F_2 = 05$  and  $N_2 =$  variable number) or the last independent variable may be replaced by a new one (i.e. enter 407 with  $F_2 = 03$  and  $N_2 =$  new variable numbers). At each stage the regression equation is output in the form of its coefficients  $b_0, b_1 - - b_n$  together with their standard errors and the moduli of the  $t$  - ratio. The percentage of the original sum of squares explained by the regression is also given.

Using the recorded data, the regression analysis was

carried out on the following equations:-

$$(1) \quad I = \frac{K1}{V} (V-V_0) (W + a_1 V^2)$$

$$(2) \quad I = \frac{K2}{V} (V-V_0) (W + a_2 V)$$

$$(3) \quad I = K3 (V-V_0) (W + a_3 V)$$

$$(4) \quad I = \frac{K4}{V} (V-V_0) [(W-W_0) + a_4 V^2]$$

$$(5) \quad I = \frac{K5}{V} (V-V_0) [W + a_5 V (V + V_0)]$$

$$(6) \quad I = K6 (F-H) (W + a_6) = \frac{K6}{H} (V-V_0) (W + a_6)$$

where  $K1, K2, \dots, K6$  and  $a_1, a_2, \dots, a_6$  are all constants, of course of different magnitudes.

$H$  = Height of the point.

$V$  = Potential of the point w.r.t. its surroundings with  $V_0$  as its minimum values

$W_0$  = Minimum wind speed, at which corona current is affected

Table (7.10)

SINGLE POINT

Constants	Distance between the plates A and B			
	5.0 cm		10.0 cm	
	Negative Point	+ve Point	-ve Point	+ve Point
K1	$2.35 \times 10^{-8}$	$2.90 \times 10^{-8}$	$1.44 \times 10^{-8}$	$1.51 \times 10^{-8}$
K2	$5.69 \times 10^{-8}$	$2.16 \times 10^{-8}$	$1.54 \times 10^{-8}$	$1.50 \times 10^{-8}$
K3	$0.54 \times 10^{-11}$	$0.50 \times 10^{-11}$	$0.38 \times 10^{-11}$	$0.38 \times 10^{-11}$
$a_1$	$5.81 \times 10^{-5}$	$3.97 \times 10^{-5}$	$5.37 \times 10^{-5}$	$3.66 \times 10^{-5}$
$a_2$	0.24	0.31	0.61	0.30
$a_3$	0.23	0.14	0.17	0.11

## SEVEN POINTS

Distance between the Points in Cm	K1	K2	K3	$a_1$	$a_2$	$a_3$
0.6	$4.66 \times 10^{-8}$	$4.69 \times 10^{-8}$	$1.13 \times 10^{-11}$	$3.18 \times 10^{-5}$	0.27	0.09
2.0	$9.17 \times 10^{-8}$	$8.59 \times 10^{-8}$	$2.29 \times 10^{-11}$	$2.63 \times 10^{-5}$	0.24	0.11
5.0	$1.19 \times 10^{-8}$	$0.83 \times 10^{-8}$	$2.83 \times 10^{-11}$	$4.74 \times 10^{-5}$	0.40	0.19
7.5	$10.06 \times 10^{-8}$	$8.91 \times 10^{-8}$	$3.15 \times 10^{-11}$	$3.66 \times 10^{-5}$	0.48	0.18
10.0	$11.60 \times 10^{-8}$	$12.77 \times 10^{-8}$	$2.91 \times 10^{-11}$	$3.66 \times 10^{-5}$	0.41	0.19

The above equations can be written in the forms respectively.

$$W = \frac{1}{K1} \left( \frac{IV}{V-V_0} \right) - a_1 V^2$$

$$W = \frac{1}{K2} \left( \frac{IV}{V-V_0} \right) - a_2 V$$

$$W = \frac{1}{K3} \left( \frac{I}{V-V_0} \right) - a_3 V$$

$$W = \frac{1}{K4} \left( \frac{IV}{V-V_0} \right) - a_4 V^2 + V_0$$

$$W = \frac{1}{K5} \left( \frac{IV}{V-V_0} \right) - a_5 V^2 - a_5 (V_0 V)$$

$$W = \frac{H}{K6} \left( \frac{I}{V-V_0} \right) - a_6$$

T - test showed that out of all the above equations, the order of the first three best fit equations is

$$I = \frac{K1}{V} (V-V_0) (W + a_1 V^2) \quad (9)$$

$$I = \frac{K2}{V} (V-V_0) (W + a_2 V) \quad (10)$$

$$I = K3 (V-V_0) (W + a_3 V) \quad (11)$$

Table (7.10) shows the values of K1, K2, K3, a<sub>1</sub>, a<sub>2</sub> and a<sub>3</sub> for the single point as well as the multiple points, as evaluated by Computer.

### 7.7. Conclusion

The results obtained with the experiments, described in this chapter has practically no relation with any of the experiments done by the previous workers, may be perhaps the direction of the wind applied here is parallel to the point discharge current, quite different from the natural conditions where it is usually perpendicular.

Moreover if we assume the equation (8) to be the basic equation between the point-discharge current and field without any wind and revise it by including the wind factor, so that it remains in an arrangement consistent with the former, the equations (9) and (11) seem to be the choice. Preliminary analysis showed that in equation (11) (which is the same as equation (9)), both  $K_3$  and  $a_3$  are not constants but depend upon  $V$  in a way to be consistent with the equation (9). So the conclusion is that the equation (9) seems to be the best relation between the point-discharge current, wind speed and field.

It is clear from the table (7.10) that the constant  $K_1$  is slightly greater for 5cm than for 10cm separation between the plates, in agreement with the results of Chapter II. Also the constant  $K_1$  is greater for multiple points than for a single point and increases as the separation between the points increases, again in

agreement with the results of Chapter III. Moreover the constant  $a_1$  is greater for 5cm than for 10cm separation between the plates and seems to be practically the same for multiple points with a little or no increase for greater separations between the points; the cause for this behaviour is not well understood, though it is likely to be tied up with the variations of  $K_1$ .

## CHAPTER VIII

### Measurements of Point-Discharge Pulses

#### 8.1 Introduction

The pioneering investigations of TRICHEL (1938) on point-discharge in point to plane geometry have shown that for a negative point, the discharge current consists of regular pulses; the frequency of which, at moderate currents, increases in proportion to the current, so that the quantity of charge per pulse remains nearly constant.

LARGE & PIERCE (1955) showed that the current through a metal point in the atmosphere below a thundercloud also consists of pulses. PIERCE, NADILE and MCKINNON (1960) made comprehensive investigations in the laboratory and found a continuous occurrence of families of Trichel pulses. The pulses of each family are of uniform size but amplitude differs from family to family. LOEB (1965) has reviewed the phenomenon, giving a more clear picture of the mechanism responsible for the pulses.

For natural point discharge outdoors, CHALMERS and MAPLESON (1955) first and others later have found that an increase of wind speed increases the point discharge current.



Recently CHALMERS (1965) blew air nearly parallel to the direction of the electron current from the point, with the results that the current increased while the repetition frequency of the pulses decreased, which implies that the average charge per pulse must have increased. This enhancement of ionisation in wind blown coronas has also been observed by NYGAARD (1966a).

NYGAARD (1966b) found more recently that for air flow perpendicular to or anti-parallel to the electron current, there occurs a very pronounced increase in the average charge per pulse. On the other hand for winds blowing parallel to the electron current, very little increase in charge per pulse occurs.

## 8.2 Apparatus

The apparatus used was of the same form as described in Chapter VII. The point used was a steel needle with sharp point of minimum radius 0.0025cm. The point discharge was induced in the point by mounting it in an artificial field between two parallel plates, spaced about 5cm apart and the height of the point was adjusted to be equal to 1cm. The point-discharge current was measured by connecting the point to earth

through a galvanometer. The pulse behaviour of the point-discharge was studied by means of a cathode ray oscilloscope, which was connected in series with the galvanometer and was shunted with a resistance of about 1850 Ohms, to reduce its time constant.

An air stream from the laboratory compressed air supply was available to provide a wind, which could be kept fairly constant for any particular observation and the rate of flow was measured by means of a float type flowmeter. It was arranged to be vertical i.e. nearly along the direction of the main electron current flow from the point.

### 8.3 Results

First the measurements were made without any wind. For different voltages on the H.F. plate A, the point discharge currents through the microammeter were measured. When this current exceeded about 3 or  $\frac{1}{2}$   $\mu$  A, it consisted of pulses regular enough to be recognized with the triggered time-base of the oscilloscope, and it was possible to estimate the time intervals between the pulses, the initial heights or amplitudes of the pulses on the oscilloscope. Assuming that the decay of the pulses are exponential, the time constants were also noted.

This experiment was repeated using different wind speeds and measurements were made of the corresponding values of point discharge currents, pulse intervals and amplitudes of pulses etc. Table (8.1) shows some of the results for different speeds and the charge per pulse is calculated from the ratio of the average current and the corresponding frequency.

#### 8.4 Analysis of Results

The frequency of the pulses was calculated from the pulse-interval and so the charge per pulse  $Q_1$  was found from the ratio of the average current as given by the galvanometer and the corresponding frequency of the pulses (Method I).

If we assume that the pulses decay exponentially, we can also find the charge per pulse  $Q_2$ , by integrating the actual current over the time of decay (Method II).

Let 'A' be the initial A.C. amplitude of the current,  $t$  be the pulse-interval and  $\tau$  the time constant. Then

$$Q_2 = \int_0^t A e^{-t/\tau} dt = A\tau(1 - e^{-t/\tau})$$

Table (8.1)

V (KV)	Parameters	e	Wind Speed (M/Sec)				245
			49	98	147	196	
20	Current ( $\mu A$ )	7.45	8.22	8.48	9.00	9.25	10.02
	$Q_2$ ( $\mu\mu C$ )	32.03	41.10	44.10	47.79	46.25	49.09
	A.C. Ampl. Ratio	1.00	1.20	1.26	1.30	1.30	1.40
30	Current ( $\mu A$ )	23.15	23.90	24.64	25.19	25.44	25.70
	$Q_2$ ( $\mu\mu C$ )	32.38	37.10	41.80	44.08	44.52	44.98
	Ampl. Ratio	1.00	1.13	1.23	1.28	1.28	1.28
32.5	Current ( $\mu A$ )	26.73	27.76	28.27	28.78	29.30	29.81
	$Q_2$ ( $\mu\mu C$ )	32.08	37.48	40.99	42.59	41.02	41.73
	Ampl. Ratio	1.00	1.09	1.18	1.24	1.24	1.24
37.5	Current ( $\mu A$ )	42.12	41.89	42.66	43.18	43.69	44.20
	$Q_2$ ( $\mu\mu C$ )	28.78	33.51	36.26	38.00	38.45	38.90
	Ampl. Ratio	1.00	1.23	1.28	1.35	1.35	1.35

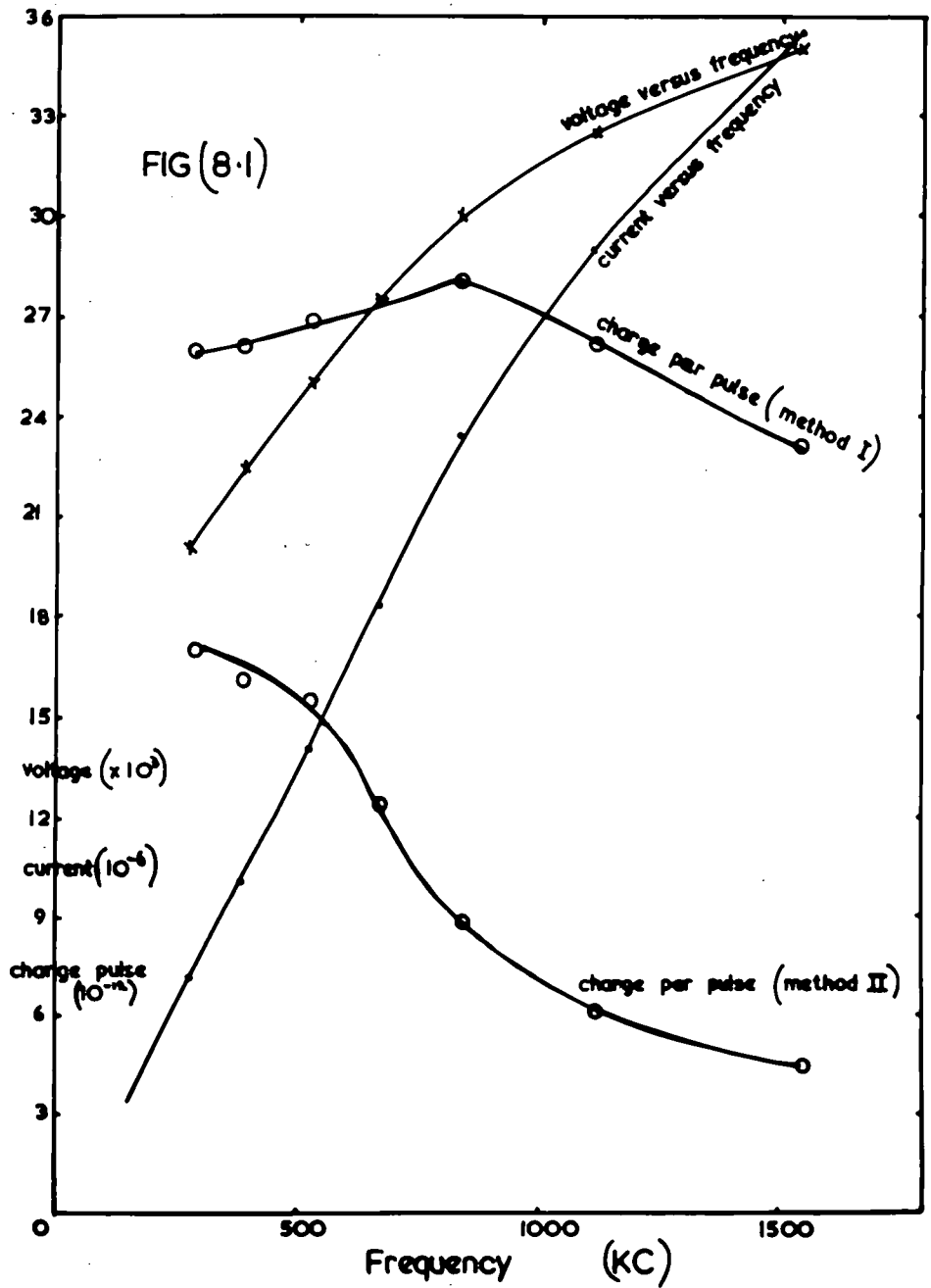
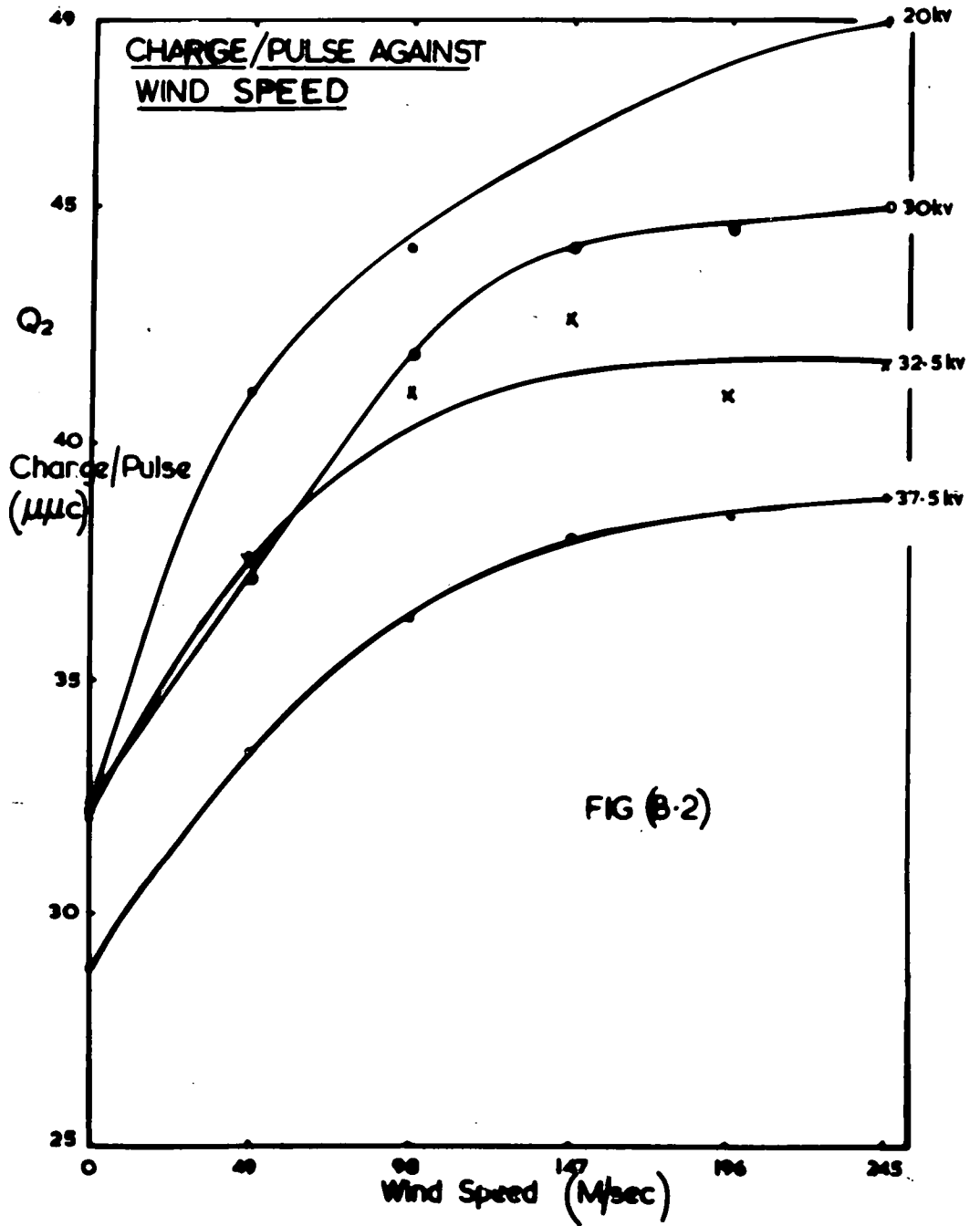

Fig. (8.1) shows the variation of current, voltage and charge per pulse (as evaluated by both the methods) against frequency.

It is quite clear that the frequency of the pulses increases with the increase in current, giving charge per pulse of the order of  $26 \times 10^{-12}$  C and is dependant of the diameter of the discharging point. At very high currents, there is a divergence from this linear law, in the sense that the frequency grows more rapidly than does the current and thus reducing the charge per pulse. This investigation is quite in agreement with the previous workers.

The most interesting thing is that the  $Q_2$  is always less than  $Q_1$ ; the divergence is more at high currents. The reasons are quite obvious, firstly because the point-discharge pulses are not quite exponential and secondly because the point-discharge current is composed of both D.C. and A.C. components, the former is not taken into account when making measurements with the oscilloscope.

Fig. (8.2) shows the variation of  $Q_2$  versus the wind speed for various plate voltages. Since the wind was applied parallel to the direction of the electron current, a very high value was needed to get a noticeable effect. As the wind



speed increases, the amplitude of the pulses increases, the frequency decreases, giving a corresponding increase in charge per pulse. A similar type of plateau occurs at about 147 m/s, as was observed by NYGAARD (1966b).

Incidentally, the ratio of the quantity of charge per pulse with and without wind is fairly close to the ratio of the initial amplitudes, so it follows that the 'shape' of the pulse is unaltered by the wind.

The effect can be understood if one considers the physical mechanism of Trichel pulses. It is generally agreed that (see LOEB (1952)) the negative space-charge (probably  $e^-$  ions) produced in the vicinity of the cathode point will reduce the local electric field to such an extent that the discharge current will be choked. When air is blowing past the cathode, some of the negative ions will be removed, thereby allowing a further growth of the current pulse, a new one can develop only when the negative ions have drifted sufficiently far away from the cathode region. These ions can be drifted away by a comparatively low wind speed when it is blown anti-parallel or perpendicular to the electron current. On the other hand a very high wind speed is needed to blow them parallel to the electron current. NYGAARD (1966b)



suggested that it is probably due to the fact that the region of the negative ion production is very close to and in the wake of the cathode tip and will, therefore, not be affected by small winds. This may be the reason why he could not observe any change in the discharge parameters for low wind speeds.

Another possibility as suggested by CHALMERS (1965) is that the extra supply of air, with its accompanying ions, may help to provide more ions in the pulse. With more charge in the pulse, it must take longer for the charge to clear away, but the wind assists in clearing the charge, so that the increase in the interval between the pulses is not as great as the increase in the charge per pulse.

### 8.5. Conclusion

The quantity of charge per pulse, as calculated by two methods, shows that  $Q_3$  (Method II) is always less than  $Q_1$  (Method I); the divergence is more at high currents. The reasons for this deviation are explained due to the fact that the point discharge pulses are not quite exponential and also the D.C. component of these pulses is neglected while making measurements.

The study of the effect of winds upon the point-discharge current pulses shows that when the wind is applied parallel to the electron current, the quantity of charge per pulse increases, linearly at first and then reaches a saturation stage at about 167 m/sec; a very high wind is needed to get a noticeable effect. The results are closely in agreement with those of NYGAARD, who made measurements with the air flow perpendicular to or anti-parallel to the electron current; he found the same type of plateau at about 10m/sec, very much smaller than the present investigations. The reason for this divergence is explained due to the fact that the region of negative ion production is very much closer to the cathode tip and will be affected only by large winds.

## CHAPTER IX

### Suggestions for Further Work

It may be useful to compare point discharge currents from single and multiple points under natural atmospheric conditions at such places on the earth where point-discharge is common, also to carry out further work with points of varying separation in order to investigate the effects of wind-speed on the point-discharge currents through such arrays.

As it is important, both from considerations of the transfer of charge between clouds and ground and in connection with relations between precipitation currents and point-discharge to be able to determine the true point discharge current density corresponding to the measured point discharge current through a particular point, it is essential to work with trees because they form an important item in the transfer of electricity. So for this purpose it is recommended to use the cube law which has been verified experimentally under controlled conditions and has some theoretical support. Moreover it would be advisable to include the effect of the wind on the current through trees.

It might be interesting to study the Trichel pulses in a tree, grown in an insulated dustbin. If it is confirmed

that the point discharge current occurs in pulses and a convenient method is designed to count them, a tree might act as the primary of a transformer wound on magnetic core round it, the secondary current would then depend upon the changes in the tree current. The pulses might then be amplified, measured and counted, the integration of which should give the total current.

The point discharge ions from a tree produce an effect on the potential gradient at the ground more on the leeward than on the windward side. By comparison of values of potential gradient on either side, it is possible to deduce the point discharge current, knowing the wind speed. (See MAUND and CHALMERS (1960)). An extension of the same to the measurements of space-charge down wind (as suggested by BENT, COLLINS, HUTCHINSON and CHALMERS (1965)) might be a very useful method to measure the total point discharge current down trees. Measurements of this kind can be done on isolated trees of different shapes or a small wood, on a continuing basis and hence to find the world-wide contribution of the total point discharge current.

ACKNOWLEDGEMENTS

The author wishes to express his sincere thanks to his supervisor Professor J.A. Chalmers for his suggestion of this project, for his continual interest and encouragement and for valuable discussions which were a constant source of inspiration.

Thanks are also due to Professor G.D. Rochester for the research facilities accorded, to Physics Department workshop staff, especially Mr. Jack Morales, for their help in constructing the apparatus.

The author owes his warm gratitude to his fellow research students and various members of the teaching staff, especially to Dr. W.C.A. Hutchingsen with whom he always had interesting and valuable discussions.

The author is greatly indebted to various authors whose literature he has freely consulted and to Pauline for typing the thesis.

Finally thanks are due to the United States Navy Office of Naval Research Contract Nr 082 - 199 for maintenance and equipment award from 1964 to 1967.

D.S.J.

March 1967.

REFERENCES

- ✓ BELIN, R.E. 1948. A radio-sonde method for atmospheric potential gradient measurements. Proc.Phys.Soc.Lond.60, pp.381-387.
- ✓ BENT, R.E., COLLIN, E.L., HUTCHINSON, W.C.A. and CHALMERS, J.A. 1965. Space charges produced by point discharge from trees during a thunderstorm. J. Atmosph. Terr.Phys.27, pp.67-72.
- ✓ CHALMERS, J.A. and LITTLE, E.W.R. 1947. Currents of atmospheric electricity. Terr. Magn.Atmos.Elec. 52, pp.239-260.
- ✓ CHALMERS, J.A. 1953. The effective separation of discharging points. J. Atmosph. Terr. Phys. 5, pp. 346-347.
- ✓ CHALMERS, J.A. and MAPLESON, W.W. 1955. Point discharge currents from a captive balloon. J. Atmosph. Terr.Phys.6,pp. 149-159.
- ✓ CHALMERS, J.A. 1957. Point discharge current, potential gradient and wind speed. J. Atmosph. Terr.Phys.II,pp. 301-302.
- ✓ CHALMERS, J.A. 1962a. The relation of point discharge current to potential difference and wind speed. J.Atmosph. Terr. Phys. 24, pp. 339-344.
- ✓ CHALMERS, J.A. 1962b. Point discharge current through a living tree during a thunderstorm. J. Atmosph. Terr. Phys. 24, pp. 1059-1063.
- ✓ CHALMERS, J.A. 1964. The electrical properties of a living tree in relation to point discharge. J.Atmosph.Terr.Phys. 26, pp. 129-134.
- ✓ CHALMERS, J.A. 1965. The effect of wind on point discharge pulses. J. Atmosph. Terr. Phys. 27, pp. 1057-1038.
- ✓ CHAPMAN, S. 1956. Electrostatic field measurements, corona discharge and thunderclouds. Report C.A.L. 68 (Buffalo, N.Y. Cornell Aeronautical Lab.)
- ✓ CHIPLONKAR, M.V. 1940. Measurement of point discharge current during disturbed weather at Colaba. Proc.Indian Acad. Sci.A. 12, pp. 50.
- ✓ DAVIDSON, R.W. 1958. The effect of temperature on the electrical resistance of wood. For. Prod. J. 8, pp.160-164.
- ✓ DAVIS, R. and STANDRING, W.G. 1947. Discharge currents associated with kite balloons. Proc. Roy.Sec.A.191, pp. 304-322.

- ✓ ETHE, A.I.I. 1966a. Anomalous electrical behaviour of a tree (looking in' between metal electrodes. J. Atmosph. Terr. Phys. 28 pp. 285-294.
- ✓ ETHE, A.I.I. 1966b. Measurement of electrode bypassing efficiency in living trees. J. Atmosph. Terr. Phys. 28. pp. 295-302.
- ✓ ETHE, A.I.I. 1966c. Point discharge pulses in multiple-point dischargers. J. Atmosph. Terr. Phys. 28. pp. 799-806.
- ✓ ETHE, A.I.I. 1966d. Estimation of displacement currents in trees during point discharge. J. Atmosph. Terr. Phys. 28. pp. 831-838.
- ✓ ETHE, A.I.I. 1966e. Laboratory studies of point-discharge from multiple points in irregular configuration. J. Atmosph. Terr. Phys. 28. pp. 983-999.
- ✓ ETHE, A.I.I. 1966f. On starting voltages in a two point discharger. J. Atmosph. Terr. Phys. 28. pp. 1001-1009.
- X EVERSLED, S. 1914. The characteristics of insulation resistance. J. Inst. Elect. Eng. 52, pp. 51-83.
- ✓ HUTCHINSON, W.C.A. 1951. Point discharge currents and earth's electric field. Quart. J. R. Met. Soc. 77. pp. 637-652.
- ✓ KIRKMAN, J.R. 1956. Durham Ph.D. thesis.
- ✓ KIRKMAN, J.R. and CHALMERS, J.A. 1957. Point discharge from an isolated point. J. Atmosph. Terr. Phys. 10. pp. 258-265.
- ✓ LARGE, M.I. and PIERCE, E.T. 1955. The fine structure of natural point discharge currents. Quart. J. R. Met. Soc. 81. pp. 92-95.
- ✓ LARGE, M.I. and PIERCE E.T. 1957. The dependence of point discharge currents on wind as examined by a new experimental approach. J. Atmosph. Terr. Phys. 10. pp. 251-257.
- ✓ LOEB, L.B., PARKER, J.H, DODD, E.E. and ENGLISH, W.N. 1950. The choice of suitable gap forms for the study of corona breakdown and field along the axis of a hemispherical capped cylindrical point to plane gap. Rev. Sci. Instr. 21. pp. 42-47.
- ✓ LOEB, L.B. 1952. The mechanism of the Trichel pulses of short time duration in air. Phys. Rev. 86. pp. 256-257.

- ✓ LOEB, L.B. 1965. Electrical coronas: Their basic physical mechanisms, University of California Press, Berkeley.
- ✓ MAUND, J.E. and CHALMERS, J.A. 1960. Point discharge currents from natural and artificial points. *Quart. J.R.Met.Soc.* 86. pp. 85-90.
- ✓ MILNER, J.W. and CHALMERS, J.A. 1961. Point discharge from natural and artificial points (Pt.II). *Quart. J.R.Met.Soc.* 87. pp.592-596.
- ✓ MURPHY, E.J. 1929. Electrical conduction in textiles. *J.Phys.Chem.* 33. pp.509-532.
- ✓ NYGAARD, H.J. 1966a. Frequency of corona discharge Trichel pulses in air flow. *J.Appl.Phys.* 37. pp. 2850-2852.
- ✓ NYGAARD, H.J. 1966b. Current pulses in wind-blown corona dischargers. *J.Atmosph. Terr. Phys.* 28. pp. 1239-1243.
- ✓ PEEK, F.W. 1929. Dielectric Phenomenon in High Voltage Engineering. New York.
- ✓ PIERCE, B.T. NADILE, R.M. and MCKINNON, P.J. 1960. Report from Avco Corporation, Wilmington, Mass. to Air Force Cambridge Research Laboratories, Bedford, Mass. on contract AF 19 (604)-7342.
- ✓ SCHONLAND, B.F.J. 1928. The interchange of electricity between thunderclouds and earth. *Proc.Roy.Soc. A.* 118. pp.252-262.
- ✓ SIMPSON, G.C. 1949. Atmospheric Electricity during disturbed weather. *Geophys.Mem. Lond.* 84 pp.1-51.
- ✓ SIVARAMAKRISHNAN, M.V. 1957. Point discharge currents, the earth's electrical field and rain charges during disturbed weather at Poona, India. *J.Met.Geophys.* 8. pp.379-390.
- ✓ SMITH, L.G. 1951. Dissertation. Rain Electricity. (Cambridge University).
- ✓ TOWNSEND, J.S. 1914. The potentials required to maintain currents between coaxial cylinders. *Phil.Mag.* 28. pp.83/90.
- ✓ Trichel, G.W. 1938. The mechanism of the negative point to plane corona near onset. *Phys.Rev.* 54. pp.1078-1084.
- ✓ WHIPPLE, F.J.W. and SCRASE, F.J. 1936. Point discharge in the electric field of the earth. *Geophys.Lond.Mem.* 68. pp.1-20.



- ✓ WILSON, C.T.R. 1920. Investigations on lightning discharges and on the electric field of thunderstorms. Phil. Trans. A. 221. pp. 73-115.
- ✓ WOOLF, B. 1951. U.R.S.S. Series B. Volume XIII No.1. pp.100-119.
- ✓ WORMELL, T.W. 1927. Currents carried by point discharge beneath thunderclouds and showers. Proc. Roy. Soc. A. 115. pp.443-455.
- ✓ YRIBERRY, A.J. 1954. Registro del campo electrostatic tormentoso en San Miguel (Argentina) y en Kew (Inglaterra). Acta. Scient. San Miguel Obs. de Fis. Cos. No.2.

