

Geometry & Topology Monographs
Volume 7: Proceedings of the Casson Fest
Pages 27–68

Seifert Klein bottles for knots with common boundary slopes

LUIS G VALDEZ-SÁNCHEZ

Abstract We consider the question of how many essential Seifert Klein bottles with common boundary slope a knot in S^3 can bound, up to ambient isotopy. We prove that any hyperbolic knot in S^3 bounds at most six Seifert Klein bottles with a given boundary slope. The Seifert Klein bottles in a minimal projection of hyperbolic pretzel knots of length 3 are shown to be unique and π_1 -injective, with surgery along their boundary slope producing irreducible toroidal manifolds. The cable knots which bound essential Seifert Klein bottles are classified; their Seifert Klein bottles are shown to be non- π_1 -injective, and unique in the case of torus knots. For satellite knots we show that, in general, there is no upper bound for the number of distinct Seifert Klein bottles a knot can bound.

AMS Classification 57M25; 57N10

Keywords Seifert Klein bottles, knot complements, boundary slope

Dedicated to Andrew J Casson on the occasion of his 60th birthday

1 Introduction

For any knot in S^3 all orientable Seifert surfaces spanned by the knot have the same boundary slope. The smallest genus of such a surface is called the *genus* of the knot, and such a minimal surface is always essential in the knot exterior. Moreover, by a result of Schubert–Soltsien [21], any simple knot admits finitely many distinct minimal genus Seifert surfaces, up to ambient isotopy, while for satellite knots infinitely many isotopy classes may exist (cf [7, 14]).

The smallest genus of the nonorientable Seifert surfaces spanned by a knot is the *crosscap number* of the knot (cf [4]). Unlike their orientable counterparts, nonorientable minimal Seifert surfaces need not have a unique boundary slope. In fact, by [13], any knot $K \subset S^3$ has at most two boundary slopes r_1, r_2 corresponding to *essential* (incompressible and boundary incompressible, in the

geometric sense) Seifert Klein bottles, and if so then $\Delta(r_1, r_2) = 4$ or 8 , the latter distance occurring only when K is the figure-8 knot. The knots for which two such slopes exist were classified in [19] and, with the exception of the $(2, 1, 1)$ and $(-2, 3, 7)$ pretzel knots (the figure-8 knot and the Fintushel-Stern knot, respectively), all are certain satellites of 2-cable knots. Also, a minimal crosscap number Seifert surface for a knot need not even be essential in the knot exterior (cf [13]).

In this paper we study the uniqueness or non-uniqueness, up to ambient isotopy, of essential Seifert Klein bottles for a knot with a fixed boundary slope; we will regard any two such surfaces as *equivalent* iff they are ambient isotopic. Our main result states that any crosscap number two hyperbolic knot admits at most 6 nonequivalent Seifert Klein bottles with a given slope; before stating our results in full we will need some definitions.

We work in the PL category; all 3-manifolds are assumed to be compact and orientable. We refer to ambient isotopies simply as isotopies. Let M^3 be a 3-manifold with boundary. The pair $(M^3, \partial M^3)$ is *irreducible* if M^3 is irreducible and ∂M^3 is incompressible in M^3 . Any embedded circle in a once punctured Klein bottle is either a *meridian* (orientation preserving and nonseparating), a *longitude* (orientation preserving and separating), or a *center* (orientation reversing); any two meridians are isotopic within the surface, but there are infinitely many isotopy classes of longitudes and centers (cf Lemma 3.1). For a knot K in S^3 with exterior $X_K = S^3 \setminus \text{int } N(K)$ and a nontrivial slope r in ∂X_K , $K(r) = X_K(r)$ denotes the manifold obtained by Dehn-filling X_K along r , that is, the result of *surgering* K along r . We denote by $\mathcal{SK}(K, r)$ the collection of equivalence classes of essential Seifert Klein bottles in X_K with boundary slope r ; as pointed out above, $\mathcal{SK}(K, r)$ is nonempty for at most two distinct integral slopes r_1, r_2 . If $|\mathcal{SK}(K, r)| \geq 2$, we will say that the collection $\mathcal{SK}(K, r)$ is *meridional* if any two distinct elements can be isotoped so as to intersect transversely in a common meridian, and that it is *central* if there is a link $c_1 \cup c_2$ in X_K such that any two distinct elements of $\mathcal{SK}(K, r)$ can be isotoped so as to intersect transversely in $c_1 \cup c_2$, and c_1, c_2 are disjoint centers in each element. For $P \in \mathcal{SK}(K, r)$, $N(P)$ denotes a small regular neighborhood of P , and $H(P) = X_K \setminus \text{int } N(P)$ denotes the *exterior* of P in X_K . We say P is *unknotted* if $H(P)$ is a handlebody, and *knotted* otherwise; if the pair $(H(P), \partial H(P))$ is irreducible, we say P is *strongly knotted*. If μ, λ is a standard meridian-longitude pair for a knot L , and K is a circle embedded in ∂X_L representing $p\mu + q\lambda$ for some relatively prime integers p, q with $|q| \geq 2$, we say K is a (p, q) *cable of* L ; we also call K a q -*cable knot*, or simply a *cable knot*. In particular, the torus knot $T(p, q)$ is the (p, q) -cable of the trivial knot.

If X is a finite set or a topological space, $|X|$ denotes its number of elements or of connected components.

Theorem 1.1 *Let K be a hyperbolic knot in S^3 and r a slope in ∂X_K for which $\mathcal{SK}(K, r)$ is nonempty. Then any element of $\mathcal{SK}(K, r)$ is either unknotted or strongly knotted, and*

- (a) *if $|\mathcal{SK}(K, r)| \geq 2$ then $\mathcal{SK}(K, r)$ is either central or meridional; in the first case the link $c_1 \cup c_2$ is unique up to isotopy in X_K and $|\mathcal{SK}(K, r)| \leq 3$, in the latter case $|\mathcal{SK}(K, r)| \leq 6$;*
- (b) *if $\mathcal{SK}(K, r)$ is central then each of its elements is strongly knotted; if some element of $\mathcal{SK}(K, r)$ is unknotted then $|\mathcal{SK}(K, r)| \leq 2$, and $\mathcal{SK}(K, r)$ is meridional if $|\mathcal{SK}(K, r)| = 2$;*
- (c) *if some element of $\mathcal{SK}(K, r)$ is not π_1 -injective then it is unknotted, K has tunnel number one, and $K(r)$ is a Seifert fibered space over S^2 with at most 3 singular fibers of indices $2, 2, n$ and finite fundamental group;*
- (d) *if some element of $\mathcal{SK}(K, r)$ is π_1 -injective and unknotted then $K(r)$ is irreducible and toroidal.*

Corollary 1.2 *Let $K \subset S^3$ be a hyperbolic knot and P an unknotted element of $\mathcal{SK}(K, r)$. Then $\pi_1(K(r))$ is finite iff P is not π_1 -injective. In particular, if $r = 0$, then P is π_1 -injective. \square*

In the case when $\mathcal{SK}(K, r)$ is meridional and contains an unknotted element we give examples in Section 6.1 realizing the bound $|\mathcal{SK}(K, r)| = 2$ for K a hyperbolic knot. Such examples are obtained from direct variations on the knots constructed by Lyon in [16]; M. Teragaito (personal communication) has constructed more examples along similar lines. It is not known if the other bounds given in Theorem 1.1 are optimal, but see the remark after Lemma 6.8 for a discussion on possible ways of realizing the bound $|\mathcal{SK}(K, r)| = 4$, and Section 6.2 for a construction of possible examples of central families $\mathcal{SK}(K, r)$ with $|\mathcal{SK}(K, r)| = 2$. On the other hand, hyperbolic knots which span a unique Seifert Klein bottle per slope are not hard to find: if we call *algorithmic* any black or white surface obtained from some regular projection of a knot, then the algorithmic Seifert Klein bottles in minimal projections of hyperbolic pretzel knots provide the simplest examples.

Theorem 1.3 *Let $K \subset S^3$ be a hyperbolic pretzel knot, and let P be any algorithmic Seifert Klein bottle in a minimal projection of K . Then P is unknotted, π_1 -injective, and unique up to equivalence; moreover, $K(\partial P)$ is irreducible and toroidal.*

We remark that any crosscap number two 2-bridge knot is a hyperbolic pretzel knot. Also, as mentioned before, the only hyperbolic knots which bound Seifert Klein bottles of distinct boundary slope are the $(2, 1, 1)$ and $(-2, 3, 7)$ pretzel knots. The standard projection of the $(2, 1, 1)$ pretzel knot simultaneously realizes two algorithmic Seifert Klein bottles of distinct slopes (in fact, this is the only nontrivial knot in S^3 with such property), so they are handled by Theorem 1.3. The $(-2, 3, 7)$ pretzel knot has both an algorithmic and a non algorithmic Seifert Klein bottle; it can be proved that the non algorithmic surface also satisfies the conclusion of Theorem 1.3, but we omit the details.

In contrast, no universal bound for $|\mathcal{SK}(K, r)|$ exists for satellite knots:

Theorem 1.4 *For any positive integer N , there are satellite knots $K \subset S^3$ with $|\mathcal{SK}(K, 0)| \geq N$.*

Among non hyperbolic knots, the families of cable or composite knots are of particular interest; we classify the crosscap number two cable knots, and find information about the Seifert Klein bottles bounded by composite knots.

Theorem 1.5 *Let K be a knot in S^3 whose exterior contains an essential annulus and an essential Seifert Klein bottle. Then either*

- (a) K is a $(2(2m + 1)n \pm 1, 4n)$ -cable for some integers m, n , $n \neq 0$,
- (b) K is a $(2(2m + 1)(2n + 1) \pm 2, 2n + 1)$ -cable of a $(2m + 1, 2)$ -cable knot for some integers m, n ,
- (c) K is a $(6(2n + 1) \pm 1, 3)$ -cable of some $(2n + 1, 2)$ -cable knot for some integer n , or
- (d) K is a connected sum of two 2-cable knots.

Any Seifert Klein bottle bounded by any composite knot is π_1 -injective, while the opposite holds for any cable knot; in case (a), such a surface is unique up to equivalence.

The next result follows from the proof of Theorem 1.5:

Corollary 1.6 *The crosscap number two torus knots are $T(\pm 5, 3)$, $T(\pm 7, 3)$, and $T(2(2m + 1)n \pm 1, 4n)$ for some m, n , $n \neq 0$; each bounds a unique Seifert Klein bottle, which is unknotted and not π_1 -injective.*

The crosscap numbers of torus knots have been determined in [23]; our classification of these knots follows from Theorem 1.5, whose proof gives detailed topological information about the construction of Seifert Klein bottles for cable knots in general. The classification of crosscap number two composite knots also follows from [22] (where many-punctured Klein bottles are considered); these knots serve as examples of satellite knots any of whose Seifert Klein bottles is π_1 -injective. The Seifert Klein bottles for the knots in Theorem 1.5(a),(b) are disjoint from the cabling annulus, and in (b) one expects the number of Seifert Klein bottles bounded by the knot to depend on the nature of its companions, as in [15, Corollary D]; in (c),(d) the Seifert Klein bottles intersect the cabling or splitting annulus, so in (d) one would expect there to be infinitely nonequivalent Seifert Klein bottles bounded by such knots, as in [7].

The paper is organized as follows. Section 2 collects a few more definitions and some general properties of Seifert Klein bottles. In Section 3 we look at a certain family of crosscap number two satellite knots which bound Seifert Klein bottles with zero boundary slope, and use it to prove Theorem 1.4. In Section 4 we first identify the minimal intersection between an essential annulus and an essential Seifert Klein bottle in a knot exterior, which is the starting point of the proof of Theorem 1.5 and its corollary. Section 5 contains some results on non boundary parallel separating annuli and pairs of pants contained in 3-manifolds with boundary, from both algebraic and geometric points of view. These results have direct applications to the case of unknotted Seifert Klein bottles, but we will see in Lemma 6.3 that if K is any hyperbolic knot and $P, Q \in \mathcal{SK}(K, r)$ are any two distinct elements, then Q splits the exterior $H(P)$ of P into two pieces, at least one of which is a genus two handlebody; this observation eventually leads to the proof of Theorem 1.1 in Section 6. After these developments, a proof of Theorem 1.3 is given within a mostly algebraic setting in Section 7.

Acknowledgements

I want to thank Francisco González-Acuña, Enrique Ramírez-Losada and Víctor Núñez for many useful conversations, and Masakazu Teragaito and the Hiroshima University Department of Mathematics for their hospitality while visiting them in the Spring of 2003, when part of this work was completed. Finally, I would like to thank the referee for his many useful suggestions and corrections to the original text.

2 Preliminaries

In this section we set some more notation we will use in the sequel, and establish some general properties of essential Seifert Klein bottles. Let M^3 be a 3-manifold with boundary. For any surface F properly embedded in M^3 and c the union of some components of ∂F , \widehat{F} denotes the surface in $M^3(c) = M^3 \cup \{2\text{-handles along } c\}$ obtained by capping off the circles of ∂F isotopic to c in ∂M^3 suitably with disjoint disks in $M^3(c)$. If G is a second surface properly embedded in M^3 which intersects F transversely with $\partial F \cap \partial G = \emptyset$, let $N(F \cap G)$ be a small regular neighborhood of $F \cap G$ in M^3 , and let \mathcal{A} be the collection of annuli obtained as the closures of the components of $\partial N(F \cap G) \setminus (F \cup G)$. We use the notation $F \asymp G$ to represent the surface obtained by capping off the boundary components in $\text{int } M^3$ of $F \cup G \setminus \text{int } N(F \cap G)$ with suitable annuli from \mathcal{A} . As usual, $\Delta(\alpha, \beta)$ denotes the minimal geometric intersection number between circles of slopes α, β embedded in a torus.

Now let P be a Seifert Klein bottle for a knot $K \subset S^3$, and let $N(P)$ be a small regular neighborhood of P in X_K ; $N(P)$ is an I -bundle over P , topologically a genus two handlebody. Let $H(P) = X_K \setminus \text{int } N(P)$ be the exterior of P in X_K . Let A_K, A'_K denote the annuli $N(P) \cap \partial X_K, H(P) \cap \partial X_K$, respectively, so that $A_K \cup A'_K = \partial X_K$ and $A_K \cap A'_K = \partial A_K = \partial A'_K$. Then ∂P is a core of A_K , and we denote the core of A'_K by K' . Finally, let T_P denote the frontier of $N(P)$ in X_K . T_P is a twice-punctured torus such that $N(P) \cap H(P) = T_P$; since $N(P)$ is an I -bundle over P , P is π_1 -injective in $N(P)$ and T_P is incompressible in $N(P)$.

For any meridian circle m of P , there is an annulus $A(m)$ properly embedded in $N(P)$ with $P \cap A(m) = m$ and $\partial A(m) \subset T_P$; we call the circles $\partial A(m) = m_1 \cup m_2$ the *lifts of m (to T_P)*. Similarly, for any center circle c of P , there is a Moebius band $B(c)$ properly embedded in $N(P)$ with $P \cap B(c) = c$ and $\partial B(c) \subset T_P$; we call $l = \partial B(c)$ the *lift of c (to T_P)*. For a pair of disjoint centers in P , similar disjoint Moebius bands can be found in $N(P)$. Since the meridian of P is unique up to isotopy, the lifts of a meridian of P are also unique up to isotopy in T_P ; the lift of a center circle of P depends only on the isotopy class of the center circle in P .

We denote the linking form in S^3 by $\ell k(\cdot, \cdot)$.

Lemma 2.1 *Let P be a Seifert Klein bottle for a knot $K \subset S^3$. If m is the meridian circle of P , then the boundary slope of P is $\pm 2 \ell k(K, m)$.*

Proof For m a meridian circle of P let P' be the pair of pants $P \setminus \text{int } N(m)$ and A' the annulus $P \cap N(m)$, where N is a small regular neighborhood of m in X_K ; thus $P = P' \cup A'$, and $\partial P' = \partial P \cup \partial A'$. Fixing an orientation of P' induces an orientation on $\partial P'$ such that the circles $\partial A'$ become coherently oriented in A' . In this way an orientation on m is induced, coherent with that of $\partial A'$, such that $\ell k(K, m_1) = \ell k(K, m_2) = \ell k(K, m)$. As the slope of ∂P is integral, hence equal to $\pm \ell k(K, \partial P)$, and $\ell k(K, m_1 \cup m_2 \cup \partial P) = 0$, the lemma follows. \square

Lemma 2.2 *If $P \in \mathcal{SK}(K, r)$ then \widehat{P} is incompressible in $K(r)$.*

Proof If \widehat{P} compresses in $K(r)$ along a circle γ then γ must be orientation-preserving in \widehat{P} . Thus, surgering \widehat{P} along a compression disk D with $\partial D = \gamma$ produces either a nonseparating 2-sphere (if γ is a meridian) or two disjoint projective planes (if γ is a longitude) in $K(r)$, neither of which is possible as K satisfies Property R [8] and $K(r)$ has cyclic integral homology. \square

Lemma 2.3 *Let m be a meridian circle and c_1, c_2 be two disjoint center circles of P ; let m_1, m_2 and l_1, l_2 be the lifts of m and c_1, c_2 , respectively. Then,*

- (a) *neither circle K', l_1, l_2 bounds a surface in $H(P)$,*
- (b) *neither pair m_1, m_2 nor l_1, l_2 cobound a surface in $H(P)$,*
- (c) *none of the circles m_i, l_i cobounds an annulus in $H(P)$ with K' , and*
- (d) *if A is an annulus in $H(P)$ with $\partial A = \partial A'_K$, then A is not parallel in X_K into A_K .*

Proof Let B_i be a Moebius band in $N(P)$ bounded by l_i . If K' or l_i bounds a surface F in $H(P)$ then out of the surfaces P, B_i, F it is possible to construct a nonorientable closed surface in S^3 , which is impossible; thus (a) holds.

Consider the circles K', α_1, α_2 in $\partial H(P)$, where $\alpha_1, \alpha_2 = m_1, m_2$ or l_1, l_2 ; such circles are mutually disjoint. Let P_1 be the closure of some component of $\partial H(P) \setminus (K' \cup \alpha_1 \cup \alpha_2)$; P_1 is a pair of pants. If α_1, α_2 cobound a surface F properly embedded in $H(P)$ then $F \cup_{\alpha_1 \cup \alpha_2} P_1$ is a surface in $H(P)$ bounded by K' , which can not be the case by (a). Hence α_1, α_2 do not cobound a surface in $H(P)$ and so (b) holds.

If any circle m_1, m_2, l_1, l_2 cobounds an annulus in $H(P)$ with K' then \widehat{P} compresses in $K(\partial P)$, which is not the case by Lemma 2.2; thus (c) holds.

Finally, if $A \subset H(P)$ is parallel to A_K then the region V cobounded by $A \cup A_K$ is a solid torus with $P \subset V$ and ∂P a core of A_K , hence $V(\partial P) = S^3$ contains the closed Klein bottle \widehat{P} , which is impossible. This proves (d). \square

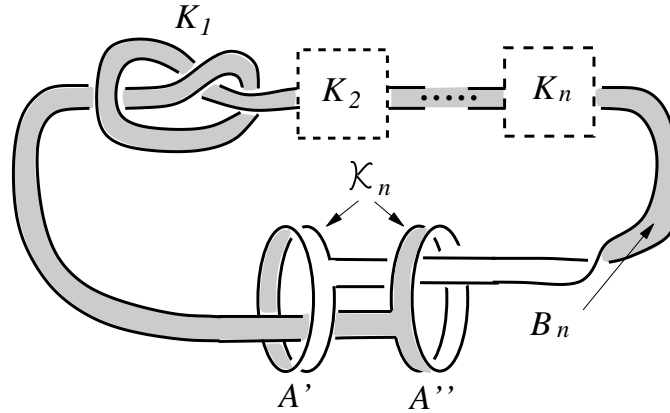

Figure 1: The pair of pants $F_n = A' \cup B_n \cup A''$ and the knot $\mathcal{K}_n \subset \partial F_n$

The next result follows from [10, Theorem 1.3] and [19, Lemma 4.2]:

Lemma 2.4 *Let K be a nontrivial knot in S^3 . If P is a once-punctured Klein bottle properly embedded in X_K then P is essential iff K is not a 2-cable knot, and in such case P has integral boundary slope. \square*

3 The size of $\mathcal{SK}(K, 0)$

In this section we consider a special family of crosscap number two satellite knots $\{\mathcal{K}_n\}$, which generalizes the example of W.R. Alford in [1]; the knots in this family are constructed as follows. For each $i \geq 1$ let K_i be a nontrivial *prime* knot in S^3 . Figure 1 shows a pair of pants F_n , $n \geq 2$, with only one shaded side, constructed with a band B_n whose core ‘follows the pattern’ of $K_1 \# K_2 \# \cdots \# K_n$, and which is attached to two disjoint, unknotted, and untwisted annuli A', A'' ; we define the knot \mathcal{K}_n to be the boundary component of F_n indicated in the same figure.

For each $1 \leq s < n$, let P_s be the Seifert Klein bottle bounded by \mathcal{K}_n constructed by attaching an annulus A_s to the two boundary circles of F_n other than \mathcal{K}_n , which *swallows* the factors K_1, \dots, K_s and *follows* the factors K_{s+1}, \dots, K_n , as indicated in Figure 2.

Notice that the core of A_s , which has linking number zero with \mathcal{K}_n , is a meridian circle of P_s , so the boundary slope of P_s is zero by Lemma 2.1. Our goal is to show that P_r and P_s are not equivalent for $r \neq s$, so that $|\mathcal{SK}(\mathcal{K}_n, 0)| \geq n - 1$,

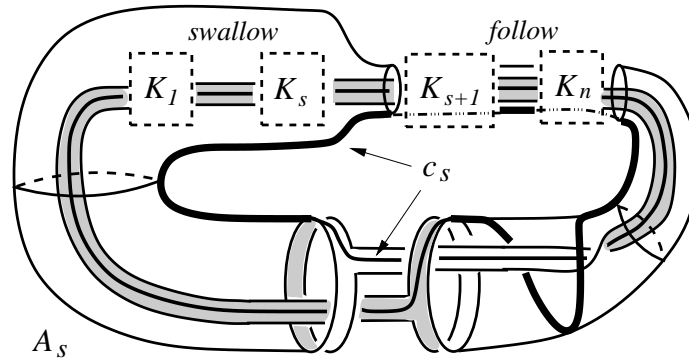

Figure 2: The Seifert Klein bottle $P_s = F_n \cup A_s$ and center $c_s \subset P_s$

which will prove Theorem 1.4. In fact, we will prove the stronger statement that P_r and P_s are not equivalent for $r \neq s$ even under homeomorphisms of S^3 .

The following elementary result on intersection properties between essential circles in a once-punctured Klein bottle will be useful in determining all centers of any of the above Seifert Klein bottles of \mathcal{K}_n ; we include its proof for the convenience of the reader.

Lemma 3.1 *Let $P = A \cup B$ be a once-punctured Klein bottle, where A is an annulus and B is a rectangle with $A \cap B = \partial A \cap \partial B$ consisting of two opposite edges of ∂B , one in each component of ∂A . Let m be a core of A (ie a meridian of P) and b a core arc in B parallel to $A \cap B$. If ω is any nontrivial circle embedded in P and not parallel to ∂P which has been isotoped so as to intersect $m \cup b$ transversely and minimally, then ω is a meridian, center, or longitude circle of P iff $(|\omega \cap m|, |\omega \cap b|) = (0, 0), (1, 1),$ or $(2, 2)$, respectively.*

Proof Let I_1, I_2 denote the components of $A \cap B = \partial A \cap \partial B$. After isotoping ω so as to intersect $m \cup b$ transversely and minimally, either ω lies in $\text{int } A$ and is parallel to m , or $\omega \cap B$ consists of disjoint spanning arcs of B with endpoints in $I_1 \cup I_2$, while $\omega \cap A$ consists of disjoint arcs which may split into at most 4 parallelism classes, denoted $\alpha, \beta, \gamma, \delta$; the situation is represented in Figure 3.

Suppose we are in the latter case. As ω is connected and necessarily $|\alpha| = |\delta|$, if $|\alpha| > 0$ then $\omega \cap A$ must consist of one arc of type α and one arc of type δ ; but then ω is parallel to ∂P , which is not the case. Thus we must have $|\alpha| = |\delta| = 0$, in which case $|\beta| + |\gamma| = |\omega \cap b| = n$ for some integer $n \geq 1$. Notice that ω is a center if $n = 1$ and a longitude if $n = 2$; in the first case

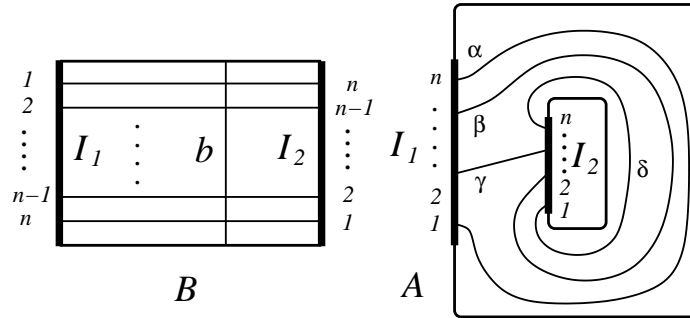

Figure 3: The arcs $\omega \cap B \subset B$ and $\omega \cap A \subset A$

$\{|\beta|, |\gamma|\} = \{0, 1\}$, while in the latter $\{|\beta|, |\gamma|\} = \{0, 2\}$. These are the only possible options for ω and n whenever $|\beta| = 0$ or $|\gamma| = 0$.

Assume that $|\beta|, |\gamma| \geq 1$, so $n \geq 3$, and label the endpoints of the arcs $\omega \cap A$ and $\omega \cap B$ in I_1, I_2 consecutively with $1, 2, \dots, n$, as in Figure 3. We assume, as we may, that $|\beta| \leq |\gamma|$. We start traversing ω from the point labelled 1 in $I_1 \subset \partial B$ in the direction of $I_2 \subset \partial B$, within B , then reach the endpoint of an arc component of $\omega \cap A$ in $I_2 \subset \partial A$, then continue within A to an endpoint in $I_1 \subset \partial A$, and so on until traversing all of ω . The arc components of $\omega \cap B$ and $\omega \cap A$ traversed in this way give rise to permutations σ, τ of $1, 2, \dots, n$, respectively, given by $\sigma(x) = n - x + 1$ for $1 \leq x \leq n$, and $\tau(x) = n + x - |\beta|$ for $1 \leq x \leq |\beta|$, $\tau(x) = x - |\beta|$ for $|\beta| < x \leq n$.

Clearly, the number of components of ω equals the number of orbits of the permutation $\tau \circ \sigma$. But, since $|\beta| \leq |\gamma|$, the orbit of $\tau \circ \sigma$ generated by 1 consists only of the numbers 1 and $n - |\beta|$; as ω is connected, we must then have $n \leq 2$, which is not the case. Therefore, the only possibilities for the pair $(|\omega \cap m|, |\omega \cap b|)$ are the ones listed in the lemma. \square

For a knot $L \subset S^3$, we will use the notation $C_2(L)$ to generically denote any 2-cable of L ; observe that any nontrivial cable knot is prime.

Lemma 3.2 For $1 \leq s < n$, any center of P_s is a knot of type

$$K_1 \# \dots \# K_s \# C_2(K_{s+1} \# \dots \# K_n).$$

Proof By Lemma 3.1, any center $c_s \subset P_s$ can be constructed as the union of two arcs: one that runs along the band B_n and the other any spanning arc of A_s . Since the annulus ‘swallows’ the factor $K_1 \# \dots \# K_s$ and ‘follows’

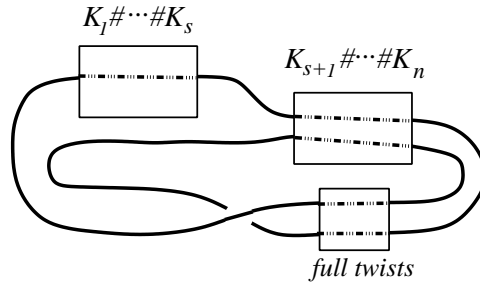

Figure 4: The knot $c_s \subset S^3$

$K_{s+1} \# \dots \# K_n$, any such center circle c_s (shown in Figure 2) isotopes into a knot of the type represented in Figure 4, which has the given form. \square

Lemma 3.3 For $1 \leq r < s < n$, there is no homeomorphism $f: S^3 \rightarrow S^3$ which maps P_r onto P_s .

Proof Suppose there is a homeomorphism $f: S^3 \rightarrow S^3$ with $f(P_r) = P_s$; then for any center c_r of P_r , $c_s = f(c_r)$ is a center of P_s . But then c_r and c_s have the same knot type in S^3 , which by Lemma 3.2 can not be the case since c_r has $r + 1$ prime factors while c_s has $s + 1$ prime factors. \square

Proof of Theorem 1.4 By Lemma 3.3, the Seifert Klein bottles P_r and P_s for \mathcal{K}_n are not equivalent for $1 \leq r < s < n$, hence $|\mathcal{SK}(\mathcal{K}_n, 0)| \geq n - 1$ and the theorem follows. \square

4 Cable and composite knots

In this section we assume that K is a nontrivial knot in S^3 whose exterior X_K contains an essential annulus A and an essential Seifert Klein bottle P ; that is, K is a crosscap number two cable or composite knot. We assume that A and P have been isotoped so as to intersect transversely with $|A \cap P|$ minimal, and denote by $G_A = A \cap P \subset A$ and $G_P = A \cap P \subset P$ their graphs of intersection. We classify these graphs in the next lemma; the case when A has meridional boundary slope is treated in full generality in [7, Lemma 7.1].

Lemma 4.1 Either $A \cap P = \emptyset$ or $\Delta(\partial A, \partial P) = 1$ and $A \cap P$ consists of a single arc which is spanning in A and separates P into two Moebius bands.

Proof Suppose first that $\Delta(\partial A, \partial P) = 0$, so that $\partial A \cap \partial P = \emptyset$; in particular, the boundary slopes of A and P are integral and K is a cable knot with cabling annulus A . If $A \cap P \neq \emptyset$ then $A \cap P$ consists of nontrivial orientation preserving circles in A and P . If any such circle $\gamma \subset A \cap P$ is parallel to ∂P in P , we may assume it cobounds an annulus A_γ with ∂P in P such that $A \cap \text{int } A_\gamma = \emptyset$, so, by minimality of $|A \cap P|$, A_γ must be an essential annulus in the closure V of the component of $X_K \setminus A$ containing it; as K is a cable knot, V must be the exterior of some nontrivial knot of whom K is a q -cable for some $q \geq 2$. But then the boundary slope of A_γ in V is of the form a/q , that is, nonintegral nor ∞ , contradicting the fact that A_γ is essential. Hence no component of $A \cap P$ is parallel to ∂P in P and so \widehat{P} compresses in $K(\partial P)$ along a subdisk of \widehat{A} , which is not possible by Lemma 2.2. Therefore A and P are disjoint in this case.

Suppose now that $\Delta(\partial A, \partial P) \neq 0$; by minimality of $|A \cap P|$, $A \cap P$ consists only of arcs which are essential in both A and P . If α is one such arc then, as α is a spanning arc of A , $|\partial P| = 1$, and X_K is orientable, it is not hard to see that α must be a *positive* arc in P , in the sense of [13] (this fact does not follow directly from the parity rule in [13] since $|\partial A| \neq 1$, but its proof is equally direct). Thus all the arcs of G_P are positive in P .

Suppose a, b are arcs of G_P which are parallel and adjacent in P , and let R be the closure of the disk component of $P \setminus (a \cup b)$. Then R lies in the closure of some component of $X_K \setminus A$ and, by minimality of $|A \cap P|$, the algebraic intersection number $\partial R \cdot \text{core}(A)$ must be ± 2 . But then K must be a 2-cable knot, with cabling annulus A , contradicting Lemma 2.4 since P is essential. Therefore no two arcs of G_P are parallel.

Since any two disjoint positive arcs in P are mutually parallel, and A separates X_K , the above arguments show that G_P consists of exactly one essential arc which is separating in P . The lemma follows. \square

Proof of Theorem 1.5 By Lemma 4.1, $A \cap P = \emptyset$ or $|A \cap P| = 1$. Throughout the proof, none of the knots considered will be a 2-cable, hence any Seifert Klein bottle constructed for them will be essential by Lemma 2.4. Let V, W be the closures of the components of $X_K \setminus A$.

Case 1 $A \cap P = \emptyset$

Here K must be a cable knot: for the slope of ∂A must be integral or ∞ , the latter case being impossible since otherwise \widehat{P} is a closed Klein bottle in

$K(\infty) = S^3$. Hence ∂V and ∂W are parallel tori in S^3 , and we may regard them as identical for framing purposes. We will assume $P \subset V$.

Suppose that V is a solid torus; then P is not π_1 -injective in X_K . Let μ, λ be a standard meridian-longitude pair for ∂V , framed as the boundary of the exterior of a core of V in S^3 . Since V is a solid torus and P is essential in X_K , P must boundary compress in V to some Moebius band B in V with $\Delta(\partial P, \partial B) = 2$. Suppose the slope of ∂P in V is $p\mu + q\lambda$; as the slope of ∂B is of the form $(2m+1)\mu + 2\lambda$ for some integer m , we must have $(2m+1)q - 2p = \pm 2$, hence $q \equiv 0 \pmod{4}$ and p is odd. Therefore, the slope of ∂P (and hence that of ∂A) must be of the form $(2(2m+1)n \pm 1)\mu + 4n\lambda$ for some $n \neq 0$. Conversely, it is not hard to see that any such slope bounds an incompressible once-punctured Klein bottle in V , which is easily seen to be unique up to equivalence. Therefore, K is a $(2(2m+1)n \pm 1, 4n)$ cable of the core of V for some integers m, n , $n \neq 0$, and (a) holds.

If V is not a solid torus then W is a solid torus and, since ∂V and ∂W are parallel in S^3 , we can frame ∂V as the boundary of the exterior of a core of W in S^3 via a standard meridian-longitude pair μ, λ . Then a core of A has slope $p\mu + q\lambda$ in ∂V with $|q| \geq 2$, so P has nonintegral boundary slope in V and hence must boundary compress in V by Lemmas 2.2 and 2.4 to an essential Moebius band B in V with $\Delta(\partial P, \partial B) = 2$; in particular, P is not π_1 -injective in V , hence neither in X_K . The slope of ∂B in ∂V must be of the form $2(2m+1)\mu + \lambda$ for some integer m , and so the slope of ∂P in ∂V is of the form $(2(2m+1)(2n+1) \pm 2)\mu + (2n+1)\lambda$ for some integer n . It follows that K is a $(2(2m+1)(2n+1) \pm 2, 2n+1)$ cable of some $(2m+1, 2)$ cable knot for some integers m, n , and (b) holds.

Case 2 $|A \cap P| = 1$

By Lemma 4.1, $B_1 = P \cap V$ and $B_2 = P \cap W$ are Moebius bands whose boundaries intersect A in a single spanning arc.

If the slope of ∂A in X_K is ∞ then $K = K_1 \# K_2$ for some nontrivial knots K_1, K_2 with $V = X_{K_1}$ and $W = X_{K_2}$. Moreover, as $B_i \subset X_{K_i}$, the K_i 's are 2-cable knots and (d) holds.

Suppose now that ∂A has integral slope in X_K ; then at least one of V, W , say V , is a solid torus. As in Case 1, we may regard ∂V and ∂W as identical tori for framing purposes. If, say, W is not a solid torus, frame ∂V and ∂W via a standard meridian-longitude pair μ, λ as the boundary of the exterior of a core of V in S^3 . Then ∂A has slope $p\mu + q\lambda$ for some integers p, q with $|q| \geq 2$ in

V and W . Also, ∂B_1 has slope $r\mu + 2\lambda$ in V while ∂B_2 has slope $2s\mu + \lambda$ in W , for some odd integers r, s . As $\Delta(\partial A, \partial B_i) = 1$ for $i = 1, 2$, we must have $2p - rq = \varepsilon$ and $p - 2sq = \delta$ for some $\varepsilon, \delta = \pm 1$. Hence $p = 2sq + \delta$ and so $2(2sq + \delta) - rq = \varepsilon$, that is, $|(4s - r)q| = |\varepsilon - 2\delta| = 1$ or 3 . As $|q| \geq 2$, it follows that $|q| = 3$, hence $p = 6s \pm 1$. Therefore, K is a $(6s \pm 1, 3)$ cable of a $(s, 2)$ cable knot for some odd integer s , and (c) holds.

The situation is somewhat different if both V and W are solid tori. Here one can find meridian-longitude framings μ, λ for ∂V and ∂W , such that μ bounds a disk in V and λ bounds a disk in W . Now, the slope of ∂A in ∂V is of the form $p\mu + q\lambda$ for some integers p, q with $|p|, |q| \geq 2$. The slope of ∂B_1 in V is of the form $a\mu + 2\lambda$, while that of ∂B_2 in W is of the form $2\mu + b\lambda$. As $\Delta(\partial A, \partial B_i) = 1$ for $i = 1, 2$, it follows that $2p - aq = \varepsilon$ and $2q - bp = \delta$ for some $\varepsilon, \delta = \pm 1$. Assuming, without loss of generality, that $|p| > |q| \geq 2$, the only solutions to the above equations can be easily shown to be $(|p|, |q|) = (5, 3)$ or $(7, 3)$. Hence K must be the torus knot $T(\pm 5, 3)$ or $T(\pm 7, 3)$. Notice that this case fits in Case (c) with $n = -1, 0$.

Thus in each of the above cases the knot K admits an essential Seifert Klein bottle, which is unique in Case (a). We have also seen that in Cases (a) and (b) such a surface is never π_1 -injective.

In case (c), K is a cable knot with cabling annulus A such that $X_K = V \cup_A W$, where V is a solid torus and W is the exterior of some (possibly trivial) knot in S^3 , and $B_1 = P \cap V$, $B_2 = P \cap W$ are Moebius bands. Using our notation for $H(P), T_P, K'$ relative to the surface P , as $N(P) = N(B_1) \cup_{A \cap N(P)} N(B_2)$, we can see that

$$H(P) = (V \setminus \text{int } N(B_1)) \cup_D (W \setminus \text{int } N(B_2))$$

where $D = \text{cl}(A \setminus N(P \cap A)) \subset A$ is a disk (a rectangle). Observe that

- (i) $V \setminus \text{int } N(B_1) = A_1 \times I$, where $A_1 = A_1 \times 0$ is the frontier annulus of $N(B_1)$ in V ,
- (ii) the rectangle $D \subset A$ has one side along one boundary component of the annulus $A'_1 = \partial(A_1 \times I) \setminus \text{int } A_1 \subset \partial(A_1 \times I)$ and the opposite side along the other boundary component, and
- (iii) $K' \cap (A_1 \times I)$ is an arc with one endpoint on each of the sides of the rectangle ∂D interior to A'_1 .

Let α be a spanning arc of A'_1 which is parallel and close to one of the arcs of ∂D interior to A'_1 , and which is disjoint from D ; such an arc exists by (i)–(iii), and α intersects K' transversely in one point by (iii). Therefore $\alpha \times I \subset A_1 \times I$

is a properly embedded disk in $H(P)$ which intersects K' transversely in one point, so T_P is boundary compressible in X_K and hence P is not π_1 -injective.

In case (d), keeping the same notation as above, if P is not π_1 -injective then T_P is not π_1 -injective either, so T_P compresses in X_K , and in fact in $H(P)$, producing a surface with at least one component an annulus $A_P \subset H(P)$ properly embedded in X_K with the same boundary slope as P . Notice that A_P can not be essential in X_K : for A_P must separate X_K , and if it is essential then not both graphs of intersection $A \cap A_P \subset A$, $A \cap A_P \subset A_P$ can consist of only essential arcs by the Gordon–Luecke parity rule [6]. Therefore A_P must be boundary parallel in X_K and the region of parallelism must lie in $H(P)$ by Lemma 2.3(d), so T_P is boundary compressible and there is a disk D' in $H(P)$ intersecting K' transversely in one point. As before,

$$H(P) = (V \setminus \text{int } N(B_1)) \cup_D (W \setminus \text{int } N(B_2)),$$

where $V = X_{K_1}$ and $W = X_{K_2}$. Isotope D' so as to intersect D transversely with $|D \cap D'|$ minimal. If $|D \cap D'| > 0$ and E' is an outermost disk component of $D' \setminus D$, then, as $|D' \cap K'| = 1$, E' is a nontrivial disk in, say, $V \setminus \text{int } N(B_1)$ with $|E' \cap K'| = 0$ or 1 . Hence $V \setminus \text{int } N(B_1)$ is a solid torus whose boundary intersects K' in a single arc K'_1 with endpoints on $D \subset \partial V$, and using E' it is possible to construct a meridian disk E'' of $V \setminus \text{int } N(B_1)$ disjoint from D which intersects K' coherently and transversely in one or two points. If $|D \cap D'| = 0$ we set $E'' = D'$.

Let L_1 be the trivial knot whose exterior X_{L_1} is the solid torus $V \setminus \text{int } N(B_1)$, so that K_1 is a 2-cable of L_1 . As $X_{K_1} = X_{L_1} \cup N(B_1)$, where the gluing annulus $X_{L_1} \cap N(B_1)$ is disjoint from the arc $K' \cap X_{L_1}$ in ∂X_{L_1} , E'' must also intersect ∂B_1 coherently and transversely in one or two points. In the first case K_1 must be a trivial knot, while in the second case $X_{K_1} \subset S^3$ contains a closed Klein bottle. As neither option is possible, P must be π_1 -injective. \square

Proof of Corollary 1.6 That any crosscap number two torus knot is of the given form follows from the proof of Theorem 1.5. The uniqueness of the slope bounded by a Seifert Klein bottle in each case follows from [19], and that no such surface is π_1 -injective also follows from the proof of Theorem 1.5. For a knot K of the form $T(\cdot, 4n)$, any Seifert Klein bottle P is disjoint from the cabling annulus and can be constructed on only one side of the cabling annulus. Since P is not π_1 -injective, T_P compresses in $H(P)$ giving rise to the cabling annulus of K ; thus uniqueness and unknottedness follows. For the knots $T(\pm 5, 3), T(\pm 7, 3)$ any Seifert Klein bottle P is separated by the cabling annulus into two Moebius bands; as a Moebius band in a solid torus is

unique up to ambient isotopy fixing its boundary, uniqueness of P again follows. Since, in the notation of the proof of Theorem 1.5, $H(P) = (V \setminus \text{int } N(B_1)) \cup_D (W \setminus \text{int } N(B_2))$, and $V \setminus \text{int } N(B_1)$, $W \setminus \text{int } N(B_2)$ are solid tori, $H(P)$ is a handlebody and so any Seifert Klein bottle in these last cases is unknotted. \square

5 Primitives, powers, and companion annuli

Let M^3 be a compact orientable 3-manifold with boundary, and let A be an annulus embedded in ∂M^3 . We say that a separating annulus A' properly embedded in M^3 is a *companion* of A if $\partial A' = \partial A$ and A' is not parallel into ∂M^3 ; we also say that A' is a companion of any circle c embedded in ∂M^3 which is isotopic to a core of A . Notice that the requirement of a companion annulus being separating is automatically met whenever $M^3 \subset S^3$, and that if ∂M^3 has no torus component then we only have to check that A' is not parallel into A . The following general result will be useful in the sequel.

Lemma 5.1 *Let M^3 be an irreducible and atoroidal 3-manifold with connected boundary, and let A', B' be companion annuli of some annuli $A, B \subset \partial M^3$. Let R, S be the regions in M^3 cobounded by A, A' and B, B' , respectively. If A is incompressible in M^3 then R is a solid torus, and if A and B are isotopic in ∂M^3 then $R \cap S \neq \emptyset$. In particular, A' is unique in M^3 up to isotopy.*

Proof Let c be a core of A ; push R slightly into $\text{int } M^3$ via a small collar $\partial M^3 \times I$ of $\partial M^3 = \partial M^3 \times 0$, and let $A'' = c \times I$. Observe the annulus A'' has its boundary components $c \times 0$ on ∂M^3 and $c \times 1$ on ∂R . Also, ∂R can not be parallel into ∂M^3 , for otherwise A' would be parallel into ∂M^3 ; M^3 being atoroidal, ∂R must compress in M^3 .

Let D be a nontrivial compression disk of ∂R in M^3 . If D lies in $N^3 = M^3 \setminus \text{int } R$ then ∂R compresses in $N^3 \cup (2\text{-handle along } c \times 0)$ along the circles ∂D and $c \times 1 \subset \partial R$, hence ∂D and $c \times 1$ are isotopic in ∂R , which implies that A compresses in M^3 , contradicting our hypothesis. Thus D lies in R , so R is a solid torus.

Suppose now that $R \cap S = \emptyset$, so that $A \cap B = \emptyset = A' \cap B'$, and that A, B are isotopic in ∂M^3 . Then one boundary component of A and one of B cobound an annulus A^* in ∂M^3 with interior disjoint from $A \cup B$ (see Figure 5(a)). Since, by the above argument, R and S are solid tori with A, B running more than once around R, S , respectively, the region $N(R \cup S \cup A^*)$ is a Seifert fibered

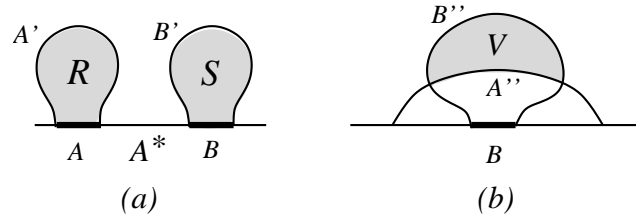

Figure 5

space over a disk with two singular fibers, hence not a solid torus, contradicting our initial argument. Therefore $R \cap S \neq \emptyset$.

Finally, isotope B into the interior of A , carrying B' along the way so that A' and B' intersect transversely and minimally. If $A' \cap B' = \emptyset$ then B' lies in the solid torus R and so must be parallel to A' in R . Otherwise, any component B'' of $B' \cap (M^3 \setminus \text{int } R)$ is an annulus that cobounds a region $V \subset M^3 \setminus \text{int } R$ with some subannulus A'' of A' (see Figure 5(b)). Since $|A' \cap B'|$ is minimal, A'' and B'' are not parallel within V and so $R \cup_{A''} V$ is not a solid torus. But then the frontier of $R \cup_{A''} V$ is a companion annulus of A , contradicting our initial argument. The lemma follows. \square

Remark In the context of Lemma 5.1, if $A \subset \partial M^3$ compresses in M^3 and M^3 is irreducible, then A has a companion iff the core of A bounds a nonseparating disk in M^3 , in which case A has infinitely many nonisotopic companion annuli.

In the special case when H is a genus two handlebody, an algebraic characterization of circles in ∂H that admit companion annuli will be useful in the sequel, particularly in Section 7; we introduce some terminology in this regard. For H a handlebody and c a circle embedded in ∂H , we say c is *algebraically primitive* if c represents a primitive element in $\pi_1(H)$ (relative to some base-point), and we say c is *geometrically primitive* if there is a disk D properly embedded in H which intersects c transversely in one point. It is well known that these two notions of primitivity for circles in ∂H coincide, so we will refer to such a circle c as being simply *primitive* in H . We say that c is a *power* in H if c represents a proper power of some nontrivial element of $\pi_1(H)$.

The next result follows essentially from [3, Theorem 4.1]; we include a short version of the argument for the convenience of the reader.

Lemma 5.2 *Let H be a genus two handlebody and c a circle embedded in ∂H which is nontrivial in H . Then,*

- (a) $\partial H \setminus c$ compresses in H iff c is primitive or a proper power in H , and
- (b) c has a companion annulus in H iff c is a power in H .

Proof For (a), let $D \subset H$ be a compression disk of $\partial H \setminus c$. If D does not separate H then, since c and ∂D can not be parallel in ∂H , there is a circle α embedded in $\partial H \setminus c$ which intersects ∂D transversely in one point, and so the frontier of a regular neighborhood in H of $D \cup \alpha$ is a separating compression disk of $\partial H \setminus c$. Thus, we may assume that D separates H into two solid tori V, W with $D = V \cap W = \partial V \cap \partial W$ and, say, $c \subset V$. Therefore c is either primitive or a power in V and hence in H . Conversely, suppose c is primitive or a power in H . Then $\pi_1(H(c))$ is either free cyclic or has nontrivial torsion by [17, Theorems N3 and 4.12] and so the pair $(H(c), \partial H(c))$ is not irreducible by [12, Theorem 9.8]. Therefore, by the 2–handle addition theorem (cf [3]), the surface $\partial H \setminus c$ must be compressible in H .

For (b), let A be an annulus neighborhood of c in ∂H . If A' is a companion annulus of A then A' must boundary compress in H into a compression disk for $\partial H \setminus A$; as in (a), we can assume that $\partial H \setminus A$ compresses along a disk D which separates H into two solid tori V, W with $D = V \cap W = \partial V \cap \partial W$ and $c, A, A' \subset V$. Since A' is parallel in V into ∂V but not into A , it follows that c is a power in V , hence in H . The converse follows in a similar way. \square

A special family of incompressible pairs of pants properly embedded in a 3–manifold $H \subset S^3$ with ∂H a genus two surface, which are not parallel into ∂H , appear naturally in Section 6. We will establish some of their properties in the next lemma; the following construction will be useful in this regard. If F is a proper subsurface of ∂H , c is a component of ∂F , and A is a companion annulus of c in H with $\partial A = \partial_1 A \cup \partial_2 A$, we isotope A so that, say, $\partial_1 A = c$ and $\partial_2 A \subset \partial H \setminus F$, and denote by $F \oplus A$ the surface $F \cup A$, isotoped slightly so as to lie properly embedded in H .

For c_1, c_2, c_3 disjoint circles embedded in ∂H and nontrivial in H , we say c_1, c_2 are *simultaneously primitive away from c_3* if there is some disk D in H disjoint from c_3 which transversely intersects c_1 and c_2 each in one point; notice that if H is a handlebody and c_1, c_2 are simultaneously primitive away from some other circle, then c_1, c_2 are indeed primitive in H . We also say c_1, c_2 are *coannular* if they cobound an annulus in H .

Lemma 5.3 *Let $H \subset S^3$ be a connected atoroidal 3–manifold with connected boundary of genus two. Let c_1, c_2, c_3 be disjoint nonseparating circles embedded*

in ∂H which are nontrivial in H , no two are coannular, and separate ∂H into two pairs of pants P_1, P_2 . Let Q_0 be a pair of pants properly embedded in H with $\partial Q_0 = c_1 \cup c_2 \cup c_3$ and not parallel into ∂H . Then Q_0 is incompressible and separates H into two components with closures H_1, H_2 and $\partial H_i = Q_0 \cup P_i$, and if Q_0 boundary compresses in H the following hold:

- (a) c_i has a companion annulus in H for some $i = 1, 2, 3$;
- (b) if only c_1 has a companion annulus in H , say A'_1 , then,
 - (i) for $i, j = 1, 2$, $P_i \oplus A'_1$ is isotopic to P_j in H iff H is a handlebody and c_2, c_3 are simultaneously primitive in H away from c_1 ;
 - (ii) if Q_0 boundary compresses in H_i then it boundary compresses into a companion annulus of c_1 in H_i , $Q_0 = P_i \oplus A'_1$ in H , H_i is a handlebody, and any pair of pants in H_i with boundary ∂Q_0 is parallel into ∂H_i ,
 - (iii) if R_0 is a boundary compressible pair of pants in H disjoint from Q_0 with ∂R_0 isotopic to ∂Q_0 in ∂H , then R_0 is parallel to Q_0 or ∂H .

Proof Observe H is irreducible and Q_0 is incompressible in H ; since $H \subset S^3$, Q_0 must separate H , otherwise $Q_0 \cup P_i$ is a closed nonseparating surface in S^3 , which is impossible. Also, by Lemma 5.1, a companion annulus of any c_i is unique up to isotopy and cobounds a solid torus with ∂H . Let H_1, H_2 be the closures of the components of $H \setminus Q_0$, with $\partial H_i = Q_0 \cup P_i$; as Q_0 is incompressible, both H_1 and H_2 are irreducible and atoroidal, so again companion annuli in H_i are unique up to isotopy and cobound solid tori with ∂H_i . Let D be a boundary compression disk for Q_0 , say $D \subset H_1$. We consider three cases.

Case 1 The arc $Q_0 \cap \partial D$ does not separate Q_0 .

Then D is a nonseparating disk in H_1 , and we may assume the arc $Q_0 \cap \partial D$ has one endpoint in c_1 and the other in c_2 , so that $|c_1 \cap D| = 1 = |c_2 \cap D|$ and $c_3 \cap D = \emptyset$. Hence the frontier D' of a small regular neighborhood of $c_1 \cup D$ is a properly embedded separating disk in H_1 which intersects c_2 in two points and whose boundary separates c_1 from c_3 in ∂H ; the situation is represented in Figure 6, with $c_1 = u, c_2 = v, c_3 = w$ and $D = \Sigma, D' = \Sigma'$. Clearly, boundary compressing Q_0 along D produces an annulus A'_3 in H_1 with boundaries parallel to c_3 in ∂H_1 , and if A'_3 is parallel into ∂H_1 then Q_0 itself must be parallel into $P_1 \subset \partial H_1$, which is not the case. Therefore c_3 has a companion annulus in H_1 , hence in H .

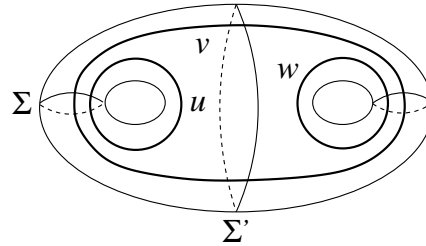

Figure 6

Notice that H_1 must be a handlebody in this case since the region cobounded by A'_3 and ∂H_1 is a solid torus by Lemma 5.1, and that $Q_0 = P_1 \oplus A'_3$ in H and c_1, c_2 are simultaneously primitive in H_1 away from c_3 .

Case 2 *The arc $Q_0 \cap \partial D$ separates Q_0 and D separates H_1 .*

Here the endpoints of the arc $Q_0 \cap \partial D$ lie in the same component of ∂Q_0 , so we may assume that $|c_1 \cap D| = 2$ with $c_1 \cdot D = 0$ while c_2, c_3 are disjoint from and separated by D ; the situation is represented in Figure 6, with $c_1 = v, c_2 = u, c_3 = w$, and $D = \Sigma'$. Thus, boundary compressing Q_0 along D produces two annuli A'_2, A'_3 in $H_1 \setminus D$ with boundaries parallel to c_2, c_3 , respectively. Since Q_0 is not parallel into $P_1 \subset \partial H_1$, at least one of these annuli must be a companion annulus.

Notice that if only one such annulus, say A'_2 , is a companion annulus then, as in Case 1, H_1 is a handlebody, $Q_0 = P_1 \oplus A'_2$ in H , and c_1, c_3 are simultaneously primitive in H_1 away from c_2 .

Case 3 *The arc $Q_0 \cap \partial D$ separates Q_0 and D does not separate H_1 .*

As in Case 2, we may assume that $|c_1 \cap D| = 2$ with $c_1 \cdot D = 0$ while c_2, c_3 are disjoint from D . Since D does not separate H_1 , boundary compressing Q_0 along D produces two nonseparating annuli in H_1 , each with one boundary parallel to c_2 and the other parallel to c_3 . Since c_2, c_3 are not coannular in H , this case does not arise. Therefore (a) holds.

For (b)(i), let V, H' be the closures of the components of $H \setminus A'_1$, with V a solid torus and $P_j \subset \partial H'$; observe that $\partial H'$ can be viewed as $(P_i \oplus A'_1) \cup P_j$. If $P_i \oplus A'_1$ and P_j are isotopic in H then $H' \approx P_j \times I$ with P_j corresponding to $P_j \times 0$, from which it follows that c_2, c_3 are simultaneously primitive in H away from c_1 . Moreover, c_1 is primitive in the handlebody H' , and so $H = H' \cup_{A'_1} V$

is also a handlebody. Conversely, suppose H is a handlebody and c_2, c_3 are simultaneously primitive away from c_1 ; notice that $c_2, c_3, A'_1 \subset \partial H'$. Suppose D is a disk in H realizing the simultaneous primitivity of c_2, c_3 away from c_1 ; we assume, as we may, that D lies in H' (see Figure 6 with $D = \Sigma$, $c_2 = u$, $c_3 = v$, $\text{core}(A'_1) = w$). Compressing $\partial H' \setminus \text{int } A'_1$ in H' along D gives rise to an annulus A''_1 in H which, due to the presence of A'_1 , is necessarily a companion annulus of c_1 in H . It follows from Lemma 5.1 that A''_1 and A'_1 are parallel in H' , hence that $P_i \oplus A'_1$ and P_j are parallel in H' and so in H .

For (b)(ii), if Q_0 boundary compresses into, say, H_1 , then it follows immediately from the proof of (a) that H_1 is a handlebody, $Q_0 = P_1 \oplus A'_1$, and c_2, c_3 are simultaneously primitive in H_1 away from c_1 , so Q_0 compresses into a companion annulus of c_1 in H_1 . If R_0 is any pair of pants in H_1 with boundary ∂Q_0 then by the same argument R_0 must be isotopic in H_1 to $Q_0 \oplus A'_1$ or $P_1 \oplus A'_1$, hence by (b)(i) R_0 is parallel into ∂H_1 .

For (b)(iii), consider the disjoint pairs of pants Q_0, R_0 and suppose R_0 is also not parallel into ∂H . By (b)(ii), $Q_0 = P_i \oplus A'_1$ and $R_0 = P_j \oplus A'_1$ for some $i, j \in \{1, 2\}$. Thus, if $i \neq j$, Q_0 boundary compresses in the direction of P_i , away from R_0 , into a companion annulus of c_1 ; a similar statement holds for R_0 , and so such companion annuli of c_1 are separated by $Q_0 \cup R_0$, contradicting Lemma 5.1. Therefore $i = j$, so Q_0 is parallel to R_0 . The lemma follows. \square

Remark If any two of the circles c_1, c_2, c_3 in Lemma 5.3 are coannular in H then part (a) need not hold; an example of this situation can be constructed as follows. Let H be a genus two handlebody and let c_1, c_2 be disjoint, nonparallel, nonseparating circles in ∂H which are nontrivial in H and cobound an annulus A in H . Let $\alpha \subset \partial H$ be an arc with one endpoint in c_1 and the other in c_2 which is otherwise disjoint from A . We then take the pair of pants Q_0 to be the frontier of $H_1 = N(A \cup \alpha)$ in H so that, up to isotopy, $\partial Q_0 = c_1 \cup c_2 \cup K$, where $K \subset \partial H$ is the sum of c_1 and c_2 along α . Observe Q_0 boundary compresses in H_1 as in Case 3 of Lemma 5.3(a). Thus, if c_1 and c_2 are primitive in H then, by Lemma 5.2, no component of ∂Q_0 has a companion in H and Q_0 need not be parallel into ∂H , as illustrated by the example in Figure 7. Moreover, if P is the once-punctured Klein bottle $A \cup B$, where $B \subset \partial H$ is a band with core α , pushed slightly off ∂H so as to properly embed in H_1 , then ∂P is isotopic to K , H_1 is a regular neighborhood of P , and the two components of ∂Q_0 isotopic to c_1, c_2 are lifts of the meridian of P .

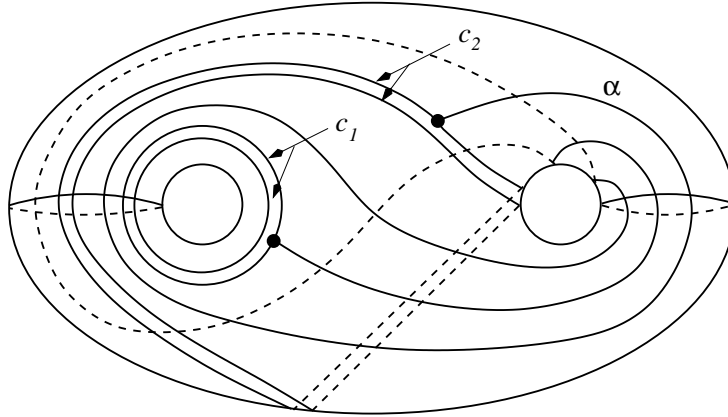

Figure 7: Coannular primitive circles c_1, c_2 in the handlebody H

6 Hyperbolic knots

In this section we fix our notation and let K be a hyperbolic knot in S^3 with exterior X_K . If P, Q are distinct elements of $\mathcal{SK}(K, r)$ which have been isotoped so as to intersect transversely and minimally, then $|P \cap Q| > 0$, $\partial P \cap \partial Q = \emptyset$, and each circle component of $P \cap Q$ is nontrivial in P and Q . Notice that any circle component γ of $P \cap Q$ must be orientation preserving in both P, Q , or orientation reversing in both P, Q . If γ is a meridian (longitude, center) in both P and Q , we will say that γ is a *simultaneous* meridian (longitude, center, respectively) in P, Q . Recall our notation for $H(P), T_P, K', A'_K$ relative to the surface P .

Lemma 6.1 *Let $m_1, m_2 \subset T_P$ and $l \subset T_P$ be the lifts of a meridian circle and a center circle of P , respectively. Then m_1, m_2 can not both have companions in $H(P)$, and neither l nor $K' \subset \partial H(P)$ have companions.*

Proof Let A_1, A_2, A be annular neighborhoods of m_1, m_2, l in T_P , respectively, with $A_1 \cap A_2 = \emptyset$. Let A'_1, A'_2 be companions of A_1, A_2 in $H(P)$, respectively, and suppose they intersect transversely and minimally; then $A'_1 \cap A'_2 = \emptyset$ by Lemma 2.3(b). Let V_i be the region in $H(P)$ cobounded by A_i, A'_i for $i = 1, 2$. Now, the lifts m_1, m_2 cobound the annulus $A(m)$ in $N(P)$ for some meridian circle $m \subset P$. Since A'_i and A_i are not parallel in V_i , it follows that, for a small regular neighborhood $N = A(m) \times I$ of $A(m)$ in $N(P)$, $V_1 \cup N \cup V_2 \subset X_K$ is the exterior X_L of some nontrivial knot L in S^3 with $A_1 \subset X_L$ an essential annulus (see Figure 8(a)). Observe $H(P)$ is irreducible

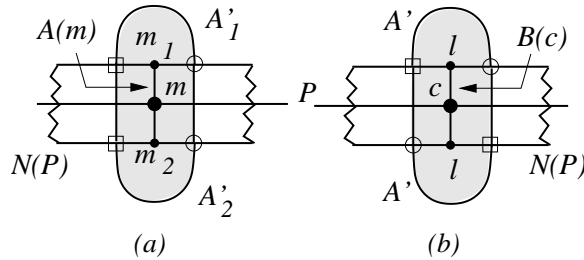

Figure 8

and atoroidal since K is hyperbolic and P is essential. As A_1, A_2 are incompressible in $H(P)$, the V_i 's are solid tori by Lemma 5.1 and so L is a nontrivial torus knot with cabling annulus A_1 . However, as the pair of pants $P_0 = P \setminus \text{int } X_L$ has two boundary components coherently oriented in ∂X_L with the same slope as ∂A_1 , K must be a satellite of L of winding number two, contradicting the hyperbolicity of K .

Suppose A' is a companion of A in $H(P)$, and let V be the region in $H(P)$ cobounded by A, A' . The circle l bounds a Moebius band $B(c)$ in $N(P)$ with $B(c) \cap P$ some center circle c of P . If M is a small regular neighborhood of $B(c)$ in $N(P)$ then, as A, A' are not parallel in V , $V \cup M$ is the exterior X_L of some nontrivial knot L in S^3 (see Figure 8(b)), and A is an essential annulus in X_L which, since M is a solid torus, necessarily has integral boundary slope in ∂X_L . This time, $P_0 = P \setminus \text{int } X_L$ is a once-punctured Moebius band with one boundary component in ∂X_L having the same slope as ∂A , so K is a nontrivial satellite of L with odd winding number, again contradicting the hyperbolicity of K .

Finally, if A'_K has a companion annulus B' then, as K is hyperbolic, B' must be boundary parallel in X_K in the direction of P , contradicting Lemma 2.3(d). The lemma follows. \square

Given distinct elements $P, Q \in \mathcal{SK}(K, r)$, if $P \cap Q$ is a single simultaneous meridian or some pair of disjoint simultaneous centers, we will say that P and Q intersect *meridionally* or *centrally*, respectively.

Lemma 6.2 *If $P, Q \in \mathcal{SK}(K, r)$ are distinct elements which intersect transversely and minimally, then P, Q intersect meridionally or centrally.*

Proof By minimality of $|P \cap Q|$, any component γ of $P \cap Q$ must be nontrivial in both P and Q , hence, in P or Q , γ is either a circle parallel to the boundary,

a meridian, a longitude, or a center circle. Observe that if γ is a center in P then, as it is orientation reversing in P it must be orientation reversing in Q , and hence γ must also be a center in Q .

Suppose γ is parallel to ∂P in P ; without loss of generality, we may assume that ∂P and γ cobound an annulus A_P in P with $Q \cap \text{int } A_P = \emptyset$. Since γ preserves orientation in P it must also preserve orientation in Q , hence γ is either a meridian or longitude of Q , or parallel to ∂Q . In the first two cases, \widehat{Q} would compress in $K(\partial Q)$ via the disk \widehat{A}_P , which is not the case by Lemma 2.2; thus, γ and ∂Q cobound an annulus A_Q in Q . As K is hyperbolic, the annulus $A_P \cup_\gamma A_Q \subset H(P)$ is boundary parallel in X_K by Lemma 6.1; but then $|P \cap Q|$ is not minimal, which is not the case. Therefore no component of $P \cap Q$ is parallel to $\partial P, \partial Q$ in P, Q , respectively.

Suppose now that γ is a meridian in P and a longitude in Q . Then $P \cap Q$ consists only of meridians of P and longitudes of Q . If γ is the only component of $P \cap Q$ then $P \asymp Q$ is a nonorientable (connected) surface properly embedded in X_K with two boundary components, which is impossible. Thus we must have $|P \cap Q| \geq 2$; as the circles $P \cap Q$ are mutually parallel meridians in P , it follows that $P \cap H(Q)$ consists of a pair of pants and at least one annulus component A . But $P \cap N(Q)$ consists of a disjoint collection of annuli $\{A_i\}$ with $\{A_i \cap Q\}$ disjoint longitude circles of Q , and so the circles $\cup \partial A_i$ form at most two parallelism classes in $T_Q \subset \partial H(Q)$, corresponding to the lifts of some disjoint pair of centers of Q . Since the circles ∂A are among those in $\cup \partial A_i$, and A is not parallel into $\partial H(Q)$ by minimality of $|P \cap Q|$, we contradict Lemmas 2.3 and 6.1.

Therefore, each component of $P \cap Q$ is a simultaneous meridian, longitude, or center of P, Q . There are now two cases left to consider.

Case 1 $P \cap Q$ consists of simultaneous meridians.

Suppose $|P \cap Q| = k + 1$, $k \geq 0$. Then $Q \cap N(P)$ consists of disjoint parallel annuli A_0, \dots, A_k , each intersecting P in a meridian circle, and $Q \cap H(P) = Q_0 \cup A'_1 \cup \dots \cup A'_k$, where Q_0 is a pair of pants with $\partial Q \subset \partial Q_0$ and the A'_i 's are annuli, none of which is parallel into $\partial H(P)$. The circles $\cup \partial A_i = \cup \partial A'_i$ consist of two parallelism classes in ∂H , denoted I and II, corresponding to the two distinct lifts of a meridian circle of P to $\partial N(P)$.

By Lemma 2.3, the circles $\partial A'_i$ are both of type I or both of type II, for each i . Also, the components of ∂Q_0 are ∂Q and two circles $\partial_1 Q_0, \partial_2 Q_0$ of type I or II. If the circles $\partial_1 Q_0, \partial_2 Q_0$ are both of type I or both of type II, then the union of

Q_0 and an annulus in T_P cobounded by $\partial_1 Q_0$ and $\partial_2 Q_0$ is a once-punctured surface in X_K disjoint from P , contradicting Lemma 2.3(b). Therefore, one of the circles $\partial_1 Q_0, \partial_2 Q_0$ is of type I and the other of type II. Thus, if $k > 0$ then some annulus A'_i has boundaries of type I and some annulus A'_j has boundaries of type II, which contradicts Lemma 6.1. Therefore $k = 0$, and so $P \cap Q$ consists of a single simultaneous meridian.

Case 2 $P \cap Q$ consists of simultaneous longitudes or centers.

$P \cap Q$ can have at most two simultaneous centers; if it has at most one simultaneous center then $P \simeq Q$ is a nonorientable surface properly embedded in X_K with two boundary components, which is not possible. Therefore $P \cap Q$ contains a pair c_1, c_2 of disjoint center circles, so $Q \cap N(P)$ consists of two Moebius bands and, perhaps, some annuli, while $Q \cap H(P)$ consists of one pair of pants Q_0 and, perhaps, some annuli. Thus the circles $Q \cap \partial H(P)$ are divided into two parallelism classes, corresponding to the lifts of c_1 and c_2 , and we may proceed as in Case 1 to show that $Q \cap H(P)$ has no annulus components. Hence $P \cap Q = c_1 \cup c_2$. \square

Remark Notice that if P, Q are any two distinct elements of $\mathcal{SK}(K, r)$, so $P \cap Q$ is central or meridional, and $Q_0 = Q \cap H(P)$, then by Lemma 2.3, since K is hyperbolic, $H(P)$ and ∂Q_0 satisfy the hypothesis of Lemma 5.3; however, Q_0 need not boundary compress in $H(P)$.

The following result gives constraints on the exteriors of distinct elements of $\mathcal{SK}(K, r)$.

Lemma 6.3 Suppose $P, Q \in \mathcal{SK}(K, r)$ are distinct elements which intersect centrally or meridionally; let $Q_0 = Q \cap H(P)$, and let V, W be the closures of the components of $H(P) \setminus Q_0$. Then Q_0 is not parallel into $\partial H(P)$, and

- (a) for $X = V, W$, or $H(P)$, either X is a handlebody or the pair $(X, \partial X)$ is irreducible and atoroidal;
- (b) if $P \cap Q$ is central then $(H(P), \partial H(P))$ is irreducible and Q_0 is boundary incompressible in $H(P)$, and
- (c) if the pair $(V, \partial V)$ is irreducible then W is a handlebody.

In particular, if P is not π_1 -injective then P is unknotted, $P \cap Q$ is meridional, and K' is primitive in $H(P)$.

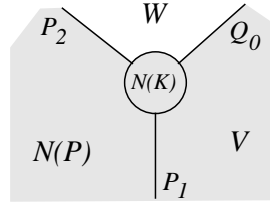

Figure 9: The manifold $\widetilde{M}^3 = \widetilde{N}(P) \cup_{P_1 \cup (V \cap N(K))} V$

Proof Let P_1, P_2 be the closures of the components of $\partial H(P) \setminus \partial Q_0$. If Q_0 is parallel to, say P_1 , then Q is isotopic in X_K to $P_1 \cup (Q \cap N(P)) \subset N(P)$, which is clearly isotopic to P in $N(P)$ (see Figure 9 and the proof of Lemma 6.7); thus Q_0 is not parallel into $\partial H(P)$.

Let R be the maximal compression body of $\partial H(P) = \partial_+ R$ in $H(P)$ (notation as in [2, 3]). Since $H(P)$ is irreducible and atoroidal, either $\partial_- R$ is empty and $H(P)$ is a handlebody or R is a trivial compression body and $(H(P), \partial H(P))$ is irreducible and atoroidal. As Q_0 is incompressible in $H(P)$, a similar argument shows that either V (W) is a handlebody or the pair $(V, \partial V)$ ($(W, \partial W)$, respectively) is irreducible and atoroidal; thus (a) holds.

If $P \cap Q$ is central and either $H(P)$ is a handlebody or Q_0 is boundary compressible, then at least one of the circles K', l_1, l_2 , where l_1, l_2 are the lifts of the simultaneous centers $P \cap Q$, has a companion annulus by Lemma 5.3(a); this contradicts Lemma 6.1, so (b) now follows from (a).

For part (c), let $\widetilde{N}(P) = N(P) \cup_{A_K} N(K) = S^3 \setminus \text{int } H(P)$, the *extended* regular neighborhood of P in S^3 ; notice that $K' \subset \partial \widetilde{N}(P)$ and, since P has integral boundary slope, that A_K and A'_K are parallel in $N(K)$, so $\widetilde{N}(P)$ and $N(P)$ are homeomorphic in a very simple way.

Suppose the pair $(V, \partial V)$ is irreducible; without loss of generality, we may assume $P_1 \subset \partial V$ and $P_2 \subset \partial W$. As none of the circles ∂P_1 bounds a disk in $N(P)$, the pair of pants P_1 is incompressible in $N(P)$ and hence in $\widetilde{N}(P)$; thus, since $(V, \partial V)$ is irreducible, it is not hard to see that, for the manifold $\widetilde{M}^3 = \widetilde{N}(P) \cup_{P_1 \cup (V \cap N(K))} V$ (see Figure 9), the pair $(\widetilde{M}^3, \partial \widetilde{M}^3)$ is irreducible. As $S^3 = \widetilde{M}^3 \cup W$, ∂W must compress in W , so W is a handlebody by (a).

Finally, if P is not π_1 -injective then T_P compresses in $H(P)$, so $H(P)$ is a handlebody by (a), K' is primitive in $H(P)$ by Lemmas 5.2 and 6.1, and $P \cap Q$ is meridional by (b). \square

Lemma 6.4 *If $P, Q, R \in \mathcal{SK}(K, r)$ are distinct elements and each intersection $P \cap Q, P \cap R$ is central or meridional, then $P \cap Q$ and $P \cap R$ are isotopic in P .*

Proof We will assume that $P \cap Q$ and $P \cap R$ are not isotopic in P and obtain a contradiction in all possible cases. Since any two meridian circles of P are isotopic in P , we may assume that $P \cap Q = m$ or $c_1 \cup c_2$ and $P \cap R = c'_1 \cup c'_2$, where m is the meridian of P and c_1, c_2 and c'_1, c'_2 are two non isotopic pairs of disjoint centers of P ; we write $\partial Q_0 = \partial Q \cup \alpha_1 \cup \alpha_2$ and $\partial R_0 = \partial R \cup l'_1 \cup l'_2$, where $\alpha_1, \alpha_2 \subset T_P$ are the lifts m_1, m_2 of m or l_1, l_2 of c_1, c_2 , and $l'_1, l'_2 \subset T_P$ are the lifts of c'_1, c'_2 . Isotope $P \cap Q$ and $P \cap R$ in P so as to intersect transversely and minimally; then their lifts $\alpha_1 \cup \alpha_2$ and $l'_1 \cup l'_2$ will also intersect minimally in $\partial H(P)$. Finally, isotope Q_0, R_0 in $H(P)$ so as to intersect transversely with $|Q_0 \cap R_0|$ minimal; necessarily, $|Q_0 \cap R_0| > 0$, and any circle component of $Q_0 \cap R_0$ is nontrivial in Q_0 and R_0 .

Let $G_{Q_0} = Q_0 \cap R_0 \subset Q_0$, $G_{R_0} = Q_0 \cap R_0 \subset R_0$ be the graphs of intersection of Q_0, R_0 . Following [6], we think of the components of ∂Q_0 as *fat vertices* of G_{Q_0} , and label each endpoint of an arc of G_{Q_0} with $1'$ or $2'$ depending on whether such endpoint arises from an intersection involving l'_1 or l'_2 , respectively; the graph G_{R_0} is labelled with $1, 2$ in a similar way. Such a graph is *essential* if each of its components is essential in the corresponding surface. As $P \cap R$ is central, R_0 is boundary incompressible in $H(P)$ by Lemma 6.3(b) and so G_{Q_0} is essential; similarly, G_{R_0} is essential if $P \cap Q$ is central. Thus, if G_{R_0} has inessential arcs then $P \cap Q$ is meridional and, by minimality of $|Q_0 \cap R_0|$, Q_0 boundary compresses along an essential arc of G_{Q_0} . By Lemma 3.1, since the meridian m and the centers c'_1, c'_2 can be isotoped so that $|m \cap c'_j| = 1$, it follows by minimality of $|\partial Q_0 \cap \partial R_0|$ that $|m_i \cap l'_j| = 1$ for $i, j = 1, 2$. Hence any inessential arc of G_{R_0} has one endpoint in m_1 and the other in m_2 and so, by Case 1 of Lemma 5.3(a), since Q_0 is not parallel into $\partial H(P)$ by Lemma 6.3, Q_0 boundary compresses to a companion annulus of K' in $H(P)$, contradicting Lemma 6.1.

Therefore the graphs G_{Q_0}, G_{R_0} are always essential. Since $P \cap Q$ and $P \cap R$ are not isotopic in $\partial H(P)$, any circle component of $Q_0 \cap R_0$ must be parallel to $\partial Q, \partial R$ in Q_0, R_0 , respectively, so, by minimality of $|Q_0 \cap R_0|$, K' must have a companion annulus in $H(P)$, contradicting Lemma 6.1. Thus $Q_0 \cap R_0$ has no circle components. We consider two cases.

Case 1 $P \cap Q = m$

In this case, we have seen that $|m_i \cap l'_j| = 1$ for $i, j = 1, 2$. Therefore the m_1, m_2 and l'_1, l'_2 fat vertices of G_{Q_0} and G_{R_0} , respectively, each have valence

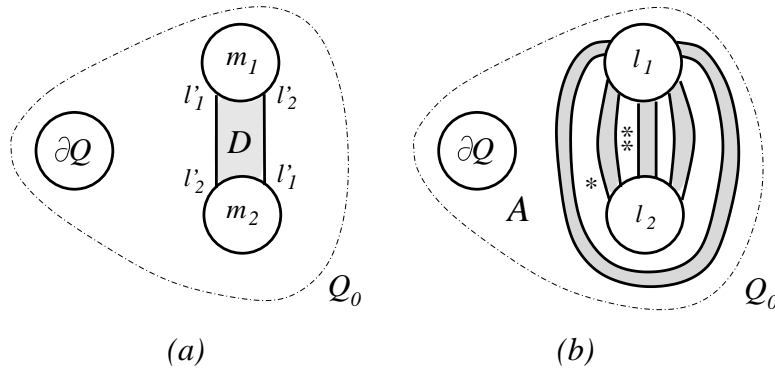

Figure 10: The possible graphs G_{Q_0}

2, and so, by essentiality, each graph G_{Q_0}, G_{R_0} consist of two parallel arcs, one annulus face, and one disk face D . The situation is represented in Figure 10(a), where only G_{Q_0} is shown; notice that the labels l_1, l_2 must alternate around ∂D .

Let V, W be the closures of the components of $H(P) \setminus R_0$, and suppose $Q_0 \cap V$ contains the disk face D of G_{Q_0} . By minimality of $|Q_0 \cap R_0|$ and $|\partial Q_0 \cap \partial R_0|$, ∂D is nontrivial in ∂V , hence V is a handlebody by Lemma 6.3 and K' is primitive in V by Lemmas 5.2 and 6.1. Since the labels l_1, l_2 alternate around ∂D , D must be nonseparating in V ; thus there is an essential disk D' in V disjoint from D such that D, D' form a complete disk system for V . Now, for $i = 1, 2$, $|\partial D \cap l'_i| = 2$ and so $D \cdot l'_i$ is even. If the intersection number $D' \cdot l'_i$ is even for some $i = 1, 2$ then l'_i is homologically trivial mod 2 in V , while if $D' \cdot l'_i$ is odd for $i = 1, 2$ then $l'_1 \cup l'_2$ is homologically trivial mod 2 in V . Thus one of l'_1, l'_2 , or $l'_1 \cup l'_2$ bounds a surface in V , hence in $H(P)$, contradicting Lemma 2.3. Therefore this case does not arise.

Case 2 $P \cap Q = c_1 \cup c_2$

Recall that $c_1 \cup c_2$ and $c'_1 \cup c'_2$ intersect transversely and minimally in P , so their lifts $l_1 \cup l_2$ and $l'_1 \cup l'_2$ also intersect minimally in $\partial H(P)$. Moreover, after exchanging the roles of Q_0, R_0 or relabelling the pairs c_1, c_2 and c'_1, c'_2 , if necessary, we must have that $|c_1 \cap (c'_1 \cup c'_2)| = 2n + 1$ and $|c_2 \cap (c'_1 \cup c'_2)| = |2n - 1|$ for some integer $n \geq 0$: this can be easily seen by viewing P as the union of an annulus \mathcal{A} with core m and a rectangle \mathcal{B} with core b , as in Lemma 3.1, and isotoping $c_1 \cup c_2$ and $c'_1 \cup c'_2$ so as to intersect $m \cup b$ minimally. Figure 11

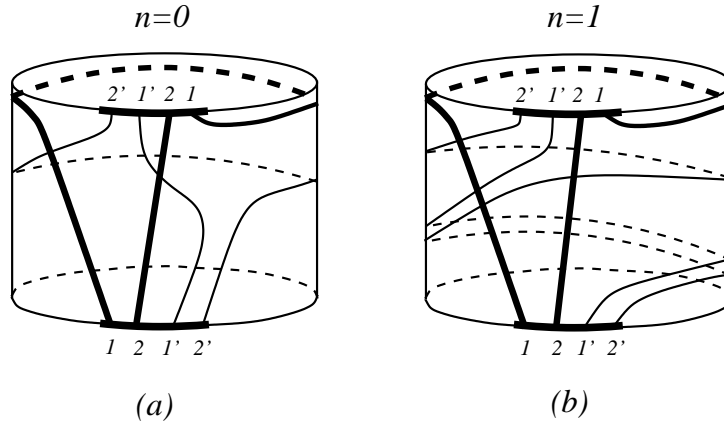

Figure 11: Minimally intersecting pairs $c_1 \cup c_2, c'_1 \cup c'_2$

represents two pairs $c_1 \cup c_2$ and $c'_1 \cup c'_2$ with minimal intersections; in fact, all examples of such pairs can be obtained from Figure 11(a) by choosing the rectangle \mathcal{B} appropriately so that the arcs of $(c_1 \cup c_2) \cap \mathcal{A}$ are as shown, and suitably Dehn-twisting the pair $c'_1 \cup c'_2$ along m .

Thus $|l_1 \cap (l'_1 \cup l'_2)| = 4n + 2$ and $|l_2 \cap (l'_1 \cup l'_2)| = |4n - 2|$, and so the essential graphs G_{Q_0}, G_{R_0} must both be of the type shown in Figure 10(b) (which is in fact produced by the intersection pattern of Figure 11(b), where $n = 1$). Let V, W be the closures of the components of $H(P) \setminus R_0$. If $n > 1$ then the graph G_{Q_0} has the two disk components D_1, D_2 labelled $*$ and $**$ in Figure 10(b), respectively, as well as an annulus face A with $\partial_1 A = \partial Q$, all lying in, say, V . Thus V is a handlebody by Lemma 6.3 and, by minimality of $|\partial Q_0 \cap \partial R_0|$ and the essentiality of G_{Q_0}, G_{R_0} , the four disjoint circles $\partial_1 A, \partial_2 A, \partial D_1, \partial D_2$ are all essential in ∂V and intersect ∂R_0 minimally. Given that $|\partial_1 A \cap (l'_1 \cup l'_2)| = 0$, $|\partial_2 A \cap (l'_1 \cup l'_2)| = 2$, $|\partial D_1 \cap (l'_1 \cup l'_2)| = 6$, and $|\partial D_2 \cap (l'_1 \cup l'_2)| = 4$, no two of such four circles can be isotopic in ∂V , an impossibility since ∂V has genus two. The case $n = 0$ is similar to Case 1 and yields the same contradiction.

Finally, for $n = 1$ the intersection pattern in P between $c_1 \cup c_2$ and $c'_1 \cup c'_2$ must be the one shown in Figure 11(b), and it is not hard to see that only two labelled graphs G_{Q_0} are produced, up to combinatorial isomorphism. The first possible labelled graph is shown in Figure 12(a); capping off l_1, l_2 and l'_1, l'_2 with the corresponding Moebius bands $Q \cap N(P)$, we can see that $Q \cap R$ consists of a single circle component (shown in Figure 12(a) as the union of the broken and solid lines), which must be a meridian by Lemma 6.2, contradicting Case 1

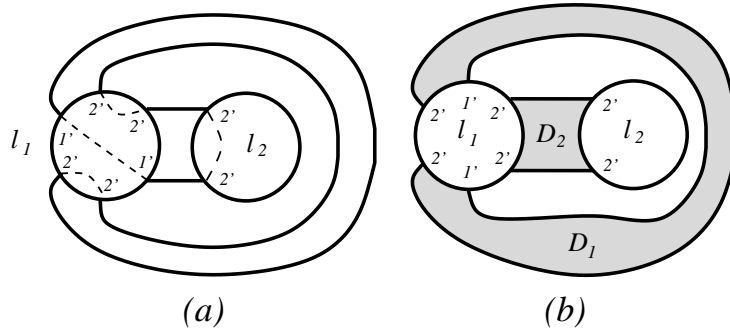

Figure 12: G_{Q_0} graphs from central intersections

since $Q \cap P$ is central. In the case of Figure 12(b), the disk faces D_1, D_2 of G_{Q_0} lie both in, say, V , so V is a handlebody by Lemma 6.3 and K' is primitive in V by Lemmas 5.2 and 6.1. Moreover, since D_1 and D_2 do not intersect $l'_1 \cup l'_2$ in the same pattern, D_1 and D_2 are nonisotopic compression disks of $\partial V \setminus K'$ in V , so at least one of the disks D_1, D_2 must be nonseparating in V . As either disk D_1, D_2 intersects each circle l'_1, l'_1 an even number of times, we get a contradiction as in Case 1. Therefore this case does not arise either. \square

The next corollary summarizes some of our results so far.

Corollary 6.5 *If K is hyperbolic and $|\mathcal{SK}(K, r)| \geq 2$ then $\mathcal{SK}(K, r)$ is either meridional or central; in the latter case, the link $c_1 \cup c_2$ obtained as the intersection of any two distinct elements of $\mathcal{SK}(K, r)$ is unique in X_K up to isotopy.* \square

If $|\mathcal{SK}(K, r)| \geq 2$ and $P \in \mathcal{SK}(K, r)$, let $\alpha_1, \alpha_2 \subset H(P)$ be the lifts of the common meridian or pair of disjoint centers of P which, by Corollary 6.5, are determined by the elements of $\mathcal{SK}(K, r)$, and define $P(K, r)$ as the collection of all pairs of pants $X \subset H(P)$ with $\partial X = K' \cup \alpha_1 \cup \alpha_2$ and not parallel into $\partial H(P)$, modulo isotopy. Notice that $\mathcal{SK}(K, r) \setminus \{P\}$ embeds in $P(K, r)$ by Corollary 6.5, and so $|\mathcal{SK}(K, r)| \leq |P(K, r)| + 1$. Our strategy for bounding $|\mathcal{SK}(K, r)|$ in the next lemmas will be to bound $|P(K, r)|$.

Lemma 6.6 *Let K be a hyperbolic knot with $|\mathcal{SK}(K, r)| \geq 2$. If $\mathcal{SK}(K, r)$ is central then $|\mathcal{SK}(K, r)| \leq 3$.*

Proof Fix $P \in \mathcal{SK}(K, r)$, and suppose Q_0, R_0, S_0 are distinct elements of $P(K, r)$, each with boundary isotopic to $K' \cup l_1 \cup l_2$, where l_1, l_2 are the lifts of

some fixed pair of disjoint centers of P . Since neither K', l_1 , nor l_2 have any companion annuli in $H(P)$ by Lemma 6.1, Q_0, R_0, S_0 can be isotoped in $H(P)$ so as to become mutually disjoint. Each of the surfaces Q_0, R_0, S_0 separates $H(P)$, and we may assume that R_0 separates Q_0 from S_0 in $H(P)$.

Let V, W be the closures of the components of $H(P) \setminus R_0$, with $Q_0 \subset V, S_0 \subset W$; then V , say, is a handlebody by Lemma 6.3. As Q_0 is not parallel into ∂V by Lemma 6.3, it follows from Lemma 5.3(a) that one of the circles ∂Q_0 has a companion annulus in V , hence in $H(P)$, contradicting Lemma 6.1. Therefore $|P(K, r)| \leq 2$, and so $|\mathcal{SK}(K, r)| \leq 3$. \square

Lemma 6.7 *Let K be a hyperbolic knot with $|\mathcal{SK}(K, r)| \geq 2$. If $\mathcal{SK}(K, r)$ has an unknotted element P then $\mathcal{SK}(K, r)$ is meridional, $|\mathcal{SK}(K, r)| = 2$, and some lift of the meridian of P has a companion annulus in $H(P)$.*

Proof Let $P, Q \in \mathcal{SK}(K, r)$ be distinct elements with P unknotted, and let $Q_0 = Q \cap H(P)$. Then $P \cap Q$ is meridional by Lemma 6.3(b), so $\mathcal{SK}(K, r)$ is meridional, and Q_0 boundary compresses into a companion annulus A of exactly one of the lifts m_1 or m_2 of the meridian circle m of P by Lemmas 5.3(a) and 6.1. Now, if P_1, P_2 are the closures of the components of $\partial H(P) \setminus \partial Q_0$ then, by Lemma 5.3(b)(ii), $Q_0 = P_i \oplus A$ for some $i = 1, 2$, so if $A(m)$ is an annulus in $N(P)$ cobounded by m_1, m_2 then Q is equivalent to one of the Seifert Klein bottles $R_i = P_i \oplus A \cup A(m)$, $i = 1, 2$. But R_1 and R_2 are isotopic in X_K : this isotopy is described in Figure 13, where a regular neighborhood $N(P)$ of P is shown (as a box) along with the lifts of the meridian m of P (as two of the solid dots in the boundary of $N(P)$); regarding P_1 as the closure of a component of $\partial N(P) \setminus (N(A(m) \cup P))$, the idea is to construct $P_1 \oplus A \cup A(m)$, start pushing P_1 onto P using the product structure of $N(P) \setminus A(m)$, and continue until reaching P_2 on the ‘other side’ of P ; as the annulus $A \cup A(m)$ is ‘carried along’ in the process, the end surface of the isotopy is $P_2 \oplus A \cup A(m)$. The lemma follows. \square

Remark For a hyperbolic knot $K \subset S^3$ with Seifert Klein bottle P and meridian lifts m_1, m_2 , if there is a pair of pants $Q_0 \subset H(P)$ with $\partial Q_0 = K' \cup m_1 \cup m_2$ which is not parallel into $\partial H(P)$, it may still be the case that the Seifert Klein bottle $Q = Q_0 \cup A(m)$ is equivalent to P in X_K . An example of this situation is provided by the hyperbolic 2-bridge knots with crosscap number two; see Section 7 and the proof of Theorem 1.3 for more details.

Lemma 6.8 *Let K be a hyperbolic knot with $|\mathcal{SK}(K, r)| \geq 2$. If $\mathcal{SK}(K, r)$ is meridional then $|\mathcal{SK}(K, r)| \leq 6$.*

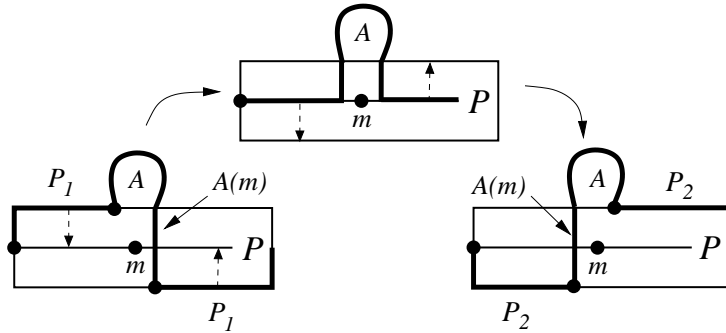

Figure 13: An isotopy between $(P_1 \oplus A) \cup A(m)$ and $(P_2 \oplus A) \cup A(m)$

Proof Fix $P \in \mathcal{SK}(K, r)$, and suppose Q_0, R_0, S_0, T_0 are distinct elements of $P(K, r)$ which can be isotoped in $H(P)$ so as to be mutually disjoint; we may assume R_0 separates Q_0 from $S_0 \cup T_0$, while S_0 separates $Q_0 \cup R_0$ from T_0 . Let V, W be the closure of the components of $H(P) \setminus R_0$, with $Q_0 \subset V$ and $S_0 \cup T_0 \subset W$. Then W can not be a handlebody by Lemma 5.3(b)(iii), hence, by Lemmas 5.3(a) and 6.3(c), V is a handlebody and Q_0 gives rise to a companion annulus in V of some lift of the meridian of P . However, a similar argument shows that T_0 gives rise to a companion annulus of some lift of the meridian of P in W , contradicting Lemmas 5.1 and 6.1.

Therefore at most three distinct elements of $P(K, r)$ can be isotoped at a time so as to be mutually disjoint in $H(P)$. Consider the case when three such disjoint elements exist, say Q_0, R_0, S_0 . Let E, F, G, H be the closure of the components of $H(P) \setminus (Q_0 \cup R_0 \cup S_0)$, and let P_1, P_2 be the closure of the pair of pants components of $\partial H(P) \setminus \partial(Q_0 \cup R_0 \cup S_0)$, as shown (abstractly) in Figure 14.

Suppose $T_0 \in P(K, r) \setminus \{Q_0, R_0, S_0\}$ has been isotoped in $H(P)$ so as to intersect $Q_0 \cup R_0 \cup S_0$ transversely and minimally. Then $|T_0 \cap (Q_0 \cup R_0 \cup S_0)| > 0$ by the above argument. Since $T_0 \cap (Q_0 \cup R_0 \cup S_0)$ consists of circles parallel to ∂T_0 , at least one component of ∂T_0 must have a companion annulus A_1 in $H(P)$; the annulus A_1 may be constructed from an outermost annulus component of $T_0 \setminus (Q_0 \cup R_0 \cup S_0)$, and hence can be assumed to lie in one of the regions E, F, G or H . By Lemma 6.1, A_1 is a companion of some lift m_1 of the meridian of P , and by Lemma 2.3(b)(c) the components of $T_0 \cap (Q_0 \cup R_0 \cup S_0)$ are all mutually parallel in each of T_0, Q_0, R_0, S_0 . So, if, say, $|T_0 \cap Q_0| \geq 2$, then m_1 gets at least one companion annulus on either side of Q_0 , which is not possible by Lemma 5.1; thus $|T_0 \cap X| \leq 1$ for $X = Q_0, R_0, S_0$.

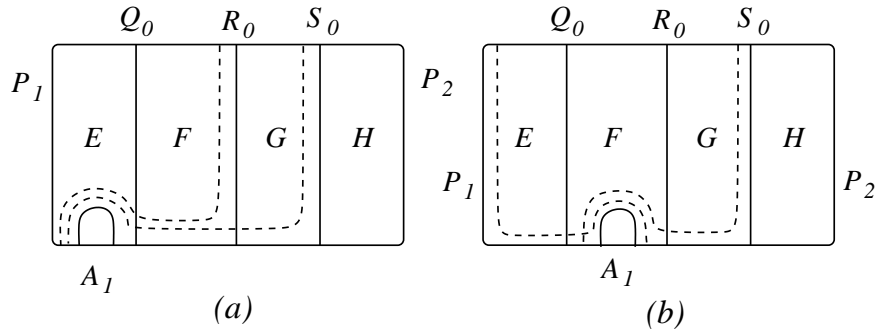

Figure 14: The possible pairs of pants T_0 (in broken lines) in $H(P)$

Let T'_0 be the closure of the pants component of $T_0 \setminus (Q_0 \cup R_0 \cup S_0)$; then T'_0 lies in one of E, F, G , or H , and so T'_0 must be isotopic to P_1, P_2, Q_0, R_0 , or S_0 . Also, since A_1 is unique up to isotopy by Lemma 5.1, we can write $T_0 = T'_0 \oplus A_1$. Therefore, the only choices for T_0 are $X \oplus A_1$ for $X = P_1, Q_0, R_0, S_0$; here we exclude $X = P_2$ since $P_1 \oplus A_1$ and $P_2 \oplus A_1$ give rise to isotopic once-punctured Klein bottles in X_K by the proof of Lemma 6.7.

If $A_1 \subset E$ (the case $A_1 \subset H$ is similar) then $P_1 \oplus A_1 = Q_0$ and $Q_0 \oplus A_1 = P_1$ (see Figure 14(a)), hence $T_0 = R_0 \oplus A_1$ or $S_0 \oplus A_1$. If $A_1 \subset F$ (the case $A_1 \subset G$ is similar) then $R_0 \oplus A_1 = Q_0$ and $Q_0 \oplus A_1 = R_0$ (see Figure 14(b)), hence $T_0 = P_1 \oplus A_1$ or $S_0 \oplus A_1$. In either case we have $|P(K, r)| \leq 5$, and hence $|\mathcal{SK}(K, r)| \leq 6$. Finally, if at most two distinct elements of $P(K, r)$ can be isotoped so as to be disjoint in $H(P)$, it is not hard to see by an argument similar to the above one that in fact the smaller bound $|\mathcal{SK}(K, r)| \leq 4$ holds. \square

Remark It is possible to realize the bound $|P(K, r)| = 3$, so $|\mathcal{SK}(K, r)| \leq 4$, as follows. By [18, Theorem 1.1], any unknotted solid torus $S^1 \times D^2$ in S^3 contains an excellent properly embedded arc whose exterior $V \subset S^1 \times D^2$ is an excellent manifold with boundary of genus two; in particular, $(V, \partial V)$ is irreducible, V is atoroidal and anannular, and $S^3 \setminus \text{int } V$ is a handlebody. Let H, Q_0, P be the genus two handlebody, pair of pants, and once-punctured Klein bottle constructed in the remark just after Lemma 5.3 (see Figure 7). Let H' be the manifold obtained by gluing a solid torus U to H along an annulus in ∂U which runs at least twice along U and which is a regular neighborhood of one of the components of ∂Q_0 which is a lift of the meridian of P ; since such a component is primitive in H , H' is a handlebody. Finally, glue V and H' together along their boundaries so that $V \cup H' = S^3$. Using our results so far

in this section it can be proved (cf proof of Lemma 6.9) that $K = \partial P$ becomes a hyperbolic knot in S^3 , $H(P)$ contains two disjoint nonparallel pair of pants with boundary isotopic to K' and the lifts of a meridian m of P , and one of the lifts of m has a companion annulus in $H(P)$, so $|P(K, r)| = 3$. The bound $|P(K, r)| = 5$ could then be realized if V contained a pair of pants not parallel into ∂V with the correct boundary.

Proof of Theorem 1.1 That $\mathcal{SK}(K, r)$ is either central or meridional and parts (a),(b) follow from Corollary 6.5 and Lemmas 6.3, 6.6, 6.7, and 6.8.

Let $P \in \mathcal{SK}(K, r)$. If P is not π_1 -injective then P is unknotted and K' is primitive in $H(P)$ by Lemma 6.3. Thus, there is a nonseparating compression disk D of T_P in $H(P)$; since K' has no companion annuli in $H(P)$, it follows that $N(P) \cup N(D)$ is homeomorphic to X_K , hence K has tunnel number one. Moreover, if $H(P)(K')$ is the manifold obtained from $H(P)$ by attaching a 2-handle along K' , then $H(P)(K')$ is a solid torus and so $K(r) = N(\widehat{P}) \cup_{\partial} H(P)(K')$ is a Seifert fibered space over S^2 with at most three singular fibers of indices $2, 2, n$. As the only such spaces with infinite fundamental group are $S^1 \times S^2$ and $RP^3 \# RP^3$, that $\pi_1(K(r))$ is finite follows from Property R [8] and the fact that $K(r)$ has cyclic integral first homology. Thus (c) holds.

If P is unknotted and π_1 -injective then T_P is incompressible in $H(P)$, hence, by the 2-handle addition theorem [3], the pair $(H(P)(K'), \partial H(P)(K'))$ is irreducible. As $K(r) = N(\widehat{P}) \cup_{\partial} H(P)(K')$, (d) follows. \square

We discuss now two constructions of crosscap number two hyperbolic knots. The first construction produces examples of meridional families $\mathcal{SK}(K, r)$ with $|\mathcal{SK}(K, r)| = 2$. The second one gives examples of knots K and surfaces P, Q in $\mathcal{SK}(K, r)$ which intersect centrally and such that $|\mathcal{SK}(K, r)| \leq 2$.

6.1 Meridional families

It is not hard to produce examples of hyperbolic knots K bounding *nonequivalent* Seifert Klein bottles P, Q which intersect meridionally: for in this case one of the surfaces can be unknotted and the other knotted, making the surfaces clearly non isotopic. This is the strategy followed by Lyon in [16] (thanks to V. Núñez for pointing out this fact) to construct nonequivalent Seifert *tori* for knots, and his construction can be easily modified to provide infinitely many examples of hyperbolic knots K with $|\mathcal{SK}(K, r)| = 2$, bounding an unknotted Seifert Klein bottle and a strongly knotted one along the same slope.

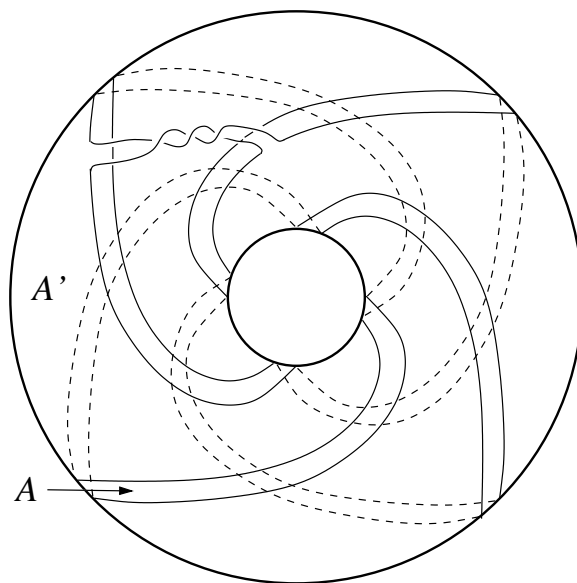

Figure 15: A modified Lyon's knot

The construction of these knots goes as follows. As in [16], let V be a solid torus standardly embedded in S^3 , let A be an annulus embedded in ∂V whose core is a $(\pm 4, 3)$ cable of the core of V , and let A' be the closure of $\partial V \setminus A$. We glue a rectangular band B to ∂A on the outside of V , as in Figure 15, with an odd number of half-twists (-3 are shown). Then the knot $K = \partial(A \cup B)$ bounds the Seifert Klein bottles $P = A \cup B$ and $Q = A' \cup B$ with common boundary slopes; clearly, P and Q can be isotoped so that $P \cap Q = A \cap A'$ is a simultaneous meridian. As in [16], P is unknotted and Q is knotted; this is clear since B is a tunnel for the core of A but not for the core of A' . It is not hard to check that if m_1, m_2 are the lifts of the meridian of P then m_1 , say, is a power (a cube) in $H(P)$ while neither K', m_2 is primitive nor a power in $H(P)$. That K has the desired properties now follows from the next general result.

Lemma 6.9 *Let K be a knot in S^3 which spans two Seifert Klein bottles P, Q with common boundary slope r , such that P is unknotted, Q is knotted, and $P \cap Q$ is meridional. For m_1, m_2 lifts of the meridian m of P , suppose m_1 is a power in $H(P)$ but neither K', m_2 is primitive nor a power in $H(P)$. Then K is hyperbolic, P is π_1 -injective, and $\mathcal{SK}(K, r) = \{P, Q\}$.*

Proof As K' is not primitive nor a power in $H(P)$, T_P is incompressible in

X_K by Lemma 5.2, so K is a nontrivial knot and P is π_1 -injective; moreover, K is not a torus knot by Corollary 1.6 since Q is knotted. Hence by Lemma 6.7 it suffices to show X_K is atoroidal.

Suppose T is an essential torus in X_K which intersects P transversely and minimally. Then $P \cap T$ is nonempty and $P \cap T \subset P$ consists of circles parallel to ∂P and meridians or longitudes of P ; by Lemmas 2.3 and 6.1, since T is not parallel into ∂X_K , it is not hard to see that $P \cap T$ consists of only meridians of P or only longitudes of P . Since the lift of a longitude of P is also a lift of some center of P then, by Lemma 2.3, either the lift l of some center c of P or both lifts m_1, m_2 of the meridian of P have companions in $H(P)$. The second option can not be the case by Lemma 5.2 since only m_1 is a power in $H(P)$. For the first option, observe that, since m and c can be isotoped in P so as to intersect transversely in one point, l can be isotoped in T_P so as to transversely intersect m_1, m_2 each in one point.

Suppose A^* is a companion annulus of l in $H(P)$ with $\partial A^* = l_1 \cup l_2$, and let $Q_0 = Q \cap H(P)$; notice Q_0 is not parallel into $\partial H(P)$, since Q and P are not equivalent in X_K . Isotope A^*, Q_0 so as to intersect transversely and minimally, and let $G_{Q_0} = Q_0 \cap A^* \subset Q_0, G_{A^*} = Q_0 \cap A^* \subset A^*$ be their graphs of intersection; each graph has two arc components. If G_{Q_0} is inessential then A^* is either parallel into $\partial H(P)$ or boundary compresses in $H(P)$ into an essential disk disjoint from K' ; the first option is not the case, while the latter can not be the case either by Lemma 5.2 since, by hypothesis, K' is neither primitive nor a power in $H(P)$. If G_{A^*} is inessential then Q_0 boundary compresses in $H(P)$ into a companion annulus for K' , which is also not the case by Lemma 5.2 since K' is not a power in $H(P)$; for the same reason, $Q_0 \cap A^*$ has no circle components. Thus G_{Q_0} and G_{A^*} are essential graphs, as shown in Figure 16. But, due to the disk face D_0 of G_{Q_0} , it follows that A^* runs twice around the solid torus region R cobounded by A^* and T_P ; hence $R \cup N(B(c)) \subset X_K$ contains a closed Klein bottle, which is impossible. Thus X_K is atoroidal. \square

6.2 Central families

Let S be a closed genus two orientable surface embedded in S^3 . Suppose there are curves $l_1, l_2 \subset S$ which bound disjoint Moebius bands B_1, B_2 , respectively, embedded in S^3 so that $B_i \cap S = l_i$ for $i = 1, 2$. Now let K be an embedded circle in $S \setminus (l_1 \cup l_2)$ which is not parallel to either l_1 or l_2 , does not separate S , and separates $S \setminus (l_1 \cup l_2)$ into two pairs of pants, each containing a copy of both l_1 and l_2 in its boundary. Let P_0, Q_0 be the closures of the components of

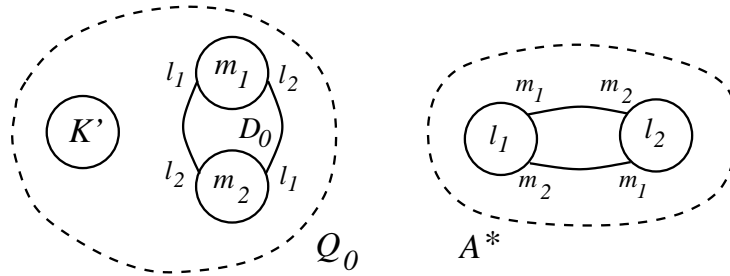

Figure 16

$S \setminus (K \cup l_1 \cup l_2)$. Then K bounds the Seifert Klein bottles $P = P_0 \cup B_1 \cup B_2$ and $Q = Q_0 \cup B_1 \cup B_2$, which have common boundary slope and can be isotoped so as to intersect centrally in the cores of B_1, B_2 . Any knot K bounding two Seifert Klein bottles P, Q with common boundary slope which intersect centrally can be constructed in this way, say via the surface $S = (P \times Q) \cup A$, where A is a suitable annulus in $N(K)$ bounded by $\partial P \cup \partial Q$.

Specific examples can be constructed as follows; however checking the nonequivalence of two Seifert Klein surfaces will not be as simple as in the meridional case, as any two such surfaces are always strongly knotted. Let S be a genus two Heegaard surface of S^3 splitting S^3 into genus 2 handlebodies H, H' . Let l_1, l_2 be disjoint circles embedded in S which bound disjoint Moebius bands B_1, B_2 in H , and let $H_0 \subset H$ be the closure of $H \setminus N(B_1 \cup B_2)$. Finally, let K be a circle in $\partial H \setminus (l_1 \cup l_2)$ as specified above, with P, Q the Seifert Klein bottles induced by K, l_1, l_2 . It is not hard to construct examples of K, l_1, l_2 satisfying the following conditions:

- (C1) l_1, l_2 are not powers in H' ,
- (C2) K is neither primitive nor a power in H_0, H' .

The simplest such example is shown in Figure 17; here l_1, l_2 are primitive in H' , and K represents $y^2x^2y^2x^{-2}y^{-2}x^{-2}$, $XYXY^{-1}X^{-1}Y^{-1}$ in $\pi_1(H), \pi_1(H')$, respectively, relative to the obvious (dual) bases shown in Figure 17. The properties of K, P, Q are given in the next result.

Lemma 6.10 *If $K, l_1, l_2 \subset \partial H$ satisfy (C1) and (C2) and r is the common boundary slope of P, Q , then K is hyperbolic, P and Q are strongly knotted, and $|\mathcal{SK}(K, r)| \leq 2$; in particular, if P and Q are not equivalent then $\mathcal{SK}(K, r) = \{P, Q\}$.*

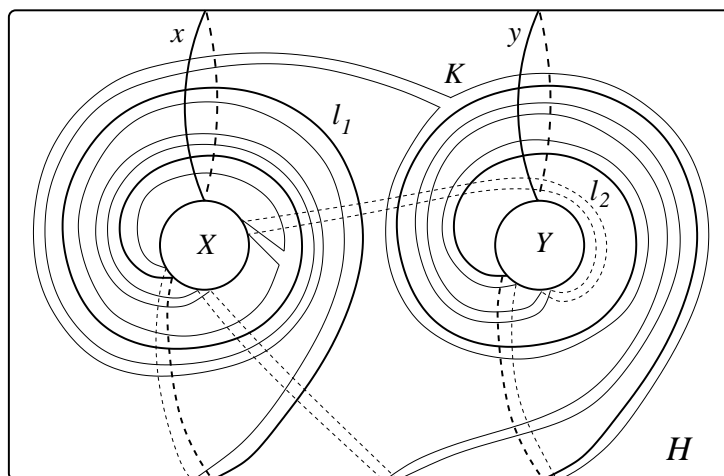
Figure 17: The circles K, l_1, l_2 in ∂H

Proof Observe that $H(P) = H_0 \cup_{Q_0} H'$ and $H(Q) = H_0 \cup_{P_0} H'$. That Q_0 is incompressible and boundary incompressible in $H(P)$ follows from (C1) and (C2) along with the fact that l_1, l_2 are primitive in H_0 . Thus $(H(P), \partial H(P))$ is irreducible, so K is nontrivial and not a cable knot by Theorem 1.5, and P (similarly Q) is strongly knotted. That K is hyperbolic follows now from an argument similar to that of the proof of Lemma 6.9 and, since both H_0 and H' are handlebodies, the bound $|\mathcal{SK}(K, r)| \leq 2$ follows from the proof of Lemma 6.6. \square

7 Pretzel knots

We will denote a pretzel knot of length three with the standard projection shown in Figure 18 by $p(a, b, c)$, where the integers a, b, c , exactly one of which is even, count the number of signed half-twists of each tangle in the boxes. It is not hard to see that if $\{a', b', c'\} = \{\varepsilon a, \varepsilon b, \varepsilon c\}$ for $\varepsilon = \pm 1$ then $p(a, b, c)$ and $p(a', b', c')$ have the same knot type. For any pretzel knot $p(a, b, c)$ with a even, the black surface of its standard projection shown in Figure 18 is an algorithmic Seifert Klein bottle with meridian circle m , which has integral boundary slope $\pm 2(b + c)$ by Lemma 2.1; an algorithmic Seifert surface is always unknotted. By [19], with the exception of the knots $p(2, 1, 1)$ (which is the only knot that has two algorithmic Seifert Klein bottles of distinct slopes produced by the

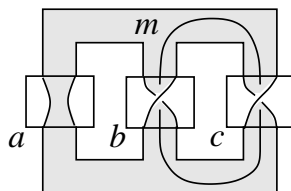

Figure 18: The pretzel knot $p(a, b, c)$ for $a = 0, b = 1, c = 1$

same projection diagram) and $p(-2, 3, 7)$, this is the only slope of $p(a, b, c)$ which bounds a Seifert Klein bottle. Finally, if at least one of a, b, c is ± 1 then $p(a, b, c)$ has bridge number at most 2, the only pretzels $p(a, b, c)$ with $|a|, |b|, |c| \geq 2$ which are torus knots are $p(-2, 3, 3)$ and $p(-2, 3, 5)$, and if one of a, b, c is zero then $p(a, b, c)$ is either a 2-torus knot or a connected sum of two 2-torus knots.

Now let F be the free group on x, y . If w is a cyclically reduced word in x, y which is primitive in F then, by [5] (cf [9]), the exponents of one of x or y , say x , are all 1 or all -1 , and the exponents of y are all of the form $n, n + 1$ for some integer n . Finally, a word of the form $x^m y^n$ is a proper power in F iff $\{m, n\} = \{0, k\}$ for some $|k| \geq 2$.

Proof of Theorem 1.3 Let K be the hyperbolic pretzel knot $p(a, b, c)$ for some integers a, b, c with a even and b, c odd. Let P be the unknotted Seifert Klein bottle spanned by K in its standard projection.

We will show that K' is never primitive in $H(P)$, so P is π_1 -injective by Lemma 6.3; thus $K(r)$ is irreducible and toroidal by Theorem 1.1(d). We will also show that whenever a lift m_1, m_2 of the meridian m of P is a power in $H(P)$ then K is a 2-bridge knot; in such case, by [11, Theorem 1], P is obtained as a plumbing of an annulus and a Moebius band (cf [20]) and P is unique up to isotopy. Along with Lemma 6.7, it will then follow that $|\mathcal{SK}(K, r)| = 1$ in all cases.

The proof is divided into cases, depending on the relative signs of a, b, c . Figure 19 shows the extended regular neighborhood $\tilde{N}(P) = N(P) \cup_{A_K} N(K)$ of P , which is a standard unknotted handlebody in S^3 , along with the circles K', m_1, m_2 with a given orientation. The disks D_x, D_y shown form a complete disk system for $H(P)$, and give rise to a basis x, y for $\pi_1(H(P))$, oriented as indicated by the head (for x) and the tail (for y) of an arrow. Figure 19 depicts the knot $p(2, 3, 3)$ and illustrates the general case when $a, b, c > 0$; we will

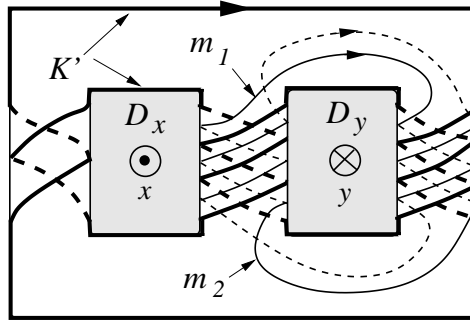

Figure 19

continue to use the same figure, with suitable modifications, in all other cases. By the remarks at the beginning of this section, the following cases suffice.

Case 1 $a = 2n > 0$, $b = 2p + 1 > 0$, $c = 2q + 1 > 0$

In this case, up to cyclic order, the words for K' , m_1 , m_2 in $\pi_1(H(P))$ are:

$$\begin{aligned} K' &= y^{q+1}(xy)^p x^{n+1}(yx)^p y^{q+1} x^{-n} \\ m_1 &= y^q (yx)^{p+1} \\ m_2 &= y^{q+1} (yx)^p \end{aligned}$$

Since $n > 0$ and $p, q \geq 0$, the word for K' is cyclically reduced and both x and x^{-1} appear in K' ; thus K' is not primitive in $H(P)$.

Consider now m_1 and m_2 ; as y and yx form a basis of $\pi_1(H(P))$, if m_1 is a power in $H(P)$ then $q = 0$, while if m_2 is a power then $p = 0$. In either case K is a pretzel knot of the form $p(\cdot, \cdot, 1)$, hence K is a 2-bridge knot.

Case 2 $a = -2n < 0$, $b = 2p + 1 > 0$, $c = 2q + 1 > 0$

This time words for K' , m_1 , m_2 are, up to cyclic order,

$$\begin{aligned} K' &= y^{q+1}(xy)^p x^{1-n}(yx)^p y^{q+1} x^n \\ m_1 &= y^q (yx)^{p+1} \\ m_2 &= y^{q+1} (yx)^p. \end{aligned}$$

If $n > 1$ then the word for K' is cyclically reduced and both x and x^{-1} appear in K' and so K' is not primitive in $H(P)$. If $n = 1$ then, switching to the basis $y, u = xy$ of $\pi_1(H(P))$, K' is represented up to cyclic order by the word

$y^q u^p y u^p y^q u$. Observe that if $p = 0$ or $q = 0$ then $K = p(-2, 1, \cdot)$ which is a 2-torus knot, so $p, q > 0$. Thus, if K' is primitive then necessarily $\{p, q\} = \{1, 2\}$ and so $K = p(-2, 3, 5)$ is a torus knot. Therefore, K' is not primitive in $H(P)$. The analysis of the words m_1 and m_2 is identical to that of Case 1 and yields the same conclusion.

Case 3 $a = 2n > 0$, $b = 2p + 1 > 0$, $c = -(2q + 1) < 0$

Up to cyclic order, words for K', m_1, m_2 are:

$$\begin{aligned} K' &= y^q (xy^{-1})^p x^{n+1} (y^{-1}x)^p y^q x^{-n} \\ m_1 &= y^{q+1} (xy^{-1})^{p+1} \\ m_2 &= y^q (y^{-1}x)^p. \end{aligned}$$

If $p, q > 0$ then the word for K' is cyclically reduced and contains all of x, x^{-1}, y, y^{-1} , so K' is not primitive in $H(P)$. If $p = 0$ then $K' = y^q x^{n+1} y^q x^{-n}$, so K' is primitive iff $q = 0$, in which case $K = p(2n, 1, -1)$ is a 2-torus knot. The case when $q = 0$ is similar, therefore K' is not primitive in $H(P)$.

In this case m_1 can not be a power in $H(P)$ for any values of $p, q \geq 0$, while if m_2 is a power then $p = 0$ or $q = 0$ and hence K is a 2-bridge knot. \square

References

- [1] **W R Alford**, *Complements of minimal spanning surfaces of knots are not unique*, Ann. of Math. 91 (1970) 419–424 MR0253312
- [2] **Francis Bonahon**, *Cobordism of automorphisms of surfaces*, Ann. Sci. École Norm. Sup. (4) 16 (1983) 237–270 MR0732345
- [3] **A J Casson, C McA Gordon**, *Reducing Heegaard splittings*, Topology Appl. 27 (1987) 275–283 MR0918537
- [4] **Bradd Evans Clark**, *Crosscaps and knots*, Internat. J. Math. Math. Sci. 1 (1978) 113–123 MR0478131
- [5] **M Cohen, Wolfgang Metzler, A Zimmermann**, *What does a basis of $F(a, b)$ look like?*, Math. Ann. 257 (1981) 435–445 MR0639577
- [6] **M Culler, C McA Gordon, J Luecke, P Shalen**, *Dehn surgery on knots*, Ann. of Math. 125 (1987) 237–300 MR0881270
- [7] **Julian R Eisner**, *Knots with infinitely many minimal spanning surfaces*, Trans. Amer. Math. Soc. 229 (1977) 329–349 MR0440528
- [8] **David Gabai**, *Foliations and the Topology of 3-Manifolds III*, J. Differential Geom. 26 (1987) 479–536 MR0910018

- [9] **Francisco González-Acuña, Arturo Ramírez**, *A composition formula in the rank two free group*, Proc. Amer. Math. Soc. 127 (1999) 2779–2782 MR1664378
- [10] **C McA Gordon, J Luecke**, *Dehn surgeries on knots creating essential tori. I*, Comm. Anal. Geom. 3 (1995) 597–644 MR1371211
- [11] **A Hatcher, W Thurston**, *Incompressible surfaces in 2-bridge knot complements*, Invent. Math. 79 (1985) 225–246 MR0778125
- [12] **John Hempel**, *3-Manifolds*, Ann. of Math. Studies 86, Princeton University Press, Princeton, N. J. (1976) MR0415619
- [13] **Kazuhiro Ichihara, Masahiro Ohtouge, Masakazu Teragaito**, *Boundary slopes of non-orientable Seifert surfaces for knots*, Topology Appl. 122 (2002) 467–478 MR1911694
- [14] **Osamu Kakimizu**, *On maximal fibred submanifolds of a knot exterior*, Math. Ann. 284 (1989) 515–528 MR1001718
- [15] **Osamu Kakimizu**, *Incompressible spanning surfaces and maximal fibred submanifolds for a knot*, Math. Z. 210 (1992) 207–223 MR1166521
- [16] **Herbert C Lyon**, *Simple knots without unique minimal surfaces*, Proc. Amer. Math. Soc. 43 (1974) 449–454 MR0377850
- [17] **Wilhelm Magnus, Abraham Karrass, Donald Solitar**, *Combinatorial group theory*, revised edition, Dover Publications Inc., New York (1976) MR0422434
- [18] **Robert Myers**, *Excellent 1-manifolds in compact 3-manifolds*, Topology Appl. 49 (1993) 115–127 MR1206219
- [19] **E Ramírez-Losada, L G Valdez-Sánchez**, *Once-punctured Klein bottles in knot exteriors*, to appear in Topology Appl.
- [20] **E Ramírez-Losada, L G Valdez-Sánchez**, *Crosscap number two knots in S^3 with (1,1) decompositions*, preprint (2004)
- [21] **Horst Schubert, Kay Soltsien**, *Isotopie von Flächen in einfachen Knoten*, Abh. Math. Sem. Univ. Hamburg 27 (1964) 116–123 MR0166780
- [22] **Masakazu Teragaito**, *Dehn surgeries on composite knots creating Klein bottles*, J. Knot Theory Ramifications 8 (1999) 391–395 MR1691488
- [23] **Masakazu Teragaito**, *Crosscap numbers of torus knots*, Topology Appl. 138 (2004), 219–238 MR2035482

Department of Mathematical Sciences, University of Texas at El Paso
El Paso, TX 79968, USA

Email: valdez@math.utep.edu

Received: 10 November 2003 Revised: 10 March 2004