

University of Nebraska - Lincoln
DigitalCommons@University of Nebraska - Lincoln

Architectural Engineering -- Faculty Publications

Architectural Engineering and Construction,
Durham School of

2018

Comfort-based Optimal Temperature Setpoint Calculation

Andrew Holthaus

University of Nebraska - Lincoln, aholthaus@unomaha.edu

Mostafa Rafaie

University of Nebraska - Lincoln, mostafa.rafaie@gmail.com

Fadi Alsaleem

University of Nebraska-Lincoln, falsaleem2@unl.edu

Follow this and additional works at: <http://digitalcommons.unl.edu/archengfacpub>

 Part of the [Architectural Engineering Commons](#), [Construction Engineering Commons](#), [Environmental Design Commons](#), and the [Other Engineering Commons](#)

Holthaus, Andrew; Rafaie, Mostafa; and Alsaleem, Fadi, "Comfort-based Optimal Temperature Setpoint Calculation" (2018).
Architectural Engineering -- Faculty Publications. 144.
<http://digitalcommons.unl.edu/archengfacpub/144>

This Article is brought to you for free and open access by the Architectural Engineering and Construction, Durham School of at DigitalCommons@University of Nebraska - Lincoln. It has been accepted for inclusion in Architectural Engineering -- Faculty Publications by an authorized administrator of DigitalCommons@University of Nebraska - Lincoln.

July 2018

Comfort-based Optimal Temperature Setpoint Calculation

Andrew Holthaus

University of Nebraska–Lincoln, United States of America, aholthaus@unomaha.edu

Mostafa Rafaie

University of Nebraska–Lincoln, United States of America, mostafa.rafaie@gmail.com

Fadi Alsaleem

University of Nebraska–Lincoln, United States of America, falsaleem2@unl.edu

Follow this and additional works at: <https://docs.lib.purdue.edu/ihpbc>

Holthaus, Andrew; Rafaie, Mostafa; and Alsaleem, Fadi, "Comfort-based Optimal Temperature Setpoint Calculation" (2018).
International High Performance Buildings Conference. Paper 262.
<https://docs.lib.purdue.edu/ihpbc/262>

This document has been made available through Purdue e-Pubs, a service of the Purdue University Libraries. Please contact epubs@purdue.edu for additional information.

Complete proceedings may be acquired in print and on CD-ROM directly from the Ray W. Herrick Laboratories at <https://engineering.purdue.edu/Herrick/Events/orderlit.html>

Comfort-based Optimal Temperature Setpoint Calculation

Andrew HOLTHAUS, Mostafa RAFAIE, Fadi ALSALEEM*

University of Nebraska - Lincoln

Durham School of Architectural Engineering and Construction

Omaha, NE

Contact Information (402 554-3283; falsaleem2@unl.edu)

* Corresponding Author

ABSTRACT

General practice in current building HVAC control is to select building temperature setpoints that comply with ASHRAE Standard 55. By meeting this standard, based on the PMV comfort model, 80% of building occupants should be satisfied with their thermal environment. However, unfortunately, this is rarely the case. One possible reason for this is the variation in occupant activity and clothing that are usually assumed default values using this standard. In this work, we present an iterative-based algorithm to solve this problem. The algorithm solves the PMV inverse model equation to determine the optimal temperature setpoint while inferring human activity level from the biometric data of wearable fitness devices. The new algorithm is also designed to handle multi-occupants with conflicting comfort preferences scenario. Using this new algorithm, our results show a significant increase in occupant comfort, specifically when occupant activity is high.

1. INTRODUCTION

Buildings owners invest large amounts of money into HVAC systems (Pérez-Lombard et al., 2008) to increase people thermal comfort. Thermal comfort affects psychological state (Maula et al., 2015) and even productivity (Seppanen et al., 2006). However, comfort goals are not always met. In one study, the satisfaction comfort goal was reached in only 11% of a 215-building sample size (Huizenga et al., 2006). Engineers typically use ASHRAE Standard 55 to calculate temperature setpoints to achieve adequate comfort conditions. The ASHRAE Standard 55 is based on P.O. Fanger's Predicted Mean Vote (PMV) thermal comfort model which predicts occupant comfort based on temperature, humidity, mean radiant temperature, air velocity, clothing insulation (CLO), and metabolic rate (MET). Within the PMV model, not all variables affect comfort equally. For example, PMV comfort has low sensitivity to humidity and high sensitivity to MET, CLO, temperature and air velocity (Hasan et al., 2016). ASHRAE Standard 55 has recommended fixed MET values that are typical of an average person activity level. However, not all people are the same and variations in age (Lazzer et al., 2010), body type (Arciero et al., 1993), and activity levels, resulting in significant differences in MET values from person to person. In this regard, the first objective of this paper is to investigate how MET variations can potentially affect PMV values.

In the past, utilizing real-world metabolic data would have been difficult, but today, wearable fitness devices make it easy to get relatively accurate readings of the human metabolic rate. Not all these devices are perfect, and some have been shown to provide daily calorie consumption data that is off by up to 200 calories (Murakami et al., 2016). While it is desirable that these devices become more accurate, their recorded MET values are still likely to be closer than assumed values. However, it is not clear yet how these wearable fitness MET values can be used to automatically update building temperature setpoints as occupant activity changes (Feldmeier and Paradiso, 2010). Investigating the

effectiveness of a setpoint optimization method that incorporates the actual MET values is the second focus of this paper. The aforementioned objectives of this paper are summarized in Figure 1.

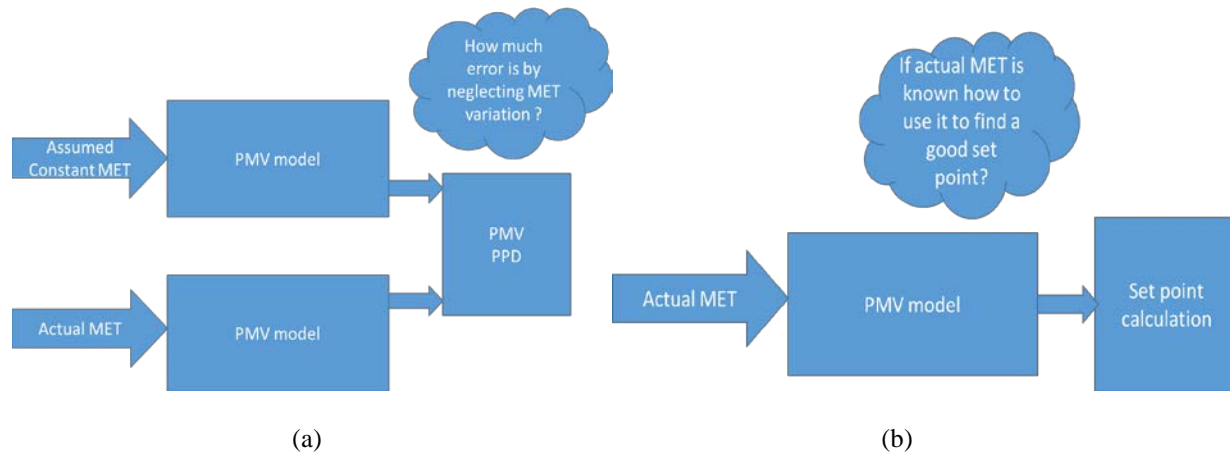

Figure 1: The paper objectives, (a) finding the effect of neglecting MET variation on the PMV model calculation accuracy, (b) if actual MET were measured how to incorporate these measurements in determining the best possible temperature set point?.

2. METHODOLOGY

This study uses simulations that are reliant on the PMV thermal comfort model as an accurate representation of human thermal comfort. For the first objective, hypothetical simulations were done based on both summer and winter CLO and three different levels of MET variation (i.e. MET was randomly varied within a given range), resulting in a total of six simulations. These MET values ranged from 1.0-1.3, 1.0-2.0, and 1.0-3.0. Although these MET values were hypothetical, they represent the variations in actual MET values. Humidity was assumed to be 50% and air velocity was assumed to be 0.1 meters per second. To compare with the standard implementation of the ASHRAE Standard 55, a MET value of 1.2 was assumed when making the setpoint selection resulting in 76°F and 71°F setpoints for summer and winter, respectively. Finally, the radiant temperature was assumed to be the same as the dry bulb temperature. Two sets of PMV and Predicted Percentage Dissatisfied (PPD) values were simulated and compared based on the varying and assumed MET values.

The second part of this paper studies setpoint optimization algorithms developed to account for the actual variation of metabolism. These algorithms use metabolic rates from wearable fitness devices. The accuracy of wearable devices is not perfect as previously described in (Murakami et al., 2016). For this study, it is assumed that these devices are completely accurate. The accuracy of these devices is not the focus of this study, but it is important to investigate wearable device accuracy in future research to verify that this method is practical. Separate algorithms were developed to be able to operate within both a single and a multi-occupant space. For the single occupant space, the algorithm described in Figure 2 calculates the PMV based on the known comfort variables within the space. If the PMV is between -0.1 and +0.1, no setpoint adjustment is made. Otherwise, the setpoint is adjusted as needed until the PMV reaches 0. Although the thermal comfort zone is between -0.5 and +0.5, it makes more sense to bring the PMV as close to zero as possible because this is where predicted comfort is at its maximum value. This algorithm requires that the temperature setpoint remains between 65°F and 80°F. This boundary was added because temperatures outside of this range are not practical setpoints. Before this boundary was added, the algorithm recommended setpoints as low as 45°F based on extremely high metabolic rates. Additionally, a maximum temperature change of 4°F is allowed for each setpoint adjustment, made at thirty-minute intervals. This was done to keep air temperatures relatively consistent and allow the assumption of equal air and radiant temperatures to be as accurate as possible. The thirty-minute interval allows frequent adjustments while still allowing the air to mix, and for a steady state condition to exist as is required for the use of the PMV model.

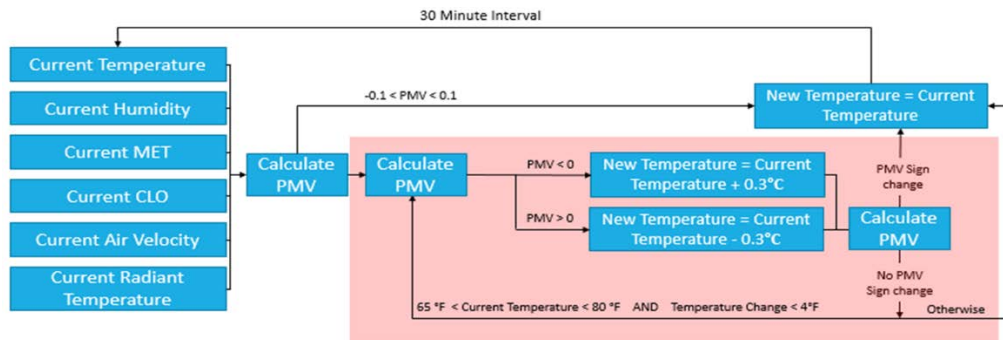

Figure 2: Single occupant optimized temperature algorithm.

The multi-occupant algorithm can negotiate comfort between multiple occupants to select the ideal temperature for all occupants in the space as shown in Figure 3 for three occupants in a room. The algorithm first calculates the existing PMV values of each occupant within the space. The negotiation begins by looking at the warmest occupant. If the occupant has a metabolic rate that is below 2.0, the algorithm adjusts the setpoint until they reach the comfort zone. Setpoint adjustments are only made if the occupant metabolic rate is below 2.0, because higher metabolic rates are associated with heavy activity levels such as exercising. It is difficult to satisfy these occupants and doing so would be at the expense of the other occupants. Instead, the algorithm focuses on occupants that can be easily satisfied. Typical summer CLO values are 0.5 and occupants will not be able to reduce this value significantly. The algorithm was designed to address the warmest occupants first because CLO can only be decreased by a finite number. CLO can be increased indefinitely until comfort is reached within the cold occupants. The algorithm only attempts to bring each occupant to the regular comfort zone, because reaching zero is difficult with conflicting occupant needs. After making the initial setpoint adjustment, the algorithm then adjusts the setpoint for the second and then the third warmest occupants. After each adjustment, a new boundary is added so that previously addressed occupant are not pushed outside of the comfort zone. Throughout all setpoint adjustments, the same temperature and temperature change boundaries from the single occupant algorithm are used. When adjustments have been made for all three occupants, the current setpoint is recommended as the optimized setpoint. The multi-occupant setpoint is also updated at thirty-minute intervals.

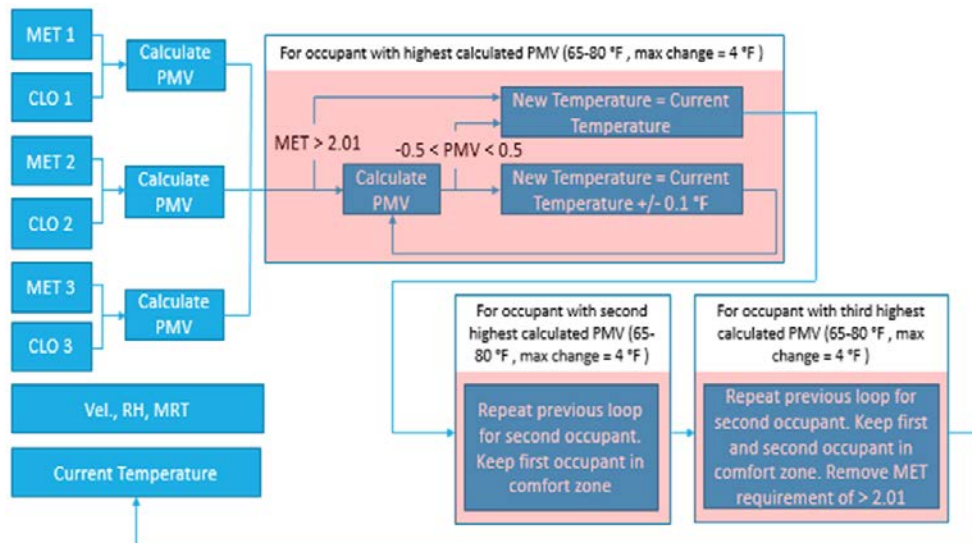

Figure 3: Multi occupant optimized temperature algorithm.

Using these algorithms, a single occupant simulation of setpoint optimizations was made using both real and hypothetical data. These simulations compare PPD values calculated using the existing temperature and PPD calculated using the optimized temperature. The hypothetical data sets were the same sets generated for the first section. Three real data sets were also used in a separate simulation to verify the results with real occupant metabolic

schedules. Datasets for 22 and 35-year-old students were previously used in (Hasan et al., 2016) and re-used with permission of the authors. A third data set was recorded by having an occupant self-identify their CLO value through a smartphone prompt, calculating their MET using caloric consumption data from a Microsoft Smart Band 2, and recording the temperature and humidity using an Acurite Indoor Digital Black Thermometer. Throughout the real and hypothetical data sets, it was assumed that the air temperature and radiant temperature were equal, and the air velocity was 0.1 meters per second. After demonstrating the impact in a single occupant space, a three-occupant space was modeled, by keeping all three occupant personal variables separate and averaging the room variables.

3. RESULTS

3.1 Real and Assumed MET Demonstration (Objective 1)

Table 1 shows the PPD variations based on three separate MET ranges. This Table shows that when the MET range gets larger, the difference between the real and assumed PPD increases. In the lowest MET range, they are very similar. In the highest MET range, average PPD disparities of nearly 23% were seen. ASHRAE Standard 55 is only applicable if the MET is between 1 and 2, and the Table shows that, if metabolic rates vary randomly within this range, there is a substantial difference between real and assumed PMV and PPD. Engineers are typically good at making reasonable MET assumptions, but sometimes personal factors mean MET estimations are not entirely accurate. ASHRAE Standard 55 is effective, but it is likely that using real metabolic information can increase comfort, by verifying the accuracy of the MET assumption.

Table 1: Potential variations between PPD values based on real and assumed MET values

MET Range	Difference Between Real and Assumed PPD	
	Summer (CLO = 0.5)	Winter (CLO = 1.0)
1.0 < MET < 1.3	2.22%	1.46%
1.0 < MET < 2.0	7.79%	7.58%
1.0 < MET < 3.0	22.86%	21.42%

3.2 Setpoint Calculations for Single-Occupant Spaces Using Hypothetical Data (objective 2)

Table 2 shows the average PPD decreases that were seen between the baseline and optimized conditions. The PPD is the percentage of dissatisfied occupants, therefore, decreasing PPD results in more comfortable occupants. For example, a 20% PPD decrease means an additional 20% of occupants within the space were satisfied. The more the MET varies, the more beneficial the implementation of setpoint optimizations is. This makes sense because, when activity varies substantially, making a singular MET assumption becomes less accurate and the need for optimized setpoint adjustments increases. The algorithm appears to be less effective during the winter. This is simply because high metabolic rates force the setpoint down. The baseline winter setpoint was only 71°F while it was 76°F during the summer. Based on the lower temperature boundary, the setpoint algorithm can only decrease the setpoint by 6°F during the winter as opposed to 11°F during the summer.

Table 2: PPD Reduction Using Optimized Setpoints on a Hypothetical Data Set

MET Range	Difference Between Baseline and Optimized PPD	
	Summer (CLO = 0.5)	Winter (CLO = 1.0)
1.0 < MET < 1.3	2.61%	1.18%
1.0 < MET < 2.0	6.58%	5.84%
1.0 < MET < 3.0	16.94%	10.64%

3.3 Setpoint Calculations for Single-Occupant Spaces Using Real Data (objective 2)

The previous simulations assumed MET variations were random within specified MET ranges. However, in Figures 4, 5, and 6 we show the results using real measured MET values for 22, 35, and 23-year-old students, respectively. These figures show that optimized setpoints can still increase predicted comfort based on real data sets including activity schedules measured in real-world building occupants rather than assumed values. When metabolic rates are high, the optimized setpoint is low. This is because the algorithm makes setpoint adjustments specifically to bring the

PMV as close to zero as possible, and increased metabolic rates require decreased temperatures to keep PMV at zero. For this reason, the optimized PMV is almost always closer to zero than the baseline PMV, or the PMV found using the real temperature reading. However, the temperature adjustment boundaries prevent the occupant from reaching the comfort zone when their metabolic rates are high. This is acceptable because the PMV equation is known to be less accurate with such high MET values.

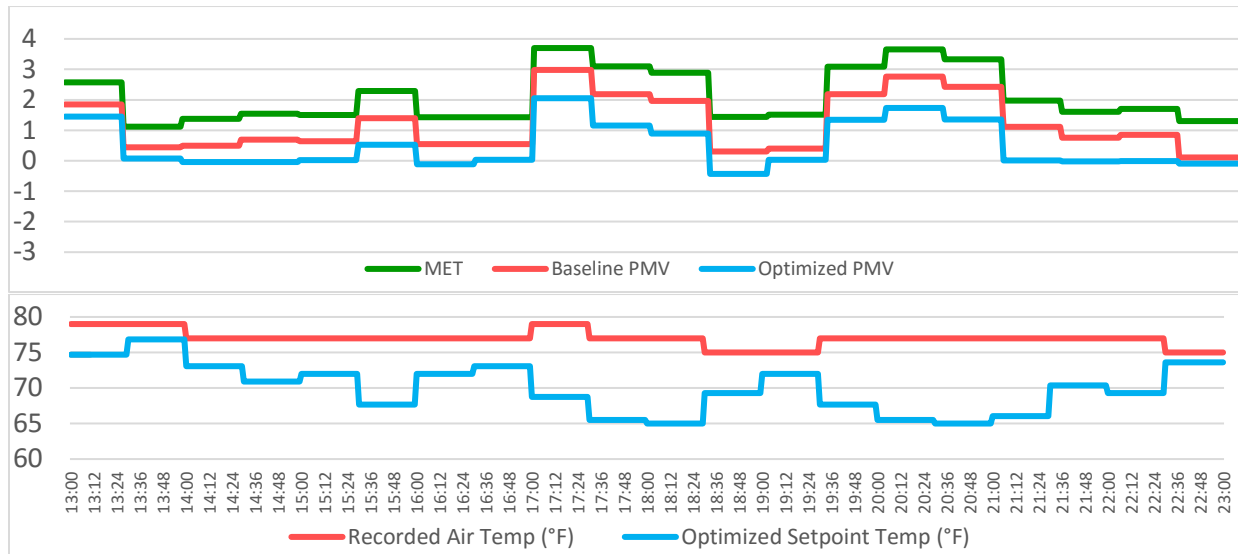

Figure 4: Single Occupant Optimized PMV for a 22-Year-Old Student.

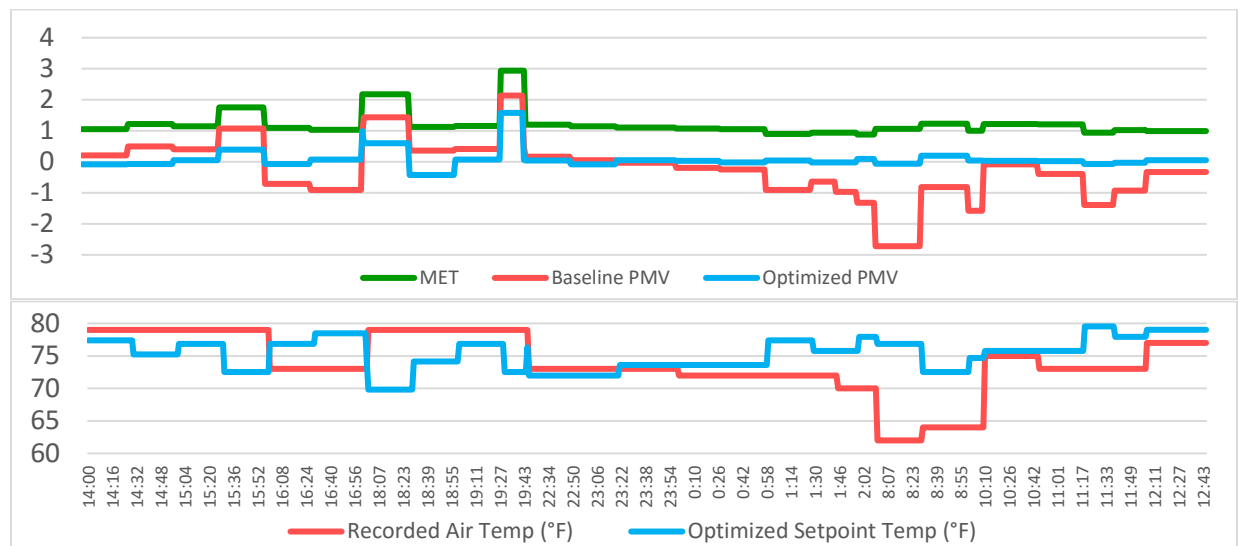

Figure 5: Single Occupant Optimized PMV for a 35-Year-old Student

Although rare, there were some instantaneous cases when applying optimized setpoints reduces predicted comfort. In nearly all cases, this was because of the maximum temperature adjustment boundary. In Figure 4, the optimized PMV is further away from zero than the baseline comfort at about 6:30 PM. The figure shows that just prior, the occupant had a high metabolic rate. This forced the temperature to its minimum value which is why predicted comfort increases were seen. However, the occupant's metabolic rate abruptly returns to their basal MET value so this previous setpoint adjustment becomes too cold for them. The algorithm can only increase the setpoint temperature by 4°F every thirty minutes, so it wasn't able to fully recover during the first setpoint adjustment and the baseline condition was already good for this time period. After making another adjustment thirty minutes later, the PMV returned to zero. This has the potential to provide problems if the occupant activity cycles between high and low activity levels frequently.

However, the data sets shown in Figures 4 and 5 already show consistent activity variation that most likely exceeds that of a typical person and the problem only occurred twice.

For the 35-year-old, the baseline temperature varies substantially, however, this variation did not seem to be helping the occupant's baseline comfort. At about 8:00 AM, this variation resulted in the temperature being 62°F. This resulted in a baseline PMV of nearly -3. However, the setpoint optimization algorithm recommended a better setpoint so that PMV remained near zero. Excluding the three cases when their metabolic rate increased significantly, the 35-year-old student's PMV was always close to zero. The 22 and 35-year-old student had large MET variations and saw the largest predicted comfort increases. The 23-year-old student had an optimized PMV of approximately zero throughout the entire simulation. This is because they had low metabolic variation. This student's optimized PMV was generally closer to zero than their baseline PMV as well.

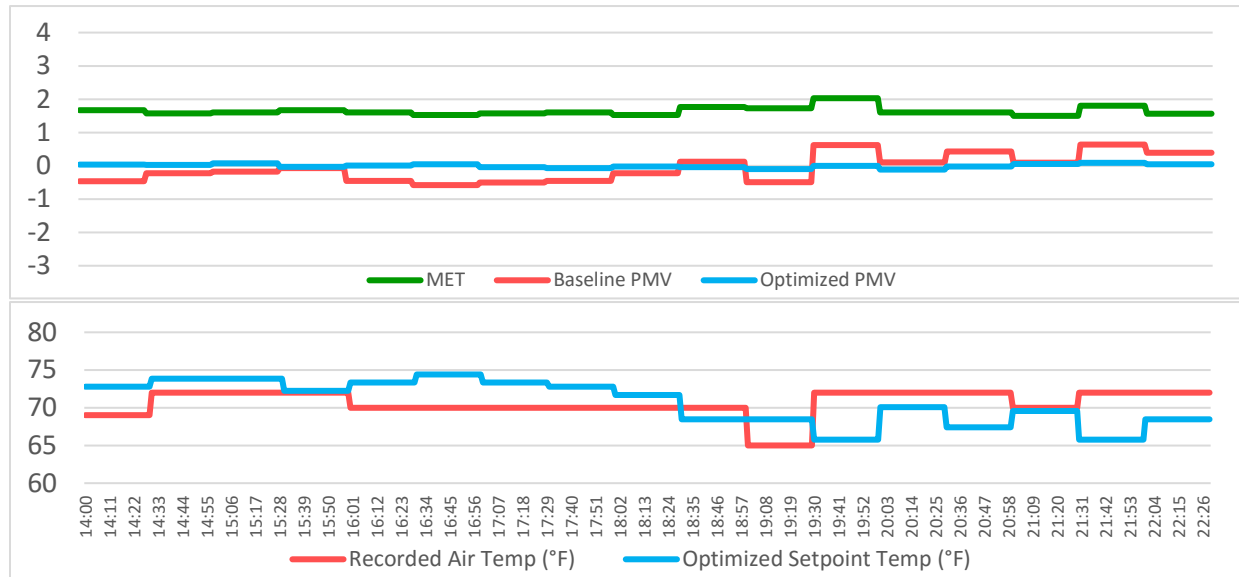

Figure 6: Single Occupant Optimized PMV for a 23-Year-Old Student.

Table 3 shows the average PPD decreases seen when optimized setpoints were applied to the real-world occupants. In this case, the PMV was calculated on an individual basis. PMV and PPD are usually applied to a group rather than a single occupant. In this case, the PMV was calculated for a single-occupant space, and by looking at how a group of people would respond to identical conditions that the individual is exposed to, PPD still indicates the likelihood that a single occupant is comfortable. The 22 and 35-year-old students had large activity variations that were indicative of residential activities that range from sleeping to exercising. The 23-year-old data set was more indicative of sedentary office activities. The occupants with high metabolic variation experienced large PPD decreases. This verifies the results seen in the hypothetical data simulation. The average PPD decrease seen by the 22 and 35-year-old students were 19.98% and 13.25% respectively. The student engaging in sedentary activity experienced a much lower PPD decrease, however, an average PPD decrease of 3.29% was still a meaningful predicted comfort increase, especially considering their PMV was consistently at zero.

Table 3: PPD Reduction Using Optimized Setpoints on a Single-Occupant Space Using Real-World Data

Student	Difference Between Baseline and Optimized PPD
22-Year-Old	19.98%
35-Year-Old	13.25%
23-Year-Old	3.29%

3.4 Setpoint Calculations for Multi-Occupant Spaces Using Real Data (objective 2)

The multi-occupant room was modeled as previously described and an optimized setpoint was negotiated using the multi-occupant python algorithm previously described. Figures 7, 8, and 9 show the results of this simulation. Figure

7 shows two periods of time when no data was available. During these times, it was assumed that this occupant had left the room, and the algorithm negotiated the setpoint between two students instead of three. Because the students were in the same room, the baseline and optimized temperatures were the same for all three students. These figures show that the optimized PMV values are rarely at zero. PMV values that are between the black lines are within the thermal comfort zone. The PMV values in nearly all cases were within the thermal comfort zone. This was because the multi-occupant algorithm uses the comfort zone rather than zero PMV as the comfort goal of each occupant. The occupants' optimized PMV was always within the thermal comfort zone, excluding cases when their metabolic rates exceeded two.

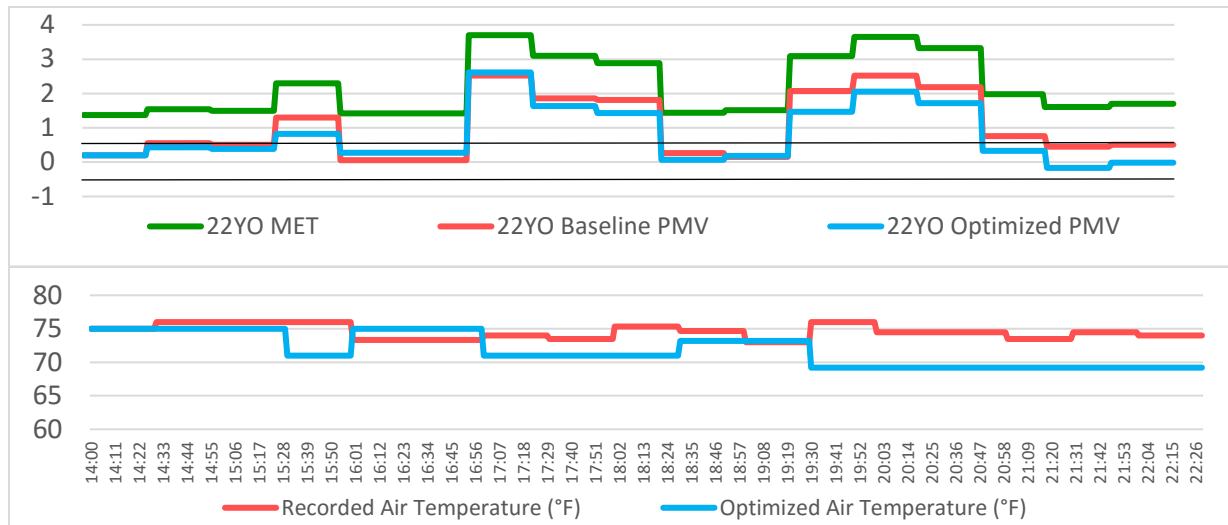

Figure 7: Multi Occupant Optimized PMV for a 22-Year-Old Student

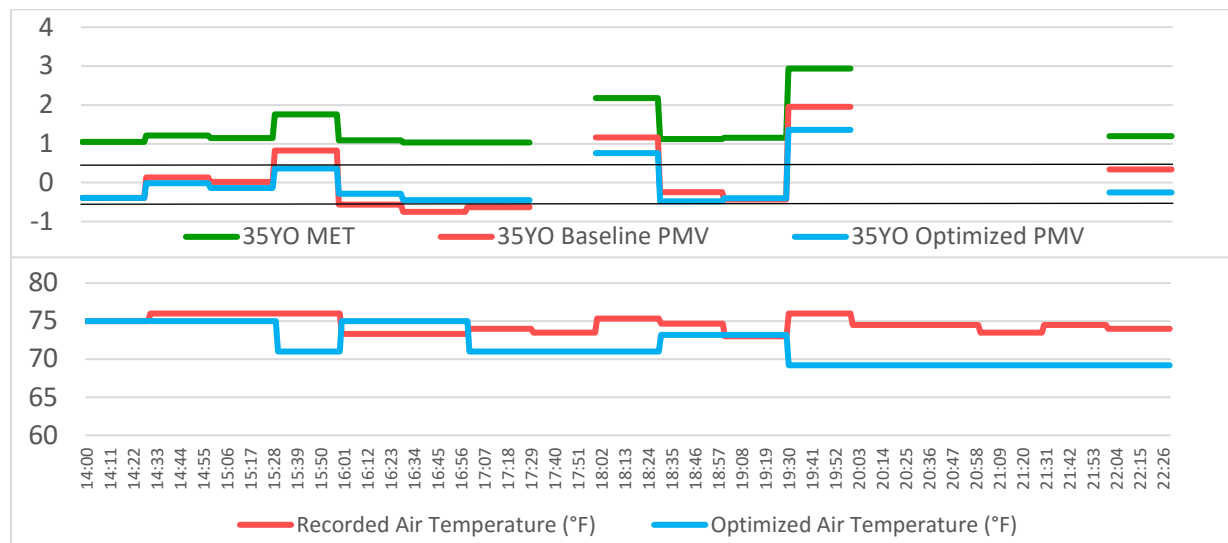

Figure 8: Multi Occupant Optimized PMV for a 35-Year-Old Student.

Table 4 shows the average PPD decrease seen when optimized setpoints were added. As with the single occupant simulation, the two students with large MET variation saw large PPD decreases while the 23-year-old student saw a lower PPD decrease. This figure also shows that, while the optimized PPD is still better than the baseline PPD for all three students, it is not by the same magnitude seen in the single-occupant simulation. For the 23-year-old student, the PPD decrease was larger in the multi-occupant simulation than in the single occupant simulation. Averaging the temperatures to produce the new baseline temperature in the multi-occupant simulation resulted in baseline comfort that was worse in the multi-occupant simulation. Because the baseline was better in the single occupant simulation,

there was less room to improve comfort. This is really the reason the algorithm was more effective in the multi-occupant space for the 23-year-old student.

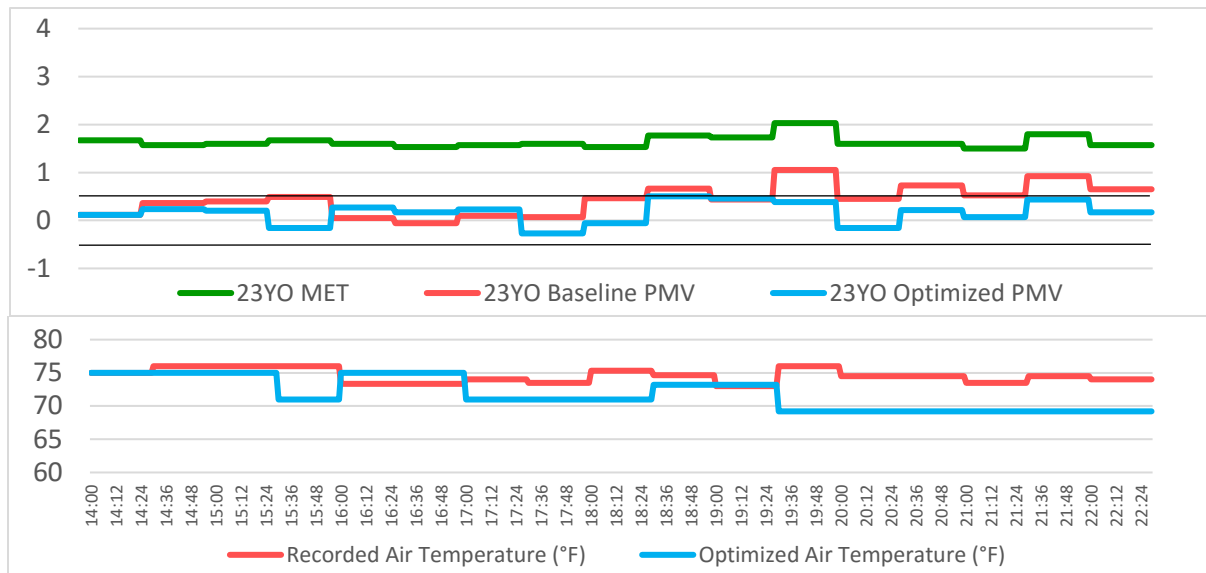

Figure 9: Multi Occupant Optimized PMV for a 23-Year-Old Student.

Although the multi-occupant method appears to be less effective, it is more practical. A typical space is likely to have more than one occupant. If this is the case, then the single occupant method cannot truly be applied. It could be applied by averaging the metabolic rate for each occupant. This would likely appear to improve predicted comfort. However, it would be because this model would not accurately account for each individual's comfort, only the average person. This method can recognize when the entire room's activity changes and make any necessary setpoint adjustments, but it still cannot account for the differences between occupants. The multi-occupant algorithm can check each individual within the room and verify that all occupants that can be satisfied are within the thermal comfort zone. For this reason, the multi-occupant algorithm is the ideal setpoint calculation method.

Table 4: PPD Reduction Using Optimized Setpoints on a Multi-Occupant Space Using Real-World Data

Student	Difference Between Baseline and Optimized PPD
22-Year-Old	8.25%
35-Year-Old	6.17%
23-Year-Old	4.36%

4. CONCLUSIONS

The simulations presented in this paper are idealized. It is based on predicted comfort rather than real comfort votes and assumes that the PMV index is representative of human comfort for all metabolic rates. In actuality, the PMV equation was derived based on metabolic rates between 1.0 and 2.0. Additionally, it calculates comfort based on the setpoint temperature and does not account for the lag between the room and setpoint temperatures. Finally, it assumes that the radiant and dry bulb temperatures are equal. These assumptions simplify the simulation; however, further investigation may be needed to account for these assumptions. With these stipulations identified, some preliminary conclusions can be made on how effective this setpoint optimization method can be.

If used properly and only when it applies, ASHRAE Standard 55 is effective. However, selecting setpoints utilizing real metabolic information rather than assumed metabolic rates appears to be able to improve predicted comfort when significant metabolic variation exists. Occupant metabolic rates can vary for a variety of reasons. Any variation between real and assumed MET values will result in discrepancies between real and assumed PPD. The largest discrepancies are seen when this variation is large. Some MET variation can be seen within the data sets collected for

this study. The 35-year-old student had a basal MET value of approximately 1.0 while the 22 and 23-year-old students had basal MET values of approximately 1.5 and 1.6 respectively. This data appears to confirm the previous findings that metabolic rates vary from person to person and are not exclusively reliant on the activity being performed.

When metabolic information was used within the setpoint selection algorithms, the PMV values improved. This means that there was an increase in predicted comfort according to the PMV model. This result was seen in simulations of three different single occupant spaces as well as a multi-occupant space. The magnitude by which PMV values improve appears to be dependent on how much occupant metabolic rates vary throughout the day. PMV improvements were smaller in the multi-occupant space due to conflicting occupant needs. However, this algorithm is more practical because most rooms will have more than one occupant at a time and this method allows the setpoint to be selected to satisfy each individual rather than the average individual.

REFERENCES

ASHRAE Standard 55 (2013). "Thermal Environmental Conditions for Human Occupancy".

Arciero, P. J., Goran, M. I., and Poehlman, E.T. (1993). "Resting metabolic rate is lower in women than in men." *Journal of Applied Physiology*, 75(6), 2514–2520

Fanger, P. O. (1970). Thermal Comfort: Analysis and applications in environmental engineering. McGraw-Hill.

Feldmeier, M., and Paradiso, J. A. (2010). "Personalized HVAC control system." *2010 Internet of Things (IOT)*.

Hasan, M. H., Alsaleem, F., and Rifaie, M. (2016). "Sensitivity study for the PMV thermal comfort model and the use of wearable devices biometric data for metabolic rate estimation." *Building and Environment*, 110, 173–183.

Hoyt Tyler, Schiavon Stefano, Piccioli Alberto, Cheung Toby, Moon Dustin, and Steinfeld Kyle, 2017, CBE Thermal Comfort Tool. Center for the Built Environment, University of California Berkeley, <http://comfort.cbe.berkeley.edu/>

Huizenga, C., Abbaszadeh, S., Zagreus, L., and Arens, E. (2006). "Air Quality and Thermal Comfort in Office Buildings: Results of a Large Indoor Environmental Quality Survey" Proc., Healthy Buildings '06, Vol.3, Lisbon, 393-397

Maula, H., Hongisto, V., Östman, L., Haapakangas, A., Koskela, H., and Hyönä, J. (2015). "The effect of slightly warm temperature on work performance and comfort in open-plan offices - a laboratory study." *Indoor Air*, 26(2), 286–297.

Murakami, H., Kawakami, R., Nakae, S., Nakata, Y., Ishikawa-Takata, K., Tanaka, S., and Miyachi, M. (2016). "Accuracy of Wearable Devices for Estimating Total Energy Expenditure." *JAMA Internal Medicine*, 176(5), 702.

Lazzer, S., Bedogni, G., Lafortuna, C. L., Marazzi, N., Busti, C., Galli, R., Col, A. D., Agosti, F., and Sartorio, A. (2010). "Relationship Between Basal Metabolic Rate, Gender, Age, and Body Composition in 8,780 White Obese Subjects." *Obesity*, 18(1), 71–78.

Pérez-Lombard, L., Ortiz, J., and Pout, C. (2008). "A review on buildings energy consumption information." *Energy and Buildings*, 40(3), 394–398.

Seppanen, O., Fisk, W., Lei, Q. (2006). "Effect of Temperature on Task Performance in Office Environment." Lawrence Berkeley National Laboratory, LNBL report 60946.