

COPYRIGHT NOTICE

The copyright of this thesis vests in the University of the Witwatersrand, Johannesburg, South Africa, in accordance with the University's Intellectual Property Policy. No portion of the text may be reproduced, stored in a retrieval system, or transmitted in any form or by any means, including analogue and digital media, without prior written permission from the University. Extracts of or quotations from this thesis may, however, be made in terms of Sections 12 and 13 of the South African Copyright Act No. 98 of 1978 (as amended), for non-commercial or educational purposes. Full acknowledgement must be made to the author and the University. An electronic version of this thesis is available on the Library webpage (www.wits.ac.za/library) under "Research Resources". For permission requests, please contact the University Legal Office or the University Research Office (www.wits.ac.za).

The Interface Between Physiology and Environment in the Rainbow Skink (*Trachylepis margaritifer*)

Ashadee Kay Miller

A thesis submitted to the Faculty of Science, University of the Witwatersrand,
Johannesburg in fulfilment of the requirements for the degree of Master of Science

JOHANNESBURG

March 2016

DECLARATION

I declare that this dissertation is my own unaided work. It is being submitted for the degree of Master of Science at the University of the Witwatersrand, Johannesburg. It has not been submitted before for any degree or examination at any other University.



Ashadee Kay Miller

23rd day of March in the year 2016

This work is dedicated to my family and close friends who remained supportive during trying times.

“... I want to stay as close to the edge as I can without going over. Out on the edge you can see all kinds of things you can't see from the center.”

Kurt Vonnegut Jr, *Player Piano*, 1952.

PUBLICATIONS EMANATING FROM THIS RESEARCH

- i. **Miller A.K.**, Erasmus B.F.N. & G.J. Alexander. 2013. Gut and intestinal passage time in the Rainbow Skink (*Trachylepis margaritifera*): implications for stress measures using faecal analysis. *Journal of Animal Physiology and Animal Nutrition* **97** (5): 960-970.
- ii. **Miller A.K.**, Erasmus B.F.N. & G.J. Alexander. 2014. Digestive efficiencies are independent of gut passage times in rainbow skink (*Trachylepis margaritifera*). *Comparative Biochemistry and Physiology – Part A: Molecular and Integrative Physiology* **175**: 110-114.

These papers are presented in their published form as chapters within this thesis.

ACKNOWLEDGEMENTS

Prof. Graham Alexander and Prof. Barend Erasmus have been patient and understanding of this project's extended timeframe. Their guidance and support have been integral in shaping this work. Graham Alexander's mentoring and friendship have determined much of the path I travel now, both academically and personally.

My parents have tolerated years of student-living, which is no simple feat especially when changes to their own situation brought on enormous challenges. Mum, Dad, I will always be aware of your sacrifices, and hope one day to pay it forward. Thank you.

Michael Byrne, Mathew Smith, and Mark Keith acted as my soundboard for frustrations over complications that thwarted this journey at regular intervals. I owe them much of my sanity during times of the "master disaster". Prof. Blair Wolf and Prof. Nigel Bennett both offered valuable support in funding applications. Bruno Lafourcade's dedicated rewriting of the BIOMOD manual made it possible for this novice to operate it. Jackobeth, Patrick, Amelia and Kershnee at the University of the Witwatersrand's Central Animal Unit provided support throughout laboratory trials. Sister Mary-Ann gave of her own personal time to facilitate late night and early morning X-ray capture during barium meal procedures. Dr. Leith Meyer provided ongoing support, medical care and advice during the keeping of lab populations.

My many field assistants gave of their time during their own research periods and worked under often-difficult conditions. Steve Tarlton for his drive and much needed encouragement during dark days on goat-covered rock faces in Swaziland, his masterful skill in capturing Skinks and unfailing energy in 40 °C heat. Graeme Ellis' logistical expertise, friendship and support during moments when things appeared to be falling apart in the field were invaluable. Helen Place showed me how to successfully trap lizards. Marc Humphries, Gareth Hunter, Michael Hensman, Anisha Dayaram, Emily Botts, Natascha and Jonathan Barry, Jason Tirant, Ryan Thomas and Stephen Williamson - your contributions in the field assisted me greatly. Bruce Patterson was monumental in getting the beast of administration tamed. Martin Whiting made available terraria, iButtons, and two years worth of food for laboratory populations. In-lab banter with Rose Sephton-Poultney and Mimmie Kgaditse made light of times when progress seemed nothing but impossible.

A great plethora of land-owners, farmers, local Chiefs, and Ndunas allowed access to sites within their properties and communities, often showing great trust in these *malungus* researching the *mkholoholos*. In South Africa: Eugene at Chimp Eden, Dirk Hoffman at Exotica Nursery and the Le Rouxs of Nelspruit. In Swaziland: the Manana village, whose children were both fascinated and fascinating during our days spent there. ~~To the~~

~~porcupines, baboons and vervet monkeys that destroyed a total of 23 040 data points due to your curiosity surrounding those detrimentally shiny iButtons.~~

Funding support was provided by the N.R.F., which was initially made accessible by Prof. Ed Wikowski, and later through Prof. Erasmus (grant code: 70958), S.A.B.I.F. and the University of the Witwatersrand. Experimental protocols were cleared by the University of the Witwatersrand's Animal Ethics Committee under permit number 2009/19/2A and permission for the collection of Skinks for laboratory populations was granted by Mpumalanga Tourism and Parks Agency under permit number MPB 5300.

LIST OF FIGURES

1. Chapter 2, Fig. 1

Terraria were fitted with slate tiles arranged in such a manner that two retreats were available to the skinks; one closed on three sides (A) and other open on two (B).

2. Chapter 2, Fig. 2

Schematic showing the anatomical position of the liver, stomach, small and large intestine in *Trachylepis margaritifer* (left) and subsequent schematic overlays onto X-ray images (ventral view) to aid in interpreting the position of barium sulphate (white).

3. Chapter 2, Fig. 3

Kaplan–Meier curve for Rainbow Skinks (*Trachylepis margaritifer*) showing completed gut passage over time (Experiment A). Inverse cumulative proportions indicate the proportions of skinks showing incomplete gut passage (i.e. at 0.6, 60% of the skinks show incomplete gut passage, whilst 40% show completed gut passage). The dashed line represents measures made from individuals that were fed barium sulphate-loaded European House crickets (*Acheta domestica*) (i.e. treatment; all temperatures combined), whilst the solid line represents measures made from skinks that were fed barium sulphate-free crickets (i.e., control; all temperatures combined). Mean gut passage times (mean \pm SD) for the treatment and control groups were 40.10 ± 21.20 and 45.25 ± 23.21 h, respectively, which are not significantly different from each other (Gehan's Wilcoxon, $w = 138.00$, $p = 0.33$).

4. Chapter 2, Fig. 4

Kaplan–Meier curve for Rainbow Skinks (*Trachylepis margaritifer*), maintained at three different environmental temperatures: 25 °C (dashed line), 27 °C (solid) and 32 °C (dotted), showing completed gut passage over time (Experiment A). Inverse cumulative proportions indicate the proportions of skinks showing incomplete gut passage (i.e. at 0.6, 60% of the skinks show incomplete gut passage, whilst 40% show completed gut passage). Temperature had a highly significant effect on gut passage times ($\chi^2 = 41.60$, $df = 2$, $p < 0.001$). Transit times recorded at 25 °C and 27 °C are significantly different (Gehan's Wilcoxon, $w = 183.00$, $p = 0.012$).

5. Chapter 2, Fig. 5

Kaplan–Meier curve for Rainbow Skinks (*Trachylepis margaritifer*) showing completed intestinal passage over time (Experiment B). Inverse cumulative proportions indicate the proportions of skinks showing incomplete intestinal passage (i.e. at 0.6, 60% of the skinks show incomplete intestinal passage, whilst 40% show completed intestinal passage). The dashed line represents data collected from skinks at 25 °C, whilst the solid line is for skinks at 27 °C. Points marked + indicate data points which have been censored (i.e. no event recorded). Uncensored (i.e. event recorded) are marked °. Intestinal passage times are significantly different between temperatures trials (Gehan's Wilcoxon: $w = 105$, $p = 0.009$).

6. Chapter 2, Fig. 6

Kaplan–Meier curves for two experimental groups (maintained at 25 and 27 °C) of Rainbow Skinks (*Trachylepis margaritifer*) showing phase completion over time (Experiment B). Inverse cumulative proportions indicate the proportions of skinks showing incomplete phase (i.e. at 0.6, 60% of skinks have not undergone phase completion, whilst 40% of skinks have). The dashed line represents data collected from skinks at 25 °C, whilst the solid line is for skinks at 27 °C. Points marked + indicate data points which have been censored (i.e. no event recorded). Uncensored (i.e. event recorded) are marked °. Graphs represent four phases of digestion; phase II: gastric emptying initiated (top left), phase III: gastric emptying complete (top right), phase IV: movement in the small intestine and entry into the large intestine (bottom left) and phase V: movement into the large intestine completed (bottom right). Temperature had a highly significant effect on Phase IV (Gehan's Wilcoxon: $w = 129.00$, $p < 0.01$) and V (Gehan's Wilcoxon: $w = 170.00$, $p < 0.001$).

7. Chapter 2, Fig. 7

Weibull estimates of time-to-event function for the Rainbow Skink (*Trachylepis margaritifer*) based on data collected from skinks maintained at environmental temperatures of 25 °C (left) and 27 °C (right; Experiment B). The inverse cumulative proportion represents the proportion of the population that has avoided the event, in this case – completing intestinal passage. The bars represent observed values, whilst the solid lines represent the theoretical distribution of weight $1/V$, where V is the variance of the hazard estimate.

8. Chapter 3, Fig. 1.

The mean number (left) and mass in grams (right) of mealworm (*Tenebrio molitor*) larvae consumed by rainbow skinks (*Trachylepis margaritifer*) maintained at three environmental temperatures (25, 27 and 32 °C). Feeding trials ($n = 3$) are presented chronologically from left to right, and their averaged values within treatment groups are presented above under "pooled". Asterisks (*) indicate trials that are significantly different from others both within and across treatment groups. Error bars represent standard error.

9. Chapter 4, Fig. 1

TSS-weighted climatic suitability predictions for Rainbow Skink (*Trachylepis margaritifer*). Black-bordered QDSs represent the species' southern African distribution, and three coarse climatic suitability categories were defined as follows: poor: 350-500; medium: 501-650; good: 651-791.

10. Chapter 4, Fig. 2

Examples of faeces containing undigested mealworms (left) collected from Rainbow Skinks (*T. margaritifer*) being maintained at 22 °C, and ventral lesions (indicated by the red markers; right) arising in the population at this environmental temperature.

11. Chapter 4, Fig. 3

The correlation between temperatures recorded from naked iButtons and those inserted in three dead Rainbow Skinks (*Trachylepis margaritifer*; Pearson's correlation: $n = 18$; $r = 0.86$; $p < 0.001$; $y = 1.34 + 0.95*x$). The solid line indicates 95% confidence.

12. Chapter 4, Fig. 4

Selected field sites, associated True Skill Statistic (TTS) scores, and climatic suitability categories. Sites were allocated to one of three coarse climatic suitability categories defined as: good: 651-791; medium: 501-650; poor: 350-500. Sites marked with * indicate sites where habitat quality proxy measures were made on skinks, in conjunction with microhabitat thermal profiling. Skink-free sites were sites where no skinks were present, despite historical records and, skink die-offs indicate where population-level extinction occurred during the study.

13. Chapter 4, Fig. 5

Average minimum (left) and maximum (right) temperature measures (°C) logged in three microhabitats types (crevices, exposed and shade) across different categories of climatically suitable sites across *Trachylepis margaritifer*'s range. Error bars represent standard error and lettering indicates significant differences detected by Tukey HSD posthoc tests.

14. Chapter 4, Fig. 6

Temperature ranges (°C) recorded within three microhabitat types (crevice, exposed, shade) across three categories of sites. Black bars indicate sites predicted to be climatically "good" and patterned and clear bars indicate sites predicted to be climatically "medium" and "poor" respectively. Dashed lines indicate averaged mean temperatures (°C) per microhabitat type across all the sampled sites, and narrow bands within bars indicate site-specific means.

15. Chapter 4, Fig. 7

The relationship between temperature measures made on dead skinks using a thermal imaging camera and those logged by iButtons implanted into the same dead skinks (Pearson's correlation = 0.95; $n = 20$; $p < 0.001$; $y = -1.715 + 1.042*x$).

16. Chapter 4, Fig. 8

Percentage of $T_{<22}$ hours logged during the day (left) and night (right) at sites from three different climatically suitability categories (poor, medium, good) over 63 days. Shared lettering indicates non-significantly different sites for day (left), night (right) and over 24-hour comparisons wherever possible (uppercase lettering; centre).

17. Chapter 4, Fig. 9

Percentage of T_{target} hours logged during the day at sites from three different climatically suitability categories (poor, medium, good) over 63 days. Shared lettering indicates non-significantly different sites. For site categories, medium (48.1%) and good (50.3%) sites were not differentiated from each other, but were from poor sites (34.6%; $\chi^2 = 96.4$, $df = 3$, $p < 0.001$). "Skink Die-Offs" mark the site where population extirpation occurred, and "Dermatitis Present" indicate the site where trapped skinks presented with ventral lesions.

18. Chapter 4, Fig. 10

Rainbow skink (*Trachylepis margaritifer*) habitat quality proxy measures across a range of predicted thermal suitability field sites: poor, medium and good. Shared lettering indicates samples that are not significantly difference from one another.

19. Chapter 4, Fig. 11

Chronic hyperplastic and ulcerative dermatitis, indicated by the red markers, present on Rainbow skinks (*Trachylepis margaritifer*) caught at Kaapschehoop (A-C), a site considered to be climatically poorly suited for the species based on modelled predictions (BIOMOD, v. 1.1-0), and an example of the same dermatitis that developed on the ventral sides of Rainbow skinks (*T. margaritifer*) maintained at a constant environmental temperature of 22 °C under laboratory conditions (D), which lead to the eventual death of ~ 50% ($n_{\text{deaths}} = 23$) of the laboratory population ($n = 47$).

20. Chapter 4, Fig. 12

Proportions of wild-caught Rainbow Skinks (*Trachylepis margaritifer*; $n = 106$) found with digesta in their systems at the time of capture (top), and the morning after (bottom), from seven sites across three climatic suitability categories across its southern African distribution. Asterisks indicate samples proportions significantly different from others at the same resolution.

LIST OF TABLES

1. Chapter 2, Table 1

Details of the experimental groups of Rainbow Skinks (*Trachylepis margaritifer*) used to test the effect of barium sulphate on times

2. Chapter 2, Table 2

Mean gut passage times measured at three different ambient temperatures in the Rainbow Skink (*Trachylepis margaritifer*; Experiment A)

3. Chapter 2, Table 3

Mean intestinal passage times of two experimental groups of Rainbow Skinks (*Trachylepis margaritifer*; Experiment B)

4. Chapter 2, Table 4

Mean duration post-ingestion of barium sulphate-loaded meals for the phases of digestion involved in intestinal transit (i.e., phase II–V) identified from X-ray (Experiment B)

5. Chapter 3, Table 1

Morphometric details of rainbow skinks (*Trachylepis margaritifer*) used to test the effect of temperature on appetite.

6. Chapter 3, Table 2

Apparent digestive and assimilation efficiencies measured in rainbow skinks (*Trachylepis margaritifer*) maintained at three environmental temperatures. Skink numbers reflect those from which suitable shed-free and successfully measured samples were collected.

7. Chapter 4, Table 1

Field sites details. GPS coordinates represent the centre position of each respective site. TSS-weighted BIOMOD values for categories are as follows: Poor: 350-500; Medium: 500-650; Good: 651-791. Site names presented in bold indicate where lizard-sampling was successful; thermal profiles were measured at all sites. *Below the elevation range for the respective QDS.

8. Chapter 4, Table 2

Repeated Measures Analysis of Variance for minimum and maximum temperatures (°C) logged by iButtons placed within three microhabitat types for the three categories of climatically-suitable sites (poor, medium and good). p values < 0.05 are considered significant and highlighted with an asterisk (*).

9. Chapter 4, Table 3

Chi² results for habitat quality proxy measures made on 106 wild-caught Rainbow Skinks (*Trachylepis margaritifer*) assessed at both site and site category resolutions. Feeding success parameters are denoted by *FS: Capture* and *FS: Moring After* for measures made on skinks immediately and the morning after capture respectively. * and ** indicate significantly and highly significantly different results respectively.

10. Chapter 4, Table 4

Assessment of BIOMOD's prediction accuracy for all environmental and skink-based measures made at the selected sites.

TABLE OF CONTENTS

CHAPTER ONE

INTRODUCTION 14
 REFERENCES 16

CHAPTER TWO

Gut and intestinal passage time in the Rainbow Skink (*Trachylepis margaritifer*): implications for stress measures using faecal analysis

SUMMARY 20
 INTRODUCTION 20
 MATERIALS AND METHODS 22
 Study animal 22
 Experimental design 22
 Experiment A: the effect of barium sulphate and temperature on gut transit rates 22
 Experiment B: temperature effect on gut and intestinal transit time 22
 Statistical treatment of results 23
 RESULTS 23
 Experiment A: the effect of barium sulphate and temperature on gut transit rates 23
 Experiment B: temperature effect on gut and intestinal transit time 24
 DISCUSSION 25
 ACKNOWLEDGEMENTS 28
 REFERENCES 28

CHAPTER THREE

Digestive efficiencies are independent of gut passage times in rainbow skinks (*Trachylepis margaritifer*)

ABSTRACT 32
 INTRODUCTION 32
 MATERIALS AND METHODS 33
 Study species 33
 Appetite trial 33
 Digestion efficiency 33
 Statistics 33
 RESULTS 33
 Appetite trial 33
 Digestive trial 34
 DISCUSSION 34
 CONCLUSION 35
 ACKNOWLEDGEMENTS 35
 REFERENCES 35

CHAPTER FOUR

A multifaceted habitat quality assessment for the Rainbow Skink (*Trachylepis margaritifer*) emphasizes the importance of a mechanistic framework

ABSTRACT 38
 INTRODUCTION 38
 MATERIALS AND METHODS 40
 Study species 40
 Climatic suitability modeling, model evaluation and site selection 40
 Microhabitat thermal profiling 41
 Standard thermal assessments 41
 Biologically relevant thermal constraints 41
 Trapping protocol and habitat quality proxy measures 44
 Statistical analyses 45
 RESULTS 45
 Microhabitat Analyses 45
 Standard Analyses of Microhabitat Temperatures 47
 Biologically Relevant Analyses of Microhabitat Temperatures 49
 Skink Sampling 52
 Habitat Quality Proxy Measures 52
 DISCUSSION 58
 REFERENCES 62

CHAPTER FIVE

CONCLUSION 69
 REFERENCES 72

CHAPTER ONE

1.1 INTRODUCTION

Physiological constraints fundamentally determine the niche of species (Liebig 1840; Kearney & Porter 2009; Bozinovic *et al.* 2011), and in a changing environment, an understanding of this interplay is becoming increasingly important. Current transformation of the global environment is widespread and rapidly growing (Pounds *et al.* 2006; Parmesan 2007; Rosenzweig *et al.* 2008). Extinction rates among vertebrates are 10-100 times that of background (Barnosky *et al.* 2011), and by 2050, an estimated 15-37% of species are likely to be destined for extinction (Thomas *et al.* 2004). These are remarkable estimations that highlight the severity of anthropogenic influence on climate and habitat transformation (Wiens *et al.* 2009). In response, much of the scientific community is actively spearheading technique-advancement (e.g., Wikelski & Cooke 2006, Parmesan 2006) to better mitigate this situation.

Currently, species distribution modeling is recognized as an invaluable predictive tool in this fight (Thomas *et al.* 2004), but much of it merely examines correlative relationships rather than mechanistic ones (Foden *et al.* 2013). While correlative models are useful for hypotheses-generation (Alexander 2007; Kearney & Porter 2009), mechanistic models directly identify proximal causes of range limitation (Davis *et al.* 1998; Dormann 2007). As such, their range-shift predictions are considered more robust than correlative ones. However, unlike correlative models that only require distribution data and at least one other geo-referenced environmental factor (typically climate) as input data, mechanistic models require data spanning a species' physiological, behavioral, and morphological traits (Kearney & Porter 2009). Due to the considerable investment of time and effort associated with acquiring these trait data, mechanistic models despite their value are therefore few and far between (Pearson & Dawson 2003; Kearney & Porter 2009).

Indeed, aside from improving on techniques within already established fields, entire fields of science are being newly developed so as to better integrate mechanistic data into both research-based and applied approaches. Of particular interest and central to the work in this dissertation is the field of 'conservation physiology' (Wileski and Cooke 2006). This newly-established field is currently defined as "*an integrative scientific discipline applying physiological concepts, tools, and knowledge to characterizing biological diversity and its ecological implications; understanding and predicting how organisms, populations, and ecosystems respond to environmental change and stressors; and solving conservation problems across the broad range of taxa*" (Cooke *et al.* 2013). Although conservation physiology draws on many established, as well as new techniques, its elevation to a standalone field by Wikelski and Cooke (2006) was not without purpose. Through this action, the authors hoped to afford the discipline every opportunity to evolve through

constant examination. In the nine years since its inception, the field has grown from an exclusively population decline-focused science (see Wikelski & Cooke 2006 for its original, rather limiting definition) to a much more inclusive one that is aimed at assessing species responses to the environment in a much broader sense.

Within the scope of conservation physiology, I assess the influence of environmental temperature on a climate-limited, saxicolous lizard species, the Rainbow Skink (*Trachylepis margaritifer*; Peters 1854), with specific interest in its potential for stress metabolite studies, appetite and digestive function, and how correlative suitability indices across its distribution translate into on-the-ground findings using logged thermal data and condition measures made on the animals. Stress measures provide direct, and often rapid, insight into how a species interfaces with its environment (Wingfield *et al.* 1997), and through the development of metabolite-focused techniques (Schwarzenberger *et al.* 1996; Whitten *et al.* 1998; Möstl & Palme 2002; Touma *et al.* 2003), can now be made with little to no disturbance to the individuals or populations in question (Stevenson *et al.* 2005). This approach however is not suitable for all species (Miller *et al.* 2013), given the constraints a species' intestinal tract time has on its successful implementation (Möstl & Palme 2002). This is particularly emphasized in ectotherms where physiological performance, and hence tract times, is often so greatly dependent on its thermal environment (Dawson 1975; Stevenson *et al.* 1985), and also to a lesser extent their life history traits (Lillywhite *et al.* 2002). Thus, quantifying the relationship between intestinal tract time and thermal environment for the Rainbow Skink was an imperative first step in assessing the species' suitability for stress metabolite measures (Chapter Two).

Species are most directly connected to climate through their energy budgets (Kearney & Porter 2009). Thus, investigating the influence of temperature on appetite and digestive efficiency (Chapter Three) was seen as central to understanding how the Rainbow Skink may react to varying, and possibly changing thermal conditions across its range. Once equipped with this information, I was then able to generate suitability indices using the correlative modeling platform BIOMOD (version 1.1-0), which required only species presence-absence data and broad-scale thermal data to do so. These suitability indices then allowed for habitat quality predictions to be made, which were then validated through several infield habitat- and skink-based measures (Chapter Four).

Finally, (Chapter Five) I summarize the main findings of this work and discuss future application of the implemented techniques. I briefly highlight the benefits and costs associated to these techniques, and discuss alternative options that may better serve us moving forward.

1.2 REFERENCES

- Alexander G.J. 2007. Thermal biology of the Southern African Python (*Python natalensis*): does temperature limit its distribution. *Biology of the boas and pythons*. Eagle Mountain Publishing, Eagle Mountain, Utah, 50-75.
- Barnosky A.D., Matzke N., Tomiya, S., Wogan G.O.U., Swartz B., Quental T.B., Marshall C., McGuire J.L, Lindsey E.L., Maguire K.C., Mersey B. and E.A. Ferrer. 2011. Has the Earth's sixth mass extinction already arrived? *Nature* 471, no. 7336: 51-57.
- Bozinovic F., Calosi, P. and J.I. Spicer. 2011. Physiological correlates of geographic range in animals. *Annual Review of Ecology, Evolution, and Systematics* 42: 155-179.
- Cooke S.J., Sack L., Franklin C.E., Farrell A.P., Beardall, J., Wikelski M. and S.L. Chown. 2013. What is conservation physiology? Perspectives on an increasingly integrated and essential science. *Conservation Physiology* 1(1): cot001.
- Dawson W.R., 1975: On the physiological significance of the preferred body temperatures of reptiles. In: D. M. Gates, R. B. Schmerl (eds), *Perspectives in Ecological Ecology*. Springer, New York, pp. 443–473.
- Davis A.J., Jenkinson L.S., Lawton J.H., Shorrocks B. and S. Wood. 1998. Making mistakes when predicting shifts in species range in response to global warming. *Nature* 391: 783–786.
- Dormann C.F. 2007. Promising the future? Global change projections of species distributions. *Basic Appl. Ecol.* 8: 387–397.
- Foden W.B, Butchart S.H.M., Stuart S.M., Vié J-C., Akçakaya H.R., Angulo A., DeVantier L.M., Gutsche A., Turak E., Cao L., Donner S.D., Katariya V., Bernard R., Holland R.A., Hughes A.F., O’Hanlon S.E., Garnett S.T., Şekercioğlu, Ç.H. and G.M. Mace. 2013. Identifying the World’s Most Climate Change Vulnerable Species: A Systematic Trait-Based Assessment of all Birds, Amphibians and Corals. *Plos One*. Vol. 8 (6): e65427.
- Liebig J. 1840. *Die organische chemie in ihrer anwendung vor agricultur und physiologie* Braunschweig.
- Lillywhite H.B., de Delva P and B.P. Noonan. 2002: Patterns of gut passage time and the chronic retention of fecal mass in viperid snakes. In: Schuett G.W., Höggren M., Douglas M.E. and H.W. Greene (eds), *Biology of the Vipers*. Eagle Mountain Publishing, Utah, pp. 497-506.
- Kearney M. and W. Porter. 2009. Mechanistic niche modelling: combining physiological and spatial data to predict species’ ranges. *Ecology letters*, 12(4): 334-350.
- Miller A.K., Erasmus B.F.N. and G.J. Alexander. 2013. Gut and intestinal passage time in the Rainbow Skink (*Trachylepis margaritifera*): implications for stress measures using

- faecal analysis. *Journal of animal physiology and animal nutrition*, **97**(5): 960-970.
- Möstl E. and R. Palme. 2002. Hormones as indicators of stress. *Dom. Anim. Endocrinol.* **23**: 67-74.
- Parmesan C. and G. Yohe. 2003. A globally coherent fingerprint of climate change impacts across natural systems. *Nature* **421**: 37-42
- Peters W.C.H. 1854. Diagnosen neuer Batrachier, welcher zusammen mit der früher (24. Juli und 17. August) gegebenen übersicht der Schlangen und Eideschen mitgetheilt werden. Ber. Bekanntmach. Geeignet. Verhandl. Königl. – Preuss. Akad. Wiss. Berlin: 614-628.
- Pounds J.A., Bustamante M.R., Coloma L.A., Consuegra J.A., Fogden M.P.L., Foster P.N., La Marca E., Masters K.L., Merino-Viteri A., Puschendorf R., Ron S.R., Sanchez-Azofeifa G.A., Still C.J. and B.E. Young. 2006. Widespread amphibian extinctions from epidemic disease driven by global warming. *Nature* **439**: 161-167.
- Rosenzweig C., Karoly D., Vicarelli M., Neofotis P., Wu Q., Casassa G., Menzel A., Root T.L., Estrella N., Seguin B., Tryjanowski P., Lui C., Rawlins S. and A. Imeson. 2008. Attributing physical and biological impacts to anthropogenic climate change. *Nature* **453**: 353-357.
- Schwarzenberger F., Möstl E., Palme R. and E. Bamberg. 1996. Faecal steroid analysys for non-invasive monitoring of reproductive status in farm, wild and zoo animals. *Anim. Repro. Sci.* **42**: 515-526.
- Stevenson R.D., Peterson C.R. and J.S. Tsuji. 1985. The thermal dependence of locomotion, tongue flicking, digestion, and oxygen consumption in the wandering garter snake. *Physiological Zoology* **58**: 46–57.
- Thomas C.D., Cameron A., Green R.E., Bakkens M., Beaumont L.J., Collingham Y.C., Erasmus B.F.N., de Siqueira M. F., Grainger A., Hannah L., Hughes L., Huntley B., van Jaarsveld A.S., Midgley G.F., Miles L., Ortega-Huerta M.A., Peterson A.T., Phillips O.L. and S.E. Williams. 2004. Extinction risk from climate change. *Letters to Nature* **427**: 145-148.
- Touma C., Palme R. and N. Sachser. 2004. Analyzing corticosterone metabolites in fecal samples of mice: a noninvasive technique to monitor stress hormones. *Hormones and Behavior* **45**: 10-22.
- Whitten P.L., Brockman D.K. and R.C. Stavisky. 1998. Recent advances in noninvasive techniques to monitor hormone-behaviour interactions. *Year Book Phys. Anthropol.* **41**: 1-23.
- Wiens J. A., Stralberg D., Jongsomjit D., Howell C. A., and M.A. Snyder. 2009. Niches,

models, and climate change: assessing the assumptions and uncertainties. *Proceedings of the National Academy of Sciences*, 106 (Supplement 2), 19729-19736.

Wikelski M. and S.J. Cooke. 2006. Conservation physiology. *Trends in Ecology and Evolution* **21**: 38-46.

Wingfield J.C., Hunt K., Breuner C., Dunlap K., Fowler G.S., Freed L. and J. Lepson. 1997. Environmental stress, field endocrinology, and conservation biology. In "*Behavioral Approaches to Conservation in the Wild*" (J.R. Clemmons and R. Buchholz eds.), pp. 95-131, Cambridge University Press, Cambridge.

CHAPTER TWO

ORIGINAL ARTICLE

Gut and intestinal passage time in the Rainbow Skink (*Trachylepis margaritifer*): implications for stress measures using faecal analysis

A. K. Miller, B. F. N. Erasmus and G. J. Alexander

School of Animal, Plant and Environmental Sciences, University of the Witwatersrand, Johannesburg, South Africa

Keywords

corticosterone metabolites, conservation physiology, barium meal

CorrespondenceA. K. Miller, School of Animal, Plant and Environmental Sciences, University of the Witwatersrand, PO Box 324, Jukskei Park, Johannesburg 2153, South Africa. Tel: +27 (0)82 375 2205; Fax: +27 (0)11 704 2358
E-mail: ashadee.k.miller@gmail.comReceived: 17 April 2012;
accepted: 20 August 2012**Summary**

Stress levels in organisms provide a rapid measure for assessing population health. Handling and capture stress, however, cause error in blood measures, so this method is rapidly being replaced by assessing levels of stress metabolites in faeces. This eliminates the source of error because there is a lag period between stress perception and the resultant stress metabolite accumulation within faeces. This lag period is correlated with specific intestinal passage time, a measure that can vary greatly between taxa, particularly amongst ectotherms. Due to two deleterious consequences associated with extended exposure of the metabolites to the intestinal environment, species that exhibit long and variable intestinal passage times are not good candidates for metabolite studies. We measured gut and intestinal passage times in *Trachylepis margaritifer* to ascertain whether it would be an appropriate candidate for stress metabolite studies. We first tested if barium sulphate in the meal had an effect on gut passage time at three ambient temperatures (25, 27 and 32 °C). Barium sulphate had no effect; however, temperature had a significant effect with an unexpected pattern: gut passage time was fastest at 32 °C but was slower at 27 °C than at 25 °C. We then used X-ray technology and barium sulphate-loaded meals to measure gut and intestinal passage times at 25 and 27 °C. This allowed us to observe which parts of the digestive process were responsible for increased passage times at 27 °C: the faster passage time at 25 °C was due to faster intestinal passage time; there was no difference in gastric emptying time. We assess the species to be a suitable candidate for studies using faeces to measure stress. It is imperative however, that the effect of temperature on passage rates is known and taken into account in such studies.

Introduction

Stress metabolite studies are growing in popularity as a result of the advantages of being able to measure stress levels using only faecal samples (Stevenson et al., 2005). The method is non-invasive, so sample collection is relatively easy, with minimal disturbance to the subject. Even in situations where samples are actively collected from captured animals

(e.g. through abdominal massage), the stress of capture and handling will not immediately reflect in samples due to the time that the stress metabolites take to accumulate in the faecal matter. Handling stress can affect experimental results (Halberg et al., 1960; Quirce and Maickel, 1981; Riley, 1981) and is a common source of error when sampling blood (Hennessy and Levine, 1976; Gärtner et al., 1980; Armario et al., 1986; Haemisch et al., 1999). Blood

samples are also less immune to episodic fluctuations in hormone levels than faecal samples are; blood samples reflect an organism's hormonal status at a single point in time (acute stress).

Stress metabolites such as glucocorticoids are ever-present at baseline levels within all vertebrates (Wingfield et al., 1997; Moore and Jessop, 2003; Wikelski and Cooke, 2006), and only deviations from these species-specific norms indicate stress. In addition to this, glucocorticoids levels may exhibit regular or episodic changes over time. However, the use of metabolite measures made from faecal samples avoids this complication by acting as a proxy for stress levels over a particular window period (Touma et al., 2004). As stress metabolites continue to accumulate in the faeces, whilst the faeces remain in the gut, intestinal passage time determines this window period and this may vary greatly between species (Möstl and Palm, 2002). Thus, without information on passage time, the potential to categorically identify stressors through matching increased metabolite levels to a particular event is greatly impaired.

Intestinal passage time is therefore a necessary metric for data interpretation and can also determine whether a species is a suitable candidate for faecal sampling for stress metabolites. Ideal candidates are those that have relatively short and invariant intestinal passage times because there are two problems associated with extended and highly variable passage times. First, metabolites continue to accumulate within faeces for as long as the faeces are present within the intestinal tract. Thus, metabolite levels within samples collected from subjects with extended and variable passage times may have accumulated over several stress-inducing events and the relative production of stress metabolites cannot be apportioned separately to these events. Second, with extended exposure to anaerobic bacteria within the gut, the structural integrity of these metabolites becomes increasingly threatened (Möstl and Palm, 2002). Therefore, the metabolite levels can not only reflect multiple stressful events, but may also degrade through time.

Endotherms generally have relatively short and consistent intestinal passage times across taxa; in mice, it is 9–10 h (Touma et al., 2004), whilst sheep, ponies and pigs have intestinal passage times of 12, 24 and 48 h respectively (Möstl and Palm, 2002). Ectotherm physiological performance is greatly affected by external factors (especially temperature) and life history (Dawson, 1975; Stevenson et al., 1985; Dorcas et al., 1997; Shine, 2005; Pafilis et al., 2007), and there is thus great variation in gut pas-

sage times (Lillywhite et al., 2002). Gaboon Adders (*Bitis gabonica*) have gut passage times of up to 183 days, whilst Burmese Pythons (*Python bivittatus*; as *Python molurus*), Western Ratsnakes (*Pantherophis obsoletus* as *Elaphe obsoleta*), Madagascan Speckled Hognose Snakes (*Leioheterodon geayi*) and Emerald Tree Boas (*Corallus caninus*), all under the same standard conditions, have gut passage times of 35.4, 2.6, 11.6 and 25.4 days respectively (Lillywhite et al., 2002). Alexander et al. (2012) report gut passage times of between 3.9 and 5.2 days, depending on temperature, for Rinkhals (*Hemachatus haemachatus*). In addition to this, the long gut passage times of stocky, terrestrial snakes also tend to be very variable (Lillywhite et al., 2002). This variation emphasizes that care must be taken when selecting reptilian candidates for stress metabolite studies.

To our knowledge, no literature on gut or intestinal passage times exists for any scincid lizard; the majority of studies on lizards focus on herbivorous species (i.e. Iguanas), with fewer than twenty studies focusing on carnivorous and insectivorous species. The digestion rates of herbivorous lizards are known to be much slower and their intestine length longer in comparison with carnivorous and insectivorous species (Secor, 2005; Diaz-Figueroa and Mitchell, 2006). The few studies that have focused on insectivorous species are reviewed by Pafilis et al. (2007). In summary, the gut passage rates of 14 insectivorous species varied greatly even when exposed to the same temperature. For example, at 30 °C, the shortest passage time was 11.2 h for *Zootoca vivipara* (as *Lacerta vivipara*), whilst the longest was 4 days for *Pseudocordylus melanotus melanotus* (as *Cordylus melanotus melanotus*) (Avery, 1971; Van Damme et al., 1991; McConnachie and Alexander, 2004). Pafilis et al. (2007) concluded that gut passage times are not only profoundly affected by temperature but also profoundly affected by life history, corroborating other findings. This emphasizes the need for focused gut and intestinal passage studies.

As part of a larger study, we measured gut and intestinal passage time in *Trachylepis margaritifer* (Rainbow Skink), a predominantly insectivorous species, to evaluate its suitability for stress metabolite studies. Gut passage time was taken as the time from ingestion of a food item to the resultant defecation, whilst intestinal passage time was from the start of gastric emptying to when faeces can be massaged from the individual. We used barium sulphate (BaSO₄) and X-ray measures to track the progress of food through the intestine. First, we measured the effect of barium sulphate on passage times, because

it has been suggested that its presence may slow the passage of digesta through the gut (Schumacher and Toal, 2001). Next, we tested the effect of temperature on both gut and intestinal passage times using barium sulphate-loaded food items to track the progression of food through the gut.

Materials and methods

Study animal

Trachylepis margaritifer is a large, colourful southern African skink with a snout-vent length (SVL) of 85–110 mm. It occurs on rocky outcrops throughout mesic and arid savannas in the north-eastern parts of southern and East Africa (Branch, 1998) in relatively dense colonies on exposed rock faces. Rainbow Skinks are active, territorial insectivores but are known to include the fruits of *Lantana camara* and the flowers of *Erythrina* spp. in their diet (personal observation). For a species description, see Broadley (2000).

Experimental design

Adult skinks were wild-caught from a population in Mpumalanga Province, South Africa (25°34'26.5" S; 31°11'05.9" E) using non-toxic Catchmaster® 90 × 120 mm Mouse Glue Traps (Atlantic Paste and Glue Co., Brooklyn, NY, USA). Set traps were monitored continuously, and trapped lizards were removed from traps immediately using cooking oil (Whiting and Alexander, 2001). Lizards were transported to the University of Witwatersrand, Johannesburg, South Africa, where all laboratory experiments were conducted. Individuals were weighed and their SVL recorded prior to experimentation. The same skinks were used in the two experimental trials.

Experiment A: the effect of barium sulphate and temperature on gut transit rates

Rainbow Skinks ($n_{\text{total}} = 31$) were randomly assigned to three temperature-controlled rooms set at 25, 27 and 32 °C ($n_{25\text{ °C}} = 11$, $n_{27\text{ °C}} = 9$, $n_{32\text{ °C}} = 11$). During this experiment, they were individually housed in glass terraria and were acclimated for a period of 3 months. Terraria were fitted with slate tiles to best approximate the rocky substrate of their habitat. The tile arrangement provided skinks with two retreats so as to minimize stress (Fig. 1). Water was provided *ad libitum* and the photoperiod was from 6 to 18 h.

Dead European House Crickets (*Acheta domestica*; mass 0.41 ± 0.08 g) were marked through the implantation of two small, coloured glass beads.

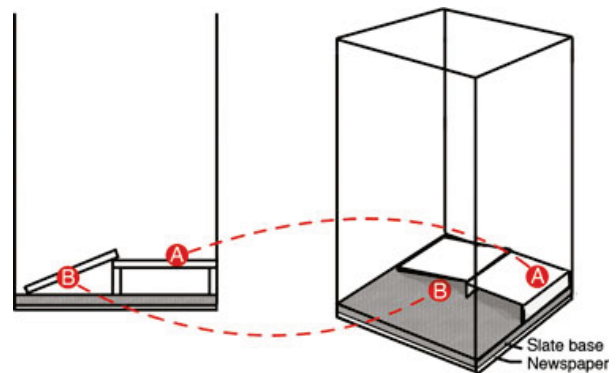

Fig. 1 Terraria were fitted with slate tiles arranged in such a manner that two retreats were available to the skinks; one closed on three sides (A) and the other open on two (B).

When allocated to treatment trials, each skink was fed one marked, dead cricket containing 0.15 ml barium sulphate liquid suspension (constituted at a 1:1 BaSO₄/H₂O ratio). Although previous reptilian studies have utilized a dosage of 10–15 ml/kg (Taylor et al., 1996), we found during calibrations that this volume was three times the amount necessary to produce an adequate visual on X-ray images. Control trials differed in one aspect only – crickets were marked with beads but were barium-free. The order of trial sequence (i.e. control then treatment or treatment then control) was randomized amongst individuals and between experimental temperatures. Trials were conducted one week apart.

Experiment B: temperature effect on gut and intestinal transit time

A total of 30 (17 females; 13 males) Rainbow Skinks (mass 37.3 ± 1.9 g) were used in this experimental component. To facilitate measures of intestinal passage time, dead crickets (*A. domestica*; mass 0.41 ± 0.08 g) were each injected with 0.15 ml of a barium sulphate liquid suspension (constituted at a 1:1 BaSO₄/H₂O ratio) and force-fed to the skinks. We fed each skink a single barium sulphate-loaded cricket.

During barium meal trials, subjects were individually housed in well-ventilated, opaque, two-litre plastic containers and only temporarily removed and transferred into smaller, transparent perspex containers for the duration of their scheduled X-ray measures. X-rays were captured on a mobile X-ray unit (Shimadzu MobileArt Plus MUX-100H, Kyoto, Japan) set at an exposure of 49 KV and 0.56 mAS per exposure. Barium meals were conducted at two ambient temperatures: 25 and 27 °C. We selected these two temperatures due to the unexpected

patterns observed in the first set of experiments (gut passage times were slower at 27 °C than at 25 °C). Due to the risks associated with multiple X-ray exposures, each skink ($n_t = 30$) was used for only one feeding trial ($n_{25\text{ °C}} = 20$; $n_{27\text{ °C}} = 10$). The unequal allocation of skinks to the two temperature trials was due to logistical constraints; access to the X-ray machine was limited. Skinks were X-rayed every 2–4 h, depending on the progress of each individual meal. Individuals were removed from trials once their respective meal was contained within the large intestine. At this stage, samples were collected by abdominal massage.

In order to better interpret the X-ray films with regards to anatomical position of the barium meal, three museum specimens of Rainbow Skinks (SVL = 95 ± 13 mm) were dissected to reveal the normal position of the digestive viscera. This step is regarded as critical when using barium sulphate in X-ray studies (Valente et al., 2008), so that X-ray images can be interpreted in the light of this information (Fig. 2).

Gut passage was divided into five phases:

- (i) Phase I – in the stomach,
- (ii) Phase II – gastric emptying initiated,
- (iii) Phase III – gastric emptying completed,
- (iv) Phase IV – movement in the small intestine and entry into the large intestine,
- (v) Phase V – movement into the large intestine completed.

The time from when gastric emptying was initiated until movement into the large intestine was complete (phase II through V) was defined as the intestinal passage time.

Statistical treatment of results

Differences in mass and SVL of skinks between treatments were tested for using ANOVA. We used time-to-

event (survival) analyses to detect differences in gut and intestinal passage times: Kaplan–Meier cumulative proportions were plotted to visualize the differences in transit times (effect of barium sulphate and temperature) detected by Gehan's Wilcoxon tests or chi-squared analysis (for multiple comparisons). Weibull estimates were plotted to test goodness-of-fit. The influence of covariates was tested through Proportional Hazard (Cox) regressions. All analyses were performed using STATISTICA v. 8 (STATISTICA Data Analysis Software System, <http://www.statsoft.com>, 2001). Results were considered statistically significant for $p < 0.05$.

Results

There were no significant differences in mass and SVL of skinks between temperature treatments for both experiments A and B (Table 1).

Experiment A: the effect of barium sulphate and temperature on gut transit rates

Individual, sex, body condition and order of experimental sequence had no significant effect on gut passage times across all temperature trials (Proportional Hazard Regression, $p > 0.05$). Barium sulphate had no significant effect on gut passage times across all three temperatures (individually or pooled; Table 2). When data from temperature trials were pooled, mean gut passage times for treatment and control components were 40.10 ± 21.20 and 45.25 ± 23.21 h respectively (Fig. 3).

Gut passage time was significantly different ($\chi^2 = 41.60$, $df = 2$, $p < 0.001$) at different temperatures. The gut passage times overall (control and treatment data combined) were fastest in the individuals exposed to 32 °C (19.34 ± 10.44 ; 3.31 h: mean \pm SD; SEM). The slowest rates were recorded

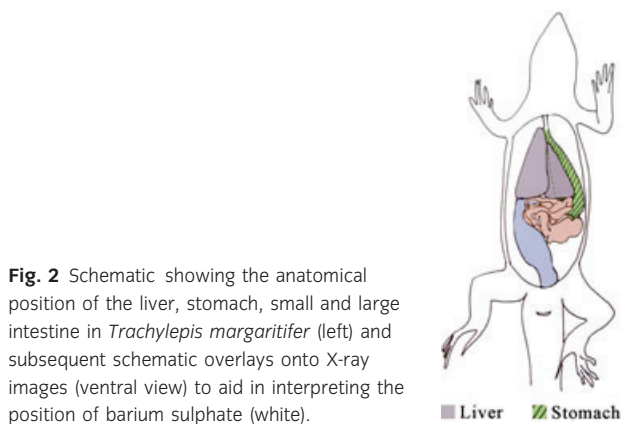

Fig. 2 Schematic showing the anatomical position of the liver, stomach, small and large intestine in *Trachylepis margaritifer* (left) and subsequent schematic overlays onto X-ray images (ventral view) to aid in interpreting the position of barium sulphate (white).

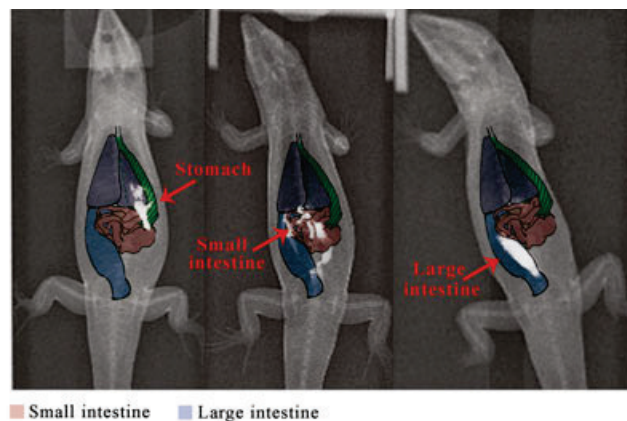

Table 1 Details of the experimental groups of Rainbow Skinks (*Trachylepis margaritifer*) used to test the effect of barium sulphate on gut passage times

Experiment	Temperature treatment (°C)	Number of skinks (♂:♀)	Mass (g ± SD)	SVL (mm ± SD)	ANOVA Mass	SVL
A	25	4:6	32.14 ± 6.64	101.00 ± 8.29	$F_{2,28} = 2.51$ $p = 0.10$	$F_{2,28} = 0.84$ $p = 0.44$
A	27	5:4	37.50 ± 5.93	104.75 ± 6.93		
A	32	4:7	31.06 ± 7.43	105.32 ± 9.59		
B	25	8:12	31.50 ± 5.23	103.00 ± 8.29	$F_{1,28} = 1.21$ $p = 0.28$	$F_{1,28} = 0.66$ $p = 0.42$
B	27	5:5	32.42 ± 5.21	104.08 ± 8.48		

SVL, snout-vent length.

Differences between treatments were tested for using ANOVA.

Ambient temperature (°C)	Treatment (BaSO ₄ -loaded) Mean ± SD; SEM (h)	Control (BaSO ₄ -free) Mean ± SD; SEM (h)	Gehan's Wilcoxon w ; p
25	49.47 ± 7.76; 4.26	53.51 ± 21.00; 4.26	-37.00; 0.23
27	56.46 ± 13.00; 4.91	61.89 ± 10.69; 4.91	-7.00; 0.79
32	16.21 ± 7.76; 4.43	22.47 ± 12.04; 4.43	-43.00; 0.13
Pooled	40.10 ± 21.20; 3.72	45.25 ± 23.13; 4.15	-138.00; 0.33

Skinks were fed both barium sulphate-loaded and barium sulphate-free European House Crickets (*Acheta domestica*) in two separate trials to test the effect of barium sulphate on these times. Differences between groups were tested for using Gehan's Wilcoxon tests.

for lizards at 27 °C (59.18 ± 11.92; 3.69 h: SD; SEM), which are significantly different (Gehan's Wilcoxon, $w = -183.00$, $p = 0.012$) to the observed rates in the 25 °C treatment (51.49 ± 16.52; 3.06 h: SD; SEM) (Fig. 4).

Experiment B: temperature effect on gut and intestinal transit time

Intestinal passage times were significantly different at different temperatures (Gehan's Wilcoxon: $w = 105$, $p = 0.009$). As with measures of gut passage times in the first set of experiments, lizards at 25 °C had significantly faster passage times than did lizards at 27 °C (Table 3). On average, digesta took 10 h less to move from the stomach into the large intestine in the skinks maintained at 25 °C than it did in the skinks maintained at 27 °C. For more than 75% of the skinks maintained at 25 °C, intestinal passage time fell within 26 h, whilst the same percentage of skinks maintained at 27 °C have intestinal passage times that fell closer to 42 h (Fig. 5).

The temporal deficit appears to originate primarily at the stage where digesta move into the large intestine (phase IV). Once established, this deficit is not recovered and experimental groups remain significantly different from each other in phase V (Table 4). The differences in phases IV and V between experimental groups (faster in skinks maintained at 25 °C)

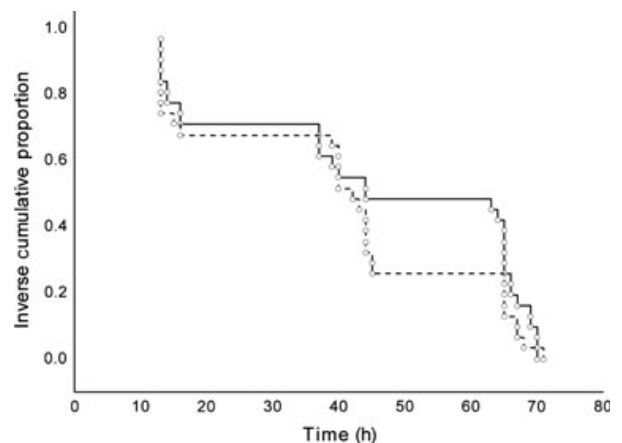
Table 2 Mean gut passage times measured at three different ambient temperatures in the Rainbow Skink (*Trachylepis margaritifer*; Experiment A)**Fig. 3** Kaplan-Meier curve for Rainbow Skinks (*Trachylepis margaritifer*) showing completed gut passage over time (Experiment A). Inverse cumulative proportions indicate the proportions of skinks showing incomplete gut passage (i.e. at 0.6, 60% of the skinks show incomplete gut passage, whilst 40% show completed gut passage). The dashed line represents measures made from individuals that were fed barium sulphate-loaded European House crickets (*Acheta domestica*) (i.e. treatment; all temperatures combined), whilst the solid line represents measures made from skinks that were fed barium sulphate-free crickets (i.e., control; all temperatures combined). Mean gut passage times (mean ± SD) for the treatment and control groups were 40.10 ± 21.20 and 45.25 ± 23.21 h, respectively, which are not significantly different from each other (Gehan's Wilcoxon, $w = -138.00$, $p = 0.33$).

are highly significant (Gehan's Wilcoxon test: $w = 129$, $p = 0.002$; $w = 170$, $p = 0.0001$ respectively). There was no significant difference observed

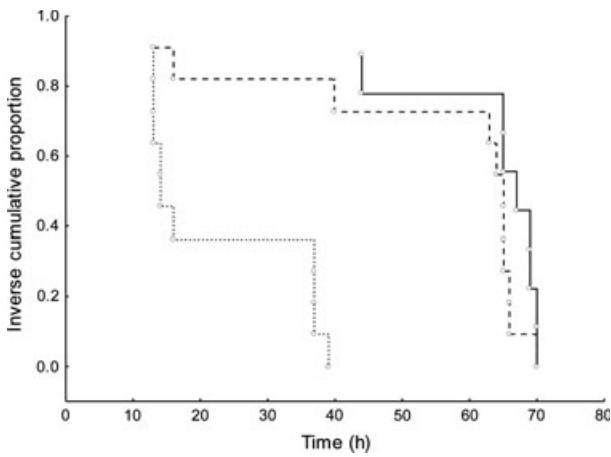

Fig. 4 Kaplan–Meier curve for Rainbow Skinks (*Trachylepis margaritifer*), maintained at three different environmental temperatures: 25 °C (dashed line), 27 °C (solid) and 32 °C (dotted), showing completed gut passage over time (Experiment A). Inverse cumulative proportions indicate the proportions of skinks showing incomplete gut passage (i.e. at 0.6, 60% of the skinks show incomplete gut passage, whilst 40% show completed gut passage). Temperature had a highly significant effect on gut passage times ($\chi^2 = 41.60$, $df = 2$, $p < 0.001$). Transit times recorded at 25 °C and 27 °C are significantly different (Gehan’s Wilcoxon, $w = -183.00$, $p = 0.012$).

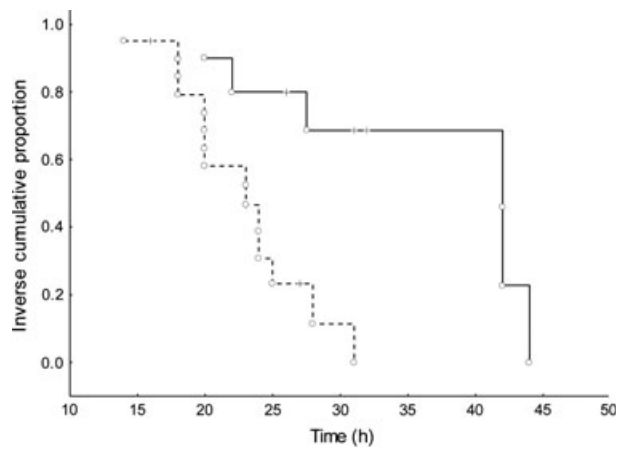

Fig. 5 Kaplan–Meier curve for Rainbow Skinks (*Trachylepis margaritifer*) showing completed intestinal passage over time (Experiment B). Inverse cumulative proportions indicate the proportions of skinks showing incomplete intestinal passage (i.e. at 0.6, 60% of the skinks show incomplete intestinal passage, whilst 40% show completed intestinal passage). The dashed line represents data collected from skinks at 25 °C, whilst the solid line is for skinks at 27 °C. Points marked + indicate data points which have been censored (i.e. no event recorded). Uncensored (i.e. event recorded) are marked °. Intestinal passage times are significantly different between temperatures trials (Gehan’s Wilcoxon: $w = 105$, $p = 0.009$).

Table 3. Mean intestinal passage times of two experimental groups of Rainbow Skinks (*Trachylepis margaritifer*; Experiment B)

Experimental group	Intestinal transit time (h ± SD)	Censored (complete: censored)	Gehan’s Wilcoxon (w; p)
25 °C	21.75 ± 4.17	14:6	105; 0.009*
27 °C	31.85 ± 8.57	5:5	

Censorship data represent the number of skinks in which intestinal passage times were available for calculation (complete) versus the number of skinks in which intestinal passage times were not available for calculation (censored). Differences between experimental groups were tested for using Gehan’s Wilcoxon.

*Significant.

in phase I or II between groups (Gehan’s Wilcoxon test: $w = 66$, $p = 0.142$; $w = -10.00$, $p = 0.764$ respectively). These trends are shown in Kaplan–Meier curves for each phase (Fig. 6).

Finally, least-squared event-avoidance function estimates (Weibull model) were calculated for each temperature trial to test goodness-of-fit (Fig. 7). This provides a weighted estimate, which performs accurately with small sample sizes. For both experimental groups, the theoretical distribution of weight $1/V$ shows the best fit, where V is the variance of the hazard estimate.

Discussion

In Rainbow Skinks, passage times were dependent on temperature but were not affected by the presence of barium sulphate in the meal. As expected, gut passage times were fastest at the warmest trial temperature (32 °C). However, passage times (both gut and intestinal) were slowest at the intermediate temperature (27 °C) and were intermediate at the lowest trial temperature (25 °C). Differences in passage time were due mainly to differences in the length of time that the digesta spent in phase IV (movement in the small intestine and entry into the large intestine), during which time, digested food is absorbed across the gut wall (Karasov and Diamond, 1983). Gut passage time was generally fast for an ectotherm, ranging from 19 h at 32 °C to 59 h at 27 °C.

The faster passage time at lower temperatures was an unexpected finding. This trend was evident for lizards in both of our experiments (gut and intestinal passage times) and is thus unlikely to be an experimental artefact. The majority of digestion studies on reptiles report a simple positive relationship between temperature and passage rate (e.g. Skoczylas, 1970a; Jiang and Claussen, 1993; Alexander et al., 2001; Angilletta et al., 2002; Wang et al., 2003; McConnachie

Table 4 Mean duration post-ingestion of barium sulphate-loaded meals for the phases of digestion involved in intestinal transit (i.e., phase II–V) identified from X-ray (Experiment B)

Phase	Experimental group	Hours post-ingestion (h ± SD)	Censorship (complete: censored)	w; p
II Gastric emptying initiated	25 °C	10.5 ± 3.17	16:4	66.00; 0.142
	27 °C	16.85 ± 8.70	10:0	
	Combined	12.61 ± 6.27	26:4	
III Gastric emptying completed	25 °C	22.60 ± 8.70	14:6	–10.00; 0.764
	27 °C	25.70 ± 11.18	8:2	
	Combined	23.20 ± 9.52	22:8	
IV Movement in the small intestine and entry into the large intestine	25 °C	29.80 ± 3.24	20:0	129.00; 0.002*
	27 °C	39.35 ± 10.53	8:2	
V Movement into the large intestine completed	25 °C	32.25 ± 4.62	18:2	170.00; 0.0001*
	27 °C	48.70 ± 7.63	6:4	

Censorship data represent the number of individuals in which each phase was categorically identified (complete) from the X-rays captured versus the number of skinks in which the phased was not identified (censored). Means of combined data are reported for phases in which no statistical difference was observed between the experimental groups.

*Significant.

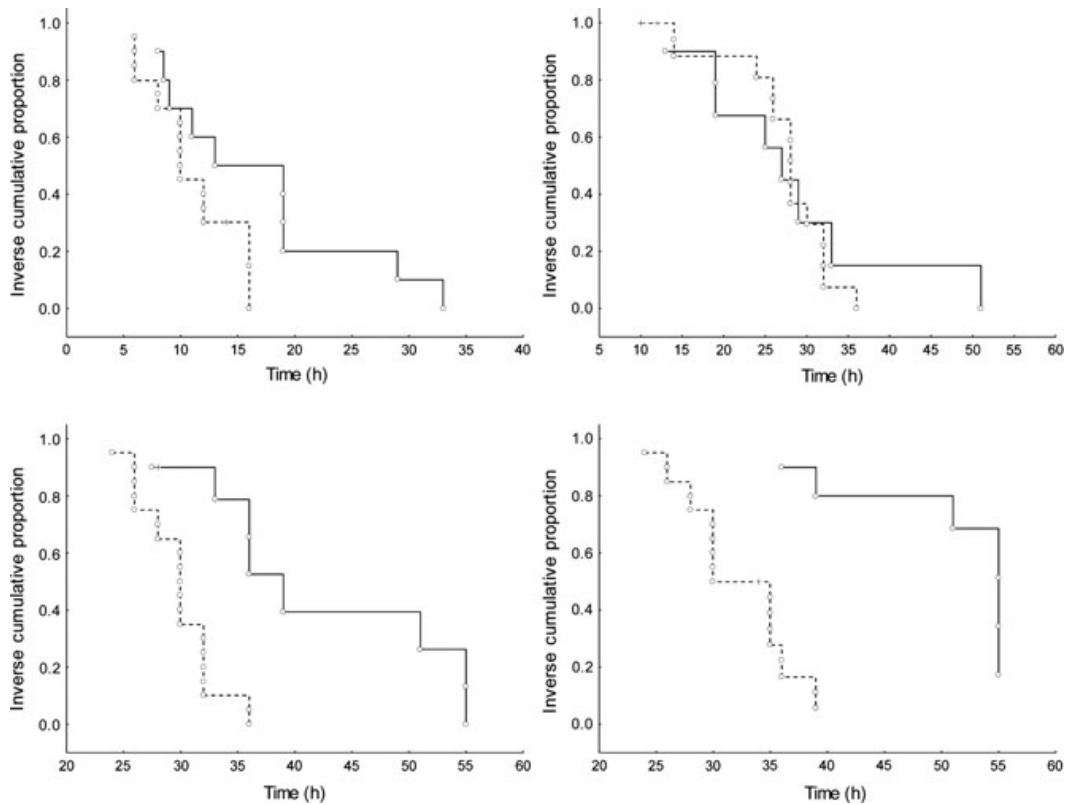

Fig. 6 Kaplan–Meier curves for two experimental groups (maintained at 25 and 27 °C) of Rainbow Skinks (*Trachylepis margaritifer*) showing phase completion over time (Experiment B). Inverse cumulative proportions indicate the proportions of skinks showing incomplete phase (i.e. at 0.6, 60% of skinks have not undergone phase completion, whilst 40% of skinks have). The dashed line represents data collected from skinks at 25 °C, whilst the solid line is for skinks at 27 °C. Points marked + indicate data points which have been censored (i.e. no event recorded). Uncensored (i.e. event recorded) are marked. Graphs represent four phases of digestion; phase II: gastric emptying initiated (top left), phase III: gastric emptying complete (top right), phase IV: movement in the small intestine and entry into the large intestine (bottom left) and phase V: movement into the large intestine completed (bottom right). Temperature had a highly significant effect on Phase IV (Gehan’s Wilcoxon: $w = 129.00$, $p < 0.01$) and V (Gehan’s Wilcoxon: $w = 170.00$, $p < 0.001$).

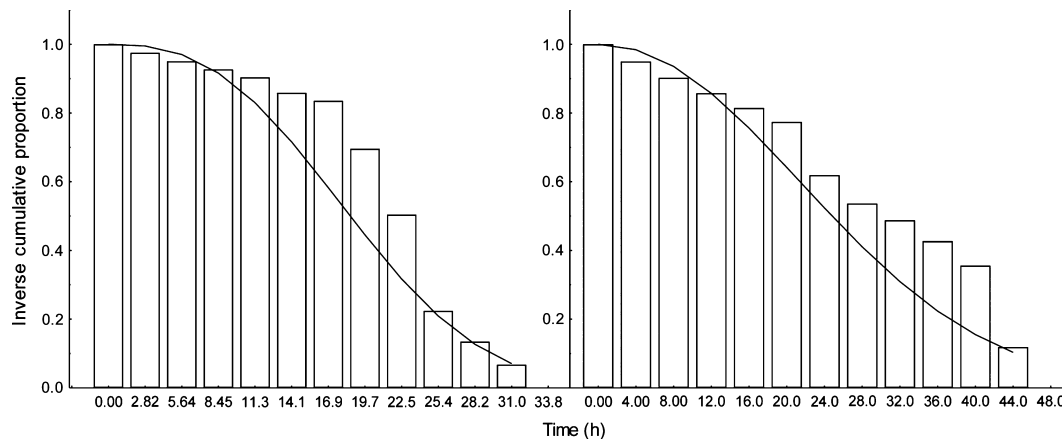

Fig. 7 Weibull estimates of time-to-event function for the Rainbow Skink (*Trachylepis margaritifer*) based on data collected from skinks maintained at environmental temperatures of 25 °C (left) and 27 °C (right; Experiment B). The inverse cumulative proportion represents the proportion of the population that has avoided the event, in this case – completing intestinal passage. The bars represent observed values, whilst the solid lines represent the theoretical distribution of weight $1/V$, where V is the variance of the hazard estimate.

and Alexander, 2004; Pafilis et al., 2007), whilst a few report temperature independence of passage rates (Karasov and Diamond, 1985; Zimmerman and Tracy, 1989; Mckinon and Alexander, 1999). Only Sadeghayobi et al. (2011) have previously reported a negative relationship between passage rate and temperature. They recorded retention times of digesta of 4 days longer at 25.5 °C than 23.3 °C in Galápagos Tortoises (*Chelonoidis nigra*), but the significance of this trend was not considered. Cases of a negative relationship between passage rate and temperature may be due to cold reptiles voiding gut contents more quickly because temperatures are too low for digestion or assimilation, resulting in a ‘cut your losses’ strategy.

We suggest that at low temperatures, risk associated with temperature-induced digestive suppression cause some reptiles to adopt mechanisms that prevent digesta rotting in the digestive tract. Some snakes avoid putrefaction of food in the stomach by regurgitating meals at low temperatures (Tsai et al., 2008). As reptiles generally do not allow meals to putrefy in their digestive systems, the consequences of this are difficult to measure. Thus, there are no documented cases of septicaemia stemming from undigested food within the gut in reptiles, although Tsai et al. (2008) do report increased mortality rates in recently fed *Viridovipera stejnegeri* (as *Trimeresurus stejnegeri stejnegeri*) at high (35 °C) and low (10 °C) temperatures. Because lizards generally feed on small prey items, a ‘cutting your losses’ strategy would entail decreasing gut passage time and foregoing the potential nutritional gain associated with an increased one. Thus, it would be expected that at

25 °C, the faster passage time seen in *T. margaritifer* would correlate with reduced apparent assimilation efficiency (AAE; see McConnachie and Alexander, 2004). This relationship is worthy of further study.

We can infer that septicaemia would be the likely outcome in cases where putrefaction occurred, because deleterious effects of low temperature on gut chemistry and enzymatic function have been well documented (Skoczylas, 1970b; Low et al., 1973). Additionally, appetite suppression at low temperatures is also known for many ectothermic taxa (Alexander et al., 2001; Wang et al., 2003; McConnachie and Alexander, 2004), and a sudden postprandial drop in temperature will elicit an emetic response in some species (Stevenson et al., 1985; Van Damme et al., 1991; Beaupre et al., 1993). This suggests that there are severe physiological consequences associated with a loaded gut at low temperatures.

Despite Schumacher and Toal’s (2001) concerns that barium sulphate might slow intestinal passage times, our study found no such effect. It is possible that this is due to the fact that we used only one-third the usual quantity of barium sulphate in our experiments (see Taylor et al., 1996). This finding suggests that barium sulphate can be used in passage time measures, at least at the concentration that we used in our study. Thus, we were able to use X-ray technology to measure the position of the digesta within the digestive tract of our lizards and observe the progression of the food bolus along the digestive tract. This information could then be used to detect where differences in passage rate occurred under various conditions. For example, we found that

lizards at 27 and 25 °C had similar rates of gastric emptying, but differed significantly in intestinal passage times.

Relative to other insectivorous lizards at equivalent temperatures (Pafilis et al., 2007), Rainbow Skinks have fast gut and intestinal passage times. We recorded gut passage times as fast as 16 and 49 h at 32 and 25 °C respectively. In fact, intestinal passage times recorded in our skinks were even faster than those documented for some endotherms such as pigs, and faster than those recorded for ponies (Möstl and Palm, 2002) when skinks were at 25 and 32 °C. From this perspective, they are ideal subjects for studies using measures of stress metabolites in faecal samples.

Although the gut passage times that we measured in Rainbow Skinks were far less variable than gut passage times reported for most snake species (see Lillywhite et al., 2002 for several examples), they were slightly more variable than passage times reported for some other lizards species (e.g. Van Damme et al., 1991; Zhang and Ji, 2004). An important source of variability in the gut passage times of our lizards stemmed from the fact that they are strictly diurnal, remaining inactive in crevices during the night. They did not defecate during this time, holding faeces in the gut until the following morning. Because our measures of intestinal passage times were not as greatly affected by night time inactivity (faeces were massaged from the lizard as soon as they entered the colon), they tended to be faster and less variable than gut passage times (21.75 ± 4.17 h rather than 49.47 ± 7.76 for 25 °C).

Overall, our study showed that *T. margaritifer* is an appropriate candidate species for stress metabolite studies using faecal analysis. The intriguing result of shorter gut passage times at 25 °C than at 27 °C emphasizes that, for stress metabolite studies on ectothermic species, the effects of temperature on specific intestinal passage times should be known.

Acknowledgements

We thank the University of the Witwatersrand's Animal Unit staff who assisted during barium meal procedures, particularly Mary-Ann Costello whose involvement also included assistance in animal husbandry. Bryan Maritz is thanked for his assistance in interpreting X-ray images and for commenting on draft versions of this manuscript. Mimmie Kgaditse and Mankurwana Mahlase assisted in data collection. All experimental protocols were cleared by the University of the Witwatersrand's Animal Ethics Committee under permit number 2009/19/2A.

Skinks were collected under permit number MPB. 5300 (Mpumalanga Tourism and Parks Agency).

References

- Alexander, G. J.; van Der Heever, C.; Lazenby, S. L., 2001: Thermal dependence of appetite and digestion rate in the Flat Lizard, *Platysaurus intermedius wilhelmi*. *Journal of Herpetology* **35**, 461–466.
- Alexander, G. J.; Hanrahan, S. A.; Mitchell, D., 2012: Assimilation efficiency and gut passage time in an African elapid snake, *Hemachatus haemachatus*. *African Journal of Herpetology* **61**, 3–13.
- Angilletta, M. J. Jr; Niewiarowski, P. H.; Navas, C. A., 2002: Invited review: the evolution of thermal physiology in ectotherms. *Journal of Thermal Biology* **27**, 249–268.
- Armario, A.; Montero, J. L.; Balasch, J., 1986: Sensitivity of corticosterone and some metabolic variables to graded levels of low intensity stresses in adult male rats. *Physiology and Behavior* **37**, 559–561.
- Avery, R. A., 1971: Estimates of food consumption by the lizard, *Lacerta vivipara* Jaquin. *Journal Animal Ecology* **40**, 351–365.
- Beaupre, S. J.; Dunham, A. E.; Overall, K. L., 1993: The effects of consumption rate and temperature on apparent digestibility coefficient, urate production, metabolizable energy coefficient and passage time in the canyon lizards (*Sceloporus merriami*) from two populations. *Functional Ecology* **7**, 273–280.
- Branch, W. R., 1998: *Field Guide to the Snakes and Other Reptiles of Southern Africa*, 3rd edn. Struik, Cape Town.
- Broadley, D. G., 2000: A review on the genus *Mabuya* in southeastern Africa (Sauria: Scincidae). *African Journal of Herpetology*, **49**, 87–100.
- Dawson, W. R., 1975: On the physiological significance of the preferred body temperatures of reptiles. In: D. M. Gates, R. B. Schmerl (eds), *Perspectives in Ecological Ecology*. Springer, New York, pp. 443–473.
- Diaz-Figueroa, O.; Mitchell, M. A., 2006: Gastrointestinal anatomy and physiology. In: D. R. Mader (ed.), *Reptile Medicine and Surgery*. Elsevier, Philadelphia, PA, pp. 145–162.
- Dorcas, M. E.; Peterson, C. R.; Flint, M. E., 1997: The thermal biology of digestion in rubber Boas (*Charina bottae*): physiology, behavior, and environmental constraints. *Physiological Zoology* **70**, 292–300.
- Gärtner, K.; Büttner, D.; Döhler, K.; Friedel, R.; Lindena, J.; Trautschold, I., 1980: Stress response of rats to handling and experimental procedures. *Laboratory Animals* **14**, 267–274.
- Haemisch, A.; Guerra, G.; Furkert, J., 1999: Adaptation of corticosterone – but not β -endorphin – secretion to repeated blood sampling in rats. *Laboratory Animals* **33**, 185–191.

- Halberg, F.; Albrecht, P. G.; Bittner, J. J., 1960: Corticosterone rhythm of mouse adrenal in relation to serum corticosterone and sampling. *American Journal of Physiology* **197**, 1083–1085.
- Hennessy, M. B.; Levine, S., 1976: Sensitive pituitary-adrenal responsiveness to varying intensities of psychological stimulation. *Physiology and Behavior* **21**, 295–297.
- Jiang, S.; Claussen, D. L., 1993: The effects of temperature on food passage time through the digestive tract in *Notophthalmus viridescens*. *Journal of Herpetology* **27**, 414–419.
- Karasov, W. H.; Diamond, J. M., 1983: Adaptive regulation of sugar and amino acid transport by vertebrate intestine. *The American Physiological Society* **245**, G443–G462.
- Karasov, W. H.; Diamond, J. M., 1985: Digestive adaptations for fueling the cost of endothermy. *Science* **228**, 202–204.
- Lillywhite, H. B.; de Delva, P.; Noonan, B. P., 2002: Patterns of gut passage time and the chronic retention of fecal mass in viperid snakes. In: G. W. Schuett, M. Höggren, M. E. Douglas, H. W. Greene (eds), *Biology of the Vipers*. Eagle Mountain Publishing, Utah, pp. 497–506.
- Low, P. S.; Bada, J. L.; Somero, G. N., 1973: Temperature adaptation of enzymes: roles of the free energy, the enthalpy and the entropy of activation. *Proceedings of the National Academy of Science of the United States of America* **70**, 430–432.
- McConnachie, S.; Alexander, G. J., 2004: The effect of temperature on digestive and assimilation efficiency, gut passage time and appetite in an ambush foraging lizard, *Cordylus melanotus melanotus*. *Journal of Comparative Physiology B* **174**, 99–105.
- Mckinon, W.; Alexander, G. J., 1999: Is temperature dependence of digestive efficiency an experimental artifact in lizards? A test using the common flat lizard (*Platysaurus intermedius*) *Copeia* **1999**, 299–303.
- Moore, I. T.; Jessop, T. S., 2003: Stress, reproduction, and adrenocortical modulation in amphibians and reptiles. *Hormones and Behavior* **43**, 39–47.
- Möstl, E.; Palm, R., 2002: Hormones as indicators of stress. *Domestic Animal Endocrinology* **23**, 67–74.
- Pafilis, P.; Foufopoulos, N.; Poulakakis, P.; Lymberakis, P.; Valakos, E., 2007: Digestive performance in five Mediterranean lizard species: effects of temperature and insularity. *Journal of Comparative Physiology B* **177**, 49–60.
- Quirce, C. M.; Maickel, R. P., 1981: Alterations of biochemical parameters by acute and repetitive stress situations in mice. *Psychoneuroendocrinology* **6**, 91–97.
- Riley, V., 1981: Psychoneuroendocrine influences on immunocompetence and neoplasia. *Science* **212**, 1100–1109.
- Sadeghayobi, E.; Blake, S.; Wikelski, M.; Gibbs, J.; Mackie, R.; Cabrera, F., 2011: Digesta retention time in the Galápagos tortoise (*Chelonoidis nigra*). *Comparative Biochemistry and Physiology, Part A* **120**, 493–497.
- Schumacher, J.; Toal, R. L., 2001: Advanced radiography and ultrasonography in reptiles. *Seminars in Avian and Exotic Pet Medicine* **10**, 162–168.
- Secor, S. M., 2005: Evolutionary and cellular mechanisms regulating intestinal performance of amphibians and reptiles. *Integrated Comparative Biology* **45**, 282–294.
- Shine, R., 2005: Life-history evolution in reptiles. *Annual Review of Ecology, Evolution and Systematics* **36**, 23–46.
- Skoczylas, R., 1970a: Influence of temperature on gastric digestion in the grass snake, *Natrix natrix* L. *Comparative Biochemistry and Physiology* **33**, 793–804.
- Skoczylas, R., 1970b: Salivary and gastric juice secretion in the grass snake, *Natrix natrix* L. *Comparative Biochemistry and Physiology* **35**, 885–903.
- Stevenson, R. D.; Peterson, C. R.; Tsuji, J. S., 1985: The thermal dependence of locomotion, tongue flicking, digestion, and oxygen consumption in the wandering garter snake. *Physiological Zoology* **58**, 46–57.
- Stevenson, R. D.; Tuberty, S. R.; de Fur, P. L.; Wingfield, J. C., 2005: Ecophysiology and conservation: the contribution of endocrinology and immunology – introduction to the symposium. *Integrative and Comparative Biology* **45**, 1–3.
- Taylor, S. K.; Citino, S. B.; Zdziarski, J. M.; Bush, R. M., 1996: Radiographic anatomy and barium sulfate transit time of the gastrointestinal tract of the leopard tortoise (*Testudo pardalis*). *Journal of Zoo and Wildlife Medicine* **27**, 180–186.
- Touma, C.; Palme, R.; Sachser, N., 2004: Analyzing corticosterone metabolites in fecal samples of mice: a non-invasive technique to monitor stress hormones. *Hormones and Behavior* **45**, 10–22.
- Tsai, T.; Lee, H.; Tu, M., 2008: Specific dynamic action, apparent assimilation efficiency, and digestive rate in an arboreal pitviper, *Trimeresurus stejnegeri stejnegeri*. *Canadian Journal of Zoology* **86**, 1139–1151.
- Valente, A. L.; Marco, I.; Parga, M. L.; Lavin, S.; Alegre, F.; Cuenca, R., 2008: Ingesta passage and gastric emptying times in loggerhead sea turtles (*Caretta caretta*). *Research in Veterinary Science* **84**, 132–139.
- Van Damme, R.; Bauwens, D.; Verheyen, R. F., 1991: The thermal dependence of feeding behaviour, food consumption and gut-passage time in the lizard *Lacerta vivipara* Jacquin. *Functional Ecology* **5**, 507–517.
- Wang, T.; Morten, Z.; Arvedsen, S.; Vedel-Smoth, C.; Overgaard, J., 2003: Effects of temperature on the metabolic response to feeding in *Python molurus*. *Comparative Biochemistry and Physiology Part A* **133**, 519–527.
- Whiting, M. J.; Alexander, G. J., 2001: Oil spills and glue: a comment on a sticky sampling problem for lizards. *Herpetological Review* **32**, 78–79.

- Wikelski, M.; Cooke, S. J., 2006: Conservation physiology. *Trends in Ecology and Evolution* **21**, 38–46.
- Wingfield, J. C.; Hunt, K.; Breuner, C.; Dunlap, K.; Fowler, G. S.; Freed, L.; Lepson, J., 1997: Environmental stress, field endocrinology, and conservation biology. In: J. R. Clemmons, R. Buchholz (eds), *Behavioral Approaches to Conservation in the Wild*. Cambridge University Press, Cambridge, pp. 95–131.
- Zhang, Y. P.; Ji, X., 2004: The thermal dependence of food assimilation and locomotor performance in southern grass lizards, *Takydromus sexlineatus* (Lacertidae). *Journal of Thermal Biology* **29**, 45–53.
- Zimmerman, L. C.; Tracy, C. R., 1989: Interactions between the environment and ectothermy and herbivory in reptiles. *Physiological Zoology* **62**, 374–409.

CHAPTER THREE



Digestive efficiencies are independent of gut passage times in rainbow skinks (*Trachylepis margaritifer*)



Ashadee K. Miller*, Barend F.N. Erasmus, Graham J. Alexander

School of Animal, Plant and Environmental Sciences, University of the Witwatersrand, Johannesburg, South Africa

ARTICLE INFO

Article history:

Received 22 March 2014

Received in revised form 4 June 2014

Accepted 9 June 2014

Available online 15 June 2014

Keywords:

Digestive performance

Thermal physiology

Appetite

Ectotherm

ABSTRACT

Constraints on physiological processes imposed on ectotherms by environmental temperatures can be severe, affecting many aspects of their biology. Included in the suite of physiological processes affected is gut motility, with below optimum temperatures generally resulting in slow gut passage. *Trachylepis margaritifer* (rainbow skink) however presents an unusual pattern whereby gut passage time decreases at a low temperature compared to when at an intermediate temperature. It has been suggested that this may be a 'cutting-your-losses' response whereby nutritional gain is sacrificed by voiding the digesta to reduce the risk of these rotting within the gut at these low temperatures, and if this is so, it should result in reduced digestive performance at 25 °C. We tested this hypothesis by measuring appetite, apparent digestive efficiency (ADE) and apparent assimilation efficiency (AAE) in *T. margaritifer*. We found that although temperature significantly affected appetite and gut passage time, it did not affect digestive efficiency. Both ADE (>90%) and AAE (>80%) were high and temperature-independent across the range tested. Thus, the 'cutting-your-losses' hypothesis does not explain faster gut passage at 25 °C. High digestive parameters could be maintained by increasing concentrations of digestive enzyme at low temperatures but remains to be tested in this species.

© 2014 Elsevier Inc. All rights reserved.

1. Introduction

In ectotherms, physiological performance is constrained by environmental temperature. Typically, when environmental temperatures are extreme, physiological processes are negatively affected, including locomotor (Bennett, 1990), digestive (Harwood, 1979), and immune functions (Le Morvan et al., 1998; Mondal and Rai, 2001; Merchant et al., 2003; Merchant and Britton, 2006; Raffel et al., 2006), as well as appetite (Harwood, 1979; Beaupre et al., 1993; Alexander et al., 2001) and feeding success (Greenwald, 1974). For species whose geographic distributions span a wide range of climatic conditions, it is likely that these temperature-dependent declines in physiological performance may carry considerable costs, which could be exacerbated by climate change (Easterling et al., 2000). Some species have adaptations that offset at least some of these costs, particularly when it comes to digestive performance. For example, at low temperatures many species extend gut passage times (Alexander et al., 2012), increasing the period over which digestion of a meal can take place. This counters lower rates

of assimilation associated with low temperatures (Xiang et al., 1993), making digestive efficiency effectively independent of temperature (McConnachie and Alexander, 2004).

The apparent uncoupling of digestive performance from temperature in ectotherms is, however, bounded within a range of temperatures because digestion must still take place at a rate faster than the putrefaction of the ingested meal. For example, Tsai et al. (2008) found that gastric and gut passage time increases with decreasing temperatures in the snake *Viridovipera stejnegeri* (as *Trimeresurus stejnegeri stejnegeri*), but that at 10 °C digestion is effectively arrested, resulting in increased incidence of emesis and death. Meal regurgitation and snake death also increased at 35 °C. Emetic responses to low temperatures have been observed in many species of snakes (e.g., *Charina bottae*, Dorcas et al., 1997; *Python bivittatus* (as *Python molurus*), Wang et al., 2002), but to our knowledge, has not been reported in any lizard species. Because snakes typically consume large, whole meals (Lillywhite, 1987), the risk of digesta rotting within their gut is likely to be pronounced when compared to risks faced by ectotherms which consume smaller, masticated meals. The lack of recorded cases of regurgitation in lizards suggests that they are not faced with such severe consequences under these circumstances, or they employ different mechanisms with which to handle the situation.

Miller et al. (2013) found no difference in gastric emptying in the rainbow skink, *Trachylepis margaritifer* (Peters, 1854), maintained at 25 °C and 27 °C, but did detect significant differences in intestinal

* Corresponding author at: School of Animal, Plant and Environmental Sciences, University of the Witwatersrand, Private Bag 3, Wits, 2050, South Africa. Tel.: +27 11 717 6439; fax: +27 11 717 6494.

E-mail address: ashadee.k.miller@gmail.com (A.K. Miller).

passage times at these temperatures, which significantly affected overall gut passage times. The fastest gut passage times were recorded for skinks maintained at the highest trial temperature (32 °C). Gut passage times were significantly slower in skinks kept at 25 °C relative to those kept at 32 °C, but were significantly faster than measures made at 27 °C. This result is unexpected since skinks had the slowest gut passage times at the intermediate temperature. It was suggested by Miller et al. (2013) that this unusual pattern could be a 'cutting-your-losses response', whereby in order to reduce the risk of digesta putrefying within the gut at temperatures as low as 25 °C, digesta are moved through the system faster, which should result in a reduced apparent digestive efficiency (ADE) and apparent assimilation efficiency (AAE) under these conditions.

We tested the 'cutting-your-losses' hypothesis by measuring ADE and AAE in *T. margaritifer* at 25, 27 and 32 °C. We predicted that both ADE and AAE would be lowest at 25 °C, but would be temperature-independent at higher temperatures. We also measured appetite at these three environmental temperatures and predicted that it would be depressed at low temperatures in response to the depressed metabolic requirements (Beaupre et al., 1993) and digestive performance.

2. Materials and methods

2.1. Study species

T. margaritifer is a substrate-specific species of insectivorous skink that occurs on rocky outcrops throughout savannas in southern Africa (Branch, 1998). The species' distribution edge very closely follows the isotherms for the south-eastern parts of southern Africa, and so the species appears to be climate-limited. Skinks were wild-caught in Mpumalanga, South Africa (25°34'26.5" S; 31°11'05.9" E), and individually housed at the University of the Witwatersrand in glass terraria set up identically to those described in Miller et al. (2013) at three environmental temperatures (25, 27 and 32 °C). Skinks were allowed to acclimate for a period of at least three weeks prior to any experimentation. Water was provided ad libitum and all three experimental rooms experienced a 12-hour photoperiod, beginning at 06:00 h. All skinks were de-wormed using Panacur® (active ingredient: fenbendazole) at least two weeks prior to commencement of trials.

2.2. Appetite trial

For appetite trials, skinks ($n_{25\text{ °C}} = 9$, $n_{27\text{ °C}} = 8$, $n_{32\text{ °C}} = 7$) were starved for a period of five days prior to the commencement of trials to ensure that their guts were empty (Miller et al., 2013) and that all skinks shared an identical feeding history. Each trial consisted of each lizard being offered 35 live mealworms (*Tenebrio molitor* larvae) of known mass. Three trials at each temperature were conducted with a three-day gap between consecutive trials. Conducting multiple trials allowed us to test not only the effect of temperature on appetite, but also the effect of feeding history on this parameter at these temperatures. Effectively, we tested appetite at these temperatures on two levels: one where skinks had recently experienced a period of starvation and another where skinks had recently fed. During each trial, skinks were allowed the opportunity to feed for a period of 4 h, after which, uneaten mealworms were collected, counted and weighed. No skink consumed all 35 mealworms provided at a feeding and measures were thus not merely a function of food availability. Although there was no significant difference in skink size (SVL and mass) across treatment groups, measures of appetite were corrected for this aspect on an individual basis since McConnachie and Alexander (2004) reported a body mass effect on food consumption in *Pseudocordylus melanotus* (as *Cordylus melanotus melanotus*).

2.3. Digestion efficiency

For digestion efficiency trials, terraria were lined with plastic sheeting to allow for the effective collection of egesta. No other changes to the terraria were made, and access to refugia remained constant. Skinks ($n_{25\text{ °C}} = 10$, $n_{27\text{ °C}} = 9$, $n_{32\text{ °C}} = 9$) were each fed a known number and mass of mealworms every three days over a period of two months. At the end of the two-month trial, each skink's collected egesta were separated into their respective faecal and ureic components and weighed. Because the energy content of urea ($\text{CH}_4\text{N}_2\text{O}$) is a constant ($151.6\text{ kcal mol}^{-1}$; Elliot and Davison, 1975), faecal and ureic components were burnt together in a bomb calorimeter (Digital Data Systems CP500 Calorimetry Systems, Johannesburg, South Africa) and the energy values apportioned between these separate components. ADE and AAE were calculated using known formulas, originally outlined in Johnson and Lillywhite (1979) and adapted by McConnachie and Alexander (2004). Briefly, ADE is the percentage of energy absorbed via the gut, whilst AAE is the percentage of energy retained by the animal (McConnachie and Alexander, 2004).

We calculated the energy content of mealworms by individually weighing live mealworms ($n = 116$) which were then placed into a freezer until dead, oven-dried to constant mass at 30 °C and reweighed to calculate water content. Thereafter, they were milled (IKA Type A10 Mill; 20000 rpm for a minimum of 30 s) together into a fine powder and subjected to bomb calorimetry in subsets of 0.5 g ($n = 10$). The total energy (kJ) consumed by each skink was calculated by converting the total consumed wet mass to dry mass (g) which was then multiplied by the averaged bomb value (kJ/g) for the mealworms.

2.4. Statistics

All data were normally distributed. Differences in skink morphometrics (i.e., mass and SVL) across treatments and digestive efficiency measures across treatments were tested for using ANOVA. For overall temperature effects on appetite measures, data were corrected for skink size and averaged across all three trials and tested using ANOVA. Testing the effect of feeding history was performed using repeated measures ANOVA. Where variances were shown to be heterogeneous, Greenhouse–Geisser corrections were applied. Significant differences among treatment groups were identified using Tukey HSD post-hoc test. Unless otherwise stated, values are reported as mean \pm standard deviation. All analyses were performed using SPSS® Statistics v. 22 (IBM® SPSS® Statistics, <http://www.spss.com>, 2013). Results were considered statistically significant for $p < 0.05$.

3. Results

3.1. Appetite trial

There was no significant difference in size or mass of skinks between temperature trials (Table 1; ANOVA: $F_{2,22(\text{mass})} = 0.72$, $p_{(\text{mass})} = 0.50$; $F_{2,22(\text{SVL})} = 0.27$, $p_{(\text{SVL})} = 0.77$). On average, when data from all three feeding trials were pooled, skinks maintained at 25 °C consumed fewer mealworms, constituting less mass, than those maintained at 27 and 32 °C (Fig. 1: pooled). These differences were significant (ANOVA: $F_{2,22(\text{mass})} = 4.96$, $p_{(\text{mass})} = 0.017$; $F_{2,22(\text{number})} = 6.31$,

Table 1
Morphometric details of rainbow skinks (*Trachylepis margaritifer*) used to test the effect of temperature on appetite.

Treatment	No. of skinks	Mass (g \pm SD)	SVL (mm \pm SD)
25 °C	9	26.4 \pm 5.3	100.4 \pm 4.6
27 °C	8	23.5 \pm 5.2	98.2 \pm 6.9
32 °C	7	26.3 \pm 6.2	100.0 \pm 8.2

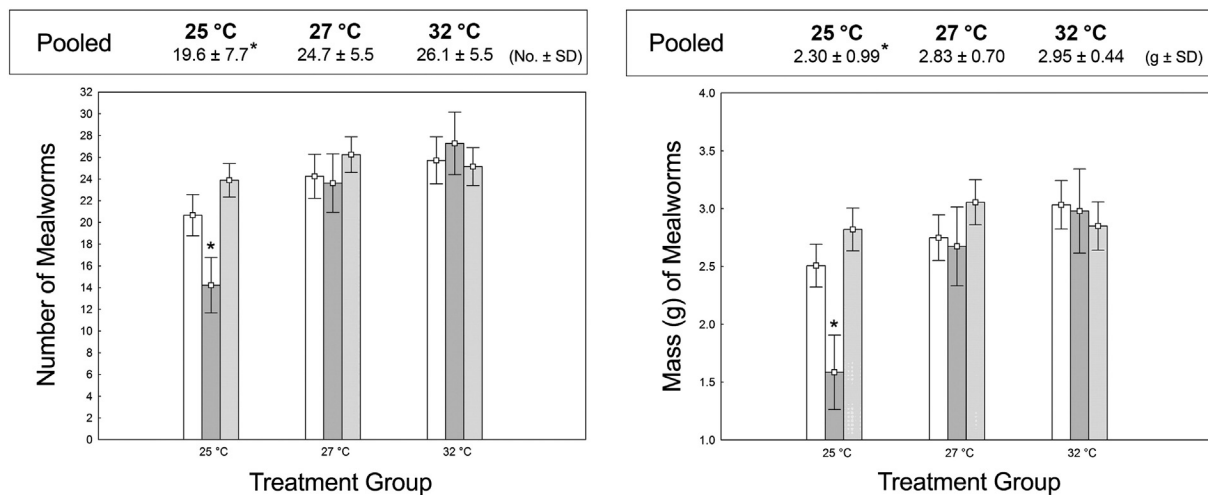

Fig. 1. The mean number (left) and mass in grams (right) of mealworm (*Tenebrio molitor*) larvae consumed by rainbow skinks (*Trachylepis margaritifera*) maintained at three environmental temperatures (25, 27 and 32 °C). Feeding trials (n = 3) are presented chronologically from left to right, and their averaged values within treatment groups are presented above under "pooled". Asterisks (*) indicate trials that are significantly different from others both within and across treatment groups. Error bars represent standard error.

$p_{(\text{number})} = 0.007$). The highest appetite measures for a single trial ($n_{(\text{mealworms})} = 34$; $\text{mass}_{(\text{mealworms})} = 3.8$ g) were recorded for a skink maintained at 32 °C, whilst the lowest measures were recorded in the second trial where one skink refused all food and another consumed only one mealworm (mass = 0.2 g) at 25 °C.

Not only did temperature have a significant effect on appetite in *T. margaritifera*, but so too did feeding history (repeated measures ANOVA: Greenhouse–Geisser $F_{3,01,31.6}(\text{mass}) = 2.94$, $p_{(\text{mass})} = 0.048$; $F_{4,42}(\text{number}) = 2.99$, $p_{(\text{number})} = 0.03$). When trials were analysed individually, temperature significantly affected the appetite of skinks maintained at 25 °C during the second feeding trial, but not the first or last trial (Fig. 1). For the first trial, appetite measures reflect those of recently starved skinks, having last been fed five days prior to this trial. Under these post-starvation circumstances, temperature had no effect (ANOVA: $F_{2,21}(\text{number}) = 2.24$, $p = 0.131$; $F_{2,21}(\text{mass}) = 2.56$, $p = 0.10$), and skinks fed equally across temperature treatments. For the second trial however, when appetite measures were made on skinks that had recently fed, having consumed non-significantly different but extreme amounts, temperature mattered significantly. Skinks maintained at 25 °C consumed significantly fewer mealworms than their counterparts maintained at 27 and 32 °C (ANOVA: $F_{2,21}(\text{number}) = 6.40$, $p = 0.007$; $F_{2,21}(\text{mass}) = 5.01$, $p = 0.017$), consuming, on average, 1.1 g (~9 mealworms) and 1.4 g (~13 mealworms) less than skinks at 27 and 32 °C did during the second trial respectively. However, by the time food was once again on offer during the third trial, three days later, skinks at 25 °C had regained the same level of appetite demonstrated in the first feeding trial and no significant differences were detected among the treatment groups (ANOVA: $F_{2,21}(\text{number}) = 1.09$, $p = 0.35$; $F_{2,21}(\text{mass}) = 0.91$, $p = 0.42$). The significant reduction in appetite in the skinks maintained at 25 °C during the second trial was however great enough to ensure that even when data for all three trials were pooled within their respective treatment groups, the effect of temperature was still evident.

Table 2

Apparent digestive and assimilation efficiencies measured in rainbow skinks (*Trachylepis margaritifera*) maintained at three environmental temperatures. Skink numbers reflect those from which suitable shed-free and successfully measured samples were collected.

Environmental temperature (°C)	Rainbow skinks (n)	Mass (g ± SD)	SVL (mm ± SD)	Apparent digestive efficiency (% ± SD)	Apparent assimilation efficiency (% ± SD)	ANOVA	
						Digestive efficiency	Assimilation efficiency
25	8	27.1 ± 4.2	103.0 ± 4.9	95.7 ± 1.1	89.7 ± 1.8	$F_{2,19} = 0.98$	$F_{2,19} = 2.39$
27	6	25.2 ± 5.1	97.5 ± 7.9	95.0 ± 1.5	89.4 ± 2.1	$p = 0.39$	$p = 0.12$
32	8	26.9 ± 6.0	99.9 ± 7.2	93.8 ± 4.2	86.8 ± 4.0		

3.2. Digestive trial

3.2.1. Mealworm energy content

Mealworms declined in mass by $64.1\% \pm 3.0$ from wet to dry state, with the energy content of dried worms being 27.3 kJ/g ± 0.3 . Our measures for water and energy content of *T. molitor* are within range (e.g., 60.1% and 23.3–28.6 kJ/g) of other published measures (Brisbin, 1966; Neuhauser and Brisbin, 1969; O'Farrell et al., 1971; Kunz, 1988; Barclay et al., 1991; Webb, 1992; McLean and Speakman, 1999).

3.2.2. Apparent digestive and assimilation efficiencies

Skink SVL and mass were not significantly different between treatments at the beginning of trials (ANOVA: $F_{2,25}(\text{mass}) = 0.33$, $p_{(\text{mass})} = 0.72$; $F_{2,25}(\text{SVL}) = 0.07$, $p_{(\text{SVL})} = 0.93$). *T. margaritifera* regularly consumes its own shed skin (pers. obs) and as a result four samples containing evidence of shed skin were excluded from analyses. Although the energy content of *T. margaritifera* shed was measured (20.3 kJ/g), the amount consumed by each skink was unknown and as a result the ADE and AAE could not be calculated for these cases. A further two samples were also lost due to the bomb calorimeter misfiring. Temperature had no significant effect on ADE or AAE (Table 2.). ADE measures were greater than 90% and AAE between 85 and 90% at the three temperatures tested.

4. Discussion

We found that temperature had a significant effect on the appetite in *T. margaritifera*, with skinks reducing food intake at low temperatures. However, appetite also appeared to be modulated by feeding history, as temperature effects on appetite were not evident immediately after lizards had been starved for five days. Because skinks maintained at 25 °C reduced their food intake significantly during the second trial,

they effectively underwent a self-imposed period of starvation. We believe that this is the reason for the subsequent trial showing a temperature-independent appetite pattern. *T. margaritifer* is typically able to empty its stomach within 10 h of feeding irrespective of temperature (Miller et al., 2013). The appetite reduction in *T. margaritifer* at low temperature is therefore unlikely to be a result of physical space constraints of a full stomach, but does echo the typical pattern of temperature-dependent appetite for squamates in general. For example, *P. bivittatus* (as *P. molurus*; Wang et al., 2002), *Uta stansburiana* (Waldschmidt et al., 1986), *Pseudocordylus melanotus* (McConnachie and Alexander, 2004) and *Platysaurus intermedius wilhelmi* (Alexander et al., 2001) all demonstrate reduced appetite at low temperatures, and is a pattern which likely reflects associated decreases in metabolic rates in ectotherms at low environmental temperatures (Beaupre et al., 1993; Karasov and Anderson, 1998).

Although appetite measures in *T. margaritifer* follow the typical temperature-dependent patterns for squamates, they do not follow the same temperature-dependent pattern recorded for gut passage time in this species (Miller et al., 2013). Appetite remained consistent at 27 °C over the three feeding trials despite this temperature eliciting the slowest gut passage time. It appears therefore that appetite is not modulated directly by the volume of digesta in the gut in *T. margaritifer*, which is at odds with Angilletta's (2001) conclusion that gut passage times are the proximal limiting factor to appetite when food is not limiting. Their appetite reductions reflect decreased metabolic rates at these low temperatures, typical of ectotherms (Andrews and Pough, 1985). We suggest that when feeding has occurred recently, allowing these skinks to meet a minimum energy budget, the drive to eat at low temperatures may be reduced compared to when little to no recent feeding has occurred.

Our measures of ADE and AAE indicate that the digestive efficiencies of *T. margaritifer* are unaffected by temperature over the temperature range tested. This is despite the significant differences in gut passage times reported by Miller et al. (2013). Thus the 'cutting-your-losses' hypothesis failed our test and cannot explain the faster passage times at 25 °C reported by Miller et al. (2013). This surprising result shows that rainbow skinks are able to digest and assimilate food as efficiently at 25 °C as 27 °C, even though the digesta are moving through the gut faster at the lower temperature. Exactly how these digestive parameters are being maintained across the wide range of passage times and temperatures remains unclear. Enzymatic performance is typically temperature-dependent, with optimal performance typically occurring at high, sub-denaturing temperatures, but decreases with decreasing temperature (Solomon et al., 2002). We propose that *T. margaritifer* may be compensating for temperature effects by changing enzyme concentrations so as to offset reduced digestive and assimilation performances at low temperatures. Such compensation has been previously reported in lizards (Knox, 1958; Prosser, 1962; Licht, 1964), but remains to be tested in this species. If such compensation exists, there must be costs involved in its application as it is only elicited at low temperatures.

Our lizards had high digestive efficiencies with measures of ADE exceeding 90%, and those of AAE exceeding 85%. These are higher than those recorded for two other species of insectivorous lizards also fed exclusively on mealworms: *Anolis carolinensis* (Licht and Jones, 1967) and *Lacerta vivipara* (Avery, 1971) both have ADEs below 90%, whilst AAE of *Sceloporus graciosus* and *Sceloporus occidentalis* have been recorded as 83% (Mueller, 1970). Food type has been shown to greatly affect ADE and AAE (Johnson and Lillywhite, 1979; McKinon and Alexander, 1999) and our measures of these digestive parameters in rainbow skinks are approaching maximum digestive capacity for mealworms since indigestible chitin forming the exoskeleton contributes 6.9% of *Tenebrio* larvae dry mass (Engelmann, 1961).

Our findings on digestive performance suggest that when food is readily available, *T. margaritifer* may suffer little to no nutritional costs associated with fluctuating environmental temperatures in the field, at least at sites where the minimum temperatures experienced are 25 °C

and where microhabitat thermal heterogeneity offers some respite from temperatures above 32 °C. The typically positive relationship between metabolic rate and temperature in ectotherms (Beaupre et al., 1993; Karasov and Anderson, 1998) could mean that even at temperatures lower than 25 °C, associated nutritional costs may mean little as a result of reduced energetic needs at these temperatures, provided appetite is not completely suppressed. Temperature limits of appetite for this species are unknown. However for other ectotherms, meal refusal has been documented at both ends of the temperature scale. At the lower end, *P. molurus* stops feeding at 20 °C (Wang et al., 2002) *P. intermedius wilhelmi* at 22 °C (Alexander et al., 2001), *S. occidentalis* at 20.2 °C (Harwood, 1979) and *Sceloporus merriami* at 28 °C (Beaupre et al., 1993). *T. margaritifer* is mainly found throughout the lowveld savannas of southern Africa (Branch, 1998) where mean daily temperatures typically range from 5 to 32 °C throughout the year (Mucina and Rutherford, 2006). The likelihood of *T. margaritifer* experiencing extended periods where appetite is completely suppressed is low and skinks have been observed hunting during the winter months at some of the coldest sites within their distribution (pers. obs.).

5. Conclusion

Rainbow skinks, to our knowledge, are the second reptile species recorded to demonstrate decreased gut passage times at low temperatures (Miller et al., 2013). Sadeghayobi et al. (2011) recorded the same trend in *Chelonoidis nigra* (Galápagos tortoise) where reducing temperatures from 25.5 to 23.3 °C significantly decreased these tortoises' gut passage times by four days. There are few studies which have investigated the effect of temperature on gut passage time in ectotherms, mostly reviewed in Van Damme and Verheyen (1991), and it is possible that this trend of decreased gut passage time at low temperatures exists for more than these two species, but has simply gone undetected. We have shown that rainbow skinks suffer no nutritional costs by decreasing their exposure to digesta at low temperatures and therefore reject Miller et al.'s (2013) "cutting-your-losses" hypothesis. Though the mechanism offsetting any potential nutritional costs remains unclear, increases in enzyme concentrations at low temperatures may be responsible, and has been recorded in other lizard species (e.g., Knox, 1958; Prosser, 1962; Licht, 1964). In our opinion, this is the most likely explanation for the patterns that we observe in rainbow skinks. Additionally, decreasing gut passage time in response to low temperatures must serve a physiological purpose in *C. nigra* and *T. margaritifer* and is worthy of further study.

Acknowledgements

We thank the University of Witwatersrand's Animal Unit staff for their continued support throughout. Bruce Patterson is thanked for his dedication in providing excellent technical support whenever it was required. All experimental protocols were cleared by the University of the Witwatersrand's Animal Ethics Committee under permit number 2009/19/2A. Skinks were collected under permit number MPB. 5300 (Mpumalanga Tourism and Parks Agency).

References

- Alexander, G.J., van Der Heever, C., Lazenby, S.L., 2001. Thermal dependence of appetite and digestive rate in the flat lizard, *Platysaurus intermedius wilhelmi*. *J. Herpetol.* 461–466.
- Alexander, G.J., Hanrahan, S.A., Mitchell, D., 2012. Assimilation efficiency in an African elapid snake, *Hemachatus haemachatus*. *Afr. J. Herpetol.* 61 (1), 3–13.
- Andrews, R.M., Pough, F.H., 1985. Metabolism of squamate reptiles: allometric and ecological relationships. *Physiol. Zool.* 58, 214–231.
- Angilletta Jr., M.J., 2001. Thermal and physiological constraints on energy assimilation in a widespread lizard (*Sceloporus undulatus*). *Ecology* 82 (11), 3044–3056.
- Avery, R.A., 1971. Estimates of food consumption by the lizard *Lacerta vivipara* Jacquin. *J. Anim. Ecol.* 40, 351–365.
- Barclay, R.M.R., Dolan, M., Dyck, A., 1991. The digestive efficiency of bats. *Can. J. Zool.* 69, 1853–1856.

- Beaupre, S.J., Dunham, A.E., Overall, K.L., 1993. The effects of consumption rate and temperature on apparent digestibility coefficient, urate production, metabolizable energy coefficient and passage time in canyon lizards (*Sceloporus merriami*) from two populations. *Funct. Ecol.* 273–280.
- Bennett, A.F., 1990. Thermal dependence of locomotor capacity. *Am. J. Physiol.* 259 (2), 253–258.
- Branch, W.R., 1998. *Field Guide to Snakes and Other Reptiles of Southern Africa*. Struik Publishers, Cape Town.
- Brisbin, I.L., 1966. Energy utilisation in a captive hoary bat. *J. Mammal.* 47, 719–720.
- Dorcas, M.E., Peterson, C.R., Flint, M.E., 1997. The thermal biology of digestion in rubber Boas (*Charina bottae*): physiology, behavior, and environmental constraints. *Physiol. Zool.* 70, 292–300.
- Easterling, D.R., Meehl, G.A., Parmesan, C., Changnon, S.A., Karl, T.R., Mearns, L.O., 2000. Climate extremes: observations, modeling, and impacts. *Science* 289, 2068–2074.
- Elliot, J.M., Davison, W., 1975. Energy equivalents of oxygen consumption in animal energetics. *Oecologia (Berl.)* 19, 195–201.
- Engelmann, M.D., 1961. The role of soil arthropods in the energetics of an old field community. *Ecol. Monogr.* 31, 221–238.
- Greenwald, O.E., 1974. Thermal dependence of striking and prey capture by Gopher snakes. *Copeia* 1, 141–148.
- Harwood, R.H., 1979. The effect of temperature on the digestive efficiency of three species of lizards, *Cnemidophorus tigris*, *Gerrhonotus multicarinatus* and *Sceloporus occidentalis*. *Comp. Biochem. Physiol. A Physiol.* 63 (3), 417–433.
- Johnson, R.N., Lillywhite, H.B., 1979. Digestive efficiency of the omnivorous lizard *Klauberiana riversiana*. *Copeia* 431–437.
- Karasov, W.H., Anderson, R.A., 1998. Correlates of average daily metabolism of field-active zebra-tailed lizards (*Callisaurus draconoides*). *Physiol. Zool.* 71, 93–105.
- Knox, W.E., 1958. Adaptive enzymes in the regulation of animal metabolism. In: Prosser, C.L. (Ed.), *Physiological Adaptation*. Am. Physiol. Soc., Washington, D.C., pp. 107–125.
- Kunz, T.H., 1988. Methods of assessing the availability of prey to insectivorous bats. In: Kunz, T.H. (Ed.), *Ecological and Behavioural Methods for the Study of Bats*. Smithsonian Institution Press, London, pp. 191–210.
- Le Morvan, C., Troutaud, D., Deschaux, P., 1998. Differential effects of temperature on specific and nonspecific immune defenses in fish. *J. Exp. Biol.* 201, 165–168.
- Licht, P., 1964. The temperature dependence of myosin adenosine triphosphate and alkaline phosphatase in lizards. *Comp. Biochem. Physiol.* 12, 331–341.
- Licht, P., Jones, R.E., 1967. Effects of exogenous prolactin on reproduction and growth in adult males of the lizard *Anolis carolinensis*. *Gen. Comp. Endocrinol.* 8 (2), 228–244.
- Lillywhite, H.B., 1987. Temperature, energetics, and physiological ecology. In: Seigel, R.A., Collins, J.T., Novak, S.S. (Eds.), *Snakes: Ecology and Evolutionary Biology*. Macmillan Publishing Co., New York, pp. 422–477.
- McConnachie, S., Alexander, G.J., 2004. The effect of temperature on digestive and assimilation efficiency, gut passage time and appetite in an ambush foraging lizard, *Cordylus melanotus melanotus*. *J. Comp. Physiol. B.* 174 (2), 99–105.
- McKinon, W., Alexander, G.J., 1999. Is temperature independence of digestive efficiency an experimental artefact in lizards? A test using the common flat lizard (*Platysaurus intermedius*). *Copeia* 1999, 299–303.
- McLean, J.A., Speakman, J.R., 1999. Non-nutritional maternal support in the brown long-eared bat (*Plecotus auritus*). *Anim. Behav.* 54, 1193–1204.
- Merchant, M., Britton, A., 2006. Characterization of serum complement activity of saltwater (*Crocodylus porosus*) and freshwater (*Crocodylus johnstoni*) crocodiles. *Comp. Biochem. Physiol. A* 143, 488–493.
- Merchant, M., Roche, C., Elsey, R.M., Prudhomme, J., 2003. Antibacterial properties of serum from the American alligator (*Alligator mississippiensis*). *Comp. Biochem. Physiol. B* 136, 505–513.
- Miller, A.K., Erasmus, B.F.N., Alexander, G.J., 2013. Gut and intestinal passage time in the rainbow skink (*Trachylepis margaritifer*): implications for stress measures using faecal analysis. *J. Anim. Physiol. Anim. Nutr.* 97, 960–970.
- Mondal, S., Rai, U., 2001. In vitro effect of temperature on phagocytic and cytotoxic activities of splenic phagocytes of the wall lizard, *Hemidactylus flaviviridis*. *Comp. Biochem. Physiol. A* 129, 391–398.
- Mucina, L., Rutherford, M.C., 2006. *The Vegetation of South Africa, Lesotho and Swaziland*. South African National Biodiversity Institute, Pretoria.
- Mueller, C.F., 1970. Energy utilization in the lizards *Sceloporus graciosus* and *S. occidentalis*. *J. Herpetol.* 131–134.
- Neuhauser, H.N., Brisbin, I.L., 1969. Energy utilisation in a captive silver-haired bat. *Bat Res. News* 10, 30–31.
- O'Farrell, M.J., Studier, E.H., Ewing, W.G., 1971. Energy utilisation and water requirements of captive *Myotis thysanodes* and *Myotis lucifugus* (Chiroptera). *Comp. Biochem. Physiol. A* 39, 549–552.
- Peters, W.C.H., 1854. Diagnosen neuer Batrachier, welche zusammen mit der früher (24 Juli und 17 August) gegebenen Übersicht der Schlangen mitgeteilt werden. *Ber. Bekanntmach. Geeignet. Verhandl. Königl.-Preuss. Akad. Wiss. Berlin*, pp. 614–628.
- Prosser, C.L., 1962. Acclimation of poikilothermic vertebrates to low temperatures. In: Hannon, J.P., Viereck, E. (Eds.), *Comparative Physiology of Temperature Regulation*. Artic Aeromedical Lab, Fort Wainwright, Alaska, pp. 1–34.
- Raffel, T.R., Rohr, J.R., Kiesecker, J.M., Hudson, P.J., 2006. Negative effects of changing temperature on amphibian immunity under field conditions. *Funct. Ecol.* 20, 819–828.
- Sadeghayobi, E., Blake, S., Wikelski, M., Gibbs, J., Mackie, R., Cabrera, F., 2011. Digesta retention time in the Galápagos tortoise (*Chelonoidis nigra*). *Comp. Biochem. Physiol. A* 160 (4), 493–497.
- Solomon, E.P., Berg, L.R., Martin, D.W., 2002. *Biology*, 6th ed. Brooks-Cole Thompson Learning, Stamford, CT.
- Tsai, T., Lee, H., Tu, M., 2008. Specific dynamic action, apparent assimilation efficiency, and digestive rate in an arboreal pitviper, *Trimeresurus stejnegeri stejnegeri*. *Can. J. Zool.* 86, 1139–1151.
- Van Damme, R., Verheyen, R.F., 1991. The thermal dependence of feeding behaviour, food consumption and gut-passage time in the lizard *Lacerta vivipara* Jacquin. *Funct. Ecol.* 5, 507–517.
- Waldschmidt, S.R., Jones, S.M., Porter, W.R., 1986. The effect of body temperature and feeding regime on the activity, passage time, and digestive coefficient in the lizard *Uta stansburiana*. *Physiol. Zool.* 59, 376–383.
- Wang, T., Zaar, M., Arvedsen, S., Vedel-Smith, C., Overgaard, J., 2002. Effects of temperature on the metabolic response to feeding in *Python molurus*. *Comp. Biochem. Physiol. A* 133 (3), 519–527.
- Webb, P.L., 1992. *Aspects of the Ecophysiology of Some Vespertilionid Bats at the Northern Borders of Their Distribution*. (PhD Thesis) University of Aberdeen, Scotland.
- Xiang, J., Zhou, W., He, G., Gu, H., 1993. Food intake, assimilation efficiency, and growth of juvenile lizards *Takydromus septentrionalis*. *Comp. Biochem. Physiol. A* 105 (2), 283–285.

CHAPTER FOUR

A Multifaceted Habitat Quality Assessment for the Rainbow Skink (*Trachylepis margaritifer*) Emphasizes the Importance of a Mechanistic Framework

ABSTRACT

Measuring climatic impacts on habitat quality is becoming increasingly relevant under conditions of climate change. However issues of species-appropriate resolution and scale are often not well addressed in these assessments, and analyses are not always biologically appropriate. We assessed whether QDS-scale climate suitability predictions from a climate niche model across the Rainbow Skink (*Trachylepis margaritifer*) distribution reflected conditions experienced at the microhabitat-scale, using both standard thermal assessments and biologically meaningful ones. Five habitat quality proxy measures, in addition to morphometric measures made on wild-caught skinks were also compared against these same suitability predictions. Proxy measures in general aligned poorly to predicted suitability scores and no morphometric differences were detected. No meaningful differences in habitat quality were found using standard thermal assessments, but were when using biologically relevant ones. At the least suitable, skink-inhabited site, skinks experienced the greatest exposure to 22 °C, the least opportunity to achieve target temperature (34 °C), and were the only population to present with skin lesions. Skink populations were absent all together from sites that experienced even greater exposure to 22 °C. For *T. margaritifer*, continuous exposure to 22 °C impairs digestion and promotes skin lesions and eventual death under controlled conditions. Our findings strongly suggest that 22 °C may represent a thermal constraint for the species, and highlights the importance of biologically relevant assessments. We also suggest that alternative techniques such as measuring glucocorticoids and their metabolites may better reflect habitat quality, as well as serving to validate selected habitat quality proxies.

4.1 INTRODUCTION

Temperature significantly influences physiological processes in ectotherms (Dawson 1975; Huey & Stevenson 1979; Huey 1982; Knapp & Casey 1986; Dunham *et al.* 1989). It is an important determinant of habitat quality, particularly for small ectotherms (Diaz 1997; Fei *et al.* 2012). It affects species distribution patterns (Huey 1991; Jeffery & Jeffery 1994; Gaston 2003), and under worst-case scenarios of climate change, it is predicted that almost a third of species will face severe extinction risk (IPPC 2014), and by 2050, 15-37% of species may already be extinct (Thomas *et al.* 2004). Assessing habitat quality and the impacts of climate change on this parameter is unsurprisingly becoming the focus of many conservation approaches (e.g., Johnson 2009), but the approach itself is not without associated challenges.

Habitat quality is typically a multifaceted parameter that can include resource availability (e.g., food and microhabitat) and ecological factors such as predation and

competition (Martín & López 1999, 2002). Identifying which of these are actual determinants of habitat quality for a given species is however difficult (Johnson 2007), and as an alternative, some studies have employed a proxy technique (Asherin *et al.* 1979; Johnson 2009). This technique operates on the principle that organisms express the impact of habitat quality through these characteristics (Hespenheide 1973; Van Horne 1983; Jakob *et al.* 1996; Speakman 2001). In this approach measurements of some population- and individual-wide characteristics are made, and in so doing, measuring of habitat quality becomes more tractable.

Microhabitats buffer broad-scale climatic conditions (Huey & Tewksbury 2009; Kearney *et al.* 2009) and are therefore considered an important aspect of habitat quality (Fuller *et al.* 2010). For reptiles, habitat selection is greatly influenced by the physical characteristics and thermal profiles of available microhabitats (Huey *et al.* 1989; Pringle *et al.* 2003; Pike *et al.* 2010). However, with minor changes to either of these two microhabitat aspects, significant declines in their use, or indeed complete abandonment (Pike *et al.* 2010) of areas can occur. Despite this, microhabitat conditions have up until recently (e.g., Foden *et al.* 2013) been largely overlooked in studies that model climate-related species distribution change and extinction vulnerability. This mismatch in species-relevant scale, where broad-scale climate data are used as a substitute for necessary fine-scale data, is a common limitation of most niche modelling approaches. This disregard has likely resulted in an overestimation of climate-related species loss and distribution change (Fuller *et al.* 2010), and further highlights the need for more integrated approaches when assessing these risks.

To address scale-mismatch issues, we compared measures of the available fine-scale thermal environment (i.e., microhabitat conditions available) across *Trachylepis margaritifer*'s distribution to thermal suitability predictions made using typical, broad-scale niche model approaches. We also assessed whether field-based thermal measures aligned to model predictions using two approaches: standard approaches (i.e. comparisons of the means, minima, and maxima across sites) and biologically more relevant approaches (i.e., using metrics related to the life history of the species, e.g., the number of hours that skinks were exposed to two physiologically relevant thermal constraints). To assess the suitability of habitat quality proxy measures, morphometric and habitat quality proxy measures were made on skinks caught at seven sites that sampled a range of predicted climatic suitability scores across *T. margaritifer*'s distribution. Since habitat quality differences should manifest most obviously at an autecophysiological level during seasonal extremes, sampling efforts were restricted to the winter months. Trends in skink-based measures were predicted to more closely align to microclimatic conditions than to broad-scale ones. We

also predicted that the lowest measures of habitat quality would be associated with sites experiencing the coldest microclimate since the species' isotherm-related distribution pattern (Miller *et al.* 2014) strongly suggests a low temperature limitation.

4.2 MATERIALS & METHODS

4.2.1. Study Species

Trachylepis margaritifer is a relatively large-bodied (85-110 m SVL) insectivorous skink, occurring on rocky outcrops throughout lowveld savannas within the north-eastern parts of southern Africa, extending into East Africa (Branch 1998). Rock crevices on exfoliating granite and gneiss act as refugia for skinks, protecting them against the elements and predation, and are thus an important component in their habitat. However, they are adaptable and will take up residence on buildings. The skinks are colourful, obviously sexually dichromatic and territorial. A detailed taxonomic species description is provided by Broadley (2000).

4.2.2. Climatic Suitability Modeling, Model Evaluation and Site Selection

Climatic suitability predictions at the quarter degree square (QDS) resolution for *T. margaritifer* across its southern African range (i.e., South Africa, Lesotho and Swaziland) were generated using BIOMOD (version 1.1-0; Thuiller 2003). Seasonal extremes data (i.e., the absolute minima, and the absolute maxima for autumn and winter) from the Climate Research Unit (CRU; <http://www.cru.uea.ac.uk/cru/data/hrg/>) and presence data (Masterson 2014) and pseudo-absences for *T. margaritifer* used as our input data. All nine models were evaluated using True Skill Statistic (TSS), which offers all the advantages of the commonly used Kappa statistic despite its insensitivity to prevalence (Allouche *et al.* 2006; Coetzee *et al.* 2009). By weighting each model output by its respective TSS score and combining these proportionally, a robust climatic suitability prediction map was produced (Fig. 1).

Three coarse climatic suitability categories (good, medium, and poor) were defined using these combined TSS scores (Fig. 1), and four QDSs from each category (n = 12) within the skink's distribution were selected. Thereafter, the respective altitudinal means (within ± 1 standard deviation) of each these twelve QDS was calculated using ArcGIS's (v. 9.2, ESRI, California, U.S.A.) zonal statistics, and suitable sites (i.e., rocky outcrops) that fell within these altitudinal means were identified using Google Earth (v. 5.0, Google Inc.). Unfortunately, one poor site (Boshalte) fell below its associated QDS's elevation mean by 97 m (Table. 1). This altitudinal anomaly could not be avoided due to limited sites within the area, but has been considered during analyses.

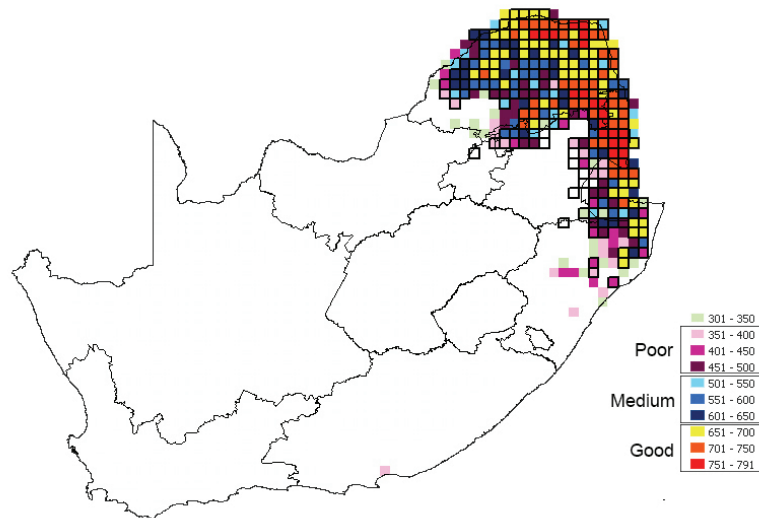

Figure 1. TSS-weighted climatic suitability predictions for Rainbow Skink (*Trachylepis margaritifera*). Black-bordered QDSs represent the species' southern African distribution, and three coarse climatic suitability categories were defined as follows: poor: 350-500; medium: 501-650; good: 651-791.

4.2.3 Microhabitat Thermal Profiling

At each site, the thermal profiles of three key microhabitat types (exposed, shade, and crevice) were measured using iButtons (Thermochron, Dallas Semiconductor, Dallas, U.S.A) that were deployed two months prior to lizard sampling. Prior to their deployment, all iButtons were calibrated using ice-water, and the appropriateness of temperatures logged by these iButtons as measures of operative temperature (T_e) for Rainbow Skinks was assessed. To do this, the correlation between temperatures recorded every minute (0.5 °C accuracy) by iButtons implanted into the abdominal cavities of three dead Rainbow Skinks with those logged by naked iButtons in the same microhabitat was measured. Site-deployed iButtons recorded temperatures every 60 minutes (at 0.5 °C). These microclimate data were assessed in two ways:

i) Standard Thermal Assessments

Daily minima and maxima were calculated for each microhabitat type for each site and site-category. This approach, although commonly-used, does not necessarily assess the habitat in a biologically meaningful way since animals may avoid extreme temperature exposure through microhabitat selection.

ii) Biologically Relevant Thermal Constraints

Thermal data were assessed in the light of physiologically relevant temperatures specific to *T. margaritifera*. Previous laboratory studies have shown that exposure to a constant T_e of 22 °C hinders digestive performance, results in a loss of condition (Fig. 2) and ultimately death in *T. margaritifera* (unpublished data, A.K. Miller 2014), usually preceded by the development of skin lesions. For these reasons, prolonged exposure to T_e s of 22 °C and below ($T_{\leq 22}$) was considered a physiologically relevant thermal constraint, and the number of hours per day that skinks would be forced to experience $T_{\leq 22}$ at each site was quantified.

Additionally, the number of hours in which skinks were able to achieve target temperatures (T_{target}) was quantified. T_{target} for Rainbow skinks was elucidated using a thermal imaging camera (FLIR E60, FLIR[®] Systems, Inc.) that recorded surface temperatures of the skinks in the field. We interpreted measures in the following way: body surface temperatures of basking lizards were considered to represent $< T_{\text{target}}$ since basking lizards are attempting to raise T_b to T_{target} . Body surface temperatures of actively-foraging skinks were considered to be within the T_{target} range, since these lizards were not focused on increasing T_b . These measures were calibrated to skink T_b s by comparing relative temperatures logged by iButtons implanted into the abdominal cavities of three dead skinks, placed within the environment, to corresponding thermal imaging measures made on these same animals.

Due to specific life history traits of Rainbow skinks, whereby skinks retreat to crevices at night, exposures to biologically relevant temperatures were quantified differently for daytime and night-time assessments. For daytime (06:00 – 18:00) assessments the duration of each day for which all three microhabitats (crevice, exposed, shade) were $T_{\leq 22}$ were calculated; lizards would only be forced to T_b s of ≤ 22 °C when none of the microhabitats provided the opportunity to attain higher T_b s. For calculating T_{target} hours, we scored the number of hours during which at least one microhabitat type was at T_{target} or higher. For night-time assessments, $T_{\leq 22}$ exposure hours were scored according to number of $T_{\leq 22}$ hours rock-crevice microhabitat logged only.

Table 1. Field sites details. GPS coordinates represent the centre position of each respective site. TSS-weighted BIOMOD values for categories are as follows: Poor: 350-500; Medium: 500-650; Good: 651-791. Site names presented in bold indicate where lizard-sampling was successful; thermal profiles were measured at all sites. *Below the elevation range for the respective QDS.

Site	Predicted Climatic Suitability (TSS Score)	Mean QDS Elevation (mean \pm std deviation)	Coordinates For Site Centre	Site Elevation (m above sea level)
Kaapschehoop	Poor (372)	976 \pm 219	S 25° 33'52.8 E 30° 59'21.1	1006
Boshalte	Poor (374)	1245 \pm 270	S 25° 27' 17.2 E 30° 42' 18.6	878*
Malolotja	Poor (361)	1136 \pm 262	S 26° 07'30.9 E 31° 14'18.2	1061
Piggs Peak	Poor (352)	702 \pm 209	S 26° 03'15.4 E 31° 25'19.6	613
Kaapmuiden	Medium (618)	609 \pm 225	S 25° 37'02.7 E 31° 17'40.6	469
Sheba	Medium (594)	797 \pm 174	S 25° 34'26.5 E 31° 11'05.9	811
Kiepersol	Medium (598)	677 \pm 157	S 25° 05'23.4 E 31° 07'42.2	622
Manzini	Medium (559)	745 \pm 186	S 26° 48'51.4 E 31° 17'22.0	627
Acornhoek	Good (750)	565 \pm 60	S 24° 39'14.1 E 31° 07'42.2	572
Kaalrug	Good (752)	348 \pm 114	S 25° 37'52.1 E 31° 30'06.7	356
Newington	Good (790)	404 \pm 44	S 24° 53'50.6 E 31° 19'03.6	378
Witrivier	Good (712)	703 \pm 141	S 25° 27'20.9 E 31° 03'30.2	582

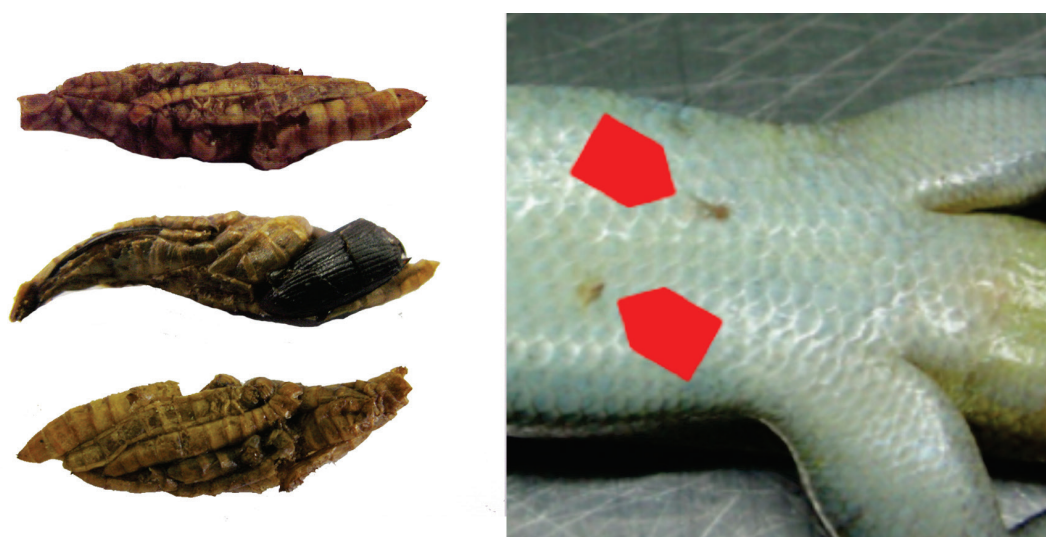

Figure 2. Examples of faeces containing undigested mealworms (left) collected from Rainbow Skinks (*T. margaritifer*) being maintained at 22 °C, and ventral lesions (indicated by the red markers; right) arising in the population at this environmental temperature.

4.2.3. Trapping Protocol and Habitat Quality Proxy Measures

Trapping was conducted at each site for one day using non-toxic Catchmaster 90 x 120 mm Mouse Glue Traps (Atlantic Paste and Glue Co., Brooklyn, NY, USA) placed in areas immediately surrounding rock-crevices. Captured skinks were immediately removed from traps using cooking oil (Whiting and Alexander 2001) and cleaned. Skinks were weighed and measured (SVL) using digital callipers (to nearest 0.1 mm) and their Body Mass Index (BMI; mass/SVL) calculated, and several habitat quality proxy measures were also made. All 'capture' measures were made immediately before the skinks were placed in cotton cloth bags, and kept overnight at room temperature. Before being released the following morning at site of capture, the 'morning-after feeding success measure' was made. Neither the total handling time per lizard during capture nor the morning-after measures exceeded five minutes, and sites were sequentially sampled in a logistically-sensible fashion (i.e., moving to the next closest site). Trapping began at 08:00 and ended after lizard activity had ceased, typically around 17:00.

Habitat quality proxy measures scored in the following way:

a) Body Condition

If skinks demonstrated an absence of any external physical ailments such as missing toes, lameness, swelling of limbs, or external wounds, they were assigned a score of 1 (good). However, if they presented with any one of these or similar ailments, they were assigned a score of 2 (moderate), and if they presented with more than one ailment, they were assigned a score of 3 (poor).

b) Bites

Evidence of bites from conspecifics were recorded as either present (1) or absent (0).

c) Colour

Skinks were assigned scores according to whether their colouration was bright (1), moderate (2) or poor (3).

d) Tail State

Skinks were assigned scores according to whether their tail was intact (1), lost (2), re-growing (3), replaced (4) or lost multiple times (5)

e) Feeding Success

We scored feeding success based on whether individuals were able to produce faeces, at two specific junctures, either voluntarily (in response to handling) or through abdominal palpation: immediately post-capture (referred to as the *capture*

measure), and second, the following morning, immediately prior to release (referred to as the *morning-after* measure).

Habitat quality proxy measures were also assessed against BIOMOD's suitability predictions, and assigned an inaccuracy status based on whether they aligned to the three suitability categories (good, medium, and poor; Table 4). Measures that aligned to the predictions in at least one aspect but not all were assigned a semi-accurate status (i.e., one category, either poor or good, being significantly different from the others). If significant differences were detected that did not fall in line with BIOMOD's predictions, for example, poor and good sites were differentiated medium, but were themselves not different from each other, predictions were considered inaccurate.

4.2.5 Statistical Analyses

Differences in morphometric measures of skinks across sites and site categories were tested for using Analysis of Variance. The biological relevance of temperatures recorded by the iButtons, and the relationship between iButton temperatures and those measured using the FLIR thermal camera were assessed using Pearson's correlation. Microhabitat thermal data were analysed using repeated measures Analysis of Variance, which compared daily minimum and maximum temperatures logged across all sites over the same time period and significant differences among treatment groups were identified using Tukey HSD post-hoc tests. We tested for trends in physiologically appropriate thermal assessments and habitat quality proxy measures using Chi-squared tests. All statistical analyses were performed using SPSS v. 22 (IBM SPSS Statistics 2015, <http://www.spss.co.in>). Unless otherwise stated, data are presented as mean \pm standard deviation. Differences were considered significant for p values ≤ 0.05 .

4.3 RESULTS

4.3.1 Microhabitat Analyses

Naked iButtons were found to closely mirror the skink T_b (Pearson's correlation: $n = 18$; $r = 0.87$; $p < 0.001$; $y = 1.34 + 0.95 * x$; Fig. 3). Since the relationship between naked iButtons and skinks was nearly isometric, we made no alterations to iButtons before deploying them to sites.

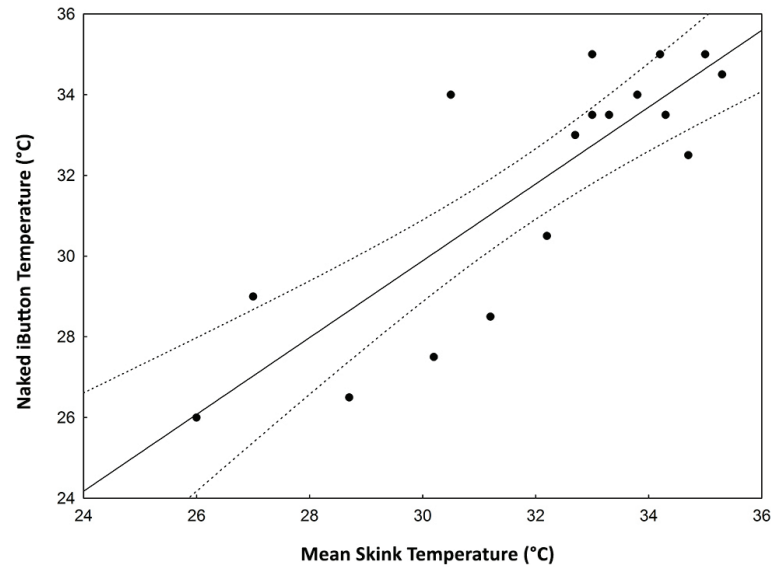

Figure 3. The correlation between temperatures recorded from naked iButtons and those inserted in three dead Rainbow Skinks (*Trachylepis margaritifera*; Pearson's correlation: $n = 18$; $r = 0.86$; $p < 0.001$; $y = 1.34 + 0.95 \cdot x$). The solid line indicates 95% confidence.

We measured microhabitat thermal profiles at all 12 sites, and used these data to summarise each microhabitat type. A total of 1512 continuous hours (63 days) of thermal data logged at each site were used in the analyses. However, a total of eight iButtons across five sites were lost during on-site temperature logging possibly as a result of interference by humans, baboons, porcupines or heavy rains during the study. A number of microhabitat thermal profiles at some sites could therefore not be assessed. Two of the poor sites (Malalotja and Boshalte) proved to be skink-less despite both QDSs having recorded species presence (Masterson 2014), and one poor site (Piggs peak) underwent population extirpation between the time of iButton-deployment and scheduled sampling. This site remained skink-free for at least three months post-sampling. Malalotja and Boshalte were therefore analysed under a new “skink-free” category and Piggs Peak under “skink die-off” (Fig. 4).

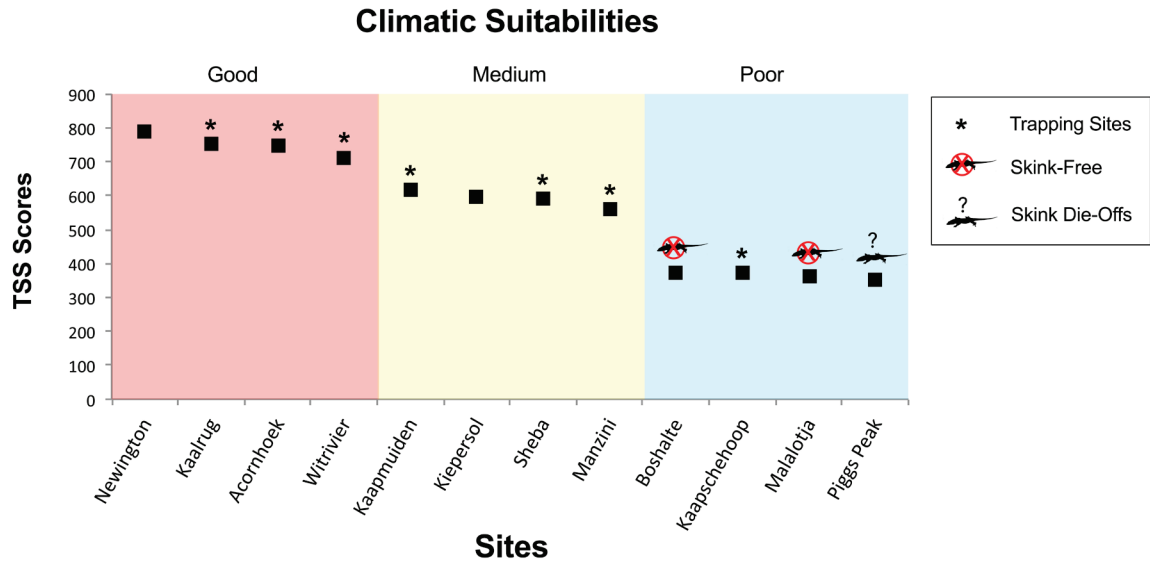

Figure 4. Selected field sites, associated True Skill Statistic (TSS) scores, and climatic suitability categories. Sites were allocated to one of three coarse climatic suitability categories defined as: good: 651-791; medium: 501-650; poor: 350-500. Sites marked with * indicate sites where habitat quality proxy measures were made on skinks, in conjunction with microhabitat thermal profiling. Skink-free sites were sites where no skinks were present, despite historical records and, skink die-offs indicate where population-level extinction occurred during the study.

i) Standard Thermal Analyses of Microhabitat

Daily minimum and maximum temperatures for each microhabitat type did not differ significantly across site categories, with one exception (Table 2; Fig. 5): Minimum temperatures recorded at poor sites for the exposed microhabitats were significantly different from those recorded at good sites (Repeated Measures ANOVA; $F_{(3,3)} = 10.3$, $p = 0.04$; Table 2; Fig. 5). Minimum temperatures of the exposed microhabitat were recorded during the night, when skinks were sheltered within thermally-buffered rock-crevices. This difference therefore likely has little impact on skinks; minimum temperatures recorded in crevices were not significantly different across site categories. Unfortunately loggers recording exposed temperatures at skink-free sites were lost, so these sites could not be assessed in this regard.

The lowest thermal averages for rock-crevices and shade were recorded at a skink-free site (crevice: $20.9\text{ }^{\circ}\text{C} \pm 2.2$; shade: $19.6\text{ }^{\circ}\text{C} \pm 2.4$; Malalotja; Fig. 6), and at a medium site for the exposed microhabitat ($21.3\text{ }^{\circ}\text{C} \pm 2.2$; Manzini). No thermal anomalies were recorded at the skink-die off site (Piggs Peak), which generally experienced above average thermal conditions for both the exposed and rock crevice microhabitats (Fig. 6).

Table 2. Repeated Measures Analysis of Variance for minimum and maximum temperatures (°C) logged by iButtons placed within three microhabitat types for the three categories of climatically-suitable sites (poor, medium and good). p values < 0.05 are considered significant and highlighted with an asterisk (*).

Microhabitat Type	Temperature Category	Repeated Measure ANOVA
Crevice	Min	$F_{(4,4)} = 1.6; p = 0.3$
	Max	$F_{(4,4)} = 1.4; p = 0.4$
Exposed	Min	$F_{(3,3)} = 10.3; p = 0.04^*$
	Max	$F_{(3,3)} = 6.0; p = 0.09$
Shade	Min	$F_{(4,5)} = 2.5; p = 0.17$
	Max	$F_{(4,8)} = 2.0; p = 0.19$

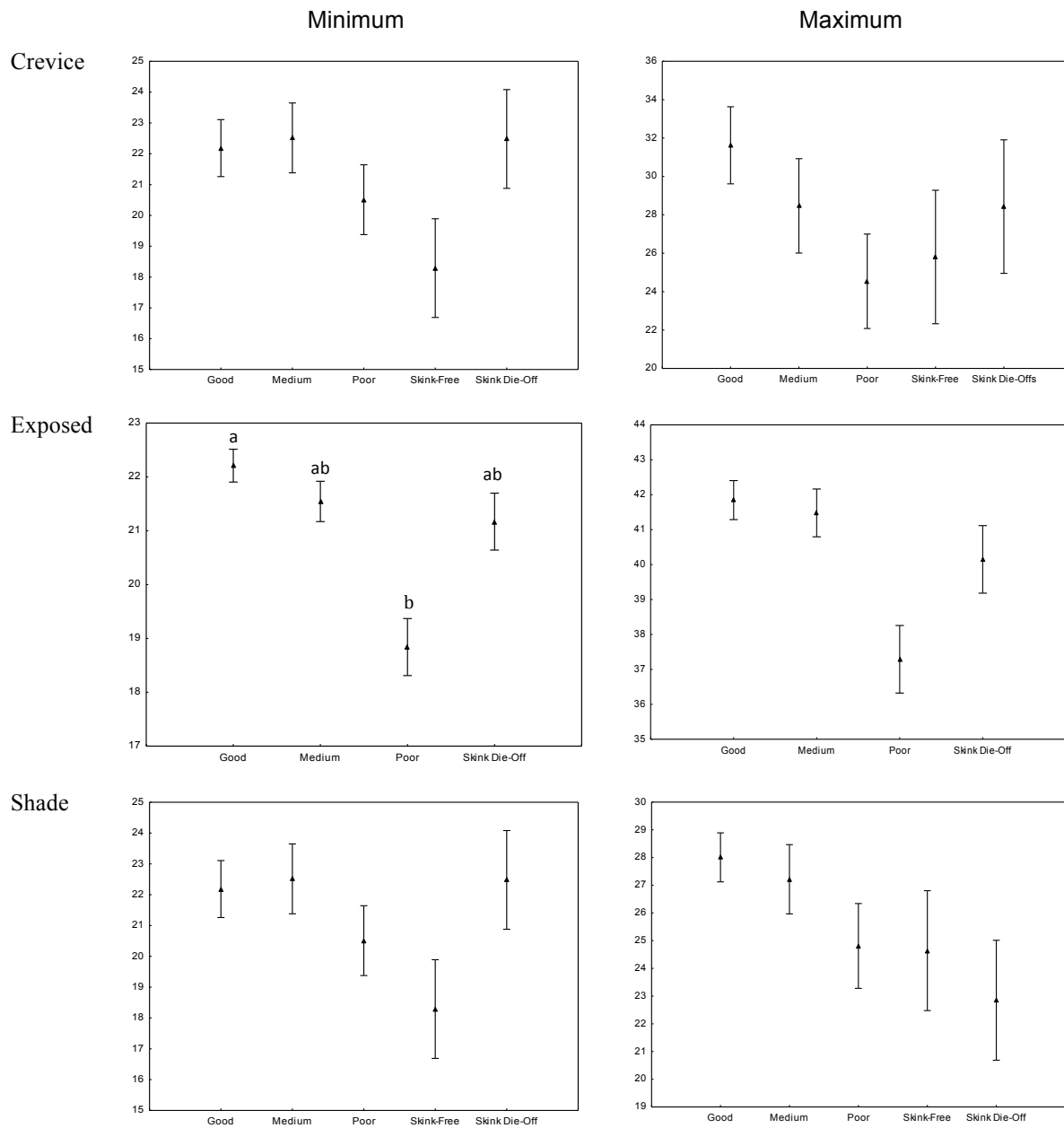

Figure 5. Average minimum (left) and maximum (right) temperature measures (°C) logged in three microhabitats types (crevices, exposed and shade) across different categories of climatically suitable sites across *Trachylepis margaritifera*'s range. Error bars represent standard error and lettering indicates significant differences detected by Tukey HSD posthoc tests.

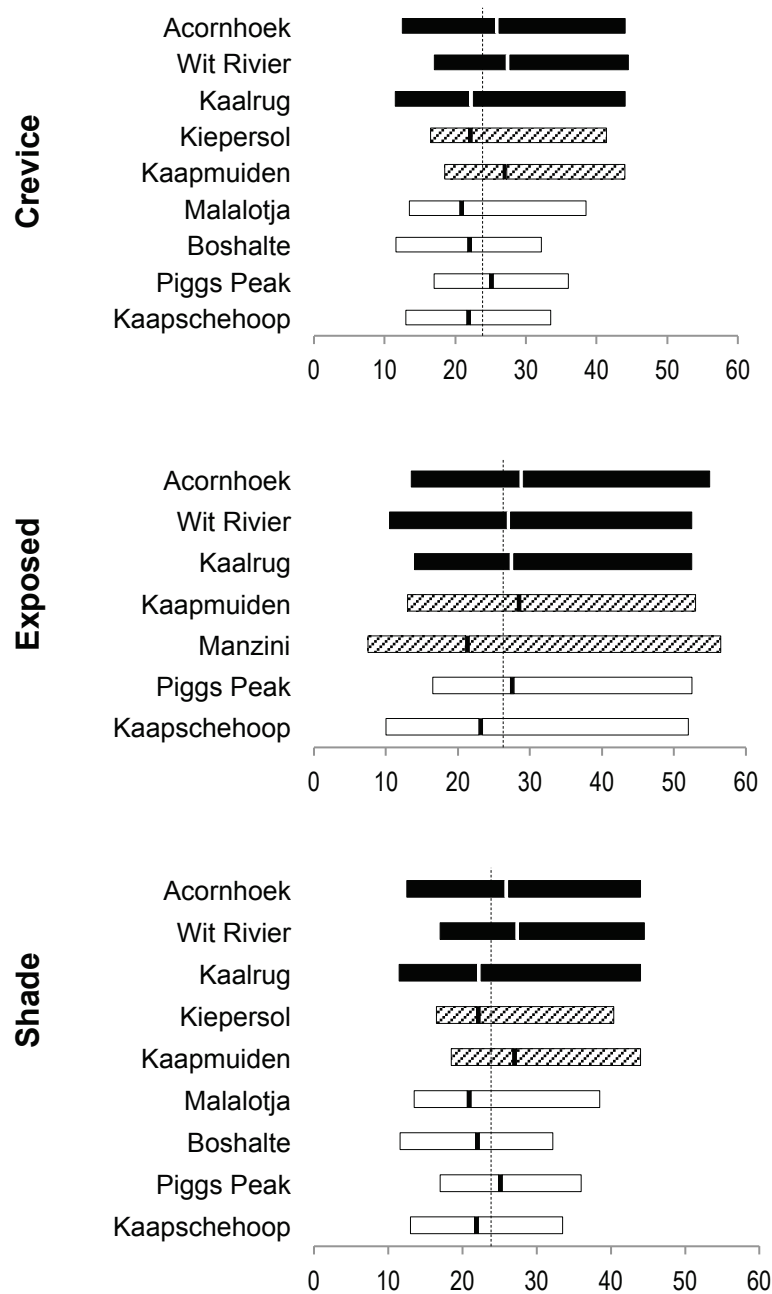

Figure 6. Temperature ranges (°C) recorded within three microhabitat types (crevice, exposed, shade) across three categories of sites. Black bars indicate sites predicted to be climatically “good” and patterned and clear bars indicate sites predicted to be climatically “medium” and “poor” respectively. Dashed lines indicate averaged mean temperatures (°C) per microhabitat type across all the sampled sites, and narrow bands within bars indicate site-specific means.

ii) Biologically Relevant Analyses of Microhabitat Temperatures

For T_{target} , thermal imaging measures were $2.6 \text{ }^{\circ}\text{C} \pm 2.5$ higher than logged $T_{\text{b}}\text{s}$. These measures were however highly correlated (Pearson’s correlation = 0.95’ $n = 20$; $p < 0.001$; $y = -1.715 + 1.042*x$; Fig. 7). Corrected mean measures made on basking ($n = 21$) and actively foraging skinks (i.e., skinks that were moving around looking for prey; $n = 5$) were $31.8 \text{ }^{\circ}\text{C} \pm 2.3$ and $33.6 \text{ }^{\circ}\text{C} \pm 2.6$ respectively. We considered $34 \text{ }^{\circ}\text{C}$ to be representative of T_{target} for *T. margaritifer*. Due to the loss of loggers at several of the sites, complete 24-hour

assessments were not always possible, and so separate night- and day-time $T_{\leq 22}$ assessments were also performed to maximise the usefulness of the available data.

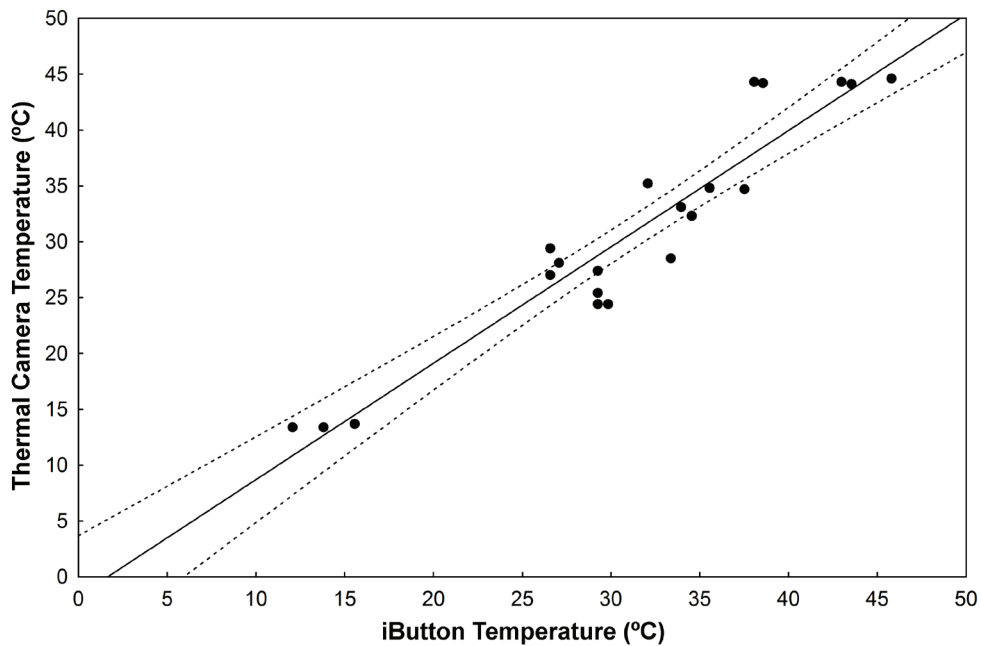

Figure 7. The relationship between temperature measures made on dead skinks using a thermal imaging camera and those logged by iButtons implanted into the same dead skinks (Pearsons' correlation = 0.95; $n = 20$; $p < 0.001$; $y = -1.715 + 1.042*x$).

24-hour $T_{\leq 22}$ Assessment

The six sites for which we had 24-hour datasets differed significantly with regard to the number of records ≤ 22 °C ($\chi^2 = 977.4$, $df = 5$ $p < 0.001$). The greatest (51.3%) and smallest (11.4%) proportions of $T_{\leq 22}$ hours were recorded at a poor (Kaapschehoop) and a medium site (Kaapmuiden) respectively. Site categories remained significantly disparate from one another ($\chi^2 = 314.9$, $df = 3$, $p < 0.001$), but not in the predicted pattern. Poor sites logged the highest percentage of $T_{\leq 22}$ hours (34.8%), however good sites logged the second highest percentage (23.1%). The sole medium site (Kaapmuiden) logged significantly less still at 11.4%.

Daytime Assessment

Sites and site categories differed significantly in the number of $T_{\leq 22}$ hours logged during the daytime (sites: $\chi^2 = 749.38$, $df = 5$, $p < 0.001$; sites categories: sites: $\chi^2 = 343.07$, $df = 2$, $p < 0.001$; Fig. 8). The highest percentage of $T_{\leq 22}$ hours (52.4%) was recorded at the poor site (Kaapschehoop), and the lowest at two good sites (6.2% - Kaalrug; 7.7% - Acornhoek). Overall good (9.6%) and medium (9.6%) sites were significantly different from poor sites (32.6 %), but not from each other. Unfortunately, data from skink-free sites do not exist due to logger-loss at these sites.

For T_{target} assessments, differences were detected among sites and site categories (sites: $\chi^2 = 171.7$, $df = 7$, $p < 0.001$; sites categories: $\chi^2 = 96.44$, $df = 2$, $p < 0.001$; Fig. 9).

The poor site (Kaapschehoop) experienced significantly fewer opportunities to reach T_{target} than any other site did at 26.4%. At the site category level, medium (48.1%) and good (50.3%) sites were not differentiated from each other, but were from poor sites (34.6 %; $\chi^2 = 96.4$, $df = 3$, $p < 0.001$).

Night-time Assessment

Sites and site categories differed significantly in the number of $T_{\leq 22}$ hours recorded (sites: $\chi^2 = 1802.9$, $df = 9$, $p < 0.001$; site category: $\chi^2 = 400.4$, $df = 2$, $p < 0.001$; Fig. 9). The highest percentage of site-specific hours spent at $T_{\leq 22}$ was logged at a skink-free site (86.2% - Malalotja), and the lowest at a medium site (12.9% - Kaapmuiden). The die-off site (Piggs Peaks) once again recorded $T_{\leq 22}$ exposures more akin to good sites than its medium site-category counterparts. Poor sites (53.6%) remained significantly different from both good (31.1%) and medium (32.1%) sites, which were undifferentiated from each other. When skink-free sites were separated from the other poor sites, skink-free (Boshalte and Malalotja; 70.5%) differed significantly ($\chi^2 = 787.9$, $df = 3$, $p < 0.001$) from the remaining poor sites (36.7%).

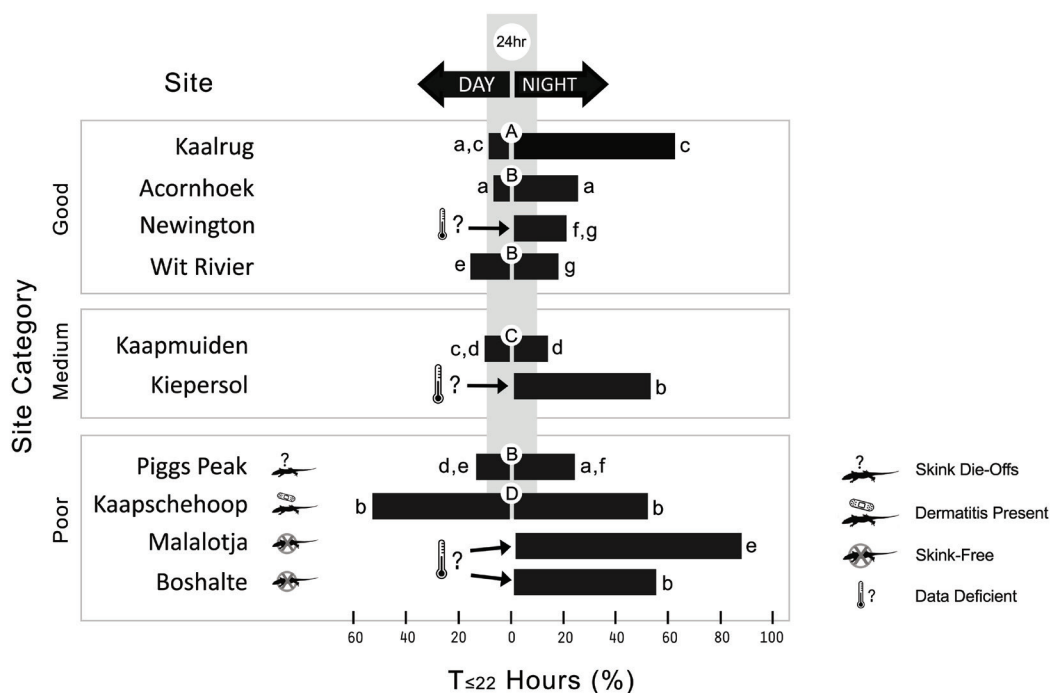

Figure 8. Percentage of $T_{\leq 22}$ hours logged during the day (left) and night (right) at sites from three different climatically suitability categories (poor, medium, good) over 63 days. Shared lettering indicates non-significantly different sites for day (left), night (right) and over 24-hour comparisons wherever possible (uppercase lettering; centre).

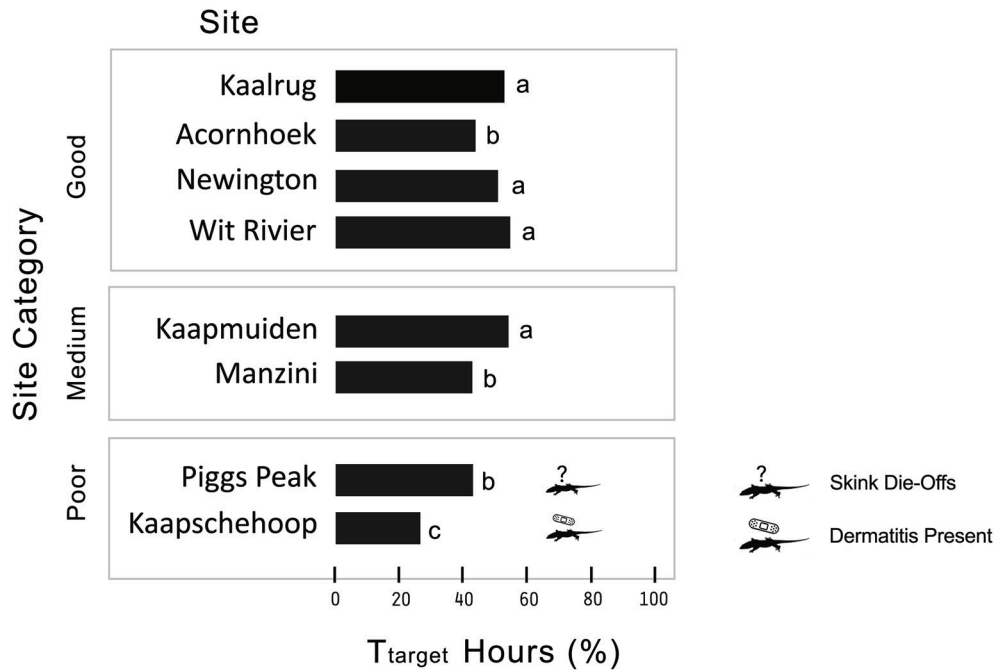

Figure 9. Percentage of T_{target} hours logged during the day at sites from three different climatically suitability categories (poor, medium, good) over 63 days. Shared lettering indicates non-significantly different sites. For site categories, medium (48.1%) and good (50.3%) sites were not differentiated from each other, but were from poor sites (34.6%; $\chi^2 = 96.4$, $df = 3$, $p < 0.001$). “Skink Die-Offs” mark the site where population extirpation occurred, and “Dermatitis Present” indicate the site where trapped skinks presented with ventral lesions.

4.3.3 Skink Sampling

Due to time constraints, only nine of the original 12 sites (three from each category) were assigned as lizard trapping sites. However, skink populations were absent at three (Malalotja, Boshalte and Piggs Peak) of the four originally selected “poor” sites. As a result, the only poor site populated with skinks (Kaapschehoop) was sampled twice, three weeks apart. By comparing morphometric measures between trapping events at this site, potentially-recaptured individuals were removed from analyses to prevent pseudoreplication. A total of 106 adult skinks were trapped during the field season, and no significant differences in morphometric measures among skinks were detected at either the site (ANOVA, mass: $F_{(6, 105)} = 1.14$, $p = 0.35$; SVL: $F_{(6, 105)} = 9.82$, $p = 0.45$; mass/SVL: $F_{(6, 76)} = 1.51$, $p = 0.12$) or site category level (ANOVA, mass: $F_{(2, 76)} = 0.85$, $p = 0.43$; SVL: $F_{(2, 105)} = 0.54$, $p = 0.58$; mass/SVL: $F_{(7, 76)} = 1.60$, $p = 2.08$).

Habitat Quality Proxy Measures

Skinks caught at good sites were in better body condition than those caught at medium and poor sites, and exhibited better colour brightness than those from medium sites, but not from those caught at the poor site (Table 3; Fig. 10). Overall, no differences were detected for bites or tail state (Table 3).

Table 3. Chi² results for habitat quality proxy measures made on 106 wild-caught Rainbow Skinks (*Trachylepis margaritifer*) assessed at both site and site category resolutions. Feeding success parameters are denoted by *FS: Capture* and *FS: Morning After* for measures made on skinks immediately and the morning after capture respectively. * and ** indicate significantly and highly significantly different results respectively.

Habitat Quality Proxy	Resolution	χ^2	df	p
Body Condition	Site Category	22.629	2	0.000**
	Site	34.852	7	0.000**
Tail State	Site Category	11.250	8	0.188
	Site	38.125	28	0.096
Colour	Site Category	12.135	4	0.016*
	Site	31.981	14	0.003**
Bites Present	Site Category	2.741	2	0.241
	Site	10.928	7	0.142
FS: Capture	Site Category	5.972	2	0.050*
	Site	15.722	7	0.028*
FS: Morning After	Site Category	1.990	2	0.370
	Site	9.462	7	0.221

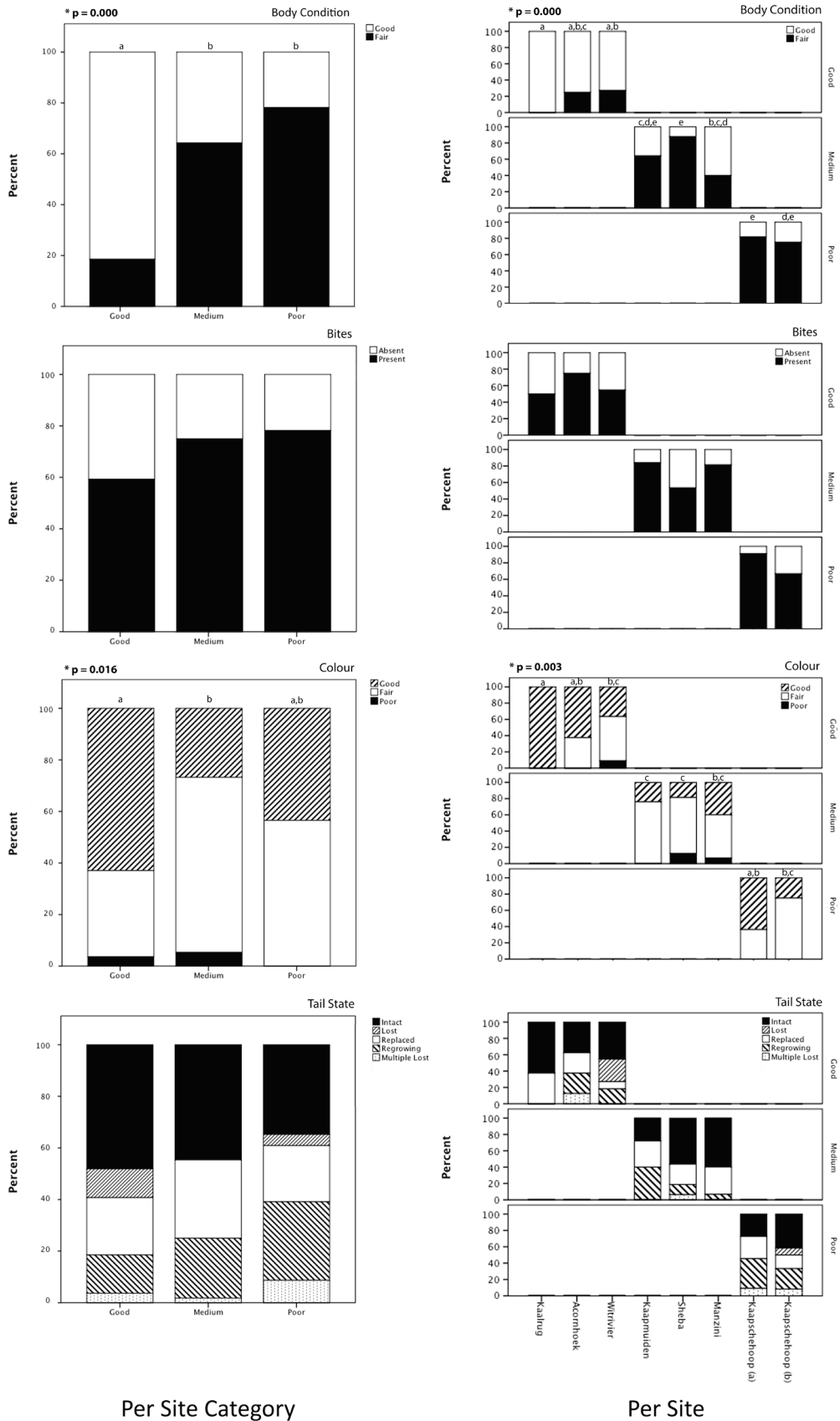

Figure 10. Rainbow skink (*Trachylepis margaritifera*) habitat quality proxy measures across a range of predicted thermal suitability field sites: poor, medium and good. Shared lettering indicates samples that are not significantly difference from one another.

Importantly, skinks caught at the poor site (Kaapschehoop) during the second sampling period exhibited ventral lesions similar to those found on laboratory skinks maintained at 22 °C for a period of five weeks (unpublished data, Miller 2014; Fig. 11). No lesions were found on skinks trapped five weeks earlier at this site. Histopathology of these wounds revealed chronic hyperplastic and ulcerative dermatitis; both fibroplasia and metaplastic benign ossification were present within the superficial dermis. Deep penetration of the inflammatory reaction was also present.

In general, measures of feeding success indicate that skinks were feeding frequently (Fig. 12). Differences were however detected at the site and site category level for capture measures (Table 3). Relatively fewer skinks at medium sites (85%) were able to produce samples at time of capture compared to skinks caught at good (96.3%) and poor sites (92.5%). This difference originates from skinks caught at a one site only (Manzini) where just 66.7% of skinks were able to provide a capture sample. No differences were detected at the category level for morning-after measures, but were at the site-level (Table 3). Only 50% of skinks caught at one good site (Acornhoek) were able to provide a morning-after sample (Fig. 10).

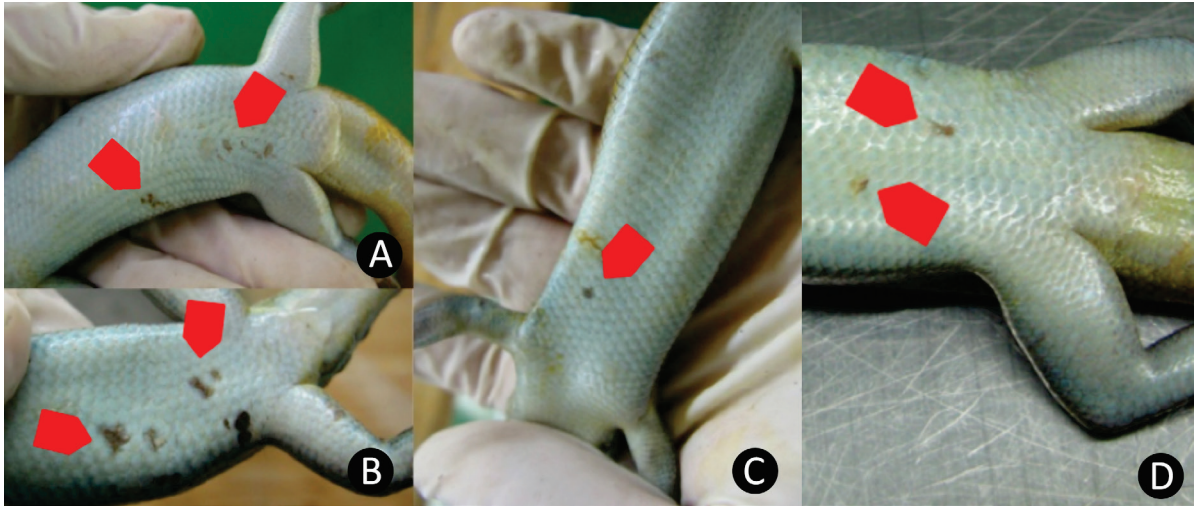

Figure 11. Chronic hyperplastic and ulcerative dermatitis, indicated by the red markers, present on Rainbow skinks (*Trachylepis margaritifer*) caught at Kaapschehoop (A-C), a site considered to be climatically poorly suited for the species based on modelled predictions (BIOMOD, v. 1.1.0), and an example of the same dermatitis that developed on the ventral sides of Rainbow skinks (*T. margaritifer*) maintained at a constant environmental temperature of 22 °C under laboratory conditions (D), which lead to the eventual death of ~ 50% ($n_{\text{deaths}} = 23$) of the laboratory population ($n = 47$).

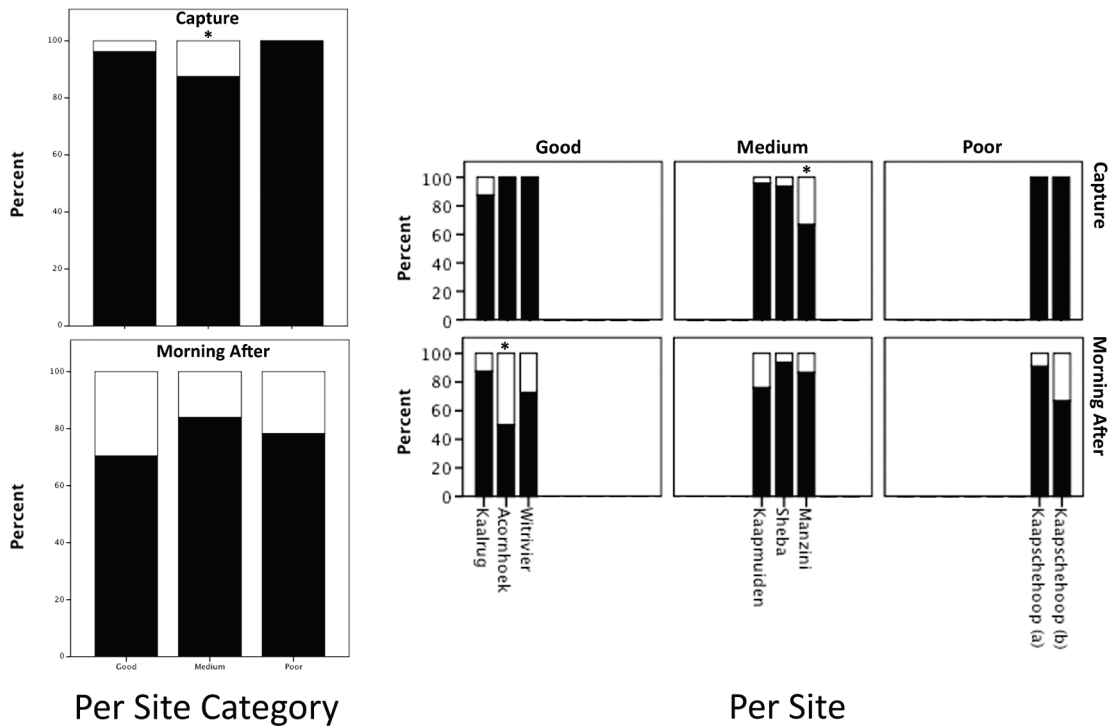

Figure 12. Proportions of wild-caught Rainbow Skinks (*Trachylepis margaritifer*; $n = 106$) found with digesta in their systems at the time of capture (top), and the morning after (bottom), from seven sites across three climatic suitability categories across its southern African distribution. Asterisks indicate samples proportions significantly different from others at the same resolution.

Table 4. Assessment of BIOMOD’s prediction accuracy for all environmental and skink–based measures made at the selected sites.

	Measure	BIOMOD Prediction	Reason
Microhabitat Thermal Profiles			
Mean Assessment	Rock-Crevice	Inaccurate	No differences across site categories detected.
	Shade	Inaccurate	No difference across site categories detected.
	Exposed	Semi-accurate	Poor sites were significantly colder at night than medium and good sites were. These differences were however recorded by exposed iButtons and, due to the life history of <i>T. margaritifera</i> whereby skinks retreat to rock crevices at night, are considered irrelevant. No differences were detected between medium and good sites.
Physiologically Appropriate Assessment	T _{≤22}	Semi-accurate	Poor sites logged significantly more T _{≤22} hours than other site categories. Differences were inconsistent between medium and good sites, potentially due to logger loss resulting insufficient data.
	T _{target}	Semi-accurate	Poor sites logged significantly fewer T _{target} hours than other site categories but good and medium sites were undifferentiated.
Morphometric Measures			
	SVL	Inaccurate	No difference across site categories detected.
	Mass	Inaccurate	No difference across site categories detected.
	Condition Index (mass/SVL)	Inaccurate	No difference across site categories detected.
Habitat Quality Proxies			
	Body Condition	Semi-accurate	Skinks at good sites were in better body condition than those at medium and poor sites. No differences were detected however between medium and poor sites.
	Tail State	Inaccurate	No differences among site categories or sites detected.
	Colour	Inaccurate	Significant differences detected but these were not aligned to site categories. Skinks from poor and good sites had significantly better colour intensity than those from medium sites, but were not different from each other.
	Bites Evidence	Inaccurate	No differences among site categories or sites detected.
	Feeding Success	Inaccurate	Differences did not align to site categories.

5.4 DISCUSSION

No meaningful significant differences in habitat quality were detected using standard thermal habitat quality measures (i.e., means, maxima and minima), but were when using biologically relevant ones. These biologically relevant assessments also aligned most closely to BIOMOD's suitability predictions of habitat quality, but this alignment was only evident at one end of the suitability predictions (i.e., the poorest). Four of the five habitat quality proxy measures, and all morphometric measures made on skinks demonstrating no alignment whatsoever. Additionally, chronic hyperplastic and ulcerative dermatitis was only present in skinks exposed to significantly more $T_{\leq 22}$ hours, either in-field or during controlled laboratory trials, with constant exposure to 22 °C resulting in the death of almost half the laboratory population. Furthermore, sites that appeared suitable but did not have *T. margaritifer* populations had even greater exposures to $T_{\leq 22}$ hours. These trends suggest that this temperature limit may represent a mechanistic constraint for the Rainbow Skink, and demonstrates that standard assessments of thermal environment, even at a microhabitat level, may mean little without an autecological understanding of a species.

Habitat quality proxy measures and standard thermal assessments were found to be largely uninformative. Mean minimum temperatures in exposed habitat between good and poor sites were the only significantly different finding using thermal assessments. However, due to the placement of the "exposed" logger, these data reflect the coldest exposed night-time temperature when skinks were sheltered within thermally-buffered rock crevices, and so this difference is not considered meaningful. For the habitat quality proxy measures, the only proxy measure that semi-aligned with climatic suitability predictions was body condition; skinks at good sites were in the best body condition (>80%) compared to those at medium (35.7%) and poor (21.7%) sites. Skinks from good sites also scored better in the colour assessment when compared to skinks caught at medium sites. However, skinks from poor sites were not significantly different from skinks from either good or medium sites in this regard. Colour measures can indicate fitness (Weiss 2006), and these in combination with body condition scores suggest that skinks at good sites were the fittest overall. However, although the body condition proxy demonstrated the best fit, our scoring design was not sensitive enough to detect significant differences between skinks collected at poor and medium sites, despite ventral lesions being found on skinks from the poor site where exposures to $T_{\leq 22}$ hours was the greatest and T_{target} the poorest. We consider the presence of these wounds to be the most important finding to come from our assessment, and as result, caution against the use of habitat quality proxy measures in isolation.

The skin serves as an important biotic barrier between an organism and its environment, and in reptiles this protective function can be compromised by sub-optimal temperatures (Divers & Mader 2005), due primarily to their effect on wound healing (Anderson & Roberts 1975) and immune function (Lucas & French 2012). Although these temperature effects are complex and often multidirectional (Archie 2013), the fact that chronic hyperplastic and ulcerative dermatitis in skinks *in situ* were from the poorest site where $T_{\leq 22}$ exposures were the greatest, and that the same type of lesion arose in a laboratory population kept at constant 22 °C, strongly suggests a thermally-induced cause. No other loss of condition in laboratory skinks was observed despite the high number of deaths and lesion development. Despite their widespread application, Wilder *et al.* (2015) argue that coarse condition indices (e.g., mass/SVL) are poor indicators of health, having found no correlation between an animal's lipid reserve and body "plumpness". Lipid reserves are also not necessarily the best measure of fitness (Wilder *et al.* 2015). Our general findings that skinks did not differ in condition across sites (Table 3 and 4) align with Wilder *et al.*'s (2015), despite indications of reduced health (i.e., lesions) at the poor site (Kaapschehoop). We therefore also consider this condition index to be unreliable in at least some instances.

Trachylepis margaritifer's digestive efficiency is independent of temperature and gut passage time at 25-32 °C (Miller *et al.* 2014), but at 22 °C digestive performance appears to be compromised (Fig. 2). Therefore, extended exposure to $T_{\leq 22}$ appears to have important effects on energy balance and may ultimately be limiting. Positive energy balance is important for growth and maintenance, and typically lizards seldom "run on empty" (Huey *et al.* 2001); of the 18 223 individuals representing 127 different species that Huey *et al.* (2001) examined, less than 13.2% had empty stomachs. Our measures of feeding success corroborate these findings: 92.5 and 79.2% of trapped skinks ($n = 106$) were able to produce faeces for capture and morning-after measures respectively. Only one skink was unable to provide any faecal sample during sampling (i.e., < 1% being of captured skinks were considered "empty"). With this parameter being invariably high among lizards, its suitability as a proxy for overall habitat quality is poor. These findings also demonstrate that appetite is seldom depressed in natural settings, despite its known temperature-dependence within the species (Miller *et al.* 2014).

Despite feeding success being considered a poor proxy measure, differences between site categories ($p = 0.05$; table 3 and Fig. 12) did exist. These differences arose as a result of a number of skinks at one medium (Manzini) and one good (Acornhoek) site, being unable to produce capture and morning-after faecal samples respectively. However,

when assessing these differences closely using known temperature-related gut transit times for *T. margaritifer* (Miller *et al.* 2013) and average and maximum site-specific temperatures (Manzini: average: 19.9 °C and max: 36 °C; Acornhoek: average: 22.2 °C and max: 42.5 °C), it became clear that these differences reflect weather events that would have affected feeding opportunity at the two sites concerned. At 27 °C, digesta typically takes one and a half days to begin moving into the large intestine, where it becomes available to sampling via abdominal massage (Miller *et al.* 2013), and this metric decreases to just over a day for skinks maintained at 25 °C. Two days prior to sampling, the medium site experienced heavy rains and, at the good site, strong winds began in the afternoon on the day prior to sampling, explaining both the increase from 66.7 to 86.7% and the decrease from 100 to 50% in sample success at these sites respectively. Given the sensitivity of this measure to weather events, feeding success is unlikely to serve as an appropriate proxy of overall habitat quality conditions at sites.

Skink-free (Malalotja and Boshalte) and skink die-off sites (Piggs Peak) fall within the original poor suitability category. Absences at the skink-free sites are well explained by the biologically relevant assessments. Skink-free sites experienced significantly more $T_{\leq 22}$ hours than did the only poor site where skinks were present (Kaapschehoop) and exhibiting ventral lesions. Unfortunately T_{target} could not be assessed at skink-free sites as a result of iButton-loss. However, due to the species absence at these sites, conditions at skink-free sites are considered inadequate to support *T. margaritifer* populations. Species presence records in the form of photographic submissions to the Southern African Reptile Conservation Assessment's (SARCA) virtual museum for these QDSs depict skinks closely associated to human infrastructure only. This close association likely acts to sufficiently buffer any unsuitable environmental conditions associated with natural sites within the QDS as has been reported for *Hemidactylus mabouia* (Alexander & Marais 2007).

The extirpation of the population at one of the poor sites (Piggs Peak) cannot be explained by the thermal data leading up to this event, and no signs of population re-establishment were evident three months post-extirpation. Its alignment to good and medium sites regarding its thermal profile likely reflects its altitudinal similarity to other medium sites, however its location on the “edge” of the species distribution may offer some insights. Range edges, although notoriously difficult to define, are usually maintained by one or several compounding factors (e.g., predation, prevalence of disease, climate, competition etc.). These factors may operate at different intensities temporally and spatially (Kearney & Porter 2004; Kearney & Porter 2009), and populations leading up to these edges typically experience different levels of persistence (Gaston 2003). This site likely

falls within the “zone of periodic extinction” (Gorodkov 1986) where populations exist for brief periods, but are unable to persist past a few generations. However, to elucidate which factor or factors may be maintaining this edge, long-term monitoring would be required.

Climatic-based niche models have been criticized for their assumption that distributions are shaped by a single factor (i.e., climate; Woodward & Beerling 1997; Davis *et al.* 1998a,b; Lawton 2000), and for their disregard of alternative factors such as biotic interactions, evolutionary change and species dispersal (Graham & Grimm 1990; Leibold 1995; Crawley 1997; Davis & Shaw 2001; Thomas *et al.* 2001; Pearson & Dawson 2003). However, despite these limitations, their predicted distributions can closely align with observed distributions (e.g., Beerling *et al.* 1995; Pearson & Dawson 2002), and are recognised as valuable hypotheses-generators (Alexander 2007; Pearson & Dawson 2002; Kearney & Porter 2009). Our findings show that, of all our approaches, biologically relevant assessments best aligned with BIOMOD’s predictions, but that even at the microhabitat scale, standard thermal assessments revealed no meaningful difference among sites of different climatic suitability predictions. Thus, the failings of correlative models may not simply be a matter of scale and resolution mismatch, but also a lack of appropriate frameworks within which to interpret their outputs.

Approaches that more directly measure an individual’s responses to its environment, such as assessing glucocorticoid (i.e., stress hormones) levels (Wingfield *et al.* 1995; Blanchard *et al.* 1998; Romero *et al.* 2004; Cockrem 2005; Wikelski & Cooke 2006), are likely to provide a much more realistic proxy for habitat quality. Glucocorticoid metabolites can be easily measured with little to no disturbance to the animal, using faecal samples (Touma *et al.* 2003). Extreme environmental temperatures can induce stress in many reptiles, including lizards (Telemeco & Addis 2014). Eliciting a stress reaction serves to aid survival and maintain homeostasis under trying times (Wingfield *et al.* 1998; McEwan & Wingfield 2003; Moore & Jessop 2003), but this mechanism can also have negative impacts on an individual (Knapp *et al.* 2003; Jessop *et al.* 2004; Berger *et al.* 2008), particularly if stress exposure is chronic (e.g., Pickering & Pottinger 1989; Cyr & Romero 2007). Resulting immune function impairment (Lucas & French 2012) and notable effects on wound healing (Archie 2103) has been documented in lizards. In fact, Telemeco and Addis (2014) go so far as suggesting that thermal stress responses may determine geographic range. The Rainbow skink has been shown to be an appropriate species for stress metabolite studies (Miller *et al.* 2013), and we recommend using this approach in future, given that our multifaceted approach yielded no definitive answers regarding habitat quality.

Overall, we found habitat quality proxy measures aligned to modelled predictions of climatic suitability poorly, and that standard thermal assessments of habitat, even at the microhabitat level, failed to detect meaningful thermal differences between sites. This highlights an important, potential shortcoming of typical thermal assessments of habitat that cannot be corrected for simply by improving the resolution or scale of the study. Through more direct methods of assessments on species using physiological markers, habitat quality and associated proxy measures are likely to be better quantified and validated respectively.

4.5 REFERENCES

- Alexander G.J. and J. Marais. 2007. A guide to the reptiles of southern Africa. Struik Publishing. Cape Town.
- Allouche O., Tsoar A. and R. Kadon. 2006. Assessing the accuracy of species distribution models: prevalence, kappa and the true skill statistic (TSS). *Journal of Applied Ecology* **43**: 1223-1232 .
- Anderson C.D. and R.J. Roberts. 1975. A comparison of the effects of temperature on wound healing in a tropical and a temperate teleost. *Journal of Fish Biology* **7**(2): 173-182.
- Archie E.A. 2013. Wound healing in the wild: stress, sociality and energetic costs affect wound healing in natural populations. *Parasite immunology* **35**(11): 374-385.
- Asherin D.A., Short H.L., and J.E. Roelle. 1979. Regional evaluation of wildlife habitat quality using rapid assessment methodologies. In *Transactions of the forty-fourth North American Wildlife and Natural Resources Conference*.
- Berling D.J., Huntley B. and J.P. Bailey. 1995. Climate and the distribution of *Fallopia japonica*: use of an introduced species to test the predictive capacity of response surfaces. *Journal of Vegetation Science* **6**: 269–282.
- Berger S., Martin L.B., Wikelski II, M., Romero L.M., Kalko E.K.V., Vitousek M.N. and T. Rodl. 2005. Corticosterone suppresses immune activity in territorial Galapagos marine iguanas during reproduction. *Hormones and Behavior* **47**: 419-429.
- Blanchard R.J., Nikulina J.N., Sakai R.R., McKittrick C., McEwen B. and D.C. Blanchard. 1998. Behavioral and Endocrine Change Following Chronic Predatory Stress. *Physiology and Behaviour* **63**: 561-569.
- Branch W. R. 1988. Field guide to the snakes and other reptiles of southern Africa. Struik. Cape Town.
- Brett J.R. 1971. Energetic responses of salmon to temperature. A study of some thermal relations in the physiology and freshwater ecology of sockeye salmon (*Oncorhynchus*

- nerka*). *American Zoologist* **11**: 99–113.
- Broadley D. G. 2000. A review on the genus *Mabuya* in southeastern Africa (Sauria: Scincidae). *African Journal of Herpetology* **49**: 87–100.
- Cockrem J.F. 2005. Conservation and behavioral neuroendocrinology. *Horm Behav* **48**: 492–501.
- Coetzee B.W.T., Robertson M.P., Erasmus B.F.N., van Rensburg B.J. and W. Thuiller. 2009. Ensemble models predict Important Bird Areas in southern Africa to become less effective for conserving endemic birds under climate change. *Global Ecology and Biogeography* **8**(6): 701-710.
- Dawson W.R. 1975. On the physiological significance of the preferred body temperatures of reptiles. In *Perspectives of biophysical ecology* (pp. 443-473). Springer Berlin Heidelberg.
- Davis A.J., Jenkinson L.S., Lawton J.L., Shorrocks B. and S. Wood. 1998a. Making mistakes when predicting shifts in species range in response to global warming. *Nature*, **391**: 783–786.
- Davis, A.J., Lawton, J.L., Shorrocks, B. & Jenkinson, L.S. 1998b. Individualistic species responses invalidate simple physiological models of community dynamics under global environmental change. *Journal of Animal Ecology*, **67**: 600–612.
- Davis M.B. and Shaw R.G. 2001. Range shifts and adaptive responses to Quaternary climate change. *Science* **292**: 673–679.
- Crawley M.J. 1997. The structure of plant communities. *Plant ecology* (ed. by M.J. Crawley), pp. 475–531. Blackwell Science, Oxford.
- Cyr N.E. and L.M. Romero. 2007. Chronic stress in free-living European starlings reduces corticosterone concentrations and reproductive success. *General and comparative endocrinology* **151**(1): 82-89.
- Diaz J.A. 1997. Ecological correlates of the thermal quality of an ectotherm's habitat: a comparison between two temperate lizard populations. *Functional Ecology* **11**:79-78.
- Divers S.J. and D.R. Mader, eds. 2005. *Reptile medicine and surgery*. Elsevier Health Sciences.
- Dunham A.E., Grant B.W. and Overall K.L. 1989. Interfaces between biophysical and physiological ecology and the population biology of terrestrial vertebrate ectotherms. *Physiological Zoology* **62**: 335-355.
- Fei T., Skidmore A.K., Venus V., Wang T., Toxopeus B., Bian M. and Y. Liu. 2012. Predicting micro thermal habitat of lizards in a dynamic thermal environment. *Ecological Modelling* **231**: 126-133.
- Foden W.B, Butchart S.H.M., Stuart S.M., Vié J-C., Akçakaya H.R., Angulo A., DeVantier

- L.M., Gutsche A., Turak E., Cao L., Donner S.D., Katariya V., Bernard R., Holland R.A., Hughes A.F., O'Hanlon S.E., Garnett S.T., Şekercioğlu, Ç.H. and G.M. Mace. 2013. Identifying the world's most climate change vulnerable species: a systematic trait-based assessment of all birds, amphibians and corals. *Plos One* Vol. **8**(6): e65427.
- Fuller A., Dawson T., Helmuth B., Hetem R.S., Mitchell D. and S.K. Maloney. 2010. Physiological mechanisms in coping with climate change. *Physiological and Biochemical Zoology* **83**(5): 713-720.
- Gaston K.J. 2003. The structure and dynamics of geographic ranges. Oxford University Press. New York.
- Gorodkov K.B. 1986. Three-dimensional climate model of potential range and some of its characteristics. II. *Entomological Review* **65**:1-18.
- Hespenheide H.A. 1973. Ecological inferences from morphological data. *Annual Review of Ecology and Systematics*, vol. 4: 213-229.
- Huey R.B. 1982. Temperature, physiology, and the ecology of reptiles, in: *Biology of the Reptilia*, vol. 12 (C. Gans and F. H. Pough, eds.) pp. 25- 91, Academic Press, New York.
- Huey R.B. 1991. Physiological consequences of habitat selection. *The American Naturalist* **137**: S91-S115.
- Huey R.B and R.D. Stevenson. 1979. Integrating thermal physiology and ecology of ectotherms: a discussion of approaches. *Integrative and Comparative Biology* **19**, 357–366.
- Huey R.B., Pianka E.R. and L.J. Vitt. 2001. How often do lizards “run on empty”? *Ecology*, **82**(1): 1-7.
- Huey R.B., Peterson C.R., Arnold S.J. and W.P. Porter. 1989. Hot rocks and not-so-hot rocks: retreat-site selection by garter snakes and its thermal consequences. *Ecology* **70**: 931-944.
- Huey R.B. and J.J. Tewksbury. 2009. Can behavior douse the fire of climate warming? *Proc. Natl. Acad. Sci. USA* **106**: 3647-3648.
- IPPC. 2014. Climate Change 2014: Synthesis Report. Contributions of Working Groups I, II and III to the Fifth Assessment Report of the Intergovernmental Panel on Climate Change [Core Writing Team, R.K. Pachauri and L.A. Meyer (eds.)] IPCC, Geneva, Switzerland, 151 pp.
- Jakob E.M., Marshall S.D. and G.W. Uetz. 1996. Estimating fitness: a comparison of body condition indices. *Oikos* **77**:61–67.
- Jessop T.S., Summer J.M., Limpus C.J. and J.M. Whittier. 2004. Interplay between plasma hormone profiles, sex and body condition in immature hawksbill turtles (*Eretmochelys*

- imbricata*) subjected to a capture stress protocol. *Comparative Biochemistry and Physiology Part A* **137**: 197-204.
- Johnson M. 2009. Measuring habitat quality: a review. *The Condor*. **109**:489–504
- Kearney M. and W. Porter. 2009. Mechanistic niche modelling: combining physiological and spatial data to predict species' ranges. *Ecology letters*, *12*(4), 334-350.
- Kearney M., Shine R. and W.R. Porter. 2009. The potential for behavioral thermoregulation to buffer "cold-blooded" animals against climate warming. *Proc. Nati. Acad. Sci. USA* **106**: 3835-3840.
- Knapp R. and T.M. Casey. 1986. Thermal ecology, behavior, and growth of gypsy moth and eastern tent caterpillars. *Ecology* **67**: 598-608.
- Knapp R., Hews D.K., Thompson C.W., Ray L.E. and M.C. Moore. 2003. Environmental and endocrine correlates of tactic switching by nonterritorial male tree lizards (*Urosaurus ornatus*). *Hormones and Behavior* **43**: 83-92.
- Lawton J.L. 2000. Concluding remarks: a review of some open questions. *Ecological consequences of heterogeneity* (ed. by M.J. Hutchings, E. John and A.J.A. Stewart), pp. 401–424. Cambridge University Press, Cambridge.
- Leibold M.A. 1995. The niche concept revisited: mechanistic models and community context. *Ecology*, **76**, 1371–1382.
- Lucas L.D. and S.S. French. 2012. Stress-induced tradeoffs in a free-living lizard across a variable landscape: consequences for individuals and populations. *PLoS ONE* **7**(11): e49895. doi:10.1371/journal.pone.0049895.
- Martín J. and P. López. 1999. An experimental test of the costs of antipredatory refuge use in the wall lizard, *Podarcis muralis*. *Oikos* **84**: 499–505.
- Martín J. and P. López. 2002. The effect of Mediterranean dehesa management on lizard distribution and conservation. *Biol. Conserv.* **108**: 213–219.
- Masterson G. 2014. *Trachylepis margaritifera* (Peters, 1854). In M.F. Bates, W.R. Branch, A.M. Bauer, M. Burger, J. Marais, G.J. Alexander and M.S. de Villiers (eds), Atlas and Red List of the Reptiles of South Africa, Lesotho and Swaziland. *Suricata* 1. South African National Biodiversity Institute, Pretoria.
- Miller A.K., Erasmus B.F.N and G.J. Alexander. 2014. Digestive efficiencies are independent of gut passage times in Rainbow Skinks (*Trachylepis margaritifera*). *Comparative Biochemistry and Physiology Part A: Molecular and Integrative Physiology* **175**: 110-114.
- Miller A.K., Erasmus B.F.N. and G.J. Alexander. 2013. Gut and intestinal passage time in the Rainbow Skink (*Trachylepis margaritifera*): implications for stress measures using faecal analyses. *Journal of Animal Physiology and Animal Nutrition* **97**(5): 960-970.

- Moore I.T. and Jessop T.S. 2003. Stress, reproduction, and adrenocortical modulation in amphibians and reptiles. *Hormones and Behavior* **43**:39-47.
- Pearson R.G. and T.P. Dawson. 2003. Predicting the impacts of climate change on the distribution of species: are bioclimate envelope models useful?. *Global ecology and biogeography* **12**(5): 361-371.
- Pickering A.D. and T.G. Pottinger. 1989. Stress responses and disease resistance in salmonid fish: effects of chronic elevation of plasma cortisol. *Fish physiology and biochemistry* **7**(1-6): 253-258.
- Pike D.A., Croak B.M., Webb J.K. and R. Shine. 2010. Subtle – but easily reversible – anthropogenic disturbance seriously degrades habitat quality for rock-dwelling reptiles. *Animal Conservation* **13**: 411–418.
- Pringle R.M., Webb J.K. and R. Shine. 2003. Canopy structure, microclimate, and habitat selection by a nocturnal snake, *Hoplocephalus bungaroides*. *Ecology*, **84**(10): 2668-2679.
- Romero L.M. and M. Wikelski. 2001. Corticosterone levels predict survival probabilities of the Galapagos marine iguanas during El Nino events. *Proc. Natl. Acad. Sci. U.S.A.* **98**: 7366-7370.
- Speakman J.R. 2001. Introduction. Pages 1–7 in J. R. Speakman, editor. Body composition analysis of animals: a handbook of non-destructive methods. Cambridge University Press, Cambridge, UK.
- Thuiller W. 2003. BIOMOD: Optimising predictions of species distributions and projecting potential future shifts under global change. *Global Change Biology* **9**:1353-1361.
- Thomas C.D., Bodsworth E.J., Wilson R.J., Simmons A.D., Davies Z.G., Musche, M. and L. Conradt. 2001 Ecological and evolutionary processes at expanding range margins. *Nature* **411**: 577–581.
- Thomas C.D., Cameron A., Green R.E., Bakkens M., Beaumont L.J., Collingham Y.C., Erasmus B.F.N., de Siqueira M. F., Grainger A., Hannah L., Hughes L., Huntley B., van Jaarsveld A.S., Midgley G.F., Miles L., Ortega-Huerta M.A., Peterson A.T., Phillips O.L. and S.E. Williams. 2004. Extinction risk from climate change. *Letters to Nature* **427**: 145-148.
- Touma C., Palme R. and N. Sachser. 2004. Analyzing corticosterone metabolites in fecal samples of mice: a noninvasive technique to monitor stress hormones. *Hormones and Behavior* **45**: 10 – 22.
- Weiss S. L. 2006. Female-specific color is a signal of quality in the striped plateau lizard (*Sceloporus virgatus*). *Behavioral Ecology* **17**(5): 726-732.
- Whiting M. J. and G.J. Alexander. 2001. Oil spills and glue: a comment on a sticky

- sampling problem for lizards. *Herpetological Review* **32**: 78–79.
- Wilder S.M., Raubenheimer D. and S.J. Simpson. 2015. Moving beyond body condition indices as an estimate of fitness in ecological and evolutionary studies. *Functional Ecology*. doi:10.1111/1365-2435.12460
- Wikelski M. and S.J. Cooke. 2006. Conservation physiology. *Trends in Ecology and Evolution* **21**: 38- 46.
- Wingfield J.C., Maney D.L., Breuner C.W., Jacobs J.D., Ramenofsky M. and R.D. Richardson. 1998. Ecological bases of hormone-behavior interactions: the “emergency life history stage.” *American Zoology* **38**: 191-206.
- Wingfield J.C., O'Reilly K. M. and L.B. Astheimer. 1995. Modulation of the adrenocortical responses to acute stress in arctic birds: a possible ecological basis. *American Zoologist* **35**: 285-294.
- Woodward F.I. and D.J. Beerling. 1997. The dynamics of vegetation change: health warnings for equilibrium ‘dodo’ models. *Global Ecology Biogeography Letters* **6**: 413–418.
- Van Horne B. 1983. Density as a misleading indicator of habitat quality. *The Journal of Wildlife Management* **47**(4): 893-901.

CHAPTER FIVE

5.1 CONCLUSION

Rainbow skinks are suitable candidates for stress metabolite measures, with gut transit times similar to those recorded in endotherms (Miller *et al.* 2013). At low, but not limiting temperatures ($> 22\text{ }^{\circ}\text{C}$), gut transit times are reduced in what appears to be a mechanism that avoids harmful exposure to putrefying digesta, without compromising on digestive efficiency (Miller *et al.* 2013; Miller *et al.* 2014). Indeed, measured digestive efficiencies for this species are comparatively high among insectivorous lizard species (Mueller 1970; Avery 1971; Licht and Jones 1976). Additionally, despite measured reductions in appetite at low temperatures ($25\text{ }^{\circ}\text{C}$), field measures of feeding success during winter months show that field T_{e} s offer few limitations to this parameter across their distribution. However, when Rainbow Skinks are exposed to a constant T_{e} of $22\text{ }^{\circ}\text{C}$, several physiological failings begin to manifest. Digestive performance is severely reduced, if not completely halted (Chapter 4, Fig. 2). Skinks also develop chronic hyperplastic and ulcerative dermatitis – a condition also found to be present in naturally-occurring skink populations where $T_{\leq 22}$ exposures were greatest. These constant T_{e} conditions of $22\text{ }^{\circ}\text{C}$ are, for Rainbow Skinks, ultimately lethal, with $\sim 50\%$ of the laboratory population dying within few weeks of exposure. The response by Rainbow Skinks to a T_{e} of $22\text{ }^{\circ}\text{C}$ and lower suggests that this temperature represents a lower limit of tolerance.

Indeed skinks were absent at sites where exposures to $T_{\leq 22}$ were significantly greater than where they do occur. Although correlative models predicted that skink-free sites were poorly suited climatically, thermal means measured at the microhabitat scale failed to elucidate meaningful significant T_{e} differences among sites. Only when T_{e} data were analyzed with exposure to this lower limit in mind, were relevant differences revealed. This highlights the fact that although correlative models may adequately predict species distributions (Beerling *et al.* 1995; Pearson *et al.* 2002) and climatic suitability within these, simply correcting issues of scale-and resolution mismatch common to correlative models (Pearson & Dawson 2002) may not necessarily offer better insight into which factors are indeed range-limiting. Misidentifying range-constraints risks undermining conservation efforts, and is unfortunately common that correlative models are not viewed within an appropriate framework.

McConnachie *et al.* (2004) showed that correlative models that identified climatic factors as being responsible for shaping the distribution of *Pseudocordylus melanotus* overlooked an important life history trait: *Pseudocordylus melanotus* is a saxicolous lizard species and this substrate fidelity is likely to be its true proximal limiting factor. Similarly, Alexander (2007) showed through a thorough assessment of *Python natalensis*' thermal and reproductive biology, the species range would demonstrate expansion, and not contraction

as Erasmus *et al.*'s (2002) modeling approaches predicted. The number of studies that recognize that trait-based models will likely better serve conservation is growing (i.e., Kearney *et al.* 2008; Diamond *et al.* 2012; Foden *et al.* 2013). Indeed, trait-based data painstakingly gleaned from the literature or expert consult formed the basis of analyses in the biggest assessment (16 857 species; Foden *et al.* 2013) to date of species' vulnerability, sensitivity, and exposure to climate change, demonstrating the value of research focused on identifying these traits.

For my assessment of habitat quality across the southern parts of *T. margaritifera*'s distribution, an understanding of multiple traits played a crucial role in separating out meaningful from irrelevant differences in the data, and revealed differences where typical approaches revealed none. Perhaps the most significant trait to be revealed in my work is that the species digestive performance is greatly reduced at 22 °C and below, and given that a successful organism must at least remain in a neutral to positive energy balance to persist and grow (Huey *et al.* 2001), an adequate digestive performance is essential. In this regard, *T. margaritifera* may indeed be advantaged in areas where climatic warming reduces $T_{\leq 22}$ conditions. However, as many others have highlighted, limiting factors are not constant through time and space (Kearney *et al.* 2002; Kearney & Porter 2004; Kearney & Porter 2009) – a fact that was corroborated by the extirpation of the population of *T. margaritifera* at Piggs Peak during my study.

Kearney *et al.* 2008 demonstrated that although mechanistic-based predictions on the spread of the invasive Cane toad (*Rhinella marina* as *Bufo marinus*) through Australia largely agreed with correlative predictions, the range-constraints varied along the distribution edge from increases in core temperature to decreases in the availability of water for spawning. Even though mechanistic models can more accurately account for changing influence of range-limiting factors across a geographic gradient, they cannot predict dynamic responses of species at the population-level that accommodate plasticity, evolution and intra-specific trait variability (Davis & Shaw 2001; Thomas *et al.* 2001; Pearson & Dawson 2003), all of which are typically most prevalent in populations on “edge” (Gaston 2003; Kearney *et al.* 2008) where edge-associated effects drive such phenomena. To this end, in-field measures made on populations from across a species distribution, including several from different “edges” may be better suited.

Proxy measures made on individual skinks were largely unsuccessful as a means of assessing habitat quality differences. Little to no difference in proxies measures existed across sites, and where differences did exist, no clear patterns were evident. These measures appeared to simply be too coarse for their intended application. Instead the gap between correlative and mechanistic approaches may be best bridged through

glucocorticoid assessments. Given that corticosterone (a glucocorticoid) measures quantify stress in individuals (Knapp & Moore 1997; Kitaysky *et al.* 1999; Comendant *et al.* 2003; Knapp *et al.* 2003; Jessop *et al.* 2004; Touma *et al.* 2004; Berger *et al.* 2005), and can be made passively through metabolite measures (Touma *et al.* 2003), their application may best serve assessments of population health and habitat quality. Though these approaches are touted as the future solution to population monitoring by several authors, it must be recognized that they require baseline measures for interpretation (Wikelski & Cooke 2006; Cooke *et al.* 2013). Measuring baselines can be both timely and costly given that they are species-specific and are likely to vary with age, sex and reproductive condition (Touma *et al.* 2013; Millspaugh and Washburn 2004). However, considering the predicted devastating loss of species due to climate change (Thomas *et al.* 2004), the long-term benefits of collecting baseline data may considerably outweigh their associated costs.

Trachylepis margaritifer is a suitable subject for metabolite-based stress measures (Miller *et al.* 2013). Due to the ease at which populations of the species can be maintained under controlled conditions, baseline data on the effects of temperature on their stress response, in conjunction with distribution-wide measures made on wild populations would allow for better assessments of how the species responds to changes in habitat quality associated with climate change. To date, few studies on stress have been performed on reptile populations *in situ*, and none have been conducted within an African system. Wilson and Wingfield (1994) assayed corticosterone levels in blood samples collected pre- and post-decapitation in North American Common Side-blotched Lizards (*Uta stansburiana*) across the distribution to assess responses to environmental conditions. They found that in-field corticosterone levels for *U. stansburiana* were influenced by sex, age and reproductive state, but not by environmental conditions, and none of the wild populations were suffering from chronic stress. These findings resulted in the authors concluding that what were perceived as “severe” conditions for the lizards were in fact well within their tolerance range. However, Bradshaw (1975) showed that the functioning of the “stress response” may itself be affected by severe conditions. Due to dehydration, the cascading physiological processes involved in eliciting a stress response in two desert-dwelling, Australian agamid lizards (*Amphibolurus inermis* and *Amphibolurus ornatus*) were greatly affected by either adrenal gland malfunction or adrenal insufficiency (Narayan, *In press*) during severe summer conditions in their desert habitat. Thus, even *in situ* corticosterone measures made on individuals may not necessarily accurately reflect associated stress when environmental conditions are extreme.

Certainly, one cannot deny that unraveling environmental effects on populations is a complex and time-consuming process, but never before has this endeavor been so

imperative to conservation. Just as Foden *et al.* (2013) recognize that perhaps the most practical conservation approach to climate change is the diversification and expansion of methods, my findings, along with many examples from the literature, emphasize that in-depth, mechanistic approaches must maintain their vital place among them.

5.2 REFERENCES

- Alexander G.J. 2007. Thermal biology of the Southern African Python (*Python natalensis*): does temperature limit its distribution. *Biology of the boas and pythons*. Eagle Mountain Publishing, Eagle Mountain, Utah, 50-75.
- Avery R.A. 1971. Estimates of food consumption by the lizard, *Lacerta vivipara* Jaquin. *Journal Animal Ecology* 40: 351–365.
- Beerling D.J., Huntley B. and J.P. Bailey. 1995 Climate and the distribution of *Fallopia japonica*: use of an introduced species to test the predictive capacity of response surfaces. *Journal of Vegetation Science* 6: 269–282.
- Bradshaw S.D. 1975. Osmoregulation and pituitary – adrenal function in desert reptiles. *General and Comparative Endocrinology* 25: 230-248.
- Berger S., Martin L.B, Wikelski, M., Romero L.M., Kalko E.K.V., Vitousek M.N. and T. Rodl. 2005. Corticosterone suppresses immune activity in territorial Galapagos marine iguanas during reproduction. *Hormones and Behavior* 47: 419-429.
- Comendant T., Sinervo B., Svensson E.I. and J. Wingfield. 2003. Social competition, corticosterone and survival in female lizard morphs. *Journal of Evolutionary Biology* 16: 948 – 955.
- Cooke S. J., Sack L., Franklin C.E., Farrell A.P., Beardall J., Wikelski M., and S.L. Chown. 2013. What is conservation physiology? Perspectives on an increasingly integrated and essential science. *Conservation Physiology* 1(1): cot001.
- Diamond S.E., Nichols L.M., McCoy N., Hirsch C., Pelini S.L., Sanders N.J., Ellison A.M., Gotelli N.J. and R.R. Dunn. 2012. A physiological trait-based approach to predicting the responses of species to experimental climate warming. *Ecology* 93(11): 2305-12.
- Erasmus B.F., Van Jaarsveld A.S., Chown S.L., Kshatriya M., and K.J Wessels. 2002. Vulnerability of South African animal taxa to climate change. *Global Change Biology* 8(7): 679-693.
- Foden W.B, Butchart S.H.M., Stuart S.M., Vié J-C., Akçakaya H.R., Angulo A., DeVantier L.M., Gutsche A., Turak E., Cao L., Donner S.D., Katariya V., Bernard R., Holland R.A., Hughes A.F., O’Hanlon S.E., Garnett S.T., Şekercioğlu, Ç.H. and G.M. Mace. 2013. Identifying the world’s most climate change vulnerable species: a systematic trait-based assessment of all birds, amphibians and corals. *Plos One* Vol. 8 (6):

e65427.

- Gaston K.J. 2003. The structure and dynamics of geographic ranges. Oxford University Press. New York.
- Jessop T.S., Summer J.M., Limpus C.J. and J.M. Whittier. 2004. Interplay between plasma hormone profiles, sex and body condition in immature hawksbill turtles (*Eretmochelys imbricata*) subjected to a capture stress protocol. *Comparative Biochemistry and Physiology Part A* **137**: 197-204.
- Kearney M., Phillips B.L., Tracy C.R., Christian K.A., Betts G. and W.P. Porter. 2008. Modelling species distributions without using species distributions: the cane toad in Australia under current and future climates. *Ecography* **31**(4): 423-34.
- Kearney M. and W. Porter. 2009. Mechanistic niche modelling: combining physiological and spatial data to predict species' ranges. *Ecology letters*, *12*(4), 334-350.
- Kearney M., Shine R. and W.R. Porter. 2009. The potential for behavioral thermoregulation to buffer "cold-blooded" animals against climate warming. *Proc. Nati. Acad. Sci. USA* **106**: 3835-3840.
- Kitaysky A.S., Wingfield J.C. and J.F Paitt. 1999. Dynamics of food availability, body condition and physiological stress response in breeding Black-legged Kittiwakes. *Functional Ecology* **13**: 577-584.
- Knapp R., Hews D.K., Thompson C.W., Ray L.E. and M.C. Moore. 2003. Environmental and endocrine correlates of tactic switching by nonterritorial male tree lizards (*Urosaurus ornatus*). *Hormones and Behavior* **43**: 83-92.
- Knapp R. and M.C. Moore. 1997. Male morphs in tree lizards have different testosterone responses to elevated levels of corticosterone. *Gen. Comp. Endocrinol.* **107**: 273-279.
- Licht P. and R.E. Jones. 1967. Effects of exogenous prolactin on reproduction and growth in adult males of the lizard *Anolis carolinensis*. *General and Comparative Endocrinology* **8**(2): 228–244.
- Narayan E.J. Evaluation of physiological stress in Australian wildlife: embracing pioneering and current knowledge as a guide for future research directions. *General and Comparative Endocrinology*. **In press**.
- McConnachie S., Alexander G.J. and M.J. Whiting. 2004. Between a rock and a hard place: is low temperature a potential distribution limiter for *Cordylus melanotus*? Abstract. Program, 7th Herpetological Association of Africa Symposium.
- Mueller C.F. 1970. Energy utilization in the lizards *Sceloporus graciosus* and *S. occidentalis*. *Journal of Herpetology* 131–134.
- Miller A.K, Erasmus B.F.N and G.J. Alexander. 2014. Digestive efficiencies are independent of gut passage times in Rainbow Skinks (*Trachylepis margaritifer*).

Comparative Biochemistry and Physiology Part A: Molecular and Integrative Physiology **175**: 110-114.

- Miller A.K., Erasmus B.F.N. and G.J. Alexander. 2013. Gut and intestinal passage time in the Rainbow Skink (*Trachylepis margaritifera*): implications for stress measures using faecal analyses. *Journal of Animal Physiology and Animal Nutrition* **97**(5): 960-970.
- Millsbaugh, J.J. and B.E. Washburn. 2004. Use of fecal glucocorticoid metabolite measures in conservation biology research: considerations for application and interpretation. *General and comparative endocrinology* **138**(3): 189-199.
- Pearson R.G. and T.P. Dawson. 2003. Predicting the impacts of climate change on the distribution of species: are bioclimate envelope models useful?. *Global ecology and biogeography* **12**(5): 361-371.
- Thomas C.D., Bodsworth E.J., Wilson R.J., Simmons A.D., Davies Z.G., Musche, M. and L. Conradt. 2001 Ecological and evolutionary processes at expanding range margins. *Nature* **411**: 577–581.
- Thomas C.D., Cameron A., Green R.E., Bakken M., Beaumont L.J., Collingham Y.C., Erasmus B.F.N., de Siqueira M. F., Grainger A., Hannah L., Hughes L., Huntley B., van Jaarsveld A.S., Midgley G.F., Miles L., Ortega-Huerta M.A., Peterson A.T., Phillips O.L. and S.E. Williams. 2004. Extinction risk from climate change. *Letters to Nature* **427**: 145-148.
- Touma C., Palme R. and N. Sachser. 2004. Analyzing corticosterone metabolites in fecal samples of mice: a noninvasive technique to monitor stress hormones. *Hormones and Behavior* **45**: 10 – 22.
- Wikelski M. and S.J. Cooke. 2006. Conservation physiology. *Trends in Ecology and Evolution* **21**: 38- 46.
- Wilson B.S. and J.C. Wingfield. 1994. Seasonal interpopulation variation in plasma levels of cort in Side-Blotched Lizards (*Uta stansburiana*). *Physiol. Zool.* **67**(4): 1025-1049.