

INITIAL MUTATION IN MODERN IRISH

AND ITS IMPLICATIONS

FOR PHONOLOGICAL THEORY

Jane Roscoe McBrearty

A thesis submitted in partial fulfilment of the requirements
for the degree of PhD at the University of London.

September 1980
University College, London

BEST COPY

AVAILABLE

Poor text in the original
thesis.

Some text bound close to
the spine.

Some images distorted

ABSTRACT
 =====

INITIAL MUTATION IN MODERN IRISH AND ITS IMPLICATIONS FOR
 PHONOLOGICAL THEORY.

Jane Roscoe McBrearty

This thesis is divided into two parts. In Part I, I discuss the implications for phonological theory of adopting a specific hypothesis concerning rule ordering in phonological grammars. The hypothesis in question claims that rules are ordered, not on a language-specific basis, but according to universally determined principles. Thus it constitutes an elaboration of the theory first developed by Koutsoudas, Sanders and Noll in 1974. Following an introductory chapter, the four remaining chapters in Part I are devoted to the explication of particular interaction-types, as exemplified in widely divergent languages. Associated with each interaction-type is a universal precedence principle. Thus in Chapter 2, Feeding, Obligatory Precedence is treated with particular reference to Mohawk, whilst in Chapter 3, Bleeding, the application of Proper Inclusion Precedence is illustrated and two attested cases of reordering are shown to follow from universal principles. In Chapter 4, Counterbleeding, it is refuted that simultaneity constitutes a possible mode of rule interaction and Deletion Cession is put forward to predict the attested applicational precedences in Amerindian data. Proper Inclusion Precedence undergoes a rigorous tightening-up in Chapter 5, where Morphological Precedence is also seen to account for certain cases of Counterfeeding. Part II draws on the hypothesis elaborated in Part I and is devoted to the phenomenon of Initial Mutation in Modern Irish. The Fragestellung spells out the dual nature of Initial Mutation and suggests a two-stage approach involving Triggering, the assignment of "triggers of mutation" to syntactic surface structures within an expanded lexicon, and the Realization of those triggers within the phonological component proper. The two subsequent chapters then examine Triggering and Realization in detail, including their formalization and interaction with other processes according to universally determined principles. It is argued that only within the framework developed here can the treatment of Initial Mutation attain descriptive adequacy.

TABLE OF CONTENTS
=====

	page
<u>ACKNOWLEDGEMENTS</u>	6
<u>PREFACE</u>	9
<u>PART I RULE ORDERING</u>	11
<u>CHAPTER ONE - INTRODUCTION</u>	12
<u>CHAPTER TWO - FEEDING</u>	27
§ 2.1 Intrinsic Feeding in KSN	28
§ 2.2 Postal's Defence of Parochial Ordering	33
§ 2.3 Rules of Epenthesis in Mohawk	41
<u>CHAPTER THREE - BLEEDING</u>	66
§ 3.1 The Characterization of Mutual Bleeding Situations	67
§ 3.2 Disjunctive and Conjunctive Ordering	79
§ 3.3 Unilateral Applicability Versus Potential Interchangeability	86
§ 3.4 Reordering out of Bleeding Order	106
§ 3.4.1 The case of "writer" and "rider"	107
§ 3.4.2 The Swiss German Case	123
<u>CHAPTER FOUR - COUNTERBLEEDING</u>	146
§ 4.1 Simultaneous Rule Application in KSN	148
§ 4.2 Deletion Cession	174
§ 4.3 Supporting Evidence from Geminatio in Berber	194
§ 4.4 Metatheoretical Considerations	216
<u>CHAPTER FIVE - COUNTERFEEDING</u>	231
§ 5.1 KSN's Re-analysis of Counterfeeding Relations	233
§ 5.2 Iverson's Constraint : Preliminary Critique	242
§ 5.2.1 Assimilation and Dissimilation in Konkani	246
§ 5.2.2 Fricative Weakening and Fricativization in Classical Greek	250
§ 5.2.3 Initial Mutation in Old Breton	260
§ 5.3 The Non-spurious Determination of Proper Inclusion	280
§ 5.4 Iverson's Constraint : The Remaining Data	291
§ 5.5 Concluding Remarks	304

TABLE OF CONTENTS contd.

	page
<u>PART II INITIAL MUTATION IN MODERN IRISH</u>	309
<u>CHAPTER ONE - FRAGESTELLUNG</u>	310
§ 1.1 The Preliminary Characterization of the Data	311
§ 1.2 Triggering and Realization under the Generative Model	322
§ 1.3 The Nature of Triggers	355
§ 1.4 Concluding Remarks : An Historical Comment	368
<u>CHAPTER TWO - TRIGGERING</u>	372
§ 2.1 A Survey of Triggering Environments	373
§ 2.2 The Status of the Particle	409
§ 2.3 A Comparison with the Literature	428
§ 2.4 Formalization	440
<u>CHAPTER THREE - REALIZATION</u>	464
§ 3.1 The Phonological Inventory	465
§ 3.2 The Set of Rules	505
§ 3.3 Two Ordering Paradoxes	539
<u>BIBLIOGRAPHY</u>	558

TABLE OF CONTENTS contd.

	page
<u>LIST OF TABLES</u>	
<u>PART I</u>	
TABLE I SIX EXTRINSICALLY ORDERED RULES FOR MOHAWK PLUS ONE	35
TABLE II THE FORMALIZATION OF LENITION IN OLD BRETON ACCORDING TO THREE POTENTIAL PRINCIPLES OF UDRA	264
<u>PART II</u>	
TABLE III DISTINCTIVE FEATURE COMPOSITION OF UNDERLYING SEGMENTS IN MODERN IRISH	467
TABLE IV PAIRING OF UNDERLYING CONSONANTAL SEGMENTS IN TERMS OF THE DISTINCTIVE FEATURE [+PALATALIZED]	471
TABLE V EPENTHESIS BETWEEN SONORANT AND OBSTRUENT	494
TABLE VI THE MAJOR MUTATION-TYPES: ECLIPSIS AND LENITION	506
<u>LIST OF FIGURES</u>	
<u>PART II</u>	
FIGURE I THE ORGANIZATION OF THE GRAMMAR INCORPORATING AN EXPANDED LEXICON	351
FIGURE II FOUR-WAY SUBCLASSIFICATION OF LATERALS AND CORONAL NASALS IN SOME DIALECTS OF MODERN IRISH	503

ACKNOWLEDGEMENTS
=====

There are many people who have contributed, both directly and indirectly, to the writing of this thesis. If I were to pinpoint the first awakenings of my interest in linguistic matters, I must thank my uncle Edward Gilliam, who aroused my enthusiasm by telling me about Indo-European philology. Ten years later I became an undergraduate in the Department of Linguistic Science at Reading University. From amongst the many members of staff who inspired me in those days, I owe a special debt to Irene Warburton and Ron Brassington, who kindled my interest in Generative Phonology.

In 1974 I was fortunate enough to spend six months at University College, Galway. There I followed a language laboratory course under the supervision of Professor Tomás S. Ó Máille. His un-failing patience at my painful attempts to come to grips with the rudiments of his language is fixed in my memories of that invaluable period: without his help in preparing my BA dissertation, I would never have put forward my postgraduate research proposal on the morphophonemics of Modern Irish. Nor can I forget the friendship offered by students at UCG, both in 1974 and afterwards, especially that of Maraithe Ní Mhaicillóin and Eithne Egan.

Having graduated from Reading, I was awarded a State Studentship by the Department of Education and Science in 1975. I should like to acknowledge how greatly I valued this: without it I would have been unable to become a full-time postgraduate. It was as a postgraduate that I attended University College, London

and this thesis is the result of my research there. I think it is true to say that the end-product could not have been as it is, if it had been written elsewhere - the Linguistics Section at UCL is electrifying. I should like to express my gratitude to Dick Hudson and Deirdre Wilson for their - often tacit - support. Particular thanks also go to Geoff Pullum for the many criticisms he made of my early drafts - they were usually justified and always constructive. I do not pretend to emulate his work on UDRA in syntax and only hope that a little of his magic has rubbed off on me.

During my time at UCL I was able to attend certain classes at the School of Oriental and African Studies. There I was able to enjoy Professor R.H. Robins' Yurok seminars, unaware at the time of the valuable contrast they would afford with work on other Amerindian languages. The 1976-77 session also provided me with a last opportunity to sit in on Professor C.E. Bazell's tutorials before his retirement. They proved to be doubly elucidating, for besides Professor Bazell's unassuming erudition, Professor R. Hetzron was also present on sabbatical leave and willing to impart his vast knowledge of Semitic and Cushitic.

In June 1977 I gave a paper at the Conference on Celtic Phonology at the New University of Ulster, Coleraine. I must therefore express my thanks to all those who took part at the conference, especially Dónall Ó Baoill who rescued me from a Celticist's "faux pas" the night before I gave my paper. Nor can I underestimate the rôle played by John Wells from the Phonetics Section at UCL, not only for telling me about the conference in the first place but also for lending me his phonetic tapes of Dónall Ó Baoill without a deadline.

Having mentioned several intellectual debts, I now come to the biggest one of all - to Neil Smith. Neil was the ideal supervisor for someone of my disposition - he knew just when to challenge, just when to disagree, just when to encourage. To him I owe not only immense admiration and deep appreciation but also my life-long affection.

Since September 1979 I have been the Lecturer in Linguistics and Phonetics in the School of Speech Therapy at the City of Birmingham Polytechnic. I should like to acknowledge my gratitude to colleagues there for their support during the final stages of preparation. Especial thanks go to Shirley Abudarham for undertaking the job of typing the final manuscript and to Sam, Judith and Leah for enabling her to do so.

Many other mentors and friends have contributed to the writing of this thesis by discussing various aspects of phonology with me. Where possible I have acknowledged their help at the appropriate point in the text. To all those whom it was not possible to mention I here cite my appreciation.

My final debt goes to my parents, most of all to Bunty, without whom this thesis would never have reached completion.

PREFACE

"The most challenging theoretical problem in linguistics is that of discovering the principles of universal grammar that interweave with the rules of particular grammars to provide explanations for phenomena that appear arbitrary and chaotic."

Noam Chomsky 'Language and Mind' 1968 p.48

This thesis was conceived as a study of a superficially arbitrary and chaotic set of phenomena, namely, Initial Mutation in Modern Irish. I had intended to explicate various aspects of Initial Mutation by devoting a separate chapter to each. One such aspect was rule interaction: accordingly, I began to write a chapter on that topic. However it became immediately apparent that to discuss rule ordering solely in relation to Initial Mutation in Modern Irish would result in a rather lop-sided view of phonological theory. To the extent that the original object of my investigation constitutes part of the "potentiality" of any natural language, I wished to relate it to the problems posed by data from other such languages. A single chapter on rule interaction would necessarily gloss over many important issues raised for phonological theory by languages other than Modern Irish.

It was at this point that I decided to extend the title of my thesis to include "Implications for Phonological Theory" and to divide it into Parts I and II. In Part I, I would be able to treat problems of rule ordering. By liberating the discussion from the confines of a chapter, I would have sufficient scope to deal with the theoretical questions in detail. Since the hypothesis I was defending could be given adequate exegesis in Part I, this in turn would mean that the discussion of Part II

could draw on it in dealing with the language-specific phenomenon of Initial Mutation in Modern Irish.

It is thus true to say that I did not envisage the final form of this thesis when I began to write. Moreover there is another sense in which the outcome was not premeditated: throughout the process of writing I have become increasingly aware of the interdependence of the various strands of phonological theory. The picture of an integrated theory which I now hold has emerged gradually as a direct result of looking in depth at a particular phenomenon in a particular language and of then trying to explain that phenomenon. If I had set out with a preconceived idea of what phonological theory should look like I might have been disappointed. Instead I am mildly surprised that so many seemingly divergent problems point in the same direction. Thus although I do not underestimate the numerous difficulties which remain to be solved in this work, I hope that it will contribute in some way to phonological theory and hence universal grammar.

PART I

RULE ORDERING

CHAPTER ONE - INTRODUCTION

Generative Phonology has an even briefer history than the theory of Transformational Generative Grammar of which it forms a part. Yet throughout that short time-span several important revisions and elaborations have been put forward, some related to developments in syntax, others specific to the phonological component. One such revision which has serious repercussions in syntax stems from a proposal, advanced in 1974 by Koutsoudas, Sanders and Noll (henceforth KSN), that grammatical rules are ordered not on a language-specific basis but according to universally determined principles. Part I of this thesis represents one attempt to continue the line of inquiry begun by KSN into the universal principles which determine rule ordering in phonological grammars.

In this chapter I propose to do four things: first, I shall examine the classical position on how the rules of the phonological component operate; second, I shall put the KSN Hypothesis into perspective; third, I shall elaborate the framework adopted from Kiparsky by KSN; finally, I shall point to the metatheoretical consequences of adopting that position.

Assumptions about ordering date back to Chomsky's (1951) Master's dissertation and are made apparent in Chomsky (1964):

- (1) "As soon as the attempt to construct explicit rules to determine the phonetic shape of a string of formatives passes the most superficial and introductory stage, it becomes obvious that a fairly strict ordering must be imposed on phonological processes, if they are to be describable in full generality".

(1964; page 70; emphasis mine)

What was considered "fairly strict" in 1964 had become rigidly so four years later, as can be seen from the following assertion from the classical work in Generative Phonology, Chomsky and Halle's 'The Sound Pattern of English' (henceforth Ch&H and SPE respectively):

- (2) "(a) The rules of the phonological component are linearly ordered in a sequence R_1, \dots, R_n .
- (b) Each rule applies to a maximal string containing no internal brackets.
- (c) After applying the rule R_n , we proceed to the rule R_1 .
- (d) Unless an application of the rule R_n intervenes, the rule R_j cannot be applied after the rule R_i ($j < i$) has applied.
(sic: read R_i for R_j and R_j for R_i - JRMcB).
- (e) R_n is the rule: erase innermost brackets".
(SPE, page 20)

Principle (2) gets to the crux of the matter by referring to "the rules of the phonological component" in toto, not just to cyclic rules (which apply first to the smallest constituents, proceeding systematically to larger and larger constituents, by the erasure of bracketting). Now if the rules of word-level phonology can be "interspersed among the cyclic transformational rules" (SPE page 163) and if the rules of the cycle re-apply in linear sequence R_1, \dots, R_n (= (2)), then it follows that word-level phonological rules are linearly ordered also. It is perhaps unnecessary to labour the point since one has only to turn to the introductory discussion beginning on page 44 of SPE to see how such rules as the e-Elision Rule and the Cluster Simplification Rule for English interact with those of Stress Placement and Vowel Reduction in a blatantly ordered framework. However, such a position which has become a point of dogma within classical generative theory, is in fact very much an open issue. It is therefore important to make absolutely clear from the start what the classical position is.

Pullum (1976a) draws a fundamental distinction between sequential and simultaneous application, and discusses the way in which this dichotomy is ignored in SPE (pages 226-7). Whereas sequential application involves

the linear application of one rule at a time, each to the output of the preceding rule, under (complete) simultaneity, each derivation consists of two and only two lines: the input to which all the rules apply at once, and the output string. As Pullum observes, in at least one introductory passage from SPE it is not so much the necessity but the possibility of strict sequential ordering which is being defended:

- (3) "It is always possible to order the rules in a sequence and to adhere strictly to this ordering in constructing derivations without any loss of generality as compared to an unordered set of rules or a set ordered on a different principle".

(SPE page 18; emphasis mine)

Thus the claim is made that for any natural language the optimal grammar will not demand that rules be ordered on a principle other than linear. Yet Ch&H do not even discuss what these different principles may be - the sole alternative to their hypothesis which they mention is simultaneous application. Simultaneity has been frequently ascribed by proponents of classical generative phonology to the "taxonomists" and more recently - with justification - to the work of Lamb and Fudge. Moreover the claim that all rule application is simultaneous had readily been falsified both in SPE and in the remaining literature (e.g. Postal 1968). However Ch&H make no attempt to refute what Pullum describes as a "mixed" theory, which combines sequential application with the claim that some rules apply simultaneously. In (3) we read that Ch&H make a comparison between linear ordering and "an unordered set of rules or a set ordered on a different principle". By focussing on complete simultaneity in SPE, Ch&H distract us from what such a "different principle" might be: it was the elaboration of such a principle which was to become the KSN Hypothesis. The fact that Ch&H do not discuss any of the potentially viable alternatives to strict sequentiality is the more surprising when one considers that the crucial distinction between intrinsic and extrinsic ordering may be traced to a footnote in Chomsky's 'Aspects of the Theory of Syntax'

(1965), cited in full as (4) (with Pullum's correction):

- (4) "In connection with ordering of rules, it is necessary to distinguish extrinsic order, imposed by the explicit ordering of rules, from intrinsic order, which is simply a consequence of how rules are formulated. Thus if the rule R_1 introduces the symbol A and R_2 analyzes A , there is an intrinsic order relating R_1 and R_2 , but not necessarily any extrinsic order. Similarly, if a certain transformation T_1 applies to a certain structure that is formed only by the application of T_2 , there is an intrinsic order T_1, T_2 (sic: this is an error for T_2, T_1 - GKP). Taxonomic linguistics disallows extrinsic ordering, but has not been clear about the status of intrinsic ordering. Generative grammars have ordinarily required both. For some discussion of this matter, see Chomsky (1964)".

(1965; footnote 6 page 223)

In his (1976b) doctoral thesis, Pullum argues that, given Chomsky's definitions, there are cases where it is impossible to tell whether two rules are ordered intrinsically or extrinsically. Suppose that rules characterized by the property P_1 must apply before those characterized by the property P_2 and that linguistic theory incorporates a statement to this effect. Then it follows that in a grammar G , rule R_1 with the property P_1 must apply before R_2 with the property P_2 . The ordering in this case will be both "imposed by the explicit ordering of the rules" and intrinsic - "a consequence of how rules are formulated". So by a reductio ad absurdum whenever one adds to linguistic theory some trivially true principle that 'No two rules A, B may apply in that order if it is impossible for them to do so', all the most obvious cases of intrinsic order are now extrinsic too. Because he finds Chomsky's distinction incoherent for this reason, Pullum proposes the distinction: parochial ordering constraint versus Universally Determined Rule Application (henceforth UDRA). This dichotomy gets down to the empirical issue of whether ordering may be imposed on a language-specific basis or whether it is part of universal linguistic theory which specifies the limitations on candidates for the title "possible human language".

Although in one sense I find Pullum's arguments valid regarding the

incoherence of the extrinsic:intrinsic distinction (i.e. valid if Chomsky is interpreted absolutely literally), these terms have been used in the literature in precisely his parochial versus UDRA sense. Because of force of habit (both my own and that of others), I shall continue to employ the term 'extrinsic' interchangeably with 'parochial' in what follows, without, I hope, any ambiguity.

Having surveyed the classical position on rule ordering in generative grammar, we now turn to the first exposition of the theory of UDRA, namely the KSN Hypothesis. KSN take advantage of both the simultaneous/sequential dichotomy and the intrinsic/parochial distinction in what may be called a "mixed" theory of rule application: a rule applies whenever its structural description is met; when more than one structural description is met at the same time both rules apply simultaneously if possible; if not, precedence principles determine uniquely which rule is to apply first.

The central KSN Hypothesis is given in (5):

- (5) "All restrictions on the relative order of application of grammatical rules are determined by universal rather than language-specific principles.

It follows from this hypothesis that no grammatical rules are extrinsically ordered"

(KSN page 1)

It is important to realize how little one needs to extend the SPE framework to incorporate such principles. Discussing notational conventions, Ch&H assert that: "disjunctive ordering is defined on the rules of the sequence constituting the grammar" (SPE page 36). Intrinsic ordering is also 'defined on' grammatical rules in the same way. Further down the same page we read:

- (6) "But now we are also making use of the notations to determine how the rules apply, in particular, to determine disjunctive ordering".

(ibid.)

Surely notations may be used in cases of intrinsic ordering too, where the formalization of a rule is used to determine when that rule will

apply? We return to this topic in §3.2 "Disjunctive and Conjunctive Ordering".

We have placed the KSN Hypothesis in historical perspective. The question which must now be posed is the following: What is the relationship between the KSN Hypothesis and subsequent theories of UDRA? Pullum provides a pellucid answer to this question in his doctoral thesis:

- (7) "The KSN Hypothesis is one specific proposal as to the correct form of the principles governing rule application in the grammars of natural languages. It represents a first serious attempt at fleshing out the more basic and more general hypothesis that is stated in its first sentence, and which Koutsoudas refers to as the hypothesis of Universally Determined Rule Application: "All restrictions on the application of rules are determined by universal principles". This, and not any specific detail of the KSN Hypothesis or any other, is the essence of the claim that parochial ordering constraints do not exist. The claim is that it will be possible to find universal principles that are sufficient to predict correctly all applicational precedence between rules of natural language grammars, and thus that any use of parochial principles will prove to have been unnecessary".

(1976b, page 18)

From (7) it will be clear that, whilst the principles developed in Part I of this thesis purport to be principles of UDRA, they may not necessarily conform to the proposals put forward in the KSN Hypothesis. In fact, this turns out to be the case: in parts the theory elaborated here is at variance with the KSN Hypothesis. To take a case in point, I shall argue in Chapter Four that simultaneity is not a possible mode of rule interaction. Thus at that stage in the exegesis and at others I shall delineate areas of KSN's thesis which a fully developed theory of UDRA must amend.

The way in which Part I is organized follows directly from KSN's exposition and it is their framework, adopted from Kiparsky, which I shall now outline, before alluding to the subject-matter of the remaining chapters.

Implicit in the assumption that rules are extrinsically ordered, is the

claim that languages may differ solely in their relative ordering of a pair of rules A and B. This consequence of the extrinsic ordering hypothesis dates back to Kiparsky (1968). One way of looking at KSN's task is therefore to say that they must refute the statement that two languages L_1 and L_2 may differ in their ordering of the same set of rules. This holds both when L_1 and L_2 are synchronically related dialects and when they are subsequent stages of the same language i.e. diachronically related. To set about this task KSN take Kiparsky as a starting-point and consider the various relations which may obtain between rule A and rule B. They then use this framework to discuss first synchronically related languages and second diachronically related ones. I shall also adopt Kiparsky's framework but, unlike KSN, I shall treat synchronic and diachronic data together just in case both exemplify a particular interaction-type.

Kiparsky defines rule A's effect on rule B as one of the following if A applies before B:

(8) "A feeds B iff the application of A increases the number of forms to which B can apply.

A bleeds B iff the application of A decreases the number of forms to which B can apply.

A does not affect B iff A neither feeds nor bleeds B".

(cited by KSN, page 2)

I shall refer to feeding and bleeding as the Primary Modes of Rule Interaction, since they describe the effect of the first rule, A, on a second rule, B, which is ordered to apply after A. But also to be considered are B's potential effects on A, which, however, are not realized since B is by definition prevented from applying before A. These I shall refer to as the Secondary Modes of Rule Interaction. KSN use the terms 'Counterfeeding' and 'Counterbleeding' for the secondary modes, as defined in (9):

- (9) "B counterfeeds A iff the application of B would increase the number of forms to which A could apply if B were to apply before A. B counterbleeds A iff the application of B would decrease the number of forms to which A could apply if B were to apply before A. B does not affect A iff B neither counterfeeds nor counterbleeds A."

(KSN *ibid.*)

Both the primary and secondary modes of rule-interaction have been referred to in the literature under different labels. Feeding and bleeding correspond to Chafe's (1968) "appropriate additive interference" and "appropriate subtractive interference" respectively. Chafe refers to Counterfeeding and Counterbleeding as "inappropriate additive interference" and "inappropriate subtractive interference" respectively. (See § 3.1 for a discussion of KSN's remarks concerning Chafe's exposition.) Wang (1969) uses the terms "replenishing" and "voiding" for the secondary modes.

Given that A can affect B in three ways and that B can potentially affect A in three ways, there is a total of nine ways in which A and B can interact. However we shall not discuss each of these nine interactions separately. Rather, I shall devote one chapter to each of the primary modes and one to each of the secondary modes (the non-affecting relation being of no empirical consequence).

To clarify the relationships between the interaction-types, we now turn briefly to the principles of linguistic change developed by Kiparsky (1968) using the feeding/bleeding distinction. Since Kiparsky was expanding Halle's (1962) claim that the class of possible sound changes is the same as the class of possible phonological rules, the feeding/bleeding dichotomy characterizes all primary interaction-types, synchronic as well as diachronic. Kiparsky observed two tendencies in his data:

(10) I Feeding order tends to be maximized.

II Bleeding order tends to be minimized.

From these he inferred the following principle as a mechanism of linguistic change:

(11) III Rules tend to shift into the order which allows their fullest utilization in the grammar.

Applying Principle III to the organization of synchronic phonological grammars, we would expect to find relatively few rule-pairs in a bleeding relation and the majority of rule-pairs in a feeding relation. However within the classical position on generative phonology to which Kiparsky subscribes, rules have not been maximally utilized. To put this slightly differently, it is not the case that we find a preponderance of rules in a feeding relation as opposed to a bleeding relation within the generative literature. A second criticism which may be made of the maximal utilization principle, is, like the first, pointed out by Kenstowicz and Kisseberth (1977): to claim that bleeding orders are minimized suggests that they are marked in some way whereas feeding orders are unmarked. Yet as Hooper also remarks (1976, Chapter 5), there are many examples in the literature of mutual bleeding orders where the attested order is the unmarked, natural one. A theory of rule interaction must account for this. Furthermore - a point which is not made by Hooper or Kenstowicz and Kisseberth - a theory of UDRA must find the means to predict which rule takes applicational precedence in mutual bleeding situations. In Chapter 3, Bleeding, it will be shown that KSN propose an appropriate principle. The principle in question, Proper Inclusion Precedence, also figures in Chapter 5, Counterfeeding, where it is rendered more explicit and associated algorithms put forward.

One solution to the problem raised by the fact that certain bleeding orders are unmarked is that another principle overrides (10) II, the

minimization of bleeding orders. Indeed Kiparsky himself suggests such a principle (1971), namely Paradigm Uniformity, cited as (12):

(12) Allomorphy tends to be minimized in a paradigm.

(1971, pages 598-9)

It is clear that (12) constitutes a restatement of the phenomenon of analogical levelling. The appropriateness of such a principle to data from Swiss German will be demonstrated in § 3.4.2.

More important for the theory of rule interaction than what may be regarded as a slightly retrograde step towards the reformulation of analogy current in the Structuralist literature, is the concept of 'opacity' which Kiparsky also introduced in 1971. Let us therefore evaluate the KSN Hypothesis in the light of this more recent distinction.

The process P of the form

$$A \longrightarrow B / C \text{ ______ } D$$

is opaque to the extent that:

i) there are phonetic counterexamples to it i.e. phonetic strings of the type [CAD] and

ii) there are phonetic instances of B in environments other than C ______ D.

In a later publication (1973), Kiparsky divides ii) into the following two cases of opacity:

iiia) B derived by the process P in environments other than C ______ D

iiib) B not derived by the process P (i.e. underlying or derived by another process) in environment C ______ D.

The following quotation states what Kiparsky is claiming to explain by introducing the term 'opacity':

(13) "Opacity (converse: transparency) is intended as a measure of one of the properties of a rule which determine how hard it is to learn: the 'distance' between what the rule says and the phonetic forms in the language of whose grammar the rule is a part."

(1973, page 79)

Clauses i) and iiia) have to do with the pervasive problem of learning

the class of segments affected by a rule and what its context is.

i)-type opacity arises when there are phonetic counterexamples to the first of a pair of rules. Often in particular derivations this is because the first rule is not allowed to apply nonvacuously - at the point in the derivation where it applies the input structure has not yet been modified to yield the necessary structural description.

Typically there obtains a counterfeeding relation between the pair of rules: the final phonetic string contains a surface violation of rule A. Clause iia) describes the kind of opacity which typically results when two rules apply in a counterbleeding order: the second rule obscures the context which calls for the first rule. Clause iib) has to do with learning underlying representations which are later subject to neutralization. We shall also treat neutralization processes and their relation to the abstractness issue in Chapter 4, Counterbleeding.

If rules apply in such a way that opacity is minimized, clearly counterfeeding and counterbleeding will be marked interactions. This is the claim made by Kiparsky's opacity principle. How does it compare with the predictions of the KSN Hypothesis? KSN assert that only certain relations may obtain between a pair of rules: feeding, counterbleeding and (of necessity) mutual bleeding relations. KSN actually state their case so strongly that all other relations must be wrong analyses. They then proceed to reanalyze the remaining relations - see particularly the discussions of bleeding in Chapter 3 and counterfeeding in Chapter 5.

To summarize, KSN's claim is at variance with that of Kiparsky: the latter classifies counterfeeding and counterbleeding - what I have termed the secondary modes of rule interaction - as unnatural; whilst KSN "outlaw" counterfeeding and bleeding orders other than mutual ones.

Hooper (1976 pages 77-78) accuses KSN of not having any metatheoretical

principle which explains why feeding and counterbleeding should be preferred over bleeding and counterfeeding. She cannot therefore have read the introductory paragraphs of § 3 where KSN characterize bleeding and counterfeeding as "domain-reducing" as opposed to the "more natural more general and more law-like (sic: JRMcB) character" of feeding and counterbleeding. This is the case since the latter relations hold whenever every rule applies once its structural description is met i.e. they express a true generalization about language. Thus a rule stating that "All X are Y" (as in examples of feeding and counterbleeding) is to be preferred over one which says that "All X which are Z are Y" (as with bleeding and counterfeeding). Ceteris paribus we would expect the child constructing his grammar to select hypotheses of the former type rather than hypotheses of the latter type, and hence that his grammar will contain more instances of rules in feeding and counterbleeding relations than that of his parents, and similarly fewer instances of bleeding and counterfeeding relations. From this it follows that grammars of temporally subsequent dialects will contain fewer cases of bleeding and counterfeeding than temporally antecedent ones.

In the chapters which follow I shall agree with both Kiparsky and KSN that feeding represents perhaps the most natural relation between rules (Chapter 2), and that under scrutiny putative cases of counterfeeding turn out to be based on dubious analyses (Chapter 5). However I shall disagree with KSN in my treatment of certain bleeding relations in Chapter 3. I shall also be at variance with Kiparsky in Chapter 4 when I entertain counterbleeding interactions despite the fact that the principle of UDRA developed here to account for certain counterbleeding relations derives from his (1973) paper.

In closing this Introduction to Part I, I should like to point to the

metatheoretical consequences which ensue once the UDRA Hypothesis is accepted as a linguistic universal. At first glance it might be supposed that the adoption of the UDRA Hypothesis rather than a set of parochial ordering constraints is on a par with formal universals like the selection of one particular set of distinctive features rather than another set (where 'formal' universal contrasts with 'functional' universal and subsumes the earlier 'substantive' universal; see Chomsky and Lasnik (1977)). However to take such a view would be to disregard the relative strengths of the two positions.

As a metatheoretical term 'strength' is to be distinguished from 'power'. The latter is ascribed to a particular theory of grammar with reference to the number of languages, both natural and artificial, defined by it. Hence the more powerful the theory the greater the number of not only natural but also unnatural, artificial languages it generates. It has long been recognized that T(ransformational) G(enerative) Grammar is over-powerful in this sense. Hence an important goal of linguistic theory has been to restrict TG grammars by imposing universal constraints on them. Each time the theory is constrained in this way by "skimming off" some of its excessive power, it becomes a stronger theory just in case it comes closer to defining the set of all and only natural languages. I now propose to demonstrate that by entertaining parochial ordering we increase the power of linguistic theory without a concomittant gain in strength. On the other hand the adoption of the UDRA Hypothesis results in a far less powerful but stronger theory of language.

Consider the claim that a grammar G_1 of some natural language L_1 contains n rules, which are extrinsically ordered. The implication here is that there may exist a related language - call it L_2 - with a grammar G_2 also containing those n rules but that those rules are in a different extrin

order. Now consider the total number of distinct extrinsic orders in which it is possible to place those n rules: the total is $n \times (n-1) \times (n-2) \times (n-3) \dots \times 1 = n!$ or n factorial. In other words, under the parochial position, a set of n rules defines $n!$ different grammars for $n!$ different languages (or dialects). To appreciate the unbridled powerfulness of such a position let me cite Pullum's calculations from his (1979) review of Koutsoudas (1976). Taking the fragment of English phonology presented in Chomsky and Halle's "Sound Pattern of English" (1968), Pullum notes that there are fifty separate rules. Thus under the extrinsic ordering hypothesis the number of grammars defined is 50 ($50 \times 49 \times 48 \times \dots \times 1$). Pullum approximates this number as 3×10^{14} . To give some idea of the enormity of such a figure he compares it with the distance from the earth to the sun in millimetres which is only about 10^{14} ! Moreover the number of possible grammars soars even higher if, as is often the case in the generative literature, partial extrinsic order is also entertained.

From such calculations it is clear that by any standards the parochial ordering position commits one to a theory of unbridled power but little strength. By contrast, for our n rules the UDRA Hypothesis claims that only one grammar - and hence one language - is defined. To put this another way, the UDRA Hypothesis predicts that no two languages (or dialects) will differ solely in the relative ordering of the same set of rules. Thus for all those data where such a claim has been made it behoves the theory of UDRA to explicate the facts using different means if it is to maintain its position as the stronger theory.

Within Part I of this thesis I shall propose that a number of factors other than extrinsic ordering constraints determine the attested differences between synchronically related dialects and diachronic sta

of the same language. In some cases I shall call for the reformulation of the rules themselves. Elsewhere I shall cite restructuring in the lexicon as the cause of the divergence. In other places I shall make appeal to the functional status of the processes concerned. However at no point shall I rely on an extrinsic ordering device to determine the applicational precedence of a particular rule over another. Thus I am confident that, in narrowing down the set of possible phonological systems which are found in natural language grammars, the phonological theory developed here shares the metatheoretical attributes of other theories of UDRA.

CHAPTER TWO: FEEDING

Like the next, this chapter deals with one of the Primary Modes of Rule Interaction. It will concern itself with the characterization of Feeding and the exemplification of the principle, Obligatory Precedence. In keeping with the first sections of the remaining chapters in Part I, § 2.1, 'Intrinsic Feeding in KSN', provides a critique of KSN's treatment of the interaction-type, and looks at data from three different languages. In contrast, § 2.2 and § 2.3 deal with data from one language only, namely Mohawk. Postal's original (1968) analysis is reviewed in detail, secondary treatments by KSN and Karin Michelson are discussed and additional solutions provided. The material is divided between the two sections as follows. In § 2.2, 'Postal's Defence of Parochial Ordering', the typical pattern of argumentation found in the literature of classical generative phonology is critically examined in the light of KSN's treatment of a set of rules from Mohawk. At the same time, KSN's re-analysis of a piece of Postal's data is shown also to be unsatisfactory and a more adequate solution provided. § 2.3, 'Rules of Epenthesis in Mohawk', draws together a number of issues related to rules of this type. It is my contention that, far from clouding the exposition of Obligatory Precedence and the feeding interactions it accounts for, the ensuing discussion will demonstrate the interdependence between questions of rule ordering and other aspects of phonological theory.

§ 2.1 Intrinsic Feeding in KSN

Throughout the literature of generative phonology there are many examples of rules standing in a feeding relation i.e. where rule A increases the number of forms to which rule B can apply. To spell this out a little more clearly, consider an underlying representation S and a pair of rules A and B. * Although S does not meet the structural description of B, it meets that of A. Furthermore, the structure which results from applying A to S does now meet the structural description of B : then A feeds B.

As their first example of feeding, KSN take Kiparsky's rules for Finnish:-

(1) Kiparsky 1968: Finnish

A Consonant Deletion	$\gamma \longrightarrow \emptyset / V _ V$
B Diphthongization	$ee \longrightarrow ie$

Following KSN and given these rules, let us examine how they would apply to the underlying representations /vee/ and /teye/. Clearly /vee/ but not /teye/ meets the structural description of Diphthongization. Yet once Consonant Deletion has applied to /teye/ (it is not applicable to /vee/), the intermediate structure /tee/ does meet the structural description of Diphthongization and we obtain the following derivations:-

(2)	S	vee	teye
	A	-	tee
	B	vie	tie

* Footnote

In the next four chapters I shall use S for underlying representations, A for the first rule in question and B for the second. Underlying representation, Structural Description and Structural change are frequently abbreviated as UR, SD and SC, respectively.

From this example KSN point out that an extrinsic ordering statement, Consonant Deletion before Diphthongization, is wholly redundant - each rule simply does apply to every representation to which it can apply. Hence stating that two rules are in a feeding relation is tantamount to saying that they are entirely unrestricted in their order of application i.e. each (obligatory) rule must be applied to every representation that satisfies its structural description. In 1980, Koutsoudas encapsulated this principle as Obligatory Precedence, which is defined as follows:

- (3) "An obligatory rule must apply wherever its structural description is met". (1980, page 20)

In this sense, feeding is intrinsic order par excellence - the type of case which I suspect Chomsky had in mind when he first formulated the extrinsic/intrinsic distinction in 1965. Given a "typical" derivation in classical generative phonology, it is not surprising how many rules stand in feeding relations to each other, when one considers that later rules are formulated to apply to the structures generated by earlier rules, so that it is ~~logically~~ possible for a form to have as many intermediate representations as there are rules in the grammar. To put this another way, if instead all rules were to bleed each other we would expect one rule only to apply to each underlying form and each derivation to consist of two lines. Under the UDRA hypothesis the characteristic intrinsic feeding order follows naturally as a part of the definition of obligatory rule. It is important to see how easily the SPE framework can be adapted to incorporate intrinsic ordering, - especially feeding relations: all we have to do here is to allow the formalization of the rule to determine that it apply whenever possible.

Since examples of intrinsic feeding order are so common in the literature

it is paradoxical that time and time again these very cases are cited as proof of the necessity for parochial ordering statements. Indeed KSN cite two examples from SPE of the tautological nature of the typical argumentation for parochial ordering, where Ch&H present facts which argue against rather than for the claim that "a fairly strict ordering must be imposed on phonological processes". (page 88).

Given two rules for English:-

(4) SPE : English *

A Spirantization $t \rightarrow s / \text{_____} + i$

B Palatalization $si \rightarrow \text{ʃ} / \text{_____} V$

and given an underlying representation /prezident + i + al/, it is clear that only A is applicable, yielding /prezidens + i + al/, the appropriate environment for B to produce [prezidens^ʃal]. B is no more applicable to the initial string than it is to any other sequence of /consonant + i/ which does not happen to have the derivational properties of /prezident/. Yet Ch&H make the ordering extrinsic by numbering Spirantization (26) and Palatalization (37) in their summary of rules (Chapter 5 page 236).

Despite the fact that KSN's arguments are valid when applied to the processes of spirantization and palatalization typical of the world's languages, I must note here that I find their oversimplification of the rules presented in SPE for English unfair to Ch&H. In fact Spirantization subsumes four subcases operating on all $\left[\begin{array}{l} + \text{ anterior} \\ + \text{ coronal} \end{array} \right]$ consonants, whilst the SPE formulation of Palatalization applies to coronal consonants before the glide [y] which is subsequently deleted

* Footnote

KSN cite informally the appropriate subcases of these complex rules - see below for comment.

under certain conditions. Although KSN's oversimplification does not vitiate their overall argument, the precedence of Spirantization over Palatalization as formulated in SPE is not a case of feeding order comparable in lack of complexity to their other examples.

KSN demonstrate that SPE proposals to handle Sapir's data from Southern Paiute in terms of an extrinsic ordering restriction have no empirical justification. Given the two rules cited below, the only possible derivation of an input /paawa/ is the following:-

(5) SPE : Southern Paiute

- A Vowel Devoicing
$$V \longrightarrow [- \text{voice}] / \text{---} \left\{ \begin{array}{l} \# \\ [- \text{son}] V \end{array} \right\}$$
- B Glide/Nasal Devoicing
$$\left[\begin{array}{l} + \text{son} \\ - \text{voc} \end{array} \right] \longrightarrow [- \text{voice}] / \text{---} \left[\begin{array}{l} - \text{cons} \\ - \text{voice} \end{array} \right]$$
- S /paawa/
- A paawa_o
- B [paawa_{oo}]

B could not apply directly to the underlying representation alone since its environmental conditions are not met, the glide being followed by a

$\left[\begin{array}{l} - \text{cons} \\ + \text{voice} \end{array} \right]$ segment, rather than by a $\left[\begin{array}{l} - \text{cons} \\ - \text{voice} \end{array} \right]$ one. Ch&H are

therefore right when they state that these rules "require endless repetition of environments if the rules are made to apply simultaneously", but in error when they claim that such examples "are handled quite naturally if rules are applied in accordance with the ordering conventions we have postulated". (page 349). In fact Sapir's data can best be handled without the heavy machinery proposed in SPE.

In this section we have reviewed rules from Finnish, English and Southern Paiute which KSN argue do not require parochial ordering statements.

Rather, in each case the application of rule B to the output of rule A follows from Obligatory Precedence. We have characterized this type of

interaction as intrinsic feeding. Having seen intrinsic feeding relations for rule-pairs, we now turn with KSN to a set of rules in a purportedly extrinsic order.

§ 2.2 Postal's Defence of Parochial Ordering

In this section we consider the pattern of argumentation for parochial ordering in Postal's 'Aspects', published in the same year as SPE. I turn to Postal for several reasons. Firstly, since the data are taken from Mohawk, the language of Postal's linguistic apprenticeship, rather than from a language with which I am familiar, I can have no unsympathetic intuitions regarding what I suspect are highly abstract underlying representations. Despite this, or rather because I have such qualms, I think it is fair to take Postal's work on Mohawk as a typical - and competent - treatment within the framework of classical generative phonology. This linguistic excursion finds its conclusive support in the fact that KSN discuss three examples of Postal's in detail, in an attempt to apply their hypothesis to sets as well as pairs of rules. In this section I shall treat the first of these, introduce additional data and - somewhat unavoidably - pass comment on Postal's polemic.

Postal's world-view of possible rule interaction presented in Chapter 7 'Rule Ordering and Stratificational Phonology' may be represented as:

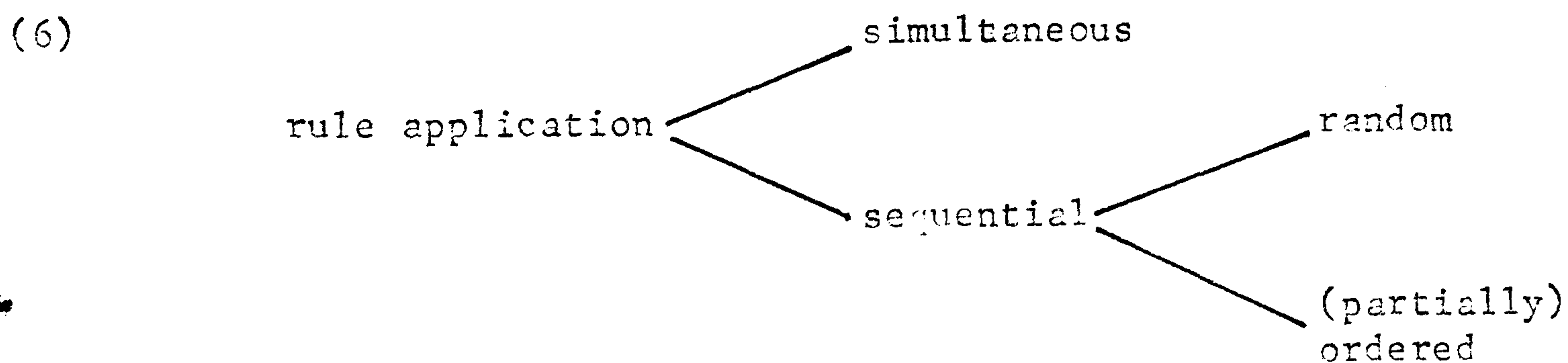

At first glance this fails to recognize the intrinsic/parochial dichotomy (see below for caveat). In fairness to Postal it should be noted that the purpose of his chapter (indeed the purpose of the whole of Part I Section II 'Real Arguments Against Autonomous Phonology') is to bring down fire and brimstone upon the head of Lamb's Stratificational Phonology. Lamb attacks the claim that a derivation consists of more than two lines and defends the hypothesis that all rules apply simultaneously. It is

this that Postal successfully disproves. However it is to Postal's detriment that, having introduced a refinement of McCawley's (1968) bifurcation of sequential rules into random and ordered (= parochially) - a step which seems to suggest that extrinsic ordering is not universal - he proceeds as if he had never mentioned it and confines his onslaught to a barrage against complete simultaneity. It is not surprising therefore to find that his arguments simply do not hold against a "mixed" theory of universally predictable simultaneous and sequential rule interaction like KSN's.

At the beginning of this section I stressed that the application of rules in a feeding relation is a tautological consequence of the definition of obligatory rule. Now consider with KSN how any possible derivation of underlying /t + ni + ek + s/ * ("you and I eat it") could proceed. Of the "Six Extrinsicly Ordered Rules For Mohawk Plus One" cited in Table I page 35, the structural description of only one is met, namely Truncation. Since each rule in the set is obligatory, Truncation must apply, yielding the intermediate representation /tneks/. Thus a parochial statement that Truncation is ordered before Prothesis is totally redundant. The form /tneks/ now meets the structural description of Prothesis whose status as a phonological rule KSN accept. Let us assume for the moment that they are right to do so, in order to follow their example through, noting the minor modification of the environment of Prothesis and Stress from DO^n to D^n : **

* Footnote

Morpheme boundaries are reproduced following Postal in underlying representations but omitted thereafter by courtesy of KSN since they do not figure in any of the rules under examination.

** Although KSN find evidence that the vowel in the following syllable may be preceded by an indefinite number of non-vowels (hence superscript n), they find no empirical justification for the claim (represented by subscript o) that the vowel may be morpheme-initial i.e. preceded by no non-vowels whatsoever. Thus their alteration constitutes, if anything, a slight improvement on Postal's original formulation.

TABLE I

SIX EXTRINSICALLY ORDERED RULES FOR MOHAWK PLUS ONE

<u>Postal's Rules</u>	<u>UDRA Rules</u>
(1) TRUNCATION	TRUNCATION
$V \rightarrow \emptyset / \text{---} V$	as Postal
(2) PROTHESIS	PROTHESIS
$\emptyset \rightarrow i / \underset{\text{Verb}}{[\# \text{---} D^n V D^n \#]}$	= an MSC on well-formed URs
	$\emptyset \rightarrow i$ just in case
	$\underset{\text{Verb}}{[\# \text{---} D^n V D^n \#]} \underset{\text{Verb}}$
(\leftarrow 3) not listed explicitly by Postal	
EPENTHESIS	EPENTHESIS
$\emptyset \rightarrow \acute{a} / \dots \text{---} \dots$	as Postal
(3) STRESS	STRESS
$V \rightarrow \acute{V} / \text{---} D^n V D^n \#$	modified by KSN
	$V \rightarrow \acute{V} / \left\{ \begin{matrix} \# \\ \check{V} \end{matrix} \right\} D^n \text{---} D^n V D^n \#$
(4) STRESS JUMP	no rule necessary
$V D^n \acute{a} \rightarrow \acute{V} D^n \acute{a}$	
(5) TONE	TONE
$\acute{V} \rightarrow \hat{V} / \text{---} \left\{ \begin{matrix} ? \\ h \ R \end{matrix} \right\}$	as Postal
(6) LENGTH	LENGTH
$\acute{V} \rightarrow \acute{V}: / \left\{ \begin{matrix} \text{---}^C V \\ [\wedge] \end{matrix} \right\}$	as Postal

where C = any consonant, resonant or not, including systematic w, y.

D = any non-vowel, i.e. consonant or h, ?.

R = any resonant, i.e. w, y, n, r.

\wedge = falling tone.

Now, it is clear that if Prothesis is to be incorporated into the phonology of Mohawk, it is unnecessary to order it extrinsically after Truncation. The same is true of Rule Number 3, Stress, for this rule, being obligatory, automatically applies to the output of Prothesis /itneks/. Any statement to the effect that Stress must follow Prothesis in the parochial ordering constitutes a redundancy in the grammar. Since the form derived from the application of Stress does not satisfy the structural description of any other rule in the set the derivation terminates (final phonetic [i'deneks] resulting from the application of further rules not listed by Postal). So runs KSN's convincing argument regarding the derivation of /i'tneks/:-

(7) "You and I eat it"

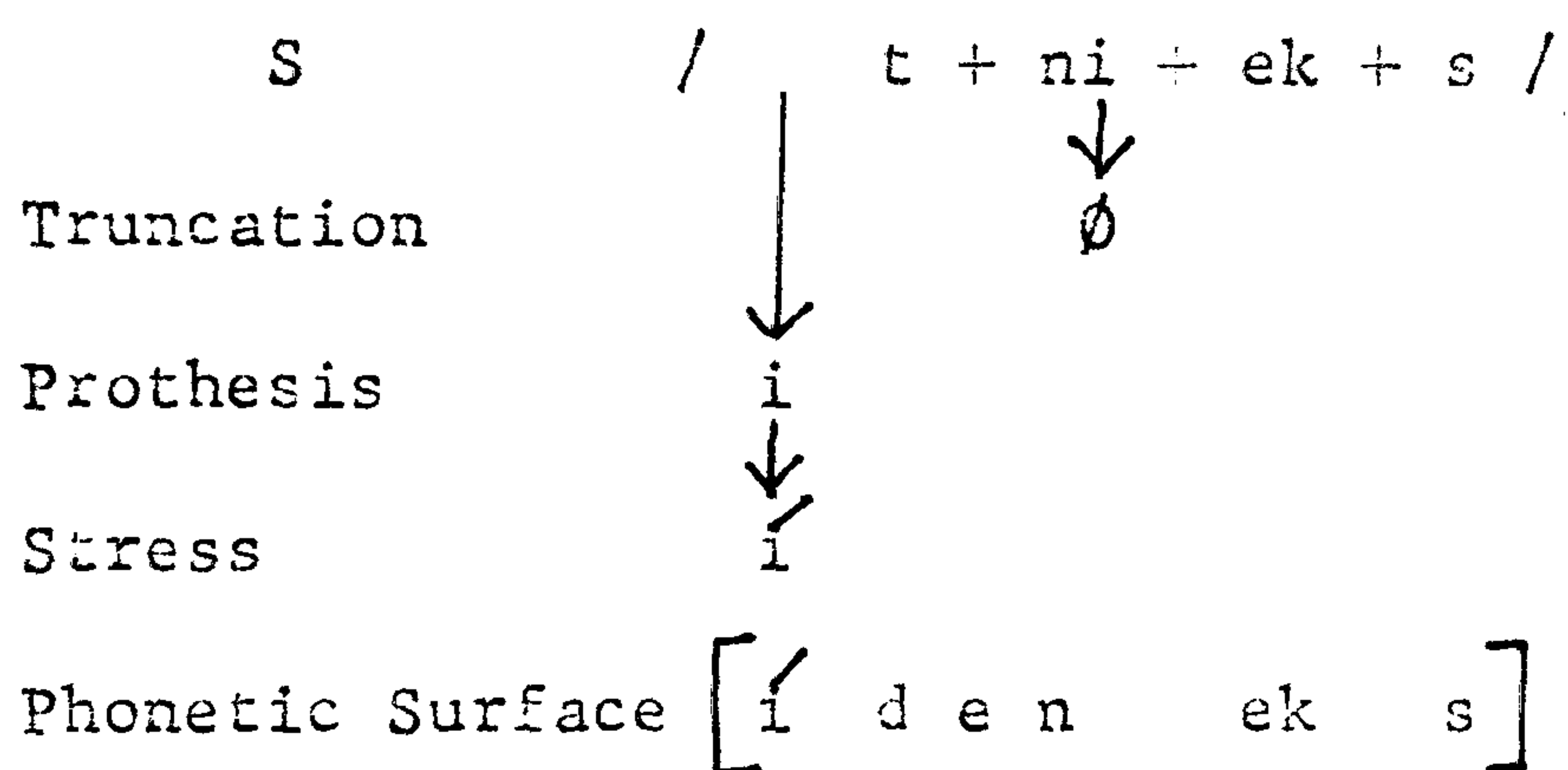

For Postal however this clearcut example of three rules applying sequentially in a feeding relation constitutes evidence of the necessity of extrinsic ordering. The pattern of his argumentation for the parochial ordering Truncation before Prothesis is entirely typical of generative rule ordering dogma (GROD for short). A GROD argument against intrinsic feeding relations runs something like this:

Rule A can apply to S but rule B cannot. However, B can apply to the structure that results from the application of A to S. If we abandon an extrinsic ordering constraint, B after A - and here comes the fallacy - B will automatically apply before A. But since B's structural description is not met by S, it will have to be modified to B' by incorporating

part of A. Therefore B' is a more complex rule than B and hence a grammar with the rules B', A is more complex and less highly valued than one containing the extrinsically ordered rules A, B. QED!

Of course the fallacy lies in the assumption that "no ordering" = "opposite ordering". Lest there be any doubt that GROD arguments really exist, I cite in full the appropriate one from 'Aspects' for Truncation (A) and Prothesis (B):-

(3) "After the Truncation rule eliminates the first vowel, the structure meets the 'one vowel' condition of Prothesis in verbs".

"But without the ordering, it is necessary to modify the Prothesis rule to apply not only if there is one vowel in a verb but also when there are two vowels which are contiguous (except for intervening morpheme boundary)".

(I.e. non sequitur - Postal is claiming that without the ordering Prothesis applies before Truncation - JRMcB.)

"That is, structural facts which are completely predicted by the Truncation rule, namely, that at one stage two contiguous vowels behave like a single vowel, must be redundantly built into another rule, in this case Prothesis."

(original emphasis, 'Aspects' pages 144/5).

I refrain from commenting further.

Instead let me turn to the nature of Prothesis whose dubious status as a phonological rule I hinted at earlier. Of course removing Prothesis from the phonological component proper will in no way jeopardize KSN's (justified) arguments and favour Postal's (fallacious) arguments: Postal also argues in GROD vein for the parochial order Truncation-Stress that "as in the Truncation-Prothesis case, eliminating the order again means that generalizations are lost and linguistic information which one rule predicts must be redundantly listed in another." (page 145). Yet as I trust I have demonstrated, it is his grammar rather than Lamb's or anyone else's that is to be accused of redundancy - by

assigning a number to each rule when no such devices are necessary. In fact Postal is guilty of defending GROD for every rule-pair in his list. What I am about to comment on is whether Prothesis should have been included in that list in the first place.

Consider the formulation of Prothesis: it differs from the other rules in the list by appealing to categorial structure. Postal himself admits that because of this "it is in any event impossible in a stratificational system". (page 144). Having said that, he promptly goes on to ignore it "in favour of concentration on ordering". But surely such a fact cannot be ignored. One cannot argue that Lamb's simultaneous rule application fails with respect to Prothesis when Prothesis is not a rule which Lamb recognizes! Although I disagree both that rules apply simultaneously *, and that phonological rules should have no appeal to grammatical information - two basic tenets of Lamb's phonology - in this case I go along with the Stratificationalists by not including Prothesis in the phonological component of Mohawk. The reason is not that I would ban grammatical prerequisites in phonology but rather that prothetic vowels behave as if they were present in underlying representations - unlike epenthetic a's to be discussed below. Like all other non-epenthetic vowels, prothetic i's can bear stress, tone and length. Postal admits as much when he states that: "in fact the stress, length, and tone properties of prothetic [i] vowels follow in every respect the general rules of the language required for all other vowels" (page 148). However, he fails to reflect these facts since he introduces prothetic i's in the same way that he introduces epenthetic a's.

* Footnote

This position will be fully substantiated in Chapter 4. It should be borne in mind in § 2.3 where the discussion of Chapter 4 is anticipated.

The three rules may be shown to apply to underlying /i + hra + k + s/ containing the prothetic vowel (assuming that the other elements are justifiably posited.):

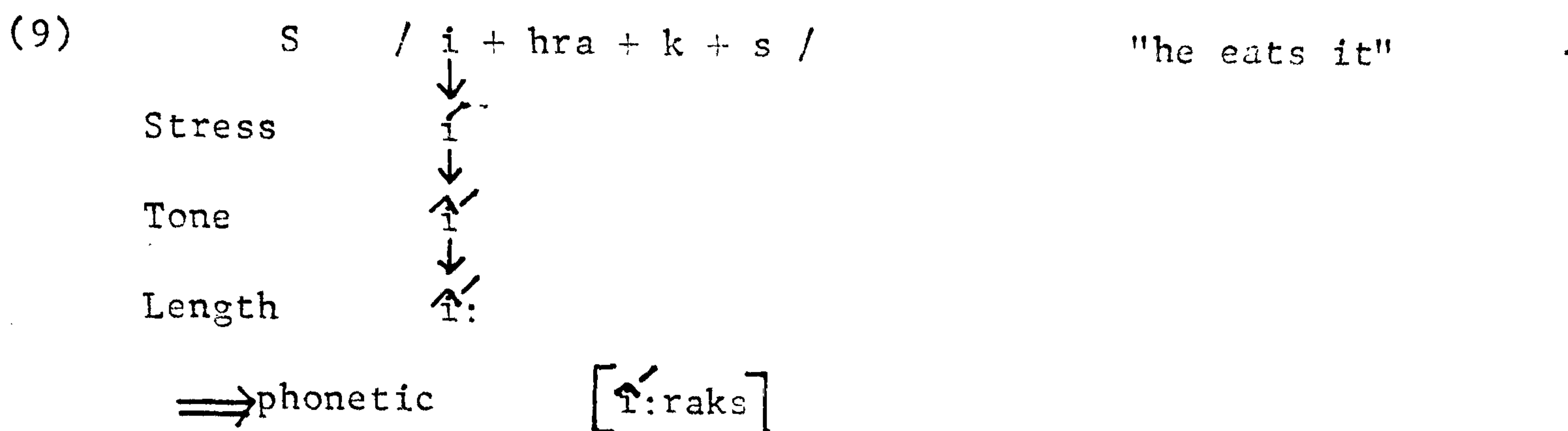

This is not to suggest that the presence of /i/ in the underlying form of "he eats it" is not rule-governed. Rather, I would propose that Postal's formulation of Prothesis acts as a well-formedness condition on verbs - it will have to be modified slightly, as shown in Table I, to apply to monosyllabic verbs which may have a diphthong, not just a single vowel, as syllabic nucleus, thus permitting the correct operation of Truncation. Prothesis, then, may be regarded as a Morpheme Structure Condition which applies prior to forms entering the phonological component proper. This analysis refutes Postal's claim, in defence of GROD, that in the derivation of [↑:raks] "since the vowel which receives the tone is not in the input representation, under the simultaneous application assumption, it cannot receive the tone from the Tone rule or any modification of it." (page 147). By specifying /i/ in the underlying representation of this form and all others subject to Postal's Prothesis, Stress can apply immediately its structural description is met, yielding a structure which may serve as an input to Tone and ultimately undergo Length. There are therefore two related reasons why Prothesis never need be a "set of three rules" (i.e. incorporating Stress, Tone and Length) : on the one hand because the three rules in question feed each other sequentially without extrinsic ordering constraints; on the other, because the behaviour of prothetic i's as

the input to this feeding clearly suggests that they are already present in underlying representations.

KSN go on to discuss two more derivations of Mohawk forms, dealt with in the next section... Summing up the above exposition of intrinsic feeding in Mohawk phonology, the typical pattern of argumentation in favour of GROD has been illustrated, and we have seen how KSN handle Postal's data. However we have not been in complete agreement with KSN's re-analysis. In particular, the status of Prothesis as a phonological rule was questioned. Despite this the conclusion that rules are ordered according to universally determined principles is essentially what KSN claim to be the case for any set of n rules. In other words, although a fully developed theory of UDRA may not be in accord with the KSN hypothesis regarding the exact nature of universal precedence principles involved, both deny that parochial ordering is ever necessary. Thus no matter what might be the precise character of the principles of UDRA, KSN's concluding remarks to their Mohawk section still stand:

- (10) "There is every reason to believe that similar evidence of the non-necessity of language-specific constraints on rule application could be provided with respect to still larger sets of rules for Mohawk and other languages, and that the hypothesis of universally determined rule application is ultimately defensible with respect to all motivated phonological rules of all languages."

(KSN page 18).

§ 2.3 Rules of Epenthesis in Mohawk

In the preceding section we discussed rules from Postal's (1963) work on Mohawk which were in an intrinsic feeding relation. During the course of that discussion we accepted KSN's re-analysis of the data. In this section we consider two further derivations from Mohawk treated by KSN. These derivations differ from those dealt with in § 2.2 in that KSN's treatment involves the simultaneous application of Stress and a-Epenthesis. Now one of the central claims of this thesis is that simultaneity is not a possible mode of rule interaction - this position will be fully substantiated in Chapter 4. There it will be argued that not only does simultaneous application lead to incorrect phonetic representations for certain data, but also that it is always possible to predict the correct order of application from an independently motivated principle of UDRA. However since one of the derivations from Mohawk treated by KSN also involves intrinsic feeding, I have decided to discuss them both here, even though doing so necessitates the adoption of certain precedence principles without argumentation. Moreover, a closer examination of the data adopted by KSN reveals that the more general issue of Epenthesis rules in Mohawk has a direct bearing on the analysis of the two derivations in question. It is therefore apposite to deal with this issue in the same place as Postal's other data.

Once we have looked at Postal's original analysis and KSN's emendation, it will be expedient to examine rules of Epenthesis as presented in Karin Michelson's (1977) defence of Postal and GRCO. Finally two further rules postulated by Postal for Mohawk (1969) will be shown to express spurious generalizations and hence not to support GRCO.

In Postal's analysis of [niganúhzageh] ("houses"), from underlying /ni + ka + nuhs + ke/, three rules apply in the following parochial order: Epenthesis, Stress, Stress Jump. The particular rule of epenthesis involved here inserts a between the last two morphemes of the underlying form. In fact Mohawk is also ascribed epenthetic e's by Postal. However he does not mention the latter in 'Aspects' and hence they do not figure in KSN's reanalysis - although we must assume that an e-Epenthesis rule applies in reaching the surface phonetic representation of [ídeneks] from /t + ni + ek + s/ (see § 2.2 for a discussion of this derivation.) Nor is Postal specific about the structural description of a-Epenthesis in 'Aspects' - we are simply told that certain epenthetic a vowels do not bear Stress when penultimate. Thus the penultimate a in [gatgáhtos] ("I look at it") which does bear Stress is to be contrasted with the epenthetic a in the same position in [niganúhzageh] which "is of the special non-stress-bearing sort" (page 145). Postal encodes the difference between the two vowels by indicating epenthetic a with a diacritic as á. After diacritically marked á's have been inserted penultimately, Stress is permitted to apply to them, yielding an incorrect output. Consequently Stress Jump is required to shift the wrongly assigned Stress on á's to the antepenultimate vowel. In Postal's words "the Stress Jump rule is required because of certain epenthetic a vowels which will not bear the stress when penultimate. In such cases the accent is displaced to the antepenult." (page 145).

Postal casually brushes aside his appeal to a global property in a footnote:

- (11) "There are, of course, fundamental questions of Mohawk phonology concerning how such vowels are to be introduced, how they are to be represented, and especially how they are to be distinguished from stress-bearing a vowels. These questions have, however, no direct bearing on the question of ordering."

(footnote 3, page 145)

But these questions do have a direct bearing on the rule ordering controversy and it will soon become clear that the satisfactory answer to them is available only within UDRA. Consider whether GROD necessarily substantiates the "theoretical plausibility" of global rules *. Put slightly differently, "does Postal's espousal of GROD force him to permit globality as well as extrinsic ordering? Given that a theory with global properties is excessively powerful, if it can be shown that UDRA does not require global statements, the hypothesis will be considerably strengthened metatheoretically. Before turning to KSN's demonstration of the latter, however, there are two aspects of Postal's analysis within GROD which need to be pointed out.

In fact there are two reasons for not needing a rule of Stress Jump at all, even within the extrinsic ordering framework. Firstly, if Postal permits rules to have global power as he clearly does by using a diacritic in the structural change of Epenthesis and in the structural description of Stress Jump, why does he not place a negative condition on Stress itself, referring to epenthetic á's i.e. stress the penultimate vowel unless it is á in which case stress the antepenult. Such a condition would do away with Stress Jump and could be readily schematized as (12):

$$(12) \quad v \longrightarrow \acute{v} / \text{ ______ } (D\overset{n}{o} \acute{a}) \quad D\overset{n}{o} v \quad D\overset{n}{o} \quad \#$$

The second reason for not needing Stress Jump, even within GROD, is pointed out by Michelson and makes Postal's analysis look even more ludicrous: with the power of extrinsic ordering, Postal is free to

* Footnote

In the metatheoretical sense whereby one hypothesis substantiates another if the validity of the first necessarily presupposes the validity of the second - see R. P. Botha (1971).

order Epenthesis after Stress producing the correct output in all cases. (In fact in the 1969 paper he does order e-Epenthesis after Stress without comment.) The accent is assigned to the vowel which is penultimate in underlying structure and the fact that that vowel becomes the antepenult after a-Epenthesis, cannot cause reapplication of Stress in an extrinsic ordering theory where each rule is tested for applicability once only. Furthermore, no reference to globality is required in the extrinsic ordering Stress, Epenthesis - a point not made by Michelson but one which nevertheless resolves the question of the theoretical dependency of GROD on global statements, for these data at least.

From these two points we may conclude that GROD is capable of generating the derivation of "houses" in Mohawk by extrinsically ordering a-Epenthesis after Stress - that is, without a rule of Stress Jump operating on a diacritically marked segment. In other words, the global marking of epenthetic a's to distinguish them from underlying vowels of the same quality (or a vowels derived by other rules?), and the postulation of a rule of Stress Jump are both peculiar to Postal's particular analysis. Unfortunately the fact that Postal's treatment and GROD are not to be equated here weakens KSN's claim that their revision of the 1968 rules accounts for the facts in a somewhat simpler and more natural manner. I cite KSN in full below:

- (13) "Unlike Postal's rules, the a introduced by Epenthesis is given no diacritic to distinguish it from a's which are stressed regularly. The stress rule itself, however, is formulated to capture directly the observation that a vowel can never be stressed if there is a stressed vowel preceding it in the same word. One effect of this quite natural modification of the context for Stress is that there is now no motivation for Stress Jump, so that it can be eliminated from the grammar. This modification also eliminates any need for Postal's diacritic marking of epenthetic a's, thereby simplifying the rule of Epenthesis and the vocabulary for element-types which must be assumed for the grammar of Mohawk."

(KSN page 16)

We have seen that GROD necessitates neither diacritics nor Stress Jump. As for the observation which revised Stress indeed captures, such a fact is automatically accounted for by GROD in any phonology with a non-cyclic rule of stress-assignment, since Stress is permitted to apply once only within each word. Provided that Stress may be predicted to apply before Epenthesis by the UDRA hypothesis, the choice between that hypothesis and GROD can only be made on metatheoretical grounds for these particular Mohawk data. Of course, on such grounds UDRA will prove the stronger theory. However I do not feel that KSN's proposal constitutes the most highly valued hypothesis within the theory of UDRA.

My reason for making such a criticism of KSN is of course that their analysis of Stress and a-Epenthesis in Mohawk involves a mode of rule interaction whose ontological status is denied under the theory of UDRA developed in this thesis. To spell this out a little more clearly, KSN derive "houses" by applying Stress and a-Epenthesis simultaneously, as shown in (14):

(14) UR	/ni + ka + n	u	hs	+ ke/
		↓ Stress		↓ <u>a</u> -Ep
	ni	ka	n	u
			hs	a
				ke
Final phonetic form	[niganúhʒageh]			

Below the presentation of this derivation, KSN state the following:

(15) "All the rules relevant to this derivation apply simultaneously, a fact which again is not determined by any independent statement in the theory, but is merely a consequence of the particular underlying forms, the structural descriptions of the particular rules, and the fact that the rules are obligatory."

(KSN page 17; my emphasis)

(15) seems to be recapitulating Obligatory Precedence. However it is at variance with KSN's principle, Proper Inclusion Precedence (PIPrec), whereby, when the SDs of both A and B are met, A takes applicational

precedence over B just in case the SD of A properly includes that of B. Now the SD of KSN's revised Stress spans three syllables (even in Postal's formalization it spans two), whilst a-Epenthesis is applicable by virtue of the contiguity of two consonants. Therefore the SD of Stress properly includes that of a-Epenthesis and the former takes applicational precedence.

To sum up, if we accept that simultaneity is not a possible mode of rule interaction, we must reject KSN's analysis of Stress and a-Epenthesis in Mohawk. However we see that an independently motivated principle within the KSN hypothesis, namely PIPrec, predicts a unique ordering for this rule-pair. Furthermore, by applying Stress and a-Epenthesis in accordance with the predictions of PIPrec a correct phonetic surface representation results. Thus if we accept PIPrec as a principle of UDRA, we are able to account for the Mohawk data.

In fact Koutsoudas (1980) claims that "Obligatory Precedence is to be consulted for applicability after Proper Inclusion Precedence has been consulted." (page 4). Thus although he permits simultaneity in those cases where PIPrec is inapplicable, he would apply the latter to these Mohawk data. The crucial difference between Koutsoudas' (1980) development of UDRA and that elaborated in this thesis therefore hinges upon the following claim incorporated here:

- (16) Where the SDs of two rules are met simultaneously, a universally determined principle will predict a unique ordering.

The points that were illustrated in "houses" could have been made regarding the interaction of Stress and a-Epenthesis in KSN's final example from Mohawk - "he picks bodies". This derivation involves the sequential application of two rules in a feeding order after the purported simultaneous application of Stress and a-Epenthesis. Under

Postal's analysis of "he picks bodies" epenthetic ə is stressed and Stress Jump transfers the accent to the antepenult. Tone is then extrinsically ordered to apply to the output of Stress Jump, with Length operating on the output of Tone. As with the previous example, the diacritic marking of epenthetic ə and the rule of Stress Jump can both be dispensed with under GROD. In KSN's treatment after Stress and a-Epenthesis have applied directly to the underlying representation, with the environment for Stress preventing any deviant reapplication of the rule to epenthetic vowels, the structural description of Tone is met, yielding a structure which in turn feeds Length:

(17) KSN's derivation of "he picks bodies"

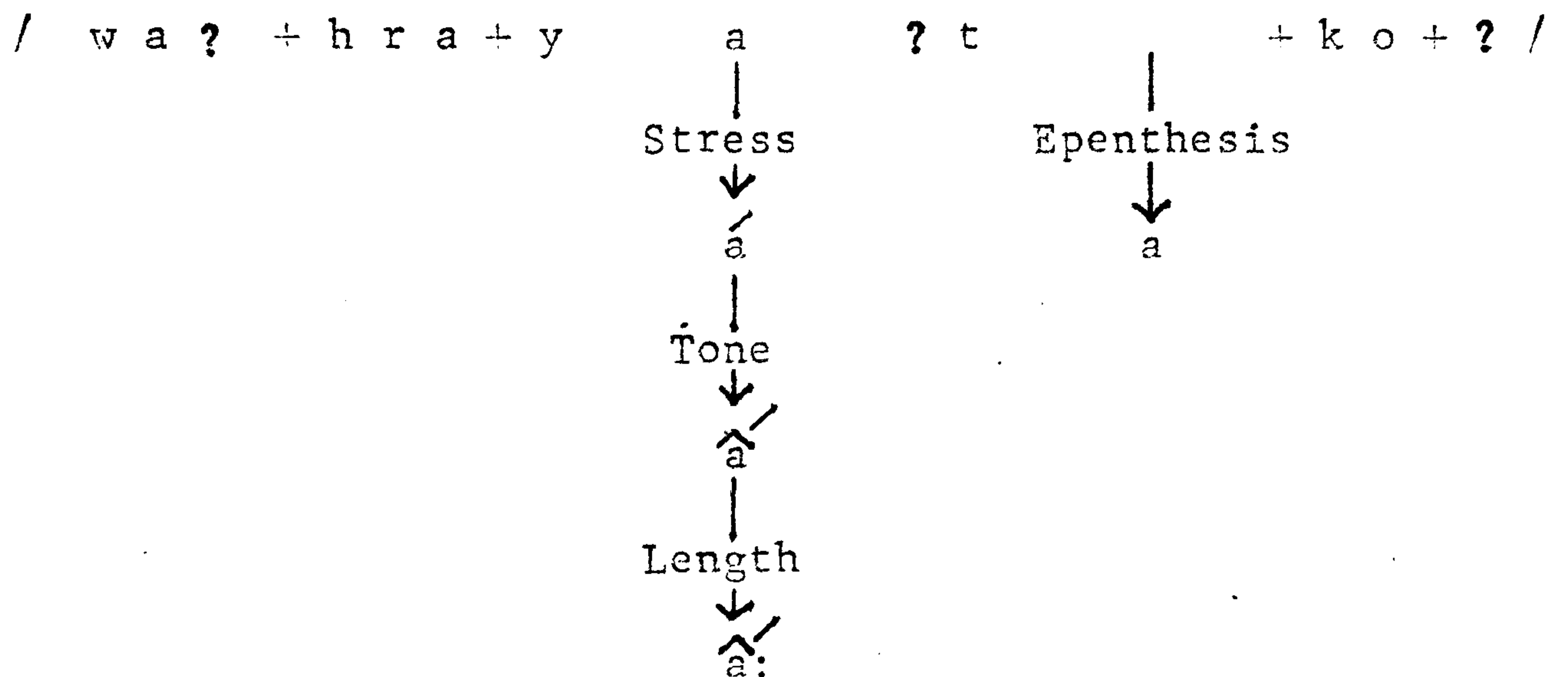

Final phonetic form [wəhəy^ˆ :dago?]

KSN are justified in claiming that no extrinsic ordering constraints are needed to ensure the correct application of the latter two rules, whilst the contradiction between Proper Inclusion Precedence and simultaneous application for Stress and a-Epenthesis can readily be resolved under the UDRA statement (16).

As we have noted above, Karin Michelson points out one reason for the non-necessity of Stress Jump under GROD - the possibility of ordering a-Epenthesis extrinsically after Stress. Michelson then goes on to outline the KSN hypothesis and the simultaneous application of Epenthesis and modified Stress to the underlying representation of "houses".

Curiously, although she cites the definition of Proper Inclusion Precedence, she does not consider the applicability of this principle to the particular example under discussion. It would seem that the reader is intended to conclude the GROD requires a simpler rule of Stress than the KSN hypothesis and hence is the more highly valued theory - an argument which does not hold once metatheoretical considerations of "power" are introduced.

Having failed to notice the actual precedence relation between Stress and a-Epenthesis, Michelson turns to the more recalcitrant data involving e-Epenthesis and Length. Before examining this case let us review Postal's three purported vowel insertion rules for Mohawk, i-Prothesis, a-Epenthesis and e-Epenthesis. We shall see that certain crucial differences emerge between them in relation to the rules of Stress, Tone and Length.

Prothesis was discussed in § 2.2, where I demonstrated that in fact it is not a regular phonological rule at all but rather that it constitutes a well-formedness condition on the underlying shape of verbal morphemes. The facts which led to this conclusion were the behaviour of prothetic /i/ with regard to Stress, Tone and Length, all of which may be assigned to it in the course of a derivation. In other words, the initial vowel of [i^ˆ:raks] ("he eats it") behaves in exactly the same way as the second vowel of [ranu^ˆ:wa?s] ("he likes it"). The Morpheme Structure Condition which demanded that Postal's underlying representations /hra + k + s/ ("he eats it") and /t + ni + ek + s/ ("you and I eat it")* have an initial /i/, is stated with reference to the

* Footnote

Ultimately [ideneks] - the conditions for Tone and Length not being met in this particular form, unlike phonetic [i^ˆ:raks].

monosyllabic nature of the forms. In this respect Postal's phonological rule of Prothesis differs from its formulation as an MSC, for Postal orders Prothesis after Truncation and its structural description refers to the single vowel remaining after the operation of the latter rule; KSN blindly accept the status of Prothesis but note that the extrinsic ordering of Truncation, Prothesis is unnecessary and redundant as they are in a feeding relation. Now since the MSC Prothesis stipulates that the vowel in question be in the penultimate syllable, that vowel may be subject to Stress, Tone and Length but, by its very nature, it will never occur in their conditioning environments, i.e. final syllables.

Turning now to epenthetic a, we see that according to Michelson, it is inserted "under two very different conditions" (page 340). Although Michelson does not concern herself with the consequences of this claim, I feel it would be expedient to do so. In particular, the environments for vowel insertion need to be stated explicitly, since under one set of assumptions one would be led to distinguish a well-formedness condition from a phonological rule of epenthesis. Consider Michelson's example of the first condition for a-Epenthesis: /ka + rist + kvhra/ (/v/ represents a low, central, nasal vowel); 3 sing. non-masc. + noun root "iron, steel" + verb root "to be white" → [karistakv̄:ra] "tin". Here an a vowel intervenes between a noun root ending in a consonant and a verb root beginning with a consonant. It may be schematized as (18):

(18) 1 condition for a-Epenthesis:

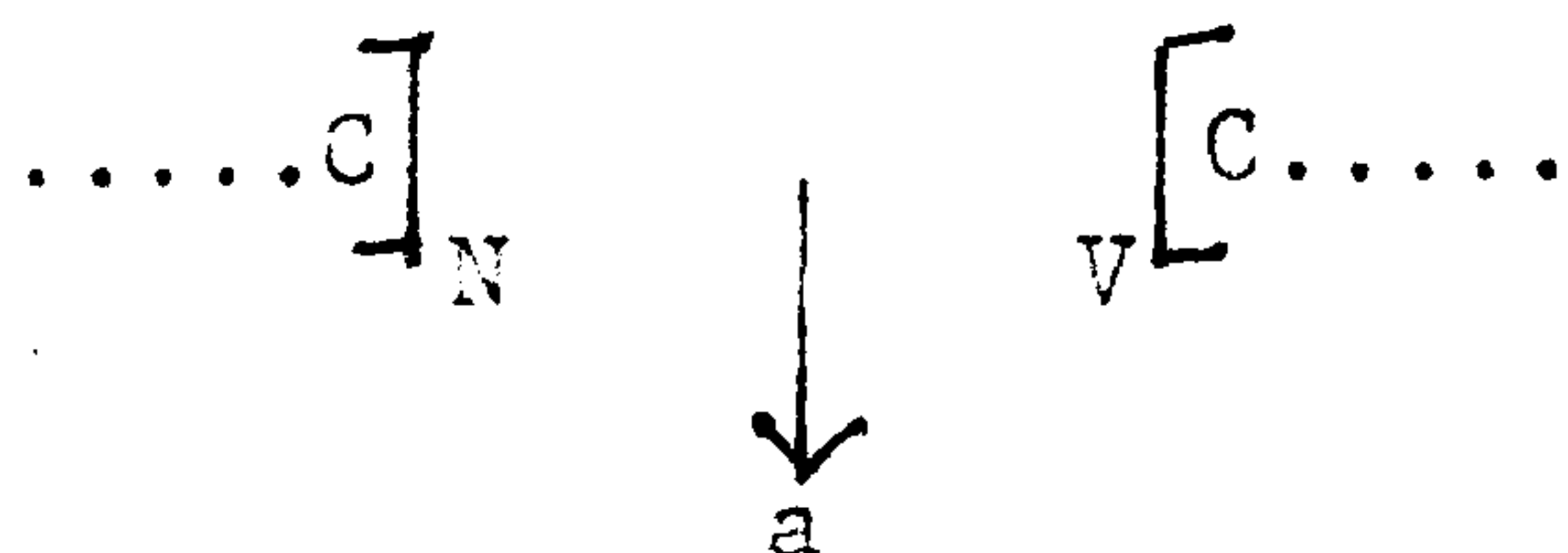

and interpreted as a condition on the well-formedness of compound nouns, operating before the phonological component proper.

But what of the interaction of such a condition with Stress, for we would expect prephonological epenthetic a to be subject to penultimate Stress. However this is not the case. Note that if we choose the obvious interpretation of Postal's reference to the syntactic category 'verb' in his formulation of Prothesis as being the same as a verbal root in forming compound nouns, then we must conclude that before the condition (18) on the structure of compound words can apply, the condition on the well-formedness of verbs - Prothesis - will have insured that the righthand environment of (18) contains two syllables. Consequently the inserted vowel of (18) will never have the opportunity either to bear Stress, Tone or Length, or to be in the conditioning environment of any of them, since it is always antepenultimate in underlying structure.

Attractive as this analysis may appear, there is a hint from Michelson's footnote that it rests upon a wrong interpretation of 'verbal root' in equating it with the category 'verb' in Postal's Prothesis. The footnote (fn. 2, page 347) claims that the rule under discussion accounts for [nikanúhzake] * (where a = epenthetic) from /ni + ka + nuhs + ke/; partitive + 3 sing. non.masc. + noun root "house" + pluralization; since the pluralizer is in fact a verb root serving that function. But /ke/ does not satisfy what has been said regarding the well-formedness of verbal roots prior to nominal compounding. However, from the limited evidence available, I am not convinced that the pluralizer /ke/ is also a verbal root. Put differently, it is by no means a foregone conclusion that /ke/ is a lexical morpheme as well as a grammatical one.

* Footnote

Michelson actually cites nikanuhsáke which must be presumed to be an intermediate representation prior to stress and s-voicing.

For if it is a verbal root in "houses" it must surely have reference to some such notion as "dwell". How then can this lexical morpheme reappear as the pluralizer in [tekaya?kará:ke] "two blouses"?

The other environment for inserting epenthetic a is between a consonant and r e.g. /ka + nyatra + ? / → [kanya:tars?] "lake". The epenthetic process in this example is clearly phonological in status, applying after Stress by Proper Inclusion Precedence and hence not receiving the accent despite its penultimate position on the phonetic surface. The epenthetic a in "houses" shares such a derivational history though not the phonetic environment - this much is clear. Unfortunately the question of whether there also exists a well-formedness condition on compound nouns like "tin" by which an a vowel intervenes between nominal and verbal roots, cannot be resolved from the data made available by Michelson or from her sources of reference. Consequently the phonological environment demanding the insertion of a cannot be formalized here (is it /C ___ r/ or /C ___ C/ ?) The desirability of preciseness of statement and indeed its necessity if precedence relations are to be determined will be emphasized at many points throughout this thesis: I hardly need labour its importance here.

It has been shown that epenthetic a, as a phonologically inserted segment, may not receive Stress and may not figure in the environment for Stress i.e. taking phonetic surface [kanyá:tara?], the accent has been assigned as if epenthetic a were not present - a misleading way of saying that a has not been inserted at the point in the derivation when Stress applies. We may now ask why Tone does not apply to this form and find that it is dependent for its operation on the presence of a glottal stop, or a glottal fricative followed by a resonant. Neither intermediate /kanyátra?/ to which only Stress has applied, nor

later intermediate /kanyátara?/ to which Epenthesis has also applied, therefore meet the structural description of Tone, since they contain no glottal consonants. On the other hand, one of the environments for Length mentions a vowel - Length applies to all Tone bearing (therefore stressed) vowels and $\bar{\sim}$ before a single consonant followed by a vowel. Now reconsider surface phonetic [kanya:tara?]. Clearly epenthetic a (not marked in phonetic representations because its quality is that of those a vowels not derived by rule) may serve as part of the CV environment for Length, as the vowel to be lengthened is stressed (a stipulation in the structural descriptions of both Tone and Length). In GROD theory this derivation can be generated by ordering Length extrinsically after a-Epenthesis. But without GROD the ordering Stress, a-Epenthesis, Length falls out as a natural consequence of the UDRA hypothesis. We have seen that Stress must be the first of the regular phonological rules discussed by Postal or Michelson to apply to underlying representations, simply because its structural description, spanning three syllables, will properly include any other. When the application of Stress has yielded intermediate /kanyátra?/, the structural descriptions of Length and a-Epenthesis are tested for applicability. That of Length is not met but that of a-Epenthesis is met. So a-Epenthesis applies yielding (still intermediate) /kanyátara?. Next the structural description of Length is once more tested for applicability and it is met now that the underlying consonant cluster following stressed underlying a has been broken up by a-Epenthesis.

There is no direct interaction between Tone and a-Epenthesis since the structural description of the former specifies stressed vowels followed by /ʔ/ or /h/ + resonant and the latter inserts unstressable vowels into consonant clusters. (Note that under Postal's categorization /ʔ/ and /h/ are not considered true consonants and are covered by D 'non-

vowel' rather than C - therefore the first consonant in a cluster by definition cannot be glottal). There are two possible situations where both Tone and a-Epenthesis may apply to the same underlying representation both involving clusters of three consonants (= Postal's DDD). Where the first is glottal, the second is a resonant if the first was a fricative, and the third is /r/ i.e. sequences of /?Cr/ and /hRr/ = /h $\begin{Bmatrix} w \\ y \\ n \\ *r \end{Bmatrix}$ r/ (medial /r/ is starred since there are no geminate r's in

Mohawk phonotactics - see 'Aspects' page 212). Michelson gives an attested example of each "3D" cluster: /o + na?kra + ?/ "horn"; /o + nuhwra + ?/ "brain". Once Stress has applied to these underlying representations due to Proper Inclusion Precedence, we obtain /oná?kra?/ and /onúhwra?/ respectively. The structural descriptions of both Tone and a-Epenthesis are met by these intermediate forms.

Now according to statement (15), a principle of UDRA should determine a unique ordering of Tone and a-Epenthesis for each representation. However an examination of /oná?kra?/ reveals that the SD of Tone is met by virtue of the juxtaposition of /a/ and /?/, whilst the SD of a-Epenthesis is met by virtue of the juxtaposition of /k/ and /r/. Thus whilst the SDs of both rules are met by the intermediate representation /oná?kra?/, they are met at different points in that representation: to put this another way, the two rules are mutually non-affecting. Clearly then they cannot interact here, and no principle is required to stipulate their relative ordering. Some general statement like (19) will render this tautologous fact an explicit part of the theory of UDRA:

- (19) Whenever any subset, S_a , of representation S meets the SD of rule A, and any subset, S_b , of representation S meets the SD of rule B, a precedence principle is required just in case subset

S_a and subset S_b intersect. If subset S_a and subset S_b are disjoint, no such precedence principle is required.

Turning now to the relation between Tone and a-Epenthesis in the derivation of /*cnúhwra?*/, we see that the SD of the former is met by /*úhw*/ since this constitutes a sequence of the type /*VhR*/. On the other hand, a-Epenthesis is applicable merely because of the presence of /*wr*/ (= /*Cr*/). Clearly then the SD of Tone is the larger environment and Tone will therefore take applicational precedence over a-Epenthesis by PIPrec. As for the interaction of Length with a-Epenthesis, notice that one environment for that rule is a Tone-bearing vowel. Thus once Tone has applied, the SD of Length will be met at a point in the representation which is disjoint with the environment for a-Epenthesis. Hence there is no possible interaction between Length and a-Epenthesis and in accordance with (19), UDRA provides no precedence principle. Finally the rule of Laryngeal Deletion (indicated in (20) as LD to avoid confusion with Le = Length) is mentioned though not formalized by Michelson (page 339) and corresponds to Postal's (1969) Laryngeal Erasure. It is ordered late in the phonological rules since it effects a deletion (see Chapter 4 for a full explication of the precedence principle, Deletion Cession).

(20) schematizes the derivations of "horn" and "brain" in Mohawk as predicted by the principles of UDRA. It should be emphasized that where two rules apply to a single line of the derivation this does not imply that they are ordered simultaneously. Rather, this schematization indicates that the two rules in question apply to disjoint subparts of the representation. Hence they do not interact and their relative ordering is therefore of no empirical consequence.

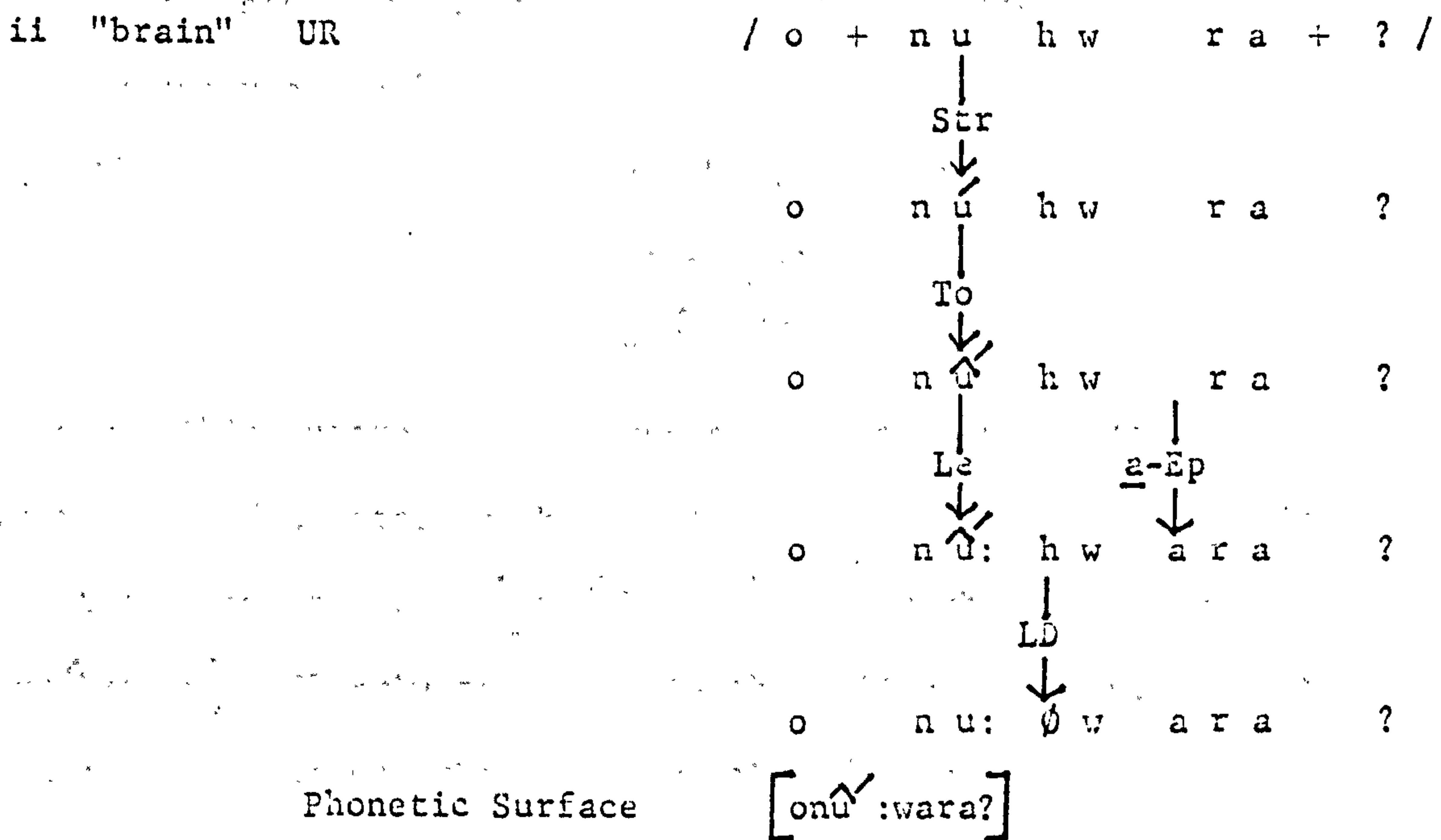
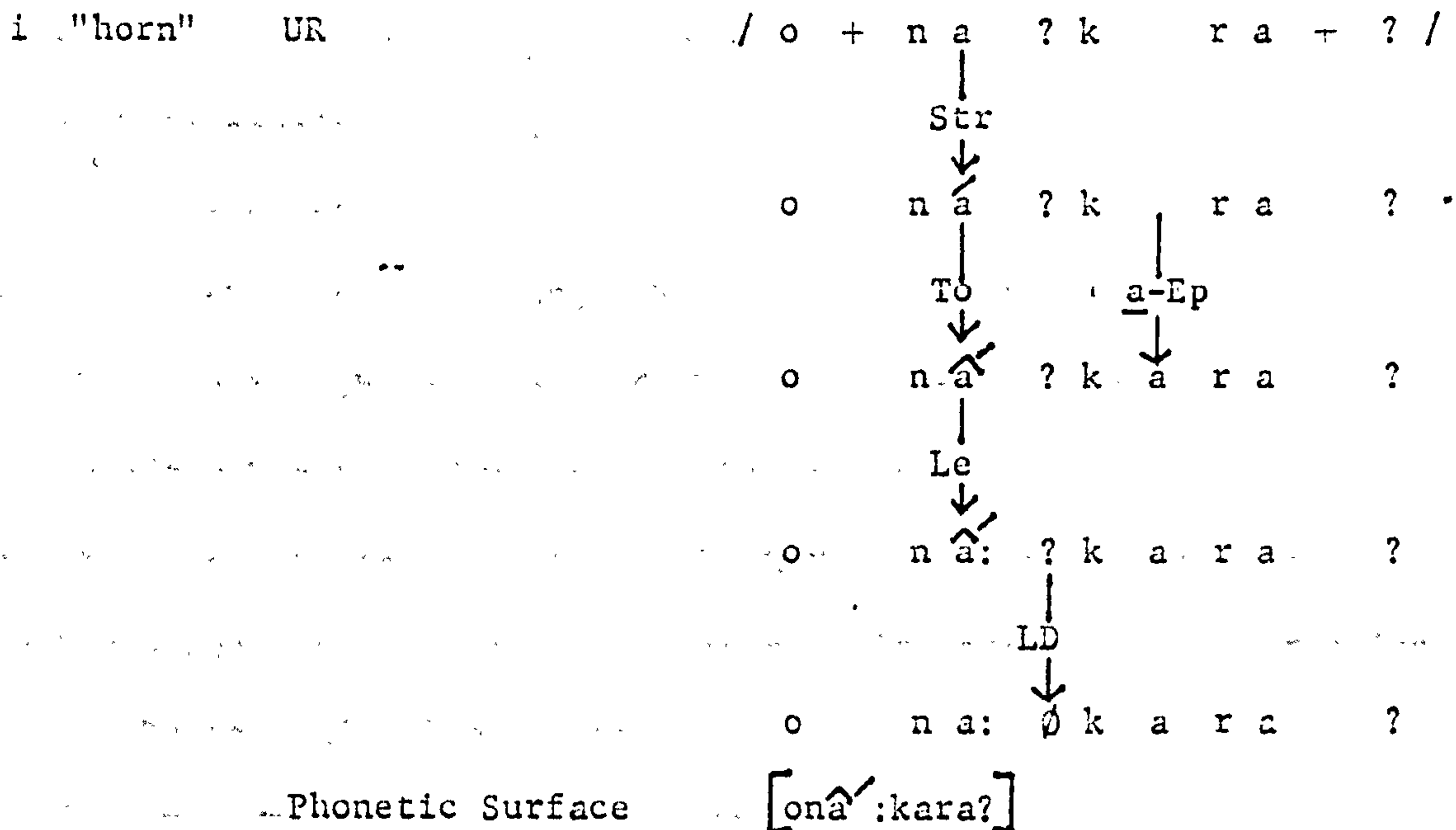
(20) The derivation of "horn" and "brain" in Mohawk:

To summarize the discussion so far, whereas prothetic i may bear Stress, Tone and Length but never figures in the righthand conditioning environments of these rules because of its penultimate position, epenthetic a is unstressable (and therefore can never bear Tone and Length) but may play a rôle in conditioning Length. The remaining epenthetic vowel in Mohawk, epenthetic e, may neither bear Stress, Tone or Length, nor condition them: crucially, in contrast to epenthetic a, it never serves

from being met by forms of the type... $\acute{V}Ce$ could be expressed as the disjunction of the features $[+high]$, $[+low]$, $[+back]$: the presence of one of these feature values would insure that the vowel of the environment for Length was not a mid front vowel - $\begin{bmatrix} -high \\ -low \\ -back \end{bmatrix}$. The reformulation is cited as (22):

(22) Length reformulated by Michelson (page 344)

$$v \rightarrow \acute{v} : / \left\{ \begin{array}{l} \text{---} C \begin{bmatrix} V \\ [+high] \\ [+low] \\ [+back] \end{bmatrix} \\ [\hat{_}] \end{array} \right.$$

However, Michelson points out that, even if she were prepared to admit such extra complexity into the grammar of Mohawk, (22) is, in fact, incorrect since "not all e's prevent vowel length, just those introduced by epenthesis" (page 345). She then cites two forms containing e's in their final syllables which do condition Length just because they are underlying:

(23) /yo + kvnore? + s/ \longrightarrow [yokvnó:r?s] "It is always raining"
 /k + kawe + s/ \longrightarrow [kká:wes] "I am paddling"

According to (22) the stressed vowels of these forms should be short i.e. *[yokvnóre?s], *[kkáwes]. In a word: (22) is wrong.

Next Michelson discusses "a final attempt to maintain the unordered rule hypothesis" (= KSN : JRMcB) by placing a negative condition on Length. Such a negative condition would necessarily repeat the environment of e-Epenthesis i.e. Length would apply except in those environments where e-Epenthesis was applicable, and it is to those environments that we now turn. Epenthetic e is inserted between a consonant and a word-final glottal stop or to break up a CR cluster. How then, one must ask, do we differentiate between one of the structural descriptions for a-Epen-

thesis, C r, and one of the structural descriptions for e-Epenthesis, C R - as soon as we note that R properly includes r, it is clear that under GROD both are applicable to underlying Cr clusters. (Note also that if these rules were assumed to be correct under UDRA, e-Epenthesis would be ^{ble}bled of all Cr clusters by Proper Inclusion Precedence and hence would never apply before r, contrary to the data e.g. (21).) Once again we are faced with rules which are not precisely formalized. Nevertheless, in fairness to Michelson, it must be admitted that the precise statement of the epenthesis rule would not remove the problem of restricting the application of Length to forms which have not undergone e-Epenthesis. Michelson sums up the problem by saying that "if we state the exceptions to length as a negative condition on the length rule, we find that this repeats exactly the environment of the epenthesis rule and still does not describe all forms correctly" (page 346). This latter difficulty is illustrated, for example, by /ro + yaner/ → [royá:ner] ("he is a confederate chief") for underlying /CeR/ sequences (actually Cer - why then does not a-Epenthesis apply?); and /v + k + hvte + ?/ → [vkhv:te?] ("I shall go ahead") for underlying final /Ce?/ sequences.

The solution of these purported counterexamples to UDRA lies, I believe, in two directions, one justified by the available exempla, the other necessarily tentative and admittedly unsatisfactory due to the scanty amount of data in both Postal's 1968 and 1969 publications. I shall present a concrete solution, show how it fails to explain other cases and then speculate on the purported validity of such cases as evidence for a theory of sound change.

Epenthetic e is inserted in two distinct environments, C ? # and C R. We have questioned the latter statement but the former seems

reasonably precise. As exemplified above, not all final [Ce?] sequences result from the epenthesis of e to contiguous underlying /C?/ clusters e.g. [vkhv:te?] from /v + k + hvte + ?/ ("I shall go ahead") cited above. Nor is this an isolated example: underlying /te + k + kaner + ?/ becomes [tekká:nere?]*. Underlying /Ce?/ sequences may also occur morpheme-internally, as attested in two places by /wake + nuhwe? + u + ne?/ which becomes [wakenuhwe?ú:ne?] with the underlying final e vowel conditioning Length. However, it does seem to be the case that if no underlying vowel intervenes between a consonant and a final glottal stop, an epenthetic e is "automatically" inserted. By "automatically" I refer to a process which admits of no exceptions, is not morphologically or syntactically conditioned and which applies after all phonological rules, here crucially Stress, Tone and Length. Of course this avoids the question of whether e-Epenthesis is not rather simply the last of a series of extrinsically ordered phonological rules. In the face of such a criticism the defender of UDRA may point out that the conception of Detail Rule was developed by Postal in 'Aspects' where GROD is advocated, and thus is not a device invented by GROD opponents as an ad hoc escape-hatch.

It would indeed be theoretically satisfying if e-Epenthesis in the environment C _____ R could be explained in such a nice way within UDRA, and indeed from Michelson's data alone such an analysis would be justifiable. It is therefore to her disadvantage that she does not countenance such a solution and refute it by referring to the discussion on pages 245 through 255 of 'Aspects'. In this section, Postal brings empirical evidence from Mohawk and Oneida (a more conservative Iroquian

* Footnote

An interesting example because of the different sources of the two e vowels, the penultimate underlying, the one in the final syllable epenthetic; it is by virtue of the penultimate e that Length applies.

language) to bear on the mentalistic nature of sound change. His argument runs as follows: if it can be shown that there are "quite regular and generally characterizable sound changes" which cannot be stated in terms of purely phonetic environments but which are readily describable once appeal is made to systematic phonemic structure (and surface syntactic structure), then this will be direct evidence of the mentalistic rule-property character of sound change. Needless to say, the sound change in question is the introduction of e-Epenthesis into the grammar of Mohawk. The environment in which appeal to non-phonetic structure must apparently be made consists of CR sequences of the type kw.

Certain kw sequences do not undergo epenthesis, although on the basis of phonetics alone these are indistinguishable from underlying /kw/ sequences, such as [kewí stos] from Mohawk with e-Epenthesis contrasted with cognate [kwí stos] from conservative Oneida ("I am cold"). What is crucial for Postal's position is the fact that whether e-Epenthesis takes place or not is entirely predictable in terms of morphophonemic structure: in one case Surface Syntactic Structure is relevant; more generally, underlying phonological structure is the factor differentiating like phonetic elements.

The first kind of kw which does not undergo e-Epenthesis has a morpheme boundary in the middle e.g. [yakwanú:we?s] ("we several exclusive like it"), where the [k] is the first person morpheme and [w] the first element of the plural morpheme. This behaviour is idiosyncratic and non-explanatory considering the following facts:-

- i) the same k marker plus stems beginning with w do yield e-Epenthesis e.g. [kewístos].
- ii) e-Epenthesis does occur when the w which belongs to the plural

morpheme is preceded by the s of the second person morpheme or the t of the inclusive person sequence e.g. [tewanúːwe?s] ("we several like it") cf. Oneida [twanúːwehse?]; [sewanúːwe?s] ("you several like it") cf. Oneida [swanúːwehse?].

Nevertheless, the idiosyncratic nonepenthesis of kw when it is assigned to the morphemes in question is predictable from Surface Syntactic Structure and hence disconfirms the hypothesis that e-Epenthesis is a Phonetic Detail Rule (henceforth PDR).

Postal's next example involves kw in Mohawk [rákwas] ("he picks it up") cf. cognate Oneida [lákwas]. (Mohawk r = Oneida l.) He claims that this form does not undergo e-Epenthesis since it is derived from underlying /ko/, not from a consonant-resonant cluster. e-Epenthesis does not break up such sequences and only later does /ko/ become [kw].

Choice of underlying representation for the morphemes in question is motivated, according to Postal, by the following considerations:-

- i) there is a morpheme structure condition such that sequences of the type Cw are not allowed within morphemes, whereas /ko/ breaks no such restriction.
- ii) the rule of e-Epenthesis itself would need to be complicated to exclude specific kw sequences if this were the representation at the systematic phonemic level - an invalid point because of unashamed circularity.
- iii) the necessary ko → kw rule is a general one operating before another vowel and one which is motivated elsewhere in the grammar.

The last point merits elaboration. If ko → kw is a general rule pre-vocally, under what circumstances does the rule of Truncation apply? Postal fails to explain, even though the formulation of Truncation (as

$V \rightarrow \emptyset / \text{ ______ } V$) and its purported extrinsic ordering figured in a preceding chapter. Another more crucial point diminishes the viability of underlying /ko/ ; since there are no stressed semivowels in Mohawk, one must conclude that $ko \rightarrow kw$ applies before Stress, to prevent underlying /rakoas/ \rightarrow rakóas \rightarrow *[rakwas] (the structural descriptions of Tone and Length are not met). Postal notes that such sequences never condition Length i.e. disregarding the problem of Stress placement, intermediate */rákoas/ does not become */rá:koas/ to yield phonetic *[rá:kwas]. To cite Postal's parenthetical comment: "here absence of length is due to rule ordering" (page 251). In other words $ko \rightarrow kw$ must apply very early in derivations - at least before Stress, Tone and Length. What then is the motivation for a distinct underlying form for these kw sequences if neutralization occurs on entry into the phonological component and if no rule is sensitive to it? But sensitivity of e-Epenthesis to /ko/ provided motivation for that underlying representation, according to Postal and e-Epenthesis applies after Stress. This is clearly a case of an ordering paradox within GROD.

The evidence for deriving a further kind of phonetic surface kw is even more implausible since it involves a considerable amount of abstraction for such sequences come, Postal claims, from underlying /p/. His supporting evidence takes the form below:-

- i) no exceptions to e-Epenthesis need be posited. (Circular again, since this is the only reason for looking for further evidence in the first place.)
- ii) kw \langle p conditions Length since at the point when Length applies, ultimate [kw] constitutes a single consonant in CV environments. e.g. underlying /rupeh/ "man" — (Stress) \rightarrow rúpeh — (Length) \rightarrow rú:peh — (Neutralization) \rightarrow [rú:kweh].
- iii) by recognizing systematic /p/, Postal is able to simplify the

statement of restrictions on the occurrence of Unmarked /p,w/ before rounded vowels (o, u) as against Marked /k, y/ before i. Yet why cannot markedness restrictions operate on /kw, w/ as a natural class?

iv) in cases where true /w/ becomes [f] (word-finally) or [y] (before rounded vowels), systematic /p/ yields [k].

With reference to iv), as far as I can determine such a claim simply points to the relatedness of forms with labials, like p, f, to those with velars, like k, kw. This fact might be explained by making explicit the alternation among [- coronal] elements in terms of via-rules in the lexicon (see Vennemann (1972) and elsewhere).

However, it does not constitute concrete evidence for deriving certain phonetic [kw] sequences from underlying /p/.

From considerations such as those just presented, I conclude that the morphological and syntactic constraints which Postal wishes to place on e-Epenthesis by means of abstract underlying forms not meeting its ~~structural~~ description, are by no means clearly definable. As a final attempt to discredit Postal's analysis of these recalcitrant data, I suggest that the addition of e-Epenthesis to the grammar of Mohawk constitutes an unattested type of sound change. Apart from the issue of where in a grammar rules may be added (we must presume that e-Epenthesis represents the marked case of rule addition in the middle of the phonological component), when we consider those surface phonetic forms to which e-Epenthesis has applied, we find that they are either transparent for the wrong reasons or opaque. Yet it is a well-documented claim in the work of Kiparsky (19) that languages add only transparent rules to their grammars. If it can be shown that e-Epenthesis is opaque, then we can cast doubt on Postal's claim that such a rule is an innovation in the grammar of Mohawk.

Let us take an example of opacity first (from 'Aspects' page 246):

[satáweya?t] ("come in") where the Oneida cognate has no penultimate epenthetic e, [satáwyaht]. Here the structural description of Length is met but it fails to apply i.e. is opaque, as in Michelson's example.

But now consider Mohawk [ká^ˆ:sereh]: Oneida [ká^ˆ:slet]. This form appears to be transparent with respect to Length, the structural description of which is met by the CV sequence after the stressed vowel; whilst it is Tone which is opaque because of the absence of a conditioning laryngeal. Yet if I read Postal correctly, he would take the underlying representation of this form to be /ka?sreh/ (disregarding morpheme boundaries which are irrelevant to the point being made). The a vowel is assigned Tone before the deletion of the glottal stop and subsequently acquires Length by virtue of bearing Tone, before epenthetic e is inserted. [yé^ˆ:teru?] is another apparently transparent example where one would conclude from the phonetic surface that the sequence te conditioned Length, whilst the presence of Tone is opaque. According to Postal, the opposite situation obtains: Tone is conditioned by an underlying glottal stop before t whilst the penultimate e does not figure in the structural description of Length because it is epenthetic.

By regarding in these terms forms to which e-Epenthesis has purportedly applied, we cast further doubt on the phonological treatment of certain mid front vowels. I would suggest that it may be profitable to turn to the lexicon for a solution and consider the idiosyncratic behaviour of certain e's to be the result of lexical marking.

I end this discussion of Mohawk phonology on a more satisfying note. Michelson claims that KSN's revised Stress rule needs further revision to account for the fact that in Mohawk a word may contain more than one epenthetic e, crucially after the stressed vowel. As formulated

in KSN Stress may not apply if a stressed vowel occurs in the immediately preceding syllable. However, (24) i) does not rule out reapplication of Stress to /o + nraht + ?/ ("leaf") \rightarrow /ónerahte?/ after e-Epenthesis to yield incorrect * $[\acute{o}neráhte?]$. Michelson claims that KSN's should state Stress as (24) ii):-

$$(24) \text{ i) } V \rightarrow \acute{V} / \left\{ \begin{array}{c} \# \\ V \end{array} \right\} D^n \text{ ______ } D^n V D^n \#$$

$$\text{ii) } V \rightarrow \acute{V} / \left\{ \begin{array}{c} \# \\ V D^n V \end{array} \right\} D^n \text{ ______ } D^n V D^n \#$$

But as I trust I have demonstrated, the final epenthetic e in such a form is not inserted in the phonological component proper but rather it is a PDR. Hence a is never penultimate as long as it remains in the phonological component whilst (24) i) adequately prevents Stress assignment to phonologically epenthetic antepenultimate e. I challenge future defenders of GROD to cite a Mohawk word with two phonologically inserted e's after the stressed vowel.

In the final section of this chapter we have examined several inter-related facts which bear upon the more general issue of rules of Epenthesis in Mohawk. During the discussion I trust that it will have become apparent that the theory of UDRA cannot be divorced from other considerations pertinent to the "design" of the phonological component. In particular, attention has been drawn to the interface between the phonological component proper, and the PDRs on the one hand, and the syntactic component and lexicon on the other. The question of Abstractness has also figured in our discussion. We shall be constantly returning to these issues in the remainder of this thesis. Indeed I hope to demonstrate that it is only by taking such issues into account that we can develop a fully "integrated" theory of phonology incorporating UDRA.

CHAPTER THREE - BLEEDING

We have discussed one of Kiparsky's fundamental relationships between rules, relationships which I have termed the Primary Modes of Rule Interaction. In this chapter we focus our attention away from feeding onto the other primary mode - bleeding. Following the precedent set in Chapter Two, we begin our discussion with a review of KSN's treatment of the interaction-type. In so doing, § 3.1 will provide a characterization of mutual bleeding situations and introduce the associated principle of UDRA, namely Proper Inclusion Precedence. One of the observations to be made during the examination of mutual bleeding concerns the Elsewhere Condition and the fact that mutually bleeding rules are in effect disjunctively ordered. This claim is more fully substantiated in § 3.2 along with the development of the hypothesis that rule formalization may determine disjunctive and conjunctive ordering. Having noted certain properties shared by KSN's examples of feeding and bleeding, we turn in § 3.3 to Hetzron's classification of interaction-types. Since this classification cuts right across the more familiar framework of Kiparsky, the section is able to provide an overview of the primary modes. Finally § 3.4, "Reordering out of Bleeding Order", deals with diachrony: the claim that parochial ordering figures as a mechanism of linguistic change is refuted and alternative solutions which are consistent with the theory of UDRA are argued for.

§ 3.1 The Characterization of Mutual Bleeding Situations

We have discussed one of Kiparsky's fundamental relationships between rules, relationships which I have termed the Primary Modes of Rule Interaction. Now we focus our attention away from feeding onto the other primary mode - bleeding. This is the relation which arises when rule A decreases the number of forms to which rule B can apply with regard to underlying representation S (where A, B, S are used consistently as in Chapter 2 and also Chapters 4 and 5.) Let us consider how this situation differs from feeding, by spelling out a little more explicitly what bleeding entails.

Unlike feeding, when A bleeds B, S satisfies the structural descriptions of both rules (recall that when A feeds B, S does not initially meet the structural description of B). At this point it may be helpful to differentiate between mutual bleeding situations and those in which A bleeds B but B does not potentially (counter)-bleed A. Under mutual bleeding, the application of either rule so modifies S that the other rule is no longer applicable. To put this another way, either A or B applies - but never both. When bleeding is not a mutual relation, although in actuality A's application renders S no longer able to meet the structural description of B, it would be logically possible for the rules to apply in the order B, A instead. It is just this possibility of non-bleeding application which permitted Kiparsky to posit reordering out of a bleeding relation for a pair of rules in Swiss German dialects. As noted above, this controversial example will be treated in § 3.4.2, where alternative analyses are considered. Firstly, however, let us characterize mutual bleeding.

In Chapter 1, I introduced the metatheoretical arguments behind KSN's conclusion that feeding and counterbleeding are more natural than

bleeding and counterfeeding, because of the domain-reducing properties of the latter. This was in keeping with Kiparsky's (1963) hypothesis that bleeding orders tend to be minimized. However in 1971 Kiparsky radically modified his former claim and developed the principle of opacity, whereby rules in counterfeeding and counterbleeding relations, the secondary modes of rule interaction, are less accessible to the learner - and hence less natural - than those in the primary modes, feeding and bleeding. If we accept this, bleeding is no longer the "undesirable" that Kiparsky's earlier work and KSN would make it out to be. As I also noted in Chapter 1, Kenstowicz and Kisseberth, and Hooper argue for the natural, unmarked character of mutual bleeding situations. Since KSN do not deny that such relations obtain, how can they predict which of two applicable bleeding rules will actually take precedence? This section is concerned with the precise status of such an applicational precedence principle for mutual bleeding rules.

Let us take a concrete example of mutual bleeding from KSN, Saporta's (1965) rules for South American Spanish:-

(1) South American Spanish: Saporta

A Final Depalatalization $\lambda \rightarrow l / ___\#$
 B Delateralization $\lambda \rightarrow y$

Saporta posits identical underlying representations for Latin American and Castilian Spanish. He then claims that Final Depalatalization, rule A, is common to both dialects, whereas Delateralization, rule B, applies only in Latin American. Hence in Castilian palatal laterals are depalatalized in word-final position but occur on the phonetic surface elsewhere. On the other hand, in South American those underlying palatal laterals which do not depalatalize by rule A are subject to rule B, Delateralization, which is extrinsically ordered after Final Depalatalization; hence they never appear on the phonetic surface as

palatal laterals, as shown in (2):-

(2)		(i)		(ii)
		Castilian		Latin American
	S	akeʎ	akeʎos	akeʎ akeʎos
	A	akel	-	akel -
	B	-	-	- akeyos

Since rule ordering does not figure in this Castilian example because only one rule is involved, the dialect data merely serve as a contrast to South American where both rules are operative. Therefore Castilian is not referred to again below.

For the moment we shall assume that the rules of (1) and derivation (2) ii for South American Spanish epitomize mutual bleeding situations. We shall now note their salient characteristics. Firstly, both Final Depalatalization and Delateralization affect the same segment, a palatal lateral. Secondly, their outputs are mutually exclusive - either a lateral which has lost its palatality, or a glide with no lateral manner of articulation. Thirdly, the environments of the two rules differ - and here it will be necessary to speculate about Saporta's use of notational conventions. At first glance, it would appear that Final Depalatalization is context-sensitive whilst Delateralization is context-free. Thus A bleeds B of word-final palatal laterals - the correct result - whereas if B were permitted to apply before A, all palatal laterals would become glides regardless of environment. As a consequence of the (apparent) relative sensitivity to context shown by the two rules, the structural description of Final Depalatalization (i.e. the segment affected by the rule and its environment, the word-boundary) properly includes the structural description of Delateralization (i.e. just the segment affected, since its environment is unspecified). KSN take advantage of this consequence of Saporta's

formulation in order to set up Proper Inclusion Precedence whereby the (more) context-sensitive rule will apply before the (more) context-free.*

(3) "Proper Inclusion Precedence

For any representation R, which meets the structural descriptions of each of two rules A and B, A takes applicational precedence over B with respect to R, if and only if the structural description of A properly includes the structural description of B."

(KSN; (17) page 8)

Since PIPrec constitutes a universal principle which determines uniquely that A, Final Depalatalization, must apply before B, Delateralization, in South American Spanish, there is no need to specify this ordering extrinsically in a grammar of the dialect.

In an important footnote (fn.7) KSN point out the following: (I have changed the order of presentation):-

i) The structural description of any rule $X \rightarrow Y / W \text{ ____ } Z$ is WXZ not just X cf. the rule's notational variant $WXZ \rightarrow WYZ$.

ii) To ensure correct application of PIPrec, rules should be given in terms of distinctive features. I should like to add that although there is clearly no risk of misinterpretation for the Spanish example, certain crucial and fallacious arguments in the literature rely on confusion caused by the misuse of alphabetic symbols. One such case contributes to the misunderstanding shrouding the Swiss German rule-pairs already alluded to, which will be dealt with below. (Indeed, confusion with features is even pertinent in KSN's paper). It is recurrent examples which can only be resolved by formulating the rules in question with distinctive features, that will lead to the Pre-Condition on PI in Chapter 5.

iii) If the structural description of A properly includes the structural description of B, then the set of representations which meet the struc-

* Footnote

This is of course the principle whose explication was anticipated in Chapter 2. In keeping with the practice established there, the principle will henceforth be designated as PIPrec.

tural description of A will be properly included in the set of representations which meet the structural description of B. (i.e. B. representations, the less context-restricted, will properly include A representations, the more detailed, - since loss of features leads to greater generality. Therefore it is crucial whether one is referring to rule A or A representations - JRMcB).

iv) A practical test of proper inclusion is to place the structural description of B "on top of" that of A and see if part of the structural description of A is left over. If so, A properly includes B.

v) The last of the KSN points to be mentioned may have slipped by unnoticed above. I quote it here since it is the most important in the characterization of mutual bleeding:

(4) "It will also be observed that the proposed precedence principle subsumes as a special case the familiar ordering of a context-sensitive rule before its corresponding context-free 'elsewhere' rule."

(KSN; fn. 7, page 9)

Once again we must refer to the work of Kiparsky, this time 1973 "Elsewhere in Phonology". Because of concern in classical generative phonology with succinctness of statement it is customary for the final environment in a set of subrules to be left blank. When the entire rule is expanded, this blank will be interpreted as the environment(s) not previously specified i.e. "elsewhere" as regards the environment(s) of the preceding subrule(s). In keeping with the early rather simplistic conception of the evaluation metric whereby the simplicity of a rule is measured exclusively by the number of symbols appearing in its formulation (obviously prior to the development of the theory of markedness), the environment(s) specified will be that/those which can be expressed most briefly. The "Elsewhere Condition", by which the subrule with the unspecified environment is expanded last, ensures that earlier subrules are applied in their particular environments. To put

this slightly differently, the Elsewhere Condition prevents the apparently context-free final subrule from applying to the segment in question in all environments. However it is important to realize that the context-free appearance of the "elsewhere" subrule belies the true relation of such a subrule to the remaining subrule(s). In fact, that relation is one of complementarity. By the same token, when we are dealing "as a special case" with "the familiar ordering of a context-sensitive rule before its corresponding context-free 'elsewhere' rule", we are dealing with two rules which could be treated as complementary subrules of a single schema.

Of course, it is important to note that the single schema into which such rules could be collapsed is not always "equivalent" to their separate formalization, at least intuitively. This is because frequently the 'elsewhere' rule represents the regular case, whilst the context-sensitive rule is exceptional in some way. Thus the 'elsewhere' rule may stipulate the behaviour of an open class whereas the environment(s) of the closed classes need(s) to be specified explicitly. There is no doubt that such considerations have been particularly important in the formulation of morphological statements, such as the realization of the morphosyntactic category Past in English. There suppletion and vowel alternation constitute the irregular, closed class of exponents, whilst the phonologically conditioned suffixes /t, d, id/ represent the regular, open 'elsewhere' case. However, despite the relevance of considerations of this type to the application of the Elsewhere Condition, it is also clear that they do not figure in the same way when we are dealing with strictly phonological rules in **mutual bleeding relations**.

Moreover, it is important to recognize the complementary relation

this slightly differently, the Elsewhere Condition prevents the apparently context-free final subrule from applying to the segment in question in all environments. However it is important to realize that the context-free appearance of the "elsewhere" subrule belies the true relation of such a subrule to the remaining subrule(s). In fact, that relation is one of complementarity. By the same token, when we are dealing "as a special case" with "the familiar ordering of a context-sensitive rule before its corresponding context-free 'elsewhere' rule", we are dealing with two rules which could be treated as complementary subrules of a single schema.

Of course, it is important to note that the single schema into which such rules could be collapsed is not always "equivalent" to their separate formalization, at least intuitively. This is because frequently the 'elsewhere' rule represents the regular case, whilst the context-sensitive rule is exceptional in some way. Thus the 'elsewhere' rule may stipulate the behaviour of an open class whereas the environment(s) of the closed classes need(s) to be specified explicitly. There is no doubt that such considerations have been particularly important in the formulation of morphological statements, such as the realization of the morphosyntactic category Past in English. There suppletion and vowel alternation constitute the irregular, closed class of exponents, whilst the phonologically conditioned suffixes /t, d, id/ represent the regular, open 'elsewhere' case. However, despite the relevance of considerations of this type to the application of the Elsewhere Condition, it is also clear that they do not figure in the same way when we are dealing with strictly phonological rules in mutual bleeding relations.

Moreover, it is important to recognize the complementary relation

between rule-pairs in mutual bleeding situations because it leads us to see that in fact we are dealing with disjunctive ordering. The task which faces the linguist is therefore one of ensuring that these complementary subrules apply disjunctively just when their appropriate conditions are met. Given the power of extrinsic ordering and the convention of the Elsewhere Condition, this can be done by leaving blank the formulation of the more cumbersome environment and ordering that subrule extrinsically after its fully specified complement. KSN's hypothesis does not reject the Elsewhere Condition; nor, given that convention, does it alter which (sub)rule will apply first. What it does by establishing PIPrec is to guarantee that the more particular context-restricted rule applies before a complementary rule formulated without environmental restrictions. Of course, given the practice of rule formulation stemming from the Elsewhere Condition, it constitutes a truism to say that the SD of the (more) context-restricted rule will properly include that of the 'elsewhere' rule. Seen in this way, PIPrec is simply a corollary of the Elsewhere Condition and conventions on disjunctive ordering.

However, before moving on to the latter in § 3.2, let us discuss the second example of PIPrec cited by KSN. It is taken from a treatment of Caddo included in Chafe's (1968) paper. I shall outline Chafe's framework, present KSN's application of PIPrec, and conclude with a summary of Chafe's pellucid comments.

As Chafe remarks in two footnotes (fns. 8 and 9, page 122; 1968), his use of the terms "additive" and "subtractive interference" are to be equated with Kiparsky's "feeding" and "bleeding", respectively. Like Kiparsky's contemporary work, Chafe's paper is concerned with the characterization of modes of rule interaction, rather than with the

determination of precedence principles. In fact the difference between Kiparsky's and Chafe's treatments lies in that the former is essentially diachronic, the latter synchronic.

Chafe consults the phonetic output of a particular rule to determine whether it is appropriately or inappropriately additive or subtractive. An additive rule "is characterized by the fact that the interfering rule adds to or expands the stock of instances upon which the interfered-with rule operates, or could operate". (page 122; *ibid.*) If this potential interference is actualized, the rule is appropriately additive, otherwise it is inappropriately so. A rule interferes subtractively with another if it has the potentiality of removing some of the instances affected by that second rule. Once again Chafe looks to the phonetic output of the rule-pair to determine whether they are appropriately or inappropriately subtractive: this depends on the actualization of the potential interference.

It is clear that whilst appropriate additive and appropriate subtractive interference correspond to the primary modes, respectively, feeding and bleeding, inappropriate additive and inappropriate subtractive interference correspond to the secondary modes, respectively, counter-feeding and counterbleeding. Chafe captures the fact that under the primary modes the feeding or bleeding rule precedes the fed or bled rule with the following statement:

- (5) "We can say that if rule (x) is appropriately either additive or subtractive with respect to rule (y), then (x) must be ordered to precede (y)."

(*ibid.*; page 123)

Going on to discuss subtractive interference, Chafe notes that the SD of (y) (= my B) properly includes the input of (x) (= my A). Yet it is also possible for the input of (y) to properly include the SD of (x). In this situation, subtractive interference will be symmetric.

In other words, Chafe has defined mutual bleeding. The rule-pair which exemplifies his point is taken from Caddo and cited in (6):

(6) (= Chafe's (n), (o) page 124; *ibid.*)

A kw → p
 B k → h / _____ C

Let us now turn to KSN's exposition of PIPrec viz. the rules of (6).

Following their stipulation about the use of distinctive features noted in ii above, they restate (6) as (7):

(7) (= KSN's (18), page 9)

A $\begin{bmatrix} + \text{ cons} \\ + \text{ back} \\ + \text{ stop} \end{bmatrix}$ $\begin{bmatrix} - \text{ voc} \\ + \text{ round} \end{bmatrix}$ → $\begin{bmatrix} + \text{ cons} \\ - \text{ back} \\ + \text{ stop} \\ + \text{ round} \end{bmatrix}$
 B $\begin{bmatrix} + \text{ cons} \\ + \text{ back} \\ + \text{ stop} \end{bmatrix}$ $[- \text{ voc}]$ → $\begin{bmatrix} + \text{ cons} \\ + \text{ back} \\ - \text{ stop} \end{bmatrix}$ $[- \text{ voc}]$

Since $\begin{bmatrix} - \text{ voc} \\ + \text{ round} \end{bmatrix}$ properly includes $[- \text{ voc}]$, A must precede B by PIPrec.

Nor does the use of Ch&H's distinctive feature system invalidate the principles, as seen in (8), where $\begin{bmatrix} - \text{ cons} \\ - \text{ voc} \\ + \text{ back} \end{bmatrix}$ properly includes $[- \text{ voc}]$.

(8) (= KSN's (18) a'. and b'., footnote 8; *ibid.*)

A $\begin{bmatrix} + \text{ cons} \\ - \text{ ant} \\ - \text{ cor} \\ - \text{ cont} \\ - \text{ voice} \end{bmatrix}$ $\begin{bmatrix} - \text{ cons} \\ - \text{ voc} \\ + \text{ back} \end{bmatrix}$ → $\begin{bmatrix} + \text{ cons} \\ + \text{ ant} \\ - \text{ cor} \\ - \text{ cont} \\ - \text{ voice} \end{bmatrix}$
 B $\begin{bmatrix} + \text{ cons} \\ - \text{ ant} \\ - \text{ cor} \\ - \text{ cont} \\ - \text{ voice} \end{bmatrix}$ $[- \text{ voc}]$ → $\begin{bmatrix} - \text{ cons} \\ - \text{ voc} \\ + \text{ low} \end{bmatrix}$ $[- \text{ voc}]$

However despite the validity of the point KSN are making regarding the precise formalization of rules, it is perhaps worth noting that in this instance PIPrec operates correctly on Chafe's original segmental statement. Thus if we adopt Ch&H's convention whereby "C" is a cover

symbol for the disjunction $\left\{ \begin{array}{l} [- \text{ cons}] \\ [- \text{ voc}] \end{array} \right\}$, then C properly includes /w/. Moreover, it is also clear that whilst the use of "C" in (6) E allows for a liquid to follow underlying /k/, this possibility is not catered for in either of KSN's formulations with distinctive features. If absolute rigour is to be attained, the feature specification of (6) as (7) or (8) should contain a disjunction. Only in this way do we preclude the possibility that /kl/, /kr/ clusters arise in Caddo.

We now turn to Chafe's discussion of mutual bleeding, a discussion which points to what we might term the 'naturalness' of such relations. As noted above, Chafe refers to the output of rules to ascertain the relationship between them. This is, then, rather different from the UDRA procedure, whereby inspection of the formalization of a rule-pair determines their relative ordering. However Chafe does adopt the latter approach for the rules of (6), when he notes that we know A precedes B "without looking any further than the rules themselves" (page 124; *ibid.*) The basis for this statement is the plausible assumption that no rule is completely vacuous - unless there are at least some forms to which a rule can apply, there is no reason to incorporate it into the grammar. Therefore to prevent B from removing all those instances of /k/ which A affects, A must be ordered to precede B. Chafe calls such interactions 'self-ordering', noting parenthetically that the term 'intrinsic ordering' has also been used.

To sum up Chafe's discussion so far, the rules of (6) are appropriately subtractive, symmetric and self-ordering. Chafe now poses the question of whether all symmetrically subtractive rules are self-ordering. To answer this in the negative, he cites the hypothetical rule-pair (9):

(9) (= Chafe's (n) and (o'), page 124; *ibid.*)

A kw → p
 B k → h / i C

The rules of (9) are in a mutual bleeding relation when applied to the representation /ikw/. Furthermore PIPrec, as formalized so far, is unable to predict a PI relation between /ikC/ and /kw/. Chafe concludes that the rules of (9) are symmetrically subtractive but not self-ordering. However, there is no need to take this to mean that if such an interaction obtained in natural language, the UDRA hypothesis would be unable to account for it. Rather, since (9) is hypothetical, there is no way in which the predictions of UDRA can be tested against it. Insofar as there are data for which the formalization (3) of PIPrec is indeterminate, the principle must be elaborated and made explicit. This is precisely the purpose of Chapter 5.

Chafe's second hypothetical example illustrates self-ordering rules which are not symmetric - see (10):

(10) (= Chafe's (1') and (m) page 124; *ibid.*)

A r → ∅ / ___ V

B a → æ / r ___

Although A would bleed B of any input if ordered before it, B does not affect A. It is interesting to note that, to the extent that rule-pairs like (10) obtain in natural language, the UDRA hypothesis provides two principles which both predict that B does not apply vacuously, namely, Deletion Cession and PIPrec. Deletion Cession is applicable just in case the null segment occurs in the SC of A. PIPrec is operative because /ra/ is properly included in /rV/. Chafe is clearly aware that the latter principle is pertinent to self-ordering when he notes that "subtractive interference results in self-ordering - and the interfering rule must be ordered to follow the interfered-with rule - whenever the input plus the environment (that is, the structural description) of the interfering rule INCLUDES the structural description of the interfered-with rule." (page 124; *ibid.*; original

emphasis).

Before closing this section it should be pointed out that just as Delateralization ((1)B) in the Latin American Spanish example could be viewed as the 'elsewhere' subrule of a single schema, so it is possible to view "/ ____ C" as the 'elsewhere' environment for the Caddo rule-pair. Thus, whilst a particular process affects /k/ following the specific C(onsonant) /w/, another change occurs after all other C(onsonant)s. In other words, the environments of (6) A and B are complementary.

We may conclude from this discussion that, far from being an ad hoc principle fabricated to account for a particular set of random data, PIPrec constitutes a natural relation between rules in a bleeding situation. Although we have only given two (non-hypothetical) examples of mutual bleeding, the rationale behind the principle's applicability has been self-evident in both cases. While there remain several instances which could be cited where its preliminary formalization seems inadequate, these will be explicated in this chapter and Chapter 5.

§ 3.2 Disjunctive and Conjunctive Ordering

In Chapter 2 and the first section of this chapter we have partially examined the primary modes of rule interaction, feeding and bleeding. We saw that an extrinsic statement to the effect that A feeds B is tantamount to saying that A and B are entirely unrestricted in applicability, given that each obligatory rule must apply to every representation which meets its structural description. When we discussed mutual bleeding situations earlier in this chapter we noted the complementary relation between the environments of the rules involved, and we concluded that a precedence principle ensuring that the more context-restricted rule applied first amounted to a corollary of the Elsewhere Condition and conventions on disjunctive ordering. The question was raised whether a pair of rules in a mutual bleeding relation applying disjunctively to the same segment might not be restated as a single schema. It would then be a consequence of the Elsewhere Condition that if one subrule applied, the other would be prevented from applying. In this way examples like those from Latin American Spanish and Caddo seem to epitomize not only mutual bleeding situations but also cases where notational conventions determine how the rules apply i.e. disjunctively. Since the changes effected by the rules are mutually exclusive, it is inevitable that their application should comprise a disjunction.

On the other hand, KSN's examples of feeding discussed in Chapter 2, typify intrinsic order in Chomsky's original 1965 sense, for in those cases ordering is "simply a consequence of how rules are formulated" ('Aspects' page 223). It is crucial for such data that the rule apply conjunctively, the output of rule A providing the input to rule B. For these reasons, one might be tempted to talk of "intrinsic feeding",

where rules are inherently conjunctive, and "intrinsic bleeding", where rules are inherently disjunctive. With these terms we would be referring to just those data already dealt with above.

It is in SPE that Ch&H first develop the notion of allowing notational conventions to determine how rules apply. In Chapter 1, we noted the similarity between defining disjunctive ordering on the sequence of rules constituting the grammar and defining intrinsic ordering on the formulation of those rules. Let us examine in more detail exactly how disjunctive ordering will be established by the theory for pairs of rules. Defining the grammar as a linear sequence of rules (applying in accordance with the principle of the transformational cycle), Ch&H assert that:

- (11) "The relation of disjunctive ordering is defined on certain pairs of rules of this sequence by virtue of their formal similarities. To determine disjunctive ordering, we apply to the fullest possible extent the notational conventions involving parenthesization, bracketing, and the slash-dash notation In this way we form an underlying schema which represents this sequence of rules and which is expandable into this sequence by the successive application of conventions involving the notations."

(SPE page 36)

A few pages earlier (page 30), Ch&H had introduced the first case where a notational convention was used to determine rule application. Disjunctive ordering was established as a condition on the parenthesis convention itself to prevent both expansions of a rule which is formulated with parentheses from applying one after the other to the same representation e.g. (12) which expands as shown:

$$(12) \quad V \longrightarrow [1 \text{ stress}] / X \text{ ______ } C_0 \text{ (W)}$$

where X contains no internal occurrence of C_0 and

W is a weak cluster

Expansion:

$$a) \quad V \longrightarrow [1 \text{ stress}] / X \text{ ______ } C_0 \text{ W}$$

$$b) \quad V \longrightarrow [1 \text{ stress}] / X \text{ ______ } C_0$$

Thus whereas a) applies to "edit" with a final weak cluster, b)

applies to "exist" with a final strong cluster. Disjunctive ordering ensures that b) does not apply to the output of a), yielding incorrect

*"edit".

During a brief preliminary discussion of notational conventions in the introduction to Chapter 3, Ch&H note that previous generative grammars generally assumed, albeit tacitly, that "the ordering abbreviated by the use of parentheses is disjunctive", whereas in the case of braces the ordering is assumed to be conjunctive. This is entirely in keeping with their earlier practice in the preceding chapters of SPE, e.g. in the initial formulation of the Main Stress Rule before its various elaborations where (13) is expanded as shown:

$$(13) \quad V \rightarrow [1 \text{ stress}] / X \text{ --- } C_0 \text{ } ^1(W) / \text{ --- } (\left\{ \begin{array}{l} + \text{affix} \\ \Sigma \end{array} \right\})]$$

where Σ = a stressed syllable i.e. a string of the form $C_0 \overset{1}{VC}_0$

Expansion:

$$a) \quad V \rightarrow [1 \text{ stress}] / X \text{ --- } C_0 W + \text{affix}]$$

$$b) \quad V \rightarrow [1 \text{ stress}] / X \text{ --- } C_0 + \text{affix}]$$

$$c) \quad V \rightarrow [1 \text{ stress}] / X \text{ --- } C_0 W \Sigma']$$

$$d) \quad V \rightarrow [1 \text{ stress}] / X \text{ --- } C_0 \Sigma']$$

$$e) \quad V \rightarrow [1 \text{ stress}] / X \text{ --- } C_0 W]$$

$$f) \quad V \rightarrow [1 \text{ stress}] / X \text{ --- } C_0]$$

Using the "tacitly assumed" conventions the only permitted sequences are:

a) c)

a) d)

b) c)

b) d)

i.e. the environments $[+ \text{affix}]$ and $[\Sigma]$ are conjunctively ordered with respect to each other but disjunctively ordered with respect to the remaining environments.

The next notational convention used to determine disjunctive ordering is that of angled brackets. Ch&H describe an expression with angled brackets as "a generalization of the use of parentheses to the case of discontinuous dependencies". (SPE page 77). When such an expression is expanded, first all the angled elements are rewritten, then none of these elements is rewritten. Angled brackets are therefore a kind of "all or nothing" notation: whichever expansion one chooses, the other is automatically rendered inapplicable.

Further down the same page Ch&H make a strong claim about when and where to use the notational devices they have been discussing:

(14) "As far as we know, the only cases of disjunctive ordering are those in which rules can be simplified in terms of parentheses and angled brackets, and in all such cases the rules are disjunctively ordered. If this is correct, we can tentatively propose the following quite strong empirical hypothesis: where parentheses or angled brackets are required ... for the abbreviation of a sequence of rules, these rules are disjunctively ordered; in all other cases, rules are conjunctively ordered."

(SPE page 77; original emphasis)

By the time they reach the Formalism in the Appendix to Chapter 8 of SPE, Ch&H have added the notational device of Greek letter variables to their list of those conventions determining disjunctive ordering. They point out that "rules expanded from schemata involving variables for feature specifications are disjunctively ordered, as are rules

expanded by the use of parenthesis and angled bracket notations".

(SPE page 396). The empirical nature of the claims involved here is stressed by Ch&H each time they are made. Before quoting them on this point and looking at their practice in a particular instance, I should like to cite Hyman's discussion of notational equivalence in Fe?fe?-Bamileke (1975). My reason for including this example is that it demonstrates how conventions on disjunctive and conjunctive ordering can radically alter the interpretation of particular formalisms.

Fe?fe?-Bamileke has two related lowering rules, one applying to underlying /u/ so that it is realized as [o], the other lowering underlying /o/ to [ɔ]. Both rules apply in closed syllables but whereas the latter rule is found in all dialects, the former is more restricted. Hyman abbreviates the two processes both with angled bracket notation and using alpha variables:

- (15) a)
$$\begin{bmatrix} - \text{ low} \\ \langle - \text{ high} \rangle \end{bmatrix} \rightarrow \begin{bmatrix} - \text{ high} \\ \langle + \text{ low} \rangle \end{bmatrix} / \text{ ______ } C$$
- b)
$$\begin{bmatrix} - \text{ low} \\ \alpha \text{ high} \end{bmatrix} \rightarrow \begin{bmatrix} - \text{ high} \\ -\alpha \text{ low} \end{bmatrix} / \text{ ______ } C$$
- a) i
$$\begin{bmatrix} - \text{ low} \\ - \text{ high} \end{bmatrix} \rightarrow \begin{bmatrix} - \text{ high} \\ + \text{ low} \end{bmatrix} / \text{ ______ } C \quad \overset{/}{o} \rightarrow \text{ɔ}$$
- ii
$$[- \text{ low}] \rightarrow [- \text{ high}] / \text{ ______ } C \quad u \rightarrow o$$
- b) i
$$\begin{bmatrix} - \text{ low} \\ + \text{ high} \end{bmatrix} \rightarrow \begin{bmatrix} - \text{ high} \\ - \text{ low} \end{bmatrix} / \text{ ______ } C \quad u \rightarrow o$$
- ii
$$\begin{bmatrix} - \text{ low} \\ - \text{ high} \end{bmatrix} \rightarrow \begin{bmatrix} - \text{ high} \\ + \text{ low} \end{bmatrix} / \text{ ______ } C \quad o \rightarrow \text{ɔ}$$

(Hyman page 123)

From the order of expansion (15) a) i and ii, [o] derived from /u/ by

ii cannot serve as an input to i, since when it is lowered the $o \rightarrow \text{ɔ}$ subrule has already applied. In other words, the angled bracket notation in a) does not impose disjunctive ordering per se: it simply falls out as a result of conventions on the expansion of angled brackets. In contrast, it is logically possible for b) to apply either disjunctively or conjunctively, given the order of expansion b) i followed by b) ii i.e. $u \rightarrow o \rightarrow \text{ɔ}$. Therefore whilst disjunctivity must be imposed upon (15) b), expansion conventions will automatically guarantee it in (15) a).

Ch&H would claim that just such a set of data confirms their hypothesis that rules abbreviated with alpha variables apply disjunctively.

Because of the empirical status of the conventions involved, they cannot be revised in an ad hoc way. Ch&H appear scrupulous in maintaining this principle when they do not specify a disjunction between a condition on the Main Stress Rule and the Stressed Syllable Rule. Their reason is that the two subrules are not related in a way expressible by angled brackets or parentheses. However it could be argued that their solution is also ad hoc for it adds yet another condition to the subrule for Main Stress involved. (See SPE page 98 and fn. 50).

We have seen that Ch&H have extended "the general theory of the organization of a grammar ... by observing that certain subsequences of the linearly ordered rules may be disjunctively ordered." Note here that they refer to subsequences rather than pairs of rules. KSN on the other hand are concerned with predicting which "whole" rule takes applicational precedence over which other "whole" rule. It is worth considering whether rule pairs such as those formulated by Saporta for Spanish could not be better formulated as single rules with parenthetical elements under the disjunctive ordering convention.

According to SPE, the choice should not be open but rather it is an empirical issue:

- (16) "The question of when a sequence of rules is to be abbreviated by the parenthesis convention is not a matter of choice but rather one of fact. That is, the convention regarding parentheses is just one part of an evaluation procedure to be applied to grammars. This procedure is perfectly general (language-independent) and performs the function of determining which of the grammars consistent with the data is to be selected as the grammar of the language for which the data provide a sample."

(SPE page 30, fn. 20; my emphasis)

I would venture to suggest that it is this language-independent procedure which is involved when rules in intrinsic-feeding and intrinsic-bleeding relations are formulated along universal principles.

§ 3.3 Unilateral Applicability Versus Potential Interchangeability

The preceding section closed with the hypothesis, developed in SPE, that the conventions regarding rule formulation be allowed to determine disjunctive and conjunctive ordering. If such a procedure were followed, it would ensure that a pair of rules in an "intrinsic feeding" relation (see beginning of § 2.1 for a definition) were expressed as two separate schemata (which could both apply to representation S); on the other hand, a pair of rules in an "intrinsic bleeding" (= mutual bleeding) relation would necessarily be formalized as subrules of a single schema, in which the less contextually restricted subrule constituted the "elsewhere" case (and hence applied disjunctively to those representations not meeting the structural description of the more contextually restricted subrule). Thus the notational conventions employed in formalizing rules might be used to determine how rules apply in intrinsic feeding and intrinsic bleeding situations.

The fact that such a claim is logically possible suggests that the types of rule interaction so far discussed must share some property beyond that captured by the epithet "intrinsic". Robert Hetzron encapsulates this common property when he refers to those rules whose relative ordering is simply a consequence of their formulation as exhibiting Unilateral Applicability (1974). Hetzron's paper is an important one despite the fact that it has frequently been overlooked in the subsequent literature. This is unfortunate since it represents what one might almost call a reluctant attempt to substantiate recalcitrant counterexamples to KSN. Unlike other critics of KSN, Hetzron cannot be accused of misrepresenting his opponents nor of failing to grasp their line of argumentation. Indeed, it is because of his perspicacity in defining the issues involved that I adopt his terminol-

ogy from '§1. The Concept of Order of Rules' to elucidate the present discussion.

I have cited Hetzron's term "Unilateral Applicability" which I want to contrast with Potential Interchangeability - as will be apparent from the title of this section. However, before explicating these two terms - in particular by examining how Unilateral Applicability differentiates intrinsic feeding from intrinsic bleeding, and how they in turn are distinguished from Potential Interchangeability - let me introduce Hetzron's first two types of ordering relation, and illustrate all four, as he does, from the syntax and morphology of English. In addition to this, I have endeavoured to supply phonological examples. Below I have schematized the relations for a pair of rules, A and B, applying to the same segment. The abbreviatory devices will become clear during the course of the explication of Hetzron's Classification.

SCHEMA

Hetzron's Classification of Ordering Relations

1)	NEUTRALITY	$A, B \rightarrow c$
		$E, A \rightarrow c$
2)	EQUIVALENT INTERCHANGEABILITY	$A, B \rightarrow c$
		$B, A \rightarrow d$
		$c \sim d$
3)	UNILATERAL APPLICABILITY	$A, B \rightarrow c$
	(i)	$B, *A$
	(ii)	$*B, A$
4)	POTENTIAL INTERCHANGEABILITY	$A, B \rightarrow c$
		$B, A \rightarrow *d$

Neutrality of application between rules A and B is the situation which obtains when either ordering yields the same results. This is indicated schematically above by giving the orders A, B and B, A to the left of the arrow and rewriting both as lower case c. Consider the interaction of "subject-verb agreement" and "tense-agreement" (= "sequence of tenses") down-grading the tense of a clause which is the complement of a quotative verb in the past. Together these two rules produce surface "I said that they were ill" from "I say-PAST 'they BE ill' ".*

It does not matter whether subject-verb agreement applies before tense-agreement or vice versa: if subject-verb agreement takes precedence, underlying BE is converted to are and then "down-graded" to were; if tense-agreement applies first, we derive was from BE, but still obtain were after subject-verb agreement. Since both intermediate forms in the derivations, are and was, occur on the surface too, it may be difficult to select one ordering over the other. Under the KSN hypothesis this problem will be removed, since both agreement rules may apply simultaneously to BE just because both structural descriptions are met. Note crucially that under the theory of UDRA developed in this thesis the problem will persist but without theoretical import in this case.

To take a phonological example of Neutrality from English, consider the PDRs which assign the features 'fortis' and 'aspirated' to voiceless plosives in initial position. In English these are phonologically redundant features which nevertheless are present at the phonetic surface. Since neither is superordinate to the other, it is immaterial whether we first derive the consonant at the beginning of "pin" as

* Footnote

Here Hetzron cites what I assume to be the shallow structure "I said 'They are ill' ". Tracing the derivation to a deeper level in no way affects the point being made but rather brings out the origin of underlying BE which is otherwise assumed but left unexplained.

- syll	but unspecified for HSP (heightened subglottal pressure),
+ cons	
- cont	
+ ant	
- cor	
- voice	
+ tense	

or leave blank the value for tenseness and first specify HSP:

- syll
+ cons
- cont
+ ant
- cor
- voice
+ HSP

Under Neutrality, the order of application of the rules involved produces identical results: the only difference between the alternate orderings is the intermediate level of derivation which results if - as we shall argue for Yawelmani Yokuts in Ch. 4 - the rules are unable to apply simultaneously. Neutrality may arise if the second rule expresses a generalization applying to other representations as well as those which result from the application of the first rule. To put this another way, the first rule may effect a modification which makes its input segment eligible for a more general process of the language (= the second rule). Such an analysis may be made of the Lenition of /d/ to [ɣ] in Irish and Modern Scots Gaelic (and of its palatalized counterpart to [j]). The general result of Lenition is that plosives become homorganic spirants. One way of maintaining this generalization is to modify the point of articulation of /d/ to /g/ before Spirantization applies. Alternatively, if we accept the KSN hypothesis, both rules could apply simultaneously. However, as has already been indicated, there are strong empirical grounds against maintaining the simultaneity hypothesis (see Chapter Four). Given that simultaneous application is not a possible mode of rule interaction, $\underline{d} \rightarrow \underline{g}$ must precede Spirantization by PIPrec. This follows naturally from the fact that Spirantization is the general process subsumed under Lenition.

The data could also be treated so that the more general process applies first and the second rule adjusts its output where necessary. If Spirantization applied first, /d/ would become intermediate /z/. A second rule would change the point of articulation of the spirant to velar. The process cannot be simultaneous because the $\underline{z} \rightarrow \underline{\gamma}$ rule makes reference to the feature [+cont] which only has a positive value after Spirantization.

The evidence which may be brought into consideration in favour of the first analysis with intermediate /g/ and against the second with intermediate /z/ involves the fact that in these languages /g/ is an underlying segment, which itself mutates to $[\gamma]$; /z/ on the other hand never appears on the phonetic surface of native words. This may be tautologous: it is precisely because there is no /z/ available to which /d/ can be spirantized, that it is forced to change its place of articulation to $[\gamma]$ under mutation. This point has not been raised in order that it may be resolved here - it will be treated exhaustively in Part II. Rather, it was introduced as a means of demonstrating the way in which other issues are inextricably bound up with questions of rule ordering. We shall see that this is so at various points in later chapters.

Under Hetzron's second order type, Equivalent Interchangeability, the order of application produces different surface results. However, both outputs are acceptable. This is schematized above by specifying \underline{c} as the output yielded when A applies before B, and \underline{d} as the output yielded when B applies before A but indicating the \underline{c} and \underline{d} are mutually substitutable ($\underline{c} \sim \underline{d}$). To illustrate such a situation Hetzron cites Koutsoudas' (1972) example which is in turn based on the work of G. Lakoff. According to Standard Theory, pronouns are not present in deep

structure but are introduced by a transformation which replaces a noun with the appropriate pronoun if that noun has a coreferential antecedent. Also in Standard Theory, WH-questions are formed by a transformation effecting the leftward movement of the base-generated element WH. In the sentence "Which of the men who hated Charley did he attack?", the WH-NP and the clause it dominates (the men hate-PAST Charley) have been fronted first. Pronominalization therefore applies to the coreferential Proper Noun in the Main Clause, since this now follows the other occurrence of "Charley" in the WH-clause. In the equivalent and equally acceptable sentence "Which of the men who hated him did Charley attack?", the order of application of WH-fronting and Pronominalization has been reversed. Pronominalization has applied to the deep structure in which the Proper Noun in the Main Clause still precedes the "Charley" in the subordinate WH-clause. Consequently it is the Main Clause Proper Noun which remains in surface structure and that of the WH-clause which is pronominalized. Later the WH-NP + subordinate clause containing the pronoun are shifted leftwards, with the result that in surface structure the pronoun precedes its deep structure coreferential antecedent.

From the above example in which two surface variants of a single deep structure were acceptable, one might conclude that Equivalent Interchangeability in phonology is the phenomenon of "free variation". However, on reflection, it seems more plausible to claim that free variation most commonly results because of the application or non-application of an optional phonological rule. To return to the aspiration of plosives with which we illustrated Neutrality, the "noisy" release or lack of explosion of word-final voiceless plosives may be ascribed to the presence or absence of the PDR assigning the feature [+HSP] in the grammar of the idiolect concerned. This is not to say that the optionality of a particular rule is the sole source of free

variation: the choice of alternating segment may actually be reflected by two segments in the lexicon e.g. /ɛkɒnɒmɪks/ vs. /i:kɒnɒmɪks/.

In addition the labelled bracketing of free variants may lead to a difference in the application of cyclic rules e.g. the NP

NP $\left[\begin{array}{c} \text{N} \\ \left[\text{ars} \right] \end{array} \right] \text{N N} \left[\begin{array}{c} \text{N} \\ \left[\text{kri:m} \right] \end{array} \right] \text{NP}$ which receives two primary stresses

only, surfacing as $\left[\begin{array}{c} 1 \\ \text{ars} \end{array} \right] \left[\begin{array}{c} 1 \\ \text{kri:m} \end{array} \right]$ vs. the Noun $\text{N} \left[\begin{array}{c} \text{N} \\ \left[\text{ars} \right] \end{array} \right] \text{N}$

$\text{N} \left[\begin{array}{c} \left[\text{kri:m} \right] \\ \text{N} \end{array} \right] \text{N}$ which undergoes stress reduction in accordance with

the principles of the transformational cycle to yield phonetic surface

$\left[\begin{array}{c} 1 \\ \text{ars} \end{array} \right] \left[\begin{array}{c} 3 \\ \text{kri:m} \end{array} \right]$.

Despite the fact that I feel justified in citing rule optionality or alternate lexical entries as the usual sources of free variation, it is possible, in certain cases, to ascribe the difference between equally acceptable phonetic variants to a difference in rule ordering, in other words, Equivalent Interchangeability. Consider the two rules of American English originally discussed in Chomsky 1964 as part of an argument against the "linearity condition" in Structuralist phonemics:-

(17) American English: Chomsky 1964

A $V \rightarrow V: / \text{ ______ } G [+ \text{ voice}] *$

B $\left\{ \begin{array}{l} t \\ d \end{array} \right\} \rightarrow D / V \text{ ______ } V$

For many speakers of American English "writer" and "rider" are pronounced as $[\text{ra:yDr}]$ and $[\text{ra:yDr}]$ respectively i.e. with a contrast in vowel

* Footnote

The diphthongs are transcribed with a glide G following the nucleus to facilitate the statement of Lengthening. However the transcription in no way effects the point under discussion.

length but with identical medial consonants (a voiced flap). Chomsky assumes that the underlying representations of these forms contain different consonants (on the basis of the contrast in the verb "write" and "ride" from which the nouns are derived), and identical vowels (since vowel length is predictable given a consonantal voicing contrast and, in any case, length is not an underlying feature). In order to derive the surface phonetic forms within the framework of classical generative phonology, one simply orders (17) A extrinsically before (17) B, as Chomsky does. Thus the difference in vowel length between "writer" and "rider" is established on the basis of the voicing of the following /t/ or /d/, before these two stops are neutralized to a flap. If intervocalic flapping applies before vowel lengthening, the vowels of both words become long and "writer" and "rider" are pronounced identically as [ra:yDr]. Indeed, this situation does obtain in certain dialects.

(13) shows the derivations of "ride", "rider", "write" and "writer" in Dialect X (that originally described by Chomsky) and Dialect Y (where "rider" and "writer" are homonymous on the phonetic surface).

(13) American Dialects

X	UR	/rayd/	/raydr/	/rayt/	/raytr/
	A	ra:yd	ra:ydr	-	-
	B	-	ra:yDr	-	rayDr
	PR	[ra:yɔ̃]	[ra:yDr]	[rayt]	[rayDr]
Y	UR	/rayd/	/raydr/	/rayt/	/raytr/
	B	-	rayDr	-	rayDr
	A	ra:yd	ra:yDr	-	ra:yDr
	PR	[ra:yɔ̃]	[ra:yDr]	[rayt]	[ra:yDr]

Given the dialectal variation in the pronunciations of "writer", it

is reasonable to suppose that in certain idiolects [rayDr] and [ra:yDr] occur as free surface variants. Let us refer to such an idiolect as Idiolect Z. For Z the ordering of the rules in (17) is interchangeable and furthermore equivalent (in the technical sense defined above).

It should be emphasized that in Idiolect Z it is not the case that Lengthening is simply optional and follows Flapping. Assuming such a status for Lengthening would indeed correctly predict the variants [rayDr], [ra:yDr]. However, the fact that the rule is obligatory is shown by the realizations (in all dialects) of "ride" and "rider" with long vowels. Furthermore, any attempt to salvage such a solution by making rule optionality dependent upon the phonological make-up of "riter" would not only be ad hoc but would also comprise a notational variant of GPOD, inasmuch as the extrinsic ordering of rules provides access to the derivational history of each successive input string (see Dinnsen 1974).

Another example of Equivalent Interchangeability involving (17) B, Flapping, a rule modifying the vowel in pairs like "rider"/"riter" can be shown to obtain in Canadian English, described by Joes (1942). Halle's (1962) analysis is treated in detail following Linda Norman, in the next subsection where the precedence principles operating in American dialects X and Y are also dealt with. Here it will suffice to state the rule of vowel raising involved, (19) A, along with the relevant derivations (20), and to note that according to Joes, the introduction of Flapping under American influence into the dialect of Ontario resulted either in the distinction of "rider"/"riter" by the height of the diphthong alone, or in their homonymy.

(19) Raising in Canadian English

a → ə / _____ G [- voice]

(20) Ontario Dialects

X	UR	/rayd/	/raydr/	/rayt/	/raytr/
	A	-	-	rəyt	rəytr
	B	-	rayDr	-	rəyDr
	PR	[rayd]	[rayDr]	[rəyt]	[rəyDr]
Y	UR	/rayd/	/raydr/	/rayt/	/raytr/
	B	-	rayDr	-	rayDr
	A	-	-	rəyt	-
	PR	[rayd]	[rayDr]	[rəyt]	[rayDr]

The dialectal situation in Ontario English in 1942 thus provides an additional example of a rule-pair whose alternate orderings have different phonetic reflexes, both of which are acceptable.

It will be clear from this limited discussion of Equivalent Interchangeability, that the crucial factor which keeps the latter ordering type separate from type 4), Potential Interchangeability, is the relative acceptability of the two ~~outputs~~. Under the "equivalent" brand of Interchangeability, both orderings produce acceptable results; under the "potential" variety, only one order of application yields an acceptable form. This is indicated above by rewriting the output of the ordering A, B as c as under Equivalent Interchangeability, but by marking the output of the ordering B, A with an asterisk to show that it is unacceptable. The fact that c and *d are not mutually substitutable is further shown by the absence of cd. To return to the data, although I have suggested that the two pronunciations of "writer" may be in free variation in some idiolects, the alternate orderings may be adduced as constituting the difference between neighbouring dialects. Extending the line of argumentation to its logical conclusion, the mechanism of reordering could be used to explain

similar phenomena in language change. One has only to turn to Kiparsky's 1968 paper, referred to at the beginning of this section, to see how reordering has been posited for Swiss German dialects both synchronically and diachronically. This analysis forms the subject-matter of the next section.

It might seem that the discussion has taken a retrograde step: surely it is the contention of this thesis that extrinsic ordering is unnecessary and that the application of all (phonological) rules is predictable on a language-independent basis? Consequently, I must hold to be false the hypothesis that two dialects may differ solely in the relative ordering of a pair of rules. Indeed, such a claim will be refuted in the next section. If Potential Interchangeability is fictitious, does it not also follow that Equivalent Interchangeability cannot "exist"? Let me provide an example from Hungarian to demonstrate that only the UDRA hypothesis is capable of accounting for Equivalent Interchangeability.

According to Vago (1974), Hungarian has two assimilation rules, regressive z-Assimilation (z-Ass) and progressive w-Assimilation (w-Ass).^{*} Vago's statement of the rules is reproduced in (21):-

(21) Hungarian: Vago 1974

$$\begin{array}{ll}
 \text{A} & \underline{z}\text{-Ass} \quad z \rightarrow [\alpha_F] \quad / \quad \underline{\quad} \quad + \begin{bmatrix} C \\ \alpha_T \end{bmatrix} \\
 \text{B} & \underline{w}\text{-Ass} \quad w \rightarrow [\alpha_T] \quad / \quad \begin{bmatrix} C \\ \alpha_F \end{bmatrix} \quad + \quad \underline{\quad}
 \end{array}$$

Clearly the simultaneous application of both rules to underlying

* Footnote

In fact the positing of underlying /w/ is suspect since a late rule merges it unconditionally with /v/; however this absolute neutralization is irrelevant to the present argument.

/ɔɪ + wɛl/ and /aɪ + wɛl/ would result in Metathesis of /n + w/, rather than Assimilation. Since their relative ordering must therefore be sequential, the application of the one yields a form not meeting the structural description of the other. In fact, such an interaction produces exactly the correct surface phonetic forms, since [ɛɪwɛl], [ɔɪwɛl] and [aɪwɛl], [ɔɪwɛl] are free variants.

Now consider once again the GROD hypothesis as spelt out in SPE:-

- (22) "It is always possible to order the rules in a sequence and to adhere strictly to this ordering in constructing derivations
....."

(page 18)

There is simply no way of ordering (21) A and B and of adhering strictly to that ordering which will derive both sets of variants for Hungarian. But under the UDRA hypothesis both possible orders are permissible. Notice furthermore that these data from Hungarian serve to refute the original KSN-version of the UDRA hypothesis, under which simultaneous application is permitted. Of course, it could be argued by proponents of the simultaneity hypothesis that this mode of interaction does not operate on assimilation rules. However, as has been indicated, further data are presented in Chapter 5 from Yavelmani Yokuts (and other languages) which cannot be accounted for in this way, but which can only be regarded as counterexamples to the claim that rules may apply simultaneously.

By now it will be apparent that only the UDRA hypothesis is capable of describing Idiolect Z for American English regarding the rules of (17), and the dialectal situation in Ontario described by Joos. Under GROD there could never exist free variation between the alternate pronunciations of "writer", one with a short vowel, the other with a long vowel, in American English, one with a low diphthong, the other with a raised diphthong in Canadian English - for GROD claims that it

is always possible to adhere to a strict ordering in constructing derivations. Only UDRA permits the (apparently) random application of (17) in Idiolect Z and of (19) and (17) B in Ontario. Furthermore UDRA is also capable of describing the dialects without free variation in a more insightful way. This will be demonstrated in full in the next section where purported reordering from conservative to innovative dialects is refuted as a mechanism of linguistic change. In other words, potential interchangeability as opposed to equivalent interchangeability is shown to be a fiction.

Having pointed out the salient characteristics of the "potential" brand of Interchangeability by contrasting it with the "equivalent" variety, it now remains for us to recapitulate on the nature of Hetzron's third order type, Unilateral Applicability. In the Schema this is shown by giving the output c to a single ordering, namely, A, B. The impossibility of the ordering B, A is indicated by marking A with an asterisk when it follows B (= i) or by marking B in this way when it precedes A (= ii). Now recall that the label Unilateral Applicability subsumes the "intrinsic element" of intrinsic feeding and intrinsic (mutual) bleeding. Let us first take case 3) (ii) from the Schema. In the text Hetzron glosses this unilateral relation as "coextensive supplying" and notes that in such a case "the output of A supplies all the 'raw material' for B, whereas if A only supplies part of the input for B, which could still apply without this specific source, we have an instance of (1d)" (= 4), Potential Interchangeability - JPMcB; page 3, original emphasis). This statement cuts right across the feeding/bleeding categorization in an interesting way. In saying that A must supply all the inputs for B if the interaction is to be classified as unilateral applicability, it stipulates that any representation undergoing B will previously have undergone A.

This does not necessarily mean that every output string from A will meet the structural description of B - as we shall see, both possible situations obtain.

Consider again the rule of Spirantization in Goidelic Celtic and the necessity of a rule shifting the place of articulation either of $d \rightarrow g$ or of $z \rightarrow \gamma$, depending on whether Spirantization applies first or second. Under the analysis with intermediate /z/ (which never surfaces phonetically), the general process of Spirantization resulted in an unacceptable output in the case of one segment. Put slightly differently, part of the function of Spirantization could be viewed as the provision of the 'raw material' for the $z \rightarrow \gamma$ rule. Note that only one of A's output segments undergoes B i.e. /z/; so although the analysis qualifies as Unilateral Applicability subtype (ii) in which A coextensively supplies B, there exist segments which have undergone Spirantization but which do not meet the structural description of B e.g. A spirantizes $p \rightarrow f$, $b \rightarrow w$, $k \rightarrow x$, etc. The other treatment of these data with intermediate /g/, is not an instance of Unilateral Applicability subtype (ii), for Spirantization, ordered after the $d \rightarrow g$ rule by Proper Inclusion Precedence, could still apply without this specific source to all other initial plosives. As we shall see presently, the analysis falls under subtype (i). Before moving on to discuss it, let us pose the following question regarding the "phonologically fictitious" segment which arises in the $d \rightarrow z$ analysis:

Is it necessarily the case that a phonologically fictitious segment results at an intermediate level of derivation when A coextensively supplies B?

In §2.2 we have already discussed a case in which every output segment

from A undergoes B - Postal's treatment of Mohawk (see Table I on page 35). In Postal's analysis, Stress applies to a vowel before D, Tone to a stressed vowel before ?, h, R and Length to a stressed vowel before C or to any Tone-bearing vowel regardless of context. In stating the rules as he does with cover-symbols, Postal obscures the fact that all Tone-bearing vowels in Mohawk are also long, so that his intermediate stressed short Tone-bearing vowel is an artifact. (Recall that R = any resonant i.e. w, y, n, r; C = any consonant, resonant or not, including systematic w and y; D = any non-vowel i.e. C or h,?). In (23) I list the output vowel of each rule alongside its environment, but using only one cover-symbol 'O', to be interpreted as any obstruent, i.e. $\begin{bmatrix} + \text{ cons} \\ - \text{ son} \end{bmatrix}$.

(23)	Rule	Output	Following Environment
	Stress	\acute{V}	O, w, y, n, r, h, ?
	Tone	\hat{V}	w, y, n, r, h, ?
	Length	$\acute{V}:$	O_1^1 V
		$\hat{V}:$	w, y, n, r, h, ?

(23) makes explicit the fact that, whereas not all stressed vowels receive Tone, they all undergo Length.

I do not think that the argument against phonologically fictitious segments can be brought against Postal's analysis quite as forcefully as it can be brought against the analysis of Goidelic with intermediate /z/ (assuming, of course, that Postal's rules with minor modifications are in fact intrinsically ordered - as argued by KSN). For instance, one could regard intermediate \acute{V} as unspecified (blank) for Length, as are all stressed vowels prior to the application of the Lengthening Rule. Once that feature has been assigned, a redundancy rule could fill in the unmarked value for length in all other cases.

/z/, on the other hand, represents a cooccurrence of features which are not within the phonological or phonetic inventories of the languages concerned. In this respect its status is far more suspect.

It may well be that if a constraint on abstractness were formulated with enough rigour to rule out the fictitious /z/ analysis, it would also encompass Postal's analysis of Stress and Length in Mohawk: I leave this question for future research and merely criticize Postal here for his opaque use of cover-symbols in rule formalization.

However, the point to which I hope to have drawn attention is the way in which Hetzron's classification cuts right across the more widely accepted dichotomy of feeding/bleeding. Whenever it is possible to reverse an ordering, we have an instance of Potential Interchangeability, irrespective of whether A increases or decreases B's input. The only examples of feeding which can be classified as applying unilaterally are instances of coextensive supplying - and we have discussed the salient properties of this limited type of interaction.

It does not follow, because no extrinsic ordering statement is necessary for A to feed B, that the relation is not interchangeable. KSN are equating feeding order with intrinsic order but a bleeding relation is theoretically possible in such cases. Take KSN's first example of feeding from Kiparsky's analysis of Finnish (1965; see page 28 above). In fact Kiparsky proposes the counterfeeding order of the two rules for the Standard dialect, whilst the feeding relation discussed in the main text of KSN, obtains for eastern dialects. In Chapter 5 it will be shown that reordering has not in fact taken place. However, the logical possibility of reordering means that the Finnish data cannot be said to apply unilaterally. Nor can KSN's example from SPE involving Spirantization of /t/ to /s/ in English which feeds the Palatalization

of /sɪ/: Spirantization does not supply all the 'raw material' for Palatalization, which would still apply without this source.

As a final point on coextensive supplying or "irreversible feeding", consider the SPE treatment of Sapir's Southern Paiute data taken from his famous 1949 paper, 'The Psychological Reality of Phonemes'. The rules which will concern us are those effecting devoicing (SPE page 349; see page 31 above - (5)), since KSN cite them as examples of intrinsic feeding. The interesting point here is that although the segment which is affected by A does not undergo B, it provides the crucial environment for the operation of B. Thus coextensive supplying does not occur in the usual sense but nevertheless, B could not exist if it preceded A: the first rule devoices vowels in word-final position and before nongeminate obstruents: the second rule devoices nonstrident continuants before voiceless vowels. This contextual dependency of B on A is not immediately clear from Chomsky and Halle's formalization since the environment of B, "Glide/Nasal Devoicing", is specified as $\begin{bmatrix} - \text{ cons} \\ - \text{ voice} \end{bmatrix}$. However, in effect this specification can

only be met by vowels rather than semivowels, since the latter are not underlying in Southern Paiute but result only as sandhi phenomena and therefore cannot cooccur.

The difference between coextensive supplying of the type discussed for Celtic and Mohawk, and the contextual dependency of one Devoicing rule on the other might be compared to the distinction made by Kenstowicz and Kisseberth (1977 Chapter 2) regarding (positive and negative) "input exceptions" and "environment exceptions". The term negative input exception applies when a segment is specified as failing to undergo a particular phonological rule; when a segment is a positive input exception it is specified as undergoing a minor rule. Envir-

onment exceptions, on the other hand, either fail to condition the application of a particular rule (the negative case), or they actually do condition a minor rule (the positive case). One way of capturing the parallelism might be to refer to coextensive supplying of an input and coextensive supplying of an environment.

Having made this distinction, we may tentatively answer the question posed on page 99 regarding fictitious segments:

When rule A coextensively supplies the input (but not the environment) to rule B a fictitious segment results at the intermediate level of derivation, either

- a) because rule A does not express a true surface generalization about all the segments it affects (e.g. the analysis of Celtic mutation with intermediate /z/); or
- b) because A and B are in fact one rule which specifies a change in two cooccurring features (e.g. Stress and Length in Mohawk).

Incidentally, Hetzron's syntactic example of Unilateral Applicability subtype (ii) involves the splitting up of a single transformation into two steps. Surely Dative-Movement is one rule as in (24), deriving "I gave Charley money":

(24) I gave money to Charley
 1 2 3 4 5
 ⇒ 1 2 5 3 ∅

Hetzron divides the transformation into an optional rule moving Dative-Complement to a position between verb and Accusative-Complement, and a deletion rule. Obviously the former supplies all the proper input to the latter: "*I gave to Charley money". But this fact is naturally handled if the process is stated as an optional unitary one.

Let us stay with Hetzron's examples from English and cite his illustra-

tion of Unilateral Applicability subtype (i). This type of interaction is in fact mutual bleeding which has already been dealt with in detail in the two preceding sections. We will therefore use Hetzron's example to recapitulate the points discussed above and to make concluding remarks. "Exceptional" plural formations like "man ~ men", "child ~ children", "sheep ~ sheep", are ordered before the regular morphophonemic cases. If the ordering were reversed, all nouns would receive an "s" plural and the irregular cases would never have a chance to apply. In Hetzron's words "A could not exist if it followed B" because "B refers to a class that A is a part of and alters it so that it would be no more eligible for A". To summarize the above discussion of mutual bleeding, PIPrec states that the more context-restricted of a pair of mutually bleeding rules must apply first. Although it originally met the structural description of B, once A has applied to S this is no longer the case. Since the pair of rules operate in complementary (= disjunctive) environments, the phonologist is able to state the less restricted rule as if it were context-free. In other words, PIPrec of mutually bleeding rules is simply a corollary of the Elsewhere Condition and conventions on disjunctive ordering. The particular example chosen by Hetzron brings out the fact that frequently the 'elsewhere' rule (here "s" plural formation) is the regular case which applies to open classes. This was not apparent from Saporta's Latin American Spanish data nor from Chafe's Caddo data.

By citing data from a variety of languages, this section has provided an overview of the primary mode of rule interaction, feeding and bleeding. Needless to say, I am indebted to Prof. Hetzron for his unique appraisal of the issues involved. * We now turn in the next

section to data which have been dealt with many times in the literature. I trust that by keeping in mind the distinctions made above, the discussion will prove more lucid.

* Footnote

I was also fortunate enough to have personal discussion with Prof. Hetzron, which proved invaluable in writing this section.

§ 3.4 Reordering out of Bleeding Order

In this section I shall evaluate the claim that potential interchangeability from a bleeding order to a feeding order constitutes a mechanism of linguistic change. Put slightly differently, I shall consider whether the reordering of a pair of rules out of a bleeding order can comprise the difference between two dialects. § 3.4.1 treats in detail the two dialects of American English and the two dialects of Canadian English which were cited in § 3.3. as illustrations of equivalent interchangeability just in case the surface phonetic forms of each pair were equally acceptable. § 3.4.2. discusses two rules of Swiss German and the interaction of each with Umlaut - a case which has been well documented in the literature. For both the English and the German data I shall conclude that the UDRA hypothesis is capable of dealing with the facts in a more insightful way than a theory with the power of extrinsic ordering.

§ 3.4.1. The case of "writer" and "rider"

In the dialect of American English discussed by Chomsky in 1964 the application of (17) A, Vowel Lengthening, and B, Flapping, to underlying /raytr/ and /raydr/ did not result in phonetic surface homonymy but did constitute a violation of the Linearity Condition - the underlying representations differ in their medial consonants whereas the phonetic representations differ in the length of the preceding vowel, being [rayDr] and [ra:yDr] respectively. In (25) the derivation of "writer" in this dialect (henceforth Dialect X) is contrasted with that of the same underlying form in other American dialects (henceforth Dialect Y), where A and B are purported by GROD to apply in the opposite order and "writer" and "rider" are homonymous phonetically:-

(25) Derivation of "writer" in American dialects

Dialect X	Underlying Representation	/r a y t r/
	A Lengthening - inapplicable	- ↓
	B Flapping	D
	Phonetic Representation	[r a y D R]
Dialect Y	Underlying Representation	/r a y t r/
	B Flapping	↓ D
	A Lengthening	a:
	Phonetic Representation	[r a: y D r]

Because of its greater power, GROD can claim that the relative ordering of the same pair of phonological rules applying to the same underlying representations may constitute the difference between dialects. In this case, Flapping feeds Lengthening in Dialect Y but is prevented from supplying the input to Lengthening in Dialect X because it is extrinsically ordered after it. The claim, then, implicit under GROD, is that Dialect Y has reordered the rules of (17) out of a bleeding

order. To attain descriptive adequacy, UDRA must be able to explain this dialectal variation without recourse to extrinsic ordering statements. I shall proceed to demonstrate that UDRA is capable of doing so.

Firstly, let us consider the functional relations between the rules of (17) and the phonetic representations of Dialects X and Y. In Dialect X the surface realization of "writer" as [rayDr] is opaque with respect to Vowel Lengthening, since it meets the structural description of that rule (by containing a voiced segment in the right-hand environment) but fails to undergo it. Put another way, [rayDr] constitutes a surface violation of Lengthening. Now contrast Dialect X with Dialect Y: in the latter the phonetic reflex of "writer" is transparent with respect to Vowel Lengthening. In other words, the formulation of (17) A expresses a true generalization about surface phonetic representations - vowels are long before voiced segments. *

By considering the functional relation between the rule of Vowel Lengthening and the output phonetic strings in Dialects X and Y, we have uncovered a fundamental difference between the dialects. In Dialect X, Lengthening is a regular phonological rule, sensitive for its application to the underlying voicing of the following plosive. On the other hand, in Dialect Y, Lengthening is "automatic". By "automatic" I refer to a process which admits of no exceptions, is not morphologically or syntactically conditioned and which applies after all phonological rules.

* Footnote

Yet the cost of this transparency is the more complex statement of allomorphy required in Dialect Y. In Dialect X the morpheme "write" preserves its vocalic nucleus in both allomorphs, whereas in Dialect Y the allomorphs of "write" differ not only consonantally but also in having no fixed vocalic nucleus - see Kiparsky 1971 for the concept of Paradigm Uniformity which is held to override tendencies to reorder out of bleeding order.

In this sense, "automatic rule" corresponds to Norman's "low-level phonetic rule" which she defines as "a rule which adds features to a minimally specified feature representation under non-identity" i.e. which is "not a copy operation" (1973a p. 143). As Norman notes in turn, her use of the term "low-level phonetic rule" is essentially that of Sanders' "allophonic rule" which links a (taxonomic) phonemic representation to its allophones (1972a). More significantly, the rule-type which all these terms are endeavouring to capture is defined by Postal as a "Detail Rule", applying to the output of the phonological component proper ('Aspects' 1968) - my PDRs. The significance lies in the fact that PDRs constitute part of GROD, thus countering the claim that the rule-type is an ad hoc invention by proponents of UDRA. To return to the data, we may conclude that since Dialect Y, unlike Dialect X, contains (to my knowledge) no phonetic violations of Lengthening, Vowel Lengthening is a PDR in this dialect. From this it follows that Vowel Lengthening in Dialect Y will apply after the phonological rule of Flapping. Therefore Dialect Y presents no problems to the UDRA hypothesis which is capable of predicting the precedence of Flapping over Lengthening on the basis of the function of those rules in the grammar.

It remains for us to account for the ordering Lengthening, Flapping in Dialect X without recourse to an extrinsic statement. Recall that in this dialect, unlike the situation discussed above, Vowel Lengthening constitutes a regular phonological rule, not an automatic generalization (as defined above) about surface phonetic representations. Now consider Flapping: this rule is not allophonic either - if it were, we would not be able to appeal to such a distinction in ordering Vowel Lengthening after Flapping in Dialect Y. However, it does not have the same status as the other phonological rules in Dialect X (e.g. Vowel Leng-

thening): it is a contextual neutralization process which merges the voicing distinction between underlying /t/ and /d/ intervocalically, so that both plosives appear as [D] on the phonetic surface. Kiparsky has argued (1973) that absolute (i.e. context-free) neutralization processes should be constrained to apply to derived representation. It is therefore reasonable to conclude that if such a constraint proved valid, neutralization processes must apply late in the phonological component proper - or at least "not first", assuming that the bulk of phonological rules do not effect neutralizations. This assumption also follows as an extension of the claim, to be supported in detail in Chapter 4, Counterbleeding, that deletions never take applicational precedence. Deletion is, as it were, the ultimate case of neutralization, when the presence of a segment is removed from the output of the grammar. Once we adopt such an assumption about deletion and neutralization, it follows automatically that in Dialect X Flapping applies after the non-neutralizing phonological rule of Vowel Lengthening (but nevertheless as part of the phonological component proper - rather than as a PDR). These arguments regarding the relative status of rules to which one has access under the UDRA hypothesis, are in no way vitiated by Halle's original (1959) attack against the Structuralists' phonemic level. Although Halle argued convincingly that linguistically significant generalizations are lost if one is forced to state rules linking morphophonemic and phonemic representations separately from those linking phonemic and phonetic representations, it does not follow that all the rules of the phonological component convert morphophonemic representations into phonetic representations. One can accept that final obstruent devoicing in Russian constitutes a single generalization, applying both to palatals and non-palatals, and still recognize that other rules result in intermediate levels of representation between

underlying forms and the phonetic surface - including the taxonomic phonemic level. Whilst it is clearly not the case that there is one level for every line in a derivation, I think it is empirically justifiable to claim that there are more than two linguistically significant levels to a derivation. Yet the existence of only two such levels, underlying and surface phonetic, is precisely what Halle's argument implies. Under the UDRA hypothesis the fact that derivations do contain intermediate levels is exploited in a nontrivial way - the functional relation between a rule and its output at a particular level, as well as the nature of the conditioning environment (e.g. "is it morphological?"), are taken into account in determining the intrinsic ordering of the rules. In contrast, although each independently justified level is definable within GROD in terms of a particular line in the derivation, this is merely a consequence of the strict sequential ordering imposed by that theory, whereby n rules result in a derivation with $n + 1$ lines. Unlike UDRA, GROD fails to exploit the fact that it generates gratis more than two linguistically significant levels of representation. From this it follows that UDRA is the richer, more interesting hypothesis. *

Consideration of the functional relations between the rules also plays the crucial rôle in determining their order of application for the Canadian dialects. As cited in the preceding subsection, certain dialects of Ontario (henceforth Dialect X) contrast "writer" with "rider" by the height of the diphthong, as [rɛyDr] and [rayDr] respectively. In other dialects (henceforth Dialect Y) both nouns exhibit

* Footnote

See Part II Chapter 2 for further discussion of linguistically significant levels subsequent to Syntactic Surface Structure. See also the defence of the taxonomic phoneme in Schane 1971; Hutchinson 1973; and Smith and Wilson 1979, Chapter 6.

the low diphthong and are therefore homonymous. (26) shows how GROD accounts for this dialectal variation by reordering the same pair of rules with respect to identical underlying representations.

(26) Derivation of "writer" in Canadian dialects

Dialect X	Underlying Representation	/r a y t r/
	A Raising	↓ ə
	B Flapping	↓ D
	Phonetic Representation	[r ə y D r]
Dialect Y	Underlying Representation	/r a y t r/
	B Flapping	↓ D
	A Raising - inapplicable	-
	Phonetic Representation	[r a y D r]

I shall now demonstrate how UDRA can account for these data without the power of extrinsic ordering.

We saw that American Dialect X exhibited opacity in its realization of "writer" as [rayDr]. This was opacity of the first kind discussed by Kiparsky (1971), where phonetic strings of the type [CAD] constitute counterexamples to the rule $A \rightarrow B/C _ D$ (i.e. [rayDr] meets the structural description of Lengthening but does not undergo it.) Now recall the second kind of opacity defined by Kiparsky, which obtains when there are phonetic instances of B in environments other than C D. Clearly the phonetic realization of /raytr/ as [rəyDr] in Canadian Dialect X is an example of the latter type of opacity, for Raising appears to have applied in an environment other than before a voiceless plosive. * Now contrast Canadian Dialects X and Y: in the latter

* Footnote

Note that in Canadian Dialect X, as in American Dialect X, the gain from such opacity is that the morpheme "write" preserves its vocalic nucleus in both allomorphs.

the phonetic reflex of "writer" is transparent with respect to Raising - there is no violation of the structural description of that rule on the phonetic surface, where it appears not to have applied because its structural description is not met. Thus in Dialect Y the formulation of Raising may be said to express a true phonetic generalization.

Bearing in mind the status of Lengthening in American Dialect Y, could it be that Raising constitutes a PDR in this dialect?

The matter is, however, not as clearcut as it was when we claimed that Lengthening was a PDR. This is because Lengthening is a general process applying to any vowel and well attested before voiced obstruents for other dialects of English. Raising, on the other hand, involves one diphthong and to my knowledge is not pervasive throughout other dialects. Yet if we could claim that it is a phonetically natural process, this would help to substantiate its status as an automatic rule of pronunciation. Indeed such evidence is to hand as soon as one takes into account the manner in which the tenser articulation of [t] as opposed to [d] is anticipated in the articulation of the preceding vocalic nucleus. Consider the phonetic consequences of the assimilation of tenseness by a vocalic nucleus before fortis [t]. Ch&H note that:

- (27) "One of the differences between tense and lax vowels is that the former are executed with a greater deviation from the neutral or rest position of the vocal tract than are the latter. It has been observed, for instance, that the tongue constriction in tense [ɪ] is narrower than that in lax [i]." (SPE page 324)

More recently (1977) Halle has reviewed the "long and complicated career" of the feature [± tense]. He asserts that he and Stevens (1969) were in error when they attributed the difference between tense and lax vowels to the position of the tongue root, and goes on to substantiate the conclusions reached in SPE. Although I am aware of Ch&H's warning against the correlation of tenseness with tongue-height alone,

I think it justifiable to conclude that the Raising of the diphthong [ay] to [ey] is phonetically natural before the tense articulation of a following [t]. Thus it is plausible to argue that in Canadian Dialect Y where Raising occurs only in "write", this process constitutes a PDR, being the automatic reflex of the tenseness assimilated from the following consonant. Notice finally that this analysis hinges on the specification of the voiced alveolar flap [D] as [- tense]. We shall see presently that the opposite specification is crucial to Linda Norman's analysis.

Having presented the argument, based on Naturalness, in favour of treating Raising in Dialect Y as a Detail Rule, it follows that Raising must, as such, apply after the regular phonological rule of Flapping. If we accept this reanalysis of Halle's extrinsically ordered rules, Dialect Y poses no problems for the UDRA hypothesis. However, it is perhaps expedient at this point to refer to two issues which might be introduced as counterarguments to the above treatment of Raising as a PDR.

The first issue revolves round the apparent contradiction between the definition of PDR and that of "low-level phonetic rule" with which the former was equated above. If Raising involves the assimilation of tenseness by a vocalic nucleus, it is not a low-level phonetic rule by Norman's definition just in case it is a "copy operation" (see quotation p. 109). The latter proviso is however a moot point: the phonetic representation will not necessarily refer to a value on a scale of tenseness but rather will specify the precise height of the diphthong. Under these assumptions, the claim that Raising is a low-level phonetic rule is entirely consistent with Postal's definition of Detail Rule:

(28) "Assume that for each feature (some specified subset of features?) there exists a set of universal Detail Rules of the form:

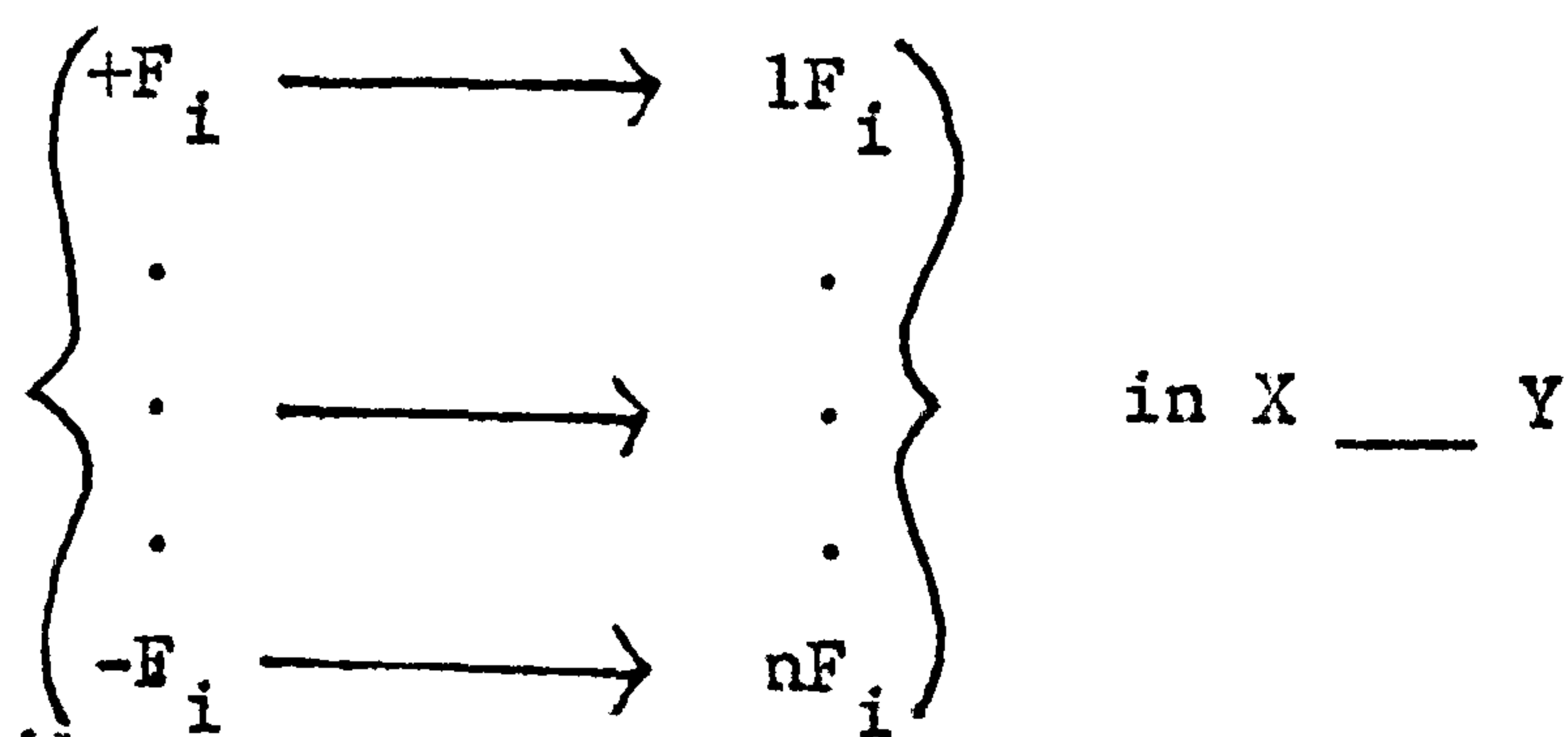

X ___ Y is a schema of environments. To fully specify the shift from binary to n-ary values it is only necessary for a particular language to indicate the proper subset of Detail Rules and to fill in the environment schemata for actual environments in each."

('Aspects', 1968 page 66)

That is, the [- low] specification for the nucleus of [əy] will be converted into an n-ary height feature. It may well be that Norman's definition can be reconciled with this formulation. In any case, it is worth emphasizing that her definition was a tentative one, as is seen in a footnote referring to her own and Hutchinson's criteria:

- (29) "... Whether either of these definitions is sufficient to exhaustively define the class of rules in the phonetic bloc is not yet clear. What is crucial to my argument is that some such formal distinction can be made to distinguish rules in the phonological bloc from rules in the phonetic bloc".

(1973a page 155, footnote 3)

As a final example against Norman's original definition, I should like to cite homorganic nasal assimilation in English. The process whereby the nasal becomes labiodental in "comfort" [ˈkʌmfət] or dental in "tenth" [tɛnθ] is clearly allophonic: in the entire literature of Phonemics I am not aware of one serious analysis postulating a labiodental nasal phoneme or a dental nasal phoneme for English. Indeed, these examples typify an allophonic process which, when formalized, duplicates a morphophonemic one i.e. the process converting the morphophoneme {n} into the phonemes /m/ and /ŋ/ in /ɪmˈprɒpə/ and /ɪŋkənˈsɪdərət/ from {ɪn} + {prɒpə} and {ɪn} + {kənˈsɪdər} + {eɪt} respectively (See reference to Smith and Wilson above). In other words, homorganic nasal assimilation in English constitutes an ideal

example in favour of Halle's argument that a linguistically significant generalization is lost by the compulsory positing of a taxonomic phonemic level. Clearly then, the rule which converts the phonemic representations of "comfort" and "tenth" into their allophones belong in Hutchinson's "phonetic bloc". From Norman's footnote 3 (= (29)) this is precisely what she wishes to subsume under "low-level phonetic rule". But surely the process is a "copy operation" for the place of articulation features distinct in labiodental /f/ are assimilated by the preceding nasal. Thus this example alone calls for a new definition by Norman of "low-level phonetic rule".

The second issue which might be raised as counterevidence to the analysis of Canadian Dialect Y presented above involves the feature [tense]. It is this feature, together with voicing which Linda Norman uses to differentiate the alveolar flap from the alveolar plosives in her 1973a paper. Before spending the remainder of this subsection in a review of Norman's analysis, I shall briefly sketch the way in which Canadian Dialect X may be treated on a par with American Dialect X. In this dialect Raising is a regular phonological rule. (This begs the question of whether it was once a PDR which has since become "phonologized"). However Flapping, although not a PDR in either dialect, is nevertheless a neutralization process for it has the same formulation for Ontario as it does in our discussion of American English. Obviously the same arguments therefore apply to the process as they did in the earlier discussion of the ordering: Lengthening, Flapping. I conclude that UDFA correctly predicts the ordering: Raising, Flapping in Dialect X, because the latter process is constrained by language-universal principles to apply late in the phonological component proper, whilst the former obeys no such restriction.

Now let us turn to Norman's analysis of both the Canadian situation and the American situation. A general point needs making first: note that in the analysis presented above it was Dialect Y in each case which was ascribed a PDR of vowel alternation, and Dialect X in each case which was given two intrinsically ordered phonological rules. However, this "rule-type symmetry" was offset by an asymmetry on the phonetic surface: in American Dialect Y the underlying representation of "write" was identical to its phonetic representation - the morpheme underwent no rules; on the other hand, in Canadian Dialect Y the opposite situation obtained, at least with respect to the vocalic nucleus - for the diphthong in "write" was the only one to meet the SD of Raising.

Norman's analysis, as we shall see, alters the balance of this asymmetry, for she postulates the diphthong of "write" [rəyt] as underlying the paradigms of "ride" and "write" in the Canadian dialects and derives [ay] from it by a rule of Lowering. This also means that Lowering will take place in exactly the same environments as Lengthening: Halle's Raising rule operated before $\begin{bmatrix} + \text{ obst} \\ - \text{ voice} \end{bmatrix}$ whereas Chomsky's Lengthening applied preceding $\begin{bmatrix} + \text{ obst} \\ + \text{ voice} \end{bmatrix}$. In the dialects which we have been referring to by the mnemonic 'Y', both Lowering and Lengthening apply in the latter environment. In (30) I present the derivations of "writer" and "rider" in both Dialects Y, following Norman's assumptions:

* Footnote

I find Norman's introductory exposition abstruse on two counts: firstly because of her delayed mention of the fact that 't-Flap' is part of a rule applying to alveolar stops regardless of voice, i.e. Flapping; and more crucially, her (41) claims that Raising applies to the output of t-Flap despite the fact that the structural description of the former specifies a $\begin{bmatrix} + \text{ obst} \\ - \text{ voice} \end{bmatrix}$ righthand environment.

(Raising = LN's (38))

(30) American Dialect Y

	<u>"writer"</u>	<u>"rider"</u>
Und. Rep.	/r a y t r/ Fl ↓ r a y D r Le ↓ r a : y . D r	/r a y d r/ Le Fl ↓ ↓ r a : y D r
Phonetic Rep.	[ra:yDr]	[ra:yDr]

Canadian Dialect Y

	<u>"writer"</u>	<u>"rider"</u>
Und. Rep.	/r ə y t r/ Fl ↓ r ə y D r Lo ↓ r a y D r	/r ə y d r/ Lo Fl ↓ ↓ r a y D r
Phonetic Rep.	[rayDr]	<u>[rayDr]</u>

Note that in both Y dialects, after Flapping has applied to "writer" the intermediate representation meets the SD of the vowel alternation rule - Flapping feeds Vowel Alternation. Yet we have seen that under the theory of UDRA developed in this thesis, Flapping follows Vowel Alternation, just in case the former effects a neutralization. Norman's analysis is therefore at variance with the one proposed here. Moreover, in the derivation of "rider" she permits simultaneity, a mode of rule application which also figures in her later discussion. Insofar as the theory presented here denies that such interactions obtain in natural language, the two treatments must be deemed mutually exclusive variants within the UDRA hypothesis. Only future research will motivate a choice

between them.

The problem posed by Dialects X is summed up by Norman as follows:

"An alternative to this analysis [= extrinsic ordering: JRMcB] (even within a theory which allows extrinsic ordering) would be to claim that alveolar flaps are inherently incapable of causing lengthening in these dialects." For a moment let us weigh up the situation: a feature is required which can be shared by [t] and [D] and hence prevent Lengthening or Lowering in Dialects X. On the other hand, [D] and [d] need to have a feature in common to account for Dialects Y. Schematically:

(31) [t]	[D]	[d]
α F1	α F1	$-\alpha$ F1
$-\beta$ F2	β F2	β F2

The features Norman decides upon are α F1 = [+ tense] and β F2

= [+ voice]. However, because of my own - rather different -

exploitation of [tense] in the Canadian dialects, it behoves me to

suggest an alternative feature specification. [length] seems a plausible

candidate, where α F1 = [- length] (and β F2 = [+ voice], as before).

That the substitution of [- α length] for [α tense] would not affect

Norman's line of argumentation can be seen from the following footnote:

(32) "It seems legitimate to question whether TENSE is the appropriate feature to use here. However, for this argument to hold, all that is necessary is that there be some feature (or combination of features) which distinguishes flaps from "full" voiced stops" (- and aligns them with voiceless stops - JRMcB).

(fn. 13, page 156; 1973a)

Returning to Norman's analysis, she reformulates Lengthening and Lowering

in Dialects X to apply only before [- tense] obstruents i.e. before /d/

alone. (33) cites (i) Lengthening and (ii) Lowering in Dialects X:

(33) (i) <u>Lengthening in American Dialect X</u>		= LN's (49)
		Lengthening II
[+ syll]	(G)	[+ obst]
↓		[- tense]
[+ long]		

(where G = glide)

"writer" = LN's (50)

Und. Rep. /r a y t r/
 |
 F1
 ↓
 r a y D r
 [ra: yDr]

"rider" = LN's (51)

/r a y d r/
 | |
 Le F1
 ↓ ↓
 r a : y D r
 [ra: yDr]

Structural Description
 of Le never met.

(ii) Lowering in Canadian Dialect K = LN's (52) Lowering A

ə (G) [+ obst
 - tense]
 ↓
 a

"writer" = LN's (53) *

Und. Rep. /r ə y t r/
 |
 F1
 ↓
 r ə y D r
 [rəyDr]

"rider" = LN's (54)

/r ə y d r/
 | |
 Lo F1
 ↓ ↓
 r a y D r
 [rəyDr]

Structural Description
 of Lo never met.

As a final point I note that the reanalysis dependent on the feature [+ tense] for the alveolar flap by no means necessitates positing the [əy] diphthong as underlying for Ontario dialects. Norman presents further dialectal evidence in its favour, on which I am unable to draw conclusions but she also admits in a footnote (fn. 15) that James Harris has pointed to the asymmetrical vowel system which results from her analysis. That Raising may be formulated as applying before [t] and [D] or just before [t] is illustrated in (34):

* Footnote

I have marginally changed the layout of LN's derivations to one which I consider more perspicuous. Notice furthermore that once again simultaneity figures crucially in her analysis.

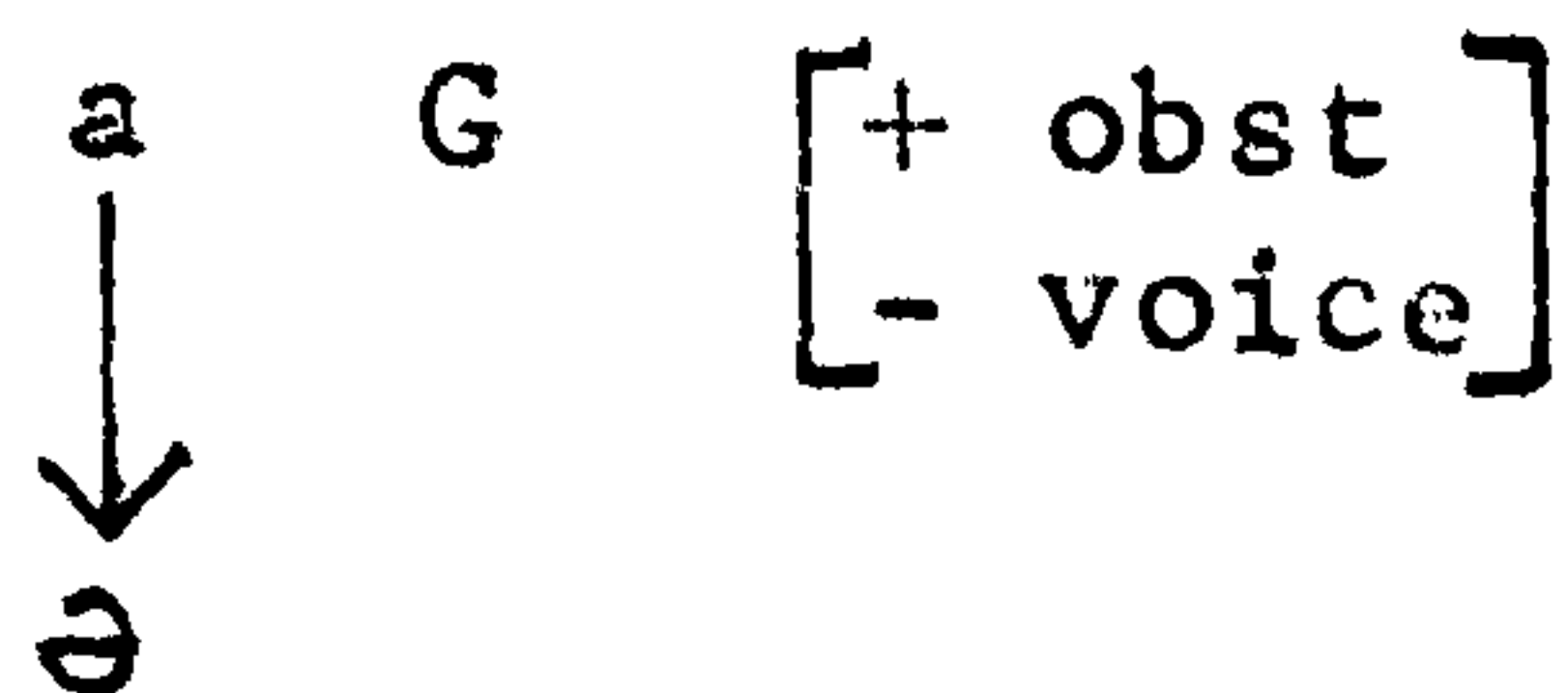
(34) Raising in Dialect X = RX"writer"

/r a y t r/

$$\begin{array}{cc}
 \downarrow & \downarrow \\
 \text{RX} & \text{F1}
 \end{array}$$

r ə y D r

[rəyDr]

"rider"

/r a y d r/

$$\begin{array}{c}
 \downarrow \\
 \text{F1} \\
 \downarrow
 \end{array}$$

r a y D r

[rayDr]

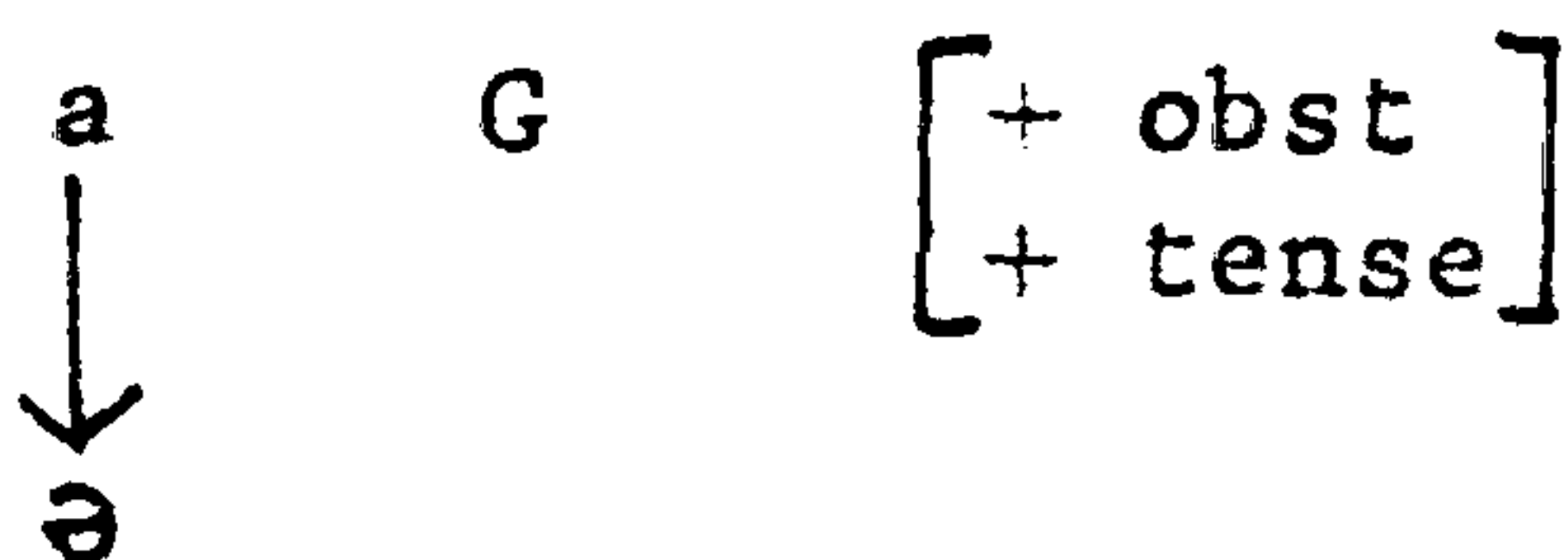
Structural Description
of RX never met.Raising in Dialect Y = RY"writer"

/r a y t r/

$$\begin{array}{cc}
 \downarrow & \downarrow \\
 \text{RY} & \text{F1}
 \end{array}$$

r ə y D r

[rəyDr]

"rider"

/r a y d r/

$$\begin{array}{c}
 \downarrow \\
 \text{F1} \\
 \downarrow
 \end{array}$$

r a y D r

[rayDr]

Structural Description
of RY never met.

The two sets of analyses presented in this subsection used widely varying "tactics" to disprove the claim that dialects may differ in their relative extrinsic ordering of the same pair of phonological rules applying to their identical underlying representations. I am confident that future research will point in favour of one or the other of these approaches and thus serve to strengthen the UDRA hypothesis which Linda Norman and myself defend. My analysis relies

upon the ontological status of phonological as opposed to phonetic rules and the claim that neutralization processes cede to others. In contrast, Linda Norman's treatment hinges upon simultaneity as a possible mode of rule interaction and the specification of the voiced-alveolar flap and the voiceless alveolar plosive as [+ tense]. To the extent that the latter specification is arbitrary and in the light of (yet to be presented) evidence against simultaneity, it is my contention that the first set of analyses be preferred to Norman's. At the same time the importance of pitting against each other different treatments within UDRA must not be underestimated. Indeed, whilst I leave the analysis of "writer" and "rider" somewhat inconclusively, I must stress my confidence that future research will point decisively to one or the other of these approaches. What needs to be emphasized at this stage in the development of UDRA is the "richness of interpretation" afforded the theory by its own plurality. Surely the fact that viable alternatives to GROD have been put forward point to the lack of theoretical satisfaction implicit in the classical explanations of "re-ordering".

§ 3.4.2 The Swiss German Case

The data from Swiss German which we are about to discuss have been well documented in the literature: Kiparsky originally brought them to the attention of generative phonologists in 1968, when he argued that the reordering of the rule of Umlaut with a vowel lowering rule had taken place in the grammar of the Kesswil dialect. Since the purported reordering took place out of bleeding order into counter-bleeding order, it substantiated Kiparsky's hypothesis that "bleeding order tends to be minimized" and established reordering as a mechanism of linguistic change. KSN challenge this analysis for, as we have seen, their hypothesis only permits mutual bleeding orders i.e. those in a PI relation. I shall argue that whilst KSN's treatment is suspect, the counterattack made by J. E. Cathey and R. A. Demers (1976; henceforth CD) is unjustified. Having shown that what may be termed the 'ideal' situation proves to be observationally inadequate, I shall turn to the theory of Natural Generative Phonology (henceforth NGP) as expounded in Joan B. Hooper's 1976 'Introduction'. The analysis we eventually decide upon will provide evidence that Hooper's conclusions are compatible with a general theory of UDR and are not tied solely to NGP's conception of "true generalization".

At various stages in the discussion reference will be made to another interaction in German dialects (Low German and Swiss German), that of vowel rounding with Umlaut. It will be seen that exactly parallel points could be made by the proponents of each position using these data.

The two Swiss German dialects which Kiparsky argues have the same pair of rules in opposite orderings are those of Schaffhausen and Kesswil. One rule involved, Umlaut, applies in morphologically conditioned

environments, whilst the other rule lowers mid back vowels before dentals, palatals and /r/. In formalizing the rules, I follow Hooper's use of the feature [coronal] rather than KSN's use of [grave]. *

- (35) A Umlaut V → [- back] / [morphological information]
- B Lowering $\begin{bmatrix} V \\ + \text{ back} \\ - \text{ high} \end{bmatrix} \rightarrow [+ \text{ low}] / \text{---} \begin{bmatrix} + \text{ cons} \\ + \text{ cor} \\ - \text{ lat} \end{bmatrix}$
- i.e. o → ɔ

In Schaffhausen, Lowering applies to singular /bodə/ "floor" to yield [bɔdə], but Lowering does not apply to the plural of that form. This, Kiparsky argues, is because Umlaut bleeds Lowering in the plural (which is one of the morphological contexts for Umlaut) by altering the [+ back] specification to [- back]. Since the structural description of Lowering requires that the vowel to be lowered is [+ back], the unlauded vowel in [bɔdə] "floors" remains mid. Translating this situation into GROD terms, Umlaut is extrinsically ordered before Lowering. The derivation of singular and plural for "floor" in the Schaffhausen dialect is given in (36):

(36) Schaffhausen

	Singular	Plural
UR	/bodə/	/bodə/
A Umlaut		↓
B Lowering	↓	-
Surface	[bɔdə]	[bʊdə]

* Footnote

Under Jakobson and Halle's (1956) system of distinctive features, palatals are classified along with dentals and alveolars as [-grave], and it is this system which KSN adopt. On the other hand in SPE palatals are distinguished from dentals and alveolars in being [- cor] while the latter are [+ cor]. However Smith (1973) cites evidence from child language acquisition which strongly suggests that palatals are [+ cor]. Although Hooper does not refer to Smith's data, she tacitly makes the same claim and it is her formulation of Lowering in

(contd.)

Now let us turn to the Kesswil dialect for which Kiparsky postulates the same underlying forms and the same rule-pair as in Schaffhausen but a different extrinsic ordering. On the phonetic surface the plural form contains a low (rounded) front vowel [ɔ̃]. Kiparsky claims that such a vowel in Kesswil [bɔ̃dɔ] "floors" derives from an underlying /o/ which has undergone both Lowering and Umlaut. In other words, in this dialect Umlaut is counterbled by Lowering - rather than bleeding the latter - just in case Lowering is extrinsically ordered before Umlaut as in (37).

(37) Kesswil

	Singular	Plural
UR	/boɔə/	/boɔə/
Lowering	↓ ɔ	↓ ɔ
Umlaut	-	↓ ɔ̃
Surface	[boɔə]	[bɔ̃ɔə]

Note, incidentally, that Lowering does not feed Umlaut in Kesswil since the latter rule applies irrespective of the height of the vowel to be fronted. Rather, the relation is one of counterbleeding for, although it is possible for Umlaut to bleed Lowering as in Schaffhausen, Lowering cannot affect the applicability of Umlaut.

Since Kesswil apparently exhibits a counterbleeding order for a pair rules which apply in a bleeding relation in Schaffhausen, Kiparsky is able to maintain his hypothesis that bleeding order tends to be min-

* Footnote contd.

Swiss German that I follow here. Indeed, insofar as the content for Lowering may be deemed phonologically natural, the very existence of the process constitutes evidence that palatals be specified along with dentals (and alveolars) as belonging to the class of [-cor] segments. For further discussion of [coronal] in relation to the underlying phonological inventory of Modern Irish and its phonetic repercussions, see Part II, § 3.1.

imized diachronically - if we take it that Schaffhausen is the conservative dialect and Kesswil the innovative one.

As we have seen, under the KSN hypothesis, every obligatory rule applies whenever its structural description is met (= Obligatory Precedence). Consequently there can be only one interaction between Umlaut and Lowering in the Swiss dialects under discussion in a KSN treatment (assuming that the dialects possess identical underlying representations) - both rules apply simultaneously. Since the difference between Schaffhausen and Kesswil cannot lie in the relative extrinsic ordering of Umlaut and Lowering, there must be another difference. According to KSN, the phonology of the Schaffhausen dialect differs from that of Kesswil by containing "a general rule to the effect that all front rounded vowels are non-low" (page 12). The rule is cited as (38) (= KSN's (20) c.)

(38) Schaffhausen

Raising

$$\left[\begin{array}{c} \text{V} \\ -\text{back} \\ +\text{round} \end{array} \right] \longrightarrow [-\text{low}]$$

In Schaffhausen, the vowel of underlying plural /bodə/ does not meet the structural description of (38) being [+back], so (38) cannot apply to the UR. But Umlaut and Lowering do apply to this form under the KSN hypothesis and once these rules have simultaneously yielded [b^uödə] the SD of (38) is met with the result that [^uö] is raised to [ö], as shown in (39) overleaf. By claiming that rule (38) is present in Schaffhausen but not in Kesswil (where Umlaut and Lowering apply simultaneously to yield [^uö] - which is the phonetic surface segment in this dialect), KSN are able to account for the change undergone by Innovative Kesswil in terms of rule loss. The implication is that previously the grammar of Kesswil contained rule (38) just as Conservative Schaffhausen still does today, but that the rule was lost resulting in the surface phonetic

occurrence of [ö]. To quote KSN: "This reflects a type of linguistic change by rule loss which is quite natural and well-attested in other languages and language families". (KSN page 22).

(39) KSN's derivation of plural [bödə] in Schaffhausen

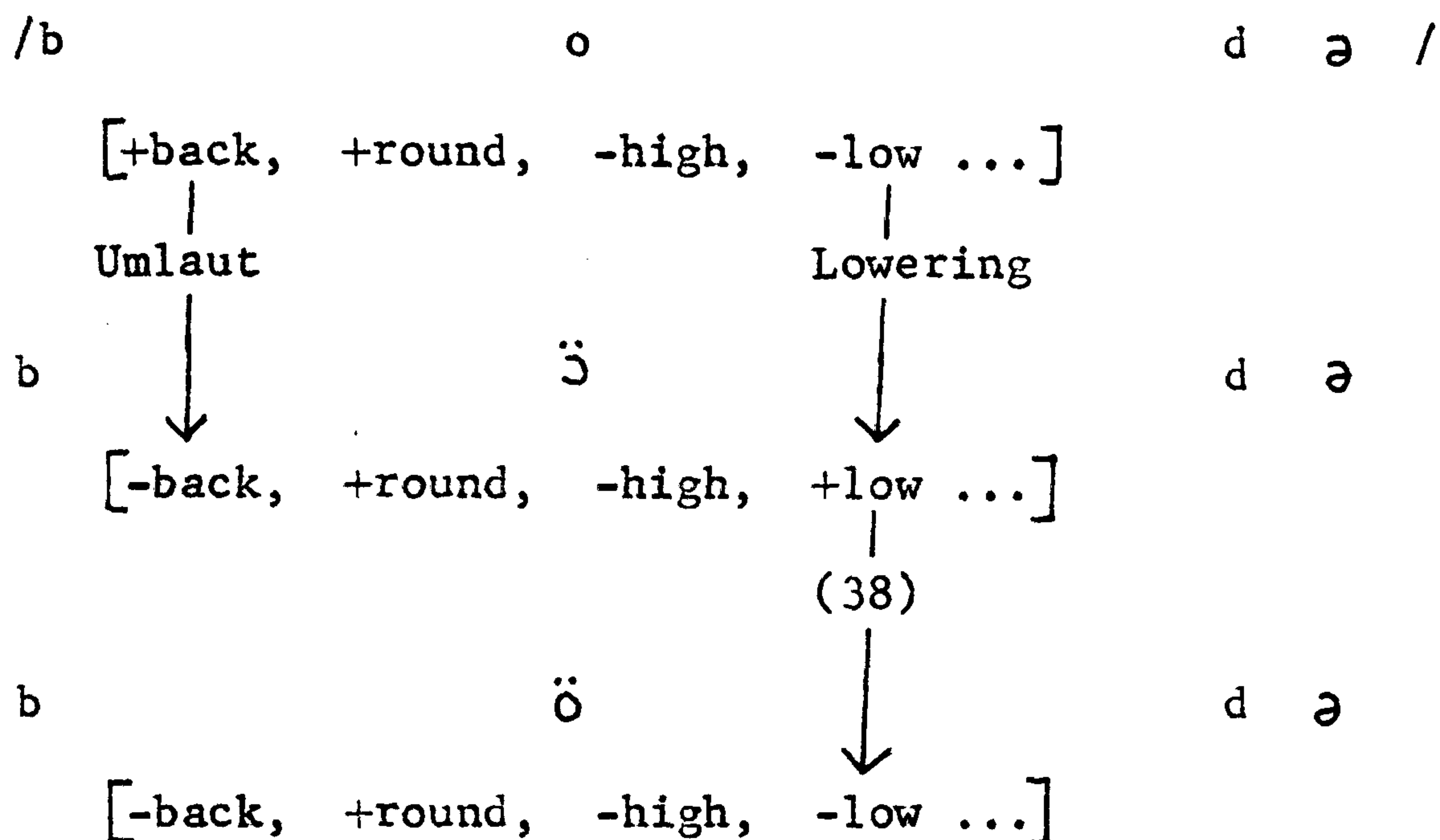

I have quoted KSN's claim for the "general rule" (38) without commenting on how such a rule is to be interpreted. The apparent tolerance of KSN's impreciseness of formulation is due not to any lapse on my part but rather to the fact that CD make a great deal (not to say too much) of this very point. However, before moving on to a critique of CD, I should like to comment on the counter-intuitive character of derivations like (39), and thereby implicitly undermine the claim, refuted by UDRA, that rules may apply simultaneously.

G. K. Pullum (1976c.) makes the following observation:

- (40) "Linguists very frequently seem to give evidence of a tacitly held belief that there is [similarly] something inept and risible about a linguistic analysis which determines that certain structures are assigned a derivation of the general form $A \rightarrow B \rightarrow A$, that is, a derivation in which an underlying representation (or some nonultimate remote representation) is mapped on to an intermediate form distinct from it, and then on to a surface (or other superficial) representation which is identical with the earlier stage."

(1976c.; page 83)

After citing syntactic and phonological examples where appeal is made to a "rule of thumb", Pullum discusses how a prohibition on what he calls 'The Duke of York Gambit' would select against exactly those analyses which seem objectionable on independent grounds. Among such cases is the SPE analysis of "table" and "tabular" which Pullum describes as "a reductio ad absurdum of the position that even distant etymological relationships are to be captured in the grammar if rules can be constructed to achieve this." (ibid. page 88). He then points out that Ch&H derive the normal pronunciation [tʰɛbjələr] through a sequence involving "underlying /tɛbulær/" * and "intermediate /tɛbjɪlær/ and /tɛbjɪlær/" (sic: JRMcB). This, he claims, runs [-tense] → [+tense] → [-tense]. Moreover the variant [tɛbjʊlər] may also be derived from /tɛbulær/ via the intermediate steps /tɛbjɪlær/ and /tɛbjɪwlær/ which involves [+round] → [-round] → [+round].

Now observe the way in which the value of the feature [low] is flipped from minus to plus by Lowering and then from plus back to minus again by rule (38). Clearly there is a striking similarity between these SPE analyses and KSN's treatment of Schaffhausen: they are all intuitively unacceptable in their exploitation of the Duke of York Gambit. Now it is true that Pullum comes to the unsatisfactory conclusion that a constraint banning the Gambit is virtually impossible to formulate. Nevertheless this does not detract from the fact that the use of the Duke of York Gambit is easy to detect in analyses which employ it. Moreover - and this is the crucial point made by Pullum - such analyses are typically those which we would want to reject on independent grounds.

* Footnote

In fact Ch&H's UR is /tɛbl + ær/ - GKP's /tɛbulær/ results after the application of an Epenthesis rule and the Laxing of /ɛ/ on the first cycle. However the important point here is that the original epenthetic vowel is [-tense]. Apart from an orthographic difference between Ch&H's [y] and GKP's [j], any divergence on GKP's part is purely expository.

Thus the SPE analyses of 'table/tabular' violate constraints on the abstractness of URs and a more realistic grammar would choose to relate such forms in the lexicon by some device comparable to Vennemann's 'via-rules'. As for KSN's proposal for Schaffhausen, this would not be permitted within a theory of phonology incorporating UDRA such as the one outlined here, just in case the ensuing analysis necessitated an impermissible mode of rule interaction. To put this another way, the claim that simultaneity is not a possible mode of rule interaction is supported by the fact that for the Swiss German data simultaneous application enables a derivation to arise which employs the undesirable gambit. We may conclude, then, that KSN's analysis not only contravenes the theory of UDRA proposed here but is also counter-intuitive.

Let us now turn to the other rule of Swiss German alluded to above. The interaction of Umlaut with a rule rounding low back vowels provides parallel instances of Kiparsky's purported reordering and KSN's "general rule" resulting in simultaneity and a Duke-of-York-style derivation. (41) gives the relevant rule of rounding (Umlaut being as in (35) A), whilst (42) presents the two orderings proposed by Kiparsky for i) Conservative dialects and ii) Innovative dialects:

(41) Rounding $\left[\begin{array}{c} \text{v} \\ + \text{ back} \\ + \text{ low} \\ + \text{ long} \end{array} \right] \longrightarrow [+ \text{ round}]$

i.e. $\bar{a} \longrightarrow \bar{o}$

(42) i) Conservative dialects

	Singular	Plural
UR	/ʃwān/	/ʃwān/
Umlaut		↓
	↓	æ
Rounding	↓	-
	ō	
Surface	[ʃvōn]	[ʃvæ̃n]

(42) ii) Innovative dialects

	Singular	Plural
UR	/ʃwān/	/ʃwān/
Rounding	↓ ɔ̄	↓ ɔ̄
Umlaut	-	↓ ɔ̄i
Surface	[ʃwɔ̄n]	[ʃwɔ̄i]

Once again Umlaut bleeds the vowel alternation rule in the conservative dialects by yielding a representation which no longer meets the SD of Rounding because it is [-back]. As Rounding cannot affect the applicability of Umlaut, the extrinsic ordering of the former before the latter in innovative dialects means that plurals undergo both processes. Kiparsky's claim is that the innovative dialects have reordered Umlaut and Rounding out of bleeding order into the counterbleeding order illustrated in (42) ii).

This explanation is of course not available to KSN who are committed to the view that Umlaut and Rounding apply simultaneously in both dialect-groups just in case their SDs are met by the underlying representations. They therefore account for the difference between the dialects in terms of the retention or loss of (43), a "generalization" that all low front vowels are unrounded:

$$(43) \quad \begin{bmatrix} \text{v} \\ - \text{back} \\ + \text{low} \end{bmatrix} \longrightarrow [- \text{round}]$$

= KSN's (23) c.

KSN are claiming, then, that whereas (43) is present in conservative dialects, it has been lost in innovative ones. Unfortunately this proposal entails simultaneous rule application and leads to Duke-of-York-style derivations in which the feature-value of [round] is flipped first from minus to plus, then back to minus again. This is shown in (44):

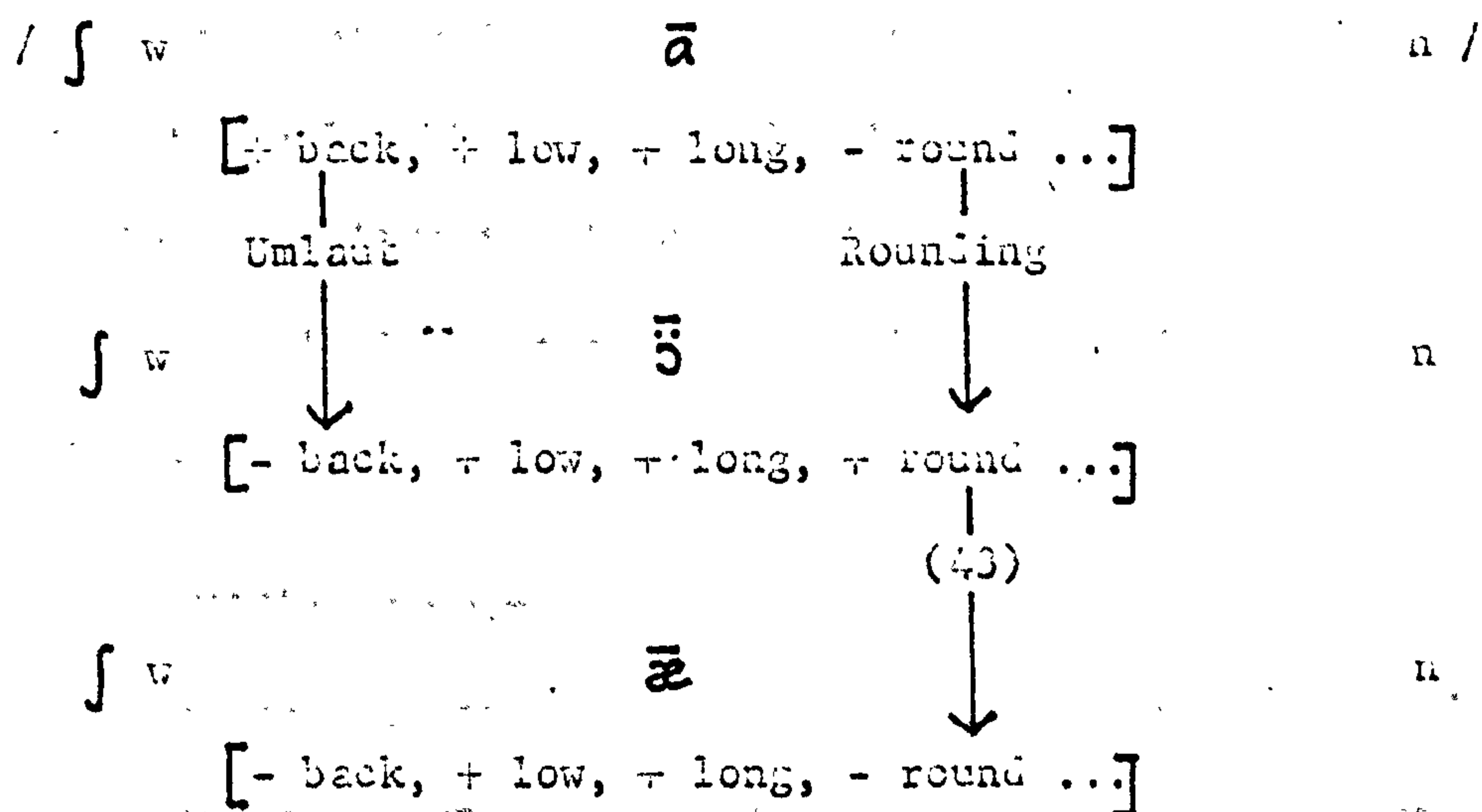
(44) KSN's derivation of plural /wæ̃n/ in conservative dialects

It is clear, then, that just as KSN's solution to the purported reordering of Umlaut and Lowering resulted in counter-intuitive derivations dependent upon simultaneity, so their reanalysis of Umlaut and Rounding invites the same criticism. I shall have nothing further to say regarding simultaneity, reserving my attack upon this hole of rule interaction until the next chapter: let me simply anticipate the fact that the UDRA treatment of the Swiss German data is independent of this issue.

Having discussed one area in which objections to KSN's "general rule" of Raising (i.e. (33); and, similarly, Rounding, i.e. (41)) could be raised, we turn to the ontological status of such a rule. Consequently I now present a (partial) critique of CD, which will take the following form. First I shall allude to the general framework of CD's counterattack on KSN but shall do so without recapitulating the remarks regarding the metatheoretical argumentation found in Chapter 1. The body of the critique will then focus on CD's discussion of Umlaut and Lowering. The interaction of Umlaut and Rounding will not figure since CD fail to mention the relevant data even though they would be equally well suited to their purposes as those from Keesvil/

Schaffhausen. Instead I shall point to CD's incoherent grasp of what may be termed the entire UDRA/GROD controversy. Finally I shall demonstrate the vulnerability of CD's claim that "any attempt to write a phonology of Old Icelandic which conforms to KSN's conditions on ordering will lead to an unacceptable loss of generality" (ibid. page 612).

CD attack KSN's arguments on the grounds that their data are shallow and scanty, and present what they describe as an "in-depth" treatment of Old Icelandic phonology demanding extrinsic ordering. Thus the only positive claim made by CD is methodological and seems to be the following: test universals on an "in-depth synchronic analysis" of one language. Such a claim perhaps seems to be the logical corollary to CD's attack on KSN's citation of data from a variety of sources. "Such selective and shallow gleanings do not necessarily contribute to the proof of universality" (page 611; my emphasis). Note the caveat here - there is nothing to say that evidence from disparate analyses does not lead the linguist to the desired conclusions. And considering that linguists by no means claim to have "in-depth" knowledge of languages before producing evidence from those languages, most of us tend to be in KSN's shoes. In any case, universals can hardly be postulated from one corpus of data alone, no matter how thorough one may be in analysing it. This suggests that the linguist after universals must either be a polyglot genius or be prepared to be falsified. Indeed, CD almost concede as much when they admit that "one of the features of a developing science is that theory must often precede total description" (page 611). This, of course, applies to all science always. Is one therefore to conclude that CD are saying, "Postulate no universals in case you are wrong!" - surely not; rather, they are claiming that since "in-depth synchronic analysis" of one language is at variance

with purported universals based on a variety of languages, the linguist should look again at the so-called universals. As I shall argue below, in fact it is CD who should look again at the "in-depth synchronic analysis" - if only because of the logical possibility that it is they and not KSN who are wrong!

Let us turn to the body of CD's counter-attack in which they discuss the Kesswil/Schaffhausen case. It will be recalled that in the above discussion I queried the precise status of KSN's "general rule" of Raising (= (38)) for Schaffhausen. It is this aspect of KSN's formulation which CD take up. Here I feel that CD are justified in bringing up the issue although they seem to be placing too much on what KSN actually fail to formalize. It is clear from KSN's paper that they simply have not considered the exact ontological status of their Raising rule. Of course this is a weakness but by no means one which necessarily leads to CD's conclusions based on interpreting it in one particular way i.e. that KSN intend to remove the distinction between Morpheme Structure rules and phonological rules. CD base this interpretation on KSN's footnote 10:

(45) "Like all other phonological rules, a segment-structure rule like 20c (= Raising, my (33): JRMCD) will apply to all representations to which it is (non-vacuously) applicable. It will thus serve the functions of a morpheme-structure rule or constraint with respect to underlying lexical representations, as well as serving the functions of a phonological rule or phonetic redundancy rule with respect to deprived representations."

(KSN; page 12, fn. 10; cited by CD on page 617)

From this quotation I by no means infer that KSN are proposing a tripartite division of rule-types with respect to the phonological component - into MS rules, regular phonological rules and a new 'anywhere' type. Their discussion is in no way to be taken as a rigid classification in opposition, say, to Stanley's 1967 findings. But having imposed such an interpretation on KSN, CD are then all set to show that

as an 'anywhere' rule of their newly invented type - ascribed to KSN - such a rule of Raising cannot be lost, since it would still stand as an MS condition. * Taking established examples of rule loss to involve late phonological rules rather than a shift of status to MS condition, they conclude that KSN's proposed change from Schaffhausen to Kesswil is unprecedented. Consequently Raising must be a late phonological rule if it exists at all - with no synchronic support as an MS generalization.

CD's argumentation is self-contradictory even in its own terms. If they are right in ascribing a tripartite division of rule-types to KSN, then why must the loss of Raising involve a change from one type (= regular phonological rule) to a second type (= MS condition) with no mention of the attributed third? It would be perfectly feasible for KSN or anyone else to demonstrate that a certain phonological rule can be lost, where this rule incorporates generalizations about what is possible at the phonetic surface. What is more, even if the rule loss involved is not attested, what principles do CD put forward to explain the reordering in Kesswil? - especially considering that they note that Kiparsky has retracted his maximal utilization principle whereby rules reorder so as to minimize bleeding orders.

As if to rouse one's innermost passions against KSN, CD compare the loss of generality associated (by them) with intrinsic ordering to

* Footnote

Note, incidentally, the second line of CD page 613 with its parenthesised "extrinsically?" in reference to the ordering of an 'anywhere' rule which has undergone a shift in status from a regular phonological rule to an MSC "but would still remain as a morpheme-structure rule which must be ordered (extrinsically?) before the two rules of Umlaut and Back Vowel Lowering". If each MSC must be parochially ordered before each phonological rule in each natural language, this would lead to unmotivated complexity in both the phonological component and the lexicon.

Halle's 1959 arguments against the taxonomic phonemic level: "The KSN proposal on ordering leads to a loss of generality fully analogous to the loss of generality arising from a taxonomic phonemic level." (page 618; my emphasis). Even assuming, contrary to what I believe to be the case, that Halle's arguments go through completely unamended, a moment's reflection shows that the two are far from being 'fully analogous'. Take away the taxonomic phonemic level and one is left with rules which map morphophonemic (= Chomsky's systematic phonemic) representations onto phonetic representations directly - yet there was never any question of the taxonomist's not requiring a morphophonemic level or a phonetic level along with his phonemic one. However, take away universal ordering precedences and one does not simply get by with what is left: one must immediately resort to heavy extra machinery - extrinsic ordering statements peculiar to each natural language.

Such a comparison is tied up with CD's incoherent grasp of KSN's arguments per se. They miss the point that intrinsic ordering conventions are part of universal linguistic theory and need not be stated over and over again for individual languages. Consequently, extrinsic and intrinsic ordering are not vying with each other as far as data from one specific language go. Rather, at the language-specific level, one is comparing particular language-specific restrictions versus no statement at all. Instead of seeing that it is intrinsic ordering which is relevant to a universal theory, CD claim that it is extrinsic ordering which results from the evaluation metric:

(46) "The choice between the two can be made by the following consideration: the extrinsic ordering of phonological rules is not something extra, but rather is a consequence of a condition which has independent motivation - the evaluation metric."

(page 619)

But what, one may ask, is this independent motivation? and how is

extrinsic ordering a consequence of it? CD remain silent.

CD refer to the only example they take from KSN as a specious generalization: "The so-called generalization is merely a statement of the fact that there are no additional sources of surface short [ɔ̃]" (page 619; my emphasis) *. I hope now briefly to show that CD's own generalizations by no means merit the label "statements of fact". There is little point in going into the formulation of CD's eleven extrinsically ordered rules from their "in-depth" treatment of OI phonology. Suffice it to say that by a misinterpretation and despite direct quotes, CD suggest that KSN think rules usually apply simultaneously (e.g. "KSN do not respond to the 'well-known' arguments presenting empirical evidence against the hypothesis that all rules are applied simultaneously" page 622; my emphasis). This is blatantly false since KSN actually propose Counterbleeding Precedence just in case rules do not apply simultaneously. However CD, having demonstrated that their rules will not work like this, go on to show a bleeding order which is inconsistent with PIPrec. I have no quibble with the fact that KSN's principles do not apply here - in fact I have every suspicion that further principles in keeping with UDRA which predicted the precedence relations between CD's rules would be impossible to formulate: there must, I suspect instead, be something radically wrong with CD's rules themselves. And once one looks at CD's underlying representations one immediately sees why they need such complex statements of Internal Syncope, Terminal Syncope, i-Mutation, u-Mutation, Unstressed Vowel Raising, æ-Raising, etc.

* Footnote

The lack of additional sources of phonetic [ɔ̃], far from being "merely a statement of fact", constitutes the crucial piece of empirical evidence ruling out the "ideal" solution to these data: see page 141 below.

Consider a case in point: underlying /vake + j + χ + ee/ which, after six rules have applied turns out to be phonetic [vek χ i]. The motivation behind this highly abstract underlying representation seems to be the desire to posit a constant reflex at the level of URs for each morphosyntactically justifiable category. In other words, CD are attempting to construct a "fictitious agglutinating analogue" to a "fusional" language, of the type discussed in the Structuralist literature. The only other motivation for a root-final vowel in the underlying representation of [vek χ i] - as far as I can deduce - is to satisfy Internal Syncope. Similarly the word-final /e/ necessitates Terminal Syncope and the /j/ glide requires Glide Drop. And this is by no means an isolated example cf. in like fashion, the four successive underlying vowels in /talaa + uum/ which result in one phonetically: [tɔlum]. Here conceivably every argument ever raised against the abstractness of URs could have some applicability, whilst I suspect that Absolute Neutralization is involved in at least one place in CD's systematic phonemic inventory. Furthermore any statement of canonical forms at the surface phonetic level will be at variance with URs like /talaa + uum/ : as an input to the phonological component a representation may have as many as four consecutive vowels, whereas 'quadriphthongs' are never found on the phonetic surface; or again, the sequence lateral + back semivowel occur in underlying representations like /gamal + w/ but are neutralized in phonetic representations like [gɔmul].

Finally CD cite a fragmentary piece of data from Old English (one might ask whether this constitutes a "selective and shallow gleaning"). The rules involved are Breaking and Umlaut, and although they are not in an "active" feeding relation, each one effects forms which the other

may affect. CD refer to this type of interaction as "mutually analysable" and claim that Breaking must be extrinsically ordered to precede Umlaut. Now while I am not conversant with Old English, there is often reason to question the relative synchrony of rules when dealing with such data. To put this differently, it is frequently the case that Rule X may not have been productive in the grammar during the same period as Rule Y, rendering suspect any purported interaction between X and Y. * On the other hand, if it could be demonstrated that Breaking and Umlaut were both productive at the same stage in the development of Old English, it is my strong suspicion that their related structural changes could be captured by a single rule schema, possibly exploiting the angled bracket notation. To sum up, despite the tentative nature of these remarks, I feel confident that the alleged rules of Breaking and Umlaut in Old English do not pose a threat to the credibility of the UDRA hypothesis.

Returning to CD's lengthy argumentation from OI, as I have demonstrated above, they do not attempt to constrain the abstractness of the underlying representations they posit. Because of this lack of restriction, the distance between CD's underlying representations and the phonetic surface is far greater than in a more "realistic" treatment. It is therefore in no way surprising that CD require phonological rules which are correspondingly the more powerful; and just such power is available in a theory which permits extrinsic ordering, but crucially not available in the theory which KSN advocate. Likewise one would

* Footnote

I owe my "linguistic caution" in treating Old English data to valuable discussion Richard Hogg.

expect the KSN hypothesis to be violated by CD's abstract analysis. * However I have every reason to believe that a "realistic treatment" of OI would not contravene KSN's principles and would certainly not contravene a more general theory of UDRA such as that elaborated in this thesis. As for CD's valid criticism of KSN's Swiss German analysis, I now propose to show that although the initial argument in favour of UDRA had weaknesses, alternative solutions to these data are available under just such a developed theory of UDRA.

For a moment let us reconsider the KSN solutions to the two sets of German data in order to contrast the first version of the UDRA hypothesis (= KSN) with the later model proposed here. In KSN's treatment it is the innovative dialects for which no extra provision is needed: under their hypothesis - both surface phonetic [bödə] and [ʃwɔ̃n] fall out as a result of the simultaneous application of Umlaut and a vowel alternation rule. On the other hand, KSN need to postulate an extra rule for the conservative dialects. In contrast to this initial formulation in a theory of UDRA, we have seen in our discussion of the case of "writer" : "rider" that a fully developed theory of UDRA exploits the relative status of different kinds of phonological rule. One such difference is that which Koutsoudas is credited with introducing into generative phonology after its elimination in the early days of the theory - I refer to the distinction between morphologically conditioned and phonetically conditioned rules and the natural claim that the former must apply before the latter . Incorporating this

* Footnote

In fact, KSN's principles are not violated by all abstract analyses, provided the rules posited are in feeding or counterbleeding relations. However, they do exclude abstract analyses where rules bleed or counter-feed each other and it is purported examples of these types which CD claim are counterexamples to KSN. See next chapter for the interaction of constraints on abstractness with UDRA, where the South American Spanish example discussed above will be shown to contain Absolute Neutralization.

claim into UDRA, we see that it is the conservative dialects which are automatically accounted for i.e. the dialects in which morphological Umlaut precedes and consequently bleeds in the one case Lowering, in the other Rounding. *

What may be termed the 'ideal' solution for the still unexplained innovative dialects involves rule simplification. In Schaffhausen, Lowering affects mid back vowels i.e. lowers /o/ → [ɔ] - it does not apply to unlauded [ö]. But in Kesswil, both [ɔ] and [ɔ̃] appear on the phonetic surface. Surely the obvious solution is the one in which in Kesswil Lowering affects both [o] and [ö] yielding [ɔ] and [ɔ̃] respectively? This is a typical case in which the expression of a rule using alphabetic symbols rather than distinctive features is misleading. Referring to Lowering as "o → ɔ", we make it look as if, by incorporating "ö → ɔ̃", we are complicating the rule. In fact, since [o, ö] and [ɔ, ɔ̃] constitute (minimal) natural classes, we are generalizing it, as seen in (47):

(47) Lowering (Simplified)

Schaffhausen - Conservative

Kesswil - Innovative

$$\left[\begin{array}{c} \text{V} \\ \text{-high} \\ \text{+back} \end{array} \right] \longrightarrow \text{[+low]} / \text{_____} \left[\begin{array}{c} \text{+cons} \\ \text{+cor} \\ \text{-lat} \end{array} \right] \quad \left[\begin{array}{c} \text{V} \\ \text{-high} \end{array} \right] \longrightarrow \text{[+low]} / \text{_____} \left[\begin{array}{c} \text{+cons} \\ \text{+cor} \\ \text{-lat} \end{array} \right]$$

The 'ideal' explanation of the Kesswil data is, then, that Lowering has been simplified to apply to both non-umlauted and umlauted vowels, i.e. mid vowels regardless of backness.

* Footnote

Originally Umlaut was phonetically transparent in Germanic and took the following form: $v \text{ --- } \text{[-back]} / \text{_____} C_1 i$

The fact that in present-day German dialects the rule must be stated in non-phonetic terms even within a designated morphological category is seen by the semantically distinct plurals of the single root /vɔ:rt/ (Wort "word"), i.e. [vɔ:rtə] (Worte = connected words as in auf seine Worte hin "on the strength of his remarks") vs. [vö:rtər] (Wörter = unconnected words as in Wörterbuch "dictionary").

The implication from Hooper is that NGP would reject such a solution on Naturalness grounds; take, for instance, this quote from page 95 of her "Introduction": "We need not make the strange claim that a phonetic rule motivated only for back vowels applies to a vowel that surfaces as a front vowel"; or again (page 94): "... there is no reason to expect a P(honetic) rule motivated for back vowels to apply to a front vowel". But the only reason we have for expecting any rule to apply to front vowels is its structural description. True, it may be more natural phonetically for Lowering to occur to back vowels in anticipation of coronal consonants than after a front vowel when the body of the tongue is already high. But we have been led to expect rules to lose phonetic plausibility rather than to gain it and this appears to be exactly what we find here. In Kesswil, the innovative dialect, Lowering has ceased to be a natural rule - it has become phonologized (Hyman 1975).

Thus although I shall accept the ultimate conclusion reached under NGP, my reason for rejecting the 'simplification-of-Lowering' solution is not Hooper's. Rather it is on the straightforward grounds of observational adequacy, for it appears that way back in 1968 Kiparsky had anticipated such a reanalysis of the reordering he was proposing:

- (48) "The solution which first might come to mind is that the lowering rule in 4 was simplified to apply to rounded vowels regardless of whether they are front or back. But this fails since phonemic (scil. underlying; JRMcB) $\underline{\text{ö}}$ does not lower to $\underline{\text{ö}}$ in the environment of 4 (= Lowering JRMcB). The crucial cases are such forms as plötsli and fröšš "frog" (originally a plural form). The behaviour of these isolated forms whose vowels are not lowered shows conclusively that we are in reality not dealing with a lowering of $\underline{\text{ö}}$ to $\underline{\text{ö}}$ at all, but rather with the umlauting of $\underline{\text{ö}}$ as well as of $\underline{\text{o}}$. That is, the order of the rules has now become

Rule 4 lowering

Rule 3 Umlaut

Applying to the same underlying forms as before, these rules now produce the segment $\underline{\text{ö}}$, which did not arise under the old ordering."

(1968b page 179)

A similar 'ideal' solution presents itself for the other dialect-pair, although I do not know if further data contradict it too. In any case, a parallel treatment of both interactions with Umlaut is preferable so that the observational inadequacy of simplification for Schaffhausen/Kesswil makes the adoption of that solution elsewhere less desirable. Just for the record, if such a simplification were possible, it would have the following form: converting both $\bar{a} \rightarrow \bar{o}$ and $\bar{e} \rightarrow \bar{o}$:

(49) Rounding (Simplified)

Conservative

$$\begin{bmatrix} \text{v} \\ +\text{back} \\ +\text{low} \\ +\text{long} \end{bmatrix} \longrightarrow [+ \text{round}]$$

Innovative

$$\begin{bmatrix} \text{v} \\ +\text{low} \\ +\text{long} \end{bmatrix} \longrightarrow [+ \text{round}]$$

Paradoxically, the solution to which NGP is committed, appears as early as 1968 in Chafe's paper and is alluded to by KSN in footnote 18, page 24. The suggestion, which we will adopt, is that the representation underlying $[\text{ʃwɔn}] / [\text{ʃw}\bar{e}n]$ is the singular $[\text{ʃwɔn}]$ to which Umlaut applies in the plural. Similarly, Hooper posits an underlying singular form $[\text{bɔd}\bar{e}]$ for Kesswil, identical to the singular which Umlaut fronts to $[\text{b}\bar{o}d\bar{e}]$ in the plural (pages 94, 95). The principle involved is that of Kiparsky's 1971 'Paradigm Uniformity' which states that 'Allomorphy tends to be minimized in the paradigm' (pages 598-599). Hooper sums up the same principle as follows: "This, of course, is merely a restatement of the long-observed and time-tested principle of analogical leveling. Nonmeaningful alternations tend to be eliminated" (page 94). She then substantiates the restructuring solution by noting that it takes place on the basis of the unmarked category, a common type of change according to Vennemann (1972).

The UDRA and NGP solutions are, then, identical for innovative dialects in which they claim that there is no vowel alternation, merely a rule

of Umlaut deriving Plural from Singular /bɔdə/ and /ʃwɔ̃n/. Both theories are at variance with KSN's original analyses of the innovative dialects in which it is claimed that a rule of vowel alternation (Lowering or Rounding) applies simultaneously with Umlaut, deriving plurals from URs which are identical to those posited by Kiparsky for the conservative dialects i.e. /bɔdə/ and /ʃwɔ̃n/. However, it is important to note that although UDRA and NGP have reached the same conclusion here, they have done so on different grounds. The reason within UDRA for the conclusion that URs in innovative dialects are identical to the phonetic representation of the singular is based on Kiparsky's paradigm uniformity principle and the traditional notion of analogical levelling, together with considerations of the abstractness of underlying representations: Kiparsky's original treatment (and KSN's) involves the postulation, at the level of URs, of the segments /o/ and / \bar{a} /, even though these segments never appear on the phonetic surface in the allomorphs of the morphemes concerned. While the latter factor is essentially what lies behind NGP's central hypothesis, the True Generalization Condition, which requires that all rules express transparent surface generalizations, the KSN treatment of innovative dialects is ruled out for another reason in NGP, namely, that NGP allows only sequential rule application, and disallows a "mixed" theory such as KSN's in which some (but not all) rules apply simultaneously. *

It is not clear whether a discrepancy exists between UDRA and NGP on the treatment of the conservative dialects. This is because Hooper

* Footnote

When the whole issue of simultaneous application which KSN posit in cases of counterbleeding is dealt with in the next chapter, it will be shown that Hooper misrepresents KSN's position on this matter.

gives no clear statement of how NGP would handle the precedence of Umlaut over vowel alternation (see her discussion of Kesswil and Schaffhausen on pages 72, 73 and again 93, 94). As we have seen, this ordering is predicted by UDRA just in case Umlaut applies first because it is morphological. Hooper notes that here we have a case of an unmarked bleeding order (because of the phonetic motivation for vowel alternation which is lost once the vowel is fronted by Umlaut - see discussion on p. 141). However she fails to cite the principle which prevents Lowering or Rounding from applying directly to the underlying representation. Presumably she cannot consider an extrinsic statement because of NGP's No-Ordering Condition. It is all the more baffling that Hooper does not explicitly adopt the morphological precedence principle when one notes the tripartite division of phonological rules in NGP into morphophonemic rules, via-rules and (regular) phonological rules; with a distinction between rules types incorporated into the theory, one wonders why NGP fails to exploit this in order to account for unmarked bleeding relations. Furthermore the model of lexical representation adopted by NGP (i.e. G. Hudson's 1975 doctoral dissertation) suggests that /bodə/ and /ʃwān/ cannot even be posited as underlying representations in conservative dialects. This is because, under Hudson's model, the lexical representation is "an archisegmental representation of all the surface allomorphs" to which "a rule applies to correctly distribute the allomorphs" (Hooper page 74). It is difficult to see how /o/ and /ā/ could be interpreted as archisegments of surface [ɔ] and [ö], [ɔ̄] and [ä] respectively.

Returning to the UDRA treatment of these data, we have seen that the insights of NGP regarding the restructuring of underlying representations in innovative dialects like Kesswil, are compatible with the intrinsic ordering of Umlaut before vowel alternation in conservative dialects.

I do not believe that this apparent eclecticism detracts from the theoretical plausibility of UDRA. Rather, it suggests that phonological theory need not necessarily be fraught by mutually irreconcilable controversies, but that ultimately issues like the abstractness of underlying representations and rule ordering will be resolved in one integrated theory. It is my contention that the analysis of Swiss German data arrived at in this subsection constitutes such an integrated, theoretically plausible solution.

CHAPTER FOUR - COUNTERBLEEDING
 =====

In the preceding section on the primary modes of rule interaction we postponed the discussion of two issues: the first arose in § 3.4.1., the subsection on "The case of 'writer' and 'rider'", when we noted that Flapping could not take applicational precedence because of its status as a neutralization process; the second concerned simultaneous application in KSN's analysis of innovative Swiss German dialects. The reason for postponing the detailed treatment of these issues was that they crucially involve the secondary modes of rule interaction: by stipulating that Lengthening can never apply to the output of Flapping in the dialect where [rayDr] is the phonetic reflex of 'writer', we are claiming that Flapping counterfeeds Lengthening; similarly, it is a secondary mode of interaction (this time the fact that Umlaut in Swiss German counterbleeds vowel alternation) which KSN reanalyze as an instance of simultaneous application.

The first section of this chapter specifically devoted to the secondary interaction, Counterbleeding, surveys KSN's use of simultaneous rule application and examines the extent to which this is a departure from GROD. It will be shown that in some cases another analysis is available within a more fully developed theory of UDRA, whilst in others KSN's treatment is unacceptable under a more "realistic" theory, including NGP. The conclusion we shall reach is that KSN's examples cannot be used as an argument for simultaneous application; however they themselves do not provide evidence against simultaneity.

In § 4.2 I shall discuss crucial data from Yawelmani Yokuts and show that simultaneous application yields an incorrect surface representation.

Various principles proposed in the literature are evaluated in the light of whether they account for the Yawelmani rule-pair. Yet all these principles fail to account for further data from Sea Dayak and Washo. On the other hand, an independently developed principle within the theory of UDRA, namely Deletion Cession, has correct empirical consequences for all the data presented.

Since the treatment of the data from Yawelmani Yokuts depends crucially upon the analysis of Vowel Shortening as the deletion of a second vocalic mora, it behoves me to demonstrate that such an analysis is not simply ad hoc. Justification is therefore provided in § 4.3 in the form of supporting evidence from Guerssel's work on Gemination in Berber, the ensuing discussion also broaching the related problems of assimilation and iterative application. The section closes when it is argued that the conclusions reached for consonants be extended to vowels.

§ 4.4 is devoted to Metatheoretical Considerations: I shall claim that the analysis of American and Canadian dialects above stems from a constraint on Abstractness first formulated by Kiparsky in 1973, and that a restriction on deletion follows from it. Once again it will become apparent that questions about rule ordering can only be framed in the context of the phonological component as a whole.

§ 4.1 Simultaneous Rule Application in KSN

KSN cite four examples of counterbleeding for which they claim that the correct surface phonetic forms result without the power of extrinsic ordering, provided the rule-pairs are allowed to apply simultaneously. Let us examine each case in turn so that we may determine whether KSN's prima facie evidence for simultaneity can stand up to closer scrutiny. But before that, some preliminary remarks concerning the "common denominator" of KSN's examples.

The first question to be asked in connection with the incorporation of simultaneous rule application into the KSN framework is the following:- What relation must hold between rules A and B in order to permit a correct surface phonetic output if A and B are applied simultaneously? On examining all the cases cited by KSN, we see that A does not affect B, whereas B counterbleeds A i.e. B would bleed A if it were permitted to apply before it. It is therefore crucial that A be permitted to apply to the input representation S. Within GEOD the obvious way to achieve the attested surface phonetic form in such cases of counterbleeding is to constrain B extrinsically to apply after A. What KSN demonstrate is that, for the data they cite, this constraint is redundant: there is no need to constrain B to apply after A, provided A is not prevented from applying to S. Put another way, B may be permitted to apply to S just in case A is not thereby constrained to apply to the output of B. This means that not only A applies to S but that B also applies to S, simultaneously with A. As we review KSN's examples we shall see that this situation obtains. KSN's first example differs from the rest in that the rules concerned both apply to the same segment (rather than each applying to the environment of the other, for instance). Kiparsky (1968) proposes

the following rules for certain Low German dialects:

(1) A Spirantization $\left[\begin{array}{l} + \text{ stop} \\ + \text{ voice} \end{array} \right] \rightarrow [- \text{ stop}] / \text{v} _$

B Devoicing $[+ \text{ obstr}] \rightarrow [- \text{ voice}] / _ \#$

By first applying A to underlying /tāg/, we derive intermediate /tāɣ/, to which B applies, yielding surface phonetic [tāx].

It is clear that the relation described above for potential simultaneous application obtains here: Spirantization (A) does not affect Devoicing (B), the structural description of which is met by any obstruent regardless of whether it is a plosive or a fricative. On the other hand, if Devoicing were permitted to apply first a segment would result which did not meet the [+ voice] specification of Spirantization i.e. Devoicing (B) counterbleeds Spirantization (A). Since the only function of Kiparsky's extrinsic ordering statement is to prevent B from applying before A, we are bound to note that KSN's simultaneity produces the forms attested on the phonetic surface, as shown in (2) (= KSN's (8) page (5)):

(2) / t ā g # /

	[+ stop, + voice]	
	A	B
	↓	↓
t ā		x
	[- stop, - voice]	

Kiparsky also claims that Low German has achieved the counterbleeding relation between Spirantization and Devoicing by reordering them out of bleeding order. The latter situation purportedly obtains in a group of Alsatian, Bavarian and Middle German dialects which are more conservative. In these dialects the alternation between [tāk] and [tāɣə] on the phonetic surface results if, when applying the rules of (1),

Devoicing is allowed to apply to word-final obstruents before Spirantization, thereby bleeding the latter. Under Kiparsky's analysis the extrinsic ordering Devoicing, Spirantization, posited for conservative dialects, has been reversed in innovative Low German. Discussing the purported reordering, KSN note "that spirantized stops occur post-vocalically in Low German (tāx, tāχə) but they occur only inter-vocalically in Alsatian and the other conservative dialects (tāχə, but not *tāχ or *tāx)" (KSN page 25; original emphasis). This leads them to the conclusion that in conservative dialects Spirantization was less general as in (3) (= KSN's (41); page (25)).

(3) A' Old Spirantization
$$\left[\begin{array}{l} + \text{ stop} \\ + \text{ voice} \end{array} \right] \rightarrow [- \text{ stop}] / V _ V$$

Generalization of a rule's domain, such as intervocalic to postvocalic position, in innovative dialects is of course an attested diachronic process and one in keeping with Kiparsky's remarks elsewhere.

Accepting KSN's reanalysis of conservative dialects, we find that Old Spirantization and Devoicing will never apply to the same underlying segment since their environments are mutually exclusive (being intervocalic and word-final respectively). Consequently, KSN's treatment of Alsatian can have no further bearing on the issue of simultaneous rule application or the principles of UDRA. Nor can Kiparsky's underlying representation - which KSN have accepted - be criticized on the grounds that it violates constraints on Abstractness. Here we have a set of morphemes which exhibit an alternation between a voiceless plosive and a voiced spirant. Clearly if we choose either of the surface phonetic reflexes as underlying, we will require a rule to flip the value of both the features [continuant] and [voice] in the other environment i.e.

$$(4) \quad [- \text{son}] \rightarrow \begin{bmatrix} + \text{cont} \\ + \text{voice} \end{bmatrix} / \text{V} \text{ ______ } \text{V}$$

OR

$$[- \text{son}] \rightarrow \begin{bmatrix} - \text{cont} \\ - \text{voice} \end{bmatrix} / \text{______ } \#$$

By selecting the value for voicing from the intervocalic environment and that of [continuant] from the word-final environment, Kiparsky is not merely recapitulating diachrony. Rather, he is formalizing processes whereby only one feature-value is affected in each of the environments where the morpheme appears. Furthermore the fact that he has posited voiced plosives as underlying rather than the logically possible voiceless spirants, reflects the frequency attested for word-final obstruent devoicing and intervocalic "weakening" (from stop to spirant) in the history of the world's languages. To sum up, Kiparsky's analysis of the conservative dialects is a natural one, in the technical sense. There is, however, a caveat in this appraisal, which will be taken up below in connection with the innovative dialects, for it is to these that we now return.

In contrast with the mutually exclusive relation between Old Spirantization and Devoicing in Alsatian and related dialects, we have seen that in innovative Low German underlying representations like /tāg/ meet the structural descriptions of both Spirantization and Devoicing. We have also seen that the sole purpose of Kiparsky's extrinsic ordering constraint was to prevent the order Devoicing, Spirantization. KSN have avoided this incorrect application by allowing both rules to apply simultaneously. However, that end could also be achieved if the attested ordering were shown to be predictable from a principle of UDRA. On examining the structural descriptions of Spirantization and Devoicing we notice that the natural class of segments affected by Devoicing properly includes the natural class of segments affected by Spirant-

ization. (where "segment affected" by a rule R refers to that segment whose feature specifications are modified by R - see §5.2 for Iverson's definition of this term.) Yet according to KSN's formulation of PIPrec, it is necessary to take the structural description of a rule $X \rightarrow Y/W \underline{\quad} Z$ as $\overset{\cdot\cdot}{WXZ}$ not merely X when determining precedences (KSN page 9, fn. 7). But then the full structural descriptions of Spirantization and Devoicing are not in a PI relation but instead overlap. The following question now arises: Could PIPrec be generalized to cases where although the same segment X may be affected by both rules, their structural descriptions overlap? Such a generalization is formalized below:

(5) Proper Class Inclusion

Let X_a be that class of segments which are affected by rule A and

let X_b be that class of segments which are affected by rule B.

For any representation R which meets the structural descriptions of both A and B, A takes applicational precedence over B if and only if the class X_b properly includes the class X_a .

When we explicated PIPrec in § 3.1, we noted the importance of stating unequivocally whether one is referring to rule A or to the set of representations which meet the structural description of A (see p. 70-1 iii). The same point is crucial in the formalization of Proper Class Inclusion. Notice that if class X_b properly includes class X_a (e.g. if X_b refers to sonorants and X_a to nasals), then the distinctive feature matrix of X_a will comprise a list of features which properly include those enumerated in the matrix of X_b (e.g. X_b will contain two features $\begin{bmatrix} + \text{son} \\ + \text{nas} \end{bmatrix}$ thus properly including the single $[+ \text{son}]$ specification for X_a .) Of course this follows from the nature of PIPrec whereby more specific rules apply prior to those which are less context-restricted. When we

transfer the principle to affected segments, we are ensuring that the rule affecting the smaller natural class - i.e. the more fully specified class - takes applicational precedence over the larger class - the one requiring fewer features for its specification.

Returning to Low German, we see that the class of segments affected by B, Devoicing, ($= X_b$) i.e. obstruents, properly includes the class of segments affected by A, Spirantization, ($= X_a$) i.e. voiced stops. It might appear that the caveat of the preceding paragraph concerning the features of each matrix is inapplicable here since the features of the affected segments in (i) are disparate. However it is soon clear that this is due rather to KSN's informal statement of the rules involved. Once they are given explicitly as in (6):

(6) A Spirantization

$$V \quad \begin{bmatrix} - \text{son} \\ + \text{voice} \end{bmatrix} \\ \downarrow \\ \begin{bmatrix} + \text{cont} \end{bmatrix}$$

B Devoicing

$$\begin{bmatrix} - \text{son} \end{bmatrix} \# \\ \downarrow \\ \begin{bmatrix} - \text{voice} \end{bmatrix}$$

We see that X_a 's matrix $\begin{bmatrix} - \text{son} \\ + \text{voice} \end{bmatrix}$ properly includes X_b 's matrix $\begin{bmatrix} - \text{son} \end{bmatrix}$.

It is of course perfectly possible to formulate an extension of PIPrec in terms of the features enumerated in matrices. And indeed this is precisely what we find in Iverson's 1973a paper, where Overlap Precedence is formulated to account for Kiparsky's Low German data without resort to simultaneous rule application. The principle is cited in (7).

(7) Overlap Precedence

In the structural description of a rule B, let B' indicate that part which is properly included in the structural description of another rule A. For any representation R meeting the structural description of both A and B, let R' indicate that part to which B' refers. A takes applicational precedence over B if the structural changes of both A and B potentially affect R'. (1973a)

(Given that /tāg/ is R, then /g/ will be R'; since the $\begin{bmatrix} - \text{son} \end{bmatrix}$ specification of Devoicing is properly included in Spirantization, this

will be B').

My contention in formulating Proper Class Inclusion rather than adopting Overlap Precedence, is simply that the former is transparent whilst the latter is opaque. By this I mean that Proper Class Inclusion "follows on from" PIPrec whereas it is not immediately clear how Overlap Precedence constitutes an extension of KSN's original principle. However, even though Iverson's Overlap Precedence is not incorporated into the theory of UDRA developed in this thesis, it is important to note that he too rejects simultaneity as a mode of rule interaction. In §4.2 his additional data will be cited since they contribute further evidence to the debate contra simultaneous rule application.

We now return to the question of the motivation for Kiparsky's underlying representation /tāg/, this time for innovative Low German dialects. As was the case when we treated the Schaffhausen and Kesswil dialects in § 3.4.2, Kiparsky is claiming that rule reordering is a mechanism of linguistic change. He is therefore bound to posit identical underlying representations for both innovative and conservative dialects. However it follows as a corollary of UDRA that such a mechanism does not exist - if extrinsic ordering is denied in synchronic grammars, Language will not be able to exploit it over time. What then, we must ask, is the motivation for positing /tāg/ as the underlying representation of the allomorphs [tāx] and [tāyə]? I can find no dialect-internal justification for such an analysis, that is, justification which does not look to the cognate form in other dialects of German. The "realistic" solution (and one which I assume NGP would adopt even though this example is not treated by Hooper) is surely to set up a voiced spirant in morpheme-final position. The word-final allomorph is then naturally accounted for by the productive German rule of final obstruent devoicing.

As a last point let me emphasize the necessity of Proper Class Inclusion despite the argument that such a principle is vacuous for Low German data. Given that we accepted KSN's adoption of underlying representation, we were able to exemplify a precedence relation to which we will have reason to refer later - our discussion has therefore not been a red herring.

As their second example of counterbleeding, KSN take "the traditional analyses of Vowel Nasalization and Nasal Consonant Deletion in French":

- (8) A Vowel Nasalization $V \rightarrow \tilde{V} / \text{---} N$
 B Nasal Consonant Deletion $N \rightarrow \emptyset / \text{---} \left\{ \begin{array}{l} \# \\ C \end{array} \right\}$

We find that our initial characterization of counterbleeding situations obtains here: if B is permitted to apply to S, underlying nasal consonants /N/ will be deleted before they have conditioned Vowel Nasalization (A), and the incorrect phonetic representation *[grɑ̃d] will surface from underlying /grande/. However, it is not necessary to order B extrinsically after A just in case A is not constrained to apply to the output of B. If A and B are both applied to S simultaneously, we obtain the correct surface phonetic representation [grɑ̃d] without an extrinsic ordering statement, as demonstrated in (9) (= KSN's (10), page 6):

- (9) / g r a n d e /
 | |
 A B
 ↓ ↓
 [g r ɑ̃ ∅ d] *

* Footnote

KSN do not justify the incorporation of a final vowel in the UR of what must be the feminine form of the adjective, nor do they comment as to its quality. Instead they tacitly assume that such a vowel is deleted at some stage between UR and phonetic surface. For the theoretical repercussions of this aspect of their analysis and a brief discussion of "e féminin" in the literature, see below.

It should be noted at this point that following Schane (1968) the rules of (8) are incorrect. Although Schane does not formulate the rules for Vowel Nasalization and Nasal Consonant Deletion (even informally as KSN have done), he does state them in words on page 48, following an exhaustive table of the "Alternation of Oral Vowel plus Nasal Consonant with Nasalized Vowel" on pages 46, 47. According to him, the right-hand environment of Nasal Consonant Deletion (i.e. $\left\{ \begin{array}{c} \# \\ C \end{array} \right\}$) belongs to Vowel Nasalization, since:-

- (10) "Before nasal consonants:
Vowels become [+nasal] whenever the nasal consonant is
a. in word final position
b. followed by a consonantal segment.
A nasal consonant is subsequently deleted if the preceding vowel has been nasalized."

(Schane 1968; page 48)

We may schematize Schane's statement as (11):

- (11) Schane's Revision:

A Vowel Nasalization	$V \rightarrow \tilde{V} / \text{---} N \left\{ \begin{array}{c} \# \\ C \end{array} \right\}$
B Nasal Consonant Deletion	$N \rightarrow \emptyset / \tilde{V} \text{---}$

In fact the discrepancy between Schane's exegesis and the rules posited by KSN is a matter of diachrony. This is clear from Mayerthaler's (1974) citation of the history of Vowel Nasalization in French as an illustrative example of the notion 'formal simplicity' (pp. 50-53). Mayerthaler characterizes the situation which obtained in early middle French by rules notationally equivalent to KSN's (i.e. my (8)). He then notes that towards the end of the middle French period a new rule became productive, denasalizing nasalized vowels before a prevocalic nasal consonant. Using KSN's notation this may be schematized as (12):

- (12) Denasalization $\tilde{V} \rightarrow V / \text{---} N V$

By this rule earlier [bɔ̃nə] (bonne "good" Fem.) became [bɔnə] As

N.V. Smith observes in his review of Mayerthaler:

- (13) "These three rules happen to generate precisely the set of forms which show up in modern French, and the question M(ayerthaler) raises is whether this fact entails that these rules (call them G1) are still 'correct' for modern French. His reply is negative, as there is no motivation in contemporary French for a rule of denasalization. Rather the simplest statement now is that vowels are nasalized only when they precede a nasal consonant which is itself followed by another consonant or a word-boundary."

(1975; page 93; original emphasis)

When we come to schematize the two rules of "G2", we see that Vowel Nasalization is identical to (11) A, which follows Schane. On the other hand, Nasal Consonant Deletion appears to diverge from Schane's statement, and conform to KSN's (i.e. (8) B). For ease of exposition, both Mayerthaler's rules are given in (14), using KSN's notation:

(14) Mayerthaler's Revision:

- | | |
|----------------------------|---|
| A Vowel Nasalization | $V \rightarrow \tilde{V} / \text{--- } N \left\{ \begin{array}{c} \# \\ C \end{array} \right\}$ |
| B Nasal Consonant Deletion | $N \rightarrow \emptyset / \text{--- } \left\{ \begin{array}{c} \# \\ C \end{array} \right\}$ |

I shall return directly to the divergence between Schane's and Mayerthaler's stipulations for the environment of Nasal Consonant Deletion (i.e. (11) B and (14) B).

Meanwhile, accepting both Schane's and Mayerthaler's analyses, we must reject KSN's on the grounds of observational inadequacy. For according to KSN's formulation of Vowel Nasalization, there are no sequences of oral vowel plus nasal consonant on the phonetic surface of French. Yet this is precisely what we find in the feminine form of some adjectives, to cite but one morphosyntactic category (e.g. [plɛn] (pleine "full"); [bɔn] (bonne "good"); [brɛn] (brune "brown"); [fin] (fine "fine").) The reason that (11) A has not applied to such forms, nasalizing the vowels, is accounted for under Schane's analysis by the presence of a final lax central vowel in their URs (i.e. /plɛn + a/; /bɔn + a/; /brɛn + a/; /fin + a/, where capitals denote the class of phonologically tense vowels). The spirit (if not the precise vocalic quality) of this

analysis is corroborated by Dell (1973) who makes the following claim:

- (15) "Nous nous proposons de montrer que le divorce entre prononciation et graphie n'est qu'apparent, et que pour rendre compte des alternances de genre dans toute leur généralité, les représentations phonétiques des adjectifs féminins doivent être dérivées de représentations phonologiques qui se terminent par un certain phonème vocalique que nous noterons à l'aide d'un e renversé ou 'schwa'."

(page 178)

Thus both Schane's and Dell's treatments differ radically from that found in Bloomfield's "Language" (1933) where masculine adjectives are derived from the surface phonetic form of the feminine by final consonant deletion. By incorporating the so-called "e féminin" of orthography, Schane and Dell's analyses are able to account for the appearance of final schwas before "h aspiré" (e.g. [ynə grãdə ʒt(ə)] (une grande honte "a great shame")) and to provide an explanation for the stylistic and dialectal difference in the treatment of the presence versus absence of "e muet". *

Apart from the observational adequacy of the revised rules of Vowel Nasalization and Nasal Consonant Deletion (as opposed to the observational inadequacy of KSN's rules), they have interesting formal implications. As they are formulated following Schane in (11) we see that they constitute a case of "intrinsic feeding" or "unilateral supplying" in the sense of § 3.3. One might therefore argue that, since nasal consonants are always deleted after nasalized vowels, that is, after they have conditioned Vowel Nasalization, the rules constitute not two but one phonological process. On the other hand, precisely the same conclusion might be reached by inspecting Mayerthaler's rules (i.e. (14)):

* Footnote

For persuasive argument from the other direction, see Baxter's (1974) dissertation, where he proposes a productive rule of [t]-Insertion and claims that only an analysis which derives feminine adjectives from the masculine has psychological validity in contemporary French. Baxter's position is maintained in Smith and Wilson's summary (1979; Chapter 10)

the rule-pair should be collapsed into a single schema just in case they are both obligatory and operate in identical environments. We might schematize such a unified process as (16):

(16) Nasalization

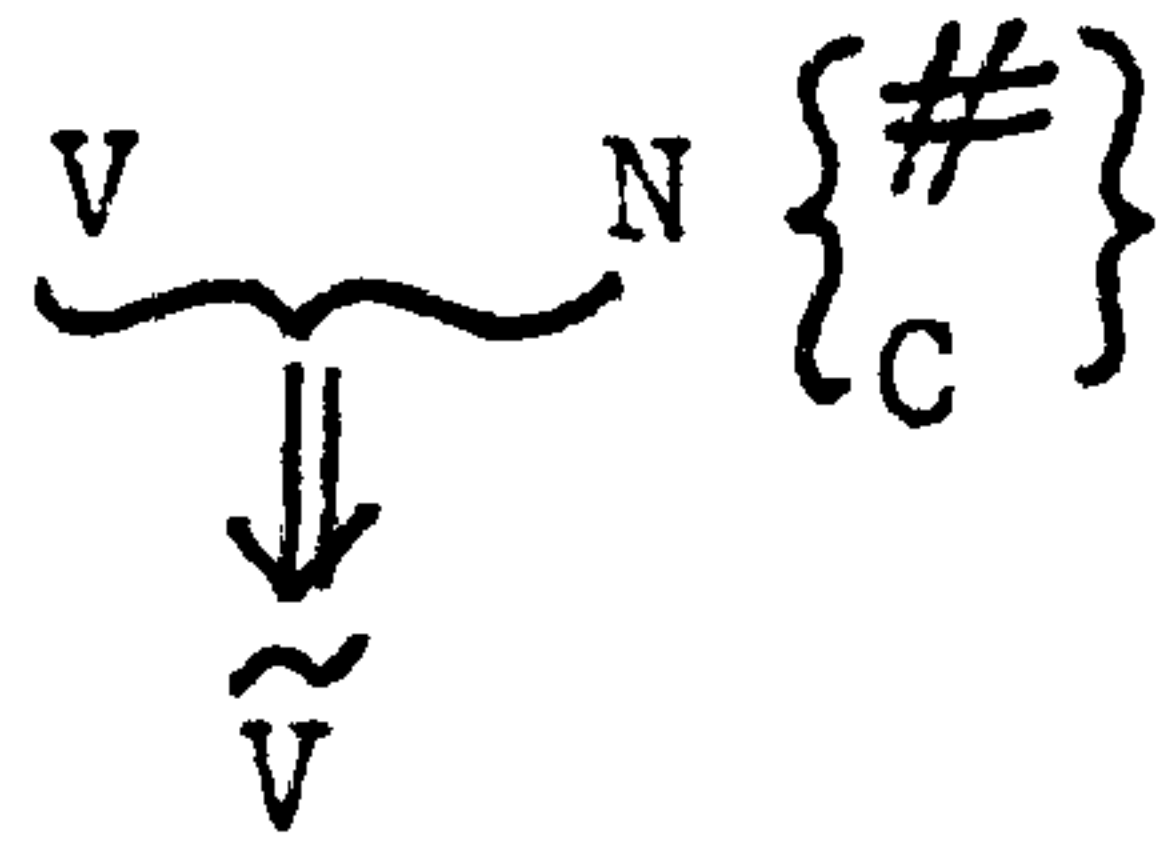

Indeed by showing that both Schane's and Mayenthaler's formalizations of Nasal Consonant Deletion (i.e. (11) B and (14) B) can be collapsed with Vowel Nasalization into (16), we can demonstrate that the two rules are formal variants of each other. In other words the divergence between (11) B and (14) B is formal rather than empirical.

Turning now to the advantages of schema (16) itself, it captures the fact that oral vowel plus nasal consonant are coalesced into a single segment sharing the properties of both i.e. a nasalized vowel.

Simultaneous application reflects this only accidentally - there is no algorithm stipulating that two rules may apply simultaneously only if they constitute one phonological process. This is clear once we consider the examples of simultaneity in KSN which we have treated so far: it is highly implausible to claim that Spirantization and Devoicing are a unified process in Low German since they may apply in independent environments; more drastically Swiss German Umlaut could not form one rule with vowel alternation, for the former is morphologically conditioned, the latter phonetically conditioned.

Notice moreover that (16) implicitly makes the claim that Vowel Nasalization and Nasal Consonant Deletion do not apply separately in contemporary French. To the extent that such a position is empirically justifiable, a grammar incorporating (16) is strengthened. In this connection it is important to point out that (16) is a fully-fledged

phonological rule and one related to processes of vocalic alternation whereby, for example, /fin/ → /fĩ/ → [fĩ̃], /bryn/ → /brỹ/ → [brõ̃]. As such it does not operate across morpheme boundaries. On the other hand, there is evidence of a phonetically transparent PDR of Nasalization, whereby any vowel in the immediate environment of a nasal consonant will acquire a nasal "timbre" - considerably lower on the n-ary scale of Nasality than a systematic nasal vowel e.g. [mã tãnt(ə)] (ma tante "my aunt"). This is precisely the same phenomenon as is found in English: [mãĩ ä:nt]. Indeed there is reason to suppose that it need only be specified once for all languages by a Universal Phonetic Theory. We have dealt at length with the observational inadequacy of KSN's rules for French. Assuming now for the sake of argumentation that (8) A were revised to (11) A, we must consider whether the KSN hypothesis could predict phonetic surface forms like feminine [bɔ̃n]. Following their derivation of feminine [grãd] from underlying /grande/, we must assume some UR-like /bɔne/. At first glance, even though (8) A wrongly predicts Nasalization here, the underlying final /e/ prevents the application of revised (11) A. Now observe that in informal registers and most dialects the final vowel is deleted on the phonetic surface. Given that under the KSN hypothesis a rule applies whenever its SD is met, what is to prevent the application of Vowel Nasalization, (11) A, once final /e/ has been deleted? The solution cannot lie, as it might under UDRA, in the fact that /e/-Deletion is a PDR, since KSN make no distinction between this kind of process and phonological rules proper. Notice however that even if it could not be shown that "e-muet" Deletion is a PDR, under the theory of UDRA developed here where iterative application but not re-application is permitted (see § 4.3), Deletion guarantees the prior single application of Vowel Nasalization. We must conclude therefore that quite apart from questions of observa-

tional adequacy, the formal apparatus proposed by KSN is incapable of generating surface phonetic representations like [bɔ̃n] for French.

In this section we have so far reviewed two examples of counterbleeding handled by simultaneous application. In each case we have found a more insightful analysis available within UDRA and we have consequently rejected KSN's claim that the data constitute evidence for simultaneity. It must be stressed at this point that our conclusion does not permit us to claim that we have a case against simultaneous rule application. We will now survey two abstract analyses from Spanish, bearing this caution in mind.

We should perhaps note before proceeding that the first example KSN cite from Latin American Spanish does not violate constraints on Abstractness to the extent that the second example does. Both are taken from Saporta (1965) and are discussed by Hooper, who notes this difference between them. With her, we will question the dialect-internal motivation behind the choice of URs and hence the need for postulating each rule-pair in the first place.

Uruguayan Spanish purportedly has the following pair of rules extrinsically ordered in a counterbleeding relation:

- (17) A Vowel Lowering $e \rightarrow \varepsilon / \text{ ______ } C$
 B Final s-Deletion $s \rightarrow \emptyset / \text{ ______ } \#$

Applying these to underlying /klases/, ("classes"), we see that since B removes the conditioning environment for A, it must not be ordered before it - this is the only constraint which must be imposed upon the rules of (17). However, once again it is possible to apply both A and B simultaneously to underlying /klases/ and obtain the correct surface phonetic representation [klasɛ]. So here we have a typical

example of KSN's reduction of rules extrinsically ordered in a counter-bleeding relation to one of simultaneous rule application.

On the other hand, the NGP analysis rules out underlying /s/ as the marker of plurality in the phonological grammar of a native speaker of the Uruguayan dialect. This is because, according to the basic tenet of NGP, the True Generalization Condition, "all rules express transparent surface generalizations" (Hooper page 13). We will beg the question here of what constitutes a "true surface generalization" (as Hooper does; for discussion of the related concept in TG of "significant linguistic generalization" see Botha 1971). Rather, we will go along with Hooper's point that since the phonetic motivation for the rules of (17) is not available on the phonetic surface, (17) does not represent an account of native speaker competence. *

NGP is interesting with regard to these data inasmuch as it makes quite explicit predictions about the situations which will result when two phonetically motivated rules such as vowel laxing (= lowering) and s-Deletion are interacting in a particular language. According to Hooper (page 33) there are two distinct possibilities here: the first is that the rules will apply in what she describes as "intrinsic" order. By "intrinsic" Hooper apparently means in an "intrinsic feeding" relation (1976; page 19; cf. § 2.1 above). Note that she does not mean "intrinsic" in the KSN sense of "whenever the structural description of a rule is met". If it did, we would expect NGP to entertain the possibility that rules may apply simultaneously. Instead Hooper

* Footnote

A states that vowels are lowered (= laxed in Hooper's formulation) in checked syllables only. Since [ɛ] is in an open syllable on the phonetic surface, A is not phonetically motivated. B is a neutralization process and hence per se cannot express a true surface generalization.

suggests that s-Deletion will apply first, creating new unchecked syllables which are no longer eligible for laxing. Under such an analysis no account is given of the non-application of laxing to the underlying representation and in fact Hooper makes no mention of it. Furthermore such a treatment actually violates two principles of UDRA. Firstly, PIPrec is seen to be operative here, when we consider that the string undergoing laxing /es\$/ (where \$ is a syllable boundary in Hooper's formulation) properly includes that eligible for s-Deletion /s\$/ . Secondly, we will formulate Deletion Cession in § 4.2 to ensure that deletions never take applicational precedence.

Citing data from Mondéjar (1970), Hooper attempts to explain the surface homonymy of 2 and 3 singular of comer ("to eat") as [kome] in western Andalusia, by the lexical restructuring of items that previously contained /s/. Under UDRA we accept that "end product" of this analysis but reject the "route" taken to reach it. This is because there is no principle of UDRA known to me which will predict the precedence of s-Deletion over Laxing.

Now we turn to the second prediction made by NGP, given the rules of (17). NGP predicts that vowel laxing will become morphologized, singular and plural now being distinguished by the openness of the final vowel only. This is the situation which has developed in eastern Andalusia and Hooper therefore discusses the latter. However the remarks which follow are also applicable to KSN's Uruguayan example, even though, according to Vasquez (1953), the Uruguayan situation is still variable.

The claim that vowel laxing has been morphologized must also be adopted in a more "realistic" theory of phonology such as one which incorporates

the UDRA hypothesis. Like NGP, such a theory does not permit an analysis where laxing is conditioned by a segment which never appears on the phonetic surface. What is particularly interesting in Hooper's discussion is the claim that morphologization took place in the dialects concerned whilst the phonetic motivation for laxing was optionally present on the surface in the form of [h], a weakened reflex of /s/. Here it might be countered that if NGP makes the strong claim that "the phonetic motivation for a phonological rule must be systematically observable on the surface" (1976; page 38), what reason is there for making the additional claim that morphologization occurred when the rule in question was still phonetically conditioned, at least for some speakers? Surely it would be preferable to postulate /h/ as the marker of plurality in just those speakers' grammars where [h] occurs on the phonetic surface?

However to argue in this way would be to deny the possibility that [h] could be optionally present in a particular idiolect after morphologization had taken place or that the speaker of a dialect with [h] could also have access to a grammar where laxing had been fully morphologized. Only by postulating that morphologization was in progress at a stage when laxing remained phonetically transparent can we account for these facts. We shall refer back to this hypothesis both in our discussion of Old Breton in the next chapter, and more particularly in Part II (§ 1.4).

To sum up, we accept the overall conclusion of NGP that there is no dialectal-internal justification for postulating /s/ in the URs of the eastern Andalusian and Uruguayan dialects of Spanish. Of course, such an analysis is motivated in Castilian - and Saporta's treatment has the purported advantage of setting up identical URs across dialects.

However I would claim that such an advantage is dubious as there is no a priori reason to assume that speakers of eastern Andalusian and more particularly Uruguayan dialects have access to competence in the standard language.

As a final point, it is interesting to note with Hooper that a morphological treatment is corroborated by the development of a vowel harmony system in Granada (located in eastern Andalusia). In this dialect, all vowels in plurals are laxed, contrasting with the occurrence of exclusively nonlax vowels in singulars (1976; page 36). Since vowel tenseness has been morphologized, it is directly related to meaning, serving to keep plural and singular "apart". The development of a vowel harmony system may be viewed as an attempt to achieve maximal differentiation between plural and singular. Inasmuch as these facts are left unexplained in Saporta's (and KSN's) analyses, the latter must be deemed deficient.

KSN's final example of counterbleeding involves the Latin American reflex of Spanish crecer ("to grow"). Let us briefly discuss the range of data for which Saporta claims to account with his analysis, and which is later reduced to simultaneous rule application by KSN. In the dialects concerned, a few verbs, of which crecer is one, show an alternation between stem-final /s/ and /sk/. /sk/ appears in the 1st. singular of the present tense and in the subjunctive, whilst /s/ is found elsewhere. This alternation cannot be predicted solely from the fact that the inflectional endings before which /sk/ appears begin with /a, o/, because other verbs like coser ("to sew") do not alternate i.e. /s/ appears in 1st. singular present and the subjunctive. Saporta exploits the fact that there is no segment [θ] on the phonetic surface of Latin American Spanish and proposes that the UR of crecer is /kreθer/

as opposed to /koser/ for coser. He then formulates a rule of k-Insertion ((18) A) which must be applied before its conditioning environment, /θ/, is removed by Stridency ((18) B):

- (18) A k-Insertion $\emptyset \rightarrow k / V\theta \text{ --- } \begin{Bmatrix} o \\ a \end{Bmatrix}$
- B Stridency $\theta \rightarrow s$

It is worth noting at this point a contradiction involved in the motivation behind Saporta's URs /kreθer/ and /klases/. We mentioned above the purported advantage (which we later denied) of setting up a single UR for all dialects of Spanish by postulating underlying /s/ as the marker of plurality. Yet, with regard to the verbs under discussion, it is just such cross-dialectal evidence which vitiates the postulation of underlying /θ/ - for, as Hooper notes in a footnote on page 6, "in Castilian, where the /s/ - /θ/ distinction is made, the /θ/ does not condition the insertion of /k/, since there is at least one verb cocer [koθer] that does not undergo /k/-insertion". Thus we see that paradoxically the saving feature of Saporta's abstract treatment of plurality - the fact that it reduces dialectal variation in the lexicon - serves as his downfall in the abstract treatment of verbs like crecer.

To return to the rules of (18), we once again find the typical situation in which a counterbleeding relation is reducible to one of simultaneous rule application by KSN - provided Stridency is not permitted to apply before k-Insertion, we need impose no extrinsic order on this rule-pair. Under the KSN hypothesis, the alternation exhibited by crecer may therefore be analyzed by means of underlying /kreθer/ and the rules of (18), applying simultaneously rather than in the extrinsic order k-Insertion, Stridency.

The question we must now ask is the following: Does Saporta's analysis

accurately reflect the competence of native speakers of Latin American Spanish? Put another way: Does the postulation of /kreθer/ as the UR of crecer violate constraints on Abstractness? At this point let us turn to the first serious attempt to constrain the abstractness of underlying representations - I am of course referring to Kiparsky's important 1968 paper, from which I quote the definitions of both the absolute and the contextual varieties of neutralization:

- (19) "Let us term the merger of distinct representations neutralization. The present theory of generative grammar allows phonological distinctions which are never realized on the phonetic surface to appear in the lexical representations of morphemes. I will term this kind of neutralization, which takes place regardless of environment, absolute neutralization, in order to distinguish it from the more usual contextual neutralization, in which an underlying distinction is lost only in a specific environment and retained elsewhere".

(1968a page 14; original emphasis)

Clearly Saporta's rule of Stridency brings about a case of absolute neutralization, for there are no environments in Latin American Spanish where [θ] appears on the phonetic surface.

Kiparsky's argument against absolute neutralization is that it permits the improper use of phonological features as arbitrary diacritic symbols, and thus mirrors on a lesser scale fully abstract morphophonemics such as that advocated by Lamb (1966) and Fudge (1967) and attacked in Postal (1968). Fully abstract morphophonemics denies that URs have "an intrinsic interpretation on the phonetic level" (Kiparsky 1968; page 6), thus violating Postal's Naturalness Condition. On the smaller scale, analyses involving absolute neutralization go against Naturalness by using a phonological feature to account for a difference between synchronically arbitrary morphological classes. In the Latin American Spanish example, the feature of stridency (/s/ is [+ strident], /θ/ is [- strident]) is being used as a diacritic to distinguish among verb classes.

While Kiparsky takes contextual neutralization to be a linguistic fact beyond dispute (e.g. intervocalic flapping in "writer" and "rider" discussed at length above), he attempts to limit the diacritic use of phonological features which lead to the questionable cases of absolute neutralization. For this purpose he formulates the Alternation Condition which has both a strong and a weak form. The Strong Alternation Condition "categorically forbids absolute neutralization". The Weak Alternation Condition constitutes "a clause of the evaluation measure which says (among other things) that absolute neutralization is linguistically complex" (1968a page 30). Kiparsky opts for the Weak Alternation Condition as a constraint on grammars, so that ceteris paribus an analysis not involving absolute neutralization would be preferred over one involving absolute neutralization. His argumentation in rejecting the Strong Alternation Condition is based largely on cases in which a phonological feature is used as a diacritic for more than one rule. In fact in 1971, he suggests that absolute neutralization always be excluded where the phonological feature is used as a diacritic for one rule only.

Hooper attacks Kiparsky's rejection of the Strong Alternation Condition, stating that "in short, the theory remains virtually unconstrained" (page 8). However she does note that Saporta's analysis would be prohibited even under the Weak Alternation Condition, since only one rule is involved (i.e. k-Insertion) (footnote 3, page 8). For our present purpose, we may leave open the choice between the strong and weak forms of the Alternation Condition, for we will return to a discussion of constraints on abstractness when we formalize Deletion in the next section. Let us simply note that Hooper is proposing (at least) a realistic model of phonology and that Saporta's analysis should not be permitted.

Thus NGP rejects Saporta's treatment of verbs like crecer above, replacing it by a morphologically conditioned rule of k-Insertion. What is more, NGP also abandons the KSN hypothesis at this point, on the grounds that, under the latter, unacceptable analyses in counter-bleeding relations are accounted for, and hence permitted by simultaneous rule application. In other words, NGP follows GROD is adhering to strict sequentiality.

It is perhaps worth reiterating here the point made in Chapter 1 that although we are accustomed to the disparaging remarks made by proponents of GROD when they ascribe simultaneity to the "taxonomists", and although attacks on Lamb's and Fudge's two line derivations are justified, there is simply no backbone in the generative literature to the case against partial simultaneity. The actual open-endedness of the issue is seen in the following passage from SPE which follows a discussion of such notations as C_0 , C_1 and other infinite schemata whose expansions must be tested simultaneously for applicability:

(20) "It should be stressed here that the existence of exceptions to linear ordering does not in any way affect the argument advanced here to establish the need for such an order. The conditions under which linear ordering does not hold have been defined precisely. The examples adduced to show the need for linear ordering do not satisfy these special conditions and remain, therefore, unaffected by the existence of ordering other than linear".

(SPE page 344)

On the other hand, KSN note that the well-known and empirically well-established arguments against all rules applying simultaneously by no means rule out the claim that some rules are applied simultaneously i.e. the number of lines in a derivation may be greater than two but less than the number of rules applied to determine it. Accordingly they adopt the position that, as noted earlier, all obligatory rules apply whenever it is possible for them to do so. They are swift to

point out that the principle whereby rules in a counterbleeding relation apply simultaneously is the same as that which accounts for rules in what was termed as "intrinsic feeding" relation above: namely, every rule applies whenever its structural description is met. The difference between the two cases is that in the case of intrinsic feeding there is no representation to which both rules can apply whereas in the case of counterbleeding there is.

To summarize the difference between KSN's and NGP's positions in the terms of Kiparsky's framework, KSN permit rules in feeding, counterbleeding and mutually bleeding relations. NGP prohibits both secondary modes of rule interaction and allows the primary modes. This is because counterbleeding and counterfeeding are opaque in the sense of Kiparsky 1971, and Hooper assumes "in accord with the principles of NGP and the evidence cited throughout this book, that the most natural, and in fact the only, rule order is the transparent rule order" (fn. 4; page 71).

In the case of counterbleeding the phonetic representation will necessarily be opaque with regard to the UR because "the conditioned variant produced by a rule shows up in surface forms where the conditioning context is not present" (fn. 3; page 64). Thus it is over crucial examples of counterbleeding that the two theories differ.

The position adopted in this thesis stands in a sense in between that of KSN and that of NGP. Taking it as being established that (phonological) rules are ordered according to universal rather than language-specific principles i.e. rejecting GROD, I nevertheless dispute the KSN claim that "all rules apply whenever their structural descriptions are met", just in case two structural descriptions are met at the same time. In this case a universal principle must determine which rule will take applicational precedence i.e. simultaneous application is not tolerated.

However, unlike NGP, I do not believe that this rejection of simultaneous rule application leads me to reject the rest of the KSN hypothesis. In fact KSN envisaged that simultaneity may not hold and formulated a supplementary principle which we will discuss below. Nor do I base my criticism of simultaneity on the crecer analysis, as Hooper appears to have done - I do not even base it solely on the other examples of counterbleeding in KSN, despite the fact that this section has demonstrated that none of them argues positively in favour of rules applying together in pairs. Rather, I shall argue on the basis of data from Yawelmani, Yokuts, Sea Dayak and Washo.

To sum up, we might characterize the KSN hypothesis as one of predictable simultaneity and sequentiality. However KSN anticipate the possible justification of the "more commonly accepted" hypothesis that all rules apply sequentially. Accordingly they formulate a supplementary universal principle, Counterbleeding Precedence, which will become operative should evidence be brought forward against the simultaneous application of rules in a counterbleeding relation.

(21) Counterbleeding Precedence

"For any representation R, which meets the structural descriptions of each of two rules A and B, A takes applicational precedence over B if there is some string that is included in the inputs of both A and B, not in the output of B".

(fn. 6; page 7)

In the second Saporta example, k-Insertion will take applicational precedence over Stridency, since whilst the structural descriptions of both rules contain / θ /, the output of the latter rule does not.

From this example, it is not clear to me why PIPrec could not be called upon to perform the function of Counterbleeding Precedence: the structural description of k-Insertion $V\theta \begin{matrix} \{o\} \\ \{a\} \end{matrix}$ properly includes the context-free input segment / θ / of Stridency. Indeed it is just such a

context-sensitive/content-free pair from Saporta's Latin American paper which is used in the following paragraph of KSN to illustrate PIPrec (/akeʌ: akeʌs/ involving Final Depalatalization and Delateralization). Of course if a universal principle permits abstract analyses involving absolute neutralization, then a theory of UDRA is not a substantive theory of phonology unless supplemented by other constraints (= Hooper's point against KSN, page 75). However, I trust that it has been demonstrated that what is required is a set of integrated hypotheses sharing theoretical plausibility if we are to characterize phonological competence in the most insightful way.

KSN themselves hypothesize as to the empirical evidence which would need to be brought to bear when deciding between Counterbleeding Precedence and simultaneous application. The kind of evidence needed to falsify counterbleeding precedence is illustrated in (22) from KSN (= fn. 6; page 7).:

$$(22) \quad A \quad \check{V} \rightarrow \bar{V} / \quad \underline{\quad} \quad \begin{bmatrix} + \text{ cons} \\ + \text{ voice} \end{bmatrix}$$

$$B \quad [+ \text{ voice}] \rightarrow [- \text{ voice}] / \check{V} \quad \underline{\quad} \quad \# \quad *$$

e.g. underlying / k ǎ d /

	A	B
	↓	↓
derived	k	ā t

The fact that [+ voice] is included in both SDs but not in the output of B, would lead to the precedence of A over B, thus bleeding B; on the other hand, the inclusion of V in the SDs of both rules but not in the output of A, predicts the reverse order and removes the possibility

* Footnote

Note that the structural descriptions partially overlap: If the word-boundary # were added to that of A, its structural description would read $\check{V} \begin{bmatrix} + \text{ cons} \\ + \text{ voice} \end{bmatrix} \#$, thus properly including that of B. Alternately, if [+ cons] were redundantly added to that of B, its structural description would read $\check{V} \begin{bmatrix} + \text{ cons} \\ + \text{ voice} \end{bmatrix} \#$, thus properly including that of A.

of A's applying. However, for this hypothetical example, simultaneous application yields the correct form.

It is indeed striking that KSN cite example (22) as hypothetical even though their rules recapitulate precisely the situation obtaining in English, where vowels are lengthened before underlying voiced obstruents and there is final obstruent devoicing phonetically. However the existence in natural language of the phenomenon adduced by KSN as potentially confirming simultaneity and refuting Counterbleeding Precedence can readily be accounted for under UDRA by the fact that final obstruent devoicing is a neutralization process - hence it cedes to vowel lengthening. Thus although (22) provides evidence against KSN's supplementary principle, there is still no positive case for simultaneity, taking the form of data which can only be explicated by that interaction-type. According to KSN, the format for a rule-pair which would disprove simultaneity and confirm Counterbleeding Precedence is the following:

(23) (= KSN's (25), page 14):

A $ab \rightarrow abab$

B $ab \rightarrow ac$

Yet as we shall see directly in § 4.2, crucial data from Yawelmani Yokuts which cannot be handled by simultaneity do not conform to KSN's hypothetical pattern. Moreover Counterbleeding Precedence is also incapable of accounting for such data. We must conclude therefore that the examples from Yawelmani Yokuts - and Sea Dayak and Washo - which we are about to discuss, constitute a type of data which KSN had not contemplated.

§ 4.2 Deletion Cession

We have seen that KSN propose that rules in counterbleeding relations apply simultaneously but that none of the examples they adduce provides positive evidence for such a position. In this section we turn to positive evidence against KSN's claim. The purpose of this section is, then, to find a viable alternative to simultaneous rule application and we shall discuss a number of proposals before deciding upon Deletion Cession.

In Yawelmani Yokuts, an Amerindian language spoken in California, the simultaneous application of a pair of rules in a potentially counterbleeding relation results in an incorrect phonetic representation. The rules involved are those of Epenthesis and Shortening, which may be schematized as (24):

(24) Yawelmani Yokuts

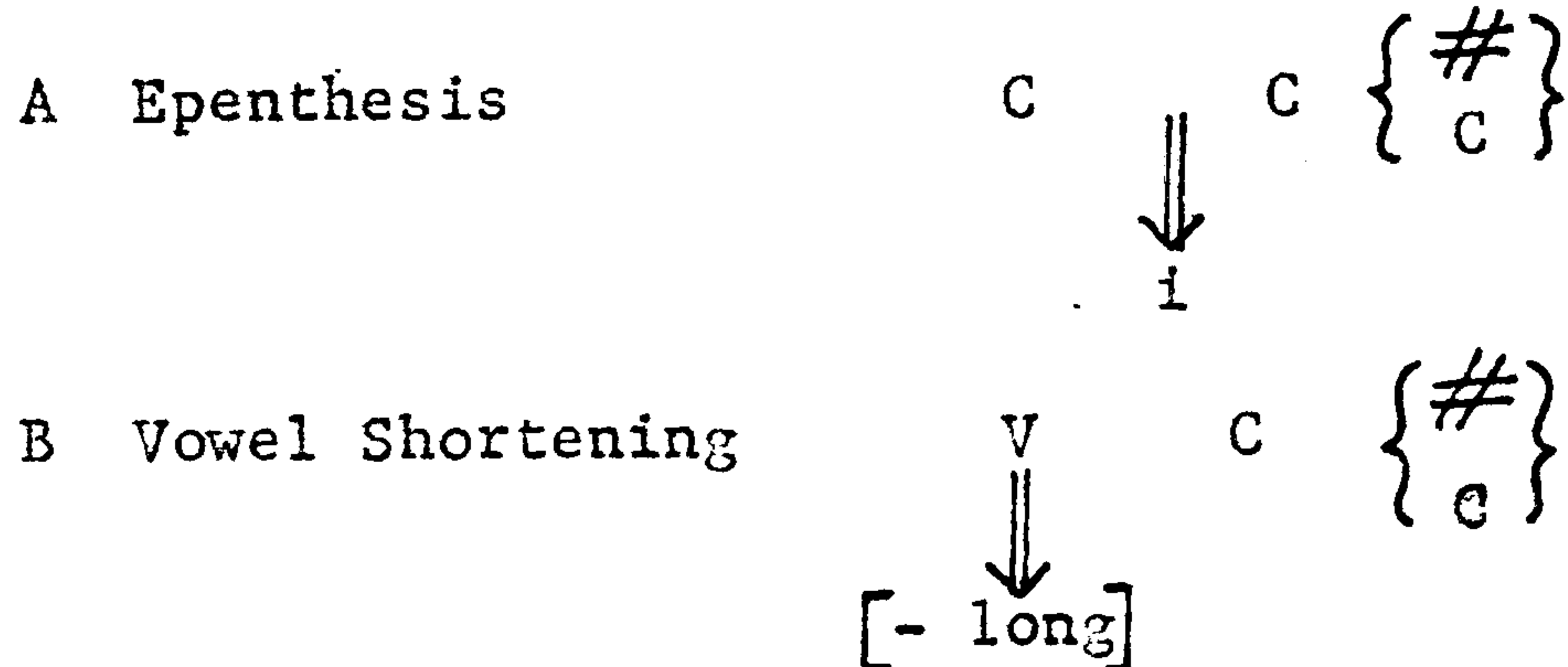

Since the rules of (24) are to play such a crucial rôle in our refutation of simultaneity as a possible mode of rule application, it is essential to establish from the outset the justification for postulating them in a grammar of Yawelmani Yokuts. This is particularly pertinent when one considers our rejection of KSN's arguments for simultaneity on the grounds that the rules involved were not motivated synchronically. Let us therefore evaluate the evidence in favour of positing rules of Epenthesis and Shortening for Yawelmani Yokuts.

C. W. Kisseberth's first published discussion of Yawelmani Yokuts (i.e.

apart from his 1969 doctoral dissertation) is his 1970 paper "On the functional unity of phonological rules". As the title indicates, in this paper Kisseberth is concerned with demonstrating that rules may have a common function or effect in the grammar, quite apart from formal, structural sameness which is the basis for collapsing rules by means of notational conventions. Accordingly, he adopts the term "conspiracy" to refer to the interaction between rules, all of which "conspire" to avoid or eliminate certain phonological sequences namely, for Yawelmani, word-final consonant clusters or tri-literal clusters. * As can be seen by referring to (24) A, Epenthesis is such a rule in the conspiracy since it breaks up a consonant cluster just in case it occurs at the end of a word or it is followed by a third consonant. We shall return to the notion of conspiracy when we discuss Iverson's treatment of Yawelmani.

Kenstowicz and Kisseberth (1977; henceforth K&K) treat Yawelmani data in some detail from a different perspective in the course of Chapter 1 devoted to 'The Abstractness of Underlying Representations'. They cite Epenthesis in Yawelmani as evidence for the tenability of the condition that the UR of a morpheme consist of all and only the invariant phonetic properties of that morpheme's various phonetic representations. (Of course, they then proceed to demonstrate the untenability of such a condition with reference to other data.) In Yawelmani verb roots which have the shape CVCC- before vowel-initial suffixes assume the shape

* Footnote

Kisseberth's original use of the term "conspiracy" was negative in that the rules referred to prevented certain phonological sequences from appearing on the phonetic surface. However the term has since been used positively, namely by N. V. Smith who defines 'infantile conspiracy' in child phonology as a set of rules, "all of them having in common the effecting of one or other unitary phenomenon" (1973; page 177). As an example of rules conspiring positively, we may cite Smith's treatment of vowel and consonant harmony in A's speech.

CVCiC before consonant-initial suffixes, as shown in (25); (= K&K's (3) page 9):

(25)	[?ilk-a]	"might sing"	[?ilik-hin]	"sings"
	* [logw-ol]	"might pulverize"	[logiw-hin]	"pulverizes"
	[?ugn-al]	"might drink"	* [?ugun-hun]	"drinks"
	[pa?ɬ-al]	"might fight"	[pa?iɬ-hin]	"might fight"
				<u>sic</u> : "fights" JRMcB

By omitting the second vowel from the URs of the morphemes concerned, the analysis conforms to the condition on the inclusion of invariant phonetic properties only. But what, apart from the fulfilment of this condition, is the motivation behind K&K's treatment? After all, Kisseberth (1970) notes that his basic course, Newman (1944) posited two vowels in all verb stems (Fudge Ed. page 265). K&K defend their analysis on two counts. The first is that since there are no trilateral clusters in the language, the proposed rule of Epenthesis "can be viewed as one that transforms underlying representations containing 'unpronounc(e)able' combinations of sounds into acceptable surface forms" (K&K 1977 page 9). This amounts to the point made earlier regarding the conspiracy in Yawelmani phonology. **

The second count is that all disyllabic verbs with nonidentical vowels have [i] (or its harmonic counterpart [u]) as their second vowel and, as Kisseberth stresses, this form always occurs before consonant-initial

* Footnote

/a/ and /i/ have become rounded and backed to o and u respectively in these forms by virtue of the productive rule of vowel harmony whereby a vowel becomes [+round, +back] if preceded by a rounded vowel of the same height within the word.

** Footnote

Notice also that such a view is incompatible with Hale's proposal (1971 in T. Sebeok, H. Hoenigswald & R. Longacre Eds.) that URs mirror surface canonical forms.

suffixes. In Kisseberth's words: "Any analysis which seeks to do without vowel epenthesis must somehow represent the fact that the i in pa?ithin, ?ilikhin, etc., is not freely selectable and furthermore that it must occur when the suffix has an initial consonant, but not when the suffix has an initial vowel". (Fudge Ed. page 265; original emphasis). Inasmuch as Newman's analysis fails to explain these facts, let us accept that Epenthesis is operative in deriving [?ilikhin] from /?ilk/ + /-hin/.

An examination of Shortening (24) B, reveals that this rule is also well motivated. K&K postulate it to account for the vowel-length alternation observed in verb roots: the root vowel is short when the root is word-final or, as illustrated below, when it precedes a consonant cluster as the result of adding a consonant-initial suffix, but long when the suffix begins with a vowel: (= K&K's (8) page 11, 1977).

(26)	[ʃa:p-al]	"might burn"	[ʃap-hin]	"burns"
	[do:s-ol]	"might report"	[dos-hin]	"reports"
	[me:k'-en]	"will swallow"	[mek'-k'a]	"swallow!"
	[c'o:m-ut]	"was destroyed"	[c'om-k'a]	"destroy!"

The evidence for postulating a rule shortening underlying long vowels, rather than a rule lengthening underlying short vowels, is seen in (27) (= K&K's (9) page 12; 1977), which gives examples of morphemes which exhibit only the short vowel in both suffixal environments:

(27)	[xat-al]	"might eat"	[xat-ka]	"let's eat"
	[xil-en]	"will tangle"	[xil-hin]	"tangles"
	[bok'-en]	"will find"	[bok'-xo]	"let's find"
	[hud-al]	"might recognize"	[hud-mu]	"having recognized"

A rule of lengthening would incorrectly derive *[xa:t-al] from under-

lying /xat/ + /-al/. We therefore accept K&K's claim that a rule of shortening must figure in a grammar of Yawelmani.

Having dispensed with preliminaries, let us consider our crucial piece of data involving the interaction of Epenthesis and Shortening, the derivation of [ʔamlal]/[ʔa:milhin] "might help/helps". In order to account for the alternations of (26), the verb root must have the underlying shape CV:CC. When /-hin/ is appended to underlying /ʔa:ml/, Epenthesis will apply to break up the resultant trilateral cluster. On the other hand, when the vowel-initial suffix /-al/ is added to the root, the underlying long vowel will shorten. In the framework of GROD, K&K note that "vowel insertion (= Epenthesis; JRMcB) is crucially ordered to apply before vowel shortening in this analysis" (1977, page 12). The correct derivations are shown in (28) (= K&K's (10); page 12).

(28)	UR	i) /ʔa:ml-al/	ii) /ʔa:ml-hin/
	Epenthesis	INAPPLICABLE	ʔa:ml-hin
	Shortening	ʔaml-al	INAPPLICABLE
	Phonetic Surface	[ʔamlal]	[ʔa:milhin]

Since underlying /ʔa:ml-al/ never meets either the word-final subcase or the trilateral subcase of Epenthesis, it may be omitted in what follows.

K&K return to the possibility of deriving of [ʔa:milhin] from underlying /ʔa:ml-hin/ in their discussion of 'Natural Rule Interactions' in Chapter 4. Here they note that the attested ordering, Epenthesis before Shortening, is a bleeding order since, whilst the underlying representation meets the SDs of both rules, the prior application of Epenthesis results in an intermediate representation which no longer meets the SD of Shortening i.e. the application of Epenthesis prevents Shortening from applying. Although K&K do not mention the possibility

of both rules applying simultaneously, they note that the reverse ordering, Shortening before Epenthesis, in other words the counterbleeding order, enables both rules to apply but derives an incorrect surface phonetic form. As we saw with the examples of counterbleeding in the last section, this mode of interaction yields the same phonetic representation as simultaneous application. This is demonstrated in (29) (where (29) i = K&K's (5b) page 158; 1977).

(29) i counterbleeding order

UR	/?a:ml-hin/
Shortening	?aml-hin
Epenthesis	?amil-hin
Phonetic Surface	*[?amilhin]

ii simultaneous application

UR	/ ? a : m l - h i n /						
	<table> <tr> <td style="text-align: center;">↓</td> <td style="text-align: center;">↓</td> </tr> <tr> <td style="text-align: center;">Sh</td> <td style="text-align: center;">Ep</td> </tr> <tr> <td style="text-align: center;">↓</td> <td style="text-align: center;">↓</td> </tr> </table>	↓	↓	Sh	Ep	↓	↓
↓	↓						
Sh	Ep						
↓	↓						
Phonetic Surface	* [? a m i l h i n]						

The derivation of [?a:milhin] from the well-motivated UR /?a:ml-hin/ constitutes a serious counterexample to the KSN hypothesis: here we have a UR which meets the SDs of two productive, obligatory rules - rules which cannot be permitted to apply simultaneously, even though the SCs they effect are not mutually exclusive. The latter caveat is important in that if the outputs of both rules were incompatible one might have a case where PIPrec would be operative. Yet this is not so and in any case neither SD properly includes the other. Nor can we proffer the possible explanation that Epenthesis and Shortening are mutually exclusive (i.e. disjunctively ordered) in a given derivation, for both are operative in (30) (after Kisseberth 1970 in Fudge Ed.; page 264):

(30)	UR	/di:yl + t /	"guard, watch" + Passive Aorist
	Epenthesis *	di:yl + it	
	Lowering	de:yl + it	
	Shortening	deryl + it	
	Phonetic Surface	[deylit]	

Gregory Iverson, in his 1973a paper (reprinted in A. Koutsoudas Ed., 1976) addresses himself to the problem of whether PIPrec or simultaneity is correct when both are possible. As Iverson notes, KSN leave this question open. ** The data discussed by Iverson are taken from K&K's 1973 paper 'Unmarked Bleeding Orders' (in Kisseberth Ed.) and include our recalcitrant example from Yawelmani Yokuts. Iverson demonstrates that K&K's data from Takelma can be handled by PIPrec but not by simultaneity even though the latter mode of application is logically possible. Their Lithuanian data can also be handled by PIPrec at the expense of simultaneity provided the occurrence of a variable is not taken into account in the determination of PI. This codicil to PIPrec, Hapax Legomenon (sic), must also be invoked in the derivation of [dɪʃɪz] in English by Epenthesis and Voicing Assimilation. The relevant rules may be stated as (31): ***

* Footnote

Here it is the word-final subcase of Epenthesis which is applicable.

** Footnote

Trommelen & Zonneveld's (1978) review of the Koutsoudas volume is misleading: they claim that in KSN, PIPrec and Obligatory Precedence are hierarchically ordered with PIPrec first (page 6).

*** Footnote

I have made marginal changes to the format of Iverson's rules in order that they may conform to my own schematization. However neither this, nor the fact that Iverson cites Epenthesis as the insertion of i, in any way affects the points under discussion.

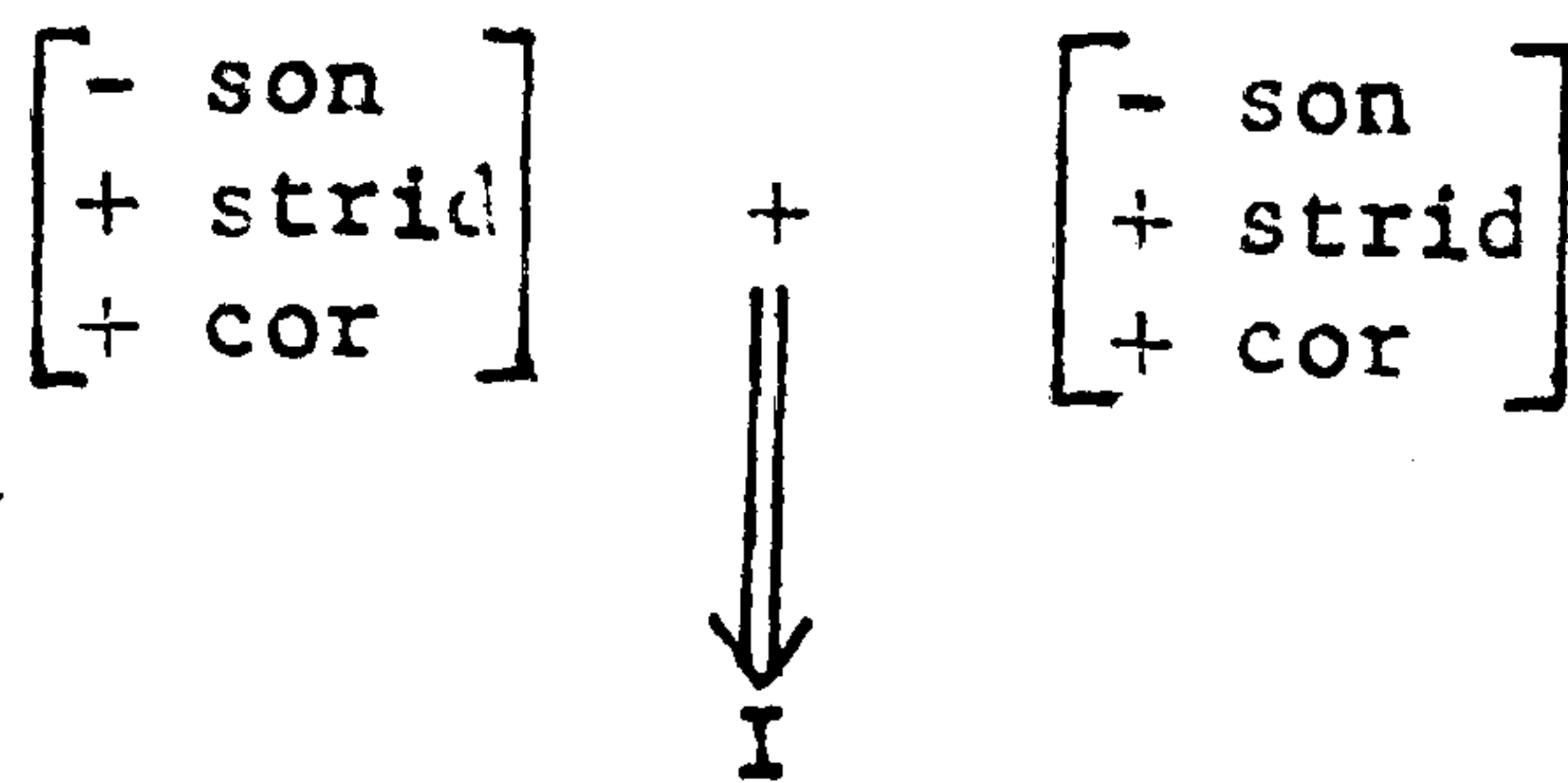
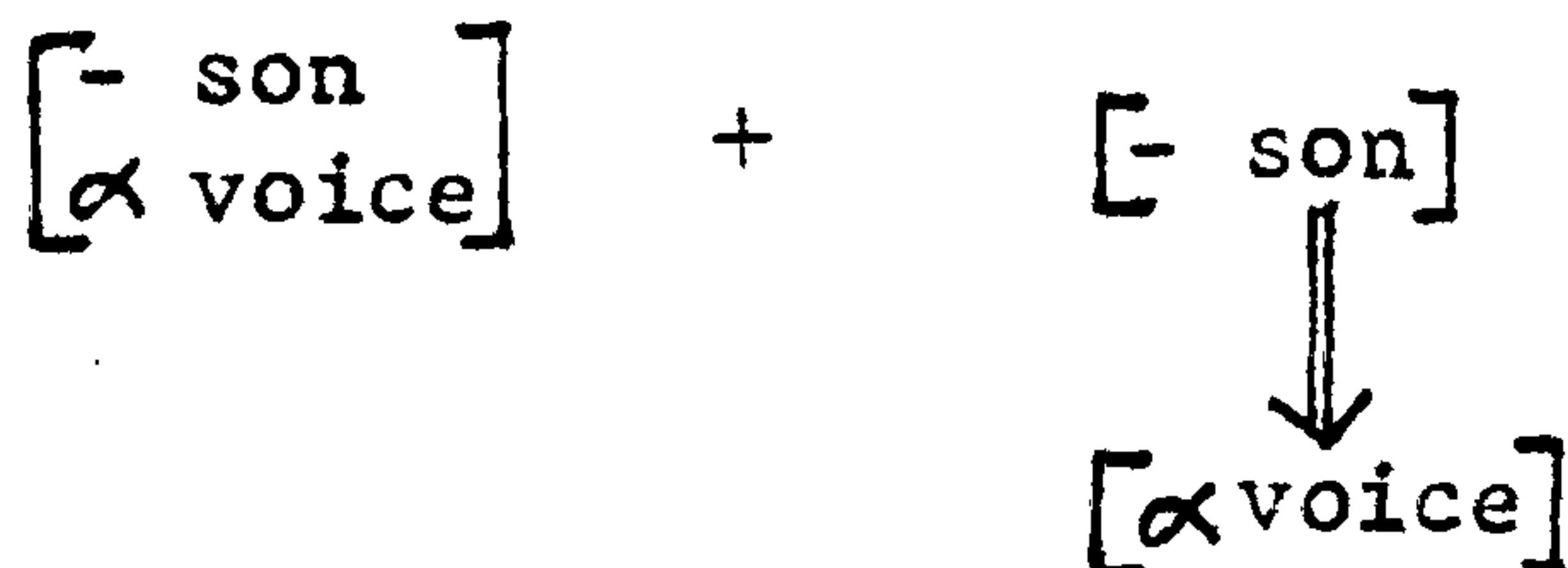
(31) EnglishA ɪ-EpenthesisB Voicing Assimilation

The validity of Iverson's codicil is evidenced by considering that the single occurrence of $[\alpha \text{voice}]$, for example, is equivalent to both $[+ \text{voice}]$ and $[- \text{voice}]$ and hence tantamount to the omission of the feature $[\text{voice}]$ altogether from the rule's SD. By applying the codicil to the rules of (31), $[\alpha \text{voice}]$ is disregarded and hence Epenthesis takes applicational precedence over and bleeds Voicing Assimilation by PIPrec. Moreover, if these rules applied simultaneously to underlying $/dɪʃ + z/$, $[dɪʃɪs]$ would result because of the adjacency of the obstruents in the UR.

It is worth pointing out that rules which contain a single occurrence of a variable (or single occurrences of different variables) in their SDs - to be matched by the occurrence of the same value in the rule's output - are typically assimilation rules. By ignoring the variable, we are left with a more general structural description, one which is more likely to be properly included in the feature specification of some other rule. Just in case the SD of this other rule is met at the same time as that of the assimilation rule, we might expect the non-assimilatory rule to take applicational precedence. In other words, it is reasonable to assume that assimilatory processes will take place

late in derivations. This ties in with the fact that some assimilations are best represented as PDRs which by definition apply to the output of the phonological component proper. (See § 3.3 for discussion of homorganic nasal assimilation as a PDR in English.)

As one might expect given the fact that KSN does not appear in their 1977 bibliography, K&K do not appeal to PIPrec in their 1973 paper. Rather they are concerned to show, as the title indicates, that certain bleeding relations are unmarked. Their claim is that in cases of bleeding a rule which alters syllable structure takes applicational precedence over (= bleeds) other kinds of rule. This principle holds for Takelma where the bleeding rule is one which forms the aorist stem by a vowel-copying operation and the bled rule is a neutralization process effecting deglottalization and devoicing in pre-consonantal position. Whilst I shall not deny the existence of K&K's principle here, indeed, it will be reinforced below when we come to discuss the late application of neutralization processes as a back-up to Deletion Cession - the fact that independent precedence principles make the same prediction only serves to strengthen the theory of UDRA being advanced here.

K&K's syllable structure principle appears also to be operative in predicting the priority of Epenthesis over voicing Assimilation in Lithuanian and again in English (although the latter example is Iverson's alone). However, in addition K&K view the Lithuanian data from a different perspective, both in the 1973 paper and the 1977 volume, by adopting the principle of Minimization of Opacity developed in Kisseberth 1973 (in Ed. B. Kachru et al; where the notion of opacity is that of Kiparsky discussed above.) Under Minimization of Opacity both rules are transparent - represent "true surface generalizations"

in NGP terms - if applied in a bleeding order. K&K (1977) note that where bleeding orders are concerned, Minimization of Opacity is at variance with the "maximal utilization" principle developed in Kiparsky 1968 for the latter favours counterbleeding (both rules apply) over bleeding (one rule applies). The Lithuanian and English data provide instances where the transparent bleeding order is the attested one when the language contains a rule assimilating the voicing of adjacent obstruents and an epenthesis rule which breaks up consonant clusters. As K&K point out (1977, page 163), if these rules are in a counterbleeding order, obstruents will assimilate in voicing even when they are phonetically separated by a vowel. We would not expect obstruents to agree in voicing on the phonetic surface if they are not contiguous at that level of representation.

Whilst the precedence of Epenthesis may be predicted for Yawelmani because it alters syllable structure, minimization of opacity may also be invoked as an explanation of these data. D. A. Dinnsen (1974) compares the outputs of the two possible orderings of Epenthesis and Shortening (= my (28) ii and (28) i) and notes that that of the correctly ordered rules is transparent whilst that of the incorrectly ordered rules is opaque: there are no surface violations of either Epenthesis or Shortening in attested [ʔa:miɫhin], the long vowel being followed by a single permissible consonant and the epenthetic [i] breaking up a potential triliteral cluster; on the other hand, unattested *[ʔamiɫhin] is opaque with respect to Shortening since a short vowel appears in a context which does not condition it.

By applying Epenthesis and Shortening in that order according to the precedence of rules changing syllable structure and the principle of minimization of opacity, K&K claim to be able to account for our

Yawelmani data. Yet there is, I contend, another explanation: if we view Shortening as a process whereby two morae are reduced to one, we can claim that Shortening is a deletion process as schematized in (32)

(32) Vowel Shortening as Deletion

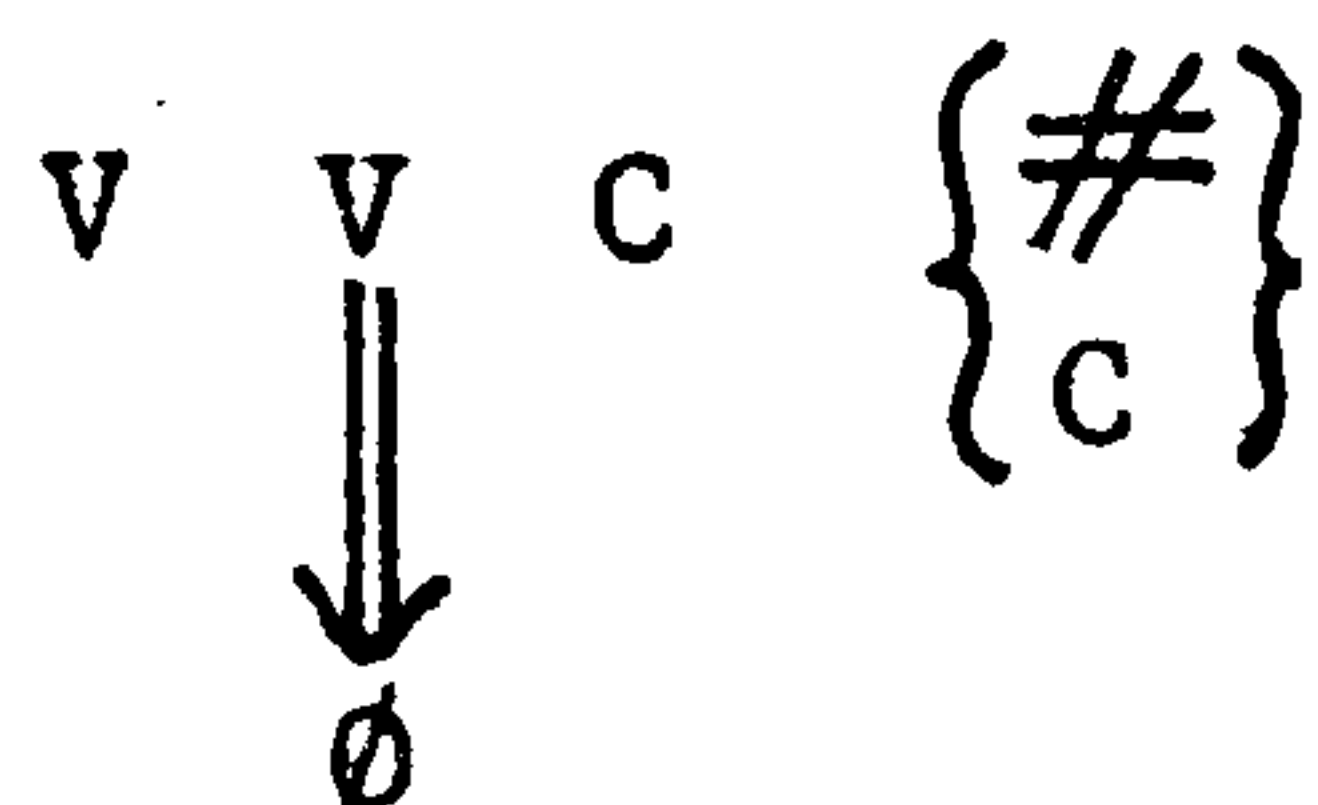

The following principle may then be formulated:

(33) Deletion Cession

Given a structure which meets the structural descriptions of two rules A and B, A takes applicational precedence over B in case B is a deletion process.

Our task, then, in the remainder of this section is to substantiate Deletion Cession both in terms of the data for which it accounts but for which other precedence principles make false predictions, and in terms of its status as an axiom of the UDRA hypothesis.

It is important to note at this point that the adoption of Deletion Cession does not per se entail the outright rejection of K&K's proposals regarding rules altering syllable structure or the minimization of opacity. Yet it does mean that we reject them as absolute principles. That is to say, they may be incorporated into a theory of UDRA as relative principles or tendencies, where a grammar which adheres to them is less marked than a grammar which violates them. Deletion Cession, on the other hand, is an absolute principle to be superseded only by PIPrec, as we shall see below.

However, two further proposals, made by Sanders and Iverson, and Iverson, respectively, must be rejected in the light of further data.* Dinnsen claims that Sanders' and Iverson's tentative principle (conveyed personally), Radical Change Precedence, accounts for Yawelmani Yokuts:

(34) Radical Change Precedence:

"For any representation R which meets the structural description of each of two rules A and B, A takes applicational precedence over B if and only if A results in a more radical change than B."

In order to remedy the lack of explicitness in this formulation - what constitutes a "more radical change"? - Dinnsen comments that "This principle would presumably order insertion and deletion rules before competing rules that simply change feature simplifications. In the case of Yawelmani, then, Epenthesis would correctly take applicational precedence over the feature-changing rule Shortening". (page 37; emphasis mine). Yet the applicability of Deletion Cession depends crucially on the interpretation of Shortening as a deletion process. Indeed such an analysis is confirmed by evidence from degemination in Berber, to be discussed in § 4.3. If such an interpretation of Shortening is correct, as I contend it is, Radical Change Precedence says nothing about the Yawelmani data, for according to Dinnsen, it makes no claim about the relative ordering of deletion and insertion rules. Furthermore, Radical Change Precedence predicts that deletion processes will apply before "feature-changing" rules. This is crucially not the case for Sea Dayak, discussed by Kisseberth and cited in Dinnsen.

* Footnote from previous page

Following Iverson himself (1973a) and Trommelen and Zonneveld's review of the Koutsoudas volume (1978), we must also reject Perry's 1972 modification of Shortening:

$$V \rightarrow [- \text{long}] / \text{---} C \left\{ \begin{array}{l} \# \\ CV \end{array} \right\}$$

By adding the rightmost vowel, Perry renders the rule inapplicable before triconsonantal clusters, thus precluding its overlapping with Epenthesis. In Iverson's words, quoted by Trommelen and Zonneveld: "This modified version of Shortening is clearly a more complicated, less general rule than the original: a requirement that vowels be short in closed syllables should not have to make reference to vowels in other syllables" (page 26). Indeed in a later Panel Discussion in the Koutsoudas volume, Kisseberth suggests that it might be possible to reject Perry's modification of Shortening in terms of a universal principle which incorporates Iverson's criticism.

In fact, the Sea Dayak data also violate minimization of opacity. The rules involved are Nasalization and Cluster Simplification (= Dinnsen's (9) and (10), page 37):

(35) Sea Dayak

A Nasalization

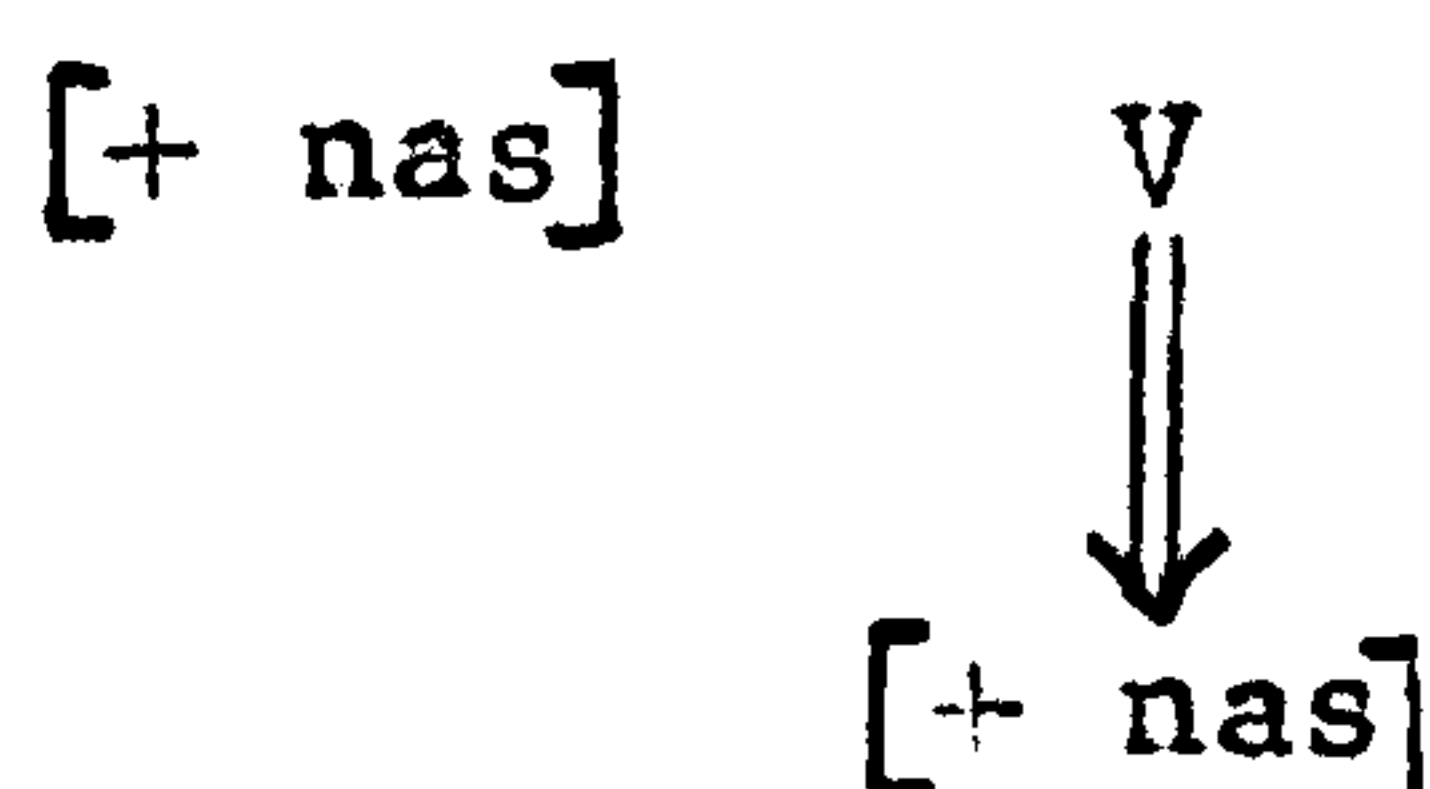

B Cluster Simplification

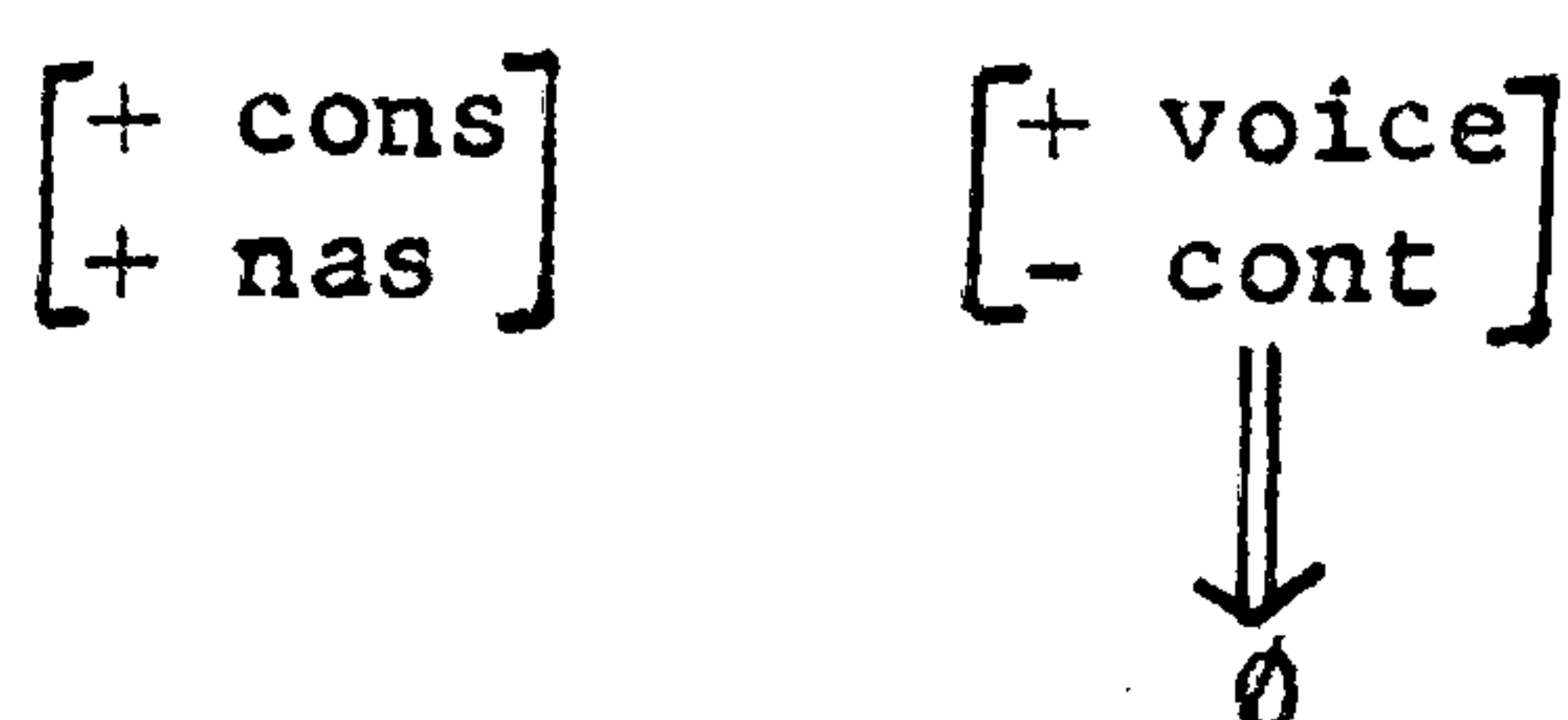

Applying Nasalization to underlying /nanga?/ "set up a ladder", we derive intermediate /nãnga?/, which then undergoes Cluster Simplification yielding surface phonetic [nãna?] (see (36) i below). Contrast this with underlying /nana?/ "straighten", which never meets the SD of Cluster Simplification but which does undergo Nasalization for both vowels, resulting in surface phonetic [nãñã?]. This is the phonetic representation which would result if Cluster Simplification preceded Nasalization, as in (36) ii:

(36) "set up a ladder"

i	UR	/nanga?/	ii	UR	/nanga?/
	Nasalization	nãnga?		Cl. Simpl.	nana?
	Cl. Simpl.	nãna?		Nasalization	nãñã?
	Surface	[nãna?]		Surface	*[nãñã?]

It should be noted here that under the KSN hypothesis of rules applying whenever their SDs are met (i.e. Obligatory Precedence), [nãna?] which has correctly undergone Nasalization and Cluster Simplification (albeit simultaneously) now meets the SD of Nasalization again. This time it

is the second vowel which is preceded by a nasal segment (due to the deletion of /g/), so this vowel is nasalized resulting in *[nãna?].

But this is the phonetic reflex of "straighten", not of "put up a ladder". As far as I can determine there is nothing to prevent the second vowel of [nãna?] from being retested for the applicability of Nasalization under KSN, given that the rule must be allowed to apply at two different points in the derivation of "straighten".

But what about K&K's principle concerning syllable structure? Let us take it that such a principle refers only to SCs involving syllabic nuclei - if we interpret it as applying to consonantal structure as well, it will be identical to Radical Change Precedence. Under the former interpretation it is clear that the precedence of rules changing syllable structure is irrelevant to the rules of (35). However Radical Change Precedence cannot itself be upheld for these data as Cluster Simplification constitutes a more radical change than feature-changing Nasalization. Moreover phonetic surface [nãna?] is a counterexample to the minimization of opacity principle, in that it contains a nasal consonant followed by an oral vowel, which constitutes a surface violation of Nasalization. However, Deletion Cession does make the correct prediction, for although both SDs are met by underlying /nanga?/, Cluster Simplification is constrained to apply after Nasalization because it is a deletion process.

A second principle formulated by Iverson alone (1973a) to account for the Yawelmani data, is inapplicable to Sea Dayak because of problems in its interpretation. Firstly let us consider its application to Epenthesis and Shortening (24). In formulating his proposed principle, 'Minimal Application', Iverson draws on Kisseberth's notion of 'conspiracy', discussed briefly above. He notes that Epenthesis actually destroys

triliteral clusters and suggests that " the motivation behind the destruction of conspiratorial targets is that the phonology be freed from their influence, e.g. the removal of triliteral clusters should not entail the operation of other processes in Yawelmani phonology" (page 27, in Koutsoudas Ed.) To paraphrase this somewhat opaque argumentation: 'Nothing should stop rules in the conspiracy from going about their business'. Accordingly, Iverson concludes: "a target destroying conspiratory rule takes precedence over other rules". (page 27). This hypothesis is thus independent of any claim regarding changes in syllable structure and the rules which effect them.

The next step in Iverson's reasoning concerning the Yawelmani data (and data from Sanskrit) is the observation that "the application of one of the rules in each pair makes unnecessary the application of the other, while still assuring that the surface requirements of both are met" (page 28). This would appear to be a recapitulation of Kisseberth's minimization of opacity principle, under a new guise. However, it is difficult to see how it can be said that "the application of Epenthesis in Yawelmani eliminates both triliteral clusters and long vowels in closed syllables" (ibid; my emphasis) - although Epenthesis never introduces or creates long vowels in that environment, it can hardly be said to eliminate them.

Iverson makes his next appeal to "economy of function", claiming that a grammar finds "the most economical way possible" to ensure that no surface representation meets the SD of an obligatory rule. Clearly this, together with the statement that "a rule fails to apply to some representation just in case the independently required application of some other rule ensures that its structural description is not met"

(ibid), is simply a recasting of Kisseberth's principle. Unfortunately however, Iverson's formulation of Minimal Application obscures the link with minimization of opacity. Indeed, if we were presented with Minimal Application in isolation, one would find nothing to suggest that it resulted from a consideration of the notions of conspiracy on the one hand, and opacity on the other. *

(37) Minimal Application

For any representation R which meets the structural description of each of two rules A and B, where the application of A to R results in a representation Ra, and the application of B to R results in a representation Rb: if Rb satisfies the structural description of A, but Ra does not satisfy the structural description of B, then A takes applicational precedence over B.

(pages 28, 29)

Applying Minimal Application to Yawelmani, /?a:milhin/ is Ra since it has undergone A, Epenthesis, and /?amlhin/ is Rb since it has undergone B, Shortening. Now Ra does not meet the SD of B for the long vowel is no longer followed by two consonants, whereas Rb does meet the trilateral subcase of Epenthesis. Thus Minimal Application predicts Epenthesis before Shortening as the correct ordering.

It was noted above that because of problems in its interpretation, Minimal Application is inapplicable to Sea Dayak. Up till now we have not mentioned the mode of interaction between Nasalization and Cluster Simplification, namely counterfeeding. For the purpose of discussing this counterfeeding relation, it must be emphasised that we are considering only the sequence /NGV/, i.e. nasal consonant + voiced plosive + oral vowel: it is irrelevant that the sequence /NV/ occurs initially in the morpheme "set up a ladder" - Nasalization will apply

* Footnote

In this respect the formulation of Minimal Application mirrors that of Iverson's Overlap Precedence which was found to be opaque in § 4.1 and accordingly replaced by Proper Class Inclusion.

to this sequence irrespective of whether Cluster Simplification has applied first. Rather, we must focus on /NGV/, since it is this substring alone which meets the SDs of both rules; and it is true of this substring that Cluster Simplification would feed Nasalization if, contrary to fact, it applied before it. Turning to Iverson's Minimal Application, we find that whilst Rb /nana?/ which has undergone B, Cluster Simplification, does meet the SD of A, Nasalization, Ra /nãnga?/ also meets the SD of B. However /nãnga?/ has not undergone A with respect to the sequence /nga/. It is therefore unclear what can legitimately be called "Ra" in this situation. Suffice it to say that Deletion Cession makes the correct prediction without being fraught with problems of interpretation. *

Lest it be thought that the Sea Dayak data have been obscured in order to argue dishonestly against Iverson's principle, I cite one more example as evidence of a case where Deletion Cession makes a correct prediction but where minimization of opacity and Minimal Application make false predictions. In fact these data from Kisseberth and K&K are treated briefly at the end of Iverson's paper. (38) schematizes Epenthesis and Degemination in Washo, an Amerindian language spoken near Lake Tahoe, Nevada:

(38) Washo

A Epenthesis

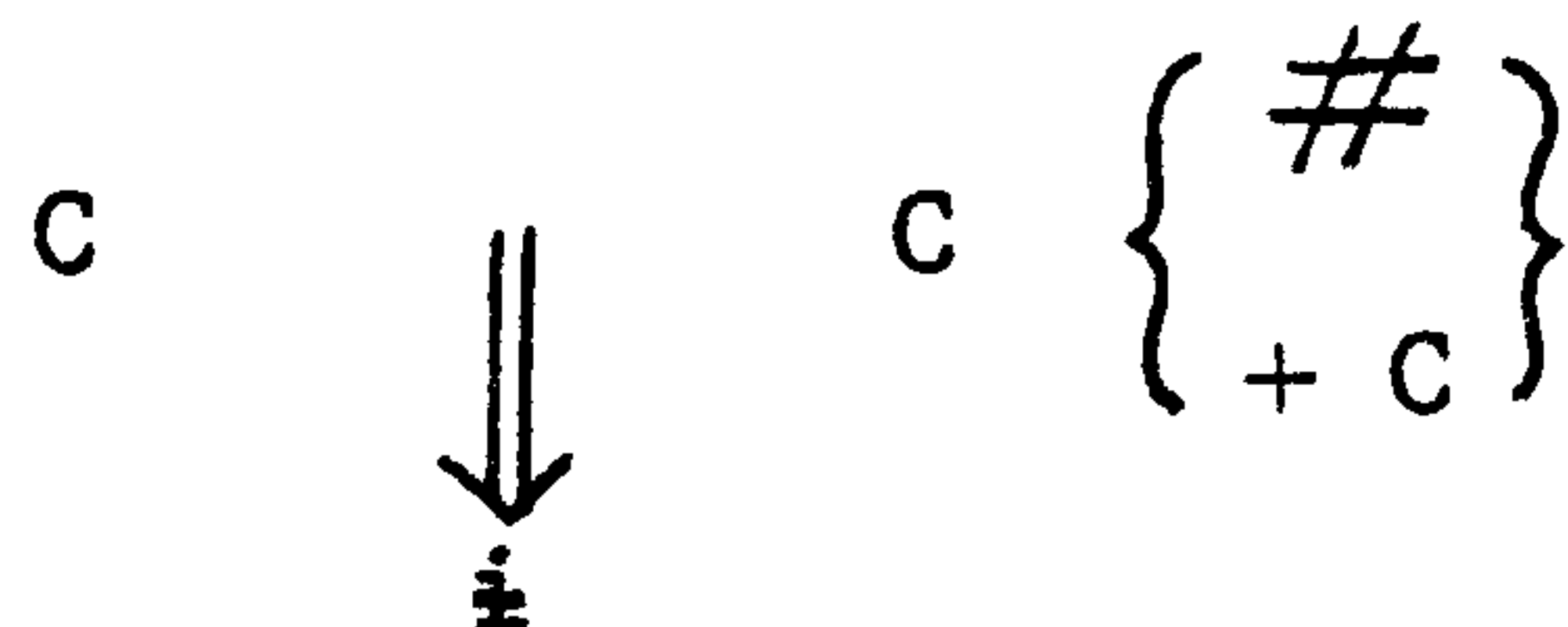

* Footnote

I also reject Dinnsen's reformulation of Nasalization incorporating derivational history i.e. in words "A vowel is nasalized following any nasal segment, where the sequence nasal-vowel is not derived from the application of Cluster Simplification (page 38; 1974). As Dinnsen himself remarks, this is no more than "a language-specific condition of overlapping notational equivalence to the language-specific statement of extrinsic ordering; thus it is totally specious to maintain that derivational history permits the abandonment of extrinsic ordering in any real sense". (page 39)

B Degemination

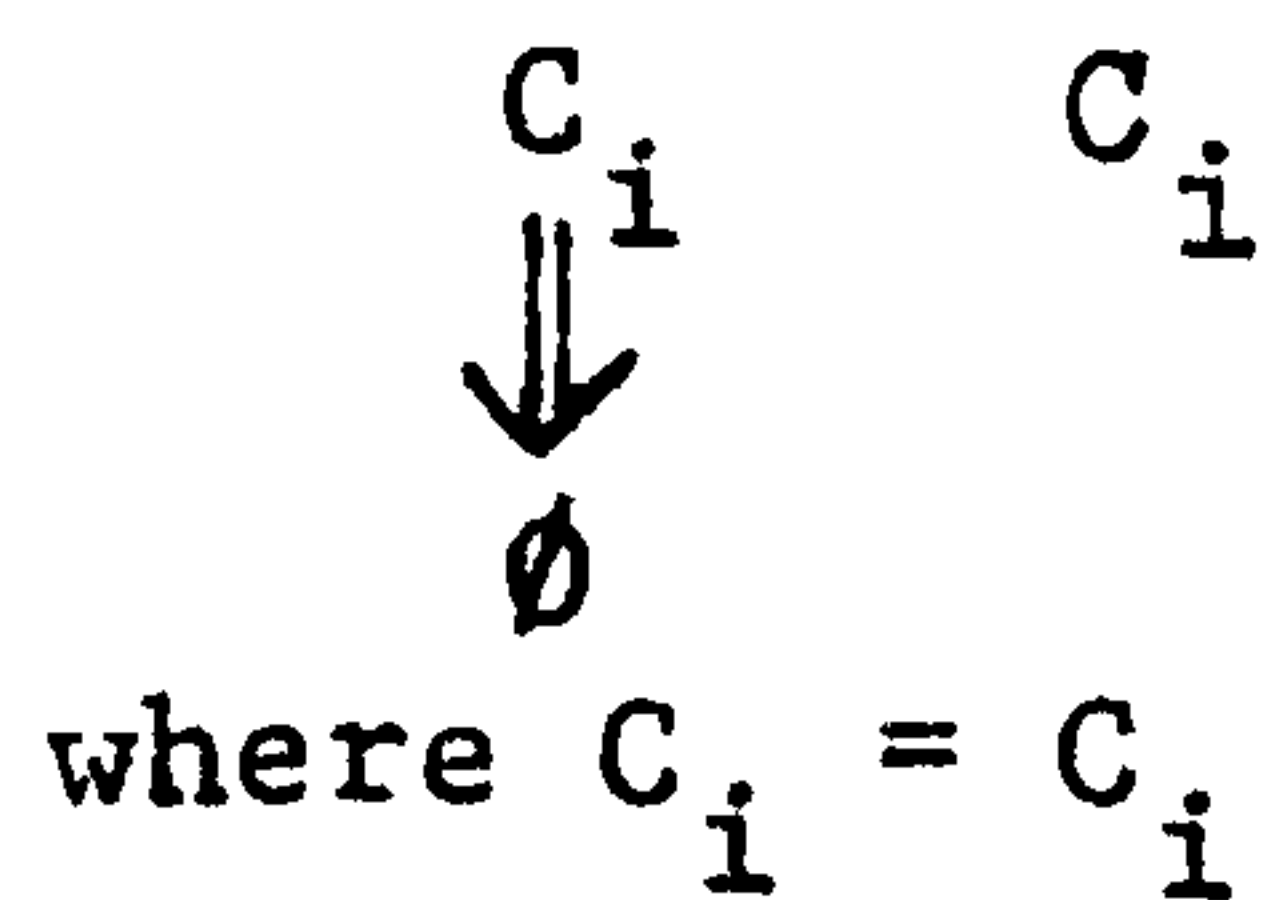

Thus Epenthesis breaks up consonant clusters in stem-final position or if a consonant-initial suffix follows. The representation of Degemination as deleting the first of two identical consonants is an arbitrary decision and follows K&K's wording (1977, page 159).

In the derivation of "he'll give it to him", /ʔl-išl-leg-i/ meets the SDs of both rules and in actuality the attested mode of application is one of counterbleeding, Epenthesis before Degimination, rather than bleeding as the phonetic representation is [ʔlišɿlegi] : see (39):

(39) "he'll give it to him"

i	<u>Bleeding Order</u>	ii	<u>Counterbleeding Order</u>
UR.	/ʔl - išl - leg - i/	UR	/ʔl - išl - leg - i/
Degem.	ʔl - iš - leg - i	ɿEp.	ʔl - išɿl - leg - i
ɿEp.	INAPPLICABLE	Degem.	ʔl - išɿ - leg - i
Surface	*[ʔlišlegi]	Surface	[ʔlišɿlegi]

Thus as K&K point out in Chapter 4 of the 1977 volume, Washo "provides an interesting comparison with the Yawelmani example" (page 158). Such a relation means firstly that an opaque surface phonetic representation will result. The specific kind of opacity is that whereby B derived from A is found in an environment other than the expected C___D: in this case an epenthetic ɿ appears even though no trilateral or final cluster exists on the phonetic surface of [ʔlišɿlegi]. Hence these data from Washo constitute a counterexample to Kisseberth's minimization

of opacity principle. Notice however that they conform to the KSN hypothesis regarding simultaneous rule application - which we have rejected on the basis of other data - since as was demonstrated in § 4.1, simultaneity has the same empirical consequences as allowing rules to apply in a counterbleeding order. More importantly, these data serve to substantiate the precedence of rules changing syllable structure. Indeed, it would appear from the data examined in this section that rules of epenthesis are typically early rules. (See § 2.3 for detailed discussion of epenthesis rules in Mohawk.)

The second implication of a counterbleeding relation is that both rules will actually apply, as opposed to the bleeding order exemplified in Yawelmani where only Epenthesis applies to underlying /?a:m1-hin/.

This in turn entails that Minimal Application will make a false prediction. According to that principle, Degemination should take precedence since its application to /?1-iš1-leg-i/ results in /?1-iš-leg-i/, which, by containing no trilateral cluster, no longer meets the SD of Epenthesis. On the other hand, the prior application of Epenthesis to the UR yields /?1-iš11-leg-i/ which may then undergo Degemination. Hence according to Iverson's principle, Degemination, Epenthesis, should be the correct order.

Iverson has two tentative suggestions to account for the fact that neither of his principles, Minimal Application nor Overlap Precedence, predicts the attested order of application for the Washo data. Firstly, it may be the case that Simplification is optional since geminates only occur across morpheme boundaries in Washo. Thus it is feasible that Simplification may fail to apply in careful speech, so that its ordering could be predicted on the basis of the precedence of obligatory rules over optional rules. (This is Ringen's Obligatory Precedence to which

we shall refer in § 4.3). Secondly, it is the identity specifications in the SD of Simplification which preclude its proper inclusion in the SD of Epenthesis, satisfying Overlap Precedence. If identity specifications could be shown to be irrelevant in the determination of PI (rather as Iverson showed the single occurrence of a variable to be irrelevant), then the correct prediction would be made. As Trommelen and Zonneveld are swift to point out in their review of Koutsoudas 1976, this constitutes an apparent inconsistency within UDRA: Koutsoudas on page 10 makes the assumption that identity specifications in degemination processes are relevant for the determination of PI. In his (1979) review, G. K. Pullum defends Iverson on the grounds that the latter's proposals are tentative, and are not to be regarded as an elaboration of the KSN hypothesis, but rather "as a total replacement for it" (Koutsoudas, page 37) In Pullum's words: "Hence to look for consistency on points of detail (as opposed to strategy) between Koutsoudas and Iverson would be a mistake" (offprint page 7; my emphasis). I need only add that by adopting Iverson's strategy, a more fully developed theory of UDRA can account for the Washo data in terms of Deletion Cession, irrespective of what may eventually be established regarding the correct way to interpret identity conditions.

§ 4.3 Supporting Evidence from Gemination in Berber

We have seen that the precedence principles proposed in the literature - depending on changes in syllable structure, the minimization of opacity, Radical Change Precedence and Minimal Application - make false predictions in at least one case for the data from Yawelmani Yokuts, Sea Dayak and Washo. Furthermore, it has been argued that Deletion Cession predicts just the right order of application for the rules in question. But the applicability of Deletion Cession has depended crucially on the interpretation of Degemination and Shortening in Washo and Yawelmani respectively as deletion processes. On the other hand, Cluster Simplification in Sea Dayak may be accepted as deletion a priori since there is no reason to represent sequences of nasal + voiced stop as one segment which then undergoes some feature-changing rule to eliminate the plosion!

However, it could be argued that Degemination and Vowel Shortening were interpreted as deletion processes above merely to salvage the UDRA hypothesis, given that other principles fail to account for all the data. I now propose to demonstrate that this is not the case. Firstly I shall discuss evidence from Mohamed Guerssel's work on Berber that geminate consonants comprise two segments (1977). In the course of this discussion I shall argue that Guerssel himself fails to make explicit the behaviour of geminates undergoing assimilation processes and I shall replace Guerssel's constraint with a natural convention on iterative rule application. The operation of this more natural approach on data from various languages serves as corroborative evidence for the segmental analysis of geminates as being a linguistic universal. Finally I shall return to the analysis of vowel length in Yawelmani and demonstrate that in fact we are dealing here with "geminate vowels".

As Guerssel points out at the beginning of his paper, two very different methods have been employed within generative phonology to represent geminate consonants i.e. geminates have been represented as a sequence of two identical segments or as a single segment which is specified [+ long]. He then adduces evidence from Berber, a language with underlying geminates (cf. /af/ "to find" versus /aff/ "to swell"), in favour of each position. Arguing for a segmental representation, Guerssel notes that a rule of Syncope fails to apply before geminates, just as it fails to apply before consonant clusters. Since the rule is operative before single consonants, it would incorrectly apply before geminate consonants if the latter were treated as a single [- long] segment. Similarly, under such an analysis, an optional rule would be expected to metathesize geminate sonorants and schwa in word-initial position just as single sonorant consonants and schwa undergo Metathesis. However this is not the case, suggesting that geminate sonorants should be treated as two segments so that the SD of Metathesis would not be met. Another optional rule counts as evidence for the segmental approach. This time the treatment of geminates as two segments means that the form in question undergoes a particular rule, rather than being excluded from it as with the first two examples: if they follow the word-boundary, geminates trigger optional schwa insertion, in the same way as clusters of two consonants, whereas schwa is not inserted before single consonants. If geminates comprise two segments, this behaviour is readily explained by specifying initial consonant clusters as the conditioning environment for optional schwa insertion. Guerssel's fourth argument is discussed in more detail below: it involves an obligatory rule of schwa epenthesis to break up trilateral clusters. A fifth argument is then dependent upon it.

Before discussing Schwa Epenthesis, let us note the three points which apparently constitute evidence for a representation of geminates in Berber as a single segment specified by the feature [+ long] - another argument in this direction also involves Schwa Epenthesis. First, verbs containing geminates and one other consonant in their simple form do not pattern with triconsonantal verbs in their intensive form. This might suggest that such verbs are biconsonantal as they would be if their geminate consonants were represented as a single [+ long] segment. Secondly, a rule of Syllabification is operative in Berber applying to glides which, due to the deletion of a prefixal vowel, are found between consonants in the course of a derivation. The rule concerned is Construct Deletion, where a noun is said to be 'in the construct state' in a specific syntactic context. If geminate glides are represented as two segments, one might expect the second segment to be in the conditioning environment for Syllabification if it precedes another consonant. The fact that the rule does not apply here could therefore be accounted for by treating the geminate glide as one [+ long] segment, which would not be interconsonantal and hence would not meet the SD of Syllabification. Guerssel's final argument in favour of a feature representation involves Obligatory Metathesis which is similar to Optional Metathesis in that a sonorant consonant and a schwa are metathesized, but which operates word-internally following a consonant, rather than word-initially. If geminate sonorants are treated as a sequence of two identical consonants, the first segment might be expected to act as the consonantal environment which would then trigger the metathesis of the second sonorant segment with a following schwa. However, such sequences are not well-formed, a fact which would be accounted for automatically if the geminate sonorant were represented as one [+ long] segment.

Although it appears that a feature representation is required for the formulation of a number of rules in Berber, the overall adoption of such an approach means that a number of other rules (those which demanded a segmental representation) will have to be restated to include a single [+long] consonant where two [-long] consonants appear. But as Guerssel notes, this does not explain why long consonants always appear in the same environment as two short consonants - it is merely a redescription of the data in a formal notation. However, it would be equally ad hoc to incorporate conditions of non-identity (i.e. $C_i \neq C_j$) into the SDs of those rules which do not apply to geminates. Such an approach simply uses a notational device to disguise its own explanatory inadequacy. This criticism also applies to Saib's use of the feature [+tense] which is assigned to geminates by convention, so that the rules which do not apply to geminates must be arbitrarily restated so as to include the feature [-tense] in their SDs. (1973 and 1977).

Returning to the evidence itself, the rule of Schwa Epenthesis in Berber is of particular interest since it apparently demands that in some cases a segmental representation of geminates be adopted, and in others a feature representation. The rule is formalized as (40)

(= Guerssel's (16) page 271):

(40) Schwa Epenthesis $\emptyset \longrightarrow \text{ə} / C \text{ ____ } C C$
in Berber

Underlying /x ṭṭəbla/ meets the SD of this rule if the geminates are treated as two segments, and yields [xəṭṭəbla] "on the table" on the phonetic surface. However the trilateral cluster in /tazzla/ also meets the SD of Schwa Epenthesis yet fails to undergo it - *[tazəzla] "running" is ill-formed. If we explain this behaviour by treating

underlying /zz/ as a single [+ long] segment, how can we also account for the acceptability of [xəttəbla]?

Of course the crucial difference between the two cases is that in [xəttəbla] the geminate cluster is not split up by Schwa Epenthesis, whereas in *[tazəzla] the epenthetic vowel would intervene between the elements of the geminate. In other words, the adjacency of the geminates must not be altered. This, then, forms the Adjacency clause of Guerssel's proposed Adjacency-Identity Constraint, which is cited as (41) (henceforth AIC):

(41) "Adjacency:

Two consonants are adjacent if no other segment, word boundary or morpheme boundary intervenes between them.

Identity:

Two segments are identical if they have the same feature specification.

The Adjacent-Identity Constraint

Given two segments A_1A_2 where $A_1 = A_2$, a phonological rule can alter the adjacency of A_1A_2 if and only if it alters the identity of A_1 or A_2 ."

(1977, pages 283-4)

It is clear that once we adopt this constraint we can account for the apparent counterexamples to the segmental representation of geminates in a more insightful way than if we incorporated conditions of non-identity into the statement of the rules in question. We have seen that Schwa Epenthesis fails to apply just in case it alters the adjacency of the two elements of a geminate without altering their identity. However, Schwa Epenthesis is not prevented by the AIC from applying to intermediate /t + tbir + t/ to yield surface phonetic [tətbirt]. This is because the geminate t's are separated by the morpheme boundary (i.e. are not adjacent as defined in (41)), the form

being derived from underlying /t + a + tbir + t/ "pigeon" by Construct Deletion just in case the latter rule does not delete both boundaries. * Since geminates which arise due to Construct Deletion must obviously be interpreted as a sequence of two identical segments, derivations such as that of "pigeon" constituted Guerssel's fifth argument in favour of a segmental representation. It can now be seen that such data are in keeping with the constraint he proposes. Adoption of the AIC also means that Obligatory Metathesis is constrained from permuting a sonorant and schwa just in case it alters the adjacency of sonorant geminates in so doing.

As stated by Guerssel, the AIC is unidirectional. That is, it permits a change of adjacency just in case it is accompanied by a change of identity and hence adequately constrains the unattested application of epenthesis and metathesis rules to geminates meeting their SDs. However, as formulated in (41), the AIC says nothing about whether changes of identity must be accompanied by changes of adjacency: it says nothing about Syllabification which, unless constrained, would syllabify one of two geminate glides without altering their adjacency. Yet Guerssel does indeed intend the constraint to be interpreted as bidirectional - this is clear from his inclusion of Syllabification amongst those rules which may potentially violate the AIC. Thus he states that Syllabification may not apply to geminate glides "since in so doing it would violate AIC. It would alter the identify of one of the identical segments without altering its adjacency" (p. 286). It must therefore be concluded that Guerssel intends the AIC (41) to be read as if it contained a final

* Footnote

The application of Construct Deletion before Schwa Epenthesis does not constitute a counterexample to Deletion Cession, since only the structural description of the former is met by the UR. In other words, Construct Deletion feeds Schwa Epenthesis.

"and vice versa". Indeed, not just Syllabification, but also his later argumentation, depend crucially on such an addendum (and this intention obviously led to his statement of Adjacency and Identity as separate clauses in (41)). In the remainder of this section the AIC will therefore be interpreted as bidirectional.

Turning to the argument that verbs containing geminates and one other consonant in their simple form do not pattern with triconsonantal verbs in their intensive form, Guerssel points out that it does not follow that such verbs must therefore be treated as biconsonantal. In fact there is evidence that they must not, for in Berber verbs with initial geminates (like [kkəs] "to remove") take the prefix tt- in the intensive form (\rightarrow [ttəkkəs]) whereas biconsonantal verbs of the shape $C_1\emptyset C_2$ (e.g. [dəl] "to cover") pattern as intensive $C_1C_1aC_2$. (\rightarrow [ddəl]). Further evidence that verbs of the kkəs type are not biconsonantal is afforded by the negative past form in which they pattern along with triconsonantal verbs. So the behaviour of verbs containing geminates in no way serves as a counterexample to the AIC.

Having cited evidence that geminates in Berber must be treated as two segments, let us turn briefly to the implications of such an analysis, firstly for Berber phonology and secondly for the grammars of other languages which also possess underlying geminates. Having sketched these implications, I shall then summarize its consequences for a universal approach to degemination processes.

Besides the formulation of the AIC, let us adopt Guerssel's assumption that rules apply iteratively. Following Ringen (1973) it is assumed that once a rule R1 has applied, it may re-apply immediately if its SD is now met again, and so on. However as soon as another rule R2 intervenes between the potential re-application of R1, R1 may no longer

be tested for applicability - it is discarded. It was implicit in the claim made on page 186 above that in Sea Dayak, Nasalization could not re-apply to [nãna?] from underlying /nanga?/. Note also that it is not implied in KSN. Guerssel's reference is to Phelps (1975).

Adopting Guerssel's AIC and his assumption that rules apply iteratively, we would not expect feature-changing rules to apply to geminates. To spell this out a little more clearly, let us consider Spirantization in Berber, which is schematized as (42) (= Guerssel's (63) page 283; but see footnote):

(42) Spirantization in Berber

$$\begin{bmatrix} - \text{son} \\ - \text{cont} \end{bmatrix} \longrightarrow [+ \text{cont}] \text{ /morphological information } *$$

In order to relate the Aorist form of verbs with their Intensive form, Guerssel postulates that the underlying forms of the Aorist contain stops which then undergo Spirantization to yield the phonetic representation. Although the underlying stops never surface as stops in the Aorist, they become geminate stops in the Intensive (e.g. underlying /ənbəš/ → surface phonetic [ənβəš] "to be nosy" cf. Intensive [nəbbəš]). But what is to prevent geminate stops from becoming geminate spirants by rule (42)? The answer is that under the AIC and assumptions regarding iterative application, Spirantization would necessarily apply first to one segment of the geminate, thereby altering its identity without changing its adjacency. Thus Spirantization is blocked from applying to geminates.

Similarly, Guerssel's constraint correctly predicts that a rule of

* Footnote

I have specified the environment as requiring morphological information since whilst it is true that nongeminate stops never appear as stops in the Aorist in Berber, Spirantization can hardly be context-free as Guerssel states it cf. the initial stop in the simple form of [dəl] "to cover", for instance.

Voicing which affects consonants with the feature specifications [- high, - low, + back] will not apply to geminates:

(43) Voicing in Berber

$$\begin{bmatrix} + \text{ cons} \\ - \text{ high} \\ - \text{ low} \\ + \text{ back} \end{bmatrix} \longrightarrow [+ \text{ voice}] \quad / \text{ morphological information } *$$

Thus whilst underlying Aorist /əʃqəl/ "to be working" undergoes Voicing (→ /əʃGəl/) and Spirantization to appear as [əʃxəl] on the phonetic surface, its Intensive form contains a stop which has been geminated: [ʃəqqəl]. Since the first application of Voicing to /qq/ would yield either /Gq/ or /qG/, both violations of the Identity clause of the AIC, Voicing is prevented from applying to Intensive forms.

Note in passing that as far as I can determine the apparent precedence of Voicing over Spirantization in the Aorist is not crucial and hence remains unpredictable. Instead of the underlying voiceless uvular stop becoming first a voiced uvular stop and then a voiced uvular fricative, a voiceless uvular fricative could equally plausibly have arisen at the intermediate level of derivation by the ordering Spirantization, Voicing. Furthermore, such a segment is not fictitious, as witness its forming part of the surface phonetic inventory of Berber e.g. [xərwəd] "to stir". **

Finally, in relation to Spirantization, Syllabification and Voicing, notice that what is common to these rules is not their morphological

* Footnote

As with Spirantization, I have given the environment of this rule as morphological although Guerssel states it as context-free. If this were in fact the case, Voicing would apply initially in [səwwras] "take a picture for him". It does not.

** Footnote

Throughout I have taken Guerssel's 'ɣ' and 'x' to be uvular rather than velar, since he consistently uses 'ç', 'ǰ' as the spirantized counterparts of 'k' and 'g' respectively.

environment, but rather, their formal properties. It is these properties which lead to their not applying to geminates. To put this slightly differently, other morphological rules may well apply to geminates: indeed this is very plausible when one considers that geminates appear in URs and figure in derivational processes. However, rather than pursuing this line of argumentation, let us turn to the more pertinent task of characterizing those rules which do not apply to geminates and hence whose behaviour is accounted for by the segmental approach and the AIC. In so doing we shall delineate the salient properties of those rules which do apply to geminates.

Velarization is a rule assimilating consonants to following velarized consonants which also applies to geminates in Berber. For nongeminate consonants the rule may be stated as (44) (= Guerssel's (75) page 291):

$$(44) \quad \underline{\text{Velarization in Berber:}} \\ [+ \text{ cons}] \longrightarrow [+ \text{ back}] / \text{ --- } \begin{bmatrix} \text{C} \\ - \text{ high} \\ - \text{ low} \\ + \text{ back} \end{bmatrix}$$

Thus when the prefix /s/ is added, underlying /s + ʎamba/ becomes [sʎamba] "with a lamp". Now note that underlying /ss + dər/ yields surface phonetic [ʃʃdər] "to bring down". Similarly, in Moroccan Arabic Voicing Assimilation affects both nongeminate and geminate dental obstruents when they precede a voiced coronal obstruent, as in (45) which schematizes the rule for nongeminate consonants (= Guerssel's (71) page 290):

(45) Voicing Assimilation in Moroccan Arabic:

$$\begin{bmatrix} - \text{ son} \\ + \text{ ant} \\ + \text{ cor} \end{bmatrix} \longrightarrow [+ \text{ voice}] / \text{ --- } \begin{bmatrix} - \text{ son} \\ + \text{ cor} \\ + \text{ voice} \end{bmatrix}$$

So just as /t + zid/ becomes [dzid] "you add", when /tt/ is prefixed to /zaʀ/, the application of (45) yields surface phonetic [ddzaʀ] "to be visited".

In order to avoid violating the AIC, the affected segments in (44) and (45) (i.e. the segment to the left of the arrow in each case) must be specified with superscript n and subscript 1 (i.e. $[+ \text{ cons}]_1^n$ and $\begin{bmatrix} - \text{ son} \\ + \text{ ant} \\ + \text{ cor} \end{bmatrix}_1^n$ respectively). However, if the SD of Velarization (44) is specified as $[+ \text{ cons}]_1^n$, what is to prevent that rule from applying to arbitrary sequences of consonants? Again, if the SD of Voicing in Moroccan Arabic is specified as $\begin{bmatrix} - \text{ son} \\ + \text{ ant} \\ + \text{ cor} \end{bmatrix}_1^n$, surely this predicts that any sequence of coronal obstruents will be subject to it? Leaving aside this difficulty in the (unlikely) possibility that some identity constraint might be written into the expansion of superscript n , the objection could still be raised that Guerssel's proposal is merely a spurious notational device to salvage the AIC. More seriously, even if this were not the case, why were Spirantization, Syllabification and Voicing in Berber not stated in the same fashion? Guerssel notes a crucial formal difference between the two groups. However, it is my contention that apart from a misnomer in the definition of the distinction, he fails to explicate it to the full.

Guerssel refers collectively to the rules involved as "feature-changing assimilation rules". He then notes that Velarization and Voicing Assimilation may be schematized as (46) i (where Y is a submatrix of Y') whilst Syllabification, Spirantization and Voicing may be schematized as (46) ii (where Y is not a submatrix of Z).

- (46) i $X \rightarrow Y / Y'$
 ii $X \rightarrow Y / Z$

In Guerssel's terms, rules of type (46) i are 'nonrestrictive' and those of type (46) ii are 'restrictive', so that the Restriction Condition is stated as (47):

(47) "The Restriction Condition:

All and only rules of type $X \rightarrow Y / Y'$ where at least one feature of Y is also contained in Y' are formulated as

$x_1^n \rightarrow Y / Y'.$ "

(page 293)

Now apart from the fact that Guerssel's definition of 'nonrestrictive' constitutes a truism just in case there is a feature [\pm segment], there is a less pedantic criticism which may be levelled against (46): even though Guerssel refers to both rule-types in (46) as "feature-changing assimilation rules", I would argue that only rules of type (46) i are strictly assimilation rules. When we turn to the definition of assimilation in SPE, we find that Ch&H assert the following: "In assimilation the coefficients of a given feature or feature set in one segment are made to agree with the coefficient of a given feature or feature set in a nearby segment". (SPE page 428). They add: "The fact that it is the same feature or feature set in both segments is crucial" (ibid.). Accepting this definition and applying it to the rules under discussion, we see that only 'nonrestrictive' rules are in fact assimilatory. On the other hand, Spirantization, Syllabification and Voicing, which Guerssel classed as restrictive feature-changing assimilation rules, although non-assimilatory, are nevertheless phonetically motivated by their immediate environment * and hence distinct from insertions, deletions and transformational rules like Metathesis. In other words they constitute the class of non-assimilatory natural processes.

Turning now to the problem of defining assimilation schematically, we might follow Ch&H's tentative proposal to the effect that "If assimilation

* Footnote

Strictly speaking, (46) ii does not schematize a phonetically motivated rule - however, Syllabification, Spirantization and Voicing with which (46) i -type rules contrast may be so described.

were a special process which was available for use whenever necessary, it could be restricted so as to affect only the same features in different segments, or it could be further constrained to affect particular features or sets of features in particular environments".

(SPE page 428). (48) represents such a schema:

$$(48) \quad [+ \text{seg}] \longrightarrow \left[\begin{array}{l} + \text{seg} \\ \alpha \text{ feature} \\ \cdot \\ \cdot \\ \cdot \end{array} \right] / \left[\begin{array}{l} + \text{seg} \\ \alpha \text{ feature} \\ \cdot \\ \cdot \\ \cdot \end{array} \right]$$

Assimilation would then be further constrained along the lines of SPE if Guerssel's Restriction Condition were replaced by a linguistic universal regarding the application of such processes:

(49) Assimilation rules apply to geminates.

Once we examine the application of assimilation rules to geminates and compare it with the non-application of other phonetically motivated rules to geminates, we find a very plausible explanation of why (49) should be an axiom about Language. Let us contrast Velarization in Berber and Voicing Assimilation on Moroccan Arabic on the one hand with Syllabification in Berber, Spirantization in Hebrew and vocalization in Amharic on the other. For the purpose of explication we shall disregard the AIC for the moment. Under iterative application (ignoring the AIC), the first application of (44), Velarization, to /ss + dər/ yields intermediate /sṣ + dər/ - the middle line of (50) :

(50) Iterative Application of Velarization in Berber

UR	/s s + ḍ ə r / "to bring down"
1st Application	↓
Intermediate Representation	s ṣ + ḍ ə r
2nd Application	↓
Phonetic Surface	[ṣ ṣ ḍ ə r]

Recalling the environment specification of (44), the second geminate spirant becomes velarized just because it precedes a consonant which is [- high, - low, + back] i.e. /d/. But after the first application of Velarization, the initial /s/ now precedes a consonant which has just those feature specifications i.e. /ṣ/. As a result the SD of (44) is met again and the rule re-applies.

Now consider the parallel application of (45), Voicing Assimilation, in Moroccan Arabic, schematized in (51):

(51) Iterative Application of Voicing Assimilation in Moroccan Arabic

UR	/t t + z a r / "to be visited"
1st. Application	↓
Intermediate Representation	t d + z a r
2nd. Application	↓
Phonetic Surface	[d d z a r]

On the first application, the SD of Voicing Assimilation is met by the second /t/ just in case it precedes a voiced coronal obstruent i.e. /z/. But once such an SC has been effected, the initial /t/ finds itself in exactly the required environment for the SD of Voicing Assimilation to be met again - before a voiced coronal obstruent i.e. /d/.

Now we may bring the AIC to bear on the situation: although the identity clause of the constraint is violated by the intermediate representations /sṣ + ḍar/ and /td + zar/, it is not contravened by the final output of each rule. Thus the two velarized spirants which comprise the phonetic representation of (50) are adjacent and identical, as the two voiced coronal obstruents in the phonetic representation of (51). Hence if we could somehow disregard the intermediate representations which arise when a single rule re-applies iteratively, the AIC would not be violated by Velarization in Berber or Voicing Assimilation in Moroccan Arabic.

What we need, then, is to redefine "input" and "output" with respect to rules which apply iteratively. This is approximated in (52):

(52) Convention on Iterative Rules:

For any rule R which applies iteratively n times, the input to R is that structural description to which R first applied, and the output to R is that structural change which resulted from R's (n)th. application.

All that is now necessary to maintain the AIC is to define "alter" in (41) as "effect a mismatch in the input and output of rule R".

Of course, it could be argued that Guerssel's Restriction Condition has the same result as Convention (52). Here I would counter that the Restriction Condition is not only ad hoc but also at variance with the arguments advanced in favour of the AIC. For if /ss/ both become velarized in a single application of (44) before /d/, and if /tt/ both become voiced in a single application of (45) before /z/, we have a basis for treating geminates as single [+ long] consonants. Yet this was precisely what Guerssel's constraint was established to rule out. In contrast, by allowing rules to apply iteratively and making the AIC insensitive to the intermediate representations in such a mode of application, we find a natural explanation of why assimilation processes should apply to geminates, that is, why (49) is an axiom of the segmental treatment of geminates.

Now consider how the phonetically motivated rules which Guerssel terms 'restrictive' do not apply iteratively and hence do not violate the AIC. If the second geminate glide in /səwras/ were to undergo Syllabification by virtue of being inter-consonantal, to yield * /səwuras/, the remaining glide would still not be situated in the environment $\left\{ \begin{array}{l} [- \text{voc}] \\ \# \end{array} \right\} \text{ --- } [- \text{voc}]$, specified in the rule's SD. Hence Syllabification does not apply

I have cited Guerssel's evidence from Berber that geminates must be treated as two identical segments. By adopting such an approach and assuming that rules apply iteratively, I have offered an explanation of why assimilation processes apply to geminates but why the latter do not undergo other phonetically motivated rules. It might be countered at this point that by proposing Convention (52) on what constitutes the input and output of iterative rules, I am advocating the incorporation of global power into the grammar. An immediate response to this would be that Guerssel's AIC is also global in nature in that a rule must scan its own output to check if the adjacency or identity of geminates has been altered. Thus, given that such output checks are an integral part of Guerssel's constraint, and that his constraint provides a very plausible explanation of seemingly anomalous facts about geminates, it follows that output checks should also figure in the treatment of the behaviour of geminates regarding assimilation processes. By way of a more metatheoretical defence, I would argue that each rule be taken as a unit so that input and output are defined vis à vis each rule, rather than in relation to the particular application of a rule. Thus whilst a particular application of an assimilation rule may temporarily result in a violation of the AIC, the "complete" rule does not bring about such an effect. My suggestion is then that the notions "rule" and "rule application" be kept distinct in the metatheory.

* Footnote continued from previous page

$$[- \text{cons}] \rightarrow [+ \text{voc}] / \text{---} \left\{ \begin{array}{c} \# \\ [- \text{voc}] \end{array} \right\}$$

underlying /ləyy/ could become intermediate */ləiy/ under the --- [-voc] subcase of Vocalization. This form could then become *[ləii] under the word-final subcase of a second iterative application, and no longer constitute a counterexample to my interpretation of the AIC, even though it is unattested. Since I do not know which formalization of Vocalization is correct, I cannot comment further. I merely note that under either, the rule does not fit schema (46) i and hence does not qualify as an assimilation process in the first place.

The interaction of conventions like (52) with constraints on rules affecting geminates, and again the consequences of our treatment of assimilations as opposed to other phonetically motivated processes for the analysis of geminates only serve to show the interdependent nature of the phenomena which a fully developed theory of UDRA sets out to characterize. We now see that these apparently disparate aspects of phonological structure have implications for the formulation of precedence principles determining rule application on a universal basis.

Turning to the process of degemination, we note that when stating it transformationally, the null segment must appear in the SC of the rule i.e. we are bound to formalize degemination processes as either (55) i or ii:

$$\begin{array}{lcl}
 (55) \text{ i} & Y \begin{bmatrix} X \\ \alpha F \end{bmatrix} \begin{bmatrix} X \\ \alpha F \end{bmatrix} Z & \text{ii} & Y \begin{bmatrix} X \\ \alpha F \end{bmatrix} \begin{bmatrix} X \\ \alpha F \end{bmatrix} Z \\
 & 1 \quad 2 \quad 3 \quad 4 \implies & & 1 \quad 2 \quad 3 \quad 4 \implies \\
 & 1 \quad 2 \quad \emptyset \quad 4 & & 1 \quad \emptyset \quad 3 \quad 4
 \end{array}$$

Given that all phonological rules can be stated transformationally, whereas not all phonological rules can be stated in other formalisms, it is misleading of Guerssel to suggest that all degemination should be stated as (56) (= Guerssel's (70) page 290, following Phelps):

$$(56) \quad \begin{bmatrix} C \\ \alpha F \end{bmatrix} \begin{bmatrix} C \\ \alpha F \end{bmatrix} \longrightarrow \begin{bmatrix} C \\ \alpha F \end{bmatrix}$$

The fact is that whilst (56) may be desirable in certain cases, (i.e. where it is indeterminate which segment deletes), if rigour demanded (56) could be restated employing the null segment.

If we define Deletion as involving the appearance of the null segment in a rule's SC, we may conclude that Degemination always constitutes a deletion process. As such, if a form meets the SD of Degemination at

the same time as that of a second rule where neither SD properly includes the other, the second rule will always take applicational precedence.

Having reached this conclusion regarding Degemination, it now behoves us to consider Vowel Shortening in Yawelmani Yokuts to determine whether this process too should be dealt with as deletion. For although we maintain Guerssel's claim that geminate consonants should be treated as two identical, adjacent segments in whichever of the world's languages they occur, it does not follow aprioristically that long vowels should be universally analyzed as a sequence of two short vowels. Indeed such a claim might readily be falsified by citing data from English R(eceived) P(ronunciation), as a case in point. The traditional dilemma for phonemicists of English was whether to regard length or quality as distinctive for the pairs [ɪ/i:, ʊ/u:, æ/a:, ɒ/o:, ə/ɜ:] . Gimson (1962) reached the following conclusion: "..... the opposition between the members of the pairs is a complex of quality and quantity; and of the two factors it is likely that quality carries the greater contrastive weight". (page 90).

To restate the problem, given an analysis of English which gives contrastive precedence to quality, one would apparently have no justification for regarding Shortening as the deletion of a second identical mora. To the extent that Yawelmani Yokuts exhibits marked qualitative differences between its long and short vowels, one might on analogy argue that Shortening in that language should not be described as deletion. In fact, however, the issue may be circumvented for Yawelmani Yokuts since, to my knowledge, there is no evidence for supposing that quantity is subordinate to quality in contrastive value. Thus although K&K note (1977) that "In many languages, long and short vowels occur 'paired'; that is, for any given short vowel there is a

corresponding long vowel structurally parallel to it (though not necessarily of precisely the same quality)" (page 34), they never mention such a caveat regarding quality when they argue for their abstract analysis of Yawelmani long vowels. Thus the underlying long vowels postulated by K&K (/i:, a:, o:, u:/) and also the three long vowels which generally occur on the phonetic surface ([e:, a:, o:]) may be treated as "geminate vowels".

It is interesting that the rules which affect these sequences of two identical adjacent morae do not violate Guerssel's AIC as interpreted above: the parts of the geminate are not broken up whilst feature-changing rules such as Lowering affect both morae rather than creating diphthongs which by definition contravene Guerssel's constraint (see below). Thus the long vowel postulated by K&K in the UR of "destroys" undergoes Lowering to both morae before one is deleted, as in (57) i. It is my contention that the logically possible derivation (57) ii is phonologically unnatural and fictitious just in case it violates the AIC:

(57) i	UR		/c' u u m - h i n/	
	Vowel Harmony *		c' u u m - h u n	
	Vowel Lowering - applying naturally		c' o o m - h u n	
	Vowel Shortening		c' o ∅ m - h u n	
	Phonetic Surface		[c'omhun]	
ii	UR		/c' u u m - h i n/	
	Vowel Harmony *		c' u u m - h u n	
	Vowel Lowering - applying unnaturally	c' uom-hun	or	c' oum-hun
	Vowel Shortening	c' ∅ om-hun	or	c' o ∅ m-hun
	Phonetic Surface			[c'omhun]

Indeed, to the extent that purportedly underlying long vowels later undergo diphthongization, as in (57) ii before Shortening has applied, we have grounds for not setting up geminates at the level of underlying phonological representation, but rather we have motivation for postulating a single vowel at that level specified with the feature [+ long] (but see below). For a segmental analysis would automatically constitute a violation of the Adjacency-Identity Constraint since the parts of the geminate would be adjacent but not identical on the phonetic surface.

Returning in conclusion to the apparently recalcitrant vowel system of English, note that Lass (1976) argues for the representation of "steady-state" long vowels in English as a sequence of two identical vowels. Under Lass' interpretation "both long vowels and diphthongs have the structure /VV/, as opposed to short vowels, which are /V/" (page 22). He goes on to note that "The dichotomy in English - even at the phonetic level - is then /V/ vs. /VV/: the difference between long vowels and diphthongs is simply a matter of identity or non-identity of nuclear constituents" (ibid.). Lass proposes to schematize long vowels as /V_iV_i/ as opposed to diphthongs which are /V_iV_j/ where 'i' and 'j' are "any potentially distinctive feature specifications". (ibid.). He poses the question: "What is meant by a representation like [e:]?" (page 21). Arguing that "presumably the symbol [:] means 'an extra mora of length', i.e. the articulation of an [e] carried over without interruption into another temporal unit beyond 'its own'", (ibid.), he "purges" phonological theory of a dubious distinctive feature i.e.

* Footnote from previous page

Since Vowel Harmony is context-sensitive by its very nature - it effects an agreement with respect to some feature between an underlying vowel and an underspecified vowel - whilst Vowel Lowering is a rule of Absolute Neutralization and hence context-free, Vowel Harmony takes precedence by PIPrec.

length, claiming "that this 'feature' is in fact not a feature but a segment" (page 22; my emphasis). If we can uphold his strong hypothesis that "the essential contrast in languages which have 'two kinds of vowels' is monomoric vs. bimoric nuclei" (page 33), then we will have to accommodate within the theory of gemination (developed for consonants) the fact that some rules will violate the AIC, namely, rules of diphthongization. Of course, rules of raising, lowering, fronting and retraction of a long vowel will result in two adjacent, identical segments in their SCs. It would be an intriguing line of investigation to pursue the question of whether the conditioning environments for the latter type of rules differ formally from the conditioning environments for diphthongization - in the way that assimilation rules were shown above to differ formally from other phonetically motivated processes. I leave this for further research. Suffice it to say in conclusion, that even for a language like English where long and short vowels exhibit marked differences in quality, Lass' treatment confirms our analysis of Shortening as deletion of an identical adjacent mora. This adds even more force to such an argument in clear-cut cases like that found in Yawelmani Yokuts. I cite Lass' schema for Shortening of a long vowel which crucially incorporates the null segment, and corroborate his assertion that such a schema characterizes Shortening as a linguistic universal.

(58) (= Lass' (21) f. page 34)

Shortening of long vowel

$$\begin{array}{ccc}
 \text{SD:} & \begin{bmatrix} V \\ \alpha F_i \end{bmatrix} & \begin{bmatrix} V \\ \alpha F_i \end{bmatrix} & & \text{SC:} & 1 & \emptyset \\
 & 1 & 2 & & & &
 \end{array}$$

§ 4.4 Metatheoretical Considerations

We have seen that Deletion Cession is well-motivated in that it accounts for the precedence relations between rules whose order of application cannot otherwise be predicted. Data from Yawelmani Yokuts, Sea Dayak and Washo proved recalcitrant in the literature in that they constituted counterexamples to KSN's simultaneous rule application whilst no single precedence principle hitherto proposed seemed to be consistent with all three. However, it became possible to account for all these data as soon as Deletion Cession was incorporated into the theory of UDRA.

In § 4.1 it was noted that KSN's purported examples of simultaneity did not provide positive evidence in favour of such a position. It may now be observed that Deletion Cession accounts gratis for Nasal Consonant Deletion in French (p. 155f) - if indeed this process is separable from Vowel Nasalization (see discussion on p.158-9).

It is also applicable to Final s-Deletion in Saporta's treatment of Uruguayan Spanish (p. ¹⁶¹161f), provided we accept his overly abstract analysis in the first place. As for KSN's proposal of simultaneous rule application for the rules of Devoicing and Spirantization in Low German dialects, we saw that this case is already covered by PIPrec, restated as Proper Class Inclusion (p. 152). Indeed, KSN remain non-committal on the priority of PIPrec (and hence Proper Class Inclusion) over Obligatory Precedence, despite the fact that Trommelen and Zonnefeld attribute the priority of Obligatory Precedence over PIPrec to KSN (1978, page 6). However, in his most recent published remarks on rule ordering, Koutsoudas (1980) claims that only if PIPrec is inapplicable does Obligatory Precedence come into play: "Notice further that Obligatory Precedence is to be consulted for applicability

after Proper Inclusion Precedence has been consulted" (page 4; my emphasis).

Turning to KSN's final example for simultaneity i.e. Saporta's reanalysis of verbs like "crecer" in South American Spanish (pp.165ff), we find that Deletion Cession seems inoperative. However, it was demonstrated on page 171 that here also it is PIPrec which predicts the correct order of application (over Obligatory Precedence) - if indeed we permit the use of an underlying segment /θ/ to function as a diacritic for a morphologically determined verb class. What then of Counterbleeding Precedence? - KSN formulate this (fn. 6, page 7) as an alternative to simultaneous rule application, just in case it be proven that the latter cannot be maintained. Taking it for granted that further research shows that simultaneity is not a possible mode of rule interaction, it should be Counterbleeding Precedence rather than Proper Inclusion Precedence which predicts the ordering k-Insertion before θ → s for Saporta's rules.

Let us briefly consider hypothetically the range of data to which Counterbleeding Precedence might be applicable. Counterbleeding Precedence claims that Rule A takes applicational precedence over Rule B if "there is some string that is included in the inputs of both A and B, not in the output of B" (= (21) page 171; = KSN *ibid.*). Let us identify such a string as X. In order for us to determine which rule is to count as A and which as B, we must infer that X is present in the SDs of both A and B, and present in the output of the one (i.e. A) but not the other (i.e. B.). For X to be absent in the output of B, B must effect a change on X, whilst A must specify X in its environment but not affect it. Once we examine the formalization of hypothetical rules, we see that two types of relation may obtain

between such a rule-pair. Firstly, A may be more context-restricted than B. In such a case the total SD of A (i.e. the segment affected + left-hand and/or right-hand environments) will properly include the SD of B (whose affected segment is $X \rightarrow X'$). Then Proper Inclusion-Precedence will automatically account for the ordering A, B - there is no need to invoke Counterbleeding Precedence here.

Secondly, B may be as context-restricted as A, or more context-restricted. Let us identify the segment affected by A as Y and the resulting output segment as Y'. Now if Y' figures in the SD of B, we have an example of intrinsic feeding or unilateral supplying (to use Hetzron's terms) and there is no need to impose a language-specific restriction on the ordering A, B. If, on the other hand, Y' does not figure in the SD of B, then the changes affected by A and B take place in disjoint environments, making an ordering statement superfluous.

Consider now the case in which A is a deletion rule. Such a rule A will either intrinsically feed B or the two will not affect each other (just as when A is not a deletion rule). (59) schematizes the situation where A is a deletion rule, with a hypothetical example:

(59) Schemata:

A $YX \rightarrow \emptyset X$ or $XY \rightarrow X\emptyset$

B $WXZ \rightarrow WX'Z$

Hypothetical example:

A $? \rightarrow \emptyset / _ t$

B $t \rightarrow d / V _ V$

A will feed B just in case there are underlying strings of the structure /WYXZ/ or /WXYZ/. In the hypothetical example, underlying form /V?tV/ will become /VtV/ by A, thus feeding B to yield phonetic surface [VdV]. Unless strings of this structure exist, the SCs brought about by A and

B will be disjoint. In other words, whichever relation obtains the UDRA hypothesis will guarantee the correct derivation without additional apparatus. So, incidentally, will the KSN hypothesis.

It should be stressed that the situation in which A effects a deletion process would not be a counterexample to Deletion Cession. This principle does not claim that deletion processes always apply after other processes, but rather it predicts this interaction for just those cases where the SD of a deletion rule is met simultaneously with that of some other (non-deletion) rule. In instances of intrinsic feeding and mutual exclusion only one SD is met by each string at one time. Notice finally that when rule B in our hypothetical exempla effects the deletion of X and A is the more context-restricted, either PIPrec or Deletion Cession will predict the correct interaction. Of course the crucial cases from Yawelmani Yokuts, Sea Dayak and Washo discussed above were accounted for only by Deletion Cession - no-one has ever suggested that they could be handled by PIPrec or Counterbleeding Precedence. Above we were concerned with cases of deletion which were analyzable in terms of PIPrec or purported Counterbleeding Precedence vis à vis another rule.

In conclusion, we may dispense with Counterbleeding Precedence as superfluous. All cases in which some string is present in the SDs of two rules but absent in the output of one, may be ordered according to PIPrec or allowed to apply in an intrinsic feeding relation or left unrestricted (because they do not affect each other). In view of the above discussion, Counterbleeding Precedence will not figure in the theory of UDRA developed in this thesis.

During the course of our rejection of Counterbleeding Precedence, we have strayed somewhat from the actual linguistic data in connection

with which KSN originally proposed the principle. Recall that unlike KSN, we questioned the validity of Saporta's analysis on the grounds of Abstractness. Let us now examine the relationship between the kinds of consideration which led us to reject highly abstract analyses in § 4.1 and the status of Deletion Cession as a linguistic universal. In this way I hope to show the interdependency which obtains between constraints on Abstractness and precedence principles in a fully integrated theory of phonology of which the UDRA hypothesis forms a part. Thus I shall clarify the sense in which the incorporation of Deletion Cession into the theory constitutes an explanation of the mode of rule interaction concerned, rather than its serving merely as an account of the facts. In other words, assuming that the evidence presented in previous sections provides grounds for asserting the observational adequacy of Deletion Cession, the metatheoretical discussion of this section will establish its explanatory adequacy.

The phonologist who has worked most within the classical theory to constrain the abstractness of URs is of course Paul Kiparsky. In § 4.1 "Simultaneous Rule Application in KSN", we quoted his (1968) definitions of Absolute and Contextual Neutralization. We also cited the Strong and Weak versions of the Alternation Condition, the former categorically forbidding the use of Absolute Neutralization in phonological grammars, the latter assigning it greater cost under the evaluation measure. It is now expedient to examine in some detail Kiparsky's 1973 paper (also edited by Fujimura), "Abstractness, Opacity, and Global Rules".

In the second section of this paper, Kiparsky discusses instances where, instead of applying in a Markovian fashion, rules appear to be "looking back" at an earlier stage of the derivation. By "Markovian" Kiparsky refers to "the most important restriction on rule ordering in

the standard theory of generative phonology" whereby "a rule applies to a form if and only if the form fits the structural analysis of the rule at the point in the derivation at which the rule is applicable" (page 57). Given this definition, it is clear that extrinsic ordering is Markovian, just in case extrinsic ordering necessarily entails linearity. However, once rules are allowed to "go global", one of the prime motives for strict sequential - and hence extrinsic - ordering has been removed. This point is brought home in Chapter 6 of K&K 1976 on "The Role of Derivational History in Phonology". K&K demonstrate that by permitting a rule to refer back to the structure of a morpheme at the level of UR, we dispense with what might be termed the most fundamental reason for (extrinsic) rule ordering: one of the basic functions of rule ordering in the literature has been to distinguish between underlying segments which undergo a particular process (the first rule), from other phonetically identical segments which result from the application of a second rule (crucially ordered after Rule 1). To sum up in K&K's words, "the localist assumption (= that derivations are Markovian and rules extrinsically ordered; JRMcb) claims, first, that the SD of a rule refers to properties that co-occur in one phonological representation, and, second, the representation in question is the structure that is the input to the rule" (page 198; original emphasis). *

We have already treated in detail the first example to which Kiparsky briefly alludes. I refer to the case of 'writer' and 'rider' in § 3.4.1 "Reordering out of Bleeding Order". There we postponed the discussion

* Footnote

Unfortunately K&K's use of the term 'localist' for Markovian detracts from their lucid discussion: 'localist' in K&K's sense must not be confused with S. Anderson's 'local ordering' (1969; see next chapter for a discussion of his Old Breton and Icelandic data.)

of why Vowel Alternation takes applicational precedence over Flapping in those dialects where both are regular phonological rules. As anticipated in the introductory remarks to this chapter, we now take up the references to Kiparsky's 1973 paper which were made on pages 110 (for American dialects) and 116 (for Canadian dialects). I shall present two examples of "looking back" with which Kiparsky deals in depth, before returning to American and Canadian English to explicate the solutions proposed for the "reordering" cases above.

The two examples of "looking back" to be taken from Kiparsky are found in data from Finnish and Sanskrit. In Finnish there is a rule of Spirantization which may be informally stated as (60) (= Kiparsky's (2-1), page 58):

(60) Spirantization in Finnish:

$$t \longrightarrow s / \text{ ___ } i$$

Three types of ti sequence are found in the language. Across morpheme-boundaries underlying t becomes s before the suffix i e.g. /halut + i/ \longrightarrow [halusi] "wanted". t \longrightarrow s also applies morpheme-internally before derived i e.g. /vete/ "water", cf. Essive [vete + nã] but Nominative [vesi] (where e \longrightarrow i is a general rule operating word-finally).

However the rule does not apply morpheme-internally before underlying i e.g. [neiti] "Miss". How are forms such as neiti to be exempted from the t \longrightarrow s rule without incorporating global power into the grammar? Notice that they cannot be treated as exceptions as they are not synchronically "foreign" or "affective" and, as Kiparsky notes, many (like neiti itself) are in fact historically native as well.

In Sanskrit it appears that the so-called ruki rule also needs to "look back". The rule is stated informally as (61): like Kiparsky, we shall side-step the controversial issue of how to characterize its environment

as a natural class.

(61) The ruki rule in Sanskrit:

$$s \rightarrow \underset{\cdot}{s} / i, u, r, k \text{ ____}$$

(= Kiparsky's (2-2) page 61).

As with the Finnish example, we may distinguish three different situations where s appears after a ruki environment. Firstly, the ruki rule applies across morpheme-boundaries when inflectional and derivational suffixes beginning with s are added to stems e.g. [da + dā + si] "give" vs. [bi + bhar + si] "carry". It also applies within morphemes when the ruki environment has arisen as the result of some phonological rule e.g. when the vowel in the root /śās/ "instruct" is weakened to i in the weak grade before /ṭa/, the surface phonetic form which results is [śiṣṭa] "taught". Lastly, the rule does not apply morpheme-internally if the ruki environment is present in underlying structure e.g. /kusuma/ → [kusuma] "flower". * Once again, how are we to explain these facts unless it is by entertaining global rules?

Kiparsky uses the term 'derived' to refer to those forms which are created by combining morphemes through inflection or derivation, together with those which arise after the application of some phonological rule. Clearly then, Spirantization in Finnish and the ruki rule in Sanskrit apply only in derived environments. Yet as Kiparsky notes, to say this "does no more than give a disjunction of two arbitrary-seeming conditions, without explaining either one of them, or their co-occurrence in the rules" (page 63).

* Footnote

In fact phonetic [ṣ] also occurs in environments other than ruki ones e.g. [ṣaṣ] "six". This leads to the postulation of underlying /ṣ/ as well as those resulting from the ruki rule. It does not however detract from the claim that the ruki rule is synchronically well-motivated in Sanskrit.

In his attempt to find an explanation for such cases where rules appear to be "looking back", Kiparsky notes first that the rules which apparently require global power apply to derived forms only. The opposite equally possible situation, where rules apply to non-derived forms only, appears not to obtain. Kiparsky then argues that the failure of rules to apply morpheme-internally to underlying forms is predictable from the make-up of those URs themselves: the fact that neiti does not undergo Spirantization and that the ruki rule does not apply to kusuma is precisely what has led to the positing of t and s in their respective URs. To put this slightly differently, if the forms in question underwent those rules, we would set up /s/ and /ʃ/ in their respective lexical entries. *

It is now clear that we are dealing with the question of the Abstractness of URs, which Kiparsky first treated in his acclaimed 1968 paper. There the Strong Alternation Condition imposed a limitation on URs. Kiparsky's 1973 proposal is that it also impose a limitation on phonological rules, as in (62) (= Kiparsky's (2-4) page 65):

(62) The Alternation Condition revised:

"Neutralization processes apply only to derived forms".

In the solution to the purported reordering of Flapping and Vowel Alternation in American and Canadian English, we tacitly adopted the revised version of the Alternation Condition as a precedence principle. The principle that was assumed may be formalized as (63), Neutralization Condition:

* Footnote

This begs the question of what happens when a morpheme occurs in isolation. See the end of this section for discussion (page 229).

(63) Neutralization Cession:

Given a representation which meets the structural descriptions of two rules, A and B, A takes applicational precedence over B just in case B is a neutralization process.

Flapping is a neutralization process since it merges the underlying voicing distinction between t and d. Consequently, in those dialects where Lengthening or Raising are regular phonological rules (i.e. American X, p.107f; Canadian X, p.111f), such rules will take applicational precedence over Flapping to yield surface phonetic [rayDr], [ra:yDr] (American) and [rəyDr], [rayDr] (Canadian).

Not only does (63) follow from Kiparsky's constraint on Abstractness, but Deletion Cession does also. Deletion is, as it were, the extreme case of neutralization: the latter erases the distinction between plus and minus for one or more of a segment's distinctive features; deletion removes all such distinctions by eliminating the segment in question from the rule's output.

Hooper has demonstrated, and we have accepted, that the Secondary Modes of rule interaction, Counterbleeding and Counterfeeding, typically result in analyses violating NGP's True Generalization Condition, inasmuch as they lead to surface opacity. In other words, Counterbleeding and Counterfeeding modes of interaction typify "abstract" analyses secundum GROD. Now consider the crucial rôle played by deletion processes in such highly abstract treatments. Cathey and Demers' (CD) "in-depth" 1976 analysis of Old Icelandic (OI) is a case in point. In § 3.4.2 "The Swiss German Case", we observed that the only apparent motivation for a root-final vowel in underlying /vake + j + δ + ee/ (3rd. person past subjunctive of "be awake") is to satisfy CD's rule of Internal Syncope. Similarly, the word-final /e/ necessitates Terminal Syncope

and the /j/ requires Glide Drop. Besides these three deletion rules applying to vowels, there is also a rule of Vowel Elision.

Of course, it is a consequence of the overpowerful machinery which GROS makes available (in other words, extrinsic ordering) that there are virtually no constraints imposed by the theory on the abstractness of URs. As a result, CD are able to make the pairing of morphosyntactic category with underlying phonological shape appear constant. The price for this constancy is paid in terms of derivational complexity within the phonological component. However within the UDRA hypothesis this plethora of deletion rules required to "actualize" the implausible URs would not be permitted on two counts: on the one hand, constraints on abstractness would stipulate that a morpheme cannot be realized as zero in all its environments - if this were the case we would be dealing instead with a 'covert' morphosyntactic category; on the other hand, Deletion Cession would demand the prior application of other phonological rules, thus leading to highly implausible derivations.

To take just two examples of this latter point, consider the following rules taken from CD:

(64) CD's rules for OI.

i) u-Mutation (= 14, page 620)

$$a \rightarrow [+ \text{round}] / \# \# _ X \quad \text{---} \quad (C_0 \ a) \ C_0 \ u$$

ii) i-Mutation (= 12, page 620)

$$\begin{array}{c} \left[\begin{array}{l} + \text{syll} \\ + \text{stress} \end{array} \right]_1^2 \\ 1 \end{array} \quad C_0 \quad \begin{array}{c} \left[\begin{array}{l} + \text{son} \\ - \text{back} \\ + \text{high} \end{array} \right]_3 \\ 2 \end{array} \quad \Rightarrow \quad \begin{array}{c} \left[- \text{back} \right]_1^2 \\ 1 \end{array} \quad , \quad 2, \quad 3$$

iii) Internal Syncope (= 11, page 619)

$$v \rightarrow \emptyset / \left[\text{---} \right] \quad (j) \ C_0^1 \quad \left[\begin{array}{c} v \\ - \text{stress} \end{array} \right] \quad \left[\begin{array}{c} v \\ - \text{stress} \end{array} \right]$$

iv) Terminal Syncope (= 15, page 620)

$$v \rightarrow \emptyset / \left[\begin{array}{c} \text{---} \\ \text{- stress} \end{array} \right] c_o^1 \# \#$$

Deletion Cession would necessitate that u-Mutation apply before Internal Syncope and Terminal Syncope to underlying /gamal + uu/ (Dative singular of adjective gamall "old"). The application of u-Mutation would yield */gɔmɔl + uu/. Given that the second */ɔ/ never appears on the phonetic surface, (nor does the final /u/) and that there is no phonetic motivation for an underlying /a/ in the first place, what evidence can be adduced for the mutation of the second /a/ to ɔ? Similarly, the /u/ of /vallu + iir/ (Nominative Plural of the masculine noun vollar "plain") would be fronted to /i/ under i-Mutation, if Internal Syncope and Terminal Syncope were constrained to follow the latter rule in accordance with Deletion Cession. This i < u would then trigger the iterative re-application of i-Mutation to /a/, yielding /vælli + iir/. Thus a triphthongal /i::/ would result at an intermediate stage of the derivation. Yet this vowel is entirely fictitious - to my knowledge it has never been claimed that OI possesses three vowel lengths (as Estonian does).

We have, then, the situation in which a particular analysis (CD's treatment of OI) violates constraints on the abstractness of URs and also presents counterexamples to one of the precedence principles of the UDRA hypothesis (i.e. Deletion Cession). Given that constraints on abstractness, such as those formulated by Kiparsky, have been generally accepted in the literature, the theory from which they derive lends "coherence" to UDRA. Kiparsky's thesis may be termed the "sustenance" of the UDRA hypothesis, in the sense of M. Bunge (1959, pp. 78-81). To cite Botha (1971), "if a statement coheres with others, and if these are known to be true, it is also taken to be true; if not, it is

regarded as false" (p. 123). Indeed arguments referring to this kind of truth, i.e. "systematic" truth have figured at various points throughout this thesis (see the work of A. Kaplan, e.g. 1964). I have been at pains to stress that the particular precedence principles proposed in Part I both depend upon and support the other hypotheses with which a fully integrated theory of phonology characterizes natural language.

In closing this chapter, a few brief remarks must be made concerning the remainder of Kiparsky's 1973 paper, the part which has not been discussed. The final version of the Alternation Condition is given in (65) (= Kiparsky's (2-6), page 67):

(65) "Non-automatic neutralization processes apply only to derived forms".

K&K 1977 supply rough definitions for the terms 'non-automatic' and 'neutralizing': "a rule will be non-automatic if there are input structures that satisfy the phonological and/or morphological conditions of the rule, but nevertheless fail to undergo the rule; a rule will be neutralizing if it creates structures identical to structures that existed prior to the rule's application" (page 209).

K&K go on to demonstrate that, contrary to (65), automatic neutralization rules too may be restricted to derived contexts, by referring to data from Chi-Mwi:ni. * They further show that non-automatic neutralization rules may apply in non-derived contexts. Their crucial data involve Yawelmani Yokuts where stems of the underlying (i.e. non-derived) shape

* Footnote

As stated, (65) does not stipulate that "only non-automatic neutralization processes apply to derived forms". That this is the intended interpretation may be inferred from Kiparsky's desire to permit automatic neutralization processes to apply in non-derived contexts. Hence his claim: "it is still possible to place a big restriction on absolute neutralization: we can exclude non-automatic absolute neutralization". (page 67).

/CV:CC/ undergo Shortening when unsuffixed. (Recall that when the suffix /al/ is added to /?a:ml/, i-Epenthesis bleeds Shortening by virtue of Deletion Cession). Referring back to Kiparsky's argumentation regarding the ruki rule of Sanskrit (cf. footnote on page 224), we notice the claim that if words like kusuma "were subject to the ruki rule, they would always undergo it, since the s is preceded by a ruki environment in every occurrence of these morphemes" (page 64). This appears to be false since frequently morphemes undergo particular rules when they occur in isolation. This is amply exemplified in K&K 1977 (Chapter 1, pp. 18-26) by final obstruent devoicing in Russian and interesting data from Lardil.

Despite the fact that in its present form (65) cannot be incorporated into phonological theory, it seems to me that the adoption of (62) as precedence principle (63) and the formulation of Deletion Cession which ensues, do figure in that theory. For whilst the notions derived/non-derived are unambiguous, it seems that automatic/non-automatic involve questions of degree. As K&K note, the existence of random exceptions could completely tip the balance as to whether a process is automatic or not. If we conclude that it is the "non-automatic clause" rather than the "neutralization clause" which is suspect in (65), we are justified in retaining the latter and discarding the former. In fact, Kiparsky formulated (65) as he did (however inexplicitly - see fn.) to permit certain abstract analyses involving Absolute Neutralization (including, interestingly, Kisseberth's analysis of Yawelmani Yokuts deriving o: < u:). Further research on this class of purported phenomena will doubtless make possible the more precise characterization of automatic and non-automatic rules. Whatever that outcome may be, it is to be expected that it will impinge upon UDRA.

This chapter has served to explicate the first of the secondary modes of rule interaction, Counterbleeding, and to present evidence in favour of the adoption of a precedence principle, Deletion Cession, into the theory of UDRA. We have of course been concerned solely with questions of phonology. However the UDRA hypothesis is one which applies to a generative grammar as a whole and that means that the rules of the syntactic component are also subject to universal principles. Now it is logically possible that those principles which function within the phonological component are independent of those which function within the syntactic component. However, to the extent that individual principles represent axioms about Language and can be justified on a metatheoretical basis, we would expect the same natural set of precedence principles to apply throughout the grammar. Indeed, although I shall have little to say in this thesis regarding the syntactic component, I shall demonstrate in Part II that the principles of UDRA developed here are operative within the extended lexicon (see in particular § 2.4). I merely note, following the discussion of Deletion Cession, that references have been made within the literature to the late application of deletion in syntax (see Kayne's 1975 reference to Postal 1970, page 37, fn. 43). Surely this kind of independent corroboration for work developed in relation to the phonological component lends plausibility to the proposals advanced in this thesis.

CHAPTER FIVE - COUNTERFEEDING

We have discussed in some detail counterexamples to KSN's claim that rules in a counterbleeding relation may be allowed to apply simultaneously. Now we turn to counterfeeding which, as we noted in the Introduction to Part I, is not considered a possible mode of rule interaction by KSN. In § 5.1 I shall discuss KSN's re-analysis of both synchronic and diachronic examples of counterfeeding. I shall demonstrate that KSN's solution to the problem posed by the Slavic data is insightful and preferable to that of NGP. When Finnish data are considered, I shall reject both KSN's treatment and one of the re-analyses cited by Hooper: rather, I shall argue for the adoption under the theory of UDRA of King's and Perry's (independent) solutions. It will be shown that once again NGP fails to come to grips with the crucial problem posed by rules in a counterfeeding relation.

In § 5.2 we shall evaluate the first three sets of data treated by Iverson in his 1973b paper as exempla of his proposed constraint on counterfeeding. § 5.2.1. deals with Assimilation and Dissimilation in Konkani, § 5.2.2. with Fricative Weakening and Fricativization in Classical Greek and § 5.2.3. with Initial Mutation in Old Breton. It will be shown that the theory of UDRA need not be expanded to account for these data, given the particular position regarding the rôle of morphological rules developed in this thesis. § 5.2.3. also provides an opportunity for us to anticipate the treatment of Initial Mutation — the morphological phenomenon which constitutes the subject-matter of Part II.

Throughout the discussion of § 5.2., I shall move towards a precise characterization of the interactions obtaining in Iverson's data. This

will pave the way for a tightening-up in § 5.3 of the manner in which PI relations are determined and two algorithms will be established to that effect. I shall also argue for a constraint on how rules are formulated to insure that precedence relations are determined in a non-spurious fashion. The Pre-Condition on PI and the PI Test are then applied in § 5.4 to the remaining data from Iverson's paper, and their efficacy demonstrated.

Part I closes in § 5.5 with an appraisal of the theoretical implications arising from the dissection of Iverson's Constraint. The rôle of morphological phenomena and the need for preciseness and rigour in the determination of precedence relations are seen as aspects of the Abstractness issue to which an integrated theory of phonology incorporating UDRA must address itself.

§ 5.1 KSN's Re-analysis of Counterfeeding Relations

The KSN hypothesis claims that only the relations of feeding, counter-bleeding and mutual bleeding obtain between rules in natural language. It therefore behoves KSN to demonstrate that purported examples of counterfeeding in the literature are fictitious. This they can achieve by offering an explanation of the synchronic data in question which is more insightful than - or at least as insightful as - the GROD explanation. They can then substantiate their position further by demonstrating that counterfeeding relations do not figure in linguistic change - in particular they can refute the claim that the same pair of rules, applying to identical URs, has been reordered out of a counterfeeding order into a feeding order.

The example of counterfeeding which appears in the body of KSN's text involves Kiparsky's 1968 analysis of Modern Polish and Old Church Slavic. Kiparsky posits the following rule-pair for these languages: (= KSN's (19) page 10).

(1) Kiparsky's Analysis of Modern Polish and Old Church Slavic:

A Deaffrication

$$\begin{bmatrix} + \text{voiced} \\ - \text{grave} \\ + \text{strident} \end{bmatrix} \longrightarrow \begin{bmatrix} + \text{continuant} \end{bmatrix}$$

i.e. $d\check{z} \longrightarrow \check{z}$
 $dz \longrightarrow z$

B Second Palatalization

$$\begin{bmatrix} + \text{obstruent} \\ - \text{grave} \\ - \text{strident} \\ - \text{diffuse} \end{bmatrix} \longrightarrow \begin{bmatrix} + \text{strident} \\ + \text{diffuse} \end{bmatrix} / \text{_____} \check{e}$$

i.e. $k, \check{e} \longrightarrow ts\check{e}$
 $g, \check{e} \longrightarrow dz\check{e}$

Under Kiparsky's treatment, First Palatalization (not given here) feeds

Deaffrication in that the voiced /dʒ/ which results from the palatalization of velar plosives becomes [ʒ]; e.g. /givŭ/ → /dʒivŭ/ → [ʒivŭ] "alive" by First Palatalization and then Deaffrication cf. /kŭto/ → [čŭto] "what" by First Palatalization only. When new instances of front vowels develop due to the ~~monophthongization~~ of /ai/ to [ĕ], Second Palatalization occurs yielding [ts] and [dz]. However, this [dz] does not deaffricate; e.g. /k,ŕna/ → [tsŕna] "price" by Second Palatalization, and /g,ŕlo/ → [dzŕlo] "very" likewise by Second Palatalization only, rather than *[zŕlo] by later Deaffrication. In brief, in Modern Polish and Old Church Slavic Second Palatalization (1) B counterfeeds Deaffrication (1) A.

Within the GROD framework the obvious way to account for these facts is to order Second Palatalization extrinsically after Deaffrication. KSN demonstrate convincingly that it is not necessary to incorporate such a language-specific constraint into the phonological grammars of Polish and Old Church Slavic. Noting that in these languages phonetic [z] never results from /dz/, they propose to restrict Deaffrication so that it applies to /dʒ/ yielding [ʒ] but not to /dz/ yielding [z]. This can be achieved by adding the feature [- diffuse] to the SD of Deaffrication, as in (2) (= KSN's (19) a', page 10).

(2) Deaffrication in Modern Polish and Old Church Slavic

secundum KSN:

$$A' \begin{bmatrix} + \text{voiced} \\ - \text{grave} \\ + \text{strident} \\ - \text{diffuse} \end{bmatrix} \longrightarrow [+ \text{continuant}]$$

i.e. dʒ → ʒ

Once A has been modified in this way both A' and B may apply whenever their SDs are met.

The KSN analysis is even more convincing once diachronic data are introduced. Kiparsky (1968b) claims that Russian and other innovative

Slavic languages have reordered Deaffrication and Second Palatalization out of a counterfeeding order into a feeding order. The evidence adduced for this claim comes from the fact that in the innovative languages the phonetic reflex of underlying /g,ǰlo/ is [zǰlo]. KSN on the other hand account for the difference between conservative and innovative Slavic in terms of the generality of their respective deaffrication processes. In conservative Polish and Old Church Slavic only non-diffuse affricates undergo the rule (i.e. A'), whereas in the innovative languages both non-diffuse /dǰ/ and diffuse /dz/ deaffricate (i.e. A). This is in keeping with Kiparsky's hypothesis that rule generalization (= rule 'simplification') is a principle of linguistic change. As KSN are swift to point out (page 21), Kiparsky is unable to use his own principle in his analysis of Slavic. Rather, he has to call upon an entirely distinct principle, that of the maximization of feeding orders. Thus KSN's proposal is consistent with a simpler theory of linguistic change than the GROD treatment with extrinsic ordering. KSN conclude that Kiparsky's Slavic data "thus serve to confirm rather than disconfirm the hypothesis that there is no extrinsic ordering of rules" (ibid.).

Unlike Hooper, I accept KSN's reanalysis as sufficient to elucidate the data and do not find Vennemann's explanation (conveyed personally) "equally plausible". According to Hooper, Vennemann proposes that "Old Church Slavic and Polish underwent a new round of deaffrication after the second palatalization" (1976; page 101). To my knowledge there is no evidence to support such a claim and furthermore, if we accept it, we invite proponents of GROD to postulate an equally ad hoc third round of palatalization, and so on, ad infinitum. In any case, putting such implications aside, how would NGP prevent the output of Second Palatali-

sation from feeding original deaffrication? This is, after all, the crucial problem for opponents of extrinsic ordering and one with which NGP seems incapable of dealing.

Whereas the NGP solution to Kiparsky's Slavic data is certainly less plausible than KSN's, I prefer Hooper's explanation of counterfeeding in Finnish to KSN's initial suggestion for these data. Recall the Finnish rules of χ-Deletion and Diphthongization where the former (which is part of the gradation process) creates ee sequences and thus feeds Diphthongization. * (See § 2.1 above.) We have seen that Kiparsky (1968) proposes that in innovative eastern dialects the rules apply in just this feeding relation. However he makes the further claim that such dialects have reordered the rules out of the counterfeeding order which obtains in the Standard language. Thus in Standard Finnish Diphthongization does not apply to the output of Gradation. According to Kiparsky, this is because in these conservative western dialects Diphthongization is extrinsically ordered to apply before χ-Deletion.

KSN do not discuss the conservative Finnish dialects in the main body of the text - instead they treat this purported case of counterfeeding in a footnote (fn. 9, page 11), referring back to their earlier discussion of innovative Finnish (on page 3) where the rules apply in a feeding relation. According to KSN, the counterfeeding order posited by Kiparsky for the standard language "can also be accounted for by assuming that

* Footnote

Note that the precedence of χ-Deletion over Diphthongization does not constitute a counterexample to Deletion Cession: given the UR /teχe/ "make!", only the SD of Gradation is met. This process applies to yield intermediate /teϕe/, which then meets the SD of Diphthongization for the first time, and consequently undergoes it. Since Deletion Cession is only operative when a form meets the SDs of two rules at the same time (one of which is a deletion process), it cannot be invoked here.

these dialects have underlying long vowels rather than geminates" (fn. 9, page 11). Consequently KSN formalize an "equally plausible long-vowel diphthongization rule" (ibid.) in place of the so-called innovative "geminate diphthongization rule". The two rules are cited as (3):

(3) Diphthongization in Finnish secundum KSN:

- i) Conservative (western) Standard dialects - long vowel diphthongization (= KSN's (2) b'. fn. 9, page 11)

$\bar{e} \rightarrow ie$

- ii) Innovative (eastern) dialects - geminate diphthongization (= KSN's (2) b. page 3)

$ee \rightarrow ie$

On the assumption that $\underline{ee} \neq \bar{e}$, the application of Gradation to underlying /te χ e/ "make!" (yielding /tee/) does not result in a representation meeting the SD of (3) i). Thus, following KSN's line of argumentation, the surface phonetic reflex of "make!" in Standard Finnish is [tee] rather than *[tie].

For the sake of discussion, let us ignore § 4.3 in which suspicion was cast on the very existence of the feature [\pm long] (which KSN posit for underlying mid vowels in Standard Finnish), and let us attempt to evaluate KSN's proposal in terms of evidence internal to the analysis. At first we might conclude that / \bar{e} / is a notational variant of /ee/ - were it not for the fact that a phonological rule distinguishes between them i.e. Diphthongization. In fact we soon see that it is precisely because of the existence of such a rule that underlying geminate mid vowels were represented as / \bar{e} / in the first place. To spell out the theoretical implications of KSN's reanalysis, it employs a notational device to distinguish between underlying and derived geminate mid vowels and as such incorporates globality into the theory. If we accept the

arguments in the literature that global rules result in a more powerful theory than the Standard theory, in that they allow for a broader definition of 'possible rule of grammar' *, we can no longer maintain the claim that the KSN hypothesis is less powerful than GROD. Viewed in this way, the first reanalysis of Standard Finnish suggested by KSN clearly falsifies their contention that the theory they advance is a more constrained and hence a more highly valued theory than one incorporating extrinsic ordering but not global power. Therefore the theory of UDRA must reject KSN's initial reanalysis.

Even though we do not accept KSN's claim that "the dialects in question are thus readily derivable without the assumption of any extrinsic-ordering constraints" (ibid.; emphasis mine), it by no means follows that the theory of UDRA (or, more particularly, the KSN hypothesis) is incapable of explaining this purported case of rule reordering. Indeed, KSN go on to cite "a more strongly supported alternative" (ibid.) proposed by Perry (1971). Perry provides evidence that only one of the two dialects has a phonological rule of diphthongization. Apart from the strength of the supporting evidence which I am not in a position to assess, such a claim is very plausible a priori: in the standard language Diphthongization (as formulated in (1) A) is opaque in that there are forms on the phonetic surface which meet its SD but fail to undergo it (i.e. [tee]). If we accept that opaque rules are more susceptible to morphologization than transparent rules, and that morpho-

* Footnote

Such a claim is made, for instance, in Dinnsen's (1974) paper. Dinnsen cites Kisseberth (1972) as arguing that the Standard Theory is too weak and therefore incapable of minimally describing natural language. In fact the conclusion reached by Dinnsen eventually is that information about derivational history may be limited to [+deletion derived]. However it is my conjecture that even this limited type of globality is unnecessary in a more 'realistic' analysis of the Klamath data.

logization in turn is likely to result in lexical restructuring, it is reasonable to assume that the opaque rule of Diphthongization in conservative western dialects has led to the reanalysis of geminate mid vowels as underlying diphthongs in the lexicon.

As KSN note in passing, Perry's analysis would be in keeping with Kiparsky's remarks elsewhere on Absolute Neutralization (their reference is to 1971), whereas Kiparsky's own original analysis is not consistent with those remarks. Whilst this is certainly a justified criticism to level against Kiparsky - and one which has been made already in this thesis (see § 3.4.2 "The Swiss German Case") - KSN's comment is somewhat untimely, in view of their apparently blind acceptance of highly abstract analyses earlier in the paper (namely, those of Kiparsky himself for Swiss German, Chomsky and Halle for English, and, most notably, Saporta for Latin American Spanish - see § 4.1 "Simultaneous Rule Application in KSN" for a full discussion of the latter).

Hooper cites an explanation of the Finnish data which seems to be along the lines of Perry's explanation. King (1973) observes that Diphthongization began in the conservative western dialects. As it spread eastwards it was generalized to low vowels as well as mid vowels (i.e. /a/ → [oa]; /ä/ → [eä]). Consonant Gradation, on the other hand, began in the east and moved westwards. King argues that by the time Gradation reached the conservative western dialects, Diphthongization was non-productive. Hence it did not apply to the results of Gradation; but in the eastern dialects, the generalized rule of Diphthongization was fully operative and thus did apply to the results of Gradation.

If we equate 'non-productive' with 'opaque', we soon relate King's explanation with the intermediate stage leading to lexical restructuring - the stage at which Diphthongization has been morphologized. Diphth-

ongization will therefore take precedence over Gradation because of its status as a morphologically conditioned rule and will not be permitted to apply to the outputs of phonologically conditioned rules like Gradation. King's and Perry's arguments thus differ only in the stage which they claim has been reached in the gradual 'submergence' of Diphthongization in Standard western dialects.

This explanation seems to me to be more natural than KSN's long-vowel diphthongization - in that it is not dependent upon an ad hoc notational device. Moreover I fail to comprehend how the other analysis cited by Hooper would explain the facts without being susceptible to the latter criticism. Apparently Campbell (1973) "suggests that the diphthong in [tie] is the result of a new and different diphthongization process and the evidence for this is that it affects a different set of vowels" (Hooper (1976) page 100; emphasis mine). Are we to assume that the vowel in intermediate /tee/ belongs to a "different set" from underlying /vee/? Since the only difference between innovative phonetic [tie] and [vie] is their derivational history, any distinctive feature by which they are assigned to different sets must be an ad hoc diacritic used to represent derived versus underlying status. Such an analysis must be rejected on the grounds that it introduces global power into the theory.

In any case the crucial problem posed by these data concerns the counter-feeding of Diphthongization by Gradation in conservative dialects - the feeding relation in innovative dialects is in no way problematic. Yet Hooper does not say how Campbell proposes to deal with this problem.

Notice that a parallel 'explanation' was given by Hooper for the Slavic data discussed above (page 235). In each case of purported counterfeeding, NGP advocates an analysis where a second counterfeeding rule is proposed (here a second Diphthongization; for the Slavic data, a second round

of deaffrication). Yet in both cases NGP does not address itself to the pertinent problem: how to prevent the counterfeeding rule from feeding the counterfed rule. Until NGP makes explicit how it proposes to explain such relations, it cannot be considered an adequate theory of UDRA.

§ 5.2 Iverson's Constraint: Preliminary Critique

Although KSN claim that counterfeeding relations cannot obtain in natural language, and, furthermore, that reordering out of a counterfeeding order into a feeding order is not a mechanism of linguistic change, there is reason to believe that such a strong position cannot be upheld. In the first place, the KSN hypothesis has serious deficiencies regarding the treatment of counterfeeding in Finnish, in that it does not determine a unique satisfactory solution: the initial reanalysis under the KSN hypothesis of the Finnish data discussed above is ad hoc and as such, must be rejected. However it does not follow from this that the theory of UDRA is incapable of explaining these data - to jump to such a conclusion would be to commit what Koutsoudas terms 'The KSN theory vs. UDRA Fallacy' (1980; see in particular page 23 ff.). Indeed it has been demonstrated that a more fully developed theory is able to handle this purported case of counterfeeding in a non-ad hoc fashion.

Nevertheless, returning to KSN's strong claim regarding the absence of counterfeeding relations in natural language, it does not seem to be the case that such a position can be upheld - even if we adopt an extended UDRA hypothesis in place of KSN's original thesis and thus account for the recalcitrant Finnish example. To spell this out more clearly, there seems to be, within the literature, a substantial body of data where rules apply in a counterfeeding relation but which cannot be reanalyzed along the lines of KSN's treatment of Slavic. Such are the data cited in Iverson's 1973b paper, in that they are taken from analyses which seem to be well-motivated in all respects except that they describe relations traditionally held to be highly "marked" or "unnatural", in other words, counterfeeding relations.

Iverson recognizes that the classical theory (= GROD) and the KSN hypothesis are "deficient to the extent that these kinds of relationships are found in natural languages" (ibid. page 2). In order to account for them he proposes the following Constraint on Counterfeeding (henceforth CCF):

(4) Iverson's Constraint on Counterfeeding (CCF)

"If the structural change of a rule A is properly included in the structures affected by a rule B, then B may not apply to the structures effected by A".

(ibid. page 4)

By "structures affected" Iverson refers to "that part of the structural description of a rule which ordinarily occurs to the left of the arrow" (ibid.; my emphasis). This is somewhat equivocal since the paper contains rules expressed in the form $X \begin{array}{c} A \\ \downarrow \\ B \end{array} Y$ (rather than $A \rightarrow B / X \text{ --- } Y$),

where it is the environment which occurs to the left (albeit the upper left) of the arrow. Indeed, in his 1973a. paper, Iverson adopts such a schematism throughout. Nevertheless, we may take "structures affected" by rule R to refer to that segment whose feature specifications are modified by R, as we did in the formulation of Proper Class Inclusion on page 152. The "structures effected" by rule R then refer to that segment which has been modified by R. *

Although I shall not adopt it as a precedence principle per se, CCF is worthy of examination on two interrelated counts. First, from the metatheoretical view-point, CCF follows as an axiom of the theory of

* Footnote

Note that by defining structures affected and effected in terms of segments we are apparently limiting the CCF to just those cases where R is a feature-changing rule i.e. excluding epenthesis, metathesis, deletion, coalescence (fusion) and decomposition (breaking). This seems reasonable in that it is difficult, if not impossible, to interpret "properly included in" for the structures involved in such processes.

phonology developed in this thesis - the type of theory which integrates UDRA with constraints designed to ensure "realistic" analyses. In other words, CCF is not independently required within the theory of UDRA in order to account for rule interactions whose precedence relations could not otherwise be handled. In fact, as I shall demonstrate, all the examples bar one in the body of the paper can be dealt with by some form of morphological precedence, alluded to in earlier sections - a closely related convention on boundaries being relevant to the remaining case. It is unclear whether the specifically morphological nature of the phenomena involved is directly responsible for the fact that Iverson's constraint constitutes an axiom within the theory of UDRA. What does appear to be clear, however, is that this axiomatic status is a direct consequence of the kind of interaction, morphological or otherwise, for which CCF accounts. Iverson attempts to define the interaction-type but does not do so sharply enough. Once the precise character of the counterfeeding relations he describes has been recognized, it becomes necessary to impose a constraint on the formalization of rules whose applicational precedence is to be determined by universal principles. This aspect of CCF, that is, the fact that it calls for rigour in the determination of precedence relations if the spurious use of rule-formalisms is to be avoided, constitutes the second count on which I deem Iverson's proposal to be interesting for phonological theory.

Apart from the issues pertinent to the theory of UDRA which make Iverson's CCF worthy of discussion, there is another more specific reason for treating it in detail in this thesis: Iverson makes the claim that it is his precedence principle which accounts for Initial Mutation in Old Breton, alluding as he does so to Norman's treatment of Anderson's original analysis outside UDRA (Norman 1973b Anderson 1969). It will be necessary to return briefly to these sources before outlining

the treatment of Initial Mutation which is central to this thesis. In thus presenting the case for the particular treatment of Old Breton, I hope to pave the way for the full discussion of the phenomenon in Modern Irish which is the concern of Part II. However before we come to look at counterfeeding in the mutations of Old Breton, let us examine the first two examples presented by Iverson.

§ 5.2.1 Assimilation and Dissimilation in Konkani

Iverson's first example is taken from Konkani. Unfortunately the source of these data is inaccessible, having been communicated personally to Iverson by R. Miranda. Despite this, I feel confident that the following remarks are valid, inasmuch as they find justification in the text. Konkani possesses an assimilation process and a dissimilation process, both applying before the initial retroflex lateral of the preterite suffix /le/ (sic: Iverson cites this suffix in isolation as /le/, but the tilde /lẽ/ appears in all examples). I shall postpone the precise formalization of these rules for expository purposes. To state the assimilation process informally, a sequence of retroflex stop plus retroflex lateral yields a sequence of two retroflex laterals: thus /pad + lẽ/, the preterite of "pick fruit", appears as [pallẽ] on the phonetic surface. The dissimilation process applies to the first of two retroflex laterals *, so that it becomes a palatal guide e.g. /pal + lẽ/, preterite of "obey", phonetic surface [paylẽ]. The rules interact in a counterfeeding relation because the output of Assimilation (i.e. [pallẽ]) does not undergo Dissimilation (\rightarrow *[paylẽ]).

It is of course "natural" that such a counterfeeding relation hold between Assimilation and Dissimilation in Konkani: if derivations of the form /pad + lẽ/ \rightarrow /pallẽ/ \rightarrow [paylẽ] were permitted, the preterite forms of underlying /pad/ "pick fruit" and /pal/ "obey" would be homophonous on the phonetic surface. Thus the phonetically opaque interaction preserves, in a displaced fashion, the underlying opposition between retroflex stop and retroflex lateral. This is what K&K refer to as

* Footnote

Apparently Dissimilation is a more general process, applying to retroflex consonants. However, I infer that retroflex laterals must needs be treated as a separate subrule.

Leopold's 'polarity of language': "In order for language to function as a communication system it must keep semantically contrasting forms distinct by phonetic means" (1977, page 170).

Iverson claims that CCF predicts the attested interaction, rather than a feeding relation, since "the structural change of assimilation will be (at least) [+ lateral], and the structures affected by dissimilation include [+ lateral, + retroflexed]." (1973b. page 5). Let us now turn to the formal statement of the rules in order to evaluate this claim. Notice first that both processes apply before the preterite suffix. As far as can be determined, this condition is part of the SD of them both. To put this slightly differently, the application of Assimilation and Dissimilation in Konkani is dependent upon the presence of the morpheme boundary /+/. Within the classical theory, the presence of a morpheme boundary cannot prevent a rule from applying. On the other hand, the absence of a morpheme boundary can never be ignored if the boundary is specified in the rule's SD. To quote Ch&H: "a rule in which the presence of formative boundary (= morpheme boundary, JRMcB) is not explicitly indicated applies also to strings containing any number of formative boundaries. The converse is not true, however: a rule that applies to the string X + Z does not also apply to the string XZ" (SPE page 364).

Taking the argument a step further, we note that unlike segments, boundaries (which are specified [- segment]) do not have universal phonetic correlates (with the possible exception of the word boundary which may be optionally actualized as a pause - see SPE *ibid.*). The morpheme boundary, then, does not appear in the output of the phonological component, i.e. on the phonetic surface. It must therefore be erased at some point within the phonological component. It is very

plausible to assume that a rule which is dependent on the presence of the morpheme boundary for its operation should delete the boundary during the course of its application. Let us put such a principle into practice in the formalization of Assimilation and Dissimilation in Konkani (Iverson does not attempt a formalization):

(5) Konkani:

$$\text{A } \underline{\text{Assimilation}} \quad \begin{bmatrix} - \text{son} \\ - \text{cont} \\ + \text{retr} \end{bmatrix} + \begin{bmatrix} + \text{lat} \\ + \text{retr} \end{bmatrix} \longrightarrow \begin{bmatrix} + \text{son} \\ + \text{lat} \end{bmatrix} \quad \begin{bmatrix} + \text{lat} \\ + \text{retr} \end{bmatrix}$$

$$\text{i.e. } \dot{d} + \dot{l} \longrightarrow \dot{l}l$$

$$\text{B } \underline{\text{Dissimilation}} \quad \begin{bmatrix} + \text{lat} \\ + \text{retr} \end{bmatrix} + \begin{bmatrix} + \text{lat} \\ + \text{retr} \end{bmatrix} \longrightarrow \begin{bmatrix} - \text{lat} \\ - \text{retr} \\ - \text{cons} \end{bmatrix} \quad \begin{bmatrix} + \text{lat} \\ + \text{retr} \end{bmatrix}$$

$$\text{i.e. } \dot{l} + \dot{l} \longrightarrow y\dot{l}$$

The rules have been schematized with two segments on each side of the arrow in order to represent most clearly the presence versus absence of the morpheme boundary.

Bearing in mind the SPE position on the specification of morpheme boundaries in SDs, let us bring the argument to its conclusion: we now see that once /paḍ + le/ has become [paḷle] by the operation of Assimilation, the resulting form no longer meets the SD of Dissimilation, since it does not contain the crucial /+/. Thus the counterfeeding relation which obtains between Assimilation and Dissimilation in Konkani can be adequately predicted without introducing CCF.

Finally, before leaving this example, I should like to return to Iverson's claim that since "the structural change of assimilation will be (at least) [+ lateral], and the structures affected by dissimilation include [+ lateral, + retroflexed]" (1973b. page 5; my emphasis), CCF correctly predicts that dissimilation does not apply to the output of assimilation. But surely the SC of Assimilation must contain the specification [+ son]

since the latter feature is independent of the feature value of [lateral] (cf. the voiceless lateral fricatives of Welsh). Furthermore, whilst it could be argued that [+cont] is omitted from the SC of Assimilation since it is subordinate to [-son] in the feature hierarchy, [sonorant] is clearly superordinate to [lateral], and a switch in the value of the former is crucial to the process being formalized. Since [+son, +lat] merely overlaps with [+retr, +lat], the structures effected by Assimilation cannot be said to be properly included in the structures affected by Dissimilation, CCF does not appear to apply to the Konkani data after all.

Of course, when we stand back for a moment, we realize that PI is not the issue involved here: in fact, the segment effected by Assimilation and the segment affected by Dissimilation are one and the same - they are co-extensive. It is therefore possible to underspecify the one and to overspecify the other and then to claim that the former is properly included in the latter. We shall need to keep this point in mind when formalizing a constraint to ensure that such a manoeuvre is not exploited in the spurious determination of precedence relations.

§ 5.2.2 Fricative Weakening and Fricativization in Classical Greek

Unlike Iverson's first example whose explanation independent of CCF was shown to involve the treatment of boundaries, his second set of data call for a less controversial account in terms of morphological conditioning. They are taken from the description of counterfeeding in Classical Greek found in Sommerstein's 1972 manuscript. As well as citing the passage from Sommerstein's manuscript reproduced in Iverson's paper, I shall also draw on the former's (1973) work "The Sound Pattern of Ancient Greek" as well as his recent textbook (1977).

The counterfeeding interaction in question involves the rule of Classical Greek whereby certain instances of s are reduced to an aspirate.

Sommerstein describes this process as "a phonological rule weakening underlying /s/ to [h] between vowels, between consonants, and initially before a vowel" (MS 1972 reproduced in Iverson). He originally formalizes this Fricative Weakening as (6) i although a less rigorous statement is found in the 1977 text - see (6) ii: *

(6) Fricative Weakening in Classical Greek

i Sommerstein's 1972 formalization

$$\left[\begin{array}{l} + \text{ obst} \\ + \text{ contin} \end{array} \right] \rightarrow \left[\begin{array}{l} + \text{ low} \\ - \text{ cons} \end{array} \right] / \left\{ \begin{array}{l} [\alpha \text{ cons}] \text{ ______ } [\alpha \text{ cons}] \\ \# \text{ ______ } \text{v} \end{array} \right\}$$

ii Sommerstein's 1977 formalization

$$\left[\begin{array}{l} - \text{ sonorant} \\ + \text{ continuant} \end{array} \right] \rightarrow \text{h} / \left\{ \begin{array}{l} \# \\ \text{v} \end{array} \right\} \text{ ______ } \text{v}$$

Since /s/ is the only fricative in URs in Classical Greek, the rule may be expressed so as to apply to fricatives in general. Apart from

* Footnote

An even more cumbersome statement appears in the 1973 text (page 133). However, (6) i, whilst being the formalization cited by Iverson, is also adequate for the ensuing discussion.

the particular distinctive features involved and their abbreviation as the segment h in (6) ii, the formalizations differ in that (6) ii omits the inter-consonantal environment. This context does not figure in the argument below, it is not referred to specifically by Iverson, nor, as far as I can determine, does it enter into Sommerstein's discussion. Hence for present purposes the discrepancy between (6) i and ii is irrelevant (see also footnote).

Whilst /s/ may be present in URs in Classical Greek and subsequently undergo weakening, other instances of s arise in the course of derivations as the output of a Fricativization process. This rule captures the alternations between s and the dental stops /t, t^h, d/ which form part of the derivational and inflectional morphology of the language. We may accept Sommerstein's claim that it is the stops which are underlying rather than s, since it is not predictable which of the three dental stops will figure in the alternation. To put this in different terms, the Fricativization of underlying dental stops in Classical Greek constitutes a neutralization process. Sommerstein's formalization is reproduced as (7):

(7) Fricativization in Classical Greek secundum Sommerstein (1972)

$$\left[\begin{array}{l} + \text{ obst} \\ + \text{ cor} \end{array} \right] \longrightarrow [+ \text{ contin}] / \left\{ \begin{array}{ll} \text{---} & [+ \text{ obst}] \\ \text{---} & \left[\begin{array}{l} + \text{ cons} \\ - \text{ cor} \end{array} \right] \\ \text{V} & \text{iv} \end{array} \right\}$$

The interaction between the rules of Fricativization and Fricative Weakening would be an instance of counterfeeding just in case s's derived from dental stops fail to undergo reduction to [h]. This is indeed what we find in the Classical, or more precisely, the Attic dialect. That is, plóúsios "rich", the adjectival derivative of plóutes

"wealth", did not become *plouhios by the further weakening to h of the s derived from t. However, during the first millennium B.C. in three distinct dialects (that of Laconia and Argolis, that of Elis, and that of Cyprus - see Sommerstein 1977, page 243), Fricativization did feed Fricative Weakening, creating forms like plouhios.

Of course, it could readily be claimed that this development is predictable under GROD - a pair of rules in a counterfeeding relation in conservative Attic become reordered so as to apply in a feeding relation in innovative Laconian et cetera. Indeed Sommerstein (1977) cites Classical Greek data in order to illustrate a closely related position. Under the apparently weaker version of GROD adopted in Sommerstein's textbook, the explanation in terms of reordering out of one extrinsic order into another extrinsic order is recast in terms of the removal of the extrinsic ordering constraint from the grammar. This is in keeping with the partial ordering hypothesis developed on pages 176-180 (ibid.) under which no extrinsic ordering statements are given for "unmarked, natural" interactions contrasting with the need to state such constraints when interactions are "marked, unnatural". * Sommerstein's partial ordering hypothesis does not set out to curb the excess power made available under GROD, by reducing the number of grammars that could be written with n extrinsically ordered rules (i.e.

* Footnote

I have supplied the terms "natural", "marked" and their antonyms at this point since it is only in so doing that Sommerstein's argumentation is rendered coherent. cf. "The partial ordering hypothesis retains two of the main features of the linear ordering hypothesis: that in at least some cases, explicit statements have to be made about specific rule pairs, restricting the applicability of one by conditions relating to the application of the other; and that all such statements are valid 'across the board', unambiguously imposing one order to the exclusion of the other". (1977, page 180; emphasis mine). Under the assumption that "at least some cases" constitute marked interactions, we can begin to define which cases they are.

n factorial). Rather, the partial ordering hypothesis seems to have been formulated in order to increase the power of GROD and thus to resolve the "ordering paradoxes" raised in the literature. (cf. the Menomini data treated on pages 174 ff. *ibid.*) Thus whilst a theory which determined fewer than n extrinsic ordering constraints for n rules might be termed a 'partial ordering hypothesis' with less power than the GROD theory, I doubt whether Sommerstein is making such a claim. In fact I suspect that he is trying to achieve the best of both worlds, by acknowledging the valid arguments pro UDRA, but at the same time refusing to relinquish mechanical extrinsic numbering procedures in order to determine universal precedence principles. Consequently Pullum's comment is appropriate to Sommerstein's position: "While there are roughly 3.6 million strict orders for a set of just ten rules, there are 54 thousand million partial orders to say that the number of grammars defined under partial ordering is astronomical would be to underestimate it" (1979 review of Koutsoudas *Ed.*, 1973).

Even apart from this there lies a contradiction behind the partial ordering hypothesis: if universal precedence principles may be contravened in certain cases, how can such principles retain their status as linguistic universals? This problem becomes particularly pertinent if, as seems to happen, there is no way of predicting which will be the exceptional cases. Moreover, even if one could determine when "universal" principles were going to be inoperative, there is no consensus in the literature as to what constitutes a "natural, unmarked" interaction - we have seen that KSN preclude non-mutual bleeding from grammars but permit counterbleeding, whilst NGP considers the former defensible and the latter bogus.

Now that we have clarified Sommerstein's position, let us return to the Classical Greek data which led to this brief excursus. We know that Sommerstein's position cannot be maintained under the theory of UDRA; we are therefore compelled to offer an alternative, less powerful explanation for the diachronic data. This I shall proceed to do once we have applied Iverson's CCF to the situation in Attic, where I shall demonstrate that the constraint is ineffective.

Referring back to the formulation of the CCF (i.e. (4) page 243), the 'structural change' of Fricativization (= 7) is specified as [+contin] whilst the structures affected by Fricative Weakening (= (6)i) are specified as [+obst, +contin]. Since the latter properly includes the former - so runs Iverson's argument - CCF prevents Fricative Weakening from applying to the structures effected by Fricativization. Of course, as we noted above when discussing the Konkani example, PI is not the real issue here: if we did not employ distinctive features in the formalization of the rules involved, the segment s would appear to the right of the arrow as the output to Fricativization whilst the same segment s would appear to the left of the arrow as the input to Fricative Weakening. As in the Konkani case, the CCF relies on the fuller specification of the counterfed rule as compared with the underspecification of the counterfeeding rule - both arising out of abbreviatory conventions - in order to claim that the relation of PI obtains. In fact the segments whose features are being manipulated are one and the same. In other words, CCF achieves the right results by the wrong means. Its real purpose has nothing to do with feature counting and PI. Its purpose is to ensure that the counterfed rule applies only to URs and not to sequences which are identical in every respect apart from their derived status.

Now the term 'derived status' is intentionally ambiguous: a sequence may be said to have derived status on two counts. First, the segment to be modified by rule B, i.e. the structure affected by rule B, may itself have been modified by rule A'. (See discussion of Iverson's use of the terms 'affected' and 'effected' on page 243 above, and my own usage on page 152 above). This is the situation which obtains when rule B is Fricative Weakening in Classical Greek and A' is Fricativization: instances of s which were not present in URs but which were derived from dental stops by Fricativization must not be permitted to undergo Fricative Weakening; and the CCF successfully ensures that this does not happen. Now consider the second count on which a sequence may be said to have derived status: whilst the segment to be affected by rule B may have been present in the UR, that segment may have been in a different environment in the UR; in other words, a rule A'' may have modified the underlying string YXZ without altering the feature specifications of segment X (= the segment affected by rule B). Since CCF stipulates only that the segment affected must not be derived (the first type of 'derived status') and since it has nothing to say about the derived status of the environment of the segment affected (the second type), it will prove ineffective just in case segments in derived environments fail to undergo rules for which they are eligible.

In Classical Greek we find just such an instance of counterfeeding. Recall that Fricative Weakening applies intervocalically. Now consider sequences of /VsV/ which arise due to the operation of Nasal Deletion:

(8) Nasal Deletion in Classical Greek secundum Sommerstein 1977

page 242

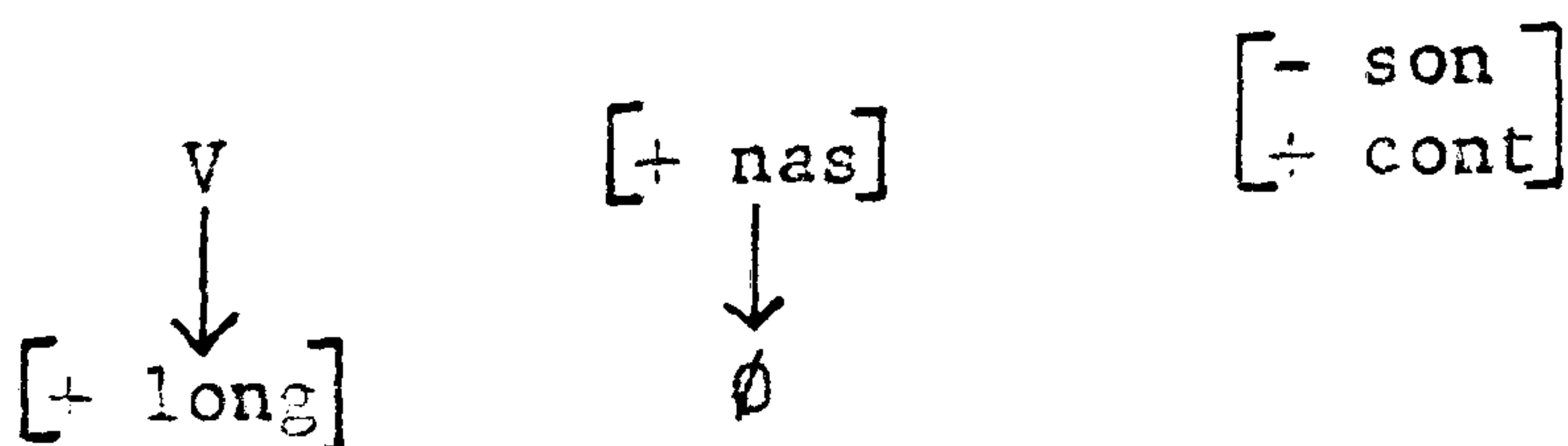

Sommerstein remarks that this rule "created new instances of intervocalic [s] by the simplification of /ns/ clusters, some underlying, some themselves derived from more complex underlying clusters" (1977, page 242; my emphasis).

Let us examine underlying VnsV sequences which undergo Nasal Deletion leaving s in intervocalic position, that is, sequences with derived status which now meet the SD of Fricative Weakening. In such cases CCF is inapplicable - Nasal Deletion cannot figure as "rule A" since the structures it effects are vowel length and the null segment and, crucially, not s which is merely a part of the environment. Moreover since Nasal Deletion affects two segments, this also renders it ineligible as 'rule A'. Consequently CCF cannot stand as an effective precedence principle to deal with the counterfeeding of Fricative Weakening in Classical Greek.

Yet the inadequacy of CCF to handle these data is even more serious.

Once we turn to s segments derived by rules other than Fricativization we find it more difficult, not to say impossible, to make PI "work".

An example of such a case is given by Sommerstein as an instance of intervocalic s arising from the simplification of an /ns/ cluster which is in turn "derived from more complex underlying clusters" (ibid.). In the derivation of underlying /pant + ja/ "all" (Nominative Singular Feminine), the glide assimilates to s, the medial plosive is deleted by cluster simplification, and new instances of intervocalic s finally emerge as the result of Nasal Deletion. * Thus phonetic surface [pa:sa] is derived; this form fails to undergo Fricative Weakening in Attic but does undergo that process in Laconian et cetera. Attempting to

* Footnote

The ordering Glide Assimilation, Cluster Simplification, Nasal Deletion presents no problem for the theory of UDRA, as each is in an "intrinsic feeding" relation to the rule following.

apply CCF, if Glide Assimilation is taken as "rule A", then its structural change (that is, $\underline{s} < /j/$) needs to be underspecified so that it will be properly included in the structures affected by Fricative Weakening. But since Iverson cites Fricative Weakening as affecting only two distinctive features - [+obstruent, +contin] - and since Glide Assimilation involves a more radical change than weakening in that it flips the values of [consonantal] and [sonorant] (= [non-obstruent]), I find it impossible to envisage how the former could be overspecified so as to include the latter.

I conclude that even if the equivocations regarding PI could be resolved for Fricativization and Fricative Weakening in Classical Greek, they would prove the stumbling blocks of CCF once it attempted to account for a major phonological class change such as Glide Assimilation. Furthermore, we have found the constraint ineffective in that it makes no claims about segments in derived environments. The existence of this latter type of counterfeeding strongly suggests that a different kind of precedence may be operative in limiting the potential inputs to rules like Fricative Weakening in Classical Greek. Let us now substantiate the claim, anticipated at the beginning of this subsection, that Fricative Weakening is not a "phonological rule" at all, but rather that it is morphologically conditioned. In contradicting Sommerstein's assertion as to the status of this process, I am indebted to Jean Aitchison for taking the time to discuss these data with me.

In earlier parts of this thesis, we have referred to the precedence of morphological rules over "true phonological" rules. The separation of "morphophonemics" from "allophonics" was a characteristic tenet of American Structuralist linguistics and was challenged by Halle in 1959 at the inception of Generative Phonology. Without going into those

arguments here, I cite Koutsoudas' Morphophonemic-Allophonic Principle as (9): (= (13), page 32, 1980)

- (9) "A morphophonemic rule application must always take precedence over an allophonic rule application.

"Given a rule $A \rightarrow B/C \text{ ___ } D$ applicable to a form cad, the application of this rule is MORPHOPHONEMIC if there are strings of the form cbd which could be derived from a source other than cad; otherwise the application of the rule is allophonic."

As Koutsoudas is swift to point out, the distinction drawn by him between morphophonemic and allophonic rules is precisely that used by Kiparsky to distinguish between neutralizing and non-neutralizing rules (1973; see discussion of Kiparsky's Neutralization Constraint on pages 222 ff. above). Since Kiparsky was endeavouring to constrain the abstractness of URs rather than formulating a precedence principle, Koutsoudas' proposal is independently motivated. * As such, it can readily be incorporated into the theory of UDRA developed here as part of a fully integrated theory of phonology.

Returning to Fricativization in Classical Greek, we hardly need refer to Koutsoudas' definition of "morphophonemic" to see that this process is conspicuously morphological. Indeed we might well set up a "rule of thumb" whereby we suspect that a process is morphological rather than phonological (= morphophonemic rather than allophonic) if its environments form a phonetically unnatural, disparate list, such as those to the right-hand-side of (7), page 251. In fact even this test can be bypassed since we know that Fricativization forms part of the derivational and inflectional morphology of the language. It would be extremely problematic for UDRA if a morphological process like Fricativization counterfeited a rule with phonological status such as that claimed for Fricative

* Footnote

For related classification of types of rule application, see also Hutchinson, 1973.

Weakening by Sommerstein and accepted by Iverson. However, less blatantly, Fricative Weakening is also morphological: it fails to apply in the Aorist and Future of verbs e.g. epausa "I stopped"; pausō "I shall stop". Given that these morphological contexts must be stated, it is very plausible to assume that other derivational and inflectional classes must also be listed, namely, those classes in which s alternates with the three dental stops.

In making such a claim, we are not incorporating any ad hoc machinery into the grammar - the specification of morphological conditions on the operation of Fricative Weakening is independently necessary. Furthermore we are able to account easily for those innovative dialects where Fricativization feeds Fricative Weakening since the loss of conditions on a rule is a well-attested mechanism of linguistic change. It is my contention that the morphological restrictions on Fricative Weakening are also responsible for its failure to apply in the other contexts on which we have touched in this discussion.

§ 5.2.3 Initial Mutation in Old Breton

We have made some attempt to characterize the counterfeeding interactions in Iverson's first two sets of data and in each case we have attributed the attested ordering to principles of UDRA other than CCF. We have also questioned the claim that it is the relation of PI which obtains in such cases. This two-pronged attack on CCF - challenging its necessity and its ontological status - becomes even more forceful once the Old Breton data are brought into the discussion.

Anderson's reason for treating Lenition in Old Breton is that the rule provides crucial evidence as to disjunctivity or conjunctivity in the expansion of neighbourhood rules. The term "neighbourhood rule" refers to a phonological process which applies in environments that are related symmetrically inasmuch as they are the mirror-image of each other - hence the gloss 'mirror-image rule'. The "%" in Anderson's formulation of Lenition in Old Breton, reproduced as (10) below, is therefore to be interpreted so that the rule applies in the environment [+ syll] _____ [+ son] and in the environment [+ son] _____ [+ syll].

(10) Lenition in Old Breton: Anderson's 1969 formulation

$$\left[\begin{array}{l} - \text{continuant} \\ \langle + \text{voice} \rangle \end{array} \right] \rightarrow \left[\begin{array}{l} \langle + \text{continuant} \rangle \\ + \text{voice} \end{array} \right] \% \text{ [+ syll] } \text{ ______ } \text{ [+ son] }$$

As Anderson is swift to point out, the process cannot be stated so as to apply between two sonorants since it fails to operate if both sonorants are [- syll]: "It thus appears essential that one of the sonorants be [+ syllabic], but irrelevant which" (1969; page 95).

Underlying intervocalic /p/ constitutes a crucial case for Anderson's thesis in that, "since vowels are sonorants, the sequence /VpV/ can be analyzed either as [+ syll] p [- son] or as [+ son] p [+ syll]" (ibid.). If the phonetic surface reflex of underlying intervocalic /p/ is [b],

then Lenition must have been expanded disjunctively, bringing about a single phonological change which voiced a non-continuant. On the other hand, if /p/ surfaces as [v] then the expansion must have been conjunctive, resulting first in intermediate [b] which then underwent the rule a second time to become [+continuant] by virtue of the fact that b is [+voice] (i.e. the subrule in angled brackets in (10)). Since it is [b] not [v] which is found as the reflex of intervocalic /p/ on the phonetic surface of Old Breton, Anderson concludes that neighbourhood rules must be expanded disjunctively.

Iverson's interest in Lenition in Old Breton does not lie in the fact that the process is a neighbourhood rule. Rather, he is concerned only with the question of whether a segment may undergo both subrules and unlike Anderson, ignores the condition that the segments flanking the segment affected on the second expansion be the mirror-image of the environment on the first expansion. For instance, Iverson cites the fact that [arbedoc] derives from /ar-petoc/ and notes that the form does not become *[arvedoc] (sic: he means *[arve^xdoc]; JRMcB). As I understand Anderson's formulation of neighbourhood rules, this could never come about in any case, since /ar-petoc/ permits only one expansion of /p/ and its environment, comprising uniquely the sequence [+son] p [+syll]; that is, /rpe/, unlike the /VpV/ sequences discussed by Anderson (and the sequence /eto/ which Iverson does not mention), is not also analyzable as [+syll] p [+son]. In view of these facts, one might assume that Iverson wishes to investigate the conjunctivity or disjunctivity of subrules abbreviated into a single schema by means of the angled bracket notation. However the fact that he is not seeking to determine conventions on expansion is evidenced by his statement of Lenition as two rules and his treatment of each as autonomous (See (11))

where Iverson's formulation is reproduced for comparison with Anderson's):

(11) Lenition in Old Breton: Iverson's 1973b Formulation

- a. Voiced stops become continuants.

(mirror-image)

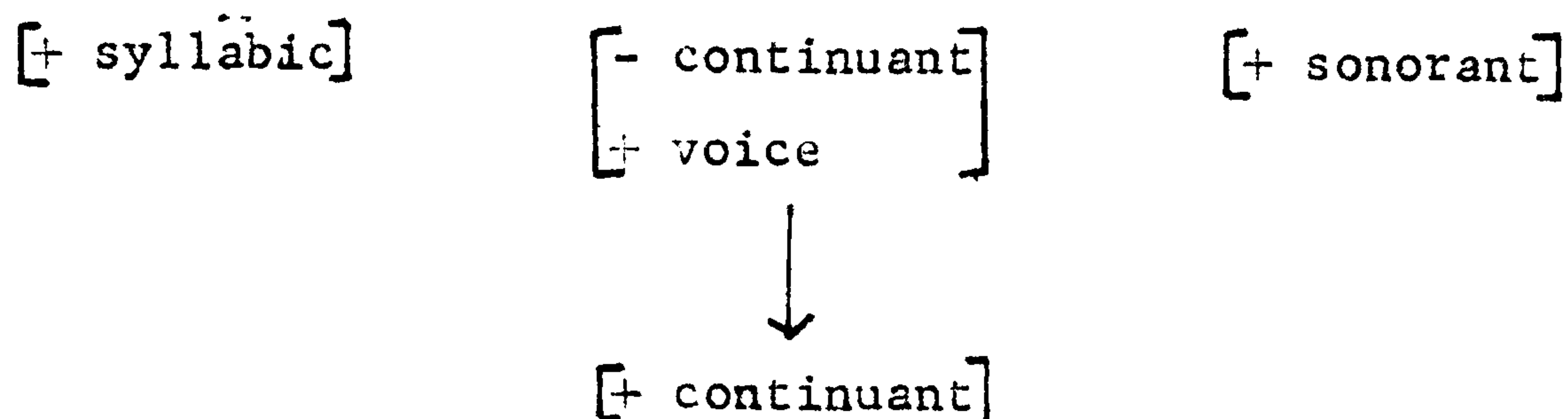

- b. Voiceless stops become voiced.

(mirror-image)

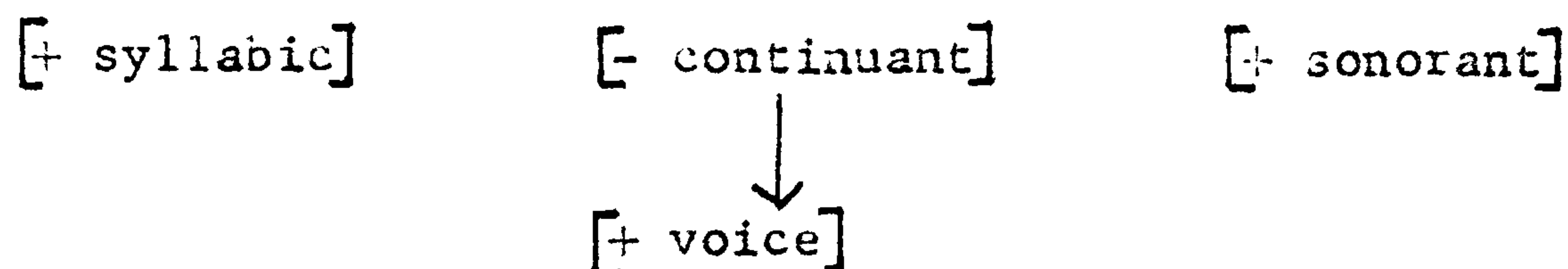

Given Iverson's formulation of Lenition in Old Breton as two separate rules - a questionable analysis in itself according to the view of Initial Mutation developed in this thesis - it is clear that CCF will be applicable in the same dubious fashion which we noted for Konkani and Classical Greek. To spell this out, under UDRA a constraint is required which will prevent an underlying voiceless plosive which has become voiced by the application of b. from undergoing a. and hence appearing as a voiced continuant on the phonetic surface.* CCF apparently succeeds here because, to quote Iverson, "In Old Breton, the

* Footnote

Notice that even here an equivocation is involved, although admittedly it is not of fundamental importance for phonological theory; in his expansion of Anderson's statement of Lenition, Iverson has labelled the counterfed rule (corresponding to the angled brackets of (10)) as a. and the counterfeeding rule as b. Consequently a. must not be permitted to apply to the output of b. However in the formulation of CCF "B may not apply to the structures effected by A". Whilst it may be considered trivial from a theoretical stand-point to single out what is obviously an error of exposition, I feel that my pedantry is justified in view of the lack of precision which permeates the paper.

structural change of the stop voicing rule ([+voice]) is properly included in the structures affected by the fricativization rule ([-continuant, +voice])". (1973b.; page 4). Iverson concludes that "fricativization may therefore not apply to the stops voiced by the stop voicing rule" (ibid.).

In reaching his conclusion, Iverson refers to Norman's 1973b paper where the precedence relations between Anderson's (sub-)rules for Old Breton - and indeed the whole problem of mirror-image rules - were treated within UDRA for the first time. As proposed in the introductory remarks to this section, let us summarize Norman's position before examining the validity of applying CCF to these data. We shall also have recourse to Hastings' universal precedence principle, Stifling. A summary of the application of Norman's, Hastings' and Iverson's principles to the Old Breton data appears in Table II.

Initially Norman retains Anderson's original statement of Lenition (= (10)). She sums up what she considers the problem posed by the data by noting that whilst the longer expansion (i.e. the material in angled brackets) must apply to underlying /darbid/ to yield [darvid], and whilst the shorter expansion (i.e. the material outside the angled brackets) must apply to underlying /arpetoc/ and /hotiern/ to yield [arbedoc] and [hodiern] respectively, the latter pair must not subsequently undergo the longer expansion to become *[arveðoc] and *[hoðiern]. Norman then presents the rule in its deconflated form as

(12) a. Voiced stops become continuants

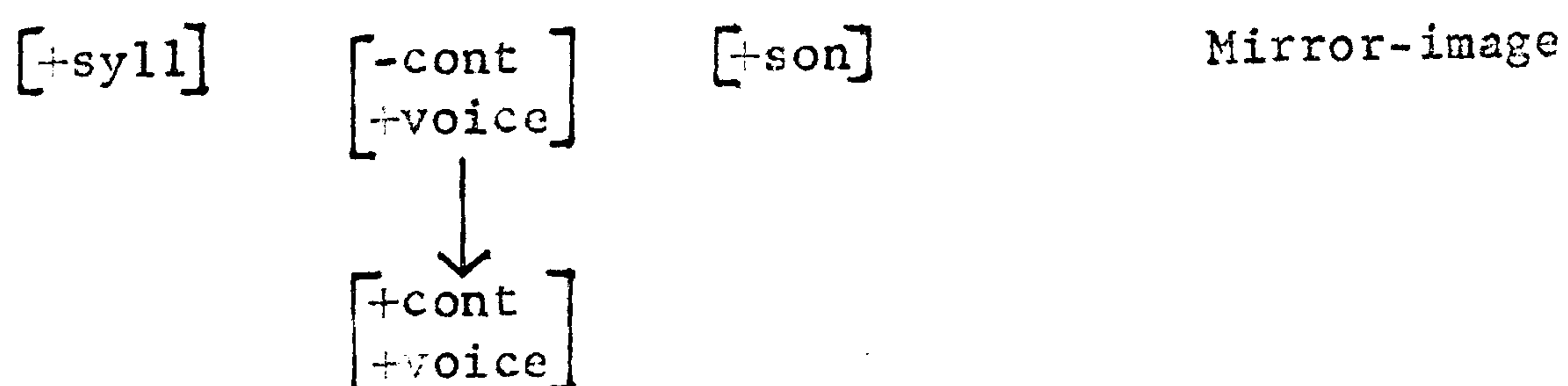

TABLE II
THE FORMALIZATION OF LENITION IN OLD BRETON ACCORDING
TO THREE POTENTIAL PRINCIPLES OF UDRA

The environment of each formulation comprises [+syll] ___ [+son] and its mirror-image.

1. Disjunctivity associated with PIPrec
 proposed by Norman (1973)

	<u>structures affected</u>	<u>structures effected</u>
(i) counterfed rule	[-cont +voice]	[+cont +voice]
(ii) counterfeeding rule	[-cont]	[+voice]

Structures affected by (i) properly include structures affected by (ii). Therefore (i) takes applicational precedence and (i) and (ii) apply disjunctively.

2. Stifling

attributed to Hastings and cited by Norman (1973)

	<u>structures affected</u>	<u>structures effected</u>
(i) counterfed rule	[+voice]	[+voice +cont]
(ii) counterfeeding rule	[-cont]	[-cont +voice]

Structures effected by (ii) properly include structures affected by (i). Therefore if (ii) has applied, (i) is stifled.

3. CCF

proposed by Iverson (1973b.)

	<u>structures affected</u>	<u>structures effected</u>
(i) counterfed rule	[-cont +voice]	[+cont]
(ii) counterfeeding rule	[-cont]	[+voice]

Structures affected by (i) properly include structures effected by (ii). Therefore (i) may not apply to the output of (ii).

b. Voiceless stops become voiced

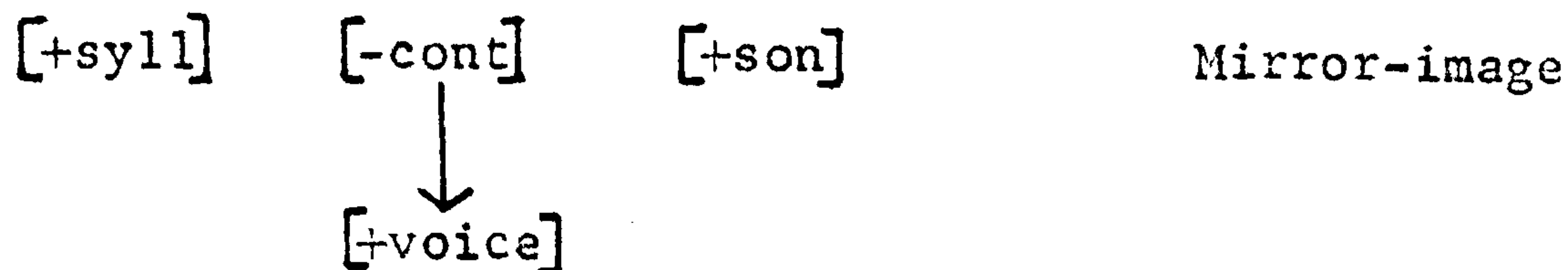

Since the SD of the longer expansion, a., properly includes the SD of the shorter expansion, b., the precedence relation could be predicted by PIPrec if disjunctivity were associated with that principle, that is, fricativization would apply first and could not be fed by stop voicing. Such a convention would ensure that once a form had been tested for applicability against both expansions, and had met the SD of the shorter one but not of the longer one, it could not be re-tested for applicability against the latter, having undergone the former.

However, despite the apparent viability of such an amendment to PIPrec, Norman fails to develop the idea, as Trommelen and Zonneveld point out in their review (1978; page 17). This reluctance to amend PIPrec may be attributed to a point made by Ashley Hastings in person communication to Linda Norman, namely, that (12) a. has been unnecessarily complicated in order to conflate it with (12) b. Norman notes that in its simplest, least redundant form, (12) a. would be stated as (13) a'.

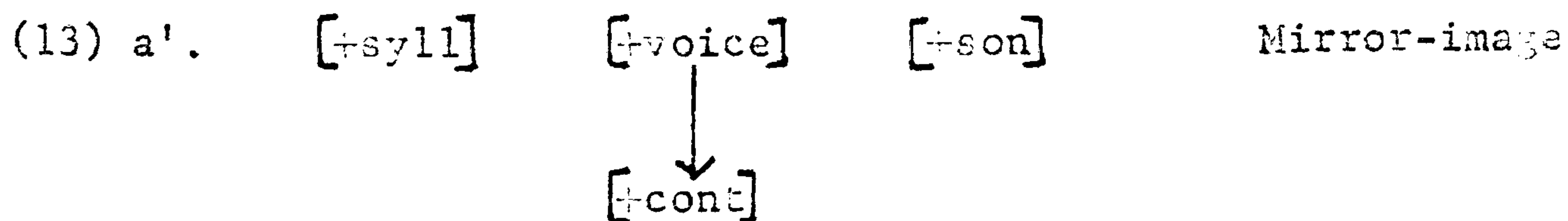

But now there is no longer a set inclusion relation. In fact, however, when we consider only the natural classes which undergo Lenition non-vacuously, there never was a PI relation; for (12) a. affects voiced stops, whilst (12) b. affects voiceless stops - and the two are mutually exclusive classes. * The spurious claim that the relation of PI obtains

* Footnote

Norman is therefore correct in her observation that, unlike the previous cases she has discussed in "Bi-directionality", in the Old Breton data no representation meets the SDs of both (sub-)rules at the same point in the derivation.

here may be ascribed to abbreviatory conventions on rule formulation. Indeed we shall see presently that just such devices make Iverson's CCF viable. Moreover we shall have reason to refer again to the notion of "natural class which non-vacuously undergoes a rule" in the formalization of the Pre-Condition to PI in section § 5.3 below.

It must be noted at this point that Norman herself does not develop this line of argument regarding the validity of applying PIPrec to Lenition in Old Breton. Instead, having merely stated that (13) a' pre-empts the claim that a relation of PI obtains, she develops Hastings' principle, Stifling, which does postulate such relations. Following Sanders (1972b) Stifling presupposes that rules be considered as equational statements rather than as rewrite instructions. I shall not explore the implications of this here - suffice it to say that I strongly suspect that Sanders' 1972 position is unrelated in any relevant sense to his standing on UDRA. I therefore simply reproduce without further comment Norman's reformulation of Lenition in terms of equational statements:

(14) Lenition in Old Breton: Norman's 1973b formulation as equational statements

$$a. \quad [+syll] \quad [-cont] \quad [+son] \quad (\alpha) = [+syll] \quad \begin{bmatrix} +voice \\ -cont \end{bmatrix} \quad [+son] \quad (\beta) \quad (MI)$$

$$b. \quad [+syll] \quad [+voice] \quad [+son] \quad (\alpha) = [+syll] \quad \begin{bmatrix} +voice \\ +cont \end{bmatrix} \quad [+son] \quad (\beta) \quad (MI)$$

Proper Inclusion Stifling is cited as (15):

(15) Stifling:

"If a representation R satisfies a term A_t of a rule A, and also satisfies the α -term of a rule B, and A_t properly includes B_α , then B does not apply to R."

By applying Stifling (15) to the equational statements of (14), it follows that "since the α -term of [(14) b.] is properly included in

the β -term of [(14) a.], the rule [(14) b.] is stifled, i.e. it cannot apply to R". (Norman in Koutsoudas Ed. 1976, page 141).

We have seen, then, that three apparently separate precedence principles have been adduced within UDRA to account for Lenition in Old Breton: Iverson's CCF, Norman's disjunctivity associated with PIPrec and Hastings' Proper Inclusion Stifling. All purport to constrain the counterfeeding rule so that it cannot feed the counterfed rule, that is, that the rule-pairs of Table II apply in the order i before ii only. The question we must now ask is the following: How do these principles differ? Each hinges on the claim that the relation of PI obtains between some part of the counterfeeding rule and some part of the counterfed rule.

Amended PIPrec says that it is the input to the counterfed rule which properly includes the input to the counterfeeding rule. But we have seen that the natural classes involved (voiced stops and voiceless stops) actually constitute a disjunction. However it would appear that the Old Breton data are in this respect "the exception" to the kind of case Iverson has been attempting to illustrate. The reason behind the "exceptional" character of the Old Breton data lies, I shall argue shortly, in the fact that Lenition is part of a system of Initial Mutation.

To return to our question regarding the differences between the three proposed precedence principles, let us consider the relation of Stifling to amended PIPrec and CCF. Notice that this principle subsumes two cases, the one in which A_t is the α -term of A and that in which A_t is the β -term of A. It therefore stipulates that either the input or the output of the counterfeeding rule properly includes the input to the counterfed rule.

Taking the case in which the input to the counterfeeding rule properly includes the input to the counterfed rule and stating it in the terms of Table II, this means that the segments affected by ii properly include the segments affected by i. Yet surely this is precisely the reverse of amended PIPrec? It is important to note that the 'rationale' behind both principles is one and the same: both claim that of two rules, each of whose SD is met, the more context-sensitive takes applicational precedence to the exclusion of the less context-sensitive takes applicational precedence to the exclusion of the less context-sensitive. In other words, there is no need to question the end-product of these principles. Rather what is under scrutiny is their manipulation of the relation of PI. In fact only the PI of the input to the counterfeeding rule by that of the counterfed rule "works" for these data* - and we have demonstrated that even this claim is spurious.

Now consider the relation of the other case of Stifling to CCF.

Reference to Table II reveals that Principle 2 stipulates PI as the reverse of Principle 3. Put less cryptically, although both principles result in the same effective end-product, they do so by demanding contrary PI relations between the terms of the rules concerned. Furthermore both PI relations "work" for the individual manners in which the rules are formulated. The following question must now be raised: How can contrary principles predict the same precedence relation for the same set of data and both be right?

The answer is of course that amended PIPrec, Stifling and CCF are spurious when applied to Lenition in Old Breton. This runs much deeper

* Footnote

This is reflected by the fact that the quote from Norman on p.266-7 refers to the other case of Stifling about to be discussed. Table II also presents this other case.

than Iverson's implication that amended PIPrec is not as far-reaching as CCF in that it is inapplicable to the Konkani and Classical Greek data. Rather the relative merits of, in particular, Stifling and CCF do not lie in their scope. Instead any evaluation of them must hinge on the relation of PI which is central to them both. Let us now examine the validity of claiming such a relation for the Old Breton data.

As we have seen, it is Iverson's contention that "the structural change of the stop voicing rule ([+voice]) is properly included in the structures affected by the fricativization rule ([-continuant, +voice])" (see pages 262-3 above). Yet it is surely obvious that the stop voicing rule (11 b.) does not generate the set of elements specified as [+voice]. Nor does it even generate the set of voiced obstruents * - this is implicit in Iverson's reference to the process as "the stop voicing rule". In fact the output of (11 b.) is coextensive with the input to (11 a.) - the structures effected by the former and affected by the latter comprise the same set. In other words, the structural change of the stop voicing rule has been underspecified.

The device which is responsible for this underspecification and thus permits the purported relation of PI is, ironically, that introduced into phonological theory to eliminate redundancy in rule formulation - I refer to the abbreviatory convention whereby a feature appearing with the value α to the left of the arrow (above the arrow in Iverson's schematism) will be taken to retain that value α to the right of the

* Footnote

In all the formulations of Lenition in Old Breton discussed here the omission of the feature [sonorant] in SD's is striking.

arrow (below the arrow) unless $-\alpha$ is specified. Iverson has exploited this abbreviatory device in failing to respecify the feature [continuant] with the value minus to the right of the arrow, just in case it has that value to the left.

In fact, Iverson has been disingenuous in his manipulation of abbreviatory devices. By a related convention, a rule flipping the value α of distinctive feature F to $-\alpha$ will not specify α to the left of the arrow. Rather the rule will be allowed to operate on all F, applying vacuously to segments which are initially $-\alpha F$. Thus in formulating the fricativization rule, it is totally redundant for [-continuant] to appear in the input: the rule would be more economically stated if it were permitted to operate on all obstruents, applying vacuously to those which were already [+continuant]. If Iverson wishes to underspecify the output to the stop voicing rule, he must adhere to such conventions in his statement of the structures affected by the fricativization rule and specify them as [+voice] alone, i.e. identical to the output of (11 b.). Once there is consistency in the formalization of both parts of the Lenition process, it becomes blatantly clear that PI plays no rôle here.

Similar criticism may be made of the manipulation of abbreviatory devices in applying Stifling to the Old Breton data (i.e. the second case of Stifling, as exemplified in Table II). If Norman were to adhere strictly to such conventions, she would omit the specification of [-cont] in the β -term of (14) a. - since the value of [continuant] remains unaltered in the rule's SC, its value will correctly be taken as minus even if it does not appear on the right-hand side. Once [-cont] is omitted from the segments effected by the counterfeeding rule, we see immediately that this class is coextensive with the segments

affected by the counterfed rule. To sum up, it is precisely because the SC of the counterfeeding rule and the SD of the counterfed rule constitute the same natural class that it is possible to contrive their precise specification so that the relation of PI appears to obtain. It is just this kind of manipulation that the Pre-Condition on PI will be set up to preclude.

Given that no relation of PI obtains between the subrules in Anderson's formulation of Lenition in Old Breton, CCF must be rejected as inapplicable - and so must the amended version of PIPrec and Proper Inclusion Stifling. By what principle of UDRA, we now ask, can the attested precedence be predicted? The answer to this question depends upon the precise stage in the development of Breton to which the data belong.

In other words, it hangs on whether Lenition was a phonological process or had been morphologized by the time concerned. In fact, I shall argue that 'grammaticalisation' had already set in; but whether I am proved right on this point or not, the theory of phonology developed in this thesis demands a particular view of Lenition itself. This view, which is to be fully substantiated in Part II, calls for the treatment of each Initial Mutation as a single two-stage process.

Of course, such a claim is equivocal - what constitutes "each mutation"? In Old Breton, where the process of Lenition may still be phonologically transparent, there may indeed be grounds for defining "mutation" on the basis of the change in a subset of initial consonants (e.g. voiceless plosives, voiced plosives) or even in a particular initial consonant (e.g. /p/, /b/, /t/). It is here that our knowledge of the later history of the language can play a decisive rôle: in Modern Breton the environments of Lenition are morphologically determined, applying, for example, to feminine singular and masculine plural nouns after the definite

article (Anderson 1969; page 94); now if Lenition had comprised two processes in the parent language, one would predict instances of, say, voiceless stops voicing in feminine singular nouns after the definite article but voiced stops being unaffected in that environment. Put slightly differently, why should disparate phonological processes morphologize in exactly the same way? Anderson makes the point succinctly: "That it (= Lenition; JRMcB) is in fact one rule is supported by the fact that in the modern language, where the conditions for the applicability of the corresponding change are rather complex morphological ones, they are the same for all the segments affected" (ibid. pp. 95-6).

The fact that mutation takes place in arbitrary morphological environments in Modern Breton means that it is unpredictable on a phonological basis. Yet the statement of the environments in a list seems unsatisfactory a priori. Furthermore, such an analysis would fail to capture an important fact about Initial Mutation, the fact made explicit in the quotation from Anderson above. The argument may be schematized in the following way: Under Mutation, in morphological environments A and B, segment x becomes segment y, whilst segment x' becomes segment y'; under Mutation N, in morphological environments C and D, segment x becomes segment z, whilst segment x' becomes segment z'. Given that {x, x' ...}, {y, y' ...}, and {z, z' ...} constitute the natural classes {X}, {Y} and {Z} respectively, we may set up the following equations:

$$x:y = x':y' \quad \text{and} \quad x:z = x':z'$$

The approach to Initial Mutation proposed in this thesis obviates the repeated ad hoc listing of morphological environments and captures the generalization that each Mutation has constant phonetic reflexes in

those disparate environments. This is achieved by introducing a diacritic marker for each Mutation. The 'triggers' of Mutation are assigned to syntactic surface structures on the basis of their labelled bracketing and the morphosyntactic categories involved, before the string enters the phonological component proper. Within the phonological component, each trigger conditions the process of 'realization'. Because disparate morphological environments have been assigned the same trigger, realization need be stated once only. In our schematization, the trigger [+M] will have been assigned to segments x and x' whenever they are found in environments A or B; similarly, the trigger [+N] will have been assigned to those same segments in environments C and D. Since {x, x' ...} form a natural class, as do {y, y' ...} and {z, z' ...}, their realization will be stateable as follows:

$$\begin{array}{ccc} \begin{array}{c} X \\ [+M] \end{array} \longrightarrow Y & & \begin{array}{c} X \\ [+N] \end{array} \longrightarrow Z \end{array}$$

Of course, this outline of the treatment of Initial Mutation begs several important questions. To take triggering first: What kind of morphological environments determine mutation? Are they all necessarily present in syntactic surface structure? Moving on to realization one must ask: Do the segments undergoing mutation always form a natural class? Does the realization process itself always effect a natural class? Does Initial Mutation necessarily involve feature-changing rules or may epenthesis and deletion figure in the process? At present I can only answer these and related questions for Modern Irish: my answers comprise the remainder of this thesis. However, I am aware that if my proposals are to have any bearing on phonological theory, I cannot make predictions in a vacuum. In other words, my claims for Modern Irish must have theoretical consequences for the treatment of the other Celtic languages - and ultimately for all languages where initial consonant

changes which were once phonetically motivated have become "grammaticalised". It is my contention, therefore, that the processes of triggering and realization became operative in Breton before Initial Mutation ceased to be phonologically transparent.

It has been suggested by Hooper that processes can become morphologized before their phonological motivation disappears from the phonetic surface (see discussion of Spanish, § 4.1 "Simultaneous Rule Application in KSN" page 161 f.; in particular page 164). Without anticipating the treatment of the 'grammaticalisation' of Initial Mutation in the transition from Old Irish in Part II § 1.4, I should claim that triggering was productive in Old Breton even at a stage when the environment still comprised a sonorant on one side and a syllabic segment on the other. Thus I strongly suspect that the principle of UDRA which applies to the Modern Irish data presented below is also applicable in Old Breton. Nevertheless, before sketching that principle, it behoves me to find another explanation for the Old Breton data - one which does not depend upon any kind of morphological precedence - since we know that in early Celtic languages, Initial Mutation was phonetically conditioned.

Let us assume a very early stage in the development of Breton when Initial Mutation may be viewed as a sandhi phenomenon. Lenition was a low-level phonetic rule comparable to aspiration in present-day English. As such, it is very natural to view its effects, namely the voicing of voiceless plosives and the fricativization of voiced plosives, as manifestations of a unitary process, applying in complementary disjunctive environments. Anderson's use of angled brackets captures the disjunctive relation between the subparts of Lenition and is in keeping with SPE notational conventions (See § 3.2 'Disjunctive and Conjunctive Ordering'). Thus in its explication of Lenition in Old Breton as a low-level phonetic rule, the theory of UDRA is able to adopt gratis the

conventions on disjunctivity that it inherited from the classical theory. Two points immediately arise in connection with such an explanation. First, why did Anderson concern himself with the question of conjunctive or disjunctive expansion, when he had already incorporated a disjunctive notational device into his formalization? The answer revolves around two interrelated matters, the first being that Anderson used angled brackets as indices (like subscript i, j) rather than strictly in the SPE manner (although, of course, indexing is one of the functions of angled brackets within GROD). Secondly, as we noted above, Anderson was interested in Lenition in Old Breton just in case it was a neighbourhood rule, that is, he was focussing his attention on its mirror-image environment, not on its internal make-up.

The second point which must be raised in connection with the proposed account of Lenition as a low-level phonetic rule is the following: Why does the notational convention not apply in Modern Breton? Why seek another (this time) "morphological" explanation? A possible answer entails going outside the Breton data to Modern Irish where (morphological) Lenition cannot be stated in one formalism even using angled bracket notation, and an explanation must be found other than one hingeing on the disjunctivity of subrules. Since the mechanism involved constitutes a more powerful theoretic device than that required by the Old Breton data, it will always be possible to explain the latter data in terms of that mechanism (- whereas the reverse is not possible i.e. it is not possible to explain Lenition in Modern Irish in terms of the weaker disjunctivity convention). However, the forcefulness behind the generalization of the treatment of Modern Irish to other languages lies in the fact that, once Initial Mutation is viewed as a two-stage process, a convention on rule ordering follows as a natural consequence of the

introduction of triggers. Given that the evidence of the identical phonetic reflexes of Lenition in disparate morphological environments compels us to adopt a two-stage treatment for Modern Breton, it follows that we should also have recourse to the apparatus this entails.

It is important to emphasize here that crucial to the abbreviation of the phonetic process of Lenition in the early history of Breton is the fact that we are dealing with a single rule. As we have seen, the development into the modern language could not have taken place if "phonetic Lenition" subsumed separate processes. And it is this very aspect of Initial Mutation which in turn provides the justification behind the formalization of Lenition as a single phonetic rule in the parent language. The use of the angled bracket notation is thus not merely an ad hoc device whereby unrelated rules are combined without capturing a significant generalization (cf. Kiparsky 1968^b).

The fundamental claim that each form of Initial Mutation is one process is based on the fact that, in all languages known to me with this phenomenon, a given underlying initial consonant never undergoes a particular * mutation more than once. To return to our schematization, let w and w' be members of set $\{X\}$ and w' and w'' be members of set $\{Y\}$ i.e. w' belongs to the intersection of $\{X\}$ and $\{Y\}$. Assuming that w has mutated to w' , w' may not then undergo Mutation M again to become w'' , despite the fact that the reflex of underlying w' is w'' . This property of Initial Mutation is captured in a natural way by the model proposed in this thesis: each trigger is allotted a life-span of one

* Footnote

The use of the term "particular" is to cover Rogers' analysis of Modern Scots Gallic, where it is claimed that certain segments undergo a combination of Lenition plus Nasalization. See critique of Rogers in Part II.

relevant phonological rule, that is, it may condition one application only of the realization rule. This is very plausible when one considers that diacritics must be deleted at some stage within the phonological component since they do not appear on the phonetic surface. Rather than erasing triggers at an arbitrary point in derivations, I propose that the application of the realization rule conditioned by a trigger should also effect the deletion of that trigger. The corollary of this convention is that a given segment may undergo mutation once only: the segment w meets the SD of the realization rule $X \rightarrow Y$ only by virtue of its associated trigger $[+M]$; the output to the rule is the segment w' . But this w' no longer meets the SD of $X \rightarrow Y$, because the trigger $[+M]$ is absent. The underlying segment w' , on the other hand, is accompanied by the trigger $[+M]$ and therefore is eligible to undergo $X \rightarrow Y$.

It remains for me to spell out the application of triggering and realization to Lenition in Old Breton. There are good grounds for assuming that the mutation was conditioned by triggers even in the period to which Anderson's data belong. Although this is not the place to substantiate such a claim in detail, let me state that only in this way can we satisfactorily explain the historical loss of phonetic transparency in the environments of the processes concerned. Take it, then, that the trigger $[+Len]$ has been assigned to the syntactic surface structure $\{ar +petoc\}$. It appears that in Old Breton we need employ an SPE convention on diacritics, which associates the morphological feature $[+Len]$ with every segment of the word. This convention is not exploited in the synchronic grammar of Modern Irish, where only the initial consonant of a morpheme from a major class category (Noun, Verb, Adjective) undergoes mutation. In fact, in Old Breton only consonants need ever be assigned the trigger $[+Len]$. This by-passing of $[+syllabic]$

segments may well be effected by a redundancy rule on triggering itself. It may then be the case that the specification of the feature [-syllabic] in the realization of Lenition is obviated (- see (16) and (17) below).

Two underlying segments of /ar-petoc/ meet the structural description of the realization of Lenition, namely /p/ and /t/, each with its associated trigger [+Len]. The applications of realization are effected as follows:

(16) The Application of Realization to /ar-petoc/ *

i p → b

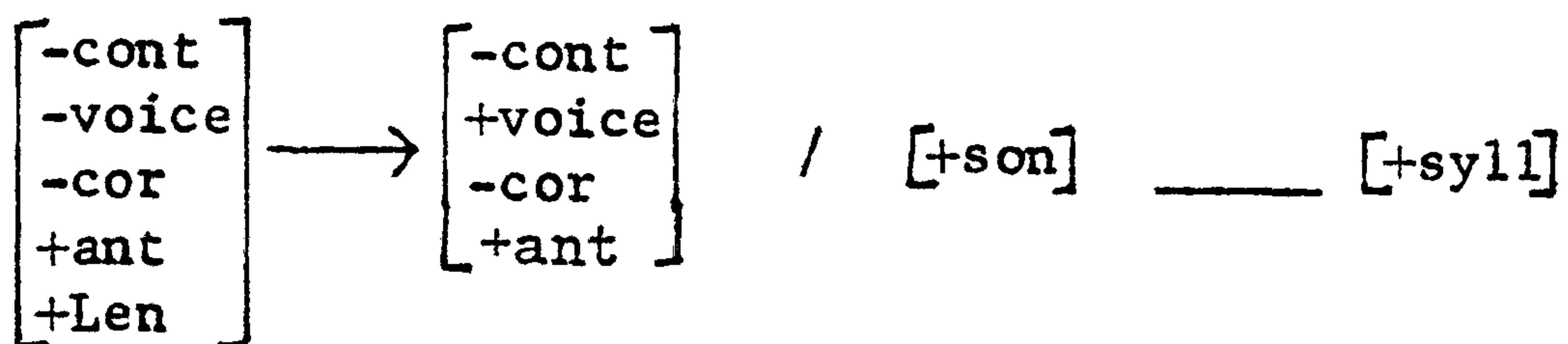

ii t → d

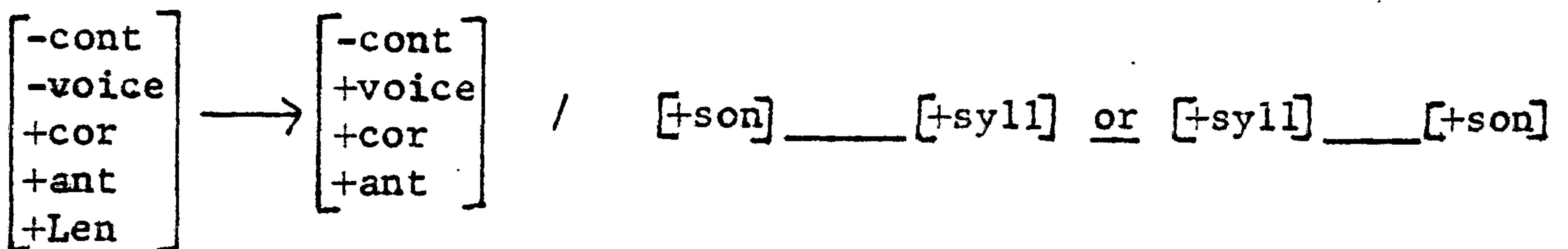

To demonstrate the operation of the part of Lenition in Anderson's formalization (= Iverson's (11) a.), let us take Norman's citation of underlying /darbid/ which appears as [darvid] on the phonetic surface. [+Len] has been assigned to {darbid} by the process of triggering before it enters the phonological component proper. In the formalization of the application of realization, I shall assume that [v] < /b/ is either

* Footnote

The voicing of the final /c/ in Anderson's citation of phonetic [arbedog] must be effected by a rule other than Lenition, since final /c/ does not meet its SD. Note that Iverson and Norman both cite the phonetic representation [arbedoc]. Indeed, this is the form given in Fleuriot's (1964) "Dictionnaire des Gloses en Vieux Breton" as 10th Century "nom de copiste". Fleuriot notes that "ce mot est exactement le même que le gallois arbedog", which is rendered as "merciful".

phonetically bilabial (cf. the velarized counterpart of /v/ in Modern Irish is /w/), or that the change in place of articulation is achieved by a PDR:

(17) The Application of Realization to /darbid/

b → v

$$\begin{bmatrix} -\text{cont} \\ +\text{voice} \\ -\text{cor} \\ +\text{ant} \\ +\text{Len} \end{bmatrix} \longrightarrow \begin{bmatrix} +\text{cont} \\ +\text{voice} \\ -\text{cor} \\ +\text{ant} \end{bmatrix} \quad / \quad [+son] \text{ ______ } [+syll]$$

By inspecting the formalizations, it is clear why the output of (16) i is not eligible to become the input to (17) i.e. why the [b] < /p/ in [arbedoc] does not become [v] to yield *[arve^χdoc] (where [d] < /t/ has similarly become [χ]). For their SDs do not match: unlike the input to (17), the output of (16) i does not contain the trigger [+Len], just in case the trigger has been deleted by the single operation of the realization process.

It is in this natural way that the hypothesis concerning Initial Mutation which is proposed here captures the generalization that a given segment may undergo a particular mutation only once. The solution to the problem posed by the purported counterfeeding relation is thus resolved within the overall treatment of Initial Mutation - without the need to encumber the theory with ad hoc machinery. Perhaps it may be argued that the case for dealing with Old Breton in such a way is not as convincing as it could be, given that voicing and fricativization can be subsumed under one disjunctive rule anyway. Nevertheless it is my contention that the case is highly convincing for Modern Irish where no such abbreviation is feasible. Moreover, only by treating Old Breton and Modern Irish according to the same theoretical model can strong universal claims be made about the analysis of the phenomenon of Initial Mutation in natural language.

§ 5.3 The Non-Spurious Determination of Proper Inclusion

In the discussion of three sets of data taken from Iverson's paper (i.e. those from Konkani, Classical Greek and Old Breton) we have found that principles independent of CCF predict the attested precedence relations. Thus these principles, based on the assumptions about morphological phenomena adopted in this thesis, render CCF superfluous. Furthermore, we have questioned the ontological status of CCF on the grounds that it claims that a relation of PI obtains between rules where no such relation exists. We noted that the purported relation is said to hold between the output of rule A and the input to rule B, whereas in the formalization of KSN's PIPrec it was the inputs to both rules which were under scrutiny. This might lead us to constrain PI only when A's output and B's input are involved. However it is clear that it is the PI relation per se which Iverson is manipulating and the question of whether it is A's SD or SC which provides the phonological material is irrelevant. Moreover it is desirable for the theory of UDRA to guard itself against any possible kind of manipulation of PI and this includes the spurious application of KSN's PIPrec.

Before formalizing a pre-condition on PI to ensure the non-spurious determination of precedence relations under all circumstances, let us briefly summarize how it comes about that this formal property of SDs and SCs may be manipulated. Recall that in the data which Iverson cites for Konkani and Classical Greek, a process B applies to a set of segments Y just in case Y is underlying and crucially not derived from X by the prior application of process A. To put this slightly differently, B may not affect the set of segments which A effects. As specified by Iverson in CCF, A may effect a larger set than that affected by B (when "the structural change of a rule A is properly included in the structures

affected by a rule B"; 1973b. page 4) and it is easy to construct a hypothetical example in which, say, the output of A was the set of all obstruents while the input to B was the set of coronal obstruents (thus the SC of A, [-son], is properly included in the SD of B, [-son, +cor]). In such a case an effective constraint on a counterfeeding interaction might indeed make reference to the formal relation of PI. This is the situation which appears to obtain when we inspect the SDs and SCs of the rules as Iverson presents them. However, on closer examination, we see that the Konkani and Classical Greek data are not of this kind. Rather, for the processes cited, the output of A and the input to B are coextensive. Given this identity of segments effected by A and affected by B, it will always be possible to underspecify the former, due to the established convention that distinctive features specified to the left of the arrow retain their values and need not be restated to the right of the arrow unless they figure in the rule's SC; and it will also always be possible to overspecify the latter, by referring to more distinctive features than economy demands. Consequently, it will be possible, under current conventions on rule formalization, to claim that the segments effected by A are properly included in the segments affected by B - even where no such relation obtains. And this is what CCF does. An analogous case was found in the Old Breton data where a single process, that of Lenition, (rather than two autonomous rules as in Konkani and Classical Greek), derived Y from underlying X and also operated on underlying Y to yield Z (cf. schematization of the argument for Old Breton on p.272-3 above).

The first task of a theory of UDRA wishing to exclude the spurious application of precedence principles based on PI must be to define formally those situations where the relation of PI may be tested for.

In other words it must rule out cases of coextension. This is achieved when the algorithm (18), the PI Test, is incorporated into the theory:

(18) The PI Test

Two representations may be tested to determine whether the relation of proper inclusion holds between them if phonological material from at least one remains extant when all the coextensive subparts of each representation have been discarded.

Because the PI Test constitutes an algorithm, not a principle of UDRA, it does not predict a precedence between rules but rather, provides a procedure for applying a particular principle (e.g. KSN's PIPrec) to representations. Now notice that the PI Test has been judiciously worded to cover both sets of circumstances where we have found PIPrec to be applicable in earlier sections. Let us term these different types of PI relations Proper Contextual Inclusion and Proper Segmental Inclusion, defined in (19) and (20) respectively:

(19) Proper Contextual Inclusion:

If, after the PI Test, phonological material from representation A remains extant whereas no phonological material from representation B remains extant, then representation A properly includes representation B.

(20) Proper Segmental Inclusion:

Let X_a be that class of segments from representation A which remains extant after the PI Test, and let X_b be that class of segments from representation B which remains extant after the PI Test. If the list of features specifying X_a properly includes the list of features specifying X_b , then representation A properly includes representation B.

It is important to emphasize that (like Hastings' Stifling) Proper Contextual Inclusion and Proper Segmental Inclusion leave open the

question of whether it is the input or output to A which is matched against the input to B. * On the other hand, KSN's PIPrec covers just those cases of Proper Contextual Inclusion and Proper Segmental Inclusion which involve the inputs to both rules. With this caveat in mind, let us examine more specifically the two types of PI defined by (19) and (20).

Proper Contextual Inclusion refers to the situation where PI is established by virtue of the fact that one rule is context-sensitive and the other context-free. It therefore covers KSN's example from Latin American Spanish, taken from Saporta and handled by PIPrec (see § 3.1 above). In that example, Delateralization is context-free converting $\underline{\lambda} \rightarrow \underline{y}$, whilst Final Depalatalization is context-sensitive converting $\underline{\lambda} \rightarrow \underline{l}$ before $\#$. By applying the PI Test the common palatal lateral is discarded from both SDs. But now nothing is left of the SD of Delateralization whereas the word boundary remains extant from the SD of Final Depalatalization. Hence the latter properly includes the former and the principle of PIPrec may predict its precedence.

Having demonstrated the working of Proper Contextual Inclusion as an algorithm, we turn to the parallel application of Proper Segmental Inclusion. Suffice it to say that it functions as an algorithm in two related situations. First, the same class of segments may be modified ** in differing environments. After the PI Test, these coextensive modified

* Footnote

However, unlike Stifling, the PI Test and its derivative procedures do not require that rules be viewed as equational statements.

** Footnote

In referring to both the segment affected by A and that effected by A, I shall use the participle "modified", since it is ambiguous temporally. This will enable me to maintain the duplicity captured by equational statements in Stifling.

segments will have been discarded, leaving the class of segments in one environment to properly include the class of segments in the other environment. Secondly, the natural class of segments modified by A may comprise a proper subset of the natural class affected by rule B. Proper Class Inclusion constitutes the principle of UDRA which stipulates the precedence relations for inputs in the latter situation, the original, more general principle of PIPrec handling the former situation. It will be recalled that Proper Class Inclusion is the precedence principle derived from KSN's PIPrec to deal with data like the Devoicing and Spirantization of obstruents in Low German dialects (see §4.1 ; Proper Class Inclusion is formalized on page 152). Thus Proper Segmental Inclusion is its procedural counterpart (as well as being the procedural counterpart to a principle referring to the segment effected by A, and that affected by B, i.e. Iverson's CCF, should such a principle be proven valid).

Two points of clarification should be made in connection with the application of Proper Segmental Inclusion as the procedural counterpart to Proper Class Inclusion. Both hinge on the crucial fact that Proper Segmental Inclusion, as an algorithm, refers to the listing of distinctive features in representations, whilst Proper Class Inclusion, as a precedence principle, refers to the natural classes actually undergoing rules. The first point requiring clarification arises when comparing the formalization of the algorithm (20) with that of the principle (5) on page 152, Section 4.1; it might appear at first glance that the relations between the classes have been reversed in each formalization. But as we have noted throughout this thesis, it is essential to bear in mind when determining PI whether one is referring to an SD itself or to the set of representations which meets that SD. Thus "if the list of

features specifying X_a properly includes the list of features specifying X_b " (= Proper Segmental Inclusion), then "the class X_b properly includes the class X_a " (= Proper Class Inclusion).

The second point materializes in the application of the PI Test to the Low German data, inasmuch as Proper Segmental Inclusion demands that the phonological material it is dealing with has already been subjected to that test. More specifically, we have seen that Proper Class Inclusion is applicable to the affected segments in these data, and hence the corresponding procedure subsumed under the algorithm Proper Segmental Inclusion will be operative on the basis that all environmental material has been discarded from the representations concerned. Only then will the algorithm determine the PI relation between the modified segments. Yet when we inspect the SDs of Spirantization and Devoicing their environments appear disparate, the former applying post-vocally, the latter word-finally. How then can the PI Test discard the contextual material to leave the class of voiced obstruents and the class of all obstruents?

The answer lies once again in the application of the algorithm to representations. In the case of Spirantization and Devoicing in Low German dialects, a representation like underlying /tāg/ meets both SDs simultaneously (hence the fact that KSN's proposal of simultaneous application "works" here), just in case they are complementary. Let us therefore add a codicil to the PI Test which will discard complementary environments, leaving only modified segments to undergo Proper Segmental Inclusion:

(21) Codicil to the PI Test:

Discard environmental material from representation A if representation B contains complementary environmental material.

Note that it will always be the case that the material discarded from representation A under the codicil comprises the left-hand environment when that discarded from representation B comprises the right-hand environment, and vice versa. This is because if A's environment and B's environment were mutually exclusive (i.e. if the two left-hand and right-hand environments were specified), no representation would ever find itself in both contexts at once. It is perhaps slightly equivocal, therefore, to refer to "representations" A and B since in fact we are always dealing with a single representation which meets the SDs of two rules. Of course, the reason behind the use of the terms "representation A" and "representation B" is the need to stress that the PI Test and its derivative algorithms apply to phonological strings meeting particular specifications given in rules, not to the rules themselves.

We have discussed the two situations in which the algorithms Proper Contextual Inclusion and Proper Segmental Inclusion operate, the latter's application itself comprising two cases. Let us characterize the situations subsumed under the two types of PI in terms of "containing more contextual material" (= Proper Contextual Inclusion) and in terms of "one natural class of segments properly including another" (= Proper Segmental Inclusion). Glossed in this way, it is easy to see why the PI of an environmental segment from B by an environmental segment from A (where the segments modified in each representation are coextensive) should fall under the rubric of Proper Segmental Inclusion, rather than under that of Proper Contextual Inclusion. Thus although it might be argued that the PI relation between environmental segments should be handled with those other instances where it is the modified segments which are coextensive and hence discarded, there is a stronger case for grouping together all PI of one class of segments by another. The reasons for doing so are even more compelling once one takes into

account the caution required in determining PI between natural classes themselves and between matrices of distinctive features: by dealing with all segmental inclusion under one rubric, the caveat need only be stated once.

A final point demands mention in our discussion of the formalization of the algorithms to define PI: we have, up till now, been concerned in the main with environmental segments. What happens when boundaries figure in a rule's SD, for they are specified [- segment]? It is important to note that despite this distinctive feature specification, boundaries nevertheless comprise phonological material. Hence they may "count" in the PI Test. However, they can never undergo a phonological rule in the strict sense. That is, although they may be deleted in the course of a rule's operation, it is never the sole function of a rule to remove a boundary; furthermore, a general low-level rule which effects the deletion of remaining boundaries prior to the surfacing of the phonetic representation is not considered a "regular phonological rule", but is instead viewed as a convention. Thus our definition of Proper Segmental Inclusion does not seem able to accommodate boundaries. Yet one can readily envisage a situation where, after the PI Test had discarded the coextensive modified segments from two context-sensitive representations, only boundaries remained extant. Here the boundaries would either be complementary (e.g. process A applies after a morpheme-boundary, process B applies before a word-boundary) and hence discarded by the Codicil to the PI Test, or they would be mutually exclusive (e.g. process A applies before a morpheme-boundary, process B applies before a word-boundary) and therefore no representation would contain both. Finally, should it be the case that, after the PI Test, a boundary remained extant from representation A whilst no phonological material remained extant from representation B, then A would properly

include B (e.g. Delateralization and Final Depalatalization in Latin American Spanish; see page 68 above).

Summing up the argument so far, we require the theory of UDRA to exclude cases of coextension from PI. The PI Test and its derivative procedures, Proper Contextual Inclusion and Proper Segmental Inclusion, provide algorithms for determining when such a formal relation may obtain between representations. Yet in themselves the PI Test et al will not prevent over- and under-specification of SDs and SCs before the PI Test which suffice to bias its results. A Pre-Condition of some kind must therefore be placed on the representations undergoing the test to ensure that conventions on rule formalization are not exploited in a spurious fashion. (22) The Pre-Condition on PI approximates just such a tightening-up:

(22) The Pre-Condition on PI:

Before representations may be tested for the determination of proper inclusion, they must meet one of the following conditions:
Input representations to a rule must be specified uniquely in terms of the natural classes affected non-vacuously by that rule.
Output representations to a rule must be specified uniquely in terms of the natural classes effected non-vacuously by that rule.

(22) prevents underspecification by stipulating that representations must specify the natural classes actually affected and effected by a rule, even at the cost of listing the same distinctive features on both sides of the arrow. Thus it ignores the convention whereby a distinctive feature specified to the left of the arrow need not be restated to the right of the arrow unless it figures in the rule's SC. It also pre-empts the related convention under which a rule flipping the value of a particular distinctive feature is allowed to operate vacuously on the

class of segments which are already specified with the resulting feature value (cf. Iverson's manipulation of the Old Breton data). Note however that the Pre-Condition does not demand that features be specified when their values can be predicted from other* features on the same side of the arrow* by Segment Structure Conditions. For example, in vocalic alternations, vowels will not be forced to bear the specifications [- lateral, - continuant, - heightened subglottal pressure] etc. since these are predictable on each side of the arrow by the presence of [+ vocalic]. The Pre-Condition maintains the generalizations expressed in the Segment Structure Conditions by the use of "uniquely" in its formulation: a matrix on either side of the arrow must determine a natural class uniquely - clearly the added specifications of [- lat, - cont, - HSP] to a vowel matrix in no way further delimits the natural class of vowels concerned. Thus the Pre-Condition ensures against redundant and irrelevant overspecification.

Because both representations must be specified according to the same principles under the Pre-Condition, we can be certain that the spurious claim that the relation of PI holds between coextensive segments will not be tolerated. Thus in Iverson's data from Konkani, the segment effected by Assimilation will be specified as [+ son, + lat, + retr] according to the Pre-Condition, whilst the segment affected by Dissimilation will be identically specified. In Classical Greek, the output to Fricativization will be given as [- son, + cont, + cor], as

* Footnote

Emphasis has been placed on "other" and "on the same side of the arrow" because it could be argued that the conventions which are exploited to bias PI determination also predict the values of particular features from each other. They do so, however, for the same feature on opposite sides of the arrow, as when a particular feature is omitted from an SD just in case it figures in the SC.

will the input to Fricative Weakening by virtue of the fact that s, underlying and derived, must be distinguished uniquely from the rest of the phonological inventory. Turning to Old Breton, the process of Lenition will operate upon the natural classes of voiceless plosives (specified [-son, -cont, -voice]) and voiced plosives (specified [-son, -cont, +voice]) to yield the uniquely defined classes of voiced plosives (specified [-son, -cont, +voice] as before) and voiced continuants (specified [-son, +cont, +voice]). In this way the Pre-Condition guarantees that voiced plosives always bear the same feature specifications whether they figure as the output or the input to Lenition, rendering it nonsensical to misconstrue a PI relation here.

§ 5.4 Iverson's Constraint: The Remaining Data

Let us now examine the three further pieces of data discussed by Iverson in his attempt to substantiate CCF. We shall see how the Pre-Condition to PI ensures the explicit statement of the classes of segments actually undergoing the particular rules. We shall also witness once again the rôle of morphological phenomena developed in this thesis.

We turn first to a putative counterexample cited by Iverson: Spirantization and Palatalization in SPE. This example figures in KSN's original paper and it has already been demonstrated that the two rules apply in an "intrinsic feeding" relation to derive English alternations like president, presidency and presidential. As Iverson notes, the feeding interaction between Spirantization and Palatalization to yield presidential appears to be "an instance of a relatively superficial yet necessary feeding interaction of the type excluded by the principle" (= CCF - JRMCB; 1973b. page 6). That is to say, the SPE analysis does not fall into the category of synchronic grammars which allow a "multiplicity of segment conversions" and which are "typically highly and perhaps unconvincingly abstract" (ibid.). Such grammars may be expected to provide counterexamples to the UDRA hypothesis, a point which was stressed in the critique of Cathey and Demers' "unrealistic" analysis of Old Icelandic (see § 3.4.2.). We shall return to the relation between CCF and abstractness in concluding this chapter. Meanwhile, let us provisionally accept the premise that counterexamples to CCF are more likely to occur in highly abstract analyses, inasmuch as CCF purports to be a principle of UDRA. Thus to the extent that Chomsky and Halle's rules are synchronically motivated, they constitute a more serious problem for CCF.

Given that we accept the authenticity of the SPE analysis of Spirantization and Palatalization in English, let us compare the formulation of the rules

cited by Iverson (23) with their statement conforming to the Pre-Condition on PI (24). Since the fact that both rules may apply to one form is evidenced by presidential, we need not consider the question of whether either or both are morphologically conditioned, i.e. we need not pursue the possibility of morphological precedence being decisive here. Thus the complex disjoint environments of Spirantization and the more phonologically plausible right-hand context of Palatalization have been omitted from (24) - as indeed they are in Iverson's citation (= (23)).

(23) SPE Spirantization and Palatalization as cited by Iverson:

i) Spirantization (= IV.120)

$$\begin{bmatrix} + \text{ cor} \\ + \text{ ant} \\ - \text{ sonor} \end{bmatrix} \longrightarrow \begin{bmatrix} + \text{ cont} \\ + \text{ strid} \end{bmatrix} / \dots$$

ii) Palatalization (= IV.121)

$$\begin{bmatrix} - \text{ sonor} \\ + \text{ cor} \end{bmatrix} \longrightarrow \begin{bmatrix} - \text{ ant} \\ + \text{ strid} \end{bmatrix} / \dots$$

(24) Spirantization and Palatalization subject to the Pre-Condition

on PI

i) Spirantization

$$\begin{bmatrix} - \text{ son} \\ + \text{ cor} \\ + \text{ ant} \\ - \text{ cont} \end{bmatrix} \longrightarrow \begin{bmatrix} - \text{ son} \\ + \text{ cor} \\ + \text{ ant} \\ + \text{ cont} \\ + \text{ strid} \end{bmatrix} / \dots$$

i.e. $[t, d, c] \rightarrow [s, z]$

ii) Palatalization

$$\begin{bmatrix} - \text{ son} \\ + \text{ cor} \\ + \text{ ant} \end{bmatrix} \longrightarrow \begin{bmatrix} - \text{ son} \\ + \text{ cor} \\ - \text{ ant} \\ + \text{ strid} \end{bmatrix} / \dots$$

i.e. $[t, d, s, z] \rightarrow [\check{c}, \check{y}, \check{s}, \check{z}]$

Ch&H's rule of Spirantization (23) i) converts underlying dental stops and [c] (a voiceless dental affricate derived from certain instances of

/k/ by Velar Softening - see below) into dental strident continuants without altering their voicing. (24) i) makes this explicit by referring to that natural class which actually undergoes the process. (23) i) on the other hand appears to apply to all dental obstruents, for it operates vacuously on its own output, [s, z]. Note in passing that even under the Pre-Condition, the value of [strident] to the left of the arrow in Spirantization cannot be minus, since affricates are positively specified for that feature.

Turning to Palatalization, (24) ii) applies to dental stops and fricatives * to yield palato-alveolar strident affricates and fricatives respectively, which, as in Spirantization, retain their voicing. In contrast, (23) ii) apparently has the class of all coronal obstruents as its input - and this includes the palato-alveolar affricates and fricatives which it effects, as well as the class of palato-alveolar plosives not found in the phonological inventory of English. Its output specification fares a little better for it defines the class of segments which are strident but not anterior. By examining the phonological inventory which Chomsky and Halle posit for English, we see that all [+strid, -ant] segments are coronal obstruents, thus ruling out the generation of strident velars by (23) ii). It remains to point out that (24) ii) expresses this generalization directly by including [-son, +cor] in its SC.

When we inspect the rules of Spirantization and Palatalization in English specified according to the Pre-Condition on PI, we cannot fail to notice that the structures modified ** by the former properly include the

* Footnote

The potential application of Palatalization to the dental affricate /c/ is taken up directly.

** Footnote

"Modified" is used here in the sense of both "affected" and "effected", as developed in the footnote to page 283.

structures affected by the latter. According to Hastings' formulation of Stifling, therefore, the α -term of rule B, Palatalization, is properly included in both the α -term and the β -term of rule A, Spirantization. (The question of the presence of \underline{c} in the α -term of A, Spirantization, and its apparent absence from the α -term of B, Palatalization, is taken up directly). Thus Proper Inclusion Stifling wrongly predicts that Palatalization should not apply to the output of Spirantization. Similarly Norman's amendment to PIPrec whereby disjunctivity is associated with that principle wrongly predicts that Spirantization cannot feed Palatalization in English.

It is interesting to note that KSN's original proposal for feeding interactions, later terms Obligatory Precedence by Koutsoudas (1980), together with Proper Class Inclusion, account for the interaction without difficulty. Thus the final plosive of /prezident + i + α l/ "presidential" meets the SD of both rules (after /i/ becomes [-voc] by SPE's IV.118, so that /prezident + y + α l/ now meets the _____ + y environment of Spirantization and ~~the SD~~ of Palatalization; see SPE pages 229-30). But since the natural class affected by Spirantization, i.e. dental non-continuants, is properly included in the natural class affected by Palatalization, i.e. dental obstruents, Proper Class Inclusion predicts that Spirantization should take precedence, yielding intermediate /s/. This dental obstruent meets the SD of Palatalization, which it then undergoes to appear as [ʃ] on the phonetic surface of [prezidénʃəl]. Were it not for the precedence of Spirantization over Palatalization predicted by Proper Class Inclusion, the final plosive of /prezident + i + α l/ might undergo Palatalization to the exclusion of Spirantization, thus surfacing as the palatalized reflex of /t/, i.e. *[prezidénčəl].

Let us now consider, for the sake of argumentation, the derivational history of the dental affricate, even though such a segment is a fiction

in English in that it never appears on the phonetic surface. Strictly speaking, /c/ is included in the SD of Palatalization: to exclude it, the rule would need to specify only those segments which agree in the values of [continuant] and [strident] (t, d being [- cont, - strid]; s, z being [+ cont, + strid]; thus the whole class is [α cont, α strid]). However, in the actual application of the two rules, (- by virtue of the morphological environments in which c < k is always found -) Palatalization never has an opportunity to apply directly to /c/, since Proper Class Inclusion has already guaranteed that it undergo Spirantization first, becoming /s/. This /s/ meets the SD of Palatalization and therefore surfaces as the palatal reflex of s (i.e. [\check{s}]). If /c/ had undergone Palatalization directly, it would have surfaced with only its specification for [anterior] having been changed i.e. as the palato-alveolar affricate [\check{c}]. That this is not the case is evidenced by "logician", underlyingly /lɔg^d + ik^d + i + æn/, where the derivation of k^d → c → s → \check{s} and the operation of other rules yield phonetic surface [lə \check{y} i \check{s} ən] rather than *[lə \check{y} i \check{c} ən].

We have now discussed a striking example of the way in which the Pre-Condition to PI forces us to recognize actual instances of the relation which might otherwise be obscured by abbreviatory conventions. It is therefore pertinent that Iverson does not mention the fact that the segments modified by Spirantization properly include the segments affected by Palatalization. Nevertheless, he is correct when he claims that "since the structural change of neither rule is properly included in the structures affected by the other COUNTERFEEDING (= CCF; JRMcB) makes no predictions at all" (1973b. page 6). Similarly Iverson points out that CCF makes no predictions regarding the feeding of Spirantization by Velar Softening (SPE IV.114). He cites the SC of the latter as [+ cor, + strid, + ant]. Clearly this specification is not properly included in the

structures affected by Spirantization ($[+ \text{cor}, + \text{ant}, - \text{son}]$), thus rendering CCF inapplicable. However, Iverson must be credited with acknowledging that "given $[+ \text{strident}]$ implies $[- \text{son}]$ ", then "the structures affected by Spirantization are properly included in the structural change of Velar Softening". He concludes "this kind of relationship, proper inclusion of structures affected in structural changes, does not satisfy the conditions under which COUNTERFEEDING is applicable" (ibid. fn.4, page 7). Whilst this is correct, it is important to stress that once again Hastings' Stifling makes a false prediction for English: the β -term of Velar Softening properly includes the α -term of Spirantization, predicting, contrary to fact, that Spirantization should not be permitted to apply to the output of Velar Softening. In fact the relation between Velar Softening and Spirantization in English as regards /c/, is one of "Unilateral Supplying" (see discussion of Hetzron's terminology in § 3.3 above). Only by permitting Velar Softening to apply to certain instances of /k/ are dental affricates created which will then meet the SD of Spirantization. It is indeed frustrating that Iverson should come so near to recognizing the relation between these rules of English - without stumbling upon the precedence principles actually at work. Of course, once the Pre-Condition to PI is incorporated into the theory of UDRA, the relations "stand out", making their identification straightforward.

When we turn to the fragmentary piece of Anderson's (1969) analysis of Modern Icelandic cited by Iverson, we witness once again both the operation of the Pre-Condition on PI and the treatment of morphological phenomena developed in this thesis. Taking the constraining effect of the Pre-Condition first, compare the formulation of Non-low Vowel Laxing as presented in Iverson's paper, (25) i, with its statement in accordance

with the Pre-Condition, (25) ii:-

(25) Non-low Vowel Laxing in Modern Icelandic:

i Anderson's 1969 formulation (= II.2.14) as cited by Iverson

$$\begin{bmatrix} + \text{syll} \\ - \text{stress} \\ - \text{low} \end{bmatrix} \longrightarrow \begin{bmatrix} + \text{high} \\ - \text{tense} \end{bmatrix}$$

ii Formulation in accordance with the Pre-Condition on PI

$$\begin{bmatrix} + \text{syll} \\ - \text{stress} \\ - \text{low} \end{bmatrix} \longrightarrow \begin{bmatrix} + \text{syll} \\ + \text{high} \\ - \text{low} \\ - \text{tense} \\ - \text{stress} \end{bmatrix}$$

i.e. $i \rightarrow I$

Whilst the output of (25) i appears to be the natural class of all high lax vowels, irrespective of whether or not they are stressed, (25) ii makes explicit the unstressed property of the class actually effected by Anderson's rule.

Another rule proposed by Anderson which deletes high lax unstressed vowels before an optional sequence of coronal consonants word-finally, is cited by Iverson as (26) i. (26) ii, formulated according to the Pre-Condition, includes the feature [- low] which is predicted from the presence of [+ high]:-

(26) High Lax Unstressed Vowel Deletion in Modern Icelandic:

i Anderson's 1969 formulation (= II.7.4) as cited by Iverson

$$\begin{bmatrix} + \text{syll} \\ + \text{high} \\ - \text{tense} \\ - \text{stress} \end{bmatrix} \longrightarrow \emptyset / \text{_____} [+ \text{coronal}]_0 \#$$

ii Formulation in accordance with the Pre-Condition on PI

$$\begin{bmatrix} + \text{syll} \\ + \text{high} \\ - \text{low} \\ - \text{tense} \\ - \text{stress} \end{bmatrix} \longrightarrow \emptyset / \text{_____} [+ \text{coronal}]_0 \#$$

Given that it is the case that vowels laxed by (25) do not delete under (26), CCF purports to predict this counterfeeding interaction. However, by incorporating the Pre-Condition on PI into the theory of UDRA, we see that it is false to claim, as Iverson does, that "the structural change of (II.2.14) (= 23) is properly included in the affected structures of (II.7.4)" (= 24) (ibid. page 6). Instead, the Pre-Condition forces us to recognize the fact that the output of Non-low Vowel Laxing (25) and the input to High Lax Unstressed Vowel Deletion (26) are coextensive: in other words, no relation of PI obtains between the output of (25) and the input of (26). Hence CCF makes no predictions at all here. This in fact amounts to the most salient feature of CCF inasmuch as the principle makes no genuine predictions for the other sets of data to which it has been applied in Iverson's paper.

Having rejected the exploitation of CCF to account for the attested counterfeeding relation in Modern Icelandic, we must now ask: How does the theory of UDRA put forward in this thesis propose to explicate the interaction? At first glance it might appear that the theory is deficient. Consider the interplay between PIPrec (as stipulated in the procedures Proper Contextual Inclusion and Proper Segmental Inclusion) on the one hand and Obligatory Precedence on the other. After the PI Test has vacuously left extant the segment affected by (25) ii and the coronal environment and segment affected by (26) ii, both Proper Contextual Inclusion and Proper Segmental Inclusion result in the precedence of (26) ii over (25) ii to representations meeting both SDs: Proper Contextual Inclusion stipulates a PI relation by virtue of the fact that (26) ii is context-sensitive and (25) ii context-free; Proper Segmental Inclusion guarantees the same result just in case the natural class affected by (26) ii (high lax unstressed vowels) constitutes a proper subset of the

natural class affected by (25) ii (non-low unstressed vowels).

At this stage in the discussion it is important to remember that the function of the theory of UDRA is not that of an algorithm which, presented with n rules and no extrinsic ordering constraints, will determine the strict linear order in which those rules will apply. Rather, it may well be the case that two rules apply in a certain order to one set of representations and in the reverse order to another set of representations. This is a direct consequence, not of any desire to increase the power of the theory by incorporating local ordering, but of the principle of Obligatory Precedence. Thus it follows that if "rules apply whenever their SDs are met", then a given rule's SD may be met by, say, the UR of one form and by a derived representation of another form. Hence while iterative applications of a rule are constrained within the theory, the repeated testing of a rule until its SD is met is unrestricted. (See § 4.3 for treatment of iterative application.)

These points become crucial, not when one is dealing with a representation which meets the SD of two rules at the same stage in a derivation, but rather when a given form fails to meet the SD of rule A at an early stage in its derivational history, only to meet that same SD at a later stage, as the result of undergoing rule B. In such a situation there is nothing within the theory of UDRA to prevent the output of rule B from being subject to rule A. This is precisely the kind of interaction - if it is a counterfeeding and not a feeding one - which might prove the theory of UDRA to be deficient.

Returning to Anderson's analysis of Modern Icelandic, we have noted the precedence of (26) ii, Deletion*, over (25) ii, Laxing, to representations

* Footnote

The apparent violation of Deletion Cession and the priority of PIPrec are taken up directly.

meeting both SDs. But what about representations which initially meet only the SD of the Laxing rule? - in their case the predictions of PIPrec are irrelevant. They simply fail initially to meet the SD of the Deletion rule. However, since it is only iterative application, not repeated testing, which is constrained under UDRA, the Deletion rule is not discarded simply because its SD was not met at a particular stage in the derivation. So when Laxing creates new instances of high lax unstressed vowels, the Deletion rule may be tested again for applicability; and the representations effected by Laxing automatically now meet the SD of Deletion. Thus we have come back full circle to our original question: How does the theory of UDRA propose to explicate the counterfeeding interaction in Modern Icelandic?

The solution to the apparent dilemma lies in the treatment of morphological phenomena within a more "realistic" theory of phonology, that is to say, a theory which, besides incorporating the UDRA hypothesis, places certain limitations on the abstractness of URs. Such a theory may be described as "integrated", in the sense that it reinforces arguments in favour of UDRA with considerations based on abstractness, and vice versa. It is to be expected, therefore, that when the theory of UDRA appears to be deficient, the analysis in question should also violate constraints on the use of phonological segments as diacritics. (See Kiparsky 1968 for the first treatment of this question in the literature).

Indeed this is precisely what we find when we examine the motivation behind Anderson's High Lax Unstressed Vowel Deletion (26). According to Iverson, "These vowels condition an umlaut process before they delete, as in derivations like /mann + I/ → menn acc. pl. 'men' " (1973b. page 6). In other words the suffixation of a high lax unstressed vowel has

functioned as the diacritic marker of a synchronically morphological umlaut process. The claim that umlaut is morphological synchronically in Modern Icelandic becomes even more of a tautology when one considers that Cathey and Demers may be justifiably attacked for positing phonological segments to condition umlaut in Old Icelandic: one could hardly maintain that umlaut has become "re-phonologized" in the transition from Old to Modern Icelandic, especially given the recession of the process common to the Germanic languages.

As we noted in our discussion of Cathey and Demers' highly abstract analysis of Old Icelandic (§ 3.4.2.), one of the practical consequences of such an unconstrained theory is the need to delete those fictitious phonological segments which have functioned solely as diacritics. It is therefore not surprising, in view of the interdependence between constraints on abstractness and principles of UDRA in an integrated theory, that these early deletion processes should violate Deletion Cession. Nor is it unexpected that apparent contradictions between PIPrec and Deletion Cession should arise in just those cases where morphological phenomena are being treated as if they were phonologically conditioned. Thus although PIPrec and Deletion Cession cannot both be consulted in the actual specification of particular rule interactions and PIPrec takes priority over Deletion Cession in the hierarchy of universal precedence principles, we are justified in deeming each the more plausible inasmuch as it does not gainsay the predictions of the other. And such a conflict is evident when the two are applied to Anderson's rules - PIPrec expressly stipulates the prior application of a deletion process over a rule of vocalic alternation. The apparent paradox is resolved once we become aware that the purported deletion process is no more than a fiction of Anderson's analysis.

How then does a "realistic" theory of phonology propose to account for the vowel alternation between Modern Icelandic nom. sg. mann and acc. pl. menn? A detailed answer can only be tentative, since I am unfamiliar with the data and, besides which, the objective of this thesis has not been to explicate the phenomenon of umlaut. One thing is clear, however: a "realistic" treatment of morphological umlaut must be morphological! Having taken this fact to be self-evident, it may well prove to be the case that a two-stage process of the type substantiated for Modern Irish in Part II is involved whereby triggers are allocated to syntactic surface structures and realization takes place within the phonological component proper. Only future research will determine whether or not this is mere speculation.

In a similar way, I suspect that an analysis in terms of triggering and realization may be applicable to the final piece of counterfeeding data which has yet to be cited from Iverson's paper. The data involve the tone sandhi processes of Amoy described in Hsieh (1972), whereby underlying tones are converted into derived tones in certain morphological contexts. According to Iverson, "no tone which is derived by rule from another can be subjected to additional sandhi processes" (1973b. page 5). For example, the sequence 33 which becomes 21 is not subject to the rule which converts underlying 21 into derived 53. We must, however, dispute the claim that this is "in accord with the principle COUNTERFEEDING" (= CCF; *ibid.* page 5). Once again we find that the output to the counterfeeding rule and the input to the counterfed rule do not stand in a PI relation - rather they are coextensive. Indeed, one cannot help wondering whether the omission of a statement of PI for these data does not stem from the fact that it is well nigh impossible to envisage how one might manipulate PI here.

Under a theory of UDRA which has rejected CCF, the sandhi processes of Amoy can readily be accounted for by making the assumption that a trigger is assigned to an underlying tone sequence in particular morphological contexts, before the string enters the phonological component proper. A realization rule within the phonological component proper will then convert all 33 sequences specified with the trigger [+ sandhi] into 21's and all 21 sequences specified [+ sandhi] into 53's. During the process, the trigger itself will be erased, with the result that 21 sequences which derive from 33 do not meet the SD of the 21 → 53 rule, just in case [+ sandhi] is not present. This treatment captures the important generalization that all underlying 33 tones have identical phonetic surface reflexes in disparate morphological contexts, whilst all underlying 21 tones have the same phonetic surface reflex in just those same morphological contexts, and so on. This somewhat sketchy analysis is partly confirmed by Iverson's footnote 3, where he credits C.-L. Hsu with the observation that "the disjunction convention in parenthetical confluations, which, as in Old Breton, might assure correct application of these processes, is not applicable due to the uncollapsibility of the separate sandhi rules" (page 7). Indeed it is just such considerations which will help to substantiate the triggering-realization analysis of Lenition for Modern Irish in Part II.

§ 5.5 Concluding Remarks

In Iverson's paper we have found genuine examples of rules in counterfeeding relations. We must therefore conclude that KSN's strong claim that such interactions do not obtain in natural language (either from a synchronic viewpoint or from a diachronic one) is untenable. Of course, this does not entail that the UDRA hypothesis rejects counterfeeding as a possible mode of rule interaction. However we have not incorporated into the theory advanced here Iverson's CCF, a constraint formulated explicitly to account for the aforementioned examples. Instead we have found that the treatment of morphological phenomena adopted in a more integrated theory of phonology readily provides a way of dealing with such counterfeeding relations. More specifically, the view of Initial Mutation developed in detail in Part II suggests a particular analysis of the Old Breton data independent of CCF (assuming the morphologization of the process in the data concerned). Summing up the UDRA position on counterfeeding, then, I contend that a "realistic" theory of phonology naturally accounts for such counterfeeding interactions as are found in language without the need to incorporate ad hoc machinery.

The question which now arises is the following: Why does it follow that a "realistic" theory automatically accounts for the data cited by Iverson? To put this slightly differently, in what sense is CCF an axiom of the theory of phonology developed here? There are two aspects to the answer to this question. The more superficial and obvious aspect has already been mentioned: CCF is not independently required within UDRA which is already equipped to handle the precedence relations for which CCF was formulated. Let us turn to the second, more metatheoretical aspect, hinted at on pages 243-4, by going back to Iverson's attempt to define the interaction-type attested in his examples. He first alludes to this interaction-type on page 2 when he compares counterfeeding in

Konkani with a case in Swahili (not discussed here because of its straightforwardness and hence lack of theoretical interest): his observation hinges on the fact that in the counterfeeding example the structure effected by one rule is not distinct from the structure affected by the other, whereas in Swahili both are distinct. A little further on Iverson refers to the blocked interaction-type in terms of "conversions of segment X to segment Y to segment Z" (page 4). Recall now that at the end of the paper, Iverson characterizes certain synchronic grammars which are "typically highly and perhaps unconvincingly abstract" (page 6) in terms of their allowing a "multiplicity of segment conversions" (ibid; see page 291 for the context of these remarks). The implication here is clearly that counterexamples to CCF must be expected to appear in such analyses: because of the greater distance between underlying representations and phonetic representations, it is likely that a given underlying segment will not surface without a change in its phonological make-up; and since CCF is a constraint which restricts the way in which one segment may be converted into another, it is extremely probable that CCF will be contravened in abstract analyses.

This is all well and good - as far as it goes. However, it has been demonstrated, convincingly I trust, that the relation of PI, which, according to CCF, obtains between the rules in counterfeeding relations, does not in fact obtain. Rather, there is a much more specific relation between the output to the counterfeeding rule and the input to the counterfed rule, namely that the sets of segments effected by the former and affected by the latter are coextensive. Now once we recognize this identity relation, a fact which Iverson does not, we see that it has far-reaching implications. In particular, such a relation between the output of one rule and the input of another is relevant to the question of whether the grammar presents a "realistic" account of the phonological

processes in operation. For if the segments effected by rule A and affected by rule B are coextensive, there should be independent motivation for splitting up the conversion of A's input into B's output in two steps. Put another way, why not convert A's input into B's output directly, given that A's output exactly matches B's input?

The answer, I suggest, is that when the so-called rules A and B interact in a feeding relation like this, we recognize one process at work and do not split that process up into two steps. Consider for a moment that in order to justify the postulation of two rules in operation, the feature specification of A's input must differ from that of B's output in at least two values. In other words, the combined effect of rules A plus B cannot be minimal, where by "minimal" I refer to a rule which flips the value of one distinctive feature only e.g. $s \rightarrow z$. The positing of two rules to account for a phonological change thus presupposes that during its operation the values of at least two features are altered e.g. $f \rightarrow z$ analyzed either as $f \rightarrow s \rightarrow z$ or $f \rightarrow v \rightarrow z$.* (This of course excludes the case where A effects a totally idiosyncratic, irrelevant and hence unmotivated change e.g. $s \rightarrow t \rightarrow z$). Such hypothetical examples are entirely parallel to the instances of counterfeeding found in Iverson's paper: they represent potential cases of counterfeeding where in fact the rules interact in a feeding relation. If we did treat such "feeding relations" as pairs of rules (or even triples or quadruples if 3, 4 features were being flipped, etc.), our grammars would be full of counterexamples to CCF. That they are not merely reflects the fact that we recognize the existence of non-minimal

* Footnote

Cf. discussion of competing analyses of $d \rightarrow \gamma$ via z or g in Rogers' treatment of Modern Scots Gaelic page 526ff.

phonological processes.

It is in this way that CCF constitutes an axiom of the theory which seeks to integrate the UDRA hypothesis with considerations of abstractness and a "realistic" approach. Also theoretically interesting is the fact that counterfeeding interactions, at least those cited by Iverson, always seem to involve morphological phenomena. This is perhaps to be expected when we consider that the abstractness issue revolves around the treatment of morphological conditioning as if it were phonetically motivated.

In establishing the existence of counterfeeding interactions in natural language, our critique of Iverson's paper has served to explicate the rôle of morphological phenomena which is central to this thesis. But apart from that, the detailed examination of CCF has demanded rigour in the determination of precedence relations, in order to avoid the spurious exploitation of rule-formalisms. This led to the formalization of the Pre-Condition to PI, which was stated in such a way that representations in a potential PI relation are never underspecified whilst at the same time pre-empting redundant and irrelevant over-specification. Thus the natural classes actually affected and effected in interactions must be uniquely stipulated. Once they have been subjected to the Pre-Condition, representations undergo the PI Test, an algorithm subsuming the procedures of Proper Contextual Inclusion and Proper Segmental Inclusion, whereby coextension between representations guarantees that no PI relation obtains between them. (A codicil to the PI Test ensures that PI is correctly determined between segments in complementary environments.) In this way, cases of coextension, such as those found in Iverson's paper, are excluded from consideration. The dissection of CCF has thus not only falsified the KSN hypothesis

regarding counterfeeding and corroborated independent principles of UDRA: it has demonstrated the necessity for preciseness and rigour in the non-spurious determination of precedence relations and called for constraints to guarantee the same.

PART II

INITIAL MUTATION IN MODERN IRISH

CHAPTER ONE - FRAGESTELLUNG

In the second half of this thesis I propose to apply the principles developed in Part I to a particular set of phenomena taken from a particular language, that of Initial Mutation (henceforth IM) in Modern Irish. More specifically, I shall attempt to answer two interdependent questions: What is the nature of the phenomenon known as IM in Modern Irish? and How can an account of this phenomenon best be incorporated into a generative phonology of the language? It is my belief that the answers to these questions will point in the same direction. In other words, to the extent that the generative model represents a true characterization of the native speaker-hearer's phonological competence, any significant generalization regarding that competence is best captured by the generative model. However, since this mode of reasoning is not true a priori, it will perhaps be expedient to tackle the two questions as if they were independent.

Having therefore given a preliminary characterization of IM in § 1.1, we shall turn to the generative model to see what theoretical devices it has to offer in § 1.2. In § 1.3, the position will be developed more specifically within the framework argued for in the previous section and it will be demonstrated that the treatment eventually adopted enables us to capture the salient features of IM. The chapter closes in § 1.4 with an historical note and anticipates the topics of Chapters Two and Three.

§ 1.1 The Preliminary Characterization of the Data

In order to address the problem of the characterization of IM in Modern Irish, we shall survey a sample of the data which requires explication. First, however, some remarks concerning the presentation of the data are in order.

Examples are given in broad phonetic transcription, then in Irish orthography, and thirdly glossed in English. The broad phonetic transcription assumes the minimum number of taxonomic phonemes distinguished in the phonemic literature on Modern Irish. For the stressable vowels this means that only five qualities are differentiated, together with two lengths. Schwa is recognized in unstressed position, and in diphthongs. In accordance with all treatments of Irish consonants known to me, palatalization is regarded as phonemic for all consonants except /h/, corresponding to the caol/leathan (broad/slender) qualities recognized by the traditional grammarians. The apostrophe after a consonant indicates that it is phonemically palatalized, otherwise it is taken to be non-palatalized with the proviso that /ʃ, ʒ, j, v/ are the palatalized counterparts of /s, x, ɣ, w/ respectively. As for the sonorant consonants, only one palatalized and one non-palatalized lateral are recognized and similarly one palatalized and one non-palatalized coronal nasal. This minimal inventory is thus consistent with Risteard B. Breatnach's 'The Irish of Ring, Co. Waterford' (1947) and Brian Ó Cuív's 'The Irish of West Muskerry, Co. Cork' (1944). *

* Footnote

The "breathed nasals", h'n', hn and hm, described by Breatnach, cannot seriously be given phonemic status, despite his claim to the contrary (p. 45 § 221), since they are rare and "occur as alternatives to h + nasal, x + nasal or ɣ + nasal in a few instances" (p. 48 § 232). Similarly, I submit ^s that Ó Cuív's postulation of voiceless coronal nasal, lateral and r phonemes is to be explained in terms of the phonetically biased version of phonemic theory which he adopted.

Its adoption avoids bringing the additional complexity of the Lenition of sonorants into the preliminary discussion. However, the treatment of dialects which further differentiate laterals and coronal nasals is taken up at the appropriate point in Chapter 3.

Turning to the data, consider the sentences of (1) below:

(1) a) [b'e: ʃe: inə xolə]

Beidh sé ina chodladh

"He will be asleep".

b) [n'i: ve: ʃiəd inə golə]

Ní bheidh siad ina gcodladh

"They won't be asleep".

c) [ə m'e: ʃi: inə kolə]

An mbeidh sí ina codladh?

"Will she be asleep?"

Here the verbal noun "sleep, sleeping" exhibits three phonetic shapes, apparently depending on the gender and number of the subject of the sentence. Both synchronically and diachronically, however, the phrases [inə xolə, inə golə, inə kolə] are sequences of coalesced preposition plus possessive, and may be glossed literally as "in his/their/her sleep(ing)" respectively. Begging the fundamental question of whether the possessive marker is located in the prepositional pronoun or in the initial consonant of the verbal noun, we note that in the PP containing the masculine singular possessive, the initial consonant of the verbal noun is [x], in the PP containing the plural possessive the initial consonant of the verbal noun is [g], whilst in the PP containing the feminine singular possessive the initial consonant is [k].

The most important thing to stress at this point in the discussion is

the fact that the alternations exhibited in (1) are rule-governed: they are not idiosyncratic features of the verbal noun "sleep, sleeping", nor indeed of verbal nouns in general. This may be demonstrated by substituting "in his/their/her car" for "in his/their/her sleep(ing)" in (1) - the initial consonant mutations are identical: [inə xa:r] ina charr, [inə ga:r] ina gcarr, [inə ka:r] ina carr. Further, the independence of the possessives in the PP's of (1) from the subjects, may be illustrated by [b'e: ʃe: inə ga:r] Beidh sé ina gcarr, "He will be in their car"; and [b'e: ʃe: inə ka:r] Beidh sé ina carr, "He will be in her car".

We can carry the generalization beyond the alternation [x:g:k] by substituting "boat" for "sleep, sleeping" in (1) to yield (2):

- (2) a) [b'e: ʃe: inə wa:d]
Beidh sé ina bhád
 "He will be in his boat".
- b) [n'i: ve: ʃiəd inə ma:d]
Ní bheidh siad ina mbád
 "They won't be in their boat".
- c) [ə m'e: ʃi: inə ba:d]
An mbeidh sí ina bád?
 "Will she be in her boat?"

We may set up the following analogical statements on the basis of these data (along the lines of the hypothetical exempla of pages 272-3):-

just as [x : w] in Masc. Sing. environment
 so [g : m] in Plur. environment
 and [k : b] in Fem. Sing. environment.

What is more, the generalization may be extended further. For note now the three phonetic shapes exhibited by the future of [ta:] tá "to be",

namely, [b', v, m'], which vary according to the presence or absence of the Negative and Interrogative particles ([n'i:] and [ə] respectively). Strikingly, these alternations between palatalized consonants mirror those amongst their non-palatalized counterparts [b, w, m]. Summing up, the same processes whereby voiced bilabial plosives alternate with voiced labial continuants and bilabial nasals operate in very disparate environments. Given that the environment of the different phonetic shapes may remain phonologically constant (i.e. /inə _____ /), we may reach the preliminary conclusion that IM results in consistent alternation among sets of systematically different phonetic elements in disparate morphosyntactic environments.

Before we go on to evaluate the significance of these two facts, another important point about IM, implicit in the data of (1) and (2), needs to be mentioned. I am referring to the observation that IM affects only the major lexical categories of Noun and Verb. Thus whilst it seems to be the case that the Negative and Interrogative particles must be present in (1) b) and c), and (2) b) and c), for IM to take place, the particles themselves retain their underlying shape. Similarly, the prepositional pronouns which induce IM in the above examples do not themselves mutate. Nor for that matter do the subject pronouns. All these non-mutating forms have in common the status of belonging to non-lexical (= grammatical) categories. On the other hand the open classes of the lexicon, the major lexical categories, are subject to IM. To the specification of Noun and Verb under this rubric we must add the other major lexical category found in Irish, i.e. Adjective e.g. [ə f'ar mo:r] an fear mór "a big man" cf. [ə van wo:r] an bhean mhór "a big woman". (Adverbs are not included as a major lexical category for the reasons discussed in § 2.2).

Bearing this in mind, it is my contention that the consistent alternation

among sets of systematically different phonetic elements which we have observed in disparate morphosyntactic environments constitute the most salient characteristics of IM in Modern Irish. Moreover, it is not the case that the sandhi phenomena from which we know IM to have developed must necessarily have evolved in this way. For instance, one could envisage a situation where a certain morphosyntactic environment induced an alternation in certain lexically specified items only. * Although isolated examples of this kind occur, it is by far more generally the case that all items of a particular major category with a particular initial consonant do alternate with a constant member of a related natural class in widely disparate morphosyntactic environments. If the treatment of IM is to attain descriptive adequacy, these two generalizations - neither of which is self-evident - need to be captured in a way which reflects the intuitions of the native speaker-hearer. But before we set our goals at explanation, the phonological grammar must undertake the less critical task of classification.

Recall that when we anticipated the treatment of IM as a two-stage process in the discussion of Old Breton data at the end of Part I, we referred to triggering and realization. Now note that couched in the observations made above are statements of two distinct kinds. On the

* Footnote

It seems to be the case that IM in Welsh is also "across the board". However, this does not mean that there are no exceptions to IM. In fact the dialects of North Wales contain more exceptions to Lenition in definite feminine nouns and their adjectives than are found in South Wales. Comrie (1979) has endeavoured to account for the failure of loan-words with initial /g/ (e.g. "guitar", "garage") to undergo Lenition, not in terms of potential homophony, but rather, in terms of maximal phonetic distance (/g/ deletes under Lenition). This hypothesis seems to explain the Nasalization of such borrowings just in case that mutation-type does not effect the null segment. I am indebted to Wyn Bellin for valuable discussion about this and numerous other issues concerning IM in Welsh. He has brought the Lenition of /g/ to my attention as the subject of linguistic jokes (e.g. /gɒlɪf/ → * [ɒlɪf]) and also points out the mutation of unassimilated loans in South Wales (e.g. /tʃɪps/ → [dʒɪps]).

one hand references are being made to the environments under which mutation takes place - the Negative particle, for instance; on the other hand, the phonological changes themselves are being specified e.g. voiced bilabial plosives being converted into voiced labial continuants. Even from such an isolated set of data two aspects to the phenomena are clearly manifest. Henceforth I shall refer to the first aspect of IM - that of its environmental specification - as triggering, reserving the term realization for the phonetic specification of IM. Any account which aspires to capture the nature of IM will thus have to stipulate not only the conditions triggering IM but also the realization of IM.

It is indeed significant that a glance at the recent literature shows that linguists have been concerned with only one or the other of the two facets to IM. Scholars like Hamp and Oftedal have been addressing themselves to the problem of the syntactic and lexical environment necessary for a given word to mutate; whilst others like Skerrett and Rogers have been formalizing the phonological rules which reflect the phonetic changes undergone by classes of initial consonants (in some cases individual initial consonants). In Chapter Two we shall examine triggering in Modern Irish in detail, postponing a rigorous treatment of the process of realization until Chapter Three. But before we turn to the generative model to cast the framework of those two chapters, let us briefly survey some further data in order to gain an idea of the scope of triggering and realization.

Consider the phenomena exemplified in (3), which parallel those of (1) and (2):-

(3) a) [f'ek'im' t'ax ən er'im'o:r']

Feicim teach an fheirmeoir

"I can see the farmer's house".

b) [ə vek'ən ə f'er'im'o:r' də hax ə he:mif]

An bhfeiceann an feirmeoir do theach, a Shéamus?

"Can the farmer see your house, Seamus?"

c) [n'i: ek'ən ∫e:məs er' ə ver'im' iəd]

Ní fheiceann Séamus ar an bhfeirm iad

"Seamus can't see them on the farm".

Here the initial consonants [f'] and [v] alternate with zero in both the Affirmative, Interrogative and Negative of the present tense of "see" and in the noun "farm" and its derivative agentive noun. There is a further alternation between [h] and [t'] due to the presence or absence of the second person singular possessive, and between initial [h] and [∫] dependent on the status of the proper noun in question as subject or vocative.

What additional facts about triggering and realization may be gleaned from the data in (3)? First, a number of morphosyntactic environments may be added to the list of those triggering mutation.* As for the process of realization, we may set up the following analogical statements:

f' : v : ∅

t' : h : ?

∫ : h : ?

Substitution readily reveals that

f':v = k:g = b:m = b':m'

as evidenced by the phrases of (4):

(4) a) i	[f'er'im']	<u>feirm</u>	"farm"	
	ii	[er' ə ver'im']	<u>ar an bhfeirm</u>	"on the farm"
b) i	[ka:r]	<u>carr</u>	"car"	
	ii	[er' ə ga:r]	<u>ar an gcarr</u>	"on the car"

* Footnote

viz. the Article preceding a Masculine noun in the Genitive; the 2nd. person Singular possessive adjective [də]; the Vocative particle [ə]; the sequence Preposition [er'] + Determiner.

(4)	c) i	[ba:d]	<u>bád</u>	"boat"
	ii	[er' ə ma:d]	<u>ar an mbád</u>	"on the boat"
	d) i	[b'inʃə]	<u>binse</u>	"bench"
	ii	[er' ə m'inʃə]	<u>ar an mbinse</u>	"on the bench"

We infer that environments triggering the IM of voiceless obstruents to homorganic voiced ones, and of voiced obstruents to homorganic nasals include the Interrogative particle, the plural possessive and the sequence Preposition [er'] + Article.* A method besides the process of elimination shows that

$$f':\emptyset = k:x = b:w = b':v = t':h = \int:h$$

just in case we substitute [f'er'im', ka r, ba:d, b'inʃə, ʃe:məs] for [t'ax] after the 2nd. person singular possessive adjective [də] to yield the following:

(5)	a) i	[f'er'im']	<u>feirm</u>	"farm"
	ii	[d'er'im']	< /də + f'er'im'/ ** <u>d'fheirm</u>	"your farm"
	b) i	[ka:r]	<u>carr</u>	"car"
	ii	[də xa:r]	<u>do charr</u>	"your car"
	c) i	[ba:d]	<u>bád</u>	"boat"
	ii	[də wa:d]	<u>do bhád</u>	"your boat"
	d) i	[b'inʃə]	<u>binse</u>	"bench"
	ii	[də vinʃə]	<u>do bhinse</u>	"your bench"
	e) i	[t'ax]	<u>teach</u>	"house"
	ii	[də hax]	<u>do theach</u>	"your house"
	f) i	[ʃe:məs]	<u>Séamus</u>	"Seamus"
	ii	[də he:məs]	<u>do Shéamus</u>	"your Seamus"

* Footnote

Dialectal variation accounts for data where the environment [er'] + Article induces forms other than those of (4). The above examples are taken from Connemara.

** Footnote

The palatalization of [d'] is a natural consequence of the deletion under Lenition of the archisegment /f/. See Chapter Three for full explication of comparable examples.

Let us accept the natural assumption that the consonant which appears initially in the citation form constitutes the underlying initial consonant of that word, traditionally specified as its "radical". (Cf. K&K's discussion of a constraint whereby only those variant phonetic properties which occur in the isolation form of the morpheme are assigned to its underlying representation, 1977, pages 18-26). Thus the underlying representation of "car" in Modern Irish will be (ka:r/ ((4) b) i and (5) b) i). Ignoring what I shall later refer to as the Minor Mutations, it is clear that two "mutation-types" are in operation in Modern Irish, inasmuch as /ka:r/ may assume two other phonetic shapes, namely [ga:r] and [xa:r]. Two labels are therefore required to denote the mutation-type whereby (amongst other alternations) voiceless plosives become homorganically voiced and also to denote the mutation-type whereby (amongst other alternations) voiceless plosives spirantize.

Turning to metatheoretical considerations for a moment, it might be argued that the term ~~IM~~ itself should be reserved for the linguistic phenomenon in general. The fact that a language exhibited IM would then become a typological statement about the way in which a given language exploited the gamut of phonological and syntactic possibilities made available under universal linguistic theory. On the other hand, it might be argued that the term IM should not be employed to denote "mutation-types" - the actual processes peculiar to the language in question. However, having already introduced new usage by applying the term "triggering" to IM and by redefining the term "realization", I do not propose to neologize further: throughout the remainder of this thesis "IM" will be used to refer to both the universally specified phenomenon and to the individual mutation-types - unless this leads to ambiguity.

To return to Modern Irish, the two labels I shall adopt to refer to IM are Eclipsis and Lenition. Thus the mutation of /b/ to [m] after /er'/ + Article is an instance of Eclipsis, whilst that of /b/ to [w] after possessive /də/ is an instance of Lenition. This practice is not unprecedented: it follows that found in Eamonn Mhac an Fhailigh's "The Irish of Erris, Co. Mayo" (1968) as well as Colmán Ó Huallacháin and Micheál Ó Murchú's more recent "Irish Grammar" (1976); furthermore it conforms to the usage of W. B. Lockwood's philological studies. The adoption of the terms Eclipsis and Lenition has the desirable advantage of being unequivocal. In particular, the term Eclipsis is to be preferred over that employed in works like David Greene's "The Irish Language" (1966), namely Nasalization, for the latter is doubly misleading: it uses the name of a well-defined phonetic process to refer to one that is not only morphological but which also subsumes voicing without nasality. The term for Lenition, namely Aspiration, current in both the traditional, and more recently, the phonemic literature, is similarly deceptive. (See the traditional "New Irish Grammar" by the Christian Brothers, or C. Ó Góididhe's "Cúrsa Nua-Aimseartha"; phonemically based works referring to Aspiration include Myles Dillon and Donncha Ó Cróinín's "Teach Yourself Irish", 1961, or Tomás Ó Domhnalláin's series of 65 lessons "Buntús Cainte", 1968). Not only does the use of the term Aspiration detract from the morphosyntactic nature of triggering, but, worse still, it is phonetically incorrect — Lenition amounts to spirantization in the largest natural class it affects (i.e. the plosives), resulting in the glottal fricative only for voiceless coronal obstruents. Moreover, the use of Nasalization and Aspiration is rendered even more abstruse by the presence in the language of these features at the phonetic level (see De Bhaldraithe's "The Irish of Cois Fhairrge, Co. Galway", 1945, revised 1975, page 28 and page 46;

and Ó Cuív, 1944, page 32 and pages 54-6). Finally, I have refrained from employing the Irish words for Eclipsis and Lenition, namely Urú and Séimhiú respectively, because of their unfamiliarity and their lack of precedence in the generative literature.

To summarize the discussion so far, we have seen that IM subsumes the independent processes of triggering and realization. In Modern Irish two main types of IM may be recognized, namely Eclipsis and Lenition. In order to attain observational adequacy, any account of IM in Modern Irish must undertake the listing of those environments triggering Eclipsis and Lenition, followed by a list of statements of their realization. However, in the chapters which follow I shall offer an explanation of the data which obviates repeated ad hoc listing. Central to that exegesis is the notion of trigger of IM. And it is to the nature of triggers that we address ourselves in § 1.3 after we have evaluated the theoretical devices made available under the generative model in § 1.2.

§ 1.2 Triggering and Realization under the Generative Model

In the Standard Theory of Generative Grammar which Chomsky first put forward in 'Aspects' (1965) and in its revised version known as the Extended Standard Theory, the output of the syntactic component provides the input to the phonological component. The level of representation reached at this point is known as surface structure. Given this early framework, then, morphological phenomena may be located in either the syntactic component or the phonological component - no separate provision is made for them. Clearly, inasmuch as the realization of IM has been defined in terms of phonetic specification, realization will take place in the phonological component. But what about triggering? Assuming a somewhat simplistic model of generative grammar, could not the triggering of IM occur as part of the syntax? To pose the question slightly differently, does triggering need to take into account facts about deep structure or intermediate structure, i.e. facts which are not present in surface structure?

The answers to these questions are by no means given a priori. It is for this reason that a detailed discussion of them is postponed until Chapter Two, where various aspects of triggering are taken up in full. For the time being, however, let us adopt the preliminary assumption that triggering needs to have access to the output of the syntactic component only, rather than to earlier stages in the syntactic derivation of the sentence. It is this claim which is to be substantiated in due course.

For reasons which will become clear as we develop a more sophisticated model of the relation between syntax and phonology, let us refer to the output of the syntactic component as syntactic surface structures. Such structures comprise a string of formatives (morphemes), together

with a specification of the hierarchical organization of the string into its grammatical constituents. This takes the form of a tree diagram or a labelled bracketing. Syntactic surface structures also contain lexical information as to the semantic, syntactic and phonological properties peculiar to each morpheme. Given that all this is specified in the output to the syntactic component, one way of characterizing the level of representation to which triggering is sensitive, in Modern Irish, is to say that triggering may be read off syntactic surface structure directly.

Inextricably tied up with this possibility is the fact that in Modern Irish IM never operates across major constituents of the sentence: it is to be found within the phrase, be it nominal, verbal, adjectival, prepositional or adverbial. This is, of course, just what one would expect, given the assumption that information about deep structure is not relevant to the operation of triggering; for such information typically refers to the rôles of subject, object and indirect object which the major NP constituents bear in relation to the verb. ~~As for~~ the possibility that a major constituent may be discontinuous in syntactic surface structure (e.g. as under Preposition-stranding), we shall see in § 2.1 that transformations do not have this effect in Irish.

Perhaps it should be stressed here that whilst it follows that in a language like Modern Irish where the environments triggering IM are present in syntactic surface structure, IM itself should be constrained to operate only within the phrase, it does not follow that these conditions are essential universal properties of IM. We shall return to this point in Chapter Two when we discuss Awbery's treatment of IM of the direct object in Welsh. Suffice it to say, nevertheless, that as

far as Modern Irish is concerned, it is only once the syntactic processes of the language have run their course that we need to begin considering IM.

We have reached the conclusion (albeit an unsubstantiated one) that the triggering of IM in Modern Irish does not take place within the syntactic component. Recall now that, for the purposes of exposition, we are assuming a somewhat simplistic model of generative grammar, where the output to the syntactic component directly provides the input to the phonological component. The question which must be raised at this stage in the argument is the following: Can both triggering and realization be accommodated within the phonological component?

A priori such a proposal has appeal for, prima facie, aspects of triggering are phonological. This appears to be true over and above the tautology that triggering has very real phonetic consequences inasmuch as it constitutes the "starting-point" for changes necessarily executed within the phonological component. Apart from this, the morphosyntactic environments conditioning IM affect segments in one "phonologically definable" position only, namely word-initially. This apparently self-evident claim, that IM is in fact initial, requires qualification, for we do find instances of IM word-internally. However since an adequate treatment of such phenomena presupposes a more sophisticated model of generative grammar than that which we are at present assuming for expository purposes, let us discuss these cases when we have examined the accommodation of triggering and realization in a less sophisticated phonological component.

Limiting the discussion to productive, word-initial IM of the type characterized in § 1.1, it is clear that an account of the phenomena in the phonological component must stipulate its phonological enviro-

onment. It might be assumed that "word-initial" position would be defined in terms of boundary configurations: inasmuch as IM can be shown to be noncyclic, it is part of word-level phonology and hence applies at that point in the derivation when the domain of the phonological word is reached. In other words, IM applies in the context $\# \# \underline{\quad}$, given that we define "word" as "an element of the form $\# \# \dots \# \#$ ", where \dots contains no occurrence of $\# \#$ " (SPE page 163). Indeed it clearly is the case that IM is noncyclic: it is not a recursive process which applies first to the smallest constituent, then to successively larger ones by the erasure of innermost brackets. However, to say that IM is a matter of word-level phonology is not to say that its context may be consistently pinned down to the phonological environment $\# \# \underline{\quad}$. Consider for instance those examples of IM following a prepositional pronoun (§ 1.1 examples (1) and (2)): it is the prepositional phrase $[\text{in} \text{ə} \text{ xol} \text{ə}]$ ("in his sleeping") which will be preceded by the double word-boundary, rather than the item to be mutated $/\text{kol} \text{ə}/$. We are, then, forced to turn back to syntactic surface structure in order to specify the environment of IM in terms of the initial consonant of a member of a major lexical category - information regarding word-boundaries alone will yield the wrong results in a large number of cases, namely, whenever a major lexical item is not phrase-initial.

Nor can a more sophisticated model remedy this dependence on non-phonological information in the stipulation of the environment of realization. For when we turn to the more detailed discussion of boundaries in Chapter 8 of SPE, we find that "the word as defined here need not be a constituent of surface structure" (page 368). In other words, the more deeply entrenched the item to be mutated becomes in the phonological component, the more difficult it becomes to state the environment of

realization as a single generalization. Thus it becomes clear that aspects of triggering which might be considered prima facie to be phonological in nature turn out upon closer inspection to be deeply rooted in syntactic surface structure. In fact the environment of IM seems to be 'phonological' only in the rather trivial sense in which all parts of the grammar are accessible through the phonetic surface alone. Nevertheless, it will be demonstrated in due course that there is a way of characterizing the environment of realization consistently in phonological terms, when appeal is made to the notion 'trigger of mutation' in a two-stage treatment. At the present point in the discussion when we have not elaborated such a notion, we may provisionally conclude that the absence of a truly phonological aspect to triggering, casts considerable doubt on the viability of accommodating triggering along with realization in the phonological component. We now turn to another serious problem in upholding such a claim within the framework proposed here.

It is important to point out that within the early framework of generative phonology the accommodation of both triggering and realization in the phonological component necessarily entails that IM be treated as a one-stage process. Perhaps the reasons for this are not altogether transparent, until we consider the history of the model. Recall that Structuralist phonemics distinguished phonemic processes, which were phonetically conditioned, from morphophonemic processes, which were morphologically conditioned. It was at the line of demarcation between these two that the level of "taxonomic phonemics" (to use Chomsky's term: 1964) was set up. With the possible exception of the incorporation of the binary distinctive feature into the theory, the most influential contribution made by Halle's pioneering work in 1959 was his argument

against a taxonomic phonemic level. Halle argued that voicing assimilation in Russian could be stated with greatest insight by mapping morphophonemic representations directly onto phonetic representations. In other words, the positing of an intermediate taxonomic phonemic level between the morphophonemic and the phonetic resulted in the loss of a significant generalization regarding Russian voicing assimilation. I shall not go into the details of the Russian data here - they have been discussed many times in the literature, in particular in the debate arising from Lamb's defence of the phonemic stratum and Chomsky's and Postal's individual attacks on Lamb. Suffice it to say that, even if Halle's argument goes through - and I think it does * - the fact that certain processes are best stated by mapping morphophonemic representations onto phonetic representations, by no means entails that all phonological processes are handled most insightfully in this way.

Nevertheless the result of the debate has become a tenet of SPE phonology (if not a dogma) - phonological rules span morphologically and phonetically conditioned alternations and do not distinguish between them. To put this slightly differently, the phonological component of a "standard" generative grammar constitutes a homogeneous interpretive component which relates syntactic surface structures to their phonetic manifestations. As such there is no provision within the component for the kind of diversification by which the triggering of IM might be kept "separate" from its realization. In particular,

* Footnote

In fact the argument for homorganic assimilation seems to "work" better than voicing assimilation e.g. nasal assimilation in English. For less passionate discussion of the issues "after the event" see also Hutchinson 1972 and 1973; Schane 1971; and for some discussion Smith 1973, pages 185-191.

the rules of triggering and realization will be extrinsically ordered processes of parallel status: there can be no appeal within GROD to the morphological precedence of triggering. (See Part I, § 5.2.2 for the treatment of morphological precedence.) To sum up, then, if we accommodate both triggering and realization within the phonological component of the classical model, there will be no principled basis for separating the two: we will be compelled to adopt a one-stage approach.

Another substantial reason why the separation of triggering and realization is not viable within a classical phonological component - or indeed any constrained phonological component - involves anticipating a little the substance behind the notion "trigger of mutation". One kind of form which a trigger might assume is that of a diacritic feature. Yet if the rules of triggering, which assign triggers, are rules of phonology, then this means that we are permitting phonological rules to introduce diacritic features. In view of post-SPE attempts to limit what may be used as a diacritic (I refer in particular to Kiparsky's 'How Abstract Is Phonology?' 1968) such a step must be considered retrograde; and even within an overpowerful framework like GROD, incorporating such a proposal would leave the theory virtually unbridled. *

* Footnote

In particular Ch&H discuss the possibility of stating the "negative contexts" of exceptions within the phonological component in the following manner:

$$\begin{array}{l} (n-1) \quad X \longrightarrow [- \text{rule } n] \quad / \quad Z \quad \underline{\hspace{1cm}} \quad W \quad (= \text{SPE p. 175 (10)}) \\ (n) \quad \quad X \longrightarrow Y \end{array}$$

Their decision to restrict the theory of exceptions to those indicated by lexical categorization and those given by lexical redundancy rules is based on a consideration of the great increase in descriptive power brought about by phonological rules like the above. Hence the conclusion that "the feature [- rule n] must either be introduced by readjustment rules or appear as a diacritic feature in the lexical representation of an item". (SPE p. 375).

(See below for the discussion of the theoretical apparatus referred to in this quotation).

Indeed, in their discussion of the theory of exceptions, Ch&H conclude that the rules of phonology may not introduce or modify diacritic features since to allow them to do so would render the theory too powerful and flexible. In accounting for IM totally within the phonological component we must therefore abandon the plausible suggestion that "trigger of mutation" may be a diacritic. To the extent that it proves expedient to view triggers in this way, we are left with even weaker grounds for entertaining the possibility that triggering be located in the phonological component.

Having pursued the metatheoretical consequences of accommodating triggering in the phonological component, it is appropriate to illustrate the more "practical" issues involved in the treatment of IM in Modern Irish as a one-stage process. When we attempt an observationally adequate statement of IM within such a framework, we run into difficulties involving "overgeneralization". By "overgeneralization" I refer to the situation in which a particular analytical concept is "stretched" beyond those cases where it may appropriately be applied. Such a situation may be viewed as an extreme instance of making the data fit the analysis rather than the analysis fitting the data. In fact there are two types of difficulty involving overgeneralization which a one-stage approach to IM encounters: the first overgeneralizes the notion of allomorphy, the second the notion of suppletion.

Consider first the way in which the conversion of underlying segment *x* into mutated segment *y* in one step in the phonological component ultimately leads to the overgeneralization of the notion of allomorphy. By 'allomorphy', I refer to the relation between a lexeme and its various phonological representations which are derivable from it by the application of morphologically conditioned rules. In this sense, then, the notion of allomorphy is not tied to its Structuralist origins in

the historical development of the morpheme as the minimal unit of grammatical analysis. Rather, it parallels Aronoff's usage for derivational morphology when he says: "A rule which effects a phonological change, but which only applies to certain morphemes in the immediate environment of certain other morphemes, we will call a rule of allomorphy." (1976, page 98).

To take a concrete example from Modern Irish, a one-stage theory would contain a phonological rule which spirantizes the initial plosive of /kran/ (crann "tree") after the first person singular possessive /mə/

(mo). This rule may be stated informally as (6): *

$$(6) \quad k \rightarrow x / \left[\begin{array}{l} +\text{poss.} \\ +\text{1st.} \\ +\text{sing.} \end{array} \right] + \left[\text{---} \dots \right]_N$$

Rule (6) will apply whenever nouns like /kran/, /kapəl/ (capall "horse"), /karə/ (cara "friend") occur after the first person singular possessive, correctly yielding [mə xran], [mə xapəl], [mə xarə] respectively. It therefore expresses the relation of allomorphy between /kran, kapəl, karə/ and [xran, xapəl, xarə].

However a possessive marker constitutes only one environment where /kran/ et alia lenite to [xran] et alia. Even assuming that the statement of the environment can be extended to cover the second person singular possessive /də/ (do) and the third person masculine singular possessive /ə/ (a), we will need to list other unrelated environments such as

* Footnote

It is not crucial to the argument being developed here whether the environment of this or subsequent rules is specified as a complex of features or as its underlying phonological representation. I have chosen the former for expository purposes here because it avoids the question of homophonous particles, which would only serve to confuse the issue at hand. For the treatment of the problem of homophonous particles, see § 2.2.

- (10) $k \rightarrow x$ / Neg. + [_____.....] v
- | | | | |
|------|-------------------|-------------------------|-------------------|
| e.g. | [kal'ən fe:] | <u>cailleann sé</u> | "he loses" |
| | [n'i: kal'ən fe:] | <u>ní chailleann sé</u> | "he doesn't lose" |
| | [kur'ən fe:] | <u>cuireann sé</u> | "he puts" |
| | [n'i: xur'ən fe:] | <u>ní chuireann sé</u> | "he doesn't put" |
- (11) $k \rightarrow x$ / Intensifier + [_____.....] Adj
- | | | | |
|------|--------------|--------------------|---------------|
| e.g. | [kluhər] | <u>cluthar</u> | "cosy" |
| | [a:n xluhər] | <u>an-chluthar</u> | "very cosy" |
| | [ke:l] | <u>caol</u> | "narrow" |
| | [a:n xe:l] | <u>an-chaol</u> | "very narrow" |
- (12) $k \rightarrow x$ / [+ Noun] + [+ Fem.] + [_____.....] Adj
- | | | | |
|------|-----------------|-------------------------|-------------------|
| e.g. | [kahi:r xluhər] | <u>cathaoir chluhər</u> | "a cosy chair" |
| | [sra:d' xe:l] | <u>sráid chaol</u> | "a narrow street" |

So far the number of allomorphy statements we have made may seem unavoidable, in view of the diverse morphosyntactic environments triggering the $k \rightarrow x$ alternation. However it is important to stress, even at this stage of the argument, that despite the heterogeneity of the rules cited - and the list has been far from exhaustive - and despite their operation in independent lexical categories, they all effect the same phonological change. This fact blatantly suggests that a significant generalization is being lost - we have been stating that nouns, verbs and adjectives with initial underlying /k/ all have an allomorph which begins with [x], as if each case existed in isolation.

In fact, the situation is even more intolerable, for not only does underlying segment x mutate to surface segment y in disparate morphosyntactic environments, but x', x'' also mutate to y', y'' and so on in each corresponding environment. In other words the model

requires the repetition of each of the rules (5) through (12), and many more besides, for every consonantal segment in the underlying phonological inventory of the language. By stating that all major category items with initial segments $x, x', x'' \dots$ in their underlying representations have phonological reflexes with initial $y, y', y'' \dots$ in morphosyntactic environments $A, B, C \dots$, we may stand accused of an overgeneralization of the notion of allomorphy. To put this slightly differently, we are taking a recognizable characteristic of the relation between certain grammatical morphemes in Irish (like Plural, for instance), and their phonological exponents, and forcing all major category lexemes to conform to this mould. No theory purporting to achieve descriptive adequacy can tolerate such an overgeneralization of the allomorphy relation.

To sum up the first set of consequences of attempting to treat IM as a one-stage process in the phonological component, if n consonants undergo a given mutation-type in m environments, the upper limit to the number of phonological mutation rules in such a framework is nm ! By the caveat 'upper limit' we acknowledge the fact that the underlying consonant and its mutated reflex may fall into natural classes, thus enabling the statement of the alternation to apply to more than one underlying segment at a time. Indeed this is true to a certain extent of Eclipsis: it was because of its lack of naturalness that I chose Lenition to make the point most forcefully. Perhaps it should be noted here that the naturalness of the realization rules, and hence their possible collapsing, comprises an essential part of the formalization of realization in a fully developed two-stage approach. We shall examine this aspect of IM in Chapter III.

We have illustrated the first type of difficulty which we run into when

we attempt to account for IM as a one-stage process. It is now time to spell out the second sort of difficulty - like the first it comprises an overgeneralization, this time not of the notion of allomorphy but of the notion of suppletion. Since the statement of suppletion takes place in the lexicon our discussion will lead naturally from a simplistic conception of that component into an examination of its rôle in a more sophisticated theory of phonology. It is from this stand-point that an insightful treatment of IM will be developed. With the rôle of the lexicon in mind we shall also be able to clear up some residual problems which could not be dealt with under the former simplistic model of generative phonology.

In its original conception, the function of the lexicon was to provide a repository of the idiosyncratic properties of the language's morphemes. These properties, which covered semantic, syntactic and phonological peculiarities, were entered into deep structures by way of lexical insertion. Lexical insertion itself is usually considered to be a transformational rule, though one of unique type, essentially different from the usual transformations which map the output of the Phrase Structure rules into syntactic surface structures. It is during the course of the transformational component that grammatical morphemes are introduced into derivations. We return directly to the phonological make-up of these morphemes and the point of its insertion.

To sum up, the lexicon, as originally conceived, comprised a list of the morphemes of the language, together with whatever information was idiosyncratic in the semantic, syntactic or phonological behaviour i.e. could not be predicted by general rule in the semantic, syntactic or phonological components, respectively. We shall have no cause to mention the semantic properties further. As for the syntactic properties, they will be relevant to our discussion insofar as they subsume the

morphological subcategorization of particular morphemes. Given the simplistic framework we have been adopting, where the output of the syntactic component directly provides the input to the phonological component, there is no basis for distinguishing 'lexical' representations from 'phonological' representations (cf. SPE pp. 9-11). Thus in such a model it is the "spelling" of a major lexical item which was inserted in deep structure, which eventually enters the phonological component to be converted into its (various) phonetic reflex(es). To put this slightly differently, the claim that the syntactic component directly provides the input to the phonological component entails that the phonological make-up of major lexical items remains the same when it enters the phonological component as it was when specified in the lexicon.

In general there will be a single underlying (= lexical or phonological) representation for each major lexical item and allomorphy will be determined by the application of morphologically conditioned rules in the phonological component. However it has been demonstrated that to treat the triggering and realization of IM in Modern Irish in this way within the phonological component leads to an undesirable overgeneralization of the notion of allomorphy. Moreover we have rejected the possibility that the triggering of IM be located in the syntactic component. The next step in the argument must therefore be to inquire whether the statement of the mutated allomorphs of major lexical items could not be made in the lexicon. We must note here that there are certain cases where allomorphs are necessarily listed in the lexicon, namely in the case of suppletion, where an allomorph can be stated by rule only at the expense of writing a particular rule specifically to account for that variant alone. For example, the Preterite Absolute and Dependent forms of the verb /f'ek'/ (feic- "see") must be given as part of the morpheme's lexical entry, i.e. as /xunik'/ (chonaic) and /fakə/ (faca)

* respectively. We might therefore consider it possible to generalize the treatment of /f'ek'/ to account for IM.

Let us illustrate what the lexical entry of a noun, verb or adjective would look like if IM was accounted for by entering the radical, lenited and eclipsed forms of the items in question in the lexicon. Take as a typical example the noun /kapəl/ (capall "horse"). Since nouns appear in their unmutated radical form in phrase-initial position, after the feminine singular possessive and after the Determiner if they are masculine (like /kapəl/), these and all other nonmutating environments must be listed as the contexts conditioning that variant. We have cited three morphosyntactic environments in which nouns are lenited. These will need to be listed along with all other leniting contexts for nouns after the slash alongside /xapəl/. As for the eclipsed reflex of "horse", the environments which must be specified include that immediately following the idiosyncratic preposition /i/ (i "in") **, that following (regular) prepositions and the Article and that following plural possessives. Of course, the environments of one of these allomorphs could be left unspecified in a non-pedagogic grammar and subsumed under the "Elsewhere Condition". It is arbitrary which list of environments may be omitted from the full lexical entry, of which (13) represents a partial one, incorporating the facts cited above.

* Footnote

/fakə/ never appears on the phonetic surface in this hypothetically unmutated form, a fact which is readily attributable to the triggering feature [+ Preterite] inherently associated with it. However its UR is unambiguously derivable from its phonetic representations, lenited [akə] (where f → ∅) and eclipsed [wakə] (where f → w). Failure to recognize /fakə/ as the underlying form would only lead to unnecessary complications in the statement that /f'ek'/ + Preterite be exceptions to IM and would destroy the obvious paradigmatic connection between /f'ek'/ and /fakə/ - even though this cannot be captured by rule.

** Footnote

/i/ must be marked in its own lexical entry as an exception to the rules

(13) "horse"

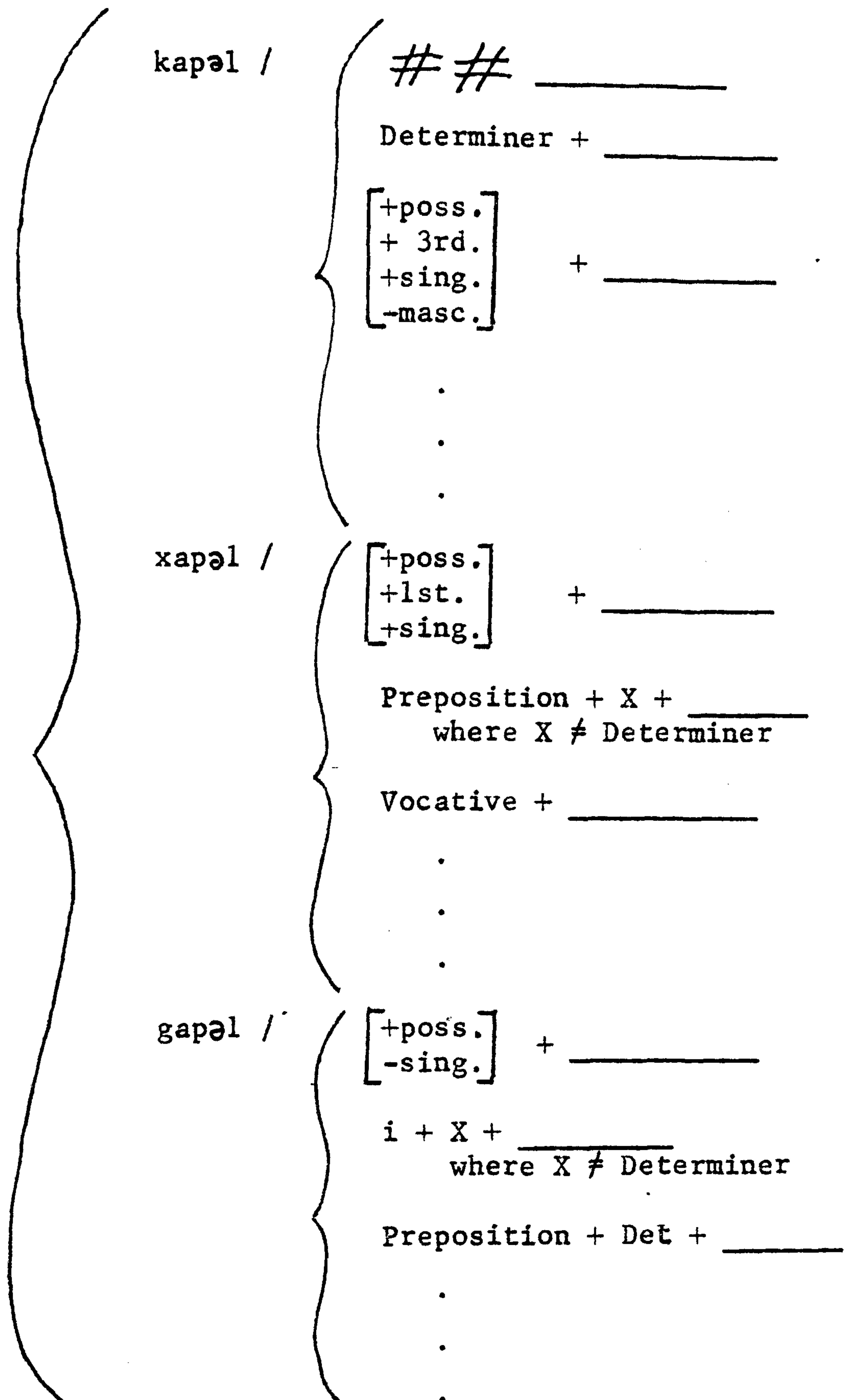

Even considering the partial lexical entry (13) in isolation, it is obvious that generalizations are being missed. For instance, the fact that another part of the entry for "horse" specifies that the noun is masculine, is not related to its behaviour after the determiner:

** Footnote continued

generally governing the behaviour of prepositions. This will account for the idiosyncratic fact that it triggers Eclipsis in the following noun when the Article is absent (regular prepositions cause Lenition here), and that it triggers Lenition in the following noun when the Article is present (regular prepositions cause Eclipsis here).

feminine singular nouns in this position undergo Lenition. Rather, the statement of gender and the distribution of variants are treated as if there were no connection between them. Another serious defect of an entry like (13), even when viewed in isolation, is that it provides no way of characterizing the notion of "radical form". In other words it treats /kapəl/ entirely on a par with /xapəl/ and /gapəl/, even though the former is intuitively considered more 'basic' by the native speaker-hearer. While it is possible to define 'radical form' in terms of the isolation variant which occurs in the environment

_____, this environment has been listed in just the same way as all others and therefore theoretically it has no special status. In other words, from a metatheoretical stand-point, it would be just as plausible to define 'radical form' in terms of the environment

[+ poss] + _____ or the environment Preposition + Article + _____,
 + 1st.
 + sing.

or for that matter any other.

However it is when we compare (13) with all other lexical entries for Modern Irish that the plausibility of such a one-stage approach is nullified. On the one hand the lexical entries of all (masculine) nouns in Modern Irish with 'mutable' initial consonants will need to repeat individually the environments specified in (13) as well as all those which have been omitted from (15). Such repeated ad hoc listing of facts which could be subsumed under significant generalizations must add heavily to the cost of the grammar. On the other hand certain salient facts cannot even be formalized, namely that there is consistent alternation among sets of systematically different phonetic elements. Not only is it impossible to account for the phonetic naturalness of many of these alternations in such a framework, but also one is bound to ignore the fact that they recur in each major lexical category. It

is clear that by treating IM as if it were suppletive, a gross overgeneralization of that notion results, with the consequence that IM can no longer be characterized as comprising the processes of triggering and realization.

As a final point in our discussion of one-stage approaches it turns out that the overgeneralization of suppletion as a means of stating IM renders lexical insertion impracticable. Recall that the lexical insertion of major lexical items takes place in deep structure (i.e. in the Phrase Structure rules) and that grammatical morphemes are typically introduced later by transformations. Now consider that it is major lexical items that are susceptible to IM and that IM is triggered by grammatical morphemes. How then are we to select which variant to insert into deep structure, given that its environment specifies grammatical morphemes which have yet to be introduced into the derivation? The only possible solution seems to be to insert all three variants into deep structure and then to select the appropriate one after the operation of the transformational rules, by some kind of filter (as proposed by Halle 1973). Yet clearly if we need to 'filter out' the appropriate variant at the level of syntactic surface structure, what motivation remains for 'cluttering up' deep structure? We are bound to conclude that the statement of IM as suppletion not only lacks insight but also results in an intolerable misuse of the theoretical apparatus.

Throughout this section we have examined a number of ways of accounting for IM, given the theoretical machinery made available by the generative model. Since we have a pre-conceived idea of the intrinsic nature of IM (outlined in § 1.1) as a two-stage process, certain logically possible treatments have necessarily been rejected, just in case they fail to

facilitate the characterization of IM as the processes of triggering and realization. In particular, the problem which has beset us has been that of accommodating triggering, the environmental specification of IM, within an appropriate component without abandoning the insightful generalizations subsumed under this process.

Consideration of the nature of triggering, however, points to the area of the grammar which can most readily be extended under a more fully developed theory. Triggering can be viewed as the "processing" of syntactic surface structures into structures in which mutation-types are specified and which are then eligible to enter the phonological component proper. Given such a characterization of triggering, we see that it constitutes readjustment, in the sense in which this was first defined in SPE. Let us therefore examine what Ch&H have to say about the subject.

It is in the very first chapter of SPE that the notion of 'readjustment rules' is introduced; when Ch&H discuss the distinction between lexical and phonological representations (cf. reference to these two types of representation on p.335 above.) They note that there are two concepts of surface structure -- the input to the phonological component and the output of the syntactic component. In their words, "It is an empirical question whether these two concepts coincide" (SPE page 9). Although they do coincide to a large extent, there exist certain discrepancies, rendering the representation as a string of formatives with surface structure provided by the syntactic rules and the lexicon inappropriate for the rules of phonological interpretation. It is then the rôle of the readjustment rules to relate syntax to phonology by converting lexical representations together with their labelled bracketing into what we shall refer to as phonological surface structures.

If triggering is to be accommodated amongst the readjustment rules, the latter must be "morphological" in the sense that they permit the triggers of mutation - in whatever form these take - to be added to the syntactic surface structure so that IM may be realized in the phonological component proper. However in the introductory passage in SPE which we cited above, Ch&H claim that the modifications in surface structure made by the readjustment rules generally "involve elimination of structure" (SPE page 10). Thus the rules referred to divide the sentence into phonological phrases, the maximal domain of phonological processes, by deleting nodes in Phrase Structure trees or paired brackets if syntactic surface structure is presented as a labelled bracketing. * Yet for the purposes of characterizing IM, unless it can be shown that readjustment is not exclusively elimination of structure, we cannot identify triggering with readjustment in the SPE sense. In fact it turns out that readjustment does subsume rules which are, to use Aronoff's phrase, "plainly morphological" (1976, page 5). As Aronoff observes, the term "readjustment" covers rules of inflectional morphology. For example, they convert $[[sing]_V \text{ past}]_V$ into sang and $[[mend]_V \text{ past}]_V$ into mended. To sum up this function in Ch&H's terms, they "construct new feature matrices for certain strings of lexical and grammatical formatives" (SPE page 10).

Aronoff recognizes a third type of readjustment rule, in addition to those which eliminate structure and rules of inflectional morphology. What Aronoff calls "rules of allomorphy" **, which spell out "the form of particular morphemes in specific morphological environments" (1976 *ibid.*), are included in Ch&H's readjustment. He refers to their claim

* Footnote

For arguments that the triggering of IM cannot be defined in terms of phonological phrases, see page 325 above.

** Footnote

For the conception of allomorphy adopted in this thesis, see pages 329-33 above, where the overgeneralization of the notion of allomorphy is discussed.

that "Among the readjustment rules, there are many that apply to specific derivable formatives" (SPE page 223). Ch&H exemplify this by formalizing a rule which voices /t/ in the environments /mi____+ive/ and /ver____+ion/ and leads ultimately to submissive and subversion via other rules.

Despite Ch&H's preliminary remarks on readjustment, there is, then, evidence that such rules are morphological. This makes the hypothesis that the triggering of IM constitutes readjustment not without precedence in SPE, just in case we define triggering as the process of assigning triggers to syntactic surface structures. Moreover, if we anticipate the discussion of § 1.3, where the arguments that triggers are diacritic features are presented, we find additional corroboration in SPE. For Aronoff fails to mention that readjustment rules may assign diacritics. To take a case in point, Ch&H advocate that the diacritic marking [+D] be assigned to the final vowel in the lexical representations of items like momentary, legendary, commentary, and that the Main Stress Rule should be reformulated so as to exclude syllables marked [+D] from consideration. Certain items, however, will be assigned [+D] redundantly, and in that case this task will be executed as part of the process of readjustment. Thus Ch&H state in a footnote that "In the case of alternate, assignment of [+D] in this position [= the second syllable: JRMcB] would be a special case of the readjustment dealing with strings of the form C₀VC₀V [+sonorant] [+consonantal]" (SPE fn. 95, page 139; original emphasis).

The fact that in SPE diacritics may be redundantly distributed by readjustment rules has implications of two kinds for the treatment of IM proposed in this thesis. The first type of implication has already been mentioned: we shall present arguments for treating the triggers of IM as diacritic features. The second kind of implication is both

less self-evident from the SPE footnote cited above and also has more far-reaching consequences for the general organization of the grammar. I am alluding to the inference which can be made from the SPE text that readjustment subsumes lexical redundancy. This in turn leads to the assumption that readjustment constitutes part of the lexicon. We shall review these issues in the light of Stanley's 1967 paper and in their development in SPE, before turning to Aronoff's thesis regarding the lexicon.

Stanley addresses himself to the rules (later formalized as conditions) whereby dictionary matrices (= lexical representations) are converted into systematic phonemic matrices (= phonological representations), given that the former are less fully specified, redundancy free versions of the latter. Fundamental to his treatment is the claim that such rules, the morpheme structure (= MS) rules, "are not regarded as forming part of the P[honological] rules but are statements which form part of the lexicon" (1967, fn. 2, page 395). Later Stanley argues that MS rules are "quite distinct from P rules, both in their logical form and in their linguistic function, and that it is both necessary and desirable to maintain this distinction" (ibid. page 407). Indeed it is on the basis of such a difference, ignored in earlier works, that MS rules are replaced by MS conditions. For our purposes it is also of theoretical import that the rules of triggering and realization be formally and functionally distinguishable. Insofar as the former may ultimately be considered part of the lexicon whilst the latter are necessarily phonological, the difference between the environmental specification of IM and its phonetic specification is reflected in the organisation of the grammar.

Crucial to Stanley's approach is the extension of the rôle of the dictionary (= lexicon) beyond that of the repository of the language's

morphemes and their idiosyncratic properties, i.e. beyond the conception of the lexicon which we adopted as a starting-point to our discussion. According to Stanley, the dictionary has two parts. Whilst one part comprises a list, the other consists of the MS rules or conditions. (1967 pages 397-8). This is not the place to pursue Stanley's proposals in detail. Suffice it to say that the theory of phonology developed in this thesis reflects the spirit, if not the letter, of Stanley's paper. In other words, whilst I shall adopt an extended view of the lexicon and tacitly accept many of Stanley's technical arguments, this will not commit me to the details of the interaction between MS conditions, lexical insertion, and so on, which he puts forward.

Turning now to SPE and the place of lexical redundancy (= Stanley's MS) in the theory, Ch&H assert that such rules "refer exclusively to the internal structure of formatives and really belong to the system of readjustment rules rather than the phonology" (SPE page 67; my emphasis). The question which now springs to mind is surely the following: if lexical redundancy constitutes readjustment, is readjustment part of the lexicon? The answer to this question is not explicitly provided by Ch&H. Indeed we find comments in the literature to the effect that readjustment itself is not well-defined in SPE (Aronoff 1976, page 5; Sommerstein 1977, fn. 3, page 115). However it is my contention that evidence may be found in SPE equating readjustment with part of the lexicon. Thus in their discussion of exceptions to the Alternating Stress Rule which retain primary stress on the final syllable (e.g. chimpanzee), Ch&H claim that "Evidently, these items must be exempted from the Alternating Stress Rule by some sort of lexical classification" (SPE page 157; my emphasis). They go on to say that although only an exhaustive analysis will determine the optimal means of achieving this, one possibility would be to exploit the = boundary, since they have

already demonstrated that the Alternating Stress Rule does not apply to final syllables containing or preceded by such a boundary. Insofar as exemption from the rule is generally associated with certain specific endings, Ch&H claim that "the boundary can be inserted by a readjustment rule" (ibid.). Here, then, we have a case where readjustment is being equated with lexical classification in SPE. Moreover Ch&H end their discussion of this set of exceptions with an unequivocal claim of the kind we have been seeking: "In any event, it is fairly clear, details aside, how to deal with these marginal contrasts within the lexicon". (SPE page 158; my emphasis).

We have seen how the lexicon is implicitly expanded in SPE so that certain morphological phenomena are now dealt with in that component. Before we spell out the organization of a grammar which explicitly contains such an expanded lexicon let us look briefly at the recent history of morphology in order to set Aronoff's treatment of derivational morphology within the lexicon in perspective.

In his initial chapter, Matthews (1974) suggests reasons for the diminished interest in morphology since the advent of Chomskyan linguistics. Such an approach, he claims, cuts right across the surface boundaries between words, rendering such entities superfluous to the analysis. This followed the Structuralist concern with morphology in the forties and early fifties, to parallel what Matthews describes as the "decade of phonology" in the thirties. It is apparent that already in Bloomfield's theory (if not his practice) the word had ceased to serve as the primary unit of morphology, so that it was in keeping with recent tradition that 'Syntactic Structures' talked of the morpheme as the minimal unit of syntax.

Aronoff sums all this up by saying that the subject matter of his monograph was not in vogue at least until 'Remarks on Nominalization' in 1970. There Chomsky noted that much of derivational morphology is semantically idiosyncratic and should be handled in the lexicon, not in the syntax. Following on from here, Jakendoff's strong lexicalist hypothesis proposes that all morphological phenomena be excluded from syntax (1972). Aronoff, on the other hand, clings more closely to Chomsky's original insight, though he does not claim that only irregular derivational morphology be kept separate or that all derivational morphology is indeed irregular in the first place. Aronoff calls his central thesis a "theory of word-based morphology". He cites his hypothesis as follows:

(14) Aronoff's Hypothesis

"All regular word-formation processes are word-based. A new word is formed by applying a regular rule to a single already existing word. Both the new word and the existing one are members of major lexical categories."

(1976, page 21)

This hypothesis is important for the treatment of IM in that it affects the members of major lexical categories within an expanded lexicon. The morphological processes with which Aronoff deals derive words of one major lexical category from those of another. The phenomenon of IM, on the other hand, involves the "marking" of major lexical items with a trigger of mutation just in case they occur in a particular morphosyntactic configuration. The important point to stress here is that, despite these differences, neither Aronoff's treatment of derivational morphology nor the present treatment of IM could be formalized in a theory without an expanded lexicon. Thus although such analyses are feasible in an SPE framework, they are not made an explicit feature of that theory. For Aronoff is specifically concerned with the

incorporation of the treatment of derivational processes into generative grammar. Similarly, it is the implied contention of this thesis that the infant is inherently endowed with an expanded lexicon, equipped to deal with the triggering of IM, should he be exposed to this linguistic phenomenon.

I shall now sketch an outline of the functioning of an expanded lexicon in the derivation of Irish sentences, given the EST model of generative grammar. In such a theory, the lexicon comprises - though only in part - a repository of the words of the language together with their idiosyncratic semantic, syntactic, morphological and phonological properties. This inventory will be similar to a list of morphemes, except that morphologically derived major lexical items will be listed as independently occurring forms just in case they are deemed not to be productively generated each time the native speaker-hearer uses them. In other words, I assume Aronoff's position that morphemes are formally but not semantically minimal to be essentially correct. Despite this difference, it is clear that the major lexical items listed in the lexicon's repository will in many cases be mono-morphemic words - these items will therefore appear unchanged whether we adopt the former conception of the lexicon as a list of morphemes or whether we view it as being made up of words. *

The phonological make-up of each major lexical item will comprise distinctive feature matrices of its radical form. It is important to emphasize that no information about its lenited or eclipsed allomorphs

* Footnote

It is interesting to note that monomorphemic words are the first major lexical items to become part of the child's vocabulary. It would seem, then, that only a 'crude' conception of the lexicon is required in the early stages of acquisition. Perhaps we may assume that refinement of the lexical repository constitutes a later process in language development.

need be given in the lexicon in a two-stage approach, since these forms are determined by regular realization rules of IM which occur in the phonological component, not in the expanded lexicon. The lexical entry will necessarily contain morphological information regarding the gender and declension-type of nouns, the conjugation-type of verbs, as well as sufficient properties to enable inflection to be unambiguously predicted. In the case of true suppletion, the forms in question will need to be listed - we have already mentioned the verb /f'ek'/ in this connection (see p.335-6 above). A parallel example of a suppletive noun is /b'an/ (bean "woman") whose plural [mnã:] (mná "women") must necessarily be listed. In certain cases idiosyncratic morphological categorization will impinge upon the triggering of IM. Sometimes this may amount to suppletive irregularity e.g. when /fai/ (faigh "get") is eclipsed after the Negative particle in the Preterite, Future and Conditional: [n'i: wuər' je:] (ní bhfuair sé "he didn't get"), [n'i: wai je:] (ní bhfaighidh sé "he won't get"), [n'i: waiəx je:] (ní bhfaigheadh sé "he wouldn't get"). Elsewhere there may be some subregularity. An example of this kind where six verbs have behaviour in common regarding IM and particle distribution will be discussed in detail in Chapter Two. It is important to stress, however, that in by far the greater number of cases the triggering of IM will be dependent on syntactic surface structure and morphosyntactic categorization of a non-suppletive kind. The distinctive feature matrices which go to make up the UR of the radical form of each major lexical item are inserted into deep structure, the output of the Phrase Structure rules which comprise the grammar's Base. It may well be the case that members of certain other categories are also inserted here, insofar as they have semantic import and not

just grammatical functions e.g. adverbs and prepositions. However this is a syntactic matter and need not concern us here. Suffice it to say that after lexical insertion has taken place, the deep structure enters the transformational component where the majority of grammatical formatives are inserted. Notice that these morphemes have yet to be spelt out.

On leaving the transformational component the syntactic surface structures are subjected to the machinery of the expanded lexicon. Here readjustment takes place, not only in its limited sense, but including various morphological processes. Since the major lexical items now find themselves in morphosyntactic configurations, suppletive allomorphy must necessarily occur here, by selection of the appropriate suppletive form and the discarding of any inappropriate one(s). It is here also that grammatical formatives are spelt out and IM is triggered. Now it necessarily follows from the theory of UDR developed in this thesis that these processes cannot be extrinsically ordered in relation to each other. This however does not preclude the possibility that each set could be ordered intrinsically in a block, one before the other. In fact we shall see in Chapter Two that both these processes are so interwoven that the latter is not the case. Rather, in some instances it will prove necessary to specify triggering in terms of grammatical categories, whilst in others triggering may appear sensitive to the phonetic shape of its immediate environment.

Once the triggering of IM has occurred, together with the other morphological processes located in the expanded lexicon, the representations constitute phonological surface structures. In other words they are now the appropriate input to the phonological component proper. Within that component, the phonological rules of the language run their course,

as determined by the UDRA hypothesis. Included in these rules are those of the realization of IM. We discuss their internal intrinsic ordering and their interaction with other phonological processes in Chapter Three. The figure on page 351 schematizes the organization of a grammar which incorporates an expanded lexicon.

We have already postponed until Chapter Two the substantiation of the claim that triggering may be read off syntactic surface structures rather than some deeper level. In connection with the discussion of this issue, various aspects of readjustment in the wider sense will be dealt with. Still to be touched on is the nature of the triggers of IM which are assigned to syntactic surface structure in the expanded lexicon. It is to this fundamental question that we address ourselves in § 1.3. Before concluding this section, however, it might prove interesting to consider the relation between derivational morphology and IM, given that the framework we have adopted to account for the latter is a development of Aronoff's treatment of derivational phenomena in English.

A residual problem from our discussion earlier in this section is that of word-internal IM. Working on the assumption that IM was historically a sandhi phenomenon, words with internal IM must be bimorphemic e.g. [kupa:n] (cupán "cup") cf. [foxupa:n] (fochupán "saucer"). On closer inspection, examples of this type fall into two general classes: in the first class it is orthography which indicates that lexemes like cladhaire ("rogue") or the stem fogh1- ("learn") were diachronically bimorphemic, with IM taking place in the initial consonant of the second morpheme. However, when we examine the typology of Old Irish, we see that to isolate these cases of IM from those which have productive synchronic correlates is of no theoretical import. For as Thurneysen explains regarding the division of words in Old Irish:

FIGURE I
THE ORGANIZATION OF THE GRAMMAR
INCORPORATING AN EXPANDED LEXICON

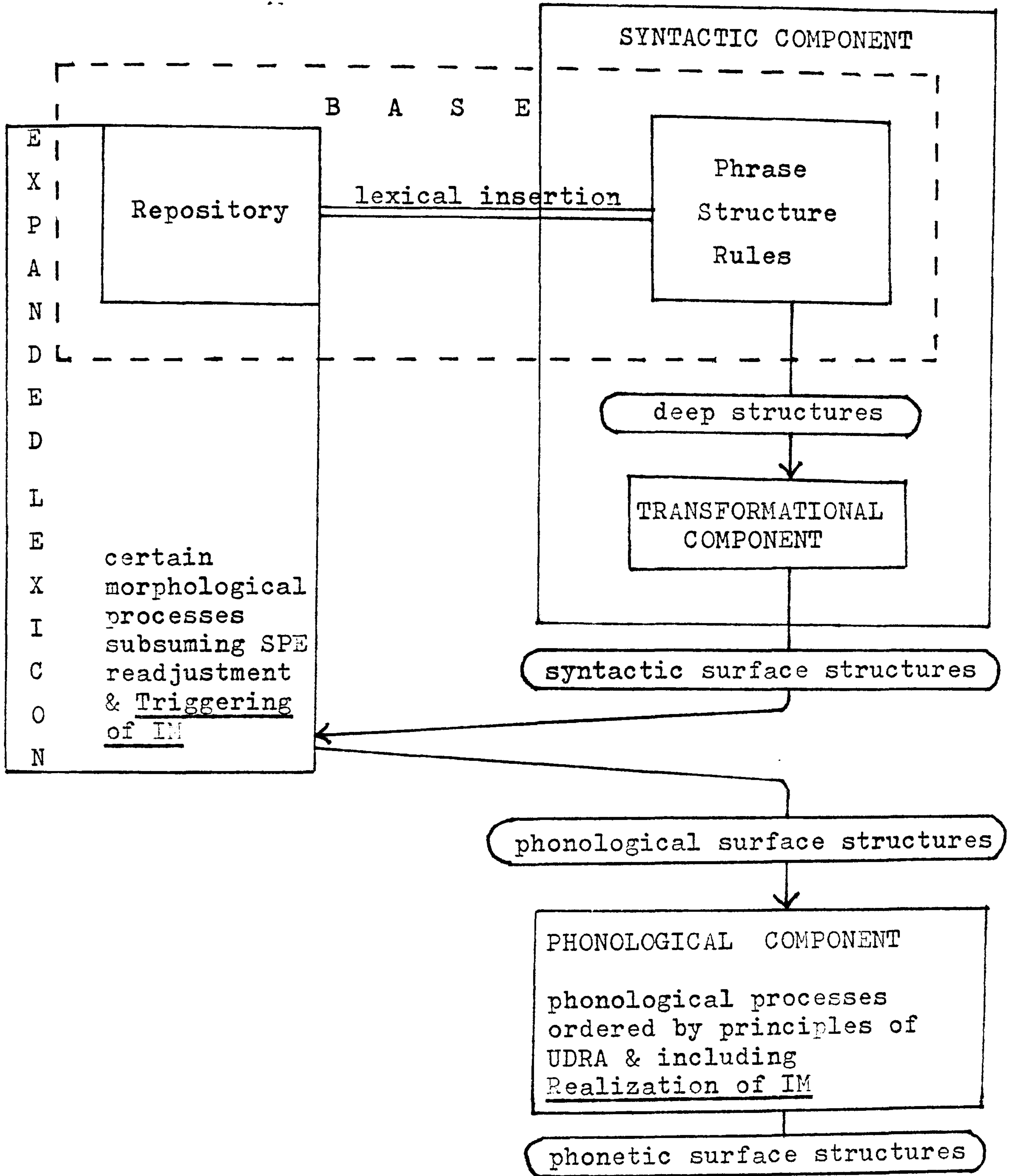

Read $\boxed{A} \rightarrow \textcircled{B}$ as "component A gives representations B as output."

Read $\textcircled{B} \rightarrow \boxed{A}$ as "component A has access only to information from B."

- (15) "In general all words which are grouped round a single chief stress and have a close syntactic connexion with each other are written as one in the manuscripts. Thus conjunctions and pronouns affixed to them are written with the following verb, the article and attached possessives with the following noun, the copula with the following predicate, prepositions and affixed pronouns or article with the following verb or noun, enclitics with the preceding stressed word, etc."

(1946, page 24, § 34)

Given that historically IM was a phonetically transparent sandhi phenomenon, the actual phrase-internal examples of that phenomenon cannot be differentiated on the basis of their present-day correlates, be they word-internal or word-initial. Rather in a synchronic grammar there are no grounds for deriving [klair'ə] or [fo:l-] from URs recapitulating their historical derivation. This is all the more the case in view of the diachronically subsequent processes of vocalization which have rendered the occurrence of IM opaque in such forms.

Examples like [klair'ə] and [fo:l-] do not share a property which is the salient characteristic of the second general class into which examples of word-internal IM fall. I am referring to productivity. It may be useful at this point to turn to Matthews' subdivision of the field of morphology (1974). Having distinguished the primary bifurcation of the field into inflection and word-formation, Matthews subclassifies the latter into derivation, involving a 'bound morpheme' as one of its elements, and composition or compounding, by which two 'free forms' combine. Traditionally, compounding is regarded as productive whilst derivation may or may not be so (it is generally irrelevant to refer to productivity in relation to inflection.) In Modern Irish there are a number of seemingly productive forms which figure as the first element in word-composition. Interesting questions arise regarding the distinction between compounding and derivation: is [fo] in [foxupa:n] a derivational prefix or a variant of the preposition /fi:/? (faoi "under"; where "saucer" = "under-cup"); is [foxupa:n] productively

derived from /fo + kupa:n/ each time it undergoes lexical insertion, or is the derivational process a "once-only" rule in the lexicon? This is essentially the question which confronts Aronoff in his chapter on Productivity (ch. 3, pp. 35-45). We shall return to the status of the first element in word-composition when we discuss the process of triggering in such environments in Chapter Two. Meanwhile let us take it as a working hypothesis that if the concatenation of a particle with a major lexical category is unrestricted regarding particular members of that category, IM is productive. If, on the other hand, concatenation is lexically governed it must be derived (and not just triggered) once only in the lexicon. It is in this sense that productive IM is syntactically defined as word-initial, even though in phonetic terms it is not located after a ## boundary.

We have reviewed in some detail the theoretical apparatus made available by the generative model. In our attempt to characterize IM as a two-stage process and thus to reflect the salient features of this linguistic phenomenon, we have argued that the organization of the grammar must incorporate an expanded lexicon where the triggering of IM may take place. Other morphological phenomena, both those formerly subsumed under SPE readjustment, and certain derivational processes, will also be accommodated in the expanded lexicon. Meanwhile the function of the lexicon as the repository of idiosyncratic information is in no way impaired.

In conclusion, it is important to see how the view of an expanded lexicon "fits together" with post-SPE approaches to phonology, such as that of Kiparsky explicated in Part I. In a conception of the lexicon which goes beyond being simply a list of the language's morphemes and their peculiar properties, the component takes on certain morphological functions. The corollary of this is that classes of morpho-

logical phenomena are removed from the domain of the phonological component. Now recall that it was demonstrated at various points throughout Part I that when morphologically conditioned processes are treated as if they were phonologically conditioned, the analysis typically results in a violation of constraints of abstractedness. It is just such analyses that we have sought to exclude in the more natural "realistic" theory of phonology developed in this thesis. Clearly, then, by providing an expanded lexicon to deal with certain morphological phenomena, we remove the central motivation behind unnatural highly abstract analyses. It is in this sense that the organization of the grammar and constraints at a particular level defined by the grammar "conspire" to ensure analyses that attain explanatory adequacy.

§ 1.3 The Nature of Triggers

It has been demonstrated that the phenomenon of IM in Modern Irish is handled in the most insightful way as a two-stage process. This process comprises triggering, the assignment of markers - or triggers - to syntactic surface structure in an expanded lexicon, and realization, the phonetic specification of those triggers in the phonological component proper. In this way various generalizations can be made about the particles and morphosyntactic categories which condition the two (major) mutation-types, Lenition and Eclipsis. Indeed, by referring to the mutation-types by individual collective labels, we follow the traditional grammarians in assuming that Lenition and Eclipsis are unitary processes. It is such a tacit inference which makes possible the following statements taken from the Christian Brothers' "New Irish Grammar" (Chapters IV and V; emphasis throughout as in the original):

- (16) a. "The Vocative Particle a aspirates [= lenites; JRMcB] nouns of both genders and both numbers." (p. 12)
- b. "The article (an) eclipses a noun in the genitive plural." (pp. 20-21)
- c. "The initial consonant of a verb (ABSOLUTE FORMS) is aspirated in the simple past [= Preterite; JRMcB], the imperfect, and the conditional." (p. 18)

If we did not presuppose a single stage at which IM was triggered in an expanded lexicon, such statements would have to take the form of lists:

- (17) i. The vocative particle /ə/ causes nouns of both genders and both numbers which begin with /p/ or /p'/ to begin with /f/ or /f'/ respectively.
- ii. The vocative particle /ə/ causes nouns of both genders and both numbers which begin with /f/ or /f'/ to delete that /f/ or /f'/.
- iii. The vocative particle /ə/ causes nouns of both genders and both numbers which begin with /s/, /ʃ/, /t/ or /t'/ to begin with /h/.

Of course, the traditional grammarians (like the Christian Brothers or C. Ó Góididhe) define IM solely in terms of the written language. Thus the generalizations made about Lenition, for example, involve merely the insertion of the letter h, so that (16) a. may be read as an instruction to rewrite páiste ("child") as pháiste (cf. the formulation of (17) i. whereby /ə + pa:ʃd'ə/ becomes [ə fa:ʃd'ə]). Similarly (16) a. may also be read as an instruction to rewrite Fionnuala (girl's name) as Fhionnuala (cf. the formulation of (16) ii whereby /ə + f'inu:lə/ becomes [ə inu:lə]); and so on. * We shall have further reason to refer to the ways in which Irish orthography reflects IM at the end of this section.

Returning to the generative model and the apparatus reviewed in § 1.2, we may summarize the nature of the phenomenon of IM in Modern Irish in the words of Ch&H, since it shows "a discrepancy between the syntactically motivated surface structure and what is apparently required as an input to the phonological component" (SPE page 372). Let us take it, then, that part of the readjustment (in the wider sense) which takes place between the syntactic and phonological components in the expanded lexicon involves the assignment of triggers of IM to syntactic surface structures. Thus the phonological surface structures enter the phonological component proper already marked in a way that will trigger the realization rules, those phonological rules which effect the changes when a lexeme "mutates".

* Footnote

Irish orthography represents palatalization by means of the vowels flanking each consonant. Palatalized "slender" consonants are flanked by "slender" vowels (e, i), non-palatalized "broad" consonants by "broad" vowels (a, o, u). In intervocalic position, when vowel quality on either side disagrees, the following vowel predominates and a vowel of the appropriate quality is inserted before the consonant. Hence the aphorism: Caol le caol agus leathan le leathan (Slender with slender and broad with broad). Ref. W. B. Lockwood, 1975. See Ch. III for the "segmenting out" of the feature [+ palatalization] and its interaction with the realization of IM.

Now phonological rules are sensitive to entities of two kinds, phonological segments and morphological features. Put another way, there are two ways in which information relevant to the operation of phonological rules may be encoded in the UR, once again, either as a segment or as a morphological feature associated with it. Referring back to the triggers of IM in the phonological component of a generative grammar of Modern Irish, one is bound to ask: Are triggers phonological segments or are they morphological features (i.e. diacritics)?

Whichever solution we choose we must handle both mutation-types in the same way. This in my opinion would be the flaw in a treatment of realization in Modern Irish along the lines of Rogers' treatment of Modern Scots Gaelic. There Lenition is a morphological feature and Nasalization (= Eclipsis) a phonological segment. Now it may be the case that the phenomena are not comparable cross-linguistically, * but there are certainly empirical grounds against extending Rogers' framework to Irish. Take two prepositions in Modern Irish, /o:/ (ó "from", the more regular), and idiosyncratic /i/ (i "in"), with and without the Article. The data are represented schematically in (18):

- (18) a. /o:/ + Noun → Lenition
 e.g. /o: + buskə/ → [o: wuskə] "from a box"
- b. /i/ + Noun → Eclipsis
 e.g. /i + buskə/ → [i muskə] "in a box"
- c. /o:/ + Art. + Noun → Eclipsis
 e.g. /o: + ən + buskə/ → [o:n muskə] "from the box"
- d. /i/ + Art. + Noun → Lenition
 e.g. /i + ən + buskə/ → [sə wuskə] "in the box"

* Footnote

I am indebted to Neil Mitcheson for referring me to Cram's 1975 paper for clarification of the phonetic motivation behind Eclipsis in Modern Scots Gaelic. I shall refer to it again in the review of Rogers' analysis in Ch. III, § 3.2.

(The sandhi process whereby /o: + ən/ is realized phonetically as [o:n] is regular, whereas the coalescence of /i + ən/ as [sə] recapitulates the historical reduction of /insən/. Nevertheless, [sə] is synchronically opaque, a fact which supports schematism (18) d.)

Given these facts, nothing seems more counter-intuitive than to "explain" half in one way and the other half in another. Why should one preposition require a morphological feature in a given environment, when that same environment attaches a phonological segment to another preposition? Furthermore, this state of affairs is repeated in reverse when the environment is modified by the presence of the Article. Nor can the differing behaviour reasonably be ascribed to the prepositions themselves: they differ only in their sandhi, both being locatives which are realized phonetically as vowels before consonants when the Article is absent. I conclude that before they can be accepted, arguments in favour of a particular treatment must encompass the full range of facts for both mutation-types. Having stressed that I am looking for a unitary treatment of the clearly parallel phenomena in Irish, I shall first consider the segment approach.

To provide a natural solution, a phonological segment conditioning IM must be motivated. Yet it is clear that synchronically there is no such motivated segment present when a given lexeme undergoes IM - one has only to cite that the Preterite requires Lenition in sentence-initial position. * Perhaps the best example of the lack of synchronic

* Footnote

One possible analysis of Lenition in the Preterite postulates the morpheme /də/ in sentence-initial position, whose vowel is elided before a verb-initial vowel and all of which is deleted elsewhere following mutation. Yet even in such a treatment, the Lenition of all consonants except /f, f'/ appears in sentence-initial position on the phonetic surface. See Ch. II for a discussion of this example with regard to triggering. The issue is taken up again in relation to realization in Ch. III.

phonological invariance in the conditioning morpheme is the numeral system where [ɣa:, t'r'i:, k'er'ə, ku:g', ʃe:] (dhá, trí, ceithre, cúig, sé, i.e. 2-6) cause Lenition and [ʃakt, oxt, ni:, d'ec̥] (seacht, ocht, naoi, deich, i.e. 7-10) cause Eclipsis.

Failing this, it would be possible to add a segment or two to the inventory, segments which were obligatorily deleted once IM had taken place. This would be a prime example of Absolute Neutralization. As we noted at various points throughout Part I, Kiparsky has attempted to limit this type of neutralization which occurs when segments are postulated in URs never to appear on the phonetic surface (1973, Fujimura Ed.). Such overly abstract analyses have been attacked in this thesis and arguments put forward in favour of constraints which insure more "realistic" grammars. More particularly, in relation to the segment/feature interpretation of triggers of IM, it is important to point out that the addition of arbitrary segments to the underlying inventory would be a device which amounts to a notational variant of using a diacritic, with the added demerit of violating the Naturalness Condition. I shall have more to say about the latter criticism in a moment.

Perhaps, since synchrony yields nothing, we can follow Halle (1959) and try to recapitulate diachrony in our search for a well-motivated phonological segment. In Insular Celtic, Eclipsis or Nasalization arose historically because sandhi phenomena involving word-final nasals became grammaticalized. The remnants of those nasals remain today when vowels are eclipsed: the Article /nə/ (na) causes Eclipsis in the genitive plural of nouns with an initial consonant and prefixes [n] to an initial vowel, see (19):

- (19) [nə gi:r'i] na gcaorigh < /ki:rə/ caora "sheep"
 [nə nan'əvi:hə] na n-ainmhíthe < /an'əvi:/ ainmhí "animal"

The dental nasal might seem, therefore, to be a strong candidate for the segmental trigger of Eclipsis. What is more, its insertion wherever there is evidence of that mutation-type is less costly just in case it is the maximally unmarked nasal (SPE page 406: marking conventions (XXIIb) and (XXIIIc)). However, an analysis involving /n/ as the trigger of Eclipsis must face two distinct problems. First, not all forms which end in /n/ condition Eclipsis. A case in point is the Common Singular of the Article /ən/, which retains its UR before a Feminine Singular noun beginning with a vowel and not only fails to induce Eclipsis in such nouns with an initial consonant but actually conditions Lenition e.g. [ən i:çə] an oíche "the night"; [ə wad'ən] < /mad'ən/ an mhaidean "the morning". This example seems to sever the connection between prevocalic prefixed /n/ and the triggering of Eclipsis in consonants. If, despite this, the analysis were pursued, it would be necessary to differentiate between those dental nasals which cause Eclipsis and those which do not. Were this effected by a diacritic, it would nullify the arguments for the segment approach. If, on the other hand, the nasals were subclassified by means of a phonetic feature, this would vitiate their unmarked status and would, furthermore, be a notational variant of a diacritic.

The second problem having to be faced by the /n/-analysis revolves round the fact that /n/ will have to be suffixed to all items which induce the mutation-type. In the case of particles which end in a vowel (e.g. the conditionals /murə, da:/ (mura, dá), a permissible surface form results. This in turn presents difficulties regarding the conditions under which [n] is obligatorily deleted following the realization of Eclipsis. On the other hand, the suffixation of the dental nasal to forms ending in a consonant - or even in consonant clusters - produces URs which differ crucially in syllable structure

from phonetic representations e.g. */ʃaxt + n/, */oxt + n/, */d'eq + n/. Of course the existence of such "impossible clusters" does facilitate the statement of n-deletion. But insofar as we accept Hale's constraint that URs should also be canonical forms (1971), such an analysis cannot be entertained.

Let us now examine whether there is a more viable solution to the search for a segmental trigger of the other mutation-type, namely Lenition. Historically speaking, Lenition is the phenomenon of weakening. This weakening was originally conditioned by the position of the consonant between a vowel and a following sonorant or between a sonorant and a following vowel. (See discussion of 'mirror-image rules'. Lenition in Old Breton, Part I § 5). This process became grammaticalized when vowels were lost in final syllables. Moreover it also spread by analogy. As a result, synchronically speaking, not only is the process phonetically opaque, but also it often proves impossible to reconstruct transparent historical correlates to the forms triggering the IM. Thus forms ending in a consonant may condition Lenition e.g. the prepositions /mər/ and /um/ as in [mər ɣin'ə] < /din'ə/ (mar dhuine "as a person"), [um xa:ʃk'] < /ka:ʃk'/ (um Cháisc "about Easter"). Conversely, by no means all particles ending in a vowel induce it - we have mentioned the conditionals /murə, da:/ which trigger Eclipsis.

As an example of the general lack of transparency associated with IM in Modern Irish - and the intractability of the segment approach - take the 3rd. person possessives, realized everywhere as schwa, prefixing [h] to an initial vowel or retaining the radical form for the Feminine Singular, leniting for the Masculine Singular and eclipsing for the Plural or prefixing [n] to an initial vowel (cf. the examples of the prepositional pronoun /in / with these effects in (1) and (2) of § 1.1).

Under the segment hypothesis, one would presumably need to set up three phonologically different URs: /əh/ for the Feminine, /ən/ for the Plural, and /ə/ - or conceivably /əhə/ or /ənə/ for the Masculine. The solutions are schematized as (20):

$$\begin{array}{l}
 (20) \quad \left[\begin{array}{l} +\text{Poss.} \\ +\text{III} \\ +\text{Sing.} \\ -\text{Masc.} \end{array} \right] \longrightarrow \text{əh} / \text{_____} \text{v} \\
 \\
 \left[\begin{array}{l} +\text{Poss.} \\ +\text{III} \\ -\text{Sing.} \end{array} \right] \longrightarrow \text{ən} / \text{_____} \text{ [+seg]} \\
 \\
 \left[\begin{array}{l} +\text{Poss.} \\ +\text{III} \\ +\text{Sing.} \\ +\text{Masc.} \end{array} \right] \longrightarrow \text{ə} \left(\left\{ \begin{array}{l} \text{h} \\ \text{n} \end{array} \right\} \text{ə} \right) / \text{_____} \text{c}
 \end{array}$$

All the statements of (20) must be supplemented by ad hoc rules: in the case of the Feminine, /h/ must be deleted before consonants. This proves less costly than the other ad hoc implementations, inasmuch as an h-insertion rule is necessary in a realistic analysis and this offsets any h-deletion rule. In the Plural, a separate preconsonantal n-deletion must be stated, to apply after the realization of Eclipsis. However, it is in the case of the Masculine that the most serious problems arise: how are we to choose between the candidates for the UR on a non-arbitrary basis? The only feasible solution appeals to tenuous markedness arguments, a fact which can hardly recommend it (cf. Schane's assignment of the vowel in 'rendre' by such a method, (1968), and frequently attacked on grounds of indeterminacy since, e.g. by Vennemann, (1972)).

To take another example of a similar type which also demonstrates the lack of viability of the segment approach to Lenition, consider the rule (21) a. spelling out the Article before consonants, and its interaction with the informally stated Lenition rule (21) b.:

$$\begin{array}{l}
 (21) \quad \text{a.} \quad \text{ən} \longrightarrow \text{ə} / \text{_____} \text{c} \\
 \\
 \text{b.} \quad \text{c} \longrightarrow \text{lenite} / \text{ə} \text{_____} \text{ [+sonorant]}
 \end{array}$$

In a GROD framework, it might well be argued that (21) a. must be extrinsically ordered before (21) b. Of course, such an argument would be fallacious, for in fact (21) a. and (21) b. are in an 'intrinsic feeding' relation - in Hetzron's terms, (21) a. partially supplies (21) b., partially because there are other sources of preconsonantal schwa besides the rule which spells out the shape of the Article. (For 'intrinsic feeding' see Part I, § 2.1; for Hetzron's terminology, see § 3.3).

Now consider the Lenition of /f/ and /f'/, whereby these consonants are deleted. One environment triggering Lenition is, as we have seen, following the Article just in case the noun is Feminine Singular. The UR /ən + farig'ə / (farrage "sea") enters the phonological component where it meets the SD of (21) a., become /ə + farig'ə/. This representation now meets the SD of (21) b. and undergoes Lenition to yield *[ə arig'ə], rather than attested [ən arig'ə] (an fharrage "the sea"). As long as the triggering of Lenition is dependent upon a preceding vowel, the only way to generate the phonetically correct surface form in this case is by a late rule inserting prevocalic [n] to the string /ə+_arig'ə/ (which is now an intermediate representation). Clearly this rule is motivated only to salvage what would otherwise be an observationally inadequate analysis. Furthermore it claims that the prevocalic [n] in [ən ora:ʃd'ə] (an oraiste "the orange") and that in [ən arig'ə] are derived from independent sources. This kind of problem is inherent in the segment approach inasmuch as it treats a morphologically conditioned process, namely Lenition, as if it were phonetically transparent. By a consideration of observational adequacy alone, then, we have a strong argument against treating triggers as phonological segments.

Moreover, there is a persistent problem with treating triggers as segments, which holds equally for both mutation-types. I am referring to the deletion of the conditioning segment once it has served its purpose. Although it is true that a plethora of deletion rules late in the phonology is less undesirable than the same rules early in the phonology (where they would violate Deletion Cession), the appearance of such a block anywhere strikes me as over-powerful. And the segment approach would necessarily result in a "string" of ad hoc deletions in most of the environments where IM is triggered. For not only is there no limit to the number of abstract segments that could be postulated nor any limit to their nature, but, as I mentioned earlier, underlying segments which are always deleted during the course of a derivation pose a serious violation of the Naturalness Condition. To the extent to which the Naturalness Condition denies that phonological structure is an arbitrary code, it asserts that the relationship between phonological and phonetic structures is a natural one. This implies that much of the mapping between phonological and phonetic features can be given universally and need not be stated time and again for each language. A segment solution to the problem of IM in Irish necessitates unnatural statements for the realization of underlying segments in particular phonological environments, namely, after the dental nasal and intervocalically across a morpheme boundary (more rigorously, in the context [+ vocalic] + _____ [+ sonorant]). Further unnatural statements are then needed to effect the absolute neutralization of the segments that constituted those environments.

In the light of these strong arguments against the segment approach, let us turn to the feature approach - the case for treating the triggers of IM as diacritic (morphological) features namely [+ Lenition] and [+ Eclipsis]. The difference between a diacritic and a phonological

segment is that whereas the former has phonetic consequences, it does not share the phonetic content of the latter. In other words diacritics are not subject to the Naturalness Condition. Thus although morphological features may at first seem more abstract than underlying segments, it is their very quality that leads to a more concrete solution. We are no longer treating IM as if it were phonologically transparent, but rather, reflecting its morphosyntactic conditioning; by analysing the phenomenon of IM as morphological, a more "realistic" grammar results. It is in this sense that the feature approach represents a more natural solution over the segment approach.

This almost paradoxical situation has desirable repercussions in relation to the other phonetic processes and morphosyntactic features that need to be posited for Modern Irish. The fact that IM is marked by a feature sets it apart from sandhi processes which have not been morphologized. These will typically be low-level assimilation processes, most commonly the assimilation of palatalization or velarization e.g. [do:l ə f'ar] d'ól an fear "the man drank", but /do:l ʃe:/ → [do:l' ʃe:] d'ól sé "he drank". Alternatively they involve the modification of the precise point of articulation of consonants or of the quality of vowels under the influence of their immediate environment. As such they are assigned to the n-ary Phonetic Detail Rules. In contrast, the kind of phonetic variation introduced by the processes of IM involves changes in the binary value of distinctive features near the top of the phonological hierarchy. To put this differently, IM brings about alternations in archisegments. This of course is simply a consequence of its morphosyntactic status, a status which is more naturally reflected by the representation of triggers as features.

In conclusion I shall make a few remarks regarding the notion of 'level of representation' in relation to Irish orthographic practice. It is

interesting to observe, in the light of the above discussion in the generative framework, that until recently Irish orthography represented Lenition as a diacritic: a lenited consonant had a dot placed above it. This may be viewed as a phonological surface structure for the radical form of the lexeme is preserved intact while a trigger has been assigned. * Today Lenition is indicated in written Irish by inserting h after the mutated consonant. Inasmuch as h has a phonetic reflex as the glottal fricative, this orthographic practice would be considered a violation of the Naturalness Condition, were it adopted in linguistic analysis. Such a treatment would be reminiscent of Lamb's defence of autonomous phonemics, (1966) where he proposes a "phoneme of devoicing", /h/, to be "segmented out" from Russian voiceless obstruent clusters. Thus any "segmenting out" of a "phoneme of weakening" from lenited consonants in Modern Irish would be subject to the rigorous arguments of Postal (1968) regarding its ontological status.

The fact that Irish orthography adopts an unnatural mode of representing Lenition whilst this is not true of the broad transcription used throughout Part II, means that the latter comes closer to being an optimal surface representation of the language. In relation to IM, Irish spelling may be criticized further for not treating the mutation-types in a parallel fashion - something which has been a prerequisite to our discussion in this section. In the case of Eclipsis, in contrast to Lenition, the eclipsed consonant is written before the radical, e.g.

* Footnote

David Greene (1966) explains that the dot was originally a "punctum delens" placed over a lenited f (= \emptyset) and lenited s (= [h]) to indicate that these sounds had been (virtually) lost. "In time the h in bh, ch, dh, etc., came frequently to be written over the letter, and was finally confused with the dot of f and s, so that bh and ḃ could be used interchangeably." (page 18).

mbosca for [muskə] < /buskə/. Complication arises with underlying /f/ and /f'/ which eclipse to [w] and [v] respectively, since the latter consonant-pair can only be rendered as bh orthographically, there being no letters w or v in the Celtic alphabet. Consequently, [ə vek'ən ʃe:] ("does he see?") must be spelt An bhfeiceann sé?

These intricacies apart, it is clear that by implicitly denying that Eclipsis and Lenition are parallel phenomena, Irish orthography fails to qualify as a near-optimal mode of representation for the language at any level. In contrast, phonological surface structures (i.e. the input to the phonological component proper) may be characterized as optimal morphophonemic representations vis à vis IM, just in case they "encapsulate" that level at which it is triggered but not realized. When such representations are evaluated in terms of their explanatory power, they may be viewed as embodying the claim that the two discrete stages of triggering and realization of IM are psychologically real for native speaker-hearers of Modern Irish.

§ 1.4 Concluding Remarks: an Historical Comment

The central argument of this chapter has been that IM in Modern Irish should be characterized in terms of the processes of triggering and realization. It was claimed that any analysis which fails to differentiate between these two, is fundamentally deficient in terms of descriptive adequacy. In § 1.2 we reviewed the theoretical apparatus made available by the generative model. Inasmuch as certain feasible treatments within that framework did not permit or facilitate the representation of IM as a two-stage process, they were rejected. It was then argued at length that the lexicon, together with readjustment, comprised a component which could be readily expanded so as to accommodate the triggering of IM, along with certain other morphological phenomena (in particular Aronoff's derivational morphology.)

Because the generative model has as its goal explanation of the native speaker-hearer's competence, rather than just the classification of the data, it must necessarily provide the linguist with a sufficiently rich set of theoretical devices with which to characterize that competence. It is in this sense that the generative model is best equipped to capture significant generalizations concerning IM in Modern Irish. Having treated questions about the nature of the phenomenon of IM and the incorporation of an account of it into generative theory as if they were independent, we have developed a framework within that theory which reflects speaker-hearer's intuitions. In other words, the answers to both questions have pointed in the same direction.

More specifically, once the exegesis leaves the overall organisation of the grammar and turns to the precise nature of triggers of IM (§ 1.3), the claim that triggering assigns diacritics to syntactic surface structures, the hypothesis accrues further support. In particular,

evidence has been provided that triggers are morphological features rather than underlying segments. This is a reflection of the fact that IM is a morphologized process, rather than a phonetically transparent one. Yet we know that historically IM was a regular phonetically conditioned sandhi phenomenon. The question which must now be raised is the following: How did the phonetic processes become morphologized?

We touched upon the topic of morphologization at two points in Part I. In § 'Simultaneous Rule Application in KSN', we cited Hooper's claim that vowel laxing had become morphologized in the eastern Andalusian dialect of Spanish whilst its phonetic motivation was still optionally present on the surface. **Then in Ch. 5** a similar proposal was put forward regarding Lenition in Old Breton. We shall now reiterate those arguments in more detail for the transition of Old Irish to the present-day language.

Whenever we have had recourse to mention the historical origins of IM in Irish, we have described it as the phenomenon of sandhi. This is a Sanskrit term meaning "joining" and its use entails what Matthews calls "some phonetic rationale" (1974, page 101). To the extent that there is a general explanation in (inter alia) articulatory terms for a particular linguistic phenomenon, it may be deemed phonetically natural. It is just this kind of phonetic explanation which is appropriately applied to the modifications which took place in Old Irish between 450 and 550 A.D. (Lockwood 1975, pages 82-3).

Three different types of process may be distinguished, each one induced by the final segment of the preceding morpheme (Thurneysen 1946, page 141, § 229): final vowels induced the weakening of consonants "which normally originated in a reduction of the energy employed in their articulation" (ibid. page 74, § 118), and resulted in Lenition; words ending in -n triggered homorganic nasal assimilation in the following

consonant and was the precursor of Eclipsis (ibid. page 147, § 236); gemination, already in decline in Old Irish, was induced by final -s or postvocalic -t and -k - the synchronic reflex of this process is the prefixation of [h] to initial vowels after a final vowel, for this Minor Mutation shares the conditions of Old Irish gemination (ibid. page 150, § 240).

Given that IM was phonetically transparent in Old Irish but phonetically opaque by Middle Irish, the crucial issue revolves round the relative timing of morphologization and the loss of the conditioning segments. It is my contention that morphologization took place whilst the conditioning segments were still present on the phonetic surface. Under the hypothesis regarding IM developed in this thesis, morphologization entails the assignment of triggers which will condition realization rules in the phonological component, rules which previously depended on final segments for their conditioning. Only by assuming that triggers came to "spark" IM whilst that phenomenon was still technically sandhi, ~~can we~~ explain the fact that each set of systematic alternations was morphologized en bloc. Logically there are numerous possible ways in which particular alternations could have become morphologically conditioned. In striking contrast to this possibility, we find that disparate phonological processes have morphologized in exactly the same way. Under the hypothesis developed here this is afforded a very natural explanation: a trigger was associated with each of the three types of final segment which conditioned sandhi in Old Irish. In time native speaker-hearers interpreted the triggers alone as being responsible for the phonetic alternations - IM had been morphologized. Precisely because of this fact the subsequent loss of final segments did not affect IM. In other words, IM was not morphologized because final segments were lost, but rather the loss of final segments was encouraged by the morpho-

logization of M (cf. the same point made by Hooper for Spanish, 1976, page 87.)

This strong hypothesis regarding the rôle of triggers in language change is borne out by diachronic evidence of parallel developments throughout Insular Celtic - i.e. in the Brythonic branch (Welsh, Cornish, Breton), as well as the other Goidelic languages (Modern Scots Gaelic, Manx Gaelic). If it would be highly implausible to attribute the uniform morphologization of disparate phonetic alternations to "linguistic coincidence" for one set of language data, such a pseudoexplanation is even more far-fetched for an entire language family - in which, furthermore, the phenomena evolved independently.

With these facts in mind, we shall pursue to its logical conclusion in the remainder of this thesis the two-stage hypothesis incorporating the notion "trigger of M ". It is to the process of triggering that we now turn in Chapter Two, reserving an examination of realization until Chapter Three.

CHAPTER TWO - TRIGGERING

The concern of this chapter is to explicate the process of triggering, given the characterization of IM presented in the Fragestellung.

Various aspects of triggering will be taken up, beginning in § 2.1 with the substantiation of the claim that triggering may be read off syntactic surface structures directly. The section will take the form of an overall survey of triggering environments and a comparison will be drawn with Welsh. In § 2.2 we examine one of the more complex areas of Irish morpholexis, namely, the status of the particle. Here it will be shown that the adverb does not constitute a major lexical category in Modern Irish and IM in compounds will be dealt with. § 2.3 turns to the literature and comprises a critique of Hamp's pioneering approach to IM and its logical extension within the structuralist framework. The chapter closes in § 2.4 with a section devoted to a rigorous formalization of triggering. Not only is there detailed discussion of the precise formal statement of each process but interaction with other processes within the expanded lexicon is exemplified.

§ 2.1 A Survey of Triggering Environments

In Chapter I the preliminary assumption was made that the triggering of IM in Modern Irish is sensitive to syntactic surface structure, but not to levels of representations prior to syntactic surface structure. The time has now come to substantiate that assumption, for, as it is important to emphasize, there is no logical reason behind the claim that triggering does not have access to deep structure. Indeed it is logically possible that some triggering should take place within the syntactic component whilst further triggering requires access only to the output of that component. Such appears to be the case for Welsh, according to Gwenllian M. Awbery (1975). Awbery's paper is particularly significant for the hypothesis developed in this thesis in recognizing two aspects to IM: "the actual sound changes" (= my realization *) and "the environments in sentences which trigger these changes".

Moreover, Awbery's position on IM is of metatheoretical interest. Having demonstrated that homonymous environments may trigger different mutation-types in Welsh, Awbery makes the preliminary observation that "the mutation rules appear to be determined by syntactic and lexical environments of several different types" (ibid. page 19). She then proceeds to cite four different types of environment, two of which require access to information present in deep structure but not in the corresponding

* Footnote

It is important to stress that Awbery uses the term "realization rules" to refer to what I call "Phonetic Detail Rules", *Secundum Postal 1968*. Thus Awbery's "realization rules" "expand the information given by the distinctive features about the segments" (ibid. page 16) e.g. after a "phonological mutation rule" has converted b to v, a "realization rule" accounts for the fact that b and v differ in place of articulation. In my analysis, a realization rule accounts for the spirantization of b to v, whilst a Phonetic Detail Rule later specifies the labiodentality of the latter segment.

surface structure. Now although it is logically possible that some instances of IM must have access to deep structure, whilst the remainder are read off surface structure, it is also a priori undesirable theoretically. To spell this out a little more fully, given that IM is in part necessarily phonological, the simplest theoretical position to assume is one that requires the least "distance" between the morphosyntactic origins of IM and its phonological repercussions. In other words, Awbery's claim represents a particularly powerful one in terms of the range of possible interactions between syntax and phonology regarding IM: aprioristically we should prefer to maintain our preliminary assumption. Given the powerfulness of Awbery's position, it will be revealing to examine instances of IM in Modern Irish in comparable environments to those which (purportedly) refer back to deep structure in Welsh. If evidence is brought to light that these and related deep structures do not condition IM, we may conclude that our preliminary assumption was justified. This, then, is the form our discussion will take: we shall examine Awbery's four triggering environments in turn, and compare each in detail with data from Modern Irish. In this way it will not only be demonstrated that such a powerful position is untenable for Irish, but the evidence supporting that claim for Welsh will also be undermined.

The first type of triggering enumerated by Awbery, is that of lexical environments, which she defines as follows: "Certain words cause the following word to undergo a mutation with the particular mutation required being an idiosyncratic property of the triggering word". (ibid. page 19). Awbery exemplifies lexical triggering with the prepositions i (to), tia (towards) and an (in), which condition the Soft, Aspirate and Nasal Mutations respectively in the following noun. Thus underlying tondi (Tondu, a place name) appears as dondi, θondi or nhondi respectively

on the phonetic surface. Here we may draw direct parallels with Modern Irish, where prepositions may also be regarded as conditioning lexical triggering. For example, the preposition /i/ (i, "in") causes Eclipsis of the following noun, as seen in [i d'ax] < /t'ax/ (i dteach "in a house"); and [i gran] < /kran/ (i gcrann "in a tree"). On the other hand, /d'e/ (de "from") lenites the following noun e.g. [d'e hax] (de theach "from a house"); and [d'e xran] (de chrann "from a tree"). The supplementary or Minor Mutation by which [h] is prefixed to a vowel may also be lexically triggered. Thus /gə/ (go "to") and /l'e/ (le "with") condition the prefixed aspirate in [gə he:r'in'] (go hÉirinn "to Ireland") and [l'e har'ig'əd] (le hairgead "with money").

Awbery captures the salient characteristic of these instances of IM between a preposition and its object when she makes the observation that "The triggering and mutated items are always in a close syntactic relation" (ibid. page 20). Another case which she classifies in this way is the possessive pronoun triggering IM in the following possessed noun. (1) a.-d. gives Awbery's exemplification of this case: (=1. - 4. page 14, ibid.)

(1) a. [maj r ti əno]

"The house is there". (literally: is the house there)

b. [maj də di əno]

"Thy house is there".

c. [maj ej θi əno]

"Her house is there".

d. [maj və nhi əno]

"My house is there".

(1) a.-d. may now be compared with the Irish data of (2) a.-d. which contain instances of unmutated, lenited and eclipsed forms of near translation-equivalents (altered only to illustrate both mutation-types).

(2) a. [ta: ə t'ax ənʃin']

Tá an teach ansin.

"The house is there".

b. [ta: də hax ənʃin']

Tá do theach ansin.

"Thy (= your*) house is there".

c. [ta: ə t'ax ənʃin']

Tá a teach ansin.

"Her house is there".

d. [ta: a:r d'ax ənʃin']

Tá ár dteach ansin.

"Our house is there".

(3) a.-d. provide examples of the triggering of the minor mutations before an initial vowel in environments comparable to those of (1):

(3) a. [ta: ə tahir' ənʃin']

Tá an t-athair ansin.

"The father is there".

b. [ta: t ahir' ənʃin']

Tá t'athair ansin.

"Your (sing.) father is there".

c. [ta: ə hahir' ənʃin']

Tá a hathair ansin.

"Her father is there".

d. [ta: a:r nahir' ənʃin']

Tá ár n-athair ansin.

"Our father is there".

* Footnote

David Greene comments that Modern Irish is unique amongst the languages of Europe in always using the 2nd person singular pronouns when one person is addressed. (1966, page 5).

In (3)b. the t preceding /ahir'/ is the prevocalic allomorph of /də/ (do "your") whereas in (3)a. the t is the realization of a Minor Mutation triggered by the Article. Notice also that the occurrence of prefixed n in (3)d. in the same environment as Eclipsis in (2)d. reflects the historical source of the latter mutation-type as a sandhi process involving final nasals.

The triggering of IM in an adjective following an adverb is also viewed as lexical triggering by Awbery, although she remarks that it is in part syntactic (presumably a reference to the rôle played by the syntactic categorization of the elements in determining IM). This leads her to the conclusion that lexical triggering "may possibly be definable in terms of the head of a phrase being mutated under the influence of a modifying 'prefix' word" (ibid. page 20). Whilst I agree with this conclusion, I do not base it on an analysis of the translation-equivalent of "too" in Awbery's example as an adverb in Irish. Rather, as I shall argue in §2.2, there are grounds for re-analysing what may traditionally be called adverbs in Modern Irish, and for claiming that Adverb is not a major lexical category in this language. Thus, whilst I am ignorant of the corresponding arguments about the situation in Welsh, I choose not to regard [ro:] in (4)b. as an adverb, despite the fact that Awbery analyses ri in (4)a. in precisely this way:

(4) a. (= Awbery's (28), page 20, ibid.)

[maj win ən ri dɛw]

"Wyn is too fat".

b. [ta: l'iəm ro: raur]

Tá Liam ró-ramhar.

"Liam is too fat".

Instead of adopting the analysis of [ro: raur] as Adverb + Adjective, the phrase may be treated as an adjectival one with a prefixal modifying

particle. Other particles whose function is to modify adjectives, are /an/ (an- "very") and /r'i:/ (rí- "exceedingly"). All three are therefore entirely comparable to /gə/ (go "-ly") whereby an adverb is derived from an adjective. The leniting effect of /ro:, an, r'i:/ is seen in the data of (5) - this effect was vacuous in the Irish sentence (4)b. since r does not mutate, but the realization of underlying /tɛw/ as [dɛw] in the Welsh sentence (4)a. is evidence of the comparable triggering of the Soft Mutation.

(5) i)	a.	[mah]	ii)	a.	[fuər]
		<u>maith</u>			<u>fuar</u>
		"good"			"cold"
	b.	[ro: wah]		b.	[ro: uər]
		<u>rómhaith</u>			<u>rófhuar</u>
		"too good"			"too cold"
	c.	[a:n wah]		c.	[a:n uər]
		<u>an-mhaith</u>			<u>an-fhuar</u>
		"very good"			"very cold"
	d.	[r'i: wah]			[r'i: uər]
		<u>rímhaith</u>			<u>rífhuar</u>
		"excellent"			"below freezing"

Summing up the argument so far, what Awbery considers a possibility, I regard as a true characterization of so-called lexical triggering - namely, the analysis of IM which affects the head of a phrase as being conditioned by a modifying 'prefix' word. In Modern Irish, the head of a phrase will be either a Noun, Verb or Adjective. Particles like the Interrogative and Negative will condition the IM in following verbs (see Table VI §3.2, where these particles are used to illustrate the phonetic extent of IM); intensifiers and other types of qualifiers will induce IM in adjectives, whilst the process whereby an adverb is

derived from an adjective may also be regarded as productive IM; finally, anything which may fill the Determiner slot potentially conditions IM in an NP, whilst the nonlexical category Preposition may have the same effect in a PP (the combination of Preposition + Article + Noun and its relation to bare Article + Noun is treated in §2.4 pages 453-5).

The most striking aspect, then, of this type of triggering which is so prevalent in Modern Irish, is the presence of a particle-like word preceding the major lexical item subject to IM. Since 'lexical' applies tautologically to the mutated word and is inappropriately applied to grammatical items like particles, determiners, possessive pronouns etc., I shall not adopt Awbery's use of the term "lexical environments".

When the need arises to refer specifically to this type of triggering environment, I shall employ the term Particle Triggering. It is important to emphasize at this point that the particle does not constitute the 'trigger of IM' in the specialized sense defined in this thesis. Rather, the trigger of IM is the diacritic feature ([+ Lenition] or [+ Eclipsis]) which is assigned to the noun, verb or adjective by virtue of the presence of a particular preceding particle (in the case of Particle Triggering). Although I cite Awbery's non-technical use of 'trigger' and 'triggering' and despite the fact that I employ these terms loosely myself in unambiguous contexts, the distinctions should be borne in mind.

Having adopted the term Particle Triggering in place of Awbery's use of 'lexical', for one particular type of conditioning environment, it must be pointed out that neither in Modern Irish nor Welsh is there a clear dividing line between this mode of triggering and Awbery's second classification, namely Categorial environments. These Awbery defines by stating that "Certain sequences of categories in the sentence trigger mutations" (ibid. page 20). However this could equally well apply to

Particle Triggering, inasmuch as particles are members of syntactic categories and the concatenation of particle-type words plus major lexical items constitute "certain sequences of categories". The obscurity of the definition is increased by the fact that Awbery cites only one example from Welsh of a categorial environment. Let us examine that example and look for comparisons in Modern Irish in an attempt to clarify Awbery's distinction.

In Welsh an adjective following a feminine singular noun undergoes Soft Mutation. A precisely parallel situation obtains in Modern Irish as is shown by the comparison of the NPs [ə van wo:r] (an bhean mhór "a big woman") and [ə f'ar mo:r] (an fear mór "a big man"). Underlying /mo:r/ is lenited to [wo:r] just in case it follows feminine singular /b'an/. Thus syntactic features may be relevant to this kind of triggering. As Awbery points out, they may be relevant to the first type of triggering in Welsh also. Furthermore, the rôle of syntactic features is a characteristic shared by Particle Triggering and (so-called) Categorial Triggering in Irish. Let us exemplify them both from Welsh and Irish. In (6) Welsh feminine singular mɛrx ("girl") is contrasted with masculine singular baxgɛn ("boy") and the feminine plural, following the Article, qualified in each case by the adjective bax ("little"):

- (6) a. [ə vɛrx vax] = Awbery's 32. (1975 p.20)
 "the little girl"
 b. [ə baxgɛn bax] = Awbery's 33. (ibid.)
 "the little boy"
 c. [ə mɛrxɛd bax] = Awbery's 34. (ibid.)
 "the little girls"

In (7) Irish feminine singular /g'ir'ʃax/ (girseach "girl") is compared with masculine singular /gasu:r/ (gasúr "boy") and the feminine plural, also following the Article, again accompanied by /b'eg/ (beag "little"):

- (7) a. [ə jir'ʃax veg]
an ghirseach bheag
 "the little girl"
- b. [ə gasu:r b'eg]
an gasúr beag
 "the little boy"
- c. [nə g'ir'ʃaxə b'egə]
na girseacha beaga
 "the little girls"

Just as the feminine noun in the singular in Welsh undergoes Soft Mutation, whilst this is not the case either for masculine nouns or plural feminines, so in Irish the feminine singular /g'ir'ʃax/ lenites, although this is not true of the masculine /gasu:r/ nor of the plural /g'ir'ʃaxə/. Similarly, it is only the adjective which qualifies the feminine singular noun that undergoes Soft Mutation in Welsh and Lenition in Irish.

The subjectivity of Irish feminine nouns both to lenite themselves and to condition Lenition in their attributive adjectives irrespective of the presence of the Article (cf. [g'ir'ʃax veg] ghirseach bheag "a little girl"), is in no way connected with their gender per se: for masculine nouns are equally susceptible to IM. Thus the Article induces a Minor Mutation, the prefixation of a voiceless coronal plosive before masculine singular nouns which have an initial vowel, e.g.

- | | | |
|--------|---------------------|-------------------|
| (8) a. | [u:l] | [ə tu:l] |
| | <u>úll</u> Masc. | <u>an t-úll</u> |
| | "an apple" | "the apple" |
| but b. | [ora:ʃd'ə] | [ən ora:ʃd'ə] |
| | <u>oráiste</u> Fem. | <u>an oráiste</u> |
| | "an orange" | "the orange" |

or again	c.	[iʃg'ə]		[ə tiʃg'ə]
		<u>uisce</u>	Masc.	<u>an t-uisce</u>
		"water"		"the water"
but	d.	[i:ç'ə]		[ən i:ç'ə]
		<u>oíche</u>	Fem.	<u>an oíche</u>
		"a night"		"the night"

The phonetic shape of the Article in b. and d. (viz. [ən] ~ [ən']) and the distribution of [t] vs. [t'] are conditioned by the following lexeme which may or may not commence with a [+pal] segment. We shall present the arguments supporting the postulation of such segments in §3.2. The related issue of sandhi before lenited /f(')/ (phonetically zero or bare /'/) is also taken up in §3.3 where the following data are explicated:

(9) a.	[farig'ə]		[ən arig'ə]
	<u>farraige</u>	Fem.	<u>an fharraige</u>
	"sea"		"the sea"
b.	[f'e:l'ə]		[ən' e:l'ə]
	<u>féile</u>	Fem.	<u>an fhéile</u>
	"a feast-day"		"the feast-day"

Let us now turn from the specific details of so-called Categorical environments, to more general considerations of the Irish data surveyed so far. In view of the rôle played by the morphosyntactic features associated with a major lexical category in triggering IM, I shall coin the term Feature Triggering. I thus abandon Awbery's label "Categorical", on the grounds that it is both opaque and unhelpful, in that it leads us to regard the IM of an adjective following a feminine noun as being essentially different from the IM which that noun itself undergoes. Of course, this is not to deny that there is a difference between the two cases - the Lenition of a feminine singular noun is indeed partially

dependent on the presence of the Article, whereas that of the accompanying adjective is not. However, by applying the term Feature Triggering to both the noun's Lenition and the adjective's Lenition, we capture the fact that both are induced by the presence of the morphosyntactic feature Feminine associated with the noun. The partial dependence on the Article evidenced in the Lenition of the feminine is then reflected by permitting Particle Triggering (henceforth PT) and Feature Triggering (henceforth FT) to operate jointly in this case. Thus a feminine singular noun mutates both by virtue of its gender (FT) and by virtue of the presence of the Article (PT).

Further motivation for singling out FT and distinguishing it from PT is the fact that phonological (rather than morphosyntactic) factors may play a rôle in conditioning FT but not PT. Thus an adjective qualifying a plural noun is lenited, if that plural noun ends in a palatalized consonant, as seen in (10):

- | | | | |
|------|----|-----------------------|-------------------------|
| (10) | a. | [ə f'ar mo:r] | [nə f'ir' wo:rə] |
| | | <u>an fear mór</u> | <u>na fir mhóra</u> |
| | | "the big man" | "the big men" |
| | b. | [ə kran glas] | [nə kran' ɣlasə] |
| | | <u>an crann glas</u> | <u>na crainn ghlasa</u> |
| | | "the green tree" | "the green trees" |
| | c. | [ə kapəl ba:n] | [nə kapəl' wa:nə] |
| | | <u>an capall ban</u> | <u>na capaill bhana</u> |
| | | "the white horse" | "the white horses" |
| | d. | [ə tu:l d'arəg] | [nə hu:lə d'arəgə] |
| | | <u>an t-úll dearg</u> | <u>na húlla dearga</u> |
| | | "the red apple" | "the red apples" |
| | e. | [ə van wo:r] | [nə mnã: mo:rə] |
| | | <u>an bhean mhór</u> | <u>na mná móra</u> |
| | | "the big woman" | "the big women" |

The nouns of a.-c. end in nonpalatalized consonants in the singular and form their plurals by palatalizing that final consonant (a process referred to in traditional grammars as 'attenuation'). This in turn conditions the Lenition of the attributive plural adjective. When it does not follow a palatalized consonant, the plural adjective will not undergo IM as seen in d. and e., despite the fact that in the singular of e. "woman" induces FT in the qualifying adjective by virtue of the feature Feminine. In fact it is unclear if the feature Masculine which accompanies the nouns a.-c. constitutes a pre-condition on the phonological aspect of FT; that is, we may ask whether a plural noun must first, be masculine and secondly, end in a palatalized consonant, before Lenition may apply. This is because of what may be called a "systematic gap" in Irish plural formation - only masculine nouns form their plurals by palatalization (cf. feminine /g'ir'ʃax/ with a final nonpalatalized consonant which forms the plural not by final palatalization but by the suffixation of schwa - see (7) c. (page 381)). Thus whether or not the feature Masculine is stipulated as part of the environment triggering Lenition in a plural adjective, the output of the grammar will be the same. We will take up the formalization of the phonological conditioning in §2.4. Suffice it to stress in the discussion of triggering, that this interplay between morphosyntactic and phonological factors is a characteristic of FT but not PT.

Leaving differences aside and returning to Awbery's analysis of Welsh, there is an important property which is shared by the first two kinds of triggering, namely that the triggering and mutated words are in a close syntactic relation. To sum this up for Modern Irish, IM subsuming PT and FT is phrase-internal. Restating this in the words of page 323, IM does not operate across major constituents of the sentence - it may be read off syntactic surface structure directly. It would seem, then, that the preliminary assumption which was made in Chapter One regarding

IM holds true, inasmuch as it is valid for the two types of triggering that we have identified i.e. PT and FT. However Awbery's two final classifications of IM remain to be examined. Only provided it can be established that these types of triggering are not evidenced in Modern Irish, will our assumption have been fully substantiated.

The third type of triggering defined by Awbery involves Structural environments. Here I cite her second example first as it is more easily dispensed with. In Welsh the vocative phrase undergoes Soft Mutation. This is true of Lenition in Irish, with the important difference that a vocative particle [ə] (a) is obligatorily present. Thus whereas the Soft Mutation of underlying /bɛxɡɪn/ ("boys") in Welsh yielding [vɛxɡɪn] may be attributed solely to its syntactic (vocative) rôle, the Irish examples of (11) may be accounted for under PT:

- | | | |
|---------|--------------|---------------------|
| (11) a. | [mak] | [ə vik'] * |
| | <u>mac</u> | <u>a mhic!</u> |
| | "son" | "my boy!" |
| b. | [gra:] | [ə ɣra:] |
| | <u>grá</u> | <u>a ghrá!</u> |
| | "love" | "my love!" |
| c. | [toma:s] | [ə homa:ʃ] |
| | <u>Tomás</u> | <u>a Thomáis!</u> |
| | "Thomas" | "Thomas!" |

* Footnote

The vocalic alternation and accompanying palatalization in [mak] > [m'ik'] is determined by case and number, the common and dative singular and the genitive plural exhibiting the open vowel, the common and dative plural and genitive singular exhibiting the close vowel plus palatalization. Since the vocative of the First Declension has the same form as the genitive in the singular, this accounts for a. Similar considerations apply in the vocative of the Proper Noun /toma:s/ = c. See also the examples of (10) for parallel phenomena in Irish noun morphology.

- | | | |
|---------|--------------|------------------|
| (11) d. | [ma:r'ə] | [ə wa:r'ə] |
| | <u>Máire</u> | <u>a Mháire!</u> |
| | "Mary" | "Mary!" |

Let us therefore account for the Lenition in (11) in terms of the presence of the vocative particle. Admittedly this begs an important question regarding the homonymity of the leniting vocative particle, on the one hand with the third person possessive particles, and on the other hand with the preconsonantal reflex of the Article. These however are problems with which we shall have to deal in any case: in other words, they do not constitute a problem peculiar to the Irish counterpart of Structural environments in Welsh. Let us therefore postpone what may be termed the problem of homonymous particles until § 2.4 and consider Awbery's first example of a Structural environment in Welsh.

According to Awbery's 1975 paper, direct objects undergo Soft Mutation in Welsh. This appears to be what is happening when ki ("dog") surfaces phonetically as [gi] in the sentence [gwɛlɔð win gi] ("Wyn saw (a) dog") (= Awbery's 35, 1975). However, upon closer inspection, to say that direct objects are subject to IM amounts to only a first approximation. A more explicit statement of the actual situation may be found in Awbery's "Syntax of Welsh" (1976). Here we learn that "The initial sound of the leftmost lexical * item in the direct object constituent must be changed into the corresponding soft mutation initial" (1976 page 8). Thus despite the fact that Awbery accounts for the triggering of IM of the direct object by the syntactic transformation (12):

* Footnote

"Lexical item" is here synonymous with "word" as opposed to "word-form" on the one hand and "lexeme" on the other, in the senses of Matthews (1974). That Awbery does not intend to refer only to major lexical categories is clear from the fact that her usage covers the definite article.

(12) = Awbery's (18) 1976

T. Soft Mutation of Direct Object (obligatory)

SD. (_S V NP NP X)

1 2 3 4 5

SC. Add the feature [+soft mut] onto 4,

when the determiner is present in 4, the noun itself is protected from undergoing IM, as in Gwelodd y ci (= Awbery's (20) page 9, *ibid.* "He/she saw the dog", where orthographic 'c' = [k]).

These facts suggest that something essentially different from PT and FT is going on when Soft Mutation is triggered in direct objects in Welsh. What is not clear, however, is whether triggering has access to information about deep structure in such cases. Perhaps we may gloss the type of triggering involved in terms of "linear position in the labelled bracketing of the sentence". Implicit in such a gloss is the rejection of "structural rôle" as the factor responsible for conditioning IM. For notice that if a noun in Welsh underwent Soft Mutation by virtue of the fact that it bore the relation of direct object to the verb, it would still mutate irrespective of whether the determiner were present or not. Put slightly differently, the grammatical status of direct object does not vary in accordance with the presence or position of the determiner.

Let us assume, then, that the Soft Mutation of the direct object in Welsh involves counting the second NP to the right of the verb and identifying whether the leftmost item of that constituent is a noun - at the level of syntactic surface structure. Two points need to be mentioned here. First, I take it to be the case that if the verb has not been directly generated in initial position by the Base rules, then the obligatory transformation which raises it from the VP has applied early in the transformational component. Secondly, moving on to syntactic

rejected, the sensitivity of the triggering of Soft Mutation to the number of NPs to the right of the verb fits in with the above characterization of the process involved. If such a treatment were to be adopted, as I am inclined to think it should be, it is plausible that the subject-verb agreement could be accounted for in terms of a rule, redundantly filling in the appropriate markers for subjectless verbs. Notice, finally, that even though it does not mutate, plant in (13)b. is nevertheless the deep structure object for the purposes of semantic interpretation. I conclude that the Soft Mutation of the direct object in Welsh is not sufficient to establish the claim that IM has access to deep structure. A detailed discussion of this and other issues regarding IM in Welsh is given in Bellin and McBrearty (in preparation).

Turning to the possibility of a comparable claim for Irish, the Lenition of the direct object in (14)a. is ascribable to the interaction of PT and FT in feminine singular nouns following the Article (an instance of triggering discussed on page 380 above).

- (14) a. [wuəl' ə gasu:rə jir'ʃax]
Bhuail an gasúr an ghirseach
 "The boy hit the girl".
- b. [wuəl' ə jir'ʃax ə gasu:r]
Bhuail an ghirseach an gasúr
 "The girl hit the boy".

The fact that /g'ir'ʃax/ does not undergo IM by virtue of its rôle as direct object of the verb /buəl'/ is seen by comparison with (14)b. in which the subject and object of (14)a. have been interchanged. The feminine noun still appears in its lenited form, irrespective of the fact that it is not the subject of /buəl'/. To sum up, the syntactic rôle of a noun is encoded by word-order and in no way affects the triggering of IM in Irish.

However, other data might be brought forward to support the claim that the direct object does undergo IM in Irish in embedded sentences. More specifically, the direct object of a verbal noun is frequently found in its mutated form. Consider [wa:ʃ] in (15), the lenited reflex of /bá:s/ (bás "death").

- (15) [vi: ə ʃandin'ə ə fa:l' wa:ʃ]
Bhí an seandúine ag faghail bháis

"The old man is dying".

If we derive the complement "dying" from an embedded sentence containing the structure [fa:n....ba:s] (faigheann....bás "(he) gets death i.e. dies"), then we might be drawn to such a conclusion. On the other hand, the idiomatic status of the PP [ə fa:l' wa:ʃ] suggests that we should look for more productive examples. (ÓHuallacháin & ÓMurchú note that this idiom is an exception to their statement of the lack of IM in the indefinite objects of verbal nouns; 1976, page 147). Consider therefore:

- (16) [xunik' m'e: ə f'er'im'o:r' ə p'ukə nə bra:ti: agəs ə ban't'
ən' e:r']

Chonaic mé an feirmeoir ag piocadh na bprátaí agus ag baint
an fhéir

"I saw the farmer picking the potatoes and cutting the hay".
 Notice first that (16) in fact provides equivocal confirmation of the claim that the direct object of a verbal noun mutates: apparently different verbs condition different mutation-types or else different nouns undergo different mutation-types, possibly traceable to number, for underlying /fe:r/ has lenited to [e:r'] whereas underlying /pra:ti:/ has eclipsed to [bra:ti:]. At any rate, syntactic relation alone cannot be involved. Now note that the palatalization of the final consonant of [e:r'] , as opposed to the nonpalatalized final consonant of underlying /f'e:r/ is an indication that we are not dealing with a noun in the common form, but rather with a genitive. Comparison of the final

consonant of underlying /ba:s/ with surface phonetic [wa:ʃ] in (15) leads to the same conclusion. In fact a literal translation of "dying" in (15) would be "at getting of death". Similarly, we might gloss (16) as "at picking of the potatoes" and "at cutting of the hay". Since in the genitive after the Article masculine singular nouns undergo Lenition and plural nouns are subject to eclipsis, the mutated forms of (16) are to be predicted. CF. [kruəx' er'] (cruach fhéir "stack of hay = haystack"); [panə nə bra:ti:] (panna na bprátaí "pan of potatoes").

Moreover we may test the validity of the claim that the IM in (16) is attributable to the case, gender and number of the noun, against the predictions it entails. Singular feminine nouns do not undergo IM in the genitive e.g. [fin'o:g] (fuinneog Fem. "window"), [bun nə fin'o:g'ə] (bun na fuinneoige "the bottom of the window"). Therefore we should not expect a feminine singular noun to undergo IM when it is the object of a verbal noun. This is precisely what we find in (17):

(17) [ta: ʃe: ə d'ɛʃu: nə fin'o:g'ə b'r'iʃd'ə]

Tá sé ag deisiú na fuinneoige briste

"He is repairing the broken window".

It is important to establish that the direct object of a verbal noun only occurs in the genitive case in prepositional constructions. Although I have not examined Irish syntax in any detail, it may well be the case that such clauses have the internal structure of NPs whereas others, in which the direct object precedes the particle /ə/ and the verbal noun, have the internal structure of VPs. This fact is reflected in ÓHuallacháin & ÓMurchú's gloss of bailiú airgid (gen.) ([bal'u: ar'ig'id']) as "collection of money", and that of airgead a bhailiú (common) ([ar'ig'əd ə wal:u]) as "to collect money" (1976, page 140). In the latter case it is the verbal noun itself, rather than its preposed object, which undergoes

IM. This may be attributed to PT, where the particle involved is /ə/. It is possible that such verbal noun constructions are transformationally related to restrictive relatives like [əf'ar ə wal'ən ar'ig'əd] (an fear a bhaileann airgead "the man who collects money"). Only a detailed analysis of Irish syntax will determine the issue.

In dealing with the question of the objects of verbal nouns, we have touched upon what might have proved to be a "transformational" environment, under Awbery's definition. Of course it turned out that when the objects of verbal nouns do undergo IM, this is attributable to the well-attested types of triggering, FT and PT. This issue has, however, led us to consider the kinds of embedded structures which might be candidates for Awbery's fourth kind of triggering environment. Yet we have failed to mention in this section a very obvious type of transformation which might provide instances where IM crosses major constituent boundaries, namely, Preposition-stranding. To spell this out, if prepositions are stranded to the right of the sentence whilst the nouns they precede in deep structure are preposed, as in English, it is crucial to our hypothesis whether or not that noun exhibits IM: if it does, we have evidence that IM is triggered before structures enter the transformational component; if not, the claim that IM can be read off syntactic surface structures directly is substantiated. Let us therefore examine the data in (18) below:

- (18) a.i. [tagən nə kin'i:n'i: as ə baul]
Tagann na coiníní as an bpoll
 "The rabbits come out of the hole".
- ii. [ə paul ə dagən nə kin'i:n'i: as]
An poll a dtagann na coiníní as
 "The hole the rabbits come out of".

b.i. [n'i:l' u:lə er' ə gran]

Níl úlla ar an gcrann

"There aren't any apples on the tree".

ii. [ə kran nax wil' u:lə er']

An crann nach bhfuil úlla air

"The tree on which there aren't any apples".

In (18)a.i. the noun /paul/ is eclipsed to [baul] when it is immediately preceded in syntactic surface structure by the preposition /as/.

Similarly in (18)b.i. /kran/ is eclipsed to [gran] following /er'/.

Now consider the ii. examples. Here the relative particles /ə/

(affirmative) and /nax/ (negative) fill COMP whilst a prepositional pronoun (here homophonous with the bare form of the preposition) is

stranded to the right. When clauses like (19)a.i. and b.i. are embedded

under a main verb we see that they function as expected within the

higher clause:

(19) a.i. [vi: si:m' agət i viləm]

Bhí suim agat i bhfilm

"You were interested in a film".

ii. [xunik' m'e: f'iləm ə rev si:m' agət a:n]

Chonaic me film a raibh suim agat ann

"I saw a film you were interested in".

b.i. [hug m'e: b'ega:n ar'ig'id' do:]

Thus me beagán airgid dó

"I gave him a little money".

ii. [is kivin' l'um b'ega:n ar'ig'id' ə ho:r't' do:]

Is cuimhin liom beagán airgid a thabhairt dó

"I remember giving him a little money".

In (19)a.i. /f'iləm/ is immediately preceded in syntactic surface

structure by the eclipsing preposition /i/; in a.ii. this is not the

case - rather /f'iləm/ appears in its radical form as the indefinite object of [xunik' m'e:] whilst the prepositional pronoun [a:n] (literally "in it") copies the preposed noun and is stranded to the right. The fact that the relative particle only triggers IM within its own phrase is shown by the lenited form of the verbal noun /to:r't'/ in (19)b.ii.

Thus Preposition-stranding in Modern Irish involves a copying operation which is tied up with the syntactic function of the prepositional pronoun. Here is not the place to discuss this complex topic. However what is relevant to our present concern is the fact that nouns separated from the preposition dominating them in deep structure do not exhibit the IM triggered by an adjacent preposition.

Of further interest is the transformation of Topicalization: do preposed items mutate as they would if left in their phrases? In fact Topicalization in Irish always involves Clefting. We shall see towards the end of this section that the copula may cause a noun to undergo IM and it is the copula which serves as the dummy verb in Clefting.

Suffice it to stress here that an adjective which has undergone Clefting does not exhibit the same IM as it would within the NP. Having dispensed with two blatant candidates for "transformational environments", let me comment briefly and inconclusively on such contexts in Welsh, before examining the regular kind of IM which is found in Irish embedded clauses. My final remarks in this general survey of triggering will illustrate the treatment of Irish main verbs.

The example which Awbery gives of a transformational environment does not serve to back up her claim that IM needs access to information prior to syntactic surface structure. Rather it seems to me that the data she cites fall together with her third classification, i.e.

'structural' environments. In the transformational environment, the normal ordering of constituents in the sentence, Verb-Subject-Complement, has been transformed into Verb-Complement-Subject. Now whereas the subject l̥avr ("book") appears in its radical form as the subject of the "kernel" sentence, it undergoes Soft Mutation to become [l̥avr] in the transform (sic: Awbery's example (38), 1975 page 21, cites l̥avr in both kernel and transform). As far as I can determine, this instance of IM could be read off syntactic surface structure by inspecting the string of labelled bracketings, just as was argued for the IM of the direct object. (i.e. the 2nd NP in a V NP NP sequence mutates irrespective of grammatical relation.) If I am justified in making this claim, a crucial difference emerges between IM in Irish and Welsh. However this difference has nothing to do with access to deep structure, or indeed any level of derivation prior to surface structure. Rather the distinguishing factor between IM in the two languages hinges on its confinement, or lack of confinement to the phrase. To spell this out, in Modern Irish IM is phrase-internal, referring to the particles and features which precede or accompany major lexical items; whilst such is also the case for Welsh, in that language a given instance of IM may also refer to the entire string of labelled bracketings which comprise syntactic surface structure. It is therefore my contention that a descriptively adequate treatment of Irish is compatible with the claim that only information available at the level of syntactic surface structure is relevant to the operation of IM. I also make the more tentative claim - in that it is less fully substantiated - that this holds good for Welsh *.

To return to the more particular account of triggering in Modern Irish, in subordinate clauses, as in main clauses, the verbal constituent is

* Footnote

For detailed discussion, see Bellin & McBrearty referred to above.

initial. Now we have seen that the head of a phrase is susceptible to IM triggered by a modifying 'prefix' word and that in the case of verbal phrases, particles like the Negative and Interrogative condition IM. It is therefore not surprising that the particles which introduce subordinate clauses should induce IM in the subordinate verb. Let us exemplify the range of PT on the verb of embedded clauses. Consider first the direct speech of (20)a. and the effect of the complementizer /gə/ (go) on the verb in the indirect statement of (20)c.

- (20) a. [tig'ən ʃe: ə ʒɛst']
Tuigeann sé an cheist
 "He understands the question".
- b. [tig'im' ə ʒɛst' er ʃeʃən]
'Tuigim an cheist', ar seisean
 "' I understand the question', he says/said".
- c. [d'er' ʃe: gə dig'ən ʃe: ə ʒɛst']
Deir sé go dtuigeann sé an cheist
 "He says that he understands the question".

The Eclipsis of the initial consonant of /tig'/ in (20)c. is attributable to the preceding particle - in other words, we appear to have an example of PT. Although the presence of [gə] is traceable to the fact that the complement of [d'er' ʃe:] is an embedded clause, this fact is not directly responsible for the IM of the verb in the subordinate clause. To illustrate this point, consider (21) a.-d.

- (21) a. [k'r'ed'ən b'r'i:d' ə ʃg'e:l]
Creideann Bríd an scéal
 "Bridget believes the story".
- b. [k'r'ed'ən b'r'i:d' ə ʃg'e:l erʃə ʃa:n]
'Creideann Bríd an scéal', arsa Seán
 "'Bridget believes the story', says/said John".

c. [d'er' ʃa:n gə g'r'ed'ən b'r'i:d' ə ʃg'e:l]

Deir Seán go gcreideann Bríd an scéal

"John says that Bridget believes the story".

d. [du:r't' ʃa:n gər ɣr'ed' b'r'i:d' ə ʃg'e:l]

Duirt Seán gur chreid Bríd an scéal

"John said that Bridget believed the story".

(21)c. illustrates the Eclipsis of /k'r'ed'/ following /gə/ in an embedded clause, as opposed to the unmutated phonetic reflex of the verb in the direct speech of (21)b. Now observe that in (21)d. the conjunction [gər] occurs triggering the Lenition of /k'r'ed'/. Since [gə] and [gər] have the same syntactic function - that of introducing embedded sentential complements - and given that they trigger different mutation-types, that syntactic function cannot per se condition IM.

Furthermore, the distribution of [gə/gər] must be determined by a factor independent of their joint status as complementizer(s). Observe now that, unlike both verbs in (21)c., both verbs in (21)d. are in the Preterite tense. The [gə/gər] alternation could therefore be ascribed to the presence of the morphosyntactic feature [+ Preterite] in either the higher or the lower verb. However, if we are to maintain in any strong form the hypothesis that IM is phrase-internal, it should be the case that the particle [gər] which conditions Lenition refers for its distribution to morphosyntactic features of the verb it precedes. It would of course be possible to account for the presence of [gər] independently of conditions on IM i.e. by referring to the main verb in stating [gər]'s distribution as if this were in no way related to IM. However to do so would substantially weaken the theory of IM developed here, since it is clear that the triggering of mutation-types is crucially dependent upon the distribution of particles. Let us therefore consider further data to resolve the issue.

(22) a. [du:r't' ʃa:n gə g'r'ed'ən b'r'i:d' ə ʃg'e:l]

Dúirt Seán go gcreideann Bríd an scéal

"John said that Bridget believes the story".

b. [d'er' ʃa:n gər çr'ed' b'r'i:d' ə ʃg'e:l]

Deir Seán gur chreid Bríd an scéal

"John says that Bridget believed the story".

c. [çr'ed' b'r'i:d' ə ʃg'e:l erfə ʃa:n]

'Chreid Bríd an scéal', arsa Seán

"'Bridget believed the story', says/said John".

(22)a. and b. present crucial data in that they illustrate cases in which the tense of the main and subordinate clauses differ. Since [gər] appears in (22)b. before a subordinate verb in the Preterite, but not in (22)a. where the subordinate verb is in the Present, despite the feature [+ Preterite] attached to the main verb, the position defended here is substantiated: the distribution of [gər] and the Lenition of the following verb are conditioned by the presence of the feature [+ Preterite] associated with that verb. Further corroborative evidence is found in (22)c., where [+ Preterite] triggers Lenition, independently of the conjunction, in main verbs. We shall return to the Lenition of main verbs in the Preterite shortly, when we have discussed a little further the interaction of the feature [+ Preterite] with the particles which introduce embedded sentences.

We have been comparing subordinate verbal phrases comprising the complementizer [gə] followed by an eclipsed verb which is not in the Preterite with those in which the complementizer [gər] precedes a lenited verb in the Preterite. Moreover, we have analyzed the former as an instance of PT. It seems that two possible analyses are open for the latter case: both the presence of the [gər] reflex of the complementizer and the Lenition of the verb could be attributed to the

morphosyntactic feature [+ Preterite] associated with the verb; alternatively, we could account for the particular shape of the complementizer in terms of the presence of [+ Preterite] and then treat the Lenition of the verb as an instance of PT conditioned by [gər]. A priori it might be argued that the former analysis is to be preferred on grounds of simplicity, inasmuch as it accounts for two phenomena (the reflex of the complementizer and the IM of the verb) by referring to a single source (the presence of [+ Preterite]). To this I would counter that such an analysis fails to capture an important generalization when it treats the Eclipsis of the verb in (21)c. and (22)a. ([gə g'r'ed'ən]) as PT but the Lenition in (21)d. and (22)b. ([gər ɟr'ed']) as FT. This could be weighed against the apparent simplicity of its rival so as to "cancel out" an isolated case of a missed generalization - provided the behaviour of [gə/gər] were indeed unique. However, such is not the case.

In their "New Irish Grammar", the Christian Brothers list six pairs of verbal particles which behave like [gə/ gər] (page 131). In each case the second member occurs before a Preterite verb. Besides [gə/ gər], the list comprises the relative [ə/ər] (a/ar), interrogative [ə/ər] (= prevocalic [ən/ər]) (an/ar), place interrogative [ka:/ka:r] (cá/cár), negative conditional [murə/murər] (mura/murar) and the time and purpose conjunction [sulə/sulər] (sula/sular). Observe that the second member of each pair is derivable from the first member by the additional of final r. (In the case of prevocalic [ən] + [r] → [ər], the nasal has been deleted since Modern Irish phonotactics does not permit sequences of consonant + liquid in syllable-final position.) Historically, the particles used in the Preterite contain the Old Irish particle ro, ru*,

* Footnote

Ro, ru is in origin an Indo-European preposition, cognate with Greek $\pi\rho\acute{o}$ (R. Thurneysen, 1946, page 339 S 526.) Its normal function in Old Irish was that of perfective

(continued)

which has coalesced with the first member of each pair. We shall discuss the exploitation of the transparent phonological relation between the pairs of particles when we formalize the Readjustment Rules for IM in § 2.4. Returning to the choice of PT or FT, if we opt for an analysis which treats Eclipsis after [gə] as PT and Lenition after [gər] as FT, then consistency demands that we also maintain the distinction between Eclipsis after [ə] but Lenition after [ər] and so on for the entire list. Clearly, then, a significant generalization is being missed.

Further support is lent to the treatment proposed here by the natural way it is able to cope with two classes of exception, which would necessitate a more cumbersome handling under the alternative solution. Consider the behaviour of the stem /f'ek'/ ("see") in (23)a. and c. and compare it with that of the stem /kloʃ'/ ("hear") in (23)b. and d.

(23) a. [murə vek'im' e: n'i: ɟ r'ed'hi: m'e: e:]

Mura bhfeicim é, ní chreidfidh mé é

"Unless I see it, I won't believe it".

b. [murə gloʃim' e: n'i: ɟ r'ed'hi: m'e: e:]

Mura gcloisim é, ní chreidfidh mé é

"Unless I hear it, I won't believe it".

c. [murə wak m'e: e:, n'i: ɟ r'ed'hin' e:]

Mura bhfaca mé é, ní chreidfinn é

"Unless I saw it, I wouldn't believe it".

d. [murər xuələ m'e: e: n'i: ɟ r'ed'hin' e:]

Murar chuala mé é, ní chreidfinn é

"Unless I heard it, I wouldn't believe it".

Footnote (contd.)

particle (ibid. page 528 § 852.) As such it occurred before verbs, nouns and adjectives and is thus the source of ro: meaning "exceedingly" (see p. 377-8 above). These facts therefore constitute striking evidence confirming our treatment of IM in all major categories in the same way.

In (23) a.-c. Present [f'ek'im'], Present [kloʃim'] and the suppletive Preterite of [f'ek'im'] have undergone Eclipsis to appear as [vek'im', gloʃim', wakə] respectively. Notice that in each of these examples the conditional has the form [murə]. By contrast in (23)d. irregular Preterite [xuələ] has been lenited, whilst the shape of the conditional is [murər]. Thus in all these cases, the IM attested is predictable from the shape of the particle - Lenition only occurs following the [murər] variant. The fact that the Preterite tense of the subordinate verb in (23)c. leads us to expect the particle to be [murər] here too, is thus irrelevant to the actual triggering of a particular mutation-type.

In order to account for the occurrence of [murə] in (23)c. we attach an exception feature to the verb /f'ek'/. In fact /f'ek'/ belongs to a class of six irregular stems, all of which are preceded by [gə, ə, ən, ka:, sulə, murə] and undergo Eclipsis in the Preterite (if they have a suitable initial consonant.) The remaining stems are /abir'/ (abair "say"), /b'i:/ (bí, "be"), /fai/ (faigh "get"), /t'e:/ (téigh "go") and /d'e:n/ (déan "do, make"). Furthermore, four of these verbs exhibit a dependent form after these particles which differs from the main verb (i.e. absolute) Preterite form, as shown in (24):

(24)	<u>Stem</u>	<u>Absolute Preterite</u>	<u>Dependent Preterite</u>	<u>Gloss</u>
a.	[b'i:] <u>bí</u>	[vi:] <u>bhí</u>	[rev] <u>raibh</u>	"be"
b.	[d'e:n] <u>déan</u>	[r'in'ə] <u>rinne</u>	[ja:rnə] <u>dhearna</u>	"do, make"
c.	[f'ek'] <u>feic</u>	[xunik'] <u>chonaic</u>	[akə] <u>fhaca</u>	"see"
d.	[t'e:] <u>téigh</u>	[xui:] <u>chuaigh</u>	[jaxi:] <u>dheachaigh</u>	"go"

This aspect of the exceptional behaviour of these verbs will be encoded in their lexical entries in just the same way as their behaviour with regard to the [gə]-type particles. Such entries will necessarily contain idiosyncratic information which may have to do with IM directly and which may not necessarily coincide with the classes of exceptions to other aspects of IM. For instance, the lexicon will need to specify that unlike regular verbs, /kloʃ/, /d'e:n/ and /f'ek'/ permit Lenition of their Past Autonomous form - in this respect, then, /kloʃ/ is irregular, even though its behaviour was regular with respect to the distribution of [gə/gər] particles. However, it is clear that any observationally adequate account of Modern Irish will need to list such facts at some point. The analysis proposed here simply claims that, given the idiosyncratic behaviour exhibited by certain irregular verbs with regard to particle distribution, the subsequent IM of those stems is predictable in a natural way consistent with the treatment of the remaining verbs in the language. On the other hand, if we were to maintain the FT analysis of particle distribution and IM in the Preterite, the occurrence of [gə] and the Eclipsis of the class of irregular verbs would be two unrelated phenomena, both attributed independently to an exception feature attached to the stems in question. At the level of descriptive adequacy, then, the PT analysis is to be preferred.

We have dealt in a principled way with a class of exceptions to the proposed PT of verbs in embedded clauses by subordinating conjunctions, namely a class of irregular verbs. The second set of exceptions, involving the parallel treatment of negative particles before main verbs, prove less "exceptional" under the analysis advanced here, but demand radically different treatment from each other under the thesis that the morphosyntactic feature [+ Preterite] determines both the shape of the preceding particle and IM. Under such a treatment the

conditioning of Lenition by [n'i:] (ní, "negative") and [nax] (nach, negative interrogative) in tenses other than the Preterite may be analyzed as an instance of PT (as we assumed on p. 376-8 above). However, since the shapes of the negative particles in the Preterite are [n'i:r] (níor) and [na:r] (nár) respectively, consistency demands that [+ Preterite] conditions those shapes and also the Lenition of the verb i.e. an instance of FT. Here the identical behaviour of the two shapes of each particle surely renders such an analysis totally implausible. Even if we were to ignore arguments for treating [gə] and [gər] in the same way because of the complementary nature of the mutation-types they trigger, we could hardly dismiss such criticism when the very same mutation-type was induced by both phonetic reflexes of each particle.

As a final comment on the interaction of particle-shape and triggering, it is interesting to note that the [n'i:/nax] variants are found before the six irregular verbs classed together above. This therefore constitutes a persuasive argument against analyzing Lenition after [n'i:, n'i:r, nax, na:r] as PT in keeping with what has been advocated above and still retaining the FT analysis of the [gər]-type particles in the Preterite. By adhering to the PT treatment for all obligatory preverbal particles we simplify the statement of particle distribution before certain irregular verbs.

In the course of the above discussion we have covered in some detail the interrelation between preverbal particles and their verbs. Given that the verb is the initial major lexical item in its clause, the claim that IM in Modern Irish is phrase-internal and that it does not cross major syntactic boundaries has been upheld. Such a claim would be contradicted if there were examples of the IM of a noun following an embedded verb whose triggering could not be attributed to the internal

structure of the NP. Compare therefore the direct speech of (25)a. with the indirect statement (25)b.

(25) a. [is f'ar k'r'i:nə e:]

Is fear críonna é

"He is a prudent man".

b. [da: n'e:rhin' gərv ar k'r'i:nə e: n'i: ɣr'ed'ha:]

Dá ndéarfainn gurbh fhear críonna é, ní chreidfeá

"If I said that he was a prudent man, you wouldn't believe (it)"

In b. the noun /f'ar/ has been lenited after the dependent Preterite of the copula. The latter also triggers Lenition in a following noun or adjective in the (non-dependent) Preterite or Conditional. Since it is the copula which is involved in Clefting and, as was noted earlier, this transformation is found in Irish in lieu of Topicalization, we appear to have grounds for establishing that transformations may introduce IM.

Let us therefore examine further examples of the copula. (26)a.-d. exemplify the same phenomenon, applying to an adjective and including the negative dependent forms of the Present and Preterite of the copula.

(26) a. [ə rud is b'r'a: l'ə di:n'ə əniʃ]

an rud is breá le daoine anois

"the thing which people consider splendid now".

(lit: which is splendid with people now)"

b. [ə rud nax b'r'a: l'ə di:n'ə əniʃ]

an rud nach breá le daoine anois

"the thing which people do not consider splendid now".

c. [ə rud bə vr'a: l'ə di:n'ə fado:]

an rud ba bhreá le daoine fadó

"the thing which people considered splendid long ago".

c. [ə rud na:r vr'a: l'ə di:n'ə fado:]

an rud ná r bhreá le daoine fadó

"the thing which people did not consider splendid long ago".

It might be argued that in (26) b. and d. the preverbal particles [nax] and [na:r] were being used before adjectives. Although this is a plausible claim it means ignoring their complementary distribution with [is] and [bə] in (26) a. and c. and their interrogative preverbal function. It is clear that here we have evidence of the coalescence of preverbal particles with the copula. A transparent example that something is being "added on" to the particle is provided by [murərv] in (27):

(27) [murərv aməda:n e: veh ə sgru:du: d'e:nt eg'ə rivə ʃo]

Murarbh amadán é, bheadh an scrúdú déanta aige roimhe seo

"If he were not a fool, he would have done the exam before now (lit: would the exam be done at him) ".

If we do not treat the copula as a major lexical item, then we can maintain the claim that IM is phrase-internal and does not cross major syntactic boundaries by analyzing the copula and its complement as one syntactic constituent. Clefting will then simply be the syntactic source of the surface configuration. Indeed further research may reveal that certain instances of the 'historical' copula have coalesced completely with the preverbal particle (even though this may not be said of [nax] and [na:r] in (26) b. and d.) Cf. (28):

(28) a. [ə f'er'im'o:r' e: ʃin]

An feirmeoir é sin?

"Is that person a farmer?"

b. [nax f'er'im'o:r' e: ʃin]

Nach feirmeoir é sin?

"Isn't that person a farmer?"

c. [ər er'im'o:r' e: ʃin]

Ar fheirmeoir e sin?

"Was that person a farmer?"

d. [na:r er'im'o:r' e: ʃin]

Nár fheirmeoir é sin?

"Wasn't that person a farmer?"

From such data I feel justified in my contention that the copula in Modern Irish demands unique treatment which divorces it from full lexical verbs and even from the other verb "to be", [ta:] (tá) *. It is important to stress that the syntax of sentences containing the copula is extremely complex and that satisfactory answers to the problems posed by (25) - (28) will only be possible once detailed study of the copula has been undertaken. Suffice it to say that the treatment of those examples proposed here seems plausible from the present standpoint.

Finally, let us turn to the verb in main clauses in the affirmative, in order to pave the way for the discussion in Chapter III of an ordering paradox which arises in this connection. Since the forms of the Preterite, Imperfect and Conditional are optionally preceded by the particle [də] (do), this particle may be analyzed as conditioning the obligatory Lenition in these tenses. Alternatively, since [də] is frequently omitted, one might view the Lenition of the main verb in the aforementioned tenses as FT, and not generate [də] at all in such cases. A problem arises, however, in that [d] (d') is obligatorily present before an initial vowel in the Preterite, Imperfect and Conditional. Exempla relevant to the discussion are set out in (29) for the Common form of each tense:

* Footnote

Diachronically the copula /is/ derives from the cognate of Vulgar Latin essere whilst /ta:/ is related to stare. The situation is thus parallel to that of Modern Spanish "ser" and "estar".

(29)	<u>Stem</u>	<u>Preterite</u>	<u>Imperfect</u>	<u>Conditional</u>	<u>Gloss</u>
a.	[du:n]	[(də) yu:n]	[(də) yu:nəx]	[(də) yu:nhəx]	"shut"
	<u>dún</u>	<u>(do) dhún</u>	<u>(do) dhúnadh</u>	<u>(do) dhúnfadh</u>	
b.	[o:l]	[do:l]	[do:ləx]	[do:lhəx]	"drink"
	<u>ól</u>	<u>d'ól</u>	<u>d'óladh</u>	<u>d'ólfadh</u>	
c.	[fan]	[dan]	[danəx]	[danhəx]	"wait"
	<u>fan</u>	<u>d'fhan</u>	<u>d'fhanadh</u>	<u>d'fhanfadh</u>	

An ordering paradox comes about because of certain complications with verbs beginning with /f/ + consonant. These complications render inadequate the solution which immediately springs to mind for preconsonantal [də], namely, to allow the tense of the verb to condition [də], which then triggers the Lenition of the verb, and then to delete [də] preconsonantly after the Lenition of /f/ → ∅. The alternative solution is the obligatory epenthesis of [d] before an initial vowel or lenited /f/ in the Preterite, Imperfect and Conditional. This may be followed by an optional rule of [də]-Insertion applying before consonants. We shall see in § 3.3 that the Epenthesis solution neatly captures the differing behaviour of preverbal [də] and its leniting homophone, the 2nd. person singular possessive adjective. For our present purposes it is worth emphasizing that the proposed treatment also has the advantage of accounting for the appearance of prevocalic [d] in the Past Subjunctive. [də] cannot be posited as the particle triggering Lenition in this tense, since it is identical to the Imperfect in every respect except for its unmutated initial consonant. Having set the scene, we must postpone a detailed discussion of these problems until their appropriate place in Chapter III.

Despite the fact that, unlike the discussion of embedded verbs, we have reached no definite conclusions regarding the triggering of main

verbs, there is an aspect to the "optional [də] issue" which merits comment. The preceding exposition of arguments in favour of PT or FT might suggest that there is a precise dividing-line to be drawn between the two types of triggering that have been defined for Modern Irish. In contrast to our treatment of preverbal particles and embedded clauses, the case of "optional [də]" brings home the opposite view that there is a great deal of interdependence between PT and FT. In summing up this lengthy section, therefore, let me stress the following - one of the most salient characteristics of triggering in Modern Irish is the fact that it may be read directly off syntactic surface structure. In other words, the preliminary assumption of Chapter I has been substantiated.

§ 2.2 The Status of the Particle

We have seen that in Modern Irish the particle plays a crucial rôle in the triggering of IM, both by independently inducing Lenition or Eclipsis in a following verb (e.g. /n'i:/ Negative, or /ən/ Interrogative), or by its interaction with a particular morphosyntactic category associated with the verb (cf. discussion of the relation between [+ Preterite] and the shape of the particle § 2.1, page 395 ff.). Whilst it is clear that pre-verbal particles, like /n'i:, ən, gə/, belong to a reasonably homogeneous class, it is questionable whether those grammatical morphemes which may be prefixed to adjectives should be classified as adverbs. In the case of prefixes which qualify nouns there may at first sight seem to be only a marginal case for treating them as particles, rather than as preposed adjectives. In this section we shall present arguments in support of the hypothesis that Modern Irish possesses a closed grammatical class, the Particle, which may be prefixed to the major lexical items, Noun, Verb and Adjective.

In the course of the discussion, we shall resolve two interrelated issues which have arisen in Chapter One and the first section of this Chapter. First we shall substantiate the claim, made in § 1.1 (page 314) that Adverb is not a major lexical category in Modern Irish. It will be shown that the label "Adverb" subsumes a heterogeneous class, to which new members may be added by the productive prefixation of a particle to the open class of adjectives. Secondly, we shall consider the status of the first element in compounds, a question on which we touched at the end of § 1.2 (page 350). In those cases where the prefixation of a morpheme is a productive process and not a lexically governed one, I shall adopt the term "particle" to refer to the morpheme concerned.

Perhaps a word is necessary as to the relevance of these issues to IM.

The question of whether or not the Adverb is a lexical category is crucial for the characterization of IM as a phenomenon which has phonetic reflexes in the initial segments of lexical items only. Furthermore, the productive processes whereby putative "adverbs" are prefixed to adjectives involve the Lenition of the initial consonant of the latter, a case of PT. Similarly, Lenition is an important aspect of the process of compounding. In this way, the derivation of qualified adjectives will provide the starting-point to our discussion: on the one hand, it will lead on to the question of the ontological status (purportedly adverbial in Modern Irish) of the prefixes involved; on the other it is directly linked to the triggering rôle of the particle.

Keeping these points in mind, recall Awbery's analysis of [r̥i d̥ɛw] ("too fat") in Welsh as that of an adverb qualifying /tɛw/ (§ 2.1, page 377). Let us substantiate the claim that in the Irish translation-equivalent [ro: raur], /ro:/ is not an adverb. Two other forms which qualify adjectives under identical conditions to /ro:/ (ró- "too"), are /a:n/ (an- "very") and /r'i:/ (rí- "exceedingly"), so we shall extend our remarks to cover them as well. Considering all three forms, a most obvious difference between /ro:, a:n, r'i:/ and the translation-equivalent of the "prototype" English adverb "well" i.e. /gə mah/, is that the former induce Lenition whilst the latter does not. Thus in [vi: an obir' d'e:ntə gə mah] (Bhí an obair déanta go maith "The work was well done"), [gə mah] occurs at the end of the sentence, pre-empting any Lenition in [d'e:ntə]. On the other hand, /boxt/ (bocht "poor") undergoes Lenition in [ro:woxt] (ró-bhocht "too poor"), [a:n woxt] (an-bhocht "very poor") and [r'i: woxt] (rí-bhocht "exceedingly poor"). However, to establish the class of Particle on the grounds that the

particles induce IM would be to use the object of our investigation (i.e. IM) as a criterion. If we are not to be accused of circularity we must find independent reasons for treating /ro:/ et alia as particles.

In fact evidence which does not involve IM is to hand. Consider the sentences (30) a. through d. below:

- (30) a. [is b'r'a: ə la: e:]
Is breá an lá é
 "The day is fine".
- b. [ta: ə la: gə b'r'a:]
Tá an lá go breá
 "The day is fine".
- c. [is donə ən am'ʃir' i:]
Is dona an aimsir í
 "The weather is bad".
- d. [ta: ən am'ʃir' gə donə]
Ta an aimsir go dona
 "The weather is bad".

In the sentences of (30), /b'r'a:/ and /donə/ are predicated of the definite Nouns /la:/ and /am'ʃir'/. (30)a. and c. differ crucially in their syntax from b. and d.: in a. and c. we find the copula /is/ followed directly by the bare adjective, whilst there is a pronominal copy (namely e: and i:) of the Noun to its right*; in b. and d. the stative verb /ta:/ is followed directly by the NP, of which there is no pronominal copy, whilst the qualifier is the so-called "adverb". The

* Footnote

Object pronouns are regularly postposed and it is these which occur with the copula cf. [hunik' m'e: in'e: i m'l'a: k'liəh e:] (Chonaic mé inné i mBaile Átha Cliath é "I saw him yesterday in Dublin").

frames of (31) show the derived structure of the UR where a quality is predicated of a Noun, given the plausible assumption that neither the structure directly underlying a. and c., nor that directly underlying b. and d., is Base-generated.

- (31) a. $\begin{array}{ccccccc} [/is/] & [Adj.] & [Det.-Noun] & & [Pro] & & \\ \underset{V}{V} & & \underset{NP}{\alpha gender} & & \underset{NP}{\alpha gender} & & \\ & & \beta number & & \beta number & & \end{array}$
- b. $\begin{array}{ccccccc} [/ta:/] & [Det.-Noun] & [/g /-Adj.] & & & & \\ \underset{V}{V} & \underset{NP}{NP} & \underset{NP}{Adv.} & & \underset{NP}{Adv.} & & \end{array}$

In contrast to /gə mah, gə b'r'a:, gə donə/, /ro:/ et alia cannot fill the Adv. slot in (31)b. An obvious reason why this should be so is the bound status of the latter.

To sum up, the morphemes /ro:, a:n, r'i:/ are restricted in distribution to pre-adjectival position where they trigger Lenition; they may not be substituted into frames where "other adverbs" contrast with lexically corresponding adjectives (i.e. the frames of (31)). This behaviour mirrors that of preverbal particles which may be characterized as follows: they never occur in isolation; they exhibit internal stability or cohesion with the verb they qualify, an important aspect of this being their triggering function; their range of distribution is limited to positions immediately preceding finite verbs. It would seem, then, that a comparison between morphemes like /ro:/ and "prototype adverbs" on the one hand, and preverbal particles on the other, is revealing, in that there are very striking similarities between /ro:/ et alia and the particles but no clear parallels to be drawn with "adverbs" of the /gə mah/ type. This evidence leads to a conclusion which hardly needs spelling out: /ro:, a:n, r'i:/ should be classed as particles, belonging more specifically to a pre-adjectival subclass but nevertheless sharing the characteristics and functions of their preverbal counterparts.

We have found substantive grounds for not treating the Irish cognate

of Welsh /ri/ as an adverb. This does not mean however that all putative "adverbs" in Modern Irish are to be re-categorized as particles. Indeed to make such a rash claim would be to nullify the force of arguments concerning the heterogeneity of the so-called adverb class, since it would entail that all its members shared particle-like properties. Rather, we shall pursue a more powerful line of argumentation and demonstrate that the label "adverb" has been applied indiscriminately to a variety of forms which have little in common, except the fact that, when translated, they are rendered as English adverbs or adverbial phrases.*

So far we have referred to /gə mah/ type "adverbs" without considering their internal make-up - in fact we have consciously disregarded this aspect for the sake of argumentation. It is clear that /gə mah/ (go maith "well") is derived from the adjective /mah/ (maith "good") by the prefixation of /gə/. This instance of /gə/ is not to be identified with the preverbal particle exemplified in (32):

(32) a. [du:r't' ʃe: gə dukəx ʃe:]

Dúirt sé go dtiocfadh sé

"He said he would come".

b. [gə dagə də r'i:xt]

Go dtaga do ríocht

"Thy kingdom come".

Concerning the question of preverbal and pre-adjectival /gə/, there are grounds for concluding that the two are not instances of the same morpheme. The evidence comes from the fact that they induce different

* Footnote

To say this is not to imply that English adverbs constitute a homogeneous class, defined in terms of syntactic criteria. In fact the category is notorious as a "rubbish-bin" where various recalcitrant items may be deposited.

mutation-types. Pre-adjectival /gə/ triggers a Minor Mutation, the prefixation of [h] to adjectives beginning with a vowel e.g. [gə holk] < /olk/ (go holc "badly"); [gə ha:lin'] < /a:lin'/ (go hálainn "beautifully"). Preverbal /gə/, on the other hand, induces Eclipsis as attested in (32). The same line of argumentation might be used to substantiate the claim that both instances of preverbal /gə/ in (32) are reflexes of a single particle, just in case they have the same "mutating effect".

Note that this difference between preverbal and pre-adjectival /gə/ is not a property which is specified in lexical entries to distinguish, say, /gə/¹ from /gə/². Rather, under the hypothesis developed in this thesis, the spelling out of grammatical morphemes and the triggering of IM take place co-extensively in the expanded lexicon. Thus the specification of the phonological reflexes of particular nodes is interspersed amongst the processes of triggering. This is because triggering can be shown to be sensitive in some instances to node labels, and in others to phonological shape. It is therefore by no means necessarily the case that a stage will arise within the expanded lexicon at which the phonological sequence /gə/ is found in strings which have yet to be assigned triggers of IM. If such a situation does obtain, it is incidental and of no theoretical import - in other words, such a hypothetical stage in the derivation does not constitute a linguistic level. This means that the statement that preverbal and pre-adjectival /gə/ are not instances of the same morpheme (made on the basis of their different behaviour viz. IM) is derivable as a function of the analysis, rather than being an explicit part of the theory. We return to a comprehensive summary of the treatment of homophonous particles like preverbal and pre-adjectival /gə/ in § 2.4.

One way, then, in which the adverb slot in VPs may be filled (including that in frame (31)b.) is by the insertion of a derived adverb, formed by the prefixation of /gə/ to the major lexical category of adjective, with concomitant IM. The mutation-type involved shares certain peculiarities with the other Minor Mutations, which set them apart from the more pervasive processes of Lenition and Eclipsis. Indeed the very gloss "H-prefixation" encapsulates the most salient feature by which the process is rendered atypical as a mutation-type: its realization constitutes a single rule of insertion, rather than modifying underlying initial consonants in various ways. Thus the trigger [+H] only has a phonetic repercussion when the initial segment to which it has been assigned is a vowel - before consonants it is discarded. Whilst we shall deal with the necessary formalization in § 2.4, it is important to stress here that these facts result in the transparency of H-prefixation. This in turn means that the morphological phenomena which "spark off" this Minor Mutation - such as adverb formation - are reflected transparently in terms of IM on the phonetic surface. Since the prefixation of /gə/ to adjectives introduces no allomorphy, apart from that caused by H-prefixation, we may conclude that adverb formation in Modern Irish is transparent.

Comparing adverb formation in Modern Irish with the parallel derivational process in English, we find that ly-suffixation is more opaque than /gə/-prefixation (and [+H] triggering). This is reflected in three areas. First, there are no phonological conditions on the "base" (to adopt Aronoff's framework) of adverb formation in Irish; in other words, all semantically qualifiable adjectives may undergo /gə/-prefixation irrespective of their phonological shape, whereas in English adjectives which already terminate in ly may not undergo

further ly-suffixation e.g. deadly→*deadlily. Secondly, there are no morphological conditions on the base in Irish adverb formation. Thus even though an adjective has already undergone modification, the complex may nevertheless be subject to /gə/-prefixation with concomitant Minor Mutation e.g. /mah/→/a:n wah/→[gə ha:n wah]* (maith "good"→an-mhaith "very good"→go han-mhaith "very well"). The comparable phenomenon involving suffixation is not always realized in English, where although child→childish→childishly, quick→quicker→*quickerly. Thirdly, suppletion is often involved in English adverb formation e.g. adjective good: adverb well. This is not the case for Modern Irish where, as we have seen, the adverb /gə mah/ is derived regularly from adjectival /mah/.

On the basis of the transparency of the process whereby adverbs are derived from adjectives in Modern Irish we shall consider it to be productive. According to Aronoff, productively derived forms - i.e. forms which can be seen on the phonetic surface to equal the sum of their parts - need not be listed in the lexicon. Adopting this criterion, I submit that, whilst Irish adverbs of the /gə mah/ type are clearly lexical rather than grammatical items, they do not constitute a major lexical category whose members are encoded in the lexical repository. Instead, under the hypothesis developed here, they constitute a derived lexical category, which can be inserted under the Adverb node in syntactic trees. From their internal composition as particle + adjective, it is clear that the complex cannot undergo IM, even though IM may obtain between its constituents. Thus we are able to substantiate

* Footnote

Notice here that [h] has been prefixed to a particle, an instance of IM with a phonetic reflex in a major lexical item which has been derived endocentrically. It is important to emphasize that such exceptional behaviour never arises in the case of non-Minor Mutations, i.e. the characteristic phenomena of Lenition and Eclipsis.

the claim that IM applies to major lexical categories only. *

To sum up, the derived adverb is a member of an open lexical class (though not a major one), which may fill the appropriate slot in, for instance, frame (31)b. On the other hand, the adjective from which it was derived may be inserted in the corresponding frame (31)a. It is for that derived category that we shall reserve the label "adverb". There are of course other forms which may be entered under the node Adverb in syntactic trees. It is important to point out here that it cannot be argued that there must be a "primitive" category adverb just because the Base generates the node Adverb. Rather it is perfectly plausible - and in my opinion correct - that there should be a PS rule rewriting Adverb as a disjunction of categories. Derived adverbs will then be one of this set. NPs and \bar{S} s may also be inserted under the Adverb node, as exemplified in (33):

(33) a. [f'ek'an ʃe: ə wa:hir' nuər ə he:ən ʃe: əwal'ə]

Feiceann sé a mháthair nuair a théann sé abhaile

"He sees his mother when he goes home".

b. [xunik' ʃe: ə wa:hir' d'e: luən']

Chonaic sé a mháthair Dé Luain

"He saw his mother (on) Monday". (Dé = lit. 'God')

* Footnote

An apparent counter-example to this claim might be that [h] -prefixation does apply to objects pronouns, [e:] (é "him") [i:] (í "her") and [iəd] (iad "them") e.g. [k'e: he:] (Cé hé? "Who is he?"); [l'e hi: ə fo:su:] (le hí a phósadh "so as to marry her"); [n'i: hiəd] (Ní hiad "It's not them"). However, these facts do not falsify the general hypothesis developed in this thesis, since:

- 1) pronouns, unlike other grammatical morphemes, fill the same nodes as full nouns = a major lexical category;
- 2) H-prefixation constitutes only a Minor Mutation and as such is both atypical of and peripheral to the characterization of Lenition and Eclipsis, which I take to be truly representative of IM in Modern Irish.

Of more immediate interest to morphological and phonological issues, are the temporals and locatives. Let us survey these before leaving the question of the adverb. Consider first the so-called "adverbs of time" as classified by the Christian Brothers (page 140) in (34)a., (35)a. and (36)a. below and compare them with the "compound prepositions" in (34)b., (35)b. and (36)b.:

(34) a. [fuər' ʃe: ba:s i_gahu: nə hi:çə]
Fuair sé baś i gcaitheamh na hoíche

"He died during the night".

b. [b'ar l'um dul i_gosəməɾ nə ba:ʃd'i:]
B'fhearr liom dul i gcosamar na bpáistí

"I'd prefer to go in the company of the children".

(35) a. [vi: ʃe: ənfə er' f'a: m'i:sə]
Bhí sé anseo ar feadh míosa

"He was here for a month".

b. [vi: m'e i mə hasəv er' ai ə dorif]
Bhí mé i mo sheasamh ar aghaidh an dorais

"I was standing in front of the door".

(36) a. [fa:shi: ə kran fi: çan b'l'iənə]
Fásfaidh an crann faoi cheann bliana

"The tree will grow within a year".

b. [xui: ʃe: er' ə ɣlu:n'ə fi: wra:d' ə r'i:]
Chuaigh sé ar a ghlúine faoi bhráid an rí

"He knelt before the king".

It is clear that the a. sentences contain phrases structurally identical to those of the b. sentences, for all six exhibit the structure Preposition + Noun + [NP_{+ genitive}]. More specifically, [i gahu: nə hi:çə] may be analyzed as Preposition /i/ + eclipsed form of the noun /kahu:/ (caitheamh; here "course", lit. "throw") followed by an NP in the genitive, comprising the Determiner /nə/ and the Noun /i:çə/ (oíche

"night") with the Minor Mutation associated with feminine singular Nouns in the genitive. In an entirely comparable way, we see that [i gosəmər nə ba:ʃd'i:] comprises the Preposition /i/ + /kosəmər/ + [Det.- /pa:ʃd'ə/]^{+pl. +gen.}. The process of triggering then assigns the trigger [+ Eclipsis] to underlying /kosəmər/ (cosamar; here "company", lit. "rabble", "refuse"), because it immediately follows the preposition /i/ ("in"). In a parallel manner, the genitive plural specifications attached to underlying /pa:ʃd'ə/ (páiste "child") insure that it too is allocated the trigger [+ Eclipsis], resulting, along with pluralization, in phonetic [ba: d'i:]. Similarly, [er' f'a: m'i:sə] and [er' ai ə dorif] are sequences of Preposition /er'/ + Noun + [(Det.)- Noun]^{+ gen.}, where the genitive case is shown not by IM as in the examples of (34) but by contrast with the Common forms /m'i:/ (mí "month" cf. genitive [m'i:sə]) and /dorəs/ (doras "doras" cf. genitive [dorif]). As in (35)a., we find that although the Determiner is absent in (36)a., the genitive case is marked in the "time" noun (Common /b'l'iən'/ bliain "year"; cf. genitive [~~b'l'iənə~~]). The head noun is lenited following /fi/ (faoi "under") in (36)a. and b. (cf. underlying /bra:d'/ (bráid "throat", here best rendered as "eye"; and underlying /k'an/ ceann "end").

The conclusion to be drawn from the data of (34), (35) and (36) is that adverbial phrases comprising Prep-N-NP cannot be subcategorized except on semantic grounds: in other words, so-called "time adverbs" function like other complex PPs. However, one would hardly expect all temporal expressions to exhibit phrasal structure. Take the items /in'uv/ (inniu "today"), /in'e:/ (inné "yesterday") and /əma:rəx/ (amárach "tomorrow"). Now these three have interesting morphological and syntactic properties. On the one hand they all bear primary stress

on the second syllable rather than the first (= the regular case), suggesting that they incorporate a proclitic and are bimorphemic. We return directly to the numerous locatives with this internal make-up. Secondly, the use of /in'uv/ and /in'e:/ to qualify /ə la:/ (an lá "the day") belies adjectival rather than adverbial properties; whilst /əma:rəx/ bears the adjectival suffix /ax/- /əx/ cf. /f'arəg/ (fearg "anger"): /f'arəgax/ (feargach "angry"); similarly /tir'ʃə/ (tuirse "tiredness"): /tir'ʃax/ (tuirseach "tired"). In short, we do not find exclusively adverb-like qualities even when we examine simple temporal expressions.

We have exemplified in some detail the way in which so-called "time adverbs" in Modern Irish demand analysis as complex PPs. It will therefore be clear from the above data, in particular (35)b. and (36)b., that English expressions of place may also be rendered as complex PPs in Modern Irish. Consequently we shall not discuss that class further. Instead we turn to those "adverbs of place" which incorporate a proclitic (see Mhac an Fhailigh, 1968, page 62 §270; de Búrca, 1958, page 74 §373; Ó Cuív, 1944, page 67 §242.) These include /ənuəs/ (anuas "down from above"), /ən'i:s/ (aníos "up from below"), /əmu/ (amuigh "outside"), /əʃd'iç/ (istigh "inside"), /əwal'ə/ (abhaile "homewards"), /əmax/ (amach "out"), /əʃd'ax/ (isteach "in"), /əduə/ (aduidh "from the north"), /ən'as/ (aneas "from the south"), /əner'/ (anoir "from the east"), /ən'iər/ (aniar "from the west"). In the case of the last four items referring to points of the compass, we may identify the proclitic in the initial syllable with the preposition /as/ (as "out of"). An interesting comparison may be made regarding the composition of "compass-terms" with static /huə/ (thuaidh "north, in the north"), /has/ (theas "south, in the south"), /her'/ (thoir "east, in the east, over, beyond"), /hiər/ (thiar "west, in the west, behind"). Whichever way we choose to

to relate the static items, it is clear that some synchronic reflex of Celtic *echs ("out of"; cognate with Latin ex and Greek ἐξ) is present in the initial schwa of the dynamic locatives. Another comparison, which partly cuts across the static-dynamic classification, is afforded by /suəs/ (suas "upwards"), /ʃi:s/ (síos "downwards") on the one hand, and static /huəs/ (thuas "above"), /hi:s/ (thíos "below") on the other cf. /ənuəs/, /ən'i:s/. The use of the dynamic pairs /ənuəs/-/suəs/ and /ən'i:s/;/ʃi:s/ is illustrated in (37)a. and b. below:

(37) a. [d'imi: ʃe: suəs ə d'r'e:m'ir'ə ax hit' ʃe: ənuəs ər'i:ʃ]

D'imigh sé suas an dréimire ach thit sé anuas arís

"He went up the ladder but fell down again".

b. [xuñik' ə t'iasgir'ə nə brada:n'ə l'e:m' ən'i:s xun ə

wa:d' agəs ə t'it'im' ʃi:s ər'i:ʃ]

Chonaic an t-iascaire na bradáin ag léim aníos chun an

bháid agus ag titim síos arís

"The fisherman saw the salmon leaping up to the boat
and falling back again".

Following ÓHuallacháin and ÓMurchú's exposition (1976), /ənuəs/, /ən'i:s/ et alia refer to motion in the direction of the focus of attention, whereas /suəs/, /ʃi:s/ et alia refer to motion away from the focus of attention (p. 160). Even if we were to analyze these locatives as synchronically monomorphemic, then, the grammar must contain some reference to their "symbolic" nature (cf. English bump, lump, thump; Bloomfield 1933, page 156).

There are, however, stronger grounds than Bloomfield's "symbolism" for treating Irish locatives and temporals as composites. I am alluding once again to the fact that they bear primary stress on the second syllable. Indeed, so pervasive is this characteristic that Mhac an

Fhailigh notes: "A pretonic ə is affixed analogically to a small number of adverbs, e.g. riamh ə r'iəw, choidhche ə xi:c(ə), chomh maith əxə maç/əxə maç." (1968, page 140 §314- egg.s="never", "ever", "as good" respectively - JRMcB). A crucial observation regarding non-initial stress comes from Breatnach (1947), when he lists certain locatives and temporals alongside prepositional pronouns based on /eɟ'/ (ag "at"). The Irish prepositional pronouns, Forainmneacha Reamhfhoclacha, are morphological fusions, comprising the coalescence of a simple preposition + a personal pronoun. Breatnach cites [ə'gum] (agam "at me"), [ə'gut] (agat "at you sing."), [ə'g'e] (aige "at him"), [ə'k'i] (aice "at her"), [ə'giŋ] (againn "at us"), [ə'giv'] (agaibh "at you plur."), [ə'ku] (aca "at them"), all of which are stressed on their second syllable (1947, page 78; Breatnach's transcription has been maintained in citation.) He then proceeds to note that certain prepositional pronouns from /er'/ (ar "on") and /i/ (= /in/ prevocally, i "in"), may be similarly stressed. Indeed, it is revealing that /a:n/ (ann) is polysemous, rendering either "in him, it" or "there". This illustrates the vacillation that exists between the locatives and the prepositional pronouns. Finally consider /ənfɔ/ (anseo "here"), /ənfɪn'/ (ansin "there, then") and /ənfu:d/ (ansiúd "there yonder"), which are (at least) bimorphemic, containing the demonstratives /fɔ/ (seo "this"), /fɪn'/ (sin "that") and /u:d/ (ud "that yonder").* Surely the internal make-up of these forms attests the fact that Irish locatives and temporals are not simple forms?

What conclusions can be reached about the status of the Irish "adverb" on the basis of these data? First, it seems clear that the facts which

* Footnote

Is the [ʃ] of /ənfu:d/ an "empty morph" on analogy with the initial consonant of the other demonstratives? The transparency of the word as a whole and its opacity when segmented surely illustrate the futility of the "chopping up" procedure.

(38)a. and (39)a. admit ready comparison with /ro:, r'i:, a:n/ for they are prefixed to adjectives with an intensifying semantic function and they induce Lenition. Although the IM effected remains the same in the b. examples, (38)b. is a verbal noun whilst (39)b. is a past participle. These two last examples, then, provide a link between particles which qualify verbs and the entirely parallel morphemes which may be prefixed to adjectives. The examples of (40) illustrate further the qualification of past participles by a particle, this time to express impossibility:

- (40) a. /do/ + /bin't'ə/ → [dowin't'ə]
 "impossible" "mown/dug" "impossible to mow/dig"
do-bhainte
- b. /do/ + /marəhə/ → [dowarəhə]
 "impossible" "killed" "immortal"
do-mharaithe

So far we have demonstrated that so-called "adverbs" may be prefixed to adjectives in a manner which is entirely parallel to the behaviour of preverbal particles. Let us now exemplify how adjectives, with particle-like function, may qualify other adjectives:

- (41) a. /duv/ + /gorəm/ → [du:ɣorəm]
 "black, dark" "blue" "dark blue"
dúghorm
- b. /drox/ + /b'e:səx/ → [droxve:səx]
 "bad" < /b'e:s/ "ill-mannered"
 "custom"
drochbhéasach

Yet the same adjective-like particle /drox/ found in (42)b. may qualify nouns:

- (42) a. /drox/ + /din'ə/ → [droxɣin'ə]
 "bad" "person" "evil person"
drochdhuine

- b. /drox/ + /kan't'/ → [droxan't'] (via degemination)
 "bad" "talk" "bad language"
droch-chaint

Although the compounds of (42) have double stress which is about equal on their component parts, other Adjective-Noun compounds bear only one primary stress - on the initial syllable e.g. (43):

- (43) a. /ʃan/ + /b'an/ → [ʃanvan]
 "old" "woman" "old woman"
sean-bhean
- b. /ʃan/ + /din'ə/ → [ʃanin'ə]
 "old" "person" "old man"
sean-dhuine

(43)b. also illustrates the elision which may occur in compounds, resulting in the stronger cohesion between the constituents (cf. the vocalization of /v/ in (41)a.) (44)a. and b. show elision of the final consonant of the first element:

- (44) a. /d'as/ + /m'e:n'/ → [d'ave:n']
 "good, nice" "wish" "goodwill"
dea-mhéin
- b. /d'as/ + /din'ə/ → [d'ayin'ə]
 "good, nice" "person" "a good person"
dea-dhuine

The Adjective-Noun compounds of (42), (43) and (44) are clearly less productive than the process whereby /ro:/ et alia are prefixed to adjectives. The former are more likely to be entered as one item in deep structures. To put this slightly differently, it is less plausible to generate /drox/ + /kan't'/ in the Base and go through the process of deriving [droxan't'], than it is to do so for, say /ro:/ + /mah/ → [ro:wah]. Even more clear-cut cases are exemplified in (45)a. and b.:

(45) a. /an'im'/ + /fokəl/ → [an'imokəl]
 "name" "word" "noun"

ainmfhocal

b. /srak/ + /f'e:xin't'/ → [srak'e:xin't']
 "wry" "look" "glance"

srac-fhéachaint

It is reasonable to assume that [an'imokəl] and [srak'e:xin't'] have attained quasi-idiomatic status. However the issue is far from clear-cut and as a final illustration, consider the relative transparency (or opacity) of compounds with the first element related to the preposition /fi:/ (faoi "under"):

(46) a. /fo/ + /ge:h/ → [foye:h]
 "minor, sub-" "wind" "gentle wind"

fo-ghaath

b. /fo/ + /bal'ə/ → [fowal'ə]
 "minor, sub-" "town" "suburb"

fo-bhaile

c. /fo/ + /kupa:n/ → [foxupa:n]
 "under" "cup" "saucer"

fochupán

(46)c. is of course the compound with which we began the discussion in § 1.2 (page 350).

Although it would be interesting to examine the possibility of relating the first elements in compounds to free forms by means of Vennemann's "via-rules" (1972), this would lead us too far afield from issues pertaining to the triggering of IM. What really concerns us in the treatment of compounds is the following: 1) What is the status of the first element in compounds? 2) Does IM take place before lexical insertion or at the same time as productive triggering? In answer to

the first point, I have attempted to illustrate in the data of (38) through (46) the cline between true particles and preposed qualifiers. I have shown that whilst all such elements may be classed together on the basis of the propensity to induce IM, other phonological factors (both segmental like elision, and prosodic involving stress assignment) may play a rôle in "welding" the compound together. To the extent that an element is productively engaged in compounding, it will be deemed a particle. Cross-classification within the lexical repository will provide a link with full items.

This leads us directly onto the second issue, the point at which IM applies in compounds. Here the model that has been developed in this thesis provides a dual solution. It has been proposed that the triggering of productive IM takes place in the expanded lexicon, a component which contains the "standard lexicon" of earlier frameworks, here referred to as the lexical repository. Now it is in the repository that compounds will be listed as single items (if they are not productive), before undergoing lexical insertion in deep structure. In this model, therefore, there is little theoretical apparatus between the repository and the location of triggering. It is thus highly feasible that particular forms could fluctuate between the two. Similarly, particular elements like /d'a(s)/ could vacillate between the status of being listed and being one of the grammatical morphemes which the remainder of the expanded lexicon spells out.

To sum up, the theory of IM and the expanded lexicon it calls for provide a framework which is sufficiently flexible to account in a natural way for an indeterminate area of the grammar, without losing its predictive power. It is my contention that the hypothesis proposed in this work finds additional support when the complex issues relating to the status of the particle are brought forward.

§ 2.3 A Comparison with the Literature

We have seen that the triggers of IM, [+ Lenition] and [+ Eclipsis], are assigned to syntactic surface structures in the expanded lexicon of a grammar of Modern Irish and we have classified the types of triggering in terms of conditioning particles (PT), conditioning morphosyntactic features (FT), and a combination of these two.

However, a chapter on Triggering would not be complete unless it made reference to Hamp's important pioneering article on IM, "Morphophonemes of the Keltic Mutations" (1951). This paper also covers realization but since it does so in phonemic terms rather than in a distinctive feature framework, it encounters none of the difficulties appertaining to rule formulation, natural classes, ordering paradoxes and so on, which we shall be discussing in Chapter Three. Moreover, what phonetic statements Hamp does make apply to Old Irish rather than to the present-day language. While this fact renders his treatment of realization of diachronic interest only irrespective of his pre-generative framework, it does not diminish the applicability to Modern Irish of his overall approach, whereby he proposes that "the so-called initial mutations of the Keltic languages" be "systematically stated as functions of morphophonemes" (ibid. pp. 230-1).

Hamp's technique for describing the Celtic languages comprises the addition of a final mnemonic letter to each form that triggers IM. Thus in Old Irish /L/, /N/, /G/ and /A/ are appropriately suffixed to forms which induce lenition, nasalization (= eclipsis), gemination and aspiration, respectively, in the initial of the following word, e.g. Hamp writes /moL/ for Old Irish mo, the first person singular possessive, indicating that it conditions lenition. Hamp refers to /L/, /N/, /G/ and /A/ as the morphophonemes of Old Irish. It is clear that this is

a departure from the original conception of the morphophoneme as a morphologically distinct phoneme (e.g. the f of cuff vs. the f of leaf, though phonemically the same, are different morphophonemes, because of the alternation leaf:leaves; Swadesh (1934)). Nor is it consistent with the view of morphophonemes as archisegments which figure in base forms, the precursors of generative phonology's URs (cf. Bloomfield's morphophonemes /ə/ and /N/ in 'Menomini Morphophonemics' 1939). In other words, Hamp's morphophonemes have no intrinsic phonetic content. In this respect they resemble triggers: Hamp describes their effect as that of "converting" a following radical into its mutated counterpart. However, as I shall now point out, there are certain fundamental differences between the morphophonemes of Hamp's system and the triggers of IM proposed in this thesis. In other words, while both treatments are two-stage approaches, the hypothesis incorporating the notion "trigger of IM" is not merely a notational variant of Hamp's earlier analysis in terms of morphophonemes.

The most obvious difference between Hamp's treatment and that advanced here is that the former extensively permits word-internal morphophonemes, whilst triggers are productively assigned in word-initial position only (cf. the treatment of diachronically internal IM in Chapter One pp. 350 f) and the discussion of IM in compounds in § 2.2 above). We shall consider the consequences of Hamp's proposal together with the general ontological status of the "Keltic morphophoneme". Hamp claims "that the morphophonemes of Irish could be advantageously projected into the interior of forms as simultaneous components, thus reducing the stock of phonemes and broadening distributions" (page 235). For example, he cites Old Irish a gcnáim [a gna:ⁱ˜v'] *

* Footnote

= narrow phonetic rather than phonemic transcription for the noun; despite this, [a] is assumed to be phonetically schwa by Hamp in fn. 7 page 235.

"their bone" as morphophonemically /aN kna:~v'/ or /kna:Lm'/. Here the phonemic inventory has been reduced by the analysis of /~v'/ as morphophonemically /Lm'//.

It is important to stress that a small phonemic stock is not to be highly valued per se - except under a simplistic conception of the evaluation measure as a simplicity metric which merely counts symbols. For instance, in a language without consonant clusters it is possible to reduce the inventory of vowels by one, a particular (arbitrarily selected) vowel being inserted by rule whenever a cluster appears. In other words, minimization of this sort should be undertaken only if it captures a salient generalization about the segmental structure of the language.

As an example of an analysis leading to a reduced inventory which is warranted by the linguistic phenomenon concerned, one may cite Lyons' treatment of vowel harmony in Turkish (1962). Lyons advocates an analysis in terms of the phonematic units i, a and the prosodies F[ront], B[ack], R[ounding] and N[on-rounding] to replace the eight vowel phonemes /i, ī, ü, u, e, a, ö, o/. Indeed superficially Lyons' prosodic transcription of phonemic /kizlar/ and /güller/ as BNkizlar and FRgillar respectively, is reminiscent of Hamp's /in tain' Nb'èLr'es/ for Old Irish in tain mberes, "when he carries".

Having begun our discussion by noting the difference between Hamp's morphophonemes and Swadesh's or Bloomfield's practice, we are now drawn away from a comparison with triggers (as developed here) to an apparent resemblance that "Keltic morphophonemes" bear to Firthian prosodies. Indeed it might be possible to view /L/, /N/, /G/ and /A/ as prosodies of the segment, on a par with Henderson's "Prosodies of Syllable Parts" (1949). However, to the extent that the latter subsume

questions of phonotactics and may be more concisely stated in terms of distinctive features, the disparate phonetic facts which word-internal /L/, /N/, /G/, /A/ represent are more appropriately derived from the feature-composition of particular segments.

In other words, the /L/'s in Hamp's analysis of [a f'ir^ʷ] (where [ʷ] = lip-rounding), a fir, "her men" as /aG f'iLr'L/ tell us nothing about possible phonological properties shared by the word's components. In contrast, the postulation of prosodies in Turkish captures the significant generalization that there is harmony between all vowels in a particular word in that language. It is on these grounds that Hamp's use of morphophonemes to reduce the phonemic inventory cannot be considered justified in the way that the prosodies of Turkish vowel harmony attain descriptive adequacy.

What then of Hamp's claim that recognizing word-internal morphophonemes "broadens distribution"? Surely if we replace every instance of labialized r (= Hamp's [r^ʷ]) by /Lr'/, we are saying nothing about the distribution of that segment. Only if morphophonemes are restricted to a particular position do we in fact achieve a distributional statement. For example, voiced palatal and velar spirants never appear in URs in Modern Irish: phonetic [j] and [ɣ] are always instances of lenited underlying /d', g'/ or /d, g/ respectively, in initial position. If morphophonemes were confined to final position, it would be possible to state the distribution of [j] and [ɣ] on the phonetic surface as always following /L/. We shall see in Chapter Three that the trigger approach captures in a parallel fashion this possible exploitation of morphophonemes by stating [j] and [ɣ]'s distribution in terms of underlying /d', g'/ or /d, g/ accompanied by [+ Lenition]. To the extent that morphophonemes permit significant

statements about productive alternations which are confined to initial position (as provisionally suggested by Hamp ^{vis-à-vis} modern Kerry Munster Irish, page 242), they may be deemed viable analytic tools. However their further projection internally, which Hamp subsequently advocates (ibid.), must be rejected.

Moreover, turning to metatheoretical considerations, the recognition (by whatever procedure) of word-internal morphophonemes implicitly contradicts Hamp's tacit adherence to the Structuralist processes of segmentation and classification. As evidence of his adoption of the latter position, I cite the following: "After the phonemes of the language have been established, the morphophonemes should be stated in a separate section, perhaps to be called the morphophonology" (page 232). If the analyst is to establish the phonemes before he posits the morphophonemes, how then, in the Structuralist framework, can he re-analyze the phonemes into "simultaneous" components" = morphophonemes? Notice that it is not the impossibility of doing so that is being denied here. Rather, it is the untenability of Hamp's position within classical phonemics that is under attack. In other words, his analysis is internally inconsistent.

As a final point concerning the status of morphophonemes in general, and internal morphophonemes in particular, I think it is fair to say that Hamp confuses diachrony with synchrony. Oftedal makes this point in a paper which adopts Hamp's approach for initial alternations (1962). Not only does Oftedal find some of Hamp's transcriptions "a little too cumbersome", he also considers that an instance of internal IM "is a mutation only in the diachronical (sic) sense of the word and does not belong to synchronical (sic) morphophonemics" (page 95). We shall return to Oftedal's extension of Hamp's framework when we

have dealt with some further differences between the morphophoneme approach and the trigger hypothesis.

When Hamp addresses himself to the question of what forms contain morphophonemes, we find fundamental differences between the two treatments. Within the gamut of forms which contain morphophonemes, Hamp distinguishes grammatical and lexical forms. It must be stressed that this distinction does not coincide with that of grammatical morphemes, which condition IM (= PT) versus major lexical categories, which undergo IM. Rather, Hamp's "grammatical forms are those which appear in the paradigms or statements of the grammar" (ibid.). As far as I can determine, this amounts to any form which exhibits allomorphy, for Hamp cites as examples "definite articles", "pronominals" and "cases of substantives". In the latter class the morphophoneme would occur initially, rather than finally as they do in Hamp's treatment of particles et alia; for notice the claim that morphophonemes "are an integral part of the declension form of the substantive" (ibid.). In other words, the occurrence of initial morphophonemes accounts for FT where the morphosyntactic feature is associated with the major lexical category undergoing IM. As for Hamp's use of "lexical form", it appears to subsume all invariant triggering morphemes "which need merely be listed in their place in the lexicon" (ibid.). For example, "Many prepositions are merely lexical items" (ibid.).

Thus Hamp's classification of forms conditioning IM (in other items or in themselves) cuts across the classification of § 2.1 in terms of PT and FT. It must be stressed however, that Hamp's distinction

between grammatical and lexical forms contributes only to his remarks as to the "all-pervading" nature of IM. Rather than serving to characterize triggering, instead it alludes only to Hamp's morphological framework. Indeed, Hamp seems to regard the process of triggering as something which does not merit detailed treatment. He makes this clear when he concludes: "In brief, such forms should be described in their appropriate place in the grammar or lexicon; the fact that they contain these morphophonemes is only incidental, and needs no comment if the morphophonology has been adequately described in an earlier chapter" (ibid.; my emphasis). Since by "morphophonology" Hamp is referring to the phonetic specification (i.e. realization) of IM, we must conclude that his description makes no provision for the explicit statement of triggering, such as that given earlier in this chapter.

In direct contrast, the hypothesis incorporating the triggers of IM gives as much weight to the process of triggering in the expanded lexicon as it does to the process of realization within the phonological component proper. It views these two processes as complementary: they are the two interdependent facets of the phenomenon of IM. Under such a treatment, it is by no means "incidental" that a particular form conditions IM. Rather, specific phonological rules (the realization rules) are sparked off just in case a particular major lexical item occurred in a certain morphosyntactic configuration in surface structure. In this way the triggers [+ Lenition] and [+ Eclipsis] have phonetic repercussions on the basis of the composition of the phrase into grammatical morphemes and morphosyntactic categories. Thus triggering presupposes syntactic structure by operating within a syntactically defined domain (the phrase) to affect

major categories. This is almost the inverse of Hamp's speculation that "phrasal morphology" (= syntax) might be established on the basis of the domain of mutations (page 239).

Furthermore, it is just because triggering "scans" morphosyntactic configurations that the property of some morphemes in Old Irish to condition mutation in the next-but-one form poses no problem for the hypothesis. Consider, for instance, the natural way in which it handles the combined effect of a preposition and the determiner on a noun in the modern language. Under Hamp's analysis, on the other hand, Old Irish "discontinuous morphemes" introduce all the difficulties traditionally associated with them in the Structuralist literature (in particular see Harris (1945); cf. discussion in Hockett (1954)). Central to this problem is the fact that Hamp treats PT in such a way that the morphophoneme is the property of the particle. The parallel claim is not made by the trigger hypothesis, under which [+ Lenition] or [+ Eclipsis] is associated with the initial consonant of a major lexical item by virtue of its syntactic environment. Let us take up this crucial point in the light of Oftedal's explication. Oftedal asserts that "It is evident that Hamp's basic view is right: that the mutating effect of a morpheme on an immediately following form is part of the mutating morpheme rather than of the mutated one, and that a morpheme is not exhaustively described unless its mutating qualities are accounted for" (1962 page 94; original emphasis). It is important to notice that both of these assertions are entrenched in a model based on the morpheme, Item and Arrangement (IA). Under this framework the linguist's task is that of identifying the morphemes of the language and stating their arrangement. In the case of Celtic languages like Irish, IM is seen to be "separable" from the particular

morphemes exhibiting alternation, on the basis of their distribution. It is thus viewed, not as part of the morpheme undergoing IM, but either as an extension of the preceding morpheme (Oftedal's 'projected mutation'), or as an autonomous morpheme (his 'incorporated mutation'). In terms of the morphemic model, where the data does not invite segmentation and classification, one means open to the linguist to preserve the model, is to posit a "fictitious agglutinating analog[ue]" (what Lounsbury refers to as "the method of internal reconstruction" page 380 in Joos). It is clear that the Keltic morphophoneme facilitates the statement of such an analogue. Let us consider Oftedal's exploitation of Hamp's morphophoneme in both projected and incorporated mutations, in terms of the IA model.

Oftedal defines projected mutation as follows: "A projected mutation is an initial mutation conditioned by a mutating quality in the morpheme which immediately precedes the mutated form" (page 97). This covers PT and those instances of FT where the morphosyntactic feature concerned ~~is~~ associated with the preceding form (e.g. Lenition of the adjective in Modern Irish following a feminine noun). Oftedal's classification does not coincide with Hamp's, for "projected mutation" subsumes IM conditioned by prepositions (Hamp's 'lexical forms') and the determiner (Hamp's 'grammatical forms'). By considering the Lenition in Scottish Gaelic /ə v̥hə́r/ "his mother" as part of the possessive, Oftedal is faced with a problem of segmentation: the fricative quality of the /v/ belongs with /ə/ as the exponents of the possessive, whilst the labiality of /v/ together with the rest of the phrase are assigned to "mother". The morphophoneme technique provides a means of representing the composition of "his" i.e. as /əL/. Oftedal notes that a consequence of this analysis is that the word boundary

(located after /ə/) does not coincide with the morpheme boundary (somewhere "within" /v/). Although it is clear that this is not the optimal situation within the morphemic model, he presumably considers that his treatment has sufficient advantages to outweigh difficulties. We turn to these difficulties in terms of Matthews' critique of IA, after we have spelt out what Oftedal means by incorporated mutation. Incorporated mutations "are part of the form in which they are manifested and not of any preceding morpheme" (page 97). As a typical example Oftedal cites Scottish Gaelic /xuʳ/, the lenited preterite of /kuʳ/ ("put"). In Hamp's transcription /Lkur/ reflects the fact that "the mutation in itself constitutes a morpheme or at least a more autonomous allomorph" (ibid.). More specifically, /xuʳ/ is an example of the subdivision of incorporated mutations into 'free mutations', since it occurs sentence-initially. This however is a consequence of the VSO word order of Celtic languages, rather than being a property of IM. In other words, it is incidental, within the trigger hypothesis, that phrase-initial position may also be sentence-initial position - what is crucial is simply that the domain of IM is the phrase. Similar attention to the "overt" aspects of IM only is evidenced in Oftedal's subclassification of 'bound' (as opposed to 'free') mutations as 'inherent' (= within the paradigm) or 'retrospective' (= Hamp's "discontinuous"). The latter class are said to express a syntactic relationship. However notice how an adjective immediately following a feminine noun in Welsh is considered to be a projected mutation, whilst the same adjective is deemed retrospective if there is interpolation. This intuitively unnatural analysis is avoided under the hypothesis developed here, by treating what is in fact one phenomenon in a unitary way as regards IM - irrespective of the general independent problems posed by interpolation.

Let us finally consider Matthews' evaluation of IA and discuss the relevance of his remarks to Oftedal's extension of Hamp's analysis. Matthews (1972) refers to the kind of "overlapping exponence" exhibited by the /v/ of /ə vāhər/ as 'fusion'. He reserves the term 'cumulative morph' for those morphemes which may be identified by syntactic criteria but which are always realized jointly * (e.g. 1st. person + singular in Latin). Clearly *Ṽ* falls under the fusion rubric. Matthews considers Hamp's morphophoneme to be, more explicitly, a 'morphophonemic operator' thus distinguishing it from Swadesh's and Bloomfield's morphophonemes. (1972, page 371 fn. 2). As he points out in an earlier chapter, morphophonemic operators enable the linguist to postpone the process of fusion until the morphophonemics, the rule system which links the morphophonemic level with the phonemic level. By exploiting these analytic devices, we are able to state the exponence of morphemes in terms of morphophonemes as a simple "pairing off". But we still have to specify the fusion of particular morphophonemes and operators at the phonemic level. Fusion, with and without the morphophoneme, are schematized in (47) for Irish

[ə wa:hir'] (a mháthair "his mother"):

(47) a morphemic representation
 phonemic representation

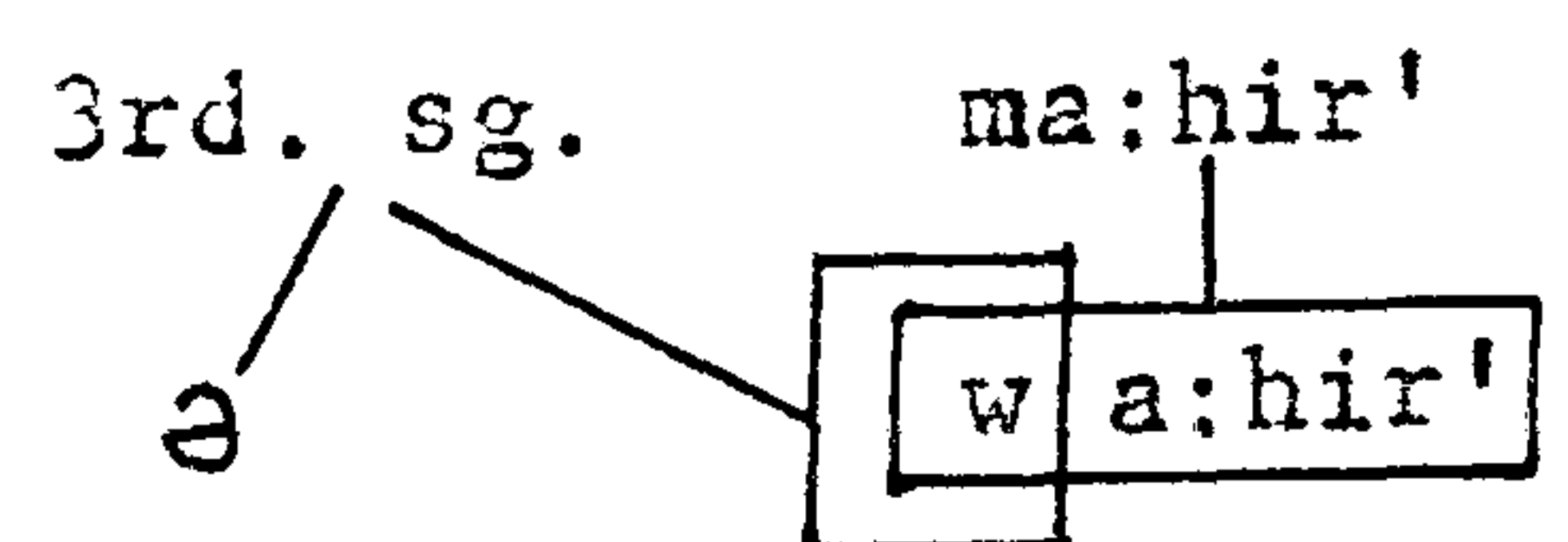

b morphemic representation
 morphophonemic representation
 phonemic representation

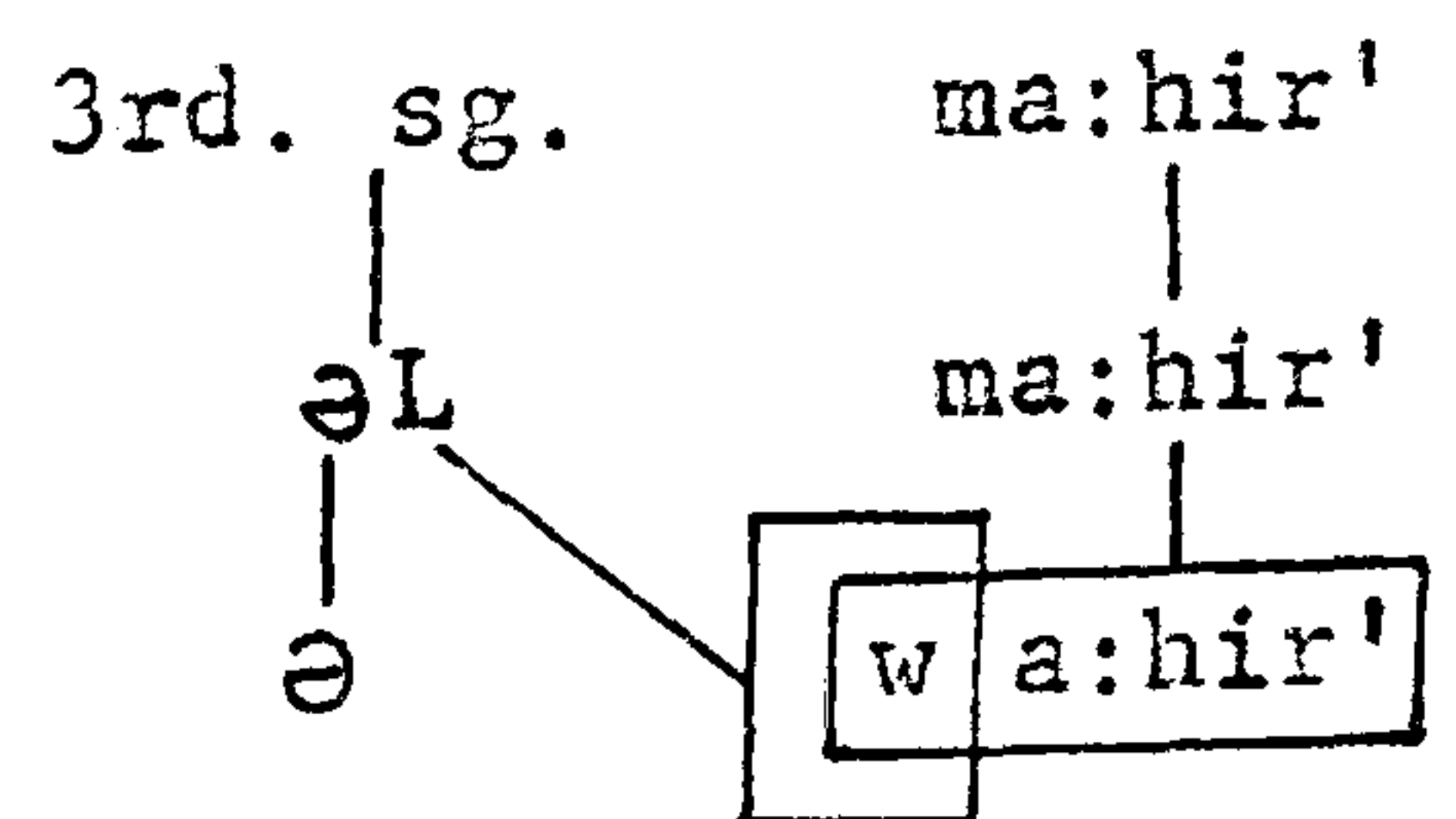

* Footnote

Fused morphs and cumulative morphs are different types of 'portmanteau' cf. Hockett (1947).

The inherent artificiality of this morphophonemic interlevel within IA is even more blatant when we schematize the postponement of fusion in Irish [xir'] (chuir "put" Pret.):

- (48) morphemic representation
 morphophonemic representation
 phonemic representation

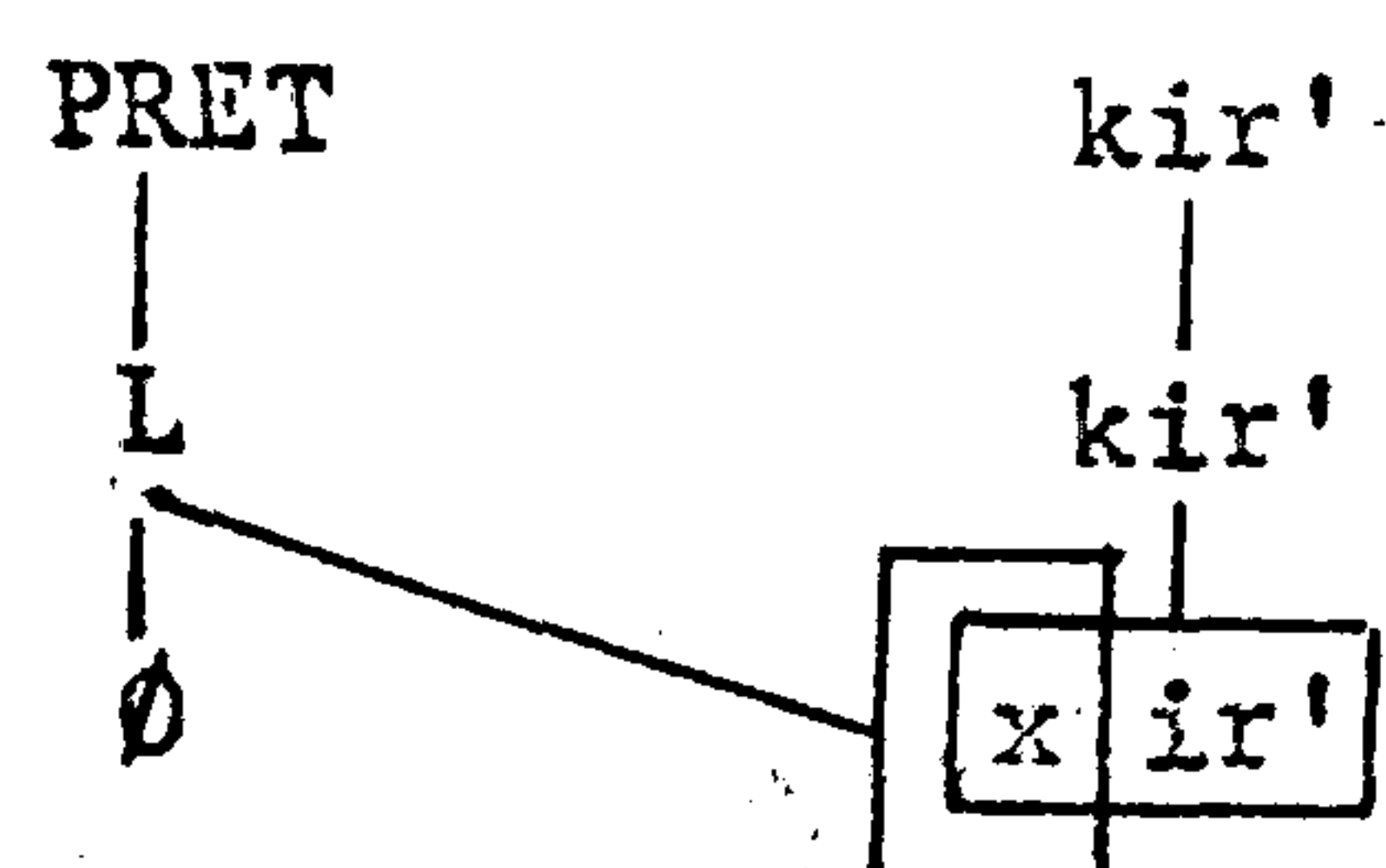

Here morphophonemic {kir'} has the phonemic exponent /kir'/ when nothing precedes (e.g. in the present affirmative), and the exponent /xir'/ when it is preceded by {L}, which is phonemically zero!

To sum up, when the IA extension of Hamp's original framework is pursued to its logical conclusion, the resultant analyses are untenable. Inasmuch as a rigorous formalization of the morphophoneme approach presupposes a model based on the morpheme, any attempt to describe IM in such terms will ultimately have to face the problems which have arisen in our critique of Oftedal's paper. However, to adopt a radically different framework merely because it does not exhibit the demerits of IA would be to argue negatively. The fundamental support for the theory developed in this thesis must therefore lie in the arguments presented in previous sections, rather than in these critiques.

§ 2.4 Formalization

In concluding our discussion of various aspects of the triggering of IM in Modern Irish, reference must be made to the formalization of that process. To spell this out a little, we know that the triggering of IM is sensitive to information present in syntactic surface structure, but that it does not require access to any deeper level of representation. This claim was substantiated in § 2.1. In relation to the formalization of triggering, this means that the process may be viewed as the scanning of syntactic surface structures. We also know that the domain of the structure to be scanned will be the phrase - this is the corollary of the assertion that IM in Modern Irish is phrase-internal. Furthermore, we know what entities will determine IM within the phrase and which categories will be assigned a particular trigger of IM: preposed particles and other grammatical morphemes may condition IM in a following major lexical item (PT), or a morphosyntactic feature associated with a particular Noun, Verb or Adjective ~~may induce~~ it (FT); we also admitted cases of combined PT and FT.

We have, then, a clear idea of the input to the individual triggering processes. Moreover, we can readily identify from within the phrase the category which will receive the trigger in the output of each process (i.e. a Noun, Verb or Adjective, see § 2.2), and which entities (particle-like or morphosyntactic feature) will have been responsible in determining that output. What remains to be stipulated is therefore the intermediate stage between the input and the output of each triggering process.

It is important to notice that we have been referring to a triggering "process" rather than to a "rule" of triggering. This is a direct

consequence of the fact that triggering takes place within the expanded lexicon, the location of Morpheme Structure Conditions and Readjustment (see § 1.2). In other words, triggering has been divorced from realization just in case the latter constitutes a set of phonological rules which convert one segment into another, whereas the former involves the assignment of diacritics (= the triggers of IM). From now on we shall refer to each formal statement of triggering as a Trigger Assignment Condition (henceforth a TAC). Our formalization of the TACs of Modern Irish will take the form of an overall survey of triggering in NPs, in which the question of homonymous particles will be resolved. We shall also discuss formalization which makes appeal to phonological shape, as well as phonological conditions on TACs. This will be followed by the exemplification of the interaction between the spelling out of grammatical formatives and IM in Verbs.

In our general survey of triggering in NPs, we shall illustrate TACs induced by PT, FT, and combined PT and FT. Recall first that in § . (p. 349) we suggested that in some cases IM may be sensitive to the grammatical formatives per se, whilst in others triggering may refer to the phonological shape of grammatical morphemes which they assume when they are spelt out. Now let us consider the possessive pronouns (see § 1.3, p. 361 ff for a discussion of the 3rd person possessive under the segment interpretation of triggers). In their case, there are strong grounds for formalizing the input of each TAC in terms of the grammatical formatives involved. This is because all three plural possessive pronouns /a:r/, (ár "our"), /wur/ (bhur "your pl."), and /ə/ (a "their") condition Eclipsis, whilst the 1st and 2nd singular pronouns /mə/ (mo "my") and /də/ (do "your sing."), together with the 3rd person masculine singular /ə/ (a "his") condition Lenition.

Thus, generalizations can be made, referring exclusively to number, if we specify the grammatical formatives directly in the SDs of the TACs.

It is only the 3rd. person feminine singular, which calls for the Minor Mutation of H-prefixation before a vowel, that is an exception to the behaviour pattern exhibited by the singulars. Let us formalize the PT induced by the relevant grammatical formatives as TAC1:

$$(49) \quad \text{TAC1} \quad \begin{bmatrix} +\text{poss.} \\ +\text{sing.} \\ +\text{III} \\ -\text{masc.} \end{bmatrix} \quad \begin{array}{c} \text{N} \\ \Downarrow \\ [+H] \end{array}$$

The trigger of the Minor Mutation has been designated [+H] since it has but one phonological repercussion (unlike Lenition and Eclipsis). Noun Radicals /ka:r/ (carr "car") and /ba:d/ (bád "boat") will thus undergo TAC1 if they are preceded in syntactic surface structure by the configuration $\begin{bmatrix} +\text{poss.} \\ +\text{sing.} \\ +\text{III} \\ -\text{masc.} \end{bmatrix}$, and will enter the phonological component proper bearing the trigger [+H]. But since the realization rule for [+H] only has a non-vacuous effect before initial vowels, and since /ka:r/ and /ba:d/ have initial consonants, the trigger will be discarded. On the other hand, when radical /et'il'a:n/ (eitleán "aeroplane") is found in the same environment in syntactic surface structure and has consequently been assigned [+H], it will undergo the realization rule of [h]-prefixation, just in case it begins with a vowel. Thus when /ka:r/ and /ba:d/ are preceded by the 3rd. person feminine possessive pronoun, they will appear unmodified on the phonetic surface as [ə ka:r] and [ə ba:d] respectively, whereas /et'il'a:n/ in the same context will surface as [ə het'il'a:n].

We may now formalize triggering in NPs containing the remaining singular possessive pronouns as TAC2:

(50) TAC2 $\begin{bmatrix} + \text{ poss.} \\ + \text{ sing.} \end{bmatrix}$

N
↓
[+Len]

Notice that the NP $\begin{bmatrix} + \text{ poss.} \\ + \text{ sing.} \\ + \text{ III} \\ - \text{ masc.} \end{bmatrix}$ /ka:r/ meets the SD of

NP NP

TAC2 as well as that of TAC1. However, the SD of TAC1 properly includes the SD of TAC2. To state this more rigorously, when we apply the PITest (see Part I §5.3 page 282) to TAC1 and TAC2, material from TAC1 remains when all the coextensive sub-parts of each representation have been discarded, i.e. $\begin{bmatrix} + \text{ III} \\ - \text{ masc.} \end{bmatrix}$ remains extant. Therefore, by

PIPrec, the string $\begin{bmatrix} + \text{ poss.} \\ + \text{ sing.} \\ + \text{ III} \\ - \text{ masc.} \end{bmatrix}$ /ka:r/ which meets the SDs of

NP NP

TAC1 and TAC2 will not undergo TAC2 to yield the incorrect reflex

* [ə xa:r] ← * $\begin{bmatrix} + \text{ poss.} \\ + \text{ sing.} \\ + \text{ III} \\ - \text{ masc.} \end{bmatrix}$ /ka:r/ [+Len] but will surface correctly

as unmutated [ə ka:r].

It might be argued at this point that there has been a gross non sequitur in our line of argumentation: why should the PITest which makes specific reference to phonological material be applicable in the case of grammatical formatives? To raise such an objection, however, would be to view the theory of UDRA as an hypothesis about rule interaction that is exclusively phonological. In other words, an attempt to limit UDRA to the phonological component would be to miss the implications of the theory as an essential part of language design. Indeed we

referred in Part I to work in syntax by Postal (1970), Kayne (1975) and Pullum (1976b) which serves to substantiate the UDRA hypothesis for that central component of the grammar.

But, it might reasonably be countered, even though UDRA is a principle governing the rules of syntax and phonology, it does not follow that TACs are subject to the hypothesis - after all, it was argued on pages 440-1 that TACs are essentially different from "rules". To this more serious objection, I would give the following reply: TACs interact, with each other as well as with the spelling out of grammatical formatives. Given this fact, we have two options: either we order TACs and spellings extrinsically or we seek to account for the attested precedence relations in terms of the principles of UDRA. Now if our grammar is based of GROD, consistency insures that we do not resort to UDRA solely within the expanded lexicon*.

On precisely parallel metatheoretical grounds, one would hardly allow extrinsic ordering to operate within the expanded lexicon and adopt UDRA elsewhere. To put this slightly differently, if we accept that the principles of UDRA constitute a set of formal universals, we have every reason to expect language to exploit those principles to the full - and that means in every area of the grammar where ordering relations obtain. It will be assumed, therefore, on the basis of these logical arguments and the evidence presented in Part I, that the UDRA hypothesis is applicable to the ordering of TACs, both amongst themselves and in relation to the spelling out of grammatical morphemes.

* Footnote

If indeed such a grammar has an expanded lexicon. As emphasized at several points throughout this work, the various aspects of the theory of phonology and morphology that has been developed here are so interwoven that it is difficult to envisage one aspect divorced from the rest. Thus it is hard if not impossible to conceptualize a grammar with an expanded lexicon of the type put forward in this thesis in a framework other than one which also seeks to extend the UDRA hypothesis.

To return to the actual formalization of possessive pronouns in Modern Irish, TAC3 accounts for the assignment of [+ Eclipsis] in all such plurals:

(51) TAC3 $\begin{bmatrix} + \text{ poss.} \\ - \text{ sing.} \end{bmatrix}$ $\begin{matrix} N \\ \Downarrow \\ [+Ecl] \end{matrix}$

TAC3 is the complement of TAC2, and the precise formalization of the condition is based on this fact. Although the specification [- sing.] could have been omitted according to the spirit of Kiparsky's Elsewhere Condition (see Part I, §3.1 pp. 71ff for discussion), such a formalization would have contravened the Pre-Condition on PI (see Part I, § 5.3 p.288). Recall that under the Pre-Condition input representations must be specified uniquely in terms of the natural classes affected non-vacuously by the rule in question. When applied to the workings of the expanded lexicon, it therefore precludes the formalization of TAC3 as if all possessives were assigned [+Ecl], and demands that the class actually participating in the PT, i.e. plural possessives, be specified uniquely.

How then, it might be asked, can TAC2 be formalized as if it applied to all singular possessives? What makes TAC2 acceptable to the Pre-Condition is the fact that 3rd person feminine singular possessives constitute the exception to a generalization about all other singulars, just in case the class of 3rd person singular possessives is properly included in the class of singular possessives. However, plural possessives can hardly be viewed as an exception in this sense to a generalization made about singulars since, as we have noted, the one class constitutes the complement of the other. Thus according to the principles of UDRA developed in Part I, possessive pronoun PT in Modern Irish requires the formalization TAC1, TAC2 and TAC3, whilst the precedence of TAC1 over TAC2 is predicted by PIPrec.

We have seen that the generalization regarding the behaviour of singular as opposed to plural possessive pronouns can be captured by permitting the input to the TACs to specify grammatical formatives. It is also apparent from these examples that if these TACs were made sensitive to the phonological shape of the possessive, problems would arise for the 3rd persons, all of which appear on the phonetic surface as schwa. By referring the TACs to the formatives themselves, at no stage in the derivation of NPs containing 3rd person possessives is there homonymy. To explicate this claim let us take the three NPs which render "her car", "his car", and "their car" in Modern Irish. In syntactic surface structure the three are distinct, as they are when they become the inputs to TAC1, TAC2 and TAC3 in the expanded

lexicon, i.e. $\begin{bmatrix} + \text{ poss.} \\ + \text{ III} \\ + \text{ sing.} \\ - \text{ masc.} \end{bmatrix} /ka:r/$, $\begin{bmatrix} + \text{ poss.} \\ + \text{ III} \\ + \text{ sing.} \\ + \text{ masc.} \end{bmatrix} /ka:r/$,

$\begin{bmatrix} + \text{ poss.} \\ + \text{ III} \\ - \text{ sing.} \end{bmatrix} /ka:r/$. After the operation of the TACs, the three

are even further differentiated:

i.e. $\begin{bmatrix} + \text{ poss.} \\ + \text{ III} \\ + \text{ sing.} \\ - \text{ masc.} \end{bmatrix} /ka:r/$ $\begin{bmatrix} +H \end{bmatrix}$, $\begin{bmatrix} + \text{ poss.} \\ + \text{ III} \\ + \text{ sing.} \\ + \text{ masc.} \end{bmatrix} /ka:r/$ $\begin{bmatrix} +Len \end{bmatrix}$, $\begin{bmatrix} + \text{ poss.} \\ + \text{ III} \\ - \text{ sing.} \end{bmatrix} /ka:r/$ $\begin{bmatrix} +Ecl \end{bmatrix}$.

Still within the expanded lexicon, 3rd person possessive pronouns are now spelt out by SP1:

(52) SP1 $\begin{bmatrix} + \text{ poss.} \\ + \text{ III} \end{bmatrix}$
 \Downarrow
 \emptyset

Note that SP1 must follow TAC1 by PIPrec. Moreover, since the application of SP1 before TAC2 and TAC3 would result in the bleeding of the TACs, we may appeal to the fact that both triggering and spellings are obligatory in derivations in order to predict the precedence relations

TAC2, TAC3, SP1. Now that SP1 has applied in accordance with the principles of UDRA, the three strings enter the phonological component proper with the following make-up: $\begin{matrix} /ə + ka:r/ \\ [+H] \end{matrix}$, $\begin{matrix} /ə + ka:r/ \\ [+Len] \end{matrix}$,

$\begin{matrix} /ə + ka:r/ \\ [+Ecl] \end{matrix}$. The rules of realization implement the phonological effects

of the triggers to yield phonetic surface: $[ə ka:r]$, $[ə xa:r]$, $[ə ga:r]$.

Thus at no time is there homonymy between phrases which are different on the phonetic surface. This is not to say that there exists a Linearity Condition (see Chomsky 1964) between syntactic surface structure and the phonetic surface. In fact it is blatantly clear that such a condition is contravened by the data we have been discussing, since in syntactic surface structure it is the possessive pronoun which differentiates the NPs whereas on the phonetic surface they are kept apart by the initial consonant of the noun. Notice furthermore that in cases of true ambiguity where NPs are differentiated in syntactic surface structure, that differentiation may persist in the input to the phonological component and only then may homonymy arise e.g. "her dog" and "their dog" will leave the expanded lexicon distinct, i.e. as $\begin{matrix} /ə madrə/ \\ [+H] \end{matrix}$ and $\begin{matrix} /ə madrə/ \\ [+Ecl] \end{matrix}$ respectively, though both appear as $[ə madrə]$ on the phonetic surface. It is because the realization rules for $[+H]$ and $[+Ecl]$ have a vacuous effect on /m/ that the output of the phonological component is identical in each case.

From the above discussion of the 3rd. person possessives, it is clear how our model will handle the problem of homonymous particles which has cropped up at various points (see, for instance, § 2.2 pages 413-4); thus in the case of preverbal and pre-adjectival /gə/, where the former conditions Eclipsis and the latter H-prefixation, the TACs which

formalize the PT will refer directly to the grammatical formatives concerned. The output of each TAC will then comprise the trigger [+Ecl] attached to the verb and the trigger [+H] attached to the adjective. Later spelling will result in an identical phonological shape for both sets of grammatical formatives. However since the VP and AdjP involved bear distinct triggers induced by the radically different syntactic correlates of each /gə/, at no time is there complete "homonymy."

We have examined several related cases of PT which were dependent upon grammatical formatives per se for their stipulation and in so doing we have resolved the problem of homonymous particles. When we turn to instances of FT, it is clear that we must again refer to the formatives themselves, in this case the particular morphosyntactic feature associated with a major lexical category. As a case in point take the FT in attributive adjectives following feminine singular nouns e.g. [ə jir'ʃax veg] (an ghirseach bheag "the little girl"). Here the Lenition of /beg/ is induced by the morphosyntactic features [+Sing., -Masc.] associated with the head of the NP /g'ir'ʃax/ *. The process may be formalized as TAC4:

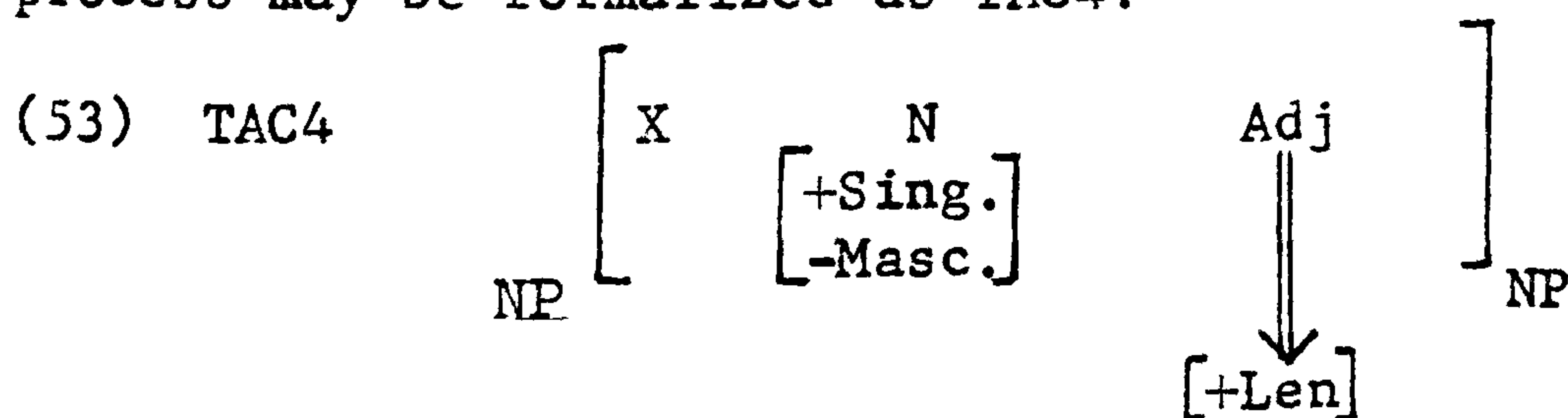

Perhaps the precise formalization of TAC4 deserves some explication. First, the stipulation of the NP-brackets insures that the entire string constitutes a single NP. This is required because predicative

* Footnote

Radical /g'ir'ʃax/ is lenited to [jir'ʃax] because it is a feminine singular noun following the determiner /ə/. For discussion of this instance of combined PT and FT, see below.

even if it is feminine singular e.g. [g'ir'ʃax veg] (girseach bheag "a little girl").

We have illustrated PT, FT and combined PT and FT in the NP in Modern Irish. However in each TAC we have cited the formalization referred to grammatical formatives. In other words, our survey has not covered cases in which TACs need to appeal directly to phonological shape. Let us therefore present an example in which a TAC operating within the NP is formalized in such a way that it follows the spelling out of particular morphemes in the expanded lexicon. A clear-cut instance is afforded by the cardinal numerals. In Modern Irish 1-6 cause Lenition in a following singular noun, 7-10 cause Eclipsis, 11-16 Lenition, 17-19 Eclipsis, 22-26 Lenition, 27-29 Eclipsis, 32-36 Lenition, 37-39 Eclipsis, 42-46 Lenition, 47-49 Eclipsis, and so on, whereas 20, 21, 30, 31, 40, 41, etc. cause no mutation. Prima facie this appears to be an impossible situation to reduce to rule. However, once one examines the forms of the numerals themselves, generalizations emerge. First the unit 1 /e:n/ (aon) only appears in two numerals, /e:n/ itself and /e:n d'e:g/ (aon déag) = 11. Secondly, "tens" (excluding 10 itself) always follow the noun being enumerated except when there is no unit i.e. [e:n xapəl d'e:g] (aon chapall déag) 11 horses = literally 1 horse 10; similarly [ʃe: xapəl əʃ t'r'i:xə] (sé chapall is tríocha) 36 horses = literally 6 horse and 30; but [t'r'i:xə xapəl] (tríocha capall) 30 horses. 21, 31, etc. are expressed by the bare noun plus a co-ordinating conjunction and the appropriate "ten" e.g. [xapəl əʃ f'icə] (capall is fiche) 21 horses. Since 20, 21, 30, 31, etc. do not mutate the following noun but 1, 10 and 11 do, it is of crucial importance that the items /e:n/ and /d'ec/ figure exclusively in the latter numerals. Thus we may formalize TAC6 and TAC7 to refer directly to the phonological shapes of 1-6 and 7-10 respectively:

(55) TAC6

}	e:n ya: t'r'i: k'er'ə ku:g' se: ..
---	--

N
[+ Sing.]
⇓
[+Len]

(56) TAC7

}	saxt hoxt ni: d'eg
---	-----------------------------

N
⇓
[+Ecl]

As the IM following cardinal numerals higher than 10 is determined by their unit, TAC6 and TAC7 will apply to all NPs which contain the specified units, whilst numerals above 20 ending in the units 0 and 1 will not undergo IM.

Perhaps once again a comment is in order regarding the precise formalization of the TACs. It is interesting to note that whilst TAC7 constitutes an instance of PT, TAC6 affords an example of combined PT and FT. The stipulation of the morphosyntactic feature [+ Sing.] associated with the noun in TAC6 is required because plural nouns following the numerals 3-6 * remain unlenited. No such restriction is needed for TAC7 since 7-10 eclipse the initial of the following noun regardless of whether it is singular or plural. There is however a Minor Mutation associated with plural nouns following 3, 4 and 6, namely H-prefixation, formalized as TAC8:

* Footnote

In Old Irish 2 was followed by the Dual. The synchronic reflex of this is that "attenuated" forms of certain nouns are required after /ya:/. The subclass in question contains items which are "semantically dual" e.g. /bos/ (bos "palm"), /bro:g/ (bróg "shoe"), /kluəs/ (cluas "ear"), /kos/ (cos "foot"), /glu:n/ (glún "knee"), /la:w/ (lámh "hand"); cf. [ya: wof] (dhá bhois), [ya: wro:g'] (dhá bhróig), [ya: xluəf] (dhá chluais), [ya: xof] (dhá chois), [ya: γlu:n'] (dhá ghlúin), [ya: la:v] (dhá láimh). We return to the fact that /ya:/ begins with a consonant which has apparently been lenited and the implications of this in Chapter Three.

(57) TAC8

$$\left\{ \begin{array}{l} t'r'i: \\ k'er'ə \\ \int e: \end{array} \right\} \quad \begin{array}{c} N \\ [- \text{Sing.}] \\ \Downarrow \\ [+H] \end{array}$$

TAC8 has a non-vacuous effect whenever the noun has an initial vowel e.g. [t'r'i: huər'ə] (trí huaire "3 hours"), [k'er'ə huən'] (ceithre huain "4 times"), [ʃe: haf'r'in'] (se haifrinn "6 Masses"). The examples attest the fact that H-prefixation is an epenthetic process which prevents impermissible sequences of vowels, due to the concatenation of numerals with open final syllables and nouns with initial vowels, from appearing on the phonetic surface. Since /ku:g'/ (5) ends in a consonant, such sequences will not arise and thus H-prefixation is phonetically unmotivated after this numeral. Hence /ku:g'/ has been omitted from the SD of TAC8.

We have seen that certain TACs may need to make direct appeal to phonological shape. We now turn to phonological conditions on TACs. The case in question was referred to in § 2.1 as a type of triggering peculiar to FT: an adjective qualifying a plural noun is lenited just in case that plural noun ends in a palatalized consonant. As was noted in § 2.1, it is unclear whether the morphosyntactic category Masculine "contributes" in the triggering or whether only phonological factors are involved. This is due to a systematic gap in Irish plural formation whereby Feminine nouns do not pluralize by the palatalization of the final consonant. However, there are Masculine nouns which do not pluralize in this way either, e.g. [ə tu:l d'arəg] (an t-úll dearg "the red apple") → [nə hu:lə d'arəgə] (na húlla dearga "the red apples") * [nə hu:lə jarəgə]. Therefore the most economical statement of the TAC for Lenition in plural adjectives contains only a [+pal] specification and omits a reference to [+Masc.], as shown below:

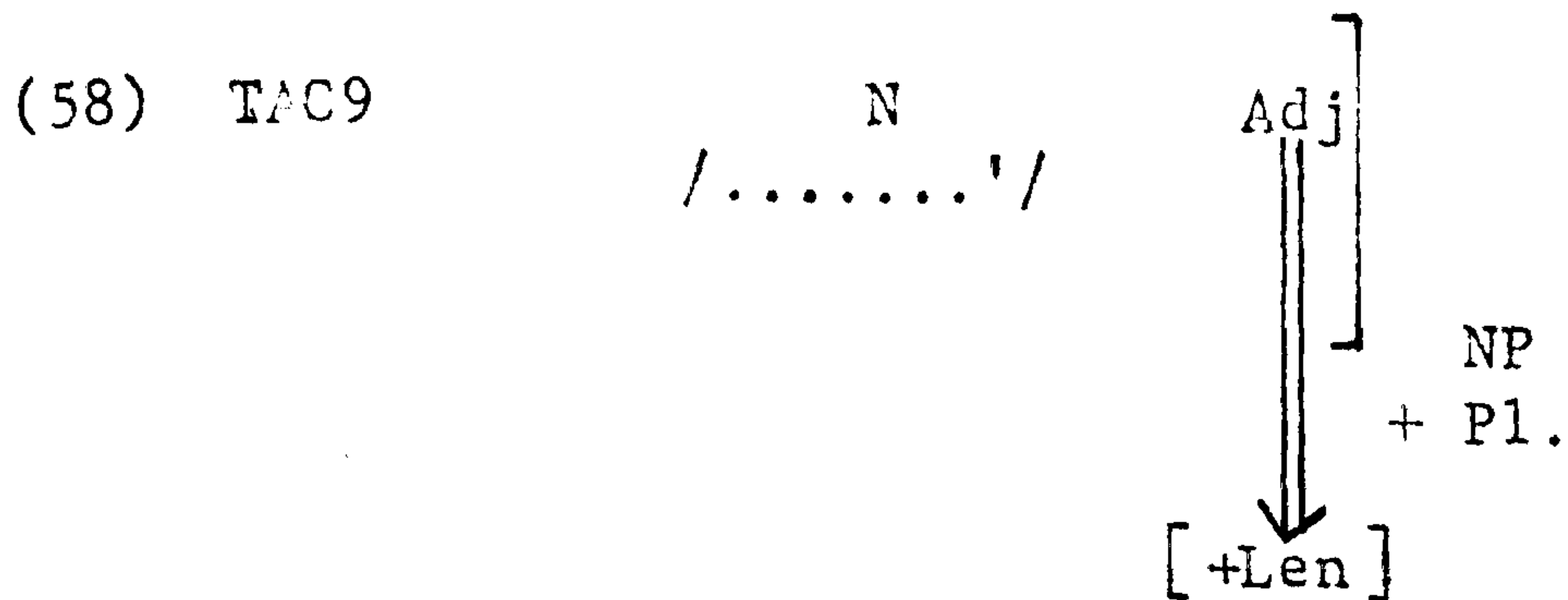

It is clear that the SD of TAC9 will only be met by plural nouns which have undergone Palatalization. In other words, the spelling rule for pluralization must precede triggering. Here, then, we have a nice example in which spelling feeds triggering. This may be contrasted with the late spelling which follows triggering in the possessive adjective, formalized above.

Let us now give one further illustration of the way in which the principles of UDRA developed in Part I predict ordering relations between TACs. Recall that many prepositions in Modern Irish induce Eclipsis in a singular noun if it is preceded by the Article (see Chapter One where /o:/ is cited, p. 357). Without concerning ourselves too much with the behaviour of irregular prepositions, let us formalize the process as TAC10:

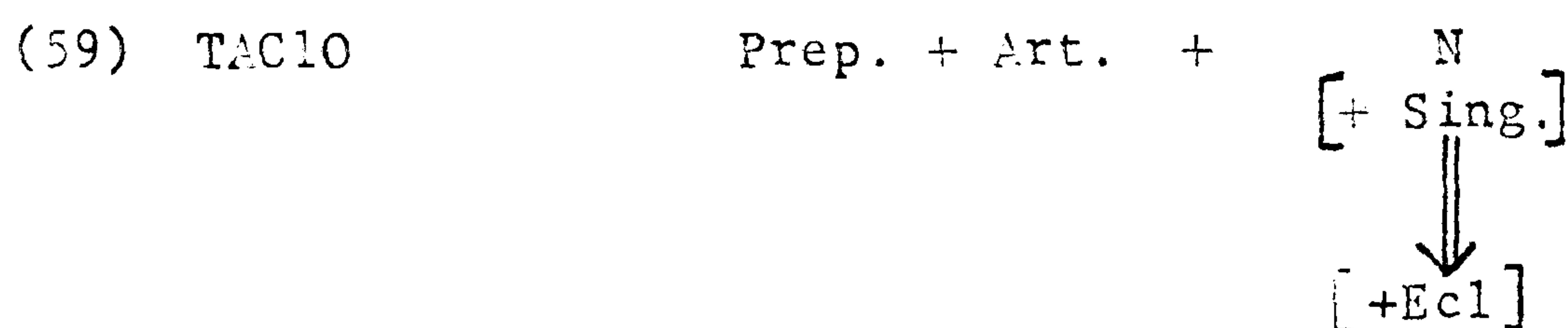

Now consider the interaction between TAC10 and TAC5 which lenites feminine singular nouns preceded by the Article. Clearly the two TACs have contradictory effects. It is therefore necessary to take a close look at the phonetic facts: feminine singular nouns like /pa:r'k/ (páirc "field") may appear in either their eclipsed or lenited forms following the preposition /as/ (as "out of") and the Article cf. [as ə ba:r'k'] (as an bpáirc "out of the field") or [as ə fa:r'k'] (as an pháirc ditto). In contrast, only the lenited form of the noun is attested when the preposition is absent cf. [ə fa:r'k'] (an pháirc

- (62) [t'r'i: huk agəs hn'axtə]
trí shioc agus shneachta
 "through frost and snow"

If a separate occurrence of the preposition is considered to precede each noun before IM, then the transformation of preposition-deletion must necessarily follow triggering. This would be contrary to the claim made in Chapter One and apparently substantiated in § 2.1 that IM may be read off syntactic surface structures directly. On the other hand, compatible with this hypothesis is the claim that certain TACs be viewed as infinite schemata. Yet is there any other evidence for such a position - apart from the fact that it salvages the previous hypothesis?

In fact evidence is to hand. Consider the prepositional phrase (63), where /id'ir'/ governs two nouns both of which undergo Lenition:

- (63) [id'ir' ir' agəs wrã:]
idir fhir agus mhná
 "between men and women"

Here we would not wish to propose the deep structure: /id'ir' f'ar + PL. agəs id'ir' b'an + PL./ "between men and between women", for the latter is clearly different from (63) semantically. Let us therefore take it that there is evidence in support of the claim that TACs containing prepositions may be interpreted according to the following convention:

- (64) Convention on Infinite Schemata

A TAC of the form

Prep + X + N

where X may be null but may not include a major constituent boundary,

may be interpreted in such a way that it re-applies to all and only the following strings:

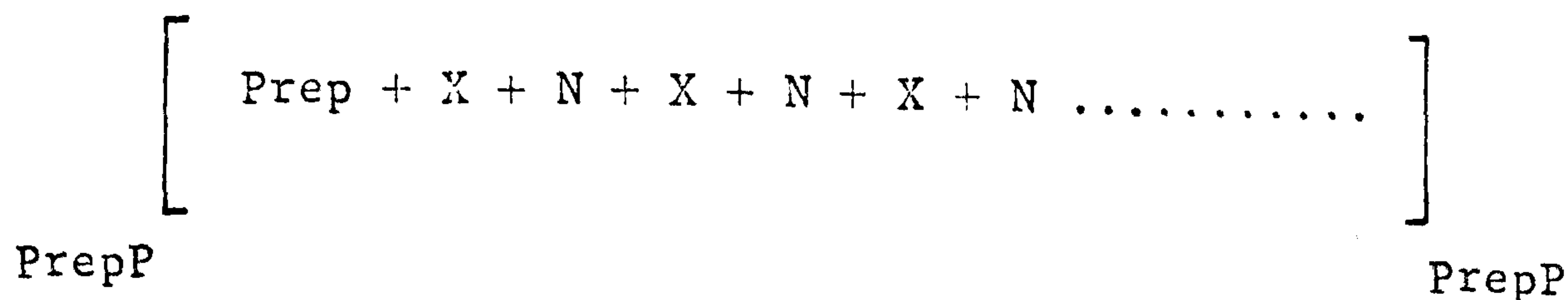

By re-applying the expanded TAC according to the Convention we insure that both /ʃuk/ and /ʃn'axtə/, and /f'ir'/ and /mnã:/ are assigned the trigger [+Len] in (61) and (62). With this piece of formalism we conclude our survey of TACs in NPs.

Leaving the several aspects of the formalization of triggering within the NP in Modern Irish, we now move on to consider the interaction between the spelling out of grammatical formatives and IM in verbs. Recall our detailed discussion in § 2.1 of the shape of the particle in subordinate clauses and the effect of the phonological make-up on the mutation-type undergone by the verb: more specifically, if a subordinate verb is preceded by a particle which terminates in /r/, the verb is lenited. The occurrence of /r/ is in turn generally determined by the presence of the morphosyntactic feature [+Pret.] associated with the verb. However this is not always the case, for six irregular stems are never preceded by a particle with final /r/ and, crucially, they do not undergo Lenition even when marked [+Pret.]

Clearly then, we must spell out the shape of the particle before we formalize TACs which refer directly to that shape. SP2 is just such a spelling:

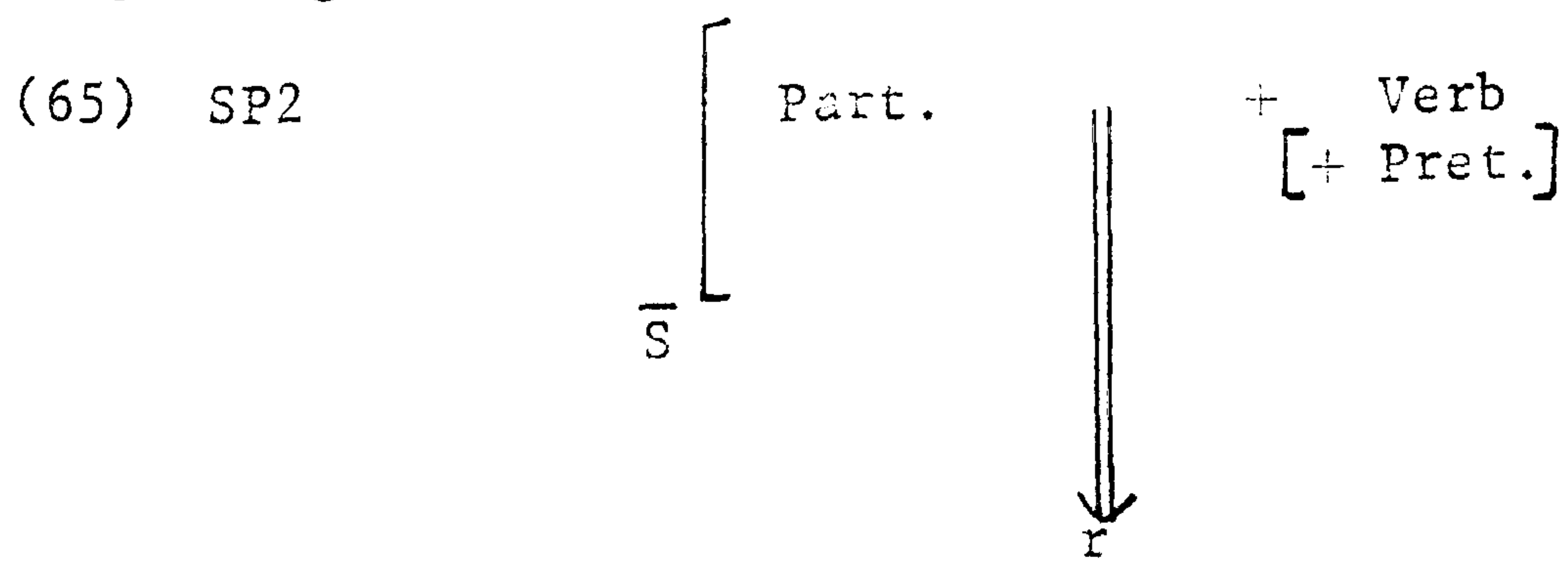

Two points need to be made regarding SP2. First it will figure in the

Given that the shape of /gər/-type particles is specified by SP2 and that the six irregular stems are exempt from it, we might formalize triggering in subordinate clauses as TAC13 and TAC14:

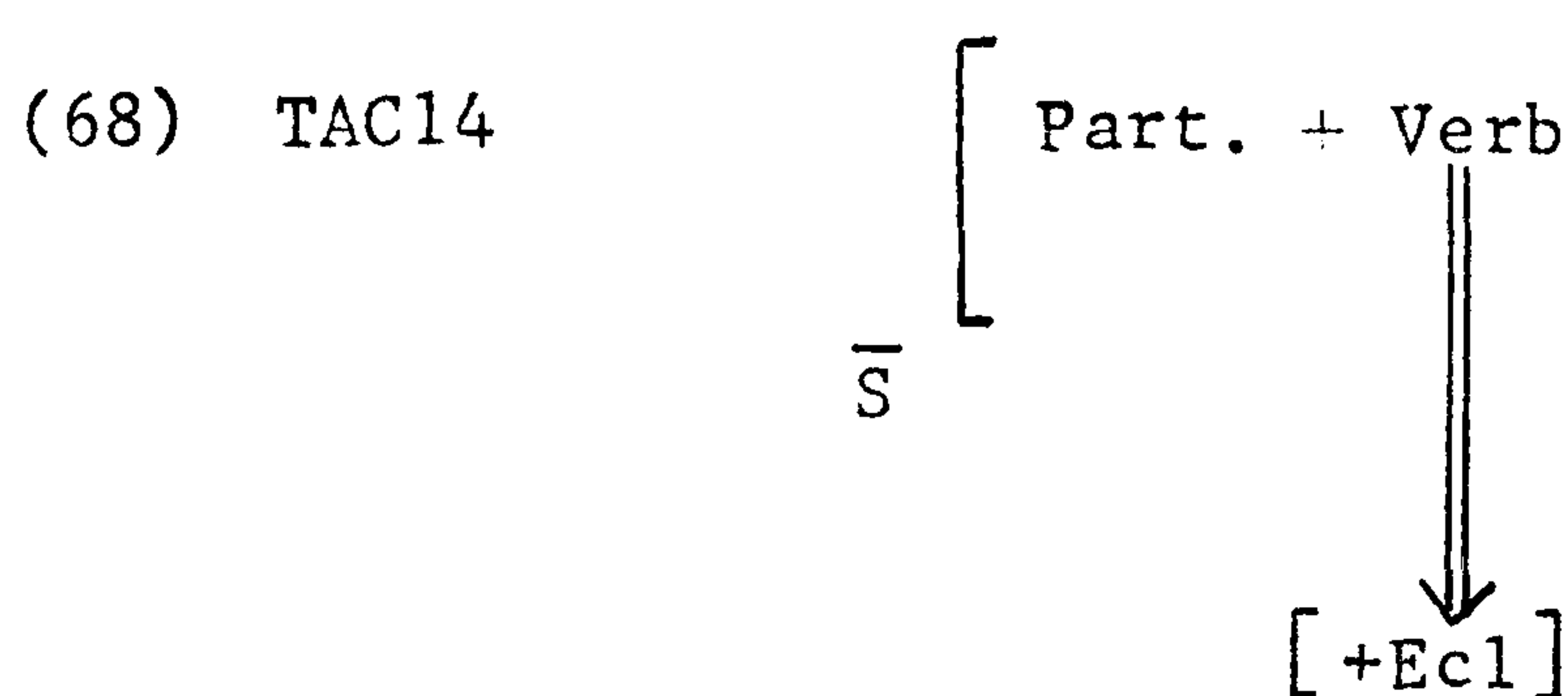
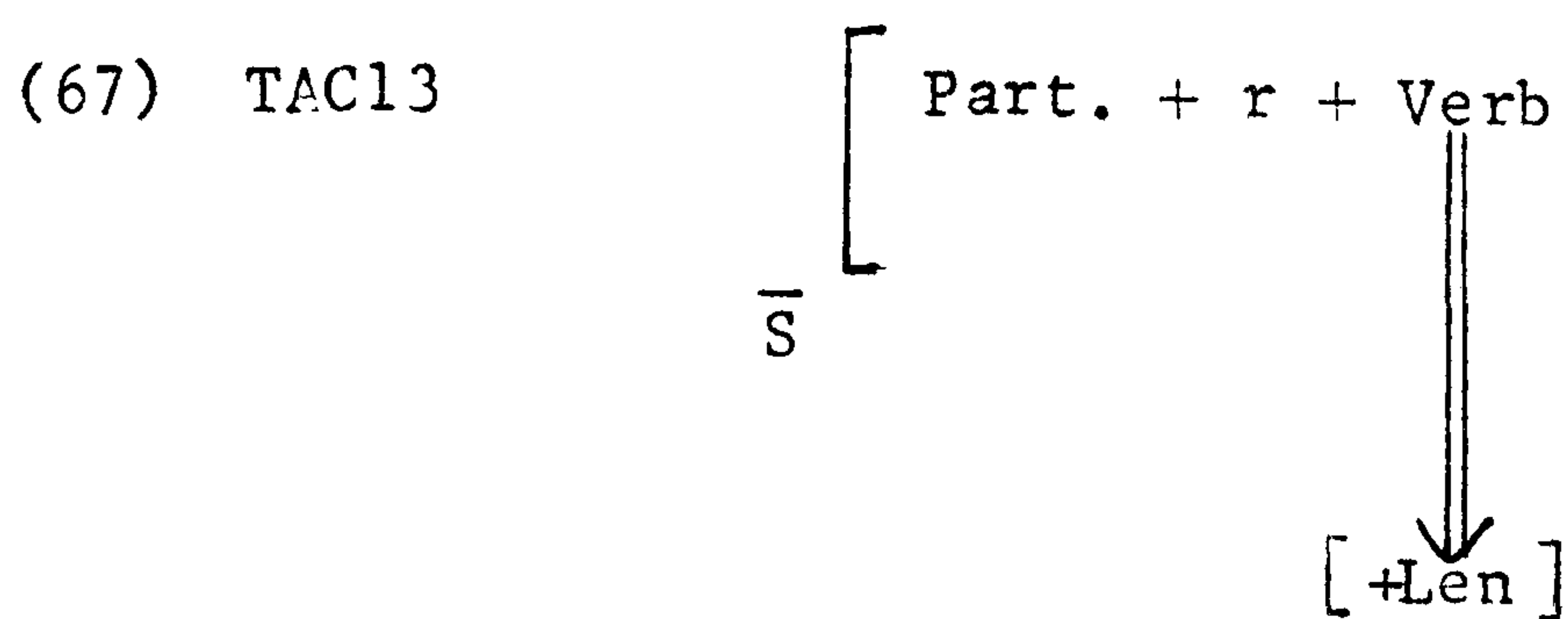

Notice that SP2 precedes TAC13 just in case the former intrinsically feeds the latter - in other words, since SP2 introduces /r/, and the SD of TAC13 refers explicitly to /r/, SP2 must have applied first in all derivations incorporating TAC13. Moreover, the precedence of SP2 over TAC14, and that of TAC13 over TAC14, are both predicted by a principle of UDRA, namely PIPrec. More specifically, after the PI Test has applied to representations meeting the SDs of SP2 and TAC14, [+Pret.] remains extant from the former. Thus Proper Segmental Inclusion insures the prior applicability of SP2. When we apply the PI Test to TAC13 and TAC14, we have an instance of Proper Contextual Inclusion, since /r/ remains extant from TAC13. Once again TAC14 does not take applicational precedence, guaranteeing that strings containing /gər/-type particles are always assigned the trigger [+Len].

As formalized TAC13 and TAC14 apply in subordinate clauses only.

However, we saw in § 2.1 that the presence of the morphosyntactic feature [+Pret.] also determines the shape of the particle in Negative, Interrogative and Negative Interrogative Main Clauses. Apart from the six irregular stems, the particle preceding a verb in the Preterite ends

in /r/. As a first step towards extending our analysis to Main Clauses, let us modify SP2 by removing the \bar{S} bracketing. SP3 is now the lexical rule which spells out the shape of preverbal particles:

(69) SP3 Preverbal Particle Allomorphy:

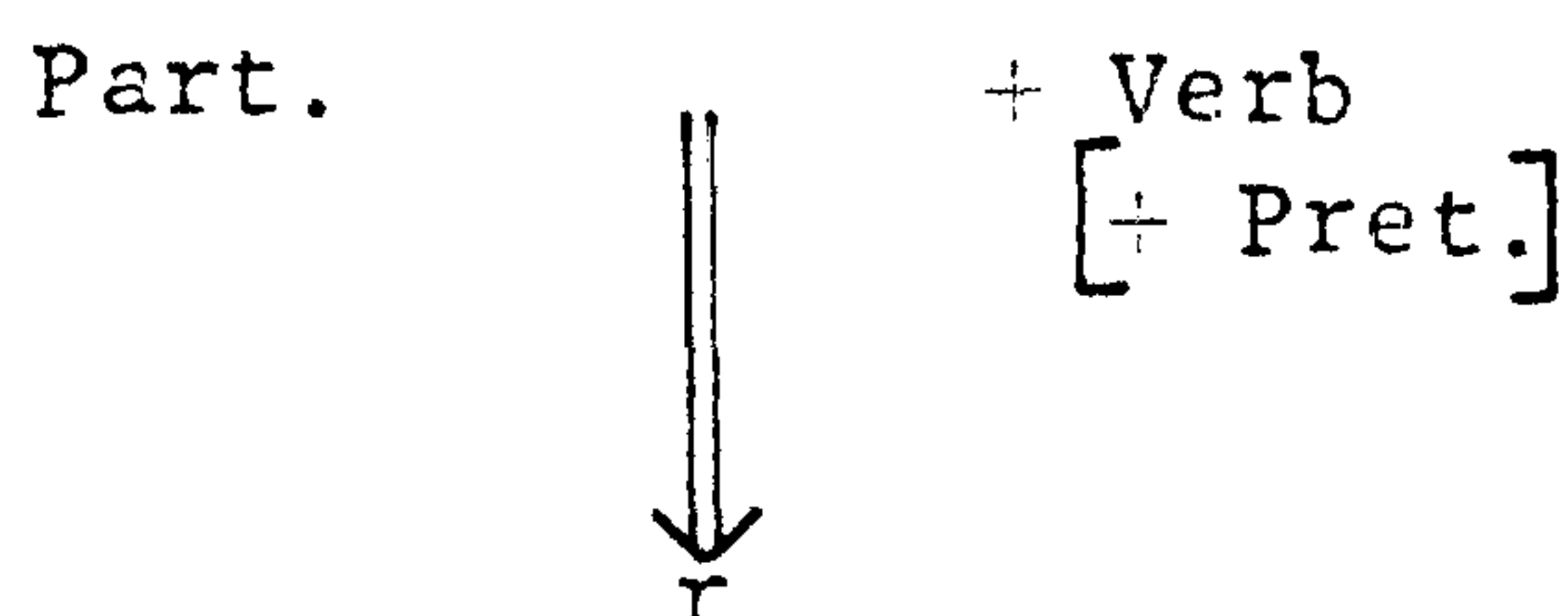

The lexical entry for /f'ek'/ and the five other irregular verbs will of course be modified to read "-SP3".

Just as SP2 was in an intrinsic feeding relation regarding TAC13, so SP3 intrinsically feeds the more general TAC dependent upon all occurrences of /r/, finally in preverbal particles. The appropriate TAC is formalized as TAC15, /r/-Triggering:

(70) TAC15 /r/-Triggering:

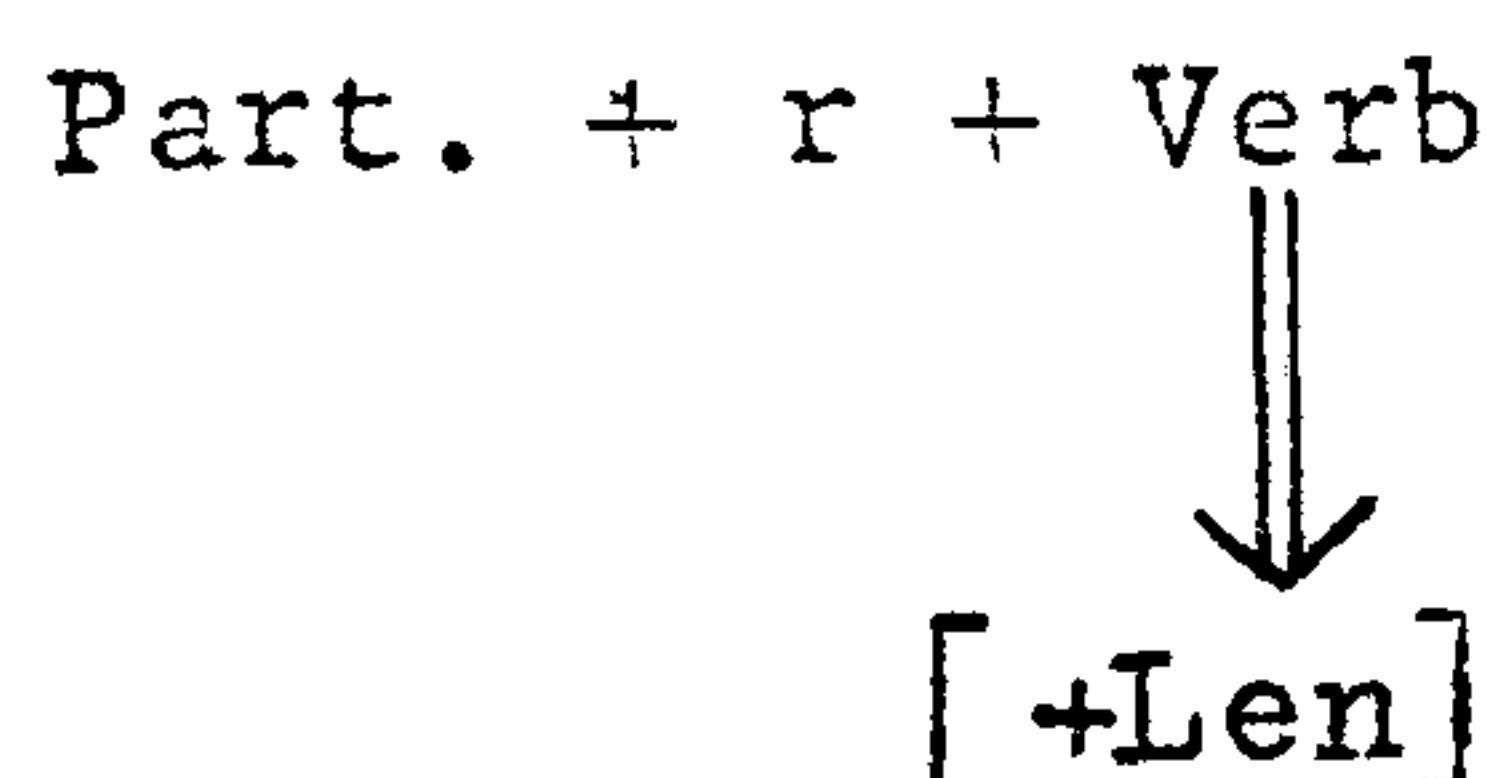

Before we go on to restate TAC14 for Main Clauses, we must account for those cases of Lenition in verbs not induced by [Part. + r]. To view this another way, we cannot permit an eclipsing TAC to apply indiscriminately to all those VPs which do not meet the SD of /r/-Triggering (= TAC15). More specifically, we must formalize the triggering whereby the Negative and Relative particles induce Lenition and whereby the Negative Imperative particle conditions H-prefixation. Taking the latter case first, TAC16 accounts for Neg. Imper. Triggering:

(71) TAC16 Neg. Imper. Triggering:

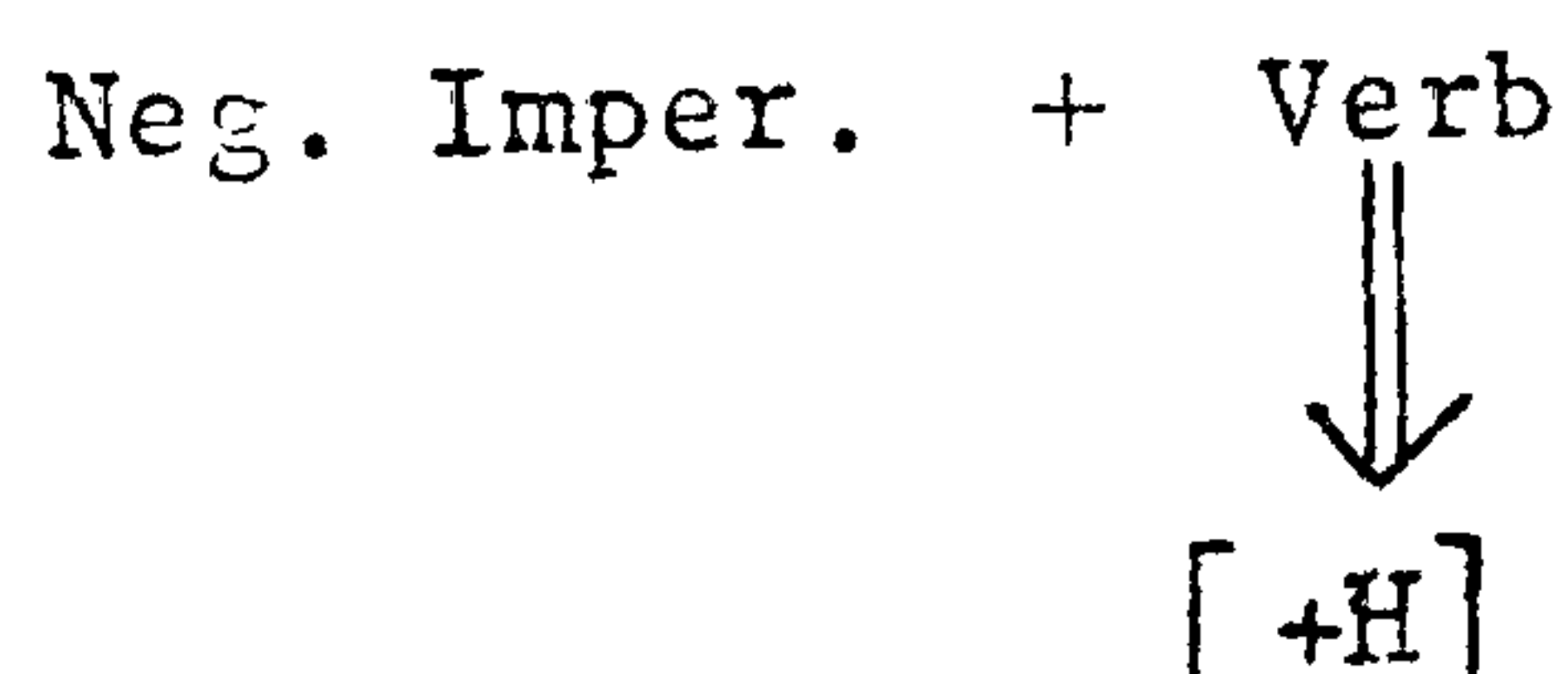

Although TAC16 has a vacuous effect on verbs with initial consonants,

it has phonetic repercussions before initial vowels cf. [na: b'r'iʃ] (ná bris "do not break") < /b'r'iʃ/ (bris- "break") but [na: him'i:] (ná himigh "do not go away") < /im'i:/ (imigh "go away"). As far as the relative ordering of TAC16 is concerned, it will precede the more general Neg. Triggering by PIPrec, if we choose to regard Neg. Imper. as the complex

$$\begin{bmatrix} + \text{Neg.} \\ + \text{Imper.} \end{bmatrix}$$

We now turn to Neg. Triggering itself and Rel. Triggering, both of which result in the assignment of the trigger [+Len]. For the sake of conciseness they are collapsed as TAC17:

(72) TAC17 Neg./Rel. Triggering:

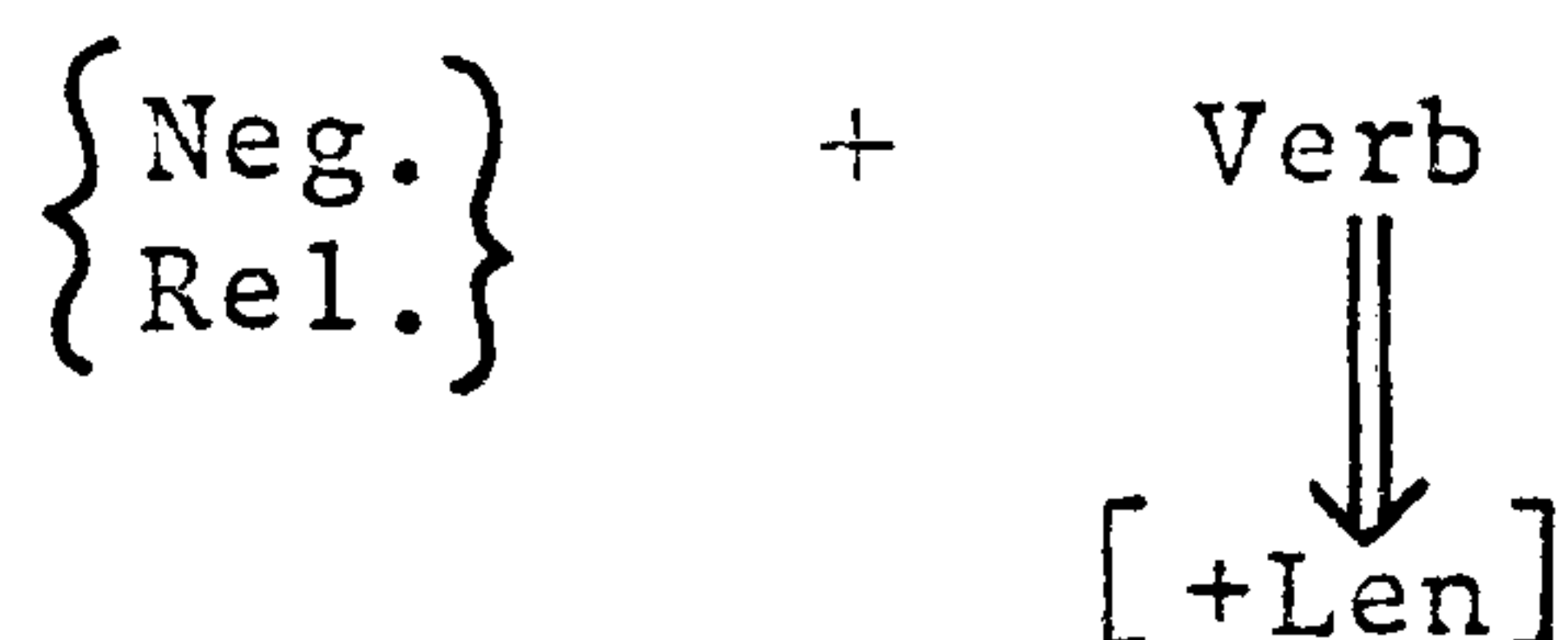

By selecting Neg. we account for [n'i: he:ən ʃe: əwal'ə] (Ní théann sé abhaile "He doesn't go home"), whilst the selection of Rel. will account for [ə f'ar ə he:ən əwal'ə] (an fear a théann abhaile "the man who goes home") as well as constructions like [nuər' ə he:ən ʃe: əwal'ə] (nuair a théann sé abhaile "when he goes home"). Notice that in the case of Preterite verbs preceded by Neg., either /r/-Triggering or Neg. Triggering will insure that /ni:r'/ (níor 'affirmative') and /na:r'/ (nár 'interrogative') induce Lenition. It is thus of no empirical consequence that a precedence relation cannot be uniquely determined between the SDs [Part. + r + Verb] and [Neg. + Verb]. Indeed the hypothesis developed here is the stronger in that it fails to predict a unique precedence only where this does not result in an incorrect derivation.

Finally let us formalize the TAC which accounts for the eclipsing effect of the remaining particles.

(73) TAC18 Verbal Ecl. Triggering

Part. + Verb
 ↓
 [+Ecl]

This TAC guarantees that complementizers like /gə, sulə / and the Interrogative particle /ən/ condition Eclipsis in non-Preterite regular verbs and in all tenses of the six irregular verbs. The principles of UDRA predict that TAC18 will follow Preverbal Particle Allomorphy (SP3), /r/-Triggering (TAC15), Neg. Imper. Triggering (TAC16) and Neg./Rel. Triggering (TAC17). Let us specify the modes of PIPrec involved. First, Proper Segmental Inclusion insures that [Part. + Verb] is properly included in $\left[\begin{array}{c} \text{Part. + Verb} \\ \text{+ Pret.} \end{array} \right]$ Hence Particle Allomorphy takes applicational precedence over Ecl. Triggering. Secondly, the fact that after the PI Test, /r/ remains extant when the SDs of /r/-Triggering and Ecl. Triggering are compared, means that /r/-Triggering will apply first (Proper Contextual Inclusion). Thirdly, Proper Segmental Inclusion, the algorithm of Proper Class Inclusion, predicts that Ecl. Triggering follows Neg. Imper. Triggering, just in case the class of particles properly includes the Neg. Imper. Particle. It is this aspect of PIPrec that accounts also for the precedence of Neg./Rel. Triggering over Ecl. Triggering - Neg. and Rel. are specific instances of the class of "particle" and are therefore properly included in it.

In this section we have seen how the principles of UDRA may be exploited within the expanded lexicon to account for the ordering relations between the conditions which assign triggers of IM (= TACs) and the rules which spell out grammatical formatives. Throughout the section I have attempted to focus upon the specific issues which arise when triggering is formalized. Thus although no new examples have been introduced here, the discussion has drawn upon the data presented in Ch. I and the earlier sections of this Chapter. By devoting an entire

section to the precise statement of triggering, we have not only supplied the formal complement to the "Survey of Triggering Environments" - we have in addition bridged the gap between the discussion of the rôle of the expanded lexicon with its implications for the overall organization of the grammar, and the phonological component proper where rigorous formalization is an integral part of the evaluation measure. It is to such a statement of the rules of realization that we now turn.

CHAPTER THREE - REALIZATION

Because IM is a morphosyntactic as well as a phonological phenomenon, much of the discussion in Chapters One and Two has necessarily been focussed outside the phonological component. In this chapter we redress the balance and take up the phonological aspects of IM, in other words, Realization. The chapter is organised as follows. § 3.1 provides the basis for the next two sections since it is here that the underlying phonological inventory is presented and its specifications substantiated. Given this foundation, we are able in § 3.2 to formalize the realization rules for all mutation-types in Modern Irish. Finally in § 3.3 we draw on the UDRA hypothesis, explicated in Part I, to resolve two apparent ordering paradoxes. It will be shown that the treatment of realization is entirely compatible with the theory of UDRA.

§ 3.1 The Phonological Inventory

Throughout the discussion of Chapters One and Two a broad phonetic transcription has been used in the citation of examples from Modern Irish. In other words, the level at which the data have been represented has been that reached after the application of the phonological rules, but before the P(honetic) D(etail) R(ule)s. Let us term the level reached at the output of the phonology proper (i.e. prior to the PDRs) the phonetic level and let us reserve the term (phonetic) surface for the maximally specified output of the PDRs.

Now it is clear that the inventory of phonetic level segments is not the same as the underlying (or phonological) inventory. With regard to word-initial position, the latter differs from the former in two significant ways. First, there are segments which figure word-initially in phonetic representations which are not found in the corresponding position in URs. Such segments appear during the course of the phonological component in the output of realization rules (e.g. [x], [h], the lenited counterparts of /k/ and the voiceless coronals respectively.) Other segments differ from their phonetic specification by being complex underlyingly. For instance, I shall argue directly that [ʃ] is phonologically /s'/, where /'/ stands for the feature [+palatalized] which has been "segmented out" from the preceding feature complex. [j] and [ç] are interesting with regard to the two significant ways in which phonetic segments may differ from underlying segments in word-initial position, for even though they do not figure in URs, we know that they comprise phonological complexes because of the rôle they play in the realization of IM. Thus since [j] is the lenited counterpart of /g'/, and [ç] is the lenited counterpart of /k'/, we might represent the former as /ɣ'/ and the latter as /x'/ at an intermediate phonological level. This means that [j] and [ç] are [-cor] underlyingly, even

though, following the arguments of N. V. Smith (1973), I assume that they are [+cor] on the phonetic surface, the necessary adjustments being effected by a PDR. (See "The Acquisition of Phonology" pps. 195-6 for the reference to SPE and the earlier (Jakobson, Fant and Halle, 1951) system where true palatals were treated like all other coronals as [-grave].)

Bearing in mind the differences between underlying and phonetic representations, let us consider the distinctive feature composition of the underlying inventory, set out in Table III. Notice first that the five rightmost columns of Table III, namely those specifying /x, w, h, ɣ, ŋ/, have been sectioned off. This is because these segments never appear in word-initial position in major lexical items. To put this differently, /x, w, h, ɣ, ŋ/ never constitute the input to realization rules. They have been included in Table III for two reasons. First, /x, w, h/ do appear in non-initial position in URs e.g. /t'ax/ (teach "house"); /la:w/ (lámh "hand"); /bo:hər/ (bóthar "road"). Secondly, they occur initially in grammatical morphemes, namely prepositions and prepositional pronouns i.e. /xun/ (chun "towards") and /har'/ (thar "beyond, over") and their related prepositional pronouns; as well as the prepositional pronouns based on /o:/ (ó "from, since")*.

* Footnote

The three paradigms of prepositional pronouns are as follows:

	/xun/		/har'/		/o:/	
Sg. 1	[xugəm]	<u>chugam</u>	[harəm]	<u>tharam</u>	[wem]	<u>uaim</u>
2	[xugət]	<u>chugat</u>	[harət]	<u>tharat</u>	[wet']	<u>uait</u>
3M	[xug'ə]	<u>chuige</u>	[har'if]	<u>thairis</u>	[wai]	<u>uaidh</u>
3F	[xuk'i]	<u>chuici</u>	[har'hi:]	<u>thairsti</u>	[wehi:]	<u>uaithe</u>
Pl. 1	[xugin']	<u>chugainn</u>	[harin']	<u>tharainn</u>	[wen']	<u>uainn</u>
2	[xugiv]	<u>chugaibh</u>	[hariv]	<u>tharaibh</u>	[uwiv]	<u>uaibh</u>
3	[xukə]	<u>chucu</u>	[harhə]	<u>tharstu</u>	[uhə]	<u>uathu</u>

It would seem totally ad hoc to derive wem etc. from, say, / m em/ [+Len]

The syllabification of /o:/ offers a more plausible source, though it too may be rejected on grounds of Abstractness.

TABLE III

DISTINCTIVE FEATURE COMPOSITION OF UNDERLYING
SEGMENTS IN MODERN IRISH

	p	t	k	b	d	g	f	s	m	n	l	r	x	w	h	ɣ	ɟ
vocalic	-	-	-	-	-	-	-	-	-	-	+	+	-	-	-	-	-
consonantal	+	+	+	+	+	+	+	+	+	+	+	+	+	+	-	+	+
sonorant	-	-	-	-	-	-	-	-	-	+	+	+	-	-	-	-	+
anterior	+	+	-	+	+	-	+	+	+	+	+	+	-	+	-	-	-
coronal	-	+	-	-	+	-	-	+	-	+	+	+	-	-	-	-	-
continuant	-	-	-	-	-	-	+	+	-	-	-	+	+	+	+	+	-
nasal	-	-	-	-	-	-	-	-	+	+	-	-	-	-	-	-	+
lateral	-	-	-	-	-	-	-	-	-	-	+	-	-	-	-	-	-
voice	-	-	-	+	+	+	-	-	+	+	+	+	-	+	-	+	+

CONTRASTIVE COMPOSITION OF SONORANT CONSONANTS IN ISOLATION

	n	l	r
continuant	-	-	+
nasal	+	-	-
lateral	-	+	-

Of course, it would be possible to represent instances of /x, w, h/ as, say, $\left/ \begin{smallmatrix} k \\ [+Len] \end{smallmatrix} \right/$, $\left/ \begin{smallmatrix} m \\ [+Len] \end{smallmatrix} \right/$, $\left/ \begin{smallmatrix} t \\ [+Len] \end{smallmatrix} \right/$, respectively in the majority of cases (but see footnote). However such a solution strikes me as being too abstract - even though it does recapitulate the diachronic facts. It is on these grounds, therefore, that I include /x, w, h/ in the overall underlying inventory but not in the inventory of segments which may appear initially in the URs of major lexical items. Notice finally with regard to the righthand section of Table III that /ɣ/ and /ŋ/ have been included for the sake of completeness even though they do not appear in URs, /ɣ/ being totally absent and instances of non-initial [ŋ] being derivable by rule from /nk/ or /ng/ (see discussion below).

The most striking overall difference between the phonological inventory in Table III and the phonetic surface of Modern Irish lies in the treatment of palatalization adopted in this thesis. Observe that the distinctive feature [\pm pal] is absent from the Table. This means that the segments listed there may either be interpreted as the natural class of non-palatalized (or velarized) consonants *, or alternatively they may be taken as archisegments which are "neutral" with regard to palatalization. As indicated above, I propose to treat the so-called "slender" (caol) consonants of Modern Irish in terms of the feature [+pal] which is segmented out from the distinctive feature complex which it modifies. Given such a treatment either interpretation of Table III is motivated and I shall leave the choice between the two open. The reasons for segmenting out [+pal] in this way stem from IM itself. We shall see in § 3.2 that in every realization rule bar

* Footnote

See discussion on p. 475 ff. for the ways in which /' / is manifested on the phonetic surface.

one the feature [pal] is unaffected. A particularly striking piece of evidence in favour of the analysis is afforded when /f(')/ * undergo Lenition. Here the fact that /'/ remains extant after the deletion of /f/ is attested by its modification of "broad" consonants with which it is subsequently concatenated. It will be demonstrated in § 3.2 that an insightful formalization of the deletion of /f/, to name but one relevant aspect of IM, is dependent upon the assumption that a feature [+pal] be segmented out from "slender" consonants.

There is, then, evidence from IM that the distinctive feature [+pal] should be segmented out from the feature complex it modifies. But what justification is there that, say, [ʃ] = /s'/, rather than some independent segment + /'/ ? To put this slightly differently, what evidence do we have for the minimal differentiation of [ʃ] and [s] at the underlying level in terms of the presence or absence of [+pal]? Or again, if we adopt the archisegmental interpretation of Table III, what evidence do we have that there is an archisegment {s} in Modern Irish which subsumes the shared features of [ʃ] and [s] minus [pal]?

The answer to this lies in the alternations between "broad" and "slender" * consonants found in certain morphosyntactic environments and known in traditional grammars as "Attenuation". Irish grammarians have continued

* Footnote

When the broad and slender counterparts of an underlying segment are both referred to, I have adopted the abbreviatory device of incorporating a parenthesized apostrophe within the slants. Thus /f(')/ refers to both /f/ and /f'/. In what follows the fuller notation is employed only where ambiguity would otherwise result.

** Footnote

I shall continue to use the labels "broad" and "slender" when referring to the natural classes of consonants specified without /'/ and specified with a following /'/, respectively. This is not to say that I am unaware of Gleasure's caveat (1968) regarding the choice of terms. Indeed, I agree that the (surface) phonetic and underlying levels demand distinct, unambiguous labels. However, since the issue is essentially terminological, the mnemonics "broad" and "slender" will serve our purposes.

the practice instigated by the Medieval scholars and the orthography indicates the broad/slender distinction by means of flanking vowels. Thus in the column showing orthography in Table IV the process of Palatalization is marked by an infix i. More importantly, the Table demonstrates that pairs of consonants, distinguished only by the fact that one is followed by /'/, figure in morphosyntactic alternations. Because of their phonotactic behaviour, [ɣ], [j], [ɥ], [ɥ'] do not appear in Table IV, but we have adduced their (intermediate) phonological composition by analogy with their non-mutated counterparts (see p.465f above).

It will be observed that /h/ is absent from Table IV and also that this segment alone has been specified as [- cons, - voc] in Table III. Let us examine /h/, the only semivowel in the underlying inventory, and then consider [w] (= /w/) and [j] (= /ɣ'/), for the latter pair are usually deemed semivowels in phonological grammars. Our discussion will lead on to an examination of the way in which the broad/slender distinction manifests itself on the phonetic surface.

Phonemic studies vary as to the way in which they treat [h]. De Bhaldraithe and Ó Cuív group all the phonetic alternants together as one phoneme, attributing the variation in articulation to the following vowel. * De Búrca considers the possibility of setting up two phonemes /h/ and /h'/ and notes the incongruity of patterning which results when only one phoneme is posited (page 28, § 134). Notwithstanding this, he too eventually opts for the monophonemic solution (page 33, § 168). Evans' treatment sets up two glottal consonants but does so not in

* Footnote

In other words, their treatment is essentially the same - if not as rigorous - as Gimson's description of /h/ in English RP (1962).

TABLE IV

PAIRING OF UNDERLYING CONSONANTAL SEGMENTS IN TERMS
OF THE DISTINCTIVE FEATURE [+PALATALIZED]

	<u>Common Sing.</u>	<u>Genitive Sing.</u>	<u>Orthography</u>	<u>Gloss</u>
/p/~/p'/	[sop]	[sep']	<u>sop</u> , <u>soip</u>	"wisp"
/t/~/t'/	[kat]	[kat']	<u>cat</u> , <u>cait</u>	"cat"
/k/~/k'/	[b'r'ak]	[b'r'ik']	<u>breac</u> , <u>bric</u>	"trout"
/b/~/b'/	[gob]	[geb']	<u>gob</u> , <u>goib</u>	"beak"
/d/~/d'/	[ba:d]	[ba:d']	<u>bád</u> , <u>báid</u>	"boat"
/g/~/g'/	[bro:g]	[bro:g'ə]	<u>bróg</u> , <u>bróige</u>	"shoe"
/f/~/f'/	[uf] *	[if']	<u>ogh</u> , <u>uigh</u>	"egg"
/s/~/s'/	[kos]	[kofə]	<u>cos</u> , <u>coise</u>	"leg"
/m/~/m'/	[tum]	[tim']	<u>tom</u> , <u>tuim</u>	"bush"
/n/~/n'/	[e:n]	[e:n']	<u>éan</u> , <u>éin</u>	"bird"
/l/~/l'/	[ʃg'e:l]	[ʃg'e:l']	<u>scéal</u> , <u>scéil</u>	"story"
/r/~/r'/	[f'ar]	[f'ir']	<u>fear</u> , <u>fir</u>	"man"
/x/~/x'/	[klox]	[kloçə]	<u>cloch</u> , <u>cloiche</u>	"stone"
/w/~/w'/	[kri:w]	[kri:və]	<u>craobh</u> , <u>craoibhe</u>	"branch"

Note:

The palatalization of the final consonant of the UR in the morpho-syntactic environment [+Genitive, +Singular] may be accompanied by schwa-suffixation or vowel alternation: forms with underlying back vowels may exhibit the corresponding front vowel before [+pal] consonants i.e. /o/ → [e], /u,a/ → [i]. Since palatalization occurs elsewhere independently of fronting, we may assume that the consonantal alternation triggers the vocalic alternation in those morphemes lexically marked to undergo it.

* Mhac an Fhailigh also cites [uw] as the Common form in free variation with [uf]. Note that [if'] is the Dative Singular. The Genitive Singular is [ivə], whilst the lexeme is defective in the Plural.

order to account for the potentially contrastive status of */h'/ but rather in order to describe the clearly allophonic possibility of voicing intervocalically (cf. English RP; see ref. in fn. on p.470). According to Mhac an Fhailigh, /h/ has one quality only. However there is alternation between /h/ and the consonants [ç] and [f] following [i] and [u] respectively (page 36, § 154). To my knowledge, the h/f alternation does not occur in Connemara Irish *, although it certainly is the case that the h/ç alternation obtains. I shall therefore confine my remarks to the exponence of a hypothetical /h'/ segment by [ç].

In contrast to the monophonemic analyses, Breatnach recognizes /h/ and /h'/, entirely parallel to the broad/slender distinction obtaining in the other consonant pairs of the language. Now notice that in many of the items which Mhac an Fhailigh transcribes with /ç/, we find /h'/ in Breatnach's transcription e.g. Mhac an Fhailigh's [içə] (ithe "eaten" p.35 § 147); [f'içə] (fiche "twenty" ditto); [xil' i:ç] (gach uile oidhche "every night" p. 53 § 237); cf. Breatnach's [ih'əm'] (ithim "I eat" p.42 § 206); [f'ih'ə] (fiche "twenty" ditto); [nə hi:h'ə] (na h-oidhche "of the night" p. 43 § 209). Moreover, despite the incorporation of palatalized /h'/ into his analysis, Breatnach posits [ç] as the lenited counterpart of [ʃ] in [ə ça:n'] (a Sheaáin "Sean!" Vocative p. 13 § 54). Given this last piece of data, it appears that in order to obtain observational adequacy, our description must be able to account for the alternation of [ʃ] and [t'] with [ç] on the phonetic surface, as well as their lenition to [h(')].

In fact the specification of /h/ in terms of distinctive features set out in Table III, together with the underlying feature composition

* Footnote

The reverse alternation is found diachronically, as attested by orthography e.g. féin "-self" → [he:n']; -faidh, -fainn etc. Future and Conditional inflectional endings → [hi:], [hin'] etc.

which has been adduced for [ç] (i.e. /x'/), not only provide the means to describe such alternations but also suggest an explanation. We shall see in § 3.2 that the realization rule which implements the lenition of voiceless coronals ([s], [ʃ], [t], [t']) to [h] flips the value of [consonantal] as well as effecting changes in point of articulation. This realization rule constitutes the one case where /'/ is affected (see p⁴⁶⁹ above). However, if there is evidence on the phonetic surface that [h] < s, t is consistently different from [h] < ʃ, t', we may simplify the realization rule by disregarding /'/ in effecting its SC (i.e. not deleting it). Thus dialects which maintain the [h]-[h'] distinction on the phonetic surface contain the simpler realization rule. This in turn may be taken as a reflection of underlying congruity of patterning, since such dialects uphold the broad/slender dichotomy throughout the consonantal system. It is therefore apposite that such dialects be deemed simpler by the evaluation measure, and this is precisely what the proposed treatment guarantees.

But what about those dialects where lenited [ʃ], [t'] appear as [ç] on the phonetic surface? Notice that /h/ differs from /x/ only in terms of the value of the distinctive feature [consonantal]. Therefore if we effect the changes necessary to yield [h'] from [ʃ], [t'] but fail to flip the value of [consonantal], the result is [x] + ['] i.e. [ç]. (We shall formalize this in § 3.2 in such a way that [+cons] is flipped only if /'/ is absent from the input representation.) Thus by distinguishing /h/ from /x/ in terms of one feature only, we are in fact offering an explanation for the [ʃ, t'] - [ç] alternation. It is in this way that the distinctive feature composition of underlying segments proposed in Table III goes beyond a mere description of the facts and accounts for the underlying regularities of the language.

It has been established that /h/ is a semivowel at the underlying level, characterized by the distinctive feature [-cons]. But why are [w] and [j] not also specified in this way phonologically? The justification for regarding [w] and [j] as true consonants lies both in their behaviour with regard to IM and Palatalization and with regard to phonotactics. Notice first that [w] is the lenited counterpart of /b/ and /m/, whilst [j] is the lenited counterpart of /g'/. If we are to characterize Lenition as the process of spirantization, we would prefer an analysis in which [w] is a voiced bilabial fricative and [j] a voiced (palato-)velar fricative. It is clear, however, that such a consideration should not be permitted to motivate the analysis in isolation: it must be corroborated by other independent evidence. The [w]-[v] and [ɣ]-[j] alternations provide the necessary corroboration. In Table IV [kri:w] (craobh), the Common Singular form of the noun meaning "branch", is contrasted with [kri:və] (craoibhe), the Genitive Singular. Many further instances of the [w]-[v] alternation may be found in Modern Irish. As for the pair [ɣ]-[j], the analogical patterning which these two consonants share with [g]-[g'] surely demonstrates that the broad/slender dichotomy obtains here. Given that [v] and [ɣ] must be specified as true consonants, once again we would prefer the analysis which also treats [w] and [j] as [+cons].

Arguments based on IM and Palatalization have been adduced in support of the claim that [w] and [j] are true consonants in Modern Irish. Nevertheless it could be countered that the behaviour of the pair with regard to these processes is essentially morphophonemic and consequently that logically there need be no correlation between such behaviour and the phonological make-up of the segments in question. This line of argumentation might indeed win the day - were it not for the phonotactics of Modern Irish and the appearance of vocalic glides

on the phonetic surface which are unrelated phonologically to [w] (= /w/) and [j] (= /ɣ'/). The glide [w] appears between a broad consonant and a preceding or following close or half-close front vowel, whilst the glide [j] appears between a slender consonant and a preceding or following back vowel. Contrast the surface exponence of phonological /fi:/ (faoi "under") and /f'u:/ (fiú "worth") as [f^wi:] and [f'^ju:] respectively; or again, the phonetic manifestation of broad and slender /l/ following a mid back vowel i.e. /o:l'/ (óil "drink(ing)" Gen.) and /o:l/ (ól "drink(ing)" Common) which appear as [ɔ:jl'] and [ɔ:^wɫ] respectively. Since the occurrence of such glides is allophonic, we need not claim that they correspond to instances of /j/ and /w/. The latter are attested in initial position and intervocalically but not between consonant + vowel or vowel + consonant. We must conclude therefore that the semivowels [j], [w] in Modern Irish are sandhi phenomena and are inserted by PDRs as the exponents of the broad/slender dichotomy. In contrast, phonological /j/, /w/ are true consonants, being the lenited counterparts of /g'/ and /b,m/ respectively.

The distribution of (1) inherently palatal or palatalized, (2) inherently velar or velarized and (3) neutral contoids may be illustrated as follows along the lines of Gleasure's schematization:

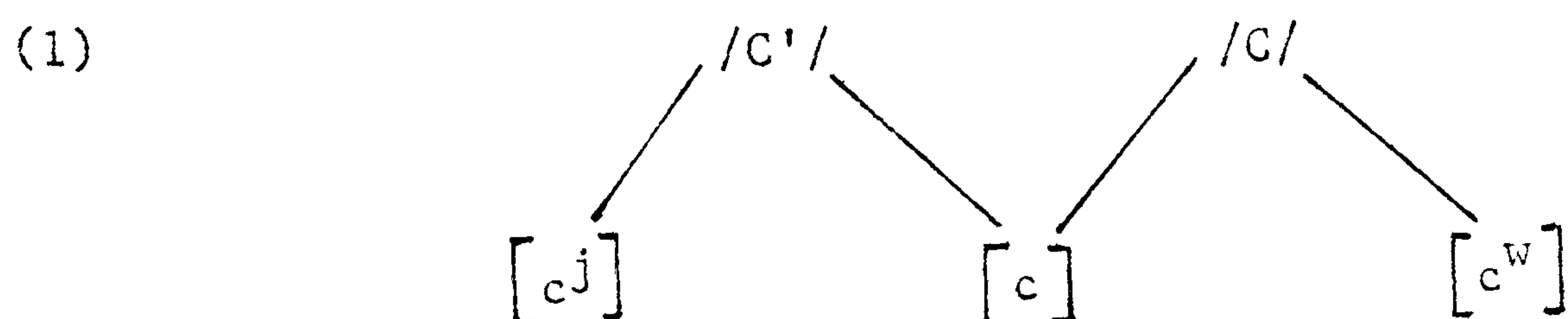

where /C'/ = underlying broad consonant

/C/ = underlying slender consonant

[cj] = palatal(ized) contoid

[c] = neutral contoid

[c^w] = velar(ized) contoid.

The fact that glides appear adjacent to vocalic nuclei of opposite quality might then be formalized as the following PDR:

(2) PDR Glide Insertion:

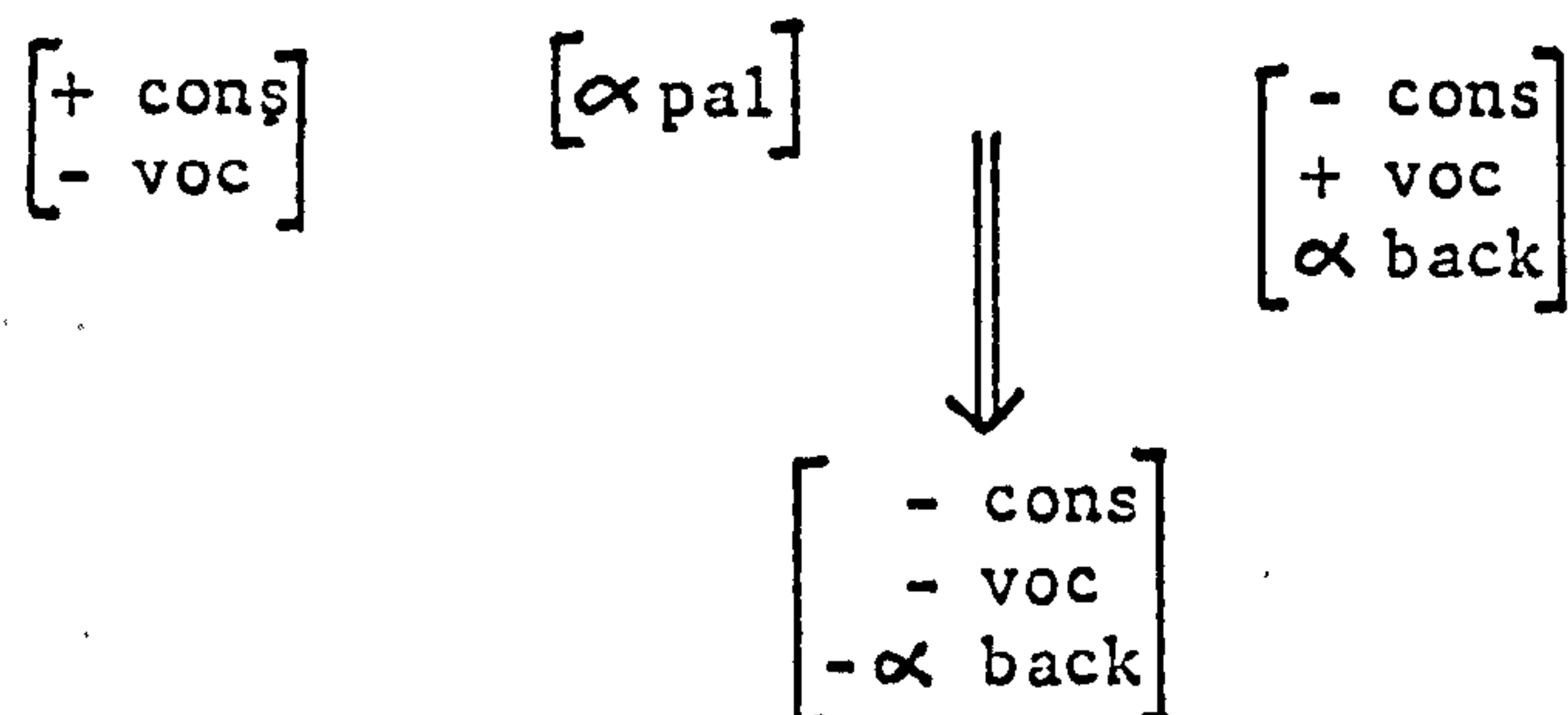

After a convention has insured that the absence of /'/ from a phonetic representation is replaced by [- pal], the PDR Glide Insertion stipulates that a [j]-glide (= [- back]) intervenes between [+ pal] and [+ back]-vowels (e.g. [f^hju:]), whilst a [w]-glide (= [+ back]) intervenes between [- pal] and [- back]-vowels (e.g. [f^wɪ:]).

We have illustrated the way in which the underlying broad/slender distinction for consonants manifests itself in contoids on the phonetic surface. Now consider not only the occurrence of a glide of schwa-like quality before coronals but also the quality of the syllabic nucleus in the following data:

(3) a.	/e:n'/	[e:n']	<u>éin</u>	"bird" Genitive.
	/e:n/	[ɛ:ᵐn]	<u>éan</u>	"bird" Common.
b.	/sa:l'ə/	[sɛ:jl'ə]	<u>sáile</u>	"luxury"
	/sa:lə/	[sa:ɾə]	<u>sála</u>	"heel" Genitive.
c.	/ve:l'ə/	[ve:jl'ə]	<u>bhéile</u>	"meal"
	/ve:lə/	[vɛ:ɾə]	<u>bhéala</u>	"mouths"
d.	/an'im'/	[an'ɪm']	<u>ainm</u>	"name"
	/an m/	[anəm]	<u>anam</u>	"soul"
e.	/in'id'/	[ɪn'ɪd']	<u>Inid</u>	"Enid"
	/inəd/	[ɪnəd]	<u>ionad</u>	"place"

Notice that the vowels preceding broad consonants are lowered. This is effected by a PDR, the precise formalization of which will not concern us. The above examples have been cited to demonstrate the way in which the underlying dichotomous distinction between the presence and absence of /'/ has a variety of exponents on the phonetic surface. Not all of these maintain Linearity between the underlying VC sequence and the surface VC sequence: /e/ and /a/ may have identical phonetic reflexes but the underlying distinction between them is maintained just in case /e/ has the allophone [ɛ] before broad consonants whereas /a/ has the allophone [æ] before slender consonants. The dichotomy may be realized in unstressed syllables by an [ɪ]-[ə] alternation. We shall see below that these vowels also function in this manner with respect to an important MSC of Epenthesis.

In keeping with the proposed treatment of phonetic semivowels and lowered nuclei, the place of articulation features, for the coronals and velars in particular, have been based on underlying oppositions rather than on the precise points of closure or constriction. Thus when we contrast the pair /t/-/t'/ we find that the former may be interdental → [t^θ] and the latter palato-alveolar → [tʃ]. This however does not weaken the claim that only they function as [+ cor, + ant]. Similar arguments from articulatory phonetics may be adduced for reflecting at the underlying level the difference in place or closure between /k/ and /k'//, /g/ and /g'//, the first member of each pair being velar, the second palato-velar. However to my knowledge the only relevant phonological arguments mitigate strongly against such a treatment. We have already mentioned the PDR which insures that [j] and [ç], although [- cor] underlyingly (i.e. /ɣ'/ and /x'/ respectively) are [+ cor] on the phonetic surface. Likewise purely phonetic considerations might lead us to specify [ʃ] (= /s'//) as

[+ cor, - ant] in the underlying inventory. Nevertheless, the fact that this segment functions as the palatalized counterpart of /s/, both with regard to IM and to Palatalization, seems to me convincing evidence that such an analysis is an inept characterization of the underlying consonantal system of Modern Irish.

We now leave the discussion of the phonetic surface, although we shall return to the treatment of /l, n, r/ below. Rather we move on to the rôle of the feature [sonorant] which figures in the composition of the liquids and /n/. It will have been noticed that we have treated /m⁽ⁿ⁾/ as **obstruents** in Modern Irish. In this respect, then, **their** distinctive feature specification differs from those of the other nasals, which are marked [+ son], in Table III. The analysis also differs from that usually posited for other languages, where all nasals are given the same specification for the feature [sonorant]. * What then is the nature of the evidence which leads to this departure from the "standard" treatment of bilabial nasals and sets them apart from other sonorant nasals?

Two types of evidence may be adduced which lead to the analysis of /m⁽ⁿ⁾/ as **obstruents** in Modern Irish, namely evidence from IM itself and evidence from phonotactics. It is significant that both types of evidence are mutually supportive. To put this slightly differently, if IM supported the proposed treatment but no corroboration were to be found elsewhere in the phonology of Modern Irish, we might (justifiably) be accused of moulding the data to fit the analysis. However, this is not the case. Moreover, our hypothesis

* Footnote

Notice however that in Rogers' treatment of Modern Scots Gaelic /m/ is an obstruent. In support of his analysis Rogers cites evidence from IM corresponding to the first argument presented below.

finds additional support from the fact that there are two types of evidence from IM and two types of evidence from phonotactics. Let us examine the former first.

One piece of evidence from IM in favour of the treatment of /m(')/ as **obstruents** may be found in Lenition. Recall that there is neutralization between /m/ and /b/ on the one hand and /m'/ and /b'/ on the other whenever these underlying segments lenite - they are realized as [w] and [v] respectively on the phonetic surface. This supports the fact that the two pairs of underlying consonants and their lenited counterparts have been given similar distinctive feature matrices in Table III - they share the same specification for [coronal], [anterior] and [voice]. What is more both pairs of underlying consonants have [-cont] in common and it is the value for this feature which is flipped during the process of realization. Now we have specified that [w] is a voiced bilabial fricative which is [+cons] [-voc], (rather than a semivowel i.e. [-cons] [-voc]). In other words, only one feature is affected when /b/ and /b'/ lenite to [w] and [v]*. A priori, then, we would prefer an analysis which changes the minimum number of feature-values when /m/ and /m'/ lenite to [w] and [v]. Since both [w] and [v] are obstruents, we will favour the treatment which flips only [-cont] and [+nasal] (but see below), rather than the one which also requires that [+son] becomes [-son]. To sum up, the most highly valued analysis will be the one in which /m/ and /m'/ are treated as obstruents.

Further support lies in the precise formalization of Lenition. We have suggested above that the value of [+nasal] may be flipped along

* Footnote

The labiodental point of articulation in the palatalized counterpart of [w] is effected by a low level PDR.

with that of [-cont] when /m(')/ lenite. Notice however, that to make such a claim would necessarily entail the complication of the statement of Lenition. To put this another way, it would mean that Lenition could only be characterized as Spirantization in a more limited set of cases. However, prevalent in the phonemic hand-books is the claim that [w] and [v] which have developed from underlying /m/ and /m'/ are not only nasalized themselves but are also preceded by nasalized vowels e.g. [lã:w](lámh "hand"), [sãwrə] (samhradh "summer") (see e.g. Mhac an Fhailigh page 48 § 208; de Bhaldraithe page 46 § 241). If we specify [w] and [v] as [\pm nasal], then not only are we able to account for the nasality associated with certain occurrences of these consonants and consequently the nasal assimilation attested in preceding vowels, but also we retain a simpler and more highly valued formalization of the realization of Lenition.

It might reasonably be asked at this point in the discussion whether similar arguments from the realization of Eclipsis might lead to the specification of all nasals as obstruents, given that /d/, /d'/, /g/, /g'/ (= voiced obstruents) eclipse to /n/, /n'/, /ŋ/, /ŋ'/ (= sonorants in Table III) respectively. Moreover, arguing on the basis of the formal simplicity of the rules of realization (as was done above for Lenition), surely their statement is complicated by the fact that voiced bilabials apparently retain their specification [-son] in the SC of the realisation rule, whereas that of the dentals and velars is flipped? The solution to this apparent anomaly lies in the nature of Eclipsis itself. We shall characterize this mutation-type in terms of movement up the sonority hierarchy. It is therefore salient to the process that the underlying voiced plosives should become homorganic nasal sonorants. Now this is just as true for bilabials as it is for dentals and velars. In other words, [m], [m'] which result from the

realization of Eclipsis in underlying /b/, /b'/ become [+son] during that process.

To sum up, at the underlying level of representation, bilabial nasals are specified [-son]. This facilitates the characterization of Lenition as Spirantization. After all the truly phonological rules have applied, a PDR "fills in" the positive specification for the feature [sonorant] when it co-occurs with [+nasal]. This PDR also insures that underlying bilabial nasals which have retained their specification as [+nasal], [+ant], [-cor] throughout the application of the phonological rules appear as [+son] on the phonetic surface. However it applies redundantly to those bilabial nasals which result from the realization of Eclipsis, since these acquire their [+son] specification as part of the SC effected by that realization process.

Let us now turn to the second piece of evidence from IM which supports the analysis of bilabial nasals as obstruents in Modern Irish. Since it involves a Minor Mutation it also provides an opportunity to exemplify the mutation-type: the Article induces the mutation of /s/ and /ʃ/ to [t] and [t'] respectively under certain specific morphosyntactic and phonological conditions. Thus the manner in which we handle these data will be significant in terms of the formalization of different types of conditions on TACs (see § 2.4 for the rôle of morphosyntactic conditioning on TACs). In fact, the morphosyntactic features which make up the necessary environment for the Minor Mutation under discussion (henceforth S-T) can readily be specified - S-T is triggered in a Feminine Singular noun in the Common form preceded by the Article, and in a Masculine Singular noun in the Genitive, also preceded by the Article. It is feasible that this morphosyntactic environment could be formalized using alpha variables i.e. as [+sing.] [α Masc.] [α Gen.]. On the other hand, there seems to be no "intrinsic

connection" between Feminine Singular Common and Masculine Singular Genitive - unless one treats the former as [+ sing.] [- Masc.] [- Gen.]. Since the grounds for doing this are not obvious, I assume that the two morphosyntactic environments which trigger S-T are disjoint.

It is when we consider the phonological conditions on S-T that we are led to treat /m(')/ as **obstruents**. Compare the data in (4) in which Feminine Singular Common nouns undergo S-T with that of (5)a. and b. which do not undergo the mutation-type:

(4) i	/su:l'/	[ə tu:l']	
	<u>súil</u>	<u>an tsúil</u>	"eye"
ii	/ʃl'i:/	[ə t'l'i:]	
	<u>slí</u>	<u>an tslí</u>	"way"
iii	/sna:həd/	[ə tna:həd]	
	<u>snáthad</u>	<u>an tsnáthad</u>	"needle"
iv	/sra:d'/	[ə tra:d']	
	<u>sráid</u>	<u>an tsráid</u>	"street"
(5)a.			
i	/ʃo:mrə/	[ə ʃo:mrə]	
		cf. *[ə t'o:mrə]	
	<u>seomra</u>	<u>an seomra</u>	"room"
ii	/ʃl:iəw/	[ə ʃl'iəw]	
		cf. *[ə t'l'iəw]	
	<u>sliabh</u>	<u>an sliabh</u>	"mountain"
iii	/sna:h/	[ə sna:h]	
		cf. *[ə tna:h]	
	<u>snáth</u>	<u>an snáth</u>	"thread"
iv	/sruha:n/	[ə sruha:n]	
		cf. *[ə truha:n]	
	<u>sruthán</u>	<u>an sruthán</u>	"stream"

(5) b.	i	/ʃg'iən/	[ə ʃg'iən]	
		<u>scian</u>	<u>an scian</u>	"knife"
			cf. *[ə t'g'iən]	
	ii	/sb'r'e:/	[ə sb'r'e:]	
		<u>spré</u>	<u>an spré</u>	"dowry"
			cf. *[ə tb'r'e:]	
	iii	/sm'e:r/	[ə sm'e:r]	
		<u>sméar</u>	<u>an sméar</u>	"blackberry"
			cf. *[ə tm'e:r]	
	iv	/smal'k'/	[ə smal'k']	
		<u>smailc</u>	<u>an smailc</u>	"chunk, mouthful"
			cf. *[ə tmal'k']	

We must now consider the following question: Why do the nouns in (5) not undergo S-T? In fact the nouns in (5)a. and those in (5)b. fail to meet the SD of S-T for different reasons - that is, the nouns in (5)a. do not meet the morphosyntactic conditions on S-T since they are Masculine and Common, even though they meet the phonological conditions. On the other hand the nouns of (5)b. do not meet the phonological conditions on S-T, although they are all Feminine Singular Common. To see that this is the case, consider the nouns of (5)a. in the Genitive preceded by the Article (i.e. Masculine Singular Genitive = (6)a.) and compare them with those of (6)b. which are also Masculine Singular Genitive but fail to meet the phonological conditions for just the same reasons as the nouns of (5)b.

(6)a.	i	/ʃo:mrə/	[bun ə t'o:mrə]	
		<u>seomra</u>	<u>bun an tseomra</u>	"the end of the room"

ii	/ʃl'iəw/	[ba:r ə t'l'e:və] *	
	<u>sliabh</u>	<u>barr an tsléibhe</u>	"the top of the mountain"
iii	/sna:h/	[bun ə tna:h]	
	<u>snáth</u>	<u>bun an tsnáth</u>	"the end of the thread"
iv	/sruha:n/	[k'o:l ə truha:n]	
	<u>sruthán</u>	<u>ceol an tsrutháin</u>	"the music of the stream"
b. i	/sgatə/	[k'an ə sgatə]	
		*[k'an ə tɡatə]	
	<u>scata</u>	<u>ceann an scata</u>	"the leader of the flock"
ii	/sbo:rt/	[la: ə sbo:r't']	
		*[la: ə tbo:r't']	
	<u>spórt</u>	<u>lá an spóirt</u>	"the sport's day"
iii	/smig'l'e:r'/	[an'im' ə smig'l'e:r']	
		*[an'im' ə tmig'l'e:r']	
	<u>smuigléir</u>	<u>ainm an smuigléir</u>	"the name of the smuggler"
iv	/sm'e:ro:d'/	[soləs ə sm'e:ro:d']	
		*[soləs ə tm'e:ro:d']	
	<u>sméaróid</u>	<u>solas an sméaróid</u>	"the light of the ember"

At a glance, it appears that the phonological environment required by S-T may be cited as "before a vowel, coronal nasal, lateral or vibrant". It is clear, however, that such a listing misses a significant generalization. We would like to say that S-T applies before a sonorant. But

* Footnote

/ʃl'iəw/ undergoes final palatalization (= "attenuation"), Schwa Suffixation and vowel alternation when the morphosyntactic feature [Genitive] is associated with it. Cf. final palatalization only in [sruha:n'] (= (6)a. iv) and [sbo:r't'] (= (6)b. ii).

we can only formalize the TAC in this way if we exclude bilabial nasals from the class of sonorant consonants - for, crucially, S-T fails to apply before /m(')/ (see (5)b. iii and iv; and (6)b. iii and iv). In fact, when S-T is incorrectly applied to /s/ * before a bilabial nasal, we obtain an unacceptable consonant cluster. To put this another way, [tm] and [tm'] are unacceptable in just the same way that sequences of [t] + obstruent are not permitted on the phonetic surface of Modern Irish. Notice moreover that the same MSC which precludes the occurrence of /ʃm'/ initial clusters is the same one which insures that /ʃb'/ clusters do not occur (if we choose to complicate the MSC - see footnote* below). Alternatively, if we decide to generate the unacceptable clusters, we find that the phonological rule of depalatalization treats /m'/ and /b'/ as a natural class since it applies only before these segments cf.

[ʃd'r'i:k] stríoc "line"; [ʃg'ian] scian "knife". However if we were to treat /m'/ as a sonorant and /b'/ as an obstruent, we would in fact be denying that depalatalization is a natural process, just in case it operated in two very different phonological environments. Thus by adopting the analysis in which /m'/ belongs to the class of bilabial obstruents, we are able to maintain that depalatalization constitutes a unitary, phonologically natural process, as formalized below: **

(7) Depalatalization $\left[\begin{array}{l} - \text{son} \\ + \text{cor} \\ - \text{ant} \\ + \text{cont} \\ + \text{pal} \end{array} \right] \longrightarrow [- \text{pal}] / \text{---} \left[\begin{array}{l} - \text{son} \\ - \text{cor} \\ + \text{ant} \end{array} \right]$

* Footnote

Initial [ʃm'] and [ʃb'] clusters do not occur in Modern Irish. However it is not clear whether underlying initial /ʃm'/ and /ʃb'/ should be generated and the sibilant later depalatalized by phonological rule (maintaining the most general MSC on palatalization assimilation) or whether the MSC should have exceptions (thus simplifying the phonological component). For expository purposes I adopt the latter solution since it enables me to refer to underlying /s/ alone in these environments.

We shall have more to say below about phonotactic constraints on clusters containing /m/, /m'/. Let us take it, then, that S-T is to be formalized in such a way that it applies before a sonorant only. In other words, the phonological environment of S-T is simply any sonorant, regardless of its vocalic and consonantal specifications (vowels being [+voc, -cons], /n(')/ [-voc, +cons], /l(')/ and /r(')/ [+voc, +cons]). Not notice that we have necessarily included the velar nasals in that environment. This however has no effect since there are no initial /sŋ/, /ʃŋ'/ clusters in Modern Irish. In fact, as we noted above, it is doubtful whether */ŋ(')/ should be posited in the underlying inventory: on the phonetic surface these nasals occur in initial position only as the eclipsed counterparts of /g(')/. Furthermore in the Irish of Cois Fhairrge at least, non-initial occurrences of [ŋ] and [ŋ'] always precede a velar plosive (with one exception; see footnote to p.490); for instance, de Bhaldraithe cites [a:ŋgəx] eangach "fishing-net"; and [sbL a:ŋk'] splaingc "ember" Genitive (where ŋ = [ŋ'] by convention since it precedes a consonant marked for palatalization, and L = a voiced velarized dental lateral). In other words [ŋ], [ŋ'] can be derived from underlying /n/, /n'/ by the general process of Homorganic Nasal Assimilation. Indeed it may be possible to extend such an analysis to the dialects which possess word-final and intervocalic [ŋ] and [ŋ'] by the application of Velar Plosive Deletion to the output of Homorganic Nasal Assimilation e.g. in the Irish of Erris, Co. Mayo, underlying /angəx/ (eangach) → intermediate /aŋgəx/ → phonetic

** Footnote from page 485

Depalatalization applies vacuously to underlying /sm/, /sb/ clusters. As for */ʃp'/ clusters, which do in fact meet its SD, these do not figure in URs due to the fact that initial clusters never contain voiceless obstruents in Modern Irish.

surface [aŋəx]*. Such a treatment would be rendered more plausible than the comparable analysis frequently proposed for English and rejected by Smith (1973) inasmuch as we have more positive cross-dialectal evidence in Irish than in English for positing underlying velar and palato-velar plosives in that environment. Moreover, in the dialect of, say, Erris, there is no distinction between words which undergo K/G Deletion and those which do not (cf. English [siŋə] singer vs. [fiŋgə] finger), a fact which surely suggests that phonetic surface [ŋ] [ŋ'] have a single source. Notice finally that K/G Deletion will follow Homorganic Nasal Assimilation by Deletion Cession.

Returning to the main theme of our discussion, we may sum up the preceding argument by saying that there is no evidence for treating the velar nasals as occurring in the inventory of underlying initial segments in Modern Irish. Indeed it may well be the case that no such segments ever appear in URs. The implications of these facts are that the phonological conditions on S-T can be stated in terms of the single distinctive feature [+son], provided the bilabial nasals are treated as obstruents at the level of underlying representation. Moreover the fact that /m^(')/ behave like obstruents in not triggering S-T when they occur in initial clusters, means that we have positive as well as negative evidence in support of our hypothesis.

Intrinsically related to the observation that clusters whose second element is /m^(')/ fail to trigger S-T, is the fact that along with

* Footnote

The phonetic representation is taken from Mhac an Fhailigh page 40 § 174. The difference in vowel length between Erris [aŋəx] and Cois Fhairrge [a:ŋgəx] is of course irrelevant to the present discussion.

other obstruent clusters, such clusters also fail to undergo Lenition. On the other hand, /s(')/ + sonorant clusters do undergo Lenition, as shown by underlying /ʃl'i:/, /sna:həd/ and /sra:d'/ below:

- (8)a. [mə hli:] mo shlí "my way"
 b. [mə hna:həd] mo shnáthad "my needle"
 c. [mə hra:d'] mo shráid "my street"

Now contrast the data of (8) with those of (9):

- (9)a. [mə ʃg'iən] mo scian "my knife"
 * [mə hg'iən] *mo shcian
 b. [mə sb'r'e:] mo spré "my dowry"
 * [mə hb'r'e:] *mo shpré
 c. [mə sm'e:r] mo sméar "my blackberry"
 * [mə hm'e:r] *mo shméar
 d. [mə smal'k'] mo smailc "my chunk, mouthful"
 * [mə hmal'k'] *mo shmailc

Here /s(')/ does not lenite to [h], just in case it is not followed by a sonorant. Nor is the Lenition of clusters confined to those which might also undergo S-T, i.e. those with initial /s(')/: the following clusters lenite, where the second element is [+son]:

- (10)a. [mə fra:tə] < /pra:tə/ mo phráta "my potato"
 b. [mə xnap'ə] < /knap'ə/ mo chnaipe "my button"
 c. [mə ɣlin'ə] < /glin'ə/ mo ghluine "my glass"

Since Irish phonotactics only permits those obstruent clusters where the first element is /s(')/, there are no other clusters of the type obstruent + /m(')/. Indeed this is precisely what we would predict from the claim that /m(')/ is an obstruent: if /m(')/ is a sonorant, why are there no obstruent + /m(')/ clusters to undergo Lenition? Similarly certain obstruent + sonorant clusters - to the exclusion of obstruent + /m(')/ - undergo Eclipsis, depending on the first element:

- (11)a. [a:r bra:ti:] ár bprátaí "our potatoes"
 b. [a:r gnap'i:] ár gnaipí "our buttons"
 c. [a:r ɟlin'i:] ár ngloiní "our glasses"

Having anticipated slightly the type of argumentation which will be presented from phonotactics, this concludes the evidence from IM in favour of treating /m^(')/ as obstruents in Modern Irish.

We now turn to the evidence from phonotactics which supports the analysis of the bilabial nasals as [-son]. Our first piece of evidence concerns the suppletive alternant of a frequently occurring lexical item, namely, [mn̩a:] mná, the plural of /b'an/ (bean "woman"). If we assume that /m/ and /n/ differ only in point of articulation, we find this item particularly recalcitrant, for it appears to contravene two different MSCs. To spell this out a little more, if both /m/ and /n/ are specified as [+son, +nas], their concatenation in /mna:/ * constitutes a sequence of two sonorant consonants as well as being a nasal cluster. Now there is an otherwise well-motivated MSC in Modern Irish which prohibits two sonorant consonants in word-initial position. Clearly, under the analysis in which /m/ is [+son], /mna:/ is a counterexample to this MSC. Secondly, the item contravenes a constraint which disallows initial nasal clusters. In fact this constraint is the corollary of a more general MSC which permits nasal clusters only if a syllable boundary intervenes cf. /l'e:m'n'əx/ léimneach "(act of) jumping"; /im'n'i:/ imní "anxiety"; where in each case /m'/ closes the first syllable and /n'/ comprises the onset of the second.

However, if we specify the bilabial nasals as [-son] in URs, we find

* Footnote

The nasalization of the vowel in the phonetic representation is effected by a PDR which is triggered by the immediately adjacent coronal nasal.

that /mna:/ no longer contravenes the MSC on sonorant consonants, whilst the MSC on nasals may now be restated in a way which readily allows for the occurrence of /mn/ sequences. To take the MSC on sonorant consonants first, we see that if /m/ is an obstruent, the UR of "women" begins with an obstruent + sonorant consonant cluster. In this respect, then, /mna:/ conforms to the regular patterning of the language, being comparable to /gra:/ (grá "love"), or /bla:h/ (bláth "flower") in its phonotactics.

What then of the MSC on nasal clusters? - how can the treatment of /m(')/ as obstruents possibly affect the fact that /mna:/ has an initial cluster which is unprecedented elsewhere in the lexicon? To answer this question we must reconsider the types of nasals which may be separated by the syllable boundary alone. In fact when such cases are cited it transpires that the first nasal is bilabial and the second coronal. In other words the clusters which arise are just those in which the members differ in sonority, for notice that clusters of coronal nasal + velar nasal or velar nasal + coronal nasal (where both are [+son]) are not attested. * The MSC on nasals is formalized more precisely below:

(12) MSC on Nasals:

$$\begin{bmatrix} + \text{nas} \\ - \text{son} \end{bmatrix} \quad \S \quad \begin{bmatrix} + \text{nas} \\ + \text{son} \end{bmatrix}$$

where § = a syllable boundary

* Footnote

Historically there were instances of /ŋ § n/, as attested by the orthography cf. congnamh "help"; iongnadh "wonder". Breatnach and Ó Cuív describe the disappearance of such sequences (page 141, § 542; page 120, § 397, respectively). It may be inferred that /ŋ/ spirantized to [ʃ], which in turn vocalized, yielding a long vowel i.e. /kuŋnə/ → intermediate /kuʃnə/ → synchronic [ku:nə]; /uŋnə/ → intermediate /uʃnə/ — synchronic [u:nə]. The only residue of the historical cluster is found in the synchronic exception [iŋ'n'i:] ingne "nail" Genitive. Two possible accounts of the [ŋ' § n'] sequence suggest themselves: 1) to mark the Genitive of [uŋə] < /ungə/ as recalcitrant in the lexical repository;

Given the above MSC, /mna:/ contravenes only one of its specifications, namely, the requirement that § intervene between the nasals. As is always the case with partial exceptions, we can account for /mna:/ either by relaxing the conditions on the MSC on Nasals or by stipulating in the lexicon the way in which the item proves recalcitrant. The former solution may be achieved by modifying the MSC on Nasals in such a way that § need be present only if the preceding nasal is not word-initial, i.e.

(13) MSC on Nasals (Modified)

$$\left\{ \begin{array}{c} \# \\ \langle [+voc] \rangle \end{array} \right\} \quad \left[\begin{array}{c} +nas \\ -son \end{array} \right] \quad \langle \S \rangle \quad \left[\begin{array}{c} +nas \\ +son \end{array} \right]$$

It is interesting to note that several dialects which have relaxed the constraint on nasal clusters have done so only at the underlying level. In the grammars of these dialects we find that the original

* Footnote contd. from page 490:

2) to maintain the MSC on Nasals as in 1) and to derive [iŋ'n'i:] from intermediate /uŋə/ + /n'i:/ by the rules of Fronting, Syncope and low-level Palatalization Assimilation (recapitulating the MSC Pal-Ass). All three rules are Minor and are attested in the derivation of the Genitive of [obir'] (obair "work") and [aun'] (abhainn "river") < /awin'/ via Vocalization and Coalescence.

UR	/uŋə/	/obir'/	/awin'/
Gen. Suffixation (morphosyntactically conditioned)	uŋə + n'i:	obir' + ə	awin' + ə
Hom. Nasal Ass.	uŋgə + n'i:	-	-
K/G Deletion	uŋə + n'i:		
Fronting	iŋən'i:	ebir'ə	ewin'ə
Syncope	iŋn'i:	ebr'ə	ewn'ə
Pal. Ass.	iŋ'n'i:	eb'r'ə	evn'ə
Phonetic Surface	[iŋ'n'i:]	[eb'r'ə]	[evn'ə]

(Fronting precedes Syncope by Deletion Cession; Hom. Nasal Ass. and K/G Deletion take precedence by Proper Contextual Inclusion since they have smaller domains than rules which incorporate the Gen. suffix in their SDs)

Only a thorough investigation of the rules of Fronting, Syncope and low-level Pal. Ass. elsewhere in the phonology of Modern Irish will determine whether the Abstractness which they bring into the analysis is justified.

formalization of the MSC has persisted as a surface constraint and the nasal cluster in /mna:/, unacceptable at the level of phonetic representation, has been modified by phonological rule. Thus Mhac an Fhailigh cites the plural of /b'an/ as [mrã:] (§ 82 page 20), while de Bhaldraithe gives [mrɑ:], noting that "certain speakers retain the nasal quality in r' and r < n" (§ 224 page 42, fnl.). The claim that speakers of Erris and Cois Fhairrge Irish retain the /mn/ cluster at the level of underlying representation is justified by the fact that only an underlying immediately adjacent nasal could condition the nasalization of the vowel. The implication of this is that even in those dialects where phonetic surface [mnã:] is not attested, the MSCs formalized above, which hinge crucially upon the differentiation of bilabial and coronal nasals in terms of the distinctive feature [sonorant], are nevertheless well-motivated.

The second piece of evidence from phonotactics in support of analysing /m/ and /m'/ as obstruents in Modern Irish involves Epenthesis between sequences of sonorant + obstruent. It is not immediately clear whether such Epenthesis should be viewed as an MSC which operates within the expanded lexicon or whether it should be formalized as an insertion rule in the phonological component proper. However, considerations of rule interaction to which I shall return directly suggest that Epenthesis is a true phonological rule. Despite this conclusion, it should be stressed that whichever interpretation turned out to be justified, the bilabial nasals would demand differential treatment from the coronal nasals with respect to the feature [sonorant].

The data relevant to the formalization of Epenthesis are presented in Table V, where combinations of each of the three coronal sonorant consonants + another consonant are given. For each sonorant, a) and b) show instances where Epenthesis does apply, whereas c) shows instances where Epenthesis does not apply. Clearly /m/ and /m'/ found in b) function like consonants of type a), rather than like consonants of type c). Moreover, in both a) and c) the second consonant in the (potential) cluster has been established as an obstruent in Modern Irish. We may validate the claim that Epenthesis only occurs between sonorant consonant + obstruent by citing instances of the reverse situation i.e. obstruent + sonorant consonant. In (14) obstruent + sonorant sequences contrast with the leftmost examples from a) in Table V.

- (14) 1. [bogl̩əx] cf. *[bogələx] but [koləg]
 boglach
 "bad weather"
2. [eb'r'ə] cf. *[eb'ir'ə] but [ker'ib']
 oibre
 "work" Gen.
3. [kivn'ə] cf. *[kivin'ə] but [ban'iv]
 cuimhne
 "memory"

We saw above that /m/ + /n/ and /m'/ + /n'/ sequences are attested in Modern Irish. However, considering such data in isolation can lead either to the conclusion that /m(')/ are obstruents or that they are sonorants: under the former interpretation, /m/ + /n/ and /m'/ + /n'/ function like the examples of (14), under the latter, they function as sonorant clusters (examples of these appear below). Yet we know from the data presented in b) of Table V that the sequences /n/ +

TABLE V

EPENTHESIS BETWEEN SONORANT AND OBSTRUENT1. After a lateral:

a)	[koləg]	[baləwa:n]	[sgoləb]
	<u>colg</u>	<u>balbhán</u>	<u>sgolb</u>
	"tow"	"dummy, stammerer"	"peg (used in thatching)"
b)	[kaləm]	[ʃel'im'id'ə]	
	<u>calm</u>	<u>seilmide</u>	
	"a calm"	"snail"	
c)	[falsə]	[olk]	
	*[faləsə]	*[olək]	
	<u>fallsa</u>	<u>olc</u>	
	"lazy"	"bad"	

2. After a vibrant:

a)	[ker'ib']	[f'arəg]	[dorəxə]
	<u>coirb</u>	<u>fearg</u>	<u>dorcha</u>
	"bridge of straddle"	"anger"	"dark"
b)	[gorəm]	[f'er'im']	
	<u>gorm</u>	<u>feirm</u>	
	"blue"	"farm"	
c)	[portəx]	[korp]	
	*[porətəx]	*[korəp]	
	<u>portach</u>	<u>corp</u>	
	"bog"	"body"	

TABLE V contd.

3. After a coronal nasal:

a)	[ban'iv]	[ʃanəxəs]	[l'anəbi:]
	<u>bainbh</u>	<u>seanchas</u>	<u>leanbaí</u>
	"piglet (Gen.)"	"traditional lore"	"childish"
b)	[an'im']	[ʃin'im']	
	<u>ainm</u>	<u>seinm</u>	
	"name"	"playing (music)"	
c)	[sla:n't'ə]	[u:n'ʃəx]	
	*[sla:n'it'ə]	*[u:n'ɪ ʃəx]	
	<u>sláinte</u>	<u>óinseach</u>	
	"health"	"fool (Fem.)"	

/m/ or /n'/ + /m'/ function as sonorant + obstruent. This therefore confirms the conclusion reached in connection with /mna:/ that the sequence bilabial nasal + coronal nasal should be treated as an obstruent + sonorant cluster.

Further crucial evidence in support of our argument is found in the behaviour of obstruent clusters and sonorant clusters. We have cited examples of the former many times e.g. [ʃn'axtə] (sneachta "snow") [gara:ɹd'ə] (garáiste "garage") etc. Now observe the following: [g'amxi:x] (geam-chaoch "pur-blind"); [gam'b'i:n] (gaimbín "interest"); [tumbə] (tomba "tomb-stone"). Clearly, if /m(')/ were sonorants we would expect Epenthesis to apply here, for the rule does so between [r + x], [r' + b'], [l + b] in Table V. Moreover, if the bilabial nasals were sonorants we would predict that they would figure as the second element in sonorant clusters cf.:

- | | | | |
|---------|----------------------|-----|------------------|
| (15) i. | [ban'r'i:n] | ii. | [bar'n'əx] |
| | * [ban'ir'i:n] | | * [bar'in'əx] |
| | <u>bainríoghan</u> | | <u>bairneach</u> |
| | "queen" | | "limpet" |
| iii. | [b'e:rlə] | iv. | [m'i:n'l'əx] |
| | * [b'e:rələ] | | * [m'i:n'il'əx] |
| | <u>Béarla</u> | | <u>mínleach</u> |
| | "English (language)" | | "fine pasture" |

Yet as the b) examples of Table V demonstrate, such is not the case. We must therefore conclude that the bilabial nasals function as obstruents rather than as sonorants with respect to Epenthesis.

Having reached this conclusion, let us formalize Epenthesis. To put this more specifically, we have seen that /m(')/ must be treated as obstruents but we have yet to determine the subclass of obstruents to

which they belong, for not all sonorant + obstruent sequences undergo Epenthesis. From the c) examples of Table V, we see that the coronal obstruents, together with /p(')/ and /k(')/ do not meet the SD of Epenthesis. It is clear, then, that as well as stipulating [-son], the rule must include [-cor]. In order to exclude the "peripheral" voiceless plosives we must guarantee that no non-coronal obstruent meets the SD of Epenthesis if it is both [-voice] and [-cont]. In other words, the rule applies if the second element is either [+voice] (e.g. /b('), g(')/ or [+cont] (e.g. /x(')/) *. The voiced continuants (i.e. /w(')/) which occur non-initially (unlike /ɣ(')/) meet either condition. Epenthesis is formalized as (16) where schwa has been specified as [-stress]:

(16) Epenthesis

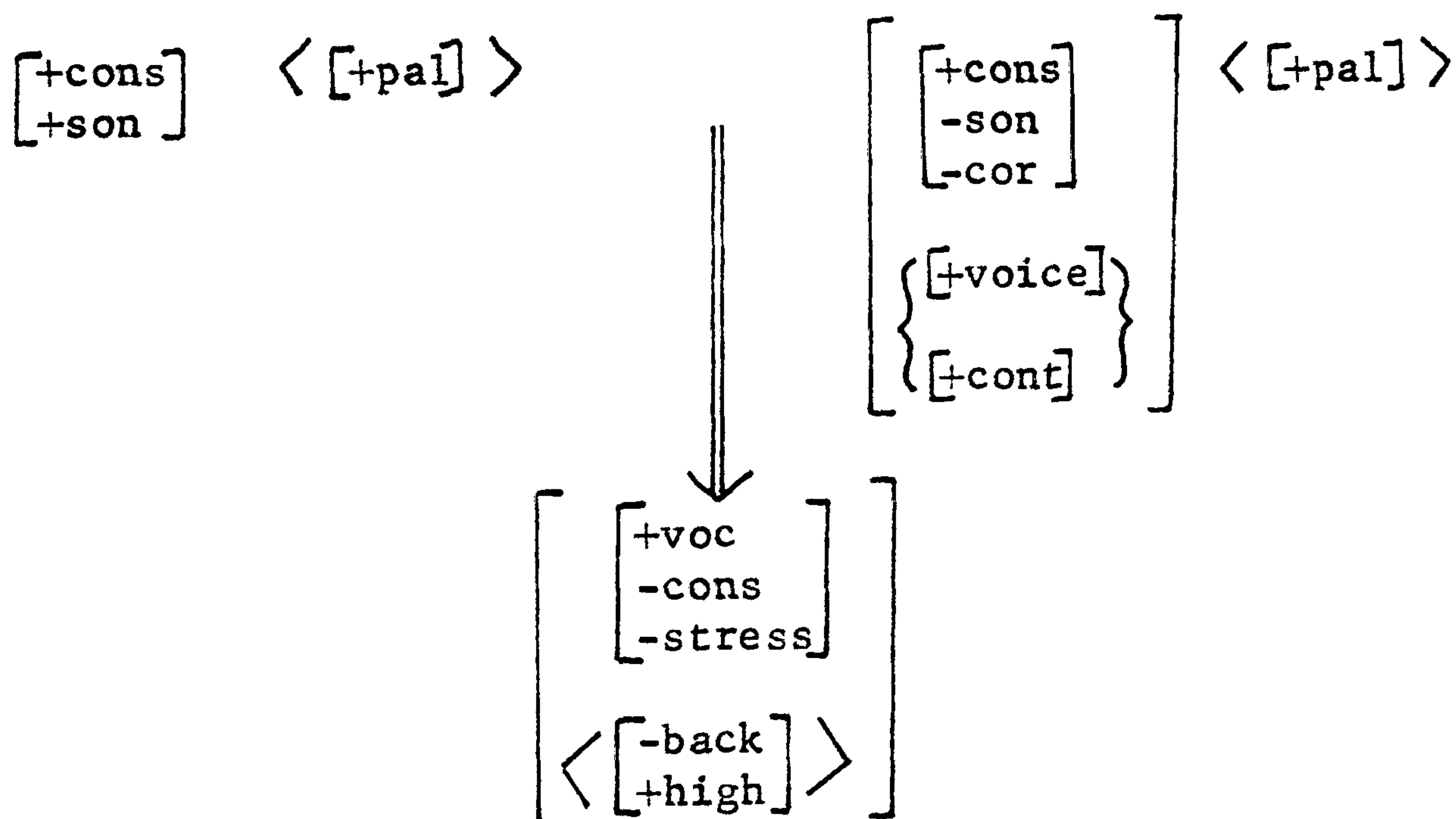

The angled bracket notation captures the fact that the epenthetic vowel between slender consonants is [i], rather than [ə]. Notice that Epenthesis must follow Pal.Ass., since it destroys the environment necessary for the latter. Since we may take Pal.Ass. to be

* Footnote

An MSC insures that sonorant consonant + /f(')/ sequences are not generated. The prior application of the MSC constitutes corroborative evidence that Epenthesis occurs in the phonological component proper.

an MSC, it seems natural that we should then regard the process which separates palatalized clusters as part of the phonological component proper.

However the most convincing evidence that Epenthesis must be viewed as a phonological rule comes from the fact that Homorganic Nasal Assimilation and K/G Deletion precede it. Given that it has been established that non-initial surface [ŋ] and [ŋ'] appear as clusters of /n/ + broad velar plosive or /n'/ + slender velar plosive (respectively) in URs (but see fn. to p. 490), we would expect Epenthesis to break up the /n + g/ and /n' + g'/ sequences before these strings entered the phonological component proper - if Epenthesis were an MSC. Thus Epenthesis would bleed Hom. Nasal Ass. of all underlying /n + g/ and /n' + g'/ clusters, yielding [nəg] and [n'ig'], and the SD of K/G Deletion would never be met. However, instances of [ŋ] and [ŋ'] from clusters containing underlying /g/ and /g'/ are attested rather than [nəg], [n'ig'] sequences e.g. /s'unga:n/ → [sʊŋa:n] (seangán "ant"); /mi:n'g'/ → [mi:ŋ'] (muing "mane, marsh"). Nor is it possible to argue that these forms fail to meet the SD of Epenthesis just in case they are instances of underlying /n + k/ and /n' + k'/. For not only would such an analysis go against the diachronic facts, but it would also complicate the statement of dialectal variation in an ad hoc manner: recall that Cois Fhairrge Irish has no K/G Deletion cf. surface [mi:ŋ'g']. In the case of seangán there is even more striking evidence of the presence of underlying /g/ since the medial nasal has been lost i.e. [sʊŋa:n] (where [N] = a velarized alveolar nasal; de Bhaldraithe page 103, § 593).

Let us take it, then, that Epenthesis, Hom. Nasal Ass. and K/G Deletion

(in those dialects which possess it) are all phonological rules. The question which must now be raised is the following: What principle of UDRA prevents Epenthesis from bleeding Hom. Nasal Ass., and K/G Deletion within the phonological component? The answer in both cases is PIPrec. Given a representation containing an /n + g/ or /n' + g'/ cluster, the SDs of Hom. Nasal Ass. and Epenthesis are both met. When we apply the PITest, we disregard the voiced velar plosive since it appears in both SDs. Now the phonological material which remains extant, namely the nasal sonorant consonant, precisely matches the structure affected by Hom. Nasal Ass. but is properly included in the SD of Epenthesis which applies following all sonorant consonants. Thus by Proper Class Inclusion Hom. Nasal Ass. takes applicational precedence. The algorithm Proper Contextual Inclusion comes into play when the output of Hom. Nasal Ass. meets the SDs of K/G Deletion and again, Epenthesis (K/G Deletion follows Hom. Nasal Ass. by Deletion Cession). The intermediate representation undergoes K/G Deletion just in case the environment of deletion contains only one segment (= /ŋ(')/) whereas under Epenthesis the inserted segment is flanked by two segments in the SD. Notice finally that PIPrec supersedes Deletion Cession - the latter operates only where PIPrec is inapplicable.

Summing up the outcome of our treatment of Epenthesis as a phonological rule in Modern Irish, we see that the above analysis has implications not only for the specification of bilabial nasals as obstruents, but also for the principles of UDRA and the distinctive feature characterization of the coronal sonorant consonants. To take the bilabial nasals first, we have corroborated evidence from IM with evidence from phonotactics in support of our original hypothesis that /m(')/ belong to the class of obstruents. More specifically

the MSC which prohibits *[[m']] and *[[b']] clusters and the precise formalization of the rule of Epenthesis serve to subclassify the bilabial nasals alongside the voiced bilabial plosives. Thus the minimal differentiation of the two pairs in terms only of the feature [nasal] finds support which is independent of any concern about the statement of IM.

As for the implications of the above discussion for the UDRA hypothesis, we shall demonstrate in further detail the applicability of the principles put forward in Part I when we turn to the actual formalization of the realization rules of IM in § 3.2 and the resolution of two apparent ordering paradoxes in § 3.3.

It remains in this section for us to survey the repercussions of the preceding exegesis for the coronal sonorant consonants. In our characterization of S-T, we saw the way in which /n, n', l, l'; r, r'/ function as a natural class with the vowels. Parallel behaviour was also attested in our treatment of Epenthesis. Clearly, then, the distinctive feature specification of /n, n', l, l', r, r'/ as [+ cons, + son, + cor, + ant, + voice] captures a significant fact about the consonantal system of Modern Irish. Let us examine the internal differentiation of the natural class which has been defined in this manner, by referring to the distinctive features [continuant], [nasal] and [lateral] (see Table III).* The specification of /n(')/ alone as [+ nas] and /l(')/ alone as [+ lat] needs no further comment. Some justification is required, however, for the distribution of [continuant],

* Footnote

Notice from Table III that the liquids are further distinguished from the nasals by being [+ voc]. Although this fact is significant, the following discussion centres crucially around "consonantal" features.

since of the sonorants only /r(')/ is positively specified for this feature. The specification of /r(')/ as [+ cont] reflects the description of their surface exponents as "fricatives" or "vibrants" in the phonemic literature. To cite Ch&H: "The fricative varieties of [r] do not present any particular difficulty; they are clearly continuant." (SPE page 318). Similarly the claim that the nasals (i.e. /m(')/ as well as /n(')/) are [- cont] follows the precedent set in SPE. Finally, as Ch&H observe, the treatment of /l(')/ with regard to this feature is a complex issue. It might be restated in terms of whether l should be classified with the stops or with the continuants. Ch&H cite Lloyd's (1908) description of certain dialects of English spoken in Scotland, where diphthongs are lax before non-continuant (e.g. [r'ʌjd]) and tense before continuants (e.g. [r'ajz]). In these dialects [l] patterns with the noncontinuant (e.g. [t'ʌjl]) and [r] with the continuants (e.g. [t'ajr]) (SPE *ibid.*). We shall see presently that the further differentiation of the laterals and coronal nasals in Irish depends upon their prior specification as [- cont]. Thus we tentatively conclude that of the sonorant consonants only /r(')/ is a continuant.

Given this tentative conclusion, we may schematize the distribution of feature values of [continuant], [nasal] and [lateral] for the sonorant consonants as [+F^α], [-F^β], [-F^γ], where α, β, γ assume the quality of the different features for the sonorant in question. The fact that we are able to schematize the oppositions in this manner suggests that not only do the sonorant consonants constitute a well-defined natural class but also that this natural class is maximally differentiated internally. Although analyses cannot be justified solely on the basis of elegance, the fact that an independently motivated description attains elegance serves to render it more highly

valued by the metatheory.

As a final point in our discussion of the phonological inventory of Modern Irish, mention must be made of those dialects which purportedly possess more than two laterals and more than two coronal nasals.

According to the phonemic studies, /l, l'/ are the lenited counterparts of /L, L'/ respectively. Figure II, based on private communication with Prof. T. S. Ó Máille, sets out the phonetic distinctions.

However, I suspect that the strong claim of Dónall Ó Baoill that these distinctions are contrastive is illusory. Moreover this scepticism is supported by Ailbhe Ní Chasaide's research where it was found that qualitatively there is no difference between [L] and [l], and between [L'] and [l'] (1979). Nonetheless, if it can be maintained that native speakers make the purported distinctions, a distinctive feature must be added to the phonological inventory. Furthermore, since descriptions of Old Irish allude to a four-way distinction which also extended to vibrants, any observationally adequate diachronic study will require an additional distinctive feature. (Indeed, the pressures from diachrony and synchrony to extend the inventory become actuality when we find older speakers who preserve the distinction.)

Two SPE features come to mind to describe a four-way subclassification by combining with [pal]: [tense] or [distributed]. Although the former has initial appeal, I know of no non-arbitrary way of deciding whether to allocate its positive specification to the radical consonants or to their lenited counterparts. The feature [distributed] on the other hand offers a solution which is not ad hoc. Ch&H posit this feature to account for languages with consonantal systems containing bilabial, dental, alveolar, retroflex and palato-alveolar plosives. Despite the fact that they do not state as much explicitly, it may be inferred that in such cases the [\pm dist] specification is

FIGURE II

FOUR-WAY SUBCLASSIFICATION OF LATERALS AND CORONAL
NASALS IN SOME DIALECTS OF MODERN IRISH

1. [n], [l]

Alveolar/post-alveolar
 velarized

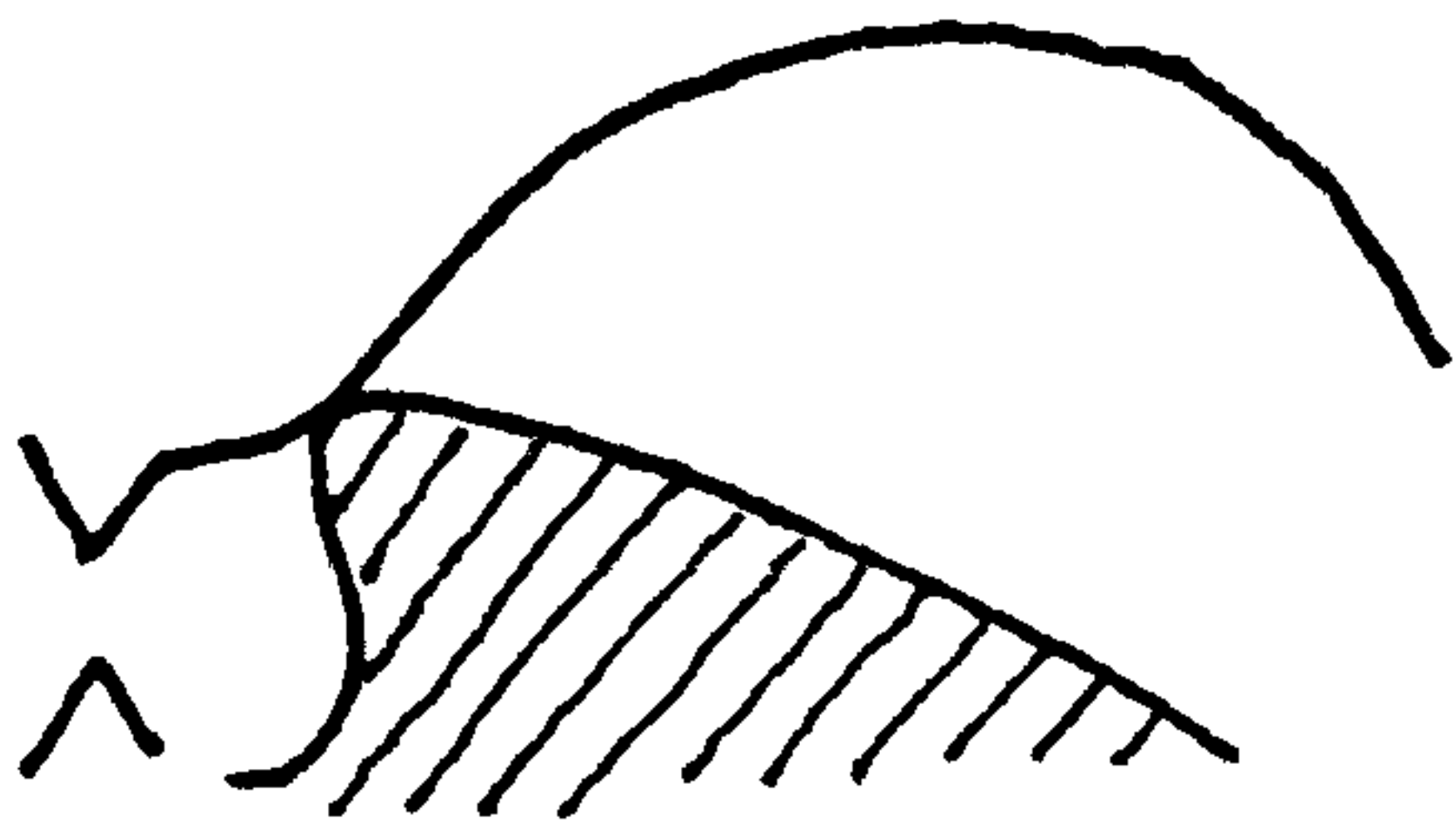

2. [n'], [l']

Apico-dental/alveolar
 palatalized

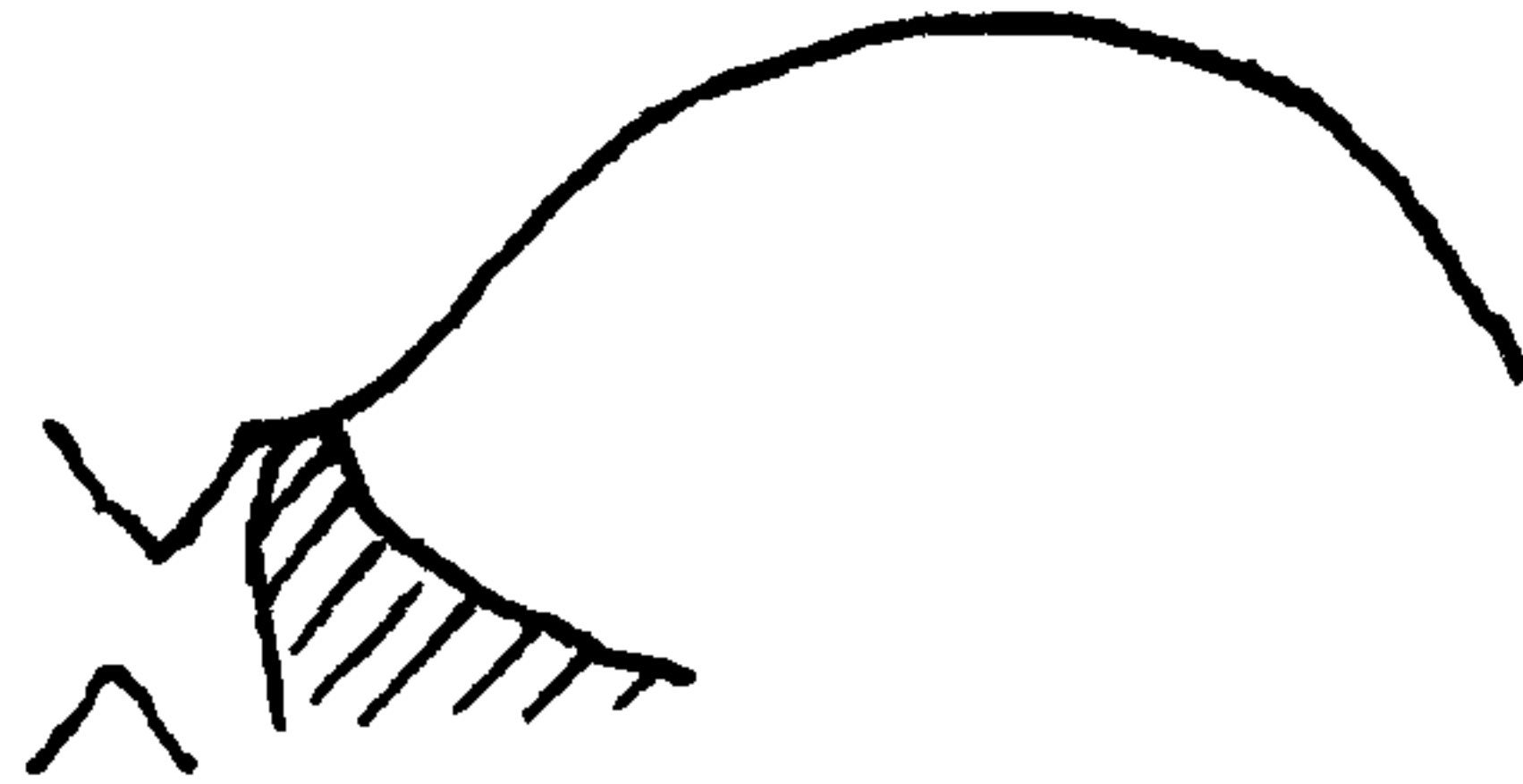

3. [N], [L]

Lamino-dental (interdental)
 velarized

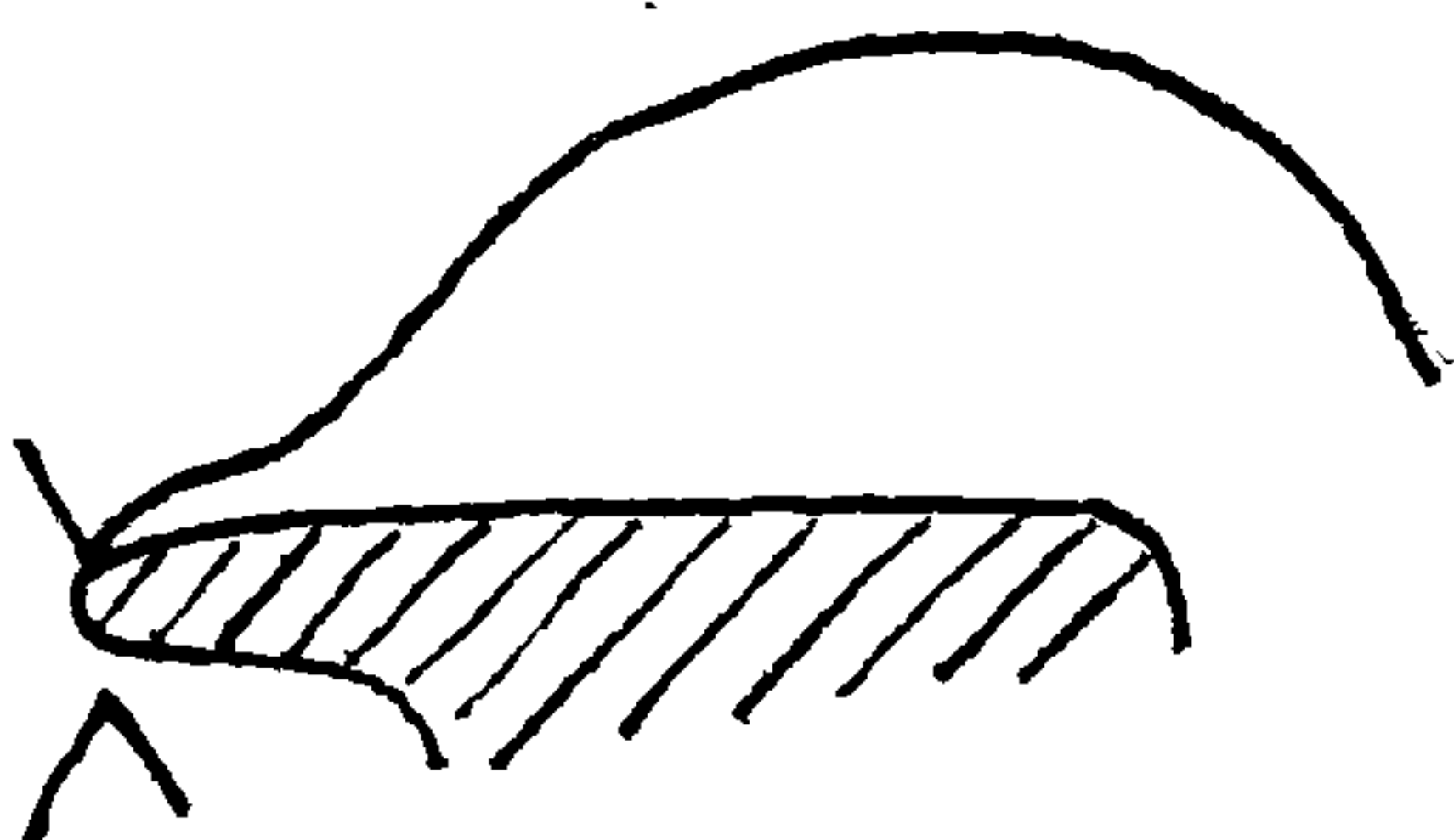

4. [N'], [L']

Alveo-palatal

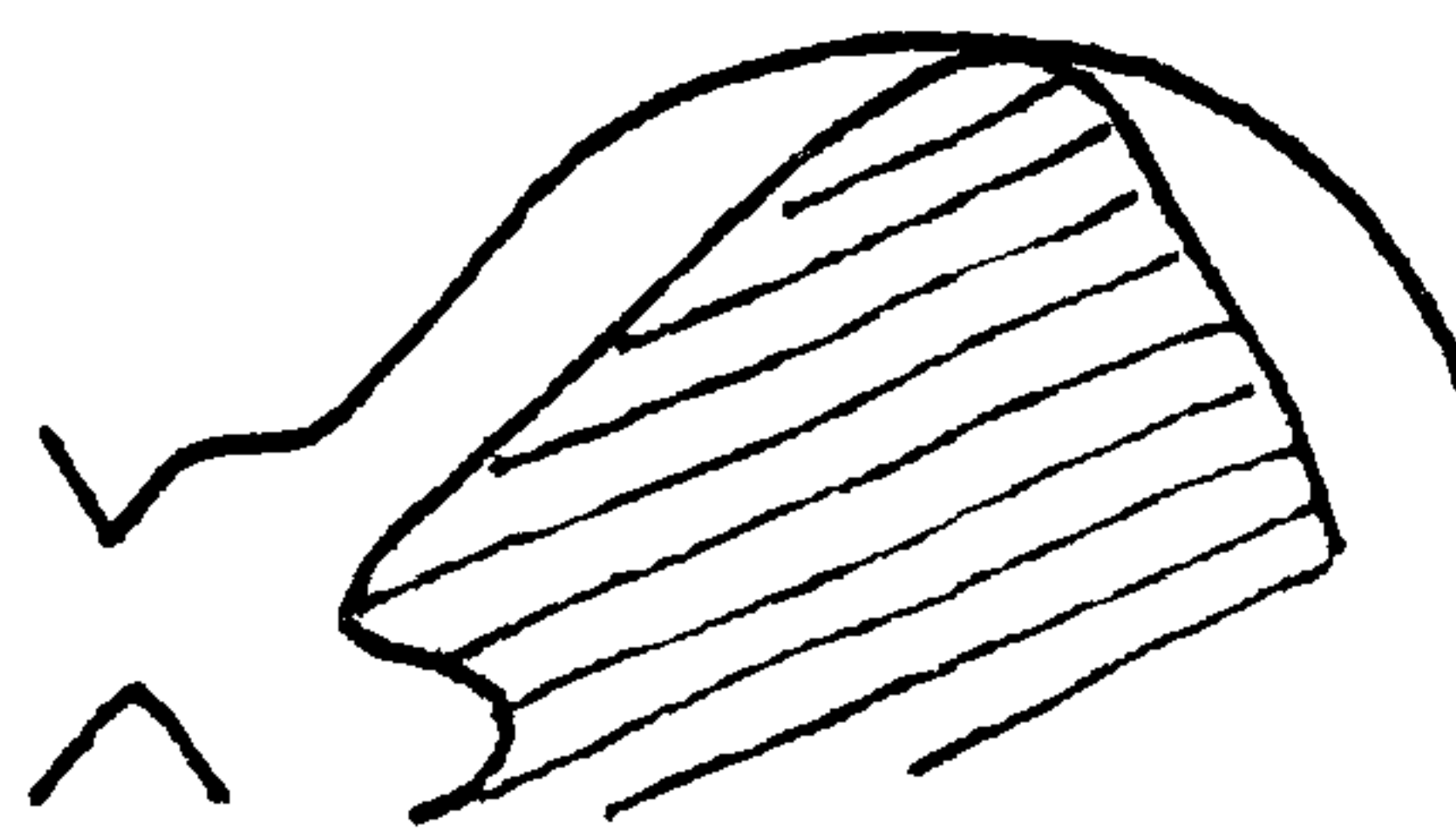

typical of the plosive series. It was this consideration which contributed to the decision to characterize /l(')/ and /n(')/ as [- cont] (in those dialects which possess only two laterals and two coronal nasals). Ch&H classify apical consonants as [- dist] and laminal consonants as [+ dist] as a first approximation (page 312), although they stress that the relevant distinction is actually "between sounds made with long constrictions and those made with short constrictions." (page 314). However, it seems plausible to specify [N], [N'] as [+ dist] and [n], [n'] as [- dist] on this preliminary basis. We shall see in the next section that Lenition in dialects which possess a four-way distinction involves the flipping of the value of [dist], whilst in dialects with a three-way distinction there is neutralization.

This concludes our somewhat lengthy discussion of the phonological inventory of Modern Irish. As will become clear when we state the realization rules of IM, their precise formalization depends crucially upon the distinctive feature specifications of each underlying segment. It is for this reason that a careful evaluation of the inventory has necessarily preceded the statement of the realization rules.

§ 3.2 The Set of Rules

In this section I shall present a formalization of the set of realization rules of IM for Modern Irish. I shall begin by setting out the phonetic effects brought about by the presence of triggers of IM with the most simply stateable surface repercussions. In other words, we shall commence with the Minor Mutations, then we shall turn to Eclipsis, and finally Lenition, the most complex trigger inasmuch as this mutation-type comprises a set of disjunctive rules in itself. (The phonetic repercussions of the Major Mutations are set out in Table VI). The section will close with a discussion of the ways in which the triggers assigned in the expanded lexicon are eradicated before reaching the phonetic surface.

The Minor Mutation with the least surface variation is H-prefixation, the process whereby the only semivowel in the underlying inventory is prefixed to initial vowels. (Recall that /h/ is the only syllabic onset which does not exhibit the broad/slender distinction.) It may be formalized as (R1):

(17) (R1) H-prefixation:

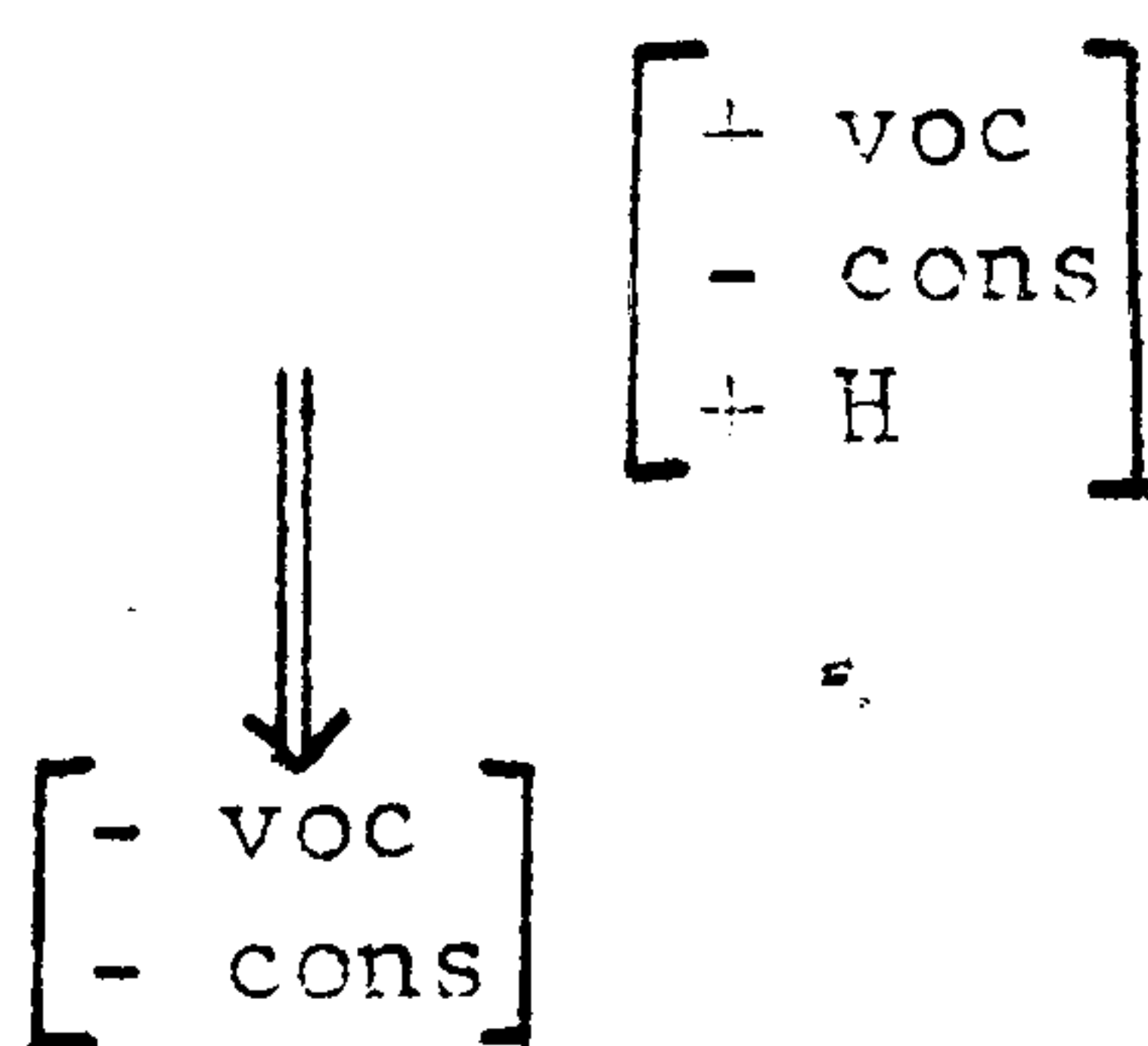

Notice that since realization rules constitute part of the phonological component proper, [h] will be specified as a semivowel throughout the operation of the rules of that component. Moreover, since [h] is the only semivowel phonologically, its other feature specifications could be provided by Linking conventions along the lines of SPE (page 419ff). Thus H-prefixation may be formalized in the above manner without loss of

TABLE VI

THE MAJOR MUTATION-TYPES: ECLIPSIS AND LENITION

Exemplified by the Unmarked form of the Verb "III Sg. Pres. Indic."

<u>Radical Consonant</u>	<u>Affirmative</u>	<u>Eclipsed Consonant</u>	<u>Interrogative</u>	<u>Lenited Consonant</u>	<u>Negative</u>	<u>Gloss</u>
p	[po:sən] <u>pósann</u>	b	[bo:sən] <u>bpósann</u>	f	[fo:sən] <u>phósann</u>	"marry"
p'	[p'l'e:skən] <u>pléascann</u>	b'	[b'l'e:skən] <u>bpléascann</u>	f'	[f'l'e:skən] <u>phléascann</u>	"explode"
t	[tig'ən] <u>tuigeann</u>	d	[dig'ən] <u>dtuigeann</u>	h	[hig'ən] <u>thuigeann</u>	"understand"
t'	[t'it'ən] <u>titeann</u>	d'	[d'it'ən] <u>dtiteann</u>	h	[hit'ən] <u>thiteann</u>	"fall"
k	[kahən] <u>caitheann</u>	g	[gahən] <u>gcaitheann</u>	x	[xahən] <u>chaitheann</u>	"throw"
k'	[k'r'ed'ən] <u>creideann</u>	g'	[g'r'ed'ən] <u>gcreideann</u>	ǵ	[ǵr'ed'ən] <u>chreideann</u>	"believe"
b	[ban'ən] <u>baineann</u>	m	[man'ən] <u>mbaineann</u>	w	[wan'ən] <u>bhaineann</u>	"reap, cut"
b'	[b'arən] <u>bearrann</u>	m'	[m'arən] <u>mbearrann</u>	v	[varən] <u>bhearrann</u>	"cut, shave"
d	[du:nən] <u>dúnann</u>	n	[nu:nən] <u>ndúnann</u>	ɣ	[ɣu:nən] <u>dhúnann</u>	"shut"

TABLE VI contd.

<u>Radical Consonant</u>	<u>Affirmative</u>	<u>Eclipsed Consonant</u>	<u>Interrogative</u>	<u>Lenited Consonant</u>	<u>Negative</u>	<u>Gloss</u>
d'	[d'e:nən] <u>deanann</u>	n'	[n'e:nən] <u>ndeannann</u>	j	[je:nən] <u>dheannann</u>	"do, make"
g	[glanən] <u>glanann</u>	ŋ	[ŋlanən] <u>nglanann</u>	ɣ	[ɣlanən] <u>ghlanann</u>	"clean"
g'	[g'alən] <u>geallann</u>	ŋ'	[ŋ'alən] <u>ngeallann</u>	j	[jalən] <u>gheallann</u>	"promise"
m	[molən] <u>molann</u>	-	[molən] <u>molann</u>	w	[wolən] <u>mholann</u>	"praise"
m'	[m'alən] <u>meallann</u>	-	[m'alən] <u>meallann</u>	v	[valən] <u>mheallann</u>	"coax"
f	[fo:lən] <u>foghlann</u>	w	[wo:lən] <u>bhfoghlann</u>	ø	[o:lən] <u>fhoghlann</u>	"learn"
f'	[f'ek'ən] <u>feiceann</u>	v	[vek'ən] <u>bhfeiceann</u>	ø	[ek'ən] <u>fheiceann</u>	"see"
s	[sakən] <u>sacann</u>	-	[sakən] <u>sacann</u>	h	[hakən] <u>shacann</u>	"stuff"
ʃ	[ʃi:l'ən] <u>sileann</u>	-	[ʃi:l'ən] <u>sileann</u>	h	[hi:l'ən] <u>shileann</u>	"think"

explicitness. The result of applying (R1) to the NP /inə a:t'/ or
 [+H]

the VP /na: im'i: wem'/ will be the phonetic representations [inə
 ha:t'] (ina háit [+H] "in her place") and [na: him'i: wem'] (ná himigh uaim
 "don't leave me"), respectively.

The second Minor Mutation which requires formalization is T-prefixation. The morphosyntactic environment of this mutation-type is that of Masculine Singular Nouns with an initial vowel following the Article (this includes numerals based on /e:n/ aon "one" and /oxt/ ocht "eight"). Now unlike /h/, the epenthetic consonant in T-prefixation exhibits the broad/slender dichotomy, which particular consonant is inserted being determined by the lexical item. Thus before /ara:n/ (arán "bread") [t] is prefixed, whereas we find [t'] before /im'/ (im "butter") cf. [ə tara:n əgus ə t'im'] (an t-arán agus an t-im "the bread and the butter").

However it must not be presumed that the selection of [t'] by /im'/ is determined by the high front quality of the vowel. Thus /iʃg'ə/ exhibits the same initial segment in the radical form but requires [t]: [ə tiʃg'ə] (an t-uisce "the water") where the selection of the epenthetic consonant is shown in the orthography by an initial back vowel.

How then are we to handle the different behaviour of initial vowels?

The two solutions which spring to mind are of course those which we discussed in § 1.3 "The Nature of Triggers", namely, the segment approach and the feature approach. Given our argument that triggers of IM be viewed as diacritic features, it might be assumed that the distribution of [t] and [t'] should be handled in the same way. There is however a significant difference between the morphosyntactic determination of mutation-type and the problem now under discussion. Recall that in § 1.3 it was noted that whilst morphological features have phonetic consequences, they differ from phonetic segments by not having phonetic

content. Yet if we were to posit an initial [+pal] segment in "butter" (i.e. /'im'/), that segment would have phonetic content wherever it was preceded by a syllabic onset. For not only do we find a contrast between [ə t'im'] and [ə tiʃg'ə], but we find a precisely parallel one in [m'im'], [d'im'] (m'im "my butter", d'im "your sing. butter") vs. [miʃg'ə], [diʃg'ə] (m'uisce "my water", d'uisce "your sing. water") where the phonological representations are /mə+ 'im'/, /də+ 'im'/, /mə+ iʃg'ə/, /də+ iʃg'ə/, respectively. * Thus by adopting the segment approach we predict the occurrence of just those aspects of the phonetic surface representation which correlate with the broad/slender distinction pervasive throughout Irish phonological structure. Moreover the presence of initial bare /'/ is not confined to Masculine nouns: Feminine nouns with an initial vowel may also demand the positing of bare /'/. For example, compare /ora:ʃd'ə/ → [ən ora:ʃd'ə] (an oráiste "the orange"); [mora:ʃd'ə] (m'oráiste); [dora:ʃd'ə] (d'oráiste); with /'aglə/ → [ən' aglə] (an eagla "the fear"); [m'aglə] (m'eagla); [d'aglə] (d'eagla). As we shall see below, a related phenomenon is the occurrence of bare /'/' due to the Lenition of /f(')/. Here only those features which comprise the archisegment are deleted.

* Footnote

The rule of elision which deletes schwa may be stated informally as follows:

ə-Elision: C ə + (') V
 ↓
 ∅

Whilst it is the case that the SD of ə-Elision could be simplified to read Cə+V if the instances of [+pal] we are dealing with were treated in terms of a diacritic feature, two points should be stressed:

1) such a notion of simplification is based upon a very crude conception of the evaluation measure;

2) in the case of lexemes like /'im'/', ə-Elision does involve the addition of [+pal] to the broad consonant immediately preceding the deleted schwa, a fact which is captured directly by the formalization which incorporates /'/' in its SD. This remains unexpressed in the formalization which omits /'/' from its SD and must be effected by an independent rule induced by a diacritic.

This results in the stranding of /'/ which was segmented out in the case of slender consonants. The crucial difference then between the appearance of /'/ in [ən' aɣlə] and its appearance attached to /ən/ in [ən' e:l'ə] (an fhéile "the feast-day") is that in the former /'/ occurs initially in the UR without being associated with a consonant, whereas in the latter /'/ constitutes the [+ pal] feature of the labiodental fricative which has been deleted.

Having substantiated the postulation of bare /'/ in certain lexemes, we may now formalize T-prefixation as the insertion of a voiceless coronal plosive unspecified for [palatalization]:

(18) (R2) T-prefixation

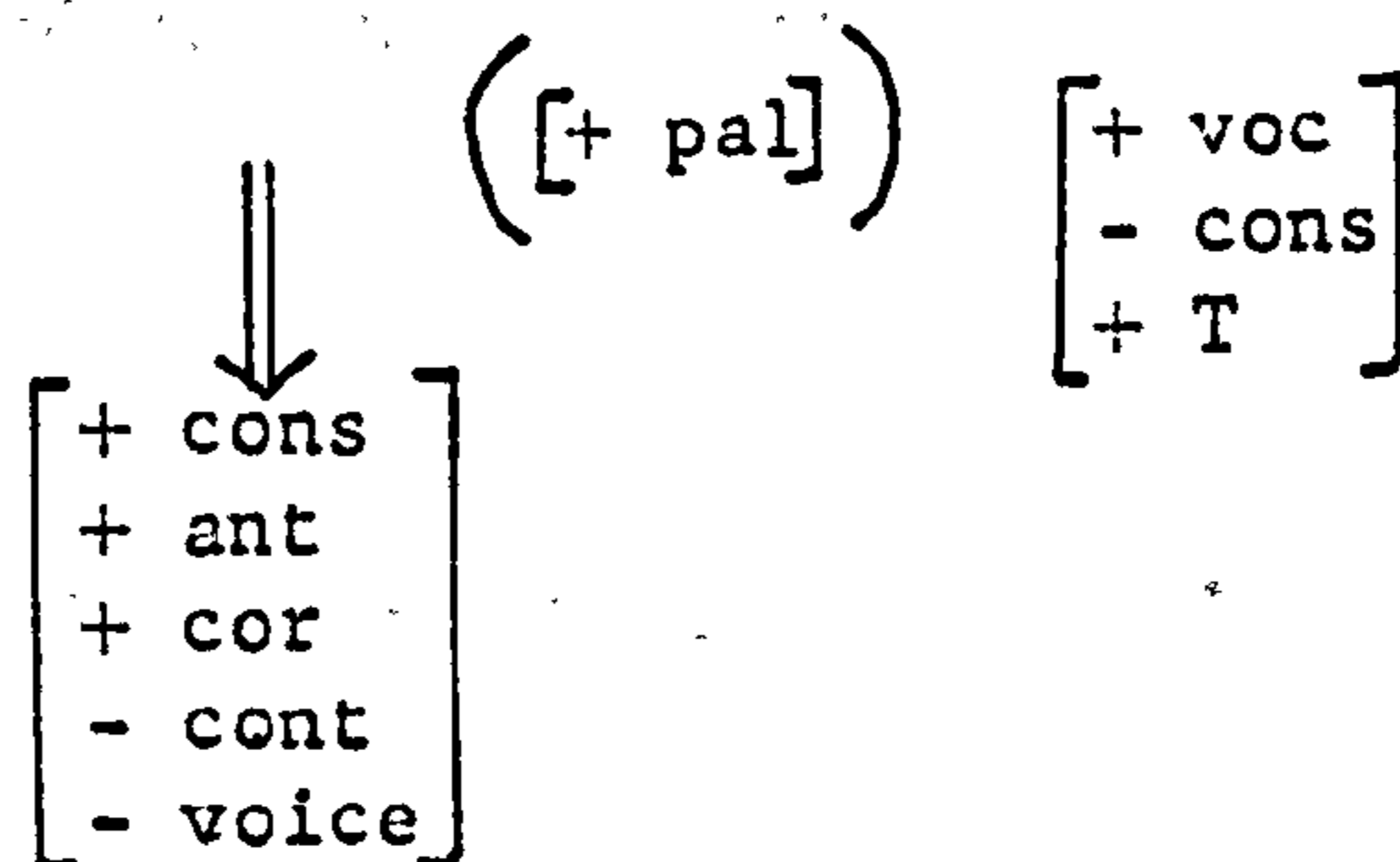

Notice first that the archisegment /t/ has been specified uniquely as the only voiceless coronal noncontinuant which occurs in the phonological inventory. The fact that no boundary is present between the epenthetic archisegment and potential occurrence of the feature [+ pal] insures that these two are associated with each other in phonetic representations.* PDRs may then operate to yield the affricated palato-alveolar plosive attested on the phonetic surface (see § 3.1 p. 477). Moreover, observe that although T-prefixation is only instanced in

* Footnote

The absence of an intervening boundary in [m'im'] < /mə + 'im'/ et alia may be considered as part of the SC of ə-Elision, when this rule is stated formally.

in the phonological inventory, the specification [-voice] may be omitted from the SD of (R3) without loss of explicitness. Notice, however, that the Pre-Condition on PI, which operates throughout the phonological component, demands that the segment affected by (R3) be specified as [+cont]. This is because only coronal obstruents which are continuants undergo (R3) non-vacuously. In other words, the natural class actually undergoing (R3) is that of coronal continuant obstruents - coronal plosives would be unaffected by it. Thus although it would be possible to simplify (R3) by allowing it to apply to all coronal obstruents, the spurious nature of such a simplification is implicit in the Pre-Condition. It is perhaps necessary to stress at this point that the omission of [-voice] does not contravene the Pre-Condition in this way, for (R3) can hardly be said to apply vacuously to */z(')/ when this configuration of distinctive features is foreign to the phonology of Modern Irish.

Having formalized the realization rules for the Minor Mutations, we now turn to Eclipsis. The phonetic repercussions of this Major Mutation are set out in the middle column of Table VI, where triggering conditioned by the Interrogative Particle is exemplified for each radical consonant in the underlying inventory. In attempting to account for these data, we shall once again draw on the discussion of the preceding section (pp. 480 - 1). Recall that we anticipated the characterization of Eclipsis in terms of movement up the sonority hierarchy. Thus in contrast to the bilabial nasals which appear in URs, those which result from the Eclipsis of /b(')/ are specified as [+son]. This is the natural corollary of the fact that under Eclipsis voiced plosives become homorganic nasal sonorants.

Bearing these points in mind, consider a statement of the realization of Eclipsis in Modern Irish comparable to Anderson's formulation of Lenition in Old Breton (see Part I, chapter 5, §5.2.3).

(20) (R4) Eclipsis -- Preliminary Formalization

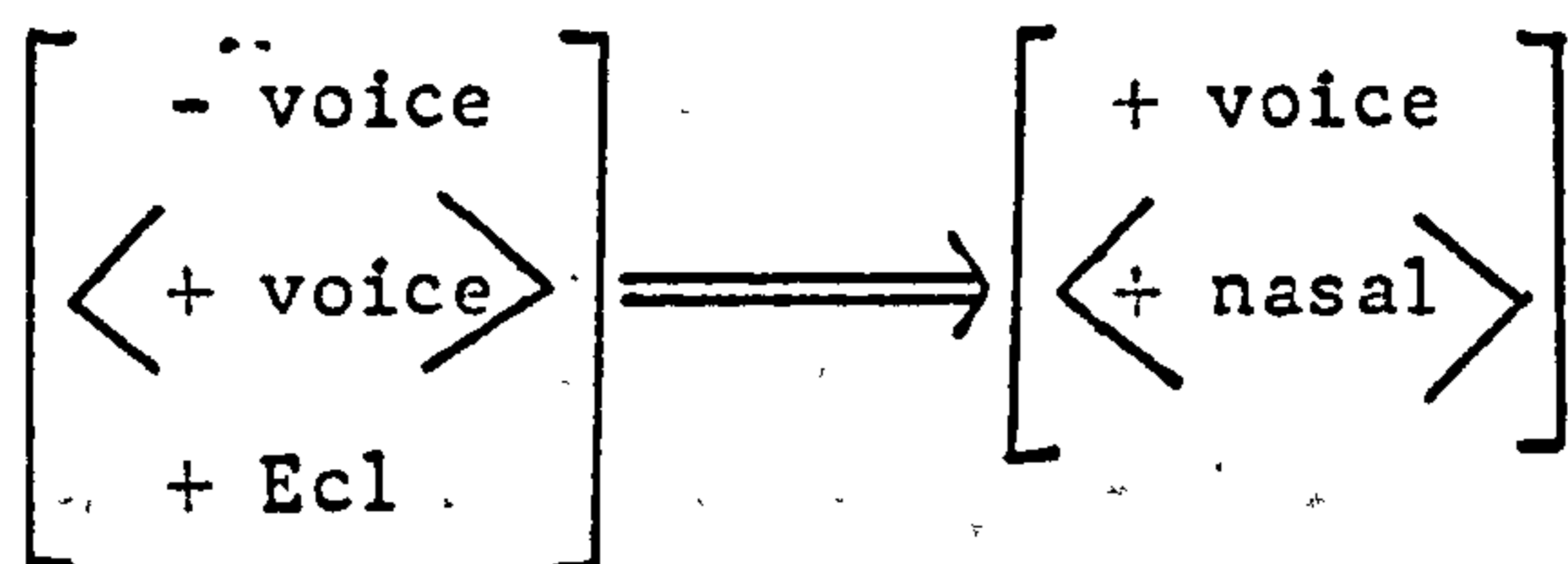

A cursory examination of (R4) shows that it fails to capture the notion "movement up the sonority hierarchy". To put this another way, this preliminary formalization does not make explicit the fact that whilst (certain) voiceless obstruents become homorganic voiced obstruents, underlying voiced plosives are consequently shifted to homorganic nasal sonorants: this insures that homonymous forms never result within the same morphosyntactic environment. Let us therefore revise the formalization of (R4) in an attempt to capture the notion explicitly:

(21) (R4') Eclipsis -- Revised Formalization

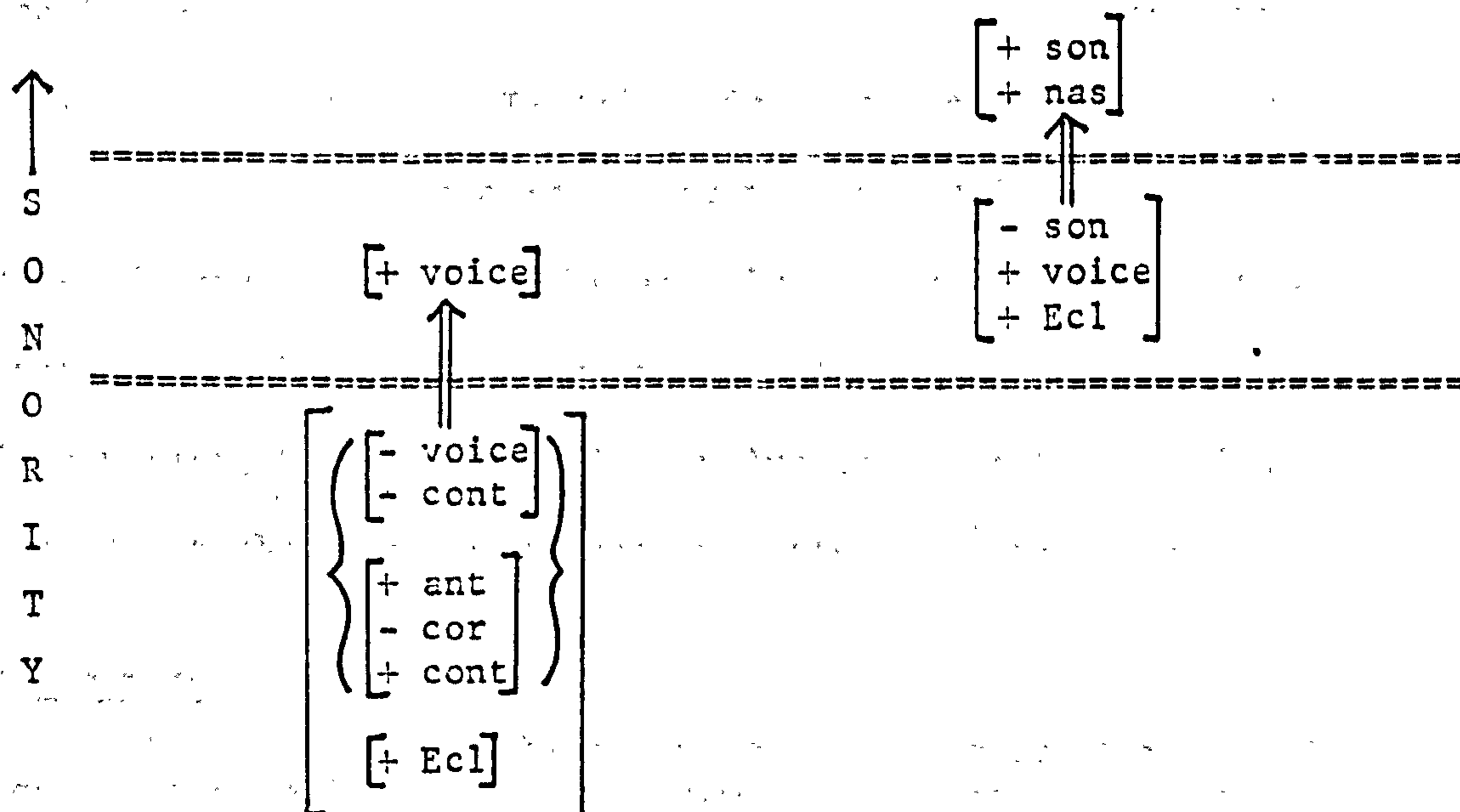

Besides capturing the notion of movement up a hierarchy, (R4') also incorporates solutions to three further inadequacies of the original (R4). The first short-coming lies in the direction of observational

adequacy, since under (R4')'s preliminary formalization, /s(')/ would become [z(')]. Of course it would be possible to pre-empt this outcome since, as we have noted, /z(')/ represents a distinctive feature configuration which is foreign to the phonological inventory of Modern Irish. However, the characterization of the bilabial nasals which result from Eclipsis as [+son] means that this archisegment too is alien to the underlying inventory. In order to maintain the claim that voiced plosives become homorganic nasal sonorants, we must admit the possible flipping of [-voice] in underlying /s(')/ unless the archisegment is explicitly excluded from undergoing Eclipsis. Revised (R4') achieves this by stipulating that the three features [+ant, -cor, +cont] must co-occur - apart from this, only voiceless plosives are affected from the class of voiceless obstruents.

In this connection, it is crucial to notice that S-T and Eclipsis are essentially different types of realization rule from H-prefixation and T-prefixation as regards their formalization. This difference lies in the fact that the latter pair are insertion rules, or, expressed another way, H-prefixation and T-prefixation contain the null element in their SDs. * Since it is a complete segment which is being inserted we can take advantage of Linking by stipulating in the SC only those distinctive features which are necessary to specify the epenthetic segment uniquely. In contrast, S-T and Eclipsis involve the switching of feature values. This being the case, we cannot guarantee that the segments effected will

* Footnote

Notice that a process subsumed under the mutation-type, Eclipsis, also constitutes an insertion rule, namely, the prefixation of [n] to initial vowels. Thus the above comparison is only strictly valid when the term "Eclipsis" is applied to the IM of consonants, that is, in the sense in which it has been explicated up till now. See below for the formalization of [n]-insertion as part of the realization of Eclipsis.

completely correspond to those in the phonological inventory. It is on these grounds, then, that the specification within **the braces** has been incorporated into the revised version, (R4').

The second inadequacy of the original statement of (R4) involves the problem that Iverson was concerned with in the formulation of his CCF, which was discussed at length in Part I, Chapter 5. The problem may be glossed as follows: What is to prevent a segment which has become voiced by the application of that part of original (R4) outside the angled brackets from undergoing the rule a second time to become nasal? (i.e. $p \rightarrow b \rightarrow m$; $t \rightarrow d \rightarrow n$; $k \rightarrow g \rightarrow \eta$). In Part I it was demonstrated that the relation of PI does not obtain here, since the segments effected by the first subrule are coextensive with the segments affected by the second subrule. It was on this basis that we proposed the Pre-Condition on PI to filter out such spurious manipulation of the PI relation. In regard to Anderson's formulation of Lenition in Old Breton, we then suggested that the angled bracket notation might in itself impose disjunctivity of application. However, (R4') does not make use of this abbreviatory device - as an inspection of its schematization reveals, the revised formulation utilizes other means to insure that derived voiced plosives do not become homorganic nasal sonorants. Observe that whilst the underlying voiceless obstruents and the underlying voiced plosives affected by (R4') have the trigger [+Ecl] associated with them, the diacritic is no longer present in their SCs. Since realization rules are only conditioned by the presence of (particular) triggers, no segments will undergo realization more than once provided we make explicit the convention whereby triggers are deleted during the application of each realization process. When we consider that triggers are not attested as such on the phonetic surface, that is, that we need some convention for erasing them apart from the re-application issue,

it becomes clear that such a convention is independently motivated. To sum up, although it is possible to prevent conjunctive application of the subrules of (R4), the device available is ad hoc in the sense that it constitutes an arbitrary notational convention with no corroborative evidence from elsewhere in the grammar. On the other hand, the Convention on Trigger Erasure (henceforth CTE) is required on grounds which are independent of the re-application of Eclipsis and common to all realization rules. In other words, CTE is a natural convention.

The third and final short-coming of the preliminary formalization of Eclipsis (i.e. (R4)) centres around the subrule by which [+ voice] segments become [+ nasal]. As given in (R4), this subrule is observationally inadequate on two counts, one regarding the input in angled brackets in (R4), revised as the lower right-hand specification in (R4'), and the other concerned with the output in angled brackets in (R4), revised as the upper right-hand specification in (R4'). Let us take the second count first since it is the more easily remedied. Original (R4) does not stipulate that the nasal segments effected during Eclipsis are sonorants.* Clearly this is tantamount to saying that, unlike the revised (R4'), (R4) failed explicitly to capture the notion "movement up the sonority hierarchy". In fact the omission of [+ son] within angled brackets in the SC of (R4) is largely artificial. The preliminary formulation of Eclipsis was made on a basis comparable to Anderson's statement of Lenition in Old Breton, which does not entail changes in sonority. It would therefore pose no significant problem

* Footnote

Recall that in Part I we noted the absence of any reference to the feature [sonorant] in Anderson's - and hence Iverson's - treatments of Old Breton (Ch. 5, pp. 269).

simply to incorporate [+ son] in the appropriate position in (R4).

Unlike the first instance of observational inadequacy presented in original (R4), the second instance requires a fundamental revision of the rule's formalization. Up till now we have been concerned with the Eclipsis of consonants rather than of vowels. However, this mutation-type also subsumes the prefixation of [n] to initial vowels cf. [a:r ba:ʃd'i:] < /pa:ʃd'i:/ (ár bpáistí "our children") but [a:r nahir'] < /ahir'/ (ár nAthair "our Father"). Thus unless the specification [- son] is included in the input in angled brackets, original (R4) will predict that initial vowels which have the trigger [+ Ecl] associated with them become nasalized. Now while it is true that there will be some vocalic nasalization attested on the phonetic surface of [a:r ^(~)nahir'], this will be effected by a PDR which is crucially dependent upon the adjacency of a nasal consonant - whose very insertion (R4) fails to stipulate. Summing up, as they stand, neither the preliminary formalization of Eclipsis (= (R4)) nor its revised version (= (R4')) account for the prefixation of [n] to vowel-initiated lexemes which have been assigned the trigger [+ Ecl]. However, whereas (R4') specifically excludes sonorants - and hence vowels - from undergoing the subrule which nasalizes voiced plosives, (R4) redundantly effects vocalic nasalization in an unnatural manner. To spell this out a little more, vocalic nasalization concurrent with Eclipsis is redundant just in case a PDR brings about this SC throughout the set of phonetic representations, and it is unnatural because as a PDR vocalic nasalization is conditioned only in the environment of a consonant which is [+ nasal] (i.e. /m('), n('), ŋ('), w(')/ see § 3.1, p. 480 for the specification of [w,v] < /m, m'/ as [+ nasal]).

The issue which must now be taken up is the following: How are we to

specify the insertion of [n] before vowel-initial lexemes marked [+ Ecl]?

(R5) approximates such a statement:

(22) (R5) Eclipsis of Vowels

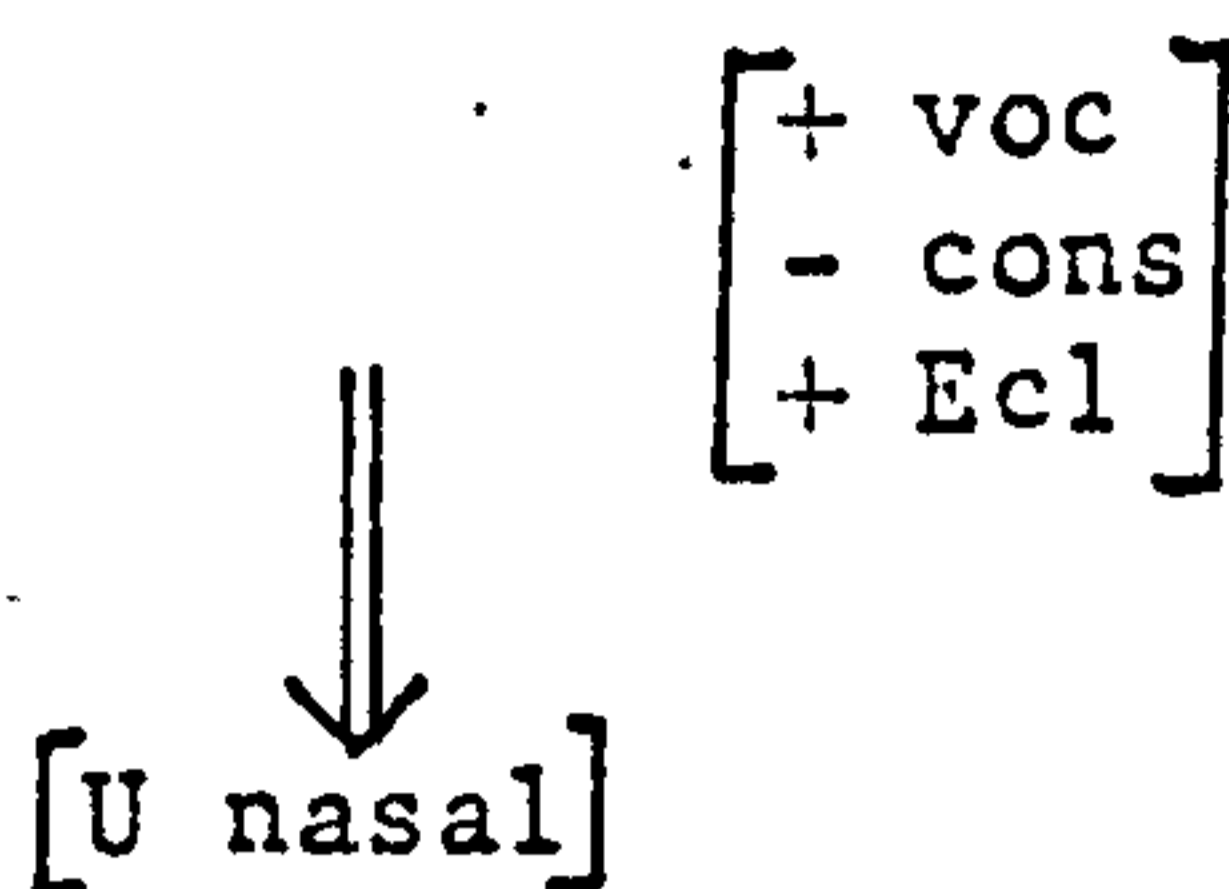

(R5) formalizes the fact that the maximally unmarked nasal segment (SPE page 406: marking conventions (XXIIb) and (XXIIIc)), the coronal nasal consonant,* is inserted before initial vowels if the lexeme has the trigger [+ Ecl] associated with it. Of course such an abbreviated statement requires corroboration from the theory of Markedness but I shall take it that the claims made in the final chapter of SPE are essentially correct. It would also be possible to incorporate (R5) into the schematization of Eclipsis for consonants (= (R4')). Note however that another sonority level would have to be introduced above that of nasal sonorant consonants and the SC would need to be indicated by a downward arrow. More specifically, the SD of (R5) could not be accommodated on the same level as the voiced plosives - a solution which might be considered desirable on the grounds that both subrules effect [n]. There are two reasons for not adopting such a schematization. The first, more blatant objection lies in the fact that vowels and voiced plosives are not at the same height in the sonority hierarchy.

* Footnote

The fact that the maximally unmarked segment which is inserted is a consonant, rather than a vowel, follows from two facts about Irish phonology. First, vocalic nasality is derived from adjacent Cs rather than being present in underlying structure: hence nasality is marked for vowels. Second, the inserted segment must be a consonant if CV(C) syllable structure is to be preserved, since the segment to its right is

$$\left[\begin{array}{l} + \text{ voc} \\ - \text{ cons} \end{array} \right]$$

The second reason is that such a formalization might be interpreted as if the nasalization of voiced plosives were in some sense more closely associated with the insertion of [n] and that there was less mutual dependence between the latter and the voicing of voiceless obstruents. Although the first objection to incorporating [n]-insertion into the revised schematization of (R4') might be overcome as indicated, by introducing a fourth sonority level at the top of the figure, I see no way of avoiding the implications inherent in the second objection. I have therefore stated [n]-insertion separately and rely upon the presence of the particular trigger [+ Ecl] to explicate the complementary relation between (R4') and (R5). It will be seen below that we shall adopt the same reliance upon the presence of [+ Len] to "unite" the various phonetic repercussions of that mutation-type.

Notice finally that in those dialects in which the distributed/non-distributed dichotomy obtains for coronal nasals and laterals, /d(')/ will eclipse to [N(')], and it is also [N(')] (rather than [n(')]) which is prefixed to initial vowels. The schematization of consonantal Eclipsis must therefore be amended in such dialects so that the right-most SD and SC are as follows:

- (23) (R4'') Eclipsis - dialectal variant of revised formalization for nasalization subrule.

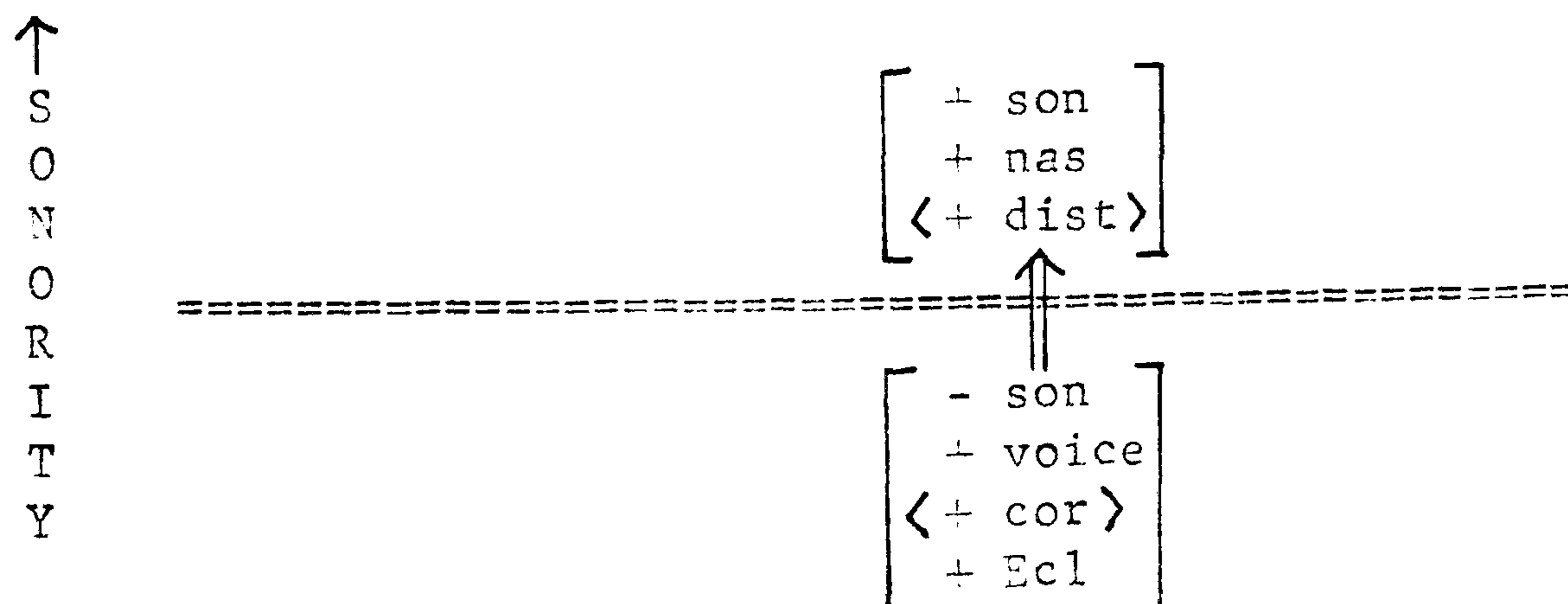

(R4'') stipulates that a voiced plosive is realized as [+ dist] just in case it is coronal. Furthermore since in the dialects in question [Unasal] will be the distributed coronal nasal consonant, Linking Conventions along the lines of those developed in SPE must ensure

this feature specification for the epenthetic segment inserted by (R5), Eclipsis of vowels.

We have pointed to three areas where the preliminary formalization of Eclipsis (= (R4)) proved deficient. During the discussion we have indicated ways in which these defects could be remedied. It is therefore important to emphasize, in concluding the treatment of the realization of Eclipsis, that even if such modifications were effected, we would ceteris paribus prefer the revised version of the process (= (R4') and its dialectal variant (R4'')) to the original formalization. This is because, as we stressed when (R4) was amended, only the final statement, (R4'), captures the notion "movement up the sonority hierarchy". To the extent that Eclipsis - and indeed all mutation-types - demand characterization as unitary phenomena, this notion is crucial to their formal representation. Throughout the second half of this thesis I have attempted to demonstrate the fact that each (major) mutation-type comprises a set of complementary phonetic processes applying in the same morphosyntactic environments. In order to capture these two aspects of IM, I have differentiated between Triggering and Realization. To put this another way, if it can be shown that the postulation of triggers of IM - and, more specifically, the trigger [+ Ecl] - are empirically justified, such evidence should wherever possible be reflected in the formal representation of the realization of the mutation-type. It is my contention that the notion "movement up the sonority hierarchy" explicitly captures the fact that Eclipsis constitutes a unitary phenomenon.

It remains for us to formalize the realization rules which give the phonetic repercussions of the trigger [+ Len]. As with Eclipsis, these phonetic effects are set out in Table VI. There the phonetic

correlate of each obstruent in the underlying inventory is given in the triggering environment of the Negative Particle. As can be seen from the Table, with one exception (namely, /f/), the process of Lenition involves Spirantization. We shall therefore require a general realization rule flipping the value of the feature [continuant]. (R6) approximates such a statement:

(24) (R6) Lenition: Spirantization

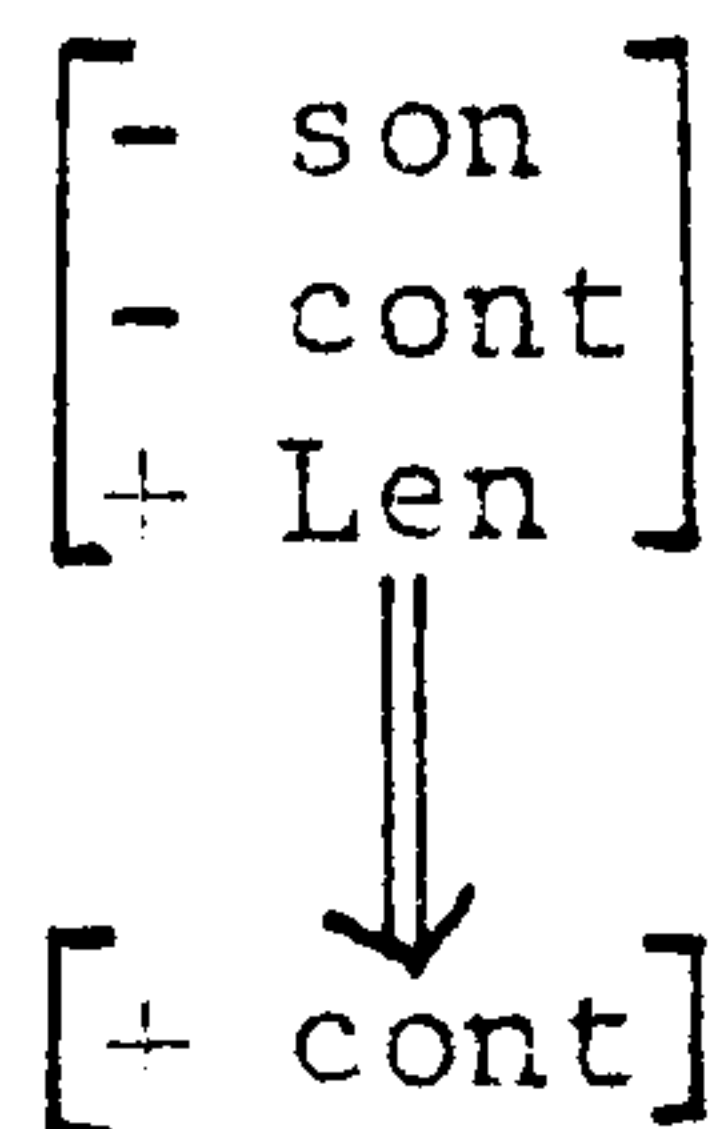

Regarding the distinctive feature specifications of (R6), notice first that the rule complies with the Pre-Condition on PI by citing the class of plosives non-vacuously as its input. In other words, the rule is not formulated in such a way that it applies to all obstruents, that application being vacuous in the case of continuants. It is necessary to stipulate the plosives as [- son] as well as simply - cont since a failure to do so would result in the Spirantization of /l/ and /n/. (Recall that /r/ is [+ cont].) Finally, the status of /m/ as an obstruent under our analysis insures that this nasal undergoes (R6).

Consider next the realization rule whereby /f/ is deleted, namely (R7):

(25) (R7) f-deletion:

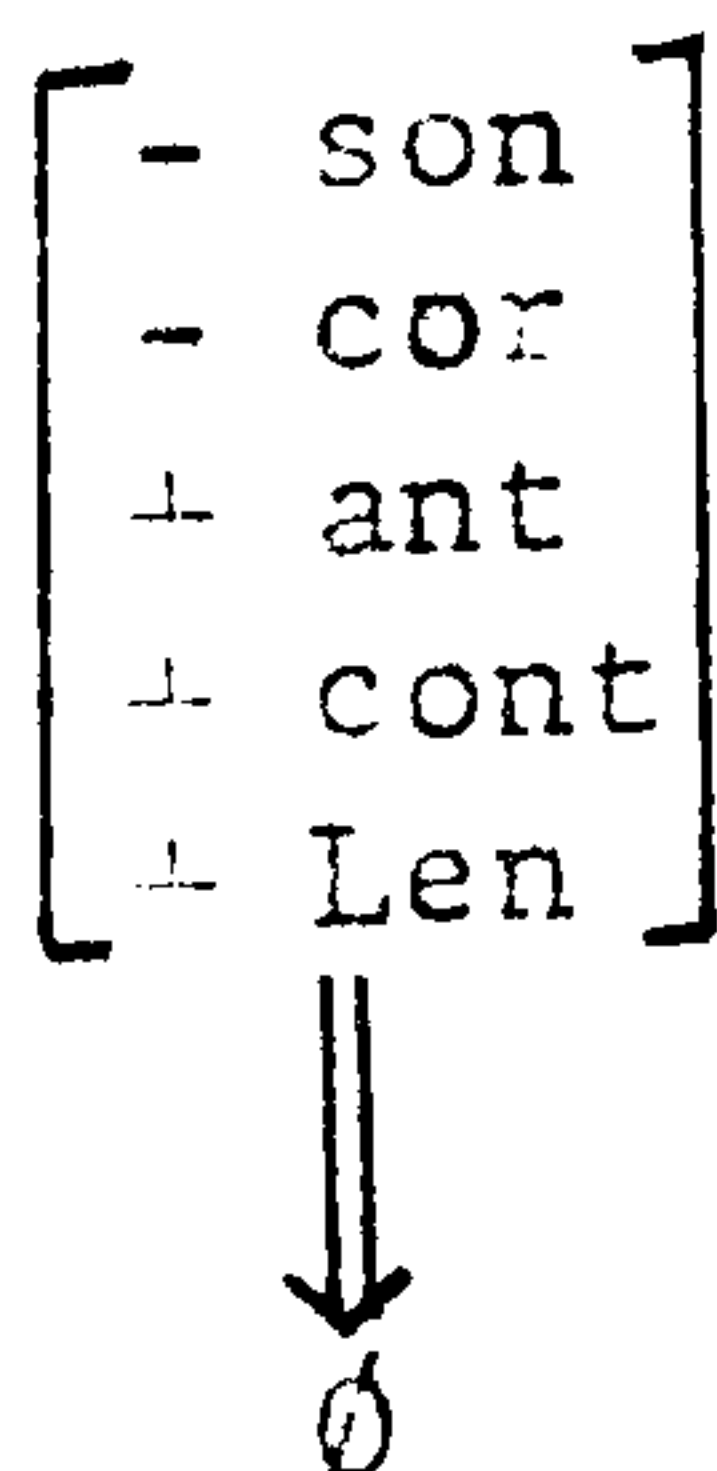

Since /f/ is the only labial continuant in the underlying inventory, it would be redundant to specify [- voice] in the SD of (R7) (as it

would be to include [- nas, - lat], for instance). However, the specification [- son] has been included in order to facilitate the determination of precedence relations between the realization rules of Lenition for obstruents. We have already had reason to mention the fact that the feature [+ pal], which has been segmented out from the distinctive feature complex, is not deleted along with the archi-segment /f/. We return to this issue in § 3.3

Of crucial importance to the correct applicability of (R7) is the CTE: observe that whilst no URs meet the SDs of both (R6) and (R7), (R6) apparently feeds (R7). To put this another way, it is the CTE which insures that [f], derived from underlying /p/ by (R6), fails subsequently to meet the SD of (R7). This is just in case the trigger [+ Len] is erased during the application of (R6), rendering the effected segment ineligible to undergo deletion.

Besides the labial continuants, the sibilants are also affected by Lenition. Underlying /s(')/ undergo reduction to [h], along with /t(')/, as formalized in (R8):

(26) (R8) Voiceless coronal reduction:

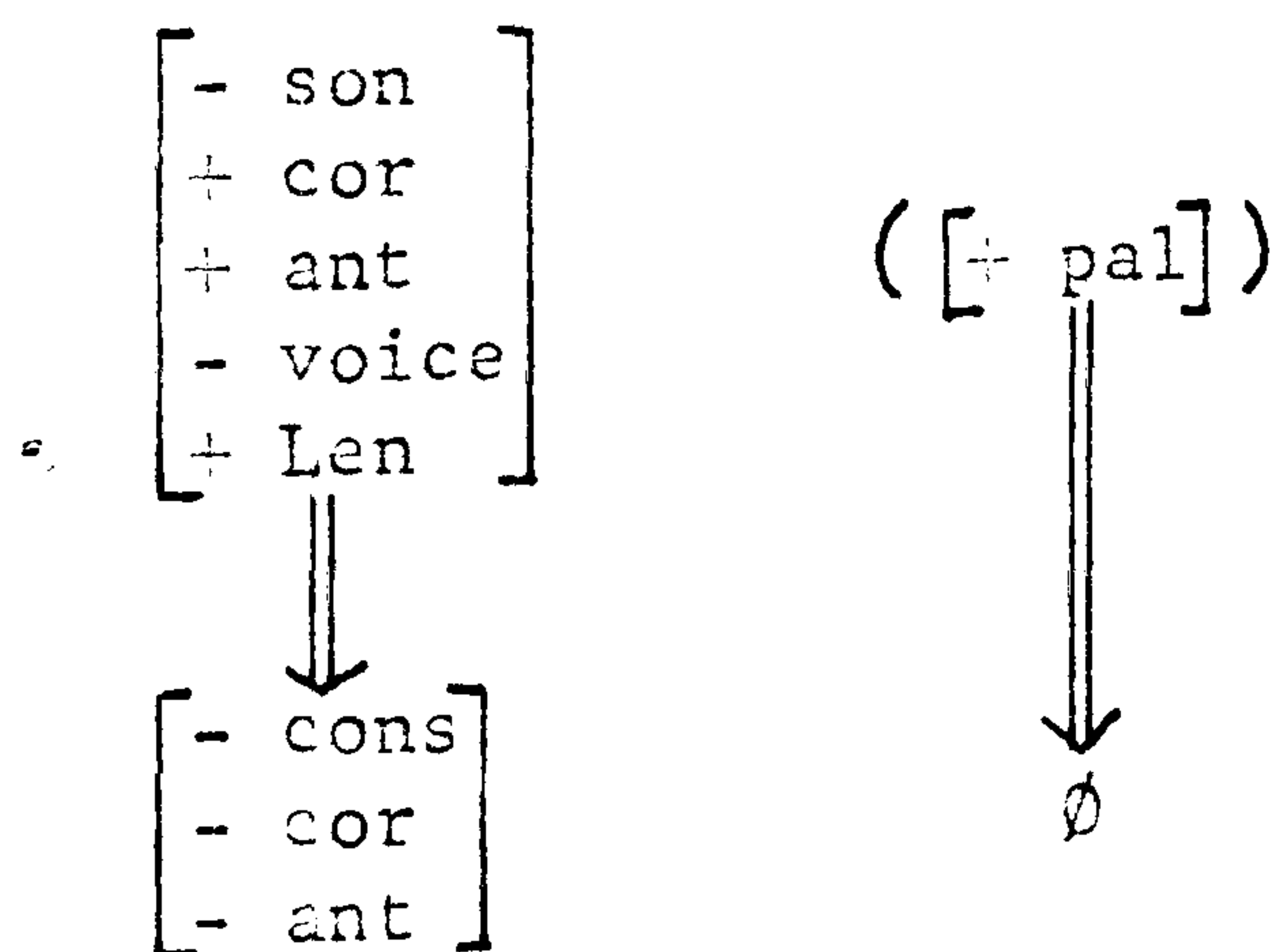

As we noted in § 3.1, p.473, this realization rule constitutes the one case where /'/ is affected, just in case (R8) effects its deletion. If we were to find evidence on the phonetic surface that the broad/slender dichotomy obtained for /h/ in a particular dialect, we would simply eradicate the deletion from the SD of (R8). Then /s/ and /t/

would lenite to [h] whilst /ʃ/ and /t'/ lenite to [h']. But what of those dialects where the lenited reflex of the broad voiceless coronals is [h] but that of the slender pair is [ç]? As we noted in § 3.1, apart from the presence of /'/, [ç] differs from [h] only in the value of [consonantal], [ç] being [+ cons], and [h] [- cons]. In other words, the value of [+ cons] is flipped to minus only where /'/ is absent from the SD, i.e. where the input segment is broad /t/ or /s/. Now recall that by convention, the presence or absence of /'/ is spelt out as [+ pal] or [- pal], respectively. Thus a structural change to [- cons] is dependent upon the specification [- pal] in the input representation. Given this correlation we can capture the facts by means of an alpha-variable, as shown in (R8'):

(27) (R8') Voiceless coronal reduction: dialectal variant:

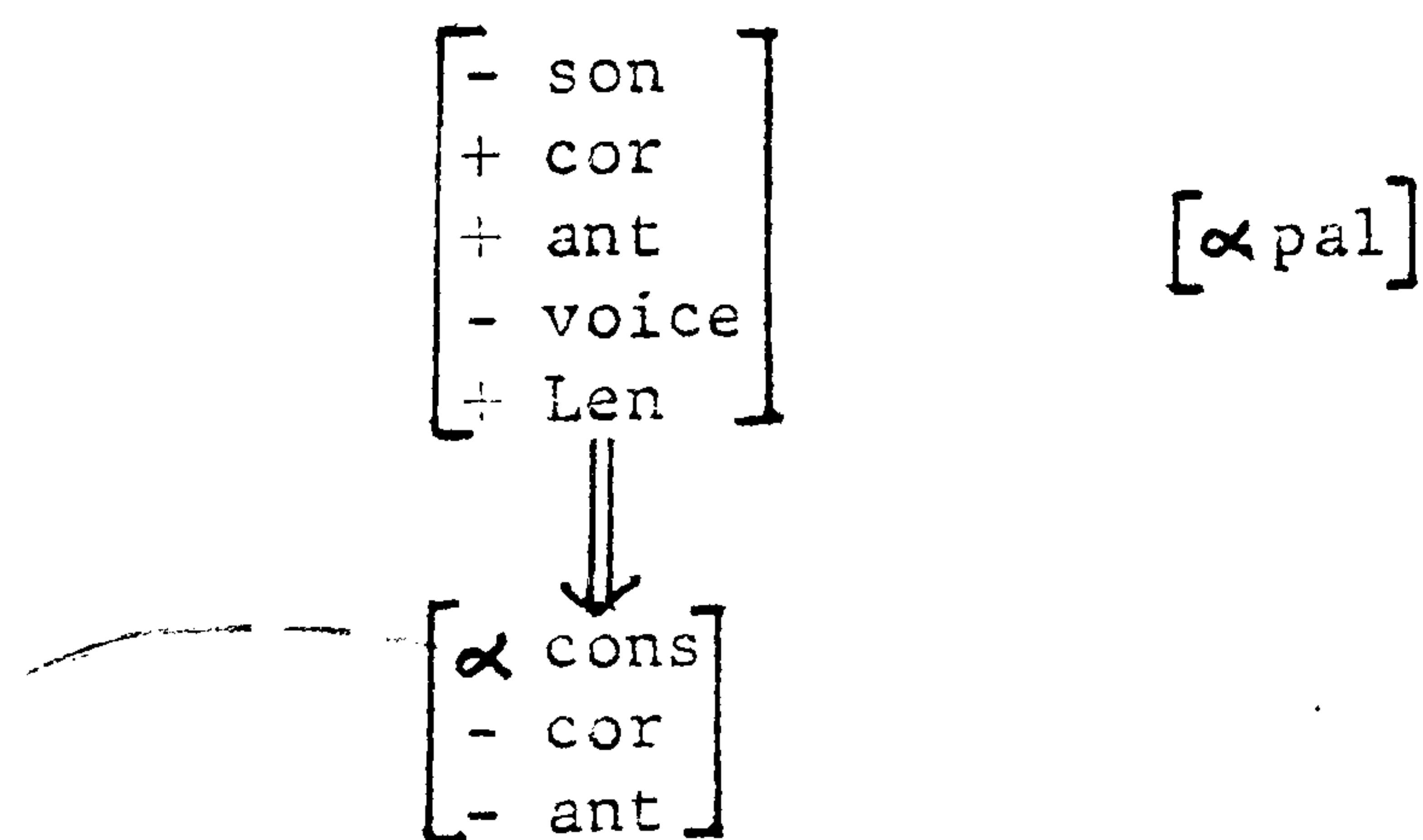

(R8) and its dialectal variants differ in their SDs only in respect to the feature [palatalization]: this is either parenthesized or preceded by an alpha-variable. As noted by Iverson (in Koutsoudas (Ed.) 1976), alpha-variables are to be disregarded in determining precedence relations (see Part I, p.180 for a reference to this point); and it seems clear that we should also disregard parenthesized segments, since they are not an obligatory part of an SD.* Given, then, that

* Footnote

It should be emphasized that what is being claimed here is that if a representation meets the SDs of two rules, one of which contains parentheses as part of its formulation, the parenthesized element is to be disregarded in the determination of applicational precedence. Thus this claim is in no way at variance with the well-established convention on expansion of a single rule formulation, whereby the elements within parentheses are rewritten first.

the SDs of (R8) and its dialectal variants are equivalent, what precedence principle guarantees that /t(')/, which meets the SDs of (R6) and (R8), correctly undergoes (R8)? The principle in question is PIPrec, or, more specifically, Proper Class Inclusion. This is because the underlying segment meets the SD of (R8) by virtue of being a voiceless coronal obstruent, but meets that of (R6) only by virtue of being a plosive. Since the former is the more specific, restricted case, Proper Class Inclusion stipulates that /t(')/ must undergo (R8).

In Part I, Chapter 3, we made reference to the realization process whereby lenited /d/ and /d'/ surface as [ɣ] and [j] respectively. There we considered two analyses, the first of which spirantized /d/ → [z] and then shifted the point of articulation feature. Under Hetzron's terminology Spirantization "coextensively supplied" $\underline{z} \rightarrow \underline{\gamma}$. Under an alternative treatment, /d/ becomes velar and then undergoes Spirantization. We argued in Part I that the second solution is preferable on the grounds that intermediate [z] constitutes a "fictitious segment" in the inventory of Modern Irish. It will now be clear that the arguments raised in this chapter substantiate that position.

At this point in the discussion, let us make a brief excursus in order to examine Rogers' treatment of the Lenition of dentals in Modern Scots Gaelic (henceforth MSG; 1972). Rogers' analysis is readily comparable to that proposed here as far as this mutation-type is concerned, although it is not readily comparable for Eclipsis. The reason is that Rogers treats Lenition as a morphological feature and Nasalization (= Eclipsis) as a phonological segment. As we saw in Chapter 1 there are strong grounds for positing parallel theoretical devices to account for both (major) mutation-types in Modern Irish. However it may well be that such evidence is not to hand in MSG. I say this despite the fact that

Rogers does not attempt to justify his thesis with reference to the earlier work of Oftedal (see Ch. 2). Indeed, it is Cram who explicates the distinction between the phonological conditioning of Nasalization and the grammatical conditioning of Lenition (1975) *. An examination of the latter's paper reveals that certain generalizations which may be made regarding MSG clearly do not hold for Irish. For instance, the claim that in the case of Nasalization there need be no reference to any specific set of syntactic categories, can be readily refuted for Modern Irish by citing the Eclipsis of Genitive Plural Nouns. On such grounds and also the ambivalent status of the boundary symbols which "regulate" the phonological conditioning, I reject any extension of Rogers' - and hence Cram's - analysis to Modern Irish. For this reason a comparison of Eclipsis and Nasalization has been pre-empted in what follows.

Turning to Lenition, Rogers formalizes a complex rule of Spirantization to account for the Lenition of stops. This rule is unnecessarily complicated because of Rogers' treatment of phonologically voiced and voiceless stops as [\pm tense]. Thus he is forced to formulate Spirantization with an alpha-variable which states that tense stops lenite to voiceless spirants whilst lax stops lenite to voiced spirants. Now it is my contention that Rogers is confusing phonological tenseness (irrelevant for MSG) with phonological voicing (which is functional for MSG). I will not go into a detailed criticism of Rogers' discussion of the distribution of [voice], [aspiration] and [tense] in mutated and unmutated stops - the strict concern of Part II is, after all, IM in Modern Irish. Suffice it to say that Rogers' discussion is misguided: whichever way one handles the phonetic facts the PDRs will look equally

* Footnote

I am indebted to Neil Mitchison for drawing my attention to Cram's paper.

inelegant. But this is no argument for imposing similar chaos upon the phonological facts: it is precisely because languages exhibit patterning and contrastiveness beyond what can be gleaned from the phonetic data alone that phonology exists as a discipline! Rogers is giving arguments for underlying segments in terms of the values assumed by the natural phonetic correlates of those segments for features which are irrelevant to the phonological system of the language, namely tensing and aspiration. Consequently he adopts an analysis in which all underlying stops are [- voice], with /b, d, g/ lax and /p, t, k/ tense. This renders his choice of a solution no more than a notational device - and an arbitrary one at that, given the wealth of phonetic data he supplies.

Having given his rule of Spirantization, Rogers notes that the dental stops are not fully accounted for by it since their place of articulation is shifted during Lenition. As a lemma (sic: does Rogers mean a corollary?) to this he also notes that a special rule is required to lenite /s/ to [h]. It can be seen that the MSG data correspond precisely to the Lenition of broad consonants in Modern Irish; or, viewed from a different stand-point, they correspond to the Lenition of archisegments in Modern Irish. It will therefore be pertinent to examine Rogers' treatment more closely.

Rogers' first observation is that an analysis which merges dentals with velars, and then allows the previously motivated Spirantization rule to apply, produces the correct results for /d/ but not for /t/. Informally:

$$d \rightarrow g \rightarrow \gamma$$

$$*t \rightarrow k \rightarrow x$$

It is a pity that Rogers does not make explicit his reasons for not

selecting this solution for /d/ and a separate /t/ → [h] rule. For it seems to me that the initial attraction of /d/ → /g/ → [ɣ] is the fact that it expresses the neutralization between /d/ and /g/: in other words, by combining the rule for /t/ with that for /d/, the treatment of /t/ robs the analysis of /d/ of any claim to generality which it might otherwise have had. However Rogers does not take up this issue: he merely remarks that the rules set up specially for the dental stops are ad hoc, though he does not say why.

In Rogers' second proposal the stops undergo Spirantization in the normal way and only then is their point of articulation changed.

Informally:

$$t \rightarrow s \rightarrow h$$

$$d \rightarrow z \rightarrow \gamma$$

The rule which converts /s/ to [h] is already motivated since it is required to account for radical /s/. As Rogers admits, /z/ → [ɣ] is ad hoc.

Thirdly, /d/ might merge with /g/, following which Spirantization applies yielding [ɣ] from /g/ and [s] from /t/, after which [s] → [h].

Again informally:

$$d \rightarrow g \rightarrow \gamma$$

$$t \rightarrow s \rightarrow h$$

It should be noted that whilst Rogers is working within a GROD framework, many of the rules he proposes are susceptible to the principles of UDRA. Thus /d/ → /g/ will precede Spirantization by PIPrec, as the voiced coronal stop is properly included in the set of stops.

(This fact was noted in Part I, page 89).

Rogers decides ultimately upon the second of these proposals. I have two criticisms of this choice, the first based on the very device which

motivates Rogers in its favour, the second raising an issue of which he appears oblivious. Rogers' reason for selecting $d \rightarrow z \rightarrow \gamma$, $t \rightarrow s \rightarrow h$ solutions lies in the claim that the second step in these changes ($z \rightarrow \gamma$, $s \rightarrow h$) can be combined into a single rule - which is thus more general - by means of angled brackets. As we have seen, this notation is similar to the use of Greek letter variables (where the value of the variable remains constant throughout the operation of the rule) in that if the features within angles to the left of the arrow are selected, then the features thus enclosed to the right of the arrow must be taken also. Rogers' formulation of his $\left\{ \begin{array}{l} z \rightarrow \gamma \\ s \rightarrow h \end{array} \right\}$ rule is as follows:

$$(28) \quad \left[\begin{array}{l} - \text{son} \\ + \text{cor} \\ + \text{cont} \\ \langle - \text{voice} \rangle \end{array} \right] \rightarrow \left[\begin{array}{l} - \text{cor} \\ - \text{ant} \\ + \text{son} \\ \langle - \text{cons} \rangle \\ + \text{low} \\ + \text{tense} \end{array} \right] / [+ \text{Lnt}] \div \text{---}$$

Kiparsky (1968b) asks the following question, regarding linguistic change as a window on the form of linguistic competence: "Do blocks of rules collapsed by braces form units of a kind which can undergo systematic change? If they do, this will be a powerful argument for this notation, and if not, we will have prima facie evidence that it is a spurious notation". (Eds. Bach & Harms, page 179). He then presents evidence from Old English to Early Middle English of two cases of simplification which can be viewed as a change in one rule if we adopt the brace notation - if we do not adopt this notation we have to explain why two separate, unrelated rules have undergone an identical modification at the same point in the history of English. Now although diachronic evidence can be found for the inclusion of braces into linguistic theory, I doubt if one could be convinced about the kind of use of angled brackets displayed in Rogers' paper. Such a notation seems to me to be no more than its name implies - a mere

notational variant of two independent rules, a device to represent as one process two unrelated processes. Of course the inputs to this spurious rule - [s] and [z] - have features in common; of course (though less obviously from Rogers' inventory) [ʎ] and [h] have features in common. But this is the case with many totally unrelated rules and merely reflects the fact that phonological inventories are made up of a limited set of distinctive features. To put this another way, one could envisage that the logical conclusion of Rogers' practice might be the pairing off of independent rules into single rules with two disjunctive subparts. Thus a set of n rules could readily be reduced to $\frac{n}{2}$ by the spurious exploitation of angled brackets! In view of such a logical possibility, the abbreviatory device in question must be used only when genuinely motivated.

My second criticism of the $d \rightarrow z \rightarrow \gamma$ solution is that cited in Part I and involves a special case of Kiparsky's definition of Absolute Neutralization (1968a), the situation which obtains when underlying distinctions are never realized on the phonetic surface. Since /z/ is not listed in the table of radical initial segments for MSG, and since it is the output of no mutation rule, I infer that [z] is never found on the phonetic surface of MSG. Therefore Rogers is violating a special case of Kiparsky's constraint, not by proposing an unrealized underlying segment but rather by positing one which lies midway between the most abstract representation and the phonetic facts. This situation would not be quite so intolerable were Rogers' Spirantization rule less complex. If he regarded voicing as distinctive for both /d/ and /z/, he would not need to use an alpha-variable introducing this feature into his formulation. Under this simpler formalization of Spirantization, only manner of articulation would be affected whilst nothing more than the value of the feature [coronal] need be switched in the $z \rightarrow \gamma$ rule. One might then

try to argue that /z/ is never actualized as such i.e. as a voiced coronal spirant, and avoid the conclusion that the native speaker "manipulates" such a segment in the operation of the rules. Yet even if Rogers' formulation invited such an escape-hatch, it is always irrelevant to base arguments on psychological reality when they cannot be tested empirically. Suffice it to say that Rogers' analysis necessitates the inclusion in his inventory of a "fictitious" segment whose sole existence is determined by the intermediate level of an ad hoc rule.

Having reviewed a crucial portion of Rogers' treatment of data from MSG by way of a comparison with Modern Irish, let us return to the latter. In Part I we cited the Lenition of /d/ via intermediate /g/ and /z/ in order to illustrate Hetzron's framework. It is now necessary to consider whether an intermediate stage of derivation is required at all in the realization of lenited /d/ and /d'/. Our characterization of realization as a unitary phenomenon suggests that the process cannot be broken down into a series of discrete steps. Indeed the CTE encapsulates just such a claim. We must therefore address ourselves to the question of whether we tolerate an exception to the CTE in the case of $d \rightarrow g \rightarrow \gamma$ (where the first step would otherwise erase the trigger specified in the SD of the second step), or whether we can adduce other evidence **in support of the** hypothesis that /d(')/ is converted into $[\gamma, j]$ directly. In fact corroboration of a negative kind is to hand once we consider the level at which neutralization between lenited /d(')/ and lenited /g(')/ takes place. In our critique of Rogers' analysis we noted the "initial attractiveness" of the treatment which merges MSG /d/ with /g/. But surely neutralization occurs at the phonetic surface? To put this another way, when /d/ and /g/ undergo Lenition that process had identical phonetic repercussions. This in no way implies that /d/ is converted to /g/ at some intermediate stage within the phonological component proper. It is

on these grounds that (R9) finds justification:

(29) (R9) Lenition of /d(')/:

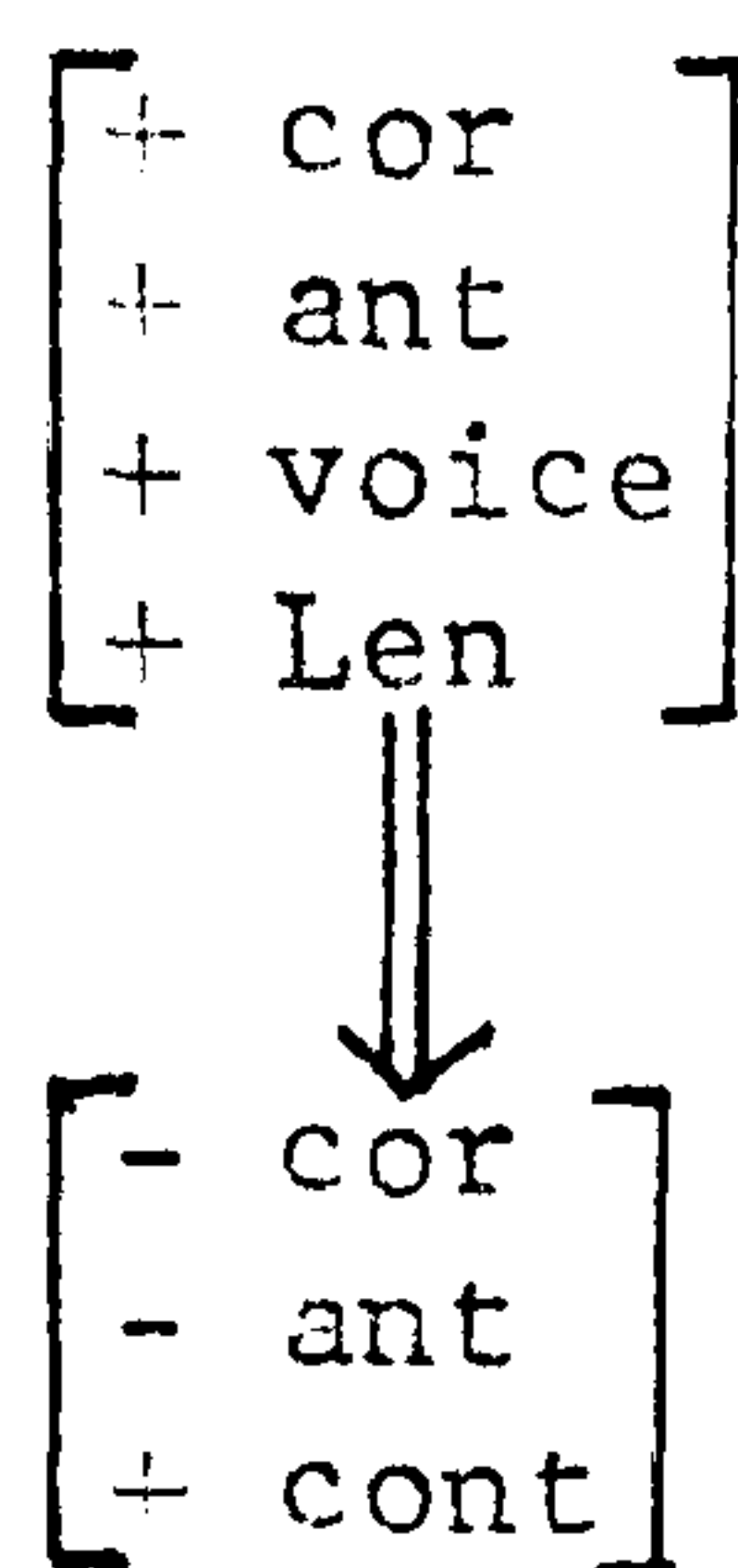

We have formalized the realization rules of Lenition for those dialects which possess only the broad/slender distinction amongst sonorant consonants. It remains therefore for us to formalize the rules for dialects which exhibit more than two coronal nasals and more than two laterals.

(R10) specifies realization for those cases where there are both distributed and nondistributed broad and slender coronal nasals and laterals:

(30) (R10) Lenition of sonorants - first dialectal variant:

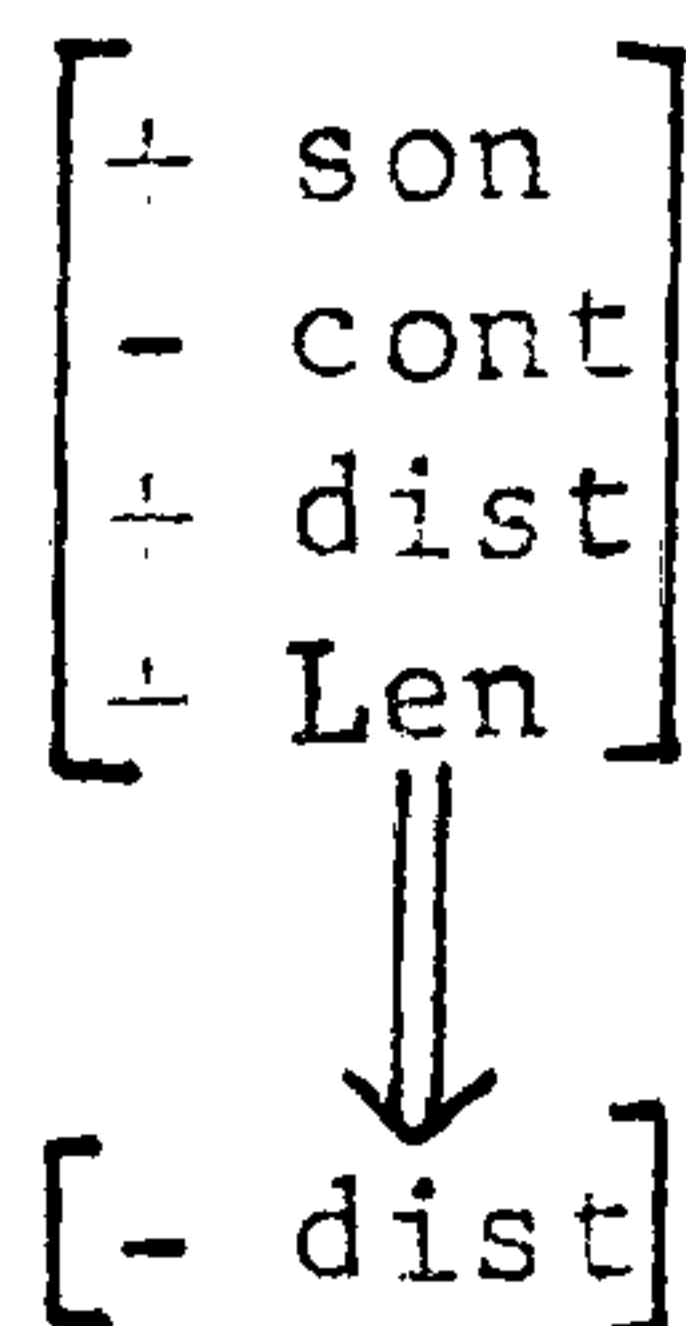

Since /r(')/ and vowels are [+ cont], they are all effectively excluded by the specification [- cont]. Thus (R10) yields [n], [n'] and [l], [l'] from underlying /N/, /N'/ and /L/, /L'/ respectively. As for those dialects where the distributed pair are neutralized to [n'], [l'] under Lenition, (R10) may be modified to (R10') as shown:

(31) (R10') Lenition of sonorants - second dialectal variant:

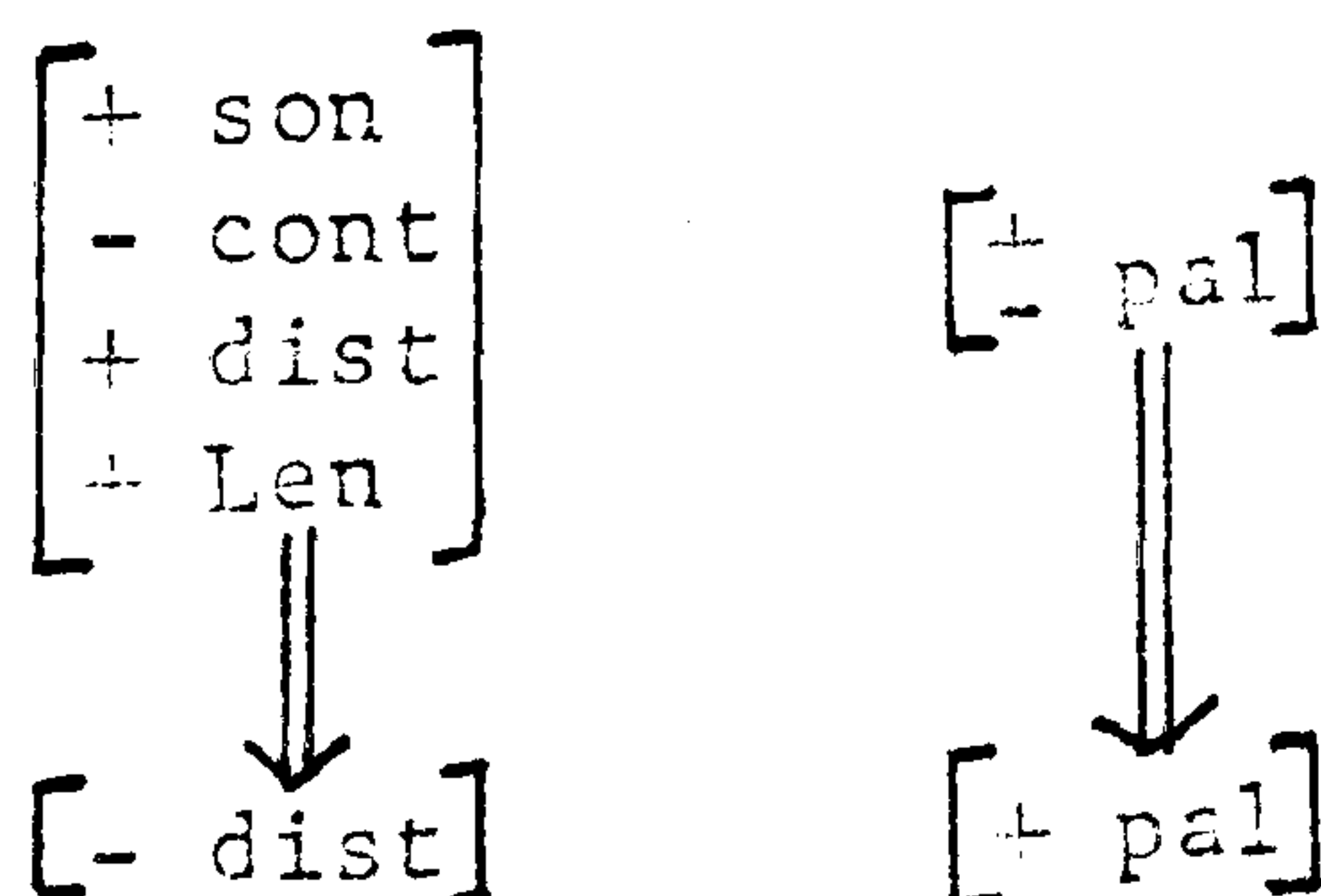

In the dialectal variant (R10'), the presence or absence of /'/ has been rewritten by convention as either [+ pal] or [- pal]. Depending upon

which value is met by the input representation, it is either retained or flipped to plus during the SC.

It remains for us to explicate the way in which (R10) and (R10') operate in conjunction with the other realization rules for Lenition, when an initial consonant cluster undergoes that mutation-type. Now in Modern Irish obstruent + sonorant clusters are the only ones which mutate. To spell this out a little more, in dialects not distinguishing the feature [±distributed], (i.e. in which sonorant consonants are not "mutable"), obstruents only undergo IM before sonorants e.g. [mə ʃg'e:l] (mo scéal "my story") * [mə hg'e:l] cf. [mə hli:] < /ʃl'i:/ (mo shlí "my way"). * In dialects where the ±distributed dichotomy obtains, morpheme-initial obstruents continue to mutate only before a sonorant but if that sonorant is a coronal nasal or lateral consonant, it too will undergo Lenition where triggered to do so e.g. [mə hl'i:] < /ʃL'i:/. Mhac an Fhailigh cites the lenited reflexes of underlying /sL, ʃL', sN, ʃN'/ in such a dialect as [hl, hl', hn, hn'] respectively. Note that he does not cite the lenited reflex of slender /ʃ/ as [ç] when it occurs as the first member of a cluster, even though this underlying segment does have a consonantal reflex (= [ç]) in isolation in the dialect concerned. We return to this point directly.

Meanwhile let us consider whether the application of two different realization rules to the same consonant cluster constitutes a contra-vention of the CTE. At first glance it might be assumed that this is the case, for [hl'e:və] < /ʃL'iev/ (sléibhe < sliabh "mountain" Genitive Sing., Common Sing.) appears to have undergone realization twice.

* Footnote

Recall that it was the patterning of /m(')/ along with the obstruents in blocking IM in clusters that provided evidence for its distinctive feature specification [-son] in the previous section.

However closer inspection soon reveals that even in this case each underlying segment has been realized once only - /f/ has become [h] and /L'/ has become [l']. This instance of realization is therefore crucially different from that in which, say, /p/ lenites to [f] and that [f] is then deleted; or again, /p/ eclipses to [b] which is subsequently nasalized to [m]. It is clear then that if both underlying /f/ and underlying /L'/ in /ʃL'iaʊv/ + Gen. have a trigger [+Len] associated with them we will derive the correct lenited counterparts of both without in any way affecting the ontological status of the CTE. What then is the convention whereby both underlying segments in a cluster are assigned a particular diacritic? The convention in question is one established in SPE whereby every segment in a word is marked for the value of each diacritic associated with the word by Lexical Redundancy Rules. Thus we might schematize the processes (both realization of IM and other) which convert underlying /ʃL'iaʊv + ə/ (where Gen. has been spelt out as /ə/) to phonetic surface [hl'e:və] as shown informally below:

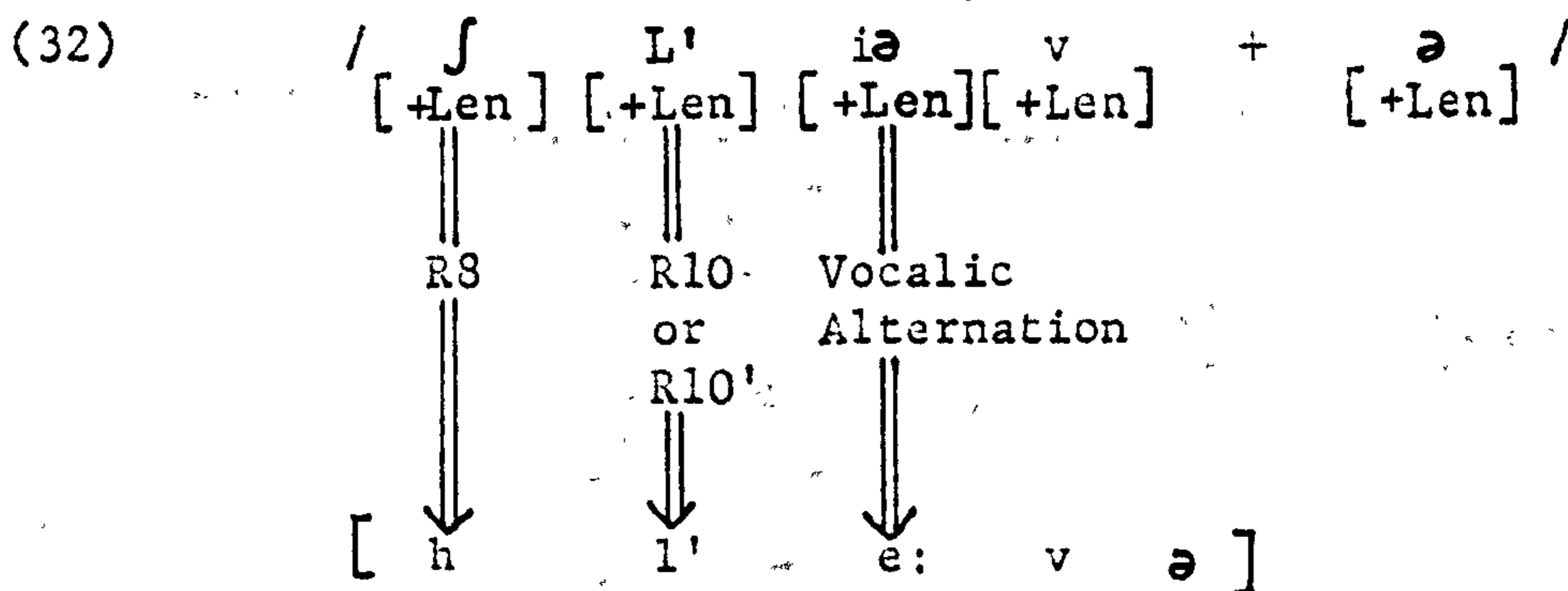

The above figure is not to be read in such a way that (R8), (R10) or (R10') and Vocalic Alternation apply simultaneously: it has been shown in Part I that such a mode of application does not obtain in natural language. Rather, the three rules apply randomly, their relative ordering having the same empirical consequences. Notice also that in the informal statement /' / has remained in association with /L/ - it has not been segmented out. However this simplification is in no way misleading for /' / is only rewritten as [-pal] after triggering assignment in the

expanded lexicon and hence after the convention by which triggers are propagated. Thus there is never a stage of derivation at which [+pal] has [+Len] directly associated with it. Rather, the former is segmented out from the archisegment, whereas the latter was previously assigned to the archisegment.

To return to the issue of how to constrain (R8') from applying in lieu of (R8) so that /ʃL'/ and /ʃN'/ clusters surface as [hl'] and [hn'] respectively, rather than as *[çl'] and *[çn'], we need to stipulate that /ʃ/ has a consonantal lenited reflex only when a vowel follows immediately to its right. Now sonorant consonants are differentiated from vowels by being [+cons]. Thus /ʃ/ is converted into a [+cons] segment (= [ç] since [h] is [-cons]) just in case it immediately precedes a [-cons] (and [+voc]) segment (i.e. a vowel). This condition can readily be incorporated into (R8') by means of an alpha-variable to yield (R8''), which formalizes Voiceless Coronal Reduction in those dialects with [+distributed] laterals and coronal nasals:

(33) (R8'') Voiceless Coronal Reduction: second dialectal variant

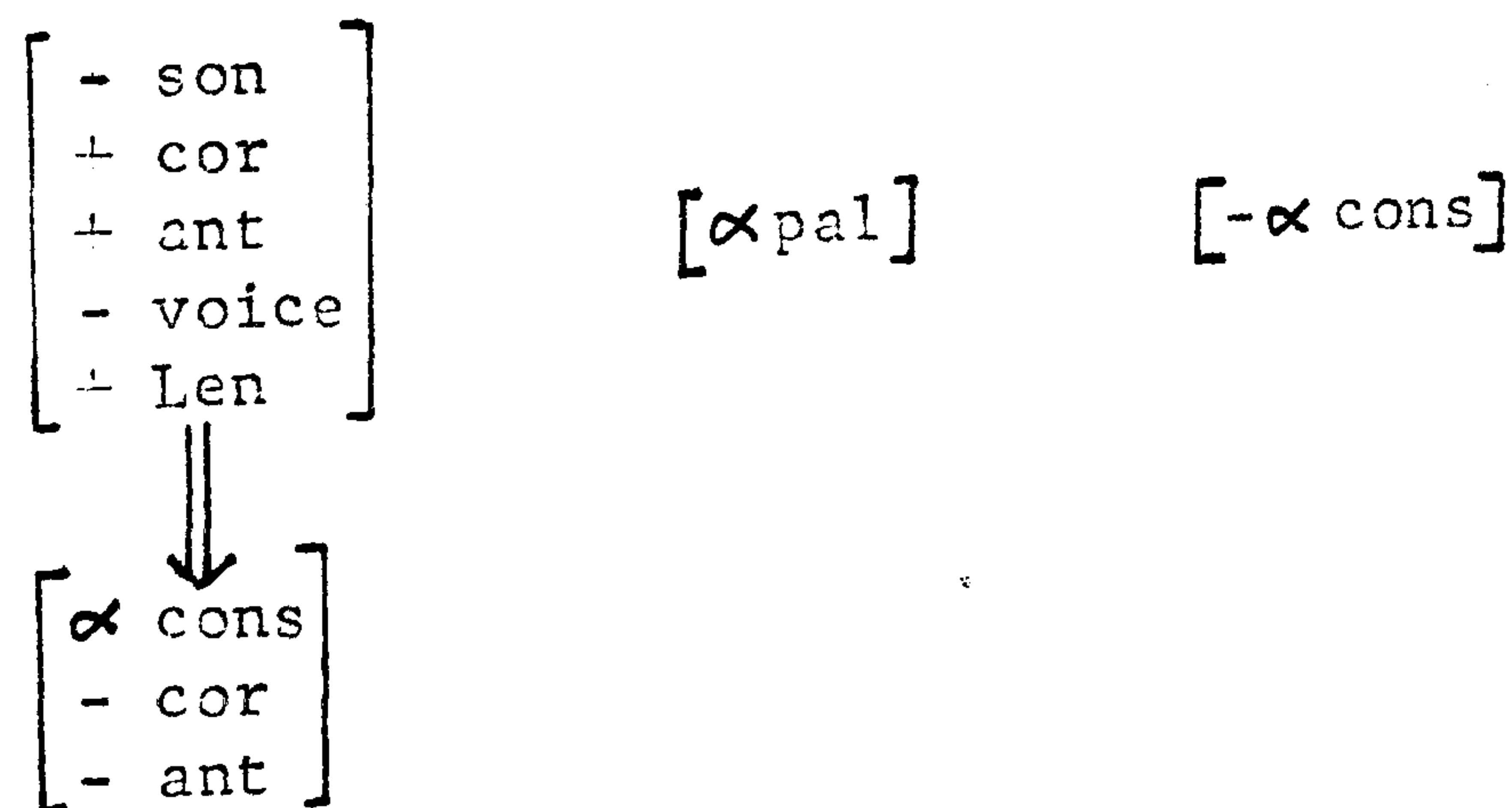

Implicit in (R8''), the last realization rule which requires formalization, is the question of the association of triggers with segments which do not undergo IM. This issue has two aspects. In the first instance there is the case of vowels which do not undergo S-T or Lenition, and consonants which never undergo any mutation-type (like /r(')/) or which do not undergo particular mutation-types (e.g. /s(')/ or /m(')/ in

relation to Eclipsis, or /p^(')/ in relation to S-T). In the second instance we find mutable consonants in non-initial position. To put this another way, how can we insure that /mə + p'i:pə/ lenites to [mə f'i:pə] (mo phíopa "my pipe") rather than to *[mə f'i:fə]? Let us follow up this aspect of the trigger issue first.

A possible solution lies in the stipulation of the presence of the morpheme boundary /+ / in realization rules. This would guarantee that IM is always morpheme-initial. Similarly we might capture the fact that initial obstruent + obstruent clusters do not mutate by including the specification [+ son] to the right of the segment affected in S-T *, Eclipsis and Lenition. So (R1) through (R9) might be modified to incorporate /+ / and [+ son] in their SDs. But the mere inclusion of /+ / would not apply to (R10) and its variant for they are operative in clusters, as we have seen. However this is not to say that (R10) and (R10') apply medially and finally. They might therefore be amended to permit an obstruent to intervene after the morpheme-boundary, MSCs having previously accounted for the occurrence of particular obstruents only before a given sonorant consonant. Revised (R10) would therefore be formulated as follows:

(34) (R10) Revised:

$$+ \quad \left(\begin{array}{l} [- \text{son}] \\ [+ \text{Len}] \end{array} \right) \quad \left(\begin{array}{l} + \text{son} \\ - \text{cont} \\ + \text{dist} \\ + \text{Len} \end{array} \right) ([+ \text{pal}]) [+ \text{son}]$$

$$\Downarrow$$

$$[- \text{dist}]$$

* Footnote

Indeed, this specification has already been incorporated into (R3), the formalization of S-T, following the discussion of the phonetic environment of this mutation-type in the preceding section.

Similarly, (R10') would be amended as follows:

(35) (R10') Revised:

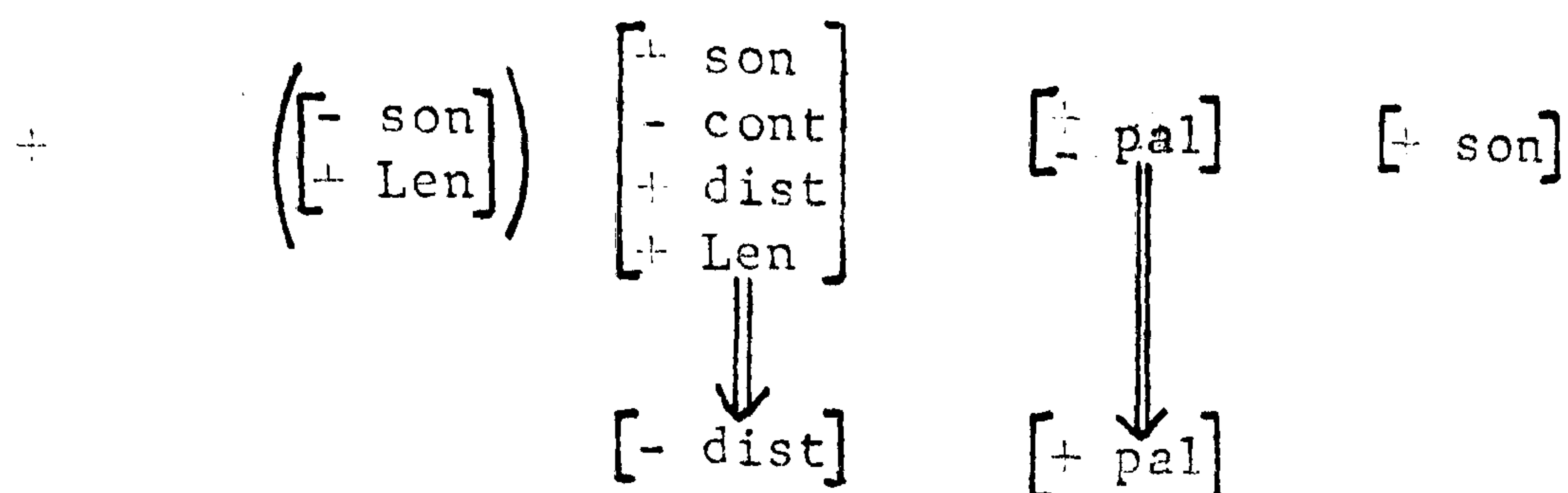

An alternative solution would be to eliminate all instances of triggers which do not appear after a morpheme-boundary and before a sonorant. Such Trigger Pruning has the advantage that the realization rules no longer need to be modified in the same way by the incorporation of /+/ and [+son] in each SD. I therefore opt for the Pruning solution. Returning to the first aspect of the trigger issue, Pruning could be extended by permitting it to delete triggers associated with non-mutating initial segments. However since most consonants qualify as non-mutating with respect to the Minor Mutations, and even in the case of Eclipsis and Lenition there are a number of segments failing to undergo each mutation-type, Pruning would become not only complex but specific to each mutation-type. By extending Pruning in this way we would thus nullify the advantages accrued by the two-stage approach to IM, which recognizes triggering as distinct from realization. It is therefore preferable to define Pruning as a general process which filters out triggers from just those environments where IM is never implemented i.e. where a particular trigger is not preceded by the morpheme-boundary and followed by a sonorant.

Notice that whichever solution were adopted, obstruent + sonorant clusters would constitute a special case in those dialects which exhibit the distributed/non-distributed dichotomy. We have seen how we might formalize this exceptional behaviour under the treatment which introduces /+/

and [+ son] into the SD of realization rules. Under the Pruning solution we need to specify the following configuration as not being eligible for Pruning:

$$(36) \quad * \quad + \quad \begin{bmatrix} - \text{son} \\ + \text{Len} \end{bmatrix} \quad + \quad \begin{bmatrix} \overline{+ \text{son}} \\ + \text{cons} \\ + \text{Len} \end{bmatrix}$$

This exception to Pruning in certain dialects may be viewed as part of their idiosyncrasy in exhibiting the feature [± distributed]. Ceteris paribus we would expect conservative dialects to abandon the distinction in their underlying inventories and hence evolve simpler Pruning. This is indeed what has proved to be the case in innovative dialects.

Notwithstanding the Pruning of non-initial triggers and their erasure during the application of realization rules (= CTE), there will still be triggers which persist into the phonetic level just in case the initial segment to which they were assigned is not affected by that mutation-type. Since triggers have phonetic consequences but not phonetic reflexes, these triggers must be disregarded by the PDRs. This is a direct result of the rôle of PDRs which confines them to mapping binary features into n-ary ones. To put this another way, PDRs are not designed to be sensitive to diacritics. Hence it is clear that if a trigger persists into the phonetic level, it will not pass through the PDRs onto the phonetic surface.

To sum up, triggers are eradicated in three ways during the course of the phonological component proper. First, Pruning applies to underlying representations to erase triggers propagated to environments where IM is never implemented. Second, during the application of each realization rule the trigger which enabled the SD of that rule to be met is deleted. This CTE has the effect that a given segment may undergo realization once only. Lastly, those triggers which are assigned to segments not

meeting the SD of the realization rule(s) they condition and which consequently persist at the phonetic level do not pass through the PDRs onto the phonetic surface.

which no longer meet the SD of Truncation. It is clear, then, that unless Truncation is constrained in some way to apply after /f/-deletion, the incorrect derivations like the following will result:

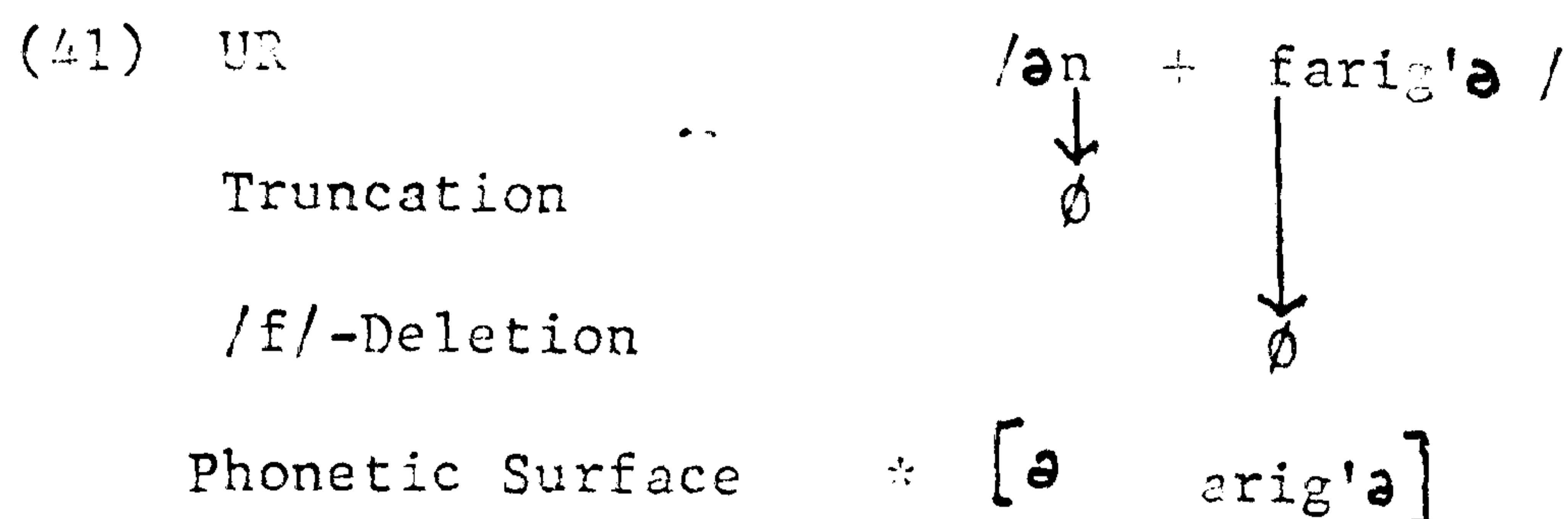

It becomes apparent that here we have an ordering paradox once one recognizes that /f/-Deletion must apply at the same point in relation to Truncation as the other realization rules for Lenition - to deny this would be to abandon the claim that /f/-Deletion constitutes part of Lenition. To put this another way, whereas the other realization rules for Lenition may freely apply **after** Truncation, the opposite ordering is required if the realization rule is /f/-Deletion. Furthermore, it is just this paradox which must result in the approach where Lenition is conditioned by the immediately preceding vowel yielded by /ən/ → [ə]. Truncation has to apply before any initial consonant can lenite.

Following the Lenition-realization of /f/, [n] must be reinserted. It was for these reasons - amongst others - that we rejected the segment approach to EM in § 1.3 (see Ch. 1 p.362-3). However, despite the fact that we are not treating Lenition as conditioned by the vowel remaining after Truncation, that process must nonetheless be constrained so that it does not apply before Lenition - otherwise surface phonetic representations like *[ə arig'a] will be generated.

I shall now explicate two independent solutions to the paradox, the one invoking the principles of UDRA, the other questioning the ontological status of Truncation. Taking the UDRA solution first, we must ask whether any principle proposed in this thesis accounts for the precedence of /f/-Deletion over Truncation when the SDs of both are met as in

underlying /əⁿ + farig'ə/. Notice that here we have a clear case in
 [+ Len]
 which simultaneous application would yield the incorrect surface representation. However the precedence principle which correctly predicted the Yawelmani Yokuts data cited to refute simultaneity (see Part I, Ch. 4), namely Deletion Cession, cannot be invoked here, since both processes involve deletion. Moreover there is no immediately obvious way in which a PI relation might be established between the two SDs, for each rule affects a different segment. Rather, it is to morphological precedence that we must turn. Consider the fact that /f/-Deletion is conditioned by the presence of a diacritic (= [+ Len]). Truncation, on the other hand, is statable in phonological terms. * Hence when a representation meets the SDs of both /f/-Deletion and Truncation, the realization rule will take applicational precedence and will bleed Truncation. There are, then independently motivated grounds within the UDRA hypothesis, for constraining Truncation to apply after /f/-Deletion. Indeed, the theory of rule application developed in this thesis which expressly denies that rules may apply simultaneously, is validated by such incorrect derivations as * [ə arig'ə]. We return to this point below.

Up till now in our discussion we have accepted without argument the claim that the UR of the Article is /əⁿ/: it is now time to question that claim and consider the ontological status of Truncation. In so doing we shall provide the alternate solution to the ordering paradox.

* Footnote

Notice that labelling provided gratis from syntactic surface structure - i.e. the bracket "Art" in the formalization of Truncation - is deemed an integral part of phonological structure and hence distinguished from diacritics which are interpolated in syntactic surface structure by the expanded lexicon for the express purpose of conditioning particular rules.

involving the Article and /f/-Deletion. Underlying /ən/ may be viewed as the archisegmental representation of the Article before initial vowels. However we find no precedent for the citation of underlying forms in their prevocalic manifestation amongst the other items which may fill the Determiner slot. This is not to say that variants do not arise. Thus /mə/ and /də/ are generally cited as the URs of the 1st and 2nd Singular possessive adjectives, and these forms occur preconsonantly - ə-Elision applies before initial vowels (or /'/ + V; see footnote to p .509 § 3.2 for comments). Would it not be more consistent, one might argue, to posit URs based on the variants which appear in a constant context? (cf. Condition (B''), page 28 ff., K&K). Weight might be added to this by considering that the greater number of nouns in Modern Irish have an initial consonant. Moreover of those with initial vowels, it is only the Feminine class which demand the [ən(')] allomorphs - Masculine nouns with initial vowels being preceded by [ə] and prefixed [t]. Following this line of argumentation, would not the more highly valued treatment of the Article be the one under which its UR was identical to its unmarked manifestation? Let us therefore provisionally adopt a rule of [n]-insertion, * operating before vowels and stated below as (42):

(42) [n]-Insertion

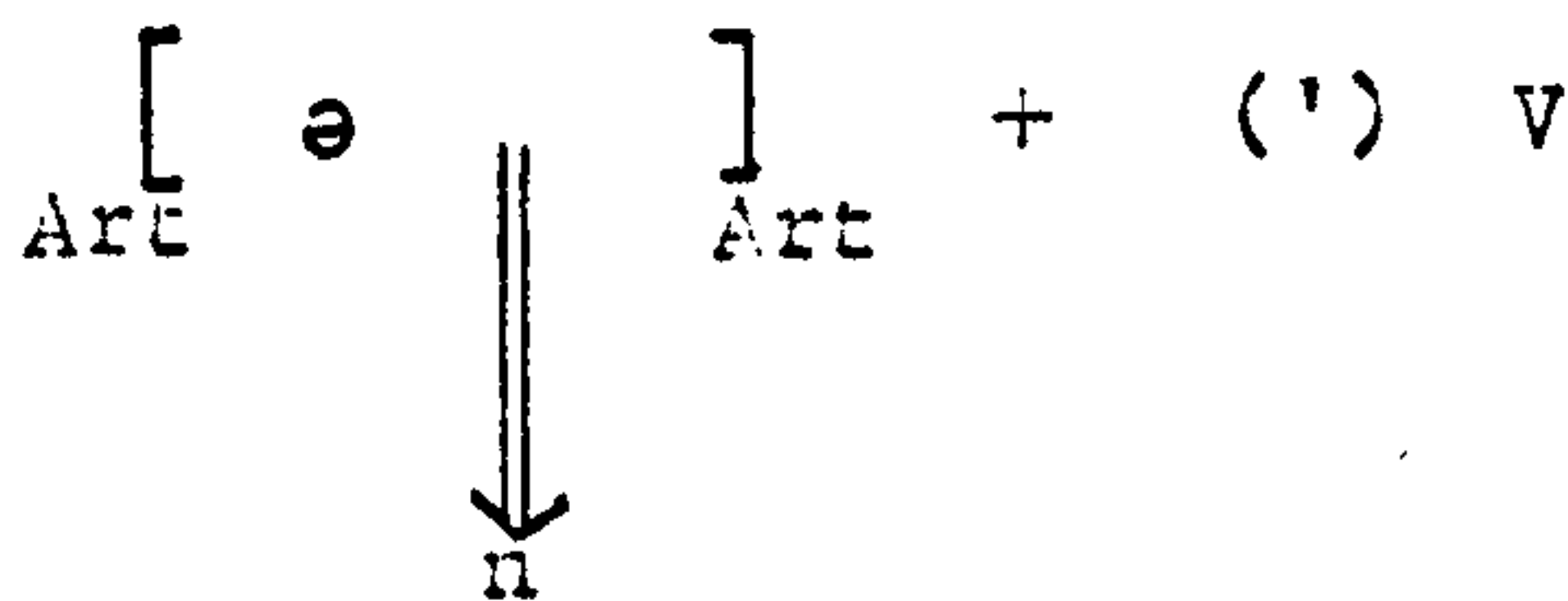

We must now consider the following: what benefits accrue from this Insertion rule? More specifically, how does the incorporation of [n]-Insertion into the grammar solve the ordering paradox with /f/-Deletion?

* Footnote

Cf. Vennemann's parallel treatment of the alternation between [ə] and [ən] for the English Indefinite Article. (1972)

The answer is that Obligatory Precedence will guarantee that [n]-Insertion applies whenever its SD is met. In other words, it will enable /f/-Deletion to feed Insertion. To take the three types of noun identified for Truncation, underlying /ə + ma:hir'/ meets only the SD of Lenition.
[+ Len]

After realization intermediate /ə + wa:hir'/ still fails to meet the SD of Insertion and consequently that rule never applies in the derivation of phonetic surface [ə wa:hir']. On the other hand, underlying /ə + obir'/ does meet the SD of Insertion but fails to meet that of the realization of Lenition. Hence only Insertion applies, yielding phonetic surface [ən obir']. Thirdly, underlying /ə + farig'a/ meets only the SD of
[+ Len]

Lenition. However, once /f/-Deletion has been implemented the intermediate derivation /ə + arig'a/ now meets the SD of Insertion, which applies to yield phonetic surface [ən arig'a].

I have presented alternate solutions to an ordering paradox involving the Article and /f/-Deletion. It now behoves me to select one over the other, by referring to the evaluation measure. Whilst the purpose for incorporating this device into linguistic metatheory is widely acknowledged, (namely, to choose between descriptively adequate analyses), its internal workings have not been explicitly defined, the implementation of the measure usually making appeal to the intuitive judgement of the linguist. Rather than rectifying this deficiency which obviously requires extensive research, I shall pit the advantages and disadvantages of the alternate solutions as I see them.

There seem to be two areas in which one might compare Truncation and Insertion, namely the formalization of these processes and their mode of interaction with /f/-Deletion. On the first count Truncation is marginally simpler than Insertion since the latter requires the stipulation

of parenthesized /'/ to account for the stranding of that feature initially. However if we were to base our selection of Truncation over Insertion on these grounds we could justly be accused of adopting a naïve conception of the evaluation measure. It is perhaps worth noting here that had Truncation been amended to apply before $\left[\begin{array}{c} f \\ +Len \end{array} \right] /$ as well as prevocally, we would be justified in valuing Insertion more highly - for the revised environment is rendered considerably more complex by the inclusion of a diacritic. The ad hoc nature of such a revision would also militate against Truncation.

Turning to the mode of rule interaction obtaining between Truncation or Insertion and /f/-Deletion, we find a clear difference between the two cases: whilst /f/-Deletion bleeds Truncation, it feeds Insertion. In Part I we discussed the relative naturalness of the four modes of rule interaction and we saw that, ceteris paribus, the situation where A bleeds B (but B does not affect A) is to be deemed less natural than that where A feeds B (but B does not affect A) *. If we accept this hypothesis we must conclude that the Insertion solution is to be more highly valued than the Truncation solution. However in adopting the Insertion solution, we are not rejecting the UDRA hypothesis. On the contrary, the fact that simultaneous application is not permitted within the theory proposed here means that some other machinery will have to be introduced to account for the prohibition of *[ə arig'ə] on the phonetic surface. The incorporation of Insertion into the grammar constitutes such a solution. To sum up, just those interactions which are precluded by UDRA are most insightfully treated by a "realistic" theory

* Footnote

Mutual bleeding is of course distinct from bleeding / non-affecting in this respect, as Hooper is at pains to point out throughout her book. For the treatment of mutual bleeding situations, see Part I, § 3.1.

of phonology.

Two solutions have been put forward to the ordering paradox involving /f/-Deletion in the Noun Phrase and we have suggested ways of choosing between them, insofar as they are incompatible. We now turn to the second paradox which arises in the Verb Phrase. As has been noted, this paradox has been treated in the literature, namely in John Armstrong's Squib "A Note on Initial Mutation in Modern Irish", which appeared in *Linguistic Inquiry* 1975. Armstrong's presentation of the data parallels his explication in such a way that the more central exempla are followed by additional material which impinges upon the issues involved. I shall therefore adhere to his order of exposition of the linguistic facts and only when all the evidence, both central and peripheral, has been cited shall I offer a solution. The examples are Armstrong's but I have not retained his phonetic symbols where they differ from my own broad transcription except to indicate the feature [\pm distributed] for coronal nasals and laterals. The dialect Armstrong describes is that of Mayo as analysed by De Búrca (1958) and Mhac an Fhailigh (1968). The verbal forms which he cites may be identified unambiguously by the orthography which is standard for all dialects, and is not influenced by the marked dialectal differences which obtain between Mayo Irish and that of Connemara. Since the latter provides the basis for my own broad transcription there are bound to be discrepancies between the data cited from Armstrong and that presented later. However I trust that I have pointed to the variation where relevant. Moreover the same basic issues are pertinent to all dialects.

In § 2.1 we set out the critical data from the Preterite, Imperfect and Conditional tenses regarding the problem of /f/-Deletion and the elision of schwa from the preverbal particle [də] (henceforth referred to as e-Elision or simply Elision, to distinguish it from e-Truncation treated

earlier in this section.) There we had a double concern: to set the scene for the present discussion of the data; and to determine whether the triggering of Lenition in the Preterite, Imperfect and Conditional constituted an instance of FT or PT. In fact we found no unambiguous answer to the second question and concluded that the "optional [d̪] issue" shows that there is a significant amount of interdependence between the two types of triggering. We shall return to this point in concluding the present section. As for our first concern in presenting the data in § 2.1, let me briefly restate the issue by following Armstrong's exposition.

Having shown in tabular form the phonetic repercussions of Lenition and Eclipsis (= Armstrong's Nasalization) for single radical consonants and "representative clusters", Armstrong commences his discussion with some brief but salient remarks on the morphosyntactic conditioning of IM. He then states in orthographic terms the rule with which he is concerned, to the effect that the vowel of the preverbal particle do is elided before a following vowel or fh. The nonapplicability or applicability of a-Elision has the following results (where parentheses signify optionality):

(43) (Corresponding to Armstrong's (4) and (6) page 319)

a. i.	[(d̪) hr'ov]	<u>(do) threabh</u>	"plowed"
a. ii.	[t'r'ov̪N]	<u>treabhann</u>	"plows"
b. i.	[(d̪) ha:g]	<u>(do) sháith</u>	"stuck"
b. ii.	[sa:g̪N]	<u>sáitheann</u>	"sticks"
c. i.	[(d̪) l'i:n]	<u>(do) líon</u>	"filled"
c. ii.	[l'i:n̪N]	<u>líonann</u>	"fills"
d. i.	[(d̪) riN']	<u>(do) roinn</u>	"divided"
d. ii.	[riN'̪N]	<u>roinneann</u>	"divides"

(44) (Corresponds to Armstrong's (5) and (7) *ibid.*)

a. i.	[do:l]	<u>d'ól</u>	"drank"
a. ii.	[o:ləN]	<u>ólanh</u>	"drinks"
b. i.	[d'ic]	<u>d'ith</u>	"ate"
b. ii.	[icəN]	<u>itheann</u>	"eats"
c. i.	[duəgar']	<u>d'fhuagair</u>	"announced"
c. ii.	[fuəgri:N] *	<u>fuagraíonn</u>	"announces"
d. i.	[d'aN]	<u>d'fheann</u>	"skinned"
d. ii.	[f'aNəN]	<u>feannann</u>	"skins"

From (44) it seems apparent that verbs with initial lenited /f/ are patterning like verbs with initial vowels, just in case lenited /f/ is realized phonetically as \emptyset . Consequently Armstrong's reformulation of Elision to the effect that it applies before a following vowel seems in order. However it fails to account for the data of (45):

(45) (Corresponds to Armstrong's (9), (10) and (11), pp. 319-20)

a. i.	[d'r'agər']	<u>d'fhreagair</u>	"answered"
	*[(də) r'agər']	<u>(do) fhreagair</u>	
a. ii.	[f'r'agri:N]	<u>freagraíonn</u>	"answers"
b. i.	[d'l'ux]	<u>d'fhliuch</u>	"wetted"
	*[(də) l'ux]	<u>(do) fhliuch</u>	
b. ii.	[f'l'uxəN]	<u>fliuchann</u>	"wets"

The reformulation of Elision to apply prevocally predicts the asterisked forms of (45), rather than those actually attested. Nor can the reformulation be amended to "... before a vowel or r, l", as

* Footnote

This differs from the other ii. forms in not being derivable from the Preterite by the concatenation of [əN]. Verbs which pattern in this way belong to the class traditionally called "Syncopated Verbs" - Briathra Coimrithe. Example (45) a. also belongs to this class. Notice furthermore their patterning in the Imperfect (see (47) c. and (48) a.) which sets them apart from the other verbs ending in [u:] in Mayo Irish.

(43) c. and d. demonstrate.

The next stage in Armstrong's exposition is to restate Elision in such a way that it precedes realization, that is, so that Elision applies before a following vowel or f. Thus derivations would proceed as follows:

/də fX/ → /dfX/ → /dX/.....

Now it is clear from the evidence presented in Part I that a derivation which proceeded in such a manner would contravene the UDRA hypothesis, for if a representation meets the SDs of Elision and realization, morphological precedence dictates that the latter must precede the former. Although Armstrong appears oblivious of the mode of rule interaction involved, he comments "A strange rule to describe a strange phenomenon" (page 320). Without dwelling further on the unnaturalness of such an analysis, he promptly presents two different pieces of evidence which show that Elision does not always apply before f. The first set of data comprise the Preterite of the Autonomous form of the verb or An Briathar Saor, which Armstrong refers to as the "past passive (indefinite actor) form". Thus (46), (47) and (48) (= Armstrong's (13), (14) and (15) respectively) correspond to (43), (44) and (45) above respectively.

(46) a.	[(də) t'r'ovu:]	<u>(do) treabhadh</u>	"was plowed"
b.	[(də) sa:xu:]	<u>(do) sáitheadh</u>	"was stuck"
c.	[(də) L'i:nu:]	<u>(do) líonadh</u>	"was filled"
d.	[(də) riN'u:]	<u>(do) roinneadh</u>	"was divided"
(47) a.	[(də) ho:lu:]	<u>(do) h-óladh</u>	"was drunk"
b.	[(də) hiçu:]	<u>(do) h-itheadh</u>	"was eaten"
c.	[(də) fuəgri:v]	<u>(do) fuagraíoch</u>	"was announced"
d.	[(də) f'aNu:]	<u>(do) feannadh</u>	"was skinned"

- (48) a. [(də) f'r'agri:v] (dó) freagraíodh "was answered"
 b. [(də) f'l'uxu:] (do) fliuchadh "was wetted"

From (46), (47) and (48) we see that the Autonomous Preterite form resists Lenition although H-prefixation is triggered. The conditioning of the latter mutation-type constitutes a clear case of FT, where the morphosyntactic category involved is {Autonomous Preterite}, for the preceding optional particle, namely [də], is not confined to this form of the verb. I shall cite other data of a similar kind in substantiating this point directly. Meanwhile let us return to Armstrong's exposition. Rather than discussing the triggering issue per se, Armstrong merely mentions in a footnote that his reformalization of Elision predicts *d'h-óladh ("was drunk") and *d'h-itheadh ("was eaten"), forms to which he offers the tentative phonetic transcriptions *[to:lu:]? and *[t'igu:]? Of course in fact such derivations are ruled out on two counts by the theory of UDRA developed here: given the URs /də + o:lu:/^[+H] and /də + ɪgu:/^[+H] which meet the SDs of H-prefixation and Elision, both morphological precedence and Deletion Cession predict that H-prefixation must apply before Elision. Although Armstrong makes no mention of the rule ordering controversy, his allusion to the three-way contrast between [ho:lu:] (h'óladh "was drunk"), [do:lu:] (d'óladh "would drink")* and [o:lu:] (óladh "let ... drink") is revealing, for it highlights the non-redundant nature of [d] on the phonetic surface in Mayo Irish.

We have seen that in the Autonomous Preterite initial f, along with the other initial consonants, does not undergo Lenition even though it may be optionally preceded by do. The second piece of evidence cited by Armstrong to demonstrate that Elision does not always apply before f,

* Footnote

Sic: Armstrong means "was drinking" - he is confusing the Conditional with the Imperfect (fn. 9, page 321). This is apparent from the orthography.

involves individual lexical items, which, like /fai/ (faigh "get"), behave irregularly with respect to IM. The relevant data from the Preterite and Autonomous Preterite are cited in (49):

(49) (Corresponds to Armstrong's (16), page 320).

- | | | | |
|----|----------------|----------------------|-----------|
| a. | [(də) fuər'] | <u>(do) fuair</u> | "got" |
| b. | [(də) fuərħəs] | <u>(do) fuarthas</u> | "was got" |

Whilst (49) b. shows that /fai/ behaves regularly in the Autonomous Preterite *, (49) a. demonstrates that it fails to undergo Lenition as expected in the Preterite - one would have predicted *[duər'] (d'fhuair).

In order to account for the anomalous behaviour of /fai/ and to preclude such "monstrosities" as *[d'f'aNu:] (d'feannadh "was skinned") cf. (47) d. and *[d'f'r'agri:v] (d'freagraíodh "was answered") cf. (48) a., Armstrong restates Elision to the effect that "the vowel of the preverbal particle 'do' is elided before a following vowel or f, except when the verb is past passive (i.e. Autonomous Preterite : JRMcB) or is specifically fuair "got" " (page 321). It is clear however that we have returned full circle in that this final reformulation is effectively equivalent to the original statement which specified in orthographic terms that Elision applies before a following vowel or fh. In other words, the correct formalization of ə-Elision must stipulate both that the following verb has underlying initial /f/ and that it does in fact undergo Elision. Having made this point and bypassing the question of precisely what descriptive device it is appropriate to use, Armstrong

* Footnote

Unlike /ta:/ (tá "be"), /f'ek'/ (faic "see"), /kloj/ (clois "hear"), /klun'/ (cluin "hear"), /t'e:/ (teigh "go"), /tag/ (tag "come"), whose Autonomous Preterite forms are lenited, a fact which Armstrong omits to mention. This irregular behaviour is of more general interest in relation to exception features and IM for it shows that they may be positive as well as negative. In other words, individual lexical items may be idiosyncratic in that they undergo IM when it is not otherwise conditioned, as well as failing to undergo IM when it is conditioned.

expresses scepticism in "a solution based on an externally motivated phonological intermediate, distinct from both underlying /f/ and surface \emptyset (e.g. /w/ or /ɸ/), corresponding directly to fh." (ibid.) Indeed, such a solution is rightly viewed with extreme caution, particularly in a "realistic" theory of phonology, for intermediate /w/ or /ɸ/ * - even if it could be externally motivated - constitutes a fictitious segment and hence is not in keeping with constraints on abstractness based on Kiparsky (1968 a, see Part I §3.3 for discussion). Although Armstrong does not refer to the abstractness issue, he is suspicious of such a solution just in case all other particles which undergo ə-Elision treat fh in the expected way. Of crucial relevance is homophonous leniting [d̪ə](do "your (sg.)"). As his concluding gesture Armstrong then presents the following additional data showing the Verbal Noun (An tAinm Briathartha):

(50) (= Armstrong's (19), page 322).

a.	[d̪ə l'i:nu:]	<u>do líonadh</u>	"your filling"
b.	[d̪ə riN']	<u>do roinn</u>	"your dividing"
c.	[do:l]	<u>d'ól</u>	"your drinking"
d.	[d'içə]	<u>d'ithe</u>	"your eating"
e.	[d̪uəgərt']	<u>d'fhuaigairt</u>	"your announcing"
f.	[d'aNu:]	<u>d'fheannadh</u>	"your skinning"

(51) (= Armstrong's (20), ibid.)

a.	[d̪ə r'agərt']	<u>do fhreagairt</u>	"your answering"
b.	[d̪ə l'uku:]	<u>do fhliuchadh</u>	"your wetting"

We have followed Armstrong's exposition in presenting data, both central and peripheral, which impinge upon the optional [d̪ə] issue. It will be

* Footnote

Where the former must be interpreted as distinct from the lenited counterpart of /b/ and /m/, given by Armstrong as [v].

apparent that an ordering paradox arises precisely because a-Elision may be permitted to apply after the realization of IM in the case of underlying initial /f/ + vowel sequences but the same rule must apply before that process if /f/ + /r, l/ clusters are to be correctly elided. Moreover the latter rule application of this ordering paradox is an extremely unnatural one. However, Armstrong does not present a solution to the paradox. It now behoves me to do just that on the basis of the theory of phonology developed in this work. Let us therefore begin where Armstrong finished and examine the implications of the fact that there exists a homophonous leniting possessive adjective [də] as well as a preverbal particle with - on occasions - that reflex.

The two most salient facts about the distinct instances of phonetic surface [də] would appear to be the following: first, preverbal [də] is optionally deletable, whilst adjectival [də] is not; second, the elision of preverbal [də] to [d] is opaque for the reasons that we have discussed, whilst that of adjectival [də] is transparent since schwa is always and only elided before a surface vowel. We shall see directly that these two facts are interdependent. For the time being let us pursue the transparency of adjectival [də]. a-Elision in the possessive adjective (and this includes /mə/ (mo "my")) would follow the realization of IM by Morphological Precedence. However no UR meets the SDs of both rules non-vacuously at the same point in the derivation. Thus in underlying /də + L'i:nu:/ only the SD of realization is met, yielding

[də l'i:nu:] and a-Elision never applies; in underlying /də + o:l / [+Len]

the realization of Lenition is never implemented and a-Elision applies to give [do:l]; whereas in underlying /də + fuəgərt' / [+Len] /f/-Deletion

feeds a-Elision, yielding [duəgərt']; finally underlying /də + f'r'agərt' / [+Len]

does not meet the SD of a-Elision either before or after /f/-Deletion. We see then that the application of Elision is a transparent process viewed from the phonetic surface. To put this another way, a-Elision may be regarded as a natural rule viz adjectival [də] (- and for that matter the other eliding particles to the exclusion of preverbal [də]). We may take this as corroboration of the UR /də/ corresponding to the

formative $\left[\begin{array}{l} + \text{ Poss.} \\ + \text{ II} \\ + \text{ Sg.} \end{array} \right]$ in syntactic surface structure. The naturalness

of the analysis finds further support from the obligatory appearance of the formative's reflex on the phonetic surface.

In sharp contrast to its adjectival homophone, preverbal [də] is neither transparent with respect to a-Elision nor obligatory on the phonetic surface. Surely the solution which presents itself is that there is no a-Elision rule for preverbal [də] simply because there is no /də/ present in URs? In other words let us propose an obligatory rule of [d]-Epenthesis which is morphologically conditioned, just in case it is opaque on the phonetic surface. Such a rule might be formalized as follows:

(52) [d]-Epenthesis:

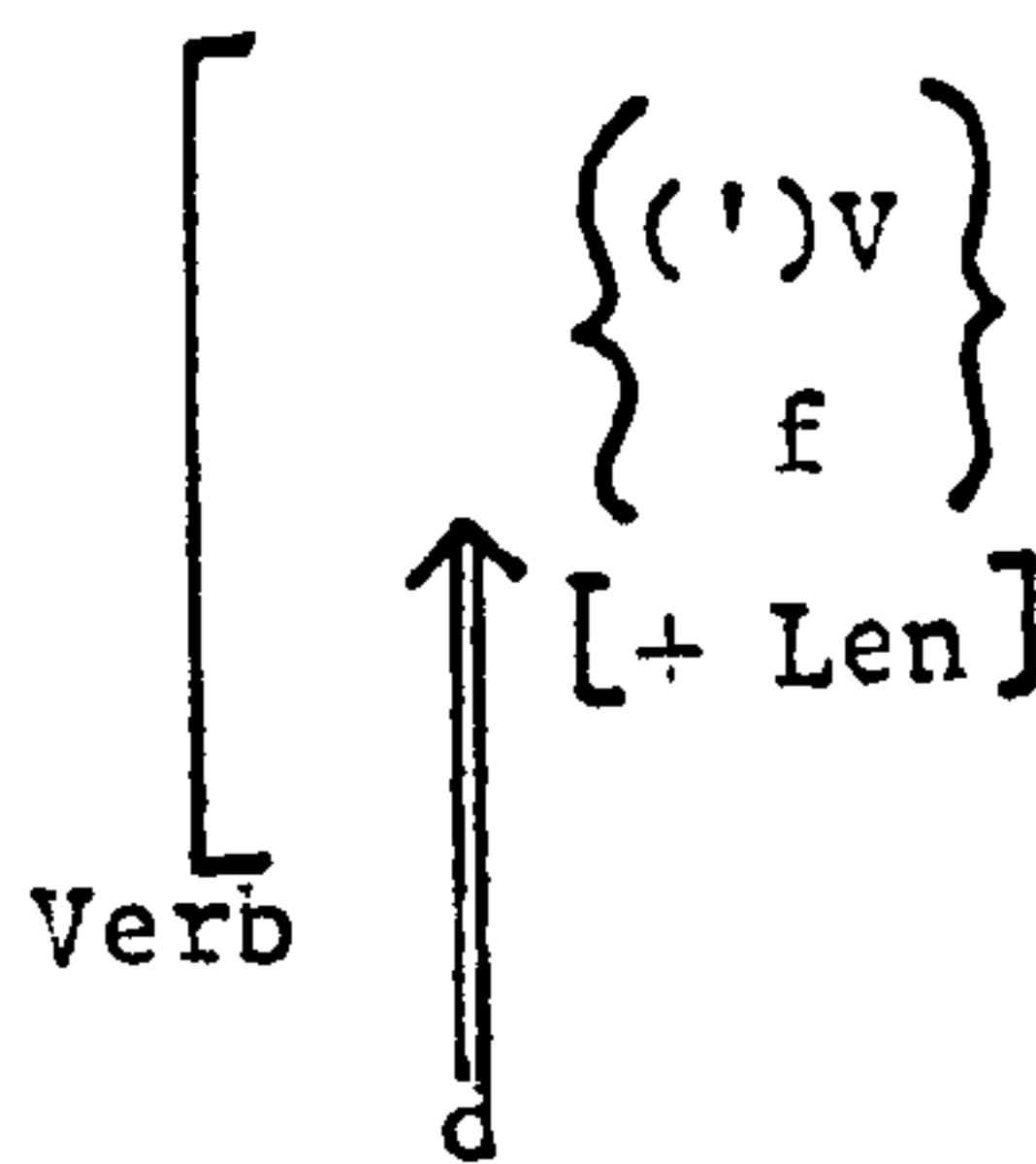

Notice that both an initial V(owel) and initial /f/ will be associated with the trigger [+ Len] because of the fact that triggers are assigned irrespective of their subsequent (non-)implementation, for the fact that [+ Len] is specified in the SD of [d]-Epenthesis guarantees that the process precedes realization. (Recall that the C(onvention on) T(ripper) E(rasure) insures that triggers are not left extant after the realization rules they condition.) Observe also that the segment

[+ pal] (= /'/) is only specified prevocally - such specification would be redundant after /f/ since /f/-Deletion does not affect /'/' but leaves the segment temporarily stranded when the lenited /f/ was preceded by a morpheme boundary (e.g. intermediate /də + 'aNu:/ Verbal Noun). However in the case of [d'aN] (Preterite), bare initial /'/' never arises, for [d]-Epenthesis precedes /f/-Deletion.

It must be emphasized that [d]-Epenthesis in no way resembles the proposal made by Armstrong in a footnote where he tentatively suggests that wrongly elided /ə/ might be reinserted into /dCr, dCl/ clusters after mutation. The only resemblance lies merely in the fact that both are rules of insertion. The objections to Armstrong's analysis are two-fold. First, it constitutes an instance of that undesirable Gambit, the Duke of York. (see Part I § 3.4.2) Second, and more seriously, an analysis based on the fact that [dr, dl] clusters were underlyingly /dCr, dCl/ must mean that it incorporates the claim that the phonetic surface representation contains some kind of trace. Without going into the (to me convincing) arguments against the Trace Theory of syntax, I can adduce no evidence for such fictitious entities on the phonetic surface. Moreover the CTE, substantiated above, explicitly claims that triggers have a life-span of one realization rule and cannot be retrieved later in derivations.

We have formalized a rule of Epenthesis to account for the appearance of [d] before a vowel or lenited /f/ in the Preterite, Imperfect and Conditional of verbs. What then of the optional preconsonantal [də] in such tenses? A rule of Optional [də]-Insertion may be formulated to apply in the appropriate tenses and is ordered after [d]-Epenthesis by PIPrec (more specifically Proper Contextual Inclusion):

(53) Optional [də]-Insertion:

[

↑
↑
]
C

Verb

də

Notice that Optional [də]-Insertion does not stipulate that the following C(onsonant) is lenited. Hence it also applies in the Autonomous Preterite. Thus H-prefixation before initial vowels will feed [də]-Insertion, to yield [(də) ho:lu:] ((do) h-óladh "was drunk").

On page 550 we noted that in the Autonomous Preterite optional [də] could not be said to condition H-prefixation, since it is not confined to that tense or voice. In other words the same particle cannot condition different mutation-types in independent morphosyntactic categories - rather, the triggering must be ascribed to those morphosyntactic categories themselves. Moreover it is now clear that the insertion of [də] after H-prefixation aptly captures the fact that the triggering of the mutation-type is not a case of PT, but rather a clear case of FT. A related piece of evidence alluded to above is that [d] appears before initial vowels in the Past Subjunctive. Here [d] can have nothing to do with the triggering of Lenition for the Past Subjunctive is identical to the Imperfect in every respect except for its unmutated initial consonant. Not all dialects (or registers) possess the Past Subjunctive. For example ÓHuallacháin and ÓMurchú do not include it in their Verb morphology (§ 6.5.1, 1976). However for those dialects and registers which do contain the Past Subjunctive, [d]-Epenthesis may be readily amended so that [+Len] is associated only with initial /f/, not with an initial vowel:

(54) [d]-Epenthesis (Dialectal Variant):

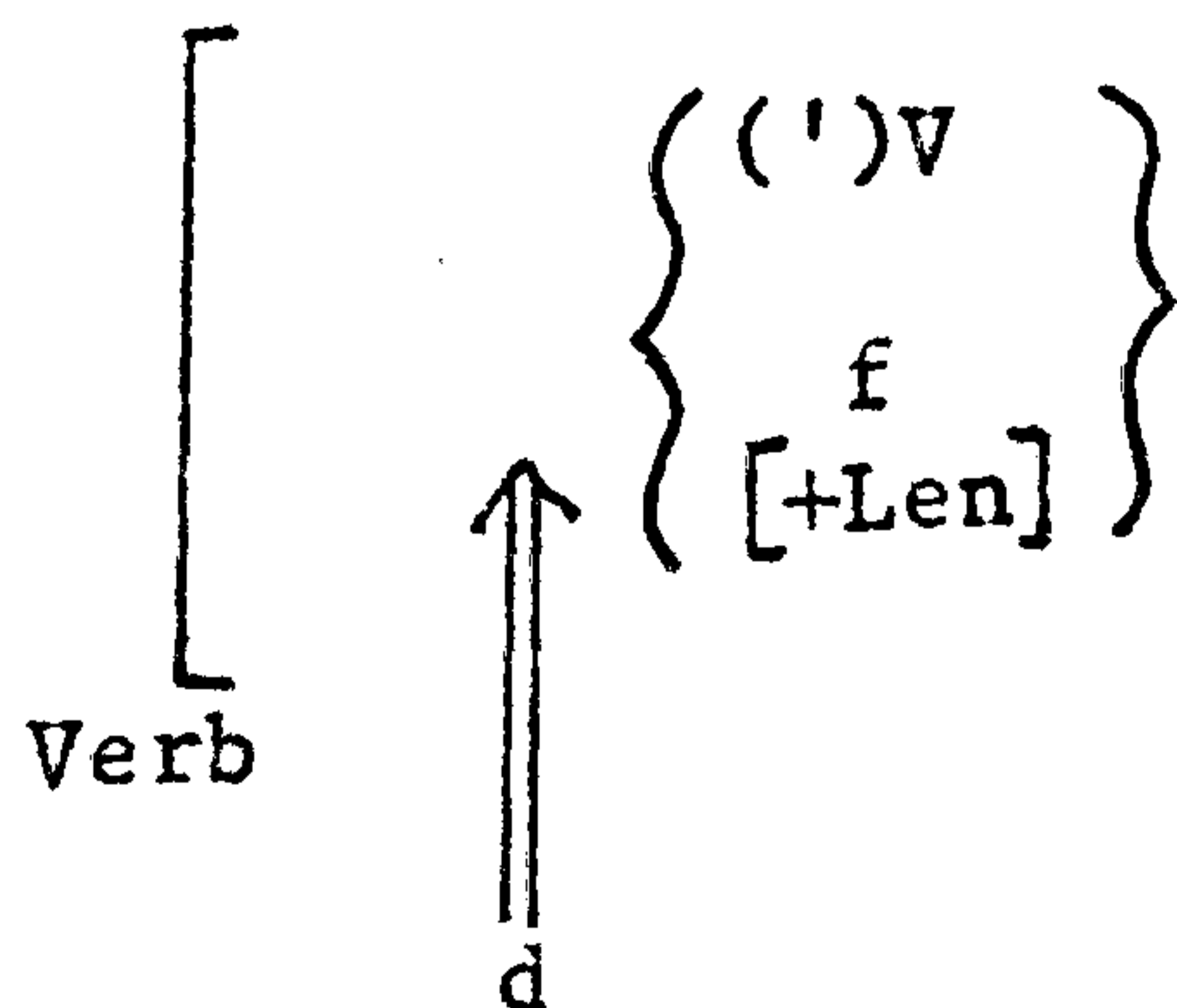

When we anticipated the present discussion in § 2.1, we had come to the conclusion that there was no rigid dividing line to be drawn between

the two types of triggering, PT and FT. Now that a solution to the optional [də] issue has been presented, it is clear that such a conclusion in fact only touches the "tip of the iceberg". For in resolving the issue we have seen that a variety of apparently disparate facts may all bear on the questions involved. When proposing analyses which are descriptively adequate to recalcitrant pieces of phonological data, the linguist must constantly measure the advantages accrued in one part of his description with its repercussions elsewhere. There can be no satisfactory phonological analysis which does not reflect upon both morphosyntactic and purely phonetic issues. And it is when considerations from both poles "conspire" to corroborate a particular treatment within the phonological component that we have an indication that we are on the right track. I hope that the bases of such an integrated theory of phonology have not only been apparent within this section and chapter, but throughout this thesis.

BIBLIOGRAPHY

- Anderson S. 1969 "West Scandinavian Vowel Systems and the Ordering of Phonological Rules" Bloomington: IULC.
- Armstrong J. 1975 "A Note on Initial Mutation in Modern Irish" LInq. 6 p.317-23.
- Aronoff M. 1976 "Word Formation in Generative Grammar" LInq. Monograph 1 Cambridge, Mass.: MIT Press.
- Awbery G.M. 1975 "Welsh Mutation: Syntax or Phonology?" Archivum Linguisticum n.s.6 p.14-25.
- 1976 "The Syntax of Welsh: A Transformational Study of the Passive" Cambridge: University Press.
- Baxter A.R.W. 1974 "Some Aspects of Naturalness in Phonological Theory" Oxford University B.Litt. thesis.
- Bellin W. & McBrearty JR «A Generative Treatment of Initial Mutation in Welsh»
- Bloomfield L. 1933 "Language" New York: Holt.
- 1939 "Menomeni Morphophonemics" TCLP 8 p.105-15.
- Botha R.P. 1971 "Methodological Aspects of Transformational Generative Phonology" The Hague: Mouton.
- Breatnach R.B. 1947 "The Irish of Ring, Co. Waterford" Dublin: Institute for Advanced Studies.
- Bunge M. 1959 "Metascientific Queries" Springfield Illinois: Charles C. Thomas.
- Campbell L. 1973 "Extrinsic Ordering Lives" Bloomington: IULC.
- Cathey J. & Demers R. 1976 "On Establishing Linguistic Universals" Lg. 52 p.611-30.
- Chafe W. 1968 "The Ordering of Phonological Rules" IJAL 34 p.115-36.
- Chomsky N. 1951 "Morphophonemics of Modern Hebrew" Unpublished Master's thesis, University of Pennsylvania.
- 1964 "Current Issues in Linguistic Theory" The Hague: Mouton.
- 1965 "Aspects of the Theory of Syntax" Cambridge, Mass.: MIT Press.
- 1968 "Language and Mind" New York: Harcourt Brace.
- 1970 "Remarks on Nominalization" in R. Jacobs & P. Rosenbaum (Eds.) "Readings in Transformational Grammar" Waltham, Mass.: Blaisdell.
- & Halle M. 1968 "The Sound Pattern of English" New York: Harper & Row.

- & Lasnik H. 1977 "Filters and Control" LInq. 8 p.425-504.
- Christian Brothers 1976 Revised Edition "New Irish Grammar" Dublin: Fallons.
- Comrie B. 1979 "Morphophonemic Exceptions and Phonetic Distance" Linguistics 17 p.51-60.
- Cram D. 1975 "Grammatical and Phonological Conditioning of Initial Mutations in Scottish Gaelic" Leuvense Bijdragen (Tijdschrift voor Germaanse Filologie) 64 p.363-75.
- De Bhaldraithe T. 1945 "The Irish of Cois Fhairrge, Co. Galway" Dublin: Institute for Advanced Studies.
- De Burca S. 1958 "The Irish of Tourmakeady, Co. Mayo" Dublin: Institute for Advanced Studies.
- Dell F. 1973 "Les egles et les Sons: Introduction a la Phonologie Generative" (Collection Savoir) Paris: Hermann.
- Derwing B.L. 1973 "Transformational Grammar as a Theory of Language Acquisition" Cambridge: University Press.
- Dillon M. & O Croinin D. 1961 "Teach Yourself Irish" London: The English Universities Press Ltd.
- Dinnsen D.A. 1974 "Constraints on Global Rules in Phonology" Lg. 50 p.29-51.
- Evans E. 1969 "The Irish Dialect of Urris, Insihowen, Co. Donegal" Lochlann (Norsk Tidsskrift for Sprogvidenskap) supplementary vol. 9 p.1-130.
- Fleuriot L. 1964 "Dictionnaire des Gloses en Vieux Breton" Paris: Klincksieck.
- Fudge E.C. 1969 "The Nature of Phonological Primes" JL 3 p.1-36.
- Gimson A.C. 1962 "An Introduction to the Pronunciation of English" London: Arnold.
- Gleasure J. 1968 "Consonant Quality in Irish and a Problem of Segmentation" Studia Celtica 3 p.79-87.
- Greene D. 1966 "The Irish Language" Dublin: Cultural Relations Committee of Ireland.
- Guerssel M. 1977 "Constraints on Phonological Rules" Linguistic Analysis 3 p.267-305.
- Hale K. 1971 "Deep-surface Canonical Disparities in Relation to Analysis and Change: an Australian Example" MS; now in T. Sebeok, H. Hoenigswald & R. Longacre (Eds.) "Current Trends in Linguistics" 11, 1973, p.401-58.
- Halle M. 1959 "The Sound Pattern of Russian" The Hague: Mouton.
- 1962 "Phonology in Generative Grammar" Word 18 p.54-72.
- 1973 "Prolegomena to a Theory of Word Formation" LInq. 4

- 1977 "Tenseness, Vowel Shift, and the Phonology of the Back Vowels in Modern English" Ling. 8 p.611-25.
- & Stevens K.N. 1969 "On the Feature Advanced Tongue Root" MIT Research Laboratory Electronics Quarterly Progress Report, Report #94, p.209-15.
- Hamp E. 1951 "Morphophonemes of the Keltic Mutations" Lg. 27 p.230-47.
- Harris Z.S. 1945 "Discontinuous Morphemes" Lg. 21 p.121-7.
- Henderson E.J.A. 1949 "Prosodies in Siamese" Asia Major n.s.1 p.189-215; also in F.R. Palmer (Ed.) "Prosodic Analysis" 1970; London: Longmans.
- Hetzron R. 1974 "Extrinsic Ordering in Classical Arabic" Afroasiatic Linguistics 1 p.1-20; Los Angeles: Urdena.
- Hockett C.F. 1947 "Problems of Morphemic Analysis" Lg. 23 p.321-43; reprinted in Joos (Ed.) "Readings in Linguistics I" Fourth edition 1966; Chicago: Chicago University Press.
- 1954 "Two Models of Grammatical Description" Word 10 p.210-34; reprinted in Joos (Ed.) "Readings in Linguistics I" Fourth edition 1966; Chicago: Chicago University Press.
- Hooper J.B. 1976 "An Introduction to Natural Generative Phonology" New York: Academic Press.
- Hudson G. 1975 "Suppletion in the Representation of Alternations" Doctoral dissertation, Los Angeles: University of California.
- Hutchinson L. 1972 "Mr. Chomsky on the Phoneme" Bloomington: IULC.
- 1973 "Levels of Representation in Phonological Derivations" University of Minnesota Working Papers in Linguistics and Philosophy of Language 1, p.63-71.
- Hyman L.M. 1975 "Phonology: Theory and Analysis" New York: Holt, Rinehart & Winston.
- Iverson G.K. 1973a "A Guide to Sanguine Relationships" Paper presented at the Indiana University Rule Ordering Conference; now in Koutsoudas (Ed.) 1976.
- 1973b "Speculations on Counterfeeding" Bloomington: IULC.
- Jackendoff R.S. 1972 "Semantic Interpretation in Generative Grammar" Cambridge, Mass.: MIT Press.
- Jakobson R., Fant C.G.M. & Halle M. 1951 "Preliminaries to Speech Analysis" Cambridge, Mass.: MIT Press.
- Jakobson R. & Halle M. 1956 "Fundamentals of Language" The Hague: Mouton.

- Joos M. 1942 "A Phonological Dilemma in Canadian English" Lg. 18 p.141-4
- Kaplan A. 1964 "The Conduct of Inquiry: Methodology for Behavioural Science" San Francisco: Chandler Publishing Co.
- Kayne R. 1975 "French Syntax: The Transformational Cycle" Cambridge, Mass.: MIT Press.
- Kenstowicz M.J. & Kisseberth C.W. 1973 "Unmarked Bleeding Orders" in Kisseberth (Ed.) "Studies in Generative Phonology" Edmonton, Alberta: Linguistic Research, Inc.
- 1977 "Topics in Phonological Theory" New York: Academic Press.
- King. R.D. 1973 "Rule Insertion" Lg. 49 p.551-78.
- Kiparsky P. 1968a "How Abstract Is Phonology?"; now in Fujimura (Ed.) "Three Dimensions of Linguistic Theory" 1973; Tokyo: TEC Co. Ltd.
- 1968b "Linguistic Universals and Linguistic Change" in Bach & Harms (Eds.) "Universals in Linguistic Theory" New York: Holt, Rinehart & Winston.
- 1971 "Historical Linguistics" in Dingwall (Ed.) "A Survey of Linguistic Science" College Park: University of Maryland Linguistics Program.
- 1973 "Abstractness, Opacity and Global Rules" Paper presented at the Indiana University Rule Ordering Conference; now in Fujimura (Ed.) "Universals in Linguistic Theory" New York: Holt, Rinehart & Winston; also in Koutsoudas (Ed.) 1976.
- Kisseberth C.W. 1969 "Theoretical Implications of Yawelmani Phonology" Doctoral dissertation, University of Illinois.
- 1970 "On the Functional Unity of Phonological Rules" Ling. 1 p.291-306; reprinted in Fudge (Ed.) "Phonology: Selected Readings" 1973, Penguin.
- 1972 "The Vowel Length Alternation in Klamath: a Global Rule" in Kenstowicz & Kisseberth (Eds.) "Issues in Phonological Theory" The Hague: Mouton.
- 1973 "Is Rule Ordering Necessary in Phonology?" in Kachru et al (Eds.) "Issues in Linguistics: Papers in Honor of Henry and Renée Kahane" Champaign-Urbana: University of Illinois Press.
- Koutsoudas A. 1972 "The Strict Order Fallacy" Lg. 48 p.88-96.
- 1976 (Ed.) "The Application and Ordering of Grammatical Rules" The Hague: Mouton.
- 1980 "The Question of Rule Ordering: Some Common Fallacies" JL 16 p.19-35.

- Sanders G. & Noll C. 1974 "On the Application of Phonological Rules" Lg. 50 p.1-28.
- Lamb S. 1966 "Prolegomena to a Theory of Phonology" Lg. 42 p.536-73.
- Lass R. 1976 "English Phonology and Phonological Theory" Cambridge: University Press.
- Lockwood W.B. 1969 "Indo-European Philology" London: Hutchinson & Co. Ltd.
- 1972 "A Panorama of Indo-European Languages" London: Hutchinson & Co. Ltd.
- 1975 "Languages of the British Isles: Past and Present" London: Andre Deutsch.
- Lounsbury R. 1953 "The Method of Descriptive Morphology" in "Oneida Verb Morphology" Yale University Publications in Anthropology No. 48 p.11-24; reprinted in Joos (Ed.) "Readings in Linguistics I" Fourth edition 1966; Chicago: Chicago University Press.
- Lyons J. 1962 "Phonemic and Non-phonemic Phonology" IJAL 28 p.127-33; reprinted in Fudge (Ed.) "Phonology: Selected Readings" 1973, Penguin.
- Matthews P.H. 1972 "Inflectional Morphology" Cambridge: University Press.
- 1974 "Morphology: An Introduction to the Theory of Word-Structure" Cambridge: University Press.
- Mayerthaler W. 1974 "Einführung in die Generative Phonologie" Romanistische Arbeitshefte 11, Max Niemeyer Verlag, Tübingen.
- McCawley J.D. 1968 "The Phonological Component of a Grammar of Japanese" The Hague: Mouton.
- Mhac an Fhailigh É. 1968 "The Irish of Erris, Co. Mayo" Dublin: Institute for Advanced Studies.
- Michelson K. 1977 "Evidence from Mohawk Against an Unordered Rule Hypothesis" Harvard Studies in Phonology 1, p.335-47.
- Mondéjar J. 1970 "El Verbo Andaluz" Revista de filología española, anejo 90.
- Newman S. 1944 "Yokuts Language of California" Viking Fund Publications in Anthropology 2: New York.
- Ní Chasaide A. 1979 "Laterals of Gaoth-Dobhair Irish and Hiberno-English" in "Papers in Celtic Phonology" p.54-78 Edited by D.P. Ó Baoill (Occasional Papers in Linguistics & Language Learning No. 6) New University of Ulster.
- Norman L.J. 1973a "Rule Addition and Intrinsic Order" University of Minnesota Working Papers in Linguistics and Philosophy of Language 1, p.135-59.

- 1973b "Bi-directional Rules and Non-extrinsic Ordering"
Paper presented at the Indiana University Rule Ordering
Conference; now in Koutsoudas (Ed.) 1976.
- Ó Cuív B. 1944 "The Irish of West Muskerry, Co. Cork" Dublin:
Institute for Advanced Studies.
- Ó Domhnalláin T. 1967 "Buntús Cainte" Dublin: Oifig an tSoláthair.
- Oftedal M. 1962 "A Morphemic Evaluation of the Celtic Initial
Mutations" Lochlann (Norsk Tidsskrift for Sprogvidenskap)
supplementary vol. 6 p.92-102.
- Ó Góilidhe C. 1970 "Cursa Nua-Aimseartha" Dublin: Folens & Co Ltd.
- Ó Huallacháin C. & Ó Murchú M. 1976 "Irish Grammar" Coleraine:
Irish Studies, New University of Ulster.
- Perry T. 1971 "On a Spurious Case of Counter-Feeding Order" MS.

1972 "On Two Theories of Rule Application" Paper presented
at the summer meeting of the Linguistic Society of America;
Bloomington: IULC.
- Phelps E. 1975 "Iteration and Disjunctive Domains in Phonology"
Linguistic Analysis 1 p.137-72.
- Postal P.M. 1968 "Aspects of Phonological Theory" New York:
Harper & Row.

1969 "Mohawk Vowel Doubling" IJAL 35 p. 291-8.

1970 "On Coreferential Complement Subject Deletion" Ling. 1
p.439-500.
- Pullum G.K. 1976a "Sequential and Simultaneous Rule Application
in Spanish Phonology" Lingua 38 p.221-62.

1976b "Rule Interaction and the Organization of a Grammar"
PhD thesis, published 1979 Garland: New York & London.

1976c "The Duke of York Gambit" JL 12 p.83-102.

1979 Review of Koutsoudas (Ed.) 1976 JL 15 p.179-87.
- Ringen C.O. 1973 "Vacuous Application, Iterative Application,
Reapplication and the Unordered Rule Hypothesis" Paper
presented at the Indiana University Rule Ordering Conference;
now in Koutsoudas (Ed.) 1976.
- Rogers H. 1972 "The Initial Mutations in Modern Scots Gaelic"
Studia Celtica 7 p.63-85.
- Saib J. 1973 "The Treatment of Geminates: Evidence from Berber"
Paper read at the Fourth Annual Conference on African Ling-
uistics, Queens College, New York.

1977 "A Phonological Study of Berber: Dialect of Ait Ndhir"
Doctoral dissertation, UCLA.

- Sanders G. 1972a "Precedence Relations in Language" Bloomington: IULC.
- 1972b "Equational Grammar" Janua Linguarum Series Minor 108 The Hague: Mouton.
- Sapir E. 1949 "The Psychological Reality of Phonemes" in Mandelbaum (Ed.) "Selected Writings of Edward Sapir" Berkeley: University of California Press.
- Saporta S. 1965 "Ordered Rules, Dialect Differences, and Historical Processes" Lg. 41 p. 218-24.
- Schane S.A. 1968 "French Phonology and Morphology" Cambridge, Mass.: MIT Press.
- 1971 "The Phoneme Revisited" Lg. 47 p.503-21.
- Skerrett R.A.Q. 1967 "Notes on the Dialect of the Inishkea Islanders" Studia Celtica 2 p.196-201.
- 1968 "Noun-Plural Inflection in a Generative Grammar of Irish" Studia Celtica 3 p.88-105.
- Smith N.V. 1973 "The Acquisition of Phonology" Cambridge: University Press.
- 1975 Review of Mayerthaler 1974 JIPA 1 p.92-5.
- & Wilson D. 1979 "Modern Linguistics: The Results of Chomsky's Revolution" Penguin.
- Sommerstein A.H. 1972 "The Place of Ordering Constraints in Phonology" MS.
- 1973 "The Sound Pattern of Ancient Greek" Oxford: Basil Blackwell.
- 1977 "Modern Phonology" London: Edward Arnold.
- Stanley R. 1967 "Redundancy Rules in Phonology" Lg. 43 p.393-435.
- Swadesh M. 1943 "The Phonemic Principle" Lg. 10 p.117-29; reprinted in Joos (Ed.) "Readings in Linguistics I" Fourth edition 1966, Chicago: Chicago University Press; also in Fudge (Ed.) "Phonology: Selected Readings" 1973, Penguin.
- Thurneysen R. 1946 "A Grammar of Old Irish" Dublin: Institute for Advanced Studies.
- Trommelen M. & Zonneveld W. 1978 "Where the Principles Fail" Review of Koutsoudas (Ed.) 1976, Bloomington: IULC.
- Vago R. 1974 "Extrinsic Ordering in Hungarian Phonology" Bloomington: IULC.
- Vasquez W. 1953 "El Fonema /s/ en el Español del Uruguay" Revista de la facultad de humanidades y ciencias, 10 p.87-94.

Vennemann T. 1972 "Rule Inversion" Lingua 29 p.209-42.

Wang W. S.-Y. 1969 "Competing Changes as a Cause of Residue"
Lg. 45 p.9-25.