

**ENERGY EFFICIENT
INDUSTRIALIZED HOUSING
RESEARCH PROGRAM**

**SUMMARY
FY 1996 RESEARCH ACTIVITIES**

**UNIVERSITY OF OREGON
AND
UNIVERSITY OF CENTRAL FLORIDA**

**ENERGY EFFICIENT INDUSTRIALIZED HOUSING
RESEARCH PROGRAM**

SUMMARY OF FY 1996 RESEARCH ACTIVITIES

**Center for Housing Innovation
University of Oregon
Eugene, Oregon 97403-1206**

**Contact:
G.Z. (Charlie) Brown
(541) 346-5647**

**and
Florida Solar Energy Center
a Research Institute of
the University of Central Florida
300 State Road 401
Cape Canaveral, Florida 32920-4099**

**Contact:
Subrato Chandra
(407) 823-0250**

**Department of Industrial Engineering
University of Central Florida
4000 Central Florida Blvd.
Orlando, Florida 32816**

**Contact:
Mike Mullens
(407) 823-5703**

U.S. Department of Energy Contract No. DE-FC51-94R020277

June 1996

AUTHORS

Center for Housing Innovation University of Oregon

Dana Bjornson	Graduate Research Fellow
G.Z. Brown	Project Director, Professor
Erik Dorsett	Graduate Research Fellow
Jeff Kline	Research Associate
Sean Fremouw	Graduate Research Fellow
Dale Northcutt	Research Assistant
Marshall Schneider	Graduate Research Fellow
Marc Slood	Graduate Research Fellow
Marie Raney	Senior Research Assistant
Tomoko Sekiguchi	Research Associate

Florida Solar Energy Center University of Central Florida

David Beal	Research Engineer
Subrato Chandra	Director of Research and Development Division
Andrew Downing	Research Assistant
Armin Rudd	Senior Research Engineer
Janet McIlvaine	Research Architect

Department of Industrial Engineering and Management Systems University of Central Florida

Robert Armacost	Assistant Professor
Tom Gawlik	Graduate Research Assistant
Mag Malek	Graduate Research Assistant
Mike Mullens	Assistant Professor
Mats Rheborg	Graduate Research Assistant

CONTENTS

	Page
1.0 EXECUTIVE SUMMARY	1
2.0 INTRODUCTION	7
3.0 DEFINITIONS	9
4.0 STRESSED SKIN INSULATING CORE PANEL COMPONENTS	13
5.0 INCORPORATION OF ENERGY ANALYSES INTO CAD SOFTWARE	25
6.0 MANUFACTURING PROCESS AUTOMATION AND SIMULATION	31
7.0 FIELD TESTING OF WHOLE HOUSES AND COMPONENTS	35
8.0 RESEARCH UTILIZATION	45
9.0 FY 96 PUBLICATIONS	55
10.0 REFERENCES	57
11.0 ACKNOWLEDGEMENTS	59

1.0 EXECUTIVE SUMMARY

This report summarizes research results from March 1996 to February 1997 for the Energy Efficient Industrialized Housing Research Program.

One of our research focuses was stressed skin insulating core (SSIC) panel construction. SSIC panels, which carry their loads entirely through their skins, are of interest because they eliminate thermal bridging caused by studs and they easily form airtight construction reducing air infiltration. We completed three projects with SSIC panels – an entry-level house design for nonprofit developers, a new floor and foundation system, and a study of alternative skins for the panels.

Working with a group of nonprofit developers and panel manufacturers, we designed an SSIC panel, solar heated 1,040 s.f. entry-level house (“Cascadia”) that costs \$59,000 and uses 20% less energy than allowed by the stringent Oregon code. We prepared a set of documents for nonprofits, including construction documents with several variations of the house, marketing and financing information, and drawings for panel manufacturers.

To publicize Cascadia we contacted over 40 nonprofit community development corporations (CDC’s) in Oregon. In addition, we conducted television and newspaper interviews, submitted articles to various newsletters targeting the housing industry, and broadcasted information on the World Wide Web through links to our web site as well as announcements posted on other related sites. We compiled information on energy efficiency rebates and energy efficient mortgage incentives, and completed a detailed cost estimate and a comparison of Cascadia versus a comparable home built using conventional stick frame methods. We also gave numerous presentations to nonprofits and governmental organizations of various levels. This effort has generated considerable interest in Cascadia. Approximately 25 Cascadia homes are currently being considered for construction by 10 different organizations.

The on-grade insulated panel floor system uses one-sided panels laid directly on a crushed gravel base and a perimeter beam of engineered lumber. A prototype floor has been built and analyzed for its constructability and structural

performance. Currently the floor is undergoing laboratory structural testing and on-site thermal testing. The floor meets all current requirements for structural performance, flatness, and heat loss. Based on a 20' x 36' test floor, we expect it to cost \$900 less than its nearest competitor, a slab on-grade. In addition, the floor can easily be disassembled and recycled.

SSIC panels used for wall construction have an oriented strand board (OSB) layer on both sides. An exterior layer of siding is put over the outer skin of OSB and drywall is installed over the inner layer of OSB to provide exterior and interior finishes. We have used an exterior skin of "Duratemp" as both a finish and structural layer thereby eliminating a layer of OSB all the way around the building. We are currently part of a consortium (UO, W.H. Porter, USG) evaluating fiber-reinforced gypsum board as an interior structural and finish layer. Fiber-reinforced gypsum has shown some promise but also has some problems, which are currently being addressed.

During FY 95, in collaboration with Softdesk, a large vendor of computer software, and Pacific Northwest National Laboratories, we developed and marketed Softdesk Energy, a module within Softdesk's CAD program, Auto Architect. Softdesk Energy interprets the drawings that architects and builders prepare and automatically inputs areas for walls, roofs, windows, etc. eliminating the need to re-enter this information and thereby making the energy design process easier, faster and more accurate.

In FY 96, we expanded the capabilities of Softdesk Energy (now owned by Autodesk) to include the Trane Co. (an HVAC manufacturer). We are now able to successfully interpret drawings for a multi-story building identifying envelope parts like walls, windows, floors, etc. and zone the building for HVAC. This geometric data along with other specifications and schedules can be exported to Trane's new HVAC design program, Trane 700. Automatic interpretation of the envelope geometry and HVAC zoning will save engineers a significant amount of time and reduce the number of input errors.

We updated our 1990 market share analysis of industrialized housing. The trends we identified in 1990 (89 data) continued in 1996 (95 data). The more industrialized producers – panelized, modular, and HUD code – took market share from production buildings, the least industrialized home building group. HUD code increased their market share from 16.6 to 23.4%, modular 5.2 to 7.3%, and panelized from 36 to 45.4%.

We have three innovative building components under development. 1) A fan recycling control, used with central heating and cooling systems to improve indoor air quality and thermal comfort, received a patent in 1996 and is being used in the U.S. DOE Building America Program as a key element of their whole house ventilation system. 2) A thermally broken steel-wood framing member to address the problem of high thermal conductivity in residential steel framing has improved energy performance by about 34%. Several large companies in the steel industry have expressed interest in the technology. 3) A connector for structural insulated roof panels was tested for structural load capacity and found to exceed by three times the withdraw capacity of the screw that the industry currently uses. This means the spacing of panel connectors could be increased, reducing the total number needed. The design was revised, and prototypes were field tested at the re-building of the house constructed for the 1997 NAHB Builder's Show in Houston. The revised design was considerably easier to use in the construction process.

UCF researchers teamed with MiTEK, a leading supplier to the truss industry, and with Glaize Components, a truss manufacturer, to explore how to integrate a manufacturing simulation with CAD software (with detailed truss design data) to improve manufacturing productivity. We developed a working simulation model of the Glaize plant and refined the model based on recommendations from MiTEK. When MiTEK completes the interface with the CAD system, the model will be tested by Glaize in its production environment. The UCF team also developed a conceptual simulation model for BuildTech to assist in visualizing the operation of a new flexible wood-frame panel manufacturing system. Research results were presented at the 1996 Building Systems Council Showcase, to Basic Automation, to the American Council for an Energy-Efficient Economy, and to the International Symposium of Automation and Robotics in Construction.

We provided technical assistance to four of the Health Houses (New Orleans, Huntsville, Birmingham, and Jacksonville), and are monitoring three of them for energy use, environmental conditions and dust mite levels. One year of monitoring was also completed on the Orlando Health House, which showed excellent energy performance (47% better than the reference case home), but dust mite and VOC levels were not as low as desired.

We performed a computer modeling study to determine the effects of sealed residential attics in hot climates on space conditioning energy use and roof temperatures. The sealed “cathedralized” attic was found to be a good way to minimize or eliminate attic moisture without an energy penalty.

Two structural insulated core panel (SIP) houses, almost identical but located in different parts of the country, were monitored for energy use and indoor air quality and were found to have very similar (and low) heating energy use requirements. We laid the groundwork for a collaborative effort with industry to investigate the use of roof-integrated, utility-interactive, photovoltaic power systems installed on manufactured housing.

We also tested and monitored for one year two new manufactured houses (HUD code) to evaluate the ventilation system and space conditioning energy performance. Results revealed a short-coming in the design of the supply ventilation system being used in most manufactured housing.

Through ReDAC (Residential Design Assistance Center) we have been working with about 50 affordable housing providers throughout the country to provide them with practical, cost-effective methods of improving the energy efficiency of their houses. We have conducted field diagnostics, presented material at workshops, conferences and professional meetings, performed Home Energy Rating Scores for several DOE demonstration houses, monitored field study houses, and are now offering a hands-on workshop for builders, designers, engineers and policy makers. We have also begun working on construction projects (Starting with Habitat for Humanity), making a list of energy tasks and explaining concepts to contractors, designers and subcontractors on the project. Three houses ReDAC worked on showed a 37% improvement in airtightness over

houses built in 1996. Working with Houston Habitat for Humanity on the Energy Affordable Home project, ReDAC put together specifications for equipment, materials, and assemblies. The affiliate has adopted about 85% of the specs as standard construction. This means a monthly savings of \$25-35 in utilities costs, money that can then go to the mortgage payment, which is important to developers of low-income housing.

2.0 INTRODUCTION

The United States' housing industry is undergoing a metamorphosis from hand-built to factory-built products. Virtually all new housing incorporates manufactured components; indeed, an increasing percentage is totally assembled in a factory. The factory-built process offers the promise of houses that are more energy efficient, of higher quality, and less costly. To ensure that this promise can be met, the U.S. industry must begin to develop and use new technologies, new design strategies, and new industrial processes. However, the current fragmentation of the industry makes research by individual companies prohibitively expensive and retards innovation.

This research program addresses the need to increase the energy efficiency of industrialized housing. Two universities have responsibility for the program: the University of Oregon (UO) and the University of Central Florida (UCF). Together, these organizations provide complementary architectural, energy, systems engineering, computer science and industrial engineering capabilities.

The research program focuses on three interdependent concerns: (1) energy use, (2) industrial process, and (3) housing design. Building homes in a factory offers the opportunity to increase energy efficiency through the use of new materials and processes, and to increase the value of these homes by improving the quality of their construction. Our work in housing design strives to ensure that these technically advanced homes are marketable and will meet the needs of the people who will live in them.

Energy efficiency is the focus of the research, but it is always viewed within the context of production and design. This approach enables researchers to solve energy problems in ways that can help industry improve its products. These improved products can help U.S. companies compete with foreign companies, which would alleviate the trade imbalance in construction products, increase the productivity of the U.S. housing industry, and decrease both the cost of housing and the use of fossil fuels, which are expensive and damaging to the environment.

3.0 DEFINITIONS

Of the many definitions currently used to describe industrialized housing, we have selected four:

- (1) **HUD code** houses (mobile homes)
- (2) **modular** houses
- (3) **panelized** houses (including domes, precuts, and log houses)
- (4) **production-built** houses (including those that use only a few industrialized parts).

These four definitions were selected because they are the categories used to collect statistical data, and so are likely to persist. However, the categories are confusing because they are based on a mix of characteristics: unit of construction (modular, panelized), method of construction (production-built), material (panelized), and governing code (HUD Code).

There are other ways to categorize industrialized housing, each of which provides a different perspective on the energy use. Japan and Sweden, for example, define industrialized housing in terms of corporate structure. Industrialized housing is equated with home building companies. These companies vertically integrate, or have under one roof, all or most of the housing process, including raw material processing, component assembly, house construction, installation, financing, marketing, and land development. This definition is useful because it addresses the extent of control a given company has over the design, production, and marketing of the house, and therefore over its energy use.

Other definitions can shed light on important aspects of industrialization and enable us to predict the impact of innovations, establish priorities for research activities, and identify targets for information. For example, industrialized housing can also be defined as to whether it uses open or closed systems. A closed system, which limits design alternatives, has the potential to benefit its supplier because it is exclusive. An open system, by contrast, is more tolerant of a wide range of designs and gives the home owner a range of component choices and the opportunity to purchase these components in a more competitive market place.

Other important ways of categorizing include 1) the level of technology used – high, intermediate, or low; 2) the percentage of value that can be supplied by the home owner, using sweat equity; 3) the physical size of the elements—components, panels, cores, modules, or complete units.

HUD Code Houses

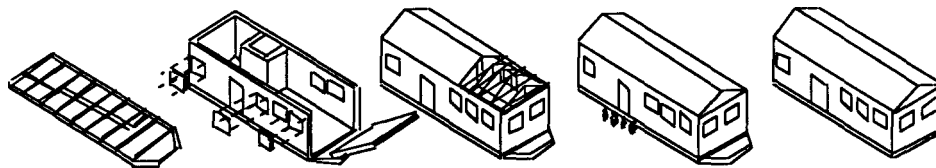

Figure 3 - 1, HUD Code House

A HUD code house is a movable or mobile dwelling constructed for year-round living, manufactured to the Manufactured Housing Construction and Safety Standard of 1974. Each unit is manufactured and towed on its own chassis, then connected to a foundation and utilities on site. A HUD code house can consist of one, two, or more units, each of which is shipped separately but designed to be joined as one unit at the site. Individual units and parts of units may be folded, collapsed or telescoped during shipment to the site.

Modular Houses

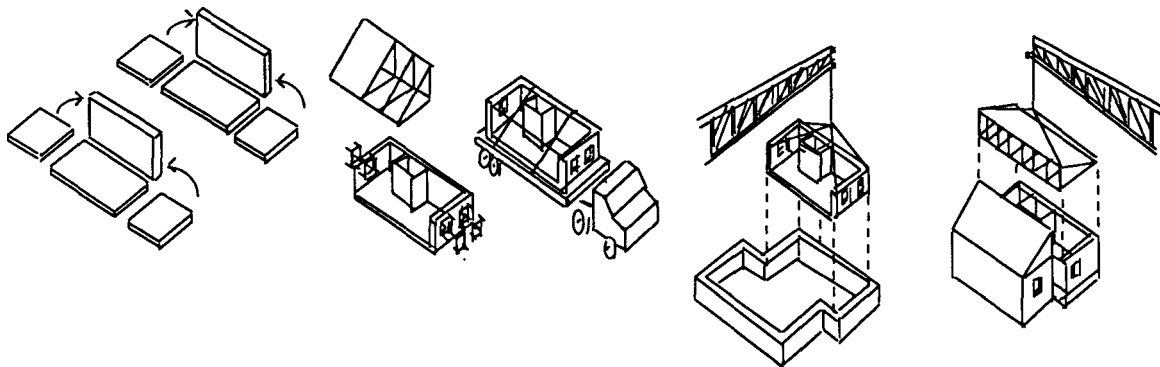

Figure 3 - 2, Modular House

Modular housing is built from self-supporting, three-dimensional house sections intended to be assembled as whole houses. Modules may be stacked to make multistory structures and/or attached in rows. Modular houses are permanently attached to foundations and comply with local building codes.

Panelized Houses

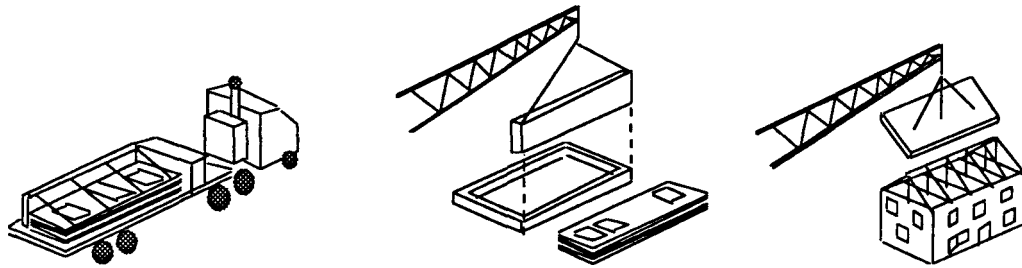

Figure 3 - 3, Panelized House

Panelized houses are whole houses built from manufactured roof, floor and wall panels designed for assembly after delivery to a site. Within this category are several sub-categories. *Framed panels* are typically stick-framed, carrying structural loads through a frame as well as the sheathing. *Open-framed panels* are sheathed on the exterior only and completed on site with interior finishes and electrical and mechanical systems. *Closed-framed panels* are sheathed on both the exterior and interior and are often pre-wired, insulated and plumbed. *Stressed-skin panels* are often foam filled, carrying structural loads in the sheathing layers of the panel only.

Production-Built Houses

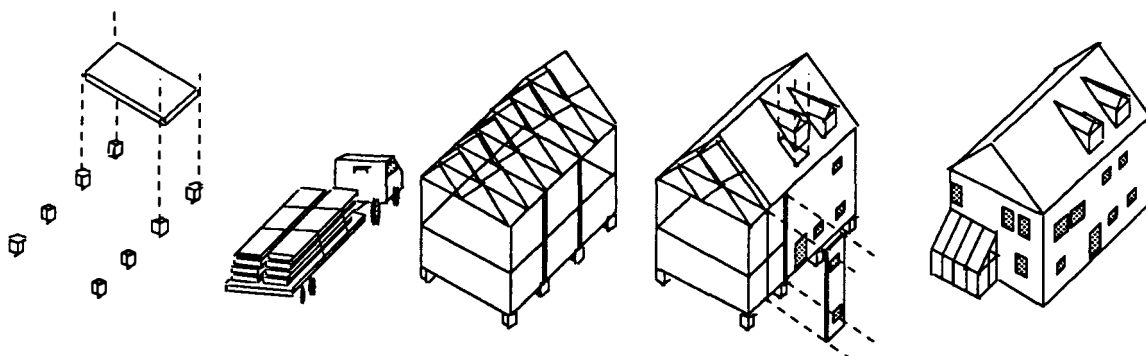

Figure 3 - 4, Production-Built House

Production building refers to the mass production of whole houses “in situ.” This large and influential industry segment is industrialized in the sense that it uses rationalized and integrated management, scheduling, and production processes, as well as factory-made components. In this instance, however, rather than the house being built in the factory and moved to the site, the building site becomes the factory – open-air assembly line through which industrialized labor and materials move.

This section describes three projects: the design of “Cascadia,” a prototype energy-efficient, entry-level house, the continued development of the on-grade panel floor/foundation system, and the development of fiber-reinforced gypsum board panel skins.

Design of Energy-Efficient, Entry-Level Housing – Cascadia

Drawing on experience gained from in building the Springfield Stressed Skin Insulating Core (SSIC) Panel Demonstration House in 1994, the University of Oregon developed designs for a set of prototypical energy-efficient, affordable houses. The objective was to develop an architecturally attractive entry-level housing system suitable for nonprofit housing developers such as the St. Vincent dePaul Society or Habitat for Humanity. These and other local nonprofit developers were brought into the design process during focus group meetings while the house design was in the development stages.

SSIC panels are an important energy saving technology. Compared to conventional stick framing, they offer greater thermal resistance by eliminating the thermal bridging caused by studs, and they more easily create airtight envelopes, which reduces infiltration. Other benefits include ease and speed of construction, the use of less framing lumber, and less construction waste due to their factory construction.

Nonprofit housing developers are often the last organizations to avail themselves of innovation in the market place. Since funding for low-income housing is very limited, nonprofit developers are drawn to projects that eliminate risk and reduce cost. By offering a very complete design package, and a variety of marketable schemes, we can allow nonprofit groups to build more energy-efficient housing without the associated risks and expense that normally prevent them from doing so. The occupants of the houses are ultimately the biggest beneficiaries since lower monthly energy costs will help them stretch their limited incomes. Also, with energy-efficient mortgage programs becoming more popular, people who normally would not be eligible for a house loan will now be able to qualify.

In the beginning of 1996 we finished the construction documents, which served as the core of the Cascadia Portfolio.

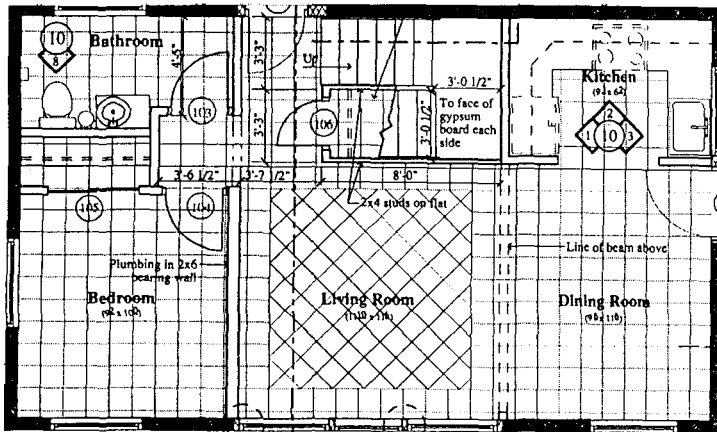

First Floor Plan

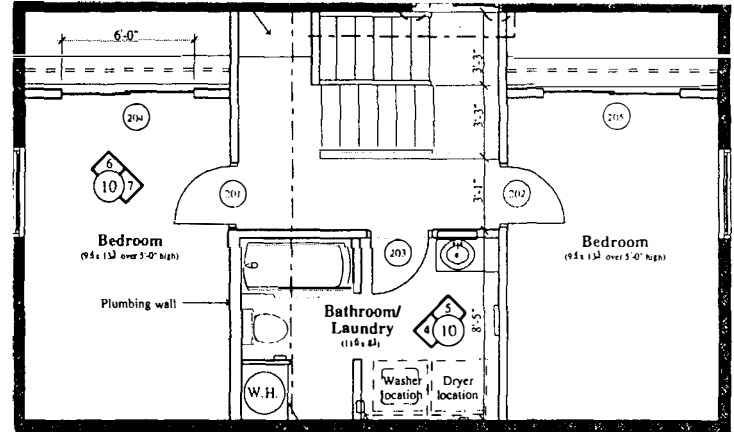

Second Floor Plan

Figure 4-1, Cascadia Floor Plans -- First and Second

Besides the construction documents, other important components of the portfolio are:

- Introduction - Contains siting guidelines to maximize the energy efficiency of Cascadia as well as increase owner and community satisfaction. Also included are energy performance calculations and cost estimates.
- Marketing - Rendered plan, elevation, and perspective drawings.
- Specifications - Complete specifications, which are important for occupant comfort and energy efficiency. In addition to the standard Cascadia specifications, an alternative set of "Green Specs" was developed to offer builders another level of environmental friendliness.
- Panel Layout - This helps the manufacturer produce shop drawings and the builder to understand how Cascadia is put together.

- Options - Detailed drawings for a number of options, including skylights, dormers, trellises, shades, and forced air heating.

Feedback on the portfolio's format and what information to include was solicited while the portfolio was in development. This was done by sending a mock-up of the portfolio to nonprofit developers and manufacturers, and by presenting it at the SIPA conference in Washington, DC. In its completed state, this portfolio now contains all the information that a developer needs to build a Cascadia home on virtually any site.



Figure 4-2, Cascadia Perspective

While final touches were being put on the portfolio, we made arrangements with Paul LaBerge at the Lawrence Berkeley National Laboratories (LBNL) to include LBNL's Integrated Window System as an option to further increase the efficiency and quality of the SSIC panel system being used in Cascadia.

The latter part of 1996 was devoted to marketing Cascadia. Our efforts included contacting over 40 nonprofit community development corporations (CDC's) in Oregon. In addition to phoning CDC's, we conducted television and newspaper interviews, submitted articles to various newsletters targeting the housing industry, and broadcasted information on the World Wide Web through links to our web site as well as announcements posted on other related sites. To aid in communicating the benefits of Cascadia and the SSIC panel system of construction, we compiled information on energy efficiency rebates for which a Cascadia home would be eligible and energy-efficient mortgage incentives. And we completed a detailed cost estimate and a comparison of Cascadia versus a comparable home built using conventional stick frame methods. In addition, we gave numerous presentations to nonprofits and governmental organizations of various levels.

This effort has generated considerable interest in Cascadia. Approximately 25 Cascadia homes are currently being considered for construction by 10 different organizations. These organizations are a mixture of nonprofit CDC's, for-profit developers and builders, and individuals interested in having a Cascadia home built for them.

We will follow up with the organizations that have already shown interest to provide them with needed site planning, training on the uses of panels in Cascadia, contacts with panel manufacturers, and any other technical assistance that may be necessary. Our region of focus for marketing will also be expanded to include Idaho and Washington.

As projects get built, video footage will be made of all critical procedures and reviewed as part of a detailed cost and construction analysis. Coheating and blower door tests will be done on the houses as a part of the energy analysis. Post-occupancy studies will provide additional input to ongoing design modifications. This research will be used to increase national exposure of the project.

On-Grade Insulated Panel Floor System

The objective of this task is to reduce floor and foundation costs, while maintaining energy and structural performance, through development of an on-grade insulated panel floor system.

The current design, shown in figure 4-3, was used as a base for a prototype floor that was built in June 1996.

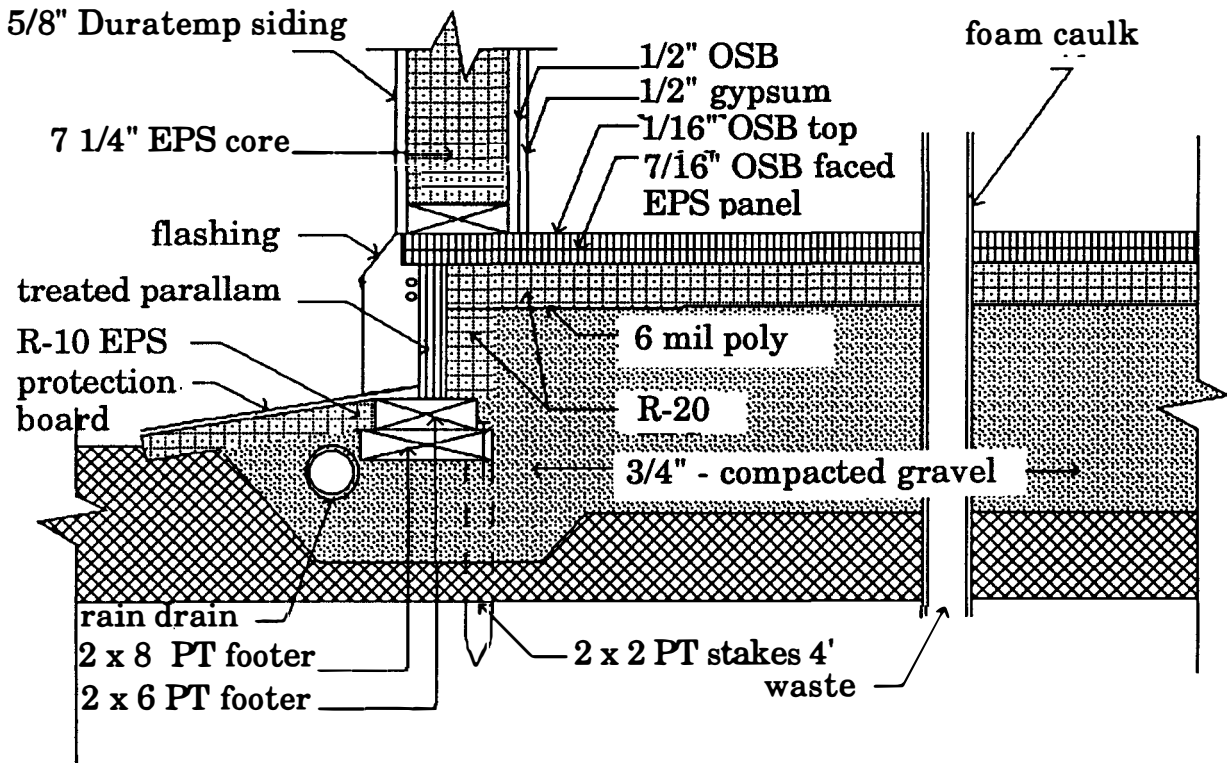

Figure 4-3, On-Grade Panel Floor Design

The prototype floor, 20' by 36', was tested for structural performance and the measured deflections were much less that expected. Seven different tests were performed including distributed load, dynamic load, interior partition, end partition, interior post, exterior post, and exterior panel wall tests. The location of the tests is shown in figure 4-4.

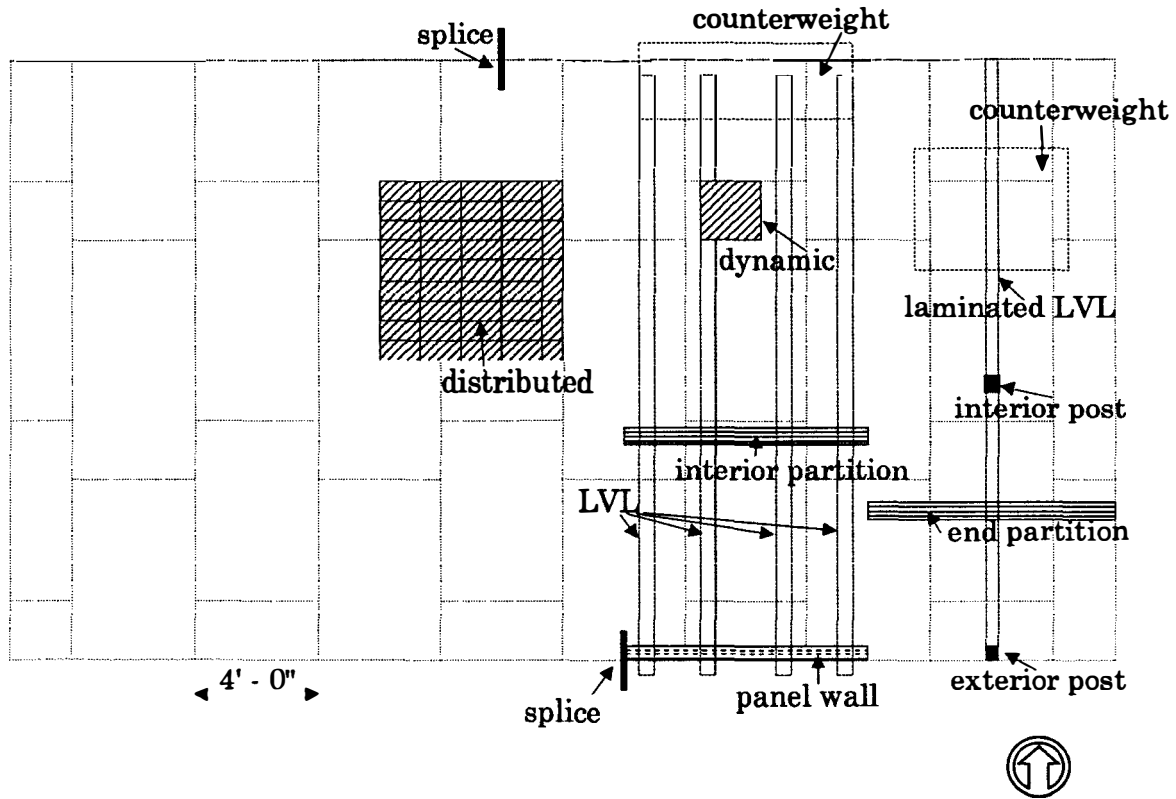

Figure 4-4, On-site Testing Layout

The exterior panel wall load provided the largest deflection, 0.65 inches at a load of 1446 lbs/linear foot. The graph in figure 4-5 shows the distribution of the deflection. Interior loads caused smaller deflections suggesting the floor could withstand bearing loads on interior locations.

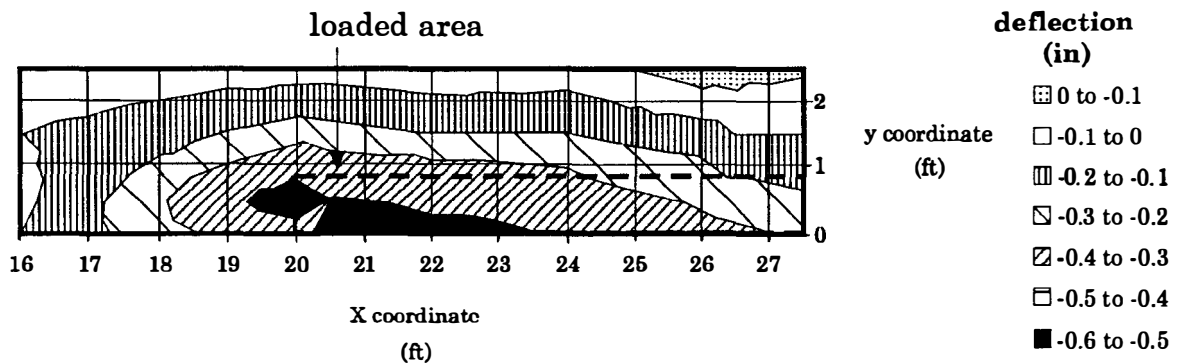

Figure 4-5, Exterior Wall (SSIC Panel) Deflections at 1446 lbs/linear foot

The initial prototype floor provided insight into design, constructability, and performance.

Current work is focusing on gathering additional structural performance, thermal performance, and creep data for additional design variables. The structural performance is being tested in a laboratory setting under controlled conditions. A second prototype floor will be built to test thermal performance. Smaller floor sections will be tested locally for creep reactions.

We have continuing support from our industry partners, Trus Joist MacMillan and AFM Manufacturing and will keep them informed of our findings and developments.

Fiber-Reinforced Gypsum Board Skins for SSIC Panels

Our objective for this task is to reduce the cost of SSIC panels yet maintain or enhance thermal and structural performance by developing alternative skin materials.

In the past we received direction from an industry group of panel manufacturers, suppliers, architects, engineers, and housing developers that the development of structural panel skins that could also function as finish surfaces had the potential to reduce panel costs. We evaluated many materials against structural, manufacturing, fire, and cost criteria and decided to pursue fiber-reinforced gypsum board as an interior skin and structural panel siding for the exterior.

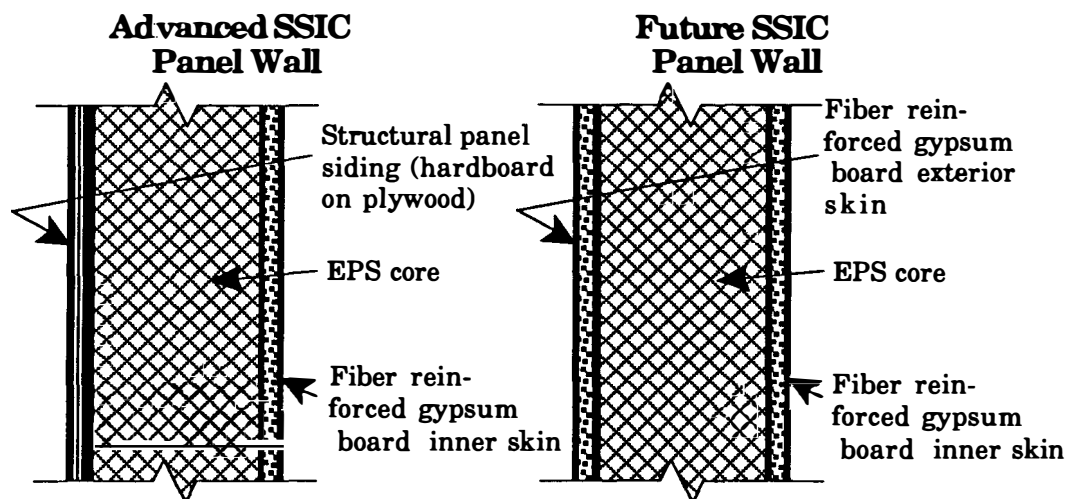

Figure 4-6, SSIC Panel with Fiber Reinforced Gypsum Board Skins

In 1996 we worked with the Fiber Reinforced Gypsum Board Panel Consortium (W.H. Porter, Inc., Fischer Corporation, and PFS Corporation), completing transverse, axial, and racking shear load tests for several panel configurations and developing preliminary transverse load charts. We interpreted these test results and outlined additional tests that we believe are necessary.

We explored additional materials for panel skins, including fiber-reinforced gypsum board on both sides and cementitious boards manufactured by U.S. Gypsum. We also tested a number of spline systems. Our interest in splines includes designing a system that is easier to install and saves labor cost, and matching splines to panel type to achieve optimum structural performance.

Further tests are underway to determine the range of applications of the innovative panels. Tests will also be conducted for code approval. We will continue working with W.H. Porter and U.S. Gypsum to design, test, and evaluate alternative SSIC panels. We will work with the Building America program in its research on alternative wall construction systems for second generation Building America houses.

We expect to reduce the cost of SSIC panel systems by 15%. By developing new panel types and applications and reducing costs, we expect that the sales of SSIC panels will increase.

Innovative Building Components Development

We have three innovative building components under development. The component we started with first is turning out to be a great success. This is the fan recycling control, which is used with central heating and cooling systems to improve indoor air quality and thermal comfort in housing. The control has received positive industry recognition and is being used by national production builders in the U.S. DOE Building America Program as a key element of their whole house ventilation system. A patent was received in 1996 (U.S. Patent 1996), and two industry license agreements were signed in early 1997. Figure 4-7 is a photograph of the control installed on an air handling unit. The control has two user selectable delays; one which governs the time the fan will stay off if there is no call for heating or cooling, and one which governs the time the fan will operate

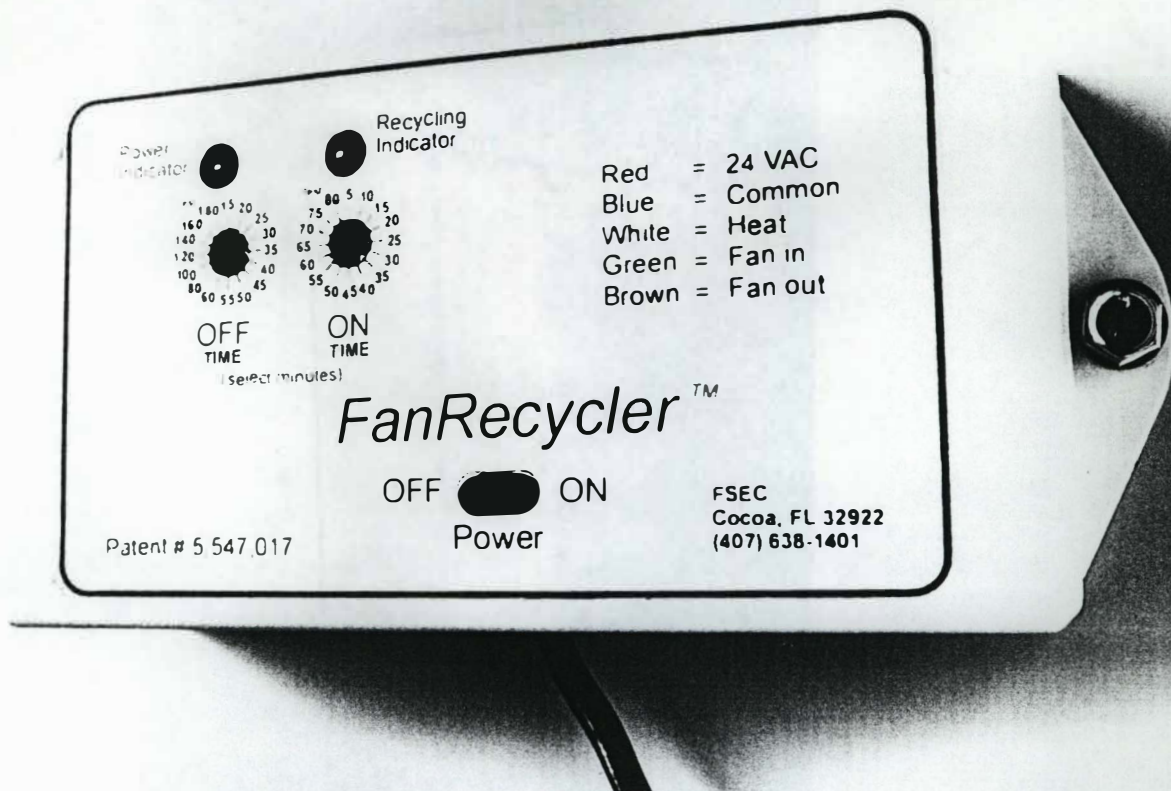

Figure 4-7, Photograph of the patented *FanRecycler* control which allows energy efficient use of a central system air distribution fan and ducts to fully distribute ventilation air, and to improve indoor air quality and thermal comfort.

in fan recycling mode. A report on the fan recycling control specifications, production cost, and marketing potential was completed (Raymer 1997).

The second component is really a set of innovative building components addressing the problem of high thermal conductivity in residential steel framing. They are various configurations of thermally broken steel framing members. A patent application was filed (U.S. Patent Application 1996). Structural and thermal testing has been conducted by independent testing laboratories (Moyer and Rudd 1996, Kosny et al. 1997). A number of structural tests have shown that the novel FSEC components can be a one-to-one substitution for conventional steel framing, while a series of thermal tests have shown an overall energy performance improvement of about 34%. Figure 4-8 shows the guarded hot box test apparatus at ORNL used for the thermal testing of our 8'x8' wall assemblies.



Figure 4-8, FSEC metal-wood wall installed in guarded hot box test facility at ORNL for thermal testing.

A comparison of the framing loss effect for walls constructed with 2x4 wood, FSEC metal-wood studs, and steel studs is given in figure 4-9. Our metal-wood stud performs nearly as well as wood, thermally, but with greater strength characteristics. Several large companies in the steel industry have expressed interest in the technology being developed and our goal is to have a licensee on board within the next year.

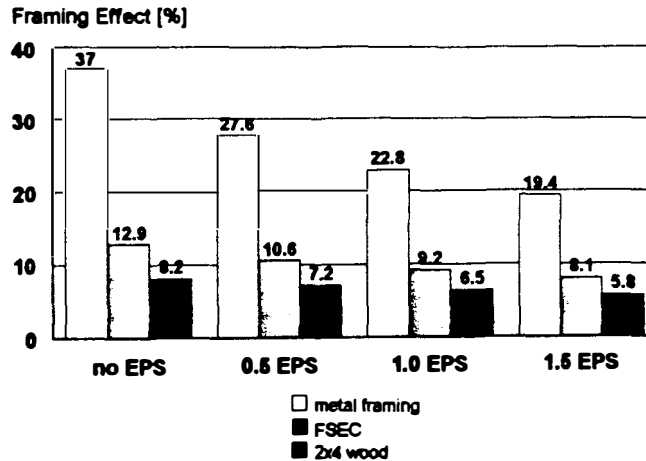

Figure 4-9, Framing loss effect for FSEC metal-wood framing compared to conventional metal framing and 2x4 wood; FSEC metal-wood framing performs nearly as well as wood.

The third component, a connector or clip for fastening structural insulated roof panels, was tested for structural load capacity by an independent testing laboratory (Gatland and Rudd 1996). The panel connector exceeded by three times the withdraw capacity of the screw that the industry presently uses. This indicated that the spacing of panel connectors could be increased, reducing the total number needed. Several different configurations of the component were field tested at the re-building of the house that was constructed for the 1997 NAHB Builder's Show in Houston (Rudd 1997a). Important lessons were learned from the field trials. Problems in using the connector were encountered due to: 1) site conditions such as overhanging trees and wind, 2) over- or under-sized panels, 3) internal framing that didn't fit well used to join and support panels, 4) the lack of ladders or scaffolding on site. All of these problems encountered would be eliminated in a factory production environment. For that reason, we are working with present efforts to utilize structural insulated panels in manufactured or modular housing plants.

5.0 INCORPORATION OF ENERGY ANALYSES INTO CAD SOFTWARE

The objective of this task was to develop an energy analysis program that would encourage architects, builders, and housing manufacturers to improve the energy efficiency of their buildings. In order for these kinds of designers to readily attempt energy-efficient designs, several things must be possible:

1. The analysis must be done early enough that design changes are still feasible.
2. The energy program should work within the user's normal design environment.
3. Accurate data about the building should be available.
4. The interface should be easy to use, highly visual, and non-technical with respect to energy.



Figure 5-1
Softdesk/Trane Toolbar Icons

These objectives were met by the development of Softdesk Energy, an energy analysis program that works within AutoCAD and Softdesk's Auto-Architect. It is now being distributed as a standard part of the Auto-Architect software. The vehicle for this project was a collaboration between industry, government, and academia, represented respectively by Autodesk (formerly Softdesk), in Henniker, New Hampshire; Pacific Northwest National Laboratory (PNNL), in Richland, Washington; and the University of Oregon. The Collaborative Research and Development Agreement (CRADA) was signed by the three groups in late 1992 and has been continued annually since.

Many architects, particularly those in larger firms, hire mechanical engineering firms or sub-contractors to do their energy analysis. Many of these energy specialists use a tool such as the Trane Corporation Load Design 700 software package to specify and size the HVAC (Heating, Ventilation, and Air Conditioning) equipment. In order for us to fully meet objective 2 (above) for these

users, it is important that our product work seamlessly with both the architectural design environment and the HVAC design environment. The addition of Trane Corporation to our CRADA team has enabled us to meet this expanded objective with the new version of our product, called Softdesk / Trane Energy.

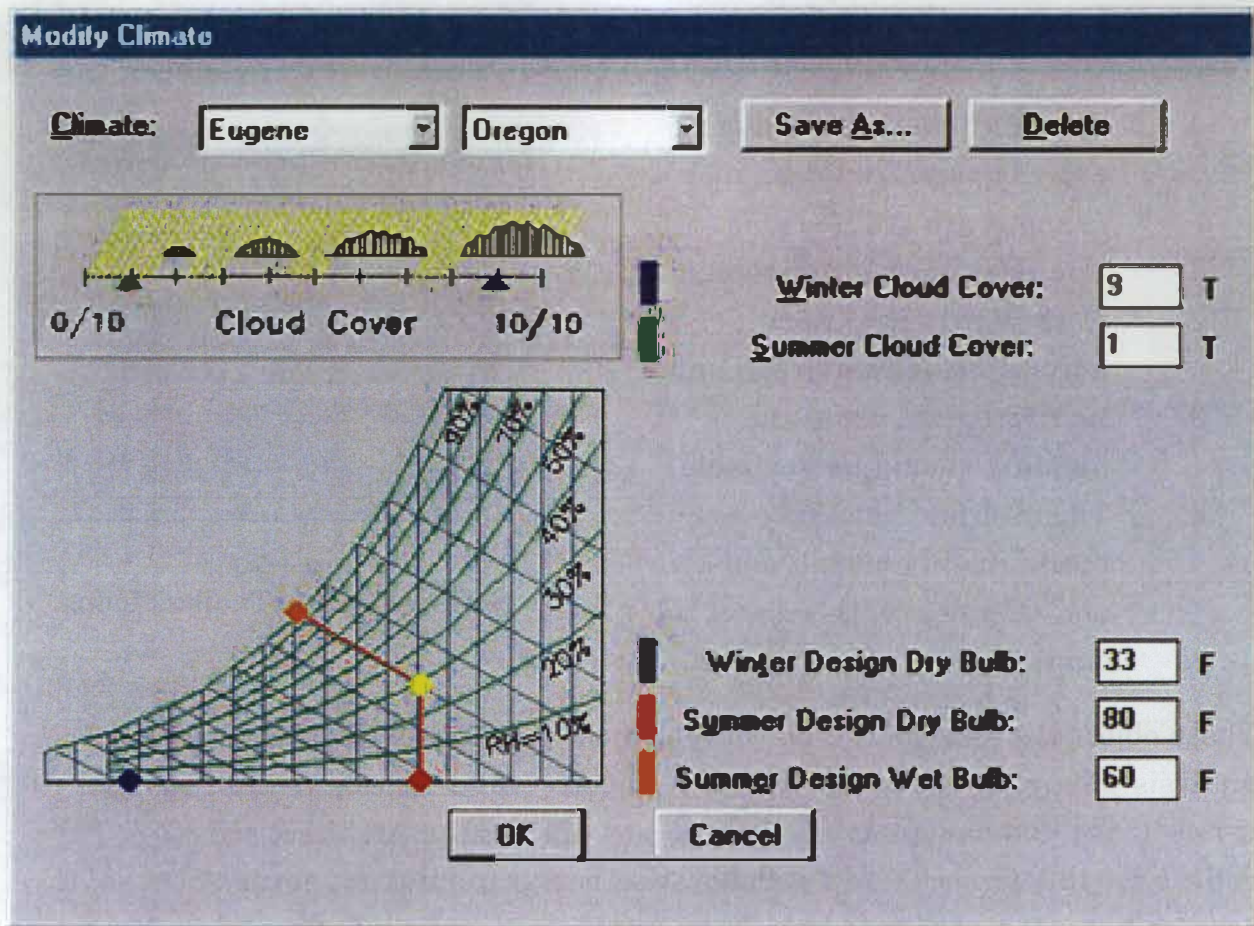

Fig 5-2, Climate Input Screen with psychrometric chart illustrating the relationship between humidity, dry bulb and wet bulb temperatures.

The new interface developed for this product continues the principles of clear visual presentation of material that were developed in the last product. Each screen presents information graphically and numerically. We strove to make each screen clear and distinctive while using a familiar and predictable style throughout.

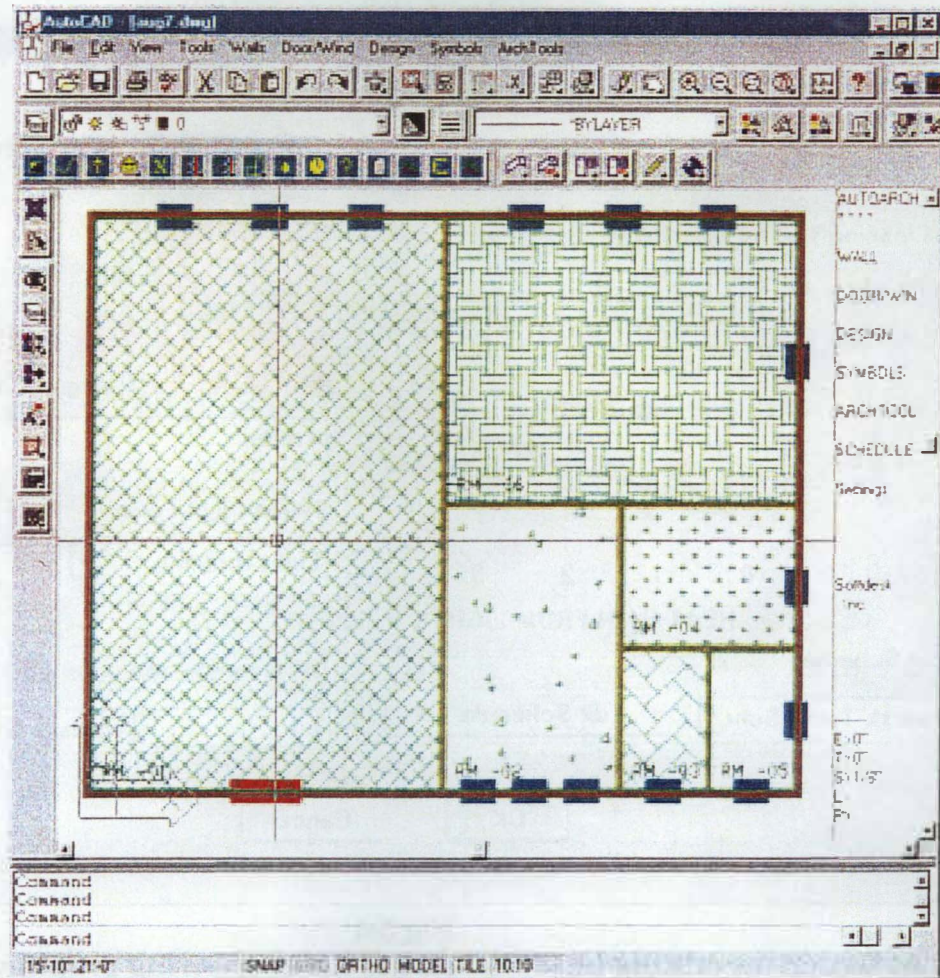

Fig 5-3, Completed geometric interpretation of interior spaces showing a different hatch pattern for each space found in the building.

Softdesk/Trane Energy expands the earlier product in three significant ways:

1. automatic **geometric interpretation of the interior spaces** in addition to the exterior envelope;
2. more **detailed specification** for materials and building usage for each space of the building;
3. **automatic export** of geometric and numeric data to Load Design 700.

Geometric interpretation of interior spaces

This capability becomes essential when analyzing large or complex buildings for HVAC selection. Simple energy analysis of the exterior of the building is adequate for design of the architectural form, but engineers need to divide the building into zones in order to fully characterize the requirements of a complex HVAC system.

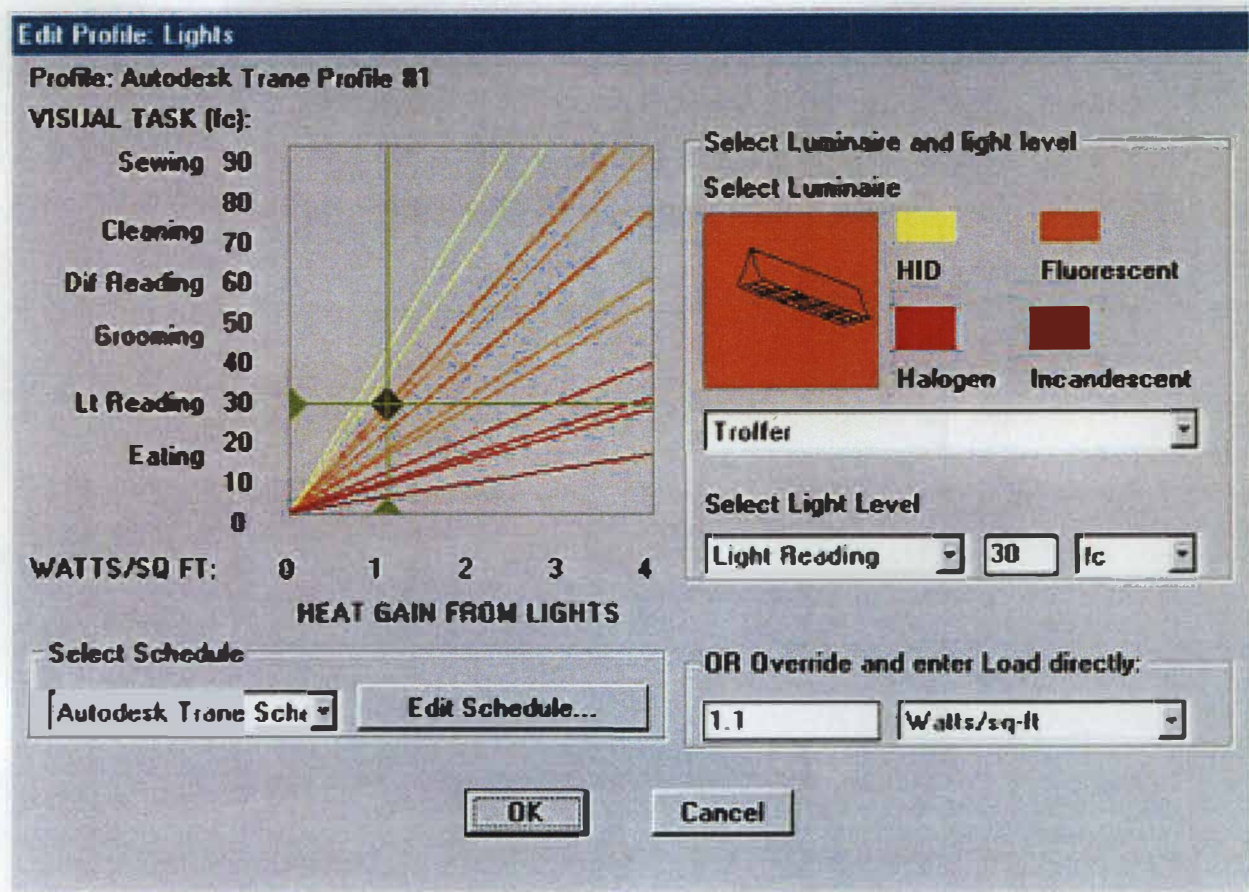

Fig 5-4

Input screen for editing heat load due to lights showing graphical input for numeric parameters. The graph at left shows the relationship between light output and heat output for different families of luminaires.

Softdesk / Trane Energy automatically divides the building into HVAC spaces based on interior walls: each physical room becomes an HVAC space. The user can then group or split these primary spaces to form larger or smaller HVAC spaces that will be useful for zone analysis. Lengths, widths, areas and volumes are calculated by the program and are available to the designer for each defined space.

Detailed Specification

We worked closely with mechanical engineers to determine the level of specification that they wanted to be able to use. We also worked closely with Trane to match their capabilities and in some cases asked them to add data we found to be important. The initial geometric interpretation of interior spaces provided the

capability of easy point-and-click specification for materials, occupancy, lighting, equipment, ventilation and infiltration, and thermostat for each space in the building. For example, one space can be designated an aerobics room at 60 degrees with 10 people per 100 square foot putting out 1000 BTUs/hr-sq-ft each from 6 a.m. to 10 p.m. while another is an office at 68 degrees and .5 people per 100 square foot expending 300 BTUs/hr-sq-ft each from 8 a.m. to 5 p.m.

Material specification has been greatly enhanced in this version since engineers get more accurate results if their material specification is accurate. Each wall, for example, can be made of up to 4 layers of materials with nearly 50 choices of material for each layer. Over a dozen common compositions are provided for the user, and the user can also create his own from the materials available. Similar capabilities are available for roofs, floors, windows and doors.

The choice of lighting fixtures has also been expanded to 14, including common fluorescents, compact fluorescents, halogens, and incandescent fixtures.

Automatic Export

Trane engineers were very interested in the automatic generation of areas and volumes of interior spaces. On a single building they will typically spend hours generating a list of spaces and calculating their sizes from the architectural drawings. By exporting this geometric information from Softdesk/Trane Energy directly into Trane Load Design 700, they save hours of work and prevent many calculation errors. The export function will also transfer all specifications for each space enabling the engineer to specify from within Softdesk/Trane Energy in a point-and-click CAD environment rather than from the list and spreadsheet environment available with Load Design 700.

Softdesk/Trane Energy is nearly complete. The interface itself is complete and undergoing testing. The export function, which had to wait for Load Design 700 to enter beta test, is now in design.

6.0 MANUFACTURING PROCESS AUTOMATION AND SIMULATION

Building Component Testing and Manufacturing Evaluation

The objective of this task is to support FSEC in designing and testing innovative building components to improve their manufacturability and constructability. In FY96 the UCF research team contributed to two component design efforts: a thermally broken steel-wood framing member and a connector for fastening structural insulated roof panels. Most FY96 efforts focused on the connector. The UCF team made several significant contributions to the connector design. Using results from a manufacturing process model and a product cost model, the team recommended design improvements which reduced the number of components by one-half and decreased manufacturing costs by 62%. Prototypes of the revised design were produced and used in construction of a test house in Houston, Texas. Results are summarized in a "Draft Report: Field Testing of Novel SIP Roof Panel Connectors" by Armin Rudd, March 19, 1997. Monitoring results indicated that the refined design was also considerably easier to use in the construction process.

Technical Assistance to Housing Manufacturers

The objective of this research task is to improve the productivity of industrialized home builders using industrial engineering technologies. Industrialized home builders face a growing productivity challenge. Housing market demands for unique, custom home designs have negated many of the traditional benefits of factory construction. Instead of building hundreds or thousands of the same component, factory home builders find themselves producing far less. The truss industry provides an excellent example. Market demand for increasingly sophisticated roof profiles has led to a proliferation of truss designs. Industry statistics suggest that the average new house is constructed with 90 trusses representing 30 unique truss designs (an average of only three trusses per design). Powerful CAD systems now enable manufacturers to quickly develop the complex, high quality truss designs demanded by the market. However, few technologies contribute to productivity on the truss factory floor. Flexible manufacturing, enabling efficient production of small volumes, is still in its infancy. The result is that truss manufacturing more closely resembles stick-building than high efficiency factory production.

To address these complex issues, UCF researchers teamed with MiTek, a leading supplier to the truss industry, and with Glaize Components, a manufacturer of wood-frame home building components. MiTek provides truss plates, CAD/CAM systems and truss manufacturing equipment to truss manufacturers like Glaize. The specific objective of this research effort is to explore the integration of manufacturing simulation with CAD software and its potential impact on manufacturing productivity. The vision is to use detailed truss design data developed by a CAD system (representing actual customer orders) to drive a simulation model of the factory floor. The model is used to estimate factory performance under various scheduling and staffing scenarios. Model output takes several forms including a working animation of the factory (Figure 6-1)

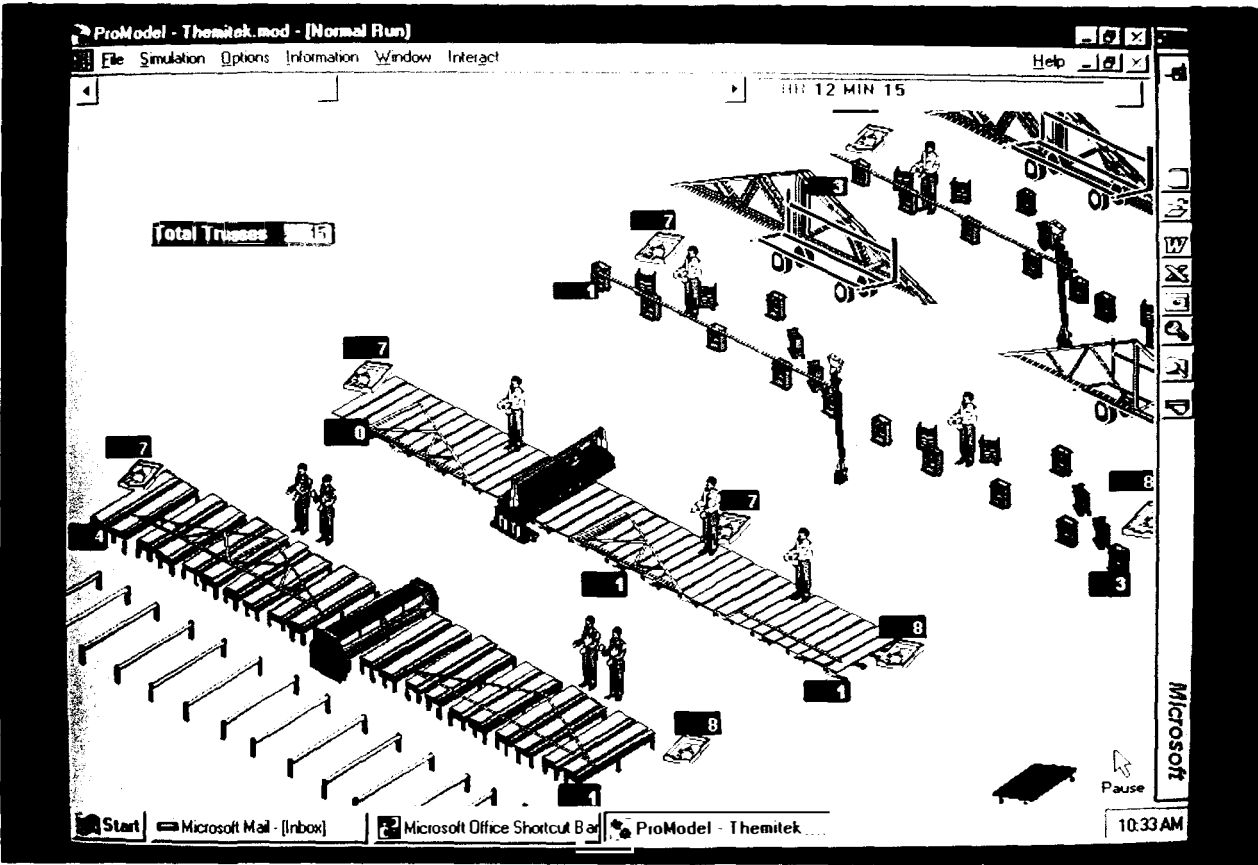

Figure 6-1, Typical Animation Screen for Truss Manufacturing Simulator

Job	Truss	Qty	Setup Start		Setup End		Setup Duration	Process Start		Process End		Process Duration	Total Duration
			Day	Time	Day	Time		Day	Time	Day	Time		
5893	101	6	1	11:16	1	12:06	19.2	1	12:06	1	12:56	50.4	69.6
5893	102	1	1	12:56	1	13:23	12	1	13:23	1	13:41	17.3	29.3
6231	103	10	1	13:41	1	14:00	19.2	1	14:00	1	15:00	60	79.2
6231	104	1	1	15:00	1	15:12	12	1	15:12	1	15:36	23	35
5677	105	9	1	15:36	1	15:52	16.8	1	15:52	1	8:44	81	97.8
5677	106	2	2	8:44	2	8:46	2.4	2	8:46	2	9:27	20.4	22.8
6678	107	9	2	9:27	2	9:55	28	2	9:55	2	11:06	70.2	99
6678	108	1	2	11:06	2	11:13	7.2	2	11:13	2	11:20	6.6	13
5445	109	1	2	11:20	2	12:02	12	2	12:02	2	12:27	24.5	36.5

Figure 6-2, Typical Production Schedule Produced By Truss Manufacturing Simulator

and a detailed schedule of expected production events (Figure 6-2). Truss manufacturers can use the model to plan daily operations, develop production expectations for each machine (based on these plans) and communicate these expectations to the factory floor.

The UCF research team developed a working simulation model of the Glaize truss plant and refined the model based on recommendations from MiTek. The research team is currently awaiting MiTek’s completion of the interface with its CAD system. Upon completion, the model will be tested by Glaize in an actual production environment.

In a related effort the UCF research team continues to support housing manufacturers as they introduce innovative flexible manufacturing technologies. The UCF team developed a conceptual simulation model (Figure 6-3) for BuildTech to assist in visualizing the operation of a new flexible wood-frame panel manufacturing system.

Research results were exhibited at the 1996 Building Systems Council Showcase in St. Louis. Detailed results were also presented to Basic Automation, a U.S. producer of manufacturing equipment and CAD/CAM software for panel

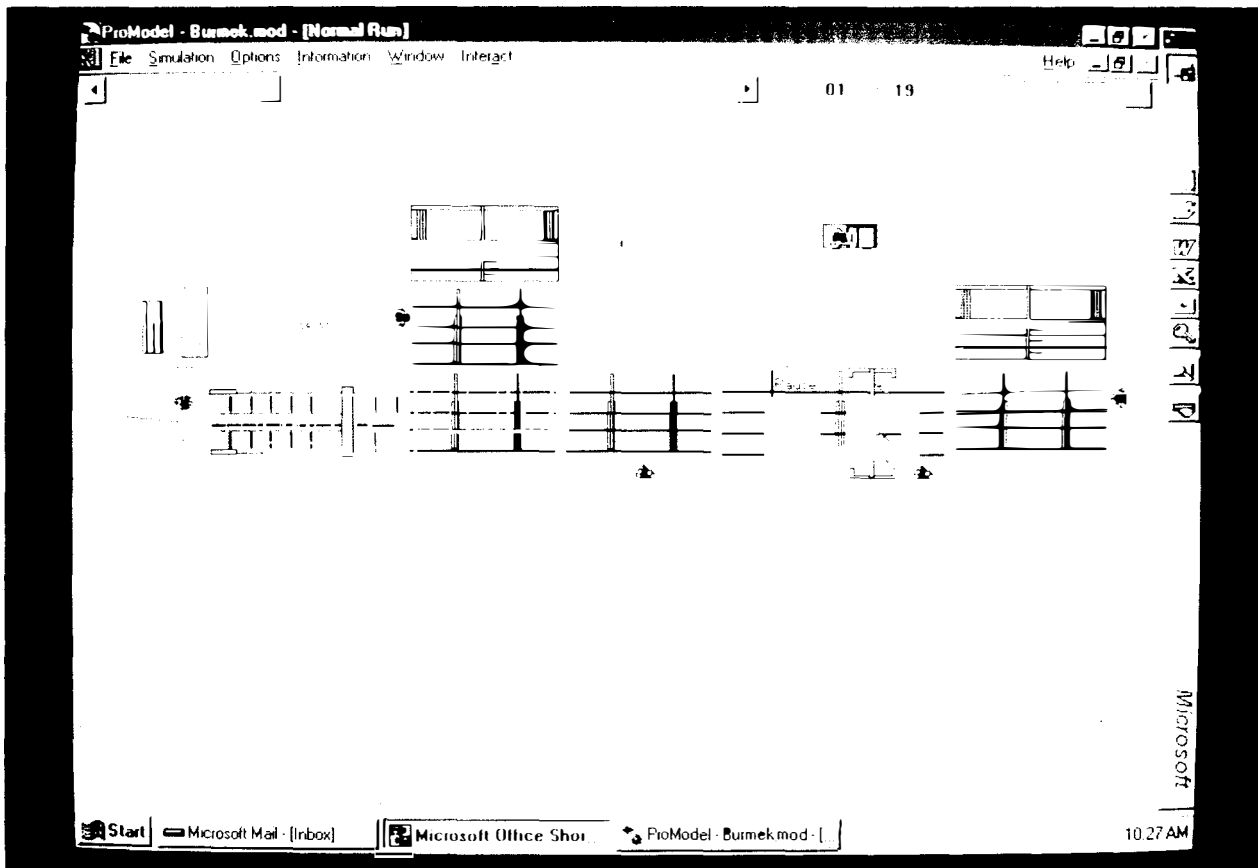

Figure 6-3, Typical Animation Screen for BuildTech Panel Manufacturing Simulator

manufacturing. The supplier envisions simulation as a tool to facilitate the introduction of their advanced manufacturing technologies. The UCF research team continues to believe that suppliers of advanced process technologies are the most likely vehicle for transitioning simulation technologies into the industrialized housing marketplace. Research results were also presented to the American Council for an Energy-Efficient Economy and the International Symposium of Automation and Robotics in Construction.

7.0

FIELD TESTING OF WHOLE HOUSES AND COMPONENTS

Health House® Testing and Research

The Health House® is a consumer education demonstration house project developed by the American Lung Association (ALA) Minneapolis affiliate. Health Houses® are constructed by local ALA affiliates and we provided technical assistance to the houses. Health Houses® showcase ways to simultaneously improve the energy efficiency and the indoor air quality (IAQ) in houses.

In the fall of 1996 four Health Houses® were completed in which we were involved. Figures figure 7-1 through figure 7-4 show these houses located in the cities of New Orleans, La; Huntsville, Al; Birmingham, Al and Jacksonville, FL. Another Health House® was built in the Minneapolis area without our involvement and is not reported here. Figure 7-5 shows some of the characteristics of these homes. As the table shows, a variety of construction and mechanical systems were used in these houses. The attendance numbers testify to the success of these demonstration homes.



Figure 7-1, The 1996 New Orleans Health House®

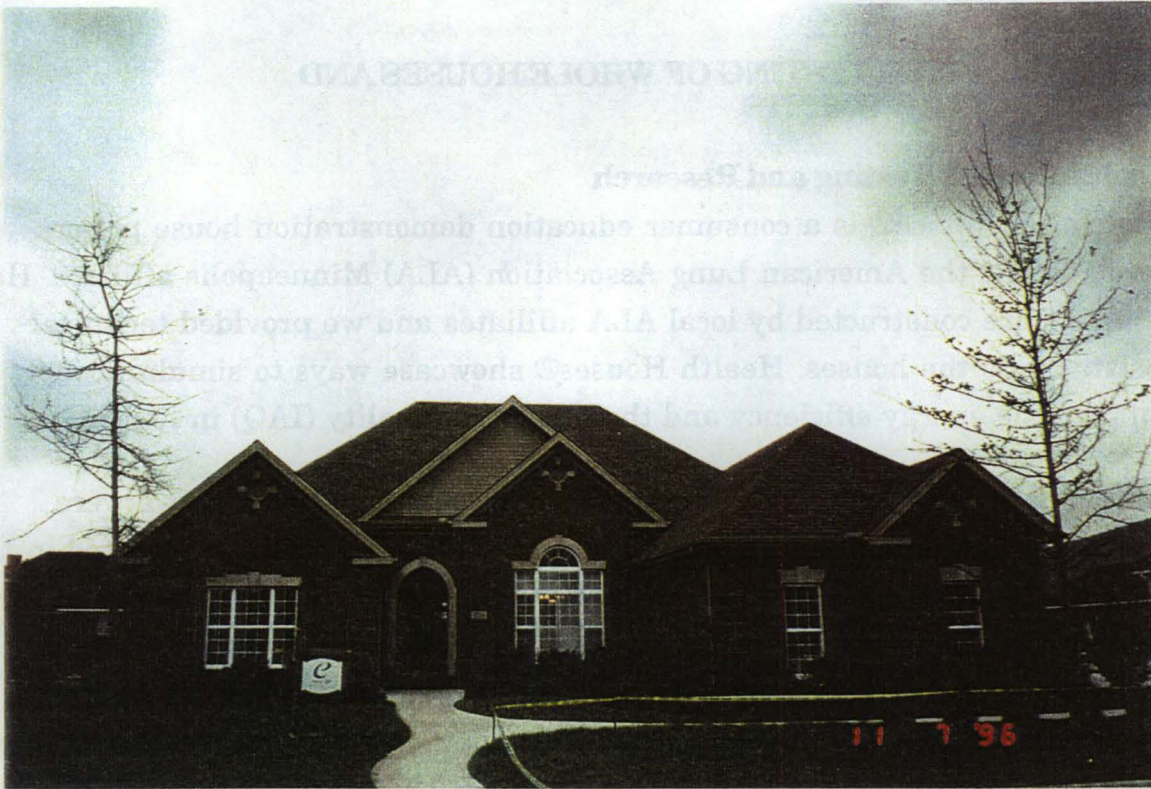

Figure 7-2, The 1996 Huntsville Health House®



Figure 7-3, The 1996 Birmingham Health House®



Figure 7-4, The 1996 Jacksonville Health House®

Three of the four homes (in New Orleans, Jacksonville and Huntsville) are being monitored for energy use, environmental conditions and dust mite levels. Results to date indicate that none of the three homes have significant levels of dust mite allergens.

One year of monitoring was completed for the 1995 Health House® in Orlando. The energy performance of this home was excellent. The measured heating, cooling, ventilation and water heating load was about 47% better than the reference case home. However, the dust mite levels and volatile organic compound levels were not as low as desired. The dust mite levels were high possibly due to the absence of a central vacuum cleaner. The VOC levels were elevated possibly due to extensive use of laminated and composite wood products for flooring and built up areas.

General

	New Orleans	Jacksonville	Birmingham	Huntsville
Location	New Orleans	Jacksonville	Birmingham	Huntsville
State	LA	FL	AL	AL
Open House	9/27/96	10/19/96	9/7/96	10/13/96
Dates	-10/13/96	-11/03/96	-9/29/96	- 11/10/96
#Visitors	2,000+	1,600+	4,500+	4,000+

Construction

#stories	3	1	2+bsmnt	1+bonus
Cond. Area	3,900	2,370	3,160	2,880
Foundation	slab on piers	slab on grade	Basement	Slab on grade
Slab Insulation	No	Yes	Yes	Yes
Walls	Insulated Concrete Form	Frame 2x4	Insulated Concrete Form	Frame 2x6
Roof	Rafters	Truss	Rafters	Rafters
Central Vacuum	Yes	No	No	Yes

Mechanical System

Cooling Load, Tons	5.0	3.0	4.8	4.0
Heating Load, Kbtu/h	61.3	26.7	40.7	37.7
# of Airhandlers	3	1	2	2
System Type	Geothermal HP	Heat Pump	Heat Pump	Heat Pump
Mechanical Vent	Yes	Yes	Yes	Yes
Vent Cfm	200	80	80	80
Central Dehum	No	Yes	Yes	Yes
Filtration	2" Pleated	HEPA + Chemical	4" Pleated	6" Pleated
Duct trunks	Coated Fiberglass	Metal	Metal in Bsmt Lined fibergl in attic	Metal
Duct Runouts	Flex	Flex	Metal/bsmnt	Flex/attic
Return system	Jump ducts	Ducted	transfer grill + ducts	trasfer
Water Heating	Heat Recovery	Solar	Heat Recovery	Heat Recovery

Measured Data

House leakage	4.8ach50	5.4ach50	6.9ach50	6.7ach50
Duct Leakage, Total	384	242	n/a	n/a
to outside, cfm	188	71	288	278

Figure 7-5, The 1996 Health Houses®

Whole House Testing and Research

A computer modeling study (Rudd 1996) was performed to determine the effects of sealed residential attics, in hot climates, on space conditioning energy use and roof temperatures. The one-dimensional, finite element computer model contained an attic model developed and validated at FSEC. Empirical modifications were made to the attic model to provide better alignment with measured ceiling heat flux reductions of ventilated attics with respect to sealed attics for summer peak days from three roof research facilities. Annual and peak cooling day simulations were made for the Orlando, Florida and Las Vegas, Nevada climates, using a 139 m² (1500 ft²) slab-on-grade ranch style house with wood frame construction. Results showed that, when compared to typically vented attics with the air distribution ducts present, the sealed "cathedralized" attic (i.e. sealed attic with the air barrier and thermal barrier [insulation] at the sloped roof plane) can be a good way to minimize or eliminate attic moisture accumulation potential in hot-humid climates, without an energy penalty. In addition, use of the sealed "cathedralized" attic in hot climates can be a successful approach to avoiding pervasive problems associated with ducts located in attics and air tightness at the ceiling level, without energy penalty. Figure 7-6 gives a summary of the observations from the hourly simulations for Orlando, Florida.

Orlando, Florida	
Simulation Description	Observations Of Results
Reference case	<i>(R-19 ceiling, 1:300 attic vent., ducts in attic, no duct leakage, R-11 walls, single glazing)</i>
White tile, sealed R-28 sloped	Excellent for cooling and heating
Sealed R-28 sloped	Good for cooling, excel. for heating, excel. for balanced peak load reduction if using heat pump
White tile, sealed R-19 sloped	Excellent for cooling, good for heating
White tile	Excellent for cooling, costs for heating due to loss of solar gains, net positive benefit
Ducts in conditioned space	Always good
Sealed R-19 sloped	A little worse for cooling, good for heating, better overall than reference case, essentially the same as placing ducts in conditioned space or 1:37 attic ventilation
1:150 attic vent	Very little net difference from 1:300 reference case
Sealed R-28 flat	Costs on cooling, saves on heating, nets essentially the same as reference case
Sealed R-19 flat	Would only do this if moisture problem remediation was more important than energy use

Figure 7-6, Observations of Annual Simulation Results for Orlando

Energy use and indoor air quality monitoring was completed for two structural insulated core panel (SIP) houses that were nearly identical but located in different parts of the country. The SSIC Demonstration House in Springfield, Oregon and READ Project house in E. Lansing, MI had very similar heating energy use requirements when the data was normalized for the actual inside to outside temperature difference and for the difference in floor area due to one house having a crawl space and the other having a well insulated basement. The heating requirements were not only similar, but also very low. In both houses, mechanical ventilation was used according to the occupants preference. Both houses were very airtight and tended to have carbon dioxide concentrations above 1000 parts per million during the heating season, indicating that the ventilation systems could have been operated at a slightly higher flow rate, or more often. Figure 7-7 shows a comparison of the temperature-difference- and floor-area-normalized heating energy use for a typical heating day for each house. The spike between 5-9 am for the Michigan house was due to an occupant lifestyle difference in the operation of the heating system. They allowed the interior temperature to dip further at night, then raised the thermostat sharply in the early morning.

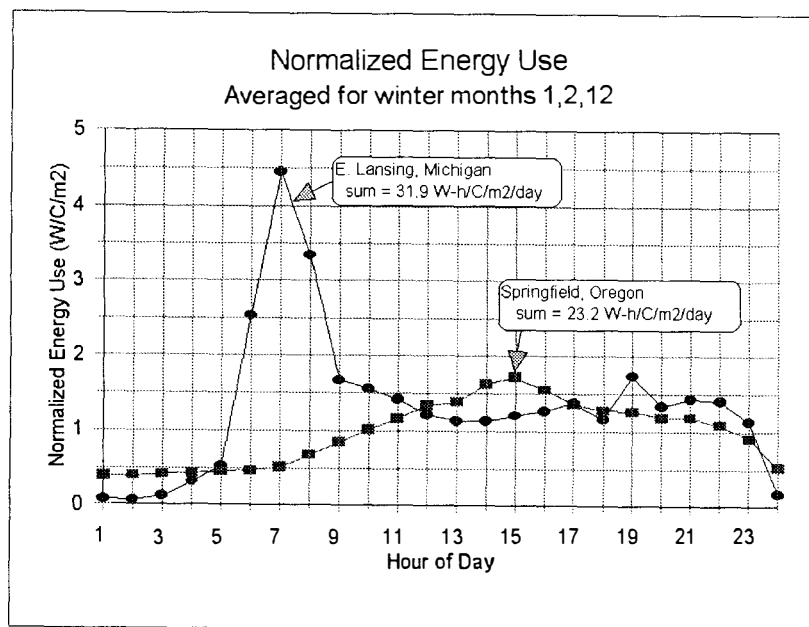

Figure 7-7, Temperature-difference and floor-area-normalized heating energy use, averaged by time of day for January, February, and December 1996, for two structural insulated panel houses.

Through collective meetings and discussions with a solar photovoltaic manufacturer, an electric utility, a housing manufacturer, and Sandia National Laboratory personnel and contractors, we established the groundwork for a collaborative effort to investigate the use of roof-integrated, utility- interactive photovoltaic power systems installed on manufactured housing. While additional funding is being sought from other sources to fuel this project, we have generated the first stages of enthusiasm for industry cooperation in this area.

Manufactured Housing Ventilation Systems

Two new manufactured houses (HUD Code) were tested, then monitored for one year to evaluate the ventilation system and space conditioning energy performance. Results from this testing and monitoring identified a short-coming in the design methodology for the supply ventilation system that was being used in most manufactured housing. This popular supply ventilation system used an

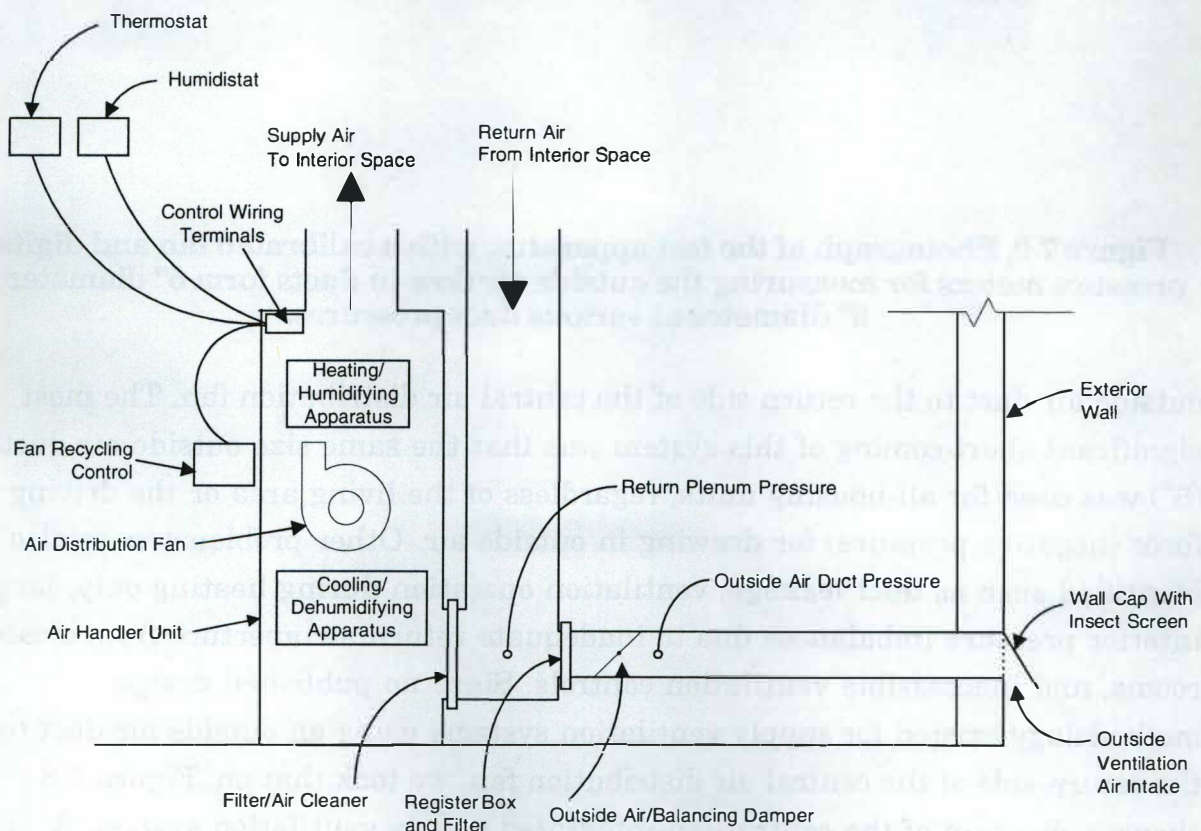

Figure 7-8, Diagram for a supply ventilation system using an outside air duct to the return side of a central system fan.

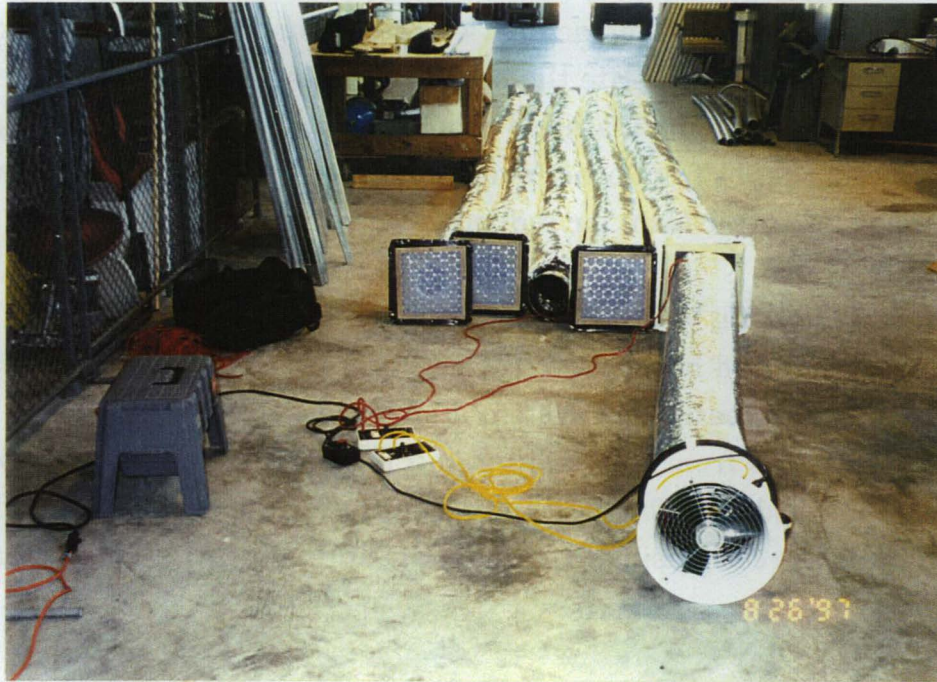

Figure 7-9, Photograph of the test apparatus, with a calibrated fan and digital pressure meters for measuring the outside air flow in ducts from 5" diameter to 9" diameter at various duct pressures

outside air duct to the return side of the central air distribution fan. The most significant short-coming of this system was that the same size outside air duct (5") was used for all housing units, regardless of the living area or the driving force (negative pressure) for drawing in outside air. Other problems were also identified such as duct leakage, ventilation operation during heating only, large interior pressure imbalances due to inadequate return air aperture from closed rooms, and inaccessible ventilation controls. Since no published design methodology existed for supply ventilation systems using an outside air duct to the return side of the central air distribution fan, we took that on. Figure 7-8 shows a diagram of the central-fan-integrated supply ventilation system. A measurement protocol was developed, and measurements were taken for 25'

lengths of 5" through 9" duct diameters at outside air duct pressures of -10 Pa to -120 Pa. A report was written (Rudd 1997b) to establish an accurate design methodology based on these measurements. The four-step design method includes calculating the required continuous ventilation air flow, selecting a fan duty-cycle, converting the continuous air flow requirement to an intermittent air flow requirement based on the selected duty-cycle, then finding the correct size outside air duct and duct pressure to give that intermittent ventilation air flow. Figure 7-9 is a photograph of the test apparatus, and figure 7-10 graphically illustrates the measurement results.

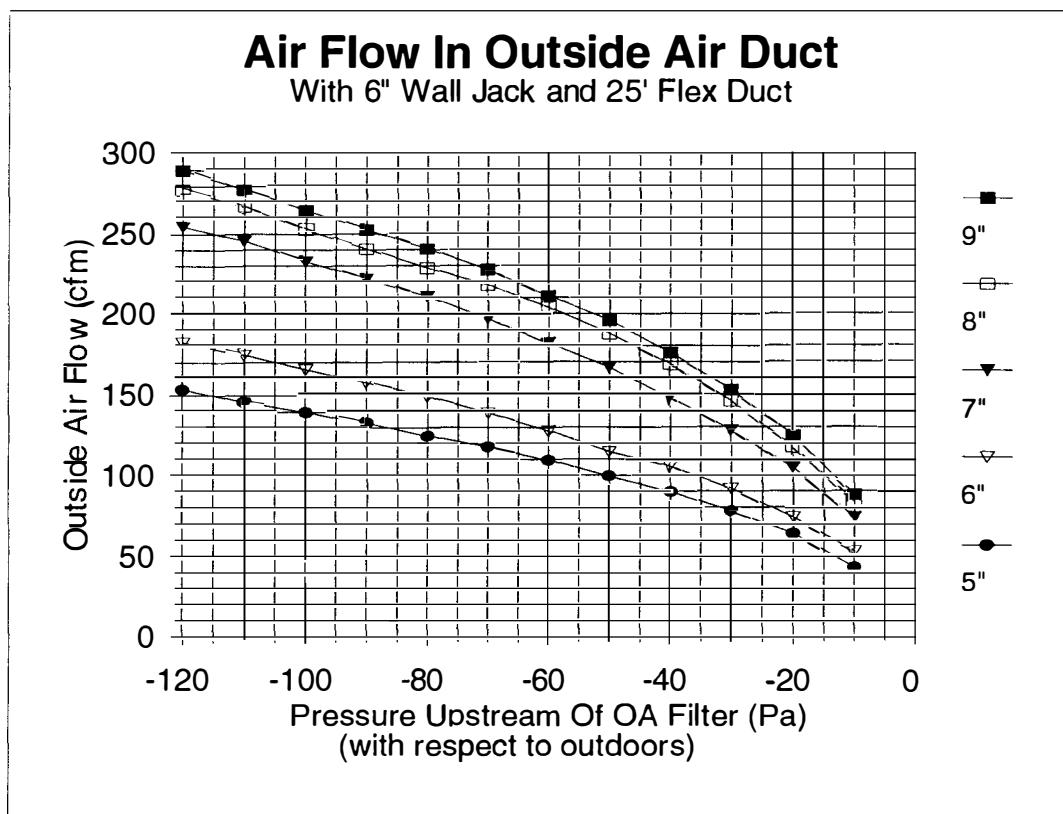

Figure 7-10, Measured air flow in outside air ducts versus duct pressure for 5' and 9' diameter.

Industrialized Housing Trends in the United States

In 1996 we conducted a study to update the information gathered in our 1990 study "Industrialized Housing Trends in the U.S." The study showed that there has been an increase in market share for industrialized housing production, which includes HUD code, modular, and panelized.

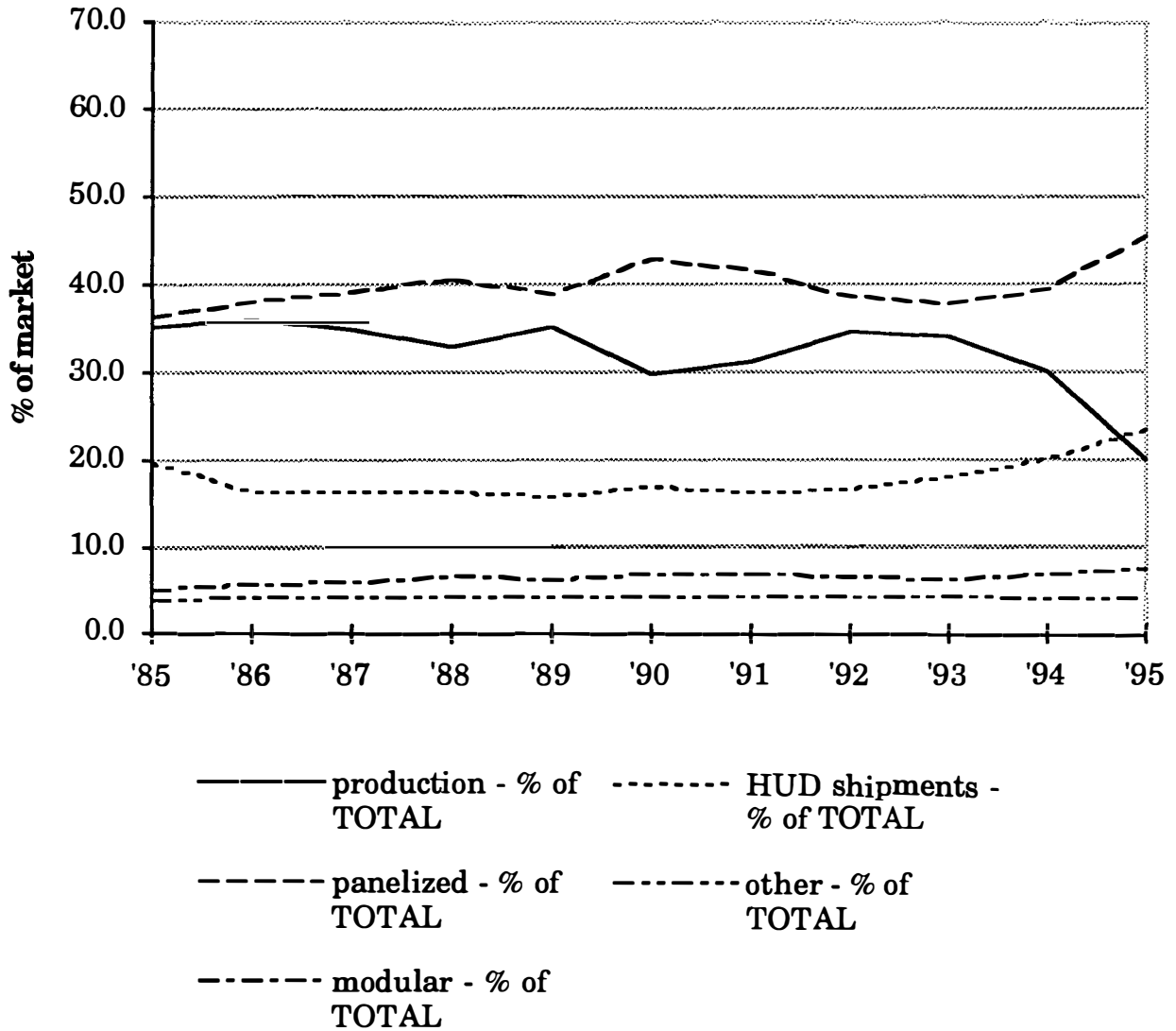

Figure 8-1, Housing Production by Market Share 1985 - 1995

HUD code homes have increased their market share from 16.6% to 23.4 %. The concentration of HUD code homes in the hot humid region of the United States provides a localized market that would be easy to target with innovations in energy-efficient construction. These efforts should emphasize cooling performance.

Modular homes have seen a small market share increase, 5.2% to 7.3%. Research focusing on modular housing would have the smallest overall impact on the housing industry.

The largest increase in market share was seen in the panelized housing category, which grew from 36.0% to 45.4%. The temperate zone has the greatest market share of industrialized housing production. Although the energy implications are smaller in this region, the central location allows shipping to more climatically demanding regions. This suggests that these centrally located companies may benefit most from research that is easily adaptable to all regions and climate conditions.

The results from this study have reiterated the importance of research in the area of industrialized housing in the United States. In particular, the panel industry continues to provide the opportunity for the largest overall impact.

Residential Design Assistance Center (ReDAC)

The multifaceted task of reducing residential energy costs involves most of the key players in the housing industry. From developers who significantly affect the potential for passive solar design to suppliers who control the availability of energy improving products. Residents affect energy use by the way they run their homes. But the builders, who often control design and specification in addition to actual construction, truly have the most power to change the face of America's residential energy consumption.

Once a home leaves the builder's custody, a great many opportunities for energy efficiency have passed. Those remaining deal primarily with reducing plug loads and improving comfort in the home (reducing the need for heating or cooling.) Thanks largely to the Department of Energy's strong efforts, weatherization is

part of the American vocabulary. Throughout the country, residents button up their houses in the winter. These steps seem obvious especially, for example, to those families eligible for federal weatherization assistance whose mean individual energy costs represent 14% of the average household income of \$11,245 (U.S. DOE, 1997).

Consider that most (90%, U.S. DOE, 1997) homes receiving weatherization assistance are weather stripped and caulked. This is a useful practice for improving air tightness of homes and hence reducing infiltration of unwanted air into the home. A majority (62%, U.S. DOE 1997) also receive some insulation improvements. These and other weatherization program measures aim at improving comfort. This in turn means the heater or air conditioner does not have to work as hard to keep the house comfortable. While this is certainly valuable to homeowners, simulations as well as monitoring show that much greater opportunities are embedded in the design and construction process.

For hot humid climates, for example, these include the wall and roof assemblies, the technical characteristics of the window frames and glass, and the efficiency of appliances, water heaters, and heating/cooling equipment. (McIlvaine, 1995 & Parker, 1992) The direct impact of these improvements can be seen in many monitored field studies. studies (Parker, 1996) In addition to these opportunities, contractors and sub-contractors affect the air tightness of walls, ceilings, and duct systems as well as the evenness of insulation surrounding the conditioned space.

At the upper ends of the housing market, this ability to provide superior energy efficiency is beginning to translate into packages of energy upgrades via residential energy rating systems and energy efficient mortgage programs. But, in the affordable housing sector, what drives a builder to improve the energy efficiency of homes?

Conservation of operating funds drives some providers, such as federal, state, county and municipal housing authorities, to consider energy efficiency. But unlike these housing providers, private sector non-profit home builders do not retain ownership of homes. For example, Habitat for Humanity sells affordable

housing at a national average of \$40,000 per house to qualified buyers (25-50% of the local median income) (Poole, 1997) at no interest. Since they give up ownership, they are not directly affected by operating costs. However, they still have a stake in energy efficiency because high energy bills can force homeowners into a choice between the mortgage payment and the utility payment. Mortgage payments often fund the next round of building for these organizations, so safeguarding the ability of their home buyers to make the house payment is in the best interest of perpetuating the building activities. In some circles of affordable housing, affordable has begun to mean affordable to operate as well as to build and buy. ReDAC staff is working to expand that circle by reaching home builders with these practical, cost-effective methods of improving energy efficiency.

Since 1995, ReDAC has worked directly with about 50 affordable housing providers throughout the country (figure 8-2). Additionally, staff members have conducted field diagnostics (figure 8-3) and presented material at workshops, conferences, and professional meetings reaching hundreds in the affordable housing community. In addition, Home Energy Rating Scores were performed for several of DOE's demonstration houses and monitored field study houses (figure 8-4).

Current ReDAC efforts reflect the affordable housing industry's hunger for concrete information. A hands-on workshop for builders, designers, engineers, and policy makers brings the ivory tower image of energy efficiency down to Earth. Participants work together to build examples of energy efficient framing details, conduct "kitchen physics" experiments to understand heat transfer and go through engage in a goal setting exercise for their individual situation. Response has been positive, two more workshops are currently slated.

Another ReDAC activity involves working on construction project to accomplish a list of energy tasks while explaining the concepts to contractors, designers, and sub contractors involved in the project. This type of assistance was inaugurated this summer at the 1997 Habitat for Humanity - Jimmy Carter Work Project where about 50 energy engineering professionals joined the volunteer ranks to build 50 energy efficient houses in a week. After the build, many of the homes

Figure 8-2, Energy Partnerships with Habitat for Humanity

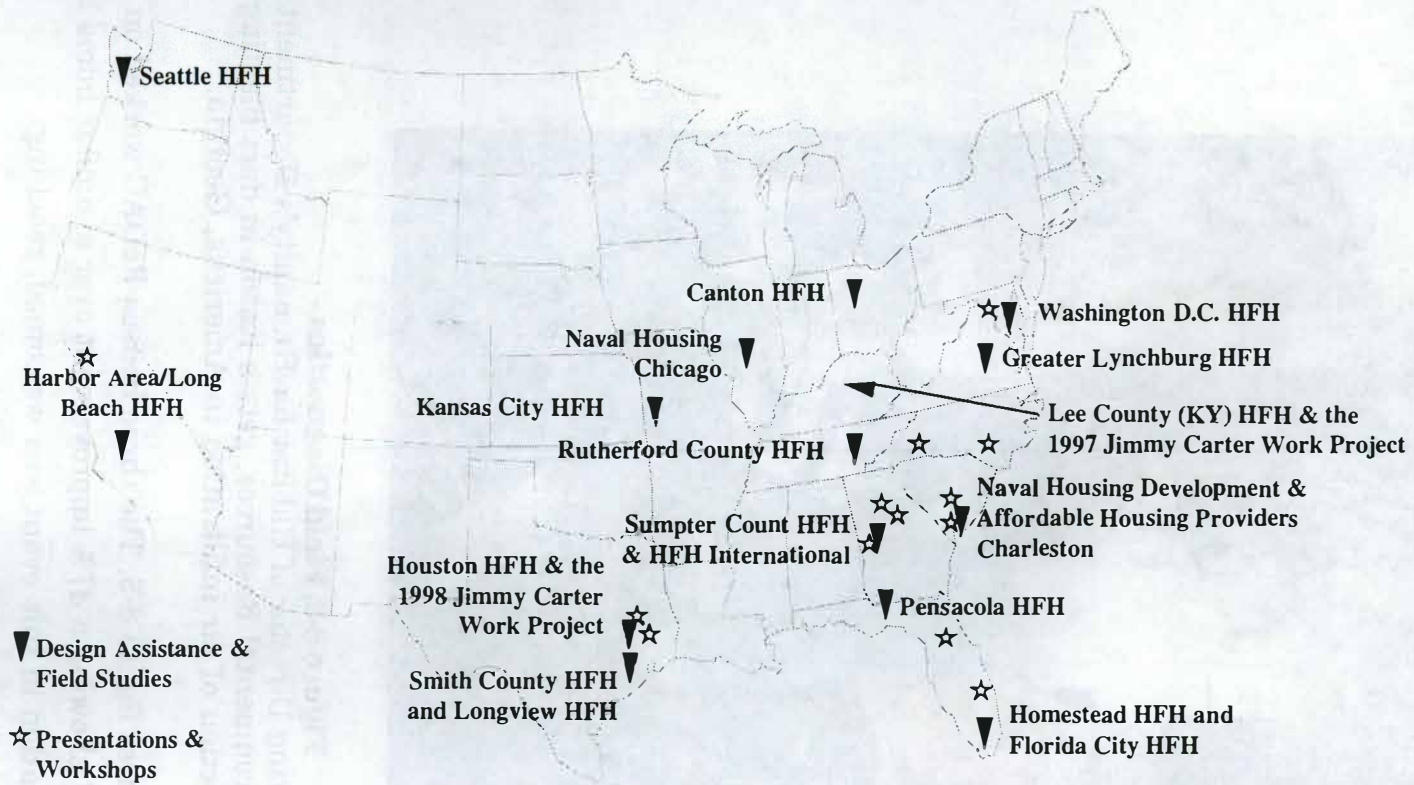

Research Sponsored By

U. S. Department of Energy
Office of Building Technology
Community and State Projects
Washington D.C.

Program Manager
MR. GEORGE JAMES
(202) 586-9472



Research Conducted By

Florida Solar Energy Center
University of Central Florida
1679 Clearlake Road
Cocoa, FL 32922

FSEC Task Leader
JANET E. R. MCILVAINE
(407) 638-1434
FAX: 407-638-1439
janet@fsec.ucf.edu



Figure 8-3, Field Diagnostics

Peter Dalva (left), acting Director of Habitat for Humanity's Department of Construction and Environmental Resources, gets a lesson in duct blasting and infrared detection of air infiltration in Americus, Georgia.

were tested for air tightness figure 8-5. The three houses ReDAC worked on had an average ACH50 of 5.7 showing a 37% improvement over a similar home built in 1996. ReDAC participation in this event was welcomed, reaching approximately 150 eager volunteers from around the country.

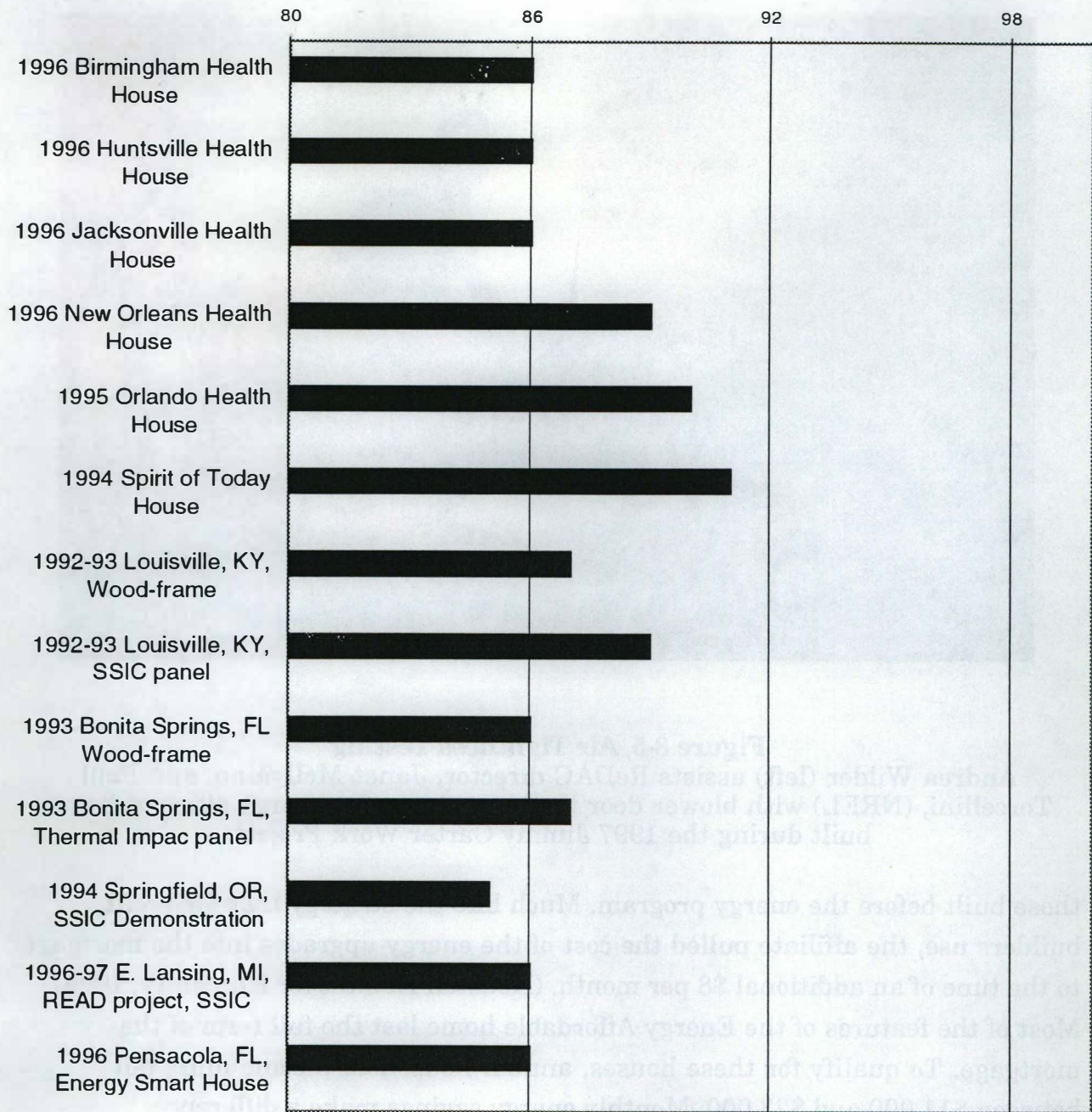

Figure 8-4, HERS Scores for EEIH Monitoring Sites and Demonstration Houses managed by the Florida Solar Energy Center

Working with the progressive Houston Habitat for Humanity on the Energy Affordable Home project figure 8-6, ReDAC helped put together specifications for equipment, materials, and assemblies. The affiliate has adopted about 85% of the spec as standard construction reflecting monthly savings of \$25-\$35 compared to



Figure 8-5, Air Tightness Testing

Andrea Wilder (left) assists ReDAC director, Janet McIlvaine, and Paul Torcellini, (NREL) with blower door testing at her new, energy efficient home built during the 1997 Jimmy Carter Work Project.

those built before the energy program. Much like the strategy that for-profit builders use, the affiliate pulled the cost of the energy upgrades into the mortgage to the tune of an additional \$8 per month. (Houston Habitat for Humanity, 1996) Most of the features of the Energy Affordable home last the full term of the mortgage. To qualify for these houses, annual household income must fall between \$11,000 and \$23,000. Monthly energy savings make a difference.

These results and those achieved by other affordable housing providers are fully reproducible since only off the shelf products and proven, cost effective practices were employed. Everyone loves predictable success.



Figure 8-6, Houston Habitat for Humanity Energy Affordable Home
Millard Fuller (right), founder of Habitat for Humanity, greets construction manager Ray McKinley (center) at the dedication of the first Energy Affordable Home. DOE program manager, George James looks on (left).

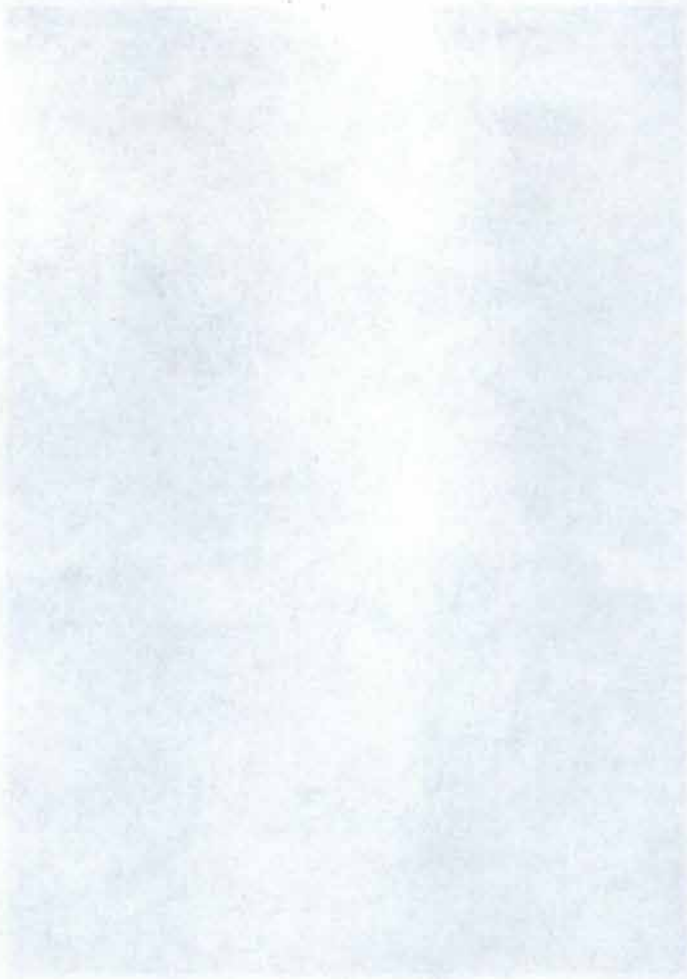

1997-98, the total number of students enrolled in the program was 1,000. This represents a 10% increase over the previous year. The increase is due to a combination of factors, including a decrease in the number of students who dropped out of the program and an increase in the number of students who enrolled in the program.

9.0 FY 96 PUBLICATIONS

- Brown, G.Z., D. Bjornson, J. Briscoe, E. Dorsett, J. Kline, J. Powell, M. Schneider, M. Sloat, Z. Wang, "On-Grade Panel Floor System Report #2." Center for Housing Innovation, University of Oregon, September 1997.
- Brown, G.Z., D. Bjornson, K. Carson, E. Dorsett, J. Kline, L. Nixt, "Industrialized Housing Trends in the U.S." Center for Housing Innovation, University of Oregon, December 1996.
- Chandra, S., Beal D. and A. Downing, "Improving Indoor Air Quality In Residences - A Systems Approach." Proc. Third International Green Building Conference and Exposition 1996. NIST special publication 908. pp. 159 - 171.
- Chandra, S., Lockey, R.F., Alidina, L.W., Beal, D., Codina, R. and K. Gehring, "Adverse Health Effects and Elimination of Dust Mites in Humid Climate Housing." Proc. 7th International Conference on Indoor Air Quality, Nagoya, Japan, July, 1996. Vol. 3: pp. 433- 438.
- Gatland, S., A. Rudd, 1996. "Physical Testing Laboratory Report: Structural Connector For Locating and Fastening Roof Panels to Walls." Testing Report submitted to U. S. Department of Energy, Office of Building Systems, Florida Solar Energy Center, Cocoa, FL, FSEC TR-002-96, July.
- Kosny, J., A. Desjarlais, J. Christian, A. Rudd, 1997. "Whole Wall Rating/Label for Florida Solar Energy Center Combined Wood/Metal Wall System; Steady State Thermal Analysis." Testing Report submitted to U. S. Department of Energy, Office of Building Systems, Florida Solar Energy Center, Cocoa, FL, FSEC TR-003-97, September.
- Moyer, D., A. Rudd, 1996. "Strength Testing: Racking, Compression, and Transverse Loading of Wall Assemblies Constructed Using Metal and Wood Composite Framing Members for Residential and Light Commercial Construction." Testing Report submitted to U. S. Department of Energy, Office of Building Systems, Florida Solar Energy Center, Cocoa, FL, FSEC TR-001-96, July.
- Mullens, M. and R. Toleti, "A Four-Day Study Helps Home Builders Move Indoors." *Interfaces* 26(4), 1996.
- Mullens, M., "A Flexible Manufacturing Approach to Wood Frame Housing Construction." *Proceedings of the 13th International Symposium on Automation and Robotic in Construction*, Tokyo, Japan, June, 1996.

- Raymer, P., 1997. Collection of informal reports regarding fan recycling control submitted by Tamarack Technologies to Florida Solar Energy Center, Cocoa, FL. FSEC RR-046-97, May.
- Rudd, A., 1996. "Vented and Sealed Attics in Hot Climates." Contract Report submitted to Building Science Corporation, Westford, MA, and the U. S. Department of Energy, 30 October. Florida Solar Energy Center, Cocoa, FL, FSEC-CR-911-96.
- Rudd, A., K. Subbarao, M. Swami, C. E. Hancock, 1996. "Development of Cooling Season Short- Term Energy Monitoring." Contract Report submitted to U.S. Department of Energy, Washington, D.C., 17 October. Florida Solar Energy Center, Cocoa, FL, FSEC-CR-907-96.
- Rudd, A. F., J. W. Lstiburek, N. A. Moyer, 1997. "Measurement of Attic Temperatures and Cooling Energy Use In Vented and Sealed Attics In Las Vegas, Nevada." EEBA Excellence, The Journal Of The Energy Efficient Building Association, Spring. Energy Efficient Building Association, Minneapolis, MN.
- Rudd, A. F., J. W. Lstiburek, N. A. Moyer, 1997. "Measurement of Attic Temperatures and Cooling Energy Use In Vented and Sealed Attics In Las Vegas, Nevada." EEBA Excellence, The Journal Of The Energy Efficient Building Association, Spring. Energy Efficient Building Association, Minneapolis, MN.
- Rudd, A. 1997a. "Field Testing of Novel SIP Roof Panel Connectors." Testing Report submitted to U. S. Department of Energy, Office of Building Systems, Florida Solar Energy Center, Cocoa, FL, FSEC TR-004-97, May."
- Rudd, A., 1997b. "Supply Ventilation System Design: Outside Air Duct To Return Side Of Central Fan." DRAFT Contract Report submitted to U. S. Department of Energy, Washington, D.C., August. Florida Solar Energy Center, Cocoa, FL, FSEC-CR-958-97.
- United States Patent, number 5,547,017, 1996. "Air Distribution Fan Recycling Control." Issued 20 August, inventor Armin F. Rudd, assignee University of Central Florida.
- United States Patent Application on "Metal and Wood Composite Framing Members for Residential and Light Commercial Construction." Filed in June 1996. Patent pending.

10.0

REFERENCES

Houston Habitat for Humanity, 1996. "The Affordable, Energy-Efficient, Award-Winning House." Alliance to Save Energy, Washington, D.C.

McIlvaine, J.E.R., D.S. Parker, P.W. Fairey, 1995. "Analysis of Energy Efficiency Options for the Abacoa Development Project." FSEC-CR-842-95, Florida Solar Energy Center, Cocoa.

Poole, Doris, 9/25/97. Phone communication with Janet McIlvaine, Florida Solar Energy Center, Cocoa, Florida.

Parker, D.S., M.D. Mazzara, J.R. Sherwin, 1996. "Monitored Energy Use Patterns in Low-Income Housing in a Hot and Humid Climate." FSEC-PF-300-96, Florida Solar Energy Center, Cocoa.

Parker, D., P. Fairey, C. Gueymard, R. McCluney, J. McIlvaine, T. Stedman, 1992. "Rebuilding for Efficiency: Improving the Energy Use of Reconstructed Residences in South Florida." FSEC-CR- 562-92, Florida Solar Energy Center, Cocoa.

U.S. Department of Energy, 1997. "Office of Building Technology, State and Community Programs Core Databook." Bill Zwack, D&R International, Silver Springs, MD.

11.0 ACKNOWLEDGEMENTS

This research is funded by the Office of Building Technology, Energy Efficiency and Renewable Energy Division of the U.S. Department of Energy, Mr. George James, Program Manager.

