

Department of Mechanical Engineering

Industrial Opportunities of Additive Manufacturing

Workflow planning and decision making of additively manufactured end-use components

Sergei Chekurov

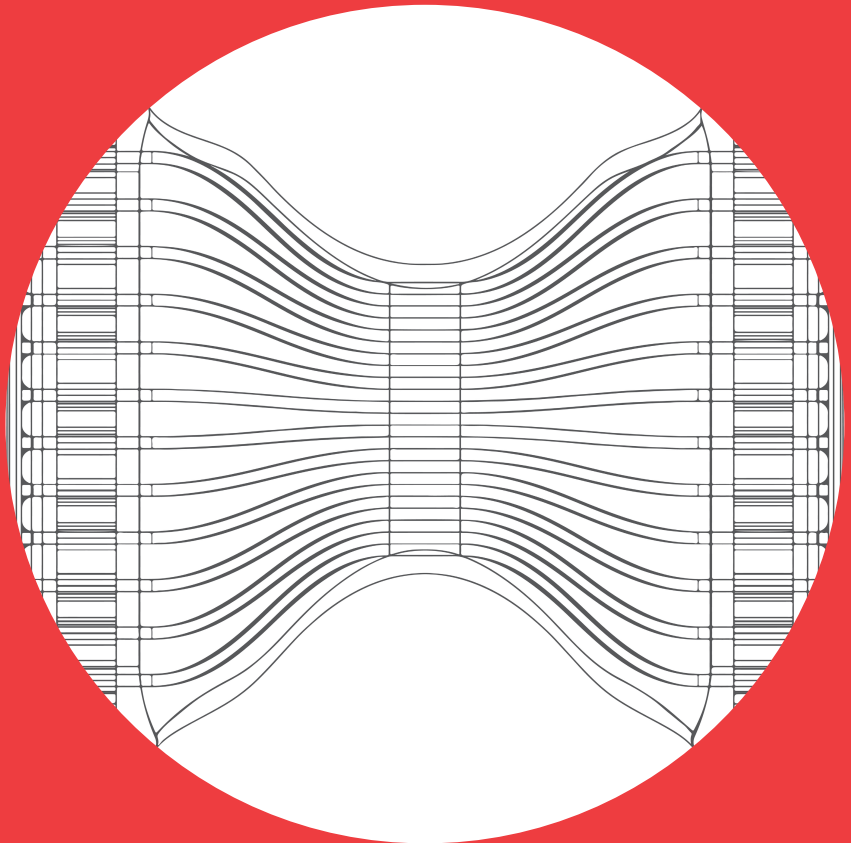

Industrial Opportunities of Additive Manufacturing

Workflow planning and decision making of additively manufactured end-use components

Sergei Chekurov

A doctoral dissertation completed for the degree of Doctor of Science (Technology) to be defended, with the permission of the Aalto University School of Engineering, at a public examination held at the lecture hall M1 of the school on 15 March 2019 at 12:00.

**Aalto University
School of Engineering
Department of Mechanical Engineering
Production Engineering Research Group**

Supervising professor

Professor Jouni Partanen, Aalto University, Finland

Thesis advisor

Mika Salmi, Aalto University, Finland

Preliminary examiners

Professor Richard Hague, University of Nottingham, United Kingdom

Professor Ian Gibson, University of Twente, The Netherlands

Opponent

Professor Alain Bernard, Ecole Centrale de Nantes, France

Aalto University publication series

DOCTORAL DISSERTATIONS 33/2019

© 2019 Sergei Chekurov

ISBN 978-952-60-8429-9 (printed)

ISBN 978-952-60-8430-5 (pdf)

ISSN 1799-4934 (printed)

ISSN 1799-4942 (pdf)

<http://urn.fi/URN:ISBN:978-952-60-8430-5>

Unigrafia Oy

Helsinki 2019

Finland



Author

Sergei Chekurov

Name of the doctoral dissertation

Industrial Opportunities of Additive Manufacturing

Publisher School of Engineering**Unit** Department of Mechanical Engineering**Series** Aalto University publication series DOCTORAL DISSERTATIONS 33/2019**Field of research** Production Engineering**Manuscript submitted** 21 August 2018**Date of the defence** 15 March 2019**Permission to publish granted (date)** 15 January 2019**Language** English **Monograph** **Article dissertation** **Essay dissertation****Abstract**

The progression of additive manufacturing—from being limited to producing prototypes to being a valuable technology in producing end-use components—has been noted by many researchers and companies. Nevertheless, the industrial opportunities of this progress are not clear to new users of the technology because the number of end-use applications for additive manufacturing is vast and growing rapidly. The major advantages of using additive manufacturing lie in the increased freedom of design and the possibility to produce components that have previously been impractical. On the other hand, additive manufacturing can also be used in situations where the component does not benefit from the additional design freedom. In such cases, the advantage of using additive manufacturing must come from operational benefits, such as improved delivery speed or cheaper manufacturing cost.

To clarify the opportunities, the thesis proposes categorizing the end-use applications from the point of view of design into "components designed for additive manufacturing", "components redesigned for additive manufacturing", and "components not designed for additive manufacturing". Each of these categories has their use in industrial applications and can help achieve specific technical and operational benefits. In the thesis, the categories are provided with design workflows that draw from the design process of Pahl & Beitz and are augmented with relevant previous research from the field of design for additive manufacturing.

To investigate the industrial opportunities in the form of technical and operational advantages of the categories, the thesis demonstrates the use of the categories and their workflows by providing a case study for each. In the case studies, the design process of the components is demonstrated with the help of the developed design workflows, and the technical and operational benefits of each component are evaluated. The case studies of the categories involve the design of a novel high-performance heat exchanger, the redesign of a digital hydraulic valve manifold, and the production of a memory cover for use in the repair of a portable computer. In addition, the thesis contains a focus group study in the category "components not designed for additive manufacturing" to discover in which scenarios it could be employed.

In the final section of the thesis, the technical and operational advantages of using additive manufacturing in each of the categories are collected and presented. The main technical advantages discovered in the investigations were the creation of new functionalities and improvement of performance, and the main operational benefits were the simplification of supply chains and shorter repairs. The thesis gives researchers in the field of design for additive manufacturing a framework to communicate their findings in a way that can be understood easily by practitioners not previously intimately familiar with designing for additive manufacturing.

Keywords Additive Manufacturing, 3D Printing, Design Workflow**ISBN (printed)** 978-952-60-8429-9**ISBN (pdf)** 978-952-60-8430-5**ISSN (printed)** 1799-4934**ISSN (pdf)** 1799-4942**Location of publisher** Helsinki**Location of printing** Helsinki **Year** 2019**Pages** 119**urn** <http://urn.fi/URN:ISBN:978-952-60-8430-5>

Tekijä

Sergei Chekurov

Väitöskirjan nimi

Materiaalia lisäävän valmistuksen teolliset mahdollisuudet:

Materiaalia lisäävällä valmistuksella tehtyjen kappaleiden työnkulun suunnittelu ja päätöksenteko

Julkaisija Insinööritieteiden korkeakoulu**Yksikkö** Konetekniikan osasto**Sarja** Aalto University publication series DOCTORAL DISSERTATIONS 33/2019**Tutkimusala** Tuotantotekniikka**Käsikirjoituksen pvm** 21.08.2018**Väitöspäivä** 15.03.2019**Julkaisuluvan myöntämispäivä** 15.01.2019**Kieli** Englanti **Monografia** **Artikkeliväitöskirja** **Esseeväitöskirja****Tiivistelmä**

Monet tutkijat ja yritykset ovat huomanneet, että materiaalia lisäävät menetelmät ovat kehittyneet pelkästään prototyypointiin tarkoitetusta teknologiasta varteenotettavaksi tuotantoteknologiaksi, jolla voi valmistaa lopputuotteita. Tästä huolimatta tämän kehityksen teolliset mahdollisuudet eivät ole täysin selkeitä teknologian uusille käyttäjille, koska sen sovelluksia on valtavasti ja niiden määrä kasvaa nopeasti. Suurin hyöty materiaalia lisäävien menetelmien käytöstä tulee vapaammasta suunnittelusta ja mahdollisuudesta valmistaa komponentteja, jotka eivät olleet aiemmin käytännöllisiä valmistaa materiaalia poistavilla menetelmillä. Materiaalia lisääviä menetelmiä voi kuitenkin käyttää myös silloin, kun tuote ei hyödy niiden suomasta suunnitteluvapaudesta. Näissä tapauksissa edun on tultava taloudellisista tekijöistä, kuten parantuneesta toimitusnopeudesta.

Tämä väitöskirja ehdottaa lopputuotemahdollisuuksien jakamisen kategorioihin "suunniteltu materiaalia lisääville menetelmille", "uudelleensuunniteltu materiaalia lisääville menetelmille" ja "ei suunniteltu materiaalia lisääville menetelmille", jotta teknologian teolliset mahdollisuudet selkiytyisivät. Jokaisella näistä kategorioista on omat käyttökohteensa teollisuudessa ja voivat auttaa saavuttamaan teknillisiä ja taloudellisia etuja. Tässä väitöskirjassa jokaiselle kategorialle annetaan suunnittelun työnkulut, jotka pohjautuvat Pahlin ja Beitzin suunnitteluprosessiin ja joita laajennetaan oleellisella aikaisemmalla tutkimuksella.

Teollisten mahdollisuuksien ja kategorioiden teknillisten ja taloudellisten hyötyjen tutkimista varten jokaiselle kategorialle esitetään tapaustutkimus. Näissä tutkimuksissa tuotteiden suunnitteluprosessi esitetään pohjautuen esitettyihin suunnittelun työnkulkuihin ja teknilliset ja taloudelliset edut arvioidaan. Kategorioiden tapaustutkimuksissa suunnitellaan korkeatehoinen lämmönvaihdin, uudelleensuunnitellaan digitaalinen hydraulikkalohko ja valmistetaan kannettavan tietokoneen muistisuoja sen korjaamiseksi. Lisäksi väitöskirja sisältää kohderyhmätutkimuksen kategoriasta "ei suunniteltu materiaalia lisääville menetelmille" sen käyttökohteiden selventämiseksi.

Väitöskirjan viimeisessä osiossa teknilliset ja taloudelliset hyödyt on kerätty ja esitetty. Suurimmat teknilliset hyödyt olivat tuotteiden uudet funktionaalisuudet ja parantunut tehokkuus. Suurimmat taloudelliset hyödyt olivat varastotasojen aleneminen ja lyhemmät korjaukset. Väitöskirja antaa alan tutkijoille kehyksen kommunikoida tutkimuksensa tavalla, joka on helposti ymmärrettävä myös niiden keskuudessa, jotka eivät ole vielä suunnitelleet tuotteita materiaalia lisääville menetelmille.

Avainsanat Materiaalia lisäävä valmistus, 3D-tulostus, Suunnittelun työnkulku**ISBN (painettu)** 978-952-60-8429-9**ISBN (pdf)** 978-952-60-8430-5**ISSN (painettu)** 1799-4934**ISSN (pdf)** 1799-4942**Julkaisupaikka** Helsinki**Painopaikka** Helsinki**Vuosi** 2019**Sivumäärä** 119**urn** <http://urn.fi/URN:ISBN:978-952-60-8430-5>

Acknowledgements

First, I would like to give thanks to the research group leader Jukka Tuomi – a researcher with an unlimited reserve of patience and sales skills that manage to surprise even after working together for half a decade.

For their academic guidance and support, I would like to thank my supervisor Professor Jouni Partanen, opponent Professor Alain Bernard, pre-examiners Professors Richard Hague and Ian Gibson, as well as all my co-authors and anonymous reviewers.

Thanks to the core team of the advanced manufacturing research group – Jukka Tuomi, Mika Salmi, Roy Björkstrand and Kirsi Kukko for keeping the group running smoothly. Thanks also to the rest of the team past and present – Eero Huotilainen, Iñigo Flores Ituarte, Afshin Hasani, Niklas Kretzschmar, Jan Akmal, Siddharth “Sid” Jayaprakash, and Tuomas Puttonen. Thanks to the ADDLAB team, Heikki Sjöman, Meng Wang and Ashish Mohite as well as Tapio Lantela from the hydraulics research group.

I would like to thank the cross-disciplinary team of Jyrki Kajaste, Kari Saari, and Olof Calonius for working with me on the topics of heat transfer and hydraulics. At the start of my doctoral candidacy I knew little about these topics and now I can say that these three people know very much about them.

Thanks to my parents for supporting me through school and university and for keeping me fed and happy for a long time. Thanks to my brothers and their families for a lot of things, including getting me the job that inspired Publication III, and especially for informing me that png is not a vector format.

Thanks to Eva, the co-author of my life. Without her, every day would be cold, grey and rainy. With her, even cold and grey rainy days feel full of sunshine. She also has all my gratitude for continuing to keep me well fed and very happy. Also, thanks to her parents and siblings for showing me the meaning of Christmas.

Thanks also to my good friend and graphic designer Georg “Stani” Steinfelder who gave very important advice regarding the design workflow graphics of the thesis. Thanks to Roman Mougnot for sharing the Aalto doctoral candidate experience with me.

Finally, I would like to thank Richard Melville Hall, alias Moby, for carrying countless doctoral candidates through the process of writing manuscripts with his sweet tunes.

The research of the thesis was funded by a variety of projects from Business Finland, European Institute of Technology, Academy of Finland, and DIMECC.

Sergei Chekurov
1.2.2019
Espoo, Finland

Contents

Acknowledgements	vii
List of Abbreviations	ix
List of Publications	x
Author's Contribution	xi
1. Introduction	1
1.1 Background	1
1.2 Research problem and aim	3
1.3 Contribution of the thesis	4
1.4 Outline of the thesis	5
2. Theory	7
2.1 Design workflow of end-use additive manufacturing	8
2.2 Redesigned components	12
2.3 AM as a digital manufacturing technology	12
2.4 End-use AM application categories	14
3. Methods.....	15
3.1 Case studies	15
3.2 Focus group interviews	16
3.3 Concept definition.....	19
4. Investigations.....	21
4.1 Design of a novel counterflow heat exchanger.....	21
4.2 Redesign of a digital hydraulic valve manifold	32
4.3 Additive manufacturing in offsite warranty repair	45
4.4 Additive manufacturing in digital spare part production.....	52
5. Conclusion and perspectives	55
5.1 Research questions and aims of the thesis.....	55
5.2 Recommendations	58
5.3 Limitations and future work.....	59
References	61
Publications.....	65

List of Abbreviations

AM	additive manufacturing
DED	directed energy deposition
DfAM	design for additive manufacturing
DSP	digital spare part
EBM	electron beam melting
FDM	fused deposition modelling
OEM	original equipment manufacturer
RP	rapid prototyping
RT	rapid tooling
SLM	selective laser melting
SLS	selective laser sintering
TAT	turn-around-time

List of Publications

This doctoral dissertation consists of a summary and of the following publications which are referred to in the text by their numerals.

I. Chekurov, Sergei; Kajaste, Jyrki; Saari, Kari; Kauranne, Heikki; Pietola, Matti; Partanen, Jouni. 2018. Additively manufactured high-performance counterflow heat exchanger. Springer. Progress in Additive Manufacturing. ISSN: 2363-9512. DOI: 10.1007/s40964-018-0059-x.

II. Chekurov, Sergei; Lantela, Tapio. 2017. Selective laser melted digital hydraulics system. Mary Ann Liebert, Inc. 3D Printing and Additive Manufacturing, volume 4, issue 4, pages 215-221. ISSN: 2329-7662. DOI: 10.1089/3dp.2017.0014.

III. Chekurov, Sergei; Salmi, Mika. 2017. Additive manufacturing in offsite repair of consumer electronics. Elsevier. Physics Procedia, volume 89, pages 23-30. ISSN: 18753892. DOI: 10.1016/j.phpro.2017.08.009.

IV. Chekurov, Sergei; Metsä-Kortelainen, Sini; Salmi, Mika; Roda, Irene; Jussila, Ari. 2018. Elsevier. The perceived value of additively manufactured digital spare parts: an empirical investigation. International Journal of Production Economics, volume 205, pages 87-97. ISSN: 0925-5273. DOI: 10.1016/j.ijpe.2018.09.008

Author's Contribution

Publication 1: Additively manufactured high-performance counterflow heat exchanger

The first author designed the heat exchanger, organized its manufacturing and was the principal writer of the manuscript. The second author (Kajaste) was responsible for the heat transfer measurements. The third author (Saari) was responsible for heat transfer calculations. The second, third, and fourth (Kauranne) authors participated extensively in preparing the manuscript. The fifth (Pietola) and sixth (Partanen) authors supervised the work of the study.

Publication 2: Selective laser melted digital hydraulics system

The writing of the manuscript was an equal joint effort between the first and second author (Lantela). Both authors contributed equally to the design of the hydraulic block. The FEM and CFD simulations and the measurements were conducted by the second author. The manufacturing of the block was organized by the first author.

Publication 3: Additive manufacturing in offsite repair of consumer electronics

The first author was the principal writer of the manuscript, conducted the experiments and the Monte Carlo simulations. The second author (Salmi) participated in preparing the manuscript.

Publication 4: The perceived value of additively manufactured digital spare parts: an empirical investigation

The first author was the principal writer of the manuscript and participated in the focus group interviews as a moderator. The second (Metsä-Kortelainen), third (Salmi), and fifth (Jussila) authors participated in the acquisition of the primary data. The fourth author (Roda) provided extensive content regarding supply network management. The second, third, and fourth authors participated extensively in preparing the manuscript.

1. Introduction

1.1 Background

Additive Manufacturing (AM) is experiencing a great influx of new practitioners. The manufacturing speed, cost, material choice and production quality of AM have improved enough that it can now be considered a serious contender for a manufacturing technology in an industrial setting. The industry is now at the point where the use of AM is about to become an expected skill in manufacturing companies around the world.

This progress brings with itself a large workforce that, while possibly familiar with AM, does not understand on a deeper level how to fully leverage the opportunities of AM. This applies to designers as well as to managers responsible for the exploitation of AM in companies.

The number of applications of AM is already too great to communicate them concisely, and more applications are being constantly discovered. This problem was already encountered at the beginning of the 2000s when the application area of AM grew so much that practitioners entering the field found it challenging to understand where AM can and cannot be used. To aid in this, AM applications were classified into separate categories. Pham and Dimov (2003) [1] introduced a simple classification method of dividing the applications into prototyping (Rapid Prototyping, RP) and tooling (Rapid Tooling, RT), which were then further divided into subcategories. The classification proposed by Pham and Dimov is shown in Figure 1.

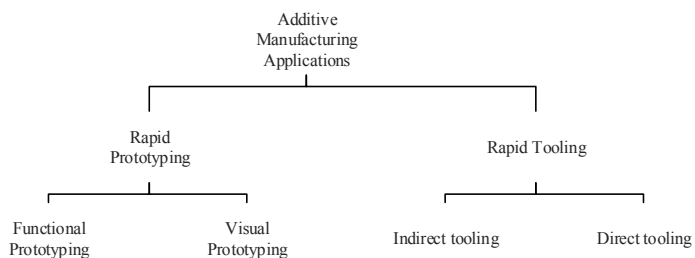

Figure 1. The division of AM applications into RP and RT as per Pham and Dimov.

The categories of RP and RT are now recognized in the international standards of AM term definitions. RP is defined by the ASTM and ISO standards as “*application of additive manufacturing intended for reducing the time needed*

for producing prototypes". RT is defined as "*application of additive manufacturing intended for the production of tools or tooling components with reduced lead times as compared to conventional tooling manufacturing*". [2]

Around the same time, at the turn of the millennium, industrial end-use parts started becoming viable to produce with AM [3], [4]. Since then, AM has been increasingly used to manufacture end-use parts, and the number of industrial applications of end-use AM has grown greatly [5]. This is also backed by the annual reports of Wohlers Associates, which state that in 2012 28.1% of all additively manufactured objects were functional parts, and in 2016 the respective percentage was already 33.8 % [6], [7]. Although this is on its own a large increase, the quantity of end-use parts has actually grown enormously because the worldwide revenue of AM products and services grew from \$2.25 billion in 2012 to \$6.05 billion in 2016 [7]. At the same time, Schniederjans (2017) reports that only 10% of companies use their AM machines to produce end-use parts [8]. This discrepancy implies that although many end-use parts are produced with AM, only a few companies are responsible for most of them.

Although manufacturing of end-use components is a major part of the field, it is not yet recognized by the ASTM or ISO standards. There is also a growing inconsistency in the nomenclature because the concept is called by many names in the literature, such as Rapid Manufacturing, Direct Manufacturing and Direct Digital Manufacturing [3], [9], [10].

With AM of end-use components becoming more common, designers and managers looking to benefit from AM are again having problems understanding all the opportunities brought by the technology. The spectrum is once again widening so much that there is a need for a classification scheme that categorizes the approaches according to application types. To achieve this, an appropriate approach needs to be employed that not only has a good overview of all types of applications, but also acts as an actionable guideline to reach said applications. As an example of a non-actionable approach, the applications could be divided according to the material used (metal, plastic and other). In such a case, the designer can become aware of several types of applications but cannot act on it because the material type of a component is usually not very flexible.

The design approach of AM components is actionable because the choice of application affects the design process and the design affects the outcome. Researchers and practitioners are using AM to achieve diverse goals, from superior performance to operational benefits. These goals can be expressed through the point of view of design approaches. In that sense, the questions of how to exploit AM and how to implement design for AM (DfAM) are coupled.

Such a classification has been offered previously by Ponche et al. (2012). The authors divided the usage of end-use AM into global and partial approaches of DfAM. In the global methodology, a new component is to be manufactured with AM from the start, so the functionality and interfaces are defined according to what is best for the component. In the partial approach, the component is redesigned, but the functionality and interfaces are determined *a priori* [11].

1.2 Research problem and aim

This thesis is grounded on the hypothesis that end-use applications of AM can be classified into three categories according to their design approach. Furthermore, this thesis proposes that the classification system of Ponche et al. be enhanced with a third category of components that are manufactured with AM from an existing design with few or no changes. In the classification system used in this thesis, the global methodology of Ponche et al. is renamed as “Components designed for AM”, and the partial methodology is renamed as “Components redesigned for AM” for increased clarity. The proposed categorization is presented in Figure 2.

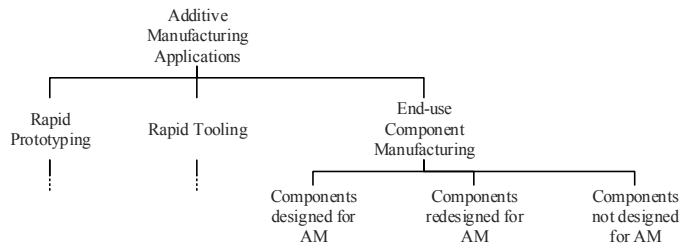

Figure 2. The classification of AM applications including rapid manufacturing and its subgroups.

The research is guided by two research questions:

RQ1. What are the observable technical benefits of AM in components of each of the proposed categories?

RQ2. What are the potential operational benefits of AM in components of each of the proposed categories?

Articles I and II primarily investigate the first research question and put a smaller emphasis on the second research question. Conversely, Article III only seeks to answer the second research question, while Article IV mostly investigates the second research question with a small contribution to the first research question. The described relationship of the articles to the research questions is shown in Table 1.

Table 1. The relationship of the articles and the two research questions, X = primary RQ, x = secondary RQ.

Article	RQ1	RQ2
I	X	x
II	X	x
III		X
IV	x	X

In addition to the research questions, the thesis has goals that increase its value to the AM research community and practitioners. The goals of the thesis are as follows:

1. Making the opportunities of end-use AM easily comprehensible for communication and dissemination by classifying end-use applications.
2. Adding to the scientific discourse surrounding DfAM.

1.3 Contribution of the thesis

The purpose of this thesis and its main contribution is to develop and demonstrate the application of design workflows that can be used to support the design process and decision making for practitioners new to AM. Additionally, the thesis presents research into the benefits of each of the three application categories of end-use AM through various methods to make the purpose of using AM in these categories more easily understandable. Articles I and II demonstrate how the design freedom of AM can be used to create superior products. Articles III and IV show how AM can be leveraged even when components are not designed for AM.

Additionally, the contributions of the individual articles are significant in their own areas. Article I brings new knowledge in the field of heat transfer geometries by demonstrating the unique possibilities that AM offers for counterflow heat exchangers. Article II solidifies AM as the manufacturing technology of preference for digital hydraulic valve manifolds. Article III demonstrates the benefits of digital spare parts in the warranty repair of consumer electronics and Article IV gives insights on the concept of digital spare parts. The relation of the articles and the three categories of AM end-use is presented in Table 2.

Table 2. The relationship of the articles and the three categories of end-use AM applications.

Article	Components designed for AM	Components redesigned for AM	Components not designed for AM
I	x		
II		x	
III			x
IV			x

1.4 Outline of the thesis

In Section 2, the thesis presents a workflow of design for AM end-use components based on existing knowledge from the literature. Subsequently, it applies the workflow to classify end-use AM components into three categories in Section 3. The definitions and workflows from the literature of DfAM are first analysed. Then a synthesis is made and a generalized workflow is presented. In Section 4, the categories are presented in more depth, and a case study is presented for each. Section 5 returns to the research questions and the aims of the thesis and provides a general view of future prospects.

2. Theory

To realize the full potential of AM, the way components are designed must be rethought. Designers who currently work in industry have extensively observed and reverse-engineered parts that were designed for manufacturing by injection moulding, casting, machining and other traditional techniques. Due to the solid knowledge base related to traditional manufacturing limitations, the designers have difficulties knowing what should be done differently when presented with a technology with limitations that differ from those of traditional manufacturing. This is especially true for AM because there are so many new opportunities that the designers often face option paralysis [12].

A part of the reason DfAM has been developed was to counteract psychological inertia, which means that designers unknowingly use old manufacturing methods as a reference point when designing objects for technologies that do not have the same limitations [13].

Designing for AM offers opportunities to make innovative products and improve components. There are at present designers with the skills necessary to design advanced products for AM with the help of personal knowledge accumulated from years of trial and error. If the knowledge is not transferred in a systematic manner, designers beginning their career with AM will need to go through the same process to design parts well.

The amount of information on DfAM is overwhelming to designers because it is fragmented and a simple framework relating all the concepts has not yet been created. Currently, DfAM means many categorically different things to different people. Understanding the different meanings and directions of DfAM is key to understanding the applications of end-use AM clearly. Therefore, it is beneficial to use a framework, in this case in the form of a design workflow, to place the concepts of DfAM in perspective to one another.

This chapter presents the creation of a design workflow for end-use AM based on the available literature. To better understand the effects of DfAM on the operational facets of production, the chapter also introduces the concept of AM as a digital manufacturing technology.

2.1 Design workflow of end-use additive manufacturing

The workflow presented in this section is based on the well-established design process of Pahl and Beitz [14] presented in Figure 3. The process is divided into discrete stages of planning and clarifying, conceptual design, embodiment design, and detail design.

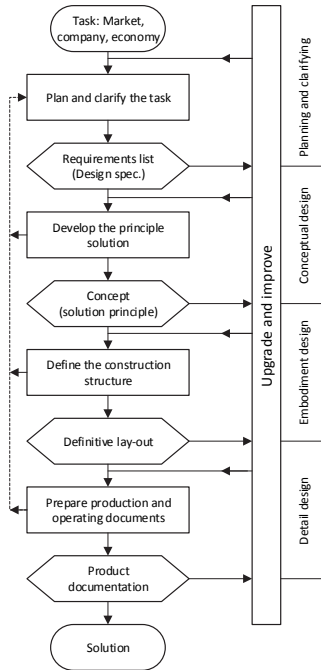

Figure 3. Steps of the Pahl and Beitz planning and design process redrawn from Pahl et al. [14].

The design process of Pahl and Beitz is supplemented with domain-specific knowledge from the DfAM literature. Rosen [15] introduced a DfAM process diagram that resembles the process of Pahl & Beitz as presented in Figure 4.

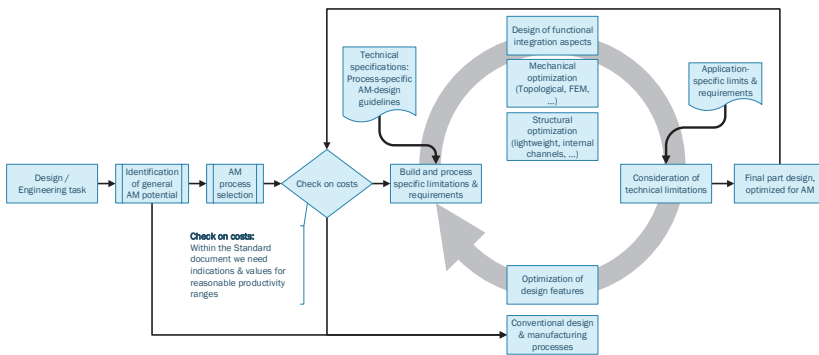

Figure 4. Workflow of DfAM of end-use components redrawn from Rosen [15].

While the process presented by Rosen et al. is undoubtedly useful for practitioners, it is not suitable for classification, as it is not semantically comprehensive and generalized enough. To create a suitable workflow, recent concepts from DfAM researchers are examined and linked to the workflow of Pahl and Beitz.

Laverne et al. (2015) [16] presented the stage of designing shapes and introducing limitations in a semantic manner. They refer to the design according to the benefits of AM as opportunistic design and the introduction of limitations as restrictive design. The authors also introduce the concept of dual design, in which opportunistic design and restrictive design are used to feed each other to develop a design that takes advantage of AM capabilities but can still be manufactured. Using Rosen's diagram and Laverne et al.'s version of the design phase, an updated design for end-use AM diagram is compiled and presented in Figure 5.

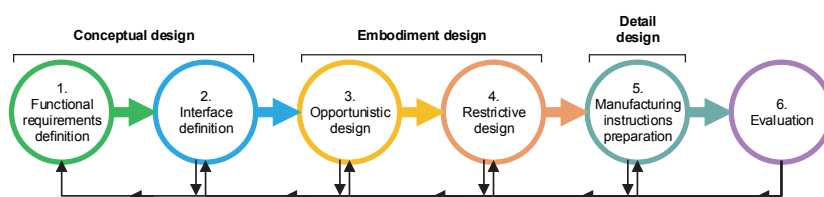

Figure 5. Workflow of DfAM of end-use components.

The workflow can be followed sequentially with recursive loops or by going through the phases out of order. By skipping ahead in the process, the designer can save time in iterations but risks limiting himself by accounting for limitations that might not be necessary if every aspect of the design were considered sequentially. The steps of the process are described in detail next individually and complemented with previous research.

Functional requirements definition

In the first stage of the workflow, the main functionality of the component and the elements that enable the functionality are decided. Functional requirements should first be presented without any consideration for the restrictions of any manufacturing technology. On the other hand, to help avoid the psychological inertia that drives designers towards subtractive manufacturing, unique AM capabilities can be considered. Gibson et al. (2008) list the unique capabilities of AM to be related to shape, functional, hierarchical, and material complexity [17].

Shape complexity refers to the ability of AM to allow shapes that have been unattainable previously. This type of complexity will be presented in more detail under opportunistic design and restrictive design.

Functional complexity refers to manufacturing components with functionality built into them, such as components that are flexible in places so that they can be bent and perform a function. With AM, functional elements such as sensors and actuators can be embedded in the structure of the component, which

enables the manufacturing of functional devices. Another example of functional complexity is the manufacturing of non-assemblies, meaning fully functional assemblies that cannot be separated after the manufacturing process [18].

Hierarchical and material complexities are ideas that are currently still in the research stage for industrial applications. Hierarchical complexity refers to the fact that some AM equipment can use different parameters when creating different parts of a component, hence achieving different localized qualities across the component. Material complexity refers to manufacturing the component with complex material compositions or gradients of different materials.

Interface definition

After the functionality of the component has been decided, it needs interfaces. In order to get the most out of AM, the interfaces should be described at this point on a general level and should only exist to bring the functionality out of the component. The chosen interfaces, and the distance between them, define the design space of the object.

Opportunistic design

Opportunistic design is the first stage of embodiment design in the workflow. During this stage, the component is brought from idea to reality for the first time. The shape complexity of Gibson et al. [17] is central to the execution of opportunistic design. The idea behind this stage is that the design is done according to the new possibilities of AM. These possibilities include, among others, relatively free shaping of internal and external surfaces of the component, lattice structures, and topology optimization. Many tools can guide the shape of the component. For example, the finite element method (FEM), computational fluid dynamics (CFD), and various mathematical software suites can be used to acquire optimal shapes that have previously been avoided because they have not been viable to manufacture.

It is beneficial at this stage to research what others have done before and implement the ideas that have already been recorded. Bin Maidin et al. [19] define AM-enabled design features as a form or other attribute that is not economical to produce via conventional methods. The authors categorized and identified 113 features, such as increased surface friction, internal structure complexity, and embossed features [19].

Restrictive design

In the restrictive design stage, the component is analysed from the point of view of manufacturability of the chosen manufacturing technology and material. The general limitations of technologies are considered, and technologies are ruled out based on them. It is at this point that the question is raised if the component needs to be manufactured with AM. The restrictive design stage marks a point

of no return in the sense of locking down the design to a specific set of design guidelines.

Because the effects of lacking restrictive design are immediately visible after manufacturing in the form of failures, it is extremely well-documented [20]–[24]. Typical aspects considered in restrictive design are, among others, the minimum wall thickness, angle of overhangs, manufacturing orientation, and support design. The commercial community is also accomplished in distributing information related to restrictions of AM. Lengthy guides for every commercially available technology are available for example from 3D Hubs [25], Shapeways [26], and Materialise [27].

At this stage, the cost of manufacturing the component with the chosen AM technology should be verified, and if it is unacceptably high, the design should be revised. If possible, simulations regarding the success of the AM process of the component should be done and the component adjusted accordingly. If no AM technology is capable of manufacturing the component that is being designed or if AM is prohibitively expensive, rapid tooling should be considered as an alternative.

Manufacturing instructions preparation

Once the design is completed, it should be locked in place but can remain parametric in case the need for customization is foreseen. The component is characterized in detail during the instructions preparation stage. This involves deciding which machine type and exact material will be used to manufacture the component, where the support structures are needed or not allowed, what its post-processing stages will be, and which surfaces will need machining after the AM process. A formalized approach to laying out the manufacturing instructions for AM has been presented by Zhang et al. (2014) [28]. They present an approach to the process of detailing the manufacturing instructions for AM including processing parameters, manufacturability analysis and selection of manufacturing scenarios. An understanding of AM process characteristics is paramount at this stage.

Evaluation

The evaluation stage of the design process is entirely dependent on the requirements set for the component. Additively manufactured components can generally be tested in the same fashion as traditionally manufactured ones.

From an economic perspective, the cost of the component should be considered already before the evaluation stage. Break-even calculations are by now ingrained in the field of AM and are commonly used to calculate the benefit of producing a component with AM compared to other manufacturing methods. However, the benefits of distributed manufacturing are quite difficult to calculate in a real-life scenario in a large supply network, and the profitability of each component should be calculated in a personalized manner.

2.2 Redesigned components

Components that were not originally designed for AM can still find benefits from the technology. Hällgren et al. (2016) [29] offer an overview of redesign for manufacturing from the points of view of part cost reduction and performance improvement. In their framework, they show a variety of paths to take to achieve this by setting correct design goals and using the right tools.

Vayre et al. (2012) [30] present a methodology of redesign of a component. In their process, the component is first analysed for functional surfaces and design space, after which initial shapes are obtained by expertise, guidelines or topology optimization. The process then continues by introducing the limitations of the manufacturing method and validating the design by virtual examination or by producing a prototype.

Schmelzle et al. (2015) [31] presented a design process to redesign assemblies for part consolidation. Their process starts by defining the system boundary by identifying the parts, interfaces, and design spaces. Then their process calls for combining the parts by redesigning external and internal features using tools such as FEA, CFD, and topology optimization. After the design is completed, the build orientation and build supports are specified and post-processing needs are identified. The presented process is recursive; each of the steps following the geometry specification has an output to a previous stage of the process. Orquera et al. (2017) [32] present a similar design process but without the recursive nature.

Based on this information, the workflow acquired in Section 2.1 can be modified to reflect the redesign process. The modified workflow is presented in Figure 6.

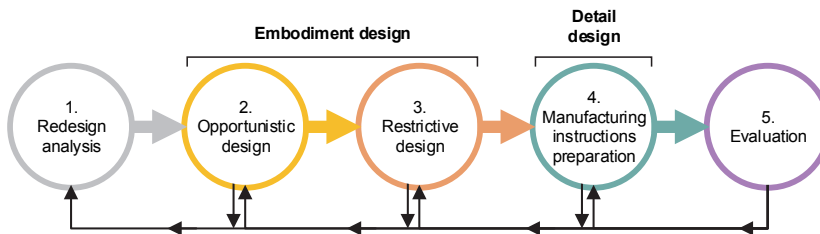

Figure 6. Workflow for redesigning components for AM.

Compared to the original workflow, the conceptual stage is removed completely and is replaced with a new stage: redesign analysis. Components that are to be redesigned for AM need to be analysed carefully for functionality and interfaces. The area that is left between the interfaces can be considered as the design space where opportunistic design can take place.

2.3 AM as a digital manufacturing technology

Klahn et al. (2014) [33] introduced the concepts of the function driven and manufacturing driven strategies. The function driven strategy aims to bring out

the benefit of components designed for AM by leveraging their design advantages. In the function driven strategy, the value of using AM comes from the fact that the component has such characteristics that it cannot be manufactured in any other way. In the manufacturing driven strategy, the benefit of AM comes from its digital nature. In other words, the function driven strategy tries to leverage the technical benefits of AM, while the manufacturing driven strategy tries to leverage its operational benefits.

The major advantage that AM has as a digital manufacturing technology is that it allows for viable lot-one-size production because it does not require tooling and only minimal set-up time [34]. In addition, the expertise needed to operate AM machinery is well transferable between products, which means that a person that is able to use an AM machine can manufacture any part that the machine is capable of manufacturing [35]. When discussing AM in supply networks, these benefits translate into decreased changeover time [36], decreased energy costs [37], increased sustainability [38] and cost reduction in long tail production [39].

Although these benefits apply to all types of components that are manufactured with AM, there are also opportunities for parts that were not primarily designed for AM to leverage the technology. Such cases are, for example, pre-production components, one-offs, and spare parts. Therefore, a modified workflow for components not designed for AM is presented in Figure 7.

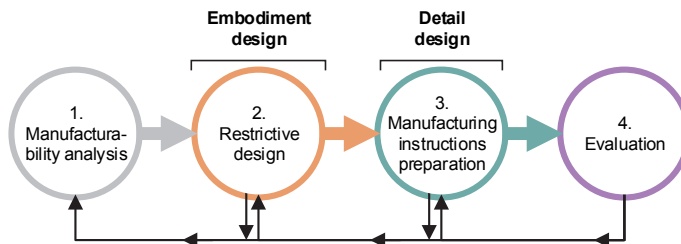

Figure 7. Workflow for components not designed for AM.

The workflow for components not designed for AM further reduces the original workflow by removing the opportunistic design stage. The modified workflow has an added manufacturability analysis stage, in which an appropriate AM technology and material are chosen, and the manufacturability of the component is evaluated. If the component cannot be directly manufactured as is, it goes through the restrictive design stage. The evaluation of the component in this case relates to the operational advantages because the performance of the component should be similar to the original counterpart.

The digital nature of AM production has attracted the interest of researchers, especially in the field of spare parts because spare part management is very important for any company that deals with physical products. The unavailability of spare parts can lead to long unproductive downtimes that affect the profit of the operating company [40]. Factors affecting this behaviour have their roots in the uncertainty regarding the timing and quantity of component demand,

coupled with the unpredictability of failure occurrences. Due to these reasons and to avoid stock-outs, companies hold very high levels of spare part inventories, which leads to high inventory holding costs [41].

Other issues related to spare part management are the low number of suppliers and the variability in the quality of the suppliers' product. Another issue is obsolescence because it can be challenging to foresee how many spare parts should be held for machines that are no longer manufactured [42]. AM may be able to solve the impossible equation of holding low inventory while still managing to maintain high spare part availability [43].

2.4 End-use AM application categories

Based on Sections 2.1–2.3, it is reasonable to argue that three categories of end-use AM applications, each with a practical design workflow, can be found when examining the literature surrounding DfAM. The categories and their properties are collected in Table 3.

Table 3. The three categories of end-use AM applications and their properties.

Category	Primary motivation	Primary strategy	Design work required	Literature available
Components designed for AM	New functionality	Functional	Extensive	Sparse
Components redesigned for AM	Improved performance	Functional and manufacturing	Average	Abundant
Components not designed for AM	Spare parts One-offs Pre-production	Manufacturing	Short	Sparse

3. Methods

A combination of engineering and social studies methods has been used in this thesis to answer the research questions. Extensive case studies are presented for the three categories of end-use AM applications to demonstrate in detail what can be achieved.

The benefits of the first two categories—components designed and redesigned for AM—are demonstrated in a similar manner. The primary method in these cases is 3D modelling and additively manufacturing a component and testing its performance.

For the category of components not designed for AM, it is of some interest how parts can be made compatible with AM with little design work. However, the main interest lies in opportunities related to the manufacturing strategy. Therefore, the opportunities of the category were investigated using Monte Carlo simulations of a supply network, focus group interviews, and concept definition. The methods used in each of the articles are listed in Table 4.

Table 4. The research methods used in each article.

Method	Article I	Article II	Article III	Article IV
Case study	X	X	X	
Focus group interviews				X
Concept definition				X
Monte Carlo simulations			X	

3.1 Case studies

One case study was chosen to represent each category. A minimalistic heat exchanger was chosen to demonstrate parts directly designed for AM. This case study shows well that parts designed for AM do not have to be overly complex to bring extra value. The heat exchanger case study contains a problem that would force the design process to be stopped in conventional manufacturing, but in AM this problem can be solved in an elegant manner. Additionally, the case study serves as a demonstration of using the weaknesses of AM as an advantage. The software used to design the heat exchanger was PTC Creo 3.0.

The heat exchanger was manufactured from AlSi10Mg using the EOS M400 system.

A complex digital hydraulic block was chosen to present how parts can be redesigned for AM. This part was chosen because it is a prime example of how the design freedom of AM can be used to bring additional value to a component. The valve was previously severely restricted by its manufacturing method and could gain from being redesigned for AM. Because of its internal complexity, the valve was also a great way to demonstrate the techniques used in redesign for AM. The redesign was likewise done in PTC Creo 3.0, and the component was manufactured from tool steel (EOS MS1) with EOS M400.

A simple part of a portable computer was chosen to demonstrate how existing parts can be made compatible with AM with little effort and what benefits it can bring to the supply chain. The part was chosen because the author has extensive work experience in warranty repair of portable computers and is intimately familiar with the supply network of spare parts in that setting. The supply network of warranty repair of consumer electronics is a simple one, yet applicable in the real world. Therefore, its performance was convenient to simulate with Monte Carlo simulations, which were done in Microsoft Excel.

3.2 Focus group interviews

To delve deeper into the opportunities of AM as a digital manufacturing method, a series of focus group interviews on the topic of digital spare parts (DSP) were conducted. Focus groups are a common tool in management research to measure the interest of company leaders in future possibilities [44] and an excellent tool to determine the perceived value of research concepts in real-life applications [45]. The research questions of the focus group interviews were related to the perception of the value of the DSP concept and its main advantages and criticalities.

Five focus group interviews were conducted in 2016 in Espoo, Finland, with 46 participants from 34 Finnish companies. The size of the groups varied from 8 to 11 participants, and no group was allowed two participants from the same company. The participants' work experience and position within their company are presented in Table 5. The participants were recruited by public invitation, and everyone was accepted as long as they were a professional working in a field related to manufacturing.

Table 5. Focus group participant characteristics.

	AM service provider (n = 7)	AM software developer (n = 2)	Manufacturing subcontractor (n = 9)	National institute (n = 3)	Original equipment manufacturer (n = 22)	Other (n = 3)	Total (n = 46)
Work experience in years							
<5	1	0	1	1	4	1	8
5-10	2	0	2	0	5	0	9
10-15	2	2	1	1	4	0	10
15-20	0	0	3	0	4	2	9
20-25	0	0	2	0	3	0	5
>25	2	0	0	1	2	0	5
Position in company							
Specialist	0	0	2	2	9	1	14
First-line management	0	0	3	1	4	0	8
Middle management	1	1	0	0	6	1	9
Top management	6	1	4	0	3	1	15

The interviews of all five groups were held simultaneously, and each lasted approximately two hours. Each group was tended to by two researchers familiar with AM. One of the researchers acted as the moderator, and the other took continuous notes during the interviews. Ten AM researchers in total participated in the moderation of the focus groups. At the beginning of the session, the participants were collectively given a short introduction to the concept of using AM to produce spare parts, as suggested by the focus group research of Angell and Klassen [46].

A pre-defined questioning routine was developed jointly by the ten researchers and used with each group to make the results comparable. The questions were based on the literature presented in Section 2.3 of this thesis. The routine and the references that inspired each question are shown in Table 6.

Table 6. Semi-structured questioning routine used in the focus group interviews.

Theme	Question	Relevant literature
Theme 1: Current status of spare parts management	1. What are the biggest problems with spare part production and logistics?	[47], [48]
	2. What type of products will benefit from being additively manufactured?	[49]
Theme 2: Digitization of spare parts, new possibilities	3. What percentage of spare parts can be additively manufactured?	[49]
	4. What do you think of the possibilities of digitizing existing spare parts?	[43]
	5. What are the obstacles in digitizing spare parts?	[49]
	6. What kind of changes will digital spare parts bring to the service functions of a company?	[50], [51]
	7. Should spare part production become more open, or should it stay locked to the OEM?	[52], [53]
	8. What type of actors and skills are needed?	[54]
	9. What could be the position of your company in the new paradigm?	[54]
Theme 3: Digital spare part network and its requirements	10. What action is required from the companies and governmental institutions?	[54]
	11. Is it realistic to create a DSP network?	[54]
	12. What kind of data issues might arise?	[52], [53]

The data were collected in four steps. First, the participants were given the task to write down their opinions on specific issues. Second, the participants were given time to compare notes in small groups. Third, the data from groups were synthesized into single-voice opinions. In the final step, the groups were free to present their views, which were used as the basis for discussions. The collected data consisted of the notes taken by the researchers and the written material of the participants. Each of the pairs of researchers made summaries of the interviews shortly after the interviews to make sure that the text represented well the voiced opinions. The material was codified by one of the researchers according to the codes that emerged inductively during the data analysis process. The used codes were:

- Problems in spare parts management
- New possibilities of digitization of spare parts
- Obstacles in digitization of spare parts
- Description of required properties of digital spare parts
- Description of a digital spare parts network
- Factors that facilitate the development of a digital spare parts network

3.3 Concept definition

To better define the concept of digital spare parts, the methodology of concept definition presented by Podsakoff [55] was used. In the methodology, the relevant literature is first scoured for key attributes related to the concept. These key attributes are then reduced until only the core attributes remain. In the concept definition of digital spare parts, this was done by comparing the key attributes from the literature to the ones acquired from the focus group interviews. After the core key attributes were acquired, they were compiled into a table and checked for necessity and sufficiency against the concepts of “additively manufactured parts” and “traditionally produced spare parts”. From this information and from the consequences of DSP found in the literature and focus group interviews, the concept of digital spare parts was given a formal definition.

4. Investigations

In this section, the work conducted in the articles is presented along with the results. The presentation is done from the perspective of categories “components designed for AM”, “components redesigned for AM” and “components not designed for AM”, and their respective workflows introduced in Section 2.

4.1 Design of a novel counterflow heat exchanger

In this case study, a powerful liquid-to-liquid heat exchanger was designed in such a way that it could not be traditionally manufactured. The design process of the heat exchanger was conducted from the beginning to demonstrate the advantages of not considering technological restrictions of the manufacturing method in the functional requirements and interface definition stages.

Functional requirements definition

Taking inspiration from a conventional counterflow heat exchanger, the heat exchanger of this study was designed to include as its central functional element of a tightly packed checkerboard of square pipes. The sides of the square pipes were defined to be as small as possible without forming a significant capillary effect, which would be detrimental to the flow of liquids. The reason for using pipes with a small hydraulic diameter is the increase in the overall internal surface area of the heat exchanger.

In addition to the miniature channels, the heat exchanger design takes advantage of the high surface roughness of AM. The surface roughness that is typically detrimental to AM further raises the surface area of the channels and keeps the turbulent flow from becoming laminar. This is beneficial because the heat transfer coefficient of a turbulent flow is much higher than that of a laminar flow [56].

The idea of the central element of the heat exchanger is pictured in Figure 8. The design process has been exaggerated in this section because designers would normally skip several of the steps demonstrated here. Nevertheless, the steps are included to improve the demonstration.

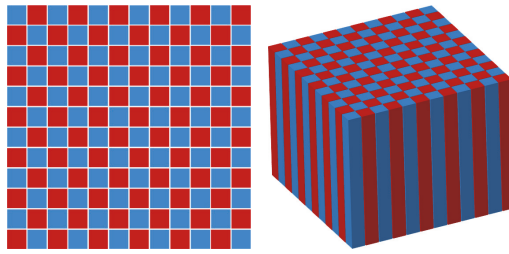

Figure 8. The central functional element of the novel heat exchanger: 144 channels in a checkerboard pattern.

Interface definition

Once the central element was developed, the interfaces necessary to connect the heat exchanger to the outside were needed. In this case, two pairs of tubes of at least 6 mm in height and 10 mm in internal diameter were chosen.

Opportunistic design

At this point, the major obstacle (and the main reason why this design cannot be subtractively manufactured) becomes evident. In order to connect the checkerboard to the outlets, every individual channel of the two sets of 72 channels has to be redirected separately and led into the four connecting flow ports.

Because the concept generation was not restrained by manufacturing limitations, a novel solution could be devised. In the solution, one set of channels would be redirected to the side of the heat exchanger through a lattice and the other set would pass through the lattice. This redirection method is presented in Figure 9.

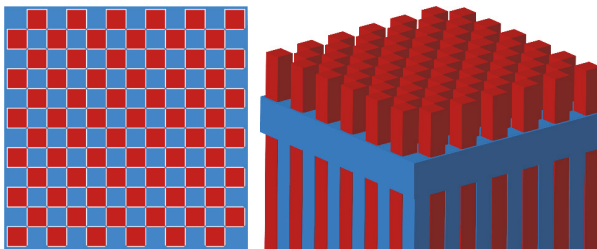

Figure 9. A redirection technique in which the cold channels are diverted into a lattice and the hot channels pass through.

Once the channels are redirected, a flow port can be added to the side of the lattice and another can be added on the end, as shown in Figure 10.

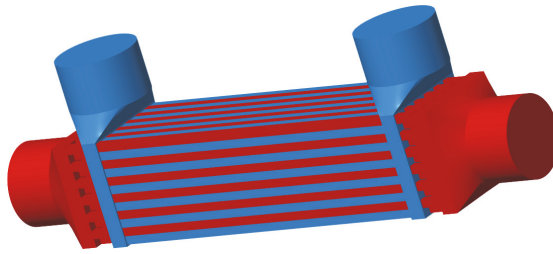

Figure 10. The heat exchanger with lattice redirection and connections to flow ports.

Restrictive design

The design shown in Figure 10 would technically work if any manufacturing technology were able to produce it. However, when considering the limitations of AM, the design is not manufacturable. At this point of the design process, the AM technology and material used to produce the heat exchanger were selected. Because of the small details in the design, the technology of highest accuracy needed to be chosen. The selection process was also guided by the material choice, which was to be a metal with decent conductivity. Once these attributes were considered, the AM technology of selective laser melting (SLM) was chosen to produce the heat exchanger. Of the metals available for SLM, the most affordable one with decent conductivity, AlSi10Mg, was chosen.

Once the technology and material were known, the restrictive design phase could be considered. In the documentation of the material, the minimum wall thickness of 0.3–0.5 mm is given [57]. However, since the functionality of the heat exchanger would be threatened if any one wall within it were to burst (causing the liquids to be mixed), a thicker wall thickness of 1 mm was implemented.

Functional requirements definition

The addition of the minimum wall thickness affected the entire design of the heat exchanger because the central element had to be redesigned. The redesigned main element with the channels 1 mm apart from one another is shown in Figure 11.

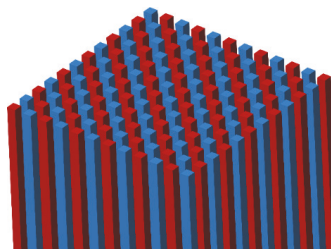

Figure 11. The main element of the heat exchanger with channels 1 mm apart from one another.

The inclusion of the wall thickness consideration was especially notable on the lattice side of the design. Because the minimum wall thickness was 1 mm and there was only 1 mm between the channels, there was no space for any connection between the channels. Therefore, the channels had to be spread out to 3 mm from one another at each end of the heat exchanger. This change can be seen in Figure 12.

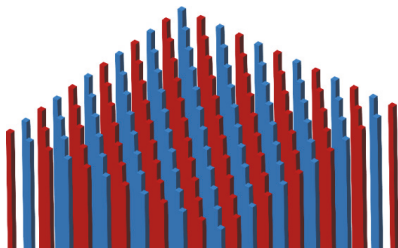

Figure 12. The channels spread out to 3 mm from one another at the lattices.

Opportunistic design

Once the channels were spread out to 1 mm from each other in the centre and to 3 mm from each other at the ends, curved channels could be created to connect these two checkerboards. Each of the channels follows its own trajectory, which would be extremely difficult if not impossible to create using subtractive manufacturing. The curved channels connecting the two checkerboards are shown in Figure 13.

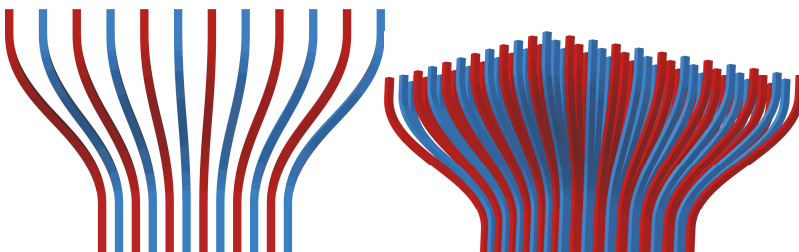

Figure 13. The curved channels between the central element and the lattice.

Because the channels were spread to 3 mm from each other, a lattice could now be created between them to connect the cold channels and to guide them to the outside. The hot channels now also had enough space to pass through the lattice. In the final phase of creating the channel system, the funnel chamber was designed to cap the hot channels, and flow ports were added to both sets of channels. These stages are shown in Figures 14 and 15.

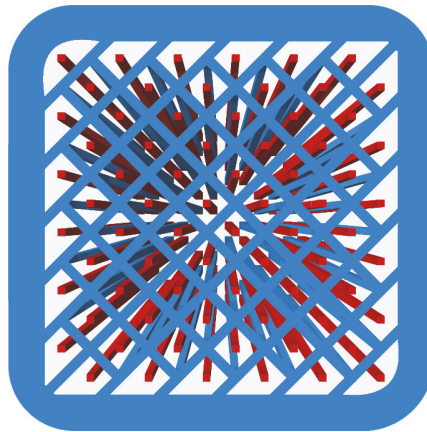

Figure 14. A section of the lattice structure showing cold channels being redirected into the lattice and hot channels passing through.

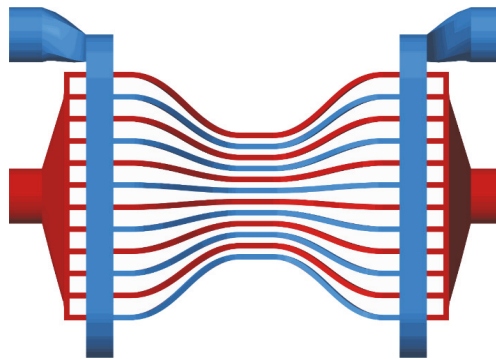

Figure 15. A side view of the finished heat exchanger channel system.

Once the design of the channel system was finished, the heat exchanger could be created. This was achieved by creating a cut-out from a solid block and removing all the material outside of the channel system at the distance of 1 mm where possible. The result of the cut-out, the finished design of the heat exchanger, is shown in Figure 16 as a wireframe projection and as a solid model in Figure 17.

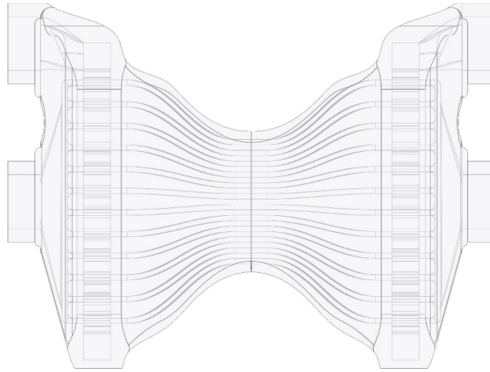

Figure 16. A wireframe side view of the finished heat exchanger design.

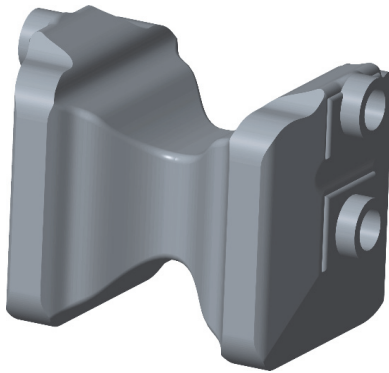

Figure 17. A solid isometric view of the finished heat exchanger design.

Restrictive design

With the design finished, it could be examined for possible necessary changes from the point of view of the used material, AlSi10Mg, and manufacturing method, SLM. Although the wall thickness had already been considered when creating the shell for the heat exchanger, the walls around the connectors were further reinforced to avoid the risk of bursting. The remaining manufacturability questions were related to the support structures used in the manufacturing process and whether the powder that would be left inside the channels in the process could be removed afterwards. Because of the nature of the component, no internal support structures could be allowed. Fortunately, the angles of the design were steep enough for AlSi10Mg not to require any internal supports, and no modification was needed. The channels inside the heat exchanger each had one overhanging side, but as it was only 1 mm long and the surface roughness requirement was not strict, this was not a major issue. The question of powder removal proved more challenging because there is not much information available on the matter. The only way to find this out was to manufacture the component and test the performance afterwards.

At this point, the cost of manufacturing the heat exchanger was considered. As the material was already decided, service providers were contacted to tender offers. The lowest offer from a German service provider, €1261.10, was accepted. It should be noted that the cost of procuring AlSi10Mg parts has become considerably lower since the heat exchanger was manufactured for this study, and it could now be procured for under €800.

Manufacturing instructions preparation

The heat exchanger was manufactured successfully from AlSi10Mg, with a layer thickness of 60 μm and sandblasted to remove traces of the external support structures. As the only machining step, threads were manually added to each flow port. The flow ports were subsequently fitted with hose adapters to test the heat transfer performance of the heat exchanger. The manufactured heat exchanger fitted with hose adapters is shown in Figure 18.

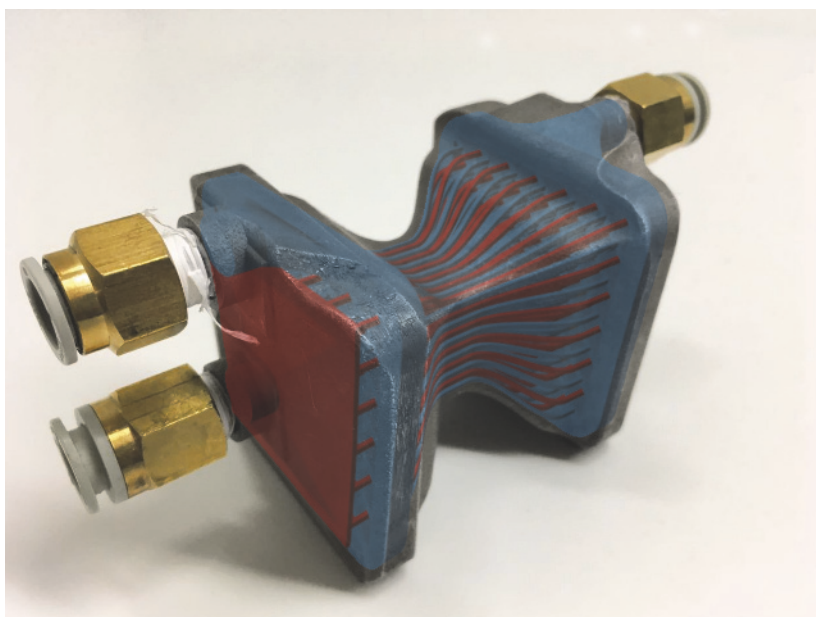

Figure 18. The designed heat exchanger channels superimposed onto the manufactured heat exchanger fitted with adapters for hose connections.

Evaluation

The heat exchanger was tested in a counterflow set-up with an approximate temperature difference of 50 degrees centigrade. The measuring set-up can be seen in Figure 19.

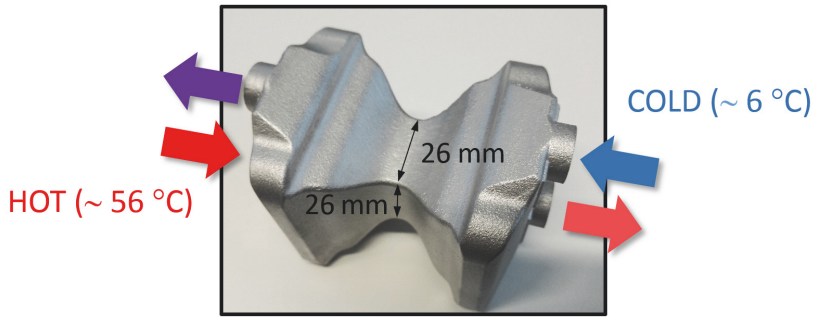

Figure 19. The test set-up of the heat exchanger.

The heat flow in relation to the liquid throughput of the heat exchanger is presented in graph format in Figure 20.

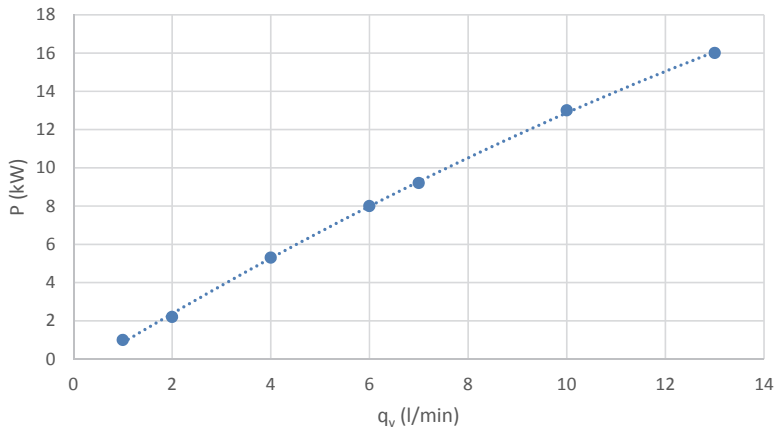

Figure 20. The heat flow of the heat exchanger designed in this study.

The heat exchanger performed exceptionally well with the peak heat transfer of 16 kW at a flow rate of 13 l/min. The measured heat transfer is not the maximum performance of the heat exchanger, but it is the limit of the source of liquid available for the experiment. Due to its construction, the heat exchanger could handle higher flow rates and pressure drops and result in even higher heat transfer rates.

To put the performance of the heat exchanger into perspective, its conductance G is calculated from the data presented in Figure 20. The conductance is then compared with commercially available liquid-to-liquid heat exchangers. Two models are chosen to represent traditional plate heat exchangers: the LL510G12 and the LL820G12 both designed and manufactured by Lytron Inc. These heat exchangers were chosen because their performance information is publicly available [58]. The conductance of the heat exchanger designed in this study and the commercial ones is presented in Figure 21.

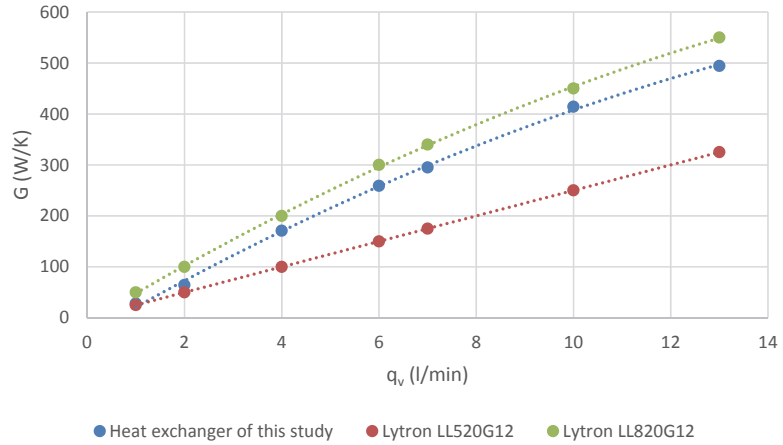

Figure 21. Conductance of the heat exchanger of this study and a commercial liquid-to-liquid plate heat exchanger.

The conductance of the heat exchanger developed in this study is between the two commercially available heat exchangers with which it was compared. This shows that the performance is comparable with commercially available solutions. However, the result is not conclusive because the presented values do not account for the size of the heat exchanger. To do so, the conductance at each point is divided by the volume of the heat exchanger and the resulting information is presented in Figure 22.

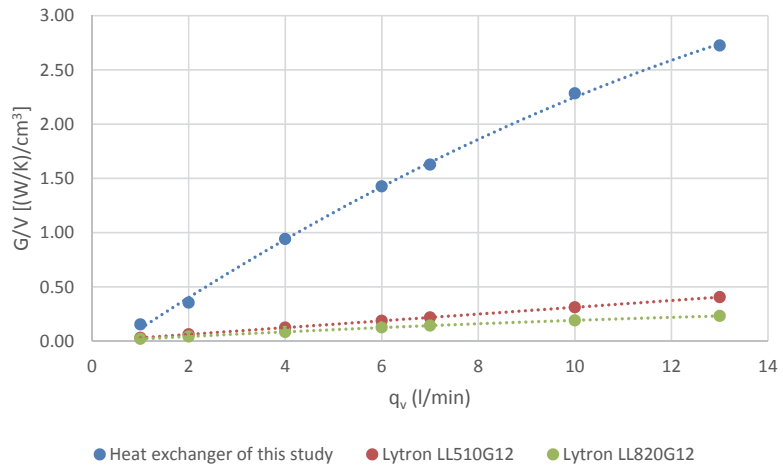

Figure 22. Conductance of the heat exchangers divided by their volume.

The volume of the heat exchanger was calculated from the outer envelope, meaning that the hollowing of the channels was not taken into account. When accounting for volume, the performance of the heat exchanger developed in this

study is significantly better than that of commercially available products. At the flow rate of 13 litres per minute, the conductance per volume of the heat exchanger designed for this study is 7.26 times higher than that of medium-sized commercial heat exchanger and 12.25 times higher than that of the large heat commercial heat exchanger.

Aside from the exceptional performance, the advantages of the heat exchanger also include benefits from the point of view of the manufacturing process. Because the heat exchanger is built in one piece, it does not need assembly; and since the walls inside of it did not burst, it is a leak-free design without using any seals. Additionally, manufacturing this design of a heat exchanger is possible with any SLM machine that can process AlSi10Mg. This contrasts with traditionally manufactured heat exchangers, which require capital-intensive machinery to manufacture. Therefore, it could be beneficial to manufacture this heat exchanger when one is needed quickly, and a traditional type is not readily available. As such, although the primary design strategy of this case study is functional, it also demonstrates how components designed for AM can also benefit from the manufacturing design strategy.

Summary of design process

The design of the heat exchanger involved each step of the process and included backtracking to earlier steps to resolve issues. A summary of the design process is presented in Figure 23.

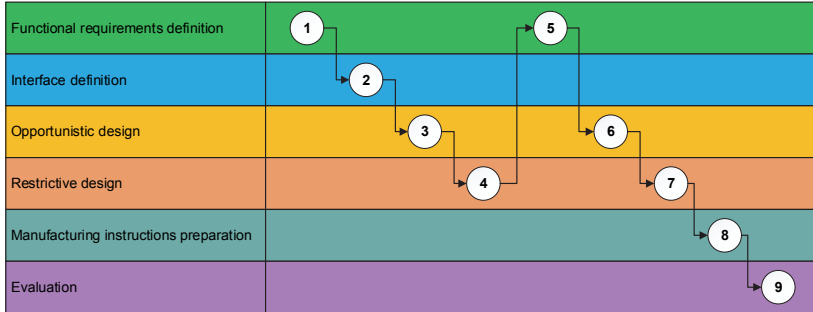

Figure 23. The design process of the counterflow heat exchanger.

The design steps of the design of the counterflow heat exchanger are thus explained:

1. Development of the checkerboard matrix heat element
2. Definition of the four outlets
3. Development of the first version of the lattice-and-chamber redirection system
4. Addition of the wall thickness requirement
5. Re-evaluation of the checkerboard matrix due to the wall thickness requirement and redesign of the lattice

6. Design of the curved channels to connect the channels of the central element to the lattice and chamber
7. Reinforcing of the walls around the connectors and cost comparison of service providers
8. Deciding the manufacturing orientation and machine
9. Fitting the heat exchanger with hose adapters and performing heat transfer tests

Summary of technical and operational benefits

The main technical benefit of using AM in the heat exchanger developed for the study is the ability to produce a functionally novel type of heat exchange element that performs exceptionally well. Other technical benefits include the omission of assembly and machining and the favourable surface roughness.

The best offer for producing the heat exchanger came from a Finnish company that quoted the cost at €545. The cost of the commercial heat exchangers when bought directly from Lytron is \$319 (€279.30) for LL510G12 and \$600 (€525.28) for LL810G12. From this, and from the conductance of the heat exchangers, their performance in relation to their cost at 13 lpm can be calculated, as shown in Table 7.

Table 7. Characteristics of the heat exchangers at 13 lpm.

Model	AM heat exchanger	Lytron LL510G12	Lytron LL820G12
Performance (W/K)	494.2	325	550
Volume (cm ³)	181.4	800.1	2361.6
Performance per unit of volume [(W/K)/cm ³]	2.72	0.41	0.23
Cost (€)	545	279.20	525.28
Cost per unit of performance [€/ (W/K)]	1.10	0.86	0.96

As can be seen in Table 7, the performance per unit of volume of the heat exchanger of designed in this study is an order of magnitude higher than that of the commercially available plate heat exchangers. However, when looking at the cost per unit of performance, the additively manufactured heat exchanger is slightly more expensive than the commercial counterparts. From the technical point of view, therefore, the heat exchanger of this study should be used only when the space is limited.

The potential operational benefits of the additively manufactured heat exchanger are limited and its main reason of application is its performance. The only operational benefit of the heat exchanger is that it can be produced by anyone with an AM machine that can process AlSi10Mg. The heat exchanger can therefore be manufactured in many more places than tube or plate heat

exchangers that require extensive production chains that are only found in specific locations.

4.2 Redesign of a digital hydraulic valve manifold

The case study chosen to represent the “Components redesigned for AM” category was the central manifold of a novel digital hydraulics system. Hydraulics, and components that benefit from internal flow optimization in general, are a common application of redesign for AM in the literature. Optimization of hydraulic components using AM has been demonstrated by several researchers, such as Wei et al. (2007), Cooper et al. (2012), and Farré-Lladós et al. (2016) [59]–[61]. In addition, AM is much used in the improvement of cooling channels in moulds and other components that heat up. In such instances, the concept is called conformal cooling. [62]

The object of the redesign in this case, the digital hydraulic valve developed by Lantela and Pietola (2017) [63], works on the principle of limiting the flow with a parallel series of miniature valves of different diameter. In the valve used in this study, there were eight valves of four different diameters. Because the flow could be restricted by a combination of any of them, there were 23 steps in restricting the flow. In such a manner, the flow can be controlled extremely precisely. This type of precision causes a very high level of complexity in the channel system of the manifold through which the liquid passes. The original design could not be manufactured with traditional manufacturing methods but had to resort to laminate brazing, a method occasionally employed in the heat transfer industry [64]. In this method, thick sheets are used as the material and they are cut into shape using a laser or water jet and subsequently machined to remove the angle of beam or stream. The sheets are then treated with a bonding material, stacked, and raised to a very high temperature in a furnace [65]. The method could be considered AM, but it is so reliant on manual labour that it would be misleading to label it as such.

The laminate brazing manufacturing method makes it possible to manufacture quite complex components. It is, however, also severely limited when compared to AM. While there is near absolute freedom in the design of the laminates in the horizontal direction, the vertical resolution of the component is decided entirely by the thickness of the sheets. Additionally, the laminate brazing manufacturing method does not allow separate shapes, or islands, on a single layer. From a more practical point of view, brazing requires a tool chain of many specialized machines that are very rarely found together [66]. The original manifold and laminates from its manufacturing method are shown in Figure 24.



Figure 24. Original design and manufacturing method of the digital hydraulic manifold.

Because of the limitations of laminate brazing, there was a great opportunity to improve the manifold by redesigning it for AM. The major advantage that AM would bring from the functionality point of view is the free shaping of the flow channels. Because of the complexity of the manifold and the foreseeable advantages, it was decided that it would be an excellent demonstration of the opportunities of redesigning components for AM. The manifold also contained some features that would require very high precision, which would give an opportunity to demonstrate how to design for demanding requirements in AM.

Redesign analysis

As with any component that is redesigned, the manifold was first analysed in order to identify the main functional features and interfaces and to define the design space. To do this, the original model was stripped of any features that could be changed until only the external and internal interfaces that had to remain unchanged were left. This process is essential in any redesign because a failure to note a feature that cannot be changed at this stage may cause significant rework in later stages. In this case, this stage was quite safe because the redesign was done in collaboration with the researcher who had designed the original manifold and could give very accurate information on its functionality and interfaces. The internal structure of the original manifold is shown in Figure 25, and the critical interfaces are shown in Figure 26.

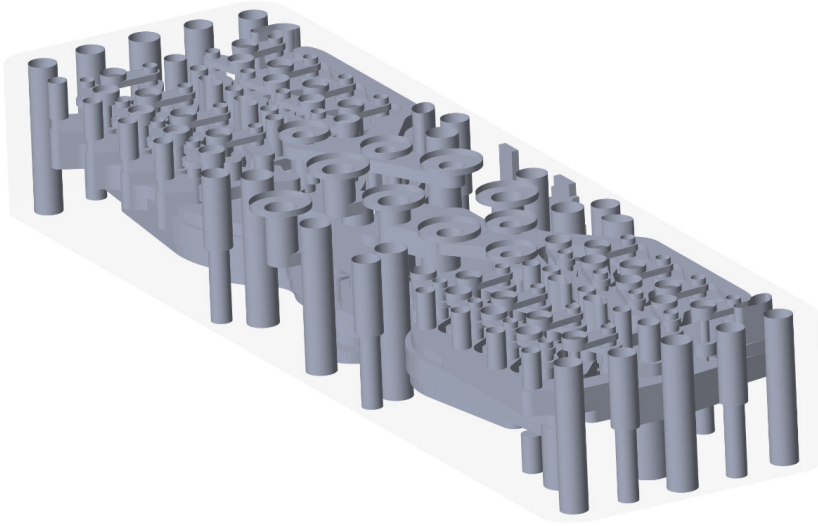

Figure 25. The internal structure of the original digital hydraulic manifold.

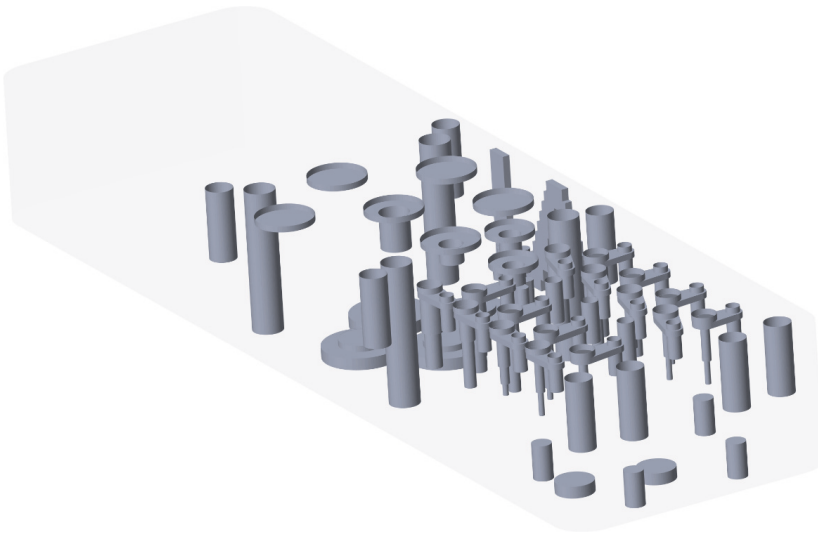

Figure 26. The functional interfaces of the digital hydraulic manifold used for the redesign.

Restrictive design

Because of manufacturing cost considerations and the workload required to redesign the channels, only half of the manifold was redesigned. This was not a significant limitation, however, because the functionality of that half of the manifold remained unchanged. Designing such a complex geometry is very time-consuming, and designing in an idealistic manner without considering manufacturing limitations could lead to significant rework at the end. Therefore, the manufacturing technology, material, and manufacturing

orientation were chosen immediately after identifying the interfaces. SLM was chosen for the technology, EOS M1 tool steel was chosen as the material, and an upright orientation was chosen as the build orientation.

SLM was chosen because it was the only technology with the required precision to manufacture the metal component, as the tolerance of a specific dimension within the manifold had to be at maximum $\pm 50 \mu\text{m}$ to maintain the functionality of the hydraulic system. The alternatives, electron beam melting (EBM) and directed energy deposition (DED), cannot normally achieve such tight tolerances [17]. As for the material, M1 tool steel was chosen as the most widespread tool steel option with a sufficient tensile strength of over 1900 MPa in all directions.

The manufacturing orientation was also chosen because of the specific internal dimensions (shown in Figure 27) that had to be as close as possible to 3 mm. The accuracy of the material as listed in the material sheet was $\pm 50 \mu\text{m}$ up to 50 mm in height and less after. $\pm 50 \mu\text{m}$ was on the border of being acceptable, so the manufacturing orientation had to be chosen accordingly. Another advantage of the chosen orientation was that the main channels would run roughly along its z-axis, which meant that they would not require internal supports.

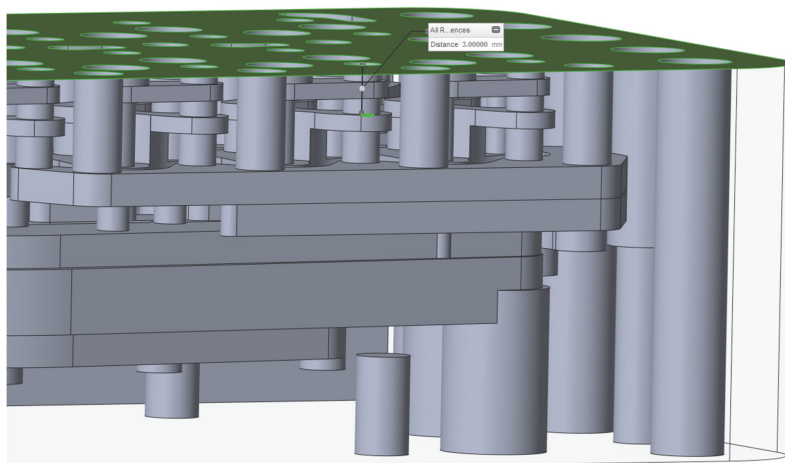

Figure 27. The dimension that had to be as close to 3 mm as possible. There were in total sixteen of these dimensions, as each of the eight valves on both sides had this feature.

The main limitation imposed by the manufacturing technology and the material was that supports could not be removed afterwards, which meant that internal supports could not be allowed. A limitation related to this was the 45-degree maximum angle of overhanging features to make sure that internal supports were not needed. The wall thickness limitation according to the material sheet was 0.3–0.4 mm [67].

Opportunistic design

After defining the set of limitations and the interfaces, the channel system was designed according to the planned flow distribution system of the manifold. The process of design was entirely driven by connecting the correct interfaces with one another through channels with correct hydraulic diameters. Because of this, and because of the intricacy of the interfaces in the throttling area, the top part of the redesigned component is quite similar to the original design. Some improvements can be seen in the smoother shape of the small risers connecting the main channels and in the more delicate dimensioning of some of the channels, but the designs look very similar from this angle. The comparison of the main interface side of the two designs is shown in Figure 28.

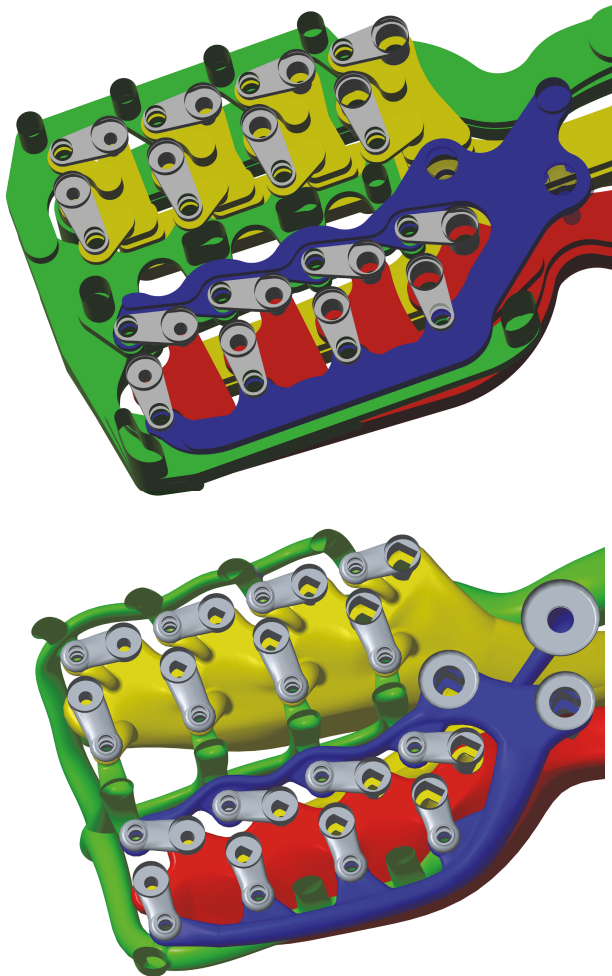

Figure 28. Comparison of the interfaces of the original model (top) and the redesigned for AM model (bottom).

A larger improvement, and indeed the main advantage of the redesigned component, can be seen in the smoother shaping of the main channels. Because the design was no longer restricted in any direction except by the, by comparison, lenient limitations of the selective laser melting process, the channels could change shape and diverge much more naturally. This made it possible to design the channels in such a way that they could fit next to one another and keep the correct hydraulic diameters. Additionally, it allowed the diverging risers to be designed in the direction of the flow instead of the earlier solution of using straight angles. An example comparison of the channel shapes is shown in Figure 29.

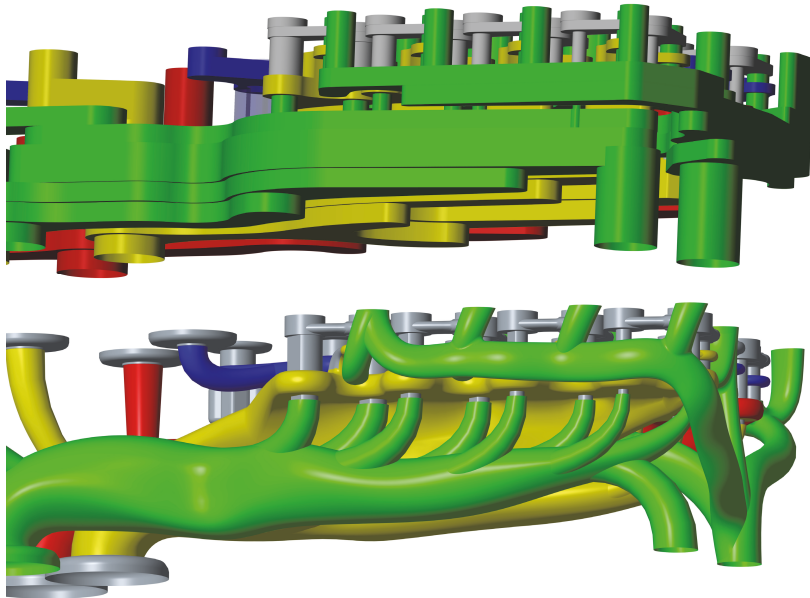

Figure 29. Comparison of channel shape of the original model (top) and redesigned for AM (bottom).

The shape of the channels had a significant impact on the side of the manifold with no interfaces. As can be seen in Figure 30, although the proportions of the flow distribution system were kept the same, redesigning the channels for AM resulted in much more organic shapes and more compact placement of features.

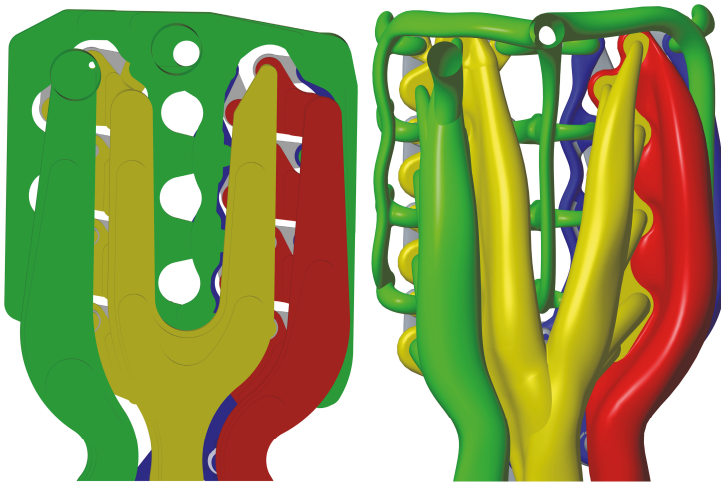

Figure 30. Comparison of overall channel system of the original model (left) and redesigned for AM (right).

To give an idea of how complex the channels were designed to be, cross-sections of the manifold at 5 mm intervals in the manufacturing orientation are shown in Figure 31.

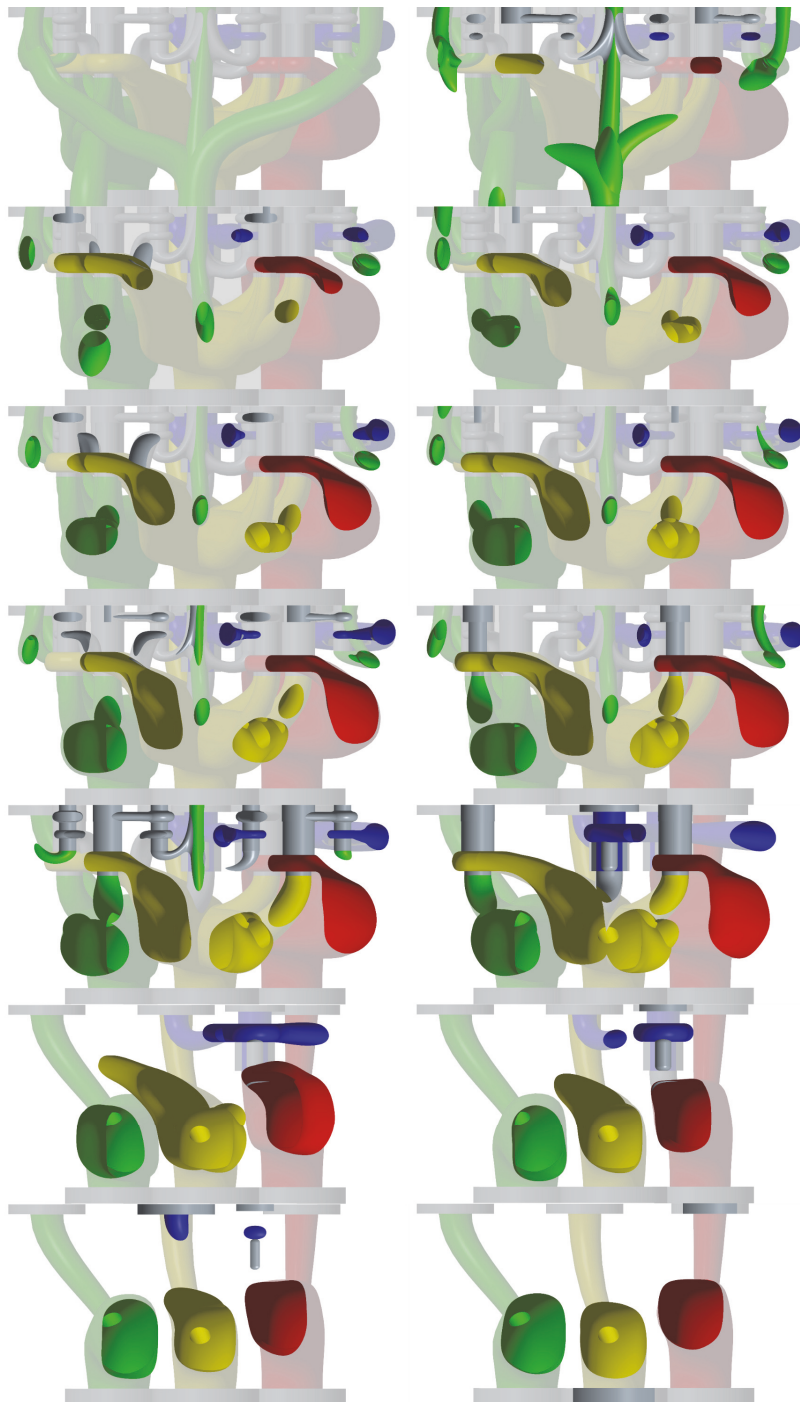

Figure 31. Cross-sections of the redesigned manifold channels at 5 mm intervals.

What should be noted about the channels is the constantly changing area of the flow cross-section and the connections to other channels. The shaping of the channels was done by hand in CAD software and was guided by the goal of minimizing deceleration of the liquid passing through the channels with a general understanding of fluid dynamics. The major advantage of the new design came from the lack of swirls in the main channels and fluent redirection in the valves. In later stages, critical channels were analysed with CFD and iterated to achieve improved results. A CFD simulation of a channel connection, the red one to the yellow one in the figures, is shown in Figure 32 as compared to the original design. The final and original channel systems are shown in Figure 33.

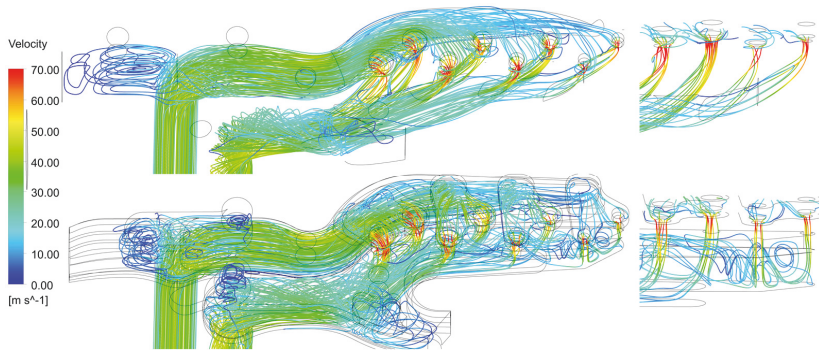

Figure 32. CFD simulation of a section of the original manifold (bottom) and the manifold redesigned for SLM (top). The improvement of the flow characteristics is most notable from the reduction of swirls.

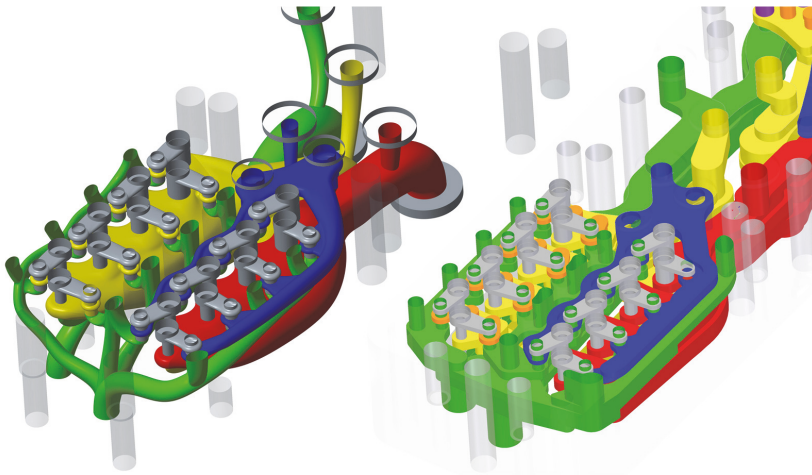

Figure 33. Channels of the original digital hydraulic manifold (right) and redesigned for SLM (left).

Restrictive design

Once the new channels of the manifold were designed, the entire structure was verified for manufacturability. This included checking each minimal wall thickness and overhang angle of the manifold. Several corrections had to be carried out to make the design manufacturable without internal supports. In the end, all internal supports could be eliminated except for a small overhang that was necessary for pressure measurement purposes and could not be changed sufficiently to avoid supports. Fortunately, the required support was in a location that allowed for it to be machined afterwards. The location and support structure of the feature is shown in Figure 34. In addition to ensuring that no internal supports would be needed, all external orifices that could be machined and that were larger than 2 mm in diameter were supported with triangular shapes to prevent as much sagging of the channels as possible. The augmentation of the holes to be triangular on one end is also shown in Figure 34.

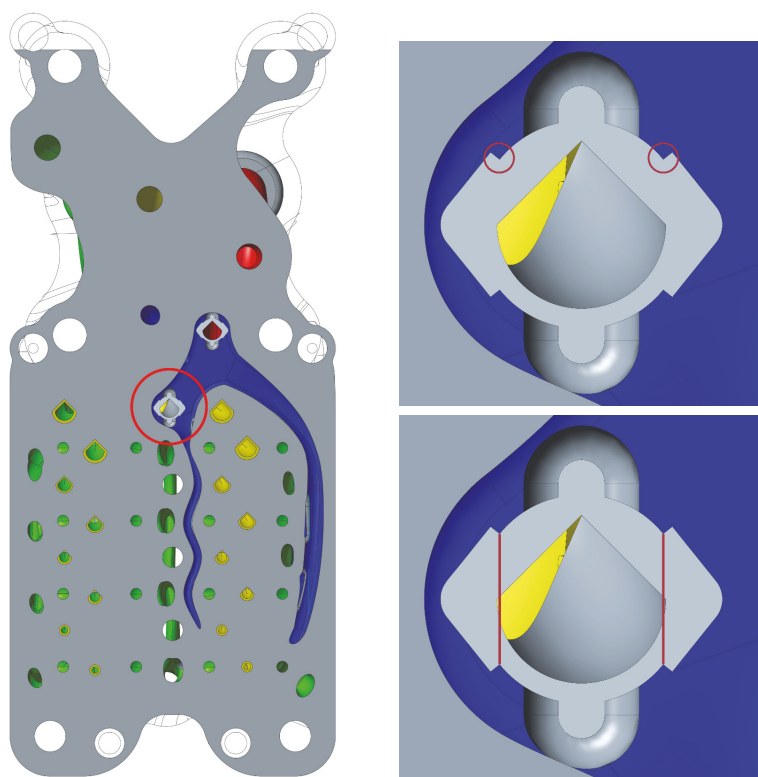

Figure 34. A section at the depth of 3 mm from the front face of the redesigned manifold (left) showing the location of the only internal support needed in the production of the component. The location of the support is shown in more detail in the top-right close-up and the type of support used is shown on the bottom-right.

The procurement cost of the manifold was considered at this stage. Because the material was already chosen, the remaining question was which service provider to use. A German service provider tendered an offer of €901.50, which was accepted.

Manufacturing instructions preparation

After the design was finished, manufacturing instructions were made, and the manifold was manufactured in an EOS M400 machine with the layer thickness of 50 μm . All the round orifices that were accessible were subsequently machined. The selective laser melted and the original hydraulic manifolds are shown in Figure 35.

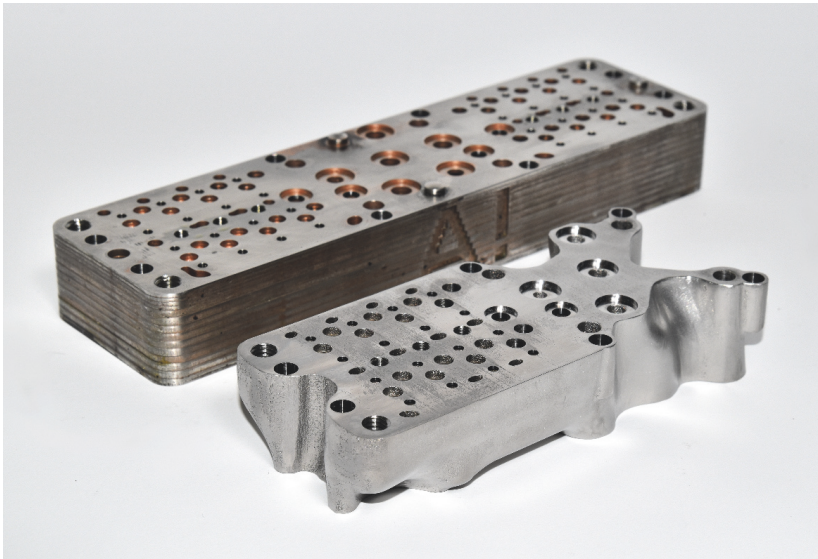

Figure 35. The original laminated digital hydraulic manifold (top) and selective laser melted manifold (bottom).

Evaluation

The redesigned and additively manufactured hydraulic manifold was tested in the same set-up as the original manifold [63]. The improved channels of the hydraulic block proved highly beneficial, as the tests showed that there was a significant increase in the flow rate compared to the original design. The largest improvement measured in a single valve was 39%. The detailed improvements in flow rates of individual metering edges are presented in Table 8. In addition to the improved flow rates, the pressure loss of the hydraulic system was reduced from 3.7 MPa with the brazed manifold to 1.9 MPa with the selective laser melted manifold. Redesigning the manifold therefore reduced the pressure drop of the hydraulic system by 49%.

Table 8. Measured flow capacities of the valves in metering edges of the laminated and selective laser melted manifolds with a 3.5 MPa pressure difference.

Valve no.	P-A Laminated [l/min]	P-A SLM [l/min]	Improvement (%)
8	21.9	26.8	22
7	19.5	27.2	39
6	12.8	16.7	30
5	12.3	16.9	37
4	9.9	12.2	23
3	9.8	12.9	32
2	5.0	5.3	6
1	5.4	5.2	-4

Summary of design process

The redesign of the digital hydraulic manifold included all the steps of the process and considering the restrictions of the SLM method before starting the design. The redesign process is summarized in Figure 36.

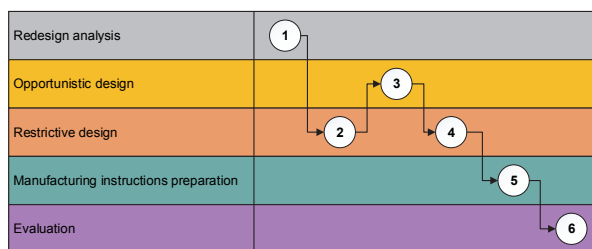

Figure 36. The design process of the digital hydraulic valve manifold.

The design steps of the redesign of the digital hydraulic valve manifold are thus explained:

1. Identification of the interfaces and the design space
2. Selection of the AM technology, material, and orientation to avoid significant rework
3. Design of the channels
4. Modification of features to conform to the guidelines of the material and technology and cost comparison of service providers
5. Selection of the machine and laying out the plan to post-process the valve manifold
6. Machining of the manifold, fitting it with measurement equipment, and carrying out the measurements

Summary of technical and operational benefits

The main technical benefit of using AM in the production of the digital hydraulic valve manifold is the improved flow capacity made possible by the ability of AM to produce complex internal structures. A secondary technical benefit is the reduction of potential failure points in the manifold because it is built as one uniform piece instead of several laminates with connecting surfaces. The manifold produced with AM is consequently lighter, better secured against leakage and other defects, while at the same time reducing pressure losses by 49%. It is therefore fair to say that AM is the preferential production technology from the technical perspective.

The operational advantages of using AM in this case are more dynamic. At the time the case study was conducted, the service provider gave quotations for orders of 46, 100, and 250 additively manufactured manifolds. The prices for these runs would have been, respectively, €415, €368.40, and €365.60 per unit. The price includes manufacturing the part, removal of supports, heat treatment, and delivery. From the trend it can be deduced that the price reaches its lowest level at around €365 and larger runs would not be much cheaper. While this is a considerable step down from the €901.50 a single part costs, the economies of scale are in favour of laminate brazing.

Obtaining an exact figure for the production of manifolds of the original design via laminate brazing is challenging because it is not a standard technique to manufacture hydraulic components and quotations can only be obtained for each separate process in the supply chain. The stages that incurred costs to produce the laminated manifold were laser cutting of the laminates, coating the surface with copper, and finally vacuum brazing the laminates together.

The suppliers of the laser cutting service quoted the price of cutting the laminates for the hydraulic block at €82 for a stack necessary to produce one manifold at volumes of 100 or higher. The coating service gave a quotation of 9€ for volumes of 100 or higher and €8 per laminate for volumes of 250 or higher. The vacuum brazing provider quoted the price at €50 for 100 or more manifolds. The price of a single laminate brazed hydraulic manifold produced at a series volume is therefore approximately €242 without shipping between the facilities and without delivery. Taking this as the cost of procuring laminate brazed manifolds, series production would be approximately €123.60 cheaper with laminate brazing than with AM.

However, it should also be noted that the manifold of this case is only a part of the hydraulic system. While additively manufacturing the redesigned manifold raises its cost, the improvement of the manifold affects the performance of the entire system. Hydraulic systems such as the one of which the manifold is the central element typically cost thousands of euros. It is therefore reasonable to argue that the increased cost of the additively manufactured manifold is justifiable in view of the 49% improvement in the operation of the hydraulic system.

4.3 Additive manufacturing in offsite warranty repair

To demonstrate how it could be beneficial to manufacture components that are not designed for AM, a component from the consumer electronics industry was chosen. The warranty repair of consumer electronics was chosen as a fitting case study because on the one hand, such repairs need to be accomplished under a certain time limit, and on the other hand, additively manufacturing some of the parts is achievable even with mid-range AM equipment.

The supply network for consumer electronics warranty repairs is straightforward. First, the customer sends a faulty device to a repair shop to be repaired, where the device is diagnosed, and a spare part is ordered from the spare part distributor. The distributor then sends the spare part to the repair shop if they have the part, or they pass the request to the original equipment manufacturer (OEM) network. Once the spare part reaches the repair shop, it is installed and the repaired device is sent back to the customer. A model of the current supply network is shown in Figure 37.

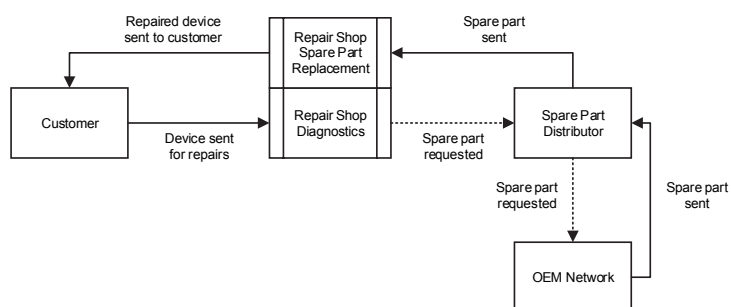

Figure 37. The current model of a supply network in off-site consumer electronics repair.

Ideally, this process should take only days and the duration of the repair is rigorously supervised. The time pressure imposed on the warranty repair providers comes from the fact that they are most often third-party repair shops that have a maintenance service contract with the OEM of the device being repaired. According to the maintenance service contract, the repair shop is obligated to achieve certain turnaround times (TAT) for a certain percentage of repairs. Typically, in the portable computer repair industry, the required TAT is less than 5 business days for most repairs and less than 10 business days for a small minority of repairs. A very small percentage of repairs can exceed 10 business days. The reasons why the 10-day limit can be exceeded at all are mistakes from the technicians, defective spare parts, wrong spare parts sent by the distribution centre, and spare parts that take a very long time to obtain. Even if spare parts could be available from local private persons with a faster delivery time, the repair shops are not allowed to use them, as they are required to use only official parts sourced from the OEM.

To demonstrate how the concept of digital spare parts can be applied in a realistic scenario, the memory cover of a Dell Latitude 4300 computer was chosen to be manufactured with AM and replaced.

Manufacturability analysis

The memory cover was reverse-engineered from the physical component by using a calliper and designed in CAD. The cover was a simple object with the minimum wall thickness of 1 mm and no internal features. Because the model could be manufactured with a variety of AM technologies without any changes, no redesign was performed. The 3D model of the memory cover is shown in Figure 38.

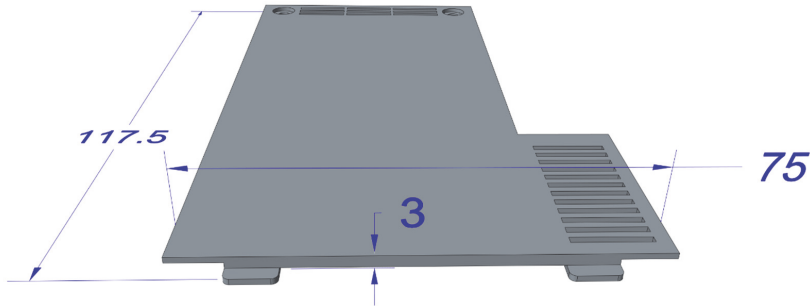

Figure 38. The 3D model of the memory cover. Dimensions in millimetres.

Restrictive design

Because no redesign was performed, the only action during the restrictive design stage was the cost evaluation between several AM technologies that were able to produce the memory cover. The most suitable technologies to employ were fused deposition modelling (FDM) or selective laser sintering (SLS). Using fused deposition modelling with PC or ABS would have provided the closest match with the original cover from the perspective of surface quality and material feel. However, FDM is exceedingly rare and prohibitively expensive when ordering parts from a service provider. For example, the price given by the automatic quotation system of service provider Materialise gives €192.01 as the price for manufacturing the memory cover with FDM from either PC or ABS. Another large service provider of additively manufactured components, Shapeways, does not publicly offer FDM parts as a service. The reason for the excessive cost and poor availability of FDM is in part due to the perceived unreliability of lower end FDM equipment, which leads service providers to use higher end devices, such as ones from Stratasys, where the cost of the proprietary material is substantially higher than that of devices with open material policies. The decentralized and private person-driven 3Dhubs does give options for parts manufactured with FDM from several materials. However, the prices on the platform also start from €38.71 for parts made from PLA and from €100 for parts made from ABS.

Due to the problems with procuring components made with FDM, the focus was shifted to SLS. As the best offer for the production came from a Finnish

service provider specializing in selective laser sintering, the part was ordered from them for the price of €15.25.

Manufacturing instructions preparation

The memory cover was set to be manufactured with EOSINT P 395 of polyamide 12 and dyed black to suit the rest of the bottom case of the portable computer. To install the memory cover, the screws from the old component would be used.

Evaluation

The selective laser sintered memory cover was installed in the computer, where it fit with no issues. The functionality and stability of the computer were then verified by running a stress test for 48 hours. No problems were encountered during the test. The installed component can be seen in Figure 39.



Figure 39. The installed selective laser sintered memory cover in the middle of the portable computer.

The simplicity of the supply network allows inserting AM machinery at any point and testing the configuration with a Monte Carlo simulation. Three supply network models were devised by inserting an AM machine at different points of the supply network. In Figure 40, the AM machine is at the premises of the spare part distributor, in Figure 41 at the repair shop, and in Figure 42 in the OEM's supply network.

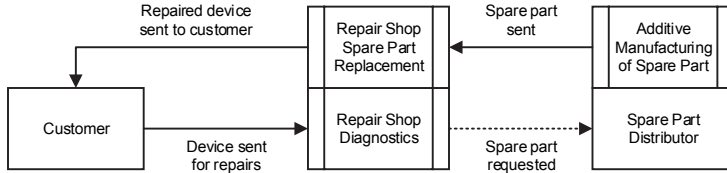

Figure 40. The supply network with AM machinery at the spare part distributor.

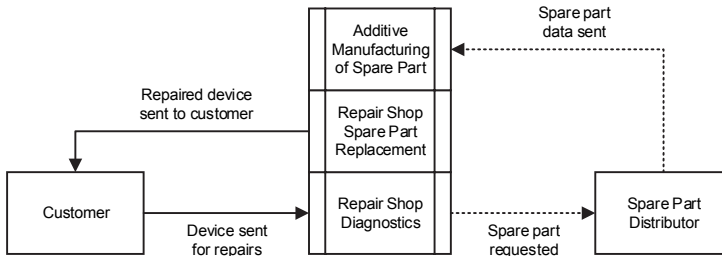

Figure 41. The supply network with AM machinery at the repair shop.

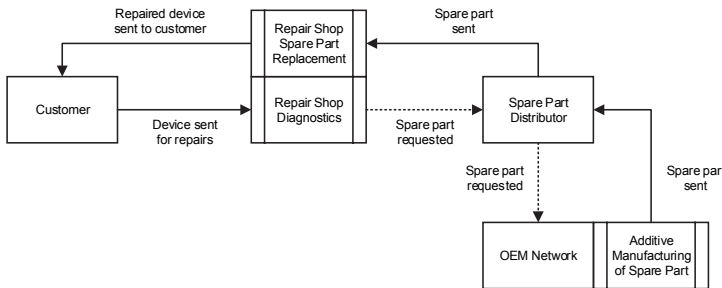

Figure 42. The supply network with AM machinery in the OEM's supply network.

The Monte Carlo simulations were performed for two scenarios. In the first scenario, the device comes in for repair of a component that is not in stock and can be additively manufactured. In the second scenario, the device comes in for repair of a component that is sent by the spare part distributor and during the repair process another part that is not in stock but can be additively manufactured is damaged. To simulate the repair time in each of the networks, the following assumptions were made:

- The TAT starts running when the device is received at the Repair Shop and stops when the device leaves the Repair Shop.
- The diagnosis of the device can happen immediately upon arrival or can take up to two days. The spare part is requested immediately at the end of the diagnosis.
- Spare part requests are immediately handled automatically at the Spare Part Distributor.

- The delivery time from the secondary location or OEM to the Spare Part Distributor is five to ten days.
- The delivery time from the Spare Part Distributor to the Repair Shop is two to four days.
- The AM of a plastic spare part at the Spare Part Distributor takes one to three days.
- The AM of a plastic spare part at the Repair Shop can happen on the same day or can take up to two days.
- The AM of a metal part at the OEM facility takes one to three days.
- The replacement process of the spare part at the Repair Shop can happen on the same day the part was received or can take up to one day.
- All durations of the ranges mentioned have the same probability.

The assumptions were entered in Excel, and Monte Carlo simulations were run for each scenario in 1,000 iterations. The results of the simulations can be seen in Table 9.

Table 9. The delivery times of the Monte Carlo simulations. Lower is better.

Scenario	Current model (days)	AM at distributor's premises (days)	AM in repair shop (days)	AM in OEM's network (days)
1	14	7	3	15
2	17	11	7	18

For both scenarios, the repair times were reduced by placing the AM machine at the spare part distributor and reduced even further by placing it in the repair shop. Placing the machine in the OEM's network had an adverse effect and delayed the repairs by a day.

The simulations were also checked for TAT threshold achievement. In other words, the share of repairs that were completed in more than 5 and 10 days were recorded. This data is shown in Table 10.

Table 10. The share of repairs exceeding TAT thresholds in the Monte Carlo simulations. Lower is better.

Scenario, TAT threshold	Current model (%)	AM at distributor's premises (%)	AM in repair shop (%)	AM in OEM's network (%)
1, 5 days	100	78.8	0	100
1, 10 days	95.8	0	0	96.9
2, 5 days	100	100	71.4	100
2, 10 days	99.9	51.2	0	100

In the current model without AM, the TAT thresholds are surpassed in almost all repair cases. The addition of AM at the premises of the distributor and the repair shop resulted in a drastic improvement in keeping the TAT in check. The most notable improvement is when the machine is placed in the repair shop in which all repairs in scenario 1 stay within the 5-day limit and all repairs in

scenario 2 stay within the 10-day limit. The effects of each model on every actor in the supply network are presented in Table 11.

Table 11. The effects of the models across the supply network.

Actor	Current model	AM at distributor's premises	AM in repair shop	AM in OEM's network
Customer	Long absence of device	Shorter absence of device	Shorter absence of device	Longer absence of device
Repair Shop	Long TAT	Reduction in TAT	Reduction in TAT; investment in AM machinery	Long TAT
Spare Part Distributor	Maintaining large inventory and complex distribution network	Lower warehousing costs; investment in AM machinery	Lower warehousing costs	Lower warehousing costs
OEM	Slow repairs damage brand	Faster repairs improve brand	Faster repairs improve brand	Slow repairs damage brand; investment in AM machinery

According to the results, the AM machine should be placed as close to the spare part requirement as possible, while keeping in mind that the demand must be sufficient. If an AM machine is placed at the repair shop but there is not enough demand for parts that can be additively manufactured, some repairs will become faster, but overall the placement of the machine will be detrimental to the profitability of the repair shop because of the initial cost and upkeep of the machinery. It is most likely that placing the AM machine at the premises of the spare part distributor would yield the largest benefits. As the spare part distributor services several repair shops, the demand should be steady and, while the repair time reduction would not be quite as high as when placing the machine in the repair shop, the improvements in achieved TATs would still be considerable. In contrast, placing AM machinery in the OEM's network and producing the spare parts on demand would be detrimental in every aspect of the repair process.

Summary of the design process

The design process of the memory cover was straightforward and is representative of rudimentary reverse engineering. The design process is summarized in Figure 43.

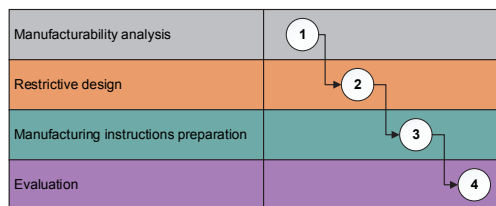

Figure 43. The design process of the memory cover.

The design process of the memory cover is thus explained:

1. Measuring the memory cover and designing it accordingly
2. Comparing the costs of suitable AM technologies and materials
3. Selecting the AM machine and material and post-processing requirements
4. Installing the memory cover in the portable computer and performing stress tests to evaluate the technical performance and Monte Carlo simulations to evaluate the effect on the supply chain performance

Summary of technical and operational benefits

The use of AM in the repair of consumer electronics components is not intended to bring any technical benefits. On the contrary, the technical limitations of AM play a bigger role because the intention of the use case is to replicate existing products in shape, look, and feel. The benefits of using AM in the repair of consumer electronics therefore lie chiefly in improving operations.

The main motivation to use AM in this setting is the severely improved TAT, which is the main performance metric used in the field. The repair shops are beholden to the OEMs through maintenance service contracts that bind them to observe a certain level of performance in relation to the TAT. The distribution of the TAT goals varies between OEMs, but a common one is that 95% of repairs must be completed within 5 days, 4% within 10 days, and 1% of repairs can lapse beyond 10 days but must be repaired or replaced within 30 days. If the repair shop fails to meet these requirements, it faces severe monetary sanctions from the OEM. Therefore, repair shops observe the running TAT statistics very actively and any way to improve them is of great interest.

According to the hypothesis of the case study, using AM to manufacture spare parts with long delivery times could reduce the duration of typically prolonged repairs enough to the TAT goal achievement rate. The hypothesis was tested by simulating the effects of AM on the supply chain of the repair process. This was done by first creating a supply chain model and placing AM equipment in it in different configurations. Then, data were gathered from repair shop operations for the duration of each of the steps present in the model. Then, scenarios were set up to evaluate the performance of each of the configurations.

According to the results, adding AM machinery at either the spare part distributor or the repair shop helps rein in the repair times of cases that would otherwise be in danger of surpassing the critical TAT thresholds. The main effects of including AM at these points would be the improvement of the overall service quality of the supply network and the avoidance of sanctions for the repair shops.

4.4 Additive manufacturing in digital spare part production

This section presents the results of the focus group study conducted for Article IV. The participants of the study gave extensive information about their views on current problems in spare parts management, new possibilities and obstacles of digitization of spare parts, required properties of digital spare parts, and the composition of the future digital spare parts network.

The participants identified the unpredictability of the availability of rare components, the loss of productivity due to stock-outs, and the propensity of employees to make mistakes due to the rush caused by the late arrival of spare parts as the biggest problems with current spare part management.

The participants saw multiple benefits in the digitization of spare parts. The main advantages listed were the reduction of delivery time, customs avoidance, remote location delivery, and positive environmental impact. These advantages are caused by the fact that digital spare parts can be manufactured anywhere the machinery is available directly from digital files and without component-specific expertise. The reduced environmental impact of DSP comes from the supposition that AM uses only the material needed to produce the components.

The participants were also well-informed of the obstacles related to the digitization of spare parts. The listed obstacles were the high cost of AM, limited size of possible components, inadequate quality of additively manufactured parts, variable quality between AM materials, piracy, file version management, 3D model unavailability, difficulty in creating 3D models, and the fact that AM parts most often require post-processing. The first three obstacles are directly related to the limitations of AM machinery, while the fourth obstacle is related to the lack of standardization of AM material production processes. The remaining obstacles are related to the insufficient ICT currently employed by the interviewed companies and the fact that most spare parts do not have 3D models readily available. On the advent of AM becoming a serious technology for end-use components, some researchers have commented on the related possible piracy issues. Appleyard claims that companies should learn from the entertainment industry and change their business models to be closer to digital distribution, while Lindemann et al. propose a more conservative approach with the introduction of copy protection for AM components [52], [53]. The participants of the study were strongly in favour of the second view, which supports copy protection.

The participants listed the ideal technical properties of DSP to be high complexity and small size. The given relevant control properties were high criticality, unpredictable demand pattern and delivery time, and high value and specificity. Additionally, the spare part should be very early or very late in its life cycle and it should ideally be frequently updated.

The participants were asked to list the necessary actors in a DSP network, and a model was built based on the answers. The participants described the potential network primarily from the point of view of data safety. While the AM service centre would be shared with other OEMs, the 3D models would always be stored only on the servers of the company and distributed on a per-need basis. The

model based on the information provided by the participants is shown in Figure 44.

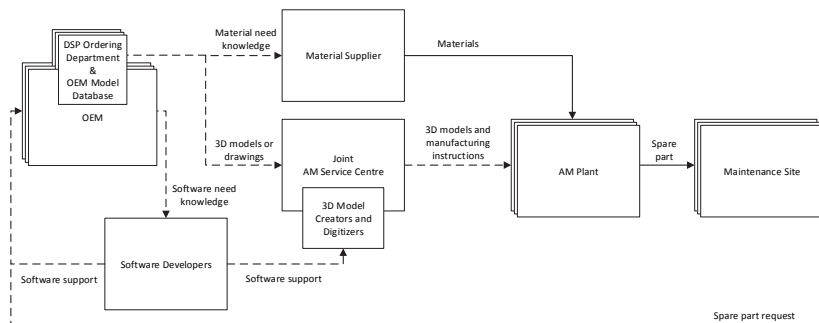

Figure 44. The generalized supply network for digital spare parts based on the information obtained from the focus group interviews.

The concept definition of a “digital spare part” was done in conjunction with the focus group interviews according to the methodology presented by Podsakoff et al. [55]. In the concept definition process, the key attributes of the concept were first extracted from the existing literature and then cross-referenced with the key attributes brought up by the participants of the focus group interviews. The attributes were then compared to those of “traditionally produced spare part” and “additively manufactured part” and evaluated for necessity and sufficiency. The key attributes are listed in Table 12.

Table 12. Identifying necessary and sufficient attributes of the concept of a “digital spare part”.

Key attributes	Digital spare part	Traditionally produced spare part	Additively manufactured part	Conclusions
A1: Delivered to replace a defective component	Present	Present	Absent	Necessary but not sufficient
A2: Parts built from 3D model data	Present	Absent	Present	Necessary but not sufficient
A3: Production documents transferred by network	Present	Absent	Present	Necessary but not sufficient
A4: Can use distributed manufacturing	Present	Absent	Present	Necessary but not sufficient

On their own, none of the attributes is sufficient to set the concept of “digital spare part” apart from the two other concepts to which it was compared. However, any combination of A1 with the other attributes is necessary and jointly sufficient. Therefore, the concept could be given a formal definition expanded with the main consequences obtained from the focus group interviews. The key consequences mentioned were the reduction of repair time, delivery time and costs, emissions and material waste, and inventory. By combination, a formal definition of the digital spare parts concept could be written as “A concept in which defective components are replaced by manufacturing spare parts close to the location of need from 3D model data

that are transferred by network, with the main consequences of reducing repair time, delivery time and costs, emissions, and inventory”.

Summary of technical and operational benefits

While the primary aim of the focus group interviews was to discover the operational benefits of producing spare parts with additive manufacturing from the perspective of OEMs, the participants voiced that digital spare parts can have a positive impact also on the technical side of products. The first technical benefit is that spare parts can be upgraded when supplying them. This would offer the company flexibility in improving their offerings by processing the feedback from the customers related to the performance of the component and supplying an improved spare part.

Another technical improvement that could be achieved with digital spare parts is embedding sensors in additively manufactured spare parts. While sensors are already commonly employed to monitor spare parts, their inclusion in the component itself could raise their reliability. The embedded sensors could therefore send information on the condition of the part and if it is due for replacement.

Although digital spare parts can have minor technical benefits, their major contribution is the improvement of operations of OEMs. The overwhelmingly most important benefit for the OEMs, according to the participants, was the reduction of delivery time, enabled by the ability to manufacture the spare parts wherever the right AM equipment is available. The main benefits coming from this would be lower costs of delivery and improved OEM service speed and flexibility. This effect of digital spare parts was also demonstrated in Article III of this thesis. The participants understood well that although the cost of producing spare parts with AM can be much higher than that of traditional manufacturing, it is still worth doing because suffering downtimes caused by spare part delays is costlier.

Another operational benefit mentioned by the participants was the ability to get rid of the slowly moving inventory of spare parts that they keep. In the digital spare part concept, it would be enough to keep digital copies of the spare parts and manufacture them on demand. OEMs would therefore spend less money on holding spare parts in stock. Another benefit identified by the participants was the ability to transport the spare parts across borders without paying customs fees, which would enable lower price of delivery and avoid getting delayed by customs. Yet another benefit that the OEMs found attractive was the prospect of being able to supply hard to reach locations with spare parts. This would be possible due to the increase of suppliers that is made possible by the fact that the expertise of using AM is easily transferable between components.

To summarize, the benefits of digital spare parts are well known to OEMs and AM service providers. It would appear to be only a question of time when the concept will achieve widespread adoption.

5. Conclusion and perspectives

In this section, the research questions and aims of the thesis are returned to, recommendations for the exploitation of the thesis research are given, and limitations and future study paths are considered.

5.1 Research questions and aims of the thesis

A wide array of DfAM literature was introduced in the theory section of the thesis. The construction of the generalized workflow for end-use AM began by analysing the design process of Pahl and Beitz and was followed by selecting its relevant aspects and augmenting them with the previous work in the DfAM field presented in that section. The generalized workflows of end-use AM including all the aspects presented in this thesis are presented in Figure 45.

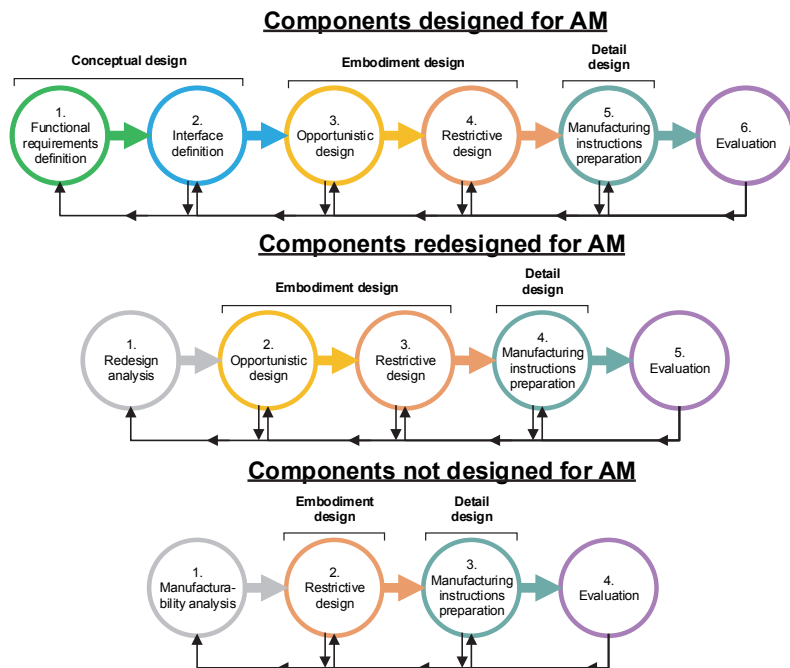

Figure 45. The generalized workflows of end-use AM design strategies.

The first research question presented in the introduction of the thesis was the following:

RQ1. What are the observable technical benefits of AM in components of each of the proposed categories?

The research question was answered via demonstrations and the results of a focus group study in Section 4. The technical benefits of each category connected with the articles are summarized in Table 13. As technical benefits can only be obtained by designing or redesigning the component for AM, the category of components not designed for AM is absent from the table.

Table 13. The technical benefits of the categories found in the research articles.

	Components designed for AM	Components redesigned for AM
Benefits	<p>Article I:</p> <ul style="list-style-type: none"> • Ability to produce a functionally novel type of heat exchange element due to high internal complexity • Exploitation of rough surface quality • Omission of assembly 	<p>Article II:</p> <ul style="list-style-type: none"> • Improved flow capacity due to high internal complexity • Reduced points of potential failure <p>Article IV:</p> <ul style="list-style-type: none"> • Upgraded spare parts • Spare parts with embedded sensors

The category of components designed for AM was represented by the design of a novel heat exchanger in Article I. Designing the heat exchanger for AM enabled introducing a checkerboard matrix heat transfer element, which would not have been possible to produce with traditional manufacturing methods due to its complexity. The element was measured to perform exceptionally well and can withstand considerable pressure drops. The heat exchanger was also manufactured as one part and therefore needed no assembly beyond the fitting of adapters. The additively manufactured heat exchanger was compared with two commercial plate heat exchangers and it was found that its performance was an order of magnitude better than that of the commercial counterparts.

For the category of components redesigned for AM, the improved digital hydraulic valve manifold showed a significant reduction of pressure losses of up to 49% due to its streamlined and optimized flow channels. The increase in performance was notable enough for AM to be considered the preferential production technology for the manufacturing of miniature digital valve manifolds in the future.

In the focus group interviews, the view of upgraded spare parts was raised on many occasions. In the concept of upgraded spare parts, components that need to be replaced could be improved every time they fail based on the failure data and the customer feedback because no change in tooling is needed when producing a redesigned part with AM. Also, the participants of the focus groups found the potential of embedding sensors in spare parts interesting. This concept would make the components able to submit data on their condition and report when their replacement is necessary.

The second research question presented in the introduction of the thesis was the following:

RQ2. What are the potential operational benefits of AM in components of each of the proposed categories?

The second research question was answered via demonstrations, Monte Carlo simulation, and a focus group study in Section 4. The operational benefits of each category connected with the articles are summarized in Table 14.

Table 14. The operational benefits of the categories found in the research articles.

	Components designed for AM	Components redesigned for AM	Components not designed for AM
Benefits	Article I: <ul style="list-style-type: none"> The supply possibilities of the heat exchanger are more ubiquitous 	Article II: <ul style="list-style-type: none"> Cheaper production of one-off manifolds Significantly simplified supply chain compared to laminate brazing 	Article III: <ul style="list-style-type: none"> Highly improved TAT in repairs Article IV: <ul style="list-style-type: none"> Reduction of delivery time Reduction of environmental impact Reduction of inventory

The main operational benefit connected to components designed for AM found in Article I was the increase in the number of potential suppliers because the developed heat exchanger can be manufactured with any machine that can process the used material. While this is a considerable benefit in situations where it is necessary to obtain a heat exchanger and no traditionally manufactured heat exchangers are easily available, it is practical in only a few cases. The technical benefits of the heat exchanger therefore must overshadow the operational benefits for it to be profitable to design and manufacture the heat exchanger in the proposed manner.

The operational benefits related to components redesigned for AM are more substantial. The production of digital manifolds in low quantities is cheaper than the previously used laminate brazing, and the supply chain is significantly simpler because AM requires fewer steps. Although series production with laminate brazing is approximately one hundred euros cheaper, the increased cost of the additively manufactured manifold is offset to the entire hydraulic system. Considering that the cost of high-end hydraulic systems adds up to thousands of euros and that the manifold improves the performance of the system by up to 49%, the additional costs from additively manufacturing the manifold are reasonable. The technical and operational benefits are therefore quite balanced for the digital hydraulic valve manifold redesigned in Article II.

The benefits of components not designed for AM are mostly operational. Article III showed that using AM in this category can greatly improve the repair time in offsite repairs of consumer electronics. The reduced repair time of cases that would otherwise cause delays makes it possible for repair shops to hit their performance targets better and avoid monetary sanctions from their OEMs.

Article IV brought up a multitude of benefits as seen by industrial companies. These benefits included the reduction of delivery time and inventory and the environmental impact. When applied on a larger scale, the use of AM to produce parts that were not designed for it could yield meaningful savings for industrial companies. The most valuable aspect of additively manufacturing spare parts

was the reduction of delivery time, which would reduce the transportation costs and improve the flexibility and service speed of OEMs. In such cases, the cost of the spare part is secondary because the downtime of the operations is far more expensive. Other operational benefits mentioned by the participants included the ability to get rid of excess spare part inventory because when using digital spare parts, it would be enough to keep 3D models of the spare parts and manufacture them when needed, which would lead to savings for the OEMs.

Aside from the research questions, the following goals were listed at the beginning of the thesis:

1. Making the opportunities of end-use AM easily comprehensible for communication and dissemination.

The opportunities of AM in end-use applications were collected in an easy-to-use framework that can be used to communicate them efficiently. The framework of end-use AM classification and the supporting case studies are easy to understand even for someone not familiar with the field of DfAM. The visualised design workflows combine all the concepts found in the theory section of this thesis in simple diagrams and can be distributed and understood with little supplementary information. Aside from being a support to designers new to AM, they can help the decision-making process of when to use AM in companies.

2. Adding to the scientific discourse surrounding DfAM

The collected theory part of the thesis does not only synthesize the findings of previous research but also gives the community a tool to discuss their field in a more concrete context. The field of DfAM is relatively young and increasingly active, and therefore it is imperative that the communication in the community be clear and the used terms well-defined.

5.2 Recommendations

The category of components designed for AM is especially promising and will be of immense value in products in the future. Its strengths lie in the technical benefits that can lead to a new generation of products in many fields. However, designing new products for AM is risky and might interfere with the existing product catalogues of companies. The category of redesigned components is better explored, and the potential is well-known among the practitioners in the field of AM. Designers new to AM are recommended to use the design process provided in this thesis and the framework of end-use AM subclasses to develop products that take AM into consideration from their conception. Managers and other personnel should familiarize themselves with the framework to better perceive the opportunities of end-use AM and use their knowledge of their specific fields to understand when each category of end-use AM could be used.

The first contact with AM for many industrial practitioners is often in the category of components redesigned for AM for better performance and lower weight. It is recommended that practitioners look beyond this and consider designing components for AM from the conceptual design phase.

The usage of the category of components not designed for AM is gaining traction due to the investigations into digital spare parts in various countries. While it is not currently practical to create most industrial spare parts with AM, it is important to follow and act on the progressive developments of AM technologies. In addition, if a company looks to use the DSP concept once AM is mature enough to produce a larger part of the spare parts in a company's catalogue, it needs to immediately start systematically collecting extensive data on all the products they foresee could benefit from DSP.

5.3 Limitations and future work

A major goal of the thesis was to create a framework that could be useful for practitioners in understanding the opportunities of end-use AM. However, this thesis does not include verification of its usefulness to practitioners. The validity of the usefulness of the framework for industrial practitioners should be tested in future studies by conducting focus group sessions with designers with various levels of involvement with AM.

Another issue with the design workflow is the rigour in the nomenclature of the design stages. Although the stages are defined and used consistently within this thesis, they carry many different names in the DfAM literature. An extensive study researching the correct nomenclature and solidifying it should be carried out. The method of concept definition could be of great help in this endeavour.

The iteration of the design workflow could be helped by constrained design methodologies. It would be interesting to investigate how methodologies such as axiomatic design could be applied to DfAM. Future work also includes different types of dissemination of the developed framework.

References

- [1] D. T. Pham and S. S. Dimov, "Rapid prototyping and rapid tooling - the key enablers for rapid manufacturing," *Proc. Inst. Mech. Eng. Part C-Journal Mech. Eng. Sci.*, vol. 217, no. 1, pp. 1–23, 2003.
- [2] ASTM International, "52900:2016 'Additive manufacturing - General principles - Terminology.'" 2016.
- [3] N. Hopkinson and P. Dickens, "Analysis of rapid manufacturing - Using layer manufacturing processes for production," *Proc. Inst. Mech. Eng. Part C J. Mech. Eng. Sci.*, vol. 217, no. 1, pp. 31–40, 2003.
- [4] N. Hopkinson, R. Hague, and P. Dickens, *Rapid Manufacturing*. Chichester: John Wiley & Sons, Ltd, 2006.
- [5] K. Kellens, M. Baumeers, T. G. Gutowski, W. Flanagan, R. Lifset, and J. R. Dufloy, "Environmental Dimensions of Additive Manufacturing: Mapping Application Domains and Their Environmental Implications," *J. Ind. Ecol.*, vol. 21, pp. S49–S68, 2017.
- [6] T. Wohlers, *Wohlers Report 2013. Additive Manufacturing and 3D printing State of the Industry: Annual Worldwide Progress Report*. Fort Collins, CO: Wohlers Associates, Inc, 2013.
- [7] T. Wohlers, *Wohlers Report 2017. Additive Manufacturing and 3D printing State of the Industry: Annual Worldwide Progress Report*. Fort Collins, CO: Wohlers Associates, Inc, 2017.
- [8] D. G. Schniederjans, "Adoption of 3D-printing technologies in manufacturing: A survey analysis," *Int. J. Prod. Econ.*, vol. 183, no. July 2016, pp. 287–298, 2017.
- [9] J. G. Prada, A. Cazon, J. Carda, and A. Aseguinolaza, "Direct digital manufacturing of an accelerator pedal for a Formula Student racing car," *Rapid Prototyp. J.*, vol. 22, no. 2, pp. 311–321, 2016.
- [10] T. Rayna and L. Striukova, "From rapid prototyping to home fabrication: How 3D printing is changing business model innovation," *Technol. Forecast. Soc. Change*, vol. 102, pp. 214–224, 2016.
- [11] R. Ponche, J. Y. Hascoet, O. Kerbrat, and P. Mognol, "A new global approach to design for additive manufacturing," *Virtual Phys. Prototyp.*, vol. 7, no. 2, pp. 93–105, 2012.
- [12] C. C. Seepersad, "Challenges and Opportunities in Design for Additive Manufacturing," *3D Print. Addit. Manuf.*, vol. 1, no. 1, pp. 10–13, 2014.
- [13] S. Mansour and R. Hague, "Impact of rapid manufacturing on design for manufacture for injection moulding," *Proc. Inst. Mech. Eng. Part B J. Eng. Manuf.*, vol. 217, no. 4, pp. 453–461, 2003.
- [14] G. Pahl, W. Beitz, J. Feldhusen, and K.-H. Grote, *Engineering Design A Systematic Approach*, 3rd ed. London: Springer-Verlag London, 2007.
- [15] D. W. Rosen, "Research supporting principles for design for additive manufacturing," *Virtual Phys. Prototyp.*, vol. 9, no. 4, pp. 225–232, 2014.
- [16] F. Laverne, F. Segonds, N. Anwer, and M. Le Coq, "Assembly Based Methods to Support Product Innovation in Design for Additive Manufacturing: An Exploratory Case Study," *J. Mech. Des.*, vol. 137, no. 12, p. 121701, 2015.
- [17] I. Gibson, D. Rosen, and B. Stucker, *Additive Manufacturing Technologies: 3D Printing, Rapid Prototyping, and Direct Digital Manufacturing*, Second Edi. New York: Springer Science+Business Media, 2015.
- [18] X. Su, Y. Yang, D. Xiao, and Y. Chen, "Processability investigation of

- non-assembly mechanisms for powder bed fusion process,” *Int. J. Adv. Manuf. Technol.*, vol. 64, no. 5–8, pp. 1193–1200, 2013.
- [19] S. Bin Maidin, I. Campbell, and E. Pei, “Development of a design feature database to support design for additive manufacturing,” *Assem. Autom.*, vol. 32, no. 3, pp. 235–244, 2012.
- [20] G. A. O. Adam and D. Zimmer, “On design for additive manufacturing: Evaluating geometrical limitations,” *Rapid Prototyp. J.*, vol. 21, no. 6, pp. 662–670, 2015.
- [21] D. Wang, S. Mai, D. Xiao, and Y. Yang, “Surface quality of the curved overhanging structure manufactured from 316-L stainless steel by SLM,” *Int. J. Adv. Manuf. Technol.*, vol. 86, no. 1–4, pp. 781–792, 2016.
- [22] C. Majewski and N. Hopkinson, “Effect of section thickness and build orientation on tensile properties and material characteristics of laser sintered nylon-12 parts,” *Rapid Prototyp. J.*, vol. 17, no. 3, pp. 176–180, 2011.
- [23] M. Kumke, H. Watschke, and T. Vietor, “A new methodological framework for design for additive manufacturing,” *Virtual Phys. Prototyp.*, vol. 11, no. 1, pp. 3–19, 2016.
- [24] B. Weiss, O. Diegel, D. Storti, and M. Ganter, “A process for estimating minimum feature size in selective laser sintering,” *Rapid Prototyp. J.*, vol. 24, no. 2, pp. 436–440, 2018.
- [25] 3D Hubs, “Key design considerations for 3D Printing.” [Online]. Available: <https://www.3dhubs.com/knowledge-base/key-design-considerations-3d-printing>. [Accessed: 14-Jun-2018].
- [26] Shapeways Inc., “Designing mechanical parts for 3D printing.” [Online]. Available: https://www.shapeways.com/tutorials/designing_mechanical_parts_for_3d_printing. [Accessed: 14-Jun-2018].
- [27] Materialise Nv, “Design Guides.” [Online]. Available: <https://i.materialise.com/en/3d-printing-materials/design-guides>. [Accessed: 14-Jun-2018].
- [28] Y. Zhang, A. Bernard, R. K. Gupta, and R. Harik, “Evaluating the design for additive manufacturing: A process planning perspective,” *Procedia CIRP*, vol. 21, pp. 144–150, 2014.
- [29] S. Hällgren, L. Pejryd, and J. Ekengren, “(Re)Design for Additive Manufacturing,” *Procedia CIRP*, vol. 50, pp. 246–251, 2016.
- [30] B. Vayre, F. Vignat, and F. Villeneuve, “Designing for additive manufacturing,” *Procedia CIRP*, vol. 3, no. 1, pp. 632–637, 2012.
- [31] J. Schmelzle, E. V. Kline, C. J. Dickman, E. W. Reutzel, G. Jones, and T. W. Simpson, “(Re)Designing for Part Consolidation: Understanding the Challenges of Metal Additive Manufacturing,” *J. Mech. Des.*, vol. 137, no. 11, pp. 1–12, 2015.
- [32] M. Orqu era, S. Campocasso, and D. Millet, “Design for Additive Manufacturing Method for a Mechanical System Downsizing,” *Procedia CIRP*, vol. 60, no. December, pp. 223–228, 2017.
- [33] C. Klahn, B. Leutenecker, and M. Meboldt, “Design for additive manufacturing - Supporting the substitution of components in series products,” *Procedia CIRP*, vol. 21, pp. 138–143, 2014.
- [34] S. Mellor, L. Hao, and D. Zhang, “Additive manufacturing: A framework for implementation,” *Int. J. Prod. Econ.*, vol. 149, pp. 194–201, 2014.
- [35] P. Jonsson and J. Holmstr om, “Future of supply chain planning: closing the gaps between practice and promise,” *Int. J. Phys. Distrib. Logist. Manag.*, vol. 46, no. 1, pp. 62–81, 2016.
- [36] C. Tuck, R. Hague, and N. Burns, “Rapid manufacturing: impact on supply chain methodologies and practice,” *Int. J. Serv. Oper. Manag.*, vol. 3, no. 1, pp. 1–22, 2007.
- [37] M. Gebler, A. J. M. Schoot Uiterkamp, and C. Visser, “A global

- sustainability perspective on 3D printing technologies,” *Energy Policy*, vol. 74, no. C, pp. 158–167, 2014.
- [38] I. Kothman and N. Faber, “How 3D printing technology changes the rules of the game: Insights from the construction sector,” *J. Manuf. Technol. Manag.*, vol. 27, no. 7, pp. 932–943, 2016.
- [39] A. Sasson and J. C. Johnson, “The 3D printing order: variability, supercenters and supply chain reconfigurations,” *Int. J. Phys. Distrib. Logist. Manag.*, vol. 46, no. 1, pp. 82–94, 2016.
- [40] R. Sarker and A. Haque, “Optimization of maintenance and spare provisioning policy using simulation,” *Appl. Math. Model.*, vol. 24, no. 10, pp. 751–760, 2000.
- [41] A. Ledwoch, H. Yasarcan, and A. Brintrup, “The moderating impact of supply network topology on the effectiveness of risk management,” *Int. J. Prod. Econ.*, vol. 197, no. January 2017, pp. 13–26, 2018.
- [42] I. Roda, M. Macchi, L. Fumagalli, and P. Viveros, “A review of multi-criteria classification of spare parts,” *J. Manuf. Technol. Manag.*, vol. 25, no. 4, pp. 528–549, 2014.
- [43] S. H. Khajavi, J. Partanen, and J. Holmström, “Additive manufacturing in the spare parts supply chain,” *Comput. Ind.*, vol. 65, no. February 2016, pp. 50–63, 2014.
- [44] B. Flynn, “Empirical research methods in operations management,” *J. Oper. Manag.*, vol. 9, no. 2, pp. 250–284, 1990.
- [45] R. Barbour, *Doing Focus Groups*, First. London: SAGE Publications, Inc., 2007.
- [46] L. C. Angell and R. D. Klassen, “Technical note: Integrating environmental issues into the mainstream: an agenda for research in operations management,” *J. Oper. Manag.*, vol. 17, pp. 575–598, 1999.
- [47] M. Driessen, J. Arts, G.-J. Van Houtum, J. W. Rustenburg, and B. Huisman, “The Management of Operations Maintenance spare parts planning and control: a framework for control and agenda for future research,” *Prod. Plan. Control*, vol. 26, no. 5, pp. 407–426, 2015.
- [48] W. J. Kennedy, W. J. Patterson, and L. D. Fredendall, “An overview of recent literature on spare parts inventories,” *Int. J. Prod. Econ.*, vol. 76, no. 2, pp. 201–215, 2002.
- [49] N. Knofius, M. C. van der Heijden, and W. H. M. Zijm, “Selecting parts for additive manufacturing in service logistics,” *J. Manuf. Technol. Manag.*, vol. 27, no. 7, pp. 915–931, 2016.
- [50] P. Liu, S. H. Huang, A. Mokeddar, H. Zhou, and L. Hou, “The impact of additive manufacturing in the aircraft spare parts supply chain: supply chain operation reference (scor) model based analysis,” *Prod. Plan. Control*, vol. 25, no. 13–14, pp. 1169–1181, 2014.
- [51] Y. Li, G. Jia, Y. Cheng, and Y. Hu, “Additive manufacturing technology in spare parts supply chain: a comparative study,” *Int. J. Prod. Res.*, vol. 55, no. 5, pp. 1498–1515, 2016.
- [52] C. Lindemann, T. Reiher, U. Jahnke, and R. Koch, “Towards a sustainable and economic selection of part candidates for additive manufacturing,” *Rapid Prototyp. J.*, vol. 21, no. January, pp. 216–227, 2015.
- [53] M. Appleyard, “Corporate responses to online music piracy: Strategic lessons for the challenge of additive manufacturing,” *Bus. Horiz.*, vol. 58, no. 1, pp. 69–76, 2015.
- [54] J. Holmström, J. Partanen, J. Tuomi, and M. Walter, “Rapid manufacturing in the spare parts supply chain: Alternative approaches to capacity deployment,” *J. Manuf. Technol. Manag.*, vol. 21, no. No.6, pp. 687–697, 2010.
- [55] P. M. Podsakoff, S. B. MacKenzie, and N. P. Podsakoff, “Recommendations for Creating Better Concept Definitions in the

- Organizational, Behavioral, and Social Sciences,” *Organ. Res. Methods*, vol. 19, no. 2, pp. 159–203, 2016.
- [56] E. Achenbach, “The effect of surface roughness on the heat transfer from a circular cylinder to the cross flow of air,” *Int. J. Heat Mass Transf.*, vol. 20, no. 4, pp. 359–369, 1977.
- [57] EOS GmbH, “Material data sheet: Aluminium AlSi10Mg.” 2011.
- [58] “Specifications of Lytron Inc. brazed-plate heat exchangers,” 2018. [Online]. Available: <https://www.lytron.com/Heat-Exchangers/Standard/Heat-Exchangers-Liquid-to-Liquid?tab=specs>. [Accessed: 07-Nov-2018].
- [59] Z. Wei, Y. Tang, W. Zhao, and B. Lu, “Rapid structural design of drip irrigation emitters based on RP technology,” *Rapid Prototyp. J.*, vol. 13, no. 5, pp. 268–275, 2007.
- [60] D. E. Cooper, M. Stanford, K. A. Kibble, and G. J. Gibbons, “Additive Manufacturing for product improvement at Red Bull Technology,” *Mater. Des.*, vol. 41, pp. 226–230, 2012.
- [61] J. Farré-Lladós, J. Casals-Terré, J. Voltas, and L. G. Westerberg, “The use of rapid prototyping techniques (RPT) to manufacture micro channels suitable for high operation pressures and μ PIV,” *Rapid Prototyp. J.*, vol. 22, no. 1, pp. 67–76, 2016.
- [62] A. Armillotta, R. Baraggi, and S. Fasoli, “SLM tooling for die casting with conformal cooling channels,” *Int. J. Adv. Manuf. Technol.*, vol. 71, no. 1–4, pp. 573–583, 2014.
- [63] T. Lantela and M. Pietola, “High-flow rate miniature digital valve system,” *Int. J. Fluid Power*, vol. 18, no. 3, pp. 188–195, 2017.
- [64] R. Lasaar and A. Stoll, “New Innovative Components for Energy Efficient Working Hydraulics in Mobile Machines,” in *7th International Fluid Power Conference*, 2010, pp. 37–52.
- [65] B. G. Bryden and I. R. Pashby, “Case study Sequential laminated tooling , joined by brazing , for injection moulding,” *Rapid Prototyp. J.*, vol. 5, no. 2, pp. 89–93, 1999.
- [66] B. G. Bryden, D. I. Wimpenny, and I. R. Pashby, “Manufacturing production tooling using metal laminations,” *Rapid Prototyp. J.*, vol. 7, no. 1, pp. 52–59, 2001.
- [67] EOS GmbH, “Material data sheet: EOS MaragingSteel MS1.” 2011.

Additive manufacturing is poised to bring improved products to the market and help simplify supply chains. To understand the industrial opportunities of the technology better, this thesis introduces a classification system, which divides additively manufactured end-use components into three categories. These categories are "components designed for additive manufacturing", "components redesigned for additive manufacturing", and "components not designed for additive manufacturing". The thesis provides a systematic design workflow for each of the categories and demonstrates their use through case studies involving a heat exchanger, a digital hydraulic block, and a replacement part for a portable computer. The thesis then analyzes the benefits of each of the case studies and makes recommendations to support the decision making as to when and why to use additive manufacturing.



ISBN 978-952-60-8429-9 (printed)
ISBN 978-952-60-8430-5 (pdf)
ISSN 1799-4934 (printed)
ISSN 1799-4942 (pdf)

Aalto University
School of Engineering
Department of Mechanical Engineering
www.aalto.fi

**BUSINESS +
ECONOMY**

**ART +
DESIGN +
ARCHITECTURE**

**SCIENCE +
TECHNOLOGY**

CROSSOVER

**DOCTORAL
DISSERTATIONS**