



46TH TURBOMACHINERY & 33RD PUMP SYMPOSIA
HOUSTON, TEXAS | DECEMBER 11-14, 2017
GEORGE R. BROWN CONVENTION CENTER

COMPANDER VIBRATION TROUBLESHOOTING

Sébastien Jaouen, Cryostar
Cliff Bauer, MOL
Stéphane Berger, Flender
Alain Guéraud, Cryostar



FLENDER
GRAFFENSTADEN



Bios



Sébastien Jaouen is currently the structural calculation team leader for Cryostar, in Hésingue, France. He began in this field in 2006. He is now responsible for rotordynamic calculation, FEA, as well as vibration diagnostic. Mr. Jaouen received his M.S.C degree (Mechanical Engineering, 2004) from Centrale Marseille.



Cliff Bower is currently the Lead Cryogenic-Cargo Superintendent for MOL/CS Yamal Project in DSME shipyard, South Korea. He began in this field in February 2013, having previously worked as a marine engineer for 25 years with a large oil major, both at sea and in land based positions. He sailed as marine engineer in conventional LNG vessels with steam turbine propulsion and later in vessels with the reliquefaction system, developed by Cryostar.



Stephane Berger is currently the Advanced Engineering team leader for Flender-Graffenstaden, in Illkirch, France. He joined Flender in 2010 and he's now responsible for FEA, vibrations analysis, advanced troubleshooting and continuous improvement. Mr. Berger received his MSC degree (Mechanical Engineering, 2001) from ENSISA Mulhouse and his PhD (Engineering sciences 2006) from UHA Mulhouse.



Alain Guéraud is currently Senior Project Manager in Hésingue, France. He joined Cryostar in 2007 after a 10 years' experience in shipbuilding (electrical Manager for Cruise Ships and LNG Carriers). He receives his MSC degree (Mechanical and Electrical Engineering, 1985) from ESTP Paris and his PHD (Physics, electro technical 1988) from Paris VI University.



Presentation summary

- 1. Introduction
- 2. Train configuration & characteristic data
- 3. RCA – by Gear Box Manufacturer (GBM)
- 4. Vibration behavior during factory acceptance test (FAT)
- 5. RCA – by Original Equipment Manufacturer (OEM)
- 6. RCA – with motor manufacturer
- 7. Conclusion
- 8. Lessons Learned



1. INTRODUCTION

The “compander” is an integrally-gearred turbo machine with three warm compressor stages and one cryogenic expander stage. It’s used on LNG carrier to liquefy the boil off gas.(Brayton cycle)
The factory acceptance test (FAT) troubleshooting concerns the last compander in a series of 8 identical machines.

It started with the GBM troubleshooting RCA that concerned pinion 2 vibration level.

Then during OEM FAT, Gear Box casing axial vibration was higher than acceptance and pinion number 2 radial displacement tripped.

After the resolution of the previous issues, the motor vibration level was found to be unacceptable.

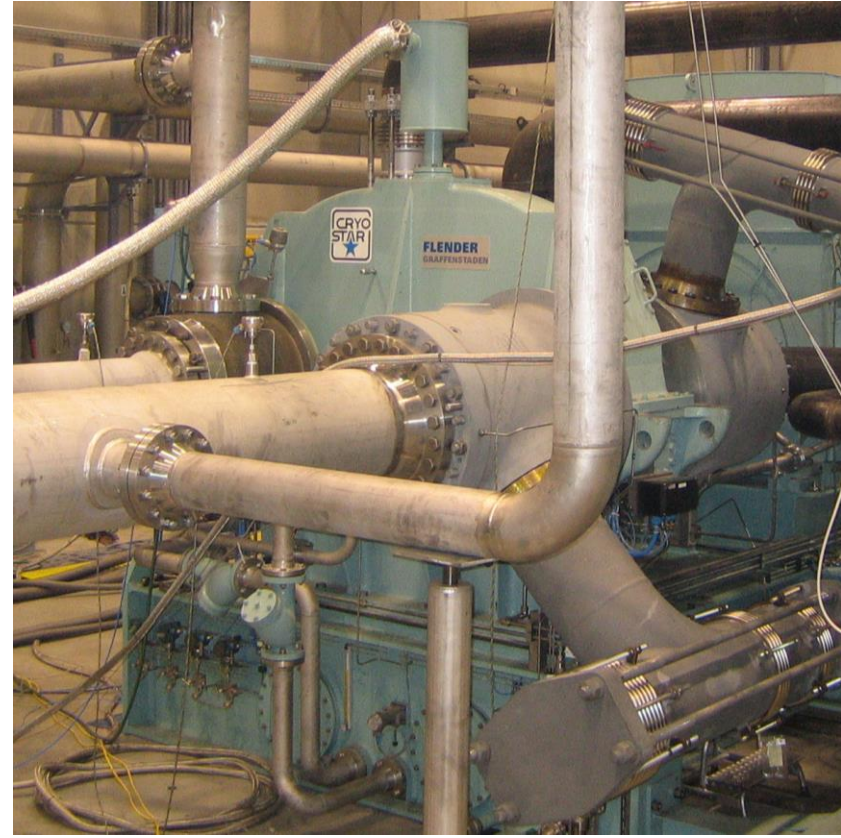

2. Train configuration & characteristic data

★Compaender

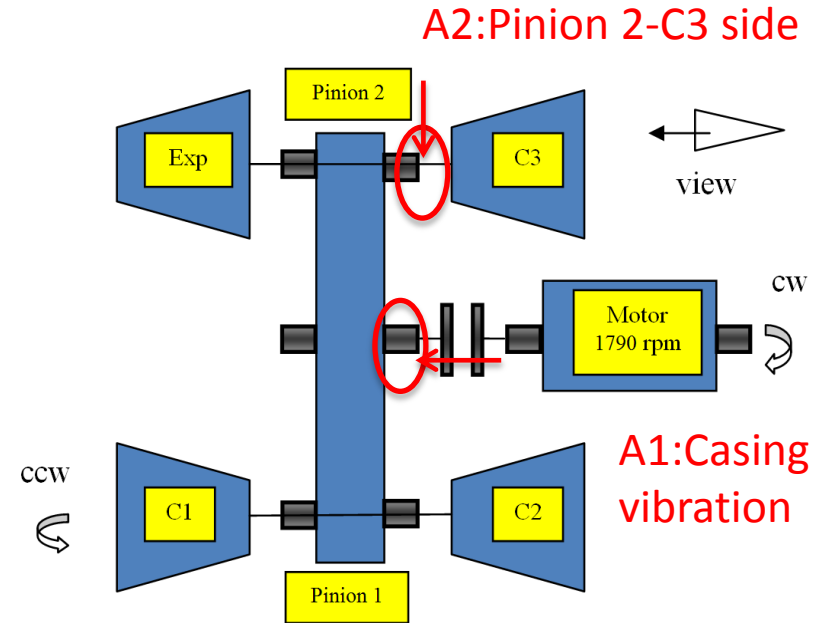
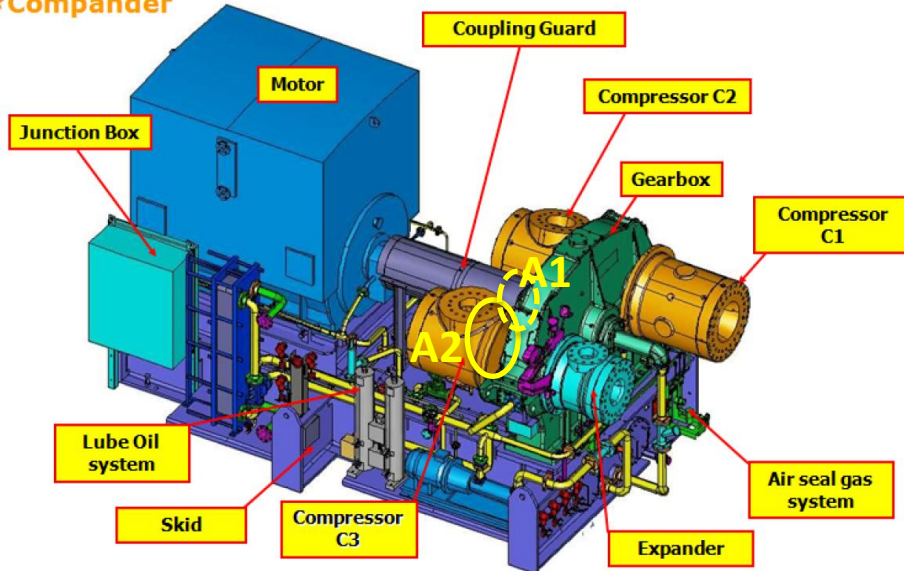

- High speed shaft speed = 20800 RPM.
- Motor speed = 1790 RPM
- FAT Power = 3.7 MW



3. Gear Box Manufacturer (GBM) RCA

Description of the problem:

During routine tests performed by the GBM, high level of vibrations were observed on high speed shaft 2.

Several tests were performed, in different configurations, in order to find the Root Cause of the vibration and reduced the amplitude from 31 to 16 $\mu\text{m pp}$.

(API criteria @19 $\mu\text{m pp}$)

API limit

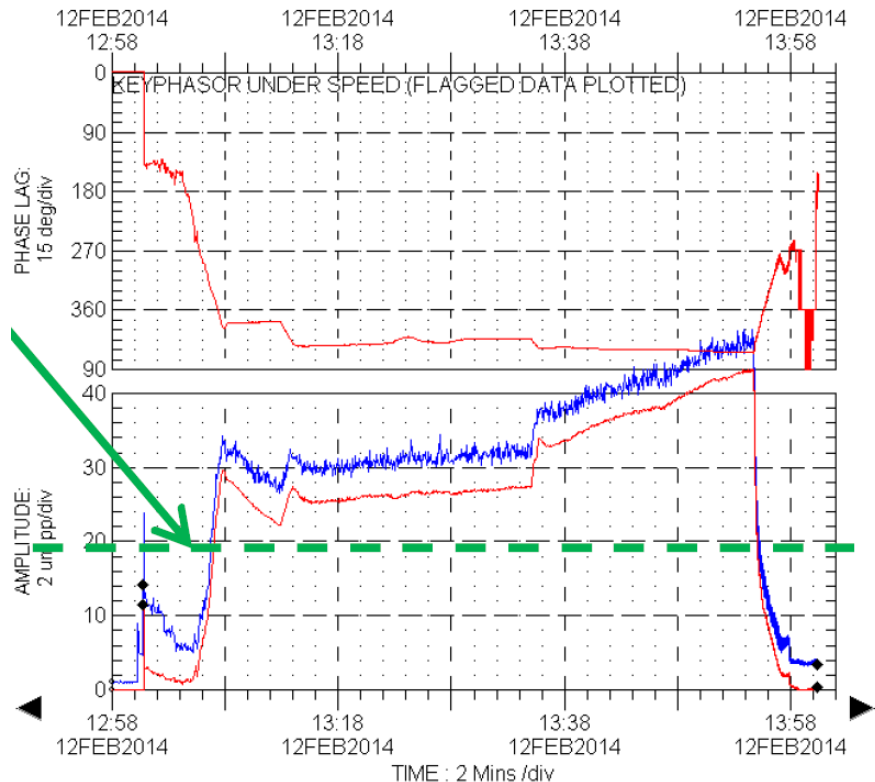

C3 vibration trend during 1st GBM MRT



3. Gear Box Manufacturer (GBM) RCA

- Identified as potential cause
- Double checked and CONFORM
- Double checked and NOT CONFORM
- Not conform but CLEARED POINT
- Still in progress

Design

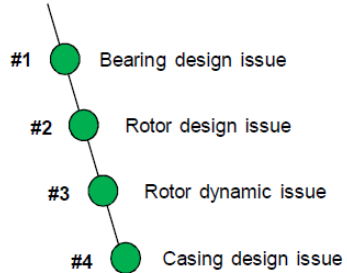

Manufacturing

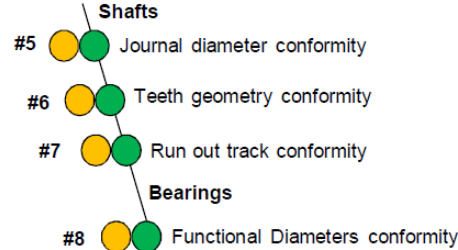

Manufacturing

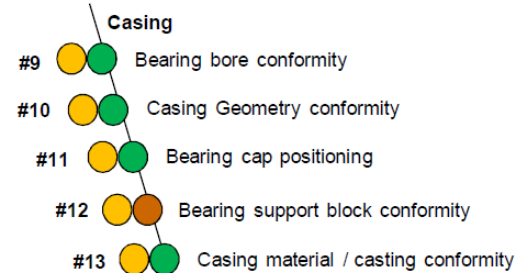

Assembly

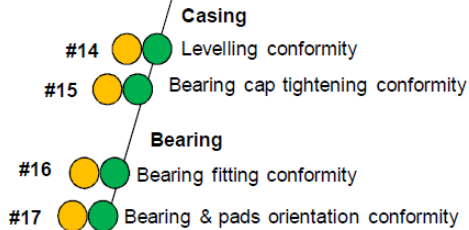

Assembly

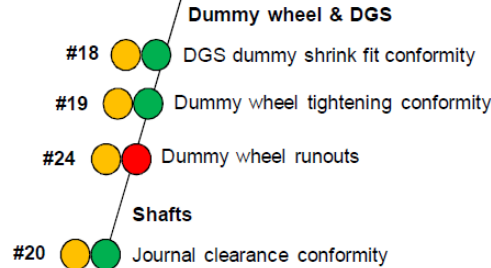

Test

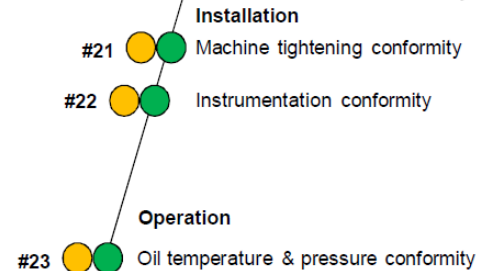

High Vibrations on HSS #2

GBM Fishbone Diagram



3. Gear Box Manufacturer (GBM) RCA

Rotordynamic behaviour: A loss of bearing stiffness may explain a shift of system critical speed, from above the operating speed range reducing towards the running speed. This effect arises from three possible causes:

1. C3 bearing non conformity:

Bearing replaced three times. Installed (measured) bearing diameters conformed to those in drawings

-> very unlikely root cause

2. Casing non conformity (Geometry) :

Rotor tested in 2 casings, this issue can be excluded.

3. Bearing support non conformity:

50 μm clearance between casing and bearing support block has been found. Putting shims between the casing and the support block did not improve the dynamical behaviour of Pinion 2

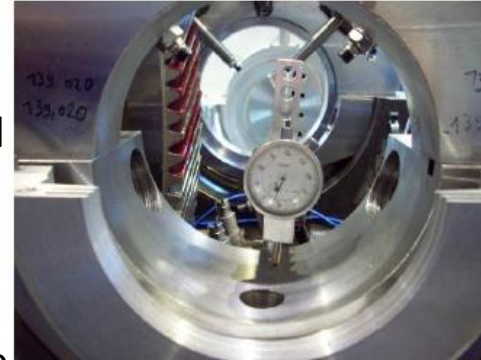

Bearing support geometry control



50 μm clearance

Bearing support potential cause

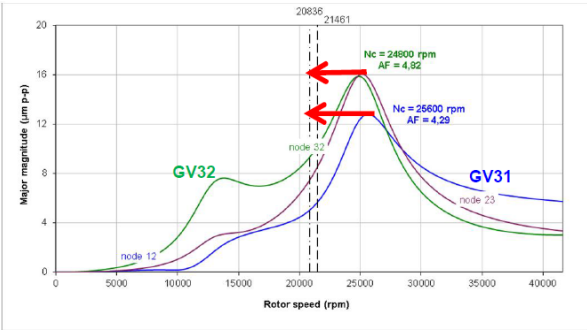
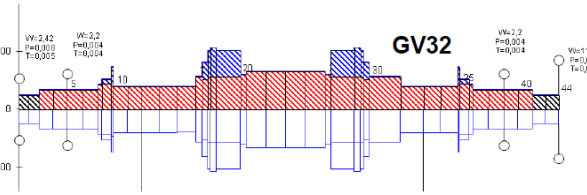

Lateral rotordynamic model and unbalance response



4. Vibration behaviour at OEM FAT: Casing Vibration

Description of the problem:

Over the 16 velocity measurement points around the machine, one (Point 9) highlighted higher values than the acceptance criteria of 4 mm/s rms [10-1000 Hz].

At this point, the magnitude varied a lot from 2.8 to 4.8 mm/s.

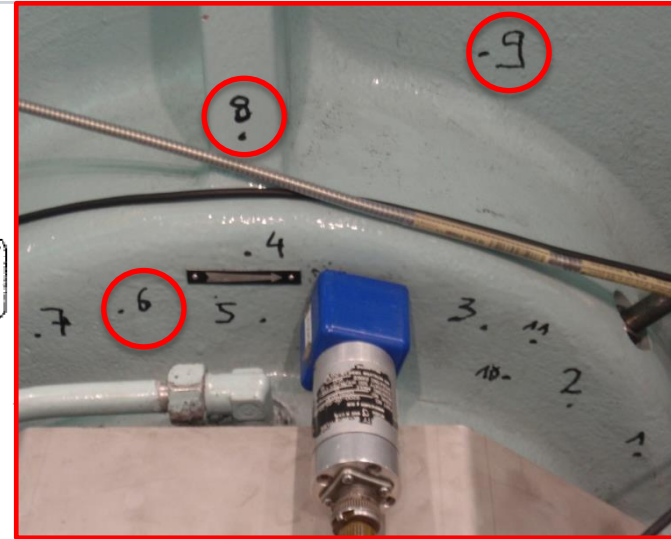
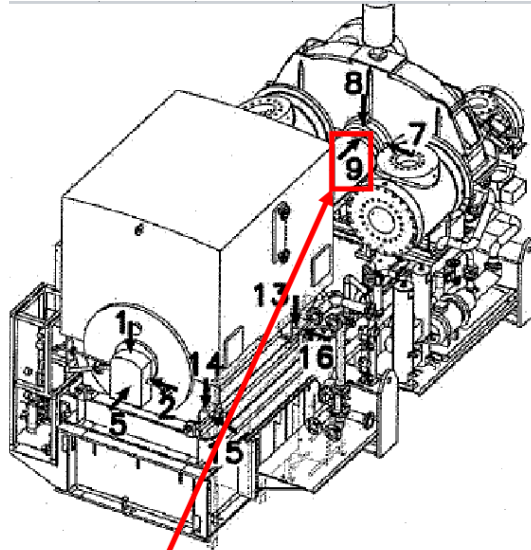

Measuring points mm/s ⁽¹⁾	Motor bearing shield						Compressor Gearbox						Motor structure			
	1	2	3	4	5	6	7	8	9	10	11	12	13	14	15	16
Acceptance Criteria ⁽²⁾	4 mm/s (in rms)															
Value (mm/s rms)	2.5	3.0	2.5	1.7	1.1	1.0	1.8	1.5	3.7	0.7	1.1	0.8	2.5	3.0	2.2	1.5

Zoom on
Point 9 axial gear box
low speed shaft
velocity discrepancy

Measurement N°	1	2	3	4	5	6	7	8	9	10	11	Average
Value (mm/s rms)	2.8	3.0	3.7	3.9	3.7	4.1	3.6	4.4	4.8	3.4	3.8	3.75



4. Vibration behaviour at OEM FAT: Casing Vibration

Continuous velocity measurements done on point 9:

1-Direct 4.2 mm/s, Bandpass 3.9 mm/s

2-Direct 4.8 mm/s, Bandpass 3.4 mm/s

Measurement point location changed only from few millimeters, but level varied a lot.

It was due to GB casing mode.

Measurements should be done on the bearing not on the thin plate (according to ISO 10816) to avoid this issue.

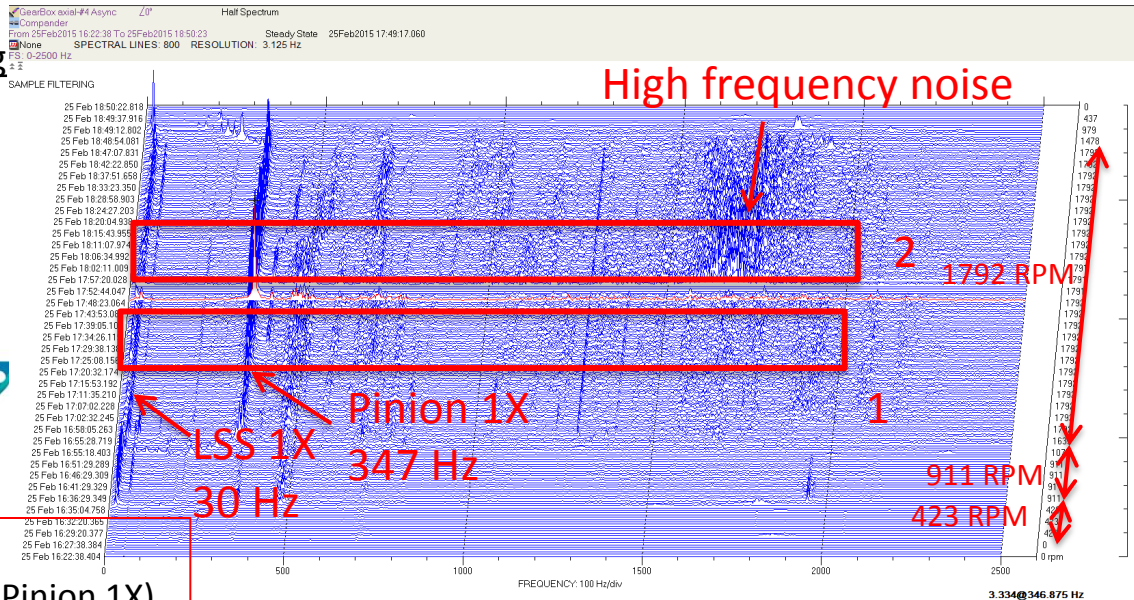
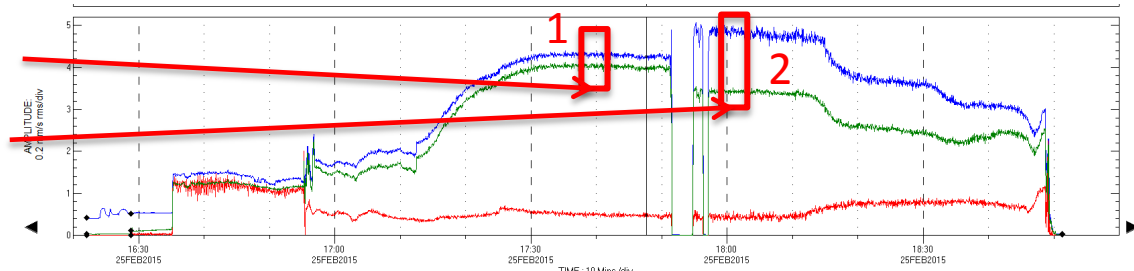

GB Casing- Modal analysis
350 Hz Mode shape (close to Pinion 1X)



4. Vibration behavior at OEM FAT: Pinion 2 vibration Trip

Further attempts of vibration measurements were done on gearbox casing and a trip happened due to high level on HSS n°2

The vibration level increased to 75 μm pp during shut down when crossing the pinion 2 critical speed at 15500 RPM.

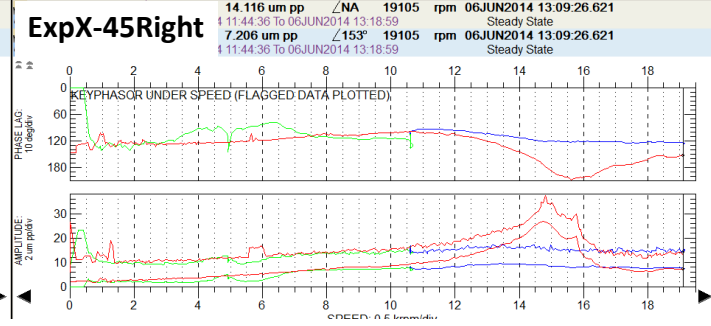
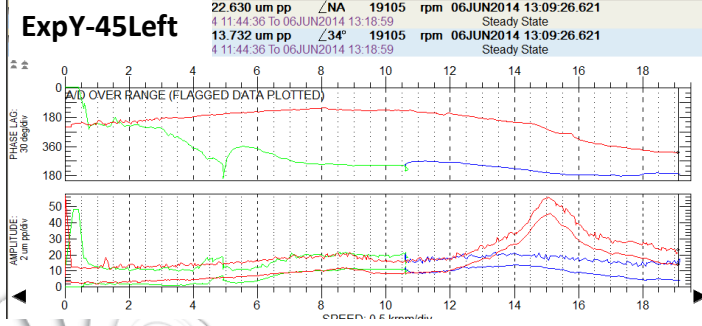
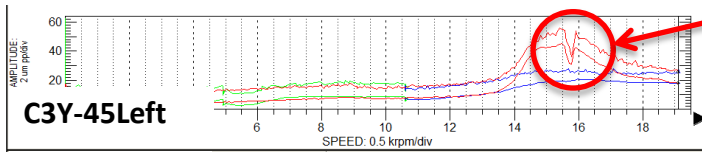
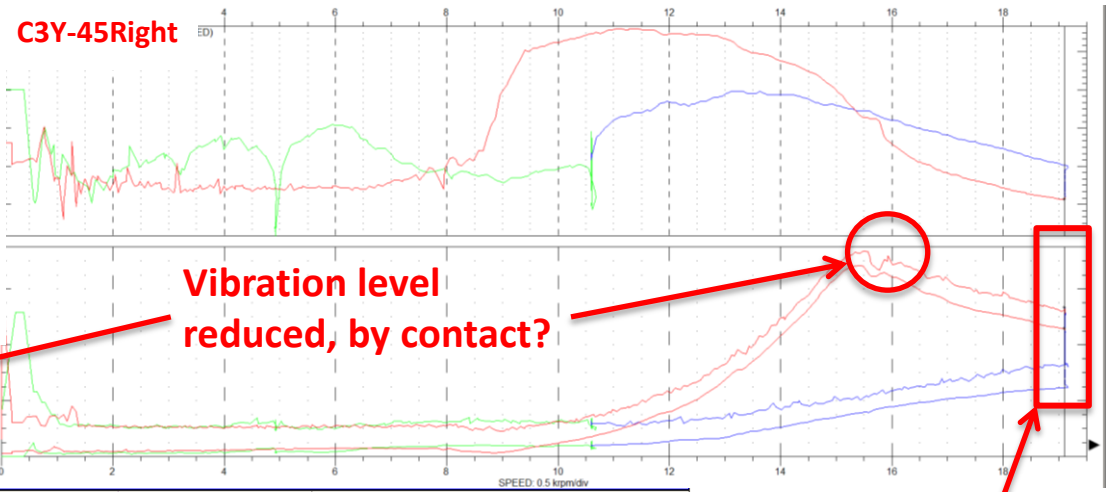

Displacement Trip on HSS n°2
Compressor 3-Right probe increased from 34 to 53 μm pp, at 19105 RPM, during 1 min, just after ramp up

Pinion 2 Bode Diagram



4. Vibration behavior at OEM FAT: Pinion 2 vibration Trip

- The same phenomenon was present during previous tests but with a lower amplitude.
- Vibration reached 49 μm pp just after speed ramp up from 10000 RPM to 19100 RPM.
- Not during critical speed crossing but 1 min after stabilisation at 19100 RPM.

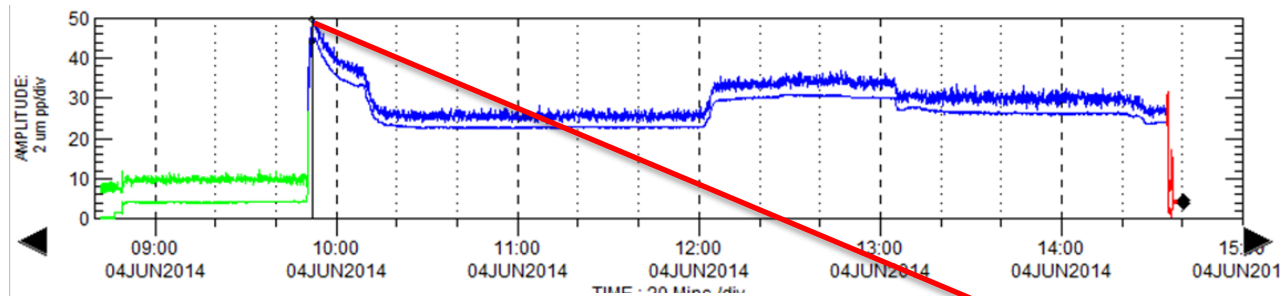
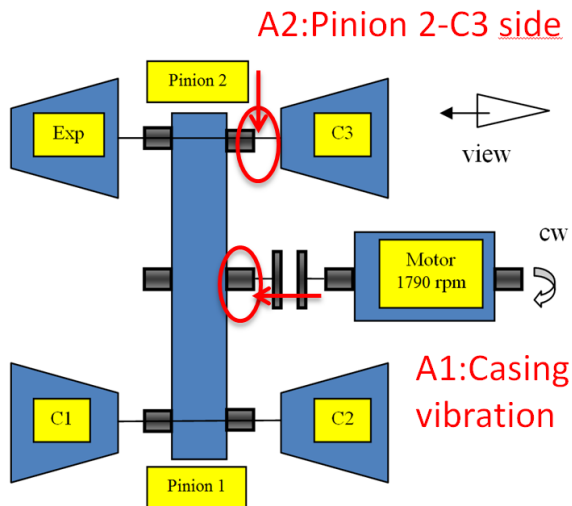

C3Y-45Right Trend

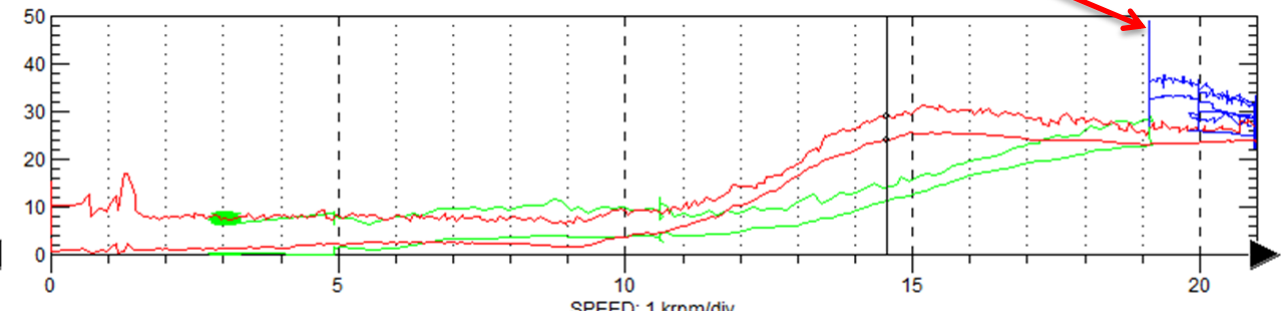

C3Y-45Right Bode



4. Vibration behaviour at OEM FAT: Pinion 2 vibration Trip

Based on the two tests comparison, pinion 2 vibration level increased, time after time. Re-reading prior internal test confirmed the observation.

Machine inspection found an oil deflector strain and plastic parts in the oil filter (coming from oil pump caps – Oil pump trip during first start up)



Oil deflector strain



Plastic parts

The 2 potential root causes creating a thermal bow during start up are:

- Pinion 2 rubs in oil deflector
- No sufficient lubrication of bearings (foreign body in oil pipe system)



5. EOM RCA-Pinion 2 vibration Trip

RCA N°	CONDITION	FACTOR-1	FACTOR-2	FACTOR-3	VERIFICATION METHOD / Resp	RESULT OF INSPECTION
1	Excessive vibrations	-> Design problem			Experience on similar equipment / Quality	7 Companders successfully accepted within the last year.
		-> Manufacturing / components defect	-> Complete pinion 2	-> Balancing	Balancing verification / Balancing cell	Complete rotor balancing out of tolerance (see second RCA below)
		-> Test set-up	-> Pinion 2 rubs in a statoric part		Visual inspection of seals and oil deflector / Quality	Oil deflector strain
			-> Abnormal lubrication of bearings	-> Foreign body inside oil system	Inspect oil filters / Test	Plastic parts found in dual filter
2	Rotor balancing result out of tolerance	-> Manufacturing / components defect	-> Shaft	-> Balancing	Balancing verification / Balancing cell	Balancing within tolerance.
			-> Wheels	-> Balancing	Balancing verification / Balancing cell	Expander wheel balancing out of tolerance (see third RCA below)
3	Expander wheel balancing result out of tolerance	-> Wheel contact with labyrinth			Visual inspection of the wheel / Quality	Slight marks on wheel surface.

- Expander wheel unbalanced was a consequence of excessive vibrations.
- The excessive vibrations root cause was the pinion 2 rub in oil deflector.



6. RCA with Motor Manufacturer

Previous OEM FAT motor velocity level high (3.5 mm/s rms) but acceptable.

Last 5 mm/s > 4 mm/s criteria

A sudden increase of 1 X vibration at constant speed and constant power (after 5 min at 3.7 Mwatt)

-> Something moving on the rotor shaft. It could be related to a thermal phenomenon.

Issue not detected earlier because motor (alone) was tested w/o load. Incidentally, note that with low power, vibration had a velocity magnitude of just 1 mm/s

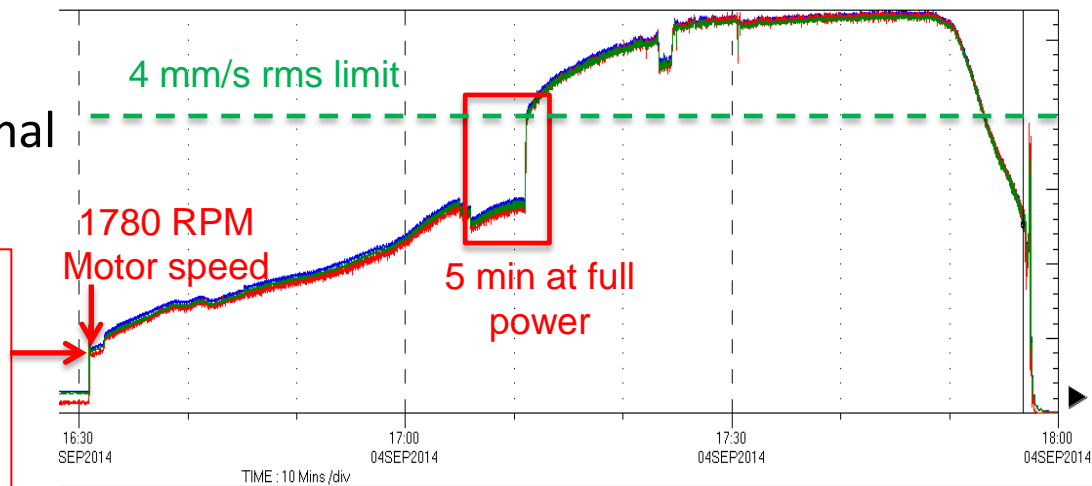

Motor velocity during EOM FAT



6. RCA with Motor Manufacturer

Motor sent back to manufacturer.

Manufacturer tested motor on both soft and rigid supports, loaded under constant power of 5 MW (full max power)

A steady increase in bearings vibration velocity with time was present for both conditions. Recommendation to rebalance rotor to ensure low vibrations for operation under high load (warm) condition.

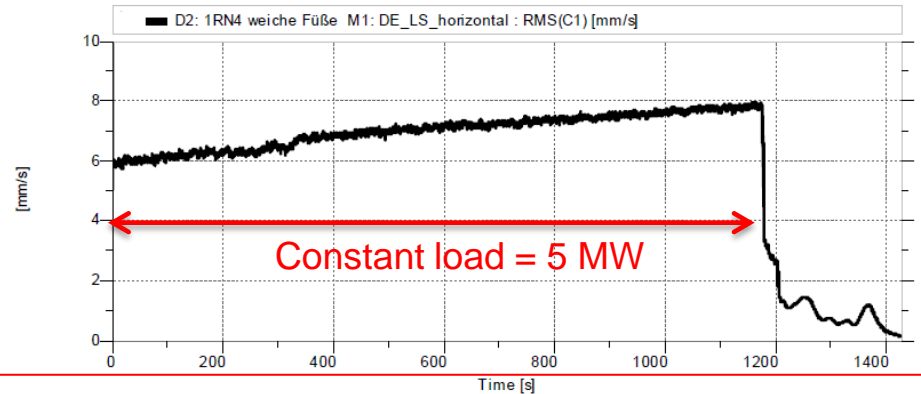

Motor manufacturer test loaded on soft support

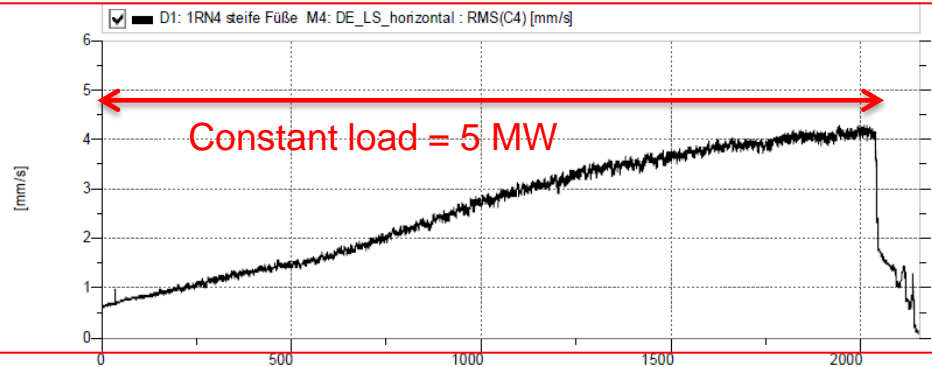

Motor manufacturer test loaded on rigid support



7. Conclusion

Multiple problems were found during this series of tests. The challenge was to determine the root cause of each problem and apply an appropriate solution. Three critical issues were resolved using modern analytical methods:

- After resolving the issue (reducing dummy wheels runout), the gear box was finally accepted
- After clarification on gear box casing velocity measurement, pinion 2 rebalance and reassembly: Machine was acceptable.
- The last point on motor balancing, has been solved by motor shaft rebalance

Since resolving those issues, the machine has been successfully operating for more than two years.



8. Lessons Learned

- When the rotor residual unbalance is found out of tolerance, it is necessary to check the residual unbalance of each rotor element to specifically update the relevant one(s).
- Velocity levels measured with a portable instrument are useful and easy-to-use indicators. But in case of high velocities, continuous monitoring is necessary to check time, rotating speed and load effect on vibrations, including frequency spectra. Measurement locations should be carefully chosen.
- Rubbing on gearbox pinion n°2 could be detected based on a deviating measurement from one test to the other, confirming the need for repeated checks.
- No-load motor tests are not as useful as loaded motor tests, thermal effect related issues not being revealed by no-load testing.
- 1 X vibrations (frequency = rotating speed) can be related to mechanical unbalance when speed-dependent or thermal unbalance when time-dependent.



Questions?

