

Aspects of the Ecology of The Northern Pennines

Occasional Papers

No. 3

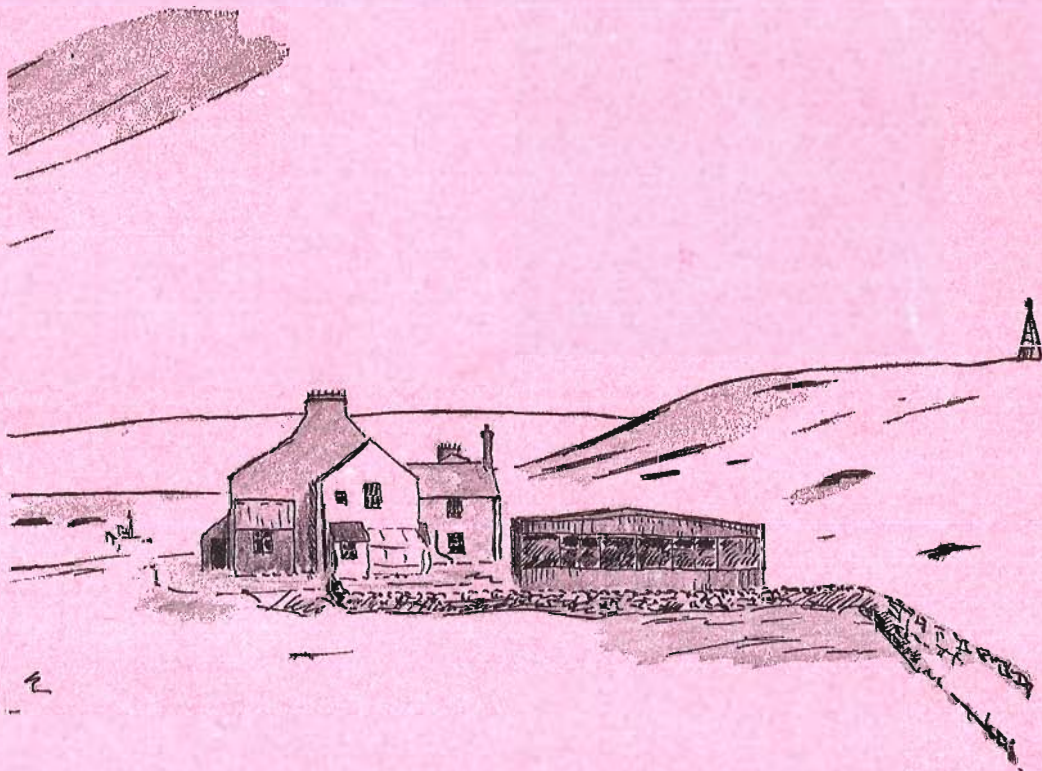

MOOR HOUSE

This paper was presented at an IBP/UNESCO meeting on Aquatic Macrophytes held in Rumania in September 1970. At the request of the hosts it was published by them (Hidrobiologia 12, 181-192, 1971). During editing whole sentences and paragraphs were removed, thus making nonsense of much that remained. We saw no proofs at any stage. A shortened, but it is hoped intelligible, version of the original paper is reproduced here.

A TENTATIVE DRY MATTER BALANCE SHEET FOR THE WET BLANKET BOG ON
BURNT HILL MOOR HOUSE NNR

R. S. Clymo and E. J. F. Reddaway

A dry matter balance is made for some Sphagnum dominated areas of blanket bog at 575 m altitude in the Pennine hills of Britain. Productivity of Sphagnum in pools is about $2.9 \text{ g dm}^{-2} \text{ yr}^{-1}$, on lawns about $3.4 \text{ g dm}^{-2} \text{ yr}^{-1}$ and on hummocks about $1.8 \text{ g dm}^{-2} \text{ yr}^{-1}$. Mean gas loss is about 1.5, 0.9 and $1.3 \text{ g (CH}_2\text{) dm}^{-2} \text{ yr}^{-1}$ from the corresponding habitats. Loss in solution averages about $0.2 \text{ g dm}^{-2} \text{ yr}^{-1}$, but distinction between habitats is not made.

Introduction

The reasons for wanting to know the productivity of Sphagnum are given in Clymo (1970). Briefly they are:

1. Sphagnum is abundant (Sjors 1961, Taylor 1964) especially in Northern countries. Attempts to explain rates of peat formation must use Sphagnum productivity estimates.
2. The structure of the plants is unusual being analogous to the surface layers of a dense algal suspension in which the cells are regularly spaced but held in fixed relative positions. They have some properties intermediate between those of an aquatic macrophyte and those of a microphyte.
3. Acidity in Sphagnum bogs is related to productivity (Clymo 1970).

In this paper an attempt is made to produce a dry matter balance sheet for parts of an area of bog in which Sphagnum is a major component.

The Experimental Area

The area is in the Moor House National Nature Reserve $2^{\circ}21' \text{ W}$, $54^{\circ}46' \text{ N}$, in Westmorland, England, at altitude about 575 m on the place known locally as Burnt Hill, National Grid reference NY (35) 754328. A general description of vegetation on the Reserve is given by Eddy, Welch and Rawes (1969). Burnt Hill is covered by blanket bog with peat 2-3.5 m deep. The wet area to the south of centre is about 300 m across, and has a well developed pool and hummock complex. The edges of the area are eroding, with (2.5 m) gullies. The erosion is discussed by Bower (1959).

A vegetational survey of the area was made in April, 1970. "Rooted" presence/absence was recorded in square samples of side 25 cm. The samples were placed on 206 random positions on a 1 m unit grid with 2500 intersections. Each sample was classified subjectively on topography, hydrology and plant cover as pool, lawn, hummock, or general blanket bog. The first three types have Sphagnum as dominant, but in the last it is a lesser component (or absent). About 40% of the whole area is Sphagnum dominated (table 1). The frequency and (where appropriate) density of the commonest species are shown in table 2 and in figure 2. By July it was obvious that some species of hemicryptophytes are also common, particularly Narthecium ossifragum, Drosera rotundifolia and also Scirpus cespitosus. The last was probably, in some cases, not noticed in the April survey though it was looked for. Other species, uncommon but of interest, are Sphagnum fuscum, Rubus chamaemorus, and Vaccinium oxycoccus. The vegetation of this area is shown on the map of Eddy, Welch and Rawes (1969) as Calluneto-Eriophoretum, but it is perhaps approaching their Trichophoro-Eriophoretum.

Table 1. Proportion of whole sample area occupied by subjectively classified types of vegetation

<u>Type of vegetation</u>	Proportion of area	
Pool	0.18)	
Lawn	0.13)	0.39
Hummock	0.08)	
General blanket bog	0.61	

Table 2. Frequency (F) of commonest species on the whole sample area*

Species	Frequency in square 625 cm ² sample	Calculated mean density (shoots m ⁻²)
Calluna vulgaris	0.70	19.5
Eriophorum vaginatum	0.67	
E. angustifolium	0.62	15.6
Sphagnum rubellum	0.47	
Erica tetralix	0.46	9.9
Cladonia arbuscula	0.41	
Sphagnum papillosum	0.35	
S. cuspidatum	0.20	

*Densities (D) have been calculated from $D = -\ln(1-F) \times 1000/625$. This assumes that the plants are randomly distributed, and that the conditions for a Poisson distribution are satisfied. The calculation has been made only for those species for which these assumptions are approximately true.

Fig. 1. Normal and inverse analyses of blanket bog on Burnt Hill, based on the information statistic. Qualitative data from 206 samples each 25 cm x 25 cm, collected in April 1970. Some species, particularly *Drosera rotundifolia*, *Narthecium ossifragum* and *Scirpus cespitosus* were more obvious later in the year. A monothetic divisive method was used (Lance and Williams, 1968).

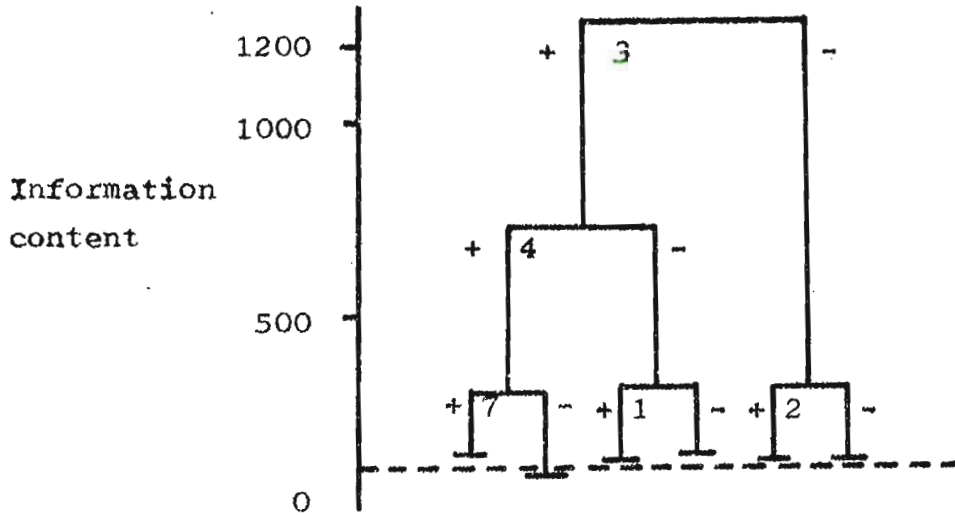

Number of quadrats	36	35	37	30	27	41
Distinguished as pool				1	1	25
Pool edge				1	7	
Pool/lawn						4
Lawn			1	11	7	6
Hummock	5	3	3	1	3	
Group number	1	2	3	4	5	6

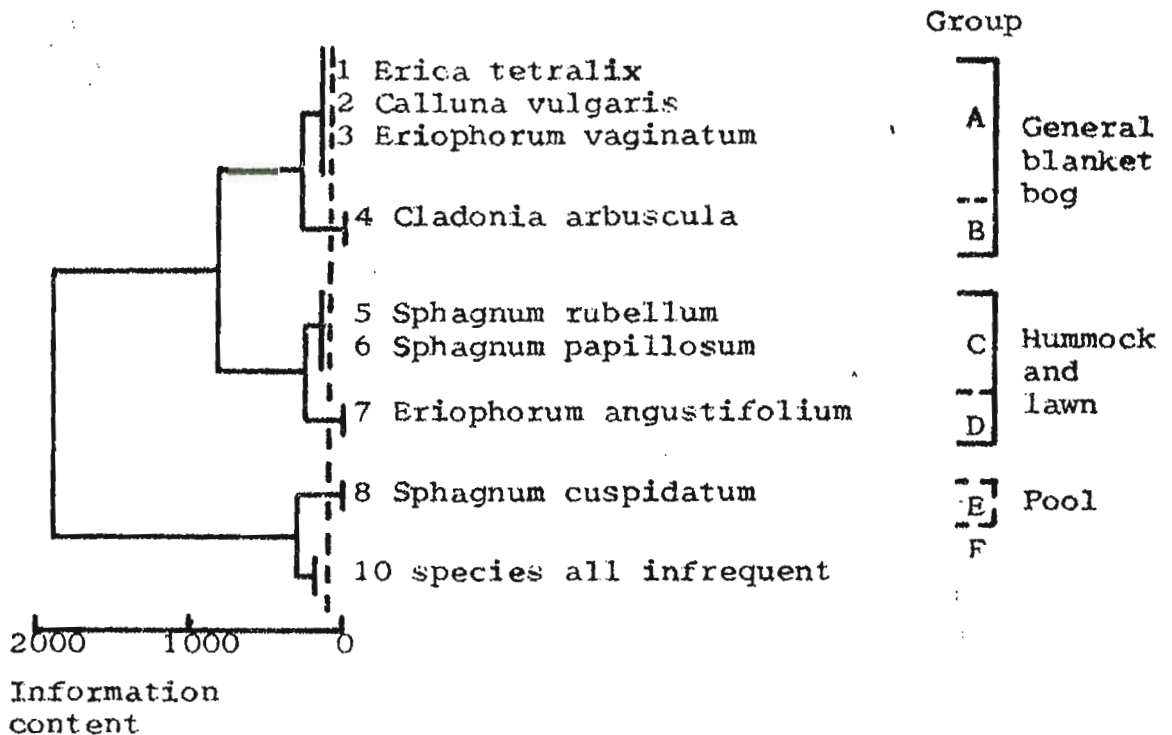
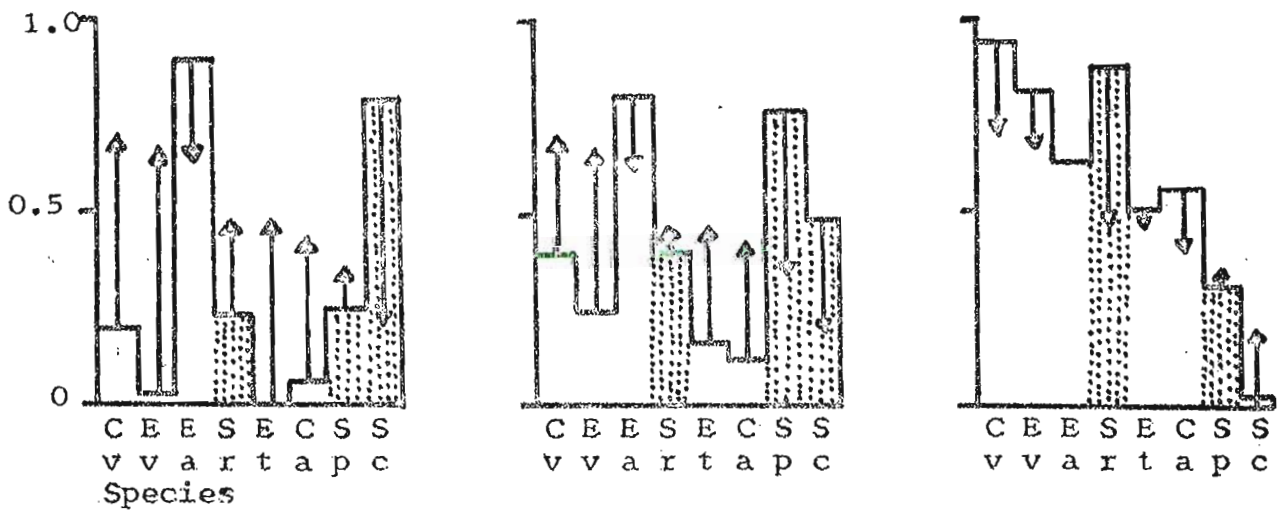
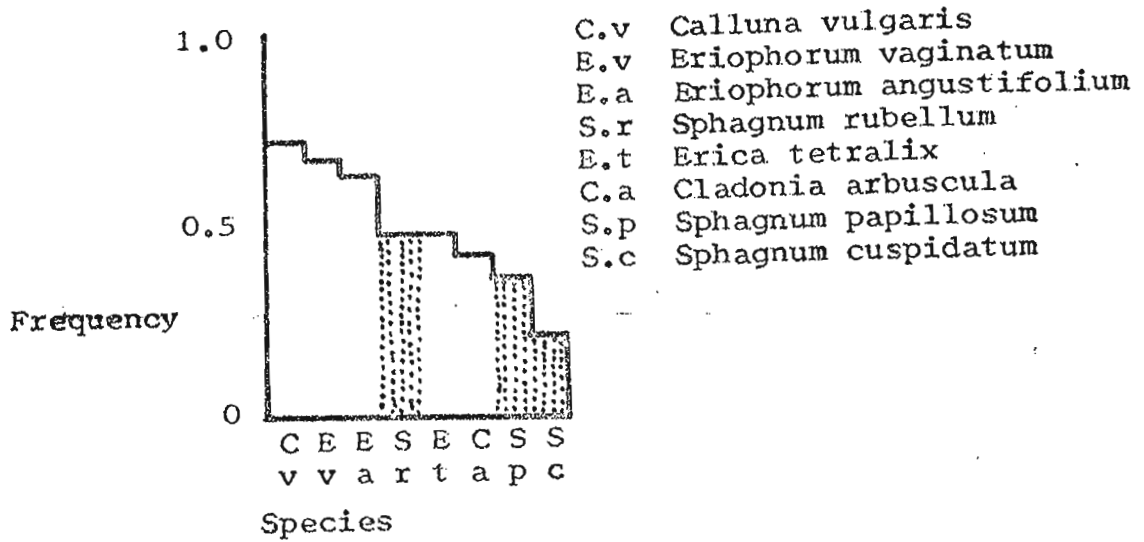

Fig. 2. Frequency (in square 625 cm² samples) of the eight most abundant species on Burnt Hill*



*The top block diagram shows data for the area as a whole. The lower three diagrams are for pools, lawns and hummocks separately. Arrows point to the frequency for the area as a whole.

Hierarchical classifications based on floristic criteria, using normal and inverse monothetic divisive information-analyses (Lambert and Williams (1966), Lance and Williams (1968), Williams, Lambert and Lance (1966)) are shown in figure 1. On the whole, the subjective grouping is confirmed, the pools appearing as group 6, whilst the lawns and hummocks are more widely spread, having greater diversity, with centres on groups 4 and 5 (lawn) or 1 to 3 (hummocks). The species groups are also fairly readily interpreted. The general blanket bog group A joins with B (containing Cladonia arbuscula alone) at a level not much above that of A. This may be due to a difference in shelter: C. arbuscula appearing mainly amongst larger Calluna bushes. The hummock and lawn Sphagnum spp. appear in group C, joined by Eriophorum angustifolium. Group F is a collection of species having little in common except their rarity (in the samples). That S. cuspidatum joins this group emphasises the floristic isolation of the pools, which are almost the sole habitat of this species, and which are particularly notable for the absence of other species.

The climate of Moor House is described by Millar (1954). The mean annual temperature at 1 ft below the surface (daily observations at 9.00 GMT) for 1953 to 1965 was 6.2°C, with monthly mean at its highest, 11.5°C in July and August, and at its lowest 1.3°C, in February. The 5 ft (182 cm) screen mean maximum temperature was highest, 14.8°C, in July, and lowest 1.8°C in February. The screen mean minimum was highest, 7.2°C, in July and lowest, -3.6°C, in February. The average rainfall was 187 cm, with an average 247 rain days per year. The average windspeed (Feb. 1956-Dec. 1965) was 13.2 knots (24.4 km hr⁻¹).

In, general, the climate is cool, fairly windy, fairly constantly damp, with few dry periods of more than a week.

Measurements and methods

Input of dry matter to the bog ecosystem is mainly as carbohydrate produced during the growth of the plants. Output is mainly as gas and in runoff in solution.

Growth and productivity of Sphagnum were measured by two methods (details given in Clymo (1970)).

1. "Cranked wire" method. A stainless wire, bent in two places to form a shape like that of a car starting handle, was pushed into the bog, leaving one end projecting. This served as a marker against which the growth in length of the plants was measured. The mass area⁻¹ for a unit depth of Sphagnum carpet (excluding capitula) was also measured, and a fairly direct estimate of net productivity was made.
2. "Capitulum correction" method. Sphagnum plants were cut to 5 cm long, and replaced (or transplanted) in the bog surface. At harvest the increase was removed, dried and weighed. A correction was made for the material originally present in the capitulum and carried into the "new growth" by internode elongation. Details and checks of both methods are given in Clymo (1970).

Loss of matter as gas from the ecosystem was measured at roughly monthly intervals. Stainless steel cylinders 27 cm diameter and 30 cm deep with a shallow channel brazed to the outer upper edge, were sunk in the bog surface. Green plant parts were cut off, and the first samples were taken 8 weeks later. For sampling, thick polyethylene pots were inverted over the steel cylinders and sealed in the channel with water. After 24 hours an evacuated flask was attached to a tube in the top of the plastic container, the tube having been closed during the sampling period with a glass rod. The tap of the evacuated container was opened and a sample of the gas thus collected. The concentration of CO₂ and CH₄ was estimated later with an infra red gas analyser.

Organic matter in solution was measured as loss in weight on ignition of filtered water samples from pools. Samples were collected at approximately monthly intervals.

Productivity of plants other than Sphagnum was calculated from measurements of above-ground biomass or standing crop. The samples were collected at the time of seasonal maximum. Conversion to productivity was made using factors calculated by Dr. G. I. Forrest from his detailed measurements on Sike Hill.

Experiments and results

1. Estimates of net primary production of Sphagnum rubellum were made by the cranked wire method on hummocks and on the general blanket bog. The Sphagnum was classified subjectively as being healthy, moderate, or unhealthy in appearance. Criteria of both density and colour were used. A total of 84 wires was set out. By the end of the second year only 57 could be found in position. Some of these however were ones not found at the end of the first year. The losses may be due to sheep, grouse, or wind-whip by Calluna. Many of the lost ones were seen lying uprooted.

This method gave mean estimates of net productivity ranging from 0.5 to $2.0 \text{ g dm}^{-2} \text{ yr}^{-1}$ (table 3) in healthy and unhealthy sites, the differences between sites being significant at the $P = 0.05$ level. The overall mean was $0.9 \text{ g dm}^{-2} \text{ yr}^{-1}$. Such a rate of growth is not exceptional for the Moor House region. Table 4 shows the growth measured on three separate areas of blanket bog having different histories and management.

Table 3. Growth in length in 2 years of Sphagnum rubellum on hummocks and general blanket bog on Burnt Hill*

Type of site	Healthy	Moderate	Unhealthy	All
Number of wires set out	15	33	36	84
Number found	11	22	24	57
Mean growth (cm)	4.3	1.9	1.0	1.9
Variance	0.53	0.99	1.34	1.15
Net productivity ($\text{g dm}^{-2} \text{ yr}^{-1}$)	2.0	0.9	0.5	0.9

*The last line shows net productivity based on a bulk density for the 3 cm below (and not including the capitulum) of $0.9 \text{ g dm}^{-2} \text{ cm}^{-1}$, Clymo (1970)

Table 4. Growth in length (cm yr^{-1}) of S. rubellum on hummocks and general blanket bog on three areas at Moor House

Area	Sheep grazed?	With pools?	Type of site		
			Healthy	Moderate	Unhealthy
Sike Hill	+	-	2.08	1.35	0.65
Bog Hill	-	some	2.14	1.40	0.63
Brnt Hill	+	+	2.17	0.97	0.51

Table 5. Growth of Sphagnum transplanted to various habitats on Burnt Hill*

Species	Habitat					
	Pool		Lawn		Hummock	
<u>S. recurvum</u>	<u>23.9</u>	12.3	<u>21.0</u>	3.4	<u>7.5</u>	2.8
<u>S. papillosum</u>	<u>10.7</u>	3.6	<u>16.8</u>	4.3	<u>11.9</u>	0.9
<u>S. rubellum</u>	<u>5.6</u>	3.2	<u>5.2</u>	1.7	<u>5.7</u>	0.8
<u>S. cuspidatum</u>	<u>16.5</u>	12.1	<u>18.1</u>	6.9		

*The period of growth was April 1968-April 1969. Underlined figures are mg plant⁻¹, other figures are cm plant⁻¹. Error variances are 2.22 mg plant⁻¹ and 1.02 cm plant⁻¹.

2. Another estimate of net primary productivity of Sphagnum on the Burnt Hill site was made in a factorial experiment using the "capitulum correction" method. Plants of four species (S. cuspidatum, S. recurvum, S. papillosum and S. rubellum) were cut to 5 cm length and transplanted to one of two sites in three habitats (pool, lawn or hummock). The original habitat of S. cuspidatum is pools, of S. papillosum is lawns, and of S. rubellum is hummocks. S. recurvum is not in general a species of the open blanket bog on this part of Burnt Hill except where water is channelled into gullies. It may be that it responds to flushing, and certainly its natural growth pattern of overlapping horizontal shoots is very different from that of S. papillosum and S. rubellum (von Bismarck 1959, Overbeck and Happach, 1956), though not dissimilar to that of S. cuspidatum. The plants grew from April 1968 to April 1969. At harvest, two groups of about 10-20 plants of each species were taken at both sites of each habitat. The groups were treated as a unit. Results, after correction for change in capitulum size, are shown in table 5. The increase in length was also measured, and is shown too. For S. rubellum on hummocks and lawns the growth averaged 0.8 and 1.7 cm, compared with 0.5 to 2.2 cm measured on cranked wires in the same area (table 3). An analysis of variance (table 6), excluding S. cuspidatum which was not completely factorial in design, showed that the interaction of species and habitat is very significant, a not entirely surprising result. The significant difference between sites (in nominally the same habitat) is perhaps due to the difficulty of selecting similar parts of the same habitat, since there is continuous variation between habitats, not a sharp division.

To allow comparisons between species the net productivity has been calculated using the data of table 7, and combined with the results of a similar experiment described in Clymo (1970).

Table 6. Analysis of variance of growth of Sphagnum recurvum, S. papillosum and S. rubellum grown from April 1968-April 1969 in three habitats on Burnt Hill

Treatment	Deg. freedom		Sum of squares		Mean square		F	
	Species (A)	<u>2</u>	2	<u>866.5</u>	119.1	<u>433.2</u>	59.6	<u>104***</u>
Habitat (B)	<u>2</u>	2	<u>239.6</u>	146.6	<u>119.8</u>	73.2	<u>29***</u>	70***
Interaction AB	<u>4</u>	4	<u>456.3</u>	114.7	<u>114.1</u>	28.7	<u>28***</u>	27***
Site at habitat	<u>1</u>	1	<u>39.1</u>	7.9	<u>39.1</u>	7.9	<u>9.4***</u>	7.5***
Error	<u>26</u>	26	<u>108.3</u>	27.4	<u>4.16</u>	1.05		
Total	<u>35</u>	35	<u>1709.7</u>	415.5				

* Underlined figures refer to growth in weight, other figures to growth in length. All treatment effects are significant at $P < 0.001$ (= ***).

Table 7. Mean values for spatial density, weight per unit depth of carpet (of stem + branches and leaves), and weight per unit length of plant*

Species	Number dm ⁻²	g dm ⁻² (cm plant) ⁻¹	calculated mg (cm plant) ⁻¹
<i>S. rubellum</i>	450	0.9	2.0
<i>S. papillosum</i>	125	0.9	7.2
<i>S. recurvum</i>	150	0.3	2.0
<i>S. cuspidatum</i>	150	0.4	2.7

*The data refer to the parts of the plants below the capitulum. The plants were from 1 dm² samples collected from natural habitats (Clymo (1970) fig. 13).

The analysis of variance (table 8) shows that three interactions are important. Two of these are connected with the methods, and the mean values are shown in table 9. For *S. papillosum*, the length method gives a higher value than the weighing method, while for *S. rubellum* and *S. recurvum* the reverse is true. The other effect is that in pools the length method gives a higher value than the weighing method, whilst the reverse is true on hummocks. The source of these differences is probably the variation in spatial density and length of branches in the different habitats. It is easily observed that in wetter conditions most species of *Sphagnum* show a laxer growth form. This is indicated by the variation in weight per unit length of stem (fig. 4) for plants from these experiments. The exception is *S. recurvum* for which there is no great change with habitat.

Table 8. Analysis of variance of net productivity of *Sphagnum recurvum*, *S. papillosum* and *S. rubellum* in pool, lawn and hummock on Burnt Hill in two years (1963-64, 1968-69)^x

Treatment	Deg. freedom	Sum of squares	Mean square	F
Species (A)	2	2.60	1.30	6.65**
Habitat (B)	2	20.27	10.13	52***
Year (C)	1	7.11	7.11	36***
Method (D)	1	0.22	0.22	1.11 NS
Interactions				
AB	4	7.49	1.87	9.55***
AC	2	1.59	0.80	4.06*
AD	2	9.36	4.68	24***
BC	2	0.29	0.15	0.75 NS
BD	2	4.29	2.15	10.94***
CD	1	0.01	0.01	0.05 NS
Other interactions (used as error)	16	3.14	0.196	
Total	35	56.36		

^xNet productivity was measured from growth in dry matter and from growth in length. Significance of treatment effects:

P < 0.05* P < 0.01** P < 0.001***

Table 9. Net productivity ($\text{g dm}^{-2} \text{ yr}^{-1}$) in two cases of strong interaction in the experiments summarised in Table 8*

Method	Species		
	<i>S. rubellum</i>	<i>S. papillosum</i>	<i>S. recurvum</i>
by weight	2.4	2.1	3.5
by length	2.1	3.1	2.4
	Habitat		
	Pool	Lawn	Hummock
by weight	3.0	3.0	2.1
by length	3.7	2.8	1.1

*The third case (species/habitat) is shown in Fig. 3.

The figure used in the calculations is that given in table 7, and shown graphically as the hatched line in the lawn habitat on figure 4. Since the plants do not normally grow in some of the habitats used in the experiment, field samples to give the data similar to those in table 7 are not available. The experimental estimates shown in fig. 4 cannot be used, since they would then give identical results with the weight method, being based on the same measurements. They also include the capitulum and hence are too large. One can however use the results shown in fig. 4 as an indication of the direction of effects due to habitat, and predict whether the length will give lower, similar or higher results than the weighing method. When this is done, 8 of the 9 predictions agree with observation. In conclusion therefore it seems that the estimates based on length growth may be reliable only for the habitat in which the plant normally grows (shown shaded in figure 3).

The third important interaction shown in table 8 is of species and habitat. Although there was an important difference between years (net production in 1968/69 was about 20% lower than in 1963/64) the interaction with species is of little significance, so we may assume that all species and habitats were nearly similarly affected. The interaction of species and habitat arises mainly because *S. rubellum* and *S. recurvum* (and *S. cuspidatum*) each have increasing net production with increase in wetness, but *S. papillosum* has a peak in the lawn habitat. It is necessary therefore to consider each species and habitat separately. *S. recurvum* and *S. cuspidatum* are perhaps the simplest. They have greatest productivity in the habitat in or near which they normally occur and of the species tested have largest net production in that habitat. It would be a major error to neglect biological features, and rely only on net productivity, when attempting to explain the restriction of a species to a particular habitat. There are numerous examples, of, for example, toxin production or special morphological features giving a less productive species the ability to suppress more productive ones (Harper 1960, Milthorpe 1961). With *Sphagnum* the ability to extend rapidly (table 5) may be such a feature. At least, in this case, biological features and net productivity are apparently in harmony.

Much the same may be said of *S. papillosum*, which has its largest net productivity in the habitat in which it normally grows, and is the fastest producer in that habitat.

Fig. 3. Net productivity of four species of *Sphagnum* in three habitats on Burnt Hill. Shaded areas show the natural habitat.

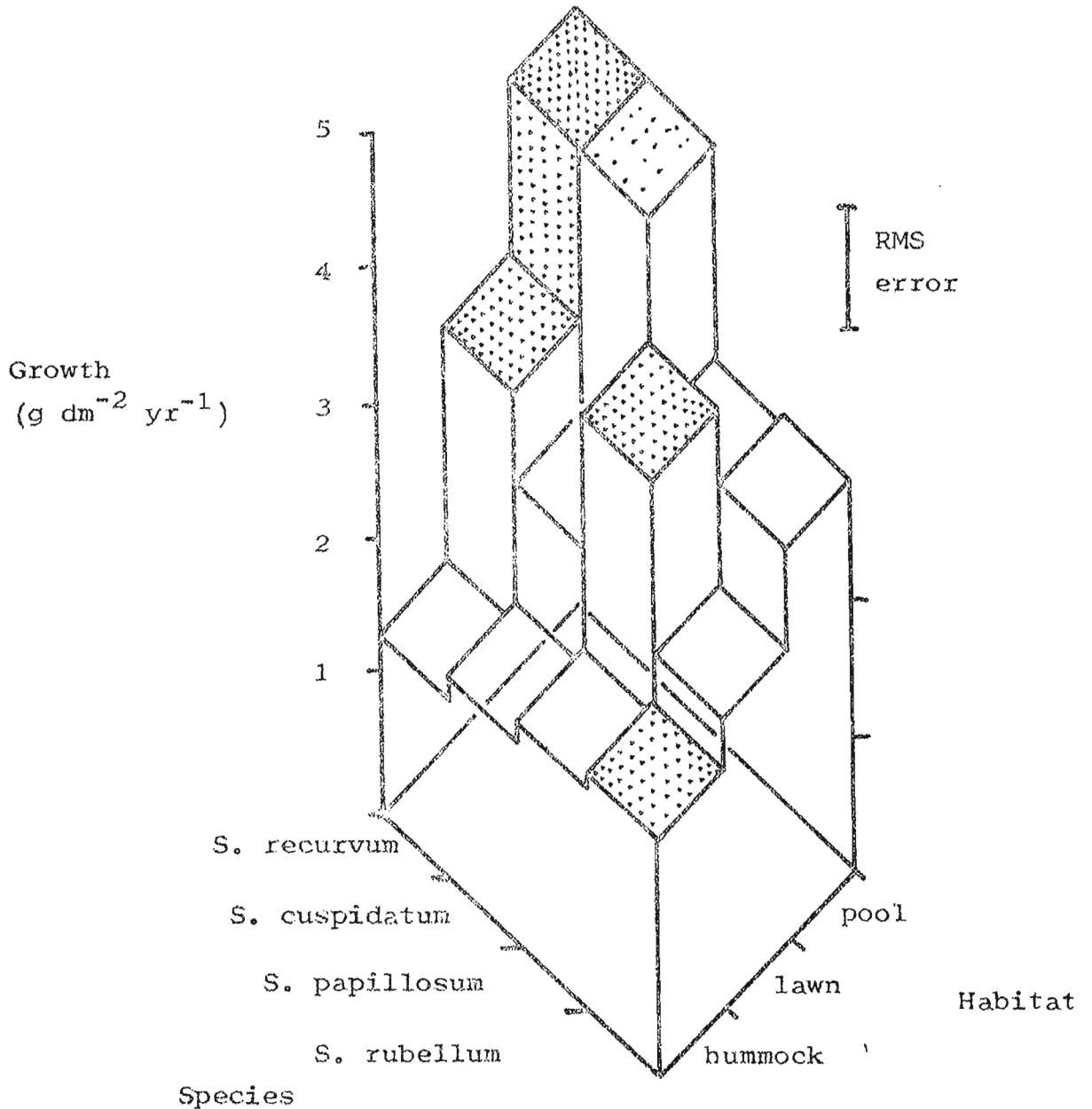
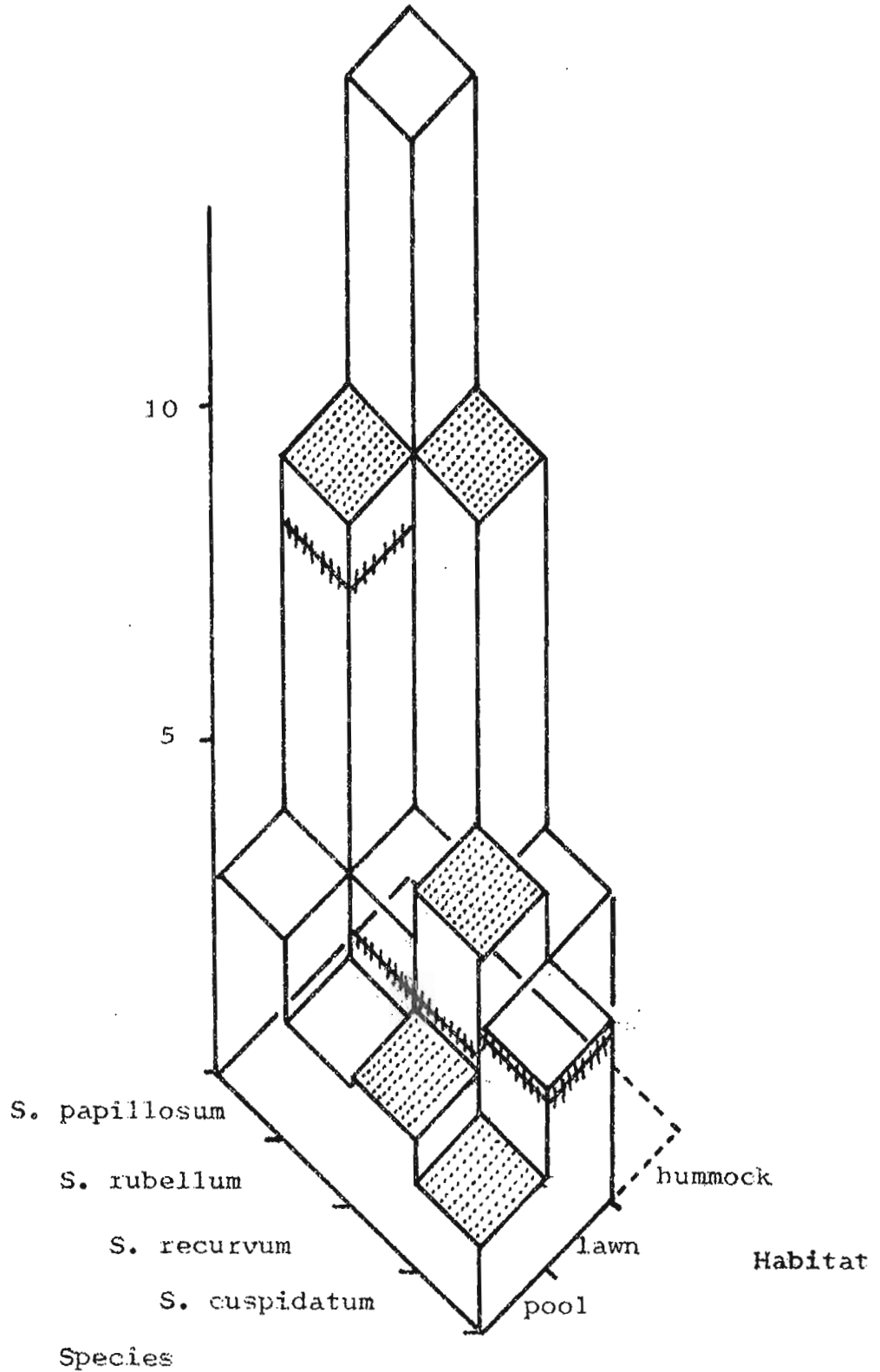

Fig. 4. $Mg\ cm^{-1}$ for the growth in 1968-69 (i.e. measure of bulk density) of four species of *Sphagnum* in three habitats on Burnt Hill. Shaded areas show natural habitat. The hatched lines for the lawn habitat show mean values of (plant dry weight) cm^{-1} for the 1-4 cm sections of the plants in natural habitats. *S. cuspidatum* was not transplanted to hummocks in 1968-69, so there is no measurement for that treatment.



Net productivity of S. rubellum is not so easily interpreted. It does have a higher value on hummocks than that for other species tested, but is even greater in wetter habitats. The obvious explanation would be that S. rubellum is prevented, by "competition" from growing in these habitats. Individual plants are smaller than the other species and extend more slowly. It is perhaps significant that one may often find individual plants of S. rubellum in lawns, but rarely a complete canopy. The biological features which enable S. rubellum to grow relatively well on hummocks are not at present known, but they may be connected with water transport abilities.

To get an estimate of net productivity by Sphagnum over the whole area, the data from figure 3 for S. rubellum on hummocks, S. papillosum on lawns and S. cuspidatum in pools are combined with the areas given in table 1 to give the results in table 10. Since the pools are, on average, only about 2/3 covered by S. cuspidatum the value has been correspondingly reduced. In pools, lawns and hummocks about 60% of Sphagnum production occurs, though they cover only 40% of the area. In the areas dominated by Sphagnum most other species are relatively less abundant, and the Ericaceous shrubs are absent or smaller than on the general blanket bog. Production by these shrubs and by the cotton grasses in these habitats is only 15% to 30% of that by Sphagnum. On the "general blanket bog", the reverse is true. The area as a whole has a productivity of about 3 t ha⁻¹ yr⁻¹. This may be compared with about 6 t ha⁻¹ yr⁻¹ estimated for the Calluna and Eriophorum vaginatum dominated Sike Hill site (Forrest 1971). On that area the individual plants are larger and distributed more densely than on Burnt Hill, and there is about 15% Sphagnum cover.

Table 10. Net productivity on Burnt Hill

Type of vegetation	Net productivity g dm ⁻² yr ⁻¹		Relative area	Total t ha ⁻¹ yr ⁻¹	
	<u>Sphagnum</u>	Other species		<u>Sphagnum</u>	All plants
Pool	4.4	0.52	+0.12 (0.18)	0.53 ± 0.11	0.62 ± 0.15
Lawn	3.4	0.42	0.13	0.44 ± 0.12	0.50 ± 0.14
Hummock	1.8	0.64	0.08	0.15 ± 0.07	0.20 ± 0.08
General blanket bog (15% cover of <u>S. rubellum</u>)	0.9	2.73	*0.09 (0.61)	0.81 ± 0.13	1.66 ± 1.06
All habitats				<u>1.93</u>	<u>2.98 ± 1.08</u>

+ Assumes pools 2/3 covered by S. cuspidatum

* 15% of 0.61 the proportion covered by this vegetation type

Confidence limits are for $P = 0.05$

Table 11. Production of gases in three sites during 1969

Habitat	Pool	Lawn	Hummock	$P = 0.05$
CO ₂)) gC dm ⁻² yr ⁻¹	0.54	0.31	0.50	± 0.22
CH ₄)	<u>0.07</u>	<u>0.04</u>	<u>0.01</u>	± 0.08
Total	0.61	0.35	0.51	
CO ₂ /CH ₄	7.7	7.7	50	

3. Loss of matter in gaseous form was estimated at about monthly intervals during April to October, and less often in winter (when the peat is often frozen or snow covered). Checks, with a mass spectrometer, showed that the only detectable carbon containing gases were CO_2 and CH_4 . Four sites were chosen on each of pool, lawn and hummock. The sites, even within the same habitat, showed striking individuality; some consistently produced much more gas than others, and most sites produced occasional unusually large amounts. The detailed statistical treatment of these data presents problems not yet satisfactorily solved. In table 11 are shown the integrated results for all 12 sites for 1969. An analysis of variance shows that the effect of habitat is significant at $P = 0.05$. Loss as CO_2 was more important than loss as CH_4 . In pools and lawns there was about 8 times as much CO_2 produced as CH_4 and on hummocks about 50 times as much. Production of CO_2 was about the same on hummocks as pools, but less than lawns. The data are not easily interpretable. If the peat in a pool is stirred with a stick any gas collected is found to contain a lot of CH_4 , N_2 and H_2 , but very little, or no, CO_2 . (This is by no means a new observation, see Dalton 1802). It seems reasonable to suppose that the CH_4 is produced by micro-organisms in the anaerobic zone below the water table. The smaller amounts of CH_4 coming from hummocks might be due to inherently smaller effluxes (resulting from a difference in microflora or peat) or could be due to metabolism of the CH_4 during diffusion through the relatively deep aerobic zone of peat. Differences in CO_2 production are equally open to speculation. It is interesting that the low CO_2 losses occur in lawns, dominated by S. papillosum which Clymo (1965) reported to break down at about half the rate of S. rubellum and S. cuspidatum.

4. Organic matter in solution was measured as loss in weight on ignition at 450°C for 24 hours. Samples (all from bog pools) averaged 20 mg l^{-1} but concentrations reached 67 mg l^{-1} during a dry period. The water in streams running off the catchments at Moor House is often dark brown. Crisp (1966) has measured the "peat concentration" in filtered samples of a stream there and finds values from 42 to 308 mg l^{-1} , but his stream drains a catchment with about 15% cover of eroding peat.

It is very difficult to assess the loss in solution from each habitat, since rain falling on hummocks runs through lawns into pools. From an undamaged bog surface there can be lateral runoff in the top 20 cms (Chapman, 1965), and from Burnt Hill the runoff is at least partly channelled through pools. In wet weather the flow out from pools is visible. An estimate of total losses was made using precipitation and potential evapotranspiration measurements recorded at Moor House. The difference between these is taken as an estimate of runoff. For the very wet area studied this is probably a reasonable estimate, though perhaps too high. Potential evapotranspiration measurements cannot be made in winter, and for October to April precipitation alone was used, since there is relatively little evaporation during these months in any case. The product of runoff and average loss on ignition for the same period gives the total loss in solution. The winter losses are about 20% of the total.

No account is taken of losses as macroscopic pieces of plants, but occasional samples collected from the pool outflow indicate that such losses are smaller by a factor of about 10 than those in solution.

The loss in solution estimated thus averages $0.2 \text{ g dm}^{-2} \text{ yr}^{-1}$. This figure must obviously be treated with caution, but it is only 13% to 25% of the estimated loss as gas.

Table 12. Preliminary balance of dry matter for three habitats

Habitat	Pool	Lawn	Hummock	P = 0.05
Net production	+3.46*	+3.82	+2.39	+ 1.07
Loss as gas	-1.50	-0.89	-1.29	+ 0.60
Loss in solution	-0.21	-0.21	-0.21	+ 0.59
Total loss	-1.71	-1.10	-1.40	
Net gain	+1.8	+2.7	+1.0	+ 1.35

* Assumes pools 2/3 covered by S. cuspidatum

Gas loss is calculated as $(\text{CH}_2\text{O})_n$. Solution loss has been assumed to be equal in all three habitats. Units are g dry matter $\text{dm}^{-2} \text{yr}^{-1}$.

Discussion

Using the results reported here, the tentative balance sheet of table 12 may be drawn up. The loss in solution has, for want of knowledge, been shown equal in all three habitats. Losses of CO_2 may be overestimated. Green material was removed from the gas samplers, but on the rest of the bog some of the CO_2 may be taken up by the green Sphagnum growing above the point where the gas was evolved. Support for this suggestion comes from an experiment in which 5 cm long Sphagnum plants in a funnel covered with a polythene bag were sprayed with a solution approximating rainwater in composition and containing $\text{H}^{14}\text{CO}_3^-$. All parts of the plants were initially strongly labelled, but after 12 weeks growth, the radioactivity was mainly in the new (green) growth and had mostly disappeared from the older parts. It is possible, however, for some movement of $^{45}\text{Ca}^{2+}$, at least, to occur by diffusion (or translocation?). In view of the high cation exchange ability of Sphagnum interpretation is not easy, and will not be attempted here. Re-absorption of CO_2 could occur only during the day (since dark fixation of CO_2 is at a very low rate if it occurs at all), whereas the rate of CO_2 evolution is relatively independent of light. At the extreme therefore, it is unlikely that more than perhaps 50% of evolved CO_2 would be re-absorbed. Monteith, Szeicz, and Yabuki (1964) found that from 6% to 20% of the carbon incorporated in crops came from CO_2 evolved by the soil.

At face value, the figures in table 12 indicate that the Sphagnum dominated parts of the bog are still growing and lawns may be extending. During the last ten years S. papillosum has encroached on some of the pools as one might expect, but it will be obvious that there are still large margins of uncertainty in each of these estimates, since the net gain is obtained as a small difference between large numbers, but the errors are all additive. The errors are simply the sampling errors; they take no account of systematic errors.

It may be concluded that the productivity of these peatlands is unimpressively small. What is impressive is the accumulation of peat resulting from the even smaller rate of breakdown.

Acknowledgements

We are grateful to Professor G. E. Fogg, F.R.S., in whose Department this work was done, and to the Natural Environment Research Council for financial support. We thank Mrs. P. Ratnesar for help with some of the growth measurements, and the staff of the Nature Conservancy at Moor House, particularly Mr. M. Rawes, and Mr. B. Marsh for help of all kinds with the experiments there. We also thank Dr. G. I. Forrest and Dr. G. Lance.

References

- Bismarck, R. (von). Flora (Jena), 1959, 148, 23-83
- Bower, M. M. A summary of available evidence and a further investigation of the causes, methods and results of erosion in blanket peat. M.Sc. thesis University of London, 1959.
- Chapman, S. D. J. Ecol., 1965, 53, 371-84
- Clymo, R. S. J. Ecol., 1965, 53, 747-51
- Clymo, R. S. J. Ecol., 1970, 58, 13-49
- Crisp, D. T. J. appl. Ecol., 1966, 3, 327-48
- Dalton, J. Experimental enquiry into the proportion of the several gases or elastic fluids constituting the atmosphere. Manchester Philosophical Society, 1802
- Eddy, A., Welch, D., Rawes, M. Vegetatio 1969, 16, 239-84
- Forrest, G. I. J. Ecol., 1971, 59, 453-79
- Harper, J. L. (ed.). The biology of weeds, Blackwells, Oxford, 1960
- Lambert, J. M., Williams, W. T. J. Ecol., 1966, 54, 635
- Lance, G. N., Williams, W. T. Comput., J. 1968, 11, 195.
- Millar, A. Quart. J. For., 1964, 58, 239
- Milthorpe, F. L. (ed.) Mechanisms in biological competition. Cambridge University Press, 1961.
- Monteith, J. L., Szeicz, G., Yabuki, K. 1964. J. appl. Ecol., 1, 321
- Overbeck, F., Happach, H. Flora, Jena, 1956, 144, 335
- Sjors, H. Endeavour, 1961, 20, 217
- Taylor, J. A. Nature, London, 1964, 201, 454
- Williams, W. T., Lambert, J. M., Lance, G. N. J. Ecol., 1966, 54, 427-45

