

UNIVERSITY OF BIRMINGHAM

Research at Birmingham

Removal of yield-stress fluids from pipework using water

Palabiyik, Ibrahim; Lopez-Quiroga, Estefania; Robbins, Phillip; Goode, Kylee; Fryer, Peter

DOI:

[10.1002/aic.16105](https://doi.org/10.1002/aic.16105)

License:

Creative Commons: Attribution (CC BY)

Document Version

Publisher's PDF, also known as Version of record

Citation for published version (Harvard):

Palabiyik, I, Lopez-Quiroga, E, Robbins, P, Goode, K & Fryer, P 2018, 'Removal of yield-stress fluids from pipework using water', *AIChE Journal*, vol. 64, no. 5, pp. 1517-1527. <https://doi.org/10.1002/aic.16105>

[Link to publication on Research at Birmingham portal](#)

Publisher Rights Statement:

Published in *AIChE Journal* on 29/01/2018

DOI: 10.1002/aic.16105

General rights

Unless a licence is specified above, all rights (including copyright and moral rights) in this document are retained by the authors and/or the copyright holders. The express permission of the copyright holder must be obtained for any use of this material other than for purposes permitted by law.

- Users may freely distribute the URL that is used to identify this publication.
- Users may download and/or print one copy of the publication from the University of Birmingham research portal for the purpose of private study or non-commercial research.
- User may use extracts from the document in line with the concept of 'fair dealing' under the Copyright, Designs and Patents Act 1988 (?)
- Users may not further distribute the material nor use it for the purposes of commercial gain.

Where a licence is displayed above, please note the terms and conditions of the licence govern your use of this document.

When citing, please reference the published version.

Take down policy

While the University of Birmingham exercises care and attention in making items available there are rare occasions when an item has been uploaded in error or has been deemed to be commercially or otherwise sensitive.

If you believe that this is the case for this document, please contact UBIRA@lists.bham.ac.uk providing details and we will remove access to the work immediately and investigate.

Removal of Yield-Stress Fluids from Pipework Using Water

Ibrahim Palabiyik

Dept. of Food Engineering, Namik Kemal University, Tekirdag, Turkey

Estefania Lopez-Quiroga, Phillip T. Robbins, Kylee R. Goode, and Peter J. Fryer 

School of Chemical Engineering, University of Birmingham, Edgbaston, Birmingham, B15 2TT, U.K.

DOI 10.1002/aic.16105

Published online February 10, 2018 in Wiley Online Library (wileyonlinelibrary.com)

The emptying of product from process plant is a significant multiphase flow problem in food and personal care industries, controlling both product recovery, and cleaning time. Product and operational losses can be significant, especially with viscous products. It is necessary to maximize product recovery while minimizing cleaning time and effluent volume. The removal of a range of products from fully filled pipework using water has been characterized and monitored by weighing pipes at intervals and by inline turbidity probe. Data is presented for a range of products (toothpaste, hand cream, apple sauce, yoghurt, and shower gel) that have been cleaned from two pipe systems. The data can be fitted by a linear relationship between a dimensionless cleaning time, and the ratio of the product yield stress to the surface shear stress. The effect of pipe fittings is to reduce cleaning times, reflecting increased shear/energy dissipation in the pipe. © 2018 The Authors AIChE Journal published by Wiley Periodicals, Inc. on behalf of American Institute of Chemical Engineers AIChE J, 64: 1517–1527, 2018

Keywords: cleaning, product recovery, food and personal care, yield stress

Introduction

Cleaning problems in industry

Fouling of processing equipment is a severe industrial problem. Cleaning is necessary to ensure process efficiency and equipment hygiene, and at plant changeover to remove one product before processing of another starts. Generally, the fast-moving consumer goods (FMCG) industry (including pharmaceutical, food, and personal products) operates cleaning-in-place (CIP) processes; these are automated systems that rinse and recirculate cleaning fluids through the equipment.¹ In these industries frequent cleaning is needed, so the economic impact of cleaning can be major in terms of energy used and production time lost. There is a need to minimize waste and energy during cleaning, reflecting the requirement to minimize the environmental impact of processes; this will require efficient ways of quantifying and controlling cleaning.² For plants in which multiple products are made, significant losses can result at changeover; product that fills tanks and pipework has to be removed, and little can be reused as product.

Fryer and Asteriadou³ categorized cleaning problems in a matrix where fouling materials can be characterized and identified according to cleaning type. Three classes of problem were highlighted;

- Type 1 soil: residue of very viscous or viscoplastic fluids that can be removed by the action of water alone; this is essentially a physical cleaning process.
- Type 2 soil: biological films which require biocides to kill adhered organisms as well as fluid action for surface removal;
- Type 3 soil: deposits which require hot cleaning chemical to effect removal, and thus involve both physical and chemical cleaning effects.

This classification allows different experiments to be compared, hopefully leading to greater understanding of the problem.⁴ A number of studies have looked at mm-scale deposits. Product changeover can involve Type 1 removal of product that forms centimeter-thick product layers on tank surfaces and completely fills pipework. Examples include, ready meals, and starch-based sauces (tomato paste, mustard⁵) confectionary fluids (milk chocolate, creams, glucose, custards, caramels, and etc.), yoghurt,⁶ and personal care products; shampoos,⁷ and toothpastes.^{8,9} Removal here is fluid mechanically driven, and the aim of research is to obtain ways in which cleaning time can be predicted from the product rheology and process geometry.

Removal of Type 1 material from process equipment involves two stages;

- *product recovery*—prior to cleaning, in which water is used to push product out from the plant. Thus, this stage is one of liquid–liquid displacement; ensuring that equipment be emptied as effectively as possible with water.
- *cleaning*—removal of the remaining product by rinsing with water that is then discarded. It is possible that a further disinfection stage might be needed using chemical to ensure sterility—in this article, “clean” refers to visual cleanliness, with no deposit visible on the surface.

Correspondence concerning this article should be addressed to P. J. Fryer at p.j.fryer@bham.ac.uk.

This is an open access article under the terms of the Creative Commons Attribution License, which permits use, distribution and reproduction in any medium, provided the original work is properly cited.

© 2018 The Authors AIChE Journal published by Wiley Periodicals, Inc. on behalf of American Institute of Chemical Engineers

Significant losses can occur when changing between products on a multiuse process line. Most plants use water, although methods such as ice-pigging can reduce losses.¹⁰ Identifying the break-through point where water is found at the plant exit is critical. Wiklund et al.¹¹ used ultrasound (rheometry) to identify the interface between fluids in laminar pipe flow (syrups, oils, and dairy products—crème fraîche, and yoghurt), while others^{6,7} used electrical resistance tomography (ERT) to identify the displacement of fluids (yoghurt and shampoo, respectively) in turbulent flows.

Generally, attention in the literature has been given to either product displacement^{12–14} to maximize product recovery, or the removal (cleaning) of residual product.^{15–20} The modeling problem, predicting the flow behavior of a high-viscosity plug, and the removal of a bound product layer, is very complex. Here, we consider the case of removing highly viscous fluids from a simple geometry, a pipe.

Emptying of pipes filled with type 1 deposit

The product recovery stage involves passage of water through the system removing the product core (at the center line of the pipe), typically leaving a thick annular layer on the pipe wall.^{8,9} Palabiyik et al.⁹ developed a method for monitoring emptying of filled pipework by successive weighing and observing the pipe at intervals, and found three stages of removal:

- A rapid *core removal regime* (duration comparable to the residence time of water in the pipe), at the end of which water is seen at the end of the pipe. Under the tested condition, about half of the material was removed as a plug that could be recovered and reused. Further rinsing completely removed the annular film by two regimes:
- *Product film thinning*: the continuous annular layer of toothpaste on the pipe wall is eroded (until ca. 1000 s); following exponential behavior, first order in deposit mass.
- *Patch removal*: (here > 1000 s) the continuous toothpaste film was broken and patches were observed on the inner pipe surface that gradually erode away with further rinsing.

Conditions in the *core removal stage* can impact the profile of the film which remains (smooth or comparatively wavy films)⁹ inducing patches of different sizes in the later cleaning stages. Removal of these patches dictates the cleaning time, perhaps due to increased friction (and energy loss) in the presence of a wavy residual film. Similar behavior was seen in removal of oil from tubes.²¹

Correlations and models for removal

Predicting cleaning times is difficult, because of the complexity of the flows in real equipment. Empirical rules of thumb are widespread (such as the statement that a cleaning flow of at least 1.5 m/s is needed for efficient cleaning). Various studies have used Reynolds number and wall shear stress (τ_w) as correlating parameters to describe cleaning times with fairly good relationship. Mickaily and Middleman²² used surface shear as the basis for a simple model that predicted cleaning of oil films; shear stress has been used to correlate biofilm removal,^{23,24} and CFD has been used to predict shear forces on wall-bound bacteria.²⁵ Wilson et al.¹⁸ have shown elegant solutions for the cleaning of thin layers in tanks, we seek similar approaches for pipe flows.

For pipes, data for the cleaning of toothpaste from 2" pipe-work using 20°C water has been presented,⁸ and the overall cleaning time (t_c) correlates with both Reynolds number and wall shear stress

$$t_c = 3500\tau_w^{-1} \quad (1)$$

Huo et al.⁷ studied the removal of shampoo (using cold water) from 1.5" geometries (1) a 0.5D down stand (dead leg), (2) an expansion (2.5"; 22 mm L), (3) 90° bend, (4) butterfly valve by visual observation and using ERT. Apart from the dead leg, they found cleaning time for the various geometries correlated with wall shear stress:

$$t_c = 189.56\tau_w^{-0.834} \quad (2)$$

The dead leg was comparatively hard to clean, as also observed⁵ for cleaning of mustard from a variable depth dead leg. Areas which were exposed to very low velocities were always last to clean. Increasing flow velocity revealed only small increases in the local velocity values of these last to clean areas. Hou et al.,⁷ also observed repeatable location of the last to clean area irrespective of the CIP water flow rate.

Studies of more complicated geometries including valves, reveal τ_w is not the sole parameter to affect cleaning, but rather τ_w and the nature and magnitude of recirculation zones in a given geometry. Efficient rinsing could be achieved when the critical wall shear stress for cleaning was not exceeded.²⁶ In fact, valves have been observed to clean more quickly than straight pipes, expansions and 90° bends.^{7,26,27} This is likely to be due to different geometries imposing greater turbulence and energy loss in the flow than straight pipes.

The aim of this work is to study the effect of shear stress systematically on a range of real process fluids, using the method presented by Palabiyik et al.⁹ The experiments have used six different fluids and two length scales spanning lab to pilot scale. The relationship between cleaning time, Reynolds number, and shear stress has been studied in detail.

Materials and Methods

Experimental apparatus

Before any cleaning experiment, the test pipe was manually filled (vertically) with the study material. Products used were largely nonperishable so the order of investigation could be completely randomized. Between individual cleaning runs a blank pipe could be substituted and the system completely rinsed. Two cleaning configurations were used:

Lab Scale. A schematic of the lab scale experimental rig is shown in Figure 1a. The details and the operation of the rig were given in Palabiyik et al.⁹ The rig comprises a water tank, a flow transmitter (PD 340, Process Data, Denmark), a conductivity and temperature transmitter (LMIT08, Ecolab, Germany) at the return and a centrifugal pump (Alfa Laval, Denmark) to supply water to the pipework system (capable of transferring up to 3.8 m³ h⁻¹). The pipe section investigated was a 1 m length section of 23.9 mm ID pipe rinsed in horizontal position. Flow velocities and temperatures used were in the range of 0.5–2.6 m s⁻¹ and 20 to 70°C, respectively, (Re: 10360–58720; τ_w : 0.8–17.9 Pa).

Pilot Scale. This has been described previously.^{7,28} The plant comprises a series of water tanks, a centrifugal pump (capable of transferring up to 20 m³ h⁻¹) (Alfa Laval, Denmark), a routing valve assembly, plate heat exchanger (GEA, Germany), and various transmitters including flow rate (Promag 51P, Endress-Hausser, Germany), conductivity, temperature (LMIT 08, Ecolab, Germany) and turbidity (Kemtrak TC007, Optek TF16). The pipe sections investigated were 0.5 m length (or 0.3 m length used in conjunction with fittings; see Figure 7 of 47.7 mm ID rinsed in horizontal position. Flow

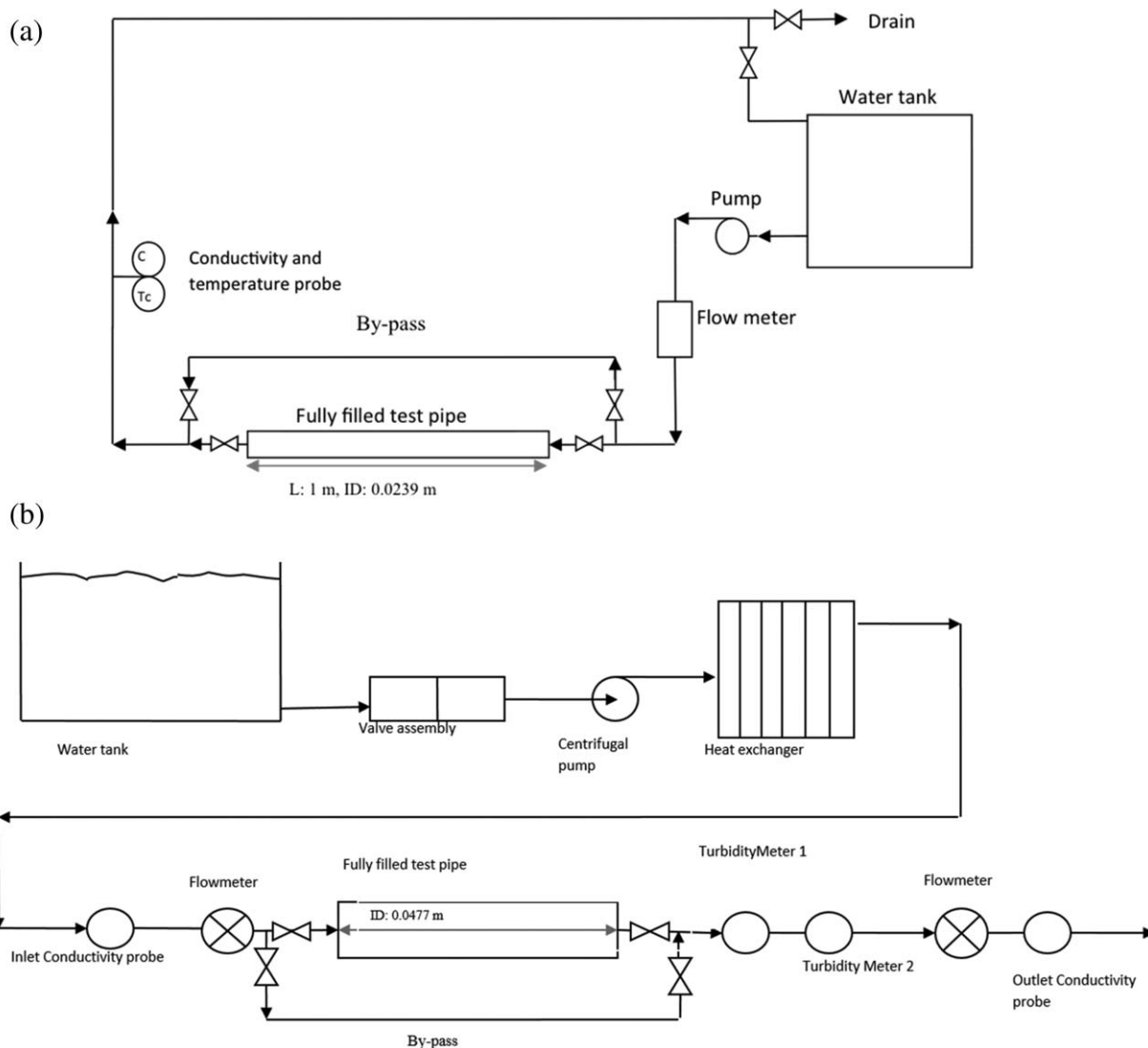

Figure 1. Schematic representation of (a) the laboratory scale cleaning rig and (b) the pilot scale cleaning system (ID: internal diameter).

velocities and temperatures were in the range $1\text{--}2.5\text{ m s}^{-1}$ and $20\text{--}70^\circ\text{C}$, respectively ($Re: 44970\text{--}102800$; $\tau_w: 2.8\text{--}12.0\text{ Pa}$).

In all geometries, experiments were carried out to confirm that the inlet length before the test section was long enough to avoid flow disturbances. Surface shear stresses (τ_w) in the clean system were estimated by the Blasius equation, for turbulent flows:

$$\tau_w = c_f \cdot \frac{1}{2} \rho U^2 \quad (3)$$

Where

$$c_f = 0.079 Re^{-0.25} \quad (4)$$

$$Re = \frac{\rho UD}{\mu} \quad (5)$$

where D is the clean pipe internal diameter (ID) and ρ , U , and μ are the density, velocity, and viscosity, respectively, of the cleaning water. These stresses are obviously at the lower bound in a partly filled pipe, but the surface shear will approach clean pipe values at the end of cleaning.

Rheology

Various Type 1 materials with a range of rheologies were investigated:

1. *Toothpaste* supplied by GSK (UK).

2. *Toothpaste* diluted with water was used to generate different soils with different yield stress values. This was done by mixing a prescribed amount of water and toothpaste for at least 5 min. Foamed samples were left for at least 24 h before use in any experiment to decrease any error caused by the air bubbles. Hand cream was also tested at 70°C to give a material with a reduced yield stress.

3. *Hand cream* supplied by GSK (UK).

4. *Shampoo* and *shower gel* supplied by Unilever (UK).

5. *Glucose syrup* supplied by Cadbury (UK). Containing: 19% glucose, 14% maltose, 11% maltotriose, and 56% higher molecular mass carbohydrates.

6. *Apple sauce* (Bramwells) and *yoghurt* (Broklea, low fat Greek Style) purchased from the local market (UK).

Table 1 summarizes the rheological type, yield stress values, and viscosity (at 15 s^{-1}) of all materials studied. The rheological behavior of each material was first determined using an AR1000 rheometer (TA Instruments, UK), using 40 mm diameter, stainless steel plate geometry with $250\text{ }\mu\text{m}$ gap between the stage and the plate. Figures 2a, b shows the rheological behavior (shear rate vs. shear stress and viscosity, respectively) of each material at 20°C . Hand cream tested at

Table 1. Rheology Type, Viscosity, Yield Stress, and Cleaning Time of Materials Tested at 20°C. Values for hand cream tested at 70°C are also shown

Material	Material Type	Yield Stress (Pa)	Viscosity (Pa s) at 15 s ⁻¹	Cleaning Time (s)
Shower gel	Herschel-Bulkley	23 ± 1	3 ± 0.1	80 ± 10
Glucose	Newtonian	0	70 ± 2	25 ± 5
Hand cream	Herschel-Bulkley	165 ± 4	12 ± 1	1200 ± 150
Yoghurt	Herschel-Bulkley	14.5 ± 0.5	1.7 ± 0.1	14 ± 5
Apple sauce	Herschel-Bulkley	12 ± 0.5	8 ± 0.5	12 ± 5
Shampoo	Shear thinning	0	6.2 ± 0.5	20 ± 5
100% toothpaste	Herschel-Bulkley	203 ± 5	24 ± 1	1000 ± 100
90% toothpaste	Herschel-Bulkley	126 ± 4	16 ± 1	650 ± 50
80% toothpaste	Herschel-Bulkley	73 ± 2	6 ± 0.1	430 ± 40
70% toothpaste	Herschel-Bulkley	52 ± 2	5.8 ± 0.1	220 ± 25
60% toothpaste	Herschel-Bulkley	35 ± 1	4 ± 0.1	130 ± 15
50% toothpaste	Herschel-Bulkley	13 ± 0.5	2 ± 0.1	25 ± 5
Hand cream at 70°C	Herschel-Bulkley	26 ± 1	0.8 ± 0.1	100 ± 15

70°C is also shown. Most of the materials are shear-thinning, and show a rapid decrease of shear stress at near zero shear rate suggesting Herschel–Bulkley-type behavior. Only glucose syrup shows Newtonian behavior, while the shampoo shear thins with the applied shear and it has no yield stress.

To quantify the material yield stress, oscillatory stress sweeps were performed at an angular frequency of 6.283 rad s⁻¹ (1 Hz) and the stage held at 20°C (also the predominant water temperature used in rinsing experiments). Figure 2c shows an example of yield stress determined for 80% diluted toothpaste at 20°C and hand cream at 70°C. If the elastic modulus (G') is higher than the viscous modulus (G'') the material is predominantly elastic, but if $G'' > G'$, the material shows predominantly viscous behavior. The crossover points of these parameters ($G' = G''$) (the “characteristic modulus”) is an approximate measure of the yield stress value. Methods for measuring yield stress are reviewed by Dinkgreve et al.,²⁹ who conclude that the G'/G'' crossover is an effective measure.

Monitoring methods

Weight analysis of the pipe and a turbidity meter were used to monitor the cleaning process:

Weight Analysis. A simple lab scale experimental method was developed⁹ to monitor removal. At intervals during cleaning, the flow was by-passed and the pipe removed and weighed, so the weight of material in the pipe could be known—the reproducibility and accuracy (± 0.5 g) of the method is detailed.⁹ The use of a balance that could account for the pipe weight meant that the error could not be reduced. So, the error measured as a portion of the remaining product mass increases towards the end of cleaning (as the amount of material remaining decreases)—this is reflected in high error bars in weight near the end point. The “end-point” was defined by a remaining mass fraction of 0.002, which gives an error of ca. 60 s in the determination of total cleaning time. The errors in time measurement are on the order ± 1 s (the lag between seeing the stopwatch and closing the valve). At pilot scale the same procedure was applied, but it was unsafe to use the by-pass loop while the pump was running, so pipes were viewed at 30 s intervals during the later stages of cleaning. Therefore, the maximum error in cleaning time at pilot scale was ± 30 s.

Turbidity. The turbidity meter (Optek) detects light scattered from particles (trace suspended solids, undissolved liquids, or gas bubbles) in the liquid. It gives a ppm response during cleaning. Although insensitive in the initial stages of cleaning, it gives a measure of the end of cleaning without disturbing the experiment.⁸ Unless stated, a numerical reading of 4 ppm was

chosen to compare cleaning effectiveness of the experiments. It is at the low end of the scale for this measurement, outside the area where electrical noise affects the signal (-2 to $+2$ ppm). When pipes were inspected, this value on the turbidity meter corresponded to ca. 0.2% of starting weight remaining.

Results and Discussion

The effect of deposit rheology on cleaning behavior

The effect of deposit rheology on the cleaning behavior of deposits has been compared for three materials with three different rheologies: shampoo (shear thinning), glucose syrup (Newtonian), and 70% diluted toothpaste (Herschel-Bulkley). Glucose and shampoo are predominantly viscous, while up to a shear stress of 50 Pa, toothpaste is predominantly elastic ($G' > G''$). Figure 3 shows the mass fraction left on the pipe surface as a function of time, around 90% of the total amount of shampoo and glucose syrup in the pipe is removed in the product recovery stage. The amount of toothpaste removed from the pipe wall after the product recovery is less than this (ca. 80%). Of the three materials shown in Figure 3, 70% diluted toothpaste has the longest cleaning time due to the existence of a very slow patch removal stage observed between cleaning at 280–600 s. The shear thinning deposit (shampoo) cleans faster than the Newtonian deposit (glucose syrup). This may be due to the decreasing viscosity of the shampoo with increased shear.

The effect of deposit rheology on cleaning time

To identify effects of viscosity and yield stress, the cleaning of thirteen different materials from a pilot scale straight pipe was investigated at 1.5 m/s⁻¹, 20°C. Material rheology, parameters, and obtained cleaning times are shown in Table 1. As shown in Table 1 (and Figure 2), the materials show different rheologies: Newtonian, Herschel-Bulkley and shear thinning behavior. Toothpaste is diluted with water to give different weight-percent soils with different rheologies. To relate their cleaning time with their rheologies, cleaning times of materials are plotted both against their viscosity and yield stress values in Figures 3b, c. The inline turbidity probe was used here to find cleaning times. Observation of the process shows that zero-yield stress deposits simply flow out of the pipe, thus their removal is more rapid than systems that show a yield stress. The patch removal stage is not observed in the cleaning of these materials. However, materials that show a yield stress are removed by fracturing and finally slow erosion. This removal mode of yield stress deposits shows similarities with that of more complex soils such as whey protein, milk, mineral deposits, and biofilms.⁴

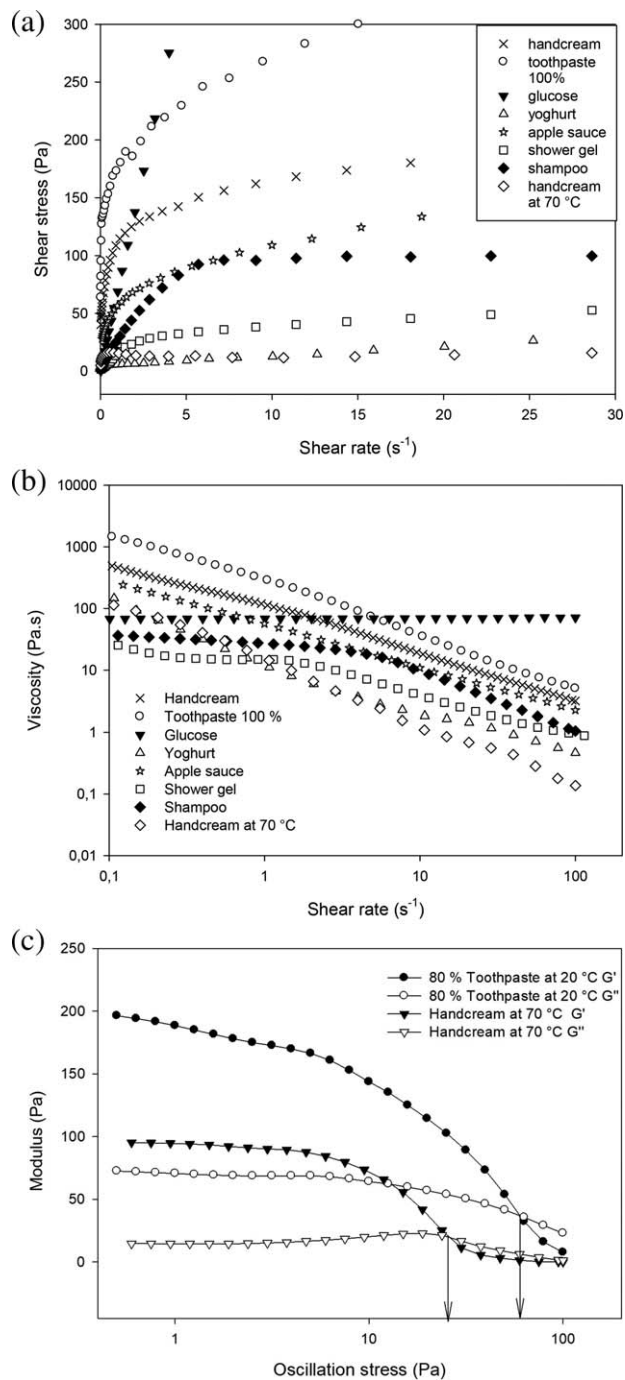

Figure 2. Rheological plots for materials studied; (a) Shear stress vs. Shear rate of materials at 20°C, with hand cream at 70°C also shown; (b) Viscosity vs. Shear rate of materials at 20°C (hand cream at 70°C is also shown); (c) Example of an oscillatory stress sweep used to determine yield stress values—the crossover of G' and G'' is indicated by the arrows.

Figure 3b shows the cleaning time of each material vs. its viscosity. A shear rate of $15 s^{-1}$ was chosen to rank the materials in the order of their viscosity values—rheological data (not shown) shows that in the shear rate range of $10\text{--}100 s^{-1}$ the viscosities of all materials are in the same order. Cleaning times as a function of material viscosity reveals a scatter of data points, which do not show any clear relationship. For

example, in Figure 3b, although glucose syrup has the highest viscosity of the studied materials ($70 Pa s$), its removal time from the pipe is only $25 \pm 5 s$. This rapid cleaning time is not due to dissolution; glucose took more than $300 s$ to dissolve in water at $20^\circ C$ by rigorous manual mixing. Hand cream has a moderate viscosity value of $12 Pa s$ but has the highest cleaning time of $1200 \pm 150 s$. In contrast, plotting cleaning times with respect to material yield stress shown in Figure 3c shows a relatively good linear relationship. This suggests that the

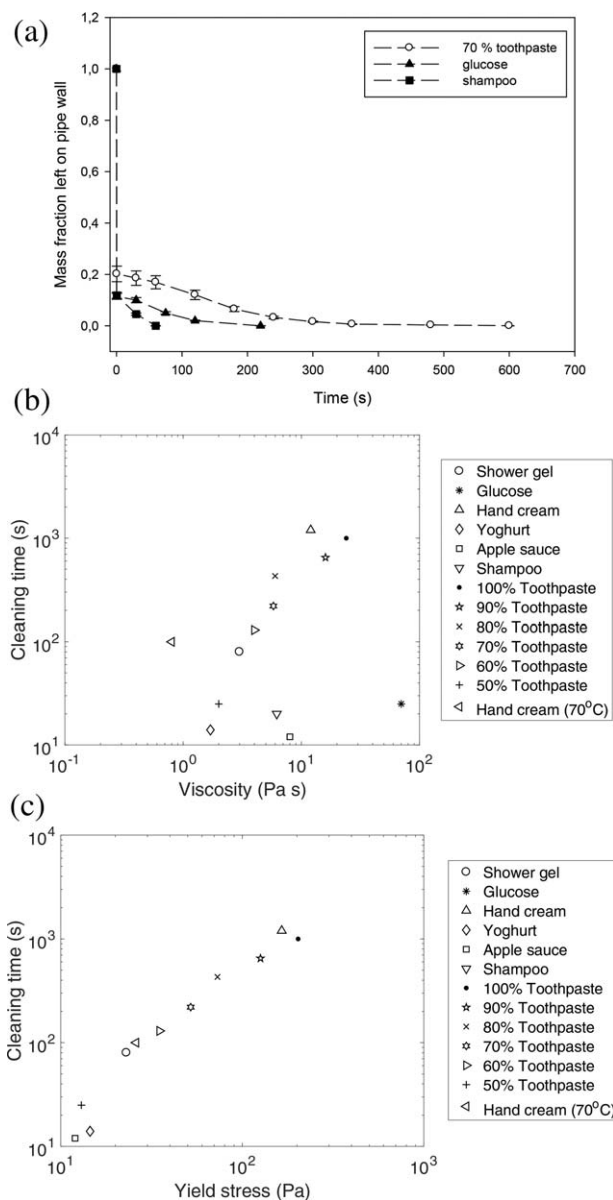

Figure 3. (a) Mass fraction of material left on the pipe vs. rinsing time studied in 1 m, 0.024 m ID pipe at $0.55 m/s^{-1}$; $20^\circ C$; (b) Cleaning time vs. viscosities of deposits at a shear rate of $15 s^{-1}$, (data from Table 1); (c) Cleaning time vs. yield stress of deposits, (data from Table 1); (b),(c) Cleaning was done at $1.5 m/s^{-1}$, $20^\circ C$ from 0.0477 m diameter pipe (pilot scale). Yield stress and viscosity values were obtained at $20^\circ C$. The exception is hand cream cleaned at $70^\circ C$, for which viscosity and yield stress values found at $70^\circ C$.

yield stress of a material rather than its viscosity affect the cleaning time.

To assess the individual effects of yield stress of a material and temperature of rinsing water on the cleaning process, the rinsing of undiluted toothpaste at different temperatures was compared with the rinsing of diluted toothpaste using the weight measurement method. Different temperatures (15, 20, 30, 50°C) were used to match deposit viscosities. Rheology tests were performed to identify the yield stress of the tested toothpaste samples, which are;

- (undiluted) toothpaste at 15°C; yield stress 203 ± 5 Pa.
- 60% diluted toothpaste at 20°C; yield stress 35 ± 1 Pa.
- (undiluted) toothpaste at 30°C; yield stress 146 ± 4 Pa.
- 90% diluted toothpaste at 20°C; yield stress 126 ± 4 Pa.
- (undiluted) toothpaste at 50°C; yield stress 75 ± 2 Pa.
- 80% diluted toothpaste at 20°C; yield stress 73 ± 2 Pa.

Cleaning was performed at the corresponding temperatures at which yield stresses are determined, at the same water flow velocity of 0.55 m/s^{-1} throughout product recovery and cleaning. Figure 4a shows the mass of deposits left on the pipe wall during cleaning. The data shows that yield stresses and

cleaning profiles match well: the higher the yield stress of a deposit, the slower the cleaning rate and the longer the cleaning time. The difference between the fastest and slowest cleaning times is between 300 and 2200 seconds, a ratio of 7.3 compared to a ratio of yield stresses of 5.8. Similar trends are observed for materials with similar yield stresses; for example, (1) 90% diluted toothpaste cleaned at 20°C and undiluted toothpaste cleaned at 30°C, (cleaning times of ca. 1400 s) and (2) 80% diluted toothpaste cleaned at 20°C and undiluted toothpaste cleaned at 50°C (cleaning times of ca. 700 s).

To analyze how cleaning of these deposits happens in the fully filled pipes, cleaning profiles of 80% diluted toothpaste cleaned at 20°C and undiluted toothpaste cleaned at 50°C are plotted on both log and linear scale in Figure 4b, which shows that substantially less material is left (125 g, i.e., 22 wt % of the initial amount) for 80% diluted toothpaste compared to the undiluted toothpaste after the product recovery stage, probably as a result of the higher temperature. However, the amount of deposit left after the product recovery stage does not affect the cleaning time. The cleaning of fully filled pipes is controlled by the cleaning of patches that comprise ca. 2% (ca. 10 g) of the total mass in the pipe (ca. 450 g).

This again suggests that yield stress is a predictor of the cleaning time.

Cleaning at different length scales

The Effect of Flow Velocity. To investigate the effect of flow velocity on cleaning, experiments have been done to study similar ranges of water flow velocity at lab and pilot scale pipes. Figure 5a shows cleaning time of hand cream plotted against the water velocity during cleaning for both scales. The data clearly illustrates that cleaning at an increased flow velocity decreases the cleaning time, and that cleaning happens substantially faster at the lab scale; decreasing the diameter of the pipe causes more rapid cleaning. For instance, at the same velocity of 1 m/s^{-1} , the lab scale pipe is cleaned at 800 ± 20 s, while pilot scale pipe is cleaned at 3420 ± 240 s.

The Effect of Reynolds Number. Figure 5b shows cleaning time plotted against Reynolds number for both length scales. The small-scale pipe again cleans significantly faster than the pilot scale pipe at the same Reynolds number. For instance, at $Re = 42000$, the lab scale pipe is cleaned at 120 ± 20 s, while the pilot scale pipe is cleaned at 3420 ± 240 s.

The Effect of Wall Shear Stress. Figure 5c shows the relation between cleaning time and wall shear stress which is considered the most relevant variable to cleaning. It shows that cleaning times are shorter in the lab scale pipe, for instance, cleaning times are 375 ± 60 s and 730 ± 90 s for lab and pilot scale pipes, respectively, at the same wall shear stress, 5.8 Pa. But although the differences in cleaning times for both scales are smaller than those for Reynolds Number and velocity, still it takes double the time to clean the larger diameter pipe than the smaller diameter pipe at the same wall shear stress.

For all three parameters, cleaning rate in the lab scale pipe is faster than that in the pilot scale pipe. The effects shown here demonstrate the difficulty in giving advice on “optimal” cleaning conditions. For example, it is commonly quoted that a flow velocity of at least 1.5 m/s^{-1} is required for satisfactory cleaning. It is clear that velocity alone cannot define cleaning. For chemical cleaning, it has been suggested³⁰ that increasing the Reynolds number increased the cleaning rate by decreasing the boundary layer thickness. Here, however, cleaning happens much faster in the lab scale experiments despite having much lower Reynolds numbers.

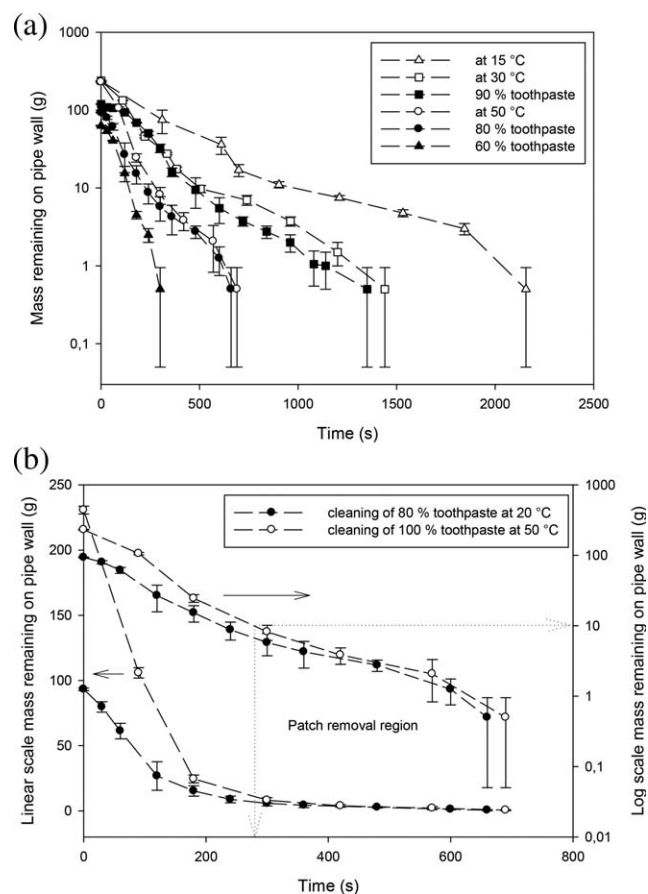

Figure 4. (a) Mass left on pipe wall vs. time graph of deposits studied in 0.0239 m diameter pipe at 0.55 m/s^{-1} . Product recovery is done at the same conditions in all experiments (0.55 m/s^{-1} and 20°C); (b) Cleaning profiles of undiluted toothpaste at 50°C and 80% diluted toothpaste at 20°C (both 0.55 m/s^{-1}) plotted in linear and logarithmic scale. Each data point is averaged from at least two experiments and the maximum and minimum values are plotted as error bars.

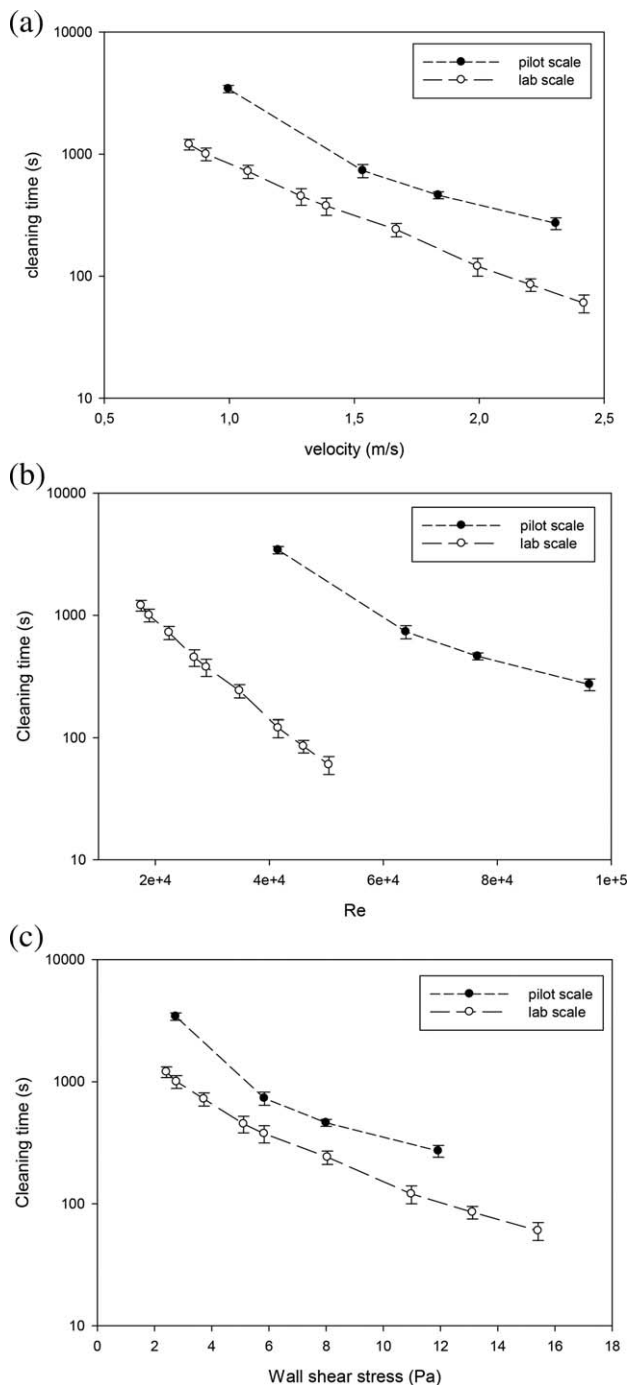

Figure 5. Cleaning time of hand cream at different length scales (pilot scale pipe—0.5 m [ID 0.0477 m], lab scale pipe—1 m [ID 0.0239 m]); (a) cleaning time as a function of velocity, (b) cleaning time as a function of cleaning fluid Reynolds number, (c) cleaning time as a function of wall shear stress.

Dimensional Analysis: A Master Curve for Cleaning

Correlation of data

The data has shown the effect of a series of flow parameters on the cleaning of a range of Type 1 materials. It is clear that deposit yield stress is a better descriptor of the cleaning process than material viscosity, and that neither flow velocity or

Reynolds number can correlate data effectively on their own. Dimensional analysis suggests that if the six variables:

$$t_c = f(\rho, U, \mu, L, D, \tau_\phi) \quad (6)$$

in which

- t_c = cleaning time
- ρ = cleaning fluid density
- μ = cleaning fluid viscosity
- L, D = tube length and diameter
- τ_w = deposit yield stress

are used, then three dimensionless groups result. The first is the Reynolds number for the cleaning fluid as in Eq. 5. Yield stress can be made dimensionless using density and velocity

$$c_y = \frac{\rho U^2}{\tau_Y} \quad (7)$$

The cleaning time is known not to be a function of the tube length,⁹ but is clearly a function of the diameter, so

$$\theta = t_c \frac{U}{D} \quad (8)$$

is a possible way to make the cleaning time dimensionless. This can be considered also as

$$\theta = t_c \frac{L}{D} \frac{U}{L} = \frac{t_c L}{t_R D} \quad (9)$$

where $t_R = L/U$ is the mean residence time of the cleaning fluid in the pipe, and (L/D) is the aspect ratio of the pipe.

Equation 7 is analogous to the friction factor equation already used to estimate the surface shear stress (in Eqs. 4 and 5), and so the dimensionless group can also be written as

$$T_Y = \frac{\tau_y}{\tau_w} \quad (10)$$

in which the wall shear stress is determined from Eq. 4; Eq. 10 thus includes the Reynolds number.

Figure 6a shows the data for cleaning times of toothpaste and hand cream at the two length scales for the ratio T_Y , showing that this dimensional group alone does not lead to correlation. Data for the two scales lies on different lines. Figure 6b shows dimensionless cleaning time data for cleaning times of toothpaste and hand cream at the two length scales for the ratio T_Y , showing that the data collapses onto a straight line save at very low T_Y .

Finally, in Figure 6c all the data of Tables 1 and 2 is plotted in terms of θ vs. T_Y . The data now falls on the same straight line

$$\theta = 636T_Y + 2630 \quad (11)$$

Over the range $500 < \theta < 10000$, $2 < T_Y < 100$, the data follows a good straight line with regression coefficient $R^2 = 0.94$ for the best fit (in the least-squares sense). The best fit has been found by minimizing a weighted sum of the squared errors (bivariate function, Matlab) to reduce the effect of outlier values at very high θ . The data spans two orders of magnitude in both dimensionless cleaning time and shear stress ratio. The data is constructed of the different experimental groups, shown in Tables 1 and 2. There is one outlier at very low flow rate and high θ . The individual datasets for toothpaste and hand cream are shown in Figure 6b, fitting a straight line

$$\theta = 591T_Y + 4309 (R^2 = 0.94) \quad (12)$$

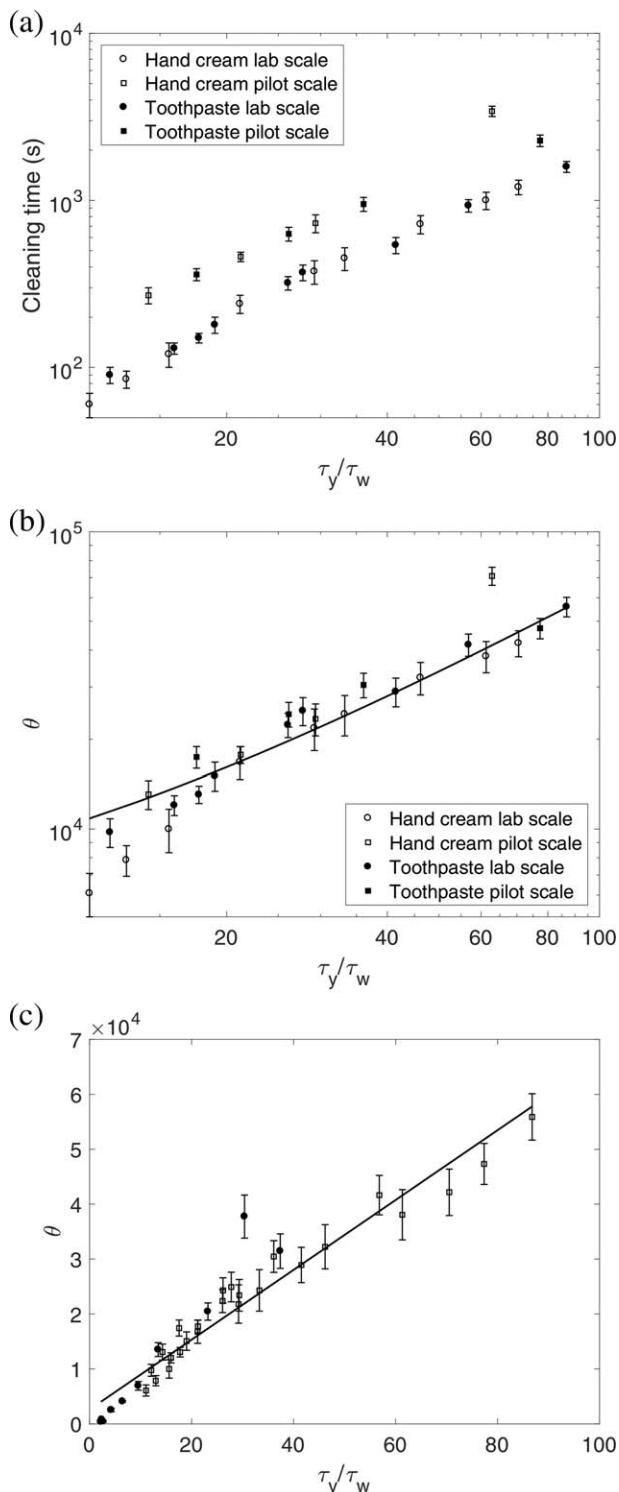

Figure 6. (a). Cleaning time vs. T_Y (dimensionless yield stress over wall shear stress) for hand cream and toothpaste at both length scales, (b) Dimensionless cleaning time vs. T_Y for hand cream and toothpaste at both length scales (c): Dimensionless cleaning time vs. T_Y of all materials; plot including all experimental data (\bullet = data from Table 1; \square = data from Table 2) at two length scales (pilot scale pipe—0.5 m [ID 0.0477 m], lab scale pipe—1 m [ID 0.0239 m]).

This result suggests that the ratio of yield to wall stress is sufficient to correlate cleaning behavior, and that the relationship between cleaning time and shear stress can be a relatively simple one. It is however interesting that the numerical value of $T_Y > 1$; the yield stress is always greater than the shear stress.

The effect of flow geometry

Equation 11 was developed using conditions of developed pipe flow, that is, where the flow is stable. In real plant, this is rarely the case, owing to the presence of bends, pipe fittings, pumps, and valves. Some exploratory experiments were done to investigate the effect of different pipe conditions. In simple plant design, the effect of pipe bends and fitting on pressure drop is generally expressed by the following empirical equation

$$\Delta P_L = K \frac{U^2 \rho}{2} \quad (13)$$

where K is the resistance coefficient and depends on the type of the fitting and U (m s^{-1}) is the mean flow velocity in the test section, that is, the section upstream of the test section. Therefore, additional turbulence occurs inside or just after fittings which may affect cleaning.

To study the effect of turbulence on removal, the straight pipe test section was positioned after various fittings in pilot plant scale and cleaned. Figure 7a shows the pipe configurations used. The 0.3 m (6.25 D) straight pipe was used as the test section here, and K -values for these configurations are shown in Table 3.³¹ The protocol followed was;

- initial product recovery was done using configuration 7(d) to get an even layer of material for each experiment, with a water velocity of 2.45 m/s^{-1} at 20°C . All experiments used pipes that had been cored out under these conditions, with 0.18 ± 0.01 wt fraction of toothpaste left on the wall. Striped area represents the test section.
- The setup was then changed to study cleaning of the test section (0.3 m pipe; 0.047 m D) in each configuration, shown in Figure 7;
- Test section pipe (6.25D) positioned after a 90° bend with radius = 2D.
- Test section positioned after three 90° bends ($r = 2D$) used to create a 180° bend ($r = 4D$) with an inverted 90° bend ($r = 2D$) in the same plane.
- Test section pipe positioned after a tee with branched flow and dead leg (length 1.25D).
- Test section positioned after the 31.0D length of straight pipe ($r = 0.5D$).
- Test section positioned after the 20.8D length of straight pipe ($r = 0.25D$) connected to an expansion joint (2.5 D in length with a trajectory of 13° from the center line on the 0.5 D pipe).

All cleaning used the same conditions, 1.5 m s^{-1} at 20°C . Experiments were done at least in duplicate. The weight analysis method was used to detect cleaning end-point.

Figure 8 illustrates the effect of turbulence caused by flow through fittings on cleaning, by showing weight fraction left in the straight pipe placed after various fittings with time. The Figure shows that the addition of different flow configurations affects the cleaning time. The data is plotted as a function of the dimensionless group $KU^2\rho/2\tau_y$, that is, a measure of pressure drop/shear induced by the fittings. $U = 1.5 \text{ m s}^{-1}$ except save for the case (e) where the velocity in the narrow pipe is used. Cleaning time is plotted against the dimensionless ratio of pressure loss due to fittings to yield stress of the deposit in Figure 8.

Table 2. Cleaning of Toothpaste and Hand Cream at Different Velocities from Lab and Pilot Scale Pipes

Pipe ID (m)	Flow Velocity (m s ⁻¹)	Cleaning Time (s) of Hand Cream ($\tau = 165$ Pa)	Flow Velocity (m s ⁻¹)	Cleaning Time (s) of Toothpaste ($\tau = 203$ Pa)
0.0239	0.84	1200 ± 120	0.84	1590 ± 120
	0.91	1000 ± 120	1.07	930 ± 80
	1.07	720 ± 90	1.28	540 ± 60
	1.29	450 ± 70	1.61	370 ± 40
	1.39	375 ± 60	1.67	320 ± 30
	1.67	240 ± 30	2.00	180 ± 20
	1.99	120 ± 20	2.08	150 ± 10
	2.21	85 ± 10	2.21	130 ± 10
	2.42	60 ± 10	2.59	90 ± 10
0.0477	0.99	3420 ± 240	0.99	2280 ± 180
	1.53	730 ± 90	1.53	950 ± 90
	1.84	460 ± 30	1.84	630 ± 60
	2.31	270 ± 30	2.31	360 ± 30

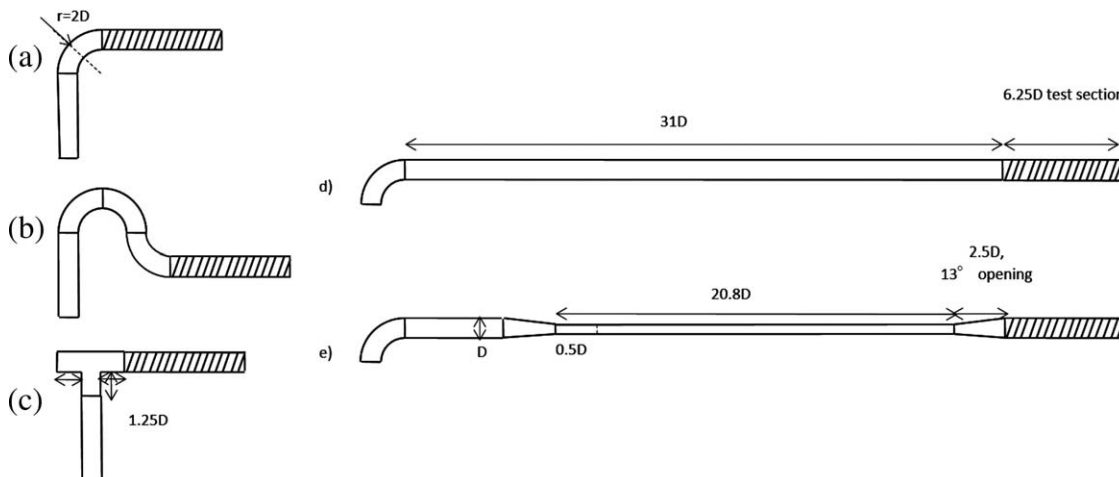

Figure 7. Schematic representation of the studied configurations. Striped area represents the test section. The test section is fully filled with toothpaste. Product recovery is only done using configuration (d) to get an even layer of material for each experiment (velocity of water was 2.45 m s⁻¹ at 20°C). For cleaning experiments following “coring,” the set-up is changed to study each configuration.

A good linear relationship is observed between the dimensionless number and the cleaning time. A linear fitting gives

$$\text{Cleaning time} = -59 \Delta P_L + 1062 \quad (R^2 = 0.94) \quad (13)$$

The results suggest there is a strong relationship between the cleaning time and the flow actions which are responsible for the energy losses in a system. Complex fluid mechanical actions are involved in the cleaning process. Nevertheless, the effect of fluid mechanical action on cleaning can be quantified by calculating the energy losses caused by the flow, either in straight pipes, or in the fittings.

Discussion and Need for Further Work

The cleaning of yield stress fluids has been studied and a series of dimensionless numbers (θ , T_Y) developed. The

Table 3. Resistance Coefficients— K Values³¹ and Velocity Values Used in Pressure Loss Calculations

Fittings	K Values	U (m s ⁻¹)
90° standard elbow	0.57	1.5
Tee (with flow through branch)	1.14	1.5
3 elbow (closed return bend and 90° elbow)	1.52	1.5
Gradual 13° expansion	0.12	6.14
No fitting	–	1.5

correlation identified works over two orders of magnitude of both shear stress ratio (T_Y) and dimensionless cleaning time (θ). It will require testing over a wider range of process

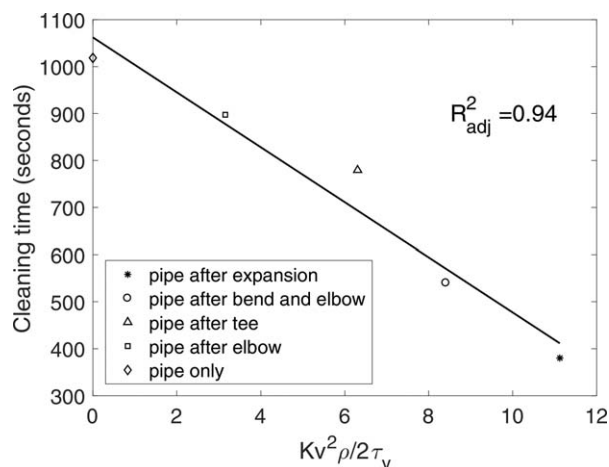

Figure 8. Cleaning time of toothpaste from straight pipe placed after various fittings (see Figure 7) vs. the dimensionless ratio of pressure loss (m) due to fittings to yield stress of the material. Linear fit gives: Cleaning time = $-59 (P_{loss}/\tau_y) + 1062$ ($R^2 = 0.94$).

conditions and fluids, but the yield stress range tested here covers most of the fluids found problematic in foods and home and personal care (HPC). The analysis has also neglected interfacial or surface tension effects; it would be valuable to repeat the experiments using pipes of different materials.

Cleanability prediction

The removal of Type 1 materials can be directly related to surface shear, and thus to the pressure drop, and energy consumption of the system. This is not surprising, given the number of studies that have correlated data in terms of wall shear stress, but the simplicity of the data fitting suggests that it may be possible to predict cleaning times if shear stress distributions and deposit rheology are known. The data of Figure 8 does suggest that extending the approach to larger-scale processes will not be straightforward; the need will be to predict shear stresses locally, through CFD analysis, and then look at the cleaning of extended pieces of plant (such as valves⁷). It is not clear to what extent the data can be used as a master curve—that is, whether the cleaning time can be predicted from combination of the shear stress distribution and Eq. 11. It is known that cleaning is most difficult in places such as dead ends, where shear is low. The modeling problem is difficult: 2-D simulations of the displacement of non-Newtonian fluids have been made³² but a 3-D problem has not been solved. The next steps should be (1) to test the validity of the equation by widening both the number of fluids and the range of process conditions studied, (2) to examine cleaning under different flow conditions where the wall shear stress can be predicted using CFD. The long-term aim is to incorporate cleanability into design too, with equipment where the cleaning time can be predicted from product rheology.

Pulsed flows also increase cleaning rates^{24,33,34} and pressure losses in pulsed flows were 4 to 19 times larger than average pressure loss during one directional flow. Therefore, pulsed flow also causes high energy losses in flow and enhances cleaning. Soils that require chemical treatment are more complex; chemical action can either dissolve the deposit or convert it into a form which can be removed by shear (such as the swelling and dissolution of protein films in dairy fouling).

The findings suggest that energy dissipated in the system is important. Energy loss depends on the friction factor (c_f) which is influenced by surface roughness. Therefore, rough soil surfaces may increase cleaning rates, as observed previously.⁹ Gordon et al.³⁵ investigated the influence of soil roughness on the cleaning of pregelatinized starch-based layers from stainless steel substrates, and found rough layers were cleaned more readily than those containing small inclusions.

In brief, the ratio of yield stress to either wall shear stress, or pressure loss due to fittings have been found best to characterize the flow effect on cleaning. Rules of thumb for cleaning (e.g., a minimum flow velocity of 1.5 m s^{-1} or a threshold Re) are not generally valid. For example, in some cases, 2 m s^{-1} may not be enough to clean large diameter pipes in an acceptable time, whereas 2 m s^{-1} will be overdesigned and wasteful for cleaning relatively small diameters of pipeline. For instance, Eq. 11 predicts that cleaning toothpaste from 0.2 m ID pipeline will take about 48 min at 2 m s^{-1} , while cleaning in 0.025 m ID pipeline will only take 3 min at the same cleaning velocity.

Conclusion

Cleaning of toothpaste and hand cream from lab and pilot scale straight pipes is studied at different flow velocities to characterize the flow effect on cleaning. A straight pipe section is also placed after various fittings to quantify the effect of turbulence on cleaning. After the investigation of these two scenarios in the groups of experiments, energy loss in flow is found to have a good relationship with cleaning times of the Type 1 materials studied.

Velocity, Reynolds number and wall shear stress solely are proved to have insignificant effect on the cleaning process. A dimensionless group ($KU^2\rho/2\tau_y$), which is present in the empirical head loss equation, is observed to be the best parameter to characterize the flow effect on cleaning. It is found that straight pipes at different scales are cleaned at similar times when this dimensionless number is the same at both scales. Further development of the dimensionless number has enabled a new expression ($\theta = 636T_Y + 2630$), enabling the collapse of all cleaning data for different materials cleaned at different scales to be plotted onto one line.

Additional turbulence occurs when water flows through fittings, for example, a valve, a bend or a T-piece. Here, cleaning rate of the straight pipe section is found to increase when placed just after these types of fittings. Moreover, the magnitude of head loss caused by the fittings is also used to quantify the turbulence effect on cleaning. A linear relationship is found for increasing head loss and decreasing cleaning time. Therefore, these findings suggest that determination of energy loss in a hydrodynamical system might be valuable for scaling up cleaning data or be used to predict and compare cleanability of any given system where cleaning is governed by fluid mechanical removal.

Acknowledgments

IP acknowledges financial support from the Turkish Ministry of Education. This paper reports results from the ZEAL project (grant no. TP//ZEE/6/1/21191). The authors would also like to acknowledge the funding received from the RCUK National Centre for Sustainable Energy Use in Food Chains (grant no. EP/K011820/1).

Notation

c_f	= Friction coefficient
c_y	= dimensionless yield stress
ρ	= cleaning fluid density (kg m^{-3})
D	= pipe diameter (m)
K	= resistance coefficient
L	= pipe length (m)
η	= deposit viscosity (Pa s)
Θ	= dimensionless cleaning time
μ	= cleaning fluid viscosity (Pa s)
P_{loss}	= pressure loss (energy loss in the system) (m)
Re	= Reynolds number
t_c	= overall cleaning time (s)
t_R	= mean residence time of the cleaning fluid in the pipe ($= L/U$)
τ_w	= wall shear stress (Pa)
τ_y	= deposit yield stress (Pa)
T_Y	= dimensionless shear stress (ratio of τ_y/τ_w)
U	= flow velocity (m s^{-1})

Literature Cited

1. Tamine AY. *Cleaning-in-Place: Dairy, Food and Beverage Operations*, 1st ed. Vol. 13. Oxford: Wiley, 2008.
2. Martin E, Montague G, Robbins P. A quality by design approach to process plant cleaning. *Chem Eng Res Des.* 2013;91(6):1095–1105.

3. Fryer PJ, Asteriadou K. A prototype cleaning map: a classification of industrial cleaning processes. *Trends Food Sci Technol.* 2009; 20(6–7):255–262.
4. Goode KR, Asteriadou K, Robbins PT, Fryer PJ. Fouling and cleaning studies in the food and beverage industry classified by cleaning type. *Comp Revs Food Sci Food Safety.* 2013;12(2):121–143.
5. Jensen BBB, Stenby M, Nielsen DF. Improving the cleaning effect by changing average velocity. *Trends Food Sci Tech.* 2007;18:S58–S63.
6. Henningsson M, Regner M, Östergren K, Trägårdh C, Dejmeck P. CFD simulation and ERT visualization of the displacement of yoghurt by water on industrial scale. *J Food Eng.* 2007;80(1):166–175.
7. Hou R, Martin PJ, Uppal HJ, Kowalski AJ. An investigation on using electrical resistance tomography (ERT) to monitor the removal of a non-Newtonian soil by water from a cleaning-in-place (CIP) circuit containing different pipe geometries. *Chem Eng Res Des.* 2016;111:332–341.
8. Cole PA, Asteriadou K, Robbins PT, Owen EG, Montague GA, Fryer PJ. Comparison of cleaning of toothpaste from surfaces and pilot scale pipework. *Food Bioprod Process.* 2012;88:392–400.
9. Palabiyik I, Olunloyo B, Fryer PJ, Robbins PT. Flow regimes in the emptying of pipes filled with a Herschel-Bulkley fluid. *Chem Eng Res Des.* 2014;92(11):2201–2212.
10. Quarini J. Ice-pigging to reduce and remove fouling and to achieve clean-in-place. *Appl Thermal Eng.* 2002;22(7):747–753.
11. Wiklund J, Stading M, Trägårdh C. Monitoring liquid displacement of model and industrial fluids in pipes by in-line ultrasonic rheometry. *J Food Eng.* 2010;99(3):330–337.
12. Gabard C, Hulin JP. Miscible displacement of non-Newtonian fluids in a vertical tube. *Eur Phys J E.* 2003;11(3):231–241.
13. Kuang J, Maxworthy T, Petitjeans P. Miscible displacements between silicone oils in capillary tubes. *Eur J Mech B/Fluids.* 2003;22(3):271–277.
14. Park CS, Baek SY, Lee KJ, Kim SW. Two-phase flow in a gas-injected capillary tube. *Adv Polymer Technol.* 2003;22(4):320–328.
15. Fryer PJ, Christian GK, Liu W. How hygiene happens: physics and chemistry of cleaning. *Int J Dairy Technol.* 2006;59(2):76–84.
16. Salo S, Friis A, Wirtanen G. Cleaning validation of fermentation tanks. *Food Bioprod Proc.* 2008;86(3):204–210.
17. Pereira A, Mendes J, Melo LF. Monitoring cleaning-in-place of shampoo films using nanovibration technology. *Sens Actuators B Chem.* 2009;136(2):376–382.
18. Wilson DI, Atkinson P, Köhler H, Mauermann M, Stoye H, Suddaby K, Wang T, Davidson JF, Majschak JP. Cleaning of soft-solid soil layers on vertical and horizontal surfaces by stationary coherent impinging liquid jets. *Chem Eng Sci.* 2014;109:183–196.
19. Pérez-Mohedano R, Letzelter N, Bakalis S. Development of a swelling-removal model for the scanning fluid dynamic gauge. *Food Bioprod Proc.* 2015;93:269–282.
20. Bhagat RK, Wilson DI. Flow in the thin film created by a coherent turbulent water jet impinging on a vertical wall. *Chem Eng Sci.* 2016;152:606–623.
21. Yan J-F, Sáez AE, Grant CS. Removal of oil films from stainless steel tubes. *AIChE J.* 1997;43(1):251–259.
22. Mickaily ES, Middleman S. Hydrodynamic cleaning of a viscous film from the inside of a long tube. *AIChE J.* 1993;39(5):885–893.
23. Lelièvre C, Legentilhomme P, Gaucher C, Legrand J, Faille C, Bénézech T. Cleaning in place: effect of local wall shear stress variation on bacterial removal from stainless steel equipment. *Chem Eng Sci.* 2002;57(8):1287–1297.
24. Blel W, Le Gentil-Lelièvre C, Bénézech T, Legrand J, Legentilhomme P. Application of turbulent pulsating flows to the bacterial removal during a cleaning in place procedure. Part 1: experimental analysis of wall shear stress in a cylindrical pipe. *J Food Eng.* 2009;90(4):433–432.
25. Boulbene B, Morchain J, Bonin MM, Janel S, Lafont F, Schmitz P. A combined computational fluid dynamics (CFD) and experimental approach to quantify the adhesion force of bacterial cells attached to a plane surface. *AIChE J.* 2012;58(12):3614–3624.
26. Jensen BBB, Friis A. Predicting the cleanability of mix-proof valves by use of wall shear stress. *J Food Proc Eng.* 2005;28(2):89–106.
27. Friis A, Jensen BBB. Prediction of hygiene in food processing equipment using flow modelling. *Food Bioprod Process.* 2002;80(4):281–285.
28. Palabiyik I, Yilmaz MT, Fryer PJ, Robbins PT, Toker OS. Minimising the environmental footprint of industrial-scaled cleaning processes by optimisation of a novel clean-in-place system protocol. *J Cleaner Prod.* 2015;108:1009–1010.
29. Dinkgreve M, Paredes J, Denn MM, Bonn D. On different ways of measuring “the” yield stress. *J Non-Newton Fluid Mech.* 2016;238:233–241.
30. De Goederen G, Pritchard NJ, Hasting APM. Improved cleaning processes for the food industry, In: Kessler HG and Lund DB, editors. *Fouling and Cleaning in Food Processing.* Munich: TU Munich, 1989.
31. Sinnott RK. *Coulson and Richardson’s Chemical Engineering, Volume 6 Chemical Engineering Design*, 4th ed. Oxford: Elsevier, 2005.
32. Swain APP, Karapetsas G, Matar OM, Sahu KC. Numerical simulation of pressure-driven displacement of a viscoplastic material by a Newtonian fluid using the lattice Boltzmann method. *Eur J Mechanics B/Fluids.* 2015;49:197–207.
33. Augustin W, Fuchs T, Föste H, Schöler M, Majschak J, Scholl S. Pulsed flow for enhanced cleaning in food processing. *Food Bioprod Proc.* 2010;88(4):384–391.
34. Gillham CR, Fryer PJ, Hasting APM, Wilson DI. Enhanced cleaning of whey protein soils using pulsed flows. *J Food Eng.* 2000;46:199–209.
35. Gordon PW, Schöler M, Föste H, Helbig M, Augustin W, Chew YMJ, Scholl S, Majschak J-P, Wilson DI. A comparison of local phosphorescence detection and fluid dynamic gauging methods for studying the removal of cohesive fouling layers: effect of layer roughness. *Food Bioprod Proc.* 2014;92(1):46–53.

Manuscript received Aug. 31, 2017, and revision received Nov. 29, 2017.