

UNIVERSITY OF BIRMINGHAM

Research at Birmingham

Optimisation of stirred vessel geometry for the drawdown and incorporation of floating solids to prepare concentrated slurries

Wood, Thomas; Simmons, Mark; Stitt, Hugh E.

DOI:

[10.1016/j.cherd.2018.03.002](https://doi.org/10.1016/j.cherd.2018.03.002)

License:

Creative Commons: Attribution (CC BY)

Document Version

Publisher's PDF, also known as Version of record

Citation for published version (Harvard):

Wood, T, Simmons, MJH & Stitt, HE 2018, 'Optimisation of stirred vessel geometry for the drawdown and incorporation of floating solids to prepare concentrated slurries', *Chemical Engineering Research and Design*, vol. 133, pp. 70-78. <https://doi.org/10.1016/j.cherd.2018.03.002>

[Link to publication on Research at Birmingham portal](#)

Publisher Rights Statement:

Published in *Chemical Engineering Research and Design* on 09/03/2018

DOI: 10.1016/j.cherd.2018.03.002

General rights

Unless a licence is specified above, all rights (including copyright and moral rights) in this document are retained by the authors and/or the copyright holders. The express permission of the copyright holder must be obtained for any use of this material other than for purposes permitted by law.

- Users may freely distribute the URL that is used to identify this publication.
- Users may download and/or print one copy of the publication from the University of Birmingham research portal for the purpose of private study or non-commercial research.
- User may use extracts from the document in line with the concept of 'fair dealing' under the Copyright, Designs and Patents Act 1988 (?)
- Users may not further distribute the material nor use it for the purposes of commercial gain.

Where a licence is displayed above, please note the terms and conditions of the licence govern your use of this document.

When citing, please reference the published version.

Take down policy

While the University of Birmingham exercises care and attention in making items available there are rare occasions when an item has been uploaded in error or has been deemed to be commercially or otherwise sensitive.

If you believe that this is the case for this document, please contact UBIRA@lists.bham.ac.uk providing details and we will remove access to the work immediately and investigate.

Contents lists available at [ScienceDirect](http://www.sciencedirect.com)

Chemical Engineering Research and Design

journal homepage: www.elsevier.com/locate/cherd

Optimisation of stirred vessel geometry for the drawdown and incorporation of floating solids to prepare concentrated slurries

Thomas Wood^{a,b}, Mark J.H. Simmons^b, E. Hugh Stitt^{a,*}

^a Johnson Matthey Technology Centre, P.O. Box 1, Belasis Avenue, Billingham, TS23 1LB, UK

^b School of Chemical Engineering, University of Birmingham, Birmingham B15 2TT, UK

ARTICLE INFO

Article history:

Received 30 October 2017

Received in revised form 28

February 2018

Accepted 2 March 2018

Available online 9 March 2018

Keywords:

Suspensions

Drawdown

Floating solids

Stirred tank

Optimisation

ABSTRACT

This paper reports on a Design of Experiments (DoE) approach to optimise the geometric configuration for effective drawdown and incorporation of floating solids to prepare high solid content slurries. The impeller speed and power draw required to ensure all dry powder is incorporated within four seconds of addition to the vessel free surface, N_{ji} and P_{ji} , were used as metrics to determine incorporation performance. Mixed flow pitched blade turbines at $D/T = 0.5$ were used. The main parameters considered were the impeller pumping direction (up versus down), impeller submergence, eccentricity, and angle of tilt. DoE was used to examine both the independent effects of the main parameters and their interactions.

Pumping mode was found to be the most significant parameter, with down-pumping impellers generally providing the best drawdown and incorporation performance. This is related to the strong interaction between pumping mode and all other parameters, where adding tilt or eccentricity reduced drawdown performance for up-pumping impellers, yet caused improvement in the case of down-pumping impellers.

The optimal geometry from the DoE was found using a down-pumping PBT, 10° tilt, 10% of the vessel diameter eccentricity and placed at an initial submergence of half the liquid height. This geometry is shown to reduce the time required to prepare a 50 wt% slurry by two thirds compared to a generic Rushton turbine design, emphasising the benefits of rational impeller and vessel design.

© 2018 The Authors. Published by Elsevier B.V. on behalf of Institution of Chemical Engineers. This is an open access article under the CC BY license (<http://creativecommons.org/licenses/by/4.0/>).

1. Introduction

Drawdown of floating solids in stirred vessels is a common process operation for many industries to incorporate solids for dissolution, reaction, or suspension and slurry preparation. Examples of drawdown processes can be found throughout the polymer, paint, food, and catalyst industries, amongst others. The specific requirement of the drawdown duty is highly dependent upon the solid and liquid phase composition. For example the drawdown, incorporation and suspension of small particle ceramic materials in concentrated slurries for paints or catalyst washcoats will behave differently to the drawdown of

low solid concentration buoyant particles for dissolution, mass transfer, ion exchange, or reaction processes (Siddiqui, 1993).

Solid particles may float for a variety of reasons (Waghmare et al., 2011). Firstly, if the density of the solid particles is lower than the fluid they will float if not agitated. Using agitation to draw these particles down into the fluid forms a dynamic equilibrium where, if agitation ceases, they will return to rest at the top surface. Secondly, if the interfacial tension between the solid and liquid is sufficiently high, this causes a force at the surface with a larger magnitude than the gravitational settling force which prevents the particles from sinking, even if they have a higher density than the fluid (Rouquerol et al., 2013). Thirdly, particles

* Corresponding author.

E-mail address: hugh.stitt@matthey.com (E.H. Stitt).

<https://doi.org/10.1016/j.cherd.2018.03.002>

0263-8762/© 2018 The Authors. Published by Elsevier B.V. on behalf of Institution of Chemical Engineers. This is an open access article under the CC BY license (<http://creativecommons.org/licenses/by/4.0/>).

Nomenclature

α	Impeller tilt angle ($^{\circ}$)
C	Impeller off-bottom clearance (m)
D	Impeller diameter (m)
E	Impeller eccentricity (m)
H	Liquid height (m)
H_0	Initial liquid height (m)
N	Impeller speed (RPM)
P	Impeller power draw (W)
S	Impeller submergence (m)
S_0	Initial impeller submergence (m)
T	Vessel diameter (m)

can agglomerate at the surface, with liquid bridges between particles, forming a large semi-wet mass with occluded air. The presence of this air gives this agglomerate a lower envelope density than the original particles and so it may float until it is broken up. An important distinction between the three cases is that whilst the first is reversible, the latter two are not. Once the particles are either pulled through the surface and/or fully wetted they will become non-buoyant and will not return to the surface once agitation is stopped; rather they will most commonly sediment.

Each of the three phenomenon described above do not necessarily happen in isolation. For example, in the case of porous ceramic powders all can potentially occur. Initially, the pores of the particles are filled with air and so the envelope density will be low. As the pores fill with fluid (a process that depends on the interfacial tension between the two phases) the envelope density will increase until it rises to above that of the fluid. However, the particles may also agglomerate as they hit the liquid surface, leading to a very complex force balance on the system.

Due to the complexity of the problem, previous studies have largely focused on simple systems. For example, large, low density buoyant particles have been used to isolate the phenomena (Hemrajani, 1988; Khazam and Kresta, 2008, 2009; Özcan-Taşkin, 2006). The effect of various geometric parameters on the impeller speed (N_{JD}) and power (P_{JD}) to just drawdown the solid from the liquid surface have been explored. The just drawdown criterion, N_{JD} , first proposed by Joosten et al. (1977), is the impeller rotation rate at which no solid spends more than four seconds at the free surface. This is analogous to the well-known “just suspended” criterion by Zwietering (1958) which is the impeller rotation rate at which no particle spends more than 2 s in contact with the vessel bottom.

Whilst N_{JD} is a useful parameter to study the effect of geometry at a given solids concentration, it relies upon the reversibility of the drawdown process. This is of course only true for the first of the above three conditions given by Waghmare et al. (2011). In the context of the present study, all three apply and hence the drawdown process is not reversible. Therefore a similar condition, the “just incorporation” condition, was proposed by Wood et al. (2018) for non-buoyant solids that can be incorporated into slurries. This measurement is very similar, measuring the impeller speed required, N_{JI} , to ensure all powder added is drawn down and incorporated within four seconds of addition, where a fixed amount of solid is added at a time at a fixed frequency, allowing measurement of drawdown to be carried out for concentrated systems.

Amongst previous studies there is a general consensus that mixed flow pitched blade turbine (PBT) impellers give the best performance, with significant power and speed savings compared to radial flow impellers (Joosten et al., 1977; Khazam and Kresta, 2009; Özcan-Taşkin, 2006; Özcan-Taşkin and McGrath, 2001; Özcan-Taşkin and Wei, 2003; Takahashi and Sasaki, 1999; Wood et al., 2018). The majority of these works have focussed on down-pumping impellers, although Özcan-Taşkin and Wei (2003) demonstrated that up-pumping impellers ran at lower N_{JD} and P_{JD} than down-pumping impellers when placed close to the surface. Given the consistent conclusions within previous litera-

ture, only pitched blade turbines are considered in this study; both up- and down-pumping.

The effect of submergence on drawdown performance has been considered by several researchers, with conflicting conclusions. Özcan-Taşkin and McGrath (2001) reported good performance at high impeller submergences, specifically for radial flow impellers and downward pumping PBTs. Khazam and Kresta (2009) showed that the cloud depth within the vessel improved with a higher submergence at the cost of increasing both the impeller speed and power required for drawdown for a novel geometry using a down-pumping impeller, regardless of baffle configuration. Özcan-Taşkin and Wei (2003) showed that whilst drawdown performance, in terms of N_{JD} , improved as the submergence was increased for down-pumping impellers, the opposite was true for up-pumping impellers. Khazam and Kresta (2009) made a similar observation that up-pumping impellers are much more sensitive to the effect of submergence than down-pumping impellers.

Previous studies focussing on low solid contents and solids that cannot be incorporated demonstrated an improvement in drawdown performance when using baffles. Various baffle geometries have been studied and generally show improved performance over the unbaffled case; this includes the use of one, two and four baffles that can either be full vessel height or surface only baffles (Hemrajani, 1988; Karcz and Mackiewicz, 2009; Khazam and Kresta, 2009; Özcan-Taşkin and McGrath, 2001; Siddiqui, 1993). However, baffles have been shown to inhibit the drawdown and incorporation of incorporable solids (i.e. those that, once wetted, incorporate to form a slurry rather than returning to the surface) during slurry preparation, especially as the slurry solid content is increased above 10% (Wood et al., 2018). Therefore, it is important to examine non-standard geometries to reduce quasi-solid body rotation and improve mixing performance within the vessel. The use of eccentric impellers is a common technique to improve mixing in unbaffled systems, shown to give equally efficient mixing as a baffled vessel (Hall et al., 2004, 2005). Waghmare et al. (2011) demonstrated some promise in the use of a tilted impeller for drawdown, a practice that has been shown to potentially improve mixing performance over unbaffled systems (Chung, 2008).

There are a limited number of studies that consider the effect of increasing the concentration of the solid phase on the mixing system. Xie et al. (2007) studied the deagglomeration of fumed silica agglomerates of up to 10 wt% and found that the drawdown requirement (in terms of drawdown time) increased exponentially with increasing solid concentration for all impellers studied. Khazam and Kresta (2009) examined a system containing expanded polystyrene up to a maximum concentration of 10% by volume and found the drawdown requirements (in terms of N_{JD}) significantly increased with increasing solid concentration. Özcan-Taşkin (2012) studied the incorporation of nanoscale clusters into a suspension using a proprietary design of mixer and found that the drawdown requirement (in terms of incorporation time) increased with increasing solid concentrations, especially above solid concentrations of 10 wt% up to a maximum of 20 wt%.

The effect of D/T is significant on drawdown performance and has been studied by multiple authors (Joosten et al., 1977; Özcan-Taşkin and McGrath, 2001; Özcan-Taşkin and Wei, 2003; Takahashi and Sasaki, 1999), again with varying conclusions. Generally larger impellers require lower speeds to achieve the same drawdown performance at the cost of increased power draw. However, Wood et al. (2018) demonstrated that a larger diameter PBT ($D/T = 0.5$) provided much better incorporation at higher solids content (>40%) and this outweighed the lower power of smaller D/T at low solids content (<20%) in overall process terms.

Design of Experiments (DoE) is a useful tool to ensure the maximum information is obtained from a process using a minimised set of experimental conditions. In a factorial DoE approach, process parameters are varied systematically within an orthogonal design space in order to assess efficiently the effect of each considered parameter on an output, or response variable. This approach also allows the consideration of interactions between the process variables while minimising aliasing between them, allowing optimisation of that response for a given system (Montgomery, 2012).

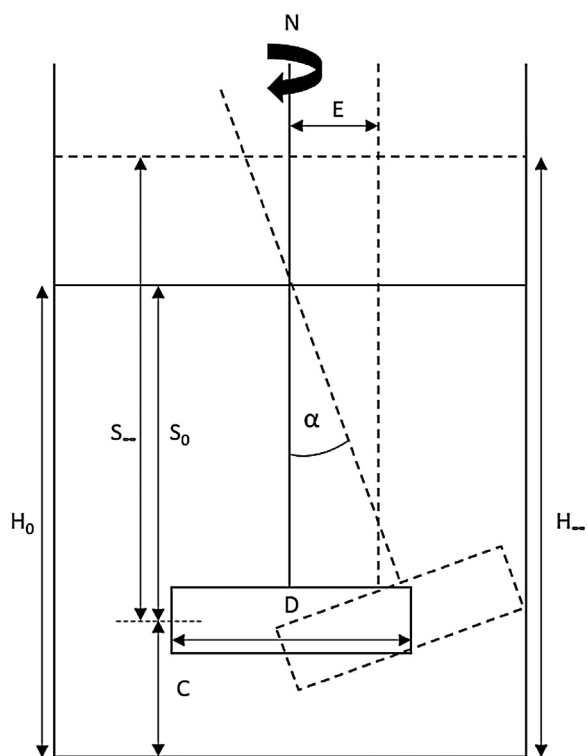

Fig. 1 – Vessel schematic.

This study considers the effect of increasing and high solid concentrations on the geometric parameters for mixing in a 5 dm³ cylindrical stirred vessel. This allows optimised vessel designs to be found for industrially relevant high solid content systems with incorporable solids. This study also considers the interactions between different geometric parameters rather than considering each in isolation; something not previously examined. Non-standard parameters, such as impeller tilt and eccentricity, are also considered as a method of reducing quasi-solid body rotation, while avoiding the use of baffles, which have previously been shown to inhibit the drawdown of incorporable solids above approximately 10 wt.% solids (Wood et al., 2018).

2. Experimental

All experiments were carried out in a flat bottomed cylindrical 5 dm³ vessel with diameter, $T = 0.17$ m and initial liquid height, $H_0 = T$. The geometric parameters considered were impeller pumping mode (up- versus down-pumping PBTs), impeller eccentricity, impeller tilt, and impeller submergence, shown in Fig. 1. No baffles were used in the vessel. The impellers studied had a diameter, $D = 0.085$ m ($D/T = 0.5$). This diameter was selected based on previous studies indicating that this would outperform smaller impellers in terms of required impeller speed and power at higher solid contents (Wood et al., 2018).

The vessel was filled to an initial height, $H_0/T = 1$, with 3.86 dm³ of liquid. An equal mass of solid was pre-weighed into 50 aliquots of 77 g using a KTron KT20 loss in weight powder feeder set to deliver a fixed mass. Each aliquot was poured in one motion to the centre of the vessel to remove disturbance effects due to addition location or rate. An aliquot was added every two minutes. The impeller speed was adjusted upwards as required to ensure that the “just incorporated” condition was maintained throughout the experiment.

The total mass of powder added was 3.85 kg, giving a final slurry concentration (X) of 50 wt.%. A porous γ -alumina, Sasol Puralox SCFa-140, was used as the dispersible solid. This alumina is a porous ceramic, with a poured bulk density

Table 1 – Design of Experiments: variable high, centre point, and low values.

Variable	High	Centre point	Low
Pumping mode	Up	–	Down
Eccentricity	0.2T	0.1T	0
Tilt (°)	20	10	0
Submergence	0.3T	0.5T	0.7T

of approximately 560 kg m⁻³ and D_{50} of 30 μ m, that initially floats. Once incorporated however, the pores fill with fluid and the particles sediment if not agitated. Powder was added in 50 aliquots to allow the effect of increasing solid concentration to be seen on drawdown performance. It also ensured each aliquot was sufficiently large to completely cover the liquid surface when at rest.

An aqueous acetic acid solution, initially 6 wt% acetic acid and pH 3, was used as the liquid. This was done in order to maintain a low viscosity, Newtonian liquid throughout the experiment by ensuring that pH remained well below the isoelectric point of the alumina slurry. The pH of a final 50 wt% slurry was in the range 4.8–5, whereas the isoelectric point for this powder is in the range 7.7–7.9 (Adegbite, 2010). The vessel was double walled with a cooling water flow through the outer jacket. The cooling water was kept at 5 °C. This was used to reduce the effect of slurry temperature on viscosity.

The incorporation performance is defined as the impeller speed and power required to ensure the Just Incorporation condition where no fresh powder spent longer than four seconds at the vessel surface, see Wood et al. (2018). These measures are termed N_{JI} and P_{JI} respectively and are similar to the Just Drawdown condition used in reported studies by other workers. However, the conditions are distinct as just drawdown is a steady state, reversible condition, whereas just incorporation is not.

An initial $H/T = 1$ was used in all experiments. As solid was added to the vessel the liquid level increased to give a final $H/T = 1.2$, meaning that the initial and final submergence of the impeller are different. This increase in liquid level and submergence does have a detrimental effect on the drawdown and incorporation of powder from the surface with all other geometric parameters remaining constant (Wood et al., 2018). However, this effect is considerably smaller than the effect of the increasing solid content.

The impeller shaft torque (Γ) was measured using a calibrated Binsfield TorqueTrak 10k wireless strain gauge attached to the shaft. The impeller power draw was then calculated from the torque as:

$$P = 2\pi N\Gamma \quad (1)$$

The measured torque, and so impeller power draw was found to fluctuate by $\pm 5\%$ of the reading value. All values quoted are the mean value recorded over time at a sampling frequency of 10 Hz.

A full factorial design of experiments (DoE) with centre points approach was used to design an experimental matrix to maximise the information captured regarding the effect of individual variables and the interactions between different variables. The high, centre point, and low values for each of the variables considered are shown in Table 1.

The design, with four variables and two centre points (one for each pumping mode) gives rise to 18 trials, as shown in Table 2. Each experiment was repeated three times. Measure-

Table 2 – List of trials.

Run order	Pumping mode	Eccentricity	Tilt	Submergence
1	Down	0.2	20	0.3
2	Up	0.2	20	0.7
3	Down	0.2	0	0.7
4	Down	0.2	0	0.3
5	Down	0	0	0.3
6	Down	0	20	0.3
7	Up	0	0	0.7
8	Down	0	20	0.7
9	Up	0	0	0.3
10	Up	0	20	0.7
11	Up	0	20	0.3
12	Down	0.1	10	0.5
13	Down	0	0	0.7
14	Down	0.2	20	0.7
15	Up	0.2	0	0.7
16	Up	0.2	0	0.3
17	Up	0.1	10	0.5
18	Up	0.2	20	0.3

ments were found to be repeatable to ± 5 RPM. The average values of the three runs are reported herein. For trials outside of the DoE design space described in Table 2 each of the other variables were kept constant, at a standard value. The standards used in these cases were taken as the “low” values from Table 1 for all parameters. These further non-orthogonal trials were added following the orthogonal DoE to probe further behaviour of a single parameter at a time.

Following this initial scoping factorial design, each of the numeric factors were further probed with additional data points both inside the initial design space, and outside where appropriate. This was done to find turning points in behaviour to find optimal configurations. This involved measuring at submergences between 0.1 T–0.8 T in 0.1 T increments, at tilts of 5° and 15°, and at eccentricities of 0.5 T, and 0.15 T as well as the initial scoping set points.

In order to validate the effect of optimising the vessel geometry, a trial was carried out. During this trial powder was added to the vessel as quickly as possible (as soon as the previous aliquot had been drawn down) at a fixed impeller speed of 450 RPM (the maximum speed required to maintain N_{JI} for the optimum configuration up to 50 wt%). The time and energy required to prepare a 50 wt% slurry was measured in this manner for both the optimal geometry and a six bladed Rushton turbine with $D/T = 0.5$, $S_0/T = 0.7$, with no baffles, eccentricity or tilt.

3. Results and discussion

Fig. 2 shows the measured of N_{JI} and P_{JI} data respectively for the first four trials in the experimental matrix. Better drawdown and incorporation performance is characterised by lower N_{JI} and lower P_{JI} at a given solids content. At low solid contents (<30 wt%) N_{JI} increases approximately linearly with solid content and so can be modelled as a straight line with the intercept and gradient values shown in Table 3. Wood et al. (2018) observed that there is a significant increase in both impeller speed and power draw required to maintain just incorporation as the solid content increases. It was also observed that, for the most part, impeller selection ranking does not change with increasing solids content; what is good at low solids remains good at high solids and vice versa. The above sample of results indicates that the same is largely true for geometrical designs. Thus, poor performing geometries

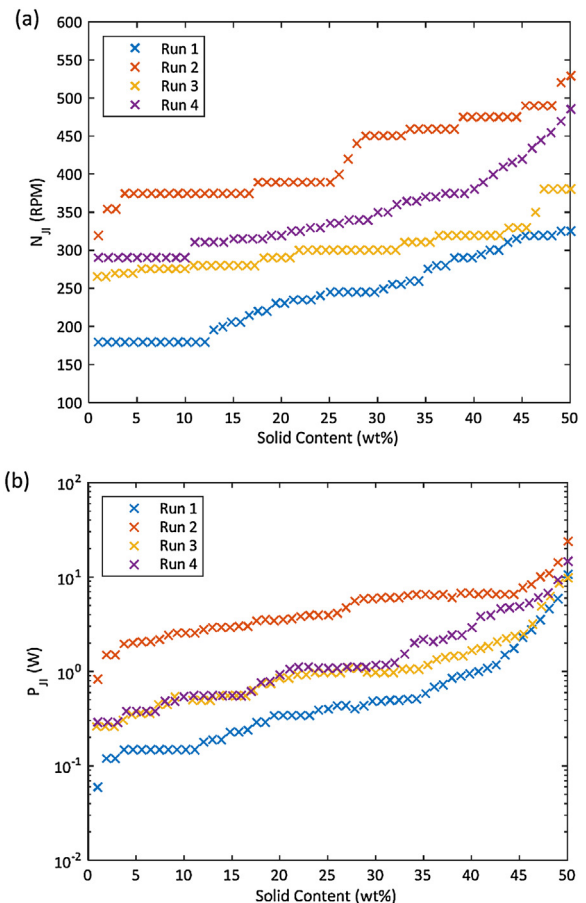

Fig. 2 – (a) N_{JI} evolution with increasing solid content for first four runs; (b) P_{JI} evolution with increasing solid content for first four runs.

Table 3 – N_{JI} results for 30 wt% slurries and linear model parameters for each trial.

Run order	N_{JI} at 30 wt%	Gradient	Intercept
1	240	3.0	163
2	450	2.6	345
3	290	1.3	264
4	320	2.5	278
5	300	2.4	275
6	250	2.1	222
7	305	0.8	281
8	260	1.1	241
9	295	1.9	267
10	440	0.6	418
11	330	2.3	295
12	250	2.1	203
13	320	1.5	294
14	265	1.8	226
15	335	2.9	271
16	320	1.3	289
17	350	1.2	314
18	360	1.3	321

perform poorly at low and high solids content. The difference in power draw between the best and worst does become less significant at highest solids, as the effect of the high viscosity dominates over geometry considerations. The impact of the specific geometric design parameters will be discussed in the context of the statistical analysis of the data.

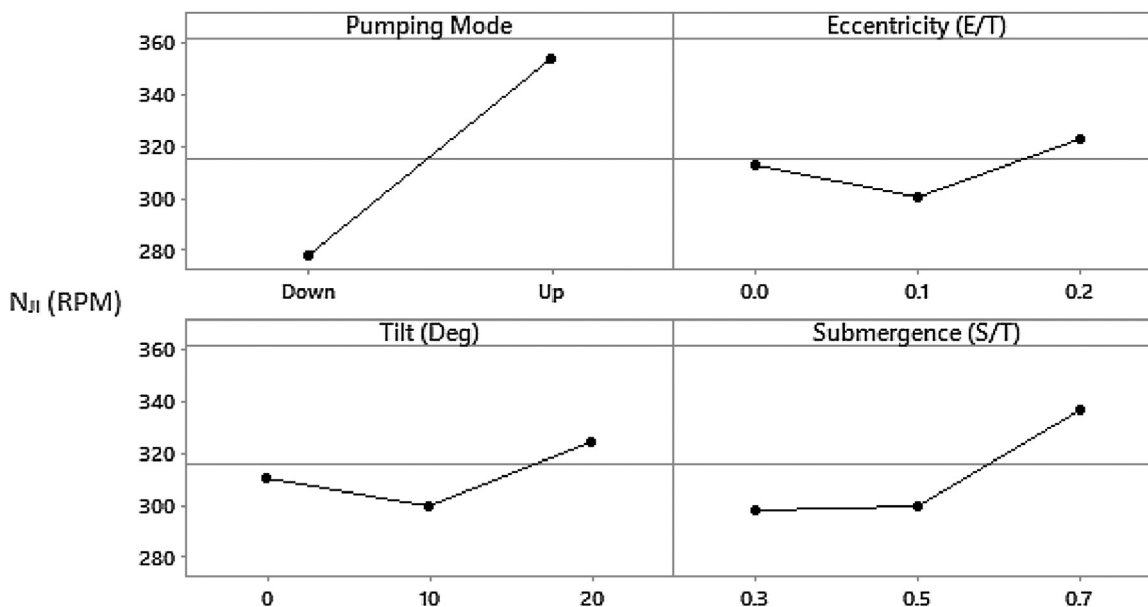

Fig. 3 – Main Effects Plot at 30 wt% for impeller speed at just incorporation condition.

3.1. Main variable effects

When using a Design of Experiments approach, the simplest method of looking at the effect of each variable is via the Main Effects plot shown in Fig. 3. This takes the mean value of all measurements for a variable at each set point. For example the Main Effect value for 'down' for pumping mode would be the average of runs 1, 3–6, 8, 12–14. Fig. 3 uses the mean value of N_{JI} for each variable under each condition studied and can be used to examine high level trends from each of the variables considered. This approach allows consideration of both categoric and numerical variables. The importance of each primary variable is reflected simply by the ranges of the output variable responses: pumping mode is the most important, tilt and eccentricity have similar (non-monotonic) but minor effects while submergence seems to become important at higher values (where the impeller is in the lower half of the vessel). Simply considering the main effects suggests that using a down pumping PBT with 10° tilt, $E/T=0.1$, and a low submergence will give the best drawdown performance, as this is the set of variable conditions which each give the lowest value of N_{JI} and therefore best incorporation performance.

Fig. 4 shows the main effects for the impeller power draw at the just incorporated condition. Pumping mode is significant, as it was for N_{JI} . Impeller tilt and eccentricity both increase the required power because both serve to increase radial and axial flow, reducing tangential flows thus giving increased whole vessel mixing. Submergence shows a similar trend for power to that for N_{JI} , becoming significant for higher values. In similar fashion to the Main Effects Plot for impeller speed, a down-pumping impeller with a small tilt and eccentricity with a submergence above the bottom half of the vessel gives the best drawdown performance, minimizing both power draw and impeller speed.

3.2. Variable interactions

The above discussion and results presentation considers only the uni-variate impact of each design parameter. Stirred vessel design is however a multi-variate problem and it is therefore important to assess the inter-dependency of the primary

parameters. Fig. 5 shows the interaction plot which presents a more detailed breakdown of the Main Effects Plot, separating the design parameters to assess the interactions between them. Each point on the interaction plot represents the mean value of all runs with both variables considered, held at a specific set point. To aid interpretation of these plots, converging lines in Fig. 5 indicate the presence of interactions between variables whereas parallel lines suggest those two variables are independent.

There is a strong interaction between pumping mode and every other variable, as seen in the first column. This means there is a significantly different response when changing tilt, eccentricity, or submergence depending on whether the impeller is in an up- or down-pumping mode. For each of these interactions the best performance for the up-pumping impeller is the low value for each variable, whereas for the down-pumping impeller it is the centre point of the high value. Each of these interactions is considered in more detail below.

There is also a slight interaction between impeller tilt and submergence, with tilting the impeller proving to be detrimental to drawdown performance at higher impeller submergences. This matches with experimental observation that at high submergence and high tilt the impeller shaft passes through the liquid surface close to the vessel wall resulting in a very narrow gap where dry or semi-wetted powder agglomerates would adhere to the wall and shaft, creating a static site for further agglomeration which could not be easily drawn down and incorporated.

There is no interaction between eccentricity and impeller tilt. This is probably because they both achieve similar effects on the flow pattern; reducing quasi-solid body rotation and increasing axial and radial flows in the vessel and increasing the impeller power delivery.

3.3. Complex variable effects

Some of the main effects and interactions present complex and non-linear trends that require further investigation, such as the interaction between pumping mode and tilt and the impact of submergence. These are explored in more detail below.

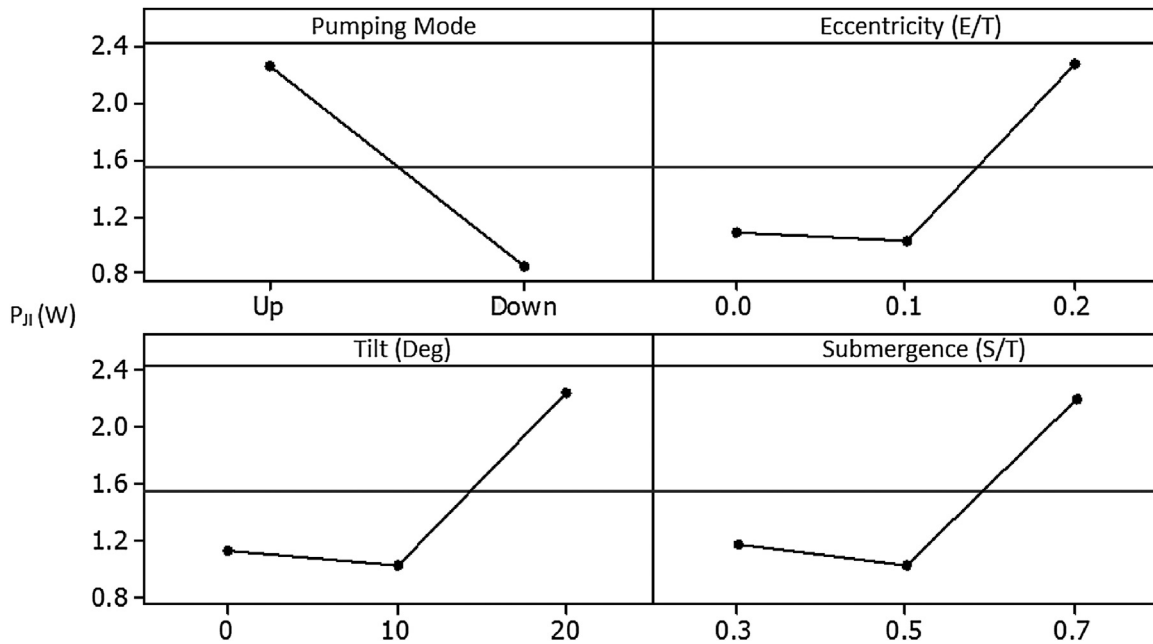

Fig. 4 – Main Effects Plot at 30 wt% for impeller power at just incorporation condition.

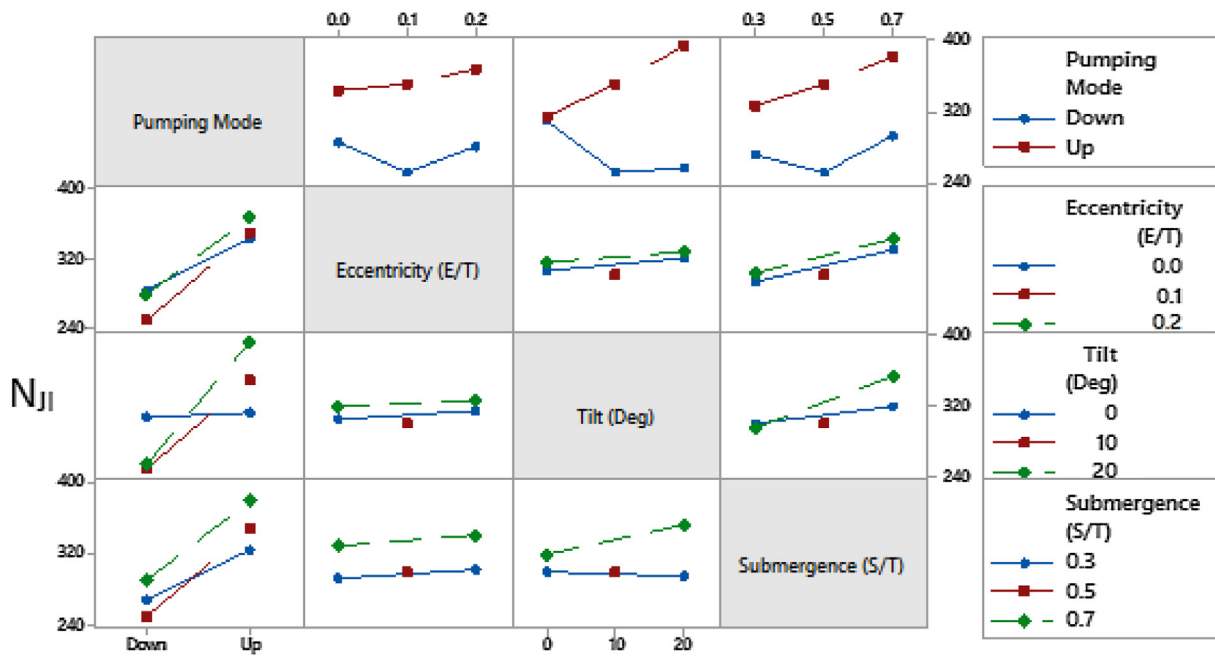

Fig. 5 – Interaction Plot at 30 wt% for impeller speed at just incorporation condition.

Fig. 6 shows a more detailed view of the interaction between pumping mode and impeller tilt, where each measurement is represented by a single point. It also includes extra measurements at tilts of 5° and 15° to further probe the linearity of the system response to impeller tilt. The spread of points at 0° and 20° show the presence of an effect from other variables. It is important to note that this spread is significantly larger for the up-pumping impeller than for down-pumping. This indicates that when pumping upwards the system is much more sensitive to the effect of the variables changing.

There is a different response to impeller tilt depending on pumping mode, with a small improvement in drawdown performance generally seen with tilting a down-pumping impeller. Conversely, there is generally a decrease in drawdown performance with increasing impeller tilt for an up-pumping impeller.

In Fig. 7, the effect of eccentricity is minimal regardless of pumping direction. Again, each individual point represents a single measurement with extra trials on top of the DoE at $E=0.05T$ and $E=0.15T$ to probe the linearity of the system response to eccentricity. There is evidence of a slight negative correlation between tilt and N_{JI} for the down-pumping impeller, suggesting that eccentricity can marginally improve drawdown performance. This is not the case for the up-pumping impeller where there is no obvious effect of eccentricity.

The up-pumping impeller again shows a significantly larger spread of values than the down-pumping impeller, showing a greater dependency on geometry interactions than the down-pumping impeller for effective drawdown to occur. The minimum impeller speed required for the down-pumping impeller is seen at a slight eccentricity of 0.1T. However, the

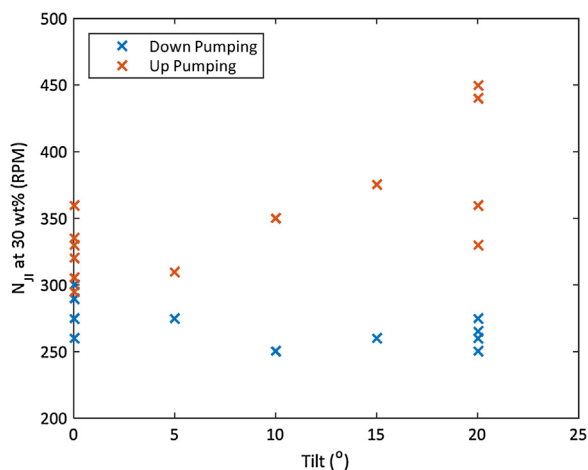

Fig. 6 – Effect of interaction between impeller tilt and pumping mode on N_{JI} at 30 wt% solid content.

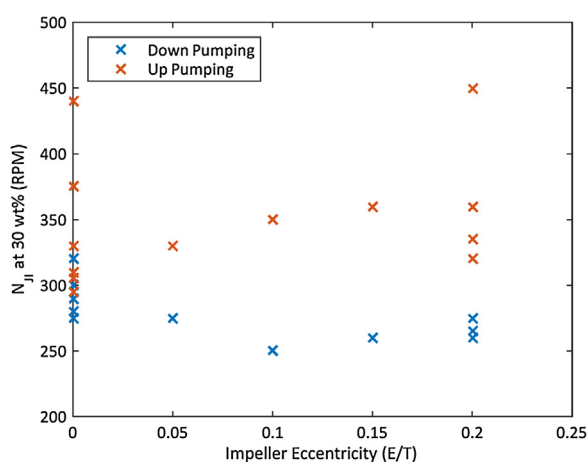

Fig. 7 – Effect of interaction between impeller eccentricity and pumping mode on N_{JI} .

minimum for the up-pumping impeller is found at zero eccentricity.

Fig. 8a shows the three-way interaction between submergence, solid content and pumping mode. Each set of points is a single experiment, where solid content was increased for a constant geometry, using “low” values for eccentricity and tilt for three different submergences for each impeller. Again; there is a different response to submergence depending on pumping mode. For the down-pumping impeller the best performance was at an initial submergence of $S_0/T=0.5$ whereas, for the up-pumping impeller best performance was as close to the surface as possible at $S_0/T=0.3$. This difference is explained by visual observations when conducting the experiments as the down-pumping impeller entrained air from the surface straight to the impeller, reducing the effectiveness of the impeller whereas the flow pattern in up-pumping mode prevented this. Both impellers gave their worst drawdown performance when in the bottom half of the vessel with an $S_0/T=0.7$.

At the lowest solid contents studied, the up-pumping impeller was more sensitive to impeller depth, with a larger difference between the impeller speeds required at the best and worst performing depths, as shown in Fig. 8b, which shows the difference between the best and worst performing submergence in Fig. 8a. This is a consistent with the observations of Khazam and Kresta (2008). However, as the solid content increases this difference between pumping mode

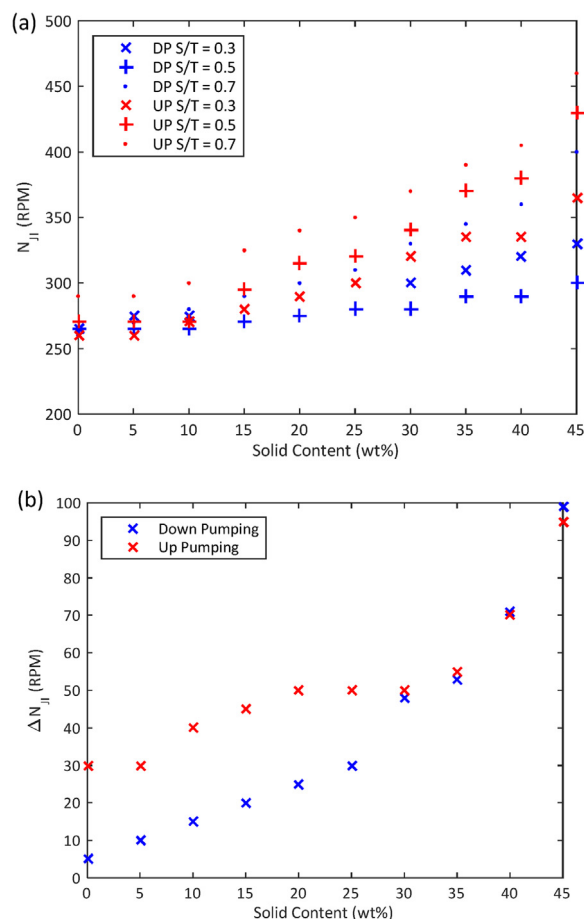

Fig. 8 – (a) Change in N_{JI} with increasing solid content and varying impeller initial submergence (b) Difference between highest and lowest required N_{JI} across all submergences measured.

becomes less marked, a new result since this phenomenon has not previously been studied at higher solid contents.

Fig. 9a shows the effect of submergence on impeller speed required for drawdown for an up-pumping impeller with no tilt or eccentricity. As seen in other studies on low solid contents; increasing the impeller submergence above $\sim 0.6T$ has a negative impact on drawdown and incorporation performance. However, in contrast to many of these other works, performance does not continue to increase indefinitely as the impeller is brought closer to the surface. At submergences less than $0.4T$ there was significant air entrainment, causing semi-permanent bubbles to form at the liquid surface. These bubbles provided surface area for dry or semi wet solid to bind to, increasing buoyancy force and preventing full incorporation into the slurry. Fig. 9b shows the P_{JI} values as a function of S_0/T and indicates that the power draw fall off significantly at S_0 below $0.3T$; despite an increasing N_{JI} . A gassed system would draw significantly less power than an un-gassed system (Middleton, 1992). This fall off in power draw thus confirms that surface aeration is significant and the probable cause of the loss of incorporation performance. Although good draw-down performance was seen for a submergence of $0.3T$, once the vessel was drained a significant amount of sediment was found on the base of the vessel. This was not true for greater impeller submergences, suggesting that for submergences of $0.3T$ and below, the impeller is too far from the base of the vessel to provide sufficient vessel turnover to ensure complete suspension at the Just Incorporation condition.

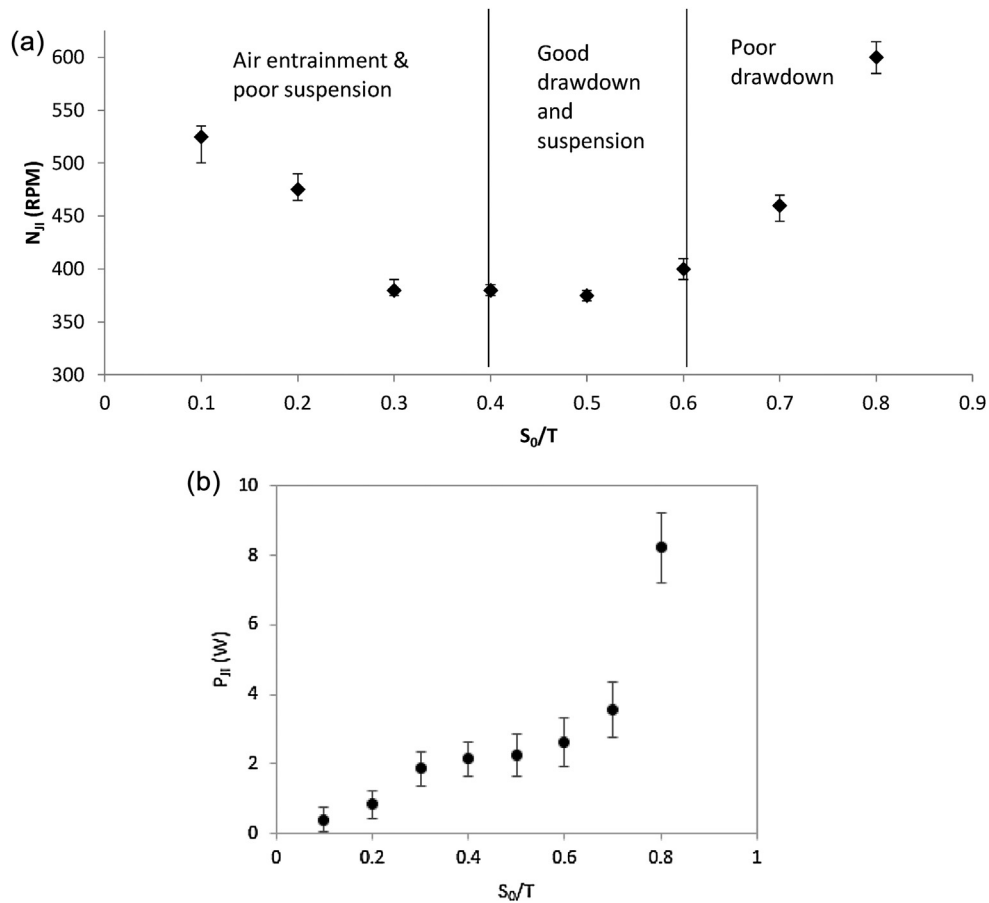

Fig. 9 – (a) N_{j1} at 40% by weight solids with varying initial impeller submergence for up pumping PBT with $D/T = 0.5$ (b) P_{j1} at 40% by weight solids with varying initial impeller submergence for up pumping PBT with $D/T = 0.5$.

Table 4 – Optimal geometry configuration.

Property	Value
Impeller type	PBT
Pumping mode	Down
Impeller diameter	0.5 T
Baffles	None
Impeller submergence	0.5 T
Impeller tilt ($^\circ$)	10
Impeller eccentricity	0.1 T

This was not true at submergences above 0.3 T, suggesting that for drawdown and incorporation processes there is an optimum range of impeller submergences between 0.4–0.6 T, as shown in Fig. 9a. This observation was true for both up- and down-pumping impellers.

3.4. Optimal geometry & validation

The DoE can be used to specify the best conditions for each of the impellers studied and then to design an optimal geometry. For the down-pumping impeller the optimum submergence occurred at $S_0 = 0.5 T$, the optimal tilt was 10° , with a slight eccentricity of 0.1T. For the up-pumping impeller the best conditions were as close to the surface as possible, whilst maintaining suitable suspension ($S_0 = 0.4 T$), with no tilt or eccentricity. The down-pumping impeller was much less sensitive to changes to other aspects of the geometry and capable of giving a better drawdown performance, so the full optimised geometry design uses a down pumping impeller, as shown in Table 4.

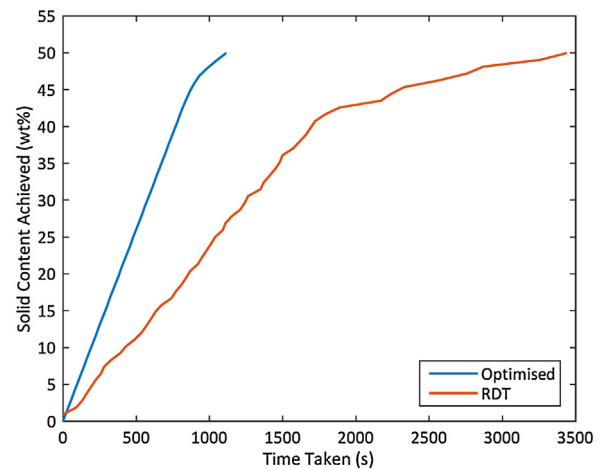

Fig. 10 – Minimum time required to prepare a 50 wt% slurry with the optimised geometry vs a Rushton turbine, both at 450 RPM.

Fig. 10 shows a comparison of the time taken to prepare a 50 wt% slurry using this optimal geometry against a Rushton turbine, both running at the same impeller speed. Whereas the Rushton required almost an hour to prepare the slurry, the optimised geometry only took 17 min. This demonstrates the effectiveness of an optimised geometry design for the drawdown and incorporation of floating solids to prepare concentrated slurries. It also serves to emphasise the importance of good impeller and vessel design in achieving effective powder incorporation.

4. Conclusions

This work uses a design of experiments approach to fully optimise a geometry for the drawdown and incorporation of floating solids to prepare high solid content suspensions. The use of a full factorial orthogonal DoE enables an analysis of the effects of key geometric variables and their interactions. The variables specifically focussed on are impeller pumping mode, tilt, eccentricity, and submergence within the mixing vessel.

The most significant variable is impeller pumping mode with down-pumping impellers generally out performing up-pumping impellers in terms of drawdown performance. Down-pumping impellers give the best possible performance in terms of the smallest possible N_{PI} required under optimal configuration, but also in terms of sensitivity to interactions with other variables. The up-pumping impeller showed significant decreases in performance if moved eccentric, tilted or at higher initial submergences whereas the down-pumping impeller showed improvements with tilt and eccentricity.

The best performing set of conditions involved using a down-pumping PBT with no baffles and $D/T = 0.5$ at an initial submergence halfway down the vessel ($S_0/T = 0.5$; $H_0/T = 1$), a 10° tilt and eccentricity of $0.1T$. The best set of conditions for using an up-pumping impeller were as close to the surface as possible ($S_0/T = 0.4$), no impeller tilt, or eccentricity. However, there was a significant amount of sedimentation at the lowest submergences for both up- and down-pumping impellers therefore it is not recommended to operate at an $S_0/T < 0.4$ to maintain effective drawdown, incorporation and suspension.

Comparison of the optimised geometry against a generic mixing geometry employing a Rushton turbine showed a dramatic reduction in processing time of one third to prepare a 50 wt% slurry by the optimised geometry. This demonstrates the effectiveness of simple geometry optimisation for this process.

Acknowledgements

Thomas Wood is funded by the EPSRC Centre for Doctoral Training in Formulation Engineering at the University of Birmingham (EP/L015153/1) and Johnson Matthey.

References

- Adegbite, S., 2010. *Coating of Catalyst Supports: Links Between Slurry Characteristics, Coating Process and Final Coating Quality* (PhD). University of Birmingham, Birmingham.
- Chung, K.H.K., 2008. *Mixing in High Throughput Experimentation Reactors* (PhD). University of Birmingham.
- Hall, J.F., Barigou, M., Simmons, M.J.H., Stitt, E.H., 2004. Mixing in unbaffled high-throughput experimentation reactors. *Ind. Eng. Chem. Res.* 43, 4149–4158, <http://dx.doi.org/10.1021/ie049872q>.
- Hall, J.R., Barigou, M., Simmons, M.J.H., Stitt, E.H., 2005. A PIV study of hydrodynamics in gas-liquid high throughput experimentation (HTE) reactors with eccentric impeller configurations. *Chem. Eng. Sci.* 60, 6403–6413, <http://dx.doi.org/10.1016/j.ces.2005.03.044>.
- Hemrajani, R.R., 1988. Suspending floating solids in stirred tanks: mixer design, scale-up and optimization. Presented at the Proceedings of the 6th European Conference on Mixing, Pavia, Italy, pp. 259–265.
- Joosten, G.E.H., Schilder, J.G.M., Broere, A.M., 1977. *Suspension of floating solids in stirred vessels*. *Trans. Inst. Chem. Eng.* 55, 220–222.
- Karcz, J., Mackiewicz, B., 2009. Effects of vessel baffling on the drawdown of floating solids. *Chem. Pap.* 63, 164–171, <http://dx.doi.org/10.2478/s11696-009-0011-0>.
- Khazam, O., Kresta, S.M., 2009. A novel geometry for solids drawdown in stirred tanks. *Chem. Eng. Res. Des.* 87, 280–290, <http://dx.doi.org/10.1016/j.cherd.2008.09.013>.
- Khazam, O., Kresta, S.M., 2008. Mechanisms of solids drawdown in stirred tanks. *Can. J. Chem. Eng.* 86, 622–634, <http://dx.doi.org/10.1002/cjce.20077>.
- Middleton, J.C., 1992. *Gas liquid dispersion and mixing*. In: Harnby, N., Edwards, M.F., Nienow, A.W. (Eds.), *Mixing in the Process Industries*. Butterworth-Heinemann, pp. 322–363.
- Montgomery, D.C., 2012. *Design and Analysis of Experiments, 8th edition*. John Wiley & Sons, Hoboken, NJ.
- Özcan-Taşkın, G., 2006. Effect of scale on the draw down of floating solids. *Chem. Eng. Sci.* 61, 2871–2879, <http://dx.doi.org/10.1016/j.ces.2005.10.061>.
- Özcan-Taşkın, G.N., 2012. Incorporation of nanoparticle clusters into a liquid using a proprietary design mixer—Ytron Y Jet. Presented at the 14th European Conference on Mixing, Warszawa, pp. 347–352.
- Özcan-Taşkın, G., McGrath, G., 2001. Draw down of light particles in stirred tanks. *Chem. Eng. Res. Des.* 79, 789–794, <http://dx.doi.org/10.1205/026387601753191966>, *Distillation and Absorption*.
- Özcan-Taşkın, G., Wei, H., 2003. The effect of impeller-to-tank diameter ratio on draw down of solids. *Chem. Eng. Sci.* 58, 2011–2022, [http://dx.doi.org/10.1016/S0009-2509\(03\)00024-1](http://dx.doi.org/10.1016/S0009-2509(03)00024-1).
- Rouquerol, J., Rouquerol, F., Llewellyn, P., Maurin, G., Sing, K.S.W., 2013. *Adsorption by Powders and Porous Solids: Principles, Methodology and Applications*. Academic Press.
- Siddiqui, H., 1993. Mixing technology for buoyant solids in a nonstandard vessel. *AIChE J.* 39, 505–509, <http://dx.doi.org/10.1002/aic.690390312>.
- Takahashi, K., Sasaki, S., 1999. Complete drawdown and dispersion of floating solids in agitated vessel equipped with ordinary impellers. *J. Chem. Eng. Jpn.* 32, 40–44, <http://dx.doi.org/10.1252/jcej.32.40>.
- Waghmare, Y., Falk, R., Graham, L., Koganti, V., 2011. Drawdown of floating solids in stirred tanks: scale-up study using CFD modeling. *Int. J. Pharm.* 418, 243–253, <http://dx.doi.org/10.1016/j.ijpharm.2011.05.039>.
- Wood, T., Simmons, M.J.H., Greenwood, R.G., Stitt, E.H., 2018. Concentrated slurry formation via drawdown and incorporation of wetttable solids in a mechanically agitated vessel. *AIChE J.*, <http://dx.doi.org/10.1002/aic.16121>.
- Xie, L., Rielly, C.D., Eagles, W., Özcan-Taşkın, G., 2007. Dispersion of nano-particle clusters using mixed flow and high shear impellers in stirred tanks. *Chem. Eng. Res. Des.* 85, 676–684, <http://dx.doi.org/10.1205/cherd06195>.
- Zwietering, T.N., 1958. Suspending of solid particles in liquid by agitators. *Chem. Eng. Sci.* 8, 244–253, [http://dx.doi.org/10.1016/0009-2509\(58\)85031-9](http://dx.doi.org/10.1016/0009-2509(58)85031-9).