

UNIVERSITY OF BIRMINGHAM

Research at Birmingham

The role of hydrogen and fuel cells in delivering energy security for the UK

Steinberger-Wilckens, Robert; Dodds, Paul; Kurban, Zeynep; Velazquez Abad, Anthony; Radcliffe, Jonathan

License:

None: All rights reserved

Document Version

Publisher's PDF, also known as Version of record

Citation for published version (Harvard):

Steinberger-Wilckens, R, Dodds, P, Kurban, Z, Velazquez Abad, A & Radcliffe, J (eds) 2017, The role of hydrogen and fuel cells in delivering energy security for the UK. H2FC SUPERGEN Hub White Papers, H2FC SUPERGEN, London.

[Link to publication on Research at Birmingham portal](#)

General rights

Unless a licence is specified above, all rights (including copyright and moral rights) in this document are retained by the authors and/or the copyright holders. The express permission of the copyright holder must be obtained for any use of this material other than for purposes permitted by law.

- Users may freely distribute the URL that is used to identify this publication.
- Users may download and/or print one copy of the publication from the University of Birmingham research portal for the purpose of private study or non-commercial research.
- User may use extracts from the document in line with the concept of 'fair dealing' under the Copyright, Designs and Patents Act 1988 (?)
- Users may not further distribute the material nor use it for the purposes of commercial gain.

Where a licence is displayed above, please note the terms and conditions of the licence govern your use of this document.

When citing, please reference the published version.

Take down policy

While the University of Birmingham exercises care and attention in making items available there are rare occasions when an item has been uploaded in error or has been deemed to be commercially or otherwise sensitive.

If you believe that this is the case for this document, please contact UBIRA@lists.bham.ac.uk providing details and we will remove access to the work immediately and investigate.



THE ROLE OF HYDROGEN AND FUEL CELLS IN DELIVERING ENERGY SECURITY FOR THE UK

A H₂FC SUPERGEN White Paper

March 2017

THE ROLE OF HYDROGEN AND FUEL CELLS IN DELIVERING ENERGY SECURITY FOR THE UK

A H₂FC SUPERGEN WHITE PAPER

Robert Steinberger-Wilckens, Jonathan Radcliffe,
Naser Al-Mufachi, Paul E. Dodds, Anthony Velazquez Abad,
Owain Jones and Zeynep Kurban

March 2017

Project lead: Robert Steinberger-Wilckens,¹ Jonathan Radcliffe¹

Editors: Robert Steinberger-Wilckens,¹ Paul E. Dodds,² Anthony Velazquez Abad,² Zeynep Kurban,³ and Jonathan Radcliffe¹

Authors: Robert Steinberger-Wilckens,¹ Jonathan Radcliffe,¹ Naser Al-Mufachi,¹ Paul E. Dodds,² Anthony Velazquez Abad,² Owain Jones² and Zeynep Kurban³

[1 University of Birmingham/Birmingham Energy Institute](#)

[2 University College London](#)

[3 Imperial College London](#)

Please cite this paper as:

Steinberger-Wilckens, R., Dodds, P.E., Kurban, Z., Velazquez Abad, A., and Radcliffe, J. (Eds.) (2017) *The role of hydrogen and fuel cells in delivering energy security for the UK*. H2FC Supergen, London, UK.

Please cite individual chapters as:

Executive summary: Steinberger-Wilckens, R., Kurban, Z., Dodds, P. E. and Radcliffe, J., Velazquez Abad, A. (2017) (Eds.) *The role of hydrogen and fuel cells in delivering energy security for the UK*. H2FC SUPERGEN, London, UK.

Chapter 1 Steinberger-Wilckens, R. and Dodds, P.E. (2017) *Introduction*.

Chapter 2 Jones, O. and Dodds, P.E. (2017) *Definitions of energy security*.

Chapter 3 Velazquez Abad, A. and Dodds, P.E. (2017) *Hydrogen production*.

Chapter 4 Al-Mufachi, N. and Steinberger-Wilckens, R. (2017) *Fuel cell technology*.

Chapter 5 Steinberger-Wilckens, R., Kurban, Z., Dodds, P.E. (2017) *Hydrogen fuels for energy security*.

Chapter 6 Steinberger-Wilckens, R. and Kurban, Z. (2017) *Fuel cells for energy security*.

Chapter 7 Dodds, P.E. (2017) *Energy security impacts of introducing hydrogen to the UK energy system*.

Chapter 8 Kurban, Z. (2017) *Policy implications*.

Chapter 9 Steinberger-Wilckens, R. (2017) *Summary and conclusions*.

BACKGROUND

This White Paper has been commissioned by the UK Hydrogen and Fuel Cell (H2FC) SUPERGEN Hub to examine the roles and potential benefits of hydrogen and fuel cell technologies in delivering energy security for the UK.

The H2FC SUPERGEN Hub is an inclusive network encompassing the entire UK hydrogen and fuel cells research community, with around 100 UK-based academics supported by key stakeholders from industry and government. It is funded by the UK EPSRC research council as part of the RCUK Energy Programme. This paper is the second of four that were published over the lifetime of the Hub, with the others examining: (i) low-carbon heat; (iii) future energy systems; and (iv) economic impact.

ACKNOWLEDGEMENTS

Many people assisted in the preparation of this report. The authors are very grateful to all of them, including:

- Amrit Chandan (BlueVine Consultants)
- Geraint Evans (Energy Technologies Institute)
- Sam French (Johnson Matthey Plc)

The authors would also like to thank the people who commented on the draft versions of this report:

- Nigel Brandon (Imperial College London), who leads the Hub project,
- Robert Evans (CENEX)
- Nigel Holmes (Scottish Hydrogen and Fuel Cell Association),
- Vladimir Molkov (Ulster University), and
- Marcus Newborough (ITM Power)
- Beatrice Sampson and Sophie Archer (University of Birmingham)

Finally, the authors would like to express their gratitude towards the Hydrogen and Fuel Cell SUPERGEN Hub for commissioning and supporting the development of this White Paper.

GLOSSARY

BEIS	Department for Business, Energy and Industrial Strategy
BFB	Bubbling Fluidised Bed
CCS	Carbon Capture and Sequestration
CFD	Contracts for Difference
CHP	Combined Heat and Power
CHP	Combined Heat and Power
DfE	Department for the Economy
DSBR	Demand Side Balancing Reserve
EMR	Electricity Market Reform
ETS	Electricity Transmission System
IEA	International Energy Agency
LOLE	Loss of Load Expectation
MCFC	Molten Carbonate Fuel Cell
Mm ³	Millions of cubic metres
MSW	Municipal Solid Waste
NG	National Grid
Ofgem	Office of Gas and Electricity Markets
PAFC	Phosphoric Acid Fuel Cell
PEMFC	Proton exchange Membrane Fuel Cell
SBR	Supplemental Balancing Reserve
SMR	Steam Methane Reformation
SNG	Synthetic Natural Gas (pure methane)
SOFC	Solid Oxide Fuel Cell
UREGNI	Utility Regulator Northern Ireland
WECS	World Energy Council's
wt%	weight per cent

Note on Efficiency and Heating Values

The energy content of a fuel can be measured using two reference points depending on whether the H₂O product from combustion or electrochemical conversion is treated as being a liquid or steam. Higher Heating Value (HHV) or Gross Calorific Value (GCV) is the strict thermodynamic definition of energy content, whereas Lower Heating Value (LHV) or Net Calorific Value (NCV) excludes the latent heat used to evaporate the water products from combustion [1]. The more practical LHV definition became prominent in the 19th Century as the heat from sulphur-rich coal combustion below 150°C could not be recovered and put to economic use. With the advent of condensing heat exchangers this latent heat can now be reclaimed, meaning modern boilers can attain efficiencies of up to ≈109% LHV. Such unintuitive values reflect an antiquated accounting convention rather than a violation of the first law of thermodynamics.

Nevertheless, all efficiencies in this paper are expressed as LHV to remain consistent with heating industry conventions. Divide these efficiencies by 1.109 to convert them into HHV for natural gas fuelled systems. Natural gas is priced by HHV energy content in the UK [2] so efficiencies must be converted when calculating the running cost of any gas-fired technology.

HEADLINE MESSAGES

Hydrogen is a fuel that offers zero point-of-use emissions and can be produced from a wide variety of energy input. **Fuel Cells** are a conversion technology that allows high efficiencies of energy supply. The UK energy security strategies do not yet embrace the potential these technologies offer. This White Paper therefore describes how hydrogen and fuel cells can contribute to energy security.

Our key messages are:

Fuel cells can contribute to UK energy system security, both now and in the future.

Fuel cells can uniquely generate electricity at high efficiencies even at very small scales, and are already being increasingly used for emergency back-up power. There are many types; some require high-purity hydrogen, while others can operate on a range of fuels including natural gas, allowing them some degree of flexibility. In the longer term, fuel cell electric vehicles could greatly reduce oil dependence in the transport sector and fuel cell micro-CHP could reduce gas consumption by generating electricity and heat at high overall efficiencies.

Hydrogen can be produced using a broad range of feedstocks and production processes, including renewable electricity. Price volatility of primary energy sources or supply disruptions can be ameliorated by switching to other energy sources. Building a diverse portfolio of hydrogen production plants, using a range of feedstocks, would cost little more than building only the cheapest plant.

Adopting hydrogen as an end-use fuel in the long term increases UK energy diversity.

Scenario analyses using an energy system model show that the diversity of the UK energy system, including primary energy consumption, electricity generation, heat and transport, would be similar for scenarios with and without hydrogen, and slightly improved compared to today's situation.

Hydrogen can be safely transported and stockpiled. Hydrogen pipelines are widely-used in industry and well-understood. It would be possible to develop large-scale storage of hydrogen more cheaply than that for electricity. This could supply many of the same markets as electricity and increase diversification compared to a system focused on electrification of heat and transport.

Hydrogen and fuel cells could improve the stability of a low-carbon electricity system with a high penetration of renewables. Hydrogen could be produced from renewable electricity using electrolyzers in a process called power-to-gas. The hydrogen could then be used as a fuel (e.g. in the transport sector), or stored and used to generate electricity at times of high demand. UK energy resource independence could be greatly increased through deploying high levels of renewables supported by hydrogen and fuel cells.

A decentralised system of hydrogen and fuel cells could improve the resilience of the energy system to threats such as terrorism, production plant and infrastructure failures, and natural disasters. Furthermore, decentralised generation that operates at peak times (such as micro-CHP on winter evenings) would reduce demand peaks needed by centralised generation systems, improving reliability and reducing the need to invest in peak generation plant.

With respect to affordability, the Government's energy security strategy concentrates on short-term resource price volatility and insufficiently addresses long-term sustainability. The strategy does not provide a comprehensive, long-term outlook for the development of a resilient, low-carbon electricity system at long-term stable costs that also includes costs to the taxpayer not covered by customer pricing. Production and infrastructure investments have long lifetimes and need a reliable and stable framework that will deliver affordable cost to the society as a whole.

The energy security strategy needs to consider the implications of closer interactions between the power, gas and transport sectors in the future. These markets will be intimately linked by using hydrogen and fuel cells across the various transport, power, and heating applications. A future strategy would ideally take a more holistic view of these markets and of the energy system.

Hydrogen and fuel cells offer many options to improve the diversity, reliability, resilience and sustainability of the UK energy system in the future. With appropriate support and a clear and reliable policy framework, UK energy security can be improved in the long term by unfolding the great potential that lies in the use of these technologies.

CONTENTS

Background	iii
Acknowledgements	iii
Glossary	iv
Headline messages	vi
Extended summary	1
1 Introduction	14
1.1 Aims of the study	15
1.2 Energy security	17
1.3 Making the case: UK energy supply today	18
1.4 Pressures on UK energy system	19
2 Definitions of energy security	21
2.1 Introduction	22
2.2 Definitions of energy security	22
2.3 Indicators of energy security	27
2.4 Assessing the impact of hydrogen and fuel cells on energy security	32
2.5 Conclusions	34
3 Hydrogen production	35
3.1 Introduction	36
3.2 Steam reforming of gas, light oils and alcohols	37
3.3 Gasification of coal, heavy oils and biomass	39
3.4 Electrolysis	44
3.5 Production methods at an earlier stage of development	47

3.6	Production of synthetic natural gas and other compounds	49
3.7	Water requirements for hydrogen production	50
3.8	Hydrogen storage and infrastructure	51
3.9	Conclusions	53

4 Fuel cell technology **54**

4.1	Fuel cell background and history	55
4.2	Fuel cell basics and types	57
4.3	Applications of fuel cells	65
4.4	Alternative fuels for fuel cells	69
4.5	Conclusions	70

5 Hydrogen fuels for energy security **72**

5.1	Introduction	73
5.2	UK energy supply today	73
5.3	Flexibility of fuel choice	78
5.4	Decarbonisation for sustainability	80
5.5	Independence of fuel imports	81
5.6	Linking energy sectors: hydrogen and methane infrastructure	81
5.7	Hydrogen transport and distribution	85
5.8	Affordability	86
5.9	Conclusions	92

6 Fuel cells for energy security **93**

6.1	Introduction	94
6.2	Distributed power generation and CHP: increasing efficiency	95
6.3	Balancing power for the electricity grid	99
6.4	Fuel flexibility	100

6.5	Versatility of technology linking energy sectors	101
6.6	Enabling technology options	103
6.7	Conclusions	104

7 Energy security impacts of introducing hydrogen to the UK energy system 106

7.1	Introduction	107
7.2	Description of the scenarios	108
7.3	Long-term changes in energy security across scenarios	111
7.4	Increasing future energy system resilience	118
7.5	Discussion	124
7.6	Conclusions	126

8 Policy implications 128

8.1	Introduction	129
8.2	UK energy regulators, system operators and suppliers	130
8.3	Rationales and drivers for energy security policy intervention	132
8.4	Maintaining the security of electricity supply	133
8.5	Maintaining the security of gas and oil supplies	136
8.6	Policy priorities	137
8.7	Global policy initiatives on hydrogen and fuel cells	147
8.8	Conclusions	150

9 Summary and conclusions 152

References	159
------------	-----

EXTENDED SUMMARY

The impacts of low-carbon technologies on energy security have received little attention in the literature, with the exception of renewables integration into the electricity system. This White Paper assesses the potential implications of deploying hydrogen and fuel cells on UK energy security. It first examines the technologies individually, then assesses potential impacts of these on the electricity, gas, and transport systems, and finally considers their energy security implications for the whole UK energy system.

The energy security challenge in a low carbon energy system

Energy security is one of the core dimensions of energy policy of governments worldwide, together with affordability and environmental sustainability. The UK government identifies energy security as a framework in which consumers have access to the energy services needed (physical security) at prices that are not excessively volatile (price security). Energy security is seen in terms of both securing supplies and securing the delivery of end products to UK consumers for heat, power, and transport.

In the last few decades, the UK has experienced a high level of energy security, with indigenous fossil fuel resources, a very stable electricity system and robust delivery systems. Energy crises have primarily had domestic causes (e.g. coal miner strikes in the 1980s and petrol tanker strikes in 2000). One challenge for the UK is related to the depletion of UK oil and gas reserves, and subsequent geopolitical risks of fossil fuel access. Hydrogen produced from renewable sources would offer greater energy resource independence for the UK and for other countries, with close-to-zero CO₂ emissions.

The UK dropped to 11th position in the World Energy Council's (WECs) Energy Trilemma Index in 2016. This index assesses a country's energy security, energy equity, and environmental sustainability simultaneously.¹ By another measure the UK's global energy security ranking has been lowered in the last few years, dropping to 6th place for the first time in 2014 in the International Index for Energy Security Risk assessment by the US Chamber of Commerce.² This change can be attributed to the rising uncertainty in the UK's energy policy, with significant challenges that need to be addressed, including:

- the closing of around a fifth of current power stations by 2020, as they come to the end of their working life or are deemed too polluting under regulations such as the EU Industrial Emissions Directive (IED);
- the need to decarbonise electricity generation to ensure that the UK can meet its legally-binding CO₂ emission reduction targets to cut greenhouse gas emissions by 80% in 2050, compared to 1990; and,
- the decline of reserves of fossil fuels in the UK Continental Shelf (UKCS), which makes the UK increasingly dependent on imports at a time of rising global demand, uncertainty in markets, and increased resource competition.

1 Wyman O. World Energy Trilemma Index. London, UK: World Energy Council; 2016.

2 Institute for 21st Century Energy. International Index of Energy Security Risk. U.S. Chamber of Commerce. Washington, D.C., USA; 2016.

The challenge for the Government is to maintain a secure energy system as the UK's fossil energy resources dwindle and as the energy system is transformed to reduce greenhouse gas emissions.

Definitions of energy security

There is no single accepted definition of energy security. A number of approaches have been proposed from economics, engineering, political science, system studies and natural science to assess energy security, but these tend to be one-off rather than holistic studies. Very little consideration has been given to analysing energy security in the context of future low-carbon energy systems.

One approach defines energy security in terms of the 'Four A's':

- **Availability:** ensures that energy supplies are available in sufficient amounts.
- **Affordability:** aims to have these resources available at competitive prices.
- **Accessibility:** focuses on ensuring all citizens have access to energy.
- **Acceptability:** minimising the negative impacts of energy, such as pollution and environmental damage.

For this White Paper, a modified version of this approach was preferred that better accounts for long-term viability. The approach presented in Figure S1 was adopted and applied to resources, energy supply and infrastructure in the UK energy system:

- **Availability:** access to primary energy resources.
- **Affordability:** the cost incurred by energy supply and infrastructure at a societal level.
- **Reliability:** resilience of the energy infrastructure.
- **Sustainability:** long-term environmental impact.

Figure S1 Framework for the assessment of low carbon energy security (LCOE is levelised cost of energy).³

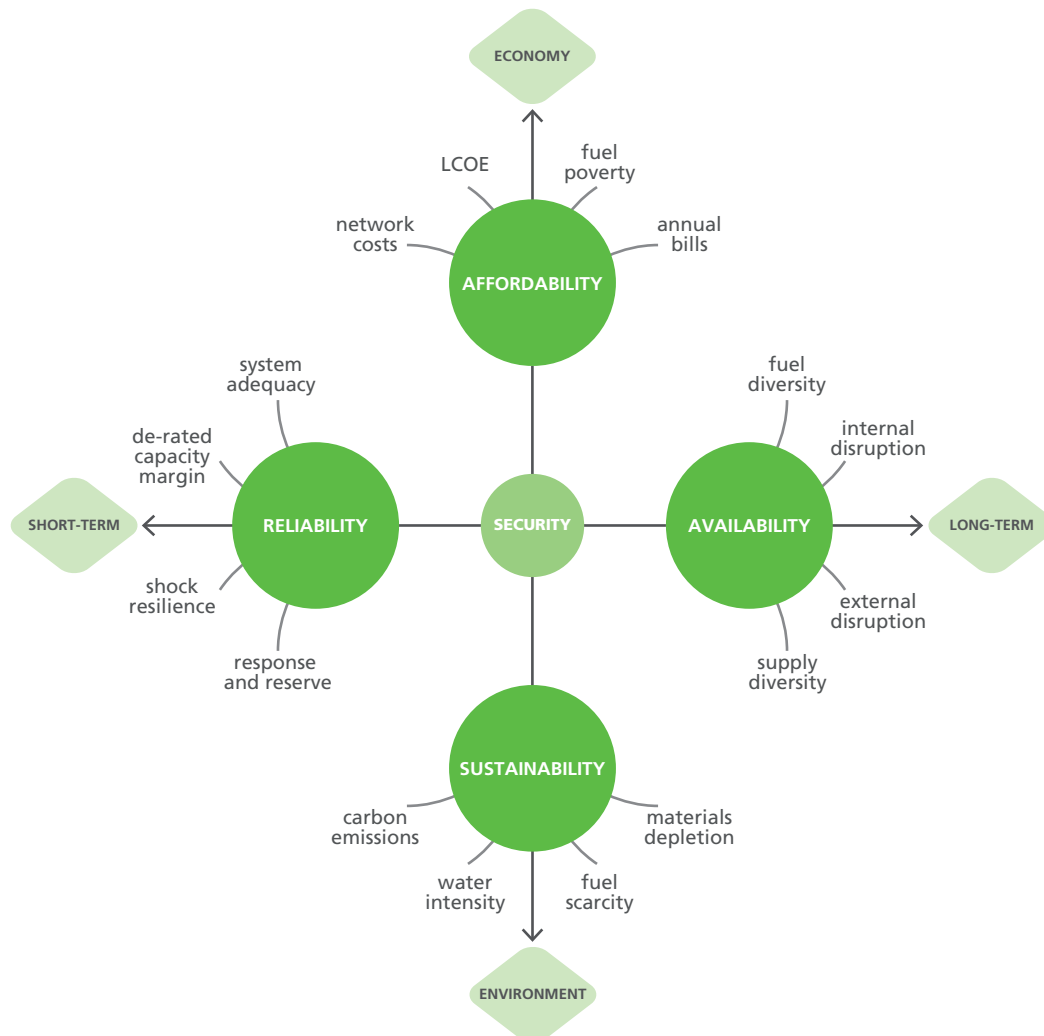

Hydrogen production from a range of feedstocks

Hydrogen is the only zero-carbon energy carrier (i.e. with no emissions at point-of-use) other than electricity that is under serious consideration in the UK. It can be used to power high-efficiency fuel cells, to provide energy storage at a range of scales, as a supplement or replacement for natural gas, and as a vehicle fuel. Whilst the advantages of using hydrogen for increasing and sustaining energy security are discussed in this White Paper, a broader discussion on its role in the energy system can be found in the H2FC Hub White Paper on Energy Systems.⁴

Hydrogen does not occur naturally and needs to be converted from chemical compounds – most commonly from water or from hydrocarbons such as methane (natural gas), requiring an energy input. Hydrogen is therefore described as an

³ Concept taken from: Cox E. Assessing the future security of the UK electricity system in a low-carbon context. BIEE 14th Academic Conference; 2014.

⁴ Staffell I, Dodds PE. The role of hydrogen and fuel cells in future energy systems. London, UK: H2FC SUPERGEN Hub; 2017.

energy vector or fuel that serves as input to energy conversion processes delivering electricity or heat.

Hydrogen can be produced using a range of processes, from a variety of feedstocks. Around 50 million tons of hydrogen are produced each year from natural gas, coal, oil, and to a lesser extent electricity, for industrial uses around the world. The choice of production technology currently depends primarily on the feedstock availability and overall cost.

Coal gasification plants have been in operation for the last two centuries, producing a syngas (town gas) mainly containing hydrogen and carbon monoxide, whilst methane reforming has been used to produce hydrogen from natural gas over the last century. These technologies are mature and the principal challenges going forward are to supply low-carbon hydrogen at an acceptably low cost. All of these technologies produce high CO₂ emissions, which depend on the carbon content of the feedstock. For steam–methane reforming (SMR) of natural gas, emissions are approximately 250 gCO₂/kWh H₂. These emissions could be avoided, although not completely, using carbon capture and storage (CCS).

The other principal way of producing hydrogen is by electrolysis, which uses electricity to split water molecules (Figure S2). This produces high-purity hydrogen with a zero to low-carbon footprint if renewable electricity is used. However, if the input electricity is generated in fossil fuel plants and has a high carbon intensity, then electrolysis may lead to a higher carbon footprint than unabated SMR. The key challenges for electrolysis are to reduce capital costs, supply low-carbon electricity, and improve the conversion efficiency.

Figure S2 Schematic illustration of a water electrolyser with an alkaline electrolyte.

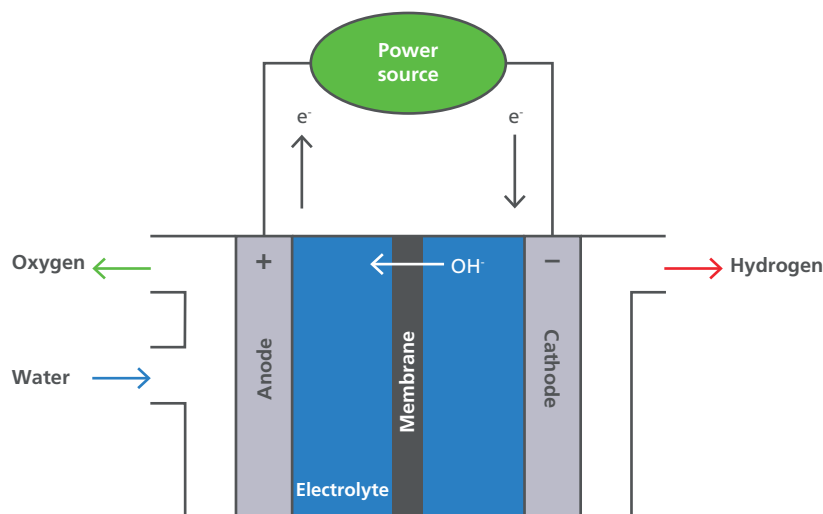

A number of novel hydrogen production methods are under development, such as bio-hydrogen from algae and photocatalytic hydrogen production from sunlight and water. They are still at the laboratory stage but could become important over the coming decades, if their development is sufficiently supported.

Hydrogen can be used to synthesise methane in order to produce synthetic natural gas (SNG), which can substitute for natural gas or be used to synthesise methanol. Hydrogen can also be used as a storage medium for electricity since it can be produced using electrolysis (power-to-gas), stored and then used to generate electricity in fuel cells or gas turbines.

Fuel cells

Fuel cells electrochemically combine a fuel, typically hydrogen, and oxygen (from air) to produce electricity, water and heat. They differ from batteries in that the reactants are continuously supplied, rather than being stored internally, and hence can operate continuously. Fuel cells do not have the same energy efficiency limits as thermal conversion processes and generally have high electrical efficiencies no matter how large or small the unit size, in contrast to thermal-based electricity generation that can only achieve similar efficiencies at large scales. The modular design of fuel cells alongside their ability to efficiently generate electricity without producing pollutants makes them suitable for a wide range of applications and markets.

Fuel cell types are distinguished by the input fuel, electrolyte material and operating temperature. Low-temperature fuel cells include polymer electrolyte fuel cells (PEFCs), using high-purity hydrogen as a fuel, and alkaline fuel cells (AFCs), with slightly lower-purity demands. Figure S3 shows the operating principle for a PEFC running on hydrogen. Intermediate and high-temperature PEFCs (IT- and HT-PEFC) and phosphoric acid fuel cells (PAFCs) operate in the 120°C to 200°C temperature range with fewer limitations on the quality of the hydrogen fuels. High-temperature fuel cells such as molten carbonate fuel cells (MCFCs), and solid oxide fuel cells (SOFCs) operate at higher temperatures between 600°C and 900°C and can use both hydrogen and hydrocarbons, including natural gas, as a fuel.

Figure S3 Schematic illustration of a polymer electrolyte fuel cell (PEFC) operated on hydrogen.

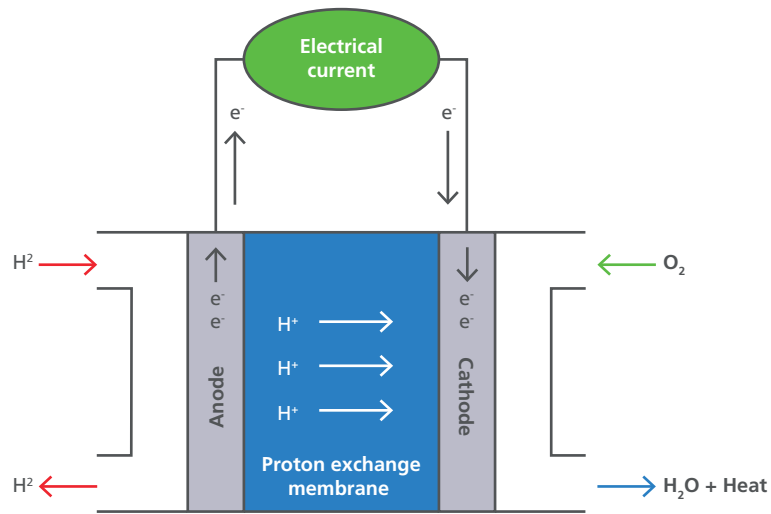

The high-purity hydrogen required by low-temperature fuel cells would typically be produced by electrolysis or with adequate purification from other hydrogen production processes. High-temperature fuel cells can produce electricity at higher efficiencies (55% to 65% net delivery to the grid) with less complex systems. Fuels for high-temperature fuel cells include hydrogen, syngas (hydrogen and carbon monoxide mix), methane, natural gas, biogas, propane, butane, methanol and ethanol. This means that they could underpin a transition from natural gas to a future low-carbon gas supply, for example based on hydrogen and synthetic natural gas.

Fuel cell emissions consist of only water, if run on hydrogen, and water and carbon dioxide, if run on fuels containing carbon. Virtually no air quality pollutants (e.g. SO_2 , NO_x , CO, particulate matter, etc.) are produced. They operate with very little noise and have little need for maintenance as they have few moving parts.

The applications of fuel cells span from a few watts to 100 MW_{el} , including portable electricity generators, small consumer devices, vehicles and stationary power generation. They can act as uninterruptible power supplies (UPS) in protecting data centres and other key infrastructure from grid failures, and supply power in locations far removed from grid access. Due to their modularity, fuel cells typically are employed in decentralised applications, offering electricity grid support, CHP installations and black start capability.

Access to energy sources

Hydrogen can be produced from a broad range of feedstocks. Short- to long-term commodity price hikes or supply interruptions could be mitigated by switching to other energy sources for hydrogen production, although this would require additional investments in production plants with low capacity factors. Hydrogen offers similar advantages to electricity in this regard. Since hydrogen can be produced by electrolysis from renewable generation and by biomass gasification, it offers the opportunity to reduce import dependence on fossil fuels.

Hydrogen could support a low-carbon electricity system in the future through the conversion of surplus renewable electricity by electrolysis. The resulting hydrogen could, for example, be sold into the transport fuels market, stored for times of peak electricity demand, or sold as a chemical process feedstock. Power-to-gas technology (Figure S4) is one of the key pathways that link the electricity and gas markets. Whilst storage of electricity at large scale remains a challenge, bulk gas storage of hydrogen in salt caverns has been carried out for many years, including on Teesside in the UK.

Gas transmission via pipeline and distribution networks offers a number of further advantages for bulk distribution such as linepack storage capacity of the gas transmission and distribution networks. Hydrogen can be used to produce synthetic natural gas (SNG) with waste CO₂ and injected into the existing gas infrastructure.

Figure S4 Schematic diagram showing the three main energy conversion pathways (power-to-gas, power-to-power and gas-to-gas) in a renewable energy integrated energy system.⁵

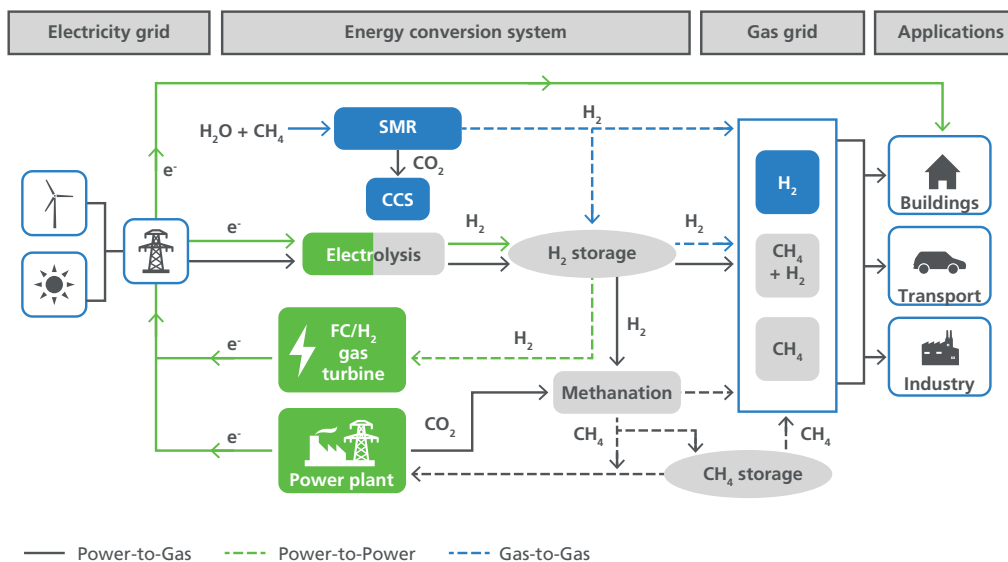

⁵ Brandon N., Kurban Z. Clean Energy and the Hydrogen Economy. Philosophical Transactions of the Royal Society. 2017.

Resilience of energy systems

Fuel cells are an inherently decentralised technology since units are rarely larger than a few MW_{el}. They can support electricity grid functions at a local level to:

- reduce electricity distribution losses;
- increase system reliability due to lower probability of total power disruption;
- allow black start capability and the option to ‘island’ those parts of a grid that are still intact following an outage;
- supply balancing power to stabilise electricity grids with high renewable electricity penetration; and,
- increase fuel economy, thus reducing operating costs and any impact of fuel price volatility.

Such a distributed system would be more robust, since the probability that the complete system could fail would be very low. Moreover, parts of the grid could be restarted without having to wait for major repairs, for instance following the loss of a large power station or major distribution line. The threat of any disasters or malevolent acts occurring in the energy infrastructure (ranging from weather events to sabotage and cyber-attacks) would be greatly reduced.

Combining the variety of fuels on which the different fuel cell types operate with the wide range of hydrogen production feedstocks would add an element of flexibility to the energy system that has hitherto not been available. Dependence on single primary energy sources such as coal, natural gas and oil would be greatly reduced. The gas infrastructure would take over part of the services of the electricity grid in balancing power distribution (power-to-gas-to-power). If fuel cell electric vehicles were widely adopted, then these could also generate electricity to supply buildings (for instance during emergencies or blackouts), as already demonstrated by the Toyota Mirai vehicles in Japan.

Affordability of energy services

Hydrogen is more expensive to produce than existing fossil fuels, but this would change in the future if a high-enough price on carbon were applied (Figure S5) and if the costs of externalities such as air pollution were internalised. Modelling using the UK TIMES energy system model shows that hydrogen could be produced economically from a range of feedstocks in the future. Markets could switch fuels and production processes in response to feedstock price volatility, if redundant hydrogen production plants were available, in a similar way to electricity at present. The capital investment required to build semi-redundant plants would increase the cost of the produced hydrogen, so there would be a trade-off between flexibility and cost.

One method to measure energy security is through fuel diversity, as more diverse systems are likely to be more resilient to an interruption to part of the system. The scenarios suggest that the energy system diversity as measured by the Shannon-Weiner Index is likely to change in the future, with increases in some areas and decreases in others. Hydrogen tends to increase diversity over strategies that focus on electrification, but not in all parts of the system or in all circumstances.

In all of the scenarios, natural gas SMR with CCS is primarily used to produce hydrogen, with energy commodity import dependence increasing over time. Yet an alternative strategy with a portfolio of diverse hydrogen production and electricity generation technologies could be followed at low additional cost, and is a potential long-term option for the UK government. Reducing reliance on energy commodity imports, on the other hand, would be much more expensive, and alternative strategies would likely be more cost-effective.

Figure S5. Levelised cost of hydrogen production forecasts for the UK from a range of sources, with a CO₂ price increasing from £50/tCO₂ in 2020 to £250/tCO₂ in 2050. No environmental levies are placed on electricity in this diagram.

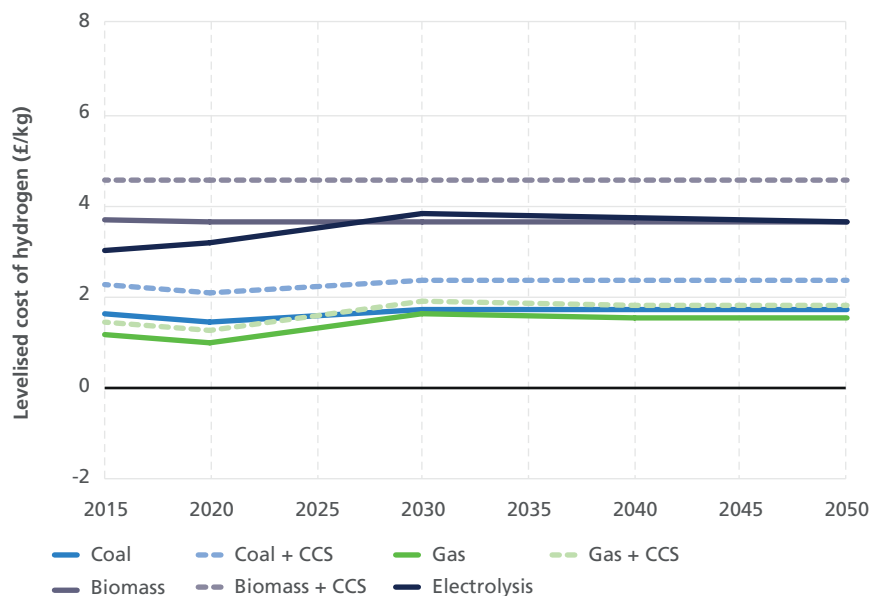

Details of data sources and calculation procedure can be found in the full text in Chapter 5.

Sustainability of the energy system

Although hydrogen can be produced from coal, oil, and natural gas, CCS facilities would be required to produce low-carbon hydrogen to meet UK emission targets. There are engineering, economic and environment challenges to using CCS that still need to be resolved.

Hydrogen and synthetic methane, produced from low-carbon sources and used in high efficiency fuel cells, offer an approach to a fully decarbonised energy system. The higher efficiency of fuel cells on a far broader scale of rated power, compared to heat engines and most thermal power stations, reduces energy consumption whilst at the same time improving air quality at the point of use. Only the largest new-builds in power generation can compete with fuel cell efficiency levels. When installing a micro-CHP based on fuel cells in a residential building, though, the fuel cell would compete with the conventional electricity generation average value, which is below 40%, including transport losses.

Using the electrochemical fuel cycle displayed in Figure S6 would allow the use of renewable energy inputs in the form of primary electricity (solar, wind, ocean etc.) and biomass/waste to drive a fully decarbonised conversion cycle of primary energy and zero-carbon fuels based on the existing natural gas infrastructure, and in future morphing into a decarbonised infrastructure using biogas, hydrogen and SNG. The issue of overall efficiency has to be addressed appropriately, though, especially if any non-renewable energy is involved. The economic viability of such a system would also need to be demonstrated. The result would be a fully sustainable system with a high degree of national independence from fuel imports, and with low price volatility.

Figure S6 Production of synthetic natural gas (SNG) via biomass conversion in gasification or anaerobic digestion, and from power-to-gas with subsequent methanation. SOFC is a solid oxide fuel cell. SOE is solid oxide electrolysis. AD is anaerobic digestion. NG is natural gas. PSA is gas purification by pressure swing adsorption.

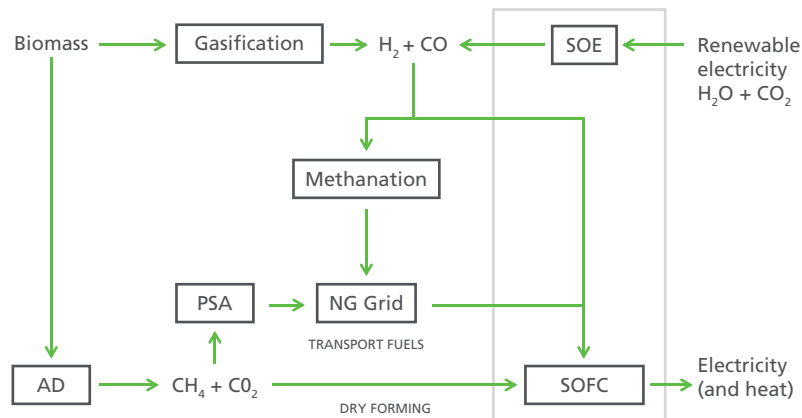

Policy implications

UK's Energy Security Strategy

The Government's approach to energy security was outlined in the Energy Security Strategy (ESS) document, published by DECC in 2012. BEIS and Ofgem review this strategy annually and publish updates in the Statutory Security of Supply Report (SSSR), which provides the Government's plans for energy security with a four-year outlook.

The UK Government's primary energy security concern is 'ensuring that consumers have access to the energy services they need (physical security) at prices that avoid excessive volatility (price security)'. The focus on consumers means that the approach to energy security is concerned with the whole energy system, from primary resources to distribution networks. The definition of price security focuses on excessive volatility. It currently does not take any account of long-term affordability, either in terms of resource price trends or the impact of transitioning to a low-carbon economy.

The ESS has a strong focus on the electricity system, with recognition that closing down older coal and nuclear power stations and deploying renewables will create capacity and balancing challenges, requiring investment in infrastructure and the development of new infrastructure technologies such as storage and interconnection. However, beyond these recommendations on specific areas of investment, it does not provide a comprehensive, long-term strategy on how to ensure these challenges will be met or when they will be met. Since de-rated supply margins reduced to around 1% without balancing services, the Electricity Market Reform (EMR) policy framework has been created that establishes new markets, some of which might provide opportunities for fuel cells in the future. Hydrogen could also contribute by supplying low-carbon peak power generation in turbines or gas engines.

Maintaining security of the gas supply, which currently has significantly higher supply margins than the electricity system (24% in 2016 supply capacity) appears less of a challenge today. The reduction in domestic production will lead to increasing reliance on imports, including from Norway and the Netherlands, but also from further afield in the form of liquefied natural gas (LNG) imports. The Government aims to strengthen the UK's bilateral trading links and promote liberalisation of EU gas markets to help secure imports in the future. Yet there is much uncertainty in the international gas price, with evolving demands and supply (e.g. shale gas exports from the USA), while Brexit might affect the availability of gas from the EU during any regional disruption.

The UK has an imbalance of petroleum products, with a surplus of petrol but a deficit of diesel and aviation fuel, which is imported from Europe and the Middle East. In the longer term, the UK will become increasingly reliant on oil imports and the case for increasing strategic oil reserves might need to be revisited. Hydrogen as a transport fuel will help to increase such reserves.

Realising the benefits of hydrogen and fuel cell for energy security

A more holistic and long-term approach to energy security could underpin the development of a more flexible, low-carbon energy system. Scenario modelling shows that resource diversity would likely increase if hydrogen were adopted, compared to a no-hydrogen scenario, but could be increased much more through forward planning and small further investments. Production and infrastructure investments have long lifetimes and an energy security policy that considers only the short to medium-term is not likely to lead to investments that maximise energy security in the long term.

Supporting the electricity system with hydrogen and fuel cells, through power-to-gas and peak generation, and using hydrogen for both heating and transport, will lead to closer interactions between the power, gas and transport sectors in the future. A strategy would ideally consider these interactions and take a more holistic view of these markets and of the energy system as a whole. It would identify acceptable levels of energy security across the system and how they could be achieved.

Indications by the Government of future policies in hydrogen and fuel cells are needed to support the long-term perspective of the transition to a low-carbon economy. Incentives and regulation are needed to for instance support and define a market framework for electrolysers to provide system services improving the reliability and operation of the electricity network. This includes understanding load fluctuation levelling and avoiding or deferring grid reinforcement as business cases in the larger societal interest. Hydrogen produced from renewable sources has a carbon benefit, but cannot compete with fossil and nuclear fuel in the absence of taxes or levies that acknowledge its benefits in avoiding environmental and health impacts.

Final summary

Adopting hydrogen and fuel cell technologies could make an important contribution to improving energy security in a number of ways:

- **Diversity and affordability:** hydrogen can be produced economically from a diverse range of feedstocks, potentially reducing price volatility.
- **Diversity of resources:** hydrogen increases resource diversity over strategies that focus on electrification.
- **Reliability:** hydrogen can help to integrate high levels of renewables into the electricity system.
- **Resilience:** fuel cells run on a diverse set of fuels and could enhance resilience and reliability of networks by supporting distributed power generation, with reduced vulnerability to disturbances.
- **Resilience:** hydrogen offers low-cost, zero-carbon energy storage.
- **Sustainability:** fuel cells and hydrogen can improve air quality through very low pollutant emissions and no CO₂ emissions at point of use.

A revised energy security framework with a more long-term view could underpin improvements in UK energy security through targeted future infrastructure investments in low-carbon technologies. A clear and reliable policy framework will enable the Government, industry, and academia to work together to determine how best to ensure the country's energy security during the transition to a low-carbon energy system.

CHAPTER 1

INTRODUCTION

**Robert Steinberger-Wilckens – University
of Birmingham/Birmingham Energy Institute**

Paul E. Dodds – University College London

1.1 AIMS OF THE STUDY

This White Paper explores the role of hydrogen and fuel cells (H2FC) technologies in contributing to UK energy security in the future, in terms of access to energy resources, energy system resilience, and affordability (cf. Chapter 2 for definitions). It examines the implications when deploying H2FC technologies across the energy system, including applications for transport, heat and electricity generation.

Hydrogen has been discussed for several decades as one potential fuel for de-carbonising the energy system [3]. The key phrase of the ‘Hydrogen Economy’ [4] has triggered the vision of an energy supply system that will not emit any pollutants but only release water to the atmosphere.

Nevertheless, it should be made clear from the start that hydrogen is not an energy source, but an energy carrier, and requires some other form of primary energy for its production. To its advantage, hydrogen can be produced from a very diverse spectrum of feedstocks and pathways, ranging from solid, liquid and gaseous fossil fuels, to nuclear and renewable electricity (cf. Chapter 3). This introduces a high degree of versatility to the energy supply system, and any energy system centred on hydrogen will be more resilient than one centred on any other fuel.

The contribution to energy resource security is thus determined by the source and diversity of the feedstocks that are used to produce the hydrogen. The UK is a net importer of oil, gas, coal, and nuclear fuels, and each of these have different geopolitical resource characteristics and market structures. While consumers relying on one of these fuels are exposed to respective price fluctuations, having a broad portfolio of hydrogen production technologies might insulate hydrogen users from feedstock price fluctuations since a broad range of fossil and renewable energy sources can alternatively be used to support hydrogen production.

One of hydrogen’s main potentials is as a transport fuel alternative to oil, which has volatile pricing often influenced by global geopolitics. Reducing oil dependence is likely to improve energy security if it reduces the need for imports. However, using hydrogen to fuel vehicles might require an expansion of feedstock supply, eventually putting pressure on the natural gas or renewable electricity markets. The US Energy Policy Act of 1992 [5], for instance, aims at reducing 30% of fossil fuel consumption from Federal vehicles. The extent to which fossil sourced hydrogen might impact on the natural gas market is not yet well understood.

The second most significant way in which hydrogen could have an impact on energy security is most likely through relieving strain on infrastructure, playing a role in grid balancing, and in energy storage. It has been suggested that a portion of renewables could be allocated solely to hydrogen production, assisting the electricity infrastructure by transmitting large amounts of renewable energy from centres of high production to centres of high demand in the form of gas. The gas grid (including hydrogen gas transport) would thereby take over some of the functions of the electricity transmission system.

At the point of use, hydrogen can be considered as ‘zero carbon’ since any use will only result in the emission of water (vapour). In a full life cycle analysis, though, the fossil energy inputs to hydrogen production have to be considered. Currently, fossil fuels are used to manufacture equipment needed for hydrogen production, and as inputs to transportation and handling. Therefore, even if the primary energy input were 100% renewable, a non-zero carbon footprint would result. For the time being this will not change, which is why we label all hydrogen use as ‘low carbon’ in this paper. The technical aspects of the implementation of hydrogen production on energy security will be further explored in Chapter 3.

Fuel cells are highly efficient converters of fuels to electricity and heat. Many types will rely on hydrogen as the fuel, but the highest efficiency is reached on methane fuels. High temperature fuel cells can achieve an unprecedented electrical (net) efficiency of over 60% and have the potential of revolutionising the electricity supply system. This is especially true since these high efficiencies are not only reached for large units, as with conventional electricity conversion, but at virtually at any scale from 1 kW_{el} to multi-MW_{el} ratings. The technical aspects of the implementation of fuel cell technology on energy security will be explained in more detail in Chapter 4.

A system of distributed generation, including both decentralised electricity generation (DG) as well as combined heat and power (CHP) plants, could increase the resilience of the energy supply system since any incidents in the system will generally affect only a limited number of units. In contrast, the unexpected shutdown of a large power generating unit can cause instability that affects the electricity supply to large areas of the country.

Fuel cells being able to convert a broad selection of fuels ranging from hydrogen and methane, to syn-gases,⁶ natural gas, propane, butane, and even liquid fuels such as methanol and ethanol, adds an element of diversity to the energy system.

In Chapters 4 to 7 this study explores the contribution that H2FC offer to ensure the long term sustainability of the UK energy system, its stability and resilience. It illustrates the role of fuel cells and hydrogen in:

- increasing the UK independence from fossil and imported energy sources,
- increasing the resilience of UK energy supply by reducing the risks from damage to the infrastructure (by natural incidents as well as malevolent interference),
- increasing the stability of the UK economy by greatly reducing the risk induced by volatile energy import prices, and
- increasing the economic stability by reducing energy price risks over the long-term.

⁶ Mixtures of hydrogen and carbon monoxide, similar to town gas

1.2 ENERGY SECURITY

From the academic literature, it is clear that there is no singular definition of what energy security is. Rather it is apparent that Energy security must be placed in to a context where the relevant actors are clearly defined.

Chapter 2 expands on this in more depth.

Three basic questions must be answered when considering energy security [6]:

1. Energy security for whom?
2. Security for which values?
3. Security from what threats?

These factors are often considered within the so-called “4A’s” framework of energy security [7]:

1. Availability (i.e. presence of fuel),
2. Accessibility (i.e. geopolitical consideration),
3. Affordability (i.e. economic aspects), and
4. Acceptability (i.e. environmental/societal elements).

Furthermore, it is important to consider the four properties of energy security that take into account different timescales and potencies of energy security threats:

1. Stability of the energy system
2. Durability of the energy system
3. Resilience of the energy system
4. Robustness of the energy system

In this framework, stability refers to the ability of the system to see out short and low intensity shocks and durability refers to the capacity for an energy system to cope with a persistent, dull stress. A resilient energy system can endure a brief but severe disruption and a robust system is one which is equipped to handle a serious stress over a long timescale.

Within the context of this study, we are considering energy security with regards to the UK energy system. In the context of the definition previously established, the goal is therefore to evaluate and comment on the availability, accessibility, affordability and acceptability of energy with regards to end users in the UK. These end users include the UK’s population in their domestic environment, commercial and industrial organisations and the public sector. This will require that access to energy services is available (physical security) whilst avoiding excessive price volatility (price security). We also note that this should include affordability, such that the prices are not prohibitive to the energy customers. The procured energy supply must be easily accessible to the end user. In Chapter 6 we will further discuss the relationship between customer (end-user) prices and overall societal cost.

UK energy security goals must align with sustainability and decarbonisation targets, which will affect the long-term stability and durability of the energy system, due to issues like intermittency of energy supply [8]. Therefore energy security supplied by hydrogen and fuel cell technologies must work with other policy aims to contribute to:

1. Deliver resilience measures over the short (year length scale), medium (up to 2020) and long terms (up to 2050). This will also lower the risk of disruption ranging from flooding to industrial action and to reduce the impact that these can have at any time.
2. Provide energy efficiency to lower UK exposure to domestic and international energy market risks.
3. Deploy reliable energy and gas networks. This will include replacing and upgrading infrastructure to deal with increasing amounts of renewable energy, along with decentralised supply.
4. Work internationally with partners to help establish hydrogen as part of the global commodity trade in the future.
5. Decarbonise UK energy services to meet climate change mitigation commitments and reduce UK dependence on international fossil fuel markets.

1.3 MAKING THE CASE: UK ENERGY SUPPLY TODAY

1.3.1 Primary fuel consumption in the current UK energy system

In 2013, the UK energy production was down 6.3% from 2012. Imports were at a record high level with exports at their lowest since 1980. The UK imports almost half of its primary energy, with fossil fuels remaining the dominant source of supply (86%); 62.9% for natural gas, 81% for coal, and 100% for nuclear fuel (the three main fuels for electricity generation); and 91% for oil (the main transport fuel) [9].

These imports costs £63bn annually and make the UK oil supply susceptible to political developments in countries such as Russia, the Middle East and Asia [9]. The large part of oil and gas imports from Norway will gradually dry up over the next decade. Market price volatility for natural gas, coal, and oil of $\pm 55\%$, $\pm 40\%$, and $\pm 80\%$, respectively, have been recorded over the last two decades.

Over the last four decades, the primary energy supply has converged on specific fuels for the different energy sectors: coal and gas for electricity production, oil products for transport, and natural gas for heating purposes. Today, shifts can be noticed: natural gas is replacing coal in power generation and beginning to diffuse into the transport fuel market. Natural gas emits 30% less CO₂ than coal and oil and could act as a 'bridge' to a low-carbon economy as a replacement for higher-polluting solid and liquid fuels in the medium term. In the long term, however, high natural gas consumption would jeopardise climate commitments and engender higher gas prices. Hydrogen, on the other hand, has the potential to supplement natural gas supplies by being mixed into the natural gas grid or for instance by synthetic natural gas production (SNG) via power-to-gas technologies.

Efforts are being made to derive more energy from renewable energy sources, since most of these are low carbon, and abundant. Renewable energies contributed 20% to total electricity generation in 2014, but only 5% of total primary energy demand due to the lower contributions to heat and transport fuels. Due to the renewable fuel obligation in the European Renewable Energy Directive of 2008/9 [10] the share of renewables in the fuel markets are slowly but steadily growing.

1.4 PRESSURES ON UK ENERGY SYSTEM

Grid reliability has decreased from an average annual outage of 6 minutes/year (2012–2013) to 15 minutes/year (2013–2014), 60 minutes/year (2014–2015) with 3–5 hours/year in 2015–2016. The supply margin of electricity dropped from 8% to 2% in 2015 [9]. Developments in other countries, like Belgium, show that once the large, centralised power stations have to be taken off the grid for maintenance and repair, electricity supply may become fragile and rationing of electricity may become reality in a not-so-distant future.

In the past the UK has already experienced major threats to energy security:

- the two oil crises in the 1970ies (external),
- the coal and miners' crisis in the 1980ies (internal), and
- the shortage of petroleum products in 2000 (internal).

Future developments will be influenced by growing shortages of readily available energy reserves and increasing import dependencies. At the same time renewable energy sources are rapidly developing across Europe [11], as well as in the UK [12]. A sustainable energy supply across all application areas (electricity generation, heating, transport) has been at the centre of European policies in the past 20 years. Besides the main driver of climate change abatement, other aspects also play a decisive role, although they are not so broadly discussed:

- renewable energies are to a high extent indigenous, allowing investments to remain within the national economy,
- the reduction of energy import dependency reduces the scope for political dependencies, and
- the decentralisation of energy supply improves the resilience and the reliability of the energy supply system.

Renewables have been making an increasing impact on the UK's energy system [13] with fears of grid outages fuelled by Australian experiences from 2016/2017 [14]. The advent of new technologies such as fuel cells, electrolysers, and hydrogen bring a new quality to the energy markets since they form a bridge across the different energy markets: electricity, gases, and transport fuels, with the potential to intimately link them. This allows for surplus (renewable) electrical energy to be moved from the electricity to the gas grid. On the other hand it opens up new opportunities to decouple the UK energy system from international developments in energy markets and the policies of fossil primary energy sources. The UK energy system has some potential for energy storage with electricity storage in pumped hydro around 30 GWh,

and natural gas system with around 21 TWh in gas storage [15]. This is an interesting insight into the importance of the gas infrastructure as energy storage and emphasises the potential role of power-to-gas technologies introducing hydrogen as a medium for electricity storage.

With future changes likely to put even more pressure on the energy systems worldwide than we see today, new technologies are required to balance, control, and store renewable energies. More integration of all elements into the energy systems is necessary, including smart grid developments for flexible control of electricity and gas infrastructure and rapid provision of operational data. Fuel cell and hydrogen technologies can offer key capabilities to the new systems with a new quality of flexibility and versatility.

One of these future changes will be the impact of Brexit on limiting the energy options for the UK. This cannot be reliably assessed at this time due to the lack of information on future procedures. We have therefore refrained from taking any such influences into account.

H2FC technologies can contribute to reduce the dependence of the UK from energy imports and centralised, gigawatt-scale electricity production; yielding substantial benefits in terms of securing economic growth, reducing geopolitical risks to energy supply dependency, eliminating disruption risks inherent to centralised infrastructure, and securing a safe, affordable and reliable energy supply to the private and industrial end users.

Hydrogen and fuel cells alone do not offer the 'silver bullet' solution to these challenges [16]. Still, they will play a key role in addressing the issues discussed above and offer unique qualities of services in ensuring a stable and secure energy delivery. The purpose of this White Paper is to explore the potential extent, and nature of that role. Some of the statements made in the following will apply to other forms of zero and low carbon energy as well. Nevertheless, in the context of this analysis the statements hold true for hydrogen and fuel cells and will be presented without pointing out the general validity for low carbon technologies in all cases.

CHAPTER 2

DEFINITIONS

OF ENERGY

SECURITY

Owain Jones and Paul E. Dodds –
University College London

2.1 INTRODUCTION

Energy security has often been viewed by governments from engineering and geopolitical perspectives. The engineering perspective is concerned with the safe and reliable operation of energy technologies, and is achieved primarily through regulation. While this has mostly focused on individual plants, such as nuclear power stations, there is now a move to considering the stability of the wider electricity system in countries such as the UK, Germany and Australia, due to the increased penetration of low-carbon intermittent renewable generation. The geopolitical perspective has historically been mostly concerned with security of resource supply, with the aims of ensuring that the UK had access to a steady supply of fossil fuels at a stable price, and to some extent promoting energy independence and the development of domestic fossil fuel reserves [17, 18].

More recent academic research has attempted to widen the scope of energy security to focus on the entire energy system, from primary energy resource acquisition to final energy consumption, and has proposed that energy security is not just about ensuring a reliable supply of fuel, but also ensuring that there is reliable infrastructure in place to carry energy to the end user [8, 19–22]. The affordability of energy to all users has become a part of some definitions of energy security, along with ensuring that energy use does not have an overly detrimental impact on the environment. Security, affordability and environmental sustainability have become known as the energy trilemma, and are the overarching aims of the UK Government. This chapter examines a range of energy security definitions from the literature. These concentrate primarily on the geopolitical aspects of energy security, although they are in some cases also applicable to the engineering aspects.

There is no accepted quantitative measurement of energy security, but a range of indicators have been proposed to measure various aspects. These examine, for example, the diversity of energy supplies, import dependence, and more recently infrastructure reliability, load factors and price levels, along with many others [8, 20, 22–25].

This chapter examines the academic debate surrounding energy security. Section 2 reviews some of the definitions of energy security in the literature. Section 3 considers how hydrogen might affect UK energy security. Section 4 identifies indicators that could be used to measure aspects of energy security. Section 5 explains the definition of energy security used in this White Paper, and the relevant indicators that are used in subsequent chapters.

2.2 DEFINITIONS OF ENERGY SECURITY

Many definitions have been proposed for energy security. Much of the academic literature in this area proposes frameworks for describing energy security, and general policies to improve energy security, rather than trying to measure energy security. Where energy security analyses have been performed, a wide range of methods from economics, engineering, political science, system studies and

natural science have been adopted [26], and these tend to be one-off rather than holistic studies. Very little consideration has been given to energy security in future low-carbon energy systems.

2.2.1 Early definitions

No concrete definition of energy security has emerged from the literature, but definitions have evolved over time. Several papers trace the origins of interest in energy security back to the oil shocks of the 1970s [17, 18, 20], and cite this as a reason for much of the energy security debate being focused on security of supply, and specifically the security of the oil supply (and more recently, gas).

Some argue that liberalisation of UK energy markets, which resulted in reduced prices and greater availability, increased energy security during the 1980s and 1990s, with energy security becoming less of a concern until increasing price volatility in the early 2000s brought it back into focus [20].

Nevertheless, geopolitical energy security at government level is still primarily concerned with the supply of fossil fuels, with a typical definition in OECD countries being summarised as ‘the availability of sufficient supplies at affordable prices’ [17].

2.2.2 Widening the definition of energy security

The definition of energy security has expanded beyond the initial focus on security of supply to include a wider range of factors, often referred to as the “four As” of energy security – availability, affordability, accessibility and acceptability (Box 2.1) [19, 20, 27]. These tend to be applied to security of supply. Cox [22], in a study focused on current and future electricity systems, argues for similar framework consisting of availability, affordability, reliability and sustainability. Reliability is defined as the ability to cope with short-term shocks. Sovacool and Mukherjee [28] identify five dimensions: availability, affordability, technology development, sustainability and regulation.

BOX 2.1 THE “FOUR AS” OF ENERGY SECURITY

Availability ensures that energy supplies are available in sufficient amounts.

Affordability aims to have these resources available at sufficiently-low prices.

Accessibility focuses on ensuring all citizens have access to energy, which is to some extent about ensuring that reliable infrastructure is in place to ensure a robust supply for the end user, but this is generally interpreted in practice as ensuring that energy prices are kept low and fuel poverty is minimised.

Acceptability is concerned with the negative impacts of energy, such as pollution and environmental damage, and ensuring that these impacts are minimised in order to make the energy acceptable to the customer.

While the “four As” approach has made progress in expanding the focus of energy security, a criticism is that they only define certain aspects of energy security, rather than providing a robust and comprehensive definition of what energy security actually is. These definitions are difficult to interpret in a practical, holistic and quantitative manner, in order to measure energy security.

2.2.3 A vulnerability-based approach to energy security

Cherp and Jewell [19] believe that it is necessary to answer three key questions to identify vital energy systems: (i) ‘security for whom?’; (ii) ‘security for which values?’; and, (iii) ‘security from what threats?’. They argue that energy security is underpinned by vital energy systems having low vulnerability, with the identities of vital systems defined by answering the three questions. Vulnerability is defined as a combination of exposure to risk and resilience of the system. Jewell et al. [24] explore this approach by identifying vital energy systems and their vulnerabilities.

Mitchell et al. [20] define energy security as a property of energy systems, which are vulnerable to a range of risks that shift with time and location, requiring a range of strategies for the resilience of the energy system as a whole. They identify four key aspects: stability (the ability to cope with internal shocks, e.g. infrastructure failure), resilience (the ability to deal with external shocks, e.g. supply disruptions), durability (the ability to cope with long term internal stresses, e.g. increased demand) and robustness (the ability to cope with long term external stresses, e.g. resource depletion).

In contrast to those that provide a wide ranging and comprehensive concept of energy security, Winzer [29] suggests narrowing the definition to the concept of energy supply continuity, concerned with risks to the continuity of supply. The risks are classified as technical (e.g. failures in infrastructure), human (e.g. demand fluctuations, withholding supplies or underinvestment), and nature (e.g. intermittent renewables, resource depletion or natural disasters).

One reason for the diversity of definitions is that stakeholders have different perspectives on energy security. It has different meanings in different markets; for example, energy security means different things for the gas market than it does for the electricity market, and more generally means different things to producers, consumers, countries, companies, policymakers and other stakeholders [18]. The government approach to national energy security depends to some extent on these perspectives; for example, if a reliable electricity supply is the norm, then an increase in interruptions is likely to have far more serious political repercussions than if a reliable supply is not normally available.

2.2.4 Timescales

The vulnerability-based approaches highlight that different aspects of energy security occur on different timescales. For example, stability and resilience are focused on short-term shocks, while durable and robust systems are those that cope well with longer-term changes to aspects of the energy system [30]. Winzer [29] argues that most studies focus on short-term shocks and that there is a need for examination

of long-term discontinuities. If a risk-based approach is taken to energy security, then the temporal dimension should be considered as risks differ across short, medium and long-term horizons [18].

Cox [22] asserts that there is too much focus on improving current energy security, with little thought of energy security in the future, and that the literature differentiates too much between short- and long-term aspects of energy security. It is argued that a more comprehensive approach is needed to assessing all aspects of energy security, both now and in the future, and presents the framework shown in Figure 2.1.

2.2.5 An emerging focus on the electricity system

Although the supply of fossil fuels has been the principal focus of governments historically, security of supply from the electricity system is attracting increasing attention. One reason is that capacity margins to meet peak demands have been steadily eroded in many countries since liberalisation in the 1990s, due to the creation of markets focused on short-run costs, and the margin in the UK for peak winter demand is now very tight. This has led to the recent creation of an electricity generation capacity market in the UK. Another reason is the increased penetration of inflexible generation such as renewables, as the electricity supply is decarbonised, which could increase the risk of supply interruptions and require a fundamental change to the electricity system [18].

In the future, some scenarios have suggested an increasingly-important role for low-carbon electricity as a replacement for natural gas in heating and oil in transport [31]. Electricity supply is increasingly becoming the subject of energy security studies. Chester [18] argues for a greater focus on electricity, as it is now the ‘world’s most dominant form of energy supply to the economy’. Some believe that long-term energy security threats are mostly related to a lack of generation capacity in the system, and identify a trade-off between increasing security and increasing cost [20]. Others have argued that energy policy should focus on supporting system flexibility, for example through network reinforcement, demand-side response and storage, rather than providing additional capacity [22].

A general theme of these studies is the wider focus on infrastructure and systems, compared to previous studies, with Yergin [17] arguing that the concept of energy security should be updated to include the protection of the entire energy supply chain and infrastructure.

2.2.6 UK Government perspective on energy security

The UK Government’s Energy Security Strategy (ESS) [8] states that the ‘Government is primarily concerned with ensuring customers have access to the services they need (physical security) at prices that avoid excessive volatility (price security)’. In stating that customers must have access to energy services, the strategy implies that physical security applies to the whole energy system, from primary resources right through to distribution networks. However, the definition of price security is less comprehensive, with the focus on excessive volatility and no consideration of long-term affordability. The ESS recognises the need to deliver energy security in conjunction

with reductions in greenhouse gas emissions, and that growth of renewable energy can improve energy security by reducing reliance on energy imports. It acknowledges that energy infrastructure should be resilient to increasingly-volatile weather that might result from climate change. The ESS recognises that major changes to energy systems are coming, and recognises that there will be capacity and balancing challenges, requiring investment in infrastructure, and the development of new infrastructure technologies such as storage and interconnection. However, beyond these recommendations on specific areas of investment, it does not provide a comprehensive strategy for how to ensure these challenges are met or when these they will have been met.

The Government's Energy Sector Indicators report [32] states that their approach towards energy security is concerned with the level of energy demand, diversity of fuel supplies, energy prices, fuel stock levels and spare capacity. This heavy focus on resources is somewhat limited compared to the more comprehensive definition proposed in the ESS. A parliamentary report on energy security [25] similarly states that energy security targets include maximising domestic fuel reserves, reducing demand and diversifying imports, but also discusses infrastructure challenges and also threats from low investment, weather disruptions and market inefficiencies.

While there is an appetite for a comprehensive energy security policy for the UK, and an acknowledgement of the principal systems that should be analysed, there is not a holistic plan that considers the energy system as a whole and states what acceptable levels of energy security should be across the system and how they can be achieved.

2.2.7 Actions to improve energy security

A number of policies have been proposed to improve energy security. Energy security is not a policy but a set of policy measures that are implemented by governments to achieve their energy security objectives, however they define these [18].

Many of these policies are focused on energy resource availability, and include diversification of supply [17], which is achieved through not relying on a limited number of energy sources and not being tied to a specific geographic region for energy sources, for countries without abundant local energy resources [18].

More generally, building a resilient system that can withstand external shocks through managing risk is a key priority [17, 18]. Infrastructure investment has a key role in a resilient system [20], and there needs to be a continual flow of investment and technology in order for new resources to be developed [17]. Yergin [17] argues that governments should recognise the reality of integration and the importance of information.

It is difficult to assess changes in energy security without using quantitative analyses. For an electricity system, this might for example include high-resolution modelling of electricity dispatch for a range of scenarios. More widely, a wide range of energy security indicators have been developed to measure different aspects national energy

security. For example, Jewell et al. [24] identify vital energy systems, including those that may emerge in future, along with identifying their vulnerabilities, and develop indicators to measure these vulnerabilities.

Figure 2.1 Framework for the assessment of low carbon energy security, source: [22].

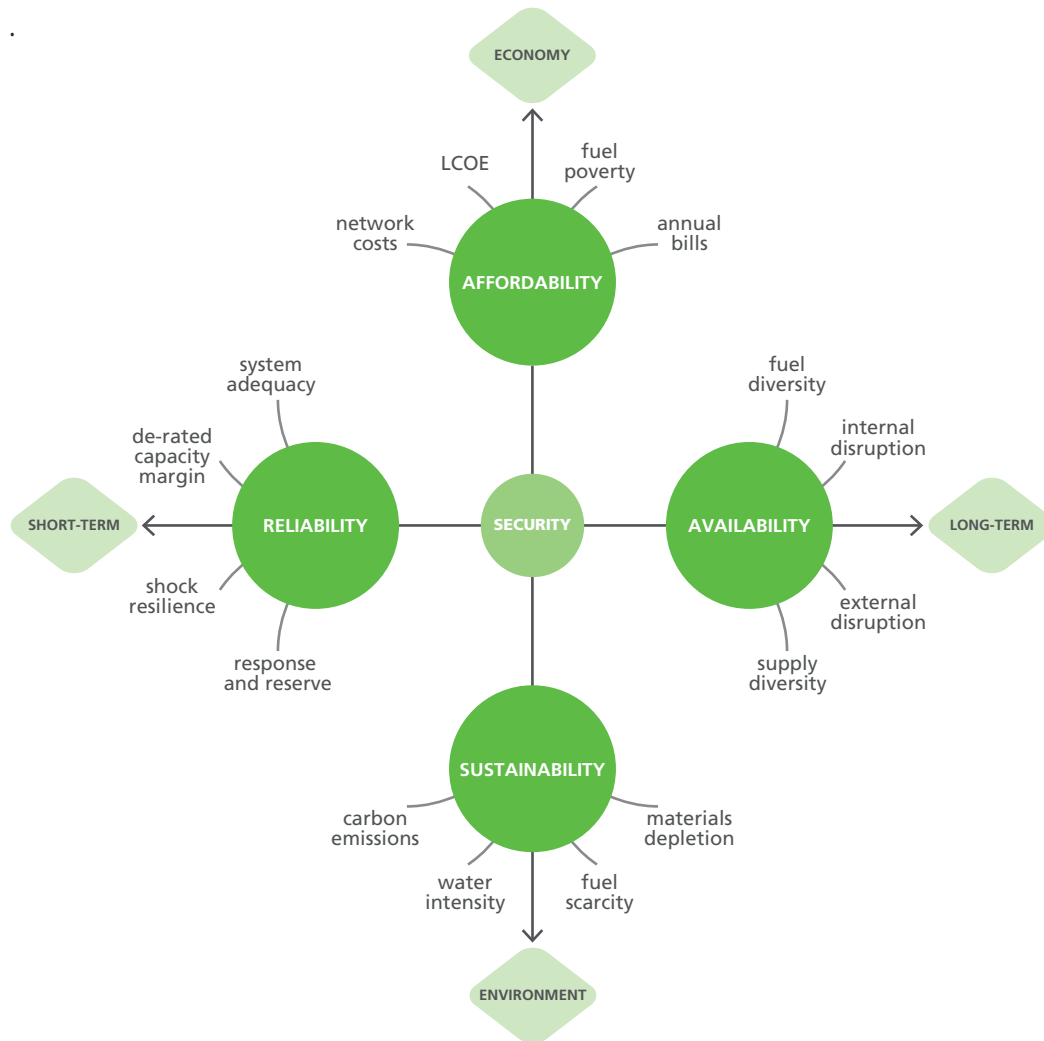

2.3 INDICATORS OF ENERGY SECURITY

Indicators are used to quantitatively measure aspects of energy security, and enable us to compare countries or systems and to explore changes in energy security over time. The choice of indicators depends to some extent on the energy security policies of a country and the definition of energy security that is being used [20].

2.3.1 Energy security indicators used by the UK Government

The UK Government, in their Energy Security Strategy [8], set out a list of indicators used to measure energy security:

- Electricity, gas and oil capacity.
- Electricity, gas and oil diversity.
- Electricity, gas and oil reliability.
- Short-term capacity margins.
- Forecast prices.
- Spare OPEC production of oil.
- Demand-side response.

These indicators are primarily concerned with security of supply and affordability, but consider both energy resources and the electricity system.

In addition to these energy security indicators, the UK Government produces a much wider range of energy system indicators [32], covering all parts of the energy system from fuel supply to infrastructure and price data. Some of them could contribute to a more comprehensive energy security strategy for the UK. More generally, the wide range of data collected in the annual Digest of UK Energy Statistics (DUKES) [33] could be used to create new indicators.

2.3.2 Complex indices

A widely-used energy security indicator quantifies the diversity of energy supply using the Shannon-Wiener diversity index [34], in which the diversity index, H , is defined as:

$$H = \sum_i p_i \ln p_i$$

where p_i is the share of final energy generated by primary energy source i . H is always a real positive number, in the range 0–2, with higher values indicating greater diversity. Some example calculations for the UK are shown in Box 2.2.

The Shannon-Weiner index has been used to measure import dependence [24, 25, 35], although some studies do not consider import dependence as an energy security issue if imports are obtained from a diverse range of suppliers [18, 20, 36, 37] (in fact, increasing imports could arguably improve energy security by increasing the diversity of the energy system). Neumann [38] proposes a modified Shannon-Weiner-Neumann index that accounts for the proportion of a resource that is produced indigenously:

$$H = \sum_i p_i \ln p_i (1 + g_i)$$

where g_i is the share of indigenous production. This index varies in the range 0–4, with higher values indicating greater diversity and lower reliance on imports.

Lefèvre [39] defines two market-focused indices. The energy security price index (ESPI) is based on the measure of market concentration in competitive fossil fuel markets. The energy security physical availability index (ESPAI) is based on the measure of supply flexibility in regulated markets.

2.3.3 Assembling a holistic dashboard of energy security indicators

Assembling a holistic set of indicators is a difficult challenge. Mitchell et al. [20] identify four key issues: (i) the range of indicators often doesn't account for all relevant factors; (ii) there may be a reliance on data with weak and varying collection methodologies; (iii) correlations can arise between different indicators, which can increase the risk of problems due to hidden dependencies; and, (iv) the use of dimensionless scales (such as the Shannon-Wiener index) can be difficult to interpret and compare.

Jewell et al. [24] split indicators into three categories: (i) sovereignty; (ii) robustness; and, (iii) resilience. Sovereignty indicators include import dependence and the geographic concentration of a particular fuel or energy carrier. Robustness indicators include the risk of electricity blackouts and concerns about resource scarcity. Resilience indicators consider factors such as resource diversity and energy intensity. They recommend that present and future indicators should:

- be policy relevant to current and/or historical energy security concerns;
- be sufficiently generic to be applicable to energy systems which are radically different from present ones;
- be calculable from available and meaningful data in the model/scenario;
- provide information which is additional to that provided by other indicators; and, reflect key vulnerabilities of vital energy systems.

One approach to organising indicators would be to categorise them according to the energy security framework that has been adopted. Sovacool and Mukherjee [28] present a large number of indicators, categorised according to their proposed energy security framework and according to their complexity (simple, intermediate or complex). Table 2.1 lists a smaller set of potential indicators for the framework proposed by Cox [40].

Table 2.1 Potential categorisation of energy security indicators, indicator sources: [8, 20, 22, 24].

Area of Energy Security	Related metric	Indicators	Notes
Internal disruption	Diversity of fuel types in the electricity mix	Using the Shannon-Wiener index	
	Public acceptability of electricity generation plants	Willingness of the public to accept construction of new electricity generation plants or domestic fuel extraction	
	Likelihood of disruptive opposition	Through such things as strikes or protests by staff, for which low commodity power could be an underlying driver	
Availability	Diversity of fuel imports	Using the Shannon-Wiener index	
	Stability of fuel exporting nations	Likelihood of disruptions to fuel supplies due to civil strife in resource-rich nations	
	Import dependence	UK's reliance on imported fuels	
	Supply chains and choke points	Points at which the supply of fuels to the UK could be disrupted	
External disruption	Geographic concentration of fuel exporting nations	Is there over-reliance on a particular world region for fuels	
	Spare OPEC production of oil	Likelihood of oil shortages	
Fuel costs	Forecast prices	Will prices of fuel increase in future?	
Generation costs	Levelised Cost of Electricity	Current and future costs of electricity generation	
	Transmission upgrade costs	What are the expected costs to the transmission networks given planned/expected developments	
Network costs	Distribution upgrade costs	What are the expected costs to the distribution networks given planned/expected developments	
	Annual losses of reserve capacity plants	Estimation of the cost of maintaining back-up generation	
Cost to households	Annual electricity and heating bills	Do consumers have reasonable access to energy?	
	Number of households in fuel poverty	Are energy prices putting an unsustainable burden on households?	
	Number of poor quality inefficient homes	Are households suffering high bills due to poor quality buildings?	

Area of Energy Security	Related metric	Indicators	Notes
Emissions	Carbon intensity of energy supplies		Measuring progress toward decarbonising the UK's energy supply
	Cumulative GHG emissions		Measuring the UK's contribution to climate change
Sustainability	Total energy use		Are we successfully reducing the UK's energy demand?
	Energy use per capita		Are we successfully reducing the UK's energy demand?
	Energy intensity		Are we successfully decoupling economic performance from energy demand?
	Reserve to production ratios		A measure of how long until we start to run out of major fuels
	Primary fuels depletion		The rate at which we are using irreplaceable fuels
	Secondary materials depletion		Rate of depletion of essential materials such as rare earth metals
	Water consumption and withdrawals		Is power generation putting an unsustainable burden on the UK's water resources?
Environment	Air quality levels		Is the UK's power generation compromising the respiratory health of its citizens?
	Generation adequacy		Is supply sufficient to meet demand on an hour-by-hour basis?
System adequacy	Network adequacy		Is the network able to cope with peak demand levels?
	Spare capacities for electricity generation		Is there enough spare capacity to cover intermittent generation?
	Average age of infrastructure		Is the UK's power infrastructure up to date
	Oil refinery capacity in the UK		Does the UK have adequate oil refining capacity?
	De-rated generation capacity margin		The amount of excess supply above peak demand
	Load factors and oversupply		Plant load factors used to identify areas of oversupply
	Frequency response capability		Capability of types of generation in the mix to provide frequency response
Resilience	Short-term operating reserve		Quantity of generation available to cover unexpectedly high demand
	Demand-side response		Demand available to be turned off as a part of demand-side response
	End-use sector diversity of carriers		How diverse are methods of delivering energy to the public?
	National grid response and reserve requirements		National grid requirements for Frequency Response and Short Term Operating Reserve

2.3.4 Interpreting indicators to quantify energy security

Some papers use aggregates of indicators to provide a single measure of energy security (or a few aggregated measures) [23, 41]. Others advocate a different approach, labelled the ‘dashboard’ approach, with a range of energy security indicators rather than an aggregated measure, and if one of the indicators is flagged as being too low/high (depending on the measure), then that would be an indication that the energy system is not secure.

While aggregated measures can provide an easily interpretable single measure, they are heavily-dependent on the aggregation methodology, and the resulting measure is likely to be overly simplistic, to miss some nuances of the energy system, and yet be difficult to interpret. On the other hand, dashboard indicators, while not providing an easily readable single value, can provide a comprehensive range of measures which is less vulnerable to the methodology used, and can easily identify the aspect(s) of the energy system that lack energy security, or are at high risk of becoming insecure.

2.4 ASSESSING THE IMPACT OF HYDROGEN AND FUEL CELLS ON ENERGY SECURITY

Most energy security analyses examine current energy systems (Section 2.4). Fuel cells can contribute to improving energy security by providing back-up power supplies to critical parts of the energy system (Chapter 4). To understand the potential implications of large-scale adoption of hydrogen and fuel cell technologies, we need to examine low-carbon future energy systems. Chapter 7 examines the implications of hydrogen for several future scenarios.

Hydrogen is an energy carrier rather than a resource, and can be produced from a similar range of fuels as electricity. It is the only zero-carbon energy carrier other than electricity that is thought able to make a major contribution to low-carbon energy systems in the future. Deploying hydrogen technologies would likely increase the diversity of a low-carbon energy system. Hydrogen technologies could also improve the stability of the electricity system if high levels of renewables were deployed, through grid balancing and energy storage.

From a supply-side perspective, since hydrogen can be produced from a similar range of fuels to electricity, similar indicators to electricity can be used to measure the energy security of hydrogen. From a demand-side perspective, hydrogen is similar to natural gas, so gas-focused indicators are likely to be suitable. Any of the energy security frameworks developed in Section 2 are likely to also be applicable to hydrogen and fuel cells. Hydrogen is unique compared to counterfactuals in that it can be stored relatively cheaply in large quantities, interseasonally if necessary, and new indicators could be developed to reflect the benefits of this characteristic.

2.4.1 Framework for energy security in this White Paper

Energy security is underpinned by vital energy systems having low vulnerability [19]. This White Paper examines key parts of hydrogen and fuel cell systems in Chapters 3, 4 and 6.

The focus of this White Paper is on assessing energy security rather than developing another new framework. We have chosen to use the broad framework proposed by Cox [22], and summarised in Figure 2.1, which broadly defines energy security in terms of availability, affordability, reliability, and sustainability, and focuses on reducing external threats, namely short term shocks and long term stresses, respectively. In our view, energy security means having access to energy at an affordable price with a reliable and robust delivery system, which is produced in a way that does not unacceptably damage the environment or come to rely on depleted resources. We take a system viewpoint and examine key energy infrastructures as well as resource availability.

2.4.2 Indicators to measure energy security with hydrogen and fuel cell systems

Indicators should cover most of the relevant aspects of energy security, both for the present and in the future. The definitions of some of them are likely to change as the energy system evolves. For example, if hydrogen started to replace natural gas, then indicators involving gas capacity or delivery would instead (or additionally) measure hydrogen capacity. If fossil fuels were phased out, their energy security implications, at least in terms of global reserves, would likely reduce. Similarly, hydrogen generation capacity would not become important until hydrogen were a significant energy carrier.

Some indicators for UK energy systems with hydrogen and/or fuel cells might include:

- Diversity of energy sources (Shannon-Wiener Index).
- Diversity of energy sources, adjusted for import dependence (Shannon-Wiener-Neumann Index).
- Level of fossil fuel dependency.
- Capacity of hydrogen producers.
- Capacity of electricity generators.
- Level of redundancy of infrastructure.
- Diversity of infrastructure.
- Capacity of energy storage.
- Hydrogen capacity and comparison to peak load.
- Total level of investment in the energy system.
- Fuel price indices for domestic, industrial and commercial sectors.
- Interruptions per 1000 customers for gas and electricity supply.
- Minutes lost per customer for gas and electricity supply.
- Ratio of final to primary energy consumption (total conversion efficiency).

2.5 CONCLUSIONS

Most definitions of energy security have focused on security of resource supply, reflecting their origin in the oil shocks of the 1970s. More recent studies have widened the scope across the energy system, with a particular focus on electricity systems, and have taken a vulnerability-based approach that widens the definition of energy security to include reliability of systems and sustainability. These aim to account for the varied timescales and severity of threats to energy security and the ability of the energy system to respond to these, which can be measured in terms of the stability, durability, resilience and robustness of the system.

A wide range of indicators have been proposed to measure national energy security. Diversity is one of the most common measurements, but indicators also measure resource reserves, capacity utilisation, fuel prices, energy consumption and greenhouse gas emissions. The choice of indicators should depend on the energy security goals of the government. Some studies take a dashboard approach that assesses energy security using a wide range of indicators, while others calculate a compound index to represent the whole system. There are advantages and disadvantages with both approaches, but the dashboard approach tends to be adopted as the indicators are easier to understand and it better captures nuances in the energy system.

Hydrogen could broadly improve energy security by increasing the diversity of primary energy sources and providing an alternative energy carrier to electricity, for example by decarbonising the gas networks, as well as helping to balance the electricity system if high levels of renewables are deployed.

Based on the insights presented in this chapter, this White Paper takes two approaches to examine the energy security implications of hydrogen and fuel cells. First, key hydrogen and fuel cell systems are examined in Chapters 3, 4 and 6. Second, the broad framework summarised in Figure 2.1, which broadly defines energy security in terms of availability, affordability, reliability, and sustainability, is used to explore the implications of deploying hydrogen and fuel cell technologies in the UK energy system in Chapter 7.

CHAPTER 3

HYDROGEN

PRODUCTION

Anthony Velazquez Abad and Paul E. Dodds –
University College London

3.1 INTRODUCTION

Hydrogen does not exist naturally and must be produced by breaking down compounds such as water or methane. For this reason, it is considered as an energy carrier rather than a primary source of energy. Numerous technologies have been developed to produce hydrogen from a wide range of feedstocks. From an energy security perspective, this means that if a feedstock such as natural gas has restricted availability, production could switch to another feedstock. However, this would require the development of redundant capital plant, to produce hydrogen from a range of feedstocks, or flexible plants that could utilise a range of feedstocks. As for electricity generation, there is a trade-off between the cost of spare generation plant and the increased security that it brings. Unlike electricity, as a gas, hydrogen can be stored relatively cheaply in underground caverns, which reduces the value of spare capacity.

Hydrogen is not a primary fuel unlike oil, coal and natural gas. However, like electricity it is an energy carrier. Hydrogen is a secondary form of energy that is produced using primary energy sources. Advocates of the Hydrogen Economy recognise that hydrogen can be an environmentally friendlier source of energy for the consumer, especially in the transport sector whereby no harmful pollutants are released into the atmosphere at the point of use.

The hydrogen economy is a system for delivering energy sourced from hydrogen. Moreover, hydrogen production, distribution, utilisation and storage are fundamental to the realisation of this system. Figure 3.1 is the life cycle of hydrogen when sourced from renewable energies. The diagram also demonstrates that hydrogen is produced from water, which is used in conjunction with oxygen to generate useful energy such as electricity giving water as a byproduct.

Figure 3.1 Hydrogen life cycle derived from a renewable energy, source: [42].

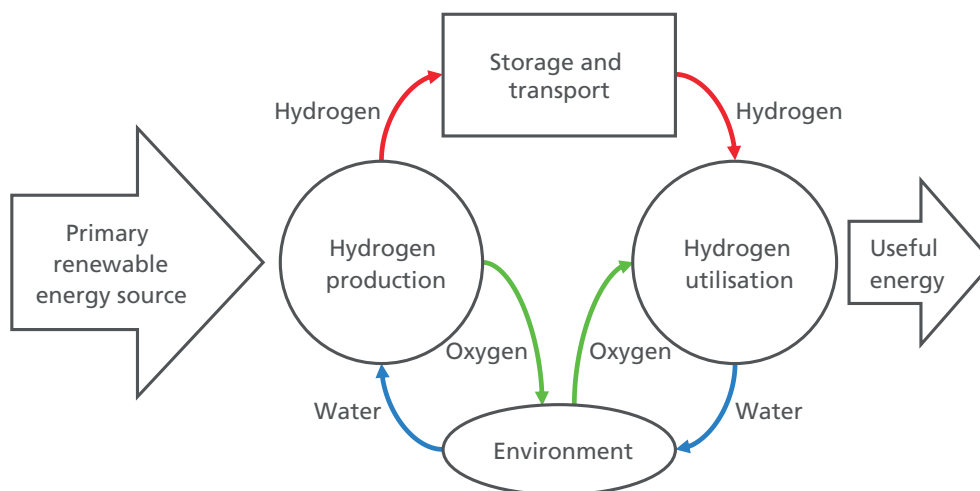

Hydrogen is mostly derived from fossil fuels at present, as these have the lowest costs [43]. Steam reforming of gases is explored in Section 3.2 and the gasification of carbonaceous solids and heavy liquids is examined in Section 3.3. Although both of these technologies currently have high CO₂ emissions, these emissions could be greatly reduced in the future using carbon capture and storage (CCS) technologies, with the potential of delivering carbon negative emissions when using biomethane and biomass feedstocks.

The other technology that is currently used to produce hydrogen is electrolysis. A number of different types of electrolyzers have been developed commercially but all have high capital costs, which might be reduced in future, and high fuel costs for electricity, which can only be reduced through efficiency improvements. An important characteristic of electrolyzers is the high purity of the hydrogen that they produce, which is much easier to prepare for use in fuel cell vehicles than hydrogen from other sources. Transport is potentially the principal market for hydrogen in the future [44–47]. Electrolyzers are examined in Section 3.4.

Numerous hydrogen production technologies are at an early stage of development that use a range of renewable feedstocks. Novel water splitting and biological hydrogen production methods are discussed in Section 3.5, hydrogen storage in Section 3.8.

The chapter compares and contrasts these technologies from an energy security perspective, before presenting the concluding remarks in section 3.9.

3.2 STEAM REFORMING OF GAS, LIGHT OILS AND ALCOHOLS

Steam methane reforming (SMR) is the most widespread hydrogen production method at present, due to the high hydrogen yield and low capital cost. This method uses a catalyst, typically nickel, to facilitate the thermo-chemical reaction of natural gas and water at temperatures of around 850°C and a pressure of up to 2.5 MPa [48]. The methane in natural gas reacts with steam to produce a syngas consisting of hydrogen and carbon monoxide. Saturating this gas with further steam (water-gas shift reaction) yields additional hydrogen as the CO is converted to CO₂. Including all energy inputs, SMR generates 9–13 kg CO₂e/kg H₂ [49]. The conversion efficiency of hydrogen produced using SMR does not normally surpass 75% [48], but this is forecast to rise to 80% in the future.

A schematic diagram of a typical SMR plant is shown in Figure 3.2. First, the water and natural gas are pre-treated, with the natural gas desulphurised to avoid poisoning the catalyst in the reformation process. The natural gas is pre-reformed with steam at a lower temperature range (400–550°C) to convert all the hydrocarbons into methane and carbon oxides. The gases are heated then at a higher temperature in the reformer (450–1,000°C) yielding carbon monoxide (CO) and hydrogen molecules. In the following stage, a water-gas shift reaction run by a higher and a lower temperature catalytic reactor manages to extract an additional mol of hydrogen from each mol of CO from the previous stage and additional water. In the final stage, impurities

are removed from the hydrogen-rich gas (e.g. unconverted CH₄ and CO) to meet the required purity. It is also possible to capture the CO₂ generated in the SMR. CO₂ could be removed from syngas, via adsorption/regeneration at the pressure swing adsorption (PSA) inlet, from the PSA tail gas, and from the SMR flue gas. Combining these different approaches, more than 99% of the CO₂ could be removed [50]. A CCS system requires additional energy inputs to scrub, compress and transport the CO₂, which could reduce the operating efficiency of the SMR plant by at least 5% [51]. The facilities to scrub the CO₂ produced in the combustion and conversion processes, and to compress, transport and inject it into a suitable geological repository for permanent storage have economies of scale so are more viable for large plants or for a series of small plants in close proximity.

In the event of a failure of the CO₂ storage infrastructure, it would be possible to vent the CO₂ to the atmosphere, so the principal energy security concern for CCS is the increased feedstock requirement, caused by the reduction in the operating efficiency of the plant, a more complicated plant design that might decrease the overall reliability, and the cost premium for effectively handling a waste with no energy merits.

SMR currently has the lowest capital costs of the hydrogen production technologies in use today [43], although these would rise if CCS capabilities were deployed [51]. Small-scale reformers have been developed in some countries such as Japan and the US, where natural gas from the national grid is used to produce hydrogen for transport or in domestic fuel cell micro-CHP reformers for heat and electricity production; however, CCS is better suited for central hydrogen production plants.

Figure 3.2 Flow diagram of a typical SMR plant.

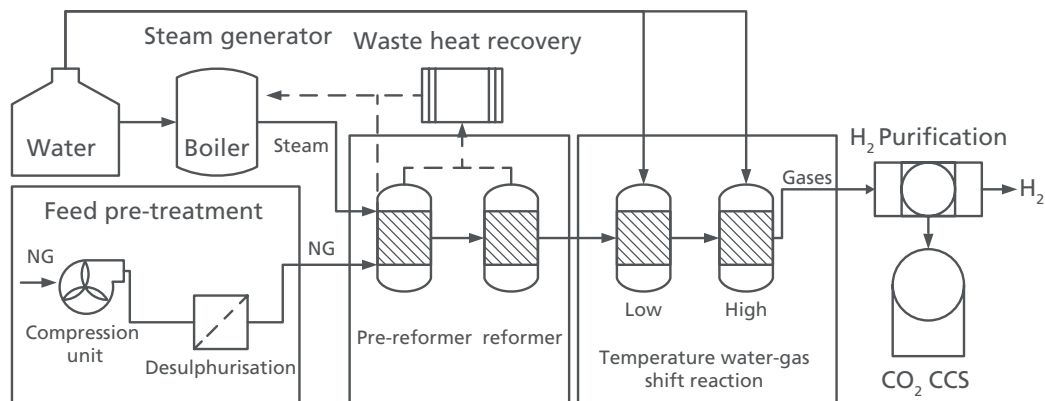

Steam methane reformers can process natural gas and biomethane, LPG, naphtha or refinery off-gas as feedstock (Figure 3.2). Achieving fuel flexibility would be a desirable energy security goal; however, this does not happen in practice. One reason is that installing an additional feeding system is expensive. Also, enabling a plant to run with different feedstocks decreases its efficiency as the catalyst choice and geometry are normally optimised for a particular feedstock. Fuel flexibility therefore reduces the hydrogen yield and hence the profitability of a plant [52]. This would not apply to switching between natural gas, biomethane, or synthetic natural gas (SNG), though.

Other potential feedstocks with higher oxygenated content, such as glycerine, glycerol, ethanol as well as other higher alcohols, have a high tendency to carbon formation and are not optimal feedstocks for steam reforming [53]. For these feedstocks, plants based on methanol cracking technologies are a better solution. Since methanol and ethanol are more valuable products than natural gas, the number and capacity of such plants tend to be small. Figure 3.3 shows that the design of methanol cracking (reforming) plants differs considerably from SMR designs such as Figure 3.2. Methanol reformation facilities are simpler and require a smaller footprint than steam methane reformers as they do not require a desulphurisation reactor, pre-reformers, steam generators or water-gas shift reactors. The hydrogen gas is sometimes purified with several adsorption processes via pressure swing adsorption to obtain pure hydrogen (99.999%).

Figure 3.3 Flow diagram of a typical methanol cracking plant.

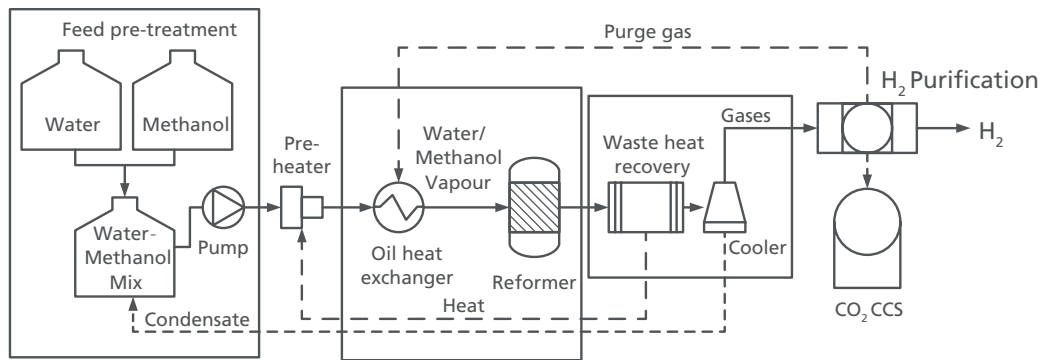

3.3 GASIFICATION OF COAL, HEAVY OILS AND BIOMASS

Gasification is a thermal process in which a feedstock with high carbonaceous content (e.g. biomass; coal; refuse-derived fuel) is heated with steam and/or oxygen at a temperature between 500°C and 1,400°C, and at a pressure that varies depending on the technology [54]. Processes using catalysts and fluidised-bed reactors are under development to decrease the operating temperature and improve their performance. Gasification produces a syngas, consisting of H₂ and CO, from which hydrogen can be extracted.

Coal gasification is a mature technology, but is an energy-intensive process with much higher carbon emissions than SMR. It is also more expensive, since lower feedstock costs are more than offset by higher capital costs and lower process energy efficiencies. NETL [55] reports overall hydrogen production efficiencies from coal gasification of 59–64% (% HHV). There are economies-of-scale for many components in gasification plants which mean that only large, centralised gasification plants are commercially-viable, generally in locations where natural gas is expensive or unavailable.

Several gasification technologies are currently used. Entrained-bed flow gasifiers produce the highest hydrogen yield from fossil fuel feedstocks (e.g. coal; petroleum coke). As shown in Figure 3.4, the coal needs to be pulverised (size <0.1 mm) and mixed with water to produce a slurry mix that is injected at the top of the gasifier. It is also possible to co-gasify small amounts of biomass with coal; however, it is good practice to pre-treat the biomass via torrefaction (mild pyrolysis at 200–300°C) and then pulverise it before adding it to the mix. Alternatively, flash pyrolysis can convert solid biomass into a liquid bio-oil which can be fed into the gasifier or mixed with the char to form a slurry [56]. Steam is introduced into the bottom of the gasifier. The coal reacts with oxygen at high temperature (1,200–1,300°C) and pressure to form syngas and a layer of slag on the gasifier walls. This slag is removed at the bottom of the gasifier. At such high temperatures, the production of hydrocarbons (e.g. methane) and tar is minimal, obtaining syngas made basically of hydrogen and carbon monoxide. Since the feedstocks have a high carbon content and numerous impurities, gasification tends to produce a substantial amount of CO₂ and other air quality pollutants (e.g. particulate matter; SO₂). The CO₂ can be captured from the flue gas and stored, although Cormos [57] argues that bed flow gasifiers are the only ones suitable for CCS applications.

Figure 3.4 Flow diagram of a typical coal gasification plant.

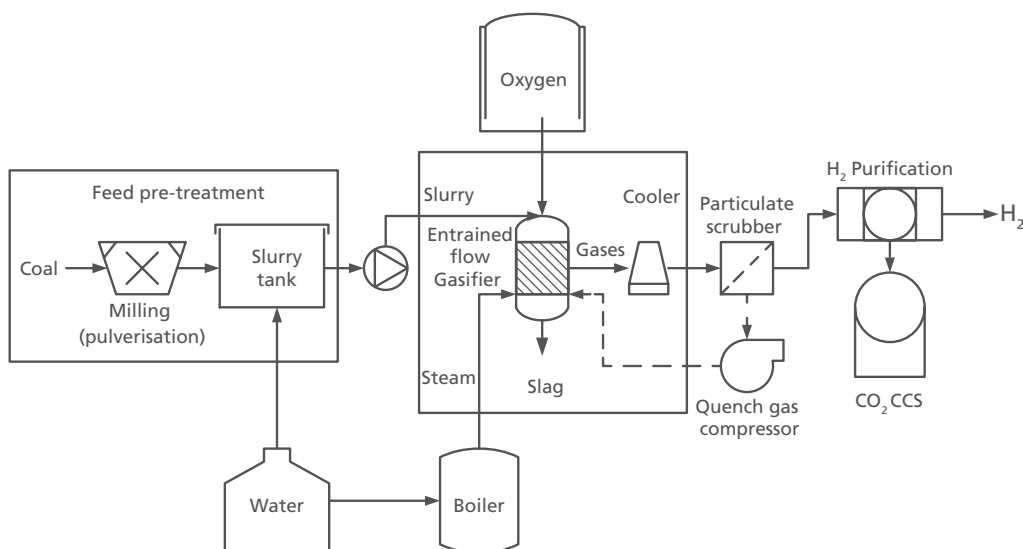

Biomass normally refers to a renewable feedstock composed of solid organic matter, but can also refer to various waste products including animal waste, sludge, food processing arisings, and part of municipal solid waste (MSW). Biomass gasification with CCS offers the opportunity to sequester atmospheric CO₂, and such “negative emissions” are valuable in a low-carbon energy system if the effective price of emitting CO₂ is high enough.

Hydrogen can be produced from biomass by applying heat and steam, and/or oxygen, to lignocellulosic feedstock, with a conversion efficiency of around 35%–50% [58]. The technology is mature and commercially available as wood gasifiers but no large commercial plants have been built. The main problem in large scale deployment has been the lack of standardisation in biomass and waste derived feedstocks, an issue that will be difficult to solve, which prevents long-term stable automatic operation. Another problem is the high investment cost. Catalysts are under development to improve the conversion efficiency; for example, Kumar [59] found that using nickel catalysts on alumina reduced the formation of methane, which maximised hydrogen yield, while a sodium hydroxide catalyst promoted hydrogen gas formation during gasification and reduced carbon emissions. That study highlighted the high cost of alkali metal catalysts and their recycling as obstacles to using sodium hydroxide in biomass gasification. No catalysts are currently used in commercial biomass gasifiers [52].

Table 3.1 shows that biomass and coal have quite different chemical compositions. While the carbon content of coal is very high (79%) and oxygen very low (15%), the carbon content of biomass is much lower (around 50%) and oxygen much higher (around 43%). This leads to the dry energy density of coal (32 MJ/kg) being almost double that of biomass (18 MJ/kg). Moreover, this difference is exacerbated by the moisture content of coal (9%) being much lower than that of biomass (10–28%, excluding torrefied feedstock and sawdust). As a result of the higher moisture content of biomass and its lower energy density, biomass feedstock transportation costs are higher than coal. Biomass feed needs to be grinded, dried and pelletised to improve gasification conditions. If the biomass is torrefied prior to gasification, there is a reduced risk of spontaneous combustion of the feed and a reduced need for precise temperature and humidity control. Bubbling fluidised bed (BFB) gasifiers are generally preferred to entrained flow gasifiers for biomass as they tolerate larger fuel particles. BFB gasifiers work well with particles of up to 80 mm in size, while entrained flow ones need pulverised feedstock smaller than 50 μm [56]. This means that as torrefaction and pulverisation of biomass is optional for BFB gasification, pre-treatment is cheaper than when preparing the same feedstock for combustion on entrained flow gasifiers. NETL [60] reports that BFB gasifiers are among the lowest capital cost options for biomass gasification and identify their suitability for fuels, chemicals, and hydrogen production.

In coal gasification the feed (slurry) is pumped into the gasifier, whilst solid biomass requires a screw conveyor to introduce the load into the gasifier as illustrated in Figure 3.5. Unless a single type of biomass is used, the different energy contents of each feedstock require careful management of the gasifier combustion parameters. Bubbling fluidised bed gasifiers run at lower temperatures (under 1,000°C) than entrained bed flow ones and this allows the formation of tars that must be removed from the producer gas at the scrubbing stage to avoid the poisoning of hydrogen purification catalysts. Wet scrubbing produces a mixture with tar particles and water but scrubbing with biodiesel is also possible; however, this only works with small amounts of tar and requires 1 kg of biodiesel/kg tar [61], which increases the costs considerably.

Figure 3.5 Flow diagram of a typical biomass fluidised bubbling bed gasification plant.

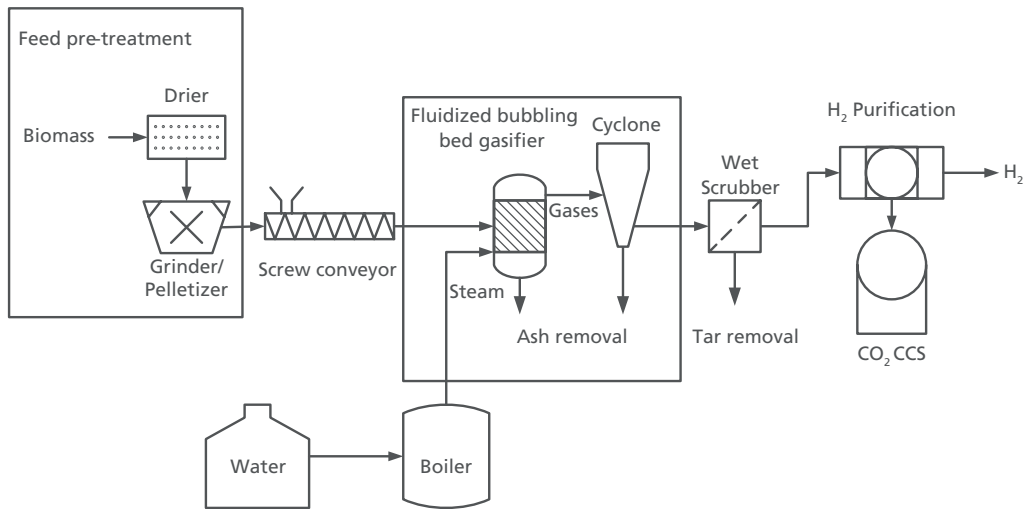

Particulates are removed at the lower end of the gasifier and also via a cyclone. Biomass gasification also produces a broad range of chemical compounds that present potential challenges to the system. Some of these issues and solutions are explained in Table 3.2.

The design of gasification plants is highly dependent on the feedstock that is used and the purpose of the plant (e.g. producing chemicals, green hydrogen, CHP or power). The differences include not only the pre-treatment of the feed, but also the selection of gasification and hydrogen purification technologies. Retrofitting or adapting a coal plant for fuel flexibility is technically and operatively challenging.

BOX 3.1 HYDROGEN PRODUCTION FROM WASTE

Hydrogen can be produced by gasifying municipal solid waste (MSW). MSW can contain a wide range of organic and inorganic materials (Table 3.1), which could lead to operational difficulties. An alternative is to use refuse-derived fuel (RDF), a higher-quality fuel that can be manufactured (at a cost) from MSW, commercial and industrial waste. It is a heterogeneous product that can contain plastics, organic and inorganic materials of homogenous particle size. However, despite RDF having a relatively high calorific value (24 MJ/kg), the energy yield of RDF gasification can barely cover the energy needed to produce the fuel [64]. Plasma gasification is a feasible technology used to obtain energy from MSW that can also generate hydrogen; however, it consumes a third of the power produced [61]. The primary purpose of these technologies are therefore waste disposal rather than hydrogen production.

Table 3.1 Chemical composition of several feedstocks. a) Weight as received; b) Weight dry; c) Weight dry and ash free.

Analysis	Fossil fuel		Biomass				Peat			Mixed waste	
	Coal	Plastic	Mis-canthus	Bagasse	Hard-wood pellets	Sawdust	Wood chips	Torried hard-wood	RDF	MSW	
Moisture content ^a	9.0	0.2	29.0	19.0	10.0	4.0	23.0	2.0	10.0	22.0	
Ash content ^b	11.0	1.0	4.0	6.0	N/A	0.9	2.0	0.4	17.0	26.0	
Volatile matter ^c	40.0	97.0	82.0	83.0	85.0	85.0	81.0	77.0	88.0	87.0	
Fixed carbon ^c	60.0	3.0	18.0	17.0	15.0	15.0	19.0	23.0	12.0	13.0	
Ultimate^c											
Carbon	79.0	74.0	49.0	49.0	51.0	52.0	52.0	54.0	55.0	49.0	
Hydrogen	5.0	10.0	6.0	6.0	8.0	6.0	6.0	6.0	8.0	6.0	
Nitrogen	2.0	0.1	0.5	0.6	0.0	0.1	0.4	0.2	1.0	2.0	
Sulphur	1.0	0.0	0.1	0.1	0.0	0.0	0.0	0.0	0.4	0.6	
Oxygen	14.0	4.0	44.0	44.0	42.0	42.0	42.0	41.0	34.0	31.0	
Total (with halides)	97.0	100.0	98.0	73.0	5.0	50.0	100.0	100.0	99.0	70.0	
Calorific Values (MJ/kg dry and ash free)											
Net calorific value (LHV)	31.0	35.0	19.0	18.0	20.0	17.0	19.0	21.0	23.0	19.0	
Gross calorific value (HHV)	32.0	38.0	20.0	19.0	17.0	18.0	21.0	22.0	24.0	20.0	
Other considerations											
Transportation cost	Low	Low	High	High	Medium	Medium	High	Low	Medium	High	
Milling requirements	Standard	Special	Special	Special	Special	N/A	Special	Standard	Special	Special	

Source: Adapted from ECN [62], Kiel [63].

Table 3.2 Challenges of biomass gasification in the post treatment of producer gas (cleaning).

Compound	Issue	Comment
Volatiles (particulates)	Carbon (coalite) is porous and reactive which increases risk of spontaneous ignition. Ash and soot are formed as well as aerosols that fouls pipe walls and equipment and causes abrasion.	Biomass has a high volatile content (~80% dry and ash free mass). Cyclone separators, filters and wet scrubbers are used to eliminate solid particles.
Tar	Tar creates deposits and fouls pipe and other equipment. It creates coke and charred materials reducing H ₂ yield.	Removal is necessary; however, it is challenging and costly. Removal methods include catalytic reactions inside and/or outside the gasifier and filtering systems or careful adjustment of operating conditions.
Alkali metals (e.g. K, Na)	Danger of agglomeration/melting in gasifier Downstream fouling by condensation of volatile salts Corrosion of metal materials Lowering of ash melting temperatures.	Additives are needed to mitigate risks. Lower temperature can help but reduce H ₂ yield. Usually treated with wet scrubbers.
Organic sulphur (H ₂ S, CS ₂ , COS, SO _x , mercaptans, etc.)	Desulphurisation requires precise temperature management to avoid poisoning of purification catalyst. It is also corrosive. Interaction with alkali metals.	Solutions include wet scrubbing using additives (expensive), sorbents and adsorption on metal catalysts.
Other aromatic hydrocarbons: BTX (benzene, toluene and xylene)	Coke forming tendency.	Can be reformed, but needs upstream S-removal to protect the catalyst, and upstream activated carbon does not make sense since it absorbs the BTX.
Nitrogen compounds	Most gas is as N ₂ ; however, ammonia is also formed by the conversion of protein and other nitrogen rich biomass components and small amounts of cyanide (HCN). It may damage scrubbers.	Elimination is possible via catalytic reduction of NO _x or using catalysts before reaching the wet scrubbing stage.

Source: Adapted from: IEA Bioenergy [56], Bram van der [61], Balas et al. [65].

3.4 ELECTROLYSIS

Water electrolysis is a process in which water is split into hydrogen and oxygen atoms. In their most basic form, all electrolyzers are composed of an anode, a cathode and an ion-conductive medium (electrolyte), as represented in Figure 3.6. In the proton conducting membrane electrolyzers, the electrical current generates

a flow of positive charged ions (protons) to the cathode (negative electrode) where these gain electrons and are reduced. In the oxygen and hydroxyl ion conducting types of electrolyzers, negatively charged ions move to the anode (positive electrode) losing electrons and oxidising. In both processes, the constituents hydrogen and oxygen of the water are separated, resulting in hydrogen being released at the cathode and oxygen at the anode. Since electricity is an expensive feedstock, the electricity conversion efficiency is a key factor for electrolyser economics [43].

Figure 3.6 Basic water electrolyser with an alkaline electrolyte (hydroxyl ion transporting membrane).

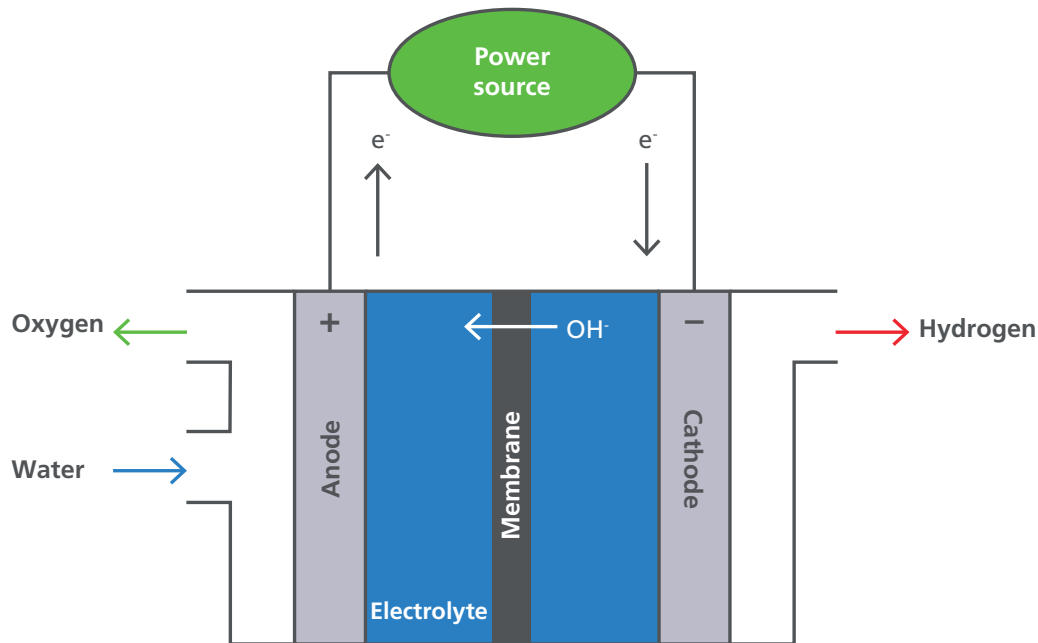

A key advantage of electrolysis over reforming and gasification technologies is the high purity of the produced hydrogen (>99.999%), which is suitable for powering fuel cells after only a drying stage. No CO₂ emissions are produced by electrolyzers, although the lifecycle emissions will depend on the emissions embodied in the electricity feedstock. Electrolyzers are the most suitable hydrogen production technology for distributed production and in combination with energy storage they can play a crucial role in supporting the generation of renewable power and improving energy security.

3.4.1 Alkaline electrolyzers

Alkaline electrolyzers are the principal commercial technology used to produce hydrogen via electrolysis at present. A direct current is applied between an anode and a cathode submerged in an electrolyte (an alkaline solution such as potassium hydroxide), which causes hydrogen to form at the cathode and oxygen at the anode. The hydrogen production rate is proportional to the current passing through the electrodes. The reaction is endothermic and reversible at ambient temperature.

Electrolysers can operate at atmospheric pressure, with the resulting gases being compressed afterwards, or can operate at higher pressures up to 20 MPa. They tend to operate at ambient temperature, with liquid water, but some high-temperature electrolysers have been proposed to reduce electricity consumption (Section 3.5.1). Commercial electrolysers have a hydrogen production efficiency of 68–80%, which depends on the cell voltage (typically 1.9–2.2 V), temperature (70–90°C), electrolyte flow conditions and the operating pressure [66]. While alkaline capital costs tend to be lower than for other electrolysers technologies, plant output cannot be easily varied and overall costs are very sensitive to the price of electricity. Bertuccioli et al. [67] estimated that the system costs of alkaline electrolysers in the EU will decrease from 1,000–1,500 €/kW in 2014 to about 600€/kW by 2020.

3.4.2 PEM electrolysers

Polymer electrolyte membrane (PEM) electrolysers are smaller than alkaline electrolysers as the electrolyte is a solid plastic material [68]. Oxygen from the water molecules and positively charged hydrogen ions (protons) are formed in the anode. The electrons flow through an external circuit and the hydrogen ions (H⁺) move to the cathode through the membrane, where they combine with the electrons to form hydrogen gas (H₂). PEM electrolysers have a faster dynamic response and wider load ranges than alkaline electrolysers; however, they have higher capital costs as they require expensive catalysts. Much research and development effort is underway to improve the catalysts, membranes and bipolar plate materials and to reduce their costs.

The low-temperature operation and power cycling capability offers the opportunity to use PEM electrolysers to generate hydrogen at times of excess intermittent renewable generation, through power-to-gas. In 2013, the first systems were connected to electricity networks, with the resulting hydrogen being injected into a local gas grid [69]. Since power-to-gas electrolysers have low capacity factors, as they only operate when there is excess electricity generation, minimising the capital cost is important for making a business case. The costs might be reduced through the use of cheap or free electricity or by income from the provision of balancing services to the electricity system. Nevertheless, US DoE [70] estimated a real levelised cost of \$5.2 per kg (by 2010) and a future cost of \$4.2 per kg by 2025. The system costs of PEM electrolysers are currently twice the cost of alkaline ones and are expected to decrease to around 1,000 €/kW by 2020; however, for small systems (<100 kW), prices are already competitive with alkaline electrolysers [67].

3.4.3 Solid oxide electrolysers

Solid oxide electrolysers (SOE) use a solid ceramic material for the electrolyte and operate at very high temperatures (700–900°C). Oxygen ions (O²⁻) flow through the ceramic membrane to the anode and react to form oxygen gas. Free electrons then flow to the cathode, splitting water and forming hydrogen gas. SOEs have higher efficiencies than other electrolysers because part of the heat generated in the electrolyser is recycled to contribute to the high operating temperature [68]. However, costs are still expected to be relatively high in the long run, with estimations of \$3.8 per kg by 2025 [71].

The high temperature makes this process well suited for environments where there is a source of cheap heat, such as a Generation 4, high-temperature nuclear power plant, but more sensibly, any source of steam, even at lower temperatures. SOEs are more efficient than conventional water electrolysis as less energy is required for breaking the steam molecules than the liquid water molecules in conventional electrolysis [72], and also because some electricity can be replaced by waste heat, adding to the improved energy efficiencies and lower feedstock costs mentioned above [66]. Mougín [72] suggests potential electrical efficiencies of 89% (LHV), well above alkaline (58%) and PEM water electrolysis (63%), respectively. The US DoE [73] estimates that the costs for this method, at \$2.9 kg by 2030, would be substantially higher than for SMR, biomass gasification and alkaline electrolysis. Other disadvantages include degradation issues during operations and the risks associated with novel technologies at an early stage of development [72]. Nevertheless, SOEs and SOFCs (solid oxide fuel cells, see Chapter 4) are essentially identical as a device and research is currently ongoing as to run ‘reversible’ fuel cells, which would operate both for generating electricity from hydrogen and splitting water to hydrogen, depending on which way they are operated. Degradation issues seem to be much reduced in such appliances and they could revolutionise the provision of balancing power for electricity grids.

3.5 PRODUCTION METHODS AT AN EARLIER STAGE OF DEVELOPMENT

3.5.1 Solar thermo-chemical water splitting

Solar thermo-chemical water splitting uses solar energy to decompose water in order to produce hydrogen and oxygen molecules, generating hydrogen with a purity of 99% [74] with an efficiency of around 10% (Table 3.3). In most designs, solar radiation is concentrated with mirrors that point towards a tower where extreme temperatures (above 2,200°C) produce the disassociation of water atoms. This presents challenges in the selection of materials for the reactors and the membranes for the separation of the gases [74], as typical materials can sinter, melt and vaporise at this temperature, decreasing the efficiency of the process [75]. Despite not being at a commercial stage just yet, several publicly-funded projects have been promoted around the world where concentrated solar power facilities produce hydrogen; examples of these include Hydrosol 2 in Spain, CSP2 in France and Solzinc in Israel. The US DoE [76] estimates that the cost of hydrogen produced in this solar-thermo-chemical pathway would be \$14.8 per kg in 2015; although it could decrease to \$3.7 per kg by 2020. These estimates have a high level of uncertainty as there are no commercial plants yet. There are considerable research challenges in the area of new materials to resolve before solar thermo-chemical water splitting can become commercially viable. Other considerations include the large land requirement and the need for high solar irradiance, which make this technology most suitable for desert areas.

Table 3.3 Comparison of hydrogen production methods.

Production technology	Main feedstocks	System energy efficiency ^a (%)		USA H ₂ cost ^b (\$/kg)		Maturity level ^c
		2015	2020	2015	2020	
Reforming: Steam methane	Natural gas + steam	74%	≥74%	2.1	≤2.1	Commercial
Gasification: Biomass	Biomass	46%	48%	2.1	2.0	Pilot projects
Electrolysis: Alkaline	Water + electricity	73% ^d	75% ^d	3.0 ^d	2.0 ^d	Commercial
		72% ^e	75% ^e	3.9 ^e	2.3 ^e	
Water splitting: Solar thermo-chemical	Water + sunlight	10% ^f	20% ^f	14.8	3.7	Pilot projects
Biological: Photolysis (photosynthesis)	Water + sunlight	2% ^f	5% ^f	N/A	9.2	Pilot projects
Biological: Dark fermentation	Biomass	4 mol H ₂ /mol glucose	6 mol H ₂ /mol glucose	N/A	N/A	Research lab
Biological: Photo fermentation	Biomass + sunlight	0.1%	N/A	N/A	N/A	Research lab

Source: Adapted from Holladay et al. [77] and US DoE [76]. a) LHV; b) Estimated hydrogen levelised cost in the USA. Source: US DoE [76]; c) As per November 2016; d) Central production; e) Distributed production; f) Solar-to-hydrogen ratio; defined as the energy of the net hydrogen produced divided by net full spectrum solar energy consumed (LHV).

3.5.2 Biological hydrogen production

Hydrogen can be produced via metabolic processes using micro-organisms such as microalgae, cyanobacteria (blue and green algae), purple non-sulphur and dark fermentative bacteria [78], operating under different environmental conditions (e.g. light, pH, temperature) and using various feedstocks. Bio-hydrogen production requires little energy, does not produce airborne pollutants, and uses renewable feedstocks that are relatively abundant and cheap (e.g. water, microorganisms, waste).

Certain micro-organisms can produce hydrogen via photosynthesis. To conduct the photolysis of water these micro-organisms need CO₂ and sunlight. Photobiological hydrogen can be produced by some micro-organisms directly by the activity of hydrogenase or indirectly when enzymes (e.g. hydrogenase, nitrogenase) decompose carbohydrates (e.g. glucose, cellulose) or glycogen into hydrogen [78]. Examples of the former include cyanobacteria (e.g. *Synechocystis*, *Nostoc* sp.) and green algae (*Chlamydomonas* sp.). Examples of the latter include microalgae and cyanobacteria that generate H₂ from intracellular energy reserves. These are typical of anaerobic

digestion, where bacteria digest organic waste generating hydrogen, CO₂ and acetogens (e.g. lactic acid) before the methanogenesis (in the acetogenesis phase).

Other micro-organisms (e.g. anaerobic bacteria such as *Clostridium*) can produce hydrogen from biomass in darkness via dark fermentation. Under this process, organic compounds (e.g. carbohydrates) are fermented delivering organic acids and a low hydrogen yield. Poudyal et al. [78] found that dark fermentation of hexose produces just around 2–4 mol H₂. Dark and photofermentation could be combined to improve the overall process productivity.

The principle drawbacks with biological production methods are low efficiencies, high capital costs of bioreactors and large land area requirements. If biological H₂ production is to succeed commercially, the energy yields of the micro-organisms and processes will need to be considerably improved. For this reason, genetic engineering of more resilient and productive micro-organisms is an active area of research [78].

3.6 PRODUCTION OF SYNTHETIC NATURAL GAS AND OTHER COMPOUNDS

Hydrogen could be used as a feedstock to produce a range of organic chemicals. One route is to gasify biomass or waste, or to produce hydrogen from power-to-gas, and then to methanate the hydrogen to produce synthetic natural gas (SNG) as shown in Figure 3.7. The resulting SNG would be carbon-neutral if the feedstock were carbon-neutral, meaning that this is one of the few methods available to decarbonise heat provision from natural gas. The challenge is the high cost relative to the cost of natural gas, which means that it might only be viable for feedstocks such as waste for which a disposal fee can also be collected. The figure shows a system of producing SNG for feed-in to the former natural gas grid. This would be using the existing infrastructure, avoiding any new investments. The primary energy source of the SNG would be biomass by anaerobic digestion and gasification as discussed in Section 5.6, on one hand, and electrolytically produced syn-gas from renewable electricity, on the other hand. Feeding an SOE with a mixture of water and carbon dioxide (co-electrolysis) produces a similar syn-gas (CO and H₂ mixture) to the product from biomass gasification. The SNG is completely zero-carbon and substitutes natural gas, thus decarbonising the current gas supply system without a need to change technologies of gas use in the short term.

In the future, hydrogen could similarly be used as a base for more complex chemical reactions to synthesise a wide range of high-value, carbon-neutral chemical compounds in the chemical industry.

Figure 3.7 Production of synthetic natural gas (SNG) via biomass conversion in gasification or anaerobic digestion, and from power-to-gas with subsequent methanation. SOFC is a solid oxide fuel cell. AD is anaerobic digestion. NG is natural gas.

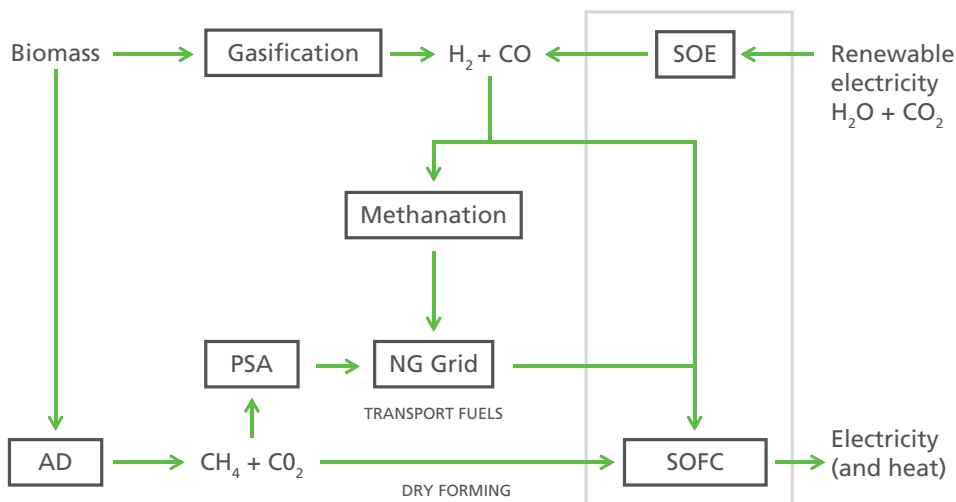

3.7 WATER REQUIREMENTS FOR HYDROGEN PRODUCTION

Hydrogen production plants have high water requirements, both as a hydrogen feedstock and for process cooling. These are similar across production technologies with a range from 9–16 l/kgH₂, as shown in Table 3.4. Electricity generation has a similar water footprint but has a much wider range. The consequences are that hydrogen production plants need to be constructed near a substantial water source such as a river. Some electrolysis technologies require a salty electrolyte, and these would be most appropriately located on a shoreline. Given that water requirements are similar to electricity generation, they are unlikely to be significant factors affecting energy security in the UK.

Table 3.4 Water requirements for several hydrogen production technologies (litres/kgH₂) and equivalent water requirements to generate an equivalent amount of electricity by energy content, hydrogen sources: [79–81, 82].

Technology	Water for hydrogen production	Water for equivalent electricity production
Gas SMR	9–15	8–28
Biomass gasification	13–14	4–39
Electrolysis	11–16	
Nuclear power		16–28

3.8 HYDROGEN STORAGE AND INFRASTRUCTURE

Hydrogen can be stored onsite at the point of production as compressed gas, liquid or chemically in a solid-state storage medium. Distribution of the hydrogen would be relatively simple since it can be delivered via pipeline to the point of use.

Currently, in most developed countries there exists a distribution pipeline infrastructure for the delivery of natural gas to homes for the purpose of heating and cooking. Hydrogen could be transported from the point of production to the point of use in a similar manner. In order to tackle hydrogen embrittlement, these pipelines are typically fabricated with low carbon and manganese content, ≤ 1 and ≈ 0.2 wt%, respectively. These low concentrations reduce the yield strength of the steel to < 290 MPa and as a result limit the operating pressure to < 10 MPa, whereby 4–6 MPa are commonly used. Research has shown that polymeric coatings for steel pipes and fibre reinforced polymer pipelines are impermeable to hydrogen and can increase the operating pressures to a range of 7 to 25 MPa [83].

In the last two decades, billions of cubic metres of hydrogen were produced and kept in intermediate storage and transported via pipeline to serve the chemical and aerospace industry. For more than 50 years Germany has been using a 200 km pipeline to transport hydrogen for the chemical industry with virtually no problems. The United States, Japan and Italy also have an established pipeline network for the delivery of hydrogen for industrial applications [84].

Currently, there are only three liquefaction plants in Europe, one operated by Air Liquide in Waziers, France, another by Air Products in Rozenburg, Netherlands and one by Linde in Ingolstadt, Germany [83]. In the United Kingdom, the majority of hydrogen is transported in compressed gas cylinders to the point of use. In some countries, hydrogen is also transported by tankers either in a pressure vessel or in liquefied form. To help facilitate the transition over to a hydrogen economy, the existing pipeline infrastructure used by natural gas could be modified to enable the delivery of a hydrogen/natural gas mixture which could then be followed by the separation of hydrogen at the point of use [83, 85].

Hydrogen has a high gravimetric energy content, approximately three times more than petrol yet by volume has an energy content four times less than petrol [86]. This presents a problem when storing hydrogen for mobile applications especially since storage is limited to the space constraints of a road vehicle. In order to achieve the 300 mile range stipulated by the US DoE [85], utilising existing storage technologies such as compressed hydrogen tanks would require a space larger than most car boot. Not only does this provide a space issue but also the added problem of weight. A common method of storing hydrogen is in compressed gas form pressurised inside a tank at 35 or 70 MPa. Increasing the storage pressure improves the energy density resulting in a smaller tank but a much heavier system. Hydrogen is a non-ideal gas meaning large amounts of energy are needed to compress hydrogen into smaller volumes. Compressed hydrogen tanks require 2.1% of the energy content to power the compressor [87].

Hydrogen can also be stored in the liquid state under cryogenic conditions. Typically, these conditions have hydrogen stored at -253°C . Storing hydrogen in a liquid state improves its volumetric density facilitating containment in a smaller tank. The associated problems with storing hydrogen in this manner include boil-off, energy for hydrogen liquefaction, tank size and the attributed costs. Boil-off can present a significant safety issue in situations where a hydrogen powered vehicle is parked in confined and poorly ventilated spaces since hydrogen is susceptible to auto-ignition. According to the U.S. DoE, approximately 30% of the hydrogen lower heating value is required for liquefaction indicating that this process is energy intensive therefore incurring large costs [85].

Currently, a hybrid system, named cryo compression, is being developed that provides a pressure vessel which is lighter and more compact than most storage media. BMW presented a hydrogen powered car in 2015 utilising a cryo-compressed hydrogen storage tank. Furthermore, the operating temperature is not as low as cryogenic storage meaning there is less of a penalty for hydrogen liquefaction and reduced boil off [85].

Alternative methods involve storing hydrogen either physically or chemically within selected materials. Hydrogen can be stored on the surface of a material through adsorption, either in molecular or monatomic form. Hydrogen can also be dissociated into atoms, absorbed into a solid material and stored in the crystal lattice such as in metal hydrides or metal organic frameworks (MOFs). Other methods include the hydrogen atoms forming strong chemical bonds giving rise to chemical compounds such as complex hydrides and chemical hydrides [86].

For stationary storage in industrial applications, space is not as important as in mobile applications since the system is not limited to the volume constraints of a vehicle. As a result, the more traditional and established storage techniques such as compressed, liquid and slush hydrogen are utilised. Slush hydrogen is a combination of solid and liquid hydrogen coexisting together in thermodynamic equilibrium at the triple point which is at a lower temperature than liquid hydrogen and at a higher density.

Hydrogen can also be stored in large quantities underground in caverns, salt domes and depleted oil and gas fields. There are many storage sites across the globe such as the ICI salt cavern in Teesside (England), storing 95% pure hydrogen and 3–4% CO_2 [88–90]. Between 1956 and 1974, the French gas company Gaz stored syngas in an aquifer in Beynes, France citing no safety issues during this period. Russia has also stored hydrogen underground specifically for their aerospace industry under 9 MPa of pressure [89].

3.9 CONCLUSIONS

Hydrogen can be produced using a range of processes, from a range of feedstocks. Large amounts of hydrogen are already produced from natural gas, coal, oil and to a lesser extent electricity, for industrial uses around the world. The choice of production technology depends at the moment primarily on the feedstock availability and overall cost. Coal gasification plants have been in operation for the last two centuries, producing a syngas containing hydrogen and numerous other gases, while electrolysis and SMR have been used for the last century. These technologies are mature and the principal challenges going forward are to produce low-carbon hydrogen at an acceptably low cost. A further range of novel production methods are at an earlier stage of development but might become important over the coming decades.

All of these technologies cause high CO₂ emissions, including electrolysis when using electricity generated in fossil fuel plants. The key challenge for existing fossil-based technologies is to cost-effectively incorporate renewable feedstock and electricity sources into existing processes, or ultimately revert to costly waste treatment such as CCS facilities. For electrolysis, the challenges are to reduce capital costs, supply low-carbon electricity and perhaps improve the conversion efficiency. For the novel bio-hydrogen production methods, which are still in their infancy, there is a need to identify and invest in newer, more resilient and productive micro-organisms.

Hydrogen can be considered as a 'zero carbon' fuel at point of use. Nevertheless, in a full life cycle analysis, it will appear that there are fossil energy inputs to the manufacturing of equipment needed for hydrogen production, as well as inputs to transportation and handling, even if the primary energy input is 100% renewable. In a future low carbon economy this might change since more and more functions are supplied by renewable energy. For the time being this is clearly not the case, which is why in most cases we label green hydrogen (from renewable primary energy sources) as 'low carbon' in this paper.

Hydrogen is more expensive to produce than existing fossil fuels, but this would change in the future if a substantial carbon tax were levied and/or externalities internalised. Also, with a higher efficiency of conversion in fuel cells (see Chapter 4), the cost of hydrogen as a fuel for fuel cell vehicles, at a pump price of £10/kgH₂, is equivalent to that of diesel fuel already today. Hydrogen offers lower price volatility than fossil fuels, since hydrogen can be produced from a range of feedstocks, energy security can be increased by diversifying the portfolio of production technologies in a similar way to electricity generation, or by constructing redundant back-up plants. The diversity of technologies and feedstocks, and maturity and resilience of hydrogen production systems, mean that hydrogen production could make a positive contribution to UK energy security.

CHAPTER 4

FUEL CELL

TECHNOLOGY

Naser Al-Mufachi and Robert Steinberger-Wilckens –
University of Birmingham

4.1 FUEL CELL BACKGROUND AND HISTORY

Welsh scientist and barrister, Sir William Robert Grove (1811–1896), was credited for the development of the first ever hydrogen fuel cell [91]. During his early years, he studied chemistry at Oxford and practiced patent law. In 1838, Grove was renowned for developing a modified version of a wet-cell battery. Grove deduced that if water could be split into hydrogen and oxygen molecules using electricity then the reverse reaction of combining hydrogen and oxygen molecules would generate electricity. From this hypothesis, Grove constructed a device capable of combining hydrogen and oxygen molecules to produce electricity. This gas battery prototype became known as the fuel cell.

Ludwig Mond (1839–1909) alongside his PhD student and assistant Carl Langer performed experiments with a hydrogen fuel cell which produced 6 A per ft² at 0.73 V [92]. Mond and Langer discovered several issues when using liquid electrolytes. Mond was quoted as saying “we have only succeeded by using an electrolyte in a quasi-solid form soaked up by a porous non-conducting material, in a similar way as has been done in the so-called dry piles and batteries.” Mond made use of an earthenware plate that was saturated with dilute sulphuric acid.

The founder of the field of physical chemistry, Friedrich Wilhelm Ostwald (1853–1932), determined the relationship between the different fuel cell components empirically, which includes the electrodes, electrolyte, oxidising and reducing agent, anions and cations. An electrode is a material that can conduct electricity, an electrolyte is a medium capable of conducting ions; an oxidising agent is an element/compound that accepts electrons from other species in a reaction, a reducing agent is an element/compound that loses electrons to other species in a reaction; anions are negatively charged ions, and cations are positively charged ions. It was the works by Ostwald that helped spearhead and inspire future research into fuel cells research [93]. Throughout the first half of the twentieth century, Emil Baur (1873–1944) conducted extensive research into the area of high temperature fuel cells using a molten silver electrolyte with the aid of his students at Braunschweig, Germany, and Zürich, Switzerland.

Francis Thomas Bacon (1904–1992) pioneered research into high pressure fuel cells. Bacon successfully developed a fuel cell that incorporated nickel gauze electrodes and operated at pressures as high as 200 bar. Bacon’s research continued throughout World War II as he attempted to design and manufacture a fuel cell for use in the Royal Navy submarines. In 1958, Bacon went on to develop the alkali fuel cell that featured a stack of 10” diameter electrodes for Britain’s National Research Development Corporation. Bacon’s work garnered the interest of Pratt and Whitney which resulted in the technology being licensed and used in the Apollo space missions. A variation of the Bacon cell is still in use today in several spacecraft.

Globally, research activities are focussed on overcoming the engineering related problems that still prevent the full commercialisation of fuel cells. These problems include the initial high cost of fuel cell manufacture, the lack of infrastructure for delivery of hydrogen, and the industry's lack of knowledge and experience with this technology [94]. In order to address these issues, manufacturers must first find ways to reduce fuel cell production costs. Then, according to the field of application, a fuel cell type must be selected for which the new infrastructures can be developed. The establishment of infrastructure will require amendments in policy which address, for example, standardisation, safety codes, and regulations for fuel cell manufacture and fuel distribution. Finally, the energy industry must become aware, educated and familiarised with fuel cell technology as a means of power generation. This will occur over time as energy companies begin to adopt increasing capacity of high-efficiency and low-carbon power generating technologies and synthetic natural gas (non-fossil methane) for power generation.

Research on fuel cells is ongoing for two main reasons. The first reason is that fuel cells are an emerging technology alternative to the conventional fossil fuel based technologies and as such require significant research and development in order to facilitate commercialisation. The second reason involves the understanding of how fuel cells can change the energy supply to electric devices in the future.

Currently, one of the biggest drawbacks of fuel cells is that they are relatively more expensive than other methods of power generation; however, with economies of scale this is set to reduce. Also, considering the full cost of operation, it is rarely appreciated that the total operating costs of fuel cells might be lower, due to their increased efficiency compared to conventional technology, especially in comparison to vehicle internal combustion engines [95]. In the past, fuel cells were limited to niche applications such as powering space capsules for NASA during the 1960s. Due to the progress in R&D, manufacturing costs have declined substantially allowing for a more varied and diverse application of fuel cells. In the year 2000, fuel cell cost was far in excess of \$10,000/kW_{el} (system), although, according to research analysts a cost target of around \$400/kW_{el} must be achieved before they can be commercialised.

There are several main advantages that fuel cells offer: namely their simple design, generally high efficiency, silent operation and virtually zero emissions [96]. The electrical efficiency of a fuel cell ranges from 35 to 60%, but when used in a combined heat and power (CHP) configuration the total efficiency (electricity and heat supply) can increase to over 85% [94]. These efficiencies are a marked improvement on the 40% achieved by internal combustion engines (ICEs) in their best point (18 to 20% in real driving cycles). Fuel cells are a relatively simple design and contain no moving parts (apart from blowers and pumps in the system) meaning these devices have high durability. Depending on the fuel cell type and fuel used, the emissions tend to fall well below current standards.

Fuel cells are capable of supplying power outputs that range between 1 W_{el} up to several 10 MW_{el} (the largest installation currently being 59 MW_{el}), making them suitable for many power applications. They can be used to power small scale electronic devices such as mobile phones and personal computers. In the 1 kW_{el} –100 kW_{el} range, fuel cells are able to power both civilian and military vehicles in addition to public transportation and can also be used for auxiliary power unit (APU) applications on-board of various vehicles, from trucks to aircraft, rail and ships. Moreover, fuel cells can be used for larger scale applications which operate in the 1–100 MW_{el} range such as producing grid quality power for distribution [96].

Vehicle and public transportation applications are one of the most important application fields of fuel cells. Companies such as Toyota and Hyundai are implementing fuel cell systems into their commercial products. Conversion to a fuel cell powered vehicle would significantly reduce the number of moving parts and improve longevity. In comparison to conventional batteries, fuel cells produce higher power densities and do not require recharging as fuel is continuously flowed through the device. Due to the relatively higher power densities, fuel cells can be made smaller in order to produce the equivalent power output of commercial batteries and enable considerable savings in space and weight. Fuel cells can operate in conjunction with turbine power plants to help boost efficiency. By using the heat generated by the fuel cell and transferring this energy to a turbine power cycle (equivalent to a combined cycle gas turbine, CCGT), the overall system efficiency can be increased up to 80%.

4.2 FUEL CELL BASICS AND TYPES

A fuel cell is a device wherein a fuel, typically hydrogen, and oxygen are electrochemically combined to produce electricity, water and heat. A fuel cell differs from a battery in that the reactants are continuously supplied and replenished after consumption. Fuel cells are not limited by the internal capacity of a battery and produce electricity from an external fuel sources. The modular design of fuel cells alongside their ability to efficiently and cleanly generate electricity makes them ideal for a wide range of applications and markets [97, 98], as mentioned above. Currently, there exist a wide range of fuel cell types which are made distinct by the fuels used, electrolyte material and operating temperatures. However, all fuel cell types have in common the anode, electrolyte and cathode components that form the ‘membrane electrode assembly’ (MEA), or simply ‘the cell’.

Low temperature fuel cells include polymer electrolyte fuel cells (PEFCs), direct methanol fuel cells (DMFCs) and alkaline fuel cells (AFCs) operating between 50 and 100°C. Intermediate and high temperature PEFC (IT- and HT-PEFC) and phosphoric acid fuel cells (PAFCs) operate in the temperature range of 120 to 200°C with less constrictions on the quality of the hydrogen fuels. High temperature fuel cells such as the molten carbonate fuel cells (MCFCs), and solid oxide fuel cells (SOFCs) operate

at higher temperatures between 600 and 900°C. The main difference between low temperature and higher temperature fuel cells is the direction of ion conduction. In most low temperature fuel cells, (apart from the AFC) the fuel is oxidised (electrons are lost) at the anode and the ions subsequently travel through the electrolyte to be reduced (electrons are gained) at the cathode. In high temperature fuel cells the oxidant is reduced at the cathode to generate ions which migrate through the electrolyte to oxidise the fuel at the anode. In both cases, the flow of electrons remains unchanged. In general, high temperature fuel cells exhibit higher efficiencies and are less sensitive to fuel impurities relative to the low temperature fuel cells. Table 4.1 compares the six main types of fuel cell indicating the electrolyte used, operating temperatures, efficiency, fuel and oxidant.

Table 4.1 Overview of fuel cell types.

Fuel cell	Electrolyte and ionic transport	Operating temperature (°C)	Efficiency (%)	Fuel	Oxidising agent
PEFC	Polymer electrolyte, proton H ⁺	50–100	45–55	H ₂ (hydrogen)	O ₂ (oxygen), air
DMFC	Polymer electrolyte, proton H ⁺	40–130	20–35	CH ₃ OH (methanol)	O ₂ , air
AFC	Potassium hydroxide (KOH) solution, hydroxyl ion OH ⁻	40–90	50–60	H ₂	O ₂
PAFC	Phosphoric acid, proton H ⁺	160–220	55	Natural gas, biogas, H ₂	O ₂ , air
MCFC	Molten mixture of alkali metal carbonates, carbonate ion CO ₃ ²⁻	550–650	55	Natural gas, biogas, coal gas, H ₂	O ₂ , air
SOFC	Oxide ion conducting ceramic, O ₂ ⁻	600–950	~50–60	Natural gas, biogas, coal gas, H ₂	O ₂ , air

4.2.1 Polymer electrolyte fuel cell (PEFC)

Stringent operating conditions of pure hydrogen are required for PEFCs since this type of fuel cell can be contaminated by carbon monoxide (CO). A PEFC makes use of a solid, proton conducting polymer electrolyte such as Nafion® [98, 99] and platinum catalysts in the electrodes. The platinum catalysts currently make up the largest proportion of cost in fuel cell production and can only use ultra-pure hydrogen (99.999%) in order to avoid contamination. Figure 4.1 shows a diagram of a typical PEFC.

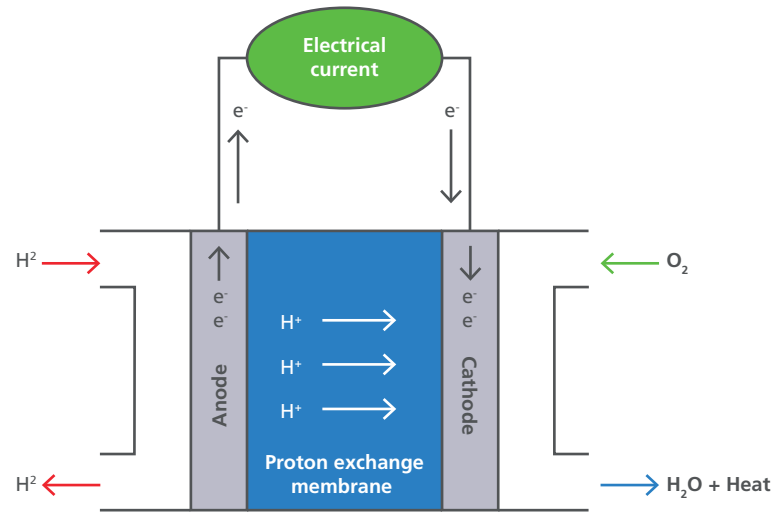
Figure 4.1 Basic fuel cell diagram for a PEFC.

Hydrogen (H₂) is supplied to the anode and is subsequently ionised to produce a proton (H⁺) and an electron (e⁻). The hydrogen ion H⁺ (proton) migrates through the proton exchange membrane (for instance Nafion®) across to the cathode while the electron e⁻ moves through an external circuit to deliver electricity. When two electrons reach the cathode they recombine with two protons H⁺ which go on to react with oxygen (O₂) from the air supply to form water. This reaction releases heat and is therefore called ‘exothermic’. The anode and cathode reactions are shown in Equation 4.1 and Equation 4.2, respectively, with the overall PEFC reaction shown in Equation 4.3. Equation 4.1 demonstrates what is commonly known as the hydrogen oxidation reaction (HOR) and Equation 4.2 shows the oxygen reduction reaction (ORR).

Anode	$2\text{H}_2 \rightarrow 4\text{H}^+ + 4\text{e}^-$	Equation 4.1
Cathode	$\text{O}_2 + 4\text{H}^+ + 4\text{e}^- \rightarrow 2\text{H}_2\text{O}$	Equation 4.2
Overall	$2\text{H}_2 + \text{O}_2 \rightarrow 2\text{H}_2\text{O}$	Equation 4.3

The PEFC typically operates at temperatures between 50 to 100°C and hydrogen pressures between 100–300 kPa [83, 100, 101] with an electrical efficiency ranging from 45 to 55% and benefits from not being limited by the Carnot efficiency associated with thermal conversion of fuels, such as in internal combustion engines (ICEs) [102]. The excess heat produced during the fuel cell reaction can be reused to further increase the efficiency to above 90% through CHP use. PEFCs are often used in vehicle applications and to power mobile devices due to their relatively low operating temperatures, rapid start-up times, low weight, and compact design.

One of the main drawbacks of the PEFC is contamination of the platinum catalyst with impurities such as carbon monoxide. Many further challenges still remain including the cost of platinum, and durability under fluctuating load conditions. Companies Johnson Matthey and Intelligent Energy are two British firms active in the area of commercialising PEFC catalysts and systems, respectively.

4.2.2 Direct methanol fuel cell (DMFC)

A variation of the PEFC is the DMFC which uses methanol (CH_3OH) directly at the anode instead of hydrogen. This type of fuel cell is between 20 and 35% (electrical) efficient due to the slow rate of methanol oxidation reaction at the anode (fuel electrode). One drawback is that methanol can be absorbed into the proton exchange membrane and be transported to the cathode, thus reducing the power delivered; however, the advantage is that liquid fuels have a higher energy density per volume than gaseous fuels. Figure 4.2 shows the operating diagram of a typical DMFC.

Figure 4.2 Basic fuel cell diagram for a DMFC.

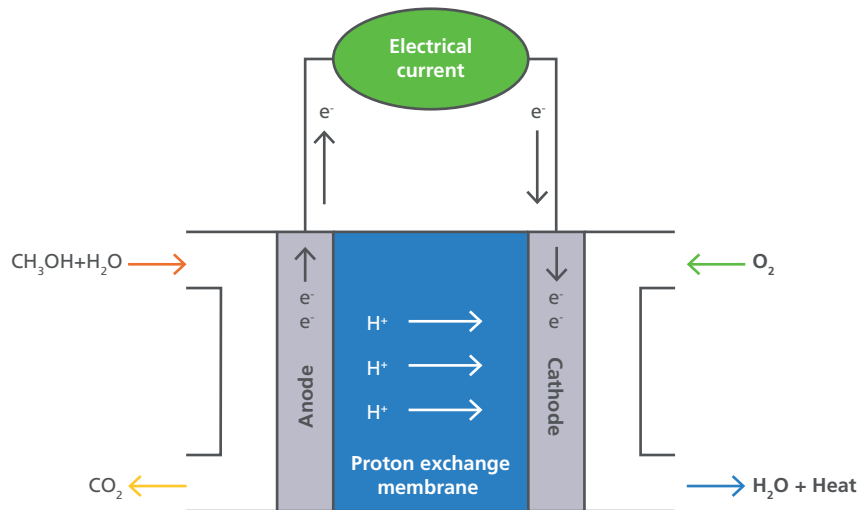

The anode and cathode reactions are shown in Equation 4.4 and Equation 4.5, respectively, with the overall DMFC reaction shown in Equation 4.6. It is evident from these reactions that CO_2 is produced, however, methanol can be produced from biomass in a similar way to ethanol hence making the overall fuel life cycle carbon-neutral.

Anode	$2\text{CH}_3\text{OH} + 2\text{H}_2\text{O} \rightarrow 2\text{CO}_2 + 12\text{H}^+ + 12\text{e}^-$	Equation 4.4
Cathode	$3\text{O}_2 + 12\text{H}^+ + 12\text{e}^- \rightarrow 6\text{H}_2\text{O}$	Equation 4.5
Overall	$2\text{CH}_3\text{OH} + 3\text{O}_2 \rightarrow 2\text{CO}_2 + 4\text{H}_2\text{O}$	Equation 4.6

4.2.3 Alkaline fuel cell (AFC)

AFCs use an electrolyte based on a strong alkali such as sodium or potassium hydroxide. In this type of fuel cell, hydrogen and hydroxide ions (OH^-) moving through the electrolyte react to form water (H_2O) and in the process release electrons into the external circuit. At the cathode, oxygen (O_2) and H_2O combine with the electrons from the external circuit to produce the OH^- ions. Figure 4.3 shows a diagram of a typical AFC.

Figure 4.3 Basic fuel cell diagram for an AFC.

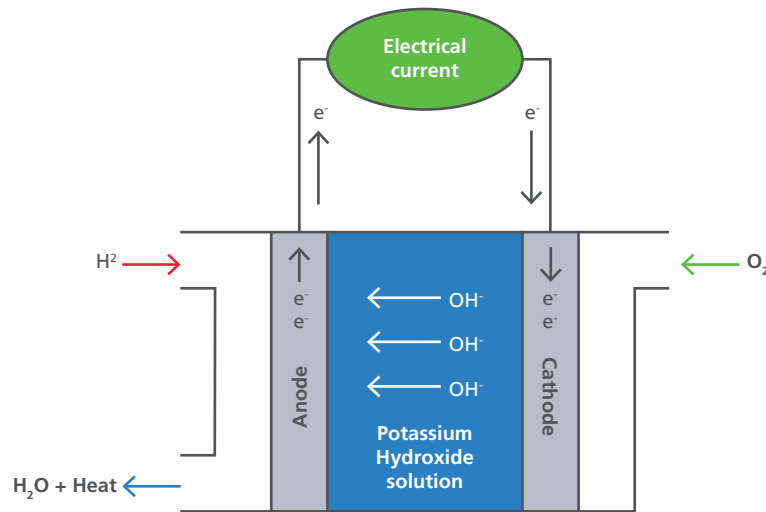

The anode and cathode reactions are shown in Equation 4.7 and Equation 4.8, respectively, with Equation 4.9 demonstrating the overall AFC reaction.

Anode	$2\text{H}_2 \rightarrow 4\text{OH}^- + 4e^-$	Equation 4.7
Cathode	$\text{O}_2 + 2\text{H}_2\text{O} + 4e^- \rightarrow 4\text{OH}^-$	Equation 4.8
Overall	$2\text{H}_2 + \text{O}_2 \rightarrow 2\text{H}_2\text{O}$	Equation 4.9

The AFC has one of the higher electrical efficiencies of all fuel cell types ranging between 50–60% (operating on pure oxygen, not air) and were used by NASA during the Apollo missions and on board their space shuttles [98]. A major drawback of AFCs is that the electrolyte reacts with the carbon dioxide (CO_2) in the air feed to form an insoluble carbonate meaning that only pure H_2 and O_2 can be used with this device. This is the reason for the very high electrical efficiency. AFCs were being phased out in favour of PEFCs but have gained new attention due to the use of cheaper nickel catalysts in place of platinum. One major company working in the field, AFC Energy, resides in the UK.

There are three main types of AFCs: mobile electrolyte, static electrolyte, and dissolved fuels alkaline fuel cells. In mobile electrolyte AFCs, the KOH solution is circulated around the fuel cell which facilitates the replenishment of the electrolyte. In the static electrolyte AFCs, the electrolyte is contained in a matrix material between the electrodes. In this version of the AFC, it is difficult to replace

the electrolyte in the event of becoming carbonated; hence it is necessary to use a pure oxygen feed at the cathode. The dissolved electrolyte AFC is fairly uncommon and features an electrolyte mixed with the fuel which in this case is either ammonia (NH₃) or hydrazine (N₂H₄) [98]. Nevertheless, the two latter examples show the high versatility of fuel cells in transforming practically any fuel that contains hydrogen in one form or the other into electrical and thermal energy, either directly or with an intermediate step (reforming, cf. Chapter 3).

4.2.4 Phosphoric acid fuel cell (PAFC)

The PAFC was originally known as the acid fuel cell due to using a sulphuric acid electrolyte. However, sulphuric acid has a relatively high vapour pressure and undergoes reduction between 80 to 100°C. As a result, phosphoric acid was used instead at concentrations greater than 95% which is also known as pyrophosphoric acid (H₄P₂O₇). The electrolyte is held in a silicon carbide (SiC) porous matrix via capillary forces. Phosphoric acid freezes at 42°C, hence PAFCs are constantly operated between 160 to 220°C throughout the lifetime of the cell. Unlike the PEFC and AFC, the PAFC is more tolerant to impurity levels (1–3%) of CO and CO₂. Figure 4.4 shows a diagram of a typical PAFC.

Figure 4.4 Basic fuel cell diagram for a PAFC.

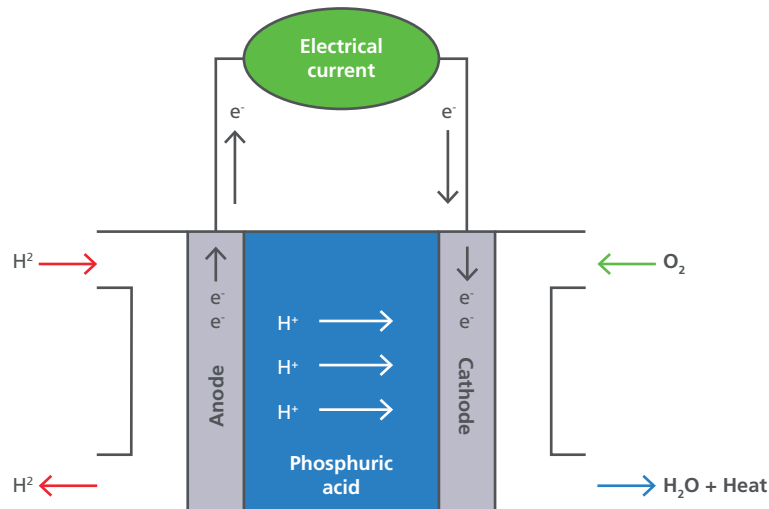

The anode and cathode reactions are shown in Equation 4.10 and Equation 4.11 with the overall PAFC reaction shown in Equation 4.12.

Anode	$2\text{H}_2 \rightarrow 4\text{H}^+ + 4\text{e}^-$	Equation 4.10
Cathode	$\text{O}_2 + 4\text{H}^+ + 4\text{e}^- \rightarrow 2\text{H}_2\text{O}$	Equation 4.11
Overall	$2\text{H}_2 + \text{O}_2 \rightarrow 2\text{H}_2\text{O}$	Equation 4.12

This type of fuel cell was the first to establish itself on the markets and has accumulated more than 1 million operational hours over the many decades. The primary application for PAFCs was as backup power units, and in combined heat and power systems in the region of 200 to 400 kW_{el}. Although PEFC seem to have taken over

most of the market, PAFC are still built by Fuji in Japan and employed as medium sized CHP units.

4.2.5 Molten carbonate fuel cell (MCFC)

The operating temperature for MCFCs range between 550 and 650°C. They are referred to as one of the two high temperature fuel cells, and have an electrical efficiency of typically 55%. The electrolyte used by this type of fuel cell is a carbonate ion-conducting mixture of sodium and potassium carbonates which are in the liquid phase at the operating temperature and contained in a ceramic matrix of lithium aluminium oxide (LiOAlO_2) by capillary forces. MCFCs are able to use hydrocarbon fuels as well as H_2 since this type of fuel cell is fully tolerant to CO and CO_2 . The MCFC electrolyte uses carbonate ions (CO_3^{2-}) for charge transport and so it is necessary to feed CO_2 to the cathode in order to produce the carbonate ions and maintain a stoichiometric supply. At temperatures above 600°C, carbon-containing fuels such as simple hydrocarbons can directly be transformed (reformed) within the fuel cell to deliver hydrogen and CO which are then oxidised by the oxygen carried by the carbonate ions. Recycling of the CO_2 that is produced at the anode back to the cathode is a common way of supplying the necessary CO_2 to the cathode. Figure 4.5 shows hydrogen operation of an MCFC, in which case there is a need for an external CO_2 feed to compensate for any losses of CO_2 from the internal cycle. Use of hydrogen fuels is therefore not so straight forward, whereas the use of methane (CH_4) results in CO_2 being formed at the anode side which can then be re-used by being added to the cathode gas stream. Figure 4.5 shows a diagram of a typical MCFC.

Figure 4.5 Basic fuel cell diagram for an MCFC.

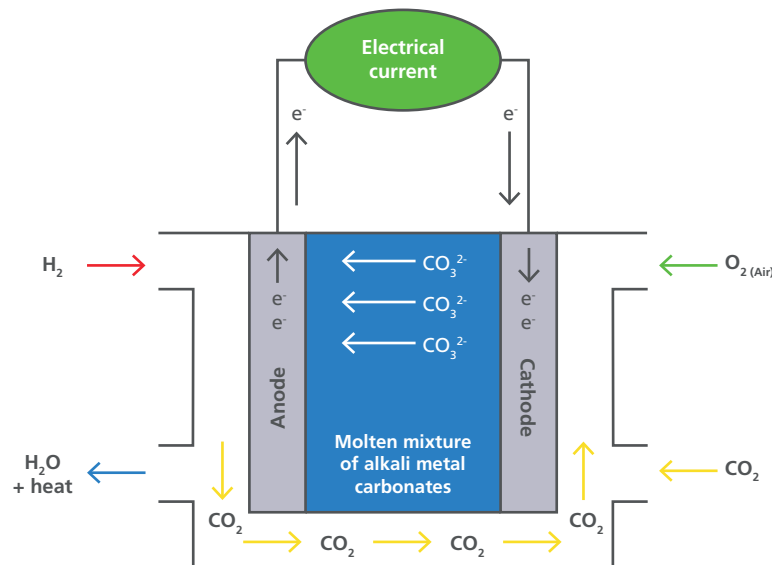

The anode and cathode reactions for hydrogen operation are shown in Equation 4.13 and Equation 4.14, respectively, and the overall MCFC reaction is shown in Equation 4.15.

Anode	$2\text{H}_2 + 2\text{CO}_3^{2-} \rightarrow 2\text{H}_2\text{O} + 2\text{CO}_2 + 4\text{e}^-$	Equation 4.13
Cathode	$\text{O}_2 + 2\text{CO}_2 + 4\text{e}^- \rightarrow 2\text{CO}_3^{2-}$	Equation 4.14
Overall	$2\text{H}_2 + \text{O}_2 \rightarrow 2\text{H}_2\text{O}$	Equation 4.15

4.2.6 Solid oxide fuel cell (SOFC)

SOFCs operate at high temperatures between 600 and 950°C and are made distinct by the solid-phase oxygen ion-conducting electrolyte [97–99]. The electrolyte is typically fabricated from ceramics such as yttrium or scandia-stabilised zirconia (YSZ or ceria, CeO₂). Similar to the MCFC, the SOFC is fully tolerant to CO and CO₂ and is capable of oxidising short-chained hydrocarbons (methane, propane, but also ethanol) directly at the anode. At temperatures above 600°C, natural gas can be supplied directly to the SOFC as a fuel. In some instances, natural gas will need some level of catalysed pre-reforming when the content of propane and butane added to increase the heating value of natural gas in winter is too high. Most SOFCs incorporate a nickel catalyst and thus can internally convert methane (CH₄) into H₂, CO and CO₂ at temperatures above 600°C, removing the need for external reforming equipment.

Natural gas mainly consists of methane and is deemed a clean fuel [102] but besides producing carbon dioxide when burnt in itself is a greenhouse gas. Converting methane to hydrogen allows the possibility to capture the CO₂ from the reforming for processing in a CCS scheme and avoids CH₄ leakages from the natural gas grid since the gas distributed would then be hydrogen. The relative abundance of natural gas would make the SOFC an ideal candidate for rapid commercialisation and qualify it as a transitional technology bridging the conversion from natural gas to methane (synthetic natural gas, SNG) and hydrogen infrastructures. A further advantage of the SOFC is the high electrical efficiency (>55%) [97, 103–105].

Another benefit of SOFCs is that they do not contain any moving parts or corrosive electrolytes. Therefore, they are more durable and are a more reliable power generation system that requires less maintenance. The SOFC manufacturing process is well established and originates from the production of electronic ceramic components. Furthermore, SOFCs do not require expensive catalysts to operate and are able to use a range of fuels such as methane, natural gas, biogas, sewage and landfill gas, syn-gas from coal or biomass gasification which eliminates the need for the costly reforming of methane for the production of hydrogen. In addition, SOFCs have the added advantage of low noise emissions. Moreover, the high operating temperature results in high-grade exhaust heat which can give a wider choice of combined heat and power options. Figure 4.6 shows a diagram of a typical SOFC. It is possible to enhance the total system efficiency to above 90% through CHP schemes when using the reaction heat for heating purposes or for steam generation. Electrical efficiencies up to 80% are possible in conjunction with micro turbines that would use the high temperature exhaust gases of the SOFC

to produce steam for a steam turbine cycle. Such efficiencies have not been achieved by any other combination of technologies.

Figure 4.6 Basic fuel cell diagram for an SOFC.

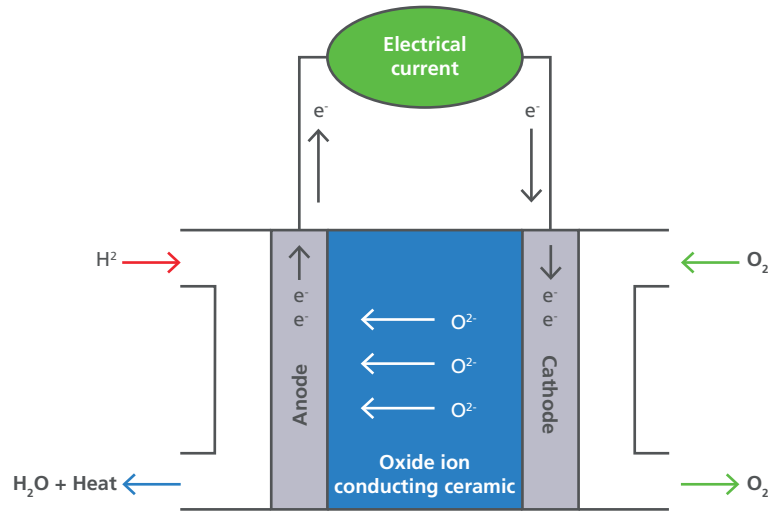

The anode and cathode reactions for hydrogen operation are shown in Equation 4.16 and Equation 4.17, respectively, with the overall SOFC reaction shown in Equation 4.18.

Anode	$2\text{H}_2 + 2\text{O}^{2-} \rightarrow 2\text{H}_2\text{O} + 4\text{e}^-$	Equation 4.16
Cathode	$\text{O}_2 + 4\text{e}^- \rightarrow 2\text{O}^{2-}$	Equation 4.17
Overall	$2\text{H}_2 + \text{O}_2 \rightarrow 2\text{H}_2\text{O}$	Equation 4.18

4.3 APPLICATIONS OF FUEL CELLS

Fuel cell applications can be broadly categorised into three areas:

- Transport,
- Portable, and
- Stationary applications.

Fuel cells will especially attract interest and gain first (niche) market access in application fields where they can offer decisive advantages and marketing value ('added value') above the incumbent, largely fossil technologies [106].

4.3.1 Transport

Fuel cells for transport applications are employed on electric or hybrid vehicles to supply on-board electric power. They form part of the power train and provide propulsive power to a vehicle either directly or indirectly (i.e. as range extenders) via the vehicle battery. In practically all cases the fuel cell employed in vehicles will be a PEFC. These vehicles will be fuelled by high-purity hydrogen (see Section 4.2.1). Once natural gas, liquefied natural gas (LNG), or synthetic natural gas (SNG) become more popular on larger vehicles (where hydrogen will not supply sufficient range),

high temperature fuel cells could be more widely employed in transport due to their ability to directly convert these fuels without additional processing.

Types of vehicles where fuel cells can offer specific advantages include:

- Forklift trucks and airport baggage trucks,
- Two- and three-wheeler vehicles such as scooters,
- Light duty vehicles (LDVs) such as cars and vans,
- Buses and trucks,
- Trains and trams,
- Ferries and smaller boats, and unmanned undersea vehicles (UUVs),
- Manned light aircraft,
- Airliners, and Unmanned aerial vehicles (UAVs).

Up until recently, fuel cell LDVs have experienced little popularity, however this is set to change as car manufacturers have started first rollout of commercial fuel cell electric vehicles (FCEV) in 2016/17, namely Hyundai and Toyota, with several others to follow suit. Initially, countries which have the most developed hydrogen refuelling infrastructure such as Japan, Germany and the USA, will be expected to have the largest number of fuel cell vehicles on the road. Rollout will spread outside of these countries once the market and fuel infrastructures become more established over time.

The fuel cell bus sector is growing on yearly basis, with more prototypes being launched onto the scene. Europe, Japan, Canada, and the USA have demonstrated successful deployments of these vehicles, yet the high capital cost presents a large hurdle for commercialisation. However, it is anticipated that the cost of fuel cell buses will be comparable to that of diesel-hybrid buses by 2020. Again, the investment premium has to be balanced with the savings in everyday operation with both fuel and maintenance/repair costs being lower than with conventional ICE buses.

To date, 'niche' transport is made up of several sub-applications with varying levels of commercial success. Materials handling vehicles make up over 90% of niche transport shipments where PEFC dominate. So far, this market has shown a lot of success in the USA. Unmanned aerial vehicles (UAVs), e-bikes and trains are under development for mass deployment in the near future.

Auxiliary Power Units (APU) are electricity generators on vehicles that will not supply energy for propulsion but on-board electricity for the various electric loads. On long-haul lorries these are the so-called 'hotel loads' for anything from heating, air-conditioning, entertainment (TV), up to preparing meals. When parked, many countries prohibit running the main engine of lorries so that other means of providing electricity are required. Similar problems exist for ships moored in harbours and aircraft at gates at airports. Ports will want to reduce the operation of main engines due to the considerable pollution from the emissions of the engines being run under very inefficient operating conditions. Supplying electricity from fuel cells offers substantial increases in efficiency, low to no emissions, low noise, no vibration,

and the potential use of the water generated for other functions on the vehicle (e.g. toilet water).

4.3.2 Portable

Portable fuel cells can be defined as fuel cells which are either built-in to electric devices or tools, or charge products that are designed to be moved (carried) around. Portable fuel cells can be used to power the following:

- Military equipment such as soldier power and skid mounted fuel cell generators,
- Portable products including torches and trimmers,
- Small personal electronics like mp3 players, cameras and mobile phones,
- Large personal electronics such as laptops, printers and radios, and
- Demonstration kits and toys.

Fuel cells are being designed in different sizes ranging between 5 and 500 W_{el} in order to power the wide variety of portable products. A fuel cell that has an output of less than 1 W_{el} is defined as a micro fuel cell the likes of which are being sold commercially for small personal electronics, phone chargers, demonstration kits, and toys applications. Large personal electronics such as laptops operate at up to 25 W meaning much larger fuel cells are required for this application. DMFC are popular for portable applications and have experienced successful deployment throughout the European leisure market selling over 50,000 units on a commercial basis without any funding. Portable PEFCs and DMFCs are set to either replace or considerably augment battery technology in some application areas, such as motor homes.

4.3.3 Stationary

Stationary fuel cells are units which typically generate electricity (and heat) for use in buildings and homes. This type of application includes combined heat and power (CHP), uninterruptible power systems (UPS) and primary (decentralised) power units (see next section for distributed and peak shaving generation). MCFC and SOFC can be employed to support the electricity grid in the form of 'distributed generation' (see further discussion in Chapter 6). This avoids or defers building additional central balancing power, for instance to compensate for large load fluctuations (often caused by industry, e.g. steel mills), upgrading grids when load is added (e.g. new residential developments), and for balancing fluctuations from renewable electricity generation. Within the confines of an industrial estate or large building block, distributed generation can also avoid excessive payments for peaks in power demand (so-called peak shaving).

Large stationary units typically generate power in the MW_{el} range for primary power applications. The aim is to develop these types of units to reduce peak demand on the grid and support areas with weak electricity grid infrastructure. In addition, these units can also be used to provide grid expansion nodes. PAFCs, MCFCs and SOFCs are common choices for large stationary applications. These types of fuel cells are mostly manufactured in the USA and Japan. When the (waste) heat generated in the electrochemical processes – which would otherwise be rejected to the environment via cooling radiators – is captured and put to use in a heating system, these systems

qualify as combined heat and power (CHP) units. Generally (with a system electrical efficiency typically in the range of 50%) this will be about half of the fuel energy fed into the system. At electric power ratings of around 1 to 2 kW_{el}, these systems are termed micro-CHP. Fuel cell micro-CHP systems offer the highest electrical efficiency of any CHP technology, >60% to AC power for some variants, nearly a factor of 2 above many conventional thermal power stations [107], while also enabling local use of waste heat without the need for distributed heating networks. Even with the use of natural gas, fuel cell micro-CHPs systems can enable well above 30% immediate reduction in CO₂ emissions [108, 109].

High temperature off-heat from MCFC and SOFC can be used for a variety of applications, including steam generation and coupling with a steam turbine to exploit the exhaust energy content. In industry, steam generation can be of value, as will be the coupling with absorption and adsorption cooling systems to deliver cold from heat. The high purity of carbon dioxide in exhaust streams from MCFC and SOFC fed with natural gas and especially pure methane (SNG) allows facile carbon capture and the use of the carbon dioxide for instance in greenhouse vegetable growing or food industry. Fuel cell systems operating on internal reforming can be operated to produce an excess of hydrogen so that from their exhaust stream hydrogen could be separated out, in this way offering an additional flexibility of the use of the fuel cell installation as a device for hydrogen co-production.

PEFCs and SOFCs are commonly used as CHP units which range between 0.5 and 10 kW_{el}. Historically, PAFC exploited this market first with typical installed capacities of 300 kW_{el} but are today hardly present as commercial products. The heat generated by these units can be used to supply hot water which improves the overall efficiency of the system up to 80 to 95%. By the end of 2016, more than 50,000 such residential CHP units with 0.7 kW_{el} had been deployed throughout Japan. Residential CHP units have also been deployed in South Korea, Germany, and across the EU, but like in Japan, purchases have relied upon government subsidies or demonstration projects. The current low volume of production means the units are still overly expensive. This will be further addressed in Chapter 8. The company Ceres Power, developing small SOFC systems, is one example for UK industry involvement in this sector.

4.3.4 Uninterruptible power

Uninterruptible Power Supply (UPS) units provide guaranteed power supply in the event of grid failure. This sector can be divided into five categories:

- Off-line short run-time systems for use in telecommunication base stations,
- Off-line extended run-time systems for use in critical communication base stations such as Terrestrial Trunked Radio (Tetra) networks,
- Off-line extended run-time rack mountable systems for use in data centres,
- On-line rack mountable systems for use in data centres, and
- Off-line systems for use in residential homes.

The first three categories are the most developed. Selection of fuels depends on the region, for example LPG and natural gas are more prevalent in Asia, hydrogen is

widely available in the USA, hydrogen and methanol are being trialled in Europe. Due to the high cost of maintaining UPS systems based on batteries and diesel generators, fuel cells meet a first competitive market opportunity here.

4.3.5 Special markets and applications

Fuel cells are also known to be employed in other fringe applications, as for example fire protection and emergency energy supply. 400 kW_{el} PAFC units are being employed to deliver the cathode off-gas which is reduced in oxygen content (the oxygen having been consumed to form water) to about 15 to 16% to feed the ventilation systems of data server buildings. These buildings are extremely critical to protect since the value of the data stored is immense. At the same time, fire protection is difficult because the use of water within the building is not favoured since it will destroy the equipment it is supposedly meant to protect. The oxygen-depleted air is sufficient for breathing (equivalent to working at 2,500 m altitude) whilst building materials will not be flammable anymore under these conditions. As mentioned above, fuel cells will in the future provide electricity on-board electric vehicles to substantially expand their range. As will be further discussed in Chapter 6, these fuel cells could also be employed to provide electricity to a building or to electric tools. FCEV could be considered as power generators on wheels that will provide electricity as long as the content of the hydrogen tank lasts (which would be several hours at maximum power). Once this concept has been embraced in its full implications, it will be realised that this opens up several opportunities current vehicle technology does not offer (describing an 'enabling' technology):

- Supply of electricity to houses in case of grid failure (UPS), as Toyota is already offering as a standard option for their FCEV in Japan, or
- Operation of FC hybrid vehicles (with battery and fuel cell system) as grid balancing storage and generation systems when parked and connected to a charging station.

Whilst the first option is rather obvious, the second builds on the possibility to use battery electric vehicle (BEV) that are parked and charging as two-way storage for the electricity grids. This has already been explored in several concept studies. The addition of a fuel cell allows for additional electric power to be integrated into the grid to cover peak load, compensate for fluctuations from renewable electricity from wind and solar, or generally deliver balancing and support power to the grid operator. The total generating capacity of a UK LDV fleet completely converted to FCEV could well be in the order of 600 GW_{el}. Clearly, regulation and suitable, incentivising tariffs are needed here and will be discussed in Chapter 8.

4.4 ALTERNATIVE FUELS FOR FUEL CELLS

Fuels cells are generally perceived to operate with pure hydrogen. Although hydrogen is considered to being an energy carrier of the future, there are a number of problems related to hydrogen generation and storage that must be overcome before it can be implemented on a wide scale. One of the biggest problems is that, at the present time, an estimated 97% of hydrogen is produced by reforming hydrocarbons [42]. Even with highly optimised large-scale production, between 15 and 25% of the fuel

value of the hydrocarbons is lost during this process, resulting in an overall (lifecycle) carbon footprint higher than that of direct natural gas use. Though this is compensated for by the higher electrical efficiency of fuel cells, production of hydrogen from fossil sources is clearly not ideal.

Since the high temperature fuel cells MCFC and SOFC use nickel anodes this allows direct use of simple hydrocarbons (e.g. methane or propane) and carbon monoxide. These fuel cells therefore can also operate on other gases than pure hydrogen. Such fuels include processed (pre-reformed) bio diesel, jet fuel, and alcohols [110, 111]. Methane contributes in excess of 95% to natural gas, making it an ideal fuel for SOFCs, enabling them to bridge the transition from fossil to renewable gaseous fuels.

Using methane as a fuel has led to the development of new anode materials for internal conversion to CO_2 and H_2O which evades the need for external reformation or production of hydrogen. Elimination of the reforming step decreases system complexity, increases the electrical efficiency, and avoids the necessity to dilute fuels with steam. Hence direct internal reforming (DIR) is the preferred route for using hydrocarbon fuels in fuel cells.

Hydrogen can be bound into a variety of compounds, including of course methane and methanol, but also ammonia (NH_3), borates, or even hydrogen sulphide (H_2S). All these can be split again at relatively mild temperatures on catalysts, making them potential fuels for fuel cells. This considerably widens the application of fuel cells in small scale applications. A UK company is developing such fuel – fuel cell combinations with borate and ammonia salts for small scale, telecommunication applications in Africa and India. The lack of hydrogen infrastructure is overcome by employing an easy-to-use, cheap, and abundant solid fuel that easily releases hydrogen.

4.5 CONCLUSIONS

Fuel cell technology has been in existence since the early 19th century and has seen substantial development over the course of time from being used on the Apollo space missions to powering today's commercial road vehicles like the Toyota Mirai. Fuel cells have a wide range of applications, depending on their physical properties (temperature of operation, weight, size, efficiency) and fuel: ranging from high-purity hydrogen up to natural gas and ethanol, to name but a few of the options. In recent times, fuel cells have become highly versatile as their usage covers transport, portable and stationary applications.

In general fuel cells offer considerably higher electrical efficiencies compared to the incumbent, mostly fossil fuelled technologies. Fuel cell micro-CHP competes with micro-internal combustion engines and Stirling engines with electrical efficiencies of 35 and 12%, respectively. In comparison, the equivalent fuel cell systems deliver electricity at 50 to 60% net electrical efficiency. This is largely true independent of electric power rating. Fuel cell systems between 1 kW_{el} and $10 \text{ MW}_{\text{el}}$ will have similarly high electrical efficiencies. Owing to the integration of such systems at or

close to 'point of use' the waste heat can be integrated into building heating systems or industrial process heat delivery, in the case of high temperature fuel cells including steam generation, air conditioning, and refrigeration.

The flexibility of using different fuels with fuel cell systems (hydrogen, natural gas, methane, methanol, ethanol, propane, LPG etc.) makes a strong case for their adoption in diversifying the heating and electricity fuel base in the UK. Natural gas could be used more efficiently in the short term, with biomass-based gases replacing in the medium term, followed by hydrogen and synthetic natural gas (SNG) in a future pipeline network, as proposed by the UK HFC Roadmap [112].

CHAPTER 5

HYDROGEN FUELS

FOR ENERGY

SECURITY

Robert Steinberger-Wilckens –
University of Birmingham

Zeynep Kurban – Imperial College London

Paul E. Dodds – University College London

5.1 INTRODUCTION

The four aspects of energy security – resilience, access to resources, affordability, and sustainability – to a large extent refer to issues of energy supply and especially the access to fuels. The latter three will be discussed at length in this chapter whereas ‘resilience’ of energy systems will be covered to a broader extent in the following Chapter 6. ‘Access to resources’ and ‘affordability’ are short-term goals. ‘Sustainability’, on the other hand, is a long-term goal of policy and aims at no less than the safe and materially secured societal life of many generations to come.

Plans for future developments in fuels used in the power supply, heating, and transport fuels sectors need to look into where the primary energy for these sectors is sourced in the long term and how the requirements of emission mitigation and sustainability can be met. At the same time, world market price volatility and access or lack of access to imports influence consumer prices and have to be kept at a level that is accepted by UK citizens. Due to the low standards of energy efficiency, especially in UK housing, energy bills tend to be higher than in other parts of Europe with a recurring theme of ‘energy poverty’. On one hand this could easily be reduced by increasing energy efficiency, on the other hand, it has been widely acknowledged that energy prices are currently too low to, in the long term, introduce the highly efficient technologies that will secure sustainable and affordable heating and electricity supply.

The vast possibilities to produce hydrogen from indigenous energy sources allow for reduction in imports and improvement of long-term security of supply. Hydrogen may also be converted to synthetic fuels based on renewable energy input that are fully compatible with today’s energy infrastructure of natural gas or transport fuels. Using the existing infrastructure for hydrogen and methane (synthetic natural gas, SNG) substantially reduces the cost of infrastructure conversion and makes best use of existing public assets.

5.2 UK ENERGY SUPPLY TODAY

Today, the UK consumes less energy than it did in 1998, with a decrease of 17% from 1998 to 2015 [113]. This decrease is largely attributed to 1) the increased use of energy-efficient technologies by consumers and companies, 2) government policies designed to reduce energy consumption, and 3) a decline of UK manufacturing, especially in energy-intensive industries. Moreover, increasing amounts of the energy consumed in the UK are coming from renewable energy sources – an increase from 1% to 9% (of total energy consumption) was seen in renewable sources, such as wind, solar and biomass, from 1998 to 2015 [114].

However, the declining supply of oil and gas from the North Sea has made the UK increasingly dependent on imports of energy. Figure 5.1 shows the change in the net import and export of UK energy sources since 1970: The UK became a net exporter of energy in 1981 due to North Sea oil and gas development, with a short period of net imports after the 1988 Piper Alpha disaster. Since 1999, when UK energy production peaked, the UK trend once again reversed to imports with the UK becoming a net importer of fuels since 2004, with the import dependency steadily increasing and peaking in 2013 due to decreases in North Sea oil and gas production. In 2014, due to overall reduction in demand caused by high fuel prices and a warm winter, imports temporarily decreased by 8% [113]. In 2015, the UK energy production was up by 9.6% on a year earlier, its first increase since 1999, which enabled reduction in imports for a second consecutive year. This rise in availability of indigenous fuel was due to the rise in UK Continental Shelf output of both oil and gas, following high world market prices, as well as the growth in renewable electricity production capacity, which accounted for 25% of the total electricity generation in 2015 [114]. Despite the reduction in imports and increase in exports in 2015, the net import was still 30% of primary energy used in the UK by the end of 2016 [114].

Figure 5.1 UK energy import dependency: the percentage of UK energy supply made up of net imports, 1970 to 2015, source: [113].

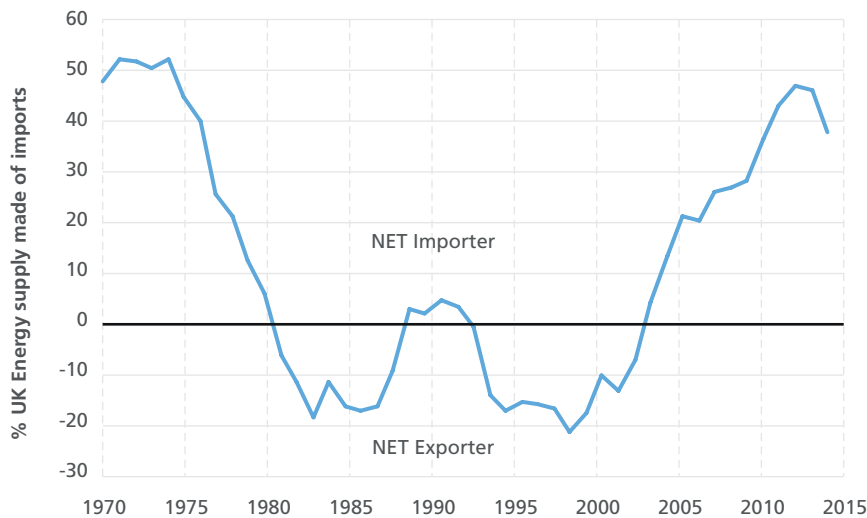

With electricity production, we currently have adequate capacity, but there are risks to security of supply over the medium term as around a fifth of capacity available in 2011 has to be closed down within this decade. The Government has implemented a capacity market within the Energy Market Reform to build a capacity market ensuring sufficient electricity generating capacity is kept available by the utilities to safely operate the electricity grid [116].

The UK's electricity demand may double by 2050 [117]. With the ongoing closures of old and polluting coal power plants, the challenge facing the future of the electricity network is growing. To keep the lights on, while transitioning to a low carbon electricity supply system, the power grid requires renewal, reinforcement and reconfiguration with a diverse, reliable, and resilient electricity supply affordable to the consumers. Currently, the UK electricity generating capacity available for peak demand (de-rated capacity) stems from a range of fuel sources: coal (27%), gas (41%), nuclear power (13%), renewables (8%) and other (5%), as shown in Figure 5.2. The UK also imports some electricity from other countries via interconnectors. The difference between total generation capacity and the highest demand peaks is defined as the capacity margin. The capacity margin has been tightening in the last few years as a result of decreased power generation capacity, mostly due to old power stations being closed down as they reach the end of their lives. The de-rated capacity margin for the 2016/17 winter is predicted as 2.5% [118]. The lack of replacement of power generation infrastructure, has driven the government, working with Ofgem, to introduce tools and mechanisms that enable National Grid to maintain system balance and to ensure sufficient supply exists to meet peak demand. The mechanisms introduced to ensure flexibility and security of electricity supply will be discussed in Chapter 8.

Figure 5.2 The de-rated capacity vs. projected peak demand for electricity in 2016/17, source: [119].

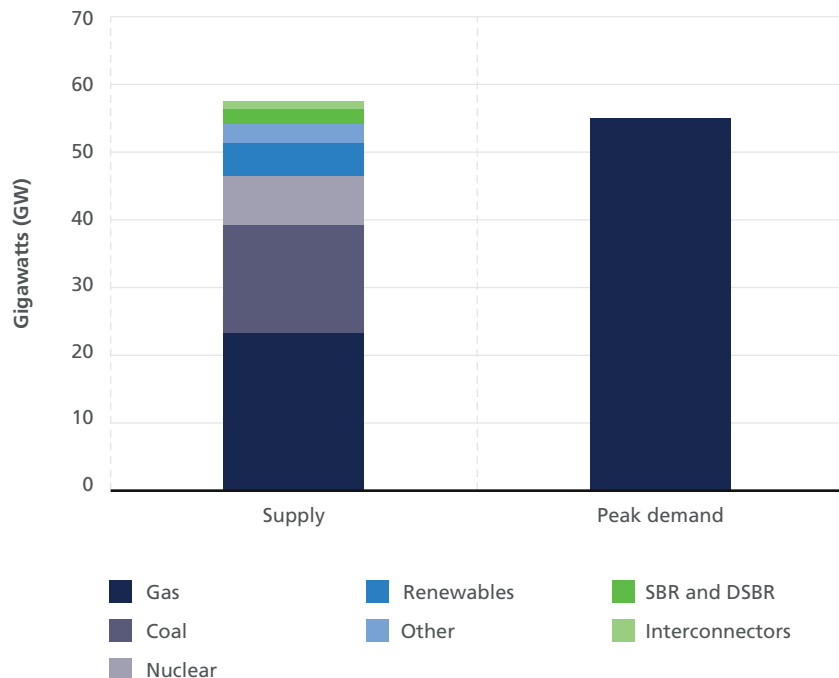

The UK, as Europe's second largest gas market, following Germany, has historically had a strong security of supply provision. The supply of gas from the North Sea enabled gas to displace the more carbon intense coal and oil products in space heating and power generation sectors over the past decades [120]. However, the considerable decline in the indigenous production of gas from the UK Continental Shelf, which began in 2001, has made the UK increasingly reliant on imports. Today, the net import dependency on gas is 50% and this is expected to increase to about 70 per cent by 2025 [116]. With the increasing costs of extraction of gas from the North Sea, the security of gas supply in the UK is on the decline. While the country has adequate capacity in terms of gas distribution infrastructure [116], more import infrastructure is needed to compensate for the loss in indigenous supply.

The composition of the gas capacity in UK and the expected demand for the 2016/17 winter is shown in Figure 5.3. Unlike the situation for electricity supplies, the margin between demand (465 Mm³/day being the highest ever) and supply, is 148 Mm³ based on current supply capacity. The supply capacity is composed of domestic Continental Shelf production (18%), gas pipeline from Norway (38%), gas interconnectors to the Netherlands, Belgium, Scotland and Ireland (19%), Liquefied Natural Gas (LNG) (16%) and stored gas (24%, the total gas storage being approximately 2,200 Mm³ of natural gas) (Figure 5.3). Future projections into 2035 by National Grid show the demand will remain constant in the future in the worst case scenario (Figure 5.4). It is projected that either the demand will decrease from today's level of about 75,000 Mm³/y in both the Gone Green and Slow Progression scenarios (based on increasing renewables in the power sector and the electrification of heating). Alternatively, demand will remain relatively stable (in the Consumer Power and No Progression scenarios) based on gas retaining a greater role in the power sector and economic growth increasing, with energy efficiency offsetting the difference arising from both factors. The figures suggest National Grid expects current gas supply capacity to be more than sufficient to meet even the highest levels of demand. However, in terms of the sources and cost of the supplies, with the declining domestic sources, the outlook is less clear.

The gas supply will become increasingly reliant on international markets. The IEA has described the global gas resource base as "vast and widely dispersed geographically", with estimated remaining recoverable resources of natural gas equivalent to 130 years [121]. However, with the increasing global demands, the uncertainty of the amount of gas available for imports in the long run is quite high. So is the political risk with dependency on energy exporting countries. Today, much of Europe's natural gas imports come from Russia with these supplies in the past years having been recurrently threatened by political intervention. LNG markets are expected to tighten towards the end of the decade. Furthermore, the supply of gas could be subject to disruption by external events, such as the geo-political situation with gas suppliers like Russia and the Middle East. Furthermore, as a result of leaving the EU, the UK increases the political risk associated with natural gas imports, as the infrastructure crosses EU territory and this could be used as a bargaining chip, if conflicts arise between both parties. All these factors create a high degree

of uncertainty about the accessibility, reliability and affordability of future gas supply to the UK. For this reason, the UK Government is interested in understanding the potential of national shale gas resources, as well as the benefits of converting the UK national gas grid to hydrogen.

Figure 5.3 UK daily gas supply vs peak demand expected for winter 2016/17, source: [119].

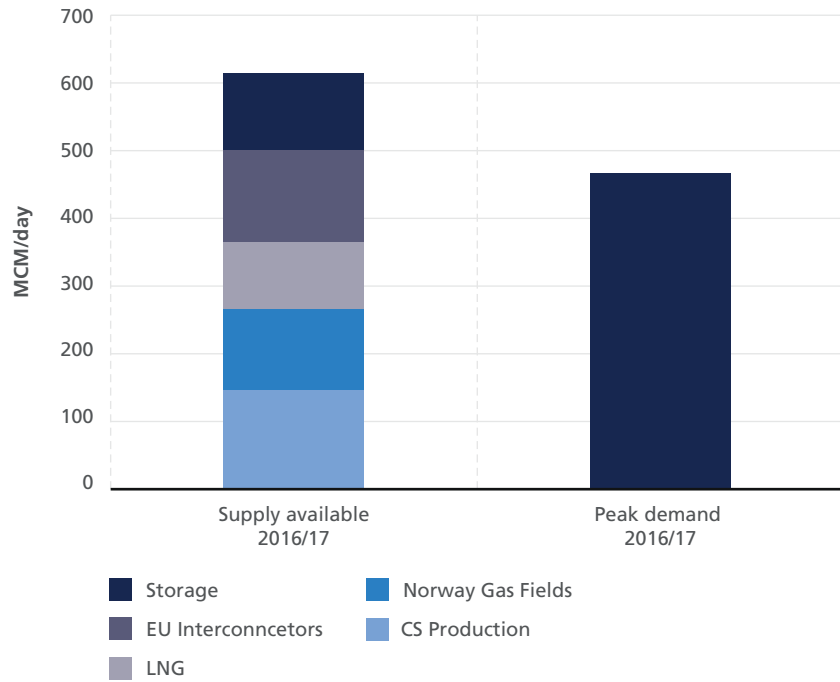
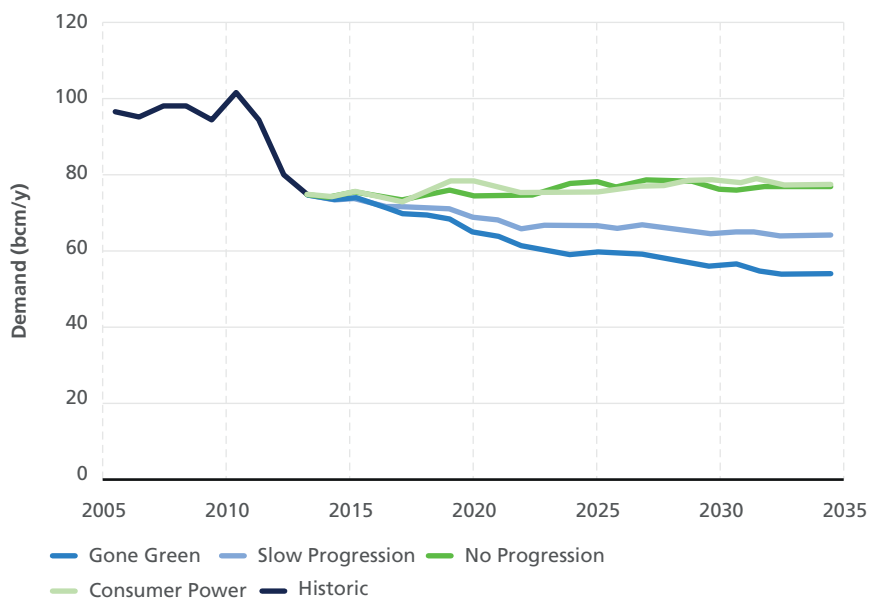

Figure 5.4 Historic and projected annual UK gas demand, source: National Grid scenarios from [121].



Oil is somewhat secondary, in which small supply interruptions can be tolerated and in which there is a stronger international market so the key risk is affordability rather than availability. Oil within the UK is currently resourced predominantly from the UK Continental Shelf. The make-up of UK's refinery capacity means that it currently has a surplus of petrol and a deficit of diesel and aviation fuel. These fuels are imported from continental Europe and the Middle East. As the production from the Continental Shelf declines, the UK will be increasingly dependent on oil imports, reducing the security of supply. To maintain the energy security of the country diversity of fuel supply, including imports, will need to increase – reliance on global oil markets will therefore surge. With demand predicted to rise globally, and oil supply becoming more diffuse due to recent technological advances, supply uncertainty and price volatility are expected to intensify. With a 90% dependency of the transport sector on oil derived fuels, this underlines the importance of developing more sustainable ways of powering transportation and linking the energy from renewables in the most cost effective way, while ensuring customer uptake of low carbon technologies.

5.3 FLEXIBILITY OF FUEL CHOICE

Historically, the UK has experienced a number of transitions between energy sources, namely the replacement of coal heating for buildings by town gas, followed by natural gas, and the replacement of coal fuel for power generation, again by natural gas. Whilst the former can be considered a permanent change of fuel source, the latter still depends on world market price developments and recent years have seen a (limited) return to coal as imported coal prices were low whilst natural gas prices increased. This relative 'fuel flexibility' relies on the availability of both coal and gas fired power stations in parallel at any given time. Transition times and barriers for changing the energy source for heating buildings, on the other hand, will be less flexible and depend on investment in new boilers rather than the potential of quickly switching fuels. Today, the UK, as previously discussed, very much depends on natural gas and very little coal as the prominent fuels for heating and power generation, and on oil for transport fuels. Few exceptions exist, for instance the fledgling market of natural gas and battery electric vehicles.

As explained in Chapter 3 hydrogen needs to be converted from other primary energy sources. This can be done from a multitude of primary energy types. Therefore, the use of hydrogen as a fuel in any of the three market segments mentioned above opens up possibilities to funnel a large variety of feedstocks into these markets. This would change the current situation dramatically where the heating market to a high extent relies on natural gas, transport fuels are dominated by oil, and electricity generation by gas and coal. In a future energy system with a major contribution from hydrogen, a diverse range of primary energy sources would feed into all these markets. This creates a hitherto unknown flexibility in the energy markets with respect to the primary energy sources at the base of end energy supplied to customers.

This also means that end-use devices using hydrogen would be decoupled from short-term commodity price hikes or supply interruptions which would be mitigated by switching to other production plants. In this regard, hydrogen offers similar advantages and versatility as electricity. A long-term strategy would be required to shape the resulting hydrogen production ‘fleet’ to:

- provide sufficient diversity in the hydrogen production portfolio to enable sufficient short-term production flexibility if one type of primary energy were to become unavailable or scarce for any reason; and,
- implement backup and reserve capacities to have sufficient production capacity to enable ramping up production from unaffected types of production when fuel switching is necessary.

With the high diversity of such a system, a ‘system architect’ or ‘clearing house’ approach is needed that allows for a well organised design, arranging for the interfaces with the players in the liberalised energy market. Policy planning needs to prepare this conversion of energy infrastructure, as we will further discuss in Chapter 8 (Section 8.4.1), in order to secure long-term investments. At the moment the choice of production technology depends primarily on the feedstock availability and overall technology and process cost. This will vary depending on the level of carbon pricing introduced over time leading up to an 80% decarbonised energy system by 2050 (cf. Section 5.8). A national hydrogen production technology roadmap is needed to show how hydrogen can be best produced in the short, medium and long-term. This needs to take into account the availability of the feedstock and technology readiness levels, with international considerations such as future price volatility of feedstocks, the cost of policy intervention (e.g. carbon pricing), and fuel import and export opportunities that can be developed over time. Currently without a CO₂ tax, the hydrogen production (based on commodity prices) from steam methane reforming (SMR) or SMR+CCS (£1–2/kgH₂eq) appears to be the cheapest way forward (cf. Chapter 3). Thus, the government needs to re-assess and make a decision on the support it will provide for developing CCS technology. But with introduction of a carbon tax at a rate of £250/tCO₂, hydrogen production from Biomass + CCS becomes cheaper than petrol and gas. With technology optimisation and economies of scale, hydrogen production costs from electrolysis can also be reduced. The U.S. DoE claims this will be the case by the year 2020 [76].

In Chapter 7 we will show that when hydrogen is introduced as a vector for decarbonising the energy system, it broadly displaces natural gas and petroleum-fuelled technologies rather than electrical devices, so the increase of diversity within the whole system is limited to the gas and transport fuel markets. On the other hand, hydrogen tends to increase diversity over strategies that focus on electrification, but not in all parts of the energy system or in all circumstances; the ‘Full Contribution Scenario’ from Chapter 7, based on high levels of hydrogen deployment, suggests the highest diversity. The policy planning for infrastructural investment for energy security should take this factor into account, in terms of both feedstock availability over time (e.g. expected changes in availability of indigenous coal and gas reserves) and the necessary funding needed to enable economic viability of more sustainable options (e.g. hydrogen

production from electrolysis and biogas). Research and development funding for hydrogen production (to name but a few of the options) will be needed to further diversify hydrogen production and to reduce reliance on fossil fuels [8].

5.4 DECARBONISATION FOR SUSTAINABILITY

Hydrogen can be produced from coal, oil, or natural gas, releasing the carbon dioxide emissions connected to these fossil energy sources. It has been demonstrated that producing hydrogen from fossil primary energy does not reduce the overall emissions as compared to direct utilisation. The increased efficiency when using hydrogen in fuel cells is offset partly or completely by the energy losses in hydrogen production [122].

With hydrogen production from renewable energy sources, including biomass, wind, solar, and also wastes, the environmental impact is minimised. Since there will be fossil fuel input to the total life cycle of hydrogen production and use, we use the term ‘low carbon’ throughout, even for ‘green hydrogen’ from 100% renewable sources, although systems can be envisaged that would supply ‘zero’ carbon in the long-term.

As mentioned in Chapter 3, the possibility of carbon sequestration exists, though not commercially viable, so that even fossil energy sourced hydrogen could be produced without immediately releasing CO₂ to the atmosphere. CCS technologies, though, remain high cost and have not been proven to be economically or environmentally viable in any way. It appears that additional cost premiums would better be spent on technologies that by principle are sustainable – such as renewable energy developments – than simply deferring release of CO₂ to the environment by decades, or maybe centuries. Nevertheless, CCS might be necessary in a transitional period if the growth of renewable energy sources is not sufficiently supported.

Hydrogen and synthetic methane fuels produced from renewables, to name the two most important options to produce zero-carbon-balance fuels, can be converted to electricity and heat in fuel cells. This indicates pathways towards a fully de-carbonised energy economy. The higher efficiency of fuel cells as compared to, for example, ICEs or many stationary power generation types contributes to the efforts of reducing energy demand whilst at the same time avoiding harmful emissions at point of use, improving air quality. Using the electrochemical fuel cycle shown in Chapter 3 (Figure 3.7) will allow to utilise renewable energy input both in the form of primary electricity (solar, wind, ocean etc.) and biomass/waste to drive a fully de-carbonised conversion cycle of primary energy and zero-carbon fuels.

The result is a fully sustainable future energy system that will deliver a de-carbonised energy supply along with a high degree of national independence from fuel imports (cf. following section), and an equally high degree of energy price stability (cf. Section 5.8).

5.5 INDEPENDENCE OF FUEL IMPORTS

Production of gas and oil from the UK Continental Shelf is declining at a sharp rate. The production of gas has decreased by 60% since 1999 [114]. The UK will therefore be increasingly dependent on imports by pipeline from Norway and The Netherlands bringing in further North Sea and Dutch production, as well as passing through gas deliveries that enter Europe from Russia, and the Middle and Far East through the major European pipeline projects. As production in The Netherlands is also reaching its climax, an overall growing dependency of Europe on gas imports is imminent. Oil import dependency has already reached the mark of 80%.

Gas will in the future also be delivered increasingly as liquified natural gas (LNG) by tankers from Indonesia, Malaysia and other production sites not connected to Europe by pipeline [123], and to a certain extent also from the U.S.A. who claim to have considerably reduced natural gas prices by extensive use of fracking. It remains to be seen, though, whether this low-cost reserve will be allowed to leave the country.

Growing dependence on imports puts the economy and politics in a difficult position since political pressure on the UK could increase with increasing dependency on gas imports, especially as much of the European gas market may in the future be dominated by Russia which is today the world's leading natural gas supplier [123]. This can be avoided if imports can be drastically reduced in the face of a domestic gaseous fuel production based on renewables.

When hydrogen is produced from renewable energy sources within the UK, it can be fully considered as an indigenous energy carrier. This will decouple domestic energy use influences from world market volatility. The flexibility of feedstock choice to produce the hydrogen, as discussed above, will allow for a more diverse energy market with less pressure from single market players since any dominating specific feedstock can to a certain extent be compensated from numerous alternatives.

5.6 LINKING ENERGY SECTORS: HYDROGEN AND METHANE INFRASTRUCTURE

Hydrogen can be produced from a number of different energy sources, including fossil and renewable resources, as was previously explained (Chapter 3 and above). Biomass and wastes in solid or liquid form can be converted into hydrogen rich gases. Renewable electricity can be used in electrolyzers to directly split water and carbon dioxide. Hydrogen and hydrogen rich gases can be converted to synthetic natural gas (SNG) through a methanation step that combines hydrogen with CO₂. These gas mixtures can also be used in chemical industry as an essential raw material for the production of plastics and fertilizers. Hydrogen and hydrocarbon gases and liquids can be converted to electricity at high efficiency in low (80 to 200°C) and high temperature (500 to 950°C) fuel cells. These brief examples are intended to underline the versatility of both hydrogen and fuel cells as elements of a future UK energy system.

The main point to be made here, though, is the linking function that both, hydrogen and synthetic natural gas, fulfil across the whole energy system. Traditionally, specific fuels are limited to certain sectors of the energy supply chain – coal being today practically exclusively used for power conversion, liquid energy carriers for mobile applications, natural gas for house heating and power generation, with a very low level of employment in transport, and with electricity being the most versatile energy form with a variety of different usages across the energy sectors, from heating buildings to powering public transport.

The use of hydrogen across a broad range of applications in all energy sectors introduces a novel aspect to the energy system, namely the linking of different applications and primary energy sources through the use of the same ‘raw material’ across these sectors. This aspect is slightly different from the ‘fuel flexibility’ aspect discussed in Section 5.3 which looked into the various sources of energy used to produce hydrogen. Here, we are looking at the ways hydrogen production supplies a ‘linking’ element between the three main energy markets by shifting flows of energy from one to the other.

This is illustrated in Figure 5.5, which shows the three main energy conversion pathways (Power-to-Gas, Power-to-Power and Gas-to-Gas) in a future renewable energy integrated system in which hydrogen acts as a common denominator to transfer energy from the electricity grid to the gas grid, and vice versa:

- **Power-to-Gas (P2G):** in this case, electricity is used to generate hydrogen via electrolysis. The hydrogen is then either injected into the gas distribution grid or transformed to synthetic methane (SNG) in a subsequent methanation step [124]. The CO₂ required for the methanation can be sourced from biogas anaerobic digesters which, combined with CCS at the point of use of the SNG, effectively results in negative CO₂ emissions [125]. A systems analysis of power-to-gas can be found in [124] and [126], with the short term and long term business opportunities analysis provided in [127].
- **Power-to-Power (P2P):** here, electricity is used to generate hydrogen via electrolysis, the hydrogen is subsequently stored, and then used to generate electricity via a fuel cell (kW_{el} to MW_{el} scale) or a hydrogen gas turbine (multi MW_{el} scale) at times of increased demand. The hydrogen produced can also be used as a fuel for fuel cell electric vehicles (FCEVs) in the transport sector, which is referred to as **Power-to-Fuel (P2F)**. In P2F the electrolyzers can be placed in re-fuelling stations and large pressurised storage tanks can be used to store the hydrogen.
- **Gas-to-Gas (G2G):** indicates the case where steam methane reforming (SMR) is used to produce hydrogen from natural gas. As discussed in Chapter 3, approximately 95% of hydrogen produced worldwide is produced via SMR. However, as CO₂ is released in this process, CCS technology is needed to reduce the carbon footprint. The hydrogen can substitute natural gas in the supply to buildings and be used in fuel cells for micro-CHP or in heating boilers. This pathway has been presented by the ‘H21 Leeds City Gate’ study for decarbonising heat in the UK [128]. Further analysis is required to clarify how much of the natural gas could be replaced by methane from biomass sources.

The hydrogen generated through these processes can be stored in pressurised tanks (for small scale applications) or in natural gas pipelines and/or underground caverns (for grid scale applications). P2G and P2P enable flexibility in a highly renewables integrated system by balancing the fluctuations of renewables. The G2G pathway, on the other hand, enables the use of the existing gas infrastructure with hydrogen replacing natural gas as the energy vector for heating, cooking etc. In the case of G2G the Leeds City Gate assessment shows that the modifications required for the gas grid will cost no more than the upgrades being undertaken through the current Iron Mains Replacement Programme [128].

Figure 5.5 Schematic diagram showing the three main energy conversion pathways (Power-to-Gas, Power-to-Power and Gas-to-Gas) in a renewable energy integrated energy system, source: [129].

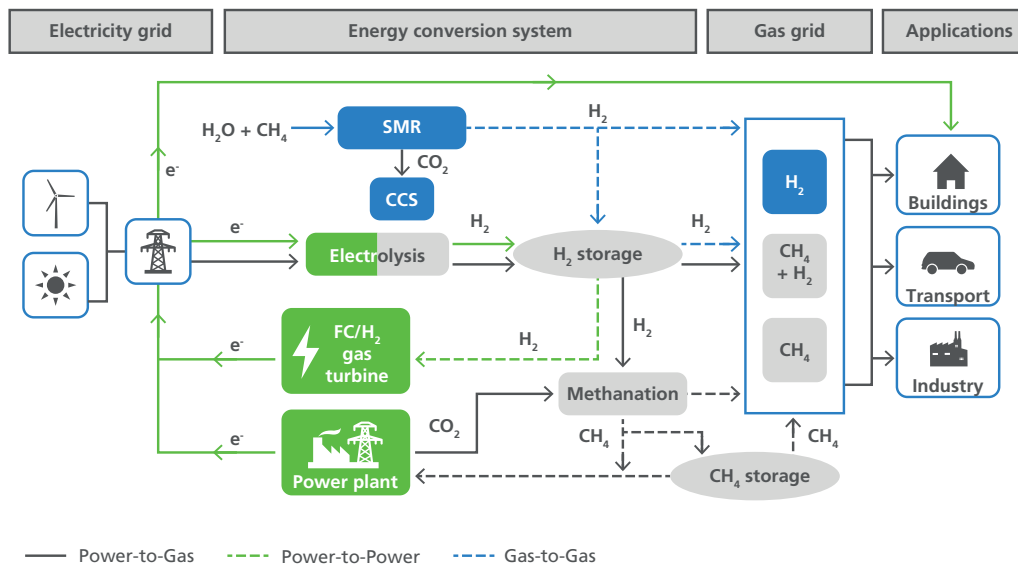

The choice of the optimum hydrogen pathway with lowest costs and highest benefits depends on the trade-off between several factors, including system costs, efficiency, decarbonisation impact, and the practical feasibility (e.g. public acceptance) of changing the existing gas distribution system in a given area to supply hydrogen. Ultimately, the choice depends on capital expenditure, policies, and the pace of commercialisation of the technologies needed for each pathway. Blending of hydrogen with natural gas in the existing gas infrastructure (using P2G) may be more desirable in the short term in view of lower initial capital expenditure, even though it is not the most optimal in terms of carbon savings. For example, 80% hydrogen in the gas mixture by volume reduces CO₂ emissions by 50% [130]. Nevertheless, it provides the opportunity to off-load surplus hydrogen produced from excess renewable power, rather than curtail it. However, the amount that can be blended depends on national gas standards, which needs to be reviewed as the current standards set a limit that is significantly lower than what the pipelines can carry from the point of view of gas safety. On the end-use point, blends in excess of 20% hydrogen requiring end-user appliances to be converted or replaced [131] because of the effects of hydrogen on the Wobbe index [132] and sustaining safe combustion.

Figure 5.6 The step conversion efficiencies for the hydrogen supply pathways being considered, data from [129].

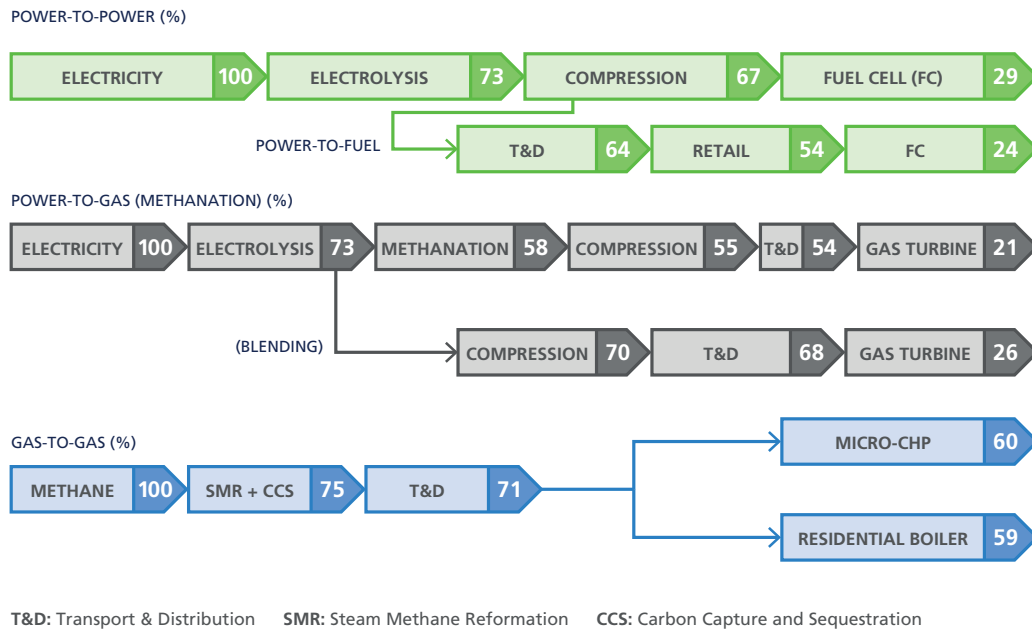

The economic benefits of implementing storage to manage high levels of renewable electricity generation have been shown in several studies. One study shows £10bn/year savings can potentially be realised in the UK with storage technologies in a 2050 high renewable energy scenario [133]. One of the balancing strategies deployed by National Grid is to pay wind farms to switch off ('wind curtailment') when energy is produced that cannot be immediately absorbed by the grid. This has cost the UK customers £80 million in 2015 [134]. With increasing level of renewables connected to the power grid, without the grid capacity increased, this cost will be increasing. In 2016 with 10% total wind capacity available on the grid, 6% was constrained at some point in time [134].

Besides hydrogen, several different technologies are being investigated for grid scale electricity storage including lithium ion batteries, redox flow batteries, compressed air energy storage, supercapacitors, thermal energy storage and flywheels [115]. A mixture of these options can be used for balancing supply and demand, supplying frequency control and other benefits such as curtailment minimisation, demand-side management, contingency grid support, etc. [135]. Hydrogen offers several advantages over these options:

- hydrogen is one of the most versatile of all energy storage options and the possibility to use it in both the power and gas grid offers the opportunity to decarbonise all energy use sectors (transport, buildings, industry). The multitude of pathways in which non-renewable and renewable primary energy can be converted into hydrogen enables unprecedented system flexibility.
- hydrogen can store larger amounts of energy per unit volume than other large scale energy storage options being considered: it has over 200 times the volumetric

energy storage density of pumped hydro storage and 50 times that of compressed air [115]. In any case, the hydrogen gravimetric energy density of 33 kWh/kg is unsurpassed by any other energy carrier.

- hydrogen can be used for both intra-day and inter-seasonal storage, enabling a greater degree of flexibility with diurnal and seasonal variations.

The most important aspect of this part of the discussion is that fuel cells and electrolysers introduce the novel possibility of the conversion of electricity to a gaseous fuel and back again, with all the advantages gaseous fuel transport and storage offers over electricity. Ultimately, a fuel can even be produced (SNG) that can be transmitted in the existing natural gas grid with no modifications at all [128]. Through these supply pathways, hydrogen can ultimately become a universal fuel that can be used across the complete energy system.

Overall energy efficiency is considered an important factor for deciding on the choice of technology and supply pathway. While fuel cells have higher electrical efficiencies (ranging from 40 to 60% based on the type, as discussed in Chapter 4) and total efficiencies (combined electrical and thermal, up to 95%) than internal combustion engines (40% in their best point), the conversion losses in P2G gas and P2P result in overall conversion chain efficiencies in the range 20% to 30% (Figure 5.6). But in the case of G2G the final efficiency can be as high as 60% due to the employment of CHP schemes. While a comparison of the overall efficiency of the different pathways with alternative options for storage can aid decisions for selecting the most optimal configurations, they must be considered in light of all the benefits enabled by hydrogen, fuel cells and electrolysers. Hydrogen, through P2G, P2P and G2G, is the only low carbon energy vector that allows a similar degree of versatility enabled by fossil fuels today, even adding further flexibility, as discussed previously.

There are approximately 40 power-to-gas demonstration projects in Europe [136]. Germany is currently leading the way in terms of demonstrating P2G and P2P concept at grid scale: 20 plants were reported to be in operation with 10 facilities being planned or under construction in August 2015 with a power range of 100 kW_{el} to 6 MW_{el} [108]. During the charging phase, the power of the system is determined by the size of the electrolyser, whereas the energy stored is determined by the size and pressure of the hydrogen store (as discussed in Chapter 3). Both elements are independent of each other so that the power absorbed by the P2G system is in no way tied to the storage capacity. This is a decisive advantage over batteries.

5.7 HYDROGEN TRANSPORT AND DISTRIBUTION

Hydrogen transport and distribution (T&D) infrastructure consists of pipelines connecting hydrogen production and storage points to end use sites. Currently, much of the existing high pressure distribution and transmission pipelines are made of high strength steel. Hydrogen can embrittle steel, so the pipelines will need to be changed if hydrogen is to be transported through the natural gas pipeline network. However, in the UK most steel pipelines originate from when town gas was distributed, which had a fraction of up to 50% of hydrogen. Low pressure natural gas pipelines require

upgrades to reduce methane leakage on both safety and environmental grounds, and these are currently being converted to polyethylene pipes through what is known as the Iron Mains Replacement Programme. Polyethylene pipes are suitable for transporting hydrogen at low pressures [137]. Further work is needed to assess the suitability and, if need be, the conversion costs of all other system components such as seals between pipes, pressure reduction stations and the end use components. Such a transition to G2G pathway will take time, and decisions will need to be made in the near term if the Government's is to meet the 2050 CO₂ reduction targets on time. Globally, the feasibility of gas network conversion should be assessed on the basis of infrastructural changes (e.g. upgrades) that will nevertheless be needed, even without the conversion to hydrogen.

The blending of hydrogen with natural gas could be a transition step towards the conversion of the gas grid to transport 100% hydrogen. Currently, the main uncertainty in this supply pathway is with the amount of hydrogen that can be blended safely. In the UK, [137] suggests that early levels of hydrogen should be limited to 2–3% within the UK natural gas pipeline. A directed assessment is needed to determine the limits of hydrogen that can actually be stored safely when mixed with natural gas.

Globally the figures differ, as the amount depends on the characteristics of the natural gas used, as well as on the design of existing appliances [138], and therefore will vary by region. An EU study (NaturalHy) [139] concludes that 30% hydrogen can be added without an adverse increase in risk to the public, another study suggests a safety limit of 20% in the Netherlands, although the current standards set the limit as 12% [138]; in Germany the set limit is 5%, with potential to increase to 20%. In the U.S. State of Hawaii, 10% hydrogen is already mixed into the natural gas grid. Furthermore, the currently used end use appliances need to be considered when setting limits. According to the NaturalHy study, with modifications to the appliances and favourable conditions of natural gas quality, the appliances can safely operate with up to 20% H₂ in natural gas [139].

5.8 AFFORDABILITY

Affordability is an important axiom of energy security. The cost of hydrogen can be estimated by calculating the levelised cost of hydrogen (LCOH), which is analogous to the levelised cost of electricity that is often used to compare power generation technologies. This approach looks into the cost of providing services, not the end-use cost to the customer. Hydrogen today is sold as a vehicle fuel at £10/kgH₂ and less at hydrogen filling stations [140, 141]. This equates to £0.30/kWh of fuel energy content, which is roughly seven times the price of natural gas. Compared to petrol, this is about double (all taxes and levies included in all prices). In this case, though, the difference is over-compensated for by the higher conversion efficiency of fuel cell electric vehicles (FCEV). This results in hydrogen today being competitive with diesel as a vehicle fuel – as far as the costs of operation (excluding the vehicle investment) are concerned.

The LCOH is shown for several of the hydrogen production technologies discussed in Chapter 3 and Figure 5.7. SMR and coal gasification have the lowest costs. As might be expected, CCS versions of each technology are more expensive than the unabated plants. Very limited cost reductions through innovation are forecast, and are generally balanced by higher feedstock prices. The impact of levying a carbon tax on hydrogen production, increasing from £50t/CO₂ in 2020 to £250/tCO₂ in 2050 are shown in Figure 5.8. Unabated plants become substantially more expensive than CCS plants as the tax increases. Biomass CCS changes from the most expensive to the cheapest option as the carbon tax increases, as it is assumed that such conversion would be paid for removing carbon from the atmosphere with effectively negative carbon emissions as atmospheric CO₂ is sequestered underground.

In Figure 5.9 the lower-cost hydrogen production technologies rely on the development of CCS in conjunction with high carbon taxes. There is much uncertainty over the technological feasibility and political will to build CCS facilities. In the absence of carbon taxes, the cost of producing low-carbon hydrogen will be much higher.

Figure 5.7 Levelised cost of hydrogen forecasts for the UK, without a CO₂ tax (£/kg).

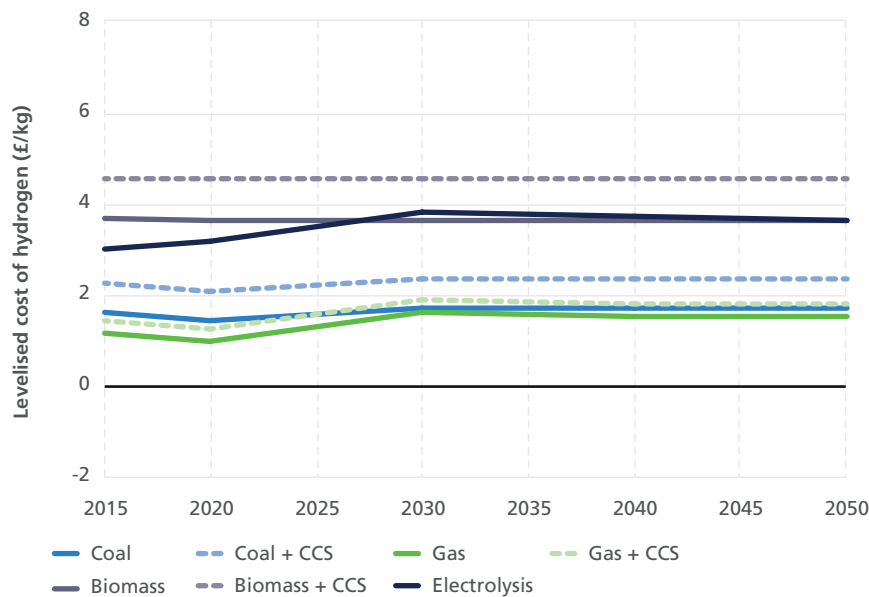

Capital cost data are from [51]. Feedstock price forecasts are primarily from [142] and [143]. Other data are taken from the UK TIMES energy system model.

Figure 5.8 Levelised cost of hydrogen forecasts for the UK, with a CO₂ tax increasing from £50/tCO₂ in 2020 to £250/tCO₂ in 2050. No tax is levied on electricity in this diagram.

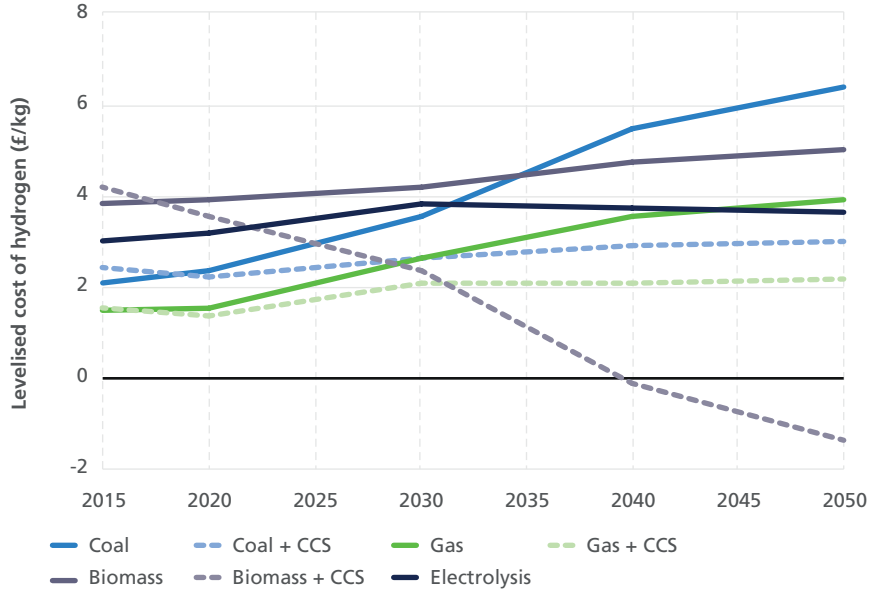

Price volatility is an important facet of energy security. Figure 5.9 shows the uncertainties in the LCOH in 2050 that result from commodity cost and capital cost uncertainties. The capital cost uncertainties would be removed once a production plant were constructed, leaving only the commodity cost uncertainty shown by the boxes. With the exception of electrolysis, the commodity cost uncertainties for hydrogen are substantially lower than the uncertainty in the oil price for transport, but similar or higher than the uncertainty in the gas price for heat provision. Figure 5.10 shows the same graph when a CO₂ tax is levied. The level of uncertainty does not increase as the overall price increases, because the tax is levied at a fixed rate of £250/tCO₂ and uncertainties in this are not considered. Hydrogen is cheaper than fossil fuels with this tax, even after accounting for price volatility.

Figure 5.9 Hydrogen production cost forecast ranges in 2050 without a CO₂ tax. The boxes show the impact of feedstock price uncertainty. The lines show the impact of capital cost uncertainty. The fossil fuel costs are for the quantities of fuel that are required to provide the same energy service that 1 kg of hydrogen would provide, assuming the dominant hydrogen technologies would be gas boilers for heating and fuel cell hybrid electric vehicles for transport.

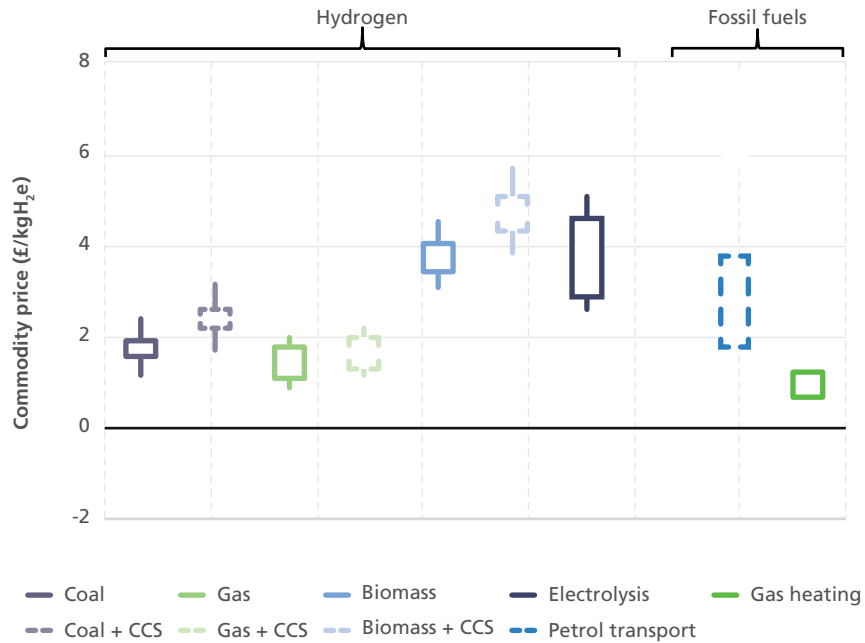
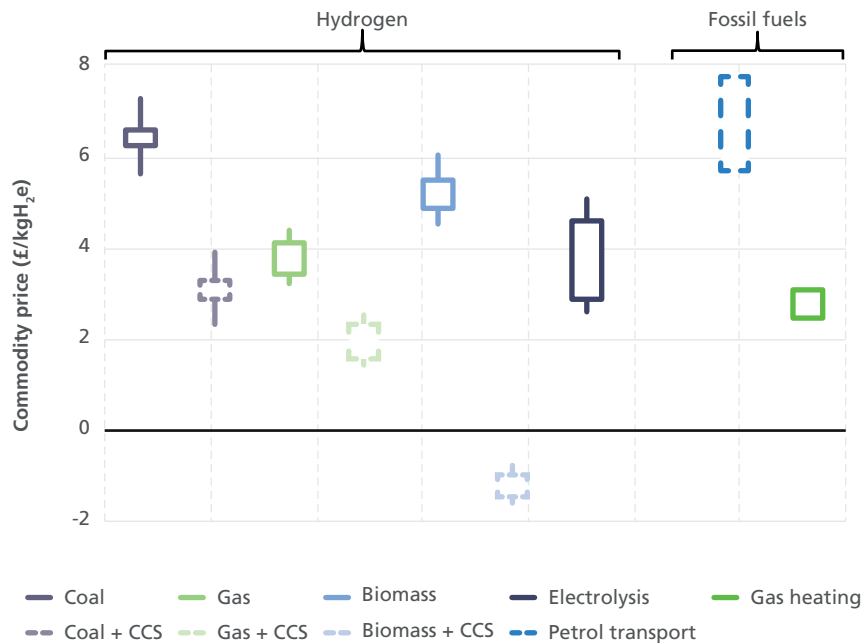

Figure 5.10 Hydrogen production cost forecast ranges in 2050 with a CO₂ tax of £250/tCO₂.



Producing bulk amounts of hydrogen from renewable energy sources not only supports a sustainable primary energy supply infrastructure but also allows investments to remain in the country and contribute to local job growth instead of being exported to the countries selling fossil energy. Since most renewable energy developments are capital intensive but low-cost on the side of operations (quite contrary to fossil energy conversion), investment in national renewable energies and hydrogen production can contribute to long-term stability of energy prices. The only exceptions are schemes that use biomass and wastes, such as the recycling business. As the business grows and with it the value of the wastes processed, companies might have to pay for waste, instead of being paid to remove it. In these cases the operating costs do not remain constant and the business model collapses. A recent move of supermarkets to give away food wastes to charities was not welcomed by waste processors [144].

When building on hydrogen from renewable energies, the UK economy significantly reduces influences from world market energy price volatility. This adds a decisive element of both security of supply and affordability, since the risk of an impact of external energy markets and policy developments on the UK economy is greatly reduced. Transport fuels are an outstanding example of the impact that world politics can take on key aspects of a healthy economic development. With a high dependency of the pricing of processed oil products on international markets, world market price volatility of crude oil and oil products will immediately take a hit at the economic competitiveness of UK businesses. Successfully introducing hydrogen and SNG fuels in road transportation will reduce the dependency on fuel imports and mitigate the impact of oil price fluctuations, as well as securing long-term price stability in this sector. It also reduces risk and therefore allows to reduce the contingency margins costed into market prices of oil products and the services that depend on them.

As mentioned above, renewable energy, fuel cell, and hydrogen projects suffer from the fact that they induce a high capital investment. This can be partly offset by operational savings. What makes things worse in the case of these technologies is that they are essentially 'very low carbon' but compete with heavily polluting incumbent technologies. The expectation in government policies that low carbon technology should not induce additional costs is misleading in that it ignores the high cost the taxpayer carries for compensation measures caused by the externalities of fossil energy use. A large part of the environmental and health costs of energy use result in Government expenditure to cover for the increasing impact of natural disasters, climate change mitigation, emission control programmes, compensation for farmers with reduced crop harvests (e.g. due to high concentrations of ozone), damage by acidification of soils and water and to the built environment (e.g. acid rain on facades) etc. The costs of fossil fuels should therefore internalise the cost of the externalities that they produce. In addition to these costs effectively carried by the tax payer, UK citizens pay in the way of considerable impacts to health and wellbeing, for instance when considering the impact of smog in urban agglomerations, such as London, on premature deaths. Air pollution levels have been substantially higher than allowed leading to an estimated 29,000 premature deaths [145, 146]. According to EU rulings,

citizens have a statutory right to healthy living conditions which is largely ignored by councils in the EU urban agglomerations. An increasing number of legal claims is being brought forward to hold councils accountable, causing considerable legal costs.

In economic assessments of the viability and competitiveness of technical alternatives to incumbent technologies, a total cost of delivery would have to be employed in order to avoid any bias in the comparisons. Today, this is not the case and zero-carbon technologies are compared to highly polluting and damaging technologies. These have a history of causing long-term costs to future generations even when they cease operation [147]. The situation results in a biased assessment. A level market field approach is needed where the full costs of service need to be costed into comparisons of different energy technologies.

A fairer distribution of costs, where cause and effect are more intimately linked, i.e. by energy use being charged with the full societal cost ('polluter pays' principle), would be difficult to implement. Nevertheless, even in the short term this would trigger the correct incentives to reform the energy market and automatically provide long-term sustainability. Fuel cells and hydrogen fuels are prone to cost more than century-old incumbent, but polluting technologies, since they are new arrivals to the energy market. Integrating the environmental costs of energy services into market pricing would immediately give these technologies the place in the market that corresponds to their environmental performance.

Much progress has been made worldwide in estimations of environmental and individual costs of energy services for instance as estimates of the cost of climate change [148], the external costs of electricity supply [149], and the external costs of transport services [150]. In all cases, a considerable premium is required to level out the cost of conventional and fossil energy provision, with the increasingly unsupported zero- and low-carbon options. In the case of passenger vehicles, this is a surcharge of around 100% on the pump price of petrol and especially diesel (depending on current oil prices). Though the inclusion of externalities in end-use pricing would increase consumer prices, it would be income-neutral at the national level, since it removes respective government expenditure sourced from taxes.

Careful analysis, though, shows [151] that even with supposedly clean fuels – such as hydrogen produced from conventional grid electricity which causes zero-emissions at point of consumption – the environmental premium may increase due to the primary energy inputs. Care has to be taken, therefore, that any implementation of hydrogen and fuel cell technology actually takes heed of the environmental and emission issues in full. Mixing technologies that will deliver zero-carbon services at point of use (e.g. battery electric or fuel cell vehicles) with a supply of fuels from highly polluting sources (e.g. grid electricity and hydrogen from natural gas steam reforming) will cause more damage than the incumbent technologies. This again underpins the need for a full societal cost analysis in going forward to choosing future energy options.

5.9 CONCLUSIONS

This chapter has shown that hydrogen can be produced close to economic viability from a range of feedstocks. Depending on the end use of hydrogen, operational costs might be cheaper than conventional fuel systems. This is certainly the case for fuel cell electric vehicles (FCEV) where hydrogen prices at filling stations already outperform diesel, considering the powertrain efficiency gains in the vehicle. In the future, the environmental benefits of hydrogen applications need to be captured in the pricing of the fuel. Fossil fuel prices do not mirror the high pollution levels that they incur and the political risks that they bear. The systematic bias of the energy supply system towards fossil fuels needs to be addressed so that fuel prices reflect their true social costs, including a contribution towards mitigating environmental damages (GHG emissions and air quality pollution). This approach will support the competitiveness of hydrogen, accelerating its market penetration.

End-use devices using hydrogen are decoupled from the primary energy source, such that the impacts of short-term commodity price hikes or supply interruptions are mitigated by switching to other production sources. Hydrogen offers similar advantages to electricity in this regard since in its application it is of no relevance where the energy used to generate it originated from. Hydrogen contributes substantially to increasing the flexibility of the energy system by increasing the options for access to primary energy sources, as well as reducing the risk of unavailability of any one source.

Hydrogen is versatile and can be either used directly or converted to many other gases, starting from a variety of feedstocks. This includes synthetic natural gas (SNG, pure methane) or town gas. In the long run, the feedstock can in principle be 100% renewable. This offers options for supplying fuels for a fully sustainable energy system with a perspective of securing energy supply for several centuries.

Using electrolyzers and fuel cells, hydrogen can contribute significantly to balancing electricity grids with high proportions of renewable electricity and links the electricity and gas networks. Excess electricity can be stored as hydrogen at lower cost, compared to other electricity storage options, for longer periods of time. Gas storage is simpler and cheaper to implement than electricity storage.

CHAPTER 6

FUEL CELLS FOR

ENERGY SECURITY

Robert Steinberger-Wilckens –
University of Birmingham

Zeynep Kurban – Imperial College London

6.1 INTRODUCTION

Conventional energy supply systems regularly have a hierarchical structure. Electricity or gas are fed in at central nodes and then distributed downwards, into increasingly diverse networks. Large power generation units are implemented to reduce cost and increase efficiency. They are placed at locations of good accessibility to fuel supply (e.g. imported coal) and centres of demand. With a low number of centralised power stations, though, the average distance to the customers grows and so do the losses on the electricity transmission and distribution lines. The relatively low number of generation units increases the impact of the failure of one such unit, which may be followed by major blackouts in the grids [152]. In conventional power generation in thermal generation units, the efficiency can only be increased by building very large (several hundred MW_{el} to GW_{el}) units. Small installations are inherently inefficient [153].

The increase of renewable energy input to the grids is putting on pressure to reform the energy supply structures since renewable energies are often supplied at local level and therefore rather decentralised than centralised – PV home systems being an example of decentralised generation, though offshore windfarms are rather an example of centralised, large scale installations. Increased levels of renewable energy feed-in into electricity and gas supply grids will therefore favour decentralisation of the energy supply. A decentralised grid will be more robust to any kind of interference, be it by natural disasters – such as storms, snow storms, or flooding – or by malevolent interference, such as sabotage, or terrorist attacks, since there is no central unit that can be targeted but a multitude of small installations that will act more like a ‘swarm’ and may even be empowered to self-organise [154].

Fuel cells, as described in Chapter 4, convert fuels to electricity and heat electrochemically, i.e. avoiding any thermal conversion with the associated pollutant emissions (e.g. nitrous oxides, NO_x, particles, sulphur dioxide, SO₂, carbon monoxide, CO, etc.). The efficiency is high since the electricity is directly generated, without any interim conversion steps, such as steam generation in thermal power stations. Furthermore, the conversion process in fuel cells is based on membranes, which makes it fully scalable: the more power is needed, the more membrane surface must be implemented. Therefore, fuel cells in principle retain a high conversion efficiency across a broad range of rated power, with little influence of the unit size, quite contrary to internal combustion engines, or gas or steam turbines.

The reliability of the power grid in the UK has decreased from an average annual outage of 6 minutes/year in 2012–2013 [155], to 15 minutes/year in 2013–2014, 60 minutes/year in 2014–2015 and as high as 9 hours/year in 2015–2016. The supply margin of electricity dropped from 8% to 2% in 2015 [9] (cf. Chapter 5). Developments in other countries, like Belgium and France [156], show that once the large, centralised power stations have to be taken off the grid for maintenance and repair, electricity supply becomes fragile and rationing of electricity results in higher electricity prices for consumers. This will be increasingly the case worldwide since there is a growing reluctance to build large power stations due

to financial risk, increasing costs, their inflexibility, and the risks they pose to grid stability [157]. They are also a growing burden on grid power balancing due to the increasing dynamics of the grid load with growing renewable feed-in since the large power stations are all base-load oriented and have only limited capability to respond to load dynamics.

All major grid outages in the last decades in Europe were caused by collapses in the power provided by large power stations, mostly nuclear [152]. Once one unit failed, the repercussions on the grid often led to a second unit being tripped. With the current size of nuclear power stations (generally 1 GW_{el}), a large contribution to the power supply is disconnected when a fault occurs, and the whole power supply balance is tipped.

6.2 DISTRIBUTED POWER GENERATION AND CHP: INCREASING EFFICIENCY

Distributed power supply systems (also known as Distributed Generation or DG) rely on relatively small units (0.7 to some 100 kW_{el}) that feed power into the grid at local level. This reduces grid losses since power generation is located close to where the demand is. The increased number of generation units reduces the probability of losses of high shares of power generation in a single incident. The distributed generation units can be controlled to optimise local power supply, for instance by providing peak power, and the waste heat from electricity generation can be recycled and put to use locally to heat buildings; if the latter is the case, these units are termed 'combined heat and power' (CHP). Decentralised systems often are more flexible in the choice of fuels, and the diversity of installations allows for the parallel use of a multitude of fuels.

Heat generation accounts for more than half of global energy consumption and a third of global energy-related carbon dioxide (CO₂) emissions [158]. In the UK, which predominantly generates heat in individual buildings and has only few district heating schemes in operation, heat currently accounts for 78% of total energy consumption [159]. The first White Paper commissioned by the H2FC SUPERGEN Research Hub in 2014 [160] drew attention to the lack of policy on decarbonising heat in the UK and presented the case for how hydrogen and fuel cells can help resolve this great challenge, and how fuel cell CHP systems in particular can create impact in this space.

Fuel cell CHP systems, which provide heat and electricity simultaneously, offer the highest electrical efficiency of any CHP technology, with >60% to AC power for some variants [161], more efficient than large conventional thermal power stations [107] while also enabling local use of waste heat without the need for heat networks. Micro-CHP systems are installed in residential, commercial and industrial buildings. Most of these systems run on natural gas or LPG, but they can be designed to use hydrogen [162]. Even with natural gas, fuel cell micro-CHPs systems can enable 30% reduction in CO₂ emissions [108, 109]. Fuel cell micro-CHP systems could for instance use natural gas efficiently in the short term, run on bio-based gases in the

medium term, and then hydrogen from a future pipeline network, as proposed by the UK HFC Roadmap [112].

The Ene-Farm project in Japan has led to the installation of over 180,000 residential fuel cell micro-CHP units between 2012 and 2016 [163]. Units up to 400 kW_{el} are available from U.S./German company FC-Energy, South Korea being the country with the largest installations, up to 59 MW_{el} [164]. With a net electrical efficiency of 50 to 60% they are considerably more efficient than the gas and diesel engine CHP units of conventional design with 29 to 35% and 35 to 45% net electrical efficiency, respectively, depending on size. The higher limit of these ranges is reached at unit sizes of several MW_{el}, the lower for units around 1 kW_{el} which are typical for single family homes. Stirling engine units, which have arrived in the market recently, only reach 10 to 15%.

6.2.1 Resilience of distributed power generation

DG units are gaining an important role in the energy market due to the:

- Reduction of transmission losses (up to 10% energy losses from power station to end user),
- Avoidance or deference of building new electricity lines as local power demand increases,
- Reduction of peak load requirements,
- Inherent support to implementation of CHP schemes, and
- Increased variety of fuels since these units exist in versions running on many different fuels ranging from diesel and natural gas to wood chips and ethanol.

DG units offer more security to the electricity grid by reducing cost and grid losses, improving the reliability of supply, and enhancing access to energy services by offering more choices of fuels [165].

In addition to these points, the application of fuel cells in distributed generation offers further advantages of increased primary energy conversion efficiency (up to a factor of 2). They therefore strengthen the case for the employment of DG units in electricity grids by:

- Considerably improving primary energy conversion in the overall electricity supply system (including reduction of grid losses and increased conversion efficiency compared to existing coal and gas fired power stations, excluding CCGT),
- Offering options for CHP employment starting from single family homes or even single flats up to multi-family blocks of flats, commercial developments, hospitals etc.

It should nevertheless be mentioned that DG systems also bring some disadvantages, namely:

- More complex grid control,
- Issues with grid maintenance safety, and
- Relocation of noise and emissions (with engine based CHP units) from central generation sites to point of use.

Today's trend to 'smart grids' is already addressing the first item by offering all the (IT) technology to embrace increasingly complex energy supply systems. The second item has already become part of grid codes that were implemented to safeguard grid maintenance workers when photovoltaic (PV) systems are connected to a local distribution grid and is therefore today state-of-the-art [166]. Whereas gas and diesel engines can cause substantial issues with pollutant and noise emissions locally, this is not the case for fuel cells, which operate at extremely low noise levels and have a substantially reduced level of pollutant emissions with generally no carbon monoxide (CO), no particles (PM), and very little or no sulphur dioxide (SO₂) and nitrous oxides (NO_x) emitted; nor would they cause any other impact such as vibration or smell of diesel fumes.

Decentralised generation as such does not automatically improve the reliability of the grid. According to the grid code, once a blackout occurs, all generating units connected to the part of the grid that is failing are disconnected [166]. This is done to protect any workers performing repairs from electrical shock and to avoid any aggravation of damages to the grid. The 50 Hz standard for frequency control in the grid is furthermore supplied by central generation units. On the other hand, this is a relic of the times when the major part of electricity supply was still hierarchical 'top down' with little or no local generation. Given a 50-Hz-standard was available (e.g. via internet, radio signal or with a suitable control unit) any building with a DG unit would be able to re-start its electricity supply in 'islanding' mode, i.e. disconnected from the grid. This would substantially improve the reliability of electricity supply and inherently provide back-up or uninterruptible power supply (UPS) which is essential for many commercial buildings, but also increasingly relevant to private homes. With smart grid technology those parts of the grid that are still functioning after a failure in another part (e.g. upstream of a transformer) could be set to islanding mode and the sub-grid restarted using a lead 50-Hz-source. This capability to 'blackstart' is extremely valuable since it avoids much of the cost of grid failures, especially when they occur at a medium voltage level. In these cases large parts of the local distribution grid are affected since the medium voltage grid supplies large numbers of sub-stations. Being able to re-start and run the sub-grids on local generation substantially reduces the loss-of-load probability and thus the level to which critical power supply needs to be backed up with UPS systems. Merely companies with critical IT server operation would still require their own UPS, which, of course, could be supplied by a local fuel cell unit. The company Bloom Energy in the U.S.A. has made a considerable business case for 100 and 200 kW_{el} SOFC units out of the unreliability of the Californian electricity grid, selling over 700 UPS units to date [167].

A system with a fully developed DG would not be safe from technical failures with the individual units. Nevertheless, the probability of losing a major part of the generation at any given time is very low, and the probability of losing 100% of generating capacity is essentially 'zero' [168] as long as not all units are connected to the same fuel supply.

6.2.2 Security challenges of electricity grid operation

Grid outages can occur due to a multitude of reasons, including:

- Wear and tear on the equipment (ranging from cable ruptures to switching gear and transformer failure),
- Unplanned repairs and maintenance on power generation units, or sudden failure of generation equipment or other components of a power station (often the sub-station transformer) with too little replacement capacity being available,
- Incidents with animals, prevalently birds, causing short circuits on overhead lines,
- Impact of foul weather on electricity cables (snow and ice weight load leading to cable ruptures, flooding threatening transformer sub-stations, storms destroying electricity line pylons etc.), and
- Sabotage or malevolent attack on infrastructure (including cyber attacks and terrorism), e.g. by disrupting power lines leading to large generation units, hacking the power station control system, theft of electric cables, etc.

In all these cases disconnecting sub-sections of the grid that are still operational and running them on DG units can limit disruptions and the considerable costs these incur. Following incidents with snow and ice on electricity lines, and extreme weather conditions, sub-grids have been known to be unsupplied for several weeks until lines were finally repaired [169]. This causes high cost and distress for the electricity customers involved.

Fuel cells offer special value with respect to grid survival in that they can be integrated into the lowest levels of power supply – especially residential buildings – due to the lack of noise and emissions, due to their modularity, the high efficiency of conversion, the lack of moving parts that reduce the level of maintenance and repairs, as well as allowing remote control of units such that smart grid technology can be used to rearrange and re-start a sub-grid from an overlooking control unit. This refers to all impacts on the electricity supply infrastructure that disrupt parts of the central generation, and high and medium voltage distribution (points 1 to 3 of above list, and part of point 4). With defects on the low voltage distribution systems down-stream of a sub-station with transformer, it will not be possible to separate the part(s) of the grid that are still functioning due to a lack of switching equipment that were able to single out the defective part. Similarly, any weather incidents, e.g. flooding, that have an immediate impact on the low voltage grid or single buildings will also impact on local DG units. Fuel cell installations are able to overcome this limitation to a certain degree, since due to their modularity, they can be installed in single (residential) buildings. These can be individually separated from the grid and continue operation. A DG unit in this way turns into an uninterruptible power supply (UPS) at little extra cost. This is a decisive ‘added value’ of micro-CHP fuel cell installations [170].

Allowing the electric utility (or an agency fulfilling the task of grid balancing, such as National Grid) to have access to the system control of the fuel cell ‘swarm’ will allow the formation of a ‘virtual’ balancing power station by manipulating the power output of the fuel cell systems according to electricity grid needs. Such a scheme

would not be possible with gas and diesel engines due to the considerable noise these would generate when in load following mode with constantly changing RPM. Since fuel cells would be generally operated in CHP mode, the heat storage implemented in such systems would allow de-coupling of electrical power and heat provision, thus allowing electricity generation at times of low heat demand.

Energy infrastructures are essential for the smooth operation of the economy and everyday life; they are today considered at substantial risk from malevolent interference. This can range from local vandalism, up to centrally guided sabotage in wartime or by terrorist act. Centralised systems offer many options to cut energy supply to a high number of companies and citizens in a single action. The considerable attention given to retrofitting nuclear power stations to be able to survive a plane crash are proof to the immediate threats perceived by governments worldwide. Apart from physical impacts by force, the growing inter-connection of key control functions by internet (Internet of Things, IoT) has recently been offering much opportunity to interfere with such control units to threaten to cause damage in order to blackmail suppliers and governments into paying ransoms. Although safety levels in power stations are high, the example of the supposed U.S. American/Israeli IT attack on the Iranian uranium plants shows that even military level protection can be overcome if sufficient effort is made and the bounty is attractive enough. In a decentralised system the effort to 'hack' generation units multiplies [171], especially when the units are not connected by the IoT. The impact of shutting down a single unit becomes negligible. It has been argued that the potentially lower level of safety and the standardisation of control units (e.g. using Microsoft products as operating systems) in DG units increases the likelihood of successful 'hacking' [172]. Though this might be true, it also remains true that such hacking attacks become more complicated and will most probably have a limited impact not comparable to 'taking out' a complete large scale power station or transmission line [173].

The decentralised system has the potential to react in the way of a multi-headed serpent, being able to re-establish its function in sub-grids after fending off any IT interference [174]. The combination of DG units with fuel cell technology therefore offers the benefits of higher modularity, bringing more resilience to disruption and thus reliability. Fuel cells supply the benefits of allowing for very low level installations in every building, so that these can be turned into 'islanding' micro grids if the main electricity supply fails.

6.3 BALANCING POWER FOR THE ELECTRICITY GRID

With a growing contribution from renewable electricity in the UK and especially Scotland, the fluctuations of solar and wind electricity fed into the electricity grid will have a growing impact. Scotland has repeatedly been able to supply 100% of its electricity demand from renewable sources recently [175]. This fact does not reflect, though, on the necessity to balance demand and supply in the electricity grid at any given moment. Therefore, so-called 'balancing' power generation has to be provided to compensate for any discrepancies between momentary load and the electricity

generation. Generally, this will be supplied by the ‘spinning reserve’ of 5% of generation capacity available in all power stations, and in the next step by fast-reacting gas turbines and pumped storage. In the near future their installed capacity, though, will not be sufficient to compensate for the growing number of photovoltaic and wind farm installations. Hydrogen, electrolyzers, and fuel cells, though, will be able to provide solutions (Chapter 5).

A distributed ‘swarm’ of small, micro-CHP DG units as explained above can offer balancing power at little or no extra costs, if combined with smart grid technologies. Fuel cell units can generally follow fast changes in electrical load as the Japanese market introduction programme for fuel cells, Ene.Farm, has proven. Since CHP units in Japan until recently were not allowed to feed back into the public grid, all 180,000 fuel cell systems employed under this scheme operated off-grid, supplying the electricity needs of households directly [163]. Units are not known to have not coped with the extremely dynamic loads of single households.

Once a sufficient density of fuel cell CHP installations has been reached and a tariff system is in place that incentivises the participation of fuel cell owners in such schemes, a high level of response of the overall DG generation capacity to renewable power supply variations can be achieved. The cost of this infrastructure is minimal; it consists of the interconnection interfaces and software, and a favourable incentivising tariff system for the unit owners. The only thing to keep in mind is the potential vulnerability of such a system to external cyber-attack disruption since it relies on an intimate internet infrastructure.

6.4 FUEL FLEXIBILITY

The low power rating of distributed generation units and the large number of units brings an increased variability and flexibility in fuels used. Whilst single large power generation units in the UK will operate on coal, uranium, or natural gas, DG units can use a multitude of fuels ranging from hydrogen, natural gas (NG), biogas (BG, from household and industry wastes, sewage sludge, farm and food wastes, grass cuttings, energy crops etc.), syn-gas (from biomass or waste gasification), synthetic natural gas (SNG) produced from hydrogen and carbon dioxide (Chapter 5), liquid natural gas (LNG), propane and butane, ethanol and methanol, up to wood chips and pellets. Some of these fuels would be provided by pipeline, others require a delivery system such as with heating oil.

Though most combustion engines will be able to cope with the named fuels, switching over from one fuel to the other will not always be possible, especially when solid fuels are considered. Fuel cells generally will be adapted to one single of these fuels. Nevertheless, all gaseous and liquid fuels mentioned are viable fuels for fuel cells with hydrogen being the lowest common denominator for all systems. Low temperature fuel cells such as PEFC and PAFC will rely on high purity hydrogen, and the DMFC on methanol. On the other hand, the high temperature variants (cf. Chapter 4) can also directly convert many hydrocarbons, including any gas mixture containing methane, but also propane and butane, and the two alcohols.

Especially the SOFC type, which is generally considered the most efficient and best suited for stationary applications, is capable of multi-fuel operation though adjustments will have to be made for differing gas mixture heating values and compositions. This will also apply to the MCFC type, though this will not operate on pure hydrogen unless carbon dioxide is added to the reactant gas streams. Combustion engines need fuel support (mostly diesel) when operating on very low heating value fuels that can occur with biogas or other anaerobic digester, landfill, or coal mine gases. Lean, low calorific fuels are no problem for fuel cells.

Fuel cells therefore introduce a complementary element of flexibility and variability to that described in Section 5.3 for hydrogen which cannot be achieved to the same level with conventional engine-based decentralised technologies. They open the door on a much wider choice of fuels with the possibility of introducing many renewable fuels and especially fuels derived from wastes. The option of producing SNG from renewable electricity (as described in Chapter 3 and 5) links this to the existing natural gas infrastructure without the need to establish a full-scale hydrogen infrastructure. SOFC and MCFC will form a link between a multitude of possible fuel feeds, including methane and hydrogen injection to the natural gas grid. They offer high efficiency, and the options (as explained in Chapter 3) to resort to indigenous fuels ('green' gases, such as green hydrogen or SNG, or direct use of raw biogas) without the need for energy imports. These fuel cell units can be adapted to run on any of the above mentioned fuels with relatively low effort, at maximum (re-) placing the fuel reforming unit.

The broadened range of potential fuels, for instance for the transport market, allows the currently narrow focus on oil derivatives to expand to hydrogen and SNG fuels, thus potentially reducing import dependencies.

High temperature fuel cells can be considered as a bridging technology that can build on the existing natural gas grid as well as a possible future 'hydrogen economy'. The same SOFC can be operated on natural gas and hydrogen, with minor adjustments to the operating conditions. SOFC can therefore support a transition from natural gas to gas mixtures, biogas, or SNG without major changes to the energy conversion units. They could help secure the investment in DG units across a fuel transition period from, say, natural gas to hydrogen with a gradually growing amount of hydrogen injected into the grid, without a need to replace end-use devices.

6.5 VERSATILITY OF TECHNOLOGY LINKING ENERGY SECTORS

6.5.1 Linking energy conversion sectors of the energy markets

In Chapter 5 we discussed the potential role of hydrogen in linking different sectors of the energy system. Fuel cell technology similarly offers a cross-platform technology in that the same base technology can be used across the sectors of stationary applications, transport, as well as portable devices. This will in future allow rapid cost depression due to a multitude of applications based on fuel cell stacks and systems made of similar components and materials, allowing suppliers to rapidly ramp up

production volume and reduce cost. This aspect is again supported by the variety of fuels fuel cells operate on, again increasing the range of applications and fuel choice.

Conventional energy supply technology for heating, transport, and portable devices differs greatly in nature. Heating boilers would draw on natural gas, internal combustion engines on petrol and diesel, and portable devices on batteries. Fuel cells – across the types that are best suited for specific applications – use the same base technology for all these three fields. Therefore advances in product development, cost reduction, marketing strategies etc. can build on considerable synergies across these markets [106]. Fuel cells therefore link the different energy markets on the energy conversion device side, also leveraging the employment of the wide range of fuels mentioned in the previous section.

6.5.2 Linking fuel supply sectors of the energy markets

Fuel cells offer another degree of freedom to the energy markets that is increasingly attracting interest: if run ‘backwards’, a fuel cell would theoretically turn into an electrolyser, for instance splitting water into hydrogen and oxygen instead of recombining the two into water. The laws of thermodynamics tell us that this process is fully reversible. And in fact, AFC, PEFC, and SOFC systems have been successfully reversed in conversion direction. Whereas some difficulties exist with the low temperature variants running both in fuel cell and electrolyser mode, SOFC have been proven to be able to operate both ways in the same device.

This behaviour opens up completely new options for integrating fuel cell technology into supply grids with fluctuating renewable electricity input or with high dynamics of loads. The one same SOFC device can be operated as ‘solid oxide electrolyser’ (SOE) and split product water back into the gaseous reactants [72]. It can therefore act as a balancing element in electricity grids with a potentially lower investment, since only one type of device is needed for two functions. Reversible SOFC (rSOFC) potentially offer very low switch-over time between supplying electricity in times of demand and acting as load in times of excess (renewable) electricity (cf. Chapter 3). The technology is still at a prototype stage but due to the current scientific and technical interest it is expected to be ready for the markets within the years up to 2025. It links into the P2G technologies discussed in Chapter 5.

From the point of view of energy infrastructure the rSOFC element is especially intriguing since it fully links the electricity with the gas market (both ways and not only gas-to-electricity). Renewable electricity can be turned to gas (hydrogen) which can be converted back to electricity (cf. Figure 3.7). Obviously, this would be one option for electricity storage, albeit the round-trip efficiency is today still rather low, between 35 and 65%, depending on type of units employed. SOE can be operated in ‘co-electrolysis’ mode when carbon dioxide and water are mixed as the feed. The result is a similar syn-gas to what is produced by biomass gasification. Using the methanation technology described in Chapter 3, this syn-gas can be converted to pure methane which is nothing else than synthetic natural gas (SNG). This is fully compatible with the existing NG infrastructures and again forms a bridge between current, polluting technology and a future

sustainable energy supply system. Hydrogen, syn-gases from biomass gasification, and co-electrolysis can thus link renewable electricity with hydrogen economy elements and the existing methane (formerly natural gas) infrastructure, as indicated in Figure 3.7.

This allows for a high number of degrees of freedom in transitioning from the current system to a more sustainable future. Access to energy resources is diversified, resulting in a higher security of supply and a higher reliability of the overall system since shortages of one fuel can be quickly compensated for by replacement by another fuel used in the same devices, as long as high temperature fuel cells are considered (cf. Chapter 4). Given the multiple sources hydrogen can be obtained from (cf. Chapter 3), even the low temperature fuel cells have some flexibility in fuel choice as far as the origin of the hydrogen is concerned.

6.6 ENABLING TECHNOLOGY OPTIONS

There are a number of applications where fuel cells play the role of an ‘enabling’ technology – offering solutions to problems and allowing for applications which were not possible with the incumbent technologies.

The aspects of fuel diversification, access to fuel resources, use of indigenous fuels, emission control, and sustainability are all addressed by fuel cell electric vehicle (FCEV). These are electric vehicles with or without a main battery that are powered by hydrogen driven fuel cells. While the battery will serve to supply the dynamics of driving, the fuel cell will continuously recharge, thus giving the electric vehicle a range that is only limited by the size of the hydrogen tank. FCEV are therefore an enabling technology to make electric vehicles compatible with everyday expectations of range and driving comfort.

FCEV are likewise an enabling technology with respect to zero emission transport. Battery electric vehicles (BEV) are limited in scope and attractiveness by a range that is not fit for today’s everyday usage. Although many boast a range that would cover 100 to 200 miles, in reality and especially in winter conditions they will only manage half that distance [176, 177]. Fuel cell technology is the one option to increase the range of BEV by constantly re-powering the battery whilst not causing any local emissions.

FCEV could in principle act as mobile power supplies. They could connect to the grid when parked and act as distributed generation units [4]. Considering the vast amount of power that is installed in motor vehicles – 30 million passenger vehicles in the UK with an average rated electric power of the fuel cell of 20 kW_{el} would be the equivalent of 600 GW_{el}, six times the installed capacity in power stations available today. There are a number of technical and organisational issues related to this idea which make it doubtful it will ever be realised. Nevertheless, the option to power a home from the family car is already offered by Japanese carmakers [178]. This is a facile option to supplying backup power during a blackout (see Section 6.2) with no extra cost at all, apart from the two-way grid interface. It shows that FCEV technology

brings a number of uses that could potentially revolutionise the way vehicles and homes are seen. The home turns into a centre of energy demand but also production, e.g. by photovoltaics. The solar electricity can be used to charge BEV batteries and thus not only serve the electricity needs of the home but also supply energy for transport. Likewise the car can support the building energy needs and back them up in case of emergency. It can also deliver power at any other location, be it a picnic, a holiday cabin, or recreational activities. Workmen can profit from the possibility to carry their own power supply with no noise and emission (and nuisance) generated. This could open up completely new ways of handling building sites or any work at remote locations with no grid access (roadworks, forestry, agriculture etc.).

The capability to blackstart following a grid outage, mentioned in Section 6.2, is another 'enabling' aspect that allows continuation of electricity supply once grid supply fails.

6.7 CONCLUSIONS

Fuel cells are an inherently decentralised technology since units are rarely larger than 4 MW_{el} and even when such units are pooled to clusters do not currently exceed 100 MW_{el} rating. They also support fuel flexibility, being able to convert a variety of fuels. They can potentially contribute to substantially reducing the vulnerability of the energy supply systems (electricity grid, natural gas grid, transport fuel supply) to political events, market volatility, and malevolent interferences.

Fuel cells will therefore support grid functions with respect to:

- Reduced distribution losses,
- Increased reliability due to lower probability of total disruption,
- Sourcing of balancing power to stabilise electricity grids with high renewable electricity penetration,
- Increased fuel economy, thus reduced operating cost and impact of fuel price volatility, and
- Allowing blackstart capability and the option to 'island' those parts of a grid that are still intact following an outage.

Fuel cells also bring new key elements to the energy markets through:

- Increased fuel flexibility by allowing for a variety of new fuels, many of which are generated from renewable energy sources, and
- Offering new applications of technology by using a cross-platform base technology that links stationary power generation with mobile and portable applications, as well as connecting the electricity and gas infrastructures.

Finally, the option to reverse fuel cells into electrolyzers opens up new perspectives for renewable electricity balancing and energy storage. Electricity grids with high penetration of wind and solar become better controllable due to the sub-second response of both electrolyzers and fuel cells. The increased interaction between gas and electricity infrastructure allows for more degrees of freedom in

balancing supply and demand, and it creates synergies between the different energy markets as the links between primary energy feedstock and energy vectors become increasingly flexible.

Introducing fuel cell installations into buildings as micro-CHP units will enable these to continue operation during grid outages. This takes the idea of Distributed Generation a little further since it enables single buildings (and not parts of the grid) to switch to 'islanding' mode. The micro-CHP installations can be combined by internet technology to form 'swarms' of generation units that can replace costly peak load fossil fuelled units in the electricity grid. The 'virtual' generation units can be pooled to deliver considerable peak power.

Employing the same or similar fuel cell technology across a variety of applications (stationary, mobile, portable) leverages cost reductions, by standardisation of components and increased volume of manufacture. Multiplied with the variety of fuels employed for the different fuel cell types, this also brings an added element of fuel flexibility to what was discussed in Chapter 5.

Fuel cells offer customers in certain areas an 'added value' in that they allow completely new applications. Fuel cell vehicles can act as storage device for buildings and renewable energy, as well as generating power for buildings and the electricity grid. In some ways this technology could open up future options similarly to the advent of the smart phone.

In addition to contributing to resilience and reliability of the energy systems, fuel cells also contribute to fuel flexibility (access to energy), reduction of emissions (sustainability), and reduction in fuel use owing to higher efficiencies (affordability), previously discussed in Chapter 5.

CHAPTER 7

ENERGY SECURITY

IMPACTS OF

INTRODUCING

HYDROGEN

TO THE UK

ENERGY SYSTEM

Paul E. Dodds – University College London

7.1 INTRODUCTION

There is no single accepted methodology for assessing energy security. Methods are used from a range of disciplines [26]:

- economics (e.g. macro-economic modelling; micro-economic surveys; financial theory);
- engineering (e.g. power and robustness engineering; operations research);
- political science (e.g. international relations theory);
- system studies (e.g. complex systems analysis; energy system scenarios); and
- natural science (e.g. geological depletion models; diversity indices).

This chapter examines the implications of the long-term introduction of hydrogen technologies to the UK energy system, primarily through the lens of energy system scenarios.

7.1.1 Energy security in low-carbon energy systems

It has been asserted that introducing hydrogen technologies would improve energy security by reducing reliance on imports of energy commodities such as oil [179, 180]. But such propositions often involve producing hydrogen from renewable electricity, which is substantially more expensive than producing it from fossil fuels (Chapter 3), and affordability is a key requirement for energy security.

The UK energy system is expected to be transformed over the coming decades into a low-carbon system in order to meet a mandated 80% reduction in greenhouse gas emissions in 2050, relative to 1990 [31]. Scenario analyses are often used to identify potential evolutions that are internally-consistent and cost-effective. These analyses tend to focus on the affordability and sustainability aspects of the energy trilemma and overlook energy security, perhaps because security has a relatively strong socio-political context that might be quite different in the future. Yet if some potential evolutions are substantially more resilient than others, and the costs of these are acceptable, then these would likely be favoured by policymakers.

Resilience, through fuel diversity, has been explored in one scenario for the UK using the UK MARKAL energy system model [181]. No previous studies have examined the system-wide impacts of introducing hydrogen on energy security using scenario analysis with an energy system model. This chapter examines how UK energy security might change as a result of the evolution to a low-carbon energy system. Three scenarios are examined using the UK TIMES energy system model (UKTM); two have varying levels of hydrogen technologies in 2050 while the third is a counterfactual with no hydrogen deployment. All three scenarios are compared with the current UK energy system using Shannon-Weiner indices to examine fuel and technology diversity in key parts of the system.

7.1.2 Structure of this chapter

The three scenarios are described in Section 7.2. Section 7.3 explains how the scenarios are modelled in UKTM, compares the results from an energy security

perspective and analyses changes in diversity and import dependence. Section 7.4 considers how the resilience of these three scenarios could be improved, and analyses the economic implications of increasing diversity and reducing imports. Some key limitations are identified in a discussion in Section 7.5 and key conclusions are presented in Section 7.6.

7.2 DESCRIPTION OF THE SCENARIOS

Three scenarios are examined in this study, of which the two hydrogen scenarios were developed for the UK Committee on Climate Change [51]:

- **Full Contribution:** hydrogen is used extensively across end-use sectors, including for most transport and heat provision, by 2050.
- **Critical Path:** hydrogen is adopted in strategically-important end-uses by 2050, primarily in the transport sector, that are difficult to decarbonise through electrification.
- **No Hydrogen:** a counterfactual scenario in which hydrogen technologies are not adopted.

7.2.1 Full Contribution scenario

The Full Contribution scenario is an aggressive hydrogen uptake scenario characterised by early, consistent and long-term commitment to the extensive use of hydrogen across the economy. This commitment is equally strong throughout the timeframe of the scenario, allowing strategic, anticipatory investments in hydrogen-enabling infrastructure in advance of the materialisation of hydrogen demand, which the model shows is more cost-effective. It is driven by an early decision to decarbonise heat provision across the UK by delivering hydrogen using existing infrastructures, and this subsequently provides some of the infrastructure for FCEV adoption in the transport sector.

Around 85% of UK homes are heated using natural gas and these households are accustomed to a small, quiet, reliable, responsive, low-cost, high-power heating system on demand. For these reasons, gas heating is very popular [182]. This scenario builds on their popularity by continuing the status quo for heating in on-gas areas, but with a national conversion programme replacing natural gas with hydrogen across the country to greatly reduce CO₂ emissions.

The use of hydrogen in the Full Contribution scenario in 2050 can be described as follows:

- Hydrogen fuel cell vehicles are the dominant technology for all private road transport, buses and light and heavy goods vehicles (HGVs), as shown in Figure 7.1.
- Hydrogen is piped into buildings in the UK that are currently heated by natural gas, across the residential, public and commercial sectors, where it is used to generate heat in hydrogen boilers (with similar operational characteristics to existing gas boilers) and, in larger homes with higher heat demands, hybrid heat pumps. Where district heating infrastructure is developed, hydrogen may also

be used as a zero-carbon energy carrier for small CHP units and for district heat boilers. The conversion of the existing gas networks to deliver hydrogen occurs over a 20-year period from 2025, roughly in line with the assumptions in the H21 Leeds City Gate study [128].

- Hydrogen is used extensively as a clean fuel in some industry sectors – it provides high-temperature and low-temperature heat for iron and steel production, non-metallic minerals, non-ferrous metals, paper, chemicals and food and drink.
- Hydrogen is used as a storage medium for excess renewable electricity generation, primarily at a large scale (salt caverns and other large scale storage). Hydrogen is also used in power generation for peak generation and also for some mid-merit generation in CCGTs.

The key to the supply of hydrogen in this scenario in 2050 are the existing gas distribution networks, which have been repurposed to carry hydrogen to domestic users and to local refuelling stations. The high-pressure gas network cannot be repurposed to carry hydrogen and a new high-pressure hydrogen transmission network has been constructed.

Figure 7.1 Fuel cell vehicle deployment in the Full Contribution scenario, source: [51].

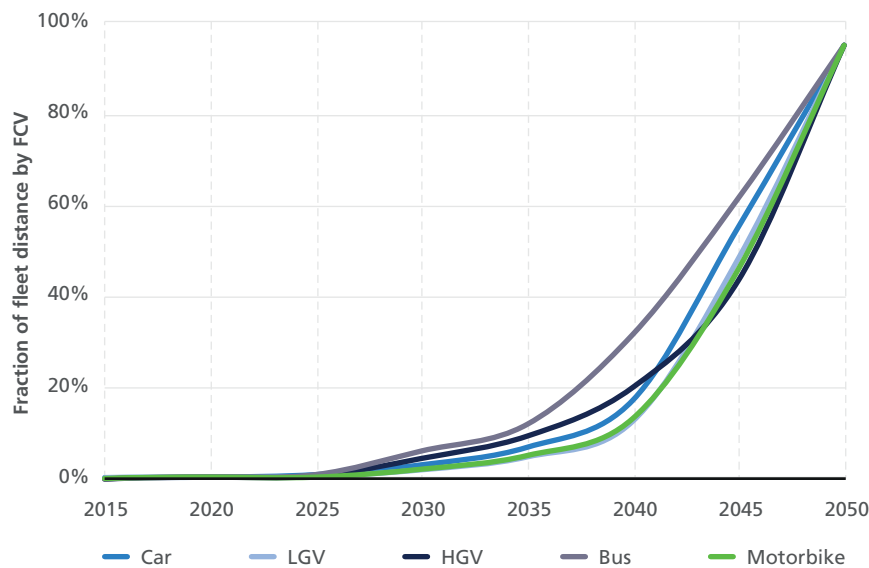

7.2.2 Critical Path scenario

The Critical Path scenario is based on keeping open the option to use hydrogen in end-uses that are seen to be ‘strategically important’, which are defined as end-use demands that are hard to decarbonise by means other than hydrogen, or for which low-carbon options other than hydrogen have inferior performance characteristics relative to incumbent technologies (e.g. vehicles with a substantially shorter range or a long refuelling time).

In this scenario, there is no wholesale and technologically-specific commitment to an extensive roll-out of hydrogen technologies, in preference to other options. It avoids large anticipatory investment commitments, such as hydrogen delivery infrastructure, ahead of an absolutely clear evidence of demand. The strategy that policy makers wish to follow is to “buy” some optionality for allowing a contribution from hydrogen in some key sectors, at some point in the future, but without a wholesale commitment to it, and with a view to not paying too much for the “option”. This means that hydrogen has a minor role in the energy system prior to 2030, in this scenario.

In end uses such as heat and power provision in buildings, and private road vehicle transport over short distances, it was judged that while hydrogen could be envisaged to play a role in a ‘Full Contribution’ scenario, there are also strong alternative options to hydrogen, such as electric, bioenergy or district heating technologies. Therefore, these end uses were not judged to be strategically important, and thus hydrogen was not envisaged to play a strong role in delivering them.

This leaves a number of end uses in which for different reasons, there remains greater uncertainty around the availability of viable low carbon options. The most strategically-important end-use demands were judged to be heavy goods vehicles (HGVs), buses, cars and light goods vehicles (LGVs) when required to undertake journeys greater than 100km, heavy industry and flexible back-up generation in the power sector. It was for these strategically-important end uses that it was judged that policy makers would value keeping open the hydrogen option.

The use of hydrogen in the energy system in 2050 is primarily for road transport, which is summarised in Figure 7.2. In particular:

- 90% of HGVs run on hydrogen – corresponding to the proportion of HGVs that operate within the UK only.
- 75% of buses and coaches (long distance and urban), operating within the UK, run on hydrogen. This is an estimate of the proportion of buses that operate on routes outside of dense urban areas where electric buses are more likely to be viable.
- 40% of private car vehicle kilometres are fuelled by hydrogen. This portion corresponds to the portion of total vehicle-kms that are travelled on journeys longer than 100km. This is considered a strategically important portion of this end use demand because while electric vehicles may operate comfortably over ranges of 100km or less, there is uncertainty that their range will be able to extend beyond 100km.
- Hydrogen is used in power generation for flexible peaking plant, to help balance a system with high penetrations of variable renewables and less-flexible nuclear.
- Hydrogen may have a limited role in decarbonising fuel supply for heat demand in industry, especially for end uses where electrification is not suitable.

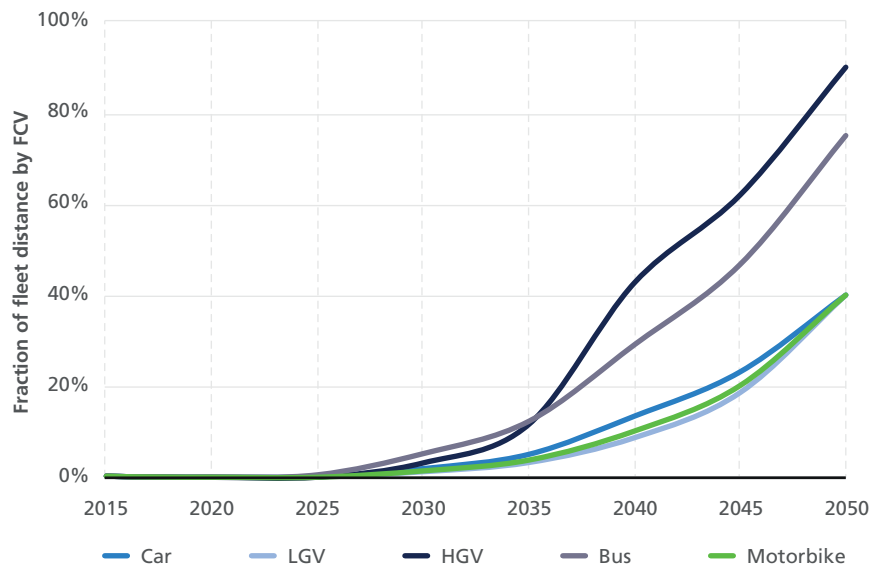
Figure 7.2 Fuel cell vehicle deployment in the Critical Path scenario, source: [51].

7.2.3 No Hydrogen scenario

The No Hydrogen scenario is a counterfactual that is analysed in order to assess the energy security implications of adopting hydrogen against an alternative low-carbon system with no hydrogen. In this scenario, hydrogen is used only for ammonia production in industry, in line with current practice.

7.3 LONG-TERM CHANGES IN ENERGY SECURITY ACROSS SCENARIOS

In this section, the UK energy systems in 2050 from each scenario are compared. The Shannon-Weiner Index is used to examine the impacts of using hydrogen on fuel diversity across several parts of the system that are particularly important for energy security. The same metrics are also compared with the current UK energy system.

7.3.1 Modelling the scenarios

These three scenarios have been modelled using the UK TIMES model (UKTM). UKTM is a multi-time period, bottom-up, technology-rich cost optimisation model of the UK energy system. It is the successor of the UK MARKAL model, which was originally developed to provide insights for the Energy White Paper 2003, and was under constant development until 2012 [183]. It was recently used by the UK Department of Business, Energy and Industrial Strategy to inform its Fifth Carbon Budget Analysis [184].

The simplest formulation of UKTM is to minimise discounted energy systems cost, under a wide variety of physical and policy constraints. This minimisation takes into account evolving costs and characteristics of resources, infrastructures, technologies, taxes and conservation measures, to meet energy service demands.

General description of data sources and assumptions in UKTM

UKTM is a very large model, with 2000 technology types, 600 energy carriers plus constraints, taxes, emissions and other model parameters. The model has more than 200,000 data elements. Model data have been obtained from a wide range of sources and have undergone quality assurance checks. Model documentation will be available from the UKTM website.⁷

The transport sector is broadly similar to that developed in Dodds and McDowall [46] and Dodds and Ekins [47] while the residential sector is derived from Dodds [185]. Conversion of the gas networks to hydrogen is based on research in Dodds and McDowall [137] and Dodds and Demoullin [186]. The EPSRC HYVE project and the UK Energy Research Centre have produced a new version of the UKTM, based on v1.2.2, that includes improvements to the representation of hydrogen and fuel cell systems, as well as to UK fossil fuel resources.

Interpretation of the scenarios in UKTM

The Full Contribution and Critical Path scenarios are modelled in UKTM by specifying the hydrogen uptake in road transport over the period to 2050 for each transport mode. In the Full Contribution scenario, the conversion of the gas networks to hydrogen and the take-up of hydrogen for heating are similarly forced into the solution. Some constraints are also placed on hydrogen infrastructure, for example so that a minimum number of refuelling stations with on-site electrolyzers are constructed in the early years of a transition when a comprehensive hydrogen infrastructure could not be justified. The remainder of the energy system is not constrained and the model identifies the least-cost evolution to achieve an 80% reduction in greenhouse gases by 2050.

In the No Hydrogen Scenario, no constraints are applied except those that exclude hydrogen technologies, so a least-cost evolution is identified.

In all three scenarios, the composition of the electricity generation portfolio is broadly chosen to minimise cost, as are the hydrogen production technologies in the Full Contribution and Critical Path scenarios.

7.3.2 Qualitative comparison of the scenarios

Carbon dioxide emissions from the scenarios in 2050 are compared with 2015 emissions in Figure 7.3. All three scenarios meet the 80% reduction in greenhouse gas emissions, relative to 1990, that is required by the UK Climate Change Act 2008 [187]. In all three cases, this is partly achieved through “negative emissions” from biomass CCS electricity generation plants, which facilitates higher emissions in other sectors. All scenarios have substantial transport emissions resulting from international aviation and shipping.

The emissions profile in the Full Contribution scenario is quite different to the other two scenarios. Since hydrogen is used to decarbonise most heat provision and road

⁷ The UKTM website is at: www.ucl.ac.uk/energy-models/models/uktm-ucl.

transport, end-use emissions are lower than for the other scenarios, which means that fewer negative emissions are required and that the upstream sectors such as hydrogen production have much higher emissions. This scenario offers the possibility to decarbonise further than the other scenarios, and the end-use consumer technologies are closest in operation to existing technologies, so it could be more resilient to the failure of some decarbonisation policies.

Figure 7.3 Sectoral CO₂ emissions in 2050 in the three scenarios, compared with emissions in 2015.

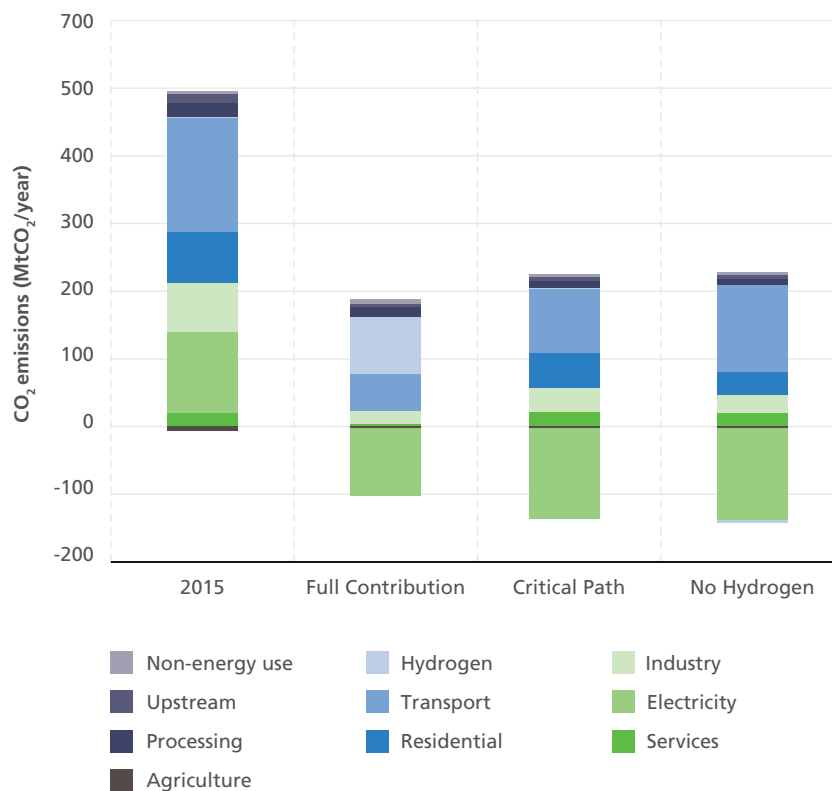

Hydrogen consumption in the scenarios is shown in Figure 7.4. Full contribution has high consumption across all end-use sectors, as well as for mid-merit electricity generation, while consumption in Critical Path is predominantly for road transport vehicles.

Electricity generation is dominated by nuclear power by 2050 in all three scenarios (Figure 7.5). The technology portfolio is similar in each scenario but quite different to 2015. Generation increases across all of the scenarios, with the No Hydrogen scenario having the highest generation due to the unavailability of hydrogen technologies in end-use sectors. Full Contribution is notable for the links between the electricity and hydrogen systems, with 70 TWh electricity generated from hydrogen in 2050 and around 35 TWh hydrogen produced from electrolysis. The rationale is for hydrogen to generate electricity at times of high demand, while the hydrogen would be mostly produced at large refuelling stations that were geographically-remote from large-scale hydrogen infrastructure.

Total primary energy supply (TPES) in all three scenarios in 2050 is similar to the present (Figure 7.6), as improvements in the efficiencies of technologies are offset by higher energy service demands in the future. Nuclear and bioenergy have much larger roles in all three scenarios, at the expense of coal and oil in particular. The importance of SMR is shown by the higher penetration of natural gas in the two hydrogen scenarios than in the No Hydrogen scenario.

Final energy demand for each commodity is shown in Figure 7.7. The principal impact of hydrogen is to displace natural gas and petroleum in the end-use sectors (with the natural gas used to produce hydrogen in upstream SMR plants). Although the share of electricity increases compared to present, it doesn't exceed 30% in any of the scenarios, compared to around 20% at present.

Much of the energy security debate is concerned with import dependence. Figure 7.8 shows that most net commodity imports increase by 2050 in the three scenarios compared to 2015. This reflects a greater role for bioenergy and nuclear power, and the winding-down of indigenous oil and gas extraction from the North Sea.

Figure 7.6 Total primary energy supply in 2015, compared to the three scenarios in 2050. The physical energy content method is used to assess the share of nuclear and renewables.

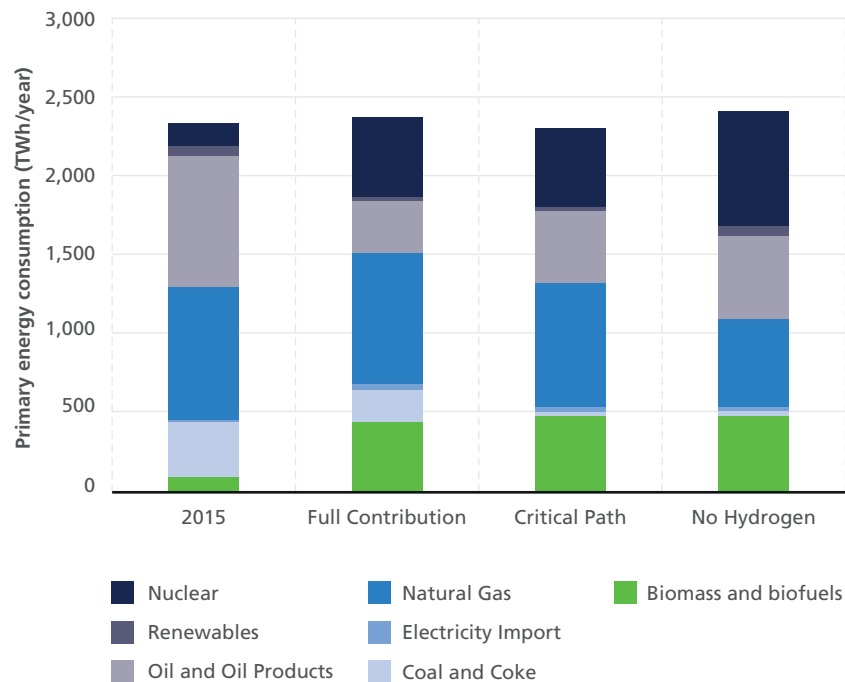

Figure 7.7 Final energy demand by commodity in 2015, compared to the three scenarios in 2050.

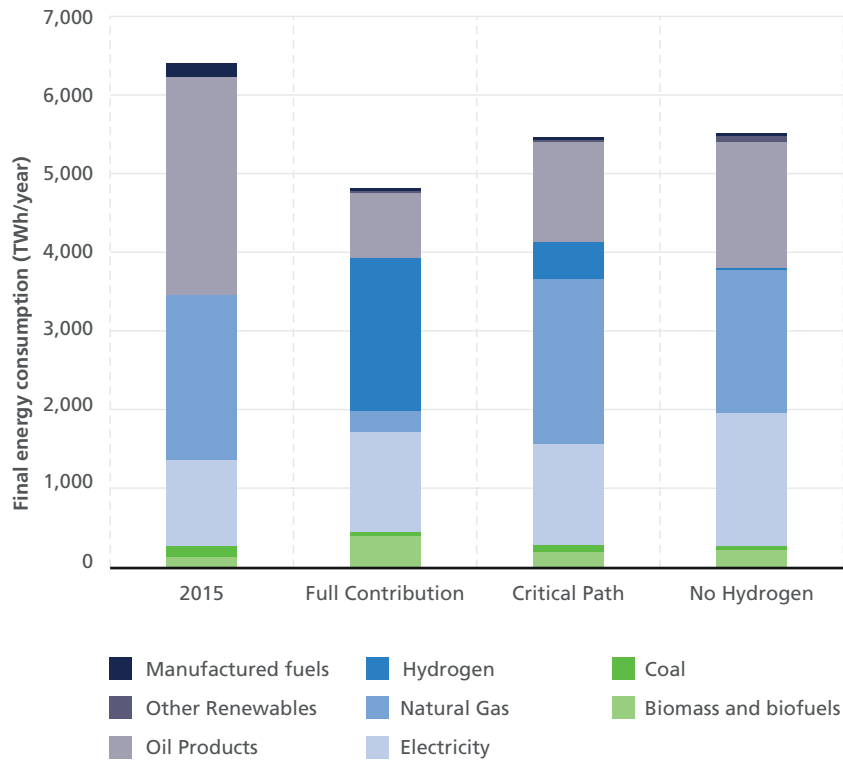
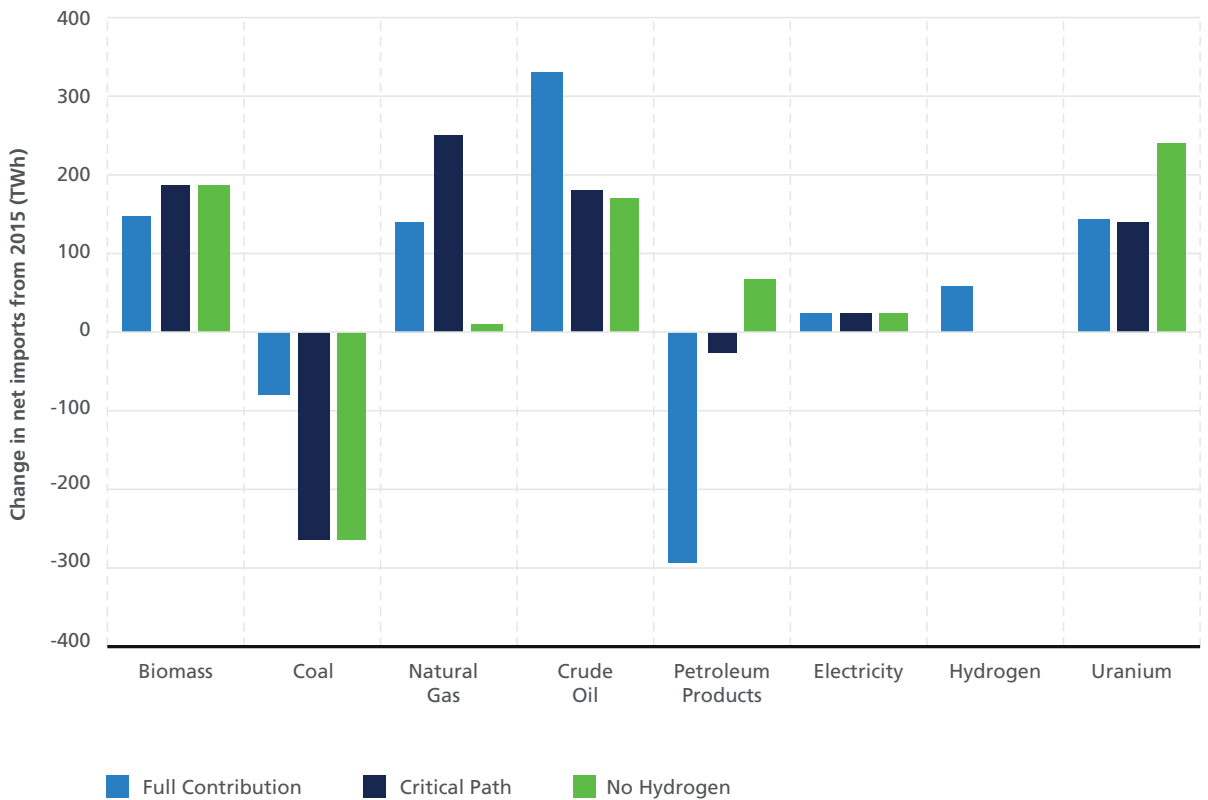

Figure 7.8 Change in net commodity imports in 2050 from 2015 in the three scenarios. The uranium figures have been reduced by a factor of 10 to aid visualization.



7.3.3 Analysing energy security changes using metrics

There are no clear differences between the scenarios from an energy security perspective. Hydrogen tends to broadly displace natural gas and petroleum-fuelled technologies rather than electrical devices, so diversity does not appear to greatly change. Although imports tend to increase relative to the present, they reduce substantially for some commodities.

A common measure of energy security is the diversity of a system, since increasing diversity is likely to spread the risk and reduce the impact of unexpected events [188]. The Shannon-Weiner index can be used to examine energy system diversity. Table 7.1 shows that all three scenarios have higher TPES diversity than the current energy system. On the other hand, if reliance on imports is taken into account using the modified Shannon-Weiner-Neumann index, then all three scenarios have lower diversity than the current energy system. For both indices, Full Contribution has the highest diversity of the three 2050 scenarios.

Table 7.1 Shannon-Weiner and Shannon-Weiner-Neumann indices for total primary energy supply (TPES) in the three scenarios and the current energy system. The Shannon-Weiner index varies between 0 and 2, with higher values indicating higher diversity, and the Shannon-Weiner-Neumann index similarly varies between 0 and 4.

	Shannon-Weiner	Shannon-Weiner-Neumann
Current energy system	1.43	2.15
Full Contribution	1.61	2.03
Critical Path	1.51	1.86
No Hydrogen	1.54	1.94

The Shannon-Weiner index can similarly be used to examine diversity across key parts of the energy system. Table 7.2 shows indices for electricity generation, hydrogen production and final energy demand in the residential and road transport sectors. Electricity generation has lower diversity in the three scenarios than at present. Higher hydrogen consumption leads to higher diversity in electricity generation and hydrogen production. The picture is more nuanced in the end-use sectors. For the residential sector, Full Contribution has the highest diversity while Critical Path has a lower diversity than at present. In contrast, Critical Path has the highest diversity for road transport and Full Contribution the lowest, although diversity in all three sectors is much higher than at present as the domination of petroleum products ceases.

Table 7.2 Shannon-Weiner indices for electricity generation, hydrogen production, and residential and road transport final energy demand.

	Electricity	Hydrogen	Residential sector	Road transport
Current energy system	1.76		0.82	0.08
Full Contribution	1.48	0.55	0.96	0.32
Critical Path	1.27	0.31	0.71	0.94
No Hydrogen	1.15		0.82	0.35

7.4 INCREASING FUTURE ENERGY SYSTEM RESILIENCE

The previous section showed that the evolution to a low-carbon energy system is likely to change the degree of diversity of the UK energy system, with diversity increasing in some areas and decreasing in others. Energy commodity import dependence increases in all of the scenarios. This section identifies strategies to increase resilience in the future and examines the financial impacts of these strategies.

7.4.1 Minimising fuel consumption

Fuel consumption can be reduced through several strategies:

- investing in end-use technologies with improved efficiencies, such as condensing boilers and hybrid cars with high fuel efficiencies;
- changing end-use fuels to reduce lifecycle fuel consumption;
- reducing energy service demands by investing in conservation measures such as building insulation, which has capital cost implications; and,
- reducing energy service demands by changing consumer behaviour, for example by travelling less or heating houses to a lower temperature, which reduces the utility of the energy service to consumers.

Regulations have tended to increase the efficiencies of end-use technologies in recent years, for example the requirement to fit condensing boilers in the UK and the minimum fleet fuel efficiency for car manufacturers in the European Union. Options for electricity and hydrogen in heat and transport are compared with current technologies, for the year 2050, in Table 7.3. Hydrogen fuel cell electric vehicles are substantially more efficient than fossil-fuel equivalents, but not as efficient as battery electric vehicles. In contrast, hydrogen boilers are no more efficient than natural gas boilers, and much less efficient than electric heat pumps.

In the future, the choice of end-use fuels is likely to become more limited due to climate change mitigation strategies, since it is difficult to capture CO₂ from the organic fuels that dominate heat and transport provision. Electricity and hydrogen are the only two zero-carbon energy carriers under serious consideration for end-use devices, with biomass also offering an option if it can be supplied sustainably and if the impact on air quality is sufficiently low.

Although switching fuels can enable an increase in the efficiency of end-use devices, for example when moving from natural gas boilers to electric heat pumps, this does not necessarily reduce fuel consumption across the energy system. This is because greater efficiency losses are incurred during electricity generation, as explained in Box 1. The impacts can be difficult to assess. For example, replacing hydrogen boilers with hybrid micro-CHP fuel cells would generate electricity in homes at high efficiency during times of peak demand, reducing central generation requirements and loads on the electricity networks and hence supporting the introduction of heat pumps in other homes [107]. The benefits of these technologies were examined in the H2FC White Paper on Heat [160].

Even if fuel consumption were reduced, supply interruptions would still have a similar impact. The frequency of supply interruptions could even be increased by fuel switching to reduce consumption, for example through an increase in electrification if it created much greater demand peaks that required high investment in both networks and generation capacity. The principal energy security benefit of reducing fuel consumption might be a reduction in import dependence for key commodities.

BOX 7.1 IMPACTS OF ELECTRIFYING HEAT ON NATURAL GAS CONSUMPTION

Natural gas is currently piped to homes and combusted in an efficient boiler at 84% efficiency.

A homeowner installing an electric air-source heat pump with an average efficiency of 250% would achieve a substantial reduction in home energy use. However, if the additional electricity were generated using natural gas, in a CCGT plant with an efficiency of 53%, then only a 37% reduction in gas use across the system would be achieved. If an OCGT were used then only a 4% saving would be realised.

Nuclear power or renewables could of course be used to generate electricity instead.

Substantial capital investments in electricity generation plant, heat pumps and possibly home insulation would be required, meaning that the total cost to the consumer would likely increase. For this reason, UK Government incentives for heat pump installation, in the Renewable Heat Incentive, are targeted at homes without connections to the gas networks in which heating is much more expensive.

Table 7.3 Comparison of expected efficiencies of key end-use technologies across the energy system in 2050. The Conventional column lists the most efficient technologies in 2050 that use the dominant fuels of today in the UK (i.e. natural gas for heat and petrol/diesel for road transport. The Hydrogen and Electric columns list the counterparts of these technologies. For CHP and micro-CHP (mCHP), including fuel cells (FC), the values in brackets show the electricity fraction of the total output. The Heat rows show conversion efficiencies (%). The Road Transport row figures show the fuel economy.

Sector	Conventional	Hydrogen	Electric
Building heat	Gas boiler: 84%	Boiler: 84% mCHP FC: 95% (44% elc)	Heat pump: 250%
Industrial heat	Boiler: 90% CHP: 76% (42% elc)	Boiler: 90% CHP: 76% (42% elc) CHP FC: 83% (63% elc)	Immersion heater: 100%
Road transport	Hybrid car: 0.68 km/MJ	FC car: 1.14 km/MJ	Battery car: 1.89 km/MJ

7.4.2 Network challenges and strategic storage opportunities

A resilient energy system depends on resilient energy delivery infrastructure. The UK electricity and natural gas networks currently operate with very high levels of availability. In the future, the electricity network could be stressed by increased demand swings from electrification of heat and/or transport and from increased deployment of inflexible generation assets such as intermittent renewables and nuclear power plants. The impacts of these are a key research area for the UK research community.

Hydrogen networks would be expected to operate similarly to existing natural gas networks. Key pinch-points in the existing system are coastal import terminals such as Bacton, where an extended interruption during winter could cause a supply shortfall [189]. A hydrogen system would likely have fewer such pinch-points, as production assets would be much greater in number and would be much more distributed around the network. One issue is that the lower density of hydrogen compared to natural gas means that the amount of network linepack, which is energy stored in the network that is used to balance variable demands, would be around a quarter of the existing natural gas linepack in pipes of the same size. From a distribution network perspective, the H21 Leeds City Gate study concluded that very little network reinforcement would be required to deliver hydrogen through the existing natural gas networks [128].

One method to improve energy security and avoid disruptions is by constructing a strategic store for a resource. For example, the UK has strategic stores of coal, oil and gas at present. Table 7.4 lists the costs of some electricity and gas storage technologies. The only electricity storage technology with a sufficiently-low storage cost that would be suitable for a strategic store would be compressed-air energy storage (CAES). The cost of this is very sensitive to the cavern geology and is also uncertain as few commercial plants have been constructed [190]. In the past, it has been cheaper to deploy excess generation capacity in preference to electricity storage; for example, gas-fired OCGTs have lower costs per power output than CAES. While the costs of CAES might reduce in the future if substantial renewable deployments lead to periods during which generation substantially exceeds demand, this change is not relevant for a strategic store which would be expected to be permanently full and on standby.

Underground geological storage would also be the cheapest option for hydrogen; salt caverns are widely used for natural gas and have also been used to store hydrogen for industrial applications. There is also evidence that larger depleted gas fields could be used for strategic hydrogen storage, in a similar way to the Rough gas field for natural gas [191], and these have lower storage costs than salt caverns. In general, hydrogen can be stored at a large scale more cheaply than electricity and the technology is mature.

Table 7.4. Capital costs of electricity and gas storage (£ in 2016).

	Cost/storage (£/kWh)	Cost per power output (£/kW)
Electricity		
Lead-acid batteries	220	266
Lithium-ion batteries	399	266
Compressed-air energy storage	0.1–18	600
Pumped hydro	50	798
Hydrogen		
Salt cavern	2–5	305

Electricity cost sources: [190, 192]. Hydrogen cost source: [193].

7.4.3 Low reliance on imports

Reducing reliance on imports is widely considered a strategy to improve energy security. For example, the USA aims to achieve energy independence from OPEC and from any nations considered hostile [194]. The increase in energy commodity import dependence by 2050 in all of the scenarios, compared with the current energy system, could be therefore considered by some as reducing UK energy security.

The implications of reducing reliance on imports can be examined in the three scenarios by setting additional constraints:

- Total imports must be less than 10% of total resource consumption.
- Oil imports must be less than 20% of total oil consumption.
- Natural gas imports must be less than 20% of total natural gas consumption.
- Coal imports must be less than 20% of total coal consumption.

The Shannon-Weiner and Shannon-Weiner-Neumann indices for primary energy consumption in these scenarios are shown in Table 7.5. Comparing these with Table 7.1 shows that the diversity of resource consumption in 2050 is reduced to similar levels to today, but that import dependence is lower than today as the modified Shannon-Weiner-Neumann indices are higher. Full Contribution, with the highest hydrogen deployment, has the highest diversity for both indices.

Table 7.5 Shannon-Weiner and Shannon-Weiner-Neumann indices for total primary energy supply (TPES) in the three scenarios and the current energy system, taking an insular approach that minimises imports in the three scenarios.

	Shannon-Weiner	Shannon-Weiner-Neumann
Current energy system	1.43	2.15
Full Contribution	1.48	2.39
Critical Path	1.42	2.27
No Hydrogen	1.44	2.27

7.4.4 Diversity and redundancy

Energy security could be improved by increasing diversity and redundancy in key parts of the energy system [26].

Increasing redundancy for hydrogen production and electricity generation would require additional capital plant investments, with lower overall capacity factors across the fleets that would increase the overall production costs and the prices for consumers. In the event of a disruption to the electricity system, demand management measures would likely be a much cheaper short-term approach to cope with a disruption. The UK electricity system already operates with substantial excess generation capacity in order to avoid supply disruptions during winter peak demand. Demand management measures are used by National Grid to cope with high demands, in which large users agree to reduce their electricity demand during the winter peak if there is a shortfall in generation capacity, in return for lower electricity prices [195]. Such measures have been successful in other countries; for example, following the Fukushima disaster in Japan, 50 nuclear power stations that are located in areas of high earthquake and tsunami risk, with a capacity of almost 50 GW, were shutdown for stress testing. A public campaign led to peak summer electricity demand reducing by 18% in the affected areas [196].

If hydrogen were predominantly used in the transport or industry sectors, then the demand would be largely flat and production plants would ideally operate with a high capacity factor. It might be possible to reduce demand if a disruption occurred, but the lack of spare capacity might make it more difficult for the system to cope. It would be possible to build additional production capacity, but since hydrogen is much cheaper to store than electricity, there might be a stronger case for building a strategic reserve. If hydrogen were used for building heat provision then demand would be much higher in winter than summer, and the H21 Leeds City Gate study envisages deploying some production plants that are only used in winter [128]. In this case, the additional capacity, which would likely be composed of gas SMR plants as these have the lowest capital costs, would provide a buffer against supply disruptions in part of the system.

A resilient energy system might have sufficient diversity so that any disruption would affect a small-enough part of the system for in-built redundancy to cope. The implications of requiring diversity in electricity generation and hydrogen production portfolios can be examined in the three scenarios in UKTM by setting additional constraints to limit the capacity of plants using each fuel type. For electricity generators, a simple limit on capacity is insufficient as the aim would be for the remaining undisrupted capacity to generate on demand and intermittent renewable generation are not controllable in this way. The capacity constraints were therefore set up to account for the contribution of each type of generation to peak. They required each type of generation, with the exception of renewables, to account for no more than 25% of total capacity by 2050 for both electricity generation and hydrogen production. Table 7.6 shows that the electricity diversity in 2050 in all three scenarios approaches the levels of the current energy system when these constraints are applied, and hydrogen production diversity is also much higher.

Table 7.6 Shannon-Weiner indices for electricity generation and hydrogen production in 2050 for the base and diversified versions of the three scenarios, together with the current energy system in 2015.

	Electricity	Electricity diversified	Hydrogen	Hydrogen diversified
Current energy system	1.76			
Full Contribution	1.48	1.70	0.55	1.35
Critical Path	1.27	1.65	0.31	1.33
No Hydrogen	1.15	1.63		

7.4.5 Cost of increasing diversity and import independence

As explained in Chapter 2, one of the key requirements of a secure energy system is affordability. There is a cost to increase the resilience of a system and so trade-offs must be chosen between increasing resilience and decreasing affordability.

UKTM can be used to examine the cost impacts of increasing resilience through increasing diversity and increasing import independence (an insular approach).

Table 7.7 shows these costs relative to the least-cost method of meeting the UK’s greenhouse gas commitments. A small cost increase is required in all three scenarios in order to diversify both electricity generation and hydrogen production. Diversifying electricity is generally cheaper than diversifying hydrogen, due to the greater number of generation options such as nuclear power and renewables, but neither is particularly expensive. On the other hand, achieving high levels of independence from imports is a very expensive approach that increases the cost of decarbonisation by a factor of 3–4. A strategy focusing on diversifying import sources would likely be much cheaper than a strategy focusing on avoiding imports, although further studies would be needed to provide evidence for this assertion.

Adopting an insular approach to imports does not lead to diversified production portfolios. Table 7.7 shows that the cost of achieving both diversified and insular systems is approximately additive of achieving either independently.

Table 7.7 Total discounted costs of constructing resilient and insular energy systems in each scenario. See the main text for definitions of “resilient” and “insular”. All costs are relative to the smallest increase in costs required to meet the UK 80% GHG reduction target in 2050 in an unconstrained UKTM scenario, relative to the reference scenario with no GHG targets. So this unconstrained scenario has a cost = 1.

	Base	Diversified	Insular	Insular and diversified
Full Contribution	2.3	2.3	6.0	6.3
Critical Path	1.2	1.2	4.8	5.0
No Hydrogen	1.1	1.2	4.8	5.0

7.5 DISCUSSION

Hydrogen is the only zero-carbon energy carrier other than electricity under serious consideration for future energy systems. Introducing hydrogen might be expected to improve energy security by adding diversify to end-use technologies. In fact, although adopting hydrogen in the scenarios increases resource diversity, the impact on end-use diversity is scenario-dependent and there is no clear trend. This reflects that not adopting hydrogen does not lead to whole-scale electrification of heat and transport, with fossil fuels continuing to supply some demand in least-cost scenarios, particularly if negative emission technologies such as biomass CCS are cost-effective and available.

Nevertheless, hydrogen does not generally reduce energy security and offers a number of opportunities to improve it in addition to increasing resource diversity, for example by contributing to electricity system balancing if high levels of renewables are introduced, or offering a cheaper option for large-scale strategic energy storage. Moreover, hydrogen pipelines are widely-used and well-understood, and an infrastructure system could be constructed as resilient as the existing natural gas system if the substantially lower linepack could be managed. The infrastructural uncertainties for

future electricity systems are arguably more uncertain than for hydrogen and are the subject of numerous research projects.

7.5.1 Improving resilience through diversity and reducing import dependence

The cost of increasing diversity in electricity generation and hydrogen production is comparison. Yet it is not clear that reducing import dependence would greatly increase energy security. Of the three energy security events faced by the UK in the last four decades, the oil refinery blockades in 2000 and coal miner strikes in the 1980s were domestic and unaffected by import dependence. The quadrupling of the oil price in the 1970s did have a substantial economic impact and underpinned the development of oil production from the North Sea. While this to some extent sheltered the UK economy from future high oil prices through increased corporate and government revenues, consumers were still required to pay higher prices. It is not clear that the high cost of reducing imports would greatly improve energy security, and a strategy to diversify suppliers and import routes would likely be much more cost-effective.

7.5.2 Systemic disruptions to energy systems

One method to increase electricity and hydrogen diversity is to use hydrogen to generate electricity in fuel cells or CCGTs, and vice versa using electrolysers, as occurs to a small extent in the Full Contribution scenario. There is a risk that systemic weaknesses could arise from this approach that would adversely affect security in both systems, for example through the loss of supply or price volatility of a key energy commodity that were used in both systems, which could be coped with by either system in isolation but not by the coupled system. Aggregation of data in large-scale models such as UKTM can disguise the vulnerability of certain sectors to systematic risk [22]. Such issues could be identified through stress testing.

7.5.3 Temporal resolution modelling issues

The general system analysis modelling approach used in this chapter can be used to examine how energy security might change as a result of long-term evolutions of an energy system. It necessarily has low resolution, which means that short-term imbalances are not considered in the analysis. A high-resolution model (e.g. an hourly dispatch model) would be an appropriate tool for verifying, for example, that sufficient peak electricity generation capacity is constructed when high levels of renewable generation are deployed. The scenarios in this chapter do not have high renewable penetrations so this is not an important issue. Nevertheless, a high-resolution dispatch model has been used to examine a range of UKTM scenarios and load curves, and the electricity generation capacity deployed by the model has generally been found to be appropriate.

Commodity prices have displayed high volatility in recent years. Important economic threats such as price volatility are not considered in this analysis as UKTM uses average prices in 5-year periods [27]. Increasing the fuel diversity of a system is a potential hedging strategy to reduce the impacts of price volatility, and the analysis in this chapter has not assessed these benefits. On the other hand,

increasing diversity offers fewer opportunities to reduce costs of technologies through innovation. Further research to explore these issues would be valuable.

7.5.4 Limitations in the chosen scenarios

Only three scenarios have been examined in this chapter, and all contain substantial investments in biomass CCS plant. The costs and performance of biomass CCS are not well understood, and the unavailability of biomass CCS or even CCS in general would be likely to substantially increase the cost of decarbonisation. The provision of affordable, low-carbon hydrogen is more dependent on CCS than affordable, low-carbon electricity, so the unavailability of CCS would make hydrogen investments more difficult to justify, making increased electrification more likely and greatly reducing energy system technology diversity.

The total economic UK oil and gas resource base is uncertain. For the analyses of resource import independence, UKTM has an estimate of yet-to-be-discovered reserves, and identifies an optimal extraction strategy to meet energy system constraints. Historically, extraction strategies for gas in particular have depended on fossil fuel price expectations and resources have been extracted and exported when economic. It is unlikely that a long-term strategy to conserve resources, as implicitly envisaged in some of the insular scenarios, would be adopted.

Most end-use technologies can use only a single fuel, but some flexible technologies have been developed, for example:

- Hybrid heat pumps that primarily use electricity but have a back-up gas or hydrogen boiler.
- Plug-in hybrid fuel cell cars that can use electricity or hydrogen. These could potentially be a substantial electricity generator for houses if the electricity supply were disrupted. They could also be used in conjunction with solar PV and batteries to supply electricity to remote buildings without a grid connection.

Electric immersion heaters offer a back-up option for heat provision, albeit much more inefficiently than heat pumps. The particular benefits of these technologies for energy security has not been considered in the analyses presented in this chapter, but could be in the future.

7.6 CONCLUSIONS

This chapter has examined how UK energy security might change as a result of the evolution to a low-carbon energy system, using three scenarios examined using the UKTM energy system model.

The energy system diversity is likely to change in the future, with increases in some areas and decreases in others. Energy commodity import dependence increases in all of the scenarios. Hydrogen tends to increase diversity over strategies that focus on electrification, but not in all parts of the system or in all circumstances. Technology diversity for hydrogen production and electricity generation could be increased at low cost and are potential long-term strategies for the UK government.

Reducing reliance on energy commodity imports, on the other hand, would be much more expensive and alternative strategies would likely be more cost-effective.

Hydrogen offers other benefits for energy security. It can contribute to electricity system balancing if high levels of renewables are introduced, through the deployment of power-to-gas electrolyzers. Hydrogen delivery infrastructure is resilient and well-understood, and hydrogen offers a cost-effective option for large-scale strategic energy storage with proven technologies.

CHAPTER 8

POLICY

IMPLICATIONS

Zeynep Kurban – Imperial College London

8.1 INTRODUCTION

In November 2015, the Government's Secretary of State for Energy and Climate Change, Amber Rudd, made it clear in her Energy Policy Reset speech that ensuring families and businesses in the UK "have secure energy supplies they can rely on now and in the future is not negotiable" and that the government will "take no risks with this." The Government identifies energy security as a framework where consumers have access to the energy services needed (physical security) at prices that are not excessively volatile (price security). The Government published its Energy Security Strategy (ESS) in 2012 [8].

Historically the UK has experienced strong energy security. The Government claims this is enabled through the creation of a liberalised energy market, secure supply of oil and gas from the North-Sea, and current lack of export curbs from OPEC as well as extensive regulation of the energy resources [8]. In fact, the UK has consistently ranked in the top three most energy secure countries by the Large Energy User Group [197]. However, the UK's global energy security ranking has been lowered in the last few years, dropping to 6th place for the first time in 2014 in the International Index for Energy Security Risk assessment by the US Chamber of Commerce [197], and it has dropped to the 11th position in the World Energy Council's (WECs) Energy Trilemma Index in 2016, which assesses a country's energy security, energy equity, and environmental sustainability simultaneously [197]. Moreover, the Government has little influence over consumer energy price volatility, such as the 10% increases recently announced by several utilities [198].

This reduction of the UK's energy security can be attributed to three significant challenges that need to be addressed [8]:

- The closure of around a fifth of power stations by the end of the decade, as they come to the end of their working life or are deemed too polluting for modern standards.
- The need to adapt the energy system to ensure that the UK can meet its legally-binding CO₂ emission reduction targets (e.g. by introducing more renewable power) to cut greenhouse gas emissions by 80% by 2050 (from 1990 levels).
- The decline of reserves of fossil fuels in the UK Continental Shelf (UKCS), which makes the UK increasingly dependent on imports at a time of rising global demand, volatile markets, and increased resource competition.

Energy security is a complex issue, and as discussed in Chapter 2, the definitions vary and have some degree of flexibility. The government recognises this need for flexibility when assessing the evolving energy system landscape and ultimately sees energy security not just in terms of securing supplies but as securing the delivery of the end products needed by the UK consumers: heat, power, and transport [8]. In this regard, the energy security policies are formulated in the context of the UK's other energy objectives for sustainable energy supplies (in particular reducing carbon emissions) and affordable energy supplies [8]. This is on a broad consensus recognised as the Energy Trilemma, through the axioms: energy security, affordability and sustainability.

In this chapter we present the UK government's Energy Security policy drivers and frameworks and discuss what new policy initiatives are needed in alignment with these, to realise the benefits to energy security across the UK in the medium to long term offered by hydrogen and fuel cells as identified in the previous chapters.

8.2 UK ENERGY REGULATORS, SYSTEM OPERATORS AND SUPPLIERS

The UK's energy security strategy is based on competitive energy markets combined with effective regulation to deliver diversity of supply and robust infrastructure for consumers. This regulatory and market framework, which consists of energy regulators, network operators and suppliers, with each having different roles and responsibilities in ensuring energy security for the UK.

The **Department for Business, Energy and Industrial Strategy (BEIS)** is the 'Competent Authority' as defined in the regulation responsible for setting the energy policy and legislative framework for Great Britain's energy market. This includes international engagement with key energy suppliers. The energy policy set by the department of BEIS is largely reserved in Scotland and Wales. However, Scottish Ministers have devolved powers relating to consents of electricity generation and transmission infrastructures under s36 and s37 of the Electricity Act 1989. The Scottish government is also responsible for resilience of the energy system, response handling, and civil contingencies [8].

8.2.1 Energy regulators

The **Office of Gas and Electricity Markets (Ofgem)** is the independent 'Regulator' charged by the government to regulate energy companies to protect the interests of present and future energy consumers. Their duty includes working with BEIS to ensure security of supply, supervising market function, and competition, and to some extent new policy development. In contrast to similar regulators in other European countries, they do not have influence on the energy pricing of utilities.

In Northern Ireland energy policy is largely transferred and therefore the responsibility of the Northern Irish Executive. Northern Ireland's gas and electricity markets also operate separately from those in GB, in particular, NI shares a market with the Republic of Ireland (the Single Electricity Market). The **Department for the Economy (DfE)** is the relevant government department in the devolved administration of Northern Ireland responsible for policy and strategy on energy, including electricity, gas, renewables, and energy efficiency. The **Utility Regulator Northern Ireland (UREGNI)** is the independent utility regulator in the devolved administration of Northern Ireland.

8.2.2 Network Operators

National Grid (NG) is the 'System Operator' that owns the high-voltage Electricity Transmission System (ETS) in England and Wales and operates it across Great Britain. The National Grid also owns and operates the high pressure Gas Transmission System (GTS) in Britain with the right to buy, sell, and store gas to keep the system in balance. These regulated businesses operate markets for electricity and gas on behalf

of the government, and they have a responsibility to the government to keep a secure supply of energy within certain probabilistic tolerances (e.g. Loss of Load Expectation, LOLE). National Grid also have unregulated businesses under a different director that are not allowed to talk to the regulated businesses for competition reasons.

Gas which leaves the National Transmission System (NTS) is distributed to end customers through eight regional, regulated monopolies owned and managed by four separate companies.

Electricity Distribution Network Operators (DNOs) own and operate the distribution network of towers and cables that bring electricity from National Grid's transmission network to customers. They don't sell electricity to consumers, this is done by the electricity suppliers.

8.2.3 Energy Suppliers

Gas shippers are the licensed shippers who buy gas from producers and importers, arrange for its transportation through the National Transmission System, and sell gas to suppliers. There are currently over 200 licensed gas shippers.

The **Suppliers** are licenced to supply gas or electricity. In the case of gas, they buy it from the shippers, to both domestic and business consumers. In the case of electricity, they may generate the electricity themselves (e.g. EDF) or buy it from independent power generators (e.g. Drax). Over 90% of the domestic market is dominated by the six larger suppliers, although recent trends show the number and market share of small suppliers to be increasing [199]. In the larger daily metered and non-daily metered market, the position of the six larger suppliers is less dominant.

8.2.4 Adding hydrogen and fuel cells to the existing framework

This framework is based on a largely centralised energy generation and distribution model. If hydrogen is introduced into the energy system through a centralised mechanism (i.e. by being fed into the gas grid at large scale, cf. Chapter 5 and [128]) this framework can be maintained to a high degree. Each of the components mentioned above will need to assess the implications of hydrogen in the energy system in terms of policy, regulation, and infrastructural changes with regards to the production, storage, transport, and distribution of hydrogen, as well as any safety implications. In any case, with the introduction of renewable power technologies, smart meters and grids, demand side response tools, more international connections (as discussed below), as well as electric and fuel cell vehicles, the electricity system is migrating from a largely centralised system to one with a much higher number of players and degrees of freedom for achieving energy security. We have discussed the benefits of a more distributed electricity production system for increasing energy security in previous chapters, and how hydrogen and fuel cells can enable this more distributed energy production model in Chapter 5 and Chapter 6, respectively. All stakeholders (listed above) as well as equipment manufacturers and suppliers, need to work together closely to manage subsystem integration of low carbon and smart grid technologies in an increasingly complicated energy production and supply system. This is specifically true for the technical and economic appraisal of having hydrogen and

fuel cells in the energy system and when developing the required system interfaces, as such a change requires a system level change across the whole supply chain. For the security of electricity a ‘system architect’ could help manage this increasing level of complexity, as discussed in the section 8.4.

8.3 RATIONALES AND DRIVERS FOR ENERGY SECURITY POLICY INTERVENTION

The Energy Security Strategy [8] is reviewed annually by BEIS and Ofgem and updated in the Statutory Security of Supply Report (SSSR) [200], which provides the Government’s plans for energy security with a four year outlook. The Government is concerned with ensuring all components of the energy system, from primary resources right through to distribution networks, are in place and functional. However, the definition and the Government’s considerations for price security are less comprehensive, with the focus on excessive volatility and no consideration of long-term affordability. With the increasing dependence on imports of oil and gas from ‘volatile’ markets, the need for increasingly costly mechanisms for extracting oil and gas from the North Sea reserves, and the Government’s plans for extracting gas through fracking, more clarity is needed on how the Government intends on ensuring long-term price security.

The ESS is formed around a broad set of energy goals [8]:

- **Maximising economic production** of UK’s oil and gas reserves to provide reliable energy supplies which are not exposed to international energy supply risks → *Availability and Affordability*
- **Energy efficiency** measures to lower the UK’s exposure to domestic and international energy market risks → *Availability and Affordability*
- **Efforts to improve the reliability of global energy markets** to enable affordable and dependable access to energy from overseas → *Reliability and Affordability*
- **Reliable networks** to ensure that the energy we need is delivered, where we need it → *Reliability*
- **Resilience measures** to prevent possible disruptions to energy infrastructure, from flooding (predicted to increase with climate change) through to industrial action, and to reduce the impact of incidents if they do occur → *Reliability and Availability*
- **Decarbonising UK’s supplies** to help reduce dependence on international fossil fuel markets in the longer term → *Sustainability*

The ESS also recognises that the imminent closure of older and polluting coal power stations will create capacity and balancing challenges, requiring investment in infrastructure and the development of new infrastructure technologies such as storage and interconnection. However, beyond these recommendations on specific areas of investment, it does not provide a comprehensive strategy on how to ensure these challenges are met or when they will be met. It appears that the Electricity Market Reform (EMR) is the current strategy forward for ensuring sufficient capacity to meet demand, as discussed below.

The government has no single objective way to assess energy security – the main approach used (as stated in the Government’s Energy Sector Indicators reports [32]) is based on the level of energy demand, diversity of fuel supplies, energy prices, fuel stock levels, and spare capacity. This heavy focus on resources is somewhat more limited than the comprehensive definition proposed in the ESS report as it does not provide a straightforward measure of how great a risk exists or when change is needed. A parliamentary report on energy security [25] similarly states that energy security targets include maximising domestic fuel reserves, reducing demand, and diversifying imports. But it also discusses infrastructure challenges and threats from low investment, weather disruptions, and market inefficiencies.

The Government acknowledges the need to strengthen the existing strategy through an extensive analysis of the principal systems [8, 200]. In order to deliver this, a holistic plan that considers the energy system as a whole (including power, gas, and transport sectors) is needed. This can quantify the acceptable levels of energy security across the system and how they can be achieved. The main existing policy instruments and tools in place to ensure energy security today and in the near future are outlined below for the electricity (power), gas (heating), and transport sectors and their suitability for a whole system integrated approach is explored.

8.4 MAINTAINING THE SECURITY OF ELECTRICITY SUPPLY

Electricity supply and demand are balanced on an instantaneous basis by National Grid. The difference between the total generation capacity and the maximum total demand is defined as the capacity margin. The GB capacity margin has been tightening in the last few years as a result of decreased fossil power generation capacity, mostly due to old power stations being closed down as they reach the end of their lives, with a fifth of the current capacity expected to close by the end of the decade.

The lack of replacement of power infrastructure has driven the Government, working with Ofgem, to introduce tools and mechanism that enable National Grid to maintain system balance and to ensure sufficient supply exists to meet demand on a cold winter evening. The policy frameworks and the mechanisms introduced to ensure security of electricity supply are listed below.

- **The Electricity Market Reform (EMR), which constitutes:**
 - **Contracts for Difference (CFD)**, which is a contract between a low carbon electricity generator and the Low Carbon Contracts Company (LCCC), a government-owned company, and is designed to provide long-term price stabilisation to low carbon plants, allowing investment to come forward at a lower cost of capital and therefore at a lower cost to consumers.
 - The **Capacity Market**, introduced in 2014, provides a regular retainer payment to reliable forms of capacity (both demand and supply side), in return for such capacity being available when the system is under pressure.

- **Balancing Reserves**, which are tools used as a safety net to protect costumers when there is insufficient capacity, these include the:
 - **Supplemental Balancing Reserve (SBR)**: targeted at participating large energy users to receive payments in return for reducing their electricity use during periods of high demand, e.g. between 4pm and 8pm on winter weekdays.
 - **Demand Side Balancing Reserve (DSBR)**: targeted at keeping power stations that would otherwise be closed or mothballed in reserve to be used when needed on a winter weekday, e.g. between 6 and 8pm.

The participation of providers in these schemes is enabled through the Government's tender process. Since the Capacity Market was introduced, coal and gas prices have dropped significantly due to the changes in the global energy markets in the last few years, leading to falling GB wholesale electricity prices. With profitability reduced for the electricity generators the likelihood of early plant closures has increased. Due to these developments, the government has announced that it would buy more capacity sooner, bringing the Capacity Market to 2017/18, in order to send a signal to the market [200]. This shows the vulnerability of such measures for supplying electricity. Ofgem is looking at the reforms to cash-out arrangements through an Electricity Balancing Significant Code Review (EBSCR), which came into effect in 2015 [201]. The objective of this reform is to address issues with balancing arrangements which undermine efficiency in balancing and security of supply.

As part of the short term strategy for managing supply and demand imbalance of electricity, the government uses several metrics for assessing the risks to security of supply. These are: loss of load expectation (LOLE), de-rated margins, and the risk of customer disconnections. The first two metrics do not directly represent the risk of customers being disconnected. The LOLE, which is the average number of hours in a year when demand is expected to exceed supply available in the market, is used as the key metric when assessing security of electricity supply [118]. In such a case the National Grid may need to take action that goes beyond the normal market operations to balance the system, using the mechanisms discussed above.

While these measures and tools are effective for balancing demand and supply, and can be used in the long term, they have a probabilistic approach to supplying electricity to users and will not ensure security of supply if there is a sudden and a major event that causes disruption to the power generation plants or the power grid. In the long term, additional capacity (low carbon reserves) are needed to increase security of supply, especially since major power generation plants are being taken offline. The government's plan for increasing this capacity in the long term include:

- **Building Smart Grids**: this involves the incorporation of information and communication technologies into the electricity system, enabling more interaction between suppliers and consumers through a more dynamic real time flow of information on the network [116]. This is an incremental process that has already started with roll out of smart electricity and gas meters, which are to be installed in all UK homes by 2020 [202]. Smart meters have a key role to play in the move towards smarter networks by providing real-time information to consumers, suppliers and the

networks. They can enable the demand to be adjusted to match available supply capacity, which is a reversal of the current paradigm for electricity. The vision for creating a smart electricity network in the UK is outlined in several different strategy documents. These include the DECC's (precursor to the BEIS) Smart Grids Vision and Routemap (2014) [203], and the Electricity Networks Strategy Group's (ENSG) Smart Grid Routemap [204]. While smart grids enable a greater degree of control and provision of data in supply demand management, they do not enable the security of supply to be enhanced, especially if the demand exceeds supply at any point in time, and they do not increase energy efficiency or reduce cost.

- **Building Interconnectors:** Great Britain currently has four interconnector links with a total supply capacity of 4GW of electricity. These connectors link to France (IFA 2GW), Ireland (East West 0.5 GW), Northern Ireland (Moyle 0.5 GW), and the Netherlands (BritNed 1GW). Ofgem has introduced the Cap and Floor regulatory regime to incentivise investment. Under this approach, if developers' revenues exceed the cap then revenue above the cap is returned to consumers. If their revenues fall below the price floor, then consumers top up developers' revenues to the level of the floor. This regime has supported Final Investment Decisions (FIDs) on new interconnectors linking the GB market to Belgium (1 GW NEMO project planned for 2019), and Norway (1.4 GW NSN project planned for 2020). Ofgem has also made decisions to grant cap and floor regulatory regime, in principle, to another two interconnectors to France (1.4 GW FAB Link and 1 GW IFA2), one interconnector to Denmark (1GW Viking Link project), and one to Ireland (500 MW GreenLink project). The FIDs for these four projects are yet to be made, but each one targets being operational by the early 2020s.

While interconnectors can potentially increase the security of supply, the additional interconnector capacity could displace domestic sources of generation and in the long run make GB's electricity supply more reliant on external sources. The price in theory should be lowered due to the pending full liberalisation of the markets across the EU, but it will depend on a range of supply and demand conditions as well as the geopolitical situation, diversification of imports, network costs, environmental protection costs, occurrence of severe weather conditions, and levels of excise and taxation across the then EU borders. The necessary infrastructure and regulatory arrangements required for effective market operation still need to be put in place. This is being done through the Internal Energy Market (Article 194 TFEU) to harmonise European markets in the EU. However, Britain's role in influencing such regulatory mechanisms within the European Commission will end once it leaves the EU.

8.4.1 Potential role of a system architect

For supply of power a market approach is broadly followed at the moment. To better manage the increasing penetration of renewables and mechanism for balancing the electricity demand, the IET proposes a System Architect that takes a whole system and long-term responsibility for designing, developing and agreeing the framework of architectures, standards, protocols and guidelines for future changes the electricity system [199]. Such an entity, working closely with the government and the many

market players and parties, could ensure the challenges arising from policy and climate change imperatives are addressed, while energy security benefits through a more flexible and distributed energy infrastructure that includes hydrogen and fuel cells are realised. The System Architect could be a single entity responsible for the more distributed and flexible energy system design, working with the National Grid to enable the management of both the electricity and gas network system with the expansion towards gaseous vehicle fuels and the many new feedstock hydrogen production would allow for. This would be a necessary move in effectively enabling the coordination and integration of the two networks (gas and electricity) through the power-to-gas and power-to-power models (cf. Chapter 5), whilst at the same time allowing for optimisation of the system towards the many new energy sources and energy end-use applications introduced with hydrogen and fuel cell technologies.

Whether this ‘System Architect’ takes the role of designing and implementing the links between the electricity, gas, and transport fuel infrastructure, and then exits, or whether it takes a continuous role of coordinating the flow of energy between these markets, will be left to discussion. In any case the role is not that of an interventionist regulator but that of a coordinator who secures sufficient information on demand and supply is available across the very complex energy system. Given the flexibility of sourcing hydrogen from various feedstock and the ways energy flows from one market can be redirected to another, an overseeing body could ensure that these flows are optimised to the best technical result.

8.5 MAINTAINING THE SECURITY OF GAS AND OIL SUPPLIES

As discussed in Chapter 5, the margin between gas demand (465 Mcbm is the highest ever daily demand) and supply is 148 Mcbm (24%) based on the 2016 supply capacity [206]. Thus the security of supply of gas is much higher than that of electricity. However, as discussed in Chapter 5, with the increasing global demands, the availability of gas for imports to the UK, in the long run, is uncertain. To counteract the increasing level of uncertainty and plan for the future supply of gas, the government has been looking at more unconventional ways of sourcing gas domestically. This includes an appraisal of the development of biogas and shale gas supply mechanisms, though the extent, timing and cost of unconventional gas exploitation outside the US remains an unknown.

To prepare for such international challenges the government is working on strengthening the UK’s bilateral trading links and promoting liberalisation of EU gas markets to help secure the imports needed [121]. Again, how these links will be affected remains unknown once the UK leaves the EU. Domestically, Ofgem has made proposals to further incentivise gas suppliers to meet their supply obligations. Currently, the UK gas supply benefits from demand side response, enabled through fuel switching (power generation switching from gas stations to coal stations when gas prices are relatively high, and interruptible contracts between gas shippers and customers). However, this demand side responsiveness is likely to decrease as the number of coal-fired power stations decreases, putting additional pressure on the gas supply and thus reducing supply security.

As discussed in Chapter 5, the UK has a surplus of petrol but due to the lack of sufficient refinery capacity it has a deficit of diesel and aviation fuel, which it imports from Europe and the Middle East. However, in consideration of the UK's legally binding commitments to reduce CO₂ emissions and the growing pressure to reduce environmental pollutants such as NO_x, there are drivers for ensuring security of low carbon sources of energy and the relevant infrastructure for cleaner transportation. Hydrogen and fuel cells are emerging as alternatives to internal combustion engine vehicles in transportation, especially for busses and long haul trucks. However, to have hydrogen produced cost effectively renewable sources (or cheap electricity) is needed with support to bring down the cost for electrolyzers. In the long run this has the potential to overcome the issue of price volatility, while reducing CO₂ emissions and pollutants.

8.6 POLICY PRIORITIES

With increasing pressure in decarbonising the energy system, an energy security strategy with a long term vision is needed for the UK. A longer terms strategy, which takes account on long term investments costs, could help identify the most optimal long term solutions and reduce costs in the long run. In the previous chapters we have outlined and discussed technologies available. While it is difficult to quantify the change in the overall energy security level of the country by introducing hydrogen, in this section we discuss how energy security might be improved through policies that introduce hydrogen and fuel cells.

The policy discussion in this section is framed around the Government's Energy Security policy objectives/drivers [8]:

- maximising economic production,
- resilience measures,
- energy efficiency,
- reliable networks,
- working internationally, and
- decarbonisation.

using the following energy security indicators:

- energy demand,
- diversity of fuel supplies,
- energy prices,
- fuel stock levels, and
- an adaptation of the current definition of spare capacity.

8.6.1 Economic hydrogen production from a diversified set of feedstocks

In Chapter 3 we have shown that if hydrogen becomes part of the energy system (Full Contribution scenario) hydrogen can be produced economically from a diverse range of feedstocks. End-use devices using hydrogen would therefore be decoupled from the primary fuel source. Short-term changes in primary energy price or supply interruptions could be mitigated by switching to other energy sources and production plants. A long-term strategy would be required to make this option available on demand:

- provision of sufficient diversity in the hydrogen production portfolio to enable sufficient short-term production from production plants if one type of primary energy source were to become unavailable for any reason; and,
- introduction of redundancy to the system, by providing sufficient alternative plants, to have sufficient production capacity to enable fuel switching.

Currently there is no procedure – other than market pricing – that would offer the energy economy any signals as to what kind of primary energy source or feedstock can/should/should not be used in the short and middle term to secure the balance of supply and demand in the energy system. As hydrogen in the future replaces some parts of the electricity market by offering fuels for electric vehicles, storage for excess electricity (Chapter 3), and additional balancing power for the electricity grid (Chapter 5), some of the immediate concerns of balancing the electricity grid are alleviated since the gas grid can compensate better for momentary discrepancies due to its inherent storage capacity. There will be a need for a public body that takes the position of a ‘System Architect’ (cf. Section 8.4.10) that issues the proper market signals so that producers and consumers of hydrogen and SNG, as well as the demand side can determine how the system is to be balanced. Without such a system architect, the higher degrees of freedom in the infrastructure relying heavily on fuel cells and hydrogen-derived gases might lead to confusion as to how exactly supply and demand are to be kept in balance since a multitude of solutions exist. Essentially this could be modelled on the current energy exchanges where supply is offered on a transparent platform with the market price adjusting to the momentary demand, thus offering a direct market feedback.

At the moment the choice of production technology depends primarily on the feedstock availability and overall technology and process cost. This will in future vary depending on the level of carbon pricing introduced over time leading up to an 80% decarbonised energy system by 2050, adding further price signals to these choices. Currently, without a CO₂ tax, the hydrogen production (based on commodity prices) from SMR is costed at £1–2/kgH_{2eq} and is the cheapest currently available, beating petrol and diesel. With introduction of a carbon tax, hydrogen production from biomass becomes cheaper than petrol and gas for heating. The same is the case even without a carbon tax if economies of scales are exploited for hydrogen production from electrolysis using wind electricity [207].

In Chapter 7 we have shown that if hydrogen is introduced as a vector for decarbonising the energy system, it primarily displaces natural gas and petroleum-fuelled technologies, diversifying the transport fuel and gas markets since many more than the primary energy sources crude oil and natural gas are involved. On the other hand, hydrogen also tends to increase diversity over strategies that focus on electrification, since it offers a storage solution to fluctuating energy input. The Full Contribution scenario (Chapter 7), based on hydrogen use across the whole energy system, suggests the highest diversity. This underpins again that the policy planning for infrastructural investment for energy security should take this factor into account, in terms of both feedstock availability over time (e.g. expected decline in availability of indigenous coal and gas reserves) and the necessary market mechanisms needed to establish a level market for more sustainable options (e.g. hydrogen production from electrolysis and biogas). Research and development funding for hydrogen production from sustainable but less developed options (e.g. high-temperature electrolysis, solar thermo-chemical water splitting, and biological hydrogen production) will be needed to further diversify hydrogen production options and to reduce reliance on fossil fuels to produce hydrogen.

The development of a green hydrogen standard will facilitate the inclusion of hydrogen in climate change abatement policymaking. The UK Government had group working on Green Hydrogen regulation in the past and such a group will be needed again if hydrogen is included as part of the Government's energy security strategy. Currently, standardisation initiatives among EU members are being developed. The UK, outside of EU, would benefit from developing a hydrogen standard aligned with its national interests and energy roadmap.

In a future with increased levels of carbon tax, if CCS technologies are not available, then the level of electrification of end-uses and the cost of decarbonisation increases substantially [208], and there would need to be a move to electrolysis for hydrogen production. In the short term, to get industry to invest in the development of these hydrogen production plants, the Government needs to have more clarity around its future strategy for providing fuel for homes and businesses, with clear incentives and guidelines put in place.

It is important to note that while no level market between hydrogen and the existing fossil fuels exists, this would change in the future if external costs were fully internalised, for instance once a substantial carbon tax were levied. Since hydrogen can be produced from a range of feedstocks, energy security can be increased by diversifying the portfolio of production technologies in a similar way to electricity generation, or by constructing redundant back-up plant. The support for innovation (R&D) will help with technology optimisation and for driving costs down for hydrogen production at grid scale.

8.6.2 Reduction of energy demand: micro-CHP systems

The UK's energy efficiency target of 20% by 2020 is part of the EU's binding 2020 Climate and Energy Package agreements. We have discussed in Chapter 6 combined heat and power (CHP) devices operating on solid oxide or polymer

electrolyte fuel cells (and a range of fuels). These can supply half the heating needs of a typical household, and reduce carbon emissions by up to 30% compared with direct combustion [107–109], as well as providing power for grid balancing, thereby offsetting balancing natural gas plants. These systems can also be used for backup-power applications in the event of a power failure provided that the grid electricity is cut off in the event of a natural disaster or a cyber-attack on the power network.

In 2015 there was 1GW of fuel cell generating capacity installed worldwide (including the generation element of micro-CHP), and data shows this growing by 25% year-on-year [209]. Despite commercial availability of fuel cell micro-CHP systems the technology has not gained adequate attention from the Government or customers in the UK. The current low volume production means that the technology is still quite expensive, which according to one study [108] can be brought down to the cost of conventional gas boilers when produced at volumes of 10,000 units (cumulative production) per manufacturer. The flexibility of using different fuels with fuel cell micro-CHP systems makes the case for adopting these technologies stronger; natural gas can be used at high efficiencies in the short term, with bio-based gases in the medium term, and then hydrogen from a future pipeline network, as proposed by the UK HFC Roadmap [112].

In GB the Government has a set of initiatives (as listed in Table 1) that make CHP systems eligible for installation support or for recovery of some of the costs. These are mostly for non-domestic applications (e.g. commercial, industry, schools, hospitals, etc.). The only support mechanisms that include the installation of fuel cell micro-CHPs are i) the Green Deal, a £125m initiative launched in 2013 allowing property owners to have their buildings assessed for potential energy-saving improvements and obtain financial support for the installation, and ii) *Feed-In Tariff scheme (FITs)* for Micro-CHP installations of less than 2 kW, which excludes all renewable fuel CHP systems other than anaerobic digestion. Currently, despite these support mechanisms there appears to be no fuel cell CHP systems awarded any support on the Government's CHP Focus database [209]. The price of fuel cells has been the greatest barrier to uptake. However, prices have been falling, since commercialisation in 2008 the price of Japanese systems has fallen by 13% per doubling of sales volume [208].

This will enable developers to ramp up production, reduce costs, and collect the necessary market experience. In fact the UK participates in the EU's ene.field project [210] which aims to deploy and monitor 1,000 residential micro-CHP units as part of a major field trial across 11 key European countries. While this initiative is a strong starting point, on its own it is unlikely to create sufficient traction for mass scale uptake to leverage the cost reductions mentioned above that are needed to make fuel cells competitive with conventional gas boilers. While economies of scale will reduce the costs, use of cheaper materials for making the technology will also bring down the costs.

A recent study [109] looking at the use of three different commercial fuel cell micro-CHPs systems in the UK has shown, based on their 2016 installation costs

and the combined cost of the energy savings made with the returns from the average excess electricity fed into the grid, the break-even point for these systems is 22, 13 and 7 years, respectively, for systems costing £22,000 (Vitovalor 300-P, 0.75kW PEFC), £6,750 (Elcore 2400, high temperature 0.3 kW PEFC) and £17,000 (BlueGen, 1.5kW SOFC). The cost premium of £5,000 to £20,000 towards a conventional boiler would need to be bridged by offering a mixture of:

- return on investment by feed-in tariffs, tax credits, credits for GHG emission reductions,
- support market mechanisms by exempting energy produced from low carbon and zero carbon sources from GHG-related levies,
- eliminating the inherent subsidies for fossil energy sources, and finally
- subsidies for employment of fuel cell micro-CHP systems, although this should be the last resort when the above market mechanisms cannot be implemented.

A set of existing UK and EU policy frameworks can be used to incentivise the adoption of more energy efficient technologies in residential and commercial applications:

- Energy Savings Opportunity Scheme (ESOS),
- Enhanced capital allowances (ECA),
- Non-domestic Renewable Heating Incentive (RHI),
- Private Rented Sector (PRS) Regulations,
- Energy Performance Buildings Directive (EPBD),
- Domestic Renewable Heating Incentive (RHI)
- Effort Sharing Decision (EU Policy),
- Effort Sharing Regulation (EU Policy).

These policies are further discussed in Chapter 7 of the Energy Systems White Paper published by the H2FC SUPERGEN Hub [160]. These can be ideally used to provide subsidies for fuel cell CHP systems, both with large fuel cells (100kW to multi MW systems) for industry and businesses and small fuel cells in micro-CHP units to replace boilers in homes. In fact, in the domestic market the fuel cell is already the leading technology for micro-CHP globally [112]. Fuel cell micro-CHPs (with total efficiencies of beyond 90%) can considerably support the energy efficiency targets even in the near term.

The UK HFC Roadmap produced by E4Tech and Element Energy [112] sets out a comprehensive road map for field-trials and large scale deployment of these systems, specifically with recommendations for actions in the near future leading up to 2025. The medium term viability of fuel cell micro-CHP systems depends on the Government's strategy for decarbonising the gas grid. If hydrogen is made available in the future, the roadmap can be developed to have the installation of fuel CHP systems that initially operate on natural gas, with the possibility of conversion to hydrogen at a later stage. If the natural gas grid is converted to biogas and SNG, no changes will be necessary at all. SOFC and MCFC based CHP systems will be able to operate on all these fuels.

There are also lessons to be learnt from countries where subsidies and policies have supported initial uptake of fuel cell micro-CHP systems. Japan is a case with the largest public-private partnership programme to date (Ene-Farm), which has enabled selling of around 180,000 residential fuel cell micro-CHP units from 2012 to September 2016, with 50,000 sold in 2016 alone [175]. Likewise, the UK should closely follow the lessons being learnt in public-private partnership initiatives in the EU, such as the ene.field and PACE programmes, which have deployed 1,000 and will deploy 2,650 fuel cell micro-CHP units, respectively, in a drive towards first market commercialisation. These initiative have proven to help the price reduction of residential systems, which have fallen dramatically – by 85% in the last 10 years in Japan [211], and by 60% over the last four years in Germany [212]. The UK has one of the leading companies developing products for this market, the AFC, and major European boiler manufacturers (Bosch, Vaillant, Viessmann, Baxi etc.) are looking at the UK market, thus the UK Government could potentially form partnerships with the private sector to speed up the commercialisation process of fuel cell micro-CHPs.

Table 8.1 Existing support for CHP systems [213, 214].

Government support	Objective
CHP Focus programme	To inform potential developers of the benefits of CHP and tools to support assessments of the viability of CHP projects. Currently there is no specific (focussed) support for Fuel Cell micro-CHP systems within this programme.
Climate Change Levy Exemption (CCL)	The CCL is designed to promote energy efficiency and encourage investment in energy saving equipment, thereby reducing emissions of greenhouse gases. CHP schemes that are fully or partially certified as Good Quality CHP under CHPQA and have obtained a Secretary of State (CHP) Exemption Certificate are exempt from the main rates of CCL on: <ul style="list-style-type: none"> the fuel they utilise (assuming they meet a power efficiency threshold of 20% otherwise this exemption is scaled back) the direct and self-supplies of the power output generated (assuming the QI is met, otherwise the qualifying power output (QPO) is scaled back).
Renewable Heat Incentive (RHI)	RHI is an initiative designed to provide support to renewable heat technologies in order to increase deployment and aid market development with the ultimate aim of reducing cost of installation. The RHI supports heat where that heat is used in a building for 'eligible purposes': heating a space, heating water, or for carrying out a process where the heat is used.
Environmental Permitting Regulations	Through this developers are required to consider CHP (as a Best Available Technique for energy efficiency) and assess the cost-benefit of CHP opportunities when seeking a permit to operate power plant and industrial installations.

Government support	Objective
Carbon Price Floor (CPF) Tax Exemption	Carbon Price Floor (CPF) ensures a minimum carbon price for emissions from electricity generation, though this is now capped at a maximum of £18 per tonne/CO ₂ from 2016 to 2020. To ensure CHP is on a level playing field with other heat sources, emissions associated with heat from CHP will not be liable for Carbon Price Support (CPS) rates. CHP systems are exempt from Carbon Price Support costs in respect of electricity generated for on-site consumption; fuel used to generate electricity for export will be still liable for CPS rates.
CRC Energy Efficiency Scheme	Under this scheme gas used in CHP installations is exempt from CRC allowance costs. CHP is only liable for CRC costs in respect of electricity produced and consumed on-site; input fuels for CHP are treated as out of scope for the CRC Energy Efficiency Scheme, meaning that no allowances need to be purchased in respect of this fuel.
The Enhanced Capital Allowance (ECA) scheme	Introduced in 2001 to increase the take-up of energy efficient equipment by industry. It allows businesses to claim 100% tax relief on qualifying energy efficiency expenditure in the tax year. There are approximately 19,000 qualifying products on the Energy Technology List (ETL). This includes Good Quality CHP.
Renewables Obligation	Renewable CHP is also supported through the Renewables Obligation, RHI and FITs.
Contracts for Difference (CfD)	A generator party to a CfD is paid the difference between the 'strike price' (a price for electricity reflecting the cost of investing in a particular low carbon technology), and the 'reference price' (a measure of the average market price for electricity). In the event that the reference price exceeds the strike price the generator pays the difference to the Low Carbon Contracts Company, a Government-owned but arms-length company.

8.6.3 Reliability of networks: flexibility enabled by hydrogen

A reliable network is one that has a supply of energy delivered to where it is needed, when it is needed. As discussed in Section 8.3.2, the national grid has a set of 'balancing services' in place (including demand side response tools) to ensure power supply and demand are matched and that the grid is not overloaded, with supplies at the correct voltage and frequency across the network. In addition to this, intermittent power generation from renewable energy technologies requires energy storage mechanisms to balance supply and demand. Hydrogen can be stored in geological formations (as discussed in Chapter 3 and 7) to provide this flexibility and hence a more reliable grid, as well as a way of offloading excess energy in the grid to avoid the curtailment costs. Studies show the economic benefits of implementing storage to manage high levels of renewable electricity generation. According to [133] the UK can save £10bn/year in a 2050 high renewable energy scenario by realising large scale storage technologies. As discussed in Chapter 6 and 7, energy system balancing needed with high penetration of renewables in the grid can be implemented at a lower cost to the customer (compared to alternatives) using existing gas networks and less costly infrastructure, as well as cheaper

large-scale strategic energy storage. Thus hydrogen brings greater price security to a low carbon energy system.

The use of hydrogen for enabling increased flexibility in the gas and electricity grid needs to be considered, as well as new hydrogen infrastructure, in a strategic and coordinated way, working with gas and electricity networks and regulators. This could also include CO₂ capture, transport, and storage infrastructures as far as CCS strategies are considered cost effective and useful in a zero carbon scenario. The synergies leveraged by hydrogen with other low carbon technologies and its use across the domestic, commercial, industrial, and transport sectors could enable cost reduction in future systems if planned and developed in a coordinated way. Policy decisions are required to drive power-to-gas projects that will begin to introduce new primarily energy sources to the gas grid, namely wind and solar electricity, but also other offshore energy, such as wave and tidal. In fact, a UK based energy storage and clean fuel company (ITM Power) is working with 13 companies from the Thüga group (Germany's largest municipal energy and water service provider) to demonstrate the use of electrolyzers in a power-to-gas concept in Germany. This project has started with support from the government of Hessen in Germany (the Hessian Ministry for the Environment, Energy, Agriculture and Consumer Protection) and has already injected hydrogen gas into the grid. In a similar way policy support could help with such projects being realised in the UK. Furthermore, the creation of an entity with the 'system architect' function as proposed by IET for the electricity network (and discussed in Section 8.4.1) could help in overcoming complexity in planning of electricity and gas networks – a recent academic publication proposes such a function for the electricity grid [199]. Hydrogen should be included as part of this discussion on decarbonising the energy systems in terms of ensuring security of supply, supporting the reliability of the electricity and gas grids, and supplying affordable energy to customers in the long term.

8.6.4 Spare capacity and fuel stock levels: hydrogen storage

One important indicator used by the UK Government for assessing short term energy security, is fuel stock levels, in case of any disruptions to global markets for that fuel (for the UK the focus is currently on oil alone). Disruptions could be avoided and energy security can be improved by constructing a strategic store for a resource. In Chapter 3 and 7 we have discussed underground geological storage that would be the cheapest option for hydrogen; salt caverns are widely used for natural gas and have also been used to store hydrogen for industrial applications. There is also evidence that larger depleted gas fields could be used for strategic hydrogen storage, in a similar way to the Rough gas field for natural gas [191], and these have lower storage costs than salt caverns. In general, hydrogen can be stored at a large scale more cheaply than electricity and the technology is already commercial.

We have also discussed in Chapter 7, that if hydrogen is predominantly used in the transport or industry sectors, then the demand fluctuations would be very low and production plants would ideally operate with a high capacity factor. It might be possible to reduce demand if a disruption occurred, but the lack of spare

capacity might make it more difficult for the system to cope. It would be possible to build additional production capacity, but since hydrogen is much cheaper to store than electricity then there might be a stronger case for building a strategic reserve. If hydrogen is used for building heat provision then demand would be higher in winter than summer, and the H21 Leeds City Gate study envisages deploying some production plants that are only used in winter [128]. In this case, the additional capacity would provide a buffer against supply disruptions in part of the system.

A broader, UK wide assessment is needed on the available geological formations for hydrogen storage and their proximity to potential hydrogen production plant locations and transmission points – with an assessment of the capacity for intra-day and inter-seasonal storage and their suitability to store hydrogen at the required purity levels for end use applications. In the UK, an initial study by Energy Technologies Institute (ETI) [193] shows over 30 large salt caverns (currently used for storing natural gas) exist as well as many salt bed resources, which can provide tens of GWeq hydrogen to the grid. Many depleted oil and gas wells in the North Sea could add to this capacity. However, the suitability of these sites need to be determined for hydrogen storage at sufficient purity levels and their availability needs to be determined in terms of competition for CCS and diurnal and seasonal energy storage requirements.

8.6.5 Enhancing resilience and reliability of networks

In Chapter 6 we have discussed how fuel cells, which can be used in the domestic, service, industry and transport sectors, can enable a more distributed power production mechanism that is less vulnerable than a centralised grid mechanism to external disruptions such as storms, flooding, or malevolent interferences, such as sabotage, computer hacking, or terrorist attacks. The increasing use of Internet of Things in smart grids opens up the possibility of devices and processes, which were never vulnerable to such interference in the past, being hacked and tampered with, with potentially disastrous consequences on the energy system. The energy sector, along with the Government, defence, finance, and telecommunications sectors, are reported to have the biggest threat of cyber-attacks [191]. Furthermore, since fuel cells can operate on a range of readily available fuels, including natural gas, with some degree of flexibility for fuel switching, a greater degree of reliability is enabled by the use of fuel cells. In the event of a power cut fuel cells can provide back-up power to homes, hospitals, schools, commercial buildings, telecommunication industry, and data centres etc., for longer durations than a battery, provided that a fuel supply is available. While it is currently costly to have a fuel cell for just backup power applications, with very low frequency of power cuts in the UK and the low time durations that make batteries more desirable option, the versatility of fuel cells can potentially mean cost reduction if the technology is developed for use across the sectors, for stationary applications, transport, as well as portable devices. For example, if fuel cells are used for powering vehicles, these can also be made available for backup power in the event of a power cut, or as described above for micro-CHP systems.

The synergies enabled by the use of fuel cells across different sectors, e.g. transport, heat and power sectors, need to be taken into account in considerations for supporting the commercialisation of fuel cells for enhanced energy security and to meet other policy targets (e.g. low carbon transportation). Furthermore, in the case of hydrogen being supplied in the gas grid in a centralised model, there is high confidence that a hydrogen infrastructure system could be constructed as resilient or more resilient (due to the variety of primary energy sources for providing the gas) as the existing natural gas system. The infrastructural uncertainties for future electricity systems are arguably more uncertain than for hydrogen and are the subject of numerous research projects. In this regard, the policy strategies should compare the vulnerabilities of the electricity and gas networks in assessing the energy security risks the electricity and gas grids can be subjected to, and assess the provision of support for the development of both networks accordingly.

8.6.6 Decarbonising supplies and affordability

Decarbonising the UK's energy supplies is considered as an important objective in the Government's Energy Security Strategy report for reducing dependence on international fossil fuel markets. Also, as explained in Chapter 2, one of the key requirements of a secure energy system is affordability, which is one of the indicators used by the Government to assess energy security. Coupling the decarbonisation of the energy system with independence from imports is an approach that increases the cost of decarbonisation by a factor of 3–4 (Chapter 7). Increasing the resilience of this low carbon system could further decrease affordability. Nevertheless, it has to be kept in mind that introducing zero carbon technologies to the energy system requires a level-market approach which is currently not available (cf. discussion in Chapter 5). We have shown (Chapter 7) that hydrogen could be produced competitively to be used in a decarbonised energy system and we have discussed in Chapters 5, 6 and 7 how hydrogen and fuel cells can potentially enable a cheaper way of decarbonising the energy system. Reducing or eliminating the inherent subsidies for the incumbent (mainly fossil) energy technologies will support and accelerate the implementation of zero carbon electricity, heat, and transport fuels.

Policy support is needed in the way of funding or incentives to enable the production of low carbon hydrogen. For example, renewable hydrogen can be included in the Renewable Transport Fuels Obligation (RTFO). There is currently a certain level of work looking at how to assess and define low carbon hydrogen (e.g. Certiffy, DECC green hydrogen work, UCL Green Hydrogen standard project), the assessment methods and the definitions need to be aligned and included in the existing policies (e.g. RTFO) and be used to develop new ones to drive decarbonisation in all systems using hydrogen for power. The alternative would be to include all external costs in the prices of energy services. This way the lower environmental impact of hydrogen and the higher efficiency of fuel cells would directly have an impact on reducing operating costs and the cost of fossil energy would better reflect the environmental cost. This is an approach that would need clear political backing bedded into clear international regulations.

8.7 GLOBAL POLICY INITIATIVES ON HYDROGEN AND FUEL CELLS

Today, due to the urgent challenge of decarbonising the energy system, and important technical advances in hydrogen technologies, the case for using hydrogen and fuel cells across the energy landscape is growing. An increasing number of reports show that that hydrogen could have a role in almost every part of the energy system – including electricity generation and transport [128, 130, 216, 217] and energy system level assessments reveal, as discussed in Chapter 5, hydrogen to be a technically and economically viable option for decarbonising heat e.g. [128, 130].

The governments of several nation states, and the European Commission, are providing strategic support for the development of hydrogen and fuel cell technologies. The main countries/regions with policy support for HFC technologies are outlined below.

8.7.1 Japan

Today, at a global level, the Japan through a public-private partnership is leading in terms of policy and industry initiatives to support the development of a hydrogen society. The national Strategic Road Map for Hydrogen and Fuel Cells (released in June 2014) stipulates that efforts among industry, academia, and government will be promoted by taking three steps, namely the dramatic expansion of hydrogen utilization, the full-fledged introduction of hydrogen power generation/establishment of a large-scale hydrogen supply system, and the establishment of a totally carbon dioxide-free hydrogen supply system, toward the realization of a hydrogen society [218].

The Road Map, with subsidy support from the government, is reported to have enabled substantial advances, including the increased dissemination of fuel cells for households with 180,000 micro-CHP units installed to date, the launch of fuel cell vehicles into the market, and steady progress in the construction of hydrogen re-fuelling stations [218]. This strategic support for hydrogen and fuel cells is part of the government's broader policy of attaining energy independence, especially with the shift away from nuclear power since the *Fukushima* Daiichi nuclear disaster in 2011. Industry, especially car manufactures such as Toyota, Honda and Nissan, have pledged to work with the government, and started market deployment of fuel cell electric vehicles (FCEVs). Toyota announced 100 FCEVs on the road by 2020 Tokyo Olympics. These cars are also intended to be plugged into homes for backup power in the event of a power cut as discussed in Chapter 6.

8.7.2 Germany

In Europe Germany has been leading in terms of R&D and technology demonstration, enabled largely by policy support. The federal government has extended its National Innovation Programme (NIP) for Hydrogen and Fuel Cell Technologies, which provided 1.4 billion Euros over 10 years (2007–16) by another 10 years (2016–26). The Federal Ministry for Economic Affairs and Energy (BMWi) has committed to spend 250 million euros by 2019 to help ramp up the commercialisation of hydrogen and fuel cell technologies [219]. The former NIP programme, which had the objective of accelerating the market penetration of hydrogen and fuel cell technologies in mobile, stationary, and portable applications, is reported to have made significant

contribution to both technical and economic evolution of fuel cell vehicles and fuel cell heating devices [219].

Furthermore, with the scientific advances and cost reductions enabled in the NIP, the BMWi is continuing its support of hydrogen and fuel cell technology in the area of applied research and development within the 6th Energy Research Programme, committing to spend 25 million euro annually on R&D. In addition the BMWi set up a funding programme for the purchase of fuel cell heating devices for private customers in August 2016 within the National Action Plan for Energy Efficiency (NAPE).

8.7.3 USA

Hydrogen was specifically referenced by the then president George W. Bush in the announcement of the Energy Independence and Security Act of 2007 [220] with strategic funding for HFC RD&D that aims to improve vehicle fuel economy and reduce U.S. dependence on petroleum. However, with the advent of fracking and shale gas, and focus on biofuels, hydrogen and fuel cells have not had specific policy support at the federal level. With stronger clean energy initiatives in California, the governor of California has supported hydrogen re-fuelling infrastructure for transportation. Currently, while there is no specific energy security strategy that makes references to the role hydrogen within the energy system, the use of hydrogen at scale is being assessed by the US Department of Energy (DOE) [221]. The funding made available for HFC technologies in 2017 continues in light of strong technical advances and cost reductions, for R&D, Technology Validation, and Market Transformation. The previous President's (Barack Obama's) FY17 Budget Request for the Fuel Cell Technologies Office was \$105.5m. This remains to be approved by the current administration under President Donald Trump. The advances that have been reported in light of the funding made available for HFC technologies include fuel cell costs being cut by 50% since 2007, still projected at \$53/kW (based on production volumes of 500,000 units annually), and significant improvements in fuel cell durability [222], which are considered as highly important advances towards the commercialisation of fuel cells.

The DOE considers fuel cells as an important technology for backup power applications in the event of a power cuts, which has historically happened due to the damage done to power infrastructure by weather events such as hurricanes, tornados, thunderstorms etc. [223]. For example, in 2012 fuel cells have provided emergency backup power to at least 100 telecommunications towers in both the Bahamas and the Northeast United States after Superstorm Sandy caused great damage in the Caribbean and the East Coast of USA.

Other government/DOE initiatives in the U.S., which can have a positive impact on the commercialisation efforts of HFC technologies and broader energy security status of the country include: *Clean Cities, Alternative Fuel Definition, Alternative Fuel and Vehicle Policy Development, and Emergency Economic Stabilization Act of 2008*.

8.7.4 United Kingdom

Currently, no strategic policy support exists for hydrogen and/or fuel cells in the UK. A National Hydrogen and Fuel Cells (HFC) Roadmap [112] has been developed by E4tech and Element Energy in 2016 through a broad consultation with UK based stakeholders (industry, academia and government) to inform Innovate UK's technology investment decisions. This roadmap, which provides a route for implementing HFC technologies at a range of scales, with the required actions set for the next 5–15 years, sets a practical way of realising the benefit of hydrogen and fuel cells for the key end-use applications across the energy landscape in the UK. This roadmap could be considered for UK's Energy Security Strategy and to inform any policy directives on hydrogen and fuel cells in the UK.

Recently the Scottish Government has announced it will be considering the role of hydrogen and fuel cells in its efforts for decarbonising the energy system in a more holistic way through the announcement of their Energy Strategy (draft report released on 19 January 2017 for consultation) [224], which targets a 66% reduction in greenhouse gas emissions by 2032. Scotland has been leading on commercialisation efforts in the UK, e.g. Aberdeen with 10 busses has the largest fuel cell operated bus fleet in Europe and two hydrogen refuelling stations. The drafted Energy Strategy: *The Future of Energy in Scotland* [224], which takes an integrated system-wide approach that considers the use of hydrogen and fuel cells for heat, power and transport, specifically mentions:

- The versatility and flexibility of hydrogen gas and fuel cells offer the potential to provide a range of services to the energy system and to integrate low carbon solutions across the heat, power and transport sectors.
- Fuel cells could enable the more efficient use of natural gas, through combined heat and power (CHP) applications at a range of scales. Fuel cells using natural gas can be modified to operate using hydrogen at a later date.
- The Scottish Government has supported a number of projects which demonstrate how hydrogen produced from renewable sources via electrolysis can be produced, stored, and used when required for local energy and transport. Hydrogen may have the potential to deliver the lowest cost and least disruptive solution for the decarbonisation of heat.

8.7.5 European Commission

The European Commission funds the Fuel Cells and Hydrogen Joint Undertaking (FCH JU), a public private partnership, which supports the technological development and demonstration (RTD) activities in fuel cell and hydrogen energy technologies in Europe. This programme, which is funded under the EU Horizon 2020 Framework has been allocated a total budget of €1.33 billion in the phase 2014–20.

The key policy initiatives that have been announced recently, which will influence the direction countries will take in ensuring energy security while meeting the EU CO₂ reduction targets of 80% by 2050 (compared to 1990 levels) include *New Renewable Energy Directive* (to help define how the EU binding target of

27% for renewables by 2030 will be achieved) and *New Electricity Market Design Directive*, which is intended to create the conditions for integrating high shares of variable renewable energy sources and the decentralisation of electricity production by enabling liquid and well-functioning short-term markets. These policy initiatives could help shape the EU's Energy security policy with opportunities for hydrogen and fuel cells created.

8.8 CONCLUSIONS

In this chapter, by recapping some of the key findings and discussion points from the previous chapters, we have discussed how policy incentives can facilitate the development and use of hydrogen and fuel cell technologies to enable energy security in a decarbonised energy system.

In conclusion, while there are no clear differences in overall energy security levels compared to today in the three scenarios we have looked at in Chapter 7, with increasing levels of hydrogen in a low carbon energy system, our analysis indicates that hydrogen and fuel cells offer many options to improve the diversity, reliability, resilience and sustainability of the UK energy system in the future.

The Government's energy security strategy concentrates on short-term resource price volatility and insufficiently addresses long-term sustainability. The strategy does not provide a comprehensive, long-term strategy for the development of a resilient, low-carbon electricity system with stable costs.

While, hydrogen and fuel cells have clear benefits over their alternatives in enabling energy security, the value of hydrogen is not recognised in the current market. With appropriate support and a clear and reliable policy framework, UK energy security can be improved in the long term by unfolding the great potential that lies in the use of these technologies. The following steps could facilitate the realisation of the benefits of hydrogen and fuel cells for energy security:

- **Policy incentives that create a level playing field for hydrogen and fuel cells.** The existing policies are quite segmented, more focused policies on hydrogen and fuel cells can enable their potential to be realised at the systems level. Clean hydrogen has a carbon benefit, but can't compete with fossil fuel in the absence of a carbon price.
- **The development of a green hydrogen standard would facilitate the inclusion of hydrogen in policymaking.** There are standardisation initiatives being established at EU level. A UK outside of EU can develop this standard in direct alignment with its energy roadmap.
- **A more holistic approach to energy security is needed to develop a low-carbon and flexible energy system, with hydrogen and fuel cells included in the Government's Energy Security Strategy.** Since diversity is improved and cost benefits are better realised with hydrogen in the Full Contribution scenario (Chapter 7) that models hydrogen being used across the energy landscape, the government needs

to consider the electricity grid, gas grid, transport and storage infrastructure and new hydrogen infrastructure in a strategic and coordinated way. This will enable the energy security and cost benefits, resulting from the synergies and diversity enabled by hydrogen in the energy system to be realised. This requires all stakeholders (gas and electricity networks and suppliers, and regulators) to work in coordination.

- **Indication from the Government on the future strategy for supplying heat and power to homes, businesses and industry**, with clear directives and support to industry to develop hydrogen generation plants for clean hydrogen generation. For example, support for developing a market framework for electrolyzers to generate value from system services, would improve the operation of the electricity network (i.e. improve its reliability) while improving the business case for electrolyzers. Likewise, support for CCS technology will enable clean hydrogen production from steam methane reformation.
- **Funding for further research on hydrogen technologies and support for feasibility work on gas grid conversion to hydrogen**, including engineering studies, trials, conversion plans, determining hydrogen production and storage sites, as well as working with the appliance developers for modifications.

Policy intervention in other countries has enabled fuel cell technologies to reach commercialisation and be competitive in some niche applications. Strong policy signals in countries such as Japan, when well-formulated, have successfully underpinned the initial deployment of fuel cells, have greatly reduced the capital costs and created a new export industry. Thus, government support can enable the realisation of the benefits hydrogen and fuel cells both for niche applications and at the systems level.

CHAPTER 9

SUMMARY AND

CONCLUSIONS

Robert Steinberger-Wilckens –
University of Birmingham

This White Paper has examined how UK energy security might change as a result of the evolution to a low-carbon energy system making extensive use of hydrogen as one choice of energy carrier and fuel cells as a high efficiency energy conversion technology.

A wide range of indicators have been proposed to measure national energy security. Diversity of energy supply, resource reserves, capacity utilisation, fuel prices, energy consumption, and greenhouse gas emissions are some examples.

As might be expected, it is hard to prove in hard fact what the actual impact of adopting hydrogen as one of the main energy vectors will be on the four aspects of energy security we have adopted here as the key indicators (Chapter 2):

- resource availability,
- resilience of the energy system,
- affordability, and
- sustainability.

Nevertheless, the discussions in Chapters 5 and 6 show that hydrogen and fuel cell technologies have the potential to considerably add to energy security under the aspects listed above. The scenarios discussed in Chapter 7 have studied the employment of hydrogen and fuel cell technology from the point of view of economics. Given the current energy markets, though, we currently find little economic incentives, apart from carbon taxes, that would direct the energy system towards adding hydrogen and fuel cells to the market options. On the other hand, no adverse effects are identified, either.

Therefore it made sense to discuss the future potential of these technologies in view of contributions to securing long-term security in the energy supply system in more detail. This led us to a number of measures listed below that need to be implemented in order to establish an energy supply system embracing hydrogen and fuel cell technologies if political consent to secure a long-term affordable energy supply for the UK is reached.

One main property of hydrogen is that it has to be produced by chemical conversion from primary energy sources such as natural gas or primary electricity. Hydrogen, though, offers numerous future options for the choice of these energy sources, since a large diversity exists in the type and source of feedstock that can be used in producing hydrogen – ranging from coal and crude oil on one end of the scale up to renewable electricity, bacteria, sunlight, and any type of biomass at the other end with practically negligible carbon footprint. As discussed in Chapter 5, hydrogen therefore offers the option of greatly **diversifying the energy system** by introducing new primary energy sources and feedstocks to the energy market. Hydrogen as a gas will compete with the current natural gas supply and potentially use the same infrastructure. It will complement and possibly replace natural gas, resulting in zero-emission at point of use in gas boilers, and small and large scale fuel cells, as discussed in Chapter 6.

It is clear, though, that a low- or zero-carbon energy system based on hydrogen is only possible if the feedstock is carbon free and/or carbon dioxide is removed using CCS technologies. In labelling hydrogen ‘zero carbon’ the production processes, including establishing equipment, would also need to be carbon-free; this, though, will be an option for the mid-term future. The use of biomass coupled with CCS technology can in fact even lead to ‘negative’ carbon pathways. By using renewable energies, hydrogen can be considered an **indigenous fuel** that reduces import dependencies.

Low temperature fuel cells (Chapter 4) can efficiently convert hydrogen to electricity, for instance on board of electric vehicles. Battery electric vehicles can thus be equipped with a driving range that is comparable and even superior to conventional petrol vehicles with zero point-of-use emissions. Hydrogen as a transport fuel introduces the primary energy sources mentioned previously to the transport sector, again allowing for a wide variety and flexibility in the choice of energy input.

High temperature fuel cells can be run on both hydrogen and methane, offering additional flexibility in the fuel choice. Their electrical efficiency can reach 60% and more, allowing for high performance electricity and heat supply (CHP), or production of electricity on a wide range of vehicles (heavy duty vehicles, ships, aeroplanes, rail) also using natural gas (methane) as a fuel.

Processing syn-gas (hydrogen and carbon monoxide) from gasification of biomass, or co-electrolysis of water and carbon dioxide as a feedstock in a methanation reactor, synthetic methane (SNG) can be formed. Besides being the perfect fuel for high temperature fuel cells, SNG is a substitute for natural gas that will allow the use of existing gas distribution networks with virtually no changes to the pipeline system or the end use appliances.

With the options of hydrogen being produced from (renewable) electricity, being converted to SNG, or fed directly into the natural gas grid, and being used as a vehicle fuel, it has the unique property of **being able to link** the three energy markets for electricity, gas, and transport fuels. Either by being employed directly as hydrogen gas, or indirectly by being the raw material out of which SNG or other fuels can be formed. Fuel cells and electrolyzers link the gas to the electricity market, being able to convert hydrogen, natural gas, SNG and many other hydrocarbons to electricity at high efficiencies, and back again.

Hydrogen and fuel cells can contribute to electricity system balancing once high levels of renewable electricity are reached, and hydrogen offers a cost-effective option for large-scale strategic energy storage with proven technologies. Both technologies contribute to a more **reliable and resilient** energy infrastructure. Reversible fuel cells that can both produce electricity and hydrogen may be a future key technology to integrate high levels of renewable electricity penetration into the energy infrastructure. Fuel cells can provide electricity and heat as distributed generation on a local and regional level. They can ‘blackstart’ electricity grids after blackouts and provide heat and power locally when major grid outages occur. Likewise, natural disasters, storm

and flooding, accidents etc. have less impact on a decentralised system than a hierarchical, ‘top down’ system of conventional design.

Hydrogen and fuel cell technology can contribute to increasing the UK energy system by supplying:

- access to resources: adding flexibility in fuel choices by being able to use a wide range of primary energy sources, providing indigenous fuels in the form of hydrogen and SNG, thus lowering energy import dependency, linking energy markets, and introducing new flexibilities in energy source choices;
- resilience: making electricity supply safer with respect to grid failures and re-starting grids after blackouts, being able to switch easily between different primary inputs when one source of energy becomes unavailable;
- sustainability: adding options for zero- and low-carbon pathways for electricity, gas, heat, and transport fuel supply, allowing for negative-carbon scenarios when biomass gasification is coupled with CCS technology, providing a fuel choice that will be able to satisfy UK energy needs for a long time to come in a well balanced economic, environmental, and political framework.

The technical viability of hydrogen and fuel cells to support UK energy security, though, still lacks one aspect: affordability.

Chapter 5 has shown that hydrogen can be **produced at competitive costs** from a range of feedstocks. This means that end-use devices using hydrogen could be decoupled from the primary fuel source, with the impacts of short-term commodity price hikes or supply interruptions mitigated by switching to other production sources. These could range from natural gas to biogas, from renewable electricity to waste gasification, etc. The economic implications of introducing a diverse range of hydrogen production plants to the UK are examined in two scenarios in Chapter 7.

A strictly economic comparison of hydrogen and fuel cell options with incumbent technology, though, is misleading since the environmental benefits are only very insufficiently recognised in such a model and cost benefits of the polluting, established technologies versus the pre-commercial low-carbon technologies are disregarded. Analysing the impact of carbon taxes is one first step in internalising the external, environmental effects, for instance, of climate change. In further steps pressure on the health system by air pollution, damage to agriculture, impacts on the wellbeing of citizens, impact of other pollutants like SO₂, NO_x, particulate matter emissions etc. need to be included. Political will is necessary to take such costs into consideration when assessing the viability of hydrogen and fuel cell technologies in preventing long-term damage to the economy and the national assets, and the personal wealth of UK citizens. Elimination of all subsidies in the way of taxation (or the lack thereof) for energy carriers, and the internalisation of all external costs into the prices of energy services would create a level market in which the consumer, taxpayer, and government can make economically educated choices with respect to future energy infrastructure.

From the points of discussion compiled here we deduct the following implications for policies that aim at a long-term secure, resilient, sustainable, and affordable energy supply for the UK:

Policies, strategies, coordination

- A more holistic approach to energy security is needed to develop a low carbon and flexible energy system. Since diversity is improved and cost benefits are better realised when hydrogen is used across the whole energy landscape, the government together with businesses needs to consider the electricity grid, gas grid, CO₂ transport and storage infrastructure, and new hydrogen infrastructure in a strategic and coordinated way. This will enable the energy security and cost benefits resulting from the synergies and diversity provided by hydrogen in the energy system to be fully realised.
- More coordination is required to manage the complex links between the energy markets and the large variety of primary energy input that hydrogen and fuel cells offer; it is most probably advisable that an independent institution manages the interactions between the various market players and ‘translates’ and links between the various primary feedstock and end use markets; this requires all stakeholders (gas and electricity networks and suppliers, and regulators) to work in a coordinated way; such a ‘clearing house’ could take the shape of an energy exchange as known in the electricity and gas markets, in this case managing the increased complexity the flexibility of hydrogen and fuel cells brings.
- The increase in fluctuations from clean energy input to the electricity grid needs to be met with an increasingly flexible and dynamic balancing power infrastructure, based on hydrogen and fuel cells, at the same time reducing the share of power generation that cannot quickly adapt to load fluctuations.
- The implementation of hydrogen as an energy balancing mechanism needs to be coordinated in a strategic way; this will allow to fully realise the implications for energy security and cost benefits, resulting from the synergies and diversity enabled by hydrogen in the energy system.
- A strategic vision on the future of supplying heat and power to homes, businesses and industry is required, with clear directives and support to industry to develop high efficiency appliances and processes with low to zero carbon intensity; this would also include the supply of chemical raw materials based on hydrogen to industry.
- A review on future strategy for CCS combined with biomass is needed to achieve an effective ‘negative’ carbon impact of using biomass in the hydrogen supply system.

- A clear vision of future pricing of energy services has to be developed, considering the full societal cost of these services and an appraisal of the value of environmentally benign energy carriers to the wellbeing and wealth of the nation.
- A long-term reliable regulatory and policies framework has to be presented that guarantees industry and investors a reliable environment for investments into new energy technologies supporting energy security. Standardisation agreements are part of this with green hydrogen standards required to develop a guarantee-of-origin market for renewable hydrogen, similar to the one of renewable electricity and bio-methane.

R&D and innovation support

Funding for research, development, and demonstration is needed for:

- Demonstration projects for power-to-gas electrolyzers and hydrogen production from biomass to support the development, cost reduction, safety, reliability, and commercialisation of scalable hydrogen production technology.
- Optimising electrolyser plant designs for more cost effective and scalable production, as well as for some of the less developed hydrogen production options that have high potential for low-cost production (e.g. bacteria, photo-catalysis).
- Developing reversible fuel cells that can contribute to very dynamic responses in balancing power markets, and bringing them to the market.
- Field trials and installation of fuel cell CHP systems in commercial buildings and blocks of flats; this will drive volume production to enable cost reduction from economies of scale; public-private partnership initiatives could facilitate here, drawing on the continuation of existing micro CHP FiT provisions for fuel cell CHP systems.
- Further research and support for feasibility work on gas grid conversion to hydrogen, including engineering studies, trials, conversion plans, inherently safer siting of hydrogen production and storage, as well as working with the appliance developers.
- Energy system analysis to evaluate the potential benefits of hydrogen in the UK energy system in a holistic way that fully assesses the use of hydrogen and fuel cells; data and evidence collection and support for more coordinated working relationships between industry, academia and government can enhance the reliability of these models, which can have decisive influence on the future energy strategy for the country.

The realisation of the benefits enabled by the use of hydrogen and fuel cells across the energy landscape is highly reliant on government support and a long-term reliable regulatory environment securing investment. The synergies (and diversity) enabled by its use across the sectors will substantially increase energy security. Energy imports will be reduced, resilience of energy grids increased, renewable electricity generation better balanced, greenhouse gas and other emissions cut dramatically, and the overall cost of energy services to the nation reduced.

Through BEIS, the government is the 'Competent Authority' in charge of the country's energy security strategy and thus has the power and duty to implement the changes required to maintain/enhance 'energy security' along with 'price security'. The policy implications and recommendations above contribute to shaping an energy strategy for the long term. To determine the best strategy for the UK a clear and reliable policy framework is needed, with clear indications for future policies being tabled. This will enable the academic community, industry, and government to work with the UK population in determining how best to ensure the country's energy security as we move towards a sustainable low carbon energy system.

REFERENCES

- [1] Petchers N. Heating Value and Combustion of Fuel. Combined Heating, Cooling and Power Handbook: Technologies and Applications. New York, USA: Fairmont Press; 2002.
- [2] National Grid. Calorific value description. Warwick, UK; 2008. Available at: <http://tinyurl.com/ng-calorific-value>.
- [3] Winter C-J, Nitsch J. Hydrogen as an Energy Carrier. Berlin, Heidelberg: Springer; 1988.
- [4] Rifkin J. The Hydrogen Economy. New York, N.Y., USA: Tarcher/Putnam; 2002.
- [5] US Congress. US Energy Policy Act (EPAAct) (42 U.S.C. 13201 et.seq.). 102nd Congress HR776ENR. Washington, D.C., USA1992.
- [6] Baldwin DA. The Concept of Security. *Review of International Studies*. 1997;23:22.
- [7] Asia Pacific Energy Research Centre. A Quest for Energy Security in the 21st Century – Resources and Constraints. Tokyo, Japan: Institute of Energy Economics, Japan; 2007. Available at: www.ieej.or.jp/aperc.
- [8] DECC. Energy Security Strategy. Department of Energy and Climate Change: URN 12D/349. London, UK; 2012. Available at: www.gov.uk/government/uploads/system/uploads/attachment_data/file/65643/7101-energy-security-strategy.pdf.
- [9] DECC. Digest of United Kingdom Energy Statistics (DUKES). Department of Energy and Climate Change. London, UK; 2015.
- [10] European Commission. Renewable Energy Directive (Directive 2009/28/EC of the European Parliament and of the Council on the promotion of the use of energy from renewable sources). Brussels, Belgium 2009.
- [11] EUROSTAT. Renewable energy in the EU – Share of renewables in energy consumption in the EU rose further to 16% in 2014 – Nine Member States already achieved their 2020 targets. Brussels, Belgium: European Commission; 2016.
- [12] BEIS. Renewable energy statistics collection covering the Digest of United Kingdom (DUKES), Energy Trends and regional data. Department for Business, Energy & Industrial Strategy. London; 2016.
- [13] Wilson G. Six energy records Britain broke last year. *The Conversation*. London, UK 18 Jan 2016. Available at: <https://theconversation.com/six-energy-records-britain-broke-last-year-52784>.
- [14] Anon. 2016 South Australian blackout. Wikipedia; 2016. Available at: https://en.wikipedia.org/wiki/2016_South_Australian_blackout.
- [15] Wilson G. A whole systems approach to Energy Storage. *Energy Storage & Connected Systems*. London; 2017.
- [16] Eames M, McDowall W. UKSHEC Hydrogen Visions. UKSHEC Social Science Working Paper London: UKSHEC; 2005.
- [17] Yergin D. Ensuring Energy Security. *Foreign Affairs*. 2006;85:69–82.
- [18] Chester L. Conceptualising energy security and making explicit its polysemic nature. *Energy Policy*. 2010;38:887–95.
- [19] Cherp A, Jewell J. The concept of energy security: Beyond the four As. *Energy Policy*. 2014;75:415–21.
- [20] Mitchell C, Watson J, Britton J. *New Challenges in Energy Security: The UK in a Multipolar World*. Palgrave Macmillan; 2013.

- [21] Checchi A, Behrens A, Egenhofer C. Long term energy security risks for europe: a sector specific approach. Brussels, Belgium: Centre for European Policy Studies; 2009. Available at: www.exeter.ac.uk/energysecurity/documents/publications/Checchi_et_al_2009.pdf.
- [22] Cox E. Assessing the future security of the UK electricity system in a low-carbon context. BIEE 14th Academic Conference. Oxford, UK; 2014.
- [23] Chaudry M, Wu J, Jenkins N. A sequential Monte Carlo model of the combined GB gas and electricity network. *Energy Policy*. 2013;62:473–83.
- [24] Jewell J, Cherp A, Riahi K. Energy security under de-carbonization scenarios: An assessment framework and evaluation under different technology and policy choices. *Energy Policy*. 2014;65:743–60.
- [25] POST. Measuring Energy Security. Parliamentary Office of Science and Technology. London, UK; 2012.
- [26] Månsson A, Johansson B, Nilsson LJ. Assessing energy security: An overview of commonly used methodologies. *Energy*. 2014;73:1–14.
- [27] Kruyt B, van Vuuren DP, de Vries HJM, Groenenberg H. Indicators for Energy Security. *Energy Policy*. 2009;37:2166–81.
- [28] Sovacool BK, Mukherjee I. Conceptualizing and measuring energy security: A synthesized approach. *Energy*. 2011;36:5343–55.
- [29] Winzer C. Conceptualizing Energy Security. *Energy Policy*. 2012;46:36–48.
- [30] Forsberg C. Hybrid systems to address seasonal mismatches between electricity production and demand in nuclear renewable electrical grids. *Energy Policy*. 2013;62:333–41.
- [31] DECC. The Carbon Plan: Delivering our low carbon future. Department of Energy and Climate Change. London, UK; 2011.
- [32] DECC. UK Energy Sector Indicators 2014. Department of Energy and Climate Change. London, UK; 2014.
- [33] DECC. Energy: Chapter 1, Digest of United Kingdom Energy Statistics (DUKES). Department of Energy and Climate Change. London, UK; 2015.
- [34] Stirling A. Diversity and ignorance in electricity supply investment: Addressing the solution rather than the problem. *Energy Policy*. 1994;22:195–216.
- [35] McCollum DL, Krey V, Riahi K, Kolp P, Grubler A, Makowski M, Nakicenovic N. Climate policies can help resolve energy security and air pollution challenges. *Climate Change*. 2013;119:479–94.
- [36] Hughes L. The four ‘R’s of energy security. *Energy Policy*. 2009;37:2459–61.
- [37] Chevalier J-M. Security of energy supply for the European Union. *European Review of Energy Markets*. 2006;1.
- [38] Neumann A. Security of Supply in Liberalised European Gas Markets: European University Viadrina; 2004. Available at: www.econ.ku.dk/okoep/Index%20paper.pdf.
- [39] Lefèvre N. Measuring the energy security implications of fossil fuel resource concentration. *Energy Policy*. 2010;38:1635–44.
- [40] DECC. Electricity: Chapter 5, Digest of United Kingdom Energy Statistics (DUKES). Department of Energy and Climate Change. London, UK; 2015.
- [41] Lesbirel SH. Diversification and Energy Security Risks: The Japanese Case. *Japanese Journal of Political Science*. 2004.
- [42] Koroneos C, Dompros A, Roumbas G, Moussiopoulos N. Life cycle assessment of hydrogen fuel production processes. *International Journal of Hydrogen Energy*. 2004;29:1443–50.

- [43] Dodds PE. Economics of hydrogen production. In: Subramani V, Basile A, Veziro lu TN, editors. *Compendium of Hydrogen Energy*. Oxford: Woodhead Publishing; 2015. p. 63–79.
- [44] King J. The King Review of low-carbon cars. Part I: the potential for CO2 reduction. Norwich, UK; 2007. Available at: www.hm-treasury.gov.uk/d/pbr_csr07_king840.pdf.
- [45] Automotive Council UK. *Automotive Technology Roadmaps*. London, UK: Automotive Council UK; 2013. Available at: www.automotivecouncil.co.uk/wp-content/uploads/2013/09/Automotive-Council-Roadmaps.pdf.
- [46] Dodds PE, McDowall W. Methodologies for representing the road transport sector in energy system models. *International Journal of Hydrogen Energy*. 2014;39:2345–58.
- [47] Dodds PE, Ekins P. A portfolio of powertrains for the UK: An energy systems analysis. *International Journal of Hydrogen Energy*. 2014;39:13941–53.
- [48] Sørensen B. *Hydrogen and fuel cells: emerging technologies and applications*: Academic Press; 2011.
- [49] Bhandari R, Trudewind CA, Zapp P. Life cycle assessment of hydrogen production via electrolysis – a review. *Journal of Cleaner Production*. 2014;85:151–63.
- [50] Collodi G. *Hydrogen Production via Steam Reforming with CO2 Capture*. Milan, Italy: Amec Foster Wheeler; 2010. Available at: www.aidic.it/CISAP4/webpapers/7Collodi.pdf.
- [51] Hart D, Howes J, Lehner F, Dodds PE, Hughes N, Fais B, Sabio N, Crowther M. *Scenarios for deployment of hydrogen in contributing to meeting carbon budgets and the 2050 target*. London, UK: Committee on Climate Change; 2015. Available at: <https://documents.theccc.org.uk/wp-content/uploads/2015/11/E4tech-for-CCC-Scenarios-for-deployment-of-hydrogen-in-contributing-to-meeting-carbon-budgets.pdf>.
- [52] French S. *Flexibly-fuelled hydrogen production plants*. London, UK: Johnson Matthey; 2016.
- [53] Topsøe H. *Fuel Feed flexibility H2 production HTCR Reformer*. Lyngby: Haldor Topsøes; 2016.
- [54] Hossain MZ, Charpentier PA. Hydrogen production by gasification of biomass and opportunity fuels. In: Basile A, Veziro lu TN, editors. *Compendium of Hydrogen Energy*. Oxford, UK: Woodhead Publishing; 2015. p. 137–75.
- [55] NETL. *Hydrogen Production from Coal without Power Export*. Accessed: 22 Nov 2016. Pittsburgh, USA: National Energy Technology Laboratory, Department of Energy; 2016. Available at: www.netl.doe.gov/research/Coal/energy-systems/gasification/gasifipedia/coal-to-hydrogen-without-power-export.
- [56] IEA Bioenergy. *Biomass as gasification feedstock. Gasification of Biomass and Waste*. Vienna: IEA; 2014. Available at: www.ieatask33.org/download.php?file=files/file/publications/Fact_sheets/IEA_Biomass_as_feedstock.pdf.
- [57] Cormos C-C. Assessment of flexible energy vectors poly-generation based on coal and biomass/solid wastes co-gasification with carbon capture. *International Journal of Hydrogen Energy*. 2013;38:7855–66.
- [58] Guoxin H, Hao H. Hydrogen rich fuel gas production by gasification of wet biomass using a CO2 sorbent. *Biomass and Bioenergy*. 2009;33:899–906.
- [59] Kumar S. *Clean hydrogen production methods*. London: Springer; 2015.
- [60] NETL. *Biomass and Municipal Solid Waste (MSW) Gasification*. Accessed: 22 Nov 2016. Pittsburgh, USA: National Energy Technology Laboratory, Department of Energy; 2016. Available at: www.netl.doe.gov/research/coal/energy-systems/gasification/gasifipedia/biomass-msw.
- [61] Bram van der D. Challenges in Biomass Gasification. In: ECN, editor. *Regatec*. Barcelona: ECN Biomass & Energy Efficiency; 2015. p. 30.

- [62] ECN. Phyllis2, database for biomass and waste. 2016 ed. Petten, Netherlands: Energy Research Centre of the Netherlands; 2016.
- [63] Kiel JHA. Torrefaction – an enabler for biomass gasification. Biomass Gasification Europe 2014. Alkmaar, Netherlands; 2014. p. 24.
- [64] Dalai AK, Batta N, Eswaramoorthi I, Schoenau GJ. Gasification of refuse derived fuel in a fixed bed reactor for syngas production. *Waste Management*. 2009;29:252–8.
- [65] Balas M, Lisy M, Skala Z, Pospisil J. Wet scrubber for cleaning of syngas from biomass gasification. *Advances in Environmental Sciences Development and Chemistry*. 2014:195–201.
- [66] Hanke-Rauschenbach R, Bensmann B, Millet P. Hydrogen production using high-pressure electrolyzers. In: Basile A, Veziro lu TN, editors. *Compendium of Hydrogen Energy*. Oxford, UK: Woodhead Publishing; 2015. p. 179–224.
- [67] Bertuccioli L, Chan A, Hart D, Lehner F, Madden B, Standen E. Development of Water Electrolysis in the European Union. Brussels, Belgium: FCH-JU; 2014. Available at: www.fch.europa.eu/sites/default/files/study%20electrolyser_0-Logos_0_0.pdf.
- [68] US DOE. Hydrogen Production: Electrolysis. Washington, D.C., USA: Office of Energy Efficiency & Renewable Energy, Department of Energy; 2016. Available at: <http://energy.gov/eere/fuelcells/hydrogen-production-electrolysis>.
- [69] ITM Power. Thüga Power-to-Gas Plant. Accessed: 20 Apr 2016. Sheffield, UK: 2015. Available at: www.itm-power.com/project/thuga-power-to-gas.
- [70] US DOE. Current Central Hydrogen Production from Natural Gas without CO₂ Sequestration. Department of Energy. Washington, D.C., USA; 2015. Available at: www.hydrogen.energy.gov/h2a_prod_studies.html.
- [71] US DOE. Future Central Hydrogen Production from Solid Oxide Electrolysis. Department of Energy. Washington, D.C., USA; 2015. Available at: www.hydrogen.energy.gov/h2a_prod_studies.html.
- [72] Mougins J. Hydrogen production by high-temperature steam electrolysis. *Compendium of Hydrogen Energy*. Oxford, UK: Woodhead Publishing; 2015. p. 225–53.
- [73] US DOE. Future Central Hydrogen Production from Nuclear Energy via High Temp Electrolysis. Department of Energy. Washington, D.C., USA; 2008. Available at: www.hydrogen.energy.gov/h2a_prod_studies.html.
- [74] Roeb M, Monnerie N, Houaijia A, Thomey D, Sattler C. Solar Thermal Water Splitting. *Renewable Hydrogen Technologies*. Amsterdam: Elsevier; 2013. p. 63–86.
- [75] Navarro RM, Guil R, Fierro JLG. Introduction to hydrogen production. In: Basile A, Veziro lu TN, editors. *Compendium of Hydrogen Energy*. Oxford, UK: Woodhead Publishing; 2015. p. 21–61.
- [76] US DOE. The Fuel Cell Technologies Office Multi-Year Research, Development, and Demonstration. Office of Energy Efficiency & Renewable Energy, Department of Energy. Washington, D.C., USA; 2015. Available at: http://energy.gov/sites/prod/files/2015/06/f23/fcto_myrrdd_production.pdf.
- [77] Holladay JD, Hu J, King DL, Wang Y. An overview of hydrogen production technologies. *Catalysis Today*. 2009;139:244–60.
- [78] Poudyal RS, Tiwari I, Koirala AR, Masukawa H, Inoue K, Tomo T, Najafpour MM, Allakhverdiev SI, Veziro lu TN. Hydrogen production using photobiological methods. *Compendium of Hydrogen Energy*. Oxford, UK: Woodhead Publishing; 2015. p. 289–317.
- [79] Elgowainy A, Wu M, Lampert D, Cai H, Han J, Wang M. Life-Cycle Analysis of Water Consumption for Hydrogen Production Pathways. 2014 DOE Hydrogen and Fuel Cells Program Annual Merit Review; 2014.

- [80] Elgowainy A, Lampert D, Cai H, Han J, Dunn J, Wang M. Life-Cycle Analysis of Water Consumption for Hydrogen Production Pathways. 2015 US DOE Hydrogen and Fuel Cells Program and Vehicle Technologies Office Annual Merit Review and Peer Evaluation Meeting; 2015.
- [81] Elgowainy A, Han J, Lee U, Li J, Dunn J, Wang M. Life-Cycle Analysis of Water Consumption for Hydrogen Production Pathways. 2016 DOE Hydrogen and Fuel Cells Program Annual Merit Review; 2016.
- [82] Elgowainy A, Lampert D, Cai H, Wu M, Dunn J, Han J, Wang M. X.4 Life-Cycle Analysis of Water Consumption for Hydrogen Production Pathways. Argonne, I.L., USA: Argonne National Laboratory; 2014. Available at: www.hydrogen.energy.gov/pdfs/progress14/x_4_elgowainy_2014.pdf.
- [83] Léon A. Hydrogen technology: mobile and portable applications. Berlin, Germany: Springer; 2008.
- [84] Quakernaat J. Hydrogen in a global long-term perspective. *International Journal of Hydrogen Energy*. 1995;20:485–92.
- [85] US DOE. Fuel cells and infrastructure technologies program, multi-year research, development and demonstration plan: planned program activities for 2005–2015. Washington, D.C., USA: Energy Efficiency and Renewable Energy, US Department of Energy; 2007.
- [86] Satyapal S, Petrovic J, Read C, Thomas G, Ordaz G. The US Department of Energy's national hydrogen storage project: Progress towards meeting hydrogen-powered vehicle requirements. *Catalysis Today*. 2007;120:246–56.
- [87] Gielen D, Simbolotti G. Prospects for hydrogen and fuel cells. Paris, France: International Energy Agency; 2005.
- [88] Marbán G, Valdés-Solís T. Towards the hydrogen economy? *International Journal of Hydrogen Energy*. 2007;32:1625–37.
- [89] Panfilov M, Gravier G, Fillacier S. Underground storage of H₂ and H₂-CO₂-CH₄ mixtures. ECMOR X-10th European Conference on the Mathematics of Oil Recovery; 2006.
- [90] Stolten D. Hydrogen and fuel cells: fundamentals, technologies and applications. Weinheim: Wiley-VCH; 2010.
- [91] Webb RK. Sir William Robert Grove (1811–1896) and the origins of the fuel cell. *Journal of the Royal Institute of Chemistry*. 1961;85:291.
- [92] Mond L, Langer C. A new form of gas battery. *Proceedings of the Royal Society of London*. 1889;46:296–304.
- [93] Ostwald W. *Electrochemistry: History and Theory*: Smithsonian Institution and the National Science Foundation; 1980.
- [94] EG&G Services. *Fuel Cell Handbook*. Fifth Edition ed. Morgantown, W.V., USA: U.S. Department of Energy; 2000.
- [95] Steinberger-Wilckens R. Introduction to Fuel Cell Basics. In: Borao M, Aricò A, editors. *Advances in Medium and High Temperature Solid Oxide Fuel Cell Technology*. Heidelberg, New York: Springer; 2017.
- [96] Dicks A, Larminie J. *Fuel cell systems explained*. Chichester, UK: John Wiley & Sons; 2000.
- [97] Singhal SC, Kendall K. *High-temperature solid oxide fuel cells: fundamentals, design and applications: fundamentals, design and applications*. Oxford: Elsevier; 2003.
- [98] Larminie J, Dicks A, McDonald MS. *Fuel cell systems explained*. Chichester: Wiley; 2003.
- [99] Hirschenhofer JH, Stauffer DB, Engleman RR, Klett MG. *Fuel Cell Handbook*. U.S. Department of Energy. Fourth ed. Morgantown, West Virginia; 1998.

- [100] Barbir F. PEM fuel cells: theory and practice. Second ed. Waltham: Academic Press; 2013.
- [101] Schlapbach L, Züttel A. Hydrogen-storage materials for mobile applications. *Nature*. 2001;414:353–8.
- [102] Rakass S, Oudghiri-Hassani H, Rowntree P, Abatzoglou N. Steam reforming of methane over unsupported nickel catalysts. *Journal of Power Sources*. 2006;158:485–96.
- [103] Alston T, Kendall K, Palin M, Prica M, Windibank P. A 1000-cell SOFC reactor for domestic cogeneration. *Journal of Power Sources*. 1998;71:271–4.
- [104] Singhal S. Advances in solid oxide fuel cell technology. *Solid State Ionics*. 2000;135:305–13.
- [105] Singhal SC. Solid oxide fuel cells for stationary, mobile, and military applications. *Solid State Ionics*. 2002;152:405–10.
- [106] Hardman S, Chandan A, Steinberger-Wilckens R. Fuel Cell Added Value for Early Market Applications. *Journal of Power Sources*. 2015;287:10.
- [107] Dodds PE, Staffell I, Hawkes AD, Li F, Grunewald P, McDowall W, Ekins P. Hydrogen and fuel cell technologies for heating: A review. *International Journal of Hydrogen Energy*. 2015;40 2065–83.
- [108] Roland Berger Strategy Consultants. Advancing Europe’s energy systems: stationary fuel cells in distributed generation. Brussels, Belgium: FCH-JU; 2015.
- [109] Sutharssan T, Montalvao D, Chen Y, Wang W-C, Pisac C. Economic Analysis of Domestic Combined Heat and Power Systems in the UK. *International Journal of Social, Behavioral, Educational, Economic, Business and Industrial Engineering*. 2016;10:73–7.
- [110] Brett DJL, Atkinson A, Cumming D, Ramírez-Cabrera E, Rudkin R, Brandon NP. Methanol as a direct fuel in intermediate temperature (500–600 °C) solid oxide fuel cells with copper based anodes. *Chemical Engineering Science*. 2005;60:5649–62.
- [111] Kendall K. Hydrocarbon fuels: Hopes for a flame-free future. *Nature*. 2000;404:233–5.
- [112] E4tech, Element Energy. Hydrogen and Fuel Cells: Opportunities for Growth – A Roadmap for the UK. InnovateUK; 2016.
- [113] BEIS. UK Energy in Brief 2016. Department for Business, Energy & Industrial Strategy. London, UK; 2016. Available at: www.gov.uk/government/uploads/system/uploads/attachment_data/file/540135/UK_Energy_in_Brief_2016_FINAL.pdf.
- [114] BEIS. Digest of United Kingdom Energy Statistics (DUKES) 2016: main chapters and annexes. Department for Business, Energy & Industrial Strategy. London, UK; 2016. Available at: www.gov.uk/government/uploads/system/uploads/attachment_data/file/577712/DUKES_2016_FINAL.pdf.
- [115] Brandon NP, Edge JS, Aunedi M, Barbour ER, Bruce PG, Carter D, Chakrabarti BK, Esterle T, Somerville JW, Ding YL, Fu C, Grant PS, Hall PJ, Huang C, Leng GH, Li YL, Martins VL, Navarro E, Posada JOG, Rennie AJR, Rogers DJ, Strbac G, Pérez Villar S, Yufit V, Wang J, Worsley DA. UK Research Needs in Grid Scale Energy Storage Technologies. Imperial College London, University of Birmingham, University of Oxford, University of Sheffield, University of Warwick, Swansea University; 2016.
- [116] DECC. 2010 to 2015 government policy: UK energy security. Department of Energy and Climate Change. London, UK; 2015. Available at: www.gov.uk/government/publications/2010-to-2015-government-policy-uk-energy-security/2010-to-2015-government-policy-uk-energy-security.
- [117] DECC. Electricity market reform: policy overview. Department of Energy and Climate Change. London, UK; 2012.
- [118] OFGEM. Electricity security of supply. Office of Gas and Electricity Markets. London, UK; 2015.

- [119] National Grid. Winter Outlook Report 2016/17. London, UK: 2016.
- [120] Le Fevre C. The Role of Gas in UK Energy Policy. Oxford, UK: Oxford Institute for Energy Studies, University of Oxford; 2015. Available at: www.oxfordenergy.org/wpcms/wp-content/uploads/2015/07/NG-100.pdf.
- [121] DECC. UK Risk Assessment on Security of Gas Supply. Department of Energy and Climate Change; 2016.
- [122] Steinberger-Wilckens R. Hydrogen as a Means of Transporting and Balancing Wind Power Production. In: Ackermann T, editor. Wind Power in Power Systems. 2nd ed: Wiley; 2012.
- [123] BP. BP Statistical Review of World Energy 2016. 65th ed London, UK: BP; 2017.
- [124] Götz M, Lefebvre J, Mörs F, McDaniel Koch A, Graf F, Bajohr S, Reimert R, Kolb T. Renewable Power-to-Gas: A technological and economic review. Renewable Energy. 2016;85:1371–90.
- [125] USDA, US EPA, US DOE. Biogas Opportunities Roadmap. U.S. Department of Agriculture, U.S. Environmental Protection Agency, U.S. Department of Energy; 2014.
- [126] Ormandy D, Ezratty V. Health and thermal comfort: From WHO guidance to housing strategies. Energy Policy. 2012;49:116–21.
- [127] Hinicio S.A L. Power-to-gas: Short term and long term opportunities to leverage synergies between the electricity and transport sectors through power-to-hydrogen Belgium: Hinicio S.A, LBST · Ludwig-Bölkow-Systemtechnik GmbH; 2016.
- [128] Sadler D, Cargill A, Crowther M, Rennie A, Watt J, Burton S, Haines M. H21 Leeds City Gate. Leeds, UK: Northern Gas Networks; 2016.
- [129] Brandon N, Kurban Z. Clean Energy and the Hydrogen Economy. Philosophical Transactions of the Royal Society. 2017.
- [130] ERP. Potential Role of Hydrogen in the UK Energy System. London, UK: Energy Research Partnership; 2016. Available at: <http://erpuk.org/wp-content/uploads/2016/10/ERP-Hydrogen-report-Oct-2016.pdf>.
- [131] Wyman O. World Energy Trilemma Index. London, UK: World Energy Council; 2016.
- [132] DNV KEMA. Systems Analyses Power to Gas. DNV KEMA Energy & Sustainability; 2013.
- [133] Strbac G, Aunedi M, Pudjianto D, Djapic P, Teng F, Sturt A, Jackravut D, Sansom R, Yufit V, Brandon N. Strategic Assessment of the Role and Value of Energy Storage Systems in the UK Low Carbon Energy Future. London, UK: Carbon Trust; 2012.
- [134] REF. Balancing Mechanism Wind Farm Constraint Payments. Renewable Energy Foundation; 2017. Available at: www.ref.org.uk/constraints/indexbymth.php.
- [135] Castagneto-Gissey G, Dodds PE. Regulatory Challenges to Energy Storage Deployment: An Overview of the UK Market. London, UK: 2016. Available at: www.restless.org.uk/documents/working-paper-1.
- [136] Heide D, von Bremen L, Greiner M, Hoffmann C, Speckmann M, Bofinger S. Seasonal optimal mix of wind and solar power in a future, highly renewable Europe. Renewable Energy. 2010;35:2483–9.
- [137] Dodds PE, McDowall W. The future of the UK gas network. Energy Policy. 2013;60:305–16.
- [138] Melaina MW, Antonia O, Penev M. Blending Hydrogen into Natural Gas Pipeline Networks: A Review of Key Issues. National Renewable Energy Laboratory, Department of Energy; 2013. Available at: www.nrel.gov/docs/fy13osti/51995.pdf.
- [139] Florisson O. NATURALHY: Assessing the potential of the existing natural gas network for hydrogen delivery. Accessed: 5 Dec 2016. KEMA; 2010. Available at: www.gerg.eu/public/uploads/files/publications/academic_network/2010/1b_Florisson.pdf.

- [140] The Coalition. A portfolio of power-trains for Europe: a fact-based analysis – The role of Battery Electric Vehicles, Plug-in Hybrids and Fuel Cell Electric Vehicles. Brussels, Belgium: 2010.
- [141] FCH-JU. Multi-Annual Working Plan 2014–2020. In: JU F, editor. Brussels 2014.
- [142] BEIS. BEIS Fossil Fuel Price Projections. Department of Business, Energy and Industrial Strategy. London, UK; 2016.
- [143] Stephenson AL, MacKay DJC. Life Cycle Impacts of Biomass Electricity in 2020. Department of Energy and Climate Change. London, UK; 2014. Available at: www.gov.uk/government/uploads/system/uploads/attachment_data/file/349024/BEAC_Report_290814.pdf.
- [144] Judkis M. How one company eliminated food waste: ‘The landfill can no longer be an option’. The Washington Post. Washington, D.C., USA 9 Jan 2017.
- [145] COMEAP. The Mortality Effects of Long-Term Exposure to Particulate Air Pollution in the United Kingdom. Public Health England. Didcot, UK; 2010. Available at: www.gov.uk/government/uploads/system/uploads/attachment_data/file/304641/COMEAP_mortality_effects_of_long_term_exposure.pdf.
- [146] Neslen A. European Commission issues final warning to UK over air pollution breaches. The Guardian. London, UK 15 Feb 2017. Available at: www.theguardian.com/environment/2017/feb/15/european-commission-issues-final-warning-to-uk-over-air-pollution-breaches.
- [147] Drollette Jr D. The rising cost of decommissioning a nuclear power plant. Bulletin of the Atomic Scientist 70 Years Speaking Knowledge to Power. 2014.
- [148] Stern N. Stern Review on the Economics of Climate Change. London, UK: 2006.
- [149] Bickel P, Friedrich R. Externalities of Energy: Methodology 2005 Update. 2005. Available at: www.externe.info/externe_d7/sites/default/files/methup05a.pdf.
- [150] Schreyer C, Schneider C, Maibach M, Rothengatter W, Doll C, Schmedding D. External Costs of Transport. INFRAS; 2004.
- [151] Odgen OM, Williams RH, Larson ED. Societal lifecycle costs of cars with alternative fuels/engines. Energy Policy. 2004;32.
- [152] Dobson I, Carreras BA, Lynch VE, Newman DE. Complex Systems Analysis of Series of Blackouts: Cascading Failure, Critical Points, and Self-Organization. Chaos. 2007;17.
- [153] ESRU. Combined Heat and Power Systems. Glasgow, UK: University of Strathclyde; 2000. Available at: www.esru.strath.ac.uk/EandE/Web_sites/99-00/bio_fuel_cells/groupproject/library/chp/text.htm.
- [154] Kjølstad Poulsen N, Madsen H, HejdeNielsen A, Gehrke O, Bindner H. Self-organising distributed control of a distributed energy system with a high penetration of renewable energy (EnMi2101-04-0006). Danish Smartgrids Group Meeting; 2008.
- [155] OFGEM. Electricity Capacity Assessment Report. Office of Gas and Electricity Markets. London, UK; 2014.
- [156] Mock V. Nuclear Shutdowns Leave Belgium Looking for Power. Wall Street Journal. Europe ed: Dow Jones; 21 Aug 2014. Available at: www.wsj.com/articles/nuclear-shutdowns-leave-belgium-looking-for-power-1408632643.
- [157] Schmalzer B. World Market Outlook. Turbomachinery International. 2013.
- [158] Eisentraut A, Brown A. Heating without global warming. Paris, France: International Energy Agency; 2014.
- [159] BEIS. Energy Consumption in the UK. Department for Business, Energy & Industrial Strategy: UK Government; 2016. Available at: www.gov.uk/government/uploads/system/uploads/attachment_data/file/541163/ECUK_2016.pdf.

- [160] Dodds PE, Staffell I, Hawkes AD, Li F, Grünewald P, McDowall W, Ekins P. The role of hydrogen and fuel cells in providing affordable, secure low-carbon heat. H2FC SUPERGEN, London, UK; 2014.
- [161] Payne R, Love J, Kah M. Generating electricity at 60% electrical efficiency from 1 to 2 kWe SOFC products. *ECS Transactions*. 2009;25:10.
- [162] Chiesa P, Lozza G, Mazzocchi L. Using Hydrogen as Gas Turbine Fuel *Journal of Engineering for Gas Turbines and Power*. 2005;127:73–80.
- [163] Fuel Cell Power. World's Largest Fuel Cell Park Operational in South Korea. Accessed: 31 Jan 2017. 2014. Available at: <http://fuelcellpower.org.uk/?p=1505>.
- [164] El-Khattam W, Salama MMA. Distributed generation technologies, definitions and benefits. *Electric Power Systems Research*. 2004;71:119–28.
- [165] Khairy H, El-Shimy M, Hashem G. Overview of Grid Code and Operational Requirements of Grid-connected Solar PV Power Plants *Industry Academia Collaboration (IAC) Conference*. Cairo, Egypt: IAC; 2015.
- [166] Fehrenbacher K. Silicon Valley Fuel Cell Maker Bloom Energy Has Secretly Filed For An IPO. *Fortune*. 16 Oct ed2016. Available at: <http://fortune.com/2016/10/06/bloom-energy-ipo/>.
- [167] Chowdhury AA, Agarwal SK, Koval DO. Reliability modeling of distributed generation in conventional distribution systems planning and analysis. *IEEE Transactions on Industry Applications*. 2003;39:1493–8.
- [168] Deutschlaender T, Wichura B. Das Münsterländer Schneechaos am 1. Adventswochenende 2005. *Deutscher Wetterdienst*; 2005. p. 163–7.
- [169] Zeineldin HH, El-saadany EF, Salama MMA. Distributed Generation Micro-Grid Operation: Control and Protection. 2006 *Power Systems Advanced Metering, Protection, Control, Communication, and Distributed Resources*; 2006. p. 105–11.
- [170] Zerriffi H, Dowlatabadi H, Strachan N. Electricity and Conflict: Advantages of a Distributed System. *The Electricity Journal*. 2002;15:55–65.
- [171] Dán G, Sandberg H, Bjorkman G, Ekstedt M. Challenges in Power System Information Security. *IEEE Security and Privacy Magazine*. 2012;10.
- [172] Reilly S. Bracing for a big power grid attack: 'One is too many'. *USA Today*. McLean, V.A., USA 24 Mar 2015.
- [173] Wang S, Li X, Xiao Z, Wang C. Multi-agent Approach for Service Restoration of Distribution System Containing Distributed Generations. *Automation of Electric Power Systems*. 2007;31:61–5.
- [174] Johnston I. Scotland's wind turbines provided more electricity than the country needed four days in a row. *The Independent*. London, UK 2017.
- [175] E4tech. *The Fuel Cell Industry Review 2016*. London: E4tech; 2016. p. 20.
- [176] Auto-Bild. Wie wintertauglich sind BMW i3 & Co? 9 Jan 2014. Available at: www.autobild.de/artikel/elektroautos-im-wintertest-4516067.html.
- [177] Masson L. Electric Car Range in Winter, From European Perspective. *Plugin Cars: 2014*. Available at: www.plugin-cars.com/reduced-ranges-electric-cars-cold-129205.html.
- [178] Voelcker J. 2016 Toyota Mirai Power-Out Jack Could Run Your Home In Emergencies. Accessed: 18 Nov 2017. *Green Car Reports*; 2014.
- [179] Sheffield JW. Energy Security Through Hydrogen. In: Sheffield JW, Sheffield Ç, editors. *Assessment of Hydrogen Energy for Sustainable Development*. Dordrecht: Springer Netherlands; 2007. p. 1–8.
- [180] NRC, NAE. *The Hydrogen Economy: Opportunities, Costs, Barriers, and R&D Needs: Implications of a Transition to Hydrogen in Vehicles for the U.S. Energy System*. Washington, D.C., USA: National Research Council, National Academy

- of Engineering; 2004. p. 256. Available at: www.nap.edu/catalog/10922/the-hydrogen-economy-opportunities-costs-barriers-and-rd-needs.
- [181] Ekins P, Keppo I, Skea J, Strachan N, Usher W, Anandarajah G. The UK Energy System in 2050: Comparing Low-Carbon, Resilient Scenarios. London, UK: UK Energy Research Centre; 2013. Available at: www.ukerc.ac.uk/support/tiki-download_file.php?fileId=2976.
- [182] Ipsos MORI, Energy Saving Trust. Homeowners' Willingness To Take Up More Efficient Heating Systems. London, UK: 2013. Available at: www.gov.uk/government/uploads/system/uploads/attachment_data/file/191541/More_efficient_heating_report_2204.pdf.
- [183] Dodds PE, Keppo I, Strachan N. Characterising the Evolution of Energy System Models Using Model Archaeology. *Environmental Modeling & Assessment*. 2015;20:83–102.
- [184] BEIS. The Carbon Budget Order 2016. Department for Business, Energy and Industrial Strategy. London, UK; 2016. Available at: www.legislation.gov.uk/uksi/2016/785/made.
- [185] Dodds PE. Integrating housing stock and energy system models as a strategy to improve heat decarbonisation assessments. *Applied Energy*. 2014;132:358–69.
- [186] Dodds PE, Demoullin S. Conversion of the UK gas system to transport hydrogen. *International Journal of Hydrogen Energy*. 2013;38:7189–200.
- [187] HM Parliament. The Climate Change Act 2008. London, UK; 2008.
- [188] Stirling A. Multicriteria diversity analysis: A novel heuristic framework for appraising energy portfolios. *Energy Policy*. 2010;38:1622–34.
- [189] Skea J, Chaudry M, Wang X. The role of gas infrastructure in promoting UK energy security. *Energy Policy*. 2012;43:202–13.
- [190] Locatelli G, Palerma E, Mancini M. Assessing the economics of large Energy Storage Plants with an optimisation methodology. *Energy*. 2015;83:15–28.
- [191] Amid A, Mignard D, Wilkinson M. Seasonal storage of hydrogen in a depleted natural gas reservoir. *International Journal of Hydrogen Energy*. 2016;41:5549–58.
- [192] Schoenung S. Energy Storage Systems Cost Update: A Study for the DOE Energy Storage Systems Program. Springfield, VA, USA: Sandia National Laboratories; 2011. Available at: <http://prod.sandia.gov/techlib/access-control.cgi/2011/112730.pdf>.
- [193] Gammer D. The role of hydrogen storage in a clean responsive power system. Loughborough, UK: Energy Technologies Institute; 2015.
- [194] The White House. An America First Energy Plan. Washington, D.C., USA: 2017. Available at: www.whitehouse.gov/america-first-energy.
- [195] OFGEM. Decision to approve National Grid Electricity Transmission plc's operational methodologies for SBR and DSBR. Office of Gas and Electricity Markets. London, UK; 2014. Available at: www.ofgem.gov.uk/sites/default/files/docs/2014/11/decision_letter_operational_methodology.pdf.
- [196] Hayashi M, Hughes L. The Fukushima nuclear accident and its effect on global energy security. *Energy Policy*. 2013;59:102–11.
- [197] Institute for 21st Century Energy. International Index of Energy Security Risk. U.S. Chamber of Commerce. Washington, D.C., USA; 2016.
- [198] Chestney N. Npower to increase energy prices by 9.8 per cent from mid-March. *The Independent*. London, UK 3 Feb 2017.
- [199] IET. Britain's Power System: The case for a System Architect. The Institution of Engineering and Technology; 2014.
- [200] OFGEM. Statutory Security of Supply Report 2016. Office of Gas and Electricity Markets. London, UK; 2016.

- [201] OFGEM. Electricity Balancing Significant Code Review. Office of Gas and Electricity Markets. London, UK; 2017. Available at: www.ofgem.gov.uk/electricity/wholesale-market/market-efficiency-review-and-reform/electricity-balancing-significant-code-review.
- [202] DECC. 2010 to 2015 government policy: household energy. Department of Energy and Climate Change. London, UK; 2015.
- [203] DECC, OFGEM. Smart Grid Vision and Routemap. Department of Energy and Climate Change, Office of Gas and Electricity Markets. London, UK; 2014.
- [204] ENSG. A Smart Grid Routemap. Electricity Networks Strategy Group; 2015. Available at: http://webarchive.nationalarchives.gov.uk/20100919181607/http://www.ensg.gov.uk/assets/ensg_routemap_final.pdf.
- [205] OFGEM. State of the Market Assessment. Office of Gas and Electricity Markets. London, UK; 2014.
- [206] OFGEM. Wholesale Energy Markets in 2016. Office of Gas and Electricity Markets. London, UK; 2016.
- [207] Linnemann J, Steinberger-Wilckens R. Realistic costs of wind-hydrogen vehicle fuel production. *International Journal of Hydrogen Energy*. 2007;32:1492–9.
- [208] Staffell I, Dodds PE. The role of hydrogen and fuel cells in future energy systems. London, UK: H2FC SUPERGEN Hub; 2017.
- [209] DECC. CHP Focus. Accessed: 01/02/2017. London, UK: Department of Energy and Climate Change; 2016. Available at: <http://chptools.decc.gov.uk/app/reporting/index/viewtable/token/2>.
- [210] ene.field. About ene.field. 2017. Available at: <http://enefield.eu/category/about/>.
- [211] Staffell I, Green R. The cost of domestic fuel cell micro-CHP systems. *International Journal of Hydrogen Energy*. 2013;38:1088–102.
- [212] Callux. Field Test of Residential Fuel Cells – Background & Activities. 2013. Available at: www.callux.net/home.English.html.
- [213] DECC. UK National Energy Efficiency Action Plan. Department of Energy and Climate Change. London, UK; 2014.
- [214] BEIS. Combined Heat and Power Incentives. Accessed: 5 Feb 2017. Department for Business, Energy & Industrial Strategy; 2017. Available at: www.gov.uk/guidance/combined-heat-and-power-incentives.
- [215] MacLean K, Sansom R, Watson T, Gross R. Managing Heat System Decarbonisation. London, UK: 2016. Available at: <http://provppl.com/wp-content/uploads/2016/05/Heat-infrastructure-paper.pdf>.
- [216] KPMG, Kiwa Gastec. 2050 Energy Scenarios: The UK Gas Networks role in a 2050 whole energy system. London, UK: Energy Networks Association; 2016.
- [217] Michael Ball MW. The hydrogen economy – Vision or reality? *International Journal of Hydrogen Energy*. 2015;40:7903–19.
- [218] METI. Compilation of the Revised Version of the Strategic Roadmap for Hydrogen and Fuel Cells. Ministry of Economy, Trade and Industry. Tokyo, Japan; 2016. Available at: www.meti.go.jp/english/press/2016/0322_05.html.
- [219] NOW. Government programme for hydrogen and fuel cell technology 2016–2026. National Organisation Hydrogen and Fuel Cell Technology; 2016.
- [220] The White House. Hydrogen Economy Fact Sheet. Accessed: 27 Nov 2016. Washington, D.C., USA: 2003. Available at: <https://georgewbush-whitehouse.archives.gov/news/releases/2003/06/20030625-6.html>.

- [221] US DOE. H2 at Scale: Deeply Decarbonising our Energy System. Accessed: 28 Nov 2016. US Department of Energy; 2016. Available at: www.hydrogen.energy.gov/pdfs/htac_apr16_10_pivovar.pdf.
- [222] IPHE. United States, IPHE Country Update: November 2016. Accessed: 27 Nov 2016. International Partnerships for Hydrogen and Fuel Cells in the Economy; 2016. Available at: <http://iphe.net/partners/unitedstates.html>.
- [223] US DOE. Fuel Cells Powering Critical Infrastructure in Disasters. U.S. Department of Energy, Fuel Cell Technologies Office; 2016. Available at: www.energy.gov/sites/prod/files/2016/12/f34/fcto_fuel_cells_during_storms.pdf.
- [224] Scottish Government. The Future of Energy in Scotland. Edinburgh, UK; 2017.

This White Paper has been commissioned by the UK Hydrogen and Fuel Cell (H₂FC) SUPERGEN Hub to examine the roles and potential benefits of hydrogen and fuel cell technologies in delivering energy security for the UK.

The H₂FC SUPERGEN Hub is an inclusive network encompassing the entire UK hydrogen and fuel cells research community, with around 100 UK-based academics supported by key stakeholders from industry and government. It is funded by the UK EPSRC research council as part of the RCUK Energy Programme. This paper is the second of four that were published over the lifetime of the Hub, with the others examining: (i) low-carbon heat; (iii) future energy systems; and (iv) economic impact.

www.h2fcsupergen.com

For enquires about this
White Paper please contact:

John Hooper

Centre for Fuel Cell and Hydrogen Research
School of Chemical Engineering
University of Birmingham
Edgbaston
Birmingham B15 2TT
Tel: +44 (0)121 414 5275
j.c.hooper@bham.ac.uk

For enquiries and to join
H₂FC SUPERGEN please contact:

Dr. Zeynep Kurban
H₂FC SUPERGEN Manager

Energy Futures Lab
Imperial College London
London SW7 2AZ
H2fc@imperial.ac.uk
Tel: +44 (0) 20 7594 5850
www.h2fcsupergen.com