



Durham E-Theses

Grammar, Ontology, and the Unity of Meaning

REICHARD, ULRICH

How to cite:

REICHARD, ULRICH (2013) *Grammar, Ontology, and the Unity of Meaning*, Durham theses, Durham University. Available at Durham E-Theses Online: <http://etheses.dur.ac.uk/9423/>

Use policy

The full-text may be used and/or reproduced, and given to third parties in any format or medium, without prior permission or charge, for personal research or study, educational, or not-for-profit purposes provided that:

- a full bibliographic reference is made to the original source
- a [link](#) is made to the metadata record in Durham E-Theses
- the full-text is not changed in any way

The full-text must not be sold in any format or medium without the formal permission of the copyright holders.

Please consult the [full Durham E-Theses policy](#) for further details.

Grammar, Ontology, and the Unity of Meaning

Submitted for the Degree of Doctor of Philosophy

by

Ulrich Reichard

Department of Philosophy

Durham University

2013

Supervisors:

Prof. Wolfram Hinzen

Prof. Nick Zangwill

Dr Jan Westerhoff

Examiners:

Prof. John Collins, University of East Anglia

Dr Sophie Gibb, University of Durham

Viva:

3 December 2013

The copyright of this thesis rests with the author. No quotation from it should be published without the author's prior written consent and information derived from it should be acknowledged.

To Bella Ruth

Abstract

Words have meaning. Sentences also have meaning, but their meaning is different in kind from any collection of the meanings of the words they contain. I discuss two puzzles related to this difference. The first is how the meanings of the parts of a sentence combine to give rise to a unified sentential meaning, as opposed to a mere collection of disparate meanings (UP1). The second is why the formal ontology of linguistic meaning changes when grammatical structure is built up (UP2). For example, the meaning of a sentence is a proposition evaluable for truth and falsity. In contrast, a collection of the meanings of its parts does not constitute a proposition and is not evaluable for truth. These two puzzles are closely related, since change in formal ontology is the clearest sign of the unity of meaning. The most popular strategy for answering them is taking the meanings of the parts as abstractions from primitive sentence meanings. However, I argue that, given plausible psychological constraints, sentence meanings cannot be taken as explanatory primitives.

Drawing on recent work in Generative Grammar and its philosophy, I suggest that the key to both unity questions is to distinguish strictly between lexical and grammatical meaning. The latter is irreducible and determines how lexical content is used in referential acts. I argue that these referential properties determine a formal ontology, which explains why and how formal ontology changes when grammatical structure is built up (UP2). As for UP1, I suggest that, strictly speaking, lexical meanings never combine. Instead, whenever grammar specifies a formal ontology for the lexical meanings entering a grammatical derivation, further lexical (or phrasal) meanings can only specify aspects of this recursive grammatical process. In this way, contemporary grammatical theory can be used to address old philosophical problems.

Contents

Preface	11
Overview.....	17
Acknowledgements.....	19
1 The Problem of Linguistic Unity	21
1.1 What is Language?.....	21
1.1.1 Two Notions of Language.....	21
1.1.2 A Brief Tutorial on Generative Grammar.....	25
1.1.3 Un-Cartesian Linguistics.....	29
1.2 Two Aspects of the Unity Problem.....	31
1.2.1 The Productivity of Language.....	31
1.2.2 Why is Linguistic Meaning Unified? (UP1)	33
1.2.3 Grammatical Structure and Formal Ontology (UP2)	38
1.3 Psychologizing Unity.....	42
1.3.1 The Unity of Apperception	43
1.3.2 Russell’s Multiple Relations Theory of Judgement	44
1.3.3 Unification: A Pseudo-Problem?	45
1.3.4 Pragmatics and Metaphysics.....	46
1.4 Bradley’s Regress: Problem or Solution?	47
2 The Dichotomy between Unity and Productivity	52
2.1 Why Predicate Conjunction is not Enough	53
2.1.1 Aristotelian Compositionality	54
2.1.2 Pietroski’s Conjunctivism.....	55
2.2 Atomism and Wholism	58
2.2.1 The Wholistic Strategy.....	59
2.2.2 Russell’s Atomism and the Unity of the Proposition.....	60
2.2.3 Bradley’s Wholism and the Productivity of Language	62
2.3 Functional Compositionality.....	64
2.3.1 Explicit Definitions of Functions and Productivity	65
2.3.2 Implicit Definitions of Functions and Unity	66
2.3.3 Deriving Functions by Abstraction: A Dilemma	68
2.4 Turning Tarski Upside Down: Truth-Conditions and Unity.....	70
2.4.1 Tarski’s Semantic Definition of Truth	71
2.4.2 Quine’s Theory of Predication and Truth	72
2.4.3 Davidson: A Primitive Notion of Absolute Truth.....	73
2.4.4 Are Davidsonian Predicates Referential, After All?	75
2.4.5 Radical Interpretation and Productivity	76
2.4.6 Unity Remains Unexplained	77
2.5 Can Unity and Productivity be Reconciled?	79
2.5.1 The Dichotomy between Unity and Productivity.....	80
2.5.2 Propositions as Pictures or Images.....	81
2.5.3 A Proposal.....	84

3 The Irreducibility of Grammar	87
3.1 A Grammarist Account of Reference and Predication	88
3.1.1 Lexical Roots, Parts of Speech, and Grammar	88
3.1.2 Lexicalism, Grammarism, and Unity	89
3.1.3 The Origin of Grammatical Structure	92
3.1.4 The Grammar of Reference and Predication.....	94
3.1.5 Generalizing the Approach: Grammatical Phases.....	98
3.2 Can Structure be Inherently Meaningful?.....	100
3.2.1 The Origin of Meaning	101
3.2.2 King’s Theory of Propositions and Bradley’s Regress	102
3.2.3 Propositions Cannot be Abstracted from Cognitive Acts or Events	105
3.2.4 Grammar is Inherently Meaningful.....	109
3.2.5 Naturalizing Grammatical Meaning.....	112
3.3 Grammar and Entailment.....	114
3.3.1 Natural Logic and Generative Grammar.....	116
3.3.2 Intersective and Non-Intersective Modification.....	118
3.3.3 Two Ambiguities.....	121
3.3.4 The Grammar of Intersective and Subjective Modification	123
4 Grammatology: A Solution to UP2	127
4.1 Grammar and the Formal Ontology of Language	128
4.1.1 Grammar and Ontology	128
4.1.2 Intrinsic and Relational Ontological Categories	129
4.2 Formal Ontological Distinctions and the Ontological Productivity of Language.....	132
4.3 Language and Thought	135
4.3.1 Language and Thought in the Generative Tradition	136
4.3.2 Monkey Talk.....	143
4.3.3 Monkey Thoughts	145
4.3.4 The Evolution of Language and Thought	148
4.4 Grammatical Structure Building and Ontological Change	150
4.4.1 The Second Unity Problem.....	150
4.4.2 The Meaning of Grammar.....	152
5 Grammatical, Lexical, and Perceptual Ontology	156
5.1 A Case Study in Grammatology	156
5.1.1 Grammar and Ontology: A Chicken-Egg Problem.....	156
5.1.2 The Grammar of Tropes and States	159
5.1.3 The Distribution of Tropes and States	162
5.1.4 The Grammar and Distribution of Events and Facts.....	165
5.2 Pre-Grammatical Ontology and the Lexicalization of Onto-Grammatical Categories	166
5.2.1 The Formal Ontology of Perception	167
5.2.2 Grammatical Ontology and Perceptual Ontology	171
5.2.3 Mismatches Between Lexical and Grammatical Ontology.....	173
5.2.4 The Paradox of the Concept <i>Horse</i> Generalized.....	175

6 Productivity without ‘Building Blocks’: A Solution to UP1..... 179

 6.1 The Paradox of the Unity of Meaning 179

 6.2 Why Merge is not Enough 182

 6.2.1 Collins’s ‘Combinatorial Unity’ and UP1..... 182

 6.2.2 A Syntactic Answer to UP1 185

 6.3 The Growth of Linguistic Meaning 187

 6.3.1 Growing Linguistic Meaning in Grammatical Soil..... 188

 6.3.2 The Meaning of Phrase Heads 189

 6.3.3 The Meaning of Specifiers 191

 6.3.4 Adjuncts and Arguments..... 196

Conclusion 200

 7.1 Concluding Remarks..... 200

 7.2 Further Directions in Grammatology 202

References..... 203

Calvin and Hobbes

by Bill Watterson

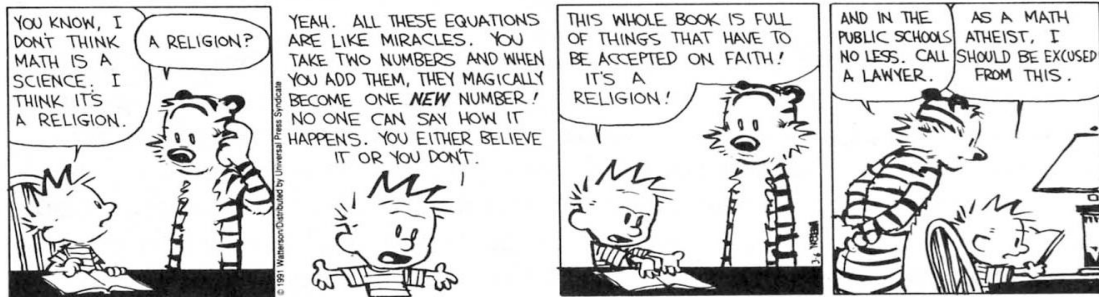

© by Bill Watterson

Preface

I will take no stance as to whether Calvin in the cartoon above should indeed be excused from his maths lessons. Yet, the problem he raises concerns unity. The result of taking two numbers, 2 and 3 say, and adding them is not the number set $\{2, 3\}$ or something alike, but a new number, 5. The original numbers 2 and 3 have ‘vanished’. Where does the new number come from? Where did the original ones go?¹

Puzzles about unity arise in many areas of philosophy and concern topics as diverse as the relation between objects and their parts, the relation between universals and their instantiations, the relation between objects and their properties, the relation between matter and form, the relation between words and sentences, and many others. Thus, it is unsurprising that unity problems have been discussed since ancient times. Many fragments of Parmenides and Heraclites concern unity, which also features prominently in Plato and Aristotle. Furthermore, unity is an important topic of scholastic theories of the *propositio*. It is also central for Kant’s

¹ Whether these questions actually arise in respect to the addition of numbers depends on what you think numbers are. Frege’s taking numbers as abstract objects certainly results in the puzzle as to how 2 and 3 ‘hold together’ to make up, not a set or list, but a new number. However, thinking of numbers as mere counters may help overcome the problem. Given a set of two pears and a set of three pears, the members of the two sets can be used to define a single set of five pears. The difference, then, is more a difference in how objects are grouped together. This strategy, recently defended in Hofweber (2005) and Moltmann (2013, ch. 6), has been dubbed ‘the adjectival strategy’ in Dummett (1991, ch. 9).

transcendental philosophy of the unity of apperception and arises in a similar way in Husserl's phenomenology. Moreover, idealist positions from Hegel to Bradley are often at least partially motivated by unity problems.

The *locus classicus* for the problem of 'the unity of the proposition', however, is early analytic philosophy. Frege (1892: 54) claims his distinction between objects and concepts to be of the 'highest importance', as it contains his solution as to how parts of the meaning of a sentence form a coherent whole rather than an aggregate of disparate objects. Also, Russell (1899: 146) writes about a unity problem that 'to solve this difficulty – if indeed it be soluble – would, I conceive, be the most valuable contribution which a modern philosopher could possibly make to philosophy'. It is thus not surprising that his urge to resolve unity problems was a main force behind Russell's changing theories of propositions (Stevens 2006).

After some years of mainly historical interest, unity has recently been rediscovered as a topic of systematic philosophical research.² Yet, whereas Frege and the early Russell, as well as some current metaphysicians, phrase the problem primarily in metaphysical terms,³ the focus of discussion has shifted towards a more linguistic setting in many recent accounts. For example, Gibson (2004) takes a pragmatic approach, Gaskin (2008: 299) thinks of unity as 'conceptual' and defends a linguistic idealist position, Hanks (2011) suggests grounding unity in cognitive acts (cf. Soames 2010b), and King (2007; 2009) proposes that propositions inherit their unity from linguistic facts. Furthermore, Peacock (2011) argues that the problem of the unity of the proposition can find its solution only in a theory of language. Also Davidson (2005), who discusses the problem under the headline of 'the problem of predication,' offers a solution based on his semantic theory. Following this general trend, I discuss a linguistic version of the unity problem, which, as Collins (2011b) points out, arises independently of its metaphysical counterpart.

On common metaphysical conceptions, propositions, states of affairs, situations or facts, whatever they are exactly taken to be, have objects, properties and relations as constituents. Yet, they are not merely the mereological sum of their respective constituents. For example, the fact that John loves Mary is not the same as the fact that Mary loves John, despite them having the same constituents.⁴ Armstrong (1997: 122) therefore argues that states of affairs 'have a non-

² Unity also remains in the focus of historical studies. Recent primarily historical treatments in book-length include Hylton (1990), Stevens (2005) and Candlish (2007).

³ See Maurin (2012) for a review of recent discussions of unity from a metaphysical point of view.

⁴ Nonetheless, given Lewis's (1991) principle of Unrestricted Composition, these mereological sums should be taken to exist whenever their parts exist.

mereological mode of combination’ and admits that non-symmetrical relations have a ‘direction’ (Armstrong 1997: 121). Yet, this is not much more than a redescription of the explanandum. Consequently, Armstrong seems to take states of affairs as primitives: ‘states of affairs come first’ and ‘hold their constituents together’ (Armstrong 1997: 118). Perhaps, then, the question of how the constituents of facts, propositions and states of affairs combine does not have an answer. This might either be seen as a reason for taking them as primitives of metaphysical theories (Schaffer 2010; Fiocco 2012) or as evidence for the claim that they should, in fact, be abandoned as metaphysical entities (Palmer 1988; Dodd 1999; Betti 2006).⁵

However, whereas there is no *prima facie* reason against abandoning propositions or taking them as primitives in a metaphysical theory, there is no straightforward way of employing either of these strategies in a theory of the unity of meaning of natural language. I take it as given that sentences have meaning. Therefore, the problem of the unity of meaning cannot be avoided by simply denying sentential meanings. However, also taking sentential meanings as explanatory primitives is problematic, since natural language is productive:⁶ every speaker can produce and comprehend any of a potentially infinite number of sentences with distinct meanings. Yet, our cognitive capacities are finite – we cannot possibly memorize an infinite number of meanings.⁷ For this reason, an account of the unity of linguistic meaning that takes sentential meanings as primitives cannot account for the fact that finite beings like us can *know* these meanings. The infinity of sentential meanings rather suggests that they can somehow be ‘assembled’ from the meanings of the words they contain (in addition to the meaning of the mode of combination), in which case the question arises how the meanings can be unified such as to give rise to the meaning of the sentence.⁸ Thus, whereas the metaphysician does not need to assume that, for example, objects and properties combine to make up states of affairs, the conclusion that word meanings combine to make up sentence meanings is hard to avoid, in light of the fact that languages can be known by beings like us.⁹

⁵ For an alternative proposal see Vallicella (2000; 2002b).

⁶ Sentential meaning has, nonetheless, often been taken as explanatory primitive in semantic theory. Referring to the Fregean tradition, Searle (2007: 26) for example argues that ‘the unity of the proposition is built into the logical structure of biological intentionality,’ for, ‘we require that sentences encode whole intentional states.’ See chapter 2 for further discussion of this strategy.

⁷ In addition, there is the familiar fact that we can comprehend and produce novel sentences with meanings we have never encountered before, which yields much the same conclusion.

⁸ For discussion of this point see chapter 1.2.1, cf. also chapter 2.

⁹ Alternative metaphysical accounts of unity include the thesis that at least some non-relational tropes (that is, instantiations of properties) depend essentially upon the objects they characterize (Lowe 2006), or that certain relational tropes depend essentially upon the objects they relate (Maurin 2010). If so, the

The problem of linguistic unity consists of several closely related puzzles.¹⁰ Without suggesting that others might not be equally relevant, I formulate and discuss two of them. The first arises since both words and sentences are meaningful. Furthermore, the meaning of a sentence depends upon the meaning of the words it contains. Yet, the meaning of the sentence *Socrates sits* differs qualitatively from that of an aggregate of the disparate meanings of *Socrates* and *sits*. The first unity problem (UP1) is thus: How are the separate meanings of words united in the meaning of a sentence?¹¹ An observation closely related to this question is that this special kind of unity often comes with a change in formal ontology.¹² For example, the meaning of *Socrates* is, say, an object, whereas the meaning of *sits* is, say, a property, but the meaning of *Socrates sits* is neither a property nor an object but a proposition (or fact, or state of affairs) and is evaluable for truth, whereas none of its parts is so evaluable. The second unity problem (UP2) is thus: Why does the formal ontological category change if meanings are combined in the right way?¹³

I argue that the solution to these questions can be found in *grammar* and I will employ contemporary grammatical theory to formulate my proposal. To a certain degree, I follow Collins (2011b) in this respect. Yet, Collins uses a reduced notion of grammar, according to which grammar consists of no more than a set-theoretical operation called *Merge*. I argue that this notion of grammar is not rich enough to tackle what I take to be the core problems of the unity of meaning (cf. chapter 6.2).

question of how object and trope combine to make up a state of affairs does not arise, as the trope only exists in case it characterizes the particular object it characterizes or relates the particular objects it relates, respectively. Yet, as these theories have to take all unifying tropes as brute, the number of primitives is at least as big as the number of unities (states of affairs). Hence, for the reasons discussed above, also this strategy cannot straightforwardly be employed to the linguistic case (cf. chapter 2.5.3 for further discussion).

¹⁰ Jespersen (2012) mentions five problems associated with propositional unity, Sainsbury (1996) and Eklund (2009) identify four unity problems, King (2009) accepts three, Collins (2011b) discusses two.

¹¹ As I explain in section 1.2.3, unity problems do in fact not only concern the relation between the meaning of words and that of sentences, but also apply to the relation between every subsentential expression that is grammatically complex and its parts. Here, I abstract from this complication for the purpose of exposition.

¹² The ontology at issue is formal in the sense that it depends on the way we refer to the world and not on properties of the world referred to: whether you assert *Joana smiles* or whether you refer to *Joana's smile* makes a difference in formal ontology – but the situation asserted/referred to may be exactly the same; cf. chapter 4.2 for discussion.

¹³ It could be argued that it is the nature of propositions to be evaluable for truth and that an object and a property put together in the right way give rise to a proposition. But this would be begging the question.

The thesis that grammar is relevant to a philosophical question concerning meaning may initially sound puzzling. First, traditional grammars are normative: they tell you which words you should or should not put next to each other, which inflections to use in which contexts, etc. But this is clearly not the main target of UP1 and UP2.¹⁴ Furthermore, an appeal to normativity would come close to begging the question. Second, whereas crosslinguistically grammatical rules seem to vary arbitrarily, there has been a long-lasting philosophical intuition according to which the meanings expressed by language are independent of the language one happens to speak.¹⁵ This suggests that grammatical structure is arbitrarily matched to the meaning of the sentence, dimming prospects of explaining aspects of meaning with the help of grammar. Finally, many aspects of meaning do not seem to be encoded in natural language expressions. To mention only one example, as Russell (1905) famously noted, the sentence *every boy danced with a girl* is ambiguous. According to one reading, every boy danced with the same girl, whereas according to the other, there may have been different girls involved. But meanings are not ambiguous – ambiguity precisely arises if one linguistic string can have two different meanings. This again suggests that the relation between grammar and meaning is not very tight, and the latter can thus not be explained in terms of the former.

However, in addition to the study of the morphological peculiarities of languages, there is an old tradition of universal or ‘philosophical’ grammar, trying to uncover the common basis of all natural languages. It is this notion of grammar which I will employ throughout. The most recent and currently most prominent version has been developed in Generative Linguistics, famously inaugurated by Noam Chomsky in the 1950s. A theory of universal grammar cannot be normative in the sense that it does not tell you how you *should* talk and write. Rather, it is a theory of why people can in fact talk and write the way they do, in that it provides an account of the generative system underlying human linguistic ability. This system operates on lexical items, which have been proposed to be the true source of crosslinguistic variation.¹⁶ The system itself

¹⁴ Nonetheless, the question of which expressions can be put next to each other making up a new whole has been discussed under the headline of the unity of the proposition (cf. Sainsbury 1996; King 2009; Eklund 2009).

¹⁵ At the beginning of the 20th century, a thesis, associated with Sapir and Whorf, was prominent, according to which the language you speak determines the way you think on a fundamental level. However, this thesis did not live up to empirical scrutiny. At most a very weak version of linguistic relativity is supported by experimental findings. For a recent discussion see Gomila (2011).

¹⁶ Even the lexicon does not vary in an unlimited way. Chomsky (1995: 170), thus, conjectures: ‘Beyond PF [phonological form] options and lexical arbitrariness [...], variation is limited to nonsubstantive parts of the lexicon and general properties of lexical items. If so, there is only one computational system and one lexicon, apart from this limited kind of variety.’

may thus well be universal in the human species, even if the sounds produced in speech differ between speakers of different languages. Given a theory of universal grammar, crosslinguistic variation is not an obstacle to using grammar in order to explain an aspect of linguistic meaning (although crosslinguistic variation is of course a challenge to any universal theory of grammar). Explanations in terms of such a universal grammar will also be more principled than an appeal to normativity. Furthermore, it turned out that the structures produced by this generative mechanism differ in important respects from those parts of language that are visible to the naked eye. First, on this conception, grammatical structures are hierarchical, not linear as speech or marks on paper. Second, grammatical structure is far richer than what is morphologically realized, since many aspects of the grammatical structure are left unpronounced. This offers a possibility of defeating the apparent mismatch between meaning and grammar. Scope ambiguities, for example, have been argued to be resolved on a grammatical level (May 1977). Thus, the prospect of explaining an aspect of meaning with the help of grammar is perhaps less dim than it originally seemed.

Indeed, unity questions often concern structure: Whether a set of bricks makes up a house or just a pile of stones depends upon the way the bricks are arranged spatially. The spatial arrangement of bricks is thus essential to what kind of unity the set of bricks exhibits (if it exhibits unity at all), but it is not itself a further brick. The example suggests that what unites the parts of an object (e.g., spatial arrangement) is not itself a part of that object, at least not in the same sense in which the parts that are united (the bricks) are parts of the object. Similarly, the ‘more’ which the meaning of the sentence is, compared to the sum of the meanings of its parts, is whatever the mode of combination contributes to the meaning of the whole. But again, the contribution of the mode of combination is not a meaning like the meanings it combines, as Bradley’s regress argument shows (chapter 1.2.2): rather it is irreducibly structural. The unity of linguistic meaning is therefore closely associated with the structure of language (I elaborate this point in chapters 1 to 3). Yet, what structures language is certainly not any spatial arrangement, as in the case of the bricks and the house. So, what kind of structure structures language? Quite plausibly, language is structured grammatically. I argue in chapter 4 that the theory of grammar developed in generative linguistics is not only a theory of how words are arranged, but also bears on linguistic meaning. As such, it will turn out to provide the key to the question about the meaning of structure, and, hence, the unity of linguistic meaning.

Overview

Since the Generative conception of language, and hence of grammar, is quite different from those more commonly employed in philosophy, I begin **chapter 1** with a brief discussion of the notion of language, and grammar in particular, that underlies Generative Linguistics (section 1.1). The main function of this chapter, however, is to develop the two core problems to be discussed in the chapters to follow (UP1 and UP2), to relate them to other problems recently discussed under the headline of unity (section 1.2), and to defend UP1 and UP2 as questions of philosophical significance against two replies. First, a common strategy of circumventing unity problems in metaphysics has been to argue that unity is not due to metaphysics, but is superimposed by our mental or cognitive capacities. I argue that such a strategy only pushes the question one step back, rather than answering it, as it raises the question of how our mental or cognitive capacities succeed in creating unity out of the assumed diversity of the external world. Indeed, as noted above, it is the cognitive problem which I will primarily be concerned with (section 1.3). Second, a central problem concerning unity is that straightforward accounts of how meanings combine into the meanings of more complex expressions generate an infinite regress (usually called ‘Bradley’s regress’). Many accounts of unity, the present study included, can be seen as different proposals of how to avoid this regress. In the final part of the first chapter (section 1.4), I argue against the recent attempt to think of Bradley’s regress not as a problem for unity but as providing the metaphysical basis of unity (Gaskin 2008).

Despite the recent philosophical attention to problems concerning the unity of meaning, they still await being generally recognized as genuine problems in semantic theory. In particular those philosophers and linguists working in more formal paradigms often assume that problems concerning unity do not arise in current semantic frameworks. In **chapter 2**, I demonstrate that none of the currently most prominent semantic frameworks can explain both the unity of linguistic meaning and its productivity. In general, either the meanings of sentences are all taken as primitives of the semantic theory, or the semantic theory allows deriving the meaning of sentences from the meanings of words, but fails to provide an account of how these meanings combine. Discussed are the semantic debate between Russell and Bradley (section 2.2) as well as recent semantic approaches based on Aristotelian compositionality (section 2.1), functional compositionality (section 2.3), and truth-conditions (section 2.4). Although I argue that Davidson’s (2005) account of unity fails to provide an answer to either UP1 or UP2, I maintain that it contains an important insight, which may also have been a motivation for Russell’s and

Wittgenstein's adopting a 'picture theory of meaning' (section 2.5). This insight is further developed in the following chapters – although perhaps in an unconventional way.

The central problem in accounting for the unity of meaning from an atomistic point of view is that even if all parts of a whole have been enumerated, the enumeration does not reconstitute the whole. What is missing in the enumeration is the structure which unifies the parts and makes them a particular whole. If the structure is taken as a further ingredient, we face Bradley's regress. In **chapter 3**, I explore the prospects of explaining unity when the temptation of reifying structure is not succumbed to. Some aspects of meaning are then inherently structural, and the parts of a unity cannot, strictly speaking, be enumerated. Following recent developments in generative linguistics and its philosophy, I identify this structural meaning with grammatical meaning (section 3.1). However, according to one tradition in philosophy, grammar is not inherently meaningful, and can thus not be used to explain a semantic phenomenon. By contrast, I argue that there is indeed good evidence that grammar is inherently meaningful (section 3.2). To add evidence that grammar can be used to explain semantic phenomena, I end with a brief review of how grammar may serve to explain the validity of certain inferences (section 3.3).

In **chapter 4**, I develop my answer to the question of why the ontological category of linguistic meanings corresponds to the grammatical complexity of linguistic expressions (UP2). I argue that an answer to this question can neither be found in metaphysics, nor in an autonomous semantic module, but has to be sought in grammar (section 4.1): Grammar determines the referential properties of the lexical meanings that enter the derivation. The referential properties, in turn, give rise to the formal ontological distinctions at issue (Hinzen and Sheehan 2014), and the problem, thus, dissolves (section 4.2). The discussion is embedded in an inquiry into the evolution of human language and rational thought (section 4.3). In **chapter 5**, I defend the idea that grammar, in effect, gives rise to a formal ontology against potential criticisms. Beginning with a case study of how the formal ontology of the meaning of linguistic expressions can be systematically derived from their grammatical makeup (section 5.1), I provide an account of the relation between pre-grammatical ontology and grammatical ontology (section 5.2), as well as that between grammatical and lexical meaning (section 5.3).

In **chapter 6** and on the basis of chapters 4 and 5, I attempt to answer UP1, that is, the question of how the meanings of subsentential expressions combine such that the result of this combination exhibits the characteristic unity. I argue that, strictly speaking, lexical meanings never combine, thus avoiding Bradley's regress. Rather, the derivation of the meaning of a grammatically complex expression begins with a lexical meaning, which is gradually modified when grammatical structure is built up.

Acknowledgements

My thesis would not have become what it is without the help and advice of more people than I can possibly mention here. The first who deserves thanks is my supervisor Wolfram Hinzen. His interest in my project has been as motivating as his enthusiasm for grammar infectious. Often, we have spent hours talking about topics related to my projects, and supervision sessions would rarely end before the sun had set and the department was deserted. The influence of Wolfram's work on my thinking will be obvious to anyone familiar with it, even if it has not always been possible to acknowledge it properly. I am also grateful to Jan Westerhoff, who always had some good advice, and to Nick Zangwill, who, joining my supervisory team only for the last couple of months, prompted me to formulate my position more clearly – if the thesis is intelligible to anyone outside of the Language and Mind Research Group in Durham, this is due to Nick's critical eye. I would also like to thank my examiners John Collins and Sophie Gibb, whose comments have been very helpful and prompted me to clarify some of my arguments and who have made the viva such a stimulating and enjoyable experience. Many thanks are also due to the AHRC and the Studienstiftung des deutschen Volkes for generously funding my dissertation project, and to the Department of Philosophy, Ustinov College, and again the AHRC and Studienstiftung des deutschen Volkes for a number of generous travel grants.

I have been lucky enough to be part of the international and interdisciplinary project *Un-Cartesian Linguistics*, led by Wolfram Hinzen and Elisabeth Leiss. The project meetings and workshops in Munich and the international conference *The Past and Future of Universal Grammar* in December 2011 in Durham have been very inspiring; and I am grateful to Elisabeth, as well as Martina Werner, Werner Abraham and Alex Drummond, for discussions that have influenced my way of thinking about language. Special thanks go to Michelle Sheehan and Txuss Martin, who have both been post-doctoral fellows in the project. I have learned so much through teaching on Michelle's *Language and Mind* module in 2010-11, her feedback to my attempts at understanding the semantics of adjectives has been irreplaceable, as are her always prompt answers to my questions on syntax. During the short time Txuss has been part of the project in summer 2012, he provided very helpful comments on a major part of an early draft of my thesis; also our long discussions have left their mark in the final version.

During the last four years, the *Language and Mind Research Group* has been my main academic forum, and I have been very fortunate to be in Durham at the same time as David Kirkby, Andrew Woodard, Tom Hughes, Alex Malt, James Miller, Pallavi Worah, and Josh Bergamin, who have at least pretended to take my often unconventional ideas seriously. Our

long discussions in and outside Research Group meetings have shaped many of my philosophical views; and in many arguments I am indebted to members of this group. I am particular grateful to James, Andrew, David, Alex, and Olley Pearson for, in some cases, extensive and very helpful comments on earlier drafts of individual chapters. I am also indebted to the participants of my EIDOS talks and to the members of the MLM group in Durham for very valuable questions and comments, in particular to Donnchadh O’Connail, Mihretu Guta, Richard Stopford, and Jonathan Lowe.

I would probably never have found my way into the intricacies of Generative Grammar, had it not been for Anders Holmberg at Newcastle University, who kindly let me participate in his syntax seminars and has been very supportive ever since. My thanks also go to all the other members of the *Syntax Reading Group* in Newcastle, who tolerated my sometimes peculiar questions and interests. Most of what I know about syntax, I have learned in Newcastle. Also Noel Burton-Roberts’s and Magdalena Sztencel’s views on language have turned out to be very inspiring and challenging. Furthermore, I wish to thank Johannes Dölling at Leipzig University, who, in his open and encouraging way, introduced me to formal semantic theory in 2008-09.

I am very grateful to Thomas Hodgson, Halldór Sigurðsson, John Collins, and Richard Gaskin for inspiring discussions and helpful comments on material that later became part of my thesis. I also owe thanks to the speakers and participants of the workshop *The Unity of the Proposition and the Unity of the Sentence*, which I co-organized with David Kirkby in September 2012 and which has been an important source of inspiration. Furthermore, I have also benefitted from the discussions with many scholars I met at other conferences, workshops, and lectures. Among them are Ewa Dąbrowska, Regine Eckardt, Paul Elbourne, Norbert Hornstein, Bjørn Jespersen, Richard Kayne, Jeffrey King, Varya Magomedova, Genoveva Martì, Ora Matushansky, Friederike Moltmann, Nirmalangshu Mukherji, Paul Pietroski, Jiří Raclavský, Tom Roeper, Stephen Schiffer, Benjamin Schnieder, Barry Smith, Markus Werning, and Dietmar Zaefferer. Also many thanks to Andy McKay, who has been a very supportive language tutor.

Finally, my biggest thanks go to Bella Ruth for her love and support in all these years. She also has proofread the whole manuscript. Hannah and David have mostly been very cooperative, and where they have not, they were usually right to remind me that the world is bigger than my desk.

The Problem of Linguistic Unity

Unities are ubiquitous. Questions about the relation between unities and their parts arise for all of them. We could, thus, inquire into the relation between plants and the molecules they contain, between houses and the stones they are built from, or between universities and all their institutions, staff and students. The problem which is in the focus of the following, however, is more specific, leaving this general question on the side: I inquire into the unity of linguistic meaning, and I leave it open as to whether the account developed here can also provide insights into other cases of unity. The diversity between these kinds of unities, however, suggests that not every kind of unity can be explained in the same way (cf. Mellor 2006). In sections 1.2.1 and 1.3 (see also chapter 2), I argue that unity-questions are particularly problematic and pressing in respect to linguistic meaning, which justifies the separate treatment. See the preface for an overview over this chapter.

1.1 What is Language?

I begin this section with a brief outline of the notion of language employed in Generative Linguistics, contrasting it to a conception more standard in philosophy (section 1.1.1). In section 1.1.2, I provide a brief introduction into the mechanics of Generative Grammar, which clarifies the notion of grammar employed in the following discussion and provides a background for the grammatical analyses discussed in later passages. In section 1.1.3, I conclude with a brief outline of the recent proposal that Generative Grammar can be used to shed light on rational thought (Hinzen 2006; 2007; Hinzen and Sheehan 2014) – a thesis which I adopt later, and which plays an important role in my argument for the claim that grammar can be used to answer problems concerning meaning.

1.1.1 Two Notions of Language

A language is often taken to be a system invented to facilitate communication within a social group. According to Morris (2006: 1), ‘it continues to be assumed that words are signs, and that

the basic business of language is communication. And it is generally accepted [...] that the meaning of words in common languages is a matter of convention.’ What is part of a language is also standardly seen as being determined externally of the individual speaker: by the community of speakers, or by speakers and institutions with a certain authority within the community, say, specialists in a certain field, writers of dictionaries, Oxford University, or the Institut Français. As Gaskin (2008: 393) writes: ‘When we learn to speak a language, we join an institution that has a being and a life quite independently of our individual contributions to its existence.’ Language, on this conception, is a cultural object like agriculture or cooking, invented by prior generations for a particular purpose. Children have to learn a language from their parents and other competent speakers in a similar way as they have to learn how to cook, how to drive a car, or how to milk a cow.

Many aspects of language and its use certainly *are* cultural. Nonetheless, language can not only be studied as a cultural object, but also as a natural one. Even if language is seen as essentially social, humans must be endowed with a ‘language faculty’ in the trivial sense that humans are capable of learning or acquiring language, a capacity which we don’t share with rocks and trees, and probably not even with our closest non-human relatives.¹ In other words, language must have a cognitive basis: there has to be a difference between the organisation of our central nervous system and that of non-linguistic animals which accounts for the fact that we can acquire language, whereas other animals cannot. From this point of view, the ability to acquire language is a species-specific property of the brains of *Homo sapiens*, and, thus, an aspect of the evolution of our species. As such, it can be made the subject of empirical inquiry (cf. Hornstein 2013: 396).

In general, cognitive capacities which enable certain abilities also constrain these abilities. The visual system, for example, allows us to see objects in the world, but also provides a limit to what we can see (e.g. only certain wave-lengths are visible) and determines many properties of our percepts (e.g. which wave-lengths correspond to which perceived colours). Equally, the cognitive resources which enable language probably constrain possible human languages in certain ways.² One of the central aims of Generative Linguistics is to work out what these constraints consist in, and (since Chomsky 1995) also how they have evolved. A theory of these

¹ For a brief review of just how different human language is from all other systems used for communication in the animal world, see chapter 4.3.

² Bickerton (1995: 36) puts the same point more radically when he argues, ‘language is the way it is because this is the only way the brain can do it.’

constraints is called ‘Universal Grammar’; it describes the ‘initial stage’ of the human ‘language faculty’.

However, not only the ability to acquire language has to be rooted in the brains of the (unimpaired) members of *Homo sapiens*; also the capacity of individual speakers to produce and understand a particular language has to have such a cognitive basis, in the trivial sense that, based on and constrained by Universal Grammar, competent speakers have acquired knowledge of the lexical and grammatical rules of the language they happen to speak, which in turn have to be somehow ‘encoded’ in their central nervous system. In the Generative tradition, this knowledge is called an ‘I-language’ (for ‘internal language’). I-languages are, obviously, not universal – some people speak English, others speak French, and the differences between English and French (two ‘E-languages’ or ‘external languages’) is reflected in differences between the I-languages of their respective speakers. Indeed, I-languages are not even shared between any two speakers of English: in all likelihood my vocabulary, for example, differs in at least some respects from yours.³

I-languages can be divided into two parts: a (mental) lexicon and a (mental) grammar. The lexicon specifies the primitives of the language, and the grammar consists of rules of how these primitives can be combined. By making lexicon and grammar of idealized I-languages explicit, Generative grammarians aim to provide a computational theory of how a speaker is capable of *generating* all the infinitely many linguistic expressions she can in principle produce and understand. To be sure: on this conception, the object of linguistic inquiry is what is or happens ‘in the heads’ of speakers. This contrasts with the more traditional conception of language, according to which linguistic expressions are taken to be ‘strings of marks or noises in the air’ (Lycan 2008: 65). Furthermore, whereas in the traditional conception, grammar is normative in the sense that it prescribes how people should talk and write, on the generative conception, grammar is not normative in this sense, but provides an empirical theory of a certain competence of speakers.⁴

³ The notion of an I-language does not mean that communication is impossible, as has sometimes been suggested (e.g. Fodor and Lepore 1992: 210). Chomsky (1993: 52) argues that if they speak the same E-language, ‘speaker and hearer have similar [I-]languages and (perhaps identical) performance systems, so what one can produce, the other can interpret, over a large range’.

⁴ I don’t wish to legislate how the words *language* and *grammar* are to be used in general. Both the normative and the cognitive notions have their applications in their respective domains. Yet, when I talk about language or grammar, it will usually be I-language and its generative system which I have in mind – for no other reason than that these notions are more useful for the purpose of the following.

In sum, our linguistic abilities have to be rooted in the organisation of our central nervous system. This allows for two related ways in which language can be studied empirically. First, we can inquire into language phylogenetically, trying to determine the cognitive basis of our ability to acquire language and the way this ability evolved. Universal Grammar is (part of) a theory of the, possibly tight, limits which this cognitive basis puts upon possible natural languages. Second, we can study language from an ontogenetic point of view, with the aim of finding out how particular speakers are capable of generating all the linguistic expressions which they in principle would be able to produce or understand and how they have acquired this competence on the basis of Universal Grammar. The (largely tacit) knowledge on which this competence relies is called I-language and consists of a grammar and a vocabulary.⁵

So far, the generative notion of grammar has been defined with the help of a definite description: grammar is whatever knowledge enables a speaker to produce and comprehend the infinitely many linguistic expressions they can, in principle, produce and comprehend (given a lexicon). This definition does not answer the question of what kind of knowledge grammar is – but it is clear that the answer to this question is ultimately empirical. Since the most straightforward way to understand the Generative answer to this question is by actually doing linguistics, I provide a very brief tutorial on Generative Grammar and how it works in section 1.1.2.

Before I come to this, however, I would like to address a possible worry: one might wonder what in the above justifies talk about a ‘language *faculty*’. The ability to learn how to cook or how to milk a cow also has to have a cognitive basis: humans can learn how to do these things, whereas all or most other animals cannot. This difference is probably due to a difference in the organisation of the central nervous systems of the respective animals. Language and other abilities seem to be on a pair here – but, as far as I know, no-one would be inclined to talk about a ‘cooking faculty’ or a ‘milking faculty’. And rightly so, since there are important differences between language acquisition and learning how to cook or milk a cow. Every unimpaired human infant acquires language, irrespective of culture or origin – but not every human learns to cook or to milk cows. Furthermore, whereas learning to cook or to milk cows requires explicit instruction, acquiring language (which is much more complicated than cooking or milking cows) doesn’t: children pick up language without being taught; and if children don’t find a language to pick up in their environment, a group of at least two children spontaneously creates

⁵ It seems to me that the only way of avoiding the conclusion that there are I-languages which may be worth studying is to uphold the behaviourist doctrine that, in Quine’s (1987: 5) words, ‘there is nothing in linguistic meaning [...] beyond what is to be gleaned from overt behaviour in observable circumstances.’

a new language, based on Universal Grammar.⁶ In this sense, we don't have a choice about whether we acquire a first language or not – our biology requires us to do so, very much like human infants develop the ability of rolling over, sitting up or walking upright irrespective of whether their pushy parents try to teach them these abilities. In contrast, we are not biologically pre-programmed to acquire cooking or milking abilities.⁷

1.1.2 A Brief Tutorial on Generative Grammar⁸

Grammatical knowledge (on the Generative conception of grammar) is largely tacit. Consider the following sentences (from Larson 2010: 11):

- (1) Homer expected to surprise him.
- (2) I wonder who Homer expected to surprise him.
- (3) I wonder who Homer expected to surprise.

⁶ In groups of at least two, deaf children borne to non-signing parents, for example, spontaneously develop full-blown sign languages even if adults refuse to sign to them (Goldin-Meadow and Mylander 1998). Compare also the well-documented spontaneous rise of Nicaraguan sign-language (e.g. Senghas and Coppola 2001), where grammatical novelties in nearly all cases have been introduced by children under the age of 10. A further example of spontaneous creations of languages by groups of children is creolization (Bickerton 1990).

⁷ Further arguments in support of the thesis that we are biologically 'pre-programmed' to acquire language and that there are rather tight limits within which natural languages can be organized include the observation that linguistic development is largely uniform between children, irrespective of their social, cultural and linguistic environment. Furthermore, all human languages share certain 'design features', despite the diversity on the surface. Finally, the historically most influential argument is the so-called 'poverty of the stimulus argument', aspects of which have already been mentioned above (cf. n. 6): in general, the data which children receive are not sufficient to determine the linguistic competence they have acquired at the age of 4 or 5. For example, natural language is structured hierarchically (see section 1.1.2). Yet, most evidence available to human infants could be accounted for with the help of a linear syntax. Thus, only an innate bias can explain that even 18-month-olds (that is, an age where most children are unable to articulate sentences longer than one or two words) have been shown to know that language is hierarchically structured. Furthermore, the level of ungrammatical expressions in spoken language is very high. Infants have to distinguish between genuine data and noise. Surprisingly, even in cases where the level of noise is higher than that of grammatical examples, children usually make the right generalisations (for a particularly nice piece of evidence see Lidz, et al. 2003). For discussion of these and other arguments see e.g. Berwick, et al. (2011), Chomsky (1959; 1965; 1975; 1986; 2000; 2006), Crain and Pietroski (2001) and Lightfoot (1982). Pinker (1994) provides a very readable introduction to one version of the Generative enterprise, directed to a general audience. A novel argument in favour of the Generative project is developed in chapter 3.2.

⁸ The first chapters of most introductions to Generative Grammar cover much the same ground, but usually in more detail. The most accessible introduction that I know of is Larson (2010). See also e.g. Haegeman (1994), Poole (2002), and Radford (1997). The interested (or puzzled) reader is referred to these works.

Whereas in (1), *him* cannot refer to Homer, in (2), it can. Furthermore, in (1) and (3), Homer is the person who does the surprising (the agent), whereas in (2) Homer is the person who is being surprised (the patient). Both facts are somehow unexpected, given that, on the surface, (1) is a proper part of (2) but not of (3). Nonetheless, every competent speaker of English knows these facts about the meaning of these sentences (irrespective of whether she ever took grammar classes). What is the basis of this knowledge? Which rule or rules are our judgements about the meaning of these and countless other, no less puzzling, examples based on? The truth is that the generative system of language and the grammatical rules that it complies to are not accessible to introspection. We are able to judge the grammaticality of complex sentences without effort, without having any explicit access to the rules that are behind this ability. Studying (Generative) grammar is, thus, a ‘black-box problem’: linguists can study the mechanisms of grammar only by studying the in- and output of speakers (that is, the relation between primary linguistic data and the competence acquired on this basis), not by observing the mechanism they want to study directly.

A study of language in the spirit of Generative Grammar may begin with the observation that there is an unlimited number of linguistic expressions which we can in principle produce and comprehend (see section 1.2.1 for discussion). Furthermore, we can produce and comprehend sentences which we have never heard before, provided we know the words they are made up of. This suggests that the mechanism generating linguistic expressions does not store full sentences, but smaller units (lexical items, which can, for the purpose of this section, be identified with words). These units can be combined in certain well-defined ways, but not in others. For example, *John runs*, *Mary runs*, *Bill runs* and *John sleeps*, *Mary sleeps*, *Bill sleeps* are possible sentences of English but *runs John*, *sleeps runs*, or *Mary John* are not. A straightforward way of capturing these facts is to classify the words in the sentences above as nouns (*John*, *Mary*, *Bill*) and verbs (*sleeps*, *runs*) respectively and to specify that a sentence consists of a noun and a verb in that order. It is immediately clear that for a full grammar of English, this rule would have to be supplemented by further rules – there are transitive and ditransitive verbs requiring two and three nouns respectively and there are words of other categories like adjectives, adverbs, determiners, auxiliaries etc.

It is also clear that some rules would have to be recursively applicable: there are English sentences which contain other, subordinate, sentences (or clauses) like *John believes that Mary thinks that John knows that....* An English sentence, thus, can consist of a noun, a verb, a complementizer and a further sentence in that order. This rule adds a further quality to the rules above, as it defines a hierarchical structure in addition to a linear one. The hierarchical structure

can be represented in a tree-diagram (S stands for sentence, N for noun, V for verb and C for complementizer):

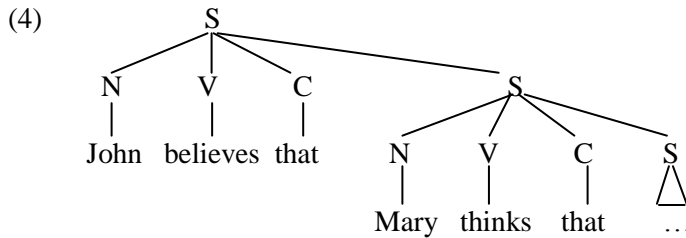

As it turns out, linguistic rules operate on hierarchical structure rather than linear structure. Consider the rule for turning a copula-sentence like (5) into a question like (6). As a first approximation, the rule seems to be that the copula has to be moved to the front of the sentence (it is not ‘move the third word to the front’, a rule which would be consistent with many cases). But which copula has to be moved in case there is more than one copula, as in (7)? The correct answer is that it is the copula of the main sentence that has to be moved (8), not, for example, the copula that comes first in linear order, as is evident from the ungrammaticality of (9).⁹

- (5) The man is smart.
- (6) Is the man smart?
- (7) The man [who is behind the shop] is smart.
- (8) Is the man [who is behind the shop] smart?
- (9) *Is the man [who behind the shop] is smart?

Not only at a clausal level is language organized hierarchically. For example, grammatically, names like *John* are on a par with definite or indefinite descriptions, in the sense that, although (in)definite descriptions are complex, names and definite descriptions can be intersubstituted without a grammatical sentence turning into an ungrammatical one; cf. *John walks* and *the teacher walks*. Thus, instead of saying that a sentence can consist of a noun and a verb as above, we should say that a sentence can consist of a noun phrase (NP) and a verb, where a NP consists of a noun and optionally a determiner (D).¹⁰ In addition to nouns and determiners, NPs can

⁹ Following common linguistic notation, constituency is marked by square brackets and grammatically deviant sentences are marked by an asterisk.

¹⁰ For further discussion of the relation between common nouns and proper names see chapter 3.2.

contain adjectives (*the clever teacher*) or preposition phrases (PPs) (*the shop at the corner*). If they do so, they are again hierarchically structured, as e.g. in (10).¹¹

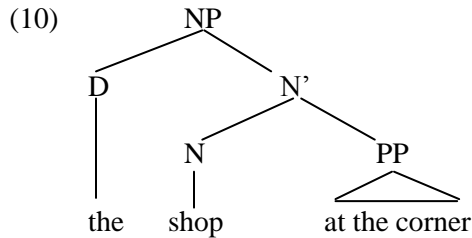

Governed by both empirical data and theoretical considerations, Generative Linguistics arrived at grammatical representations which are very uniform and require only a small number of simple but powerful laws. According to X-bar theory, all linguistic derivations follow the schema in (11), where X can be replaced by any syntactic category (N, V, P etc.). The possible categories of the Specifier (Spec) and the Complement (Comp) depend upon the category of X, the head of the phrase.¹² If the category of X is N, a possible specifier is a determiner and a possible complement is a PP as in (10).

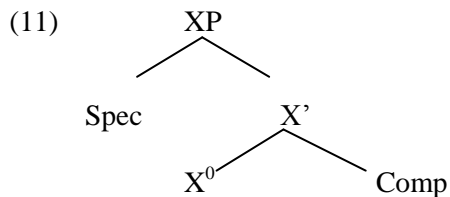

Current syntactic theories still largely follow this schema, although their analyses are much more complex than in the examples above. Definite descriptions like *the teacher* are now standardly analysed as DPs (determiner phrases) rather than NPs. Furthermore, many syntactic categories that are unfamiliar from traditional grammar and which are not always visible on the surface are used (*v* (voice), T (tense), Cl (Classifier), Num (Number) etc.). Yet, the purpose of this tutorial was not to summarize the state of the art in grammatical theory (which would have been impossible in the required brevity), but to give an idea of what kind of thing grammar is according to Generative Linguistics, and to provide a background for the more advanced

¹¹ Alternatively to the representation of grammatical structure as a tree, the same information can be encoded using labelled square brackets: $NP_D[\text{the } N'_N[\text{shop } PP[\text{at the corner}]]]$. Like all phrases and as indicated by the triangle on top of *at the corner* in the tree representation, the PP is not a primitive but can also be analyzed syntactically: $PP_{pat} [NP_D[\text{the } N_{corner}]]$.

¹² For a discussion of phrase heads see chapter 6.2.

grammatical representations that I occasionally use in the following. For more detailed introductions, the reader is referred to the literature mentioned in n. 8.

1.1.3 Un-Cartesian Linguistics

The relation between language and thought is a much and often discussed topic in philosophy. According to the Cartesian view, language is a means of freely *expressing* propositional thought. Descartes (1637: 140, my emphasis) writes:

It is quite remarkable that there are no men so dull-witted or stupid – and this includes even madmen – that they are incapable of arranging various words together and forming an utterance from them in order to *make their thoughts understood*; whereas there is no other animal, however perfect and well-endowed it may be, that can do the like.

Chomsky's inauguration of Generative linguistics was based upon a revival of this Cartesian thesis (Chomsky 1966). Indeed, Chomsky's (1959) central argument against attempts to explain human language in behaviourist terms is the stimulus-independent, yet not random, character of language use. Chomsky (1966: 65, my emphasis) concludes: 'Human language is [...] an instrument for the free *expression* of thought and for appropriate response to new situations'. The Cartesian picture, thus, is that thought, although closely related to language, is in principle independent of it. Thought is free (thoughts are independent of stimulus control but nonetheless allow for appropriate reactions to new situations) and language can be used to *express* thoughts. But, at least in principle, non-linguistic beings could have the kind of thought we enjoy, even though they could not convey their thoughts to others.

However, according to recent developments in the philosophy of linguistics, language is not only a means of expressing propositional thought, but is itself constitutive of it (Hinzen 2006; 2007; Hinzen and Sheehan 2014; see also Bickerton 1995, ch. 4; Roeper 2007; Mukherji 2010, ch. 3-4). I will adopt such an 'Un-Cartesian' view,¹³ according to which grammar is what structures propositional thought.¹⁴ This is not to suggest that non-linguistic animals cannot think, in a loose sense of the term. Yet, as I discuss in chapter 4.3, the kind of thought we find in

¹³ If Cottingham (1998) is right, Descartes was himself possibly an Un-Cartesian, as he took thought to depend on linguistic competence. However, irrespective of whether Descartes was a Cartesian in this respect, the Cartesian *tradition* took language to be purely expressive of thought (cf. Leiss 2009). The beginning of the influential *Grammar of Port Royal*, for example, reads as follows: 'Grammar is the art of speaking. Speaking is to explain our thoughts by signs, which men have invented for that purpose' (Arnauld and Lancelot 1660: 1).

¹⁴ Note that the Un-Cartesian hypothesis does not suggest that humans speaking different languages think differently, since, pathology aside, the grammatical system which is argued to underlie thought is universal within the human species.

humans differs characteristically from that of all other animals. This raises the question of which aspect of human cognition gives rise to this difference. I argue that both empirical and theoretical considerations suggest that our grammatical competence is responsible for this difference.

This thesis is in line with the fact that the modular conception of language, according to which ‘the functioning of the language faculty is guided by special principles specific to this domain’ (Chomsky 1980: 44), has recently been replaced by the thesis that many grammatical principles ‘may themselves be epiphenomenal, their consequences reducing to more general and abstract properties of the computational system’ (Chomsky 1993: 51). Thus, ‘we need no longer assume that the means of generating structured expressions are highly articulated and specific to language. We can seriously entertain the possibility that they might be reducible to language-independent principles’ (Chomsky 2005: 9). If the principles behind grammar are as general as suggested in these quotes, there is no reason why they should not also be employed in other domains of human cognition, such as rational thought. Indeed, it has already been argued that grammatical principles underlie a number of cognitive domains which are usually not taken to be linguistic in character. For example, Mukherji (2010, ch. 6-7) and Katz and Pesetsky (2011; building on Lerdahl and Jackendoff 1983; 2006) have proposed that grammatical mechanisms can also be found in musical cognition. Furthermore, the human capacity of engaging in mathematical and logical reasoning has often been suggested to be based on abstractions from our linguistic competence (Crain and Khlentzos 2008; 2010, see chapter 3.3 for a brief discussion concerning the relation between language and logic). The generative mechanism underlying language has also been argued to play an important role in moral reasoning (cf. Kirkby and Reichard 2013 for discussion).

To conclude, language can not only be studied from a social point of view, but also from a biological one. One way of biological inquiry into language is to study the rules according to which individual speakers generate linguistic expressions and to determine which aspects of these rules have to be innately specified. Whereas in the Generative tradition, these rules have long been taken to be highly specific to language, which was seen as merely expressive of thought, it has recently been suggested that linguistic rules may rely on more general rules. If this suggestion is correct, the principles underlying the generation of language may also play a role in other aspects of human cognition. In chapter 4, I will explore the thesis that they are central to propositional thought.

1.2 Two Aspects of the Unity Problem

In this section, I develop the two central questions to be discussed in the following chapters (sections 1.2.2 and 1.2.3 respectively). I begin by arguing that the productivity of natural language shows that unity questions actually concern the meaning of natural language (section 1.2.1).

1.2.1 The Productivity of Language

It is generally agreed that natural languages, as well as our thought, are productive. I use ‘productivity’ as an umbrella term for two distinct but related phenomena: the infinity and novelty found in both language and thought. Language is discretely *infinite* in the sense that every speaker of a natural language is in principle capable of producing and understanding an infinite number of different sentences with distinct meanings. This infinity of our linguistic competence contrasts with the finiteness of our brain. It follows that whatever is behind our linguistic competence has to be a mechanism, generating an infinite number of meaningful expressions by finite means. *Novelty* consists in the familiar fact that we can produce and understand complex linguistic expressions we have never encountered before. If you know the meaning of *Socrates* and the meaning of *sit*, you also know the meaning of *Socrates sits*, whether or not you have previously encountered this sentence.

The fact that finite beings like us can *generate* an infinite number of new complex linguistic expressions with new meanings suggests that there is a finite number of basic expressions (lexical items) and a finite number of rules of combination; the meaning of complex expressions is made up of the meanings of its parts and the meaning of the way they are combined. The fact that we can *understand* an infinity of expressions with different meanings suggests that we have to be able to understand the meaning of a complex expression by means of understanding their constituents and the way they are combined.¹⁵ Similar conclusions are suggested by the fact that we can understand and produce novel expressions with meanings we have never encountered before: if the new linguistic expressions are made up of familiar ones and the mode of combination is also familiar, this capacity can be accounted for.

¹⁵ Both the novelty and the infinity of language have been a driving force behind the Generative tradition in grammatical theory. Lasnik (2000: 3), e.g., claims that infinity ‘is one of the most fundamental properties of human language, maybe the most fundamental one.’

Productivity has often been taken as an argument in favour of the thesis that language is compositional.¹⁶ Davidson (1965), for example, presents an argument which is supposed to show that a non-compositional language would not be learnable by finite beings like us.¹⁷ As I discuss in chapter 2, there are several different notions of compositionality, and ‘functional compositionality’, which is most prominent in the more technical literature in semantics, for example, is not able to account for productivity (cf. chapter 2.3). The strongest notion of compositionality is advocated by Fodor¹⁸ – according to him, the meaning of a complex expression is derived compositionally only if the meaning of the complex expression is ‘constructed from’, ‘determined by’ or ‘inherited from’ the meanings of its constituents and the mode of combination:

Compositionality is the idea that the meanings of complex expressions (or concepts) are *constructed* from the meanings of the less complex expressions (or concepts) that are their constituents. (Fodor and Lepore 2001: 63, my emphasis)

The productivity of concepts/thoughts is explained by their compositionality: In general, the content of a complex mental representation (MR) is *determined* by and only by the contents of its constituent representations. (Fodor and Lepore 1996: 28-29, my emphasis)

A language is compositional if and only if (idioms aside) the meaning of its complex expressions is *inherited* from the meanings of their syntactic structure together with the meaning of their syntactic constituents. (Fodor and Lepore 1991: 14, my emphasis)

It indeed seems correct that in order for the productivity of language and thought to be explained, it has to be the case that the meanings of complex expressions are constructed or

¹⁶ The argument for compositionality from novelty has often been traced back to Frege (1923b: 374); but see chapter 2.3.3 for discussion.

¹⁷ The common argument that recursivity and compositionality follow from the infinity of natural languages in combination with the finitude of speakers has been challenged by a number of authors in different ways. One complaint is that the argument is circular: the recursivity and compositionality of language is backed up by the claim that language is infinite. But why should we believe that language is infinite? This claim is usually backed up by the observation that language comprises recursive mechanisms. Pagin (1999: 62) concludes his discussion of Davidson’s argument which makes use of the argument schema summarized above by saying: ‘the learnability argument fails, in the sense that compositionality would already have to be justified if we had good reasons for the premises of the learnability argument’ (cf. Hacking 1986). Pullum and Scholz (2010) have challenged the version of the above argument prominent in Generative Grammar.

Another point of critique is that arguments commonly cited in support of the compositionality of language in fact don’t show that the meaning of language is compositional, but only that it is computable (Werning 2005; Pagin and Westerståhl 2010). In chapter 2.3, I argue that neither computability nor the notion of compositionality usually adopted in these debates explains the productivity of language without significant supplementation.

¹⁸ Fodor provides a number of arguments for compositionality (e.g. Fodor 1975: 31-32; 1998: 97-100), but accepts only that thought is compositional, not that language is (Fodor 2001). However, Fodor’s argument is based on a different notion of language than the one I employ.

made up from the meanings of their constituents and the way they are combined. Unfortunately, to the best of my knowledge, Fodor nowhere gives an account of how these meanings combine. Nonetheless, what the productivity of language and thought shows is that in some way meanings have to be able to be combined, systematically producing new meanings. In chapter 2, I return to this point in more detail.

1.2.2 Why is Linguistic Meaning Unified? (UP1)

The meanings of complex expressions often exhibit a unity which is perhaps unexpected, or, in any case, requires an explanation: if several expressions are combined in a grammatical way, the meaning of the whole is not just the sum of the meanings of its parts. As Plato (Sophist 262) observes, combining a noun and a verb, for example *Socrates* and *sits*, gives rise to the sentence *Socrates sits*. The meaning of a sentence is a single proposition and it can be true or false. By contrast, combinations of three nouns like *lion*, *stag*, *horse* or three verbs like *goes*, *runs*, *sleeps* don't have a propositional meaning. Rather (if they have a common meaning at all) their meanings are mere aggregates of the meanings of their parts and they cannot be evaluated for truth and falsehood. Aggregates, of course, exhibit some kind of unity. Yet, there is a qualitative difference between this kind of unity and that which the meanings of the parts of a sentence exhibit when they are thus part of a sentence. Therefore, the question arises why, in favourable cases, the combination of linguistic expressions gives rise to such unified meanings.

The examples might be taken to suggest that whether or not such a unity results from the combination of linguistic expressions depends on combining the *right* lexical items: if you combine a noun and a verb, say, you get a sentence, but if you combine several nouns or several verbs without mixing the parts of speech appropriately, you don't. We may thus be led by this example to seek the answer to our question by inquiring into the difference between nouns and verbs – or more generally, by inquiring into which expressions can be combined in such a way as to make up a sentence¹⁹ and how they have to be ordered.²⁰ Yet, whilst this difference has to play a certain role, this is not the core problem in respect to unity. The reason for this is that, as Gaskin (2008) argues at length, every sentence can, in principle, be 'duplicated' by a list

¹⁹ This question is indeed sometimes discussed as one of the questions concerning unity (Sainsbury 1996: 140-41, (i); King 2009: 258, UQ3; Eklund 2009's 'combinatoriality').

²⁰ This question has been formulated as one of the unity questions in Sainsbury (1996: 141 (ii-iii)) and Eklund's (2009) 'order'.

containing exactly the same linguistic expressions.²¹ Gaskin writes: ‘There is a conceptual distinction to be made between a mere bunch of type words, however conveniently shaped and ordered to form a sentence, and a sentence actually composed of those words’ (Gaskin 2010a: 259-60). Thus, the sentence *Socrates sits* can be ‘duplicated’ by a list consisting of *Socrates* and *sits*. Whereas the former exhibits the unity we are seeking to explain, the latter doesn’t, having as its meaning an aggregate of the meanings of its parts (if it exhibits a common meaning at all),²² say *Socrates* and the universal of sitting. In sum, just putting the right words together in the right order is not enough to receive a unitary meaning. The explanation of unity, therefore, cannot rely solely on intrinsic features of the linguistic expressions to be combined.

A natural reply is that the difference between the sentence *Socrates sits* and the list consisting of the two expressions *Socrates* and *sits* concerns the way in which these expressions are combined, rather than any intrinsic features of these expressions. In the case of the list, the meanings of the two expressions form an aggregate, whereas in the case of the sentence, the meanings of the two expressions are combined in a different, non-mereological, way. This mode of combination is often called *predication*; and in case the meaning of *sits* consists in a universal, predication may be said to express the relation of instantiation: what the sentence *Socrates sits* means is that Socrates instantiates the universal of sitting.²³

The problem with this proposal is that, if we take *Socrates* to have Socrates, *sits* to have the universal of sitting, and predication to have the relation of instantiation as their respective meanings, we face the very problem which we were trying to avoid by appealing to modes of combination: there is no necessity for Socrates, the universal of sitting and the relation of instantiation per se to give rise to the unified meaning according to which Socrates instantiates the universal of sitting, instead of an aggregate consisting of Socrates, the universal of sitting, and the relation of instantiation. It seems we require a higher order relation in order to ensure

²¹ In my use of the term ‘list’, I abstract from the fact that most lists exhibit a certain order and therefore possess a (linear) syntax.

²² In the following, I disregard the possibility or intuition that there is no common meaning to lists, as it does not make a difference to my argument.

²³ There are, of course, other candidates for the meaning of predicates, and consequently the meaning of the mode of combination. For example, if predicates are taken to have properties as their meanings, the sentence *Socrates sits* means that Socrates bears the property of being seated. If predicates are taken to denote sets of objects, the sentence *Socrates sits* probably means that Socrates is a member of the set of seated objects. Yet, whatever the meanings of predicates and the mode of combination are exactly taken to be, the general lesson is that the mode of combination is itself significant and determines, *inter alia*, the difference between the meanings of lists and sentences. In the following, I will disregard the alternative conceptions of the meanings of predicates just mentioned, as they don’t change anything in the general argument.

that the relation of instantiation ‘actually relates’ Socrates and the universal of sitting (to follow the terminology of Russell (1903)). Call this relation R . The trouble is that we now face the same problem as before, since Socrates, the universal of sitting, the relation of instantiation and R may form just an aggregate, rather than giving rise to a unified proposition. Again, a higher order relation R^* is needed to ensure unity and so on *ad infinitum*.²⁴ Despite its ancient origin, the resulting regress is usually called *Bradley’s regress*.²⁵ In sum, if you think of predicates and the mode of combination as contributing entities towards the meaning of the whole, any efforts of ensuring the right kind of unity by introducing higher order predicates/relations will result in an infinite regress.²⁶

There are three ways of dealing with the problem of accounting for unity in the light of Bradley’s regress. The first is to argue that predicates or relations do not contribute a further entity towards the meaning of the whole. The second is to insist that Bradley’s regress is not a problem. And the third is to deny that there is a problem in the first place. The last strategy has been taken by Russell in *Principia*, followed recently by Soames (2010b; 2010a; 2013b). In section 1.3, I argue that this strategy does not resolve the unity problem. The second strategy has been defended by Gaskin (2008). I argue in section 1.4 that it is not viable either.

²⁴ Initially, it might be thought that Bradley’s regress presupposes an extreme form of atomism to get off the ground – taking relations as additional constituents of a proposition seems to presuppose their reification. If so, we could avoid the regress by rejecting the atomistic picture of relations (and optionally of properties). As Grossmann (1983: 169) argues:

think of non-relational entities as wooden boards; of relations, as glue. Then it is true that no two wooden boards can be fastened to each other without there being some glue between them. But the glue itself needs no further glue in order to stick to the boards. Relations are the glue of the world. As such, they need not be glued to what they hold together.

Although I am in principle sympathetic to this reply (cf. chapter 2.5.3), avoiding the regress is not as easy as this. As Vallicella (2002a: 207) points out: ‘In terms of the glue-metaphor, it is clear that there is no need for superglue [...] to cement the glue [...] to the boards. But the existence of two boards and some glue does not entail the existence of two-boards-glued-together.’

²⁵ The regress is usually attributed to Bradley (1893), as it was him who introduced the problem into analytic philosophy by challenging the new analytic conception of propositions, according to which propositions are composed of atomic concepts (cf. chapter 2.2.2). If, as Moore (1899: 8) argued, ‘a thing becomes intelligible first when it is analysed into its constituents’, the question arises how to explain what unity adds to the constituents taken for themselves.

²⁶ Orilia (1991: 104) provides a more general and formalized formulation of the regress: ‘If a proposition is an entity constituting a complex unity of a certain sort and it is such that its constituents are, say, R^n , a_1 , ..., a_n , then there must be a relationship holding together a_1 , ..., a_n [...]. If this relation is I^{n+1} , then the constituents of the proposition are really I^{n+1} , R^n , a_1 , ..., a_n and the proposition must have a form such as $I^{n+1} R^n a_1 \dots a_n$ (where “ I^{n+1} ” is meant to represent the $(n+1)$ -adic exemplification (instantiation) relation or copula). But this line of argument can be iterated *ad infinitum*, creating a “Bradley series”

(BS) $R^n a_1 \dots a_n, I^{n+1} R^n a_1 \dots a_n, I^{n+2} I^{n+1} R^n a_1 \dots a_n, \dots$ ’

The most popular strategy of circumventing the problem has been the first, which I will adopt as well. Approaches along this line have recently been developed by Davidson (2005) and Collins (2011b). Yet, Davidson's and Collins's strategies differ in interesting ways: Davidson aims to develop a theory of predicates according to which predicates do not contribute entities towards the meaning of the whole. He argues that if he succeeds in this attempt, Bradley's regress does not get off the ground in the first place: at no point in the derivation of a complex meaning are two or more entities combined; thus, we require no higher order relation to ensure the unity of subject and predicate. Collins, by contrast, develops a theory according to which the mode of combination does not add any further entities. In both cases, the main challenge to this approach is twofold: if we choose Davidson's strategy, we have to say what exactly the meaning of predicates consists in if they do not contribute entities towards the meaning of the whole. But we also have to explain how it is possible that the very same linguistic expressions sometimes contribute entities towards the meaning of the whole (namely when they occur in a list or in second order predication) and sometimes don't contribute those entities (namely when they occur as predicates in sentences). In chapter 2.4, I argue that Davidson does not succeed in explaining this latter aspect. If we choose Collins's strategy, on the other hand, we do not only have to explain why the respective mode of combination does not add entities towards the meaning of the whole, but we also have to provide a substantive account of what the mode of combination contributes towards meaning. As I argue in chapter 5.2, this is where Collins's theory falls short.

The first question I seek to answer in the following chapters is thus:

- (12) UP1 (Unity Problem 1): How can the meanings of linguistic expressions, when combined in a grammatical way, give rise to a new meaning which exhibits the characteristic kind of unity of the meaning of such expressions?**

The question of the unity of meaning is often posed in a more general way. Summers (2012: 5), for example, formulates the problem as follows:

- (13) What distinguishes a proposition, considered as a complex of discrete constituents, from a mere aggregate of those constituents?

Focussing on the linguistic aspect of the problem, the question is also often formulated as in (14):

- (14) What distinguishes a declarative sentence from a mere list of words? (Gaskin 2008: viii; cf. Peacock 2011: 393; Wiggins 1984: 324)

An account sufficient to answering (13) or (14) may, nonetheless, fall short of answering UP1. Two ways in which this could happen are associated with more precise formulations of the unity problem, which can be seen as aspects of (13) and (14). The first one is the central explanandum of Collins (2011b: 28):

- (15) (Combinatorial Unity) Given lexical items with their semantic properties, what principle or mechanism combines the items into structures that are interpretable as a function of their constituent parts?

This question mainly asks which syntactic operation puts lexical items together in such a way that, when they are interpreted by an appropriate semantic system, their interpretation exhibits the characteristic unity of sentences and other grammatically complex linguistic expressions. However, a theory concerned with the expressions that are to be interpreted, rather than with their interpretation itself, cannot settle questions about their meaning – at least not without substantial further supplementation. UP1 asks how the meanings of expressions combine, not how the expressions that have these meanings are combined. Thus, even if we know how words are combined to make up sentences, we may not have understood how their meanings give rise to the meaning of the sentence (for further discussion see chapter 5.2). An answer to (15), therefore, falls short of answering UP1.

A second, more precise, question that has to be distinguished from UP1 is formulated in King (2009: 258):

- (16) UQ1: What holds the constituents Dara and the property of swimming together and imposes structure on them in the proposition that Dara swims?

Although, unlike Collins's 'Combinatorial Unity', this question directly concerns meaning, an answer to it may nonetheless fall short of answering UP1. The difference between King's question and UP1 becomes particularly clear in a paraphrase that King provides: 'Answering UQ1 requires saying *which relation* holds the constituents of propositions together' (King 2009: 259, my emphasis). Possible answers to this question could be 'instantiation', 'conjunction', 'ascription', 'function application', etc. However, saying that, in the proposition that Dara swims, Dara and the property of swimming are 'held together' by the relation of ascription, as opposed to the relation of conjunction, say, is not of much help in respect to the question of how

the unity at issue is achieved, unless a theory of ascription is added. No-one, I take it, seriously believes that the meanings of sentences can be derived from their constituents by mere addition. It is also obvious that the relation in question has to ensure the unity to be explained. The thesis that the constituents of propositions are put together in an asymmetric way that ensures the unity to be explained is thus circular and not very illuminating – but not much of relevance to the unity question is usually added to the assertion that propositional unity is secured by a particular relation, such as ascription or instantiation. Indeed, as I argue in chapter 3.2.2, King’s way of spelling out his proposal faces a version of Bradley’s regress, which shows that an answer to UP1 has not been provided.²⁷

All this is not to suggest that (15) and (16) are irrelevant in respect to unity. They clearly are not, and they will have to be addressed to some degree in seeking an answer to UP1. The point is simply that there may be viable answers to either of these questions which nonetheless fall short of answering UP1.

1.2.3 Grammatical Structure and Formal Ontology (UP2)

If two linguistic items are combined so as to give rise to the relevant kind of unity, this is often accompanied by a change in formal ontology (cf. Jespersen 2012: 620).²⁸ For example, neither *Socrates* nor *sits* on their own have a proposition as meaning, and none of them is evaluable for truth on its own. Yet, if *Socrates* and *sits* are combined in the right grammatical way, the meaning of the resulting sentence is a proposition and it is evaluable for truth and falsity. This contrasts with the meaning of the list consisting of *Socrates* and *sits*, a mere aggregate of *Socrates* and the universal of sitting. The second question which I seek to answer is therefore:

(17) UP2 (Unity Problem 2): Why does the formal ontology change when grammatical structure is built up?

The change in the formal ontology is closely related to the special kind of unity which the meanings of the respective grammatically complex expressions exhibit. As Davidson (2005: 120) argues:

Having a truth value is the simplest and clearest mark of the unity of sentences and of the beliefs and judgments that sentences can be used to express. For it is only an expression, the

²⁷ For a discussion of function application cf. chapter 2.3.

²⁸ Although many of the formal ontological categories that I discuss may be familiar from metaphysics, I do not mean to imply that they have any metaphysical impact. Indeed, I argue in chapters 4 and 5 that the formal ontology of language is independent of metaphysical ontology.

semantics of which demonstrate a clear relevance to truth values, that has the unique unity of a sentence.

Davidson concludes from this that ‘a satisfactory account of predication depends on relating it to the truth of sentences’ (Davidson 2005: 141).²⁹

I agree with Davidson that truth is central in this respect and that any satisfactory explanation of the unity problems also has to account for why sentences but not their parts can be true and false. However, I would like to point out that the question generalizes and does not only concern truth. Consider (18):

(18) I have spent two hours eating the pineapple.

In this sentence, *eating the pineapple* is not an expression evaluable for truth. Yet, its meaning exhibits unity and comes with an ontological change. The meaning of *eating the pineapple* is a process or act or something similar. The meaning of *the pineapple*, by contrast, is an object.

Furthermore, as noted in the preface, in most cases the grammatical derivation of a linguistic expression is much more complex than is visible to the naked eye. It is in particular the rich *functional structure* of natural languages which correlates closely with systematic changes in the formal ontology. Consider, for example, the grammatical structure of (19) in (20) (in the analysis of Borer 2005a):

(19) these three lambs
 (20) DP[these NumP[three ClP[-S NP[lamb]]]]

The meaning of the Noun Phrase (NP), if it is not divided or restricted by further functional grammatical structure, is a mass, like in *I ate lamb*. In this case, what I ate is not a lamb or two lambs but some undefined amount of lamb-meat. The Classifier (Cl), which features as a separate word in some languages, for example in Chinese, divides the ‘pure lamb space’ (Hinzen 2010) into individual units. In this way, the Classifier turns the mass noun into a count noun. According to Borer, one way of realizing the Classifier morphologically in English is the enclitic plural –s. The Classifier clearly contributes something to the meaning of the whole – it is responsible for turning a mass into objects that can be counted in the next higher functional projection (Number). In this sense, count nouns like *lambs*, *a lamb*, or *the lamb* etc. are clearly

²⁹ A similar point is made by King (2009: 258) in his UQ2: ‘How does the ‘structured complex’ that is the proposition that Dara swims manage to have truth-conditions and so represent Dara as possessing the property of swimming?’ (cf. also Eklund 2009’s ‘representation’).

complex. Yet what is it about the meaning of the classifier that makes the formal ontology of the meaning contributed by the lexical item in NP change? If we want to answer UP2, this is one of the questions we have to address. From this example, it becomes also clear that UP1 is a very general question and does not only concern predicate-argument concatenation: if a Classifier is added to a noun, the meaning of the complex is not an aggregate consisting of, say, objecthood and a mass.³⁰

The two puzzles also apply to cases of adjunction. A *red house* is a building, not a colour, despite the fact that red is a colour. On the other hand, whatever a *house red* is, it will be some kind of colour and not some kind of building. Similarly, a sledge dog is a kind of dog, but a dog sledge is a kind of sledge. The question arises of why this is the case, which is an instance of UP2. Furthermore, it is also clear that the meaning of *a red house* is not an aggregate consisting of redness and houseness, but a single object; and the meaning of sledge dog is not an aggregate consisting of doghood and sledgehood. Cases of adjunction and compounding, therefore, are also instances of UP1.

Collins (2011b: 23) discusses a unity problem which is closely related to UP2:

- (21) (Interpretive Unity) Linguistic structures are atomistically decomposable (analysable) into their constituent lexical items, but when appropriately composed, they are interpretable units (expressive of propositions). How does such unity arise from the interpretability of the constituents of a host structure together with their mode of composition?

Collins's Interpretive Unity covers two questions: first, the question of why certain linguistic expressions can be combined but not others, and second, the question of what the relation between the interpretation of the parts of a sentence and the interpretation of the whole sentence consists in. UP2 may be seen as an aspect of the latter of these questions: as Collins mentions explicitly, his Interpretive Unity asks as to how the composition of lexical items can give rise to expressions that express propositions, which is probably the most obvious example of ontological changes or novelties. Collins argues that his Interpretive Unity 'is essentially descriptive' (ibid.) and as such philosophically not very illuminating. If Collins is right, also UP2 may turn out to be of an essentially descriptive nature, given the close relation between Interpretive Unity and UP2. I think Collins is right that the way in which the compositional

³⁰ See chapter 6.3 for further discussion.

tradition has dealt with Interpretive Unity is essentially descriptive.³¹ But I believe that there nonetheless is a substantial philosophical question in UP2 which goes beyond traditional compositional semantics.

In compositional semantics it is standard to assume that we know the values of some linguistic expressions and can then define the values of others as functions mapping values of one kind onto values of other kinds. Let's for the moment ignore such complications as modality, tense etc. Given that sentences are evaluable for truth and falsehood, we could, following Frege, say that they refer to a truth value and assign the type t to them – where t is the type of truth values. Names, and perhaps other singular terms, could be taken to refer to entities and, hence, can be assigned the type e – where e is the type of entities. We may then define predicates as functions from entities to truth values. Thus, *sits* is a function which maps entities, for example Socrates, to truth values.³² In this way we can construct a theory that predicts which linguistic expressions can be combined: by taking a semantic derivation to be type-driven, an entity, for example, can only be combined with a function that maps entities to something else. To what the respective predicate maps our entity is open to stipulation or empirical discovery; it may be a truth value like in the case of *sits*, or it may be another entity as in the case of *the father of*. Furthermore, such a theory, if adequate, describes correctly the ontological changes mentioned in my discussion of UP2: if an intransitive verb, e.g., is a function from entities to truth values, an intransitive verb and an entity-denoting expression denote a truth value when combined; but none of them on their own does so. The reason for the appearance of the new ontological category is that intransitive verbs are *defined* as mapping things into truth values. Also the meaning of other lexical or grammatical elements could be defined in a similar way. The classifier mentioned above, for example, could be taken to denote a function from masses to (generic) entities.

Complex as the definition of a system which more or less captures the empirical data and satisfies theoretical constraints may be, it is still a largely descriptive enterprise: we assume the different formal ontological categories as given and formalize our observation that when an

³¹ This is not to underestimate the technical ingenuity which is sometimes required in order to get an empirically and theoretically satisfying description. And it is also not to deny that philosophically substantial problems arise in carrying out this task.

³² Using a lambda calculus, the function can be expressed as follows: $\lambda x x \text{ sits}$ where x is a variable ranging over entities. The expression is true if and only if the entity which the function is applied to indeed sits. Transitive verbs work in essentially the same way, although they are slightly more complicated: either we have to assume that *hits*, for example, maps pairs of entities to truth values, or we have to assume that it maps one entity to a function which maps another entity to a truth value. In the latter case *hits* can be formalized as $\lambda x [\lambda y y \text{ hits } x]$.

expression of category A is combined with expression B, the result is an expression of category C. This practise does nothing to explain what the respective categories are, what the relations between them are and why they are part of our system of thought and language in the first place. However, as I discuss in chapter 4.3, although all unimpaired human beings are capable of making fine grained distinctions between formal ontological categories, this is probably not the case in respect to any other species. In particular, there is no evidence that non-human animals enjoy propositional thought (at least if propositionality is defined in narrow enough a way). Therefore, simply presupposing these categories in a formal system leaves out one of the most puzzling aspects of a theory of meaning (Hinzen and Sheehan 2014). Yet, if we don't presuppose the respective categories or our access to them, UP2 becomes philosophically more interesting (cf. Summers 2012, chapter 5.5-5.6 for a related point).

1.3 Psychologizing Unity

In the previous section, I have outlined two puzzles which are associated with unity. One popular strategy of circumventing unity problems in philosophy has been to attribute the unity to a judging subject. The suggestion is that if unity is brought about by a judgement, the unity question disappears as a question of how objects and relations 'hold together' to make up a proposition: it is the judging subject that puts them together. In this section, I argue that this kind of move does not dissolve unity questions – it merely relocates them: if unity in a metaphysical sense is due to, say, judgements, we still want to know how we achieve such unity in our judgements. In other words, even if we, for the sake of the argument, assume that, independently of our minds, the world is a world of atomic entities and that relations between these atoms are due to the activity of our mind, we would not have explained the apparent unity of facts, states of affairs, propositions, etc., unless we have a good account of how our mind actually unites the atomic objects out there. Merely saying that it is the mind that does the work is not equivalent to giving an account of the work the mind does. Conversely, at the end of this section (section 1.3.4), I also suggest that even if an explanation for metaphysical unity is given, there still remains the question of how such unity is established or grasped in judgements. Hence, whether or not there is a metaphysical problem regarding unity, there is a genuine problem concerning the unity of judgement or thought. And it is this version of the problem which will be in the centre of the following chapters. I demonstrate the point by discussing three attempts of dealing

with problems concerning unity in this way, put forward by Kant (section 1.3.1), Russell (section 1.3.2) and Soames (section 1.3.3).

1.3.1 The Unity of Apperception

For the British Empiricists, a version of the unity problem arises from a conflict between their basic principles. On the one hand, Locke (1689, IV. i. 2) defines knowledge as ‘the perception of the connection and agreement or disagreement and repugnancy, of any of our ideas.’ Knowledge is, hence, inherently relational. On the other hand, the only sources of knowledge were thought to be sensations and the passions – Hume (1739-40, I. iv. p. 6) argues: ‘it is from some one impression that every real idea is derived.’ Given that it was generally agreed at the time (amongst the empiricists as well as their opponents) that sensations, and therefore also the ideas abstracted from them, are atomic, the relational character of knowledge had to remain mysterious from an empiricist point of view. As Hume admits:

There are two principles which I cannot render consistent; nor is it in my power to renounce either of them, viz. that all our distinct perceptions are distinct existences, and that the mind never perceives any real connections among distinct existences. (Hume 1739-40, Appendix p. 21)³³

Kant (1787) shares Hume’s atomistic conception of perception. Yet, he aims to solve Hume’s paradox by arguing that Hume is wrong in assuming that the mind is a passive organ: what unites ‘apperception’, according to Kant, are not further ideas, abstracted from sensations or derived from our passions and emotions; for Kant, unity is nothing empirical at all, but is achieved by spontaneous acts of the mind. I argue in chapter 5.2 that Kant’s rationalist picture is more adequate than the empiricist one. Yet, as Davidson (2005: 99) points out, Kant’s move leaves the central question in respect to *unity* unanswered: ‘Kant classified the ways in which the mind puts elements together in judgment, but he does not seem to have recognized the importance of explaining exactly what the mind adds to the elements to produce a judgment.’ The point of the unity questions is not mainly to determine the locus of the uniting mechanism, but to understand how the uniting mechanism (if there is one) in fact achieves the unity at issue.

³³ As Green (1874) points out, even abstraction – the way by which Locke assumed that we arrive at knowledge on the basis of sensation – presupposes that the sensations stand in certain relations to one another (in particular relations of similarity and dissimilarity). A similar point can be made in respect to Hume’s more complex account: according to Hume, ideas *appear* to be general because similar ideas can be substituted for each other – yet again, such an account presupposes the relation of similarity (cf. Hylton 1990, ch. 1.1).

1.3.2 Russell's Multiple Relations Theory of Judgement

A further, and perhaps more explicit, attempt at getting rid of a version of the unity problem by taking the respective unities to be psychological entities can be found in Russell's philosophy. Russell changed his mind over the nature of the proposition several times significantly; and considerations concerning the unity of the proposition have, arguably, been a driving force behind these changes (Stevens 2006; Candlish 2007; Hanks 2007). At the beginning of his philosophical career, Russell, in cooperation with Moore, tried to establish a new conception of propositions. Against the wholistic³⁴ Neo-Hegelian trend, Russell and Moore maintained that propositions are complex objects composed of atomic concepts, which were taken not to depend upon psychology. The resulting problem, which Russell would be worrying about for most of his career, is that on this account there is no difference between a set of concepts and a proposition. Yet, this difference exists, as Bradley (1893) had argued and as Russell demonstrated repeatedly himself (for example in his 1903, ch. 4). Although the slogan of the new analytic philosophy was that we understand something only by analysing it into its constituents (Moore 1899), Russell (1903, §138), thus, had to conclude: 'though analysis gives us the truth and nothing but the truth, yet it can never give us the whole truth.'³⁵

In light of this and other problems, Russell gave up his original theory of propositions in favour of his new *Multiple Relations Theory of Judgement*. Abandoning his earlier convictions that propositions are independent of the minds which grasp them, Russell decided that propositions are in fact psychological entities. According to the Multiple Relations Theory of Judgements (spelled out in Whitehead and Russell 1910-13; and Russell 1912), propositions are identified with judgements and, thus, do not remain primitives of the theory: they are part of the theory only for 'symbolic convenience'. What constitutes a proposition, according to the new theory, is that a subject stands in the judging relation to various entities. One might think, and this was probably one of Russell's motivations for developing such a theory, that if propositions are not part of the basic ontology of the theory any more, there cannot be a problem about their unity. Yet, as Stevens (2006: 102-03) stresses, 'although propositions were now absent, the problem of the unity of the proposition remained and now became more pressing than ever, for the problem of the unity of the proposition now simply re-emerges as the problem of the unity of the judgement'. Indeed, the two problems that led Russell to abandon his view, often called 'the narrow direction problem' and 'the wide direction problem', are versions of the unity problem

³⁴ For a definition and discussion of wholism see chapter 2.2.

³⁵ See chapter 2.2.1 for further discussion of the unity problem in Russell's early philosophy.

which beset Russell's original theory of propositions. The lesson to be learnt is, again, that taking unity to be a mental, psychological or cognitive rather than physical or metaphysical phenomenon does not make the problem go away – unless an explanation of unity in this domain is offered.

1.3.3 Unification: A Pseudo-Problem?

Russell's strategy has nonetheless been an influential source of inspiration for recent attempts to address the unity problem. Soames (2010b; cf. also his 2010a; 2013b), for example, praising a 'neglected insight of Russell's', argues that the problem of the unity of the proposition is a 'pseudo-problem' (Soames 2010b: 106). Following King (2007), Soames rejects 'propositions as denizens of a "third realm" (beyond mind and matter), which are "grasped" by a mysterious intellectual faculty of platonic extrasensory perception' (Soames 2010b: 7). Instead, he offers a 'cognitive realist' account of propositions, according to which propositions are types of cognitive events. The cognitive events relevant to propositions are predications. Predication is thereby taken as a primitive cognitive act. Thus, according to Soames, in 'John is human' both 'John' and 'human' can be seen as singular terms that contribute entities to the meaning of the sentence and the copula could be semantically empty

provided that *something* about the proposition indicates that, in it, humanity is predicated of John. This something is, we may suppose, not itself a propositional constituent. Rather it is the structural relation in which the sense of 'human' stands to the sense of 'John' in the proposition' (Soames 2010b: 20).

If what indicates what is predicated of what is not itself a constituent of the sentence or proposition, Bradley's regress is avoided. According to this approach, then, the unity of a proposition is simply the result of predicating something of something else. Similar moves have been made by Jubien (2001), Moltmann (2003a; 2003b; 2013), Hanks (2007; 2011) and Jespersen (2012).

The price that Soames has to pay for treating the traditional unity problem as a 'pseudo-problem' is that he has to take predication as a primitive. But this amounts to stipulating the unity of the proposition – the problem of the unity of the proposition as traditionally conceived is the problem of accounting for predication, which is why, for example, Davidson discusses the problem under this latter heading. Davidson (2005: 77) argues: 'It is just this unity [of the proposition] that a theory of predication must explain'. It is true that for any explanation, some concepts have to be taken as primitives, as Soames (2010b: 29) emphasizes. But by taking

something inherently puzzling as a primitive, one thereby does not get rid of the respective puzzle – and one aspect which makes predication inherently puzzling is that the result of a predication exhibits the unity it does. Indeed, in his discussion of Soames' approach, Collins (2011b: 178) complains: 'Predication cannot arise from mere stipulation [...]; there is, as far as I can see, nothing the least bit enlightening about an appeal to a cognitively primitive capacity of predication.' Yet, even in case the stipulation of predication is accepted as a sound way of getting rid of unity problems, the traditional unity problem reappears in Soames' account, as I shall argue in chapter 3.2.3.

1.3.4 Pragmatics and Metaphysics

Thinking of unity in pragmatic terms also does not get us any closer to an answer to either of the two unity problems under discussion. Initially, one might think that unity problems could be circumvented by adopting a contextualist position and taking unity to be an aspect of pragmatics, rather than semantics.³⁶ As Gibson (2004: 140) argues, 'the unity of the sentence lies in the speaker's performing a certain act in a certain context.' However, this strategy is empty as a solution to the unity problem, unless a convincing account of how unity is achieved pragmatically is provided. In this respect the pragmatic strategy of getting rid of linguistic unity problems resembles that of the strategy of getting rid of metaphysical unity problems by thinking of them in cognitive, psychological or mental terms. The questions I have formulated in section 1.2 are, thus, independent of the debate between contextualists and minimalists.

In sum, thinking about the unity of the proposition in psychological, cognitive, mental, or pragmatic terms does not make the problem go away, as the unity problem simply reappears in these domains.

However, even in case we can provide a metaphysical account of how propositions, facts or other metaphysical entities receive their unities, there remains the question of how unity is achieved in our thought and natural language. As Peacock (2011: 396) points out, even if granted the existence of propositions, we have to answer the question of why certain linguistic

³⁶ There has been considerable disagreement as to what the semantic content of sentences consists in and whether it determines 'what is said' by a certain sentence. Whereas contextualists such as Travis (2008), Carston (2002), Sperber and Wilson (1986), and Recanati (2004; 2010) have argued that what is said always depends upon the context of use, Cappellen and Lepore (2005) and Borg (2004; 2010) want to restrict contextual influence on the meaning of a sentence to indexicals explicitly part of the syntactic structure of the sentence. For contextualists, meaning is thus determined 'top down', for minimalists it is determined 'bottom up'. Stanley (2000) has defended an intermediate position, according to which meaning is determined 'bottom up', but is enriched by hidden indexical parameters.

expressions pick out propositions, whereas others pick out aggregates of objects. This question cannot be answered by reference to conventions, since

what we want to know is, given that within the scheme of interpretation specified by a given language some strings are capable of expressing a content and some are not, what is it that is different about the way the content-expressing strings function within that language, that makes them capable of this feat?

Furthermore, as noted in section 1.2.1, thought and language are productive, but cognition is finite. So, in some sense, the possible infinity of novel, complex thoughts and expressions has to have been built from a finite number of familiar parts. Producing or grasping novel thoughts, therefore, presupposes a unifying mechanism in these domains quite independently of whether there are unities out there, metaphysically speaking.³⁷ As Collins (2011b: 50) argues:

The unity problem in the realm of language looks to be independent of the unity problem in the realm of states of affairs. [...] The latter unity problem appears to be [...] more easily resolved, albeit vacuously, for states of affairs (as complexes) fall under a metaphysical category that, as far as I can see, is not essential to any explanation. Perhaps, after all then, the unity problem just tells us that there are no facts qua complexes. Either way, no such conclusion is acceptable *vis-à-vis* interpretable linguistic structures.

It is this unity of thought and natural language which will be in the focus of the following chapters.

1.4 Bradley's Regress: Problem or Solution?³⁸

Bradley's regress is usually taken to be a major challenge in explaining the unity of meaning. However, a small number of philosophers have argued that Bradley's regress is in fact harmless, or even the solution to the problem.³⁹ In this section, I discuss Gaskin's version of this strategy, arguing that it leaves what is, from my point of view, the central aspect of unity unexplained.

³⁷ An account which, like Gibson's (2004), explains the unity of meaning with reference to causal asymmetries, therefore, necessarily fails. As Chomsky (1959) points out, any attempt to explain linguistic utterances in external causal terms faces two problems. First, identifying the right kinds of causes usually requires metaphysicalizing linguistic categories (cf. chapter 4.2 for discussion). Second, even given this, it is virtually impossible to explain why a certain 'cause' sometimes does cause the utterance of a particular sentence and sometimes fails to do so. See chapter 3.1.3 for further discussion. Compare also the preface.

³⁸ I'm indebted to Richard Gaskin for an enlightening email exchange on the topic of this chapter, as well as for very useful comments on an earlier draft.

³⁹ Armstrong (1997: 118-19) argues that Bradley's regress is harmless in respect to truth-making. Yet, an argument towards the conclusion that the regress is harmless for truth-making is not yet to have explained

For Gaskin (2010a: 261) – as for Russell and the neo-Russellians – ‘all semantically significant components of the sentence [are] names.’ Unlike Soames, however, Gaskin accepts that this contention makes Bradley’s regress ‘unavoidable’ and concludes that ‘we should see whether we can live with the regress’. Indeed, according to him, ‘Bradley’s regress emerges not as an embarrassment, something to be circumvented by careful legislation, but as the metaphysical ground of the unity of the proposition’ (Gaskin 2008: 345). Gaskin’s argument is twofold. First, he argues that Bradley’s regress is not vicious, second that the regress ensures propositional and sentential unity. The regress is argued not to be vicious, because the regress is a metaphysical one, not an epistemic or practical one, and, Gaskin adds, we can well understand infinity as long as, in understanding it, we do not have to go through every step of an infinite sequence separately.⁴⁰ For example, the infinity of the natural or real numbers is not beyond the reach of our minds.⁴¹ ‘Bradley’s regress, like the structure of the rational or real line, is infinitistic in a metaphysical, not a practical, sense, and for that reason is not vicious: it imposes a specific infinitistic condition on the structure of propositions [...] and not an infinitistic, and so unperformable, task for the understander’ (Gaskin 2008: 351).

The insight driving Gaskin’s discussion of unity is one that I have already quoted a couple of times: all sentences can be ‘duplicated’ by lists of words. According to Gaskin, the same situation can be found in metaphysics, where propositions (*a* is *F*) can be ‘duplicated’ by aggregates of objects (*a*, *Fness*). According to Gaskin, Bradley’s regress is the metaphysical ground of the unity of a sentence and proposition. The meanings of *Socrates* and *sits* are united, because there is a relation R^2 relating the two. R^2 is united with the two initial meanings, because of the presence of a second order relation R^3 , and so on ad infinitum. The unity of a proposition, therefore,

depends on the presence, in the unspoken and unwritten background, of the members of the regress: were that background not fully in place – if the regress did not get going, or if it faltered at some point – the proposition in question would not be unified, but would fall apart into a mere aggregate. (Gaskin 2010a: 262)

unity, which Armstrong seems to take as a primitive (cf. p. 13). Also Orilia (2006) and Schnieder (2004) argue that Bradley’s regress is not vicious. Yet, they too seem to take the unities as primitives. See Cameron (2008) for discussion of a related point. Klein (2003) defends a related thesis in epistemology.

⁴⁰ Burge (2007: 592) makes a similar suggestion.

⁴¹ There has been disagreement as to whether the examples of infinities that Gaskin provides are good analogies for the case of Bradley’s regress, cf. Collins (2011b: 84).

None of the infinity of relations R^2, R^3, \dots, R^n can ensure unity on its own – what explains unity is ‘the regress as a whole’ (Gaskin 2010a: 263).⁴² In this sense, every stage in the regress depends upon both the preceding and the succeeding stage. Bradley’s regress can, thus, ‘be regarded as, at each stage, comprising *necessary and sufficient conditions* for the presence of [the crucial copulative feature that unites the sentence] at any preceding, and each succeeding, stage’ (Gaskin 2008: 352).⁴³ It follows that ‘what stops a proposition from being a *mere* aggregate of entities, and the corresponding sentence from being a *mere* list, is that the proposition unfolds into an *infinite* aggregate, and the sentence into an *infinite* list’ (Gaskin 2008: 345; cf. 1995: 176-77).

We may ask how adding predicates ad infinitum could turn a list into a sentence. There certainly can be infinite, even transfinite, lists. Thus, irrespective of how many predicates we add, it seems, what we receive is a list and nothing but a list. Indeed, if Gaskin is right that every sentence can be duplicated by a mere list, it follows that if sentences contain an infinite number of elements, there have to be lists containing as many elements. Therefore, merely adding relations ad infinitum cannot do the trick, irrespective of whether Bradley’s regress is vicious or not.

At this point it transpires that Gaskin must have something else in mind. Indeed, he stresses in some passages that we cannot convert a list into a sentence just by adding predicates. The regress, rather, is what we receive when we try to *analyze* a unity. But in such a case, the unity already has to be in place prior to our analysis. Gaskin (2008: 367) argues:

At each stage of Bradley’s regress we have a unity [...]. The point about the regress [...] is not that each stage of it seeks to restore a unity which has broken down at the previous stage – that would indeed be a hopeless task – but that each stage provides an *analysis* of the unity which was securely present at the previous stage. Each stage *guarantees* the unity of the previous stage, and tells us what that unity *consists in*.

Thus, it seems as if, for Gaskin, unity is essentially a primitive. Indeed, he writes: ‘There is a sense in which you cannot go about constructing a sentence from bits; you can only find that

⁴² If what explains unity is the regress as a whole, we require a transfinite predicate that unites the different stages of the regress; and we require a further predicate which unites the transfinite predicate with the regress and so on ad infinitum (cf. Gaskin 2008: 366). In this way we get a further regress. But the regress does not stop here, as the regress of transfinite predicates will only be explanatory as a whole, thus we need a predicate which unites the second regress with the initial one – and in this way we get a regress of regresses. And then, a regress of regresses of regresses and so on. In short, we are facing the upper limits of the transfinite.

⁴³ Cf. Schnieder (2010) for a critique of this aspect of Gaskin’s theory. Cf. Gaskin (2010b: 307-09) for a reply.

you have constructed one' (Gaskin 2008: 369). The regress does not produce the unity at issue; rather it is what you get if you try to analyze a unity already in place. Rather than providing an explanation of how unities can be created from its constituents – a task that, according to Gaskin, we cannot succeed in – Gaskin offers something like a diagnostics for unities. This seems in accordance with a later passage: 'If the finished product is analysable as generating Bradley's regress at the level of reference [...] then it refers to a proposition and so is itself a declarative sentence; if not, then it is a mere list and its referent a mere aggregate' (Gaskin 2008: 369). To paraphrase, you start with a unity, and if, when you analyze your unity, you run into a version of Bradley's regress, what you have been analyzing is a unity. If the regress doesn't get going or stops at some point, it is just an aggregate.

Can this analysis differentiate between a sentence and a corresponding infinite list? As Gaskin (p.c.) emphasizes: 'infinity as such doesn't do the trick, since [...] there are infinite lists.' The difference between a sentence and a list is not an extensional one, concerning the regress itself, rather it is an intensional difference that concerns 'the way in which the infinity arises in analysis that is the key'. Unlike a sentence,

the analysis of the corresponding list doesn't *generate* Bradley's regress. It doesn't generate anything at all, other than the list of the elements of the corresponding aggregate. Nor does a list which comprises exactly the elements of the regress, as separate items, generate the regress – in that case, as it were, the regress is already there.

This seems to confirm the primitive status of unities in Gaskin's theory: if the regress is *generated* by the unity, it seems that there has to be something about the unity that generates the regress when the unity is analyzed semantically. In this case it seems that the unity explains the regress, rather than vice versa; the regress, then, seems to be a diagnostics of unity, not an explanation.⁴⁴

In some passages, however, Gaskin seems to suggest that it is the analysis which *makes* something a unity in the first place. He writes:

There is no method of constructing a sentence *as opposed* to a mere list. Whether what you end up with when you have, so to speak, followed the instructions in your assembly kit is a sentence or mere list depends on its *ex post facto* analysis, not on what you do with any components, internal or external, to arrive at the finished product. (Gaskin 2008: 369)

⁴⁴ Note, however, that Gaskin would not agree: in his comments on an earlier draft of this section, he writes 'that having what you are calling a diagnosis *is* having an explanation' (cf. Gaskin 2010b: 307-09 for discussion). Thus, whether or not Gaskin's account is accepted as an explanation of unity in other domains probably depends on what we let count as an 'explanation.'

According to this passage, nothing is intrinsically a sentence or a list: whether a linguistic expression is a sentence or a list, is, in Peacock's (2011: 399) words, '*up to us.*' This interpretation of Gaskin's theory is supported by a different passage. Gaskin (2010a: 264, my emphasis) writes: 'What makes the difference [between a list and a sentence]? My answer is that the difference concerns the semantic *analysis* of the relevant bunch of words.' Thus, although Gaskin does not aim to cognitize or psychologize unity and does in this sense not follow the kind of approach which the later Russell and recently some Neo-Russellians defend, his approach is somehow similar in that he argues that 'the distinction between a sentence and a mere list is a conceptual one' (Gaskin 2008: 299). Yet, in the previous section, I have argued that taking unity to be something cognitive or psychological, on its own, does not help us out of the unity problem, as long as we don't have a good theory of how unity is achieved in this domain. The same conclusion should be drawn in respect to taking unity as something conceptual: without a theory of how the unity is achieved conceptually, such a move is empty. Yet, as far as I can see, Gaskin does not provide an account of how unity is achieved conceptually. Rather, he seems to take the unities themselves as primitives in his account. It will be the main thrust of chapter 2 to argue that taking unity as a primitive is problematic in respect to the meaning of natural language (cf. also section 1.2.1).⁴⁵

I conclude that whether or not Bradley's regress is vicious, it is of no help in explaining the unity of linguistic meaning. It is possible to agree with Gaskin that comprehending a Bradleyan regress is not beyond our conceptual capacity, without accepting that the regress provides an answer to the questions developed in section 1.2. When comprehending such a regress, what we comprehend is an infinite list which, unfortunately, lacks the unity we are seeking to explain.

⁴⁵ As noted in the preface, taking unity as brute may be a valid way of accounting for unity in metaphysics. Given that Gaskin aims at uncovering the metaphysical ground of the unity of the proposition, this may also be a valid way of answering the question he aims to answer. Yet, if unity is brute, it is not clear why Bradley's regress is supposed to add a metaphysical foundation to it – in particular since lists can be infinitely long.

The Dichotomy between Unity and Productivity

The meaning of *Socrates sits* is a unity, qualitatively different from an aggregate of the meanings of *Socrates* and *sits*. The two unity problems discussed in chapter 1.2 concern the question of how the meanings of *Socrates* and *sits* can combine in such a way as to give rise to the meaning of *Socrates sits*. It might be thought that what accounts for the difference between the aggregate and the unity is the mode of combination: this is what tells us how the two meanings are to be combined to make up a new whole. The problem is that the meaning of the mode of combination cannot just be another ingredient of the meaning of the whole, otherwise ‘we are hurried off into the eddy of a hopeless process, since we are forced to go on finding new relations without end’ (Bradley 1893: 28): Let the meaning of the mode of combination be instantiation. In this case, the question arises what unifies instantiation with the meanings of *Socrates* and *sits*. Let, whatever unifies them, be instantiation*. We now face the question of what unifies instantiation and the meanings of *Socrates* and *sits* with instantiation*, and so on ad infinitum.

It might be objected that a conception of meaning according to which all kinds of meanings are atomic is quite implausible. Why should the mode of combination itself contribute a meaning which is on a par with the meanings it is supposed to relate? It might be tempting to think that unity problems only arise in the context of some particular philosophical programmes, such as the atomism of the early analytic philosophy. So, perhaps we should stop worrying about Bradley’s regress and just abandon such atomistic conceptions of meaning. The main aim of this chapter is to show that providing an alternative conception of meaning which avoids unity problems and also satisfies other plausible constraints on semantic theory is not at all straightforward. In the course of this chapter, I discuss a number of prominent semantic theories, arguing in each case that they neither provide a solution to the unity problems, nor succeed in avoiding them.

In section 2.1, I substantiate my claim that sentential meanings cannot be derived by conjoining the meanings of their parts. I discuss in particular Aristotelian semantics, which emphasizes the role of predicate conjunction. I argue that, despite recent attempts of revitalizing

and improving this kind of semantics, it remains impossible to derive sentential meaning purely on the basis of predicate conjunction. In section 2.2, I provide a partially historical introduction to a dichotomy that will be central for the remainder of this chapter: If sentential meanings are taken as primitives of a semantic theory, unity problems don't arise, but the productivity of language remains unexplained. If, conversely, sentential meanings are taken to be made up of the meanings of their parts, productivity may be accommodated, but unity remains to be explained. In section 2.3, I argue that semantic theories based on functional compositionality don't escape this dichotomy: there are several ways of defining functions, but each of them yields a semantic theory which is either incompatible with the productivity of language, or fails to account for the unity of meaning. In section 2.4, I turn to truth-conditional semantics and Davidson's recent account of the unity of meaning. With the help of a Quinean interpretation of Tarski's truth-definition, and by taking an absolute notion of truth as a primitive, Davidson argues that we can provide a method of how the meaning of predicates can be defined without an appeal to entities as meanings of predicates. If predicates don't contribute entities towards the meanings of the wholes in which they feature, Davidson argues, Bradley's regress can be avoided. However, whereas I argue that Davidson does indeed have a method of accounting for productivity despite the wholistic aspect of his theory, I maintain that he is not able to explain unity. In section 2.5, I conclude this chapter with a summary of the main findings. A reconsideration of some aspects of Davidson's theory and a brief discussion of the 'picture theory of meaning' lead into a suggestion of how the dichotomy between wholism and atomism may be overcome. This suggestion is then further explored and developed in the following chapters 3-6.

2.1 Why Predicate Conjunction is not Enough

I have stressed that the meaning of a sentence cannot be derived by conjoining the meanings of their parts: the meaning of a sentence is very different from that of a list of its constituents. There is, however, an influential semantic tradition that emphasizes the role of (predicate) conjunction in semantics: Aristotelian compositional semantics. However, I argue that the scope of this kind of semantics is very limited (section 2.1.1) and that also Pietroski's recent advances in Aristotelian semantics cannot overcome the general limitation of the role (predicate) conjunction can play in the semantics of natural languages (section 2.1.2).

2.1.1 Aristotelian Compositionality

In the Aristotelian tradition, the meaning of a whole is derived compositionally from the meanings of its parts iff the combination of the features of the parts gives rise to the features of the whole.¹ As Hodges (2012: 246) summarizes, Ibn Sina, for example, argues that the meaning of a word provides, *inter alia*, ‘a criterion to determine what things the word is true of.’ The meaning of the complex expression is ‘derived from [the meanings] of the words. For example, the criterion for “rational animal” to be true of something is that the thing meets the criterion for “rational” and the criterion for “animal”.’ In short, in this tradition, compositionality is closely related to predicate conjunction.²

However, not all meanings of syntactically complex expressions can be derived by predicate conjunction. Sentences containing quantifiers are a good example. Aristotelian semanticists made some progress in explaining the meaning of such quantifiers. Ammonius, for example, writes: ‘Determiners [...] combine with the subject terms and indicate how the predicate relates to the number of individuals under the subject; [...] “Every man is an animal” signifies that “animal” holds of all individuals falling under “man”’ (translation from Hodges 2012: 247). Yet, in order for this approach to work, it had to be assumed that quantifiers, along with many other expressions, are syncategorematic expressions, that is, unlike categorematic expressions (like *tree*, *house*, *Socrates*) they don’t have meaning ‘on their own’ but only in context. The same is true of prepositions and, for example, the negation. The trouble with treating these expressions

¹ A different notion of compositionality has been developed in the mathematical tradition of the 20th century. According to this notion, the meaning of the whole can be derived compositionally from the meanings of its parts iff the meaning of the whole is a function of the meanings of its parts and the way they are combined. This definition is less demanding than the traditional one since predicate conjunction can be modelled in functional terms, but many relations which can be defined in terms of functions cannot be modelled in terms of predicate conjunction (at least not without significant supplementation). Indeed, according to Pelletier (2012: 152), the two versions are not the result of ‘applying the same concept in different areas of inquiry. Instead, there just are two very different notions [of compositionality].’

² As noted in section 1.2.1, Fodor’s notion of compositionality is directly motivated by the productivity of language. Fodor and Lepore (2001: 59) argue: ‘Compositionality says, roughly, that its syntax and its lexical constituents *determine* the meaning of a complex expression’. Yet, unfortunately, Fodor doesn’t provide an account of how atomic meanings combine, apart from asserting that the meaning of the complex has to be ‘determined by’, ‘constructed from’, or ‘inherited from’ the meanings of its constituents and of the mode of combination. Indeed, it seems that for Fodor compositionality is whatever explains productivity (Szabò 2004). Nonetheless, at some points Fodor demonstrates what he means by a compositional derivation with reference to predicate conjunction: *brown* refers to the property of being brown, *cow* refers to the property of being a cow and *the brown cow* refers to the contextually most salient object which has both the property of being a cow and that of being brown (Fodor 1998: 99). In this sense, Fodor is close to the Aristotelian conception of compositionality, even though he is certainly not wedded to it.

as syncategorematic ones is that it becomes unclear in what sense the meanings of the wholes depend only on the meanings of the parts, if some of the parts don't have meaning on their own. Predicate conjunction certainly does not play a role in determining the meaning of a whole consisting of a syncategorematic and a categorematic term. Rather, the meaning of the syncategorematic part depends upon the meaning of the whole. Quantifiers are not the only problem for Aristotelian compositionists. The meaning of a genitive as occurring in 'John's mother' did not receive an explanation in this tradition and still worried, for example, Leibniz. Hodges (2012: 248) concludes: 'their inability to handle more than a few constructions should have worried the Aristotelians more than it did.' There is, however, a recent proposal in the tradition of Aristotelian compositionality which has made considerable progress in extending the coverage of Aristotelian semantics: this theory is Paul Pietroski's *Conjunctivism*, which I now turn to.

2.1.2 Pietroski's Conjunctivism

Conjunctivism is the thesis that 'when expressions are concatenated, they are interpreted as (conjoinable) monadic predicates; and the resulting phrase is interpreted as a predicate satisfied by whatever satisfies both constituents' (Pietroski 2005a: 28). The similarity between this passage and the one by Ibn Sina cited above is striking. What Pietroski adds to the old account is an additional constraint: according to him all predicates are monadic – with some exceptions, which I discuss below. Pietroski's semantic theory is motivated by an urge to reduce the complexity of the semantics of human language to a minimum. What Pietroski is looking for is 'semantic operations that [...] are, together, *just* powerful enough for descriptive adequacy (given the proposed syntax); yet they are still natural operations, in the sense of being plausible candidates for implementation by children – and at least largely, by our recent nonhuman ancestors' (Hornstein and Pietroski 2009: 125). This exercise, Pietroski argues, allows us to better understand the evolution of human language.³

In order to be able to treat most expressions as monadic predicates, Pietroski takes proper names to be predicates along the lines of Burge (1973; cf. Pietroski 2012, section 6.2.2)⁴ and, following Tarski (1936a), he thinks of sentences as predicates without free variables (Pietroski 2011). However, Pietroski openly admits that natural languages are not compatible with a view

³ I will come back to the evolution of language and thought and the constraints this issue puts upon theories of meaning in chapter 4.3.

⁴ For a critical discussion of the thesis that names (when used referentially) are predicates see chapter 3.1.4.

according to which conjunction of monadic predicates is the *only* semantic operation. Without supplementation, this proposal makes it impossible to account for such pervasive phenomena as argument structure: the meaning of *John loves Mary*, for example, cannot be captured by the intersection of John, Mary and the set of things which *love* is true of – the resulting set would probably be empty.⁵ In order to mimic predicate-argument concatenation in Conjectivist terms, Pietroski adopts and generalizes the central element of neo-Davidsonian event-semantics:⁶ In this tradition, verbs are taken to be monadic predicates which come with an argument place for an event *e*. A sentence is taken to be an existential quantification over events, that is, sentencehood is associated with existential closure of the event variable. The participants of events are added with the help of functional dyadic predicates that express thematic roles like AGENT, PATIENT, THEME etc. The meaning of *John loves Mary* can then be formalized as follows:

- (1) $\exists e \text{ loving}(e) \ \& \ \exists x \text{ AGENT}(e, x) \ \& \ \text{John}(x) \ \& \ \exists y \text{ PATIENT}(e, y) \ \& \ \text{Mary}(y)$
 In prose: ‘There is an event *e*, such that *e* is a loving and there is an *x* such that *x* is the Agent of *e* and *x* is John and there is a *y* such that *y* is the Patient of *e* and *y* is Mary.’

Prepositions like *from* and adverbs like *after* can be handled in the same way.⁷ In effect, the functional dyadic predicates act as type shifters which allow predicates to be about different, but systematically related objects. These type-shifting dyadic predicates allow reducing every semantic operation to predicate conjunction by transforming those predicates that don’t fit into the system into predicates that do fit into the system.⁸ Consider (1) again. Whereas the meaning

⁵ Pietroski defends an internalist semantics according to which truth in the real world sense is not significant for semantics (cf. Pietroski 2005b). This aspect of Pietroski’s semantics is not relevant for my current point and I shall therefore ignore it in the following. Pietroski (2005a: 32) defines a substitute predicate *T* which is close enough to truth to do the semantic work usually associated with truth.

⁶ The reader unfamiliar with Davidsonian event semantics is referred to the beginning of chapter 3.3.2, where I give a brief introduction of this framework and discuss its main motivations.

⁷ The difference between prepositions and adverbs is that, whereas prepositions and other thematic roles relate an event and an object, relational adverbs relate two events (cf. Davidson 1967a: 154).

⁸ If this method is generalized (Hornstein and Pietroski 2009; Pietroski 2011), it may be possible to give an account of the problematic genitive cases *John’s mother* or *mother of John* in the following way (although, I did not come across a place where Pietroski applies his formal tools to this kind of construction):

- (i) $\exists x \text{ mother}(x) \ \& \ \exists y \text{ OF}(x,y) \ \& \ \text{John}(y)$

There is an *x*, such that *x* is a mother and there is a *y* such that *y* is of *x* and *y* is John.

A problem of this analysis is that *of* or the genitive *-s* can indicate many different semantic relations. In order for such a proposal to be convincing, a more specific predicate than the dummy *OF* would be necessary. Whether such an analysis can be reasonably given for natural languages remains to be

of *Mary* is essentially a set with one single member, namely Mary, the PATIENT predicate transforms this meaning into the set of events of which Mary is the Patient.⁹ The intersection of this set and the set denoted by *love* (that is the set of all loving events) is the set of loving events in which Mary is the Patient (the set of all events where Mary is being loved). The same trick can be used in respect to the contribution of *John* to the meaning of the whole sentence. Whereas *John* denotes a set with John as the only member, the AGENT predicate transforms this meaning into the set of all events of which John is the Agent. The intersection of this set with the set of events where Mary is being loved is the set of all events of John's loving Mary. Existential closure turns the meaning obtained in this way into a truth-evaluable or assertable form.

It is here where a first problem arises. In order to make every semantic relation fit into his account, Pietroski assumes functional dyadic predicates, which have the power of transforming meanings into different kinds of meanings (e.g. sets of objects into sets of events). He does not give an account of this transformation, but it is clear that it goes far beyond predicate conjunction. This confirms my thesis that predicate conjunction is not sufficient to account for all complex meanings of natural language. Indeed, this transformation is a central part of the mystery to be explained (as formulated in my UP2 in chapter 1.2.3 above). Thus, in assuming these functional predicates, Pietroski labels a problem, rather than solving it.¹⁰

Furthermore, it is questionable that predicate conjunction plays an important role in the derivation of complex meanings in natural language. The best and standard case for Conjunctivism is adjunction. Yet, as already Aristotle (*De Int.* 21a) notes, there are many cases of adjunction which cannot be modelled in terms of predicate conjunction. If we call someone a 'skilful surgeon', we (usually) do not just mean that she is skilful and a surgeon – someone may be a very skilful person and still be a dreadful surgeon. Rather what we mean by saying that someone is a skilful surgeon is that she is skilful *as* a surgeon. Predicate conjunction cannot

determined. However, note that a similar situation holds of argument structure, which we started with: whether a participant is an Agent, Patient or Theme is not straightforwardly visible at the surface. Each of these thematic roles can, for example, occupy the subject position: in *John is eating*, the subject is an Agent, in *John was hit*, the subject is a Patient, and in *the soup boils*, the subject is a Theme. In this sense, *of* may be a placeholder for a number of different syntactic and/or semantic relations.

⁹ Pietroski rejects a treatment of meaning in set-theoretic terms. Mainly in order to avoid the set-theoretic paradoxes, he adopts a version of Boolean plural quantification (cf. Pietroski 2005a, ch. 2). As this move is not relevant for my argument but adds additional complications, I shall henceforth ignore it.

¹⁰ It should also be noted that functional dyadic predicates are not enough to account for some aspects of natural language. For example, in order to accommodate relative clauses into his semantics, Pietroski (2011) is forced to assume a complicated combination of a dyadic and a triadic predicate which he calls 'TARSKI'.

account for this on its own. We could of course assume another functional dyadic predicate to fix the problem. Yet, the more fixes of this kind we need, the less is left of the original Conjunctivist intuition. If these cases of non-intersective modification were rare, this would perhaps not count as a serious problem. However, most, if not all, modifiers have such a non-intersective reading (Reichard 2013a, cf. chapter 3.3.3).¹¹ Indeed, there is evidence that adjunction is never completely symmetrical, as Conjunctivism tries to make it: a red house is a building not a colour, although red is a colour; a dog sledge is a sledge and not a dog, but a sledge dog is a dog and not a sledge. This ubiquity of asymmetry is unexpected if the basic mode of semantic composition is a symmetrical operation, like predicate conjunction.¹²

In sum, Pietroski manages to increase the coverage of the traditional Aristotelian compositional semantics by introducing functional predicates which, in effect, act as meaning shifters. Yet, the shifters themselves remain unaccounted for. This makes the approach problematic from the point of view of the questions which I have raised in section 1.2, as the respective meaning shifts are on our agenda of explananda – mere stipulation of predicates that do the job won't give the required explanation. Furthermore, in Aristotelian semantics, the standard case of combination of meaning is predicate conjunction. Yet, as we have seen, real cases of predicate conjunction are rare at best in natural languages – even the best case, the adjunction of an 'intersective' modifier, turns out to be asymmetrical. We thus have to conclude that, intellectually appealing as it is, the traditional notion of compositionality does not apply to natural languages – or if it applies, it does so only marginally. As such, it will not be of much help in explaining the unity and productivity of the meaning of natural language and propositional thought.

2.2 Atomism and Wholism

Unity problems only arise in certain theoretical conditions. They can, for example, be circumvented if the unities are taken as explanatory primitives. Yet, such a strategy is problematic as far as natural language is concerned, as taking all sentential meanings as primitives of a semantic theory is incompatible with the productivity of natural languages. In section 2.2.1, I discuss the conditions under which unity problems arise in semantics. In sections

¹¹Pietroski (2011: 490) indeed accepts that fully intersective cases may be rare: 'If [*brown_A cow_N]_N really means something like *is a cow that is brown for a cow*, there may be few if any cases of pure adjunction apart from relative clauses. But that would still leave endlessly many cases.'*

¹² I will come back to this asymmetry in chapter 6.

2.2.2 and 2.2.3 I demonstrate the problem of accounting for both unity and productivity in a discussion of Russell's atomistic and Bradley's wholistic semantics, respectively.

2.2.1 The Wholistic Strategy

Consider the relation between a circle and its segments.¹³ An *atomist* takes the segments (the parts) as ontologically prior and the whole circle as 'made up' from these segments. Accordingly, she has to explain how the segments are united to make up a unified circle.¹⁴ But it is also possible to think of the circle as ontologically prior to its segments – in this case, the segments may be treated as mere abstractions from the whole circle. If so, the segments are not combined to make up the circle, and no unity-problem arises. I call this latter kind of position '*wholism*'.¹⁵ Atomism and wholism are, then, two competing theses concerning the ontological or explanatory priority of wholes and parts.¹⁶ I will mainly be concerned with the opposition between atomism and wholism in linguistic meaning: the semantic atomist takes the meanings of sub-sentential parts as ontologically or explanatorily prior, whereas the semantic wholist takes the meanings of sentences as ontologically or explanatorily prior. According to a wholistic position about meaning, there is no need to explain how meanings combine to make up new meanings, since the wholes are primitive. The unity-problem thus does not arise. As Vallicella (2010: 267) argues in a different context: 'If sentences are primary, and taken as given, then unity is not something to be achieved or effected by a combining of pre-given subsentential parts, but something presupposed.' However, adopting such a wholistic stance in respect to

¹³ The example is introduced by Schaffer (2010).

¹⁴ Alternatively, the atomist can deny that there are wholes, ontologically speaking (e.g. Heil 2006). However, such a thesis is hard to defend in respect to linguistic meaning – as noted in chapter 1.2, sentence meanings are qualitatively different from the meanings of the sum of their parts, or so at least I shall assume.

¹⁵ A different way of drawing the distinction between atomism and wholism relies on different conceptions of parthood. According to the Aristotelian conception, it is impossible to understand the full nature of a part without reference to the whole it is a part of. The nature of a hand, for example, cannot be understood without reference to the body it is a part of. Such a conception of parthood is wholistic in that the whole is given an ontological or explanatory priority over its parts. On the alternative, nominalistic, conception, however, the nature of the hand is fully determined by its intrinsic properties. Furthermore, the body as a whole (if it is at all taken to exist as an entity in its own right) is fully explained by the parts it consists of. Such a nominalist conception of parthood entails an atomistic position. Unity problems arise only on this atomistic conception, and here only if the whole is recognized as somehow more than the sum of its parts.

¹⁶ Note that atomism in respect to one (kind of) thing is in principle compatible with wholism in respect to another. It is, for example, possible to be an atomist in respect to inorganic objects and a wholist in respect to organisms.

linguistic meaning leaves the productivity of language unexplained. As noted in chapter 1.2.1, we are capable of understanding and producing sentences and thoughts which we have never encountered before. A theory of meaning should explain this generative aspect of language and thought. And here, the suggestion of those who think of the wholes as primary to parts fails us: taking sentences as ultimate explanatory primitives seems to be incompatible with explaining the productivity of language.¹⁷

The aim of the current chapter, thus, is to show that we find ourselves in a paradoxical situation. On the one hand, generating wholes from atomic parts seems impossible. On the other hand, simply taking the whole as the primitive and its parts as abstractions from them leaves the productivity of language and thought unexplained.¹⁸ The theories of Bradley and the early Russell are good examples of wholistic and atomistic theories of meaning, respectively. I therefore devote the remainder of this section to demonstrating the trouble the analytic approach runs into with respect to unity (section 2.2.2), followed by a discussion of the problem which the wholistic semantic position of Bradley runs into with respect to productivity (section 2.2.3).

2.2.2 Russell's Atomism and the Unity of the Proposition

Analytic philosophy in Britain was borne when Russell and Moore abandoned their idealist convictions in the final years of the 19th century. Their main point of departure from the tradition consisted in their rejection of the wholism defended by Bradley and others, as well as their

¹⁷ Wholism has to be distinguished from holism (in drawing this distinction, I partially rely on Pelletier (2012)). Holism is a position which does *not*, like wholism, concern the relation between parts and wholes, but, we could say, the relation between objects on the same mereological level. A theory of meaning will be called *holistic* iff it takes the meaning of a certain expression to depend upon the meanings of all other expressions (on the same level). Thus, a theory is holistic in respect to the meanings of words, for example, if, as de Saussure (1916) claims, the meaning of a word depends upon the meaning of all other words. Such a theory is compatible with atomism, for taking the meaning of words to depend upon the meanings of all other words does not entail that the meanings of words depend in any way upon the meanings of sentences. Inferential role semantics (Brandom 1994; 2000), by contrast, is holistic on the sentence level, as according to it, the meaning of a sentence depends upon the meaning of all the other sentences of a language. In this case, holism occurs in conjunction with wholism, as inferential role semantics generally takes the meanings of subsentential parts to be defined in terms of sentential meanings. Indeed, quite often holism occurs together with some form of wholism, which is why the two notions are not always kept apart. Yet, it should be kept in mind that holism on its own is not directly relevant to questions regarding unity and productivity.

¹⁸ Indeed, as we shall see in section 2.3, the paradox arises from the demand that a theory of meaning explain productivity on its own, as productivity seems to require that things be put together, which favours an atomistic approach. Yet, our theory will only be productive in the right way if it provides us with the right complex meanings. And to explain this, we need an account of how the parts give rise to the wholes, in short, of how the parts unify.

rejection of the idealist aspect of British Idealism. At the centre of the new approach was an atomistic conception of propositions, according to which propositions were non-psychological entities¹⁹ consisting of atomic parts, such as objects, concepts and relations, all of which were taken to be real, as opposed to ideal.²⁰ Russell argues: ‘a proposition, unless it happens to be linguistic, does not itself contain words: it contains the entities indicated by words’ (Russell 1903, §51). All these parts of propositions were thought to be independent of the proposition and of each other. In a famous part of a letter to Frege from 12 December 1904, Russell writes:

I believe that in spite of all its snowfields Mont Blanc itself is a component part of what is actually asserted in the proposition ‘Mont Blanc is more than 4000 metres high’. [...] The object of a thought [...] is [...] a certain complex [...] of which Mont Blanc itself is a component part (Gabriel, et al. 1976: 250-51).

Russell took concepts and relations to be equally objective as Mont Blanc with all its snowfields. As Candlish (2007: 54) argues, ‘the motivation behind [Russell’s] unusual account of the nature of the proposition is epistemological’: if Mont Blanc was not part of the respective proposition, Russell reasons, ‘we would know nothing about Mont Blanc itself’ (Gabriel, et al. 1976: 251).

Yet, as Bradley was quick to point out, and as Russell admitted repeatedly, the atomistic conception of propositions leaves out something essential: their unity. There is a difference between the set of objects denoted by the components of the sentence *Mont Blanc is 4000 metres high* and the proposition itself. Russell writes: ‘Consider, for example, the proposition “A differs from B”. The constituents of this proposition, if we analyze it, appear to be only A, difference, B. Yet, these constituents, thus placed side by side, do not reconstitute the proposition’ (Russell 1903, §54). Yet, if the unity is taken to be a further component part of the proposition, then we end up in Bradley’s regress, as Russell notes subsequently.²¹

¹⁹ A prominent argument of Russell’s against the idealist tradition consists in identifying idealism with psychologism and pointing out that psychologism must be wrong because the psychological is private, whereas the external world is not. This argument misses the target, as the attacked theories defended an absolute idealism, according to which ideas are not private (cf. Hylton 1990, chapter 1).

²⁰ The opposition between realist and idealist conceptions of metaphysics were an important aspect of the debate between Russell and Bradley. However, this topic is irrelevant in respect to unity questions and shall therefore be disregarded in the following.

²¹ As MacBride (2011: 297) formulates the point, ‘predicates cannot simply stand for properties as singular terms stand for objects.’

Bradley had developed his regress argument already years before Moore and Russell defended their new philosophical position – and both Moore and Russell were well aware of it.²² Candlish (2007: xiv, 168) concludes from his careful analysis of the debate between Russell and Bradley that, as far as his argument against Russell’s atomism is concerned, Bradley was ‘unanswerably correct.’²³ Even Russell gave up his atomistic approach to sentence meaning in the end. So, perhaps we should follow Bradley, who used his regress argument to support his thesis that wholes are always primary and atomic parts are abstractions from these wholes.²⁴

2.2.3 Bradley’s Wholism and the Productivity of Language

In accordance with his wholistic metaphysics and semantics, Bradley insists that there is an aspect of meaning which is not reducible to any of its constituents. Thus, an analysis of a judgement in terms of its constituents is always inadequate in some sense. He writes:

This is the doctrine for which I have now for so many years contended. Relations exist only in and through a whole which can not in the end be resolved into relations and terms. ‘And’, ‘together’ and ‘between’, are all in the end senseless apart from such a whole. The opposite view is maintained (as I understand) by Mr. Russell. [...] But for myself, I am unable to find that Mr. Russell has ever really faced the question. (Bradley 1883, additional note to the second edition: chapter 2, n. 50)²⁵

Thus, according to Bradley, all terms are abstractions from complete judgements and sub-sentential expressions are abstractions from sentential ones. He argues:

²² Russell and Moore both thought very highly about Bradley’s *Appearance and Reality* when they still considered themselves idealists. Russell admits that he admired Bradley ‘more than any other recent philosopher’ and Moore says that it is to Bradley that he owes his ‘conception of the fundamental problems of Metaphysics’ (quoted in Hylton 1990: 44). Furthermore, there is a continuing debate between Bradley and Russell concerning the unity of the proposition. For example, Russell writes in a letter to Bradley from 30.1.1914: ‘I fully recognize the vital importance of the questions you raise, particularly as regards to “unities”; I recognize that it is my duty to answer if I can, and, if I cannot, to look for an answer as long as I live’ (cited in Stevens 2006: 119). See Candlish (2007) for a reconstruction and discussion of this debate.

²³ Also Vallicella (2000: 239) writes that ‘Bradley’s point is rock-solid’ (cf. also Vallicella 2002b).

²⁴ The primary concern of Bradley’s argument is metaphysical. However, Bradley (as well as the early analytic tradition) does not draw a rigid distinction between metaphysics and other fields such as logic and semantics. I am mainly concerned with the semantic application of Bradley’s argument.

²⁵ According to Candlish (2007, ch. 3), Russell actually changed sides and adopts a Bradleyan position when, responding to Wittgenstein’s criticisms, he adopts a position according to which relations are ‘unreal’ (cf. section 2.6.2). Yet, this may go too far, since, as Levine (2009) points out, ‘while Russell has changed his view of the “unity” of the proposition understood as including the issue as to how propositional thought can be either true or false, he has not changed his account of the metaphysics of complexes.’

We take an ideal content, a complex totality of qualities and relations, and we then introduce divisions and distinctions, and we call these products separate ideas with relations between them. And this is quite unobjectionable. But what is objectionable, is our then proceeding to deny that the whole before our mind is a single idea. (Bradley 1883, p. 11)

As Candlish (2007: 51) comments: for Bradley, ‘judgements were not stitched together from a gaggle of individual meanings: on the contrary, the unified judgement is the real entity, and the individual meanings are derived from it’.

The trouble with Bradley’s wholistic approach to natural language and thought is that it seems incompatible with two premises advanced in chapter 1.2.1. First, our cognitive capacities are finite but we are nonetheless capable of producing a potentially infinite number of thoughts and sentences. Language and thought, therefore, have to be systems which generate a potentially infinite number of meanings by finite means. Yet, whoever takes the wholes to be primitives, it seems, is committed to an infinite number of primitives. Second, taking the wholes to be primitives does nothing to explain the possibility of novel thoughts and novel sentences, which are so characteristic for human thought and language.²⁶ In addition, U2, the question of where the categorical changes come from when meaning is built up in a grammatical way, is also impossible to address if we accept a wholistic position: in some sense the question is deflated, as the categories of the parts are just whichever categories give rise to the category of the whole when combined. Yet, the categories of the wholes are precisely the puzzling aspect of this question (cf. chapter 4). Thus, a wholistic deflation of this problem presupposes what is to be explained and is thus in danger of begging the question. In sum, given a wholistic semantics, unity is not a problem anymore, but other central aspects of language and thought are impossible to understand.

The wholist’s problem with productivity might be taken to suggest that we should, after all, adopt an atomistic conception of semantics: only if, the argument would go, more primitive objects can make up more complex objects, an infinite number of complex expressions can be derived from a finite number of primitives; only if knowing the parts is enough for knowing the whole, novel complex meanings can be understood and generated. Assuming a finite number of

²⁶ It should be noted in this respect that the British Idealists would probably have disputed the coherence of the requirement of productivity. If, as Bradley claims, reality is the experience of an absolute mind and our finiteness consists in the fact that our minds are only partial vehicles of the absolute mind, then the finiteness of our cognitive capacities in conjunction with the potential infinity of thoughts or sentences it can produce and comprehend cannot be taken as an argument for the productivity of our mental/cognitive capacities.

primitives and a finite number of rules of combination can give rise to a potentially infinite number of complex expressions, if some rules of combination can be used recursively.

However, the atomistic alternative is not better off in respect to explaining the productivity of language and thought without an account of how the atoms combine: in order for the atomist's explanation of productivity to work, the atomist has to tell us how the atoms combine in the first place, giving rise to new meanings of the right kind. What Bradley's regress shows is precisely that it is impossible to explain this unity by (purely) atomistic means.

We, thus, find ourselves in a paradoxical situation: accounting for the unity of linguistic meaning seems to suggest a wholistic approach, but wholism, as conceived above, is incompatible with the productivity of the linguistic domain. Atomistic approaches, on the other hand, seem well suited to account for productivity – yet, they face the problem of accounting for unity. And lacking an account of how atoms combine, also productivity remains unexplained.

In the remainder of this chapter, I argue that the most well-known semantic frameworks do not escape the duality between atomism and wholism. Often, there are several ways of interpreting such frameworks; yet, as I shall argue, none of the interpretations is able to explain both unity and productivity. In section 2.5, I then outline a possible way of overcoming the duality. The potential of this suggestion will be explored in chapters 3-6.

2.3 Functional Compositionality

The mathematical conception of compositionality is standardly defined in terms of functions: according to Partee (1984: 281), for example, the meaning of a compound expression is derived compositionally if it 'is a function of the meanings of its parts and the way they are syntactically combined.' The generalized notion of functions which the mathematical definition of compositionality relies on goes back to Frege and Carnap. In current formal semantics, functions are usually understood as relations or processes which map things to other things – where 'thing' is understood in the most general sense (e.g. Partee, et al. 1990). The function $x+1$, for example, maps numbers to other numbers, the function *the capital of x* maps countries to cities, and the function *x is bald* maps people to truth-values. The main point I want to make in this chapter is that functions don't tell us anything about how parts give rise to wholes (cf. Jespersen 2012: 620-21). As Hodges (2012: 248) emphasizes, in standard functional frameworks, 'compositionality doesn't assume that meanings [of complex expressions] have parts.' This is not to deny that the values of functions can be complex in, say, a metaphysical sense. But as far

as the semantic theory is concerned, they are taken as primitives. Thus, their complexity (and hence unity) is not explained by the semantic theory, but has to be presupposed or accounted for independently.

To be sure, this is problematic only under the demand that semantic theories have to provide an account of the productivity of language. The productivity of language has been motivated with reference to aspects of our cognition: we can understand and comprehend novel expressions with meanings we have never encountered before and we are finite beings who nonetheless are able to understand an infinite number of complex expressions with distinct meanings. Thus, that unities are taken as primitives in semantic theories is problematic only if these theories are constrained by cognitive facts. In contrast, formal semantic theories have been significantly influenced by the anti-psychologistic movement in philosophy. Montague (1974), for example, thinks of semantics as a sub-discipline of mathematics, which, as such, is independent of our cognition. Thus, showing that a Montagovian theory, for example, does not meet cognitive constraints is not a genuine argument against the theory. Nonetheless, what I want to show is not that formal semantic theories are not well equipped to do what they have been designed to account for, but merely that they cannot answer the question which I am concerned with – and this is (at least in part) a cognitive or psychological question. Still, the following considerations should not be too alien to the accounts discussed, given that many recent semanticists have followed the urge to integrate cognitive constraints into their research.²⁷

In the following, I discuss several ways of defining functions, arguing in each case that, on the respective definitions, functions either fail to account for the unity of meaning or are in conflict with the productivity of natural language. I begin with a discussion of explicit definitions of functions (section 2.3.1). I then turn to implicit definitions of functions (section 2.3.2). In section 2.3.3, I discuss the possibility of defining functions with the help of abstraction.

2.3.1 Explicit Definitions of Functions and Productivity

Functions can be defined explicitly as in (2). According to (2), *the father of x* denotes a function which returns James when applied to John, John when applied to Mary, etc.

²⁷ Cf. e.g. the influential textbooks by Larson and Segal (1995) and Heim and Kratzer (1998).

$$(2) \quad [[\text{the father of}]] = \left[\begin{array}{ll} \text{John} & \rightarrow \text{James} \\ \text{Mary} & \rightarrow \text{John} \\ \text{Socrates} & \rightarrow \text{Sophroniskos} \\ \vdots & \end{array} \right]$$

On this definition, the values of functions are not ‘made up’ from the function and its argument. Rather, all possible values of a function are already explicitly mentioned in the definition of the function. For this reason, questions concerning unity do not arise: the values of the function are already unities, they don’t have to be ‘created’ by combining function and argument.

However, this kind of definition leaves the productivity of language unaccounted for. *First*, our knowledge of the meaning of *father* is productive in the sense that if we get to know a new object, say Annette (that is, if Annette is introduced into the domain), we know immediately what *the father of Annette* means (even though we may, of course, not know who the father of Annette is). Yet, the above definition does not predict this. In a model containing (2) as an axiom, we would have to replace (2) by a function which includes the line *Annette* \rightarrow *Bob*, if we were to allow Annette as a new entity into the domain. *Second*, it is possible to generate an infinite number of expressions with distinct meanings by applying the predicate *the father of x* recursively. The meaning of *the father of Mary* is different from that of *the father of the father of Mary*, which in turn is distinct from the meaning of *the father of the father of the father of Mary* and so on. An explicit definition can capture this potential infinity only if it contains an infinite number of mappings of people to their fathers. However, as argued in chapter 1.2.1, the reason for why the unity problem is particularly problematic in respect to language is that speakers are finite and that they therefore cannot memorize an infinite number of meanings. By the same argument, they cannot be taken to memorize infinitely long definitions. Hence, if a semantic theory is supposed to be a theory of how speakers know facts about meaning, definitions like that in (2) cannot be part of it.²⁸

2.3.2 Implicit Definitions of Functions and Unity

It might be hoped to circumvent this problem by defining meanings not explicitly but implicitly, that is, with the help of a condition formulated in a metalanguage. Using the lambda-calculus,

²⁸ Neither of these two problems is solved by replacing the extensional definition by an intensional one – at least not as long as intensionality is treated in ways standard in the formal semantic tradition. Following Carnap (1947), we may analyze intensions in terms of functions from possible worlds to extensions (or, equivalently, in terms of sets of possible worlds). But, in this case, the definitions of predicates become even longer than their extensional counterparts.

the function *the father of x* may thus be defined as follows (taking it as a single predicate that maps entities to entities, that is, taking it as a function of type $\langle e, e \rangle$):

$$(3) \quad [[\text{the father of}]] = \lambda x \text{ the father of } x$$

It is clear that this definition does not face the problems discussed in respect to (2) – at least not directly: This definition does not specify the value for every possible argument; hence it can be applied to any argument of the right type. Therefore, novelty and infinity can be accommodated without infinitely long definitions. Assuming an appropriate syntax, taking concatenation to signify function application and given (4), the meaning of *the father of Annette* can be calculated as in (5). The predicate can also be applied recursively, as in (6).

$$(4) \quad [[\text{Annette}]] = \text{Annette}$$

$$(5) \quad [[\text{the father of Annette}]] = [[\text{the father of}]]([[\text{Annette}]]) \\ = \lambda x \text{ the father of } x (\text{Annette}) = \text{the father of Annette}$$

$$(6) \quad [[\text{the father of the father of Annette}]] \\ = [[\text{the father of}]]([[\text{the father of}]])([[\text{Annette}]]) \\ = \lambda x \text{ the father of } x (\lambda y \text{ the father of } y (\text{Annette})) \\ = \lambda x \text{ the father of } x (\text{the father of Annette}) = \text{the father of the father of Annette}$$

A semantic theory that includes implicit definitions of functions can, thus, account for the productivity of linguistic meaning. But, unfortunately, no explanation of the unity of linguistic meaning emerges. The problem is that, in the derivations above, we have not explained how meanings combine. Instead, we have used the implicit definition to derive another complex. We thus try to explain the unity of a complex with the help of another such complex, related to it in a systematic way. However, the unity of the complex used in the explanation is not better understood than the unity to be explained. In effect, we have simply replaced one puzzle by another puzzle of the very same kind, which is not particularly enlightening.

In other words, what we have achieved with the help of these definitions and function application is essentially a way of systematically translating complex expressions of an object language into a metalanguage. But whether or not the expression generated is a unity or not depends upon whether we understand the metalanguage-expression as a unity or not. Unity, then, depends upon how we understand the metalanguage and not on the mechanics of the theory which derives the translation. The unity of meaning therefore remains unexplained by the semantic theory. Implicit definitions, then, are of little help in explaining the unity of linguistic meaning.

In sum, when defined explicitly, functions do not face a unity problem, but remain incapable of accounting for productivity. When defined implicitly, their values are complexes. In this case they can account for productivity, but do not explain unity. The widespread assumption that unity problems can be solved with the help of functions may, thus, rest on an equivocation of implicitly and explicitly defined functions.

Nonetheless, the translational account gets us further than any other approach discussed so far: it explains one aspect of productivity and, even though unity remains unexplained, it is at least compatible with it. The reason for this is that the unity of meaning has to do with the meaning of syntax: that *the father of Annette* has a unitary meaning is due to the fact that *the father of* and *Annette* stand in a certain syntactic relation. When the meaning of *the father of Annette* is given in the metalanguage, the meaning of the syntactic relation in the object language is part of the syntax of the metalanguage. On the one hand, the translation does nothing to explain how the syntax ‘brings it about’ that two meanings become one. Still, it emphasizes that the syntactic (or structural) aspect of the meaning of a sentence cannot be analyzed in lexical (or non-structural) terms. I come back to this insight in section 2.5.

2.3.3 Deriving Functions by Abstraction: A Dilemma

A popular strategy of circumventing unity problems is to think of the meanings of sub-sentential expressions as abstractions from the meanings of complete sentences. This strategy is closely associated with Frege, who proposes: ‘Instead of putting a judgement together out of an individual thing as subject and an already previously formed concept as predicate, we do the opposite and arrive at a concept by having the judgeable content fall into pieces [zerfallen]’ (1880-1881: 18). There are two ways of interpreting this principle. The first interpretation is radically contextualist and incompatible with productivity; the second is less radical and accounts for productivity, but fails to provide an account of unity.²⁹

According to the first interpretation, the meaning of a predicate is relative to the particular sentence in which it occurs. Hence, the same predicate (e.g. *sits*) may have different meanings in different sentences (e.g. *sits* in *Peter sits* may not mean the same as in *John sits*). For this reason,

²⁹ In parallel, there are two interpretations of Frege’s ‘context principle’: ‘never ask for the meaning of a word in isolation, but only within sentential context’ (Frege 1884: X, translation modified). Here ‘sentential context’ can either be understood as the context of the particular sentence in which the word occurs (which is the interpretation suggested by the original English translation). Alternatively, ‘sentential context’ can be understood as generic, in which case the ‘context principle’ asserts that the (syntactic) role which a word plays (or can play) in a sentence is an aspect of its meaning. Cf. chapter 3.1.3 for further discussion.

all sentences have to be taken as primitives. If so, questions regarding unity do not arise, since the unities are primitives of the semantic theory. Yet, productivity remains unexplained.

The second interpretation still assumes that the meanings of predicates are abstracted from the meanings of sentences, but insists that a predicate has the same meaning in all sentences in which it occurs. Thus, the meaning of *sits* arrived at by abstraction from *Peter sits* is the same as that arrived at by abstraction from *John sits*.³⁰ If so, it may be possible to assemble abstracted word meanings in novel ways, thus accounting for productivity. The meaning of *sits*, for example, abstracted from *Peter sits* can be put together with the meaning of *John* to make up the meaning of *John sits*, even if we have never encountered the meaning of the sentence *John sits* before. Yet, in this case, the theory does not answer the question of how the meanings of *John* and *sits* are united in the sentence *John sits*. To be sure, if the meanings of sub-sentential expressions are abstracted from sentential ones, we can be certain that they fit perfectly together. But fitting together does not imply forming a unity – as discussed in section 1.2.2, although *John* and *sits* are as if made for each other, they can, in principle, be understood as forming a mere list, in which case they have an aggregate of the meanings of the two expressions as a meaning (if they have a common meaning at all), not a unified proposition.³¹

Frege is ambivalent in respect to which of the two interpretations he adopts. Possibly, it is this ambivalence which makes his view attractive at first sight. On the one hand, since Frege regards psychological contingencies as unimportant for semantic theory, it is unclear why Frege should want to account for the productivity of meaning. Thus, even in *Gedankengefüge*, which is often cited as the origin of the productivity argument for compositionality, Frege (1923a: 6, translation modified) asserts that ‘a thought does not come into being’, and that ‘we talk allegorically [*in einem Gleichnisse*] when we transfer the relation of whole and part to thoughts’ (Frege 1923b: 378; translation slightly modified from Frege 1923a: 1). This suggests that for Frege, strictly speaking, thoughts are primitives.³² Hence, unity is unproblematic, but productivity remains unexplained (cf. Janssen 2001; 2012 for discussion). On the other hand,

³⁰ It should be noted that such a thesis presupposes what Fodor and Lepore (2001: 59) call ‘reverse compositionality’: the full meaning of a word has to be derivable from every sentence in which the word features – not a trivial constraint at all.

³¹ A final possibility of thinking of the meanings of predicates as abstracted from the meaning of sentences is to assume that the meaning of a predicate is abstracted from all possible sentences in which it can occur. Yet, it is immediately obvious that in this case, an infinity of sentences will have to be taken as primitive and productivity remains unexplained.

³² Candlish (2007: 52) argues that in this respect, Frege’s view is essentially equivalent to Bradley’s, with the only qualification that ‘Frege’s own view is [...] less extreme than Bradley’s, since he thought that some parts of thoughts are saturated.’

Frege often talks as if word meanings could be combined into sentence meanings, once they are derived by abstraction. He writes, for example, that functions ‘arise simultaneously with the *first* judgement in which they are ascribed to things’ (Frege 1880-1881: 19, my emphasis). This suggests that they are then at hand and can also be applied in other judgements.

To conclude, when functions are explicitly defined, the values of functions are primitives of the semantic theory, which makes it impossible to use such definitions in order to account for the productivity of language. In contrast, if functions are defined implicitly, they can explain the productivity of language, but fail to provide an account of the unity of meaning. Thinking of functions as abstracted from the meanings of sentential expressions does not overcome the dilemma, since either all sentences have to be taken as primitives, which leaves productivity unexplained; or else, it has to be possible to combine meanings in novel ways after they have been derived by abstraction, in which case an account of how they are unified has to be added.

Implicit, recursive definitions have been developed and popularized by Tarski (1936a). Tarski employed them most notably in his definition of truth. His aim was not to develop a theory of the unity of meaning; the conclusion that his notions are not of any help in solving this problem, then, does not diminish his achievements. Yet, given these results, it is surprising that Davidson (2005) claims prominently that Tarski (1936a) has essentially solved the unity problem. In order to do justice to these claims, I now turn to Tarski’s definition of truth, and to the way in which Davidson hopes to employ it in his account of the unity of meaning.

2.4 Turning Tarski Upside Down: Truth-Conditions and Unity

For Davidson, the unity problem was one of the central motivations for developing his truth-conditional semantics.³³ Bradley’s regress is mentioned already on the first page of ‘Truth and Meaning’ and features prominently in Davidson’s last work *Truth and Predication*, where it is discussed under the title ‘the problem of predication’.

Consider again what gives rise to Bradley’s Regress: Beginning with the assumption that both the predicate and its argument contribute a meaning to the meaning of a sentence, we face

³³ The credibility of Davidsonian truth-conditional semantics is still a matter of debate (see Lepore and Ludwig 2005, Part I for an overview; and Lepore and Ludwig 2007 for a recent formal theory in the Davidsonian tradition; more recent criticisms can be found in Soames 2008; 2010b, ch.3; see Lepore and Ludwig 2011 for a reply; for a different line of critique see Horwich 2008; for recent discussion see also the articles in Preyer 2012). In the following, I will not be concerned with the question of whether truth-conditions provide a good foundation for semantics. My only concern is Davidson’s proposed solution to the unity problem.

the question of how the two meanings are related. It seems that a relation is needed as a third meaning. Yet, what relates the relation with the two original meanings? We seem to need a fourth meaning for this job, and so on ad infinitum. Davidson attempts to stop the regress right at the start. He proposes that predicates don't contribute 'meanings' to the meaning of the whole – at least not meanings which are on a pair with the meanings of their arguments.³⁴ The problem is to spell out in what sense predicates don't contribute meanings on a pair with the meanings of arguments. As Davidson (2005) stresses repeatedly, it is not enough to assume that the meanings of predicates are of a different ontological category than those of their arguments – it is, for example, not sufficient to assume that the meanings of predicates are properties (or other kinds of entities exhibiting generality), whereas the meanings of singular terms are objects; for, in that case we face the question with which we started: How are object and property related?

Davidson's strategy is to avoid ontological commitments to predicate meanings altogether by developing a way in which meanings of predicates can be defined in terms of an absolute notion of truth. Singular terms (if there are any) have their meaning in virtue of referring to some objects or events. Predicates, however, don't refer to abstract or any other kinds of objects; rather they are defined in terms of which entities they are true of. Thus, when combining predicates and their arguments, we don't conjoin entities. Davidson argues that by this move, Bradley's regress can be avoided.

In sections 2.4.1-2.4.3 I spell out and discuss Davidson's account in some more detail. Since Davidson's theory of predication is based on Quine's interpretation of Tarski's definition of truth, I devote the first two sub-sections to a brief discussion of Tarski and Quine respectively, before turning to Davidson in section 2.4.3. In sections 2.4.4-2.4.6, I discuss three objections to Davidson's theory. I defend the theory against two of them, but I accept the third one.

2.4.1 Tarski's Semantic Definition of Truth

Tarski begins his definition of truth by formulating *Convention T* as a criterion of the material adequacy of any definition of truth for any language (Tarski 1936a: 187-88): *x is a true sentence*

³⁴ Also Tugendhat (1976: 176) suggests giving up predicate reference in order to solve the unity problem. A somewhat similar strategy has recently been outlined by Peacock (2012: 11), who argues:

If we can find a way to reinterpret what a theory of relatedness commits us to, in such a way that we no longer have to account for the relatedness of *a*, *R* and *b* by positing a further relation in which these three entities stand, then the problem is solved: if there is no further relation in which *a*, *R* and *b* stand, then there is no reason to construe *R*'s role as that of 'just another term.'

Furthermore, Wiggins (1984: 318) proposes avoiding Bradley's Regress by assuming that the copula, which he takes to be responsible for sentential unity, lacks reference.

in L if and only if p . In this schema, L has to be replaced by the language for which the truth predicate is defined, x has to be replaced by a structural description of a sentence and p by the translation of this sentence into a metalanguage.

Tarski shows how to employ recursive definitions in order to define truth predicates for particular languages that contain an infinite number of sentences.³⁵ The central semantic notion which Tarski relies on for his definitions is the *satisfaction of a given sentential function by sequences of objects*. Which (sequences of) objects a predicate is satisfied by is defined axiomatically. Since sentences do not contain any free variable, true sentences are satisfied by all (sequences of) objects, whereas false sentences are satisfied by none. Thus, the truth predicate for a particular language can be defined in terms of satisfaction.

A theory of truth of the Tarskian kind satisfies Davidson's main criterion for a theory adequate to solve the problem of predication, since it 'does not explain the function of predicates by relating them to particular entities which somehow embody generality' (Davidson 2005: 156). However, satisfaction relations are standardly interpreted in set-theoretic terms. Yet, as Davidson stresses, a set-theoretic interpretation of satisfaction is of no use in explaining predication: it only allows us to replace, for example, the sentence *Socrates sits* by the sentence *Socrates is a member of the set of seated objects*. Since this sentence contains itself a predicate (*is a member of the set of seated objects*), no account of predicate meaning emerges (Davidson 2005: 158). Davidson, therefore, aims to provide an alternative interpretation of satisfaction, which does not itself presuppose predication.

2.4.2 Quine's Theory of Predication and Truth

The key to Davidson's solution to the problem of predication is that Tarski's definition of truth can be reversed. Thus, instead of saying that objects satisfy a predicate, we can also say that a predicate is true of objects and vice versa: if *Socrates* satisfies the predicate x *sits*, then the predicate x *sits* is true of *Socrates*; and if the predicate x *sits* is true of *Socrates*, then *Socrates* satisfies the predicate x *sits*. Davidson (2005: 34) argues:

Which of the two semantic concepts, satisfaction or truth, we take as basic is, from a formal point of view, open to choice. Truth, as Tarski showed, is easily defined on the basis of

³⁵ The technically simplest way of providing a definition which satisfies *Convention T* would be a conjunction of the T-sentences of all sentences of a certain object language. However, 'whenever a language contains infinitely many sentences, the definition constructed automatically according to the above scheme would have to consist of infinitely many words, and such sentences cannot be formulated either in the metalanguage or in any other language' (Tarski 1936a: 188-89).

satisfaction; but, alternatively, satisfaction can be taken to be whatever relation yields a correct account of truth.

This interpretation of Tarski's theory goes back to Quine, who distinguishes between general and singular terms with the help of the distinction between expressions that refer to objects (or at least purport to do so) and expressions which are true of objects:

Semantically the distinction between singular and general terms is vaguely that a singular term names or purports to name just one object, though as complex or diffuse an object as you please, while a general term is true of each, severally, of any number of objects. (Quine 1960: 90-91)

By understanding predicates not in terms of reference to some entity or other but as expressions which are true of objects, according to Davidson, Quine avoids the infinite regress associated with the problem of predication. However, 'this cannot be called a full account of the role of predicates. Its merit is negative: it does not invite a regress' (Davidson 2005: 114). The problem of Quine's account of predication is his deflationist attitude towards truth (Davidson 1996). Quine often emphasizes the 'disquotational' character of truth. In *Word and Object*, he argues: 'To say that the statement "Brutus killed Caesar" is true, or that "The atomic weight of sodium is 23" is true, is in effect simply to say that Brutus killed Caesar, or that the atomic weight of sodium is 23' (Quine 1960: 24). This deflationist aspect of Quine's theory makes his account of predication circular: predication is understood in terms of satisfaction. Satisfaction is defined in terms of truth (predicates are true of objects). But, conversely, there is nothing more to be said about truth than Tarski said; hence, truth is understood in terms of satisfaction. Bradley's regress is avoided, but we end up in a circle between truth and satisfaction.

2.4.3 Davidson: A Primitive Notion of Absolute Truth

Davidson tries to avoid the circle between truth and predication by treating an absolute notion of truth as ultimately primitive. He writes:

It will be noted that I explained satisfaction in terms of truth. If I were out to define truth, this would be circular. But defining truth is not my aim, for it cannot be done. I was not defining but *using* the concept of truth, which, however beset by paradox, is the clearest and most basic semantic concept we have. What my strategy amounts to, then, is to show how our grasp of the concept of truth can explain predication. (Davidson 2005: 160-61)

Tarskian definitions of truth can only be given relative to particular languages.³⁶ Therefore, they cannot be used to define the absolute notion of truth. Nonetheless,

unless we are prepared to say there is no single concept of truth (even as applied to sentences), but only a number of different concepts for which we use the same word, we have to conclude that there is more to the concept of truth, something absolutely basic, which Tarski's definitions do not touch. (Davidson 2005: 18)³⁷

The undefinable general concept of truth can, however, be used to define Tarskian language-relative truth-predicates. With the help of Quine's reversal of Tarski's definition of truth, the Tarskian truth-predicate of a particular language L can then be used to define the satisfaction conditions of the predicates of L. Thus, although Tarski's definitions may not tell us much about our general notion of truth, it 'may legitimately be treated as conveying substantive truths about a language' (Davidson 2005: 2).³⁸ In this way 'what does emerge is a *method* for specifying the role of each and every predicate in a specific language; this role is given by a non-recursive

³⁶ The metalanguage in which the definition is formulated always has to be richer than the object language for which the truth-predicate is defined, since a language that contains its own truth-predicate and is in other respects semantically strong enough gives rise to semantic paradoxes like the Liar.

³⁷ There is textual evidence that Tarski did not abandon such a general notion of truth himself. Tarski explicitly says that the goal of his inquiry is to provide a satisfactory definition of the traditional understanding of truth: 'The desired definition does not aim to specify the meaning of a familiar word used to denote a novel notion; on the contrary, it aims to catch hold of the actual meaning of an old notion' (Tarski 1944: 341). Furthermore, he regards 'the truth of a sentences as its "correspondence with reality"' (Tarski 1936b: 404). And when he complains about traditional definitions of truth that 'none of them can be considered a satisfactory definition of truth', he concludes that 'it is up to us to look for a more precise expression of *our intuitions*' (Tarski 1944: 343, my emphasis). Moreover, *Convention T* is supposed to ensure that a Tarskian definition of truth has the same extension as our intuitive concept of truth when applied to a particular language: we recognize as true all sentences of the form of *Convention T*, since it defines the extension of the intuitive concept of truth when applied to a given language. In this sense, Tarski insists that *Convention T* is both 'materially adequate and in accordance with ordinary usage' (Tarski 1936b: 404). Finally, Tarski writes: 'We should like our definition to do justice to the intuitions which adhere to the classical Aristotelian conception of truth – intuitions which find their expression in the well-known words of Aristotle's *Metaphysics*' (Tarski 1944: 342, Tarski refers to Aristotle *Met.* 1011b). And Aristotle seems to stand here both for the philosophical tradition and for our common sense notion of truth.

³⁸ Against the deflationist tradition about truth Davidson thus insists that there is a general notion of truth which cannot be defined in terms of Tarski's definition: 'There must be more [to truth than Tarski's definitions reveal] because there is no indication in Tarski's formal work of what it is that his various truth predicates have in common, and this must be part of the content of the concept' (Davidson 2005: 27). However, against many substantialists about truth (e.g. Black 1949; Tugendhat 1960; Dummett 1978), Davidson insists that this does not make Tarski's definition philosophically uninteresting, since it plays an important role for semantics. Indeed, according to Davidson, 'Tarski wasn't trying to define *the* concept of truth – so much is obvious – but that he was *employing* that concept to characterize the semantic structures of specific languages' (Davidson 1996: 26).

axiom which says under what conditions it is true of any number of entities taken in the order in which its blanks occur' (Davidson 2005: 161).³⁹

To conclude, Davidson inherits from Tarski's theory that the meaning of predicates is not defined in terms of (abstract) entities which predicates refer to. According to Davidson, Bradley's regress does therefore not arise. Davidson also maintains that his account provides an explanatory account of the meanings of predicates. In respect to such an explanation, Tarski's theory faces the problem that the meaning of predicates is defined in terms of satisfaction, which, according to the standard interpretation, is understood in terms of sets of objects. Since sets of objects are themselves objects (or at least very object-like), Bradley's regress is lurking again. This can be avoided by thinking with Quine of predicates as being true of whatever satisfies them. But since Quine understands truth in terms of Tarski's definition and hence in terms of satisfaction, the account does not yet advance much on Tarski's original one: the basic notion, satisfaction, still remains undefined, and the account thus unexplanatory. In order to solve this problem, Davidson suggests taking a substantive notion of truth as a primitive, such that, using Quine's understanding of predicates, satisfaction can be defined in terms of it. The upshot of the argument can be seen in the claim that what makes Tarski's definition of truth a definition of *truth* in a particular language, as opposed to any other predicate of that language, is the fact that *Convention T* assures the co-extensionality of it with the general concept of truth. Hence, the general concept of truth is presupposed in any Tarskian definition of truth.

2.4.4 Are Davidsonian Predicates Referential, After All?

Does Davidson solve the unity problem? Amongst the few who discuss Davidson's account of predication, there is a general tendency towards the conclusion that he does not – although the reasons given vary. In my discussion of three challenges to Davidson's theory (sections 2.4.4-2.4.6), I defend Davidson against the first two, but argue that his theory cannot answer the third.

Gaskin (2008: 415) complains: 'Davidson's proposal [...] is, considered objectively, hard to make sense of as a solution to the problem of unity.' Gaskin doubts that the Quinean interpretation of Tarski avoids assigning reference to predicates: 'what you have said, in saying that predicates are true of objects, *becomes* your account of predicate reference.' For, 'Quine is [...] in effect an adherent of the *suppositio* school of thinking about reference, according to which the extension of a predicate *is* its referent' (2008: 417). Quine, then, is committed to

³⁹ Hrachovec (2008) criticizes that, with this move, Davidson abandons the 'grand perspective he started with' in favour of a narrow, technical solution.

predicates having reference. ‘Far from *avoiding* referents for predicates, Tarski and Quine simply give us *alternative candidates* for that referential status’ (Gaskin 2008: 418).

However, it is not necessarily a problem for Davidson if predicates have reference: what Davidson requires is that the referent of a predicate does not play a role in respect to the meaning of the complex phrase, not that there be no referent: if it is not the referent which the predicate contributes towards the meanings of the wholes in which it features, Bradley’s regress does not arise. Thus, no harm is done by assigning referents to predicates, as long as they don’t play a role in the meaning of the wholes. Davidson (1967c: 21; cf. 1963: 319-20) argues: ‘My objection to meanings in the theory of meaning is not that they are abstract or that their identity conditions are obscure, but that they have no demonstrated use.’ What Davidson means by ‘meanings’ are primarily Carnapian intensions (cf. Davidson 1963). Yet, Davidson is free to use the same argument in respect to extensions:

There can be no doubt that Tarski’s truth definitions [...] clearly distinguish between the issue whether properties and other abstract entities exist and the semantic role of predicates. Of course, if some (second-level) predicates are true of abstract objects, those objects must exist, but their existence does not explain the role of such predicates. (Davidson 2005: 158)

Thus, the central aspect of Davidson’s proposal is not whether or not predicates have reference, but that predicates don’t contribute referents to the meanings of sentences. He aims to ensure this by defining predicate in terms of truth. Yet, by emphasizing the central role which truth plays for Davidson in defining the meaning of predicates, the question arises how Davidson can account for the productivity of language.

2.4.5 Radical Interpretation and Productivity

Davidson says repeatedly that the meanings of any word can be given only as an abstraction from a whole language (e.g. Davidson 1967c: 22). Yet, if the meanings of single sentences and words are abstracted from the language as a whole, productivity remains unexplained, as Collins (2011b) emphasizes repeatedly.

However, productivity is clearly part of Davidson’s overall theory. For example, in ‘Truth Rehabilitated’ he argues, after discussing how lexical items are acquired: ‘Once some grammar is in hand [...], separately learned parts can be assembled in new ways’ (Davidson 1997c: 15).⁴⁰

⁴⁰ Similarly, in his theory of radical interpretation (Davidson 1973), the interpreter is supposed to be able to use the limited evidence she gets from the behaviour (linguistic and otherwise) of the observed to create a semantic theory that makes predictions for novel cases. These predictions can then be used as empirical tests for the semantic theory. Yet, this again presupposes that the semantic theory is productive.

If so, the meanings of lexical items have to be richer than what can be achieved by abstraction from a finite number of sentences. The question is: why can we get more out of abstraction than goes in? How, for example, do we get from knowing that a particular object is a table to the general concept *table* which applies to all actual and possible tables, not only a particular one? For Davidson, the answer to this question is not an aspect of his semantics, but of his overall theory of interpretation in which his semantics is embedded.

According to Davidson (1992: 120), an aspect of language learning is that ‘the teacher [...] is training the child to make similar responses to what he (the teacher) perceives as similar stimuli’: the learner, for example, has to learn to classify all and only tables under the phonological label /teibl/.

Involved in our picture there are now [...] three similarity patterns. The child finds tables similar; we find tables similar; and we find the child’s responses in the presence of tables similar. It now makes sense for us to call the responses of the child responses to tables. (Davidson 1992: 119)

However, ‘for this to work, it is clear that the *innate* similarity responses of child and teacher – what they *naturally* group together – must be much alike’ (Davidson 1992: 120, my emphasis). In this sense, our ‘prelinguistic’ and ‘precognitive’ discriminative abilities ‘constitute a necessary condition for thought and language, a condition that can exist independent of thought, and can therefore precede it’ (Davidson 1997a: 128). ‘If some such discriminative mechanisms were not in our genes, none could be learned’ (Davidson 1992: 118); they have to be ‘wired in’ (Davidson 1997a: 128). In sum:

We can imagine a sort of proto-ostension [...] that allows us to get more out of ostension than goes into it. In this elementary situation we can study some of the necessary conditions for the development of thought and language. These include the fact that all people generalize naturally in much the same ways. [...] Before there can be learning there must be unlearned modes of generalization. Before there can be language there must be shared modes of generalization. (Davidson 1997b: 140; cf. 1991: 212; 2001: 134).

For Davidson, the productive aspect of language is then ultimately rooted in our innate discriminative abilities, that is, in our biology. For this reason, his semantic theory, which is explicitly non-biological, does not have to account for it.

2.4.6 Unity Remains Unexplained

If Davidson’s theory is not wholistic in the sense of presupposing all possible sentences of a language as primitives, the question arises how the meanings that individual parts contribute

towards the meaning of wholes combine, so as to make up the meaning of the wholes. Davidson's suggestion, as summarized above, is that this question is not problematic as long as predicates don't add ontological commitments to (abstract) objects to the meanings of sentences (or at least, it is not these objects which predicates contribute to the meanings of sentences). Yet, is Davidson right? It seems that he is not: as Gaskin argues at length (cf. section 1.2.2), unless every sentence is taken as a primitive, sentences can in principle be 'duplicated' by lists of the very same expressions which make up the sentence. This is independent of what we take the meaning of predicates to be. Let the meanings of *Socrates* and *sits* be specified as in the axioms in (7) and (8). With their help, in addition to universal quantifier instantiation, we can calculate that *Socrates sits* is true iff Socrates sits, which is the right result.

- (7) *Socrates* is true of Socrates
 (8) $\forall a x$ *sits* is true of a iff what satisfies a sits

However, this does not preclude the possibility of a list consisting of *Socrates* and *sits* with their respective meanings. In this sense, Davidson faces the same problem as a Fregean who thinks of the meanings of predicates as abstracted from the meanings of wholes but as recombining with new singular terms (cf. section 2.3.3). In order to distinguish the meaning of the list from the meaning of the sentence, we have to treat universal quantifier instantiation as contributing meaning to the meaning of the whole. But then we face the question of what connects the meaning contributed by universal quantifier instantiation with the meaning contributed by the two axioms in (7), and we are back in Bradley's regress.⁴¹

We could, of course, understand the axioms of a truth-theory as a mechanical device of generating truth-conditions given the input of two or more expressions (cf. Sainsbury 1996). Yet, as in the case of indefinitely defined functions discussed in section 2.3.2, in this case unity is again not explained. Object language sentences are merely mapped into a metalanguage expression. Unity, then, is due to the way the metalanguage expression giving the truth-conditions are understood, rather than being a feature of the theory itself. Yet, in this case, the problem is only pushed back one step, rather than solved.⁴² But only pushing back the question cannot be Davidson's aim, as is clear from his (1997b) rejection of a language of thought.⁴³

⁴¹ As Wiggins (1997, p. 13) also argues: 'From a standing start, we cannot [...] explain in [Tarskian] terms what distinguishes a sentence from a mere list.'

⁴² Davidson argues repeatedly that truth-conditions are not the meanings of natural-language expressions but are a way of specifying the meaning of them (or, if Lepore and Ludwig (2005) are right, they are even less – they are only ways of generating specifications of meanings). Davidson insists that we, therefore,

In sum, Davidson argues that Bradley's regress can be avoided if we find a way of defining the meaning of predicates in such a way that they don't contribute additional entities towards the meaning of the wholes in which they figure. He proposes that Quine's understanding of Tarski's definition of truth can be used to define predicates in the required way, if an absolute and unrelativized notion of truth is taken as primitive. Despite the wholistic character of Davidson's semantics, he is able to accommodate the productivity of language: it is our pre-linguistic biological makeup which (once language is in place) allows us to form concepts that can be applied in novel ways. Yet, given the productive aspect of Davidson's overall theory, we would like to know how meanings combine. I have argued that Bradley's regress arises quite independently of what kind of meaning we assign to predicates – as long as we think of the meanings of predicates as combined with the meanings of their arguments, we have to answer the question how they are so combined and inevitably face the regress. Alternatively a Davidsonian truth-theory may be taken as a way of translating a sentence into a metalanguage expression. Yet, in this case, unity is due to the understanding of the metalanguage and not explained by the theory. Hence, the approach only works if we have an independent account of unity.

2.5 Can Unity and Productivity be Reconciled?

I begin this section with a brief summary of the main findings of the present chapter (section 2.5.1). In section 2.5.2, I review the prospects of solving the unity problem by thinking of propositions in terms of pictures (as Wittgenstein did in the *Tractatus*) or mental images (as the late Russell proposed). I argue that these prospects are dim. Yet, in section 2.5.3, I suggest that the intuition behind the picture theory is promising if it can be made to work for the case of

do not need to have propositional knowledge of truth-conditions in order to understand a sentence. Rather, truth-conditions are a way of modelling what we understand when we understand an expression correctly. Davidson (1994: 113) argues: 'The point is not that speaker or hearer has a [semantic] theory [with the help of which she interprets what is said], but that they speak and understand in accord with a theory – a theory that is needed only when we want to describe their abilities and performance.' It might be thought that a similar point applies to my critique of the strategy of defining the meanings of predicates with the help of a description in a metalanguage. But this is not the case: whatever the status of truth-conditional semantics, no explanatory account of unity emerges. Thus, whatever we have achieved with the help of such a theory, it presupposes rather than gives an account of unity.

⁴³ This argument against Davidson resembles the argument which Davidson (2005: 158) advances against a set-theoretic interpretation of satisfaction (cf. section 2.4.1): in both cases, the predicate is replaced by another predicate, and no account of predication emerges.

natural languages. The idea is that unity is secured only by relations that are inherently relating. This intuition probably also lies behind Davidson's proposal that we must not think of predicates in terms of entities; and it has, more generally, been an important motivation for many wholistic theories. I briefly outline how this feature could be reconciled with the productivity of language.

2.5.1 The Dichotomy between Unity and Productivity

When it comes to the meaning of natural language expressions, there are two explanatory demands which seem to pull into different directions. On the one hand, the meanings of sentences (and other complex expressions) exhibit a unity which is qualitatively different from the unity of a set or aggregate – the meaning of the wholes is both more and less than the sum of the meanings of their parts. In section 2.1, I have argued that also predicate conjunction cannot account for sentential meanings. This suggests initially that we cannot think of the meaning of the wholes as somehow made up from the meanings of their parts. Consequently, the meanings of sentences should be taken as the primitives of a semantic theory. The meanings of the parts may then be taken to be abstractions of the meanings of the wholes. The inability of Russell's (1903) atomistic theory to account for unity seems to support this conclusion. However, natural languages are productive: finite human beings are capable of understanding and producing any of a potentially infinite number of different linguistic meanings and we can easily understand and produce expressions with meanings we have never encountered before. This suggests that all the infinite number of meaningful expressions we can understand are made up of a finite number of familiar primitives. If so, the wholistic strategy cannot work for natural language, since it cannot explain this productive aspect of natural language. As argued in section 2.2, there thus seems to be a dichotomy between the two demands on a theory of meaning for natural languages.

I have reviewed two strategies in semantic theory which could be thought to overcome this problem. As argued in section 2.3, functions don't help us out of the dichotomy between unity and productivity: functions can either be taken to be abstractions from all possible sentences, in which case productivity remains a mystery. Alternatively, sentences can be taken to be the result of applying functions to new arguments. Yet, in this case, unity remains unexplained, as it enters into the theory as part of the metalanguage used to define and calculate the meanings of the object language, rather than being explained by the theory itself. As argued in section 2.4, the latter point also applies to Davidson's recent attempt to turn Tarski's notion of predicates into an account of unity, by defining satisfaction in terms of absolute truth. Whereas Davidson's

semantics can be reconciled with both productivity and unity, it does nothing to explain them, since they enter the theory as primitives.

Nonetheless, not all accounts discussed so far do equally bad in respect to the unity/productivity dichotomy. Whereas, for example, Russell's radically atomistic (1903) methodology is incompatible with an explanation of the unity of the proposition, and whereas explicit definitions of functions give us no idea of how language could be productive, translational approaches (that is, implicitly defined functions or the second interpretation of Davidson's theory) can account for aspects of productivity and are at least compatible with unity – even if they don't explain how meanings are united. The reason for their compatibility with unity is that they do not try to reduce the syntactic (that is, structural) aspect of meaning to a lexical (that is, non-structural) one. Rather, the meaning of syntactic concatenation is represented by the syntax of the metalanguage sentence. One reason for why sentences are good tools for specifying sentential meanings is that they don't force us to reduce structural aspects of meanings to non-structural ones. There has been an attempt to achieve the same with the help of pictures rather than metalanguage sentences. It is this attempt which I turn to now.

2.5.2 Propositions as Pictures or Images

According to Russell's latest theory of propositions, which first surfaces in Russell's publications around 1919, propositions are mental images. In respect to unity, the advantage of images over complexes made up of individual objects is that, in pictures, relations always occur as actually relating ones, whereas in complexes they can occur as relations which do not in fact relate anything in particular. That is, a picture is inherently a unity, in a way in which a complex object is not. In a picture of a room, for example, the fire may be drawn to the left of the window; there is no additional component which has to signify the relation *being left of*. Russell (1919: 309, my emphasis) argues: 'The most important thing about a proposition is that, whether it consists of images or of words, it is, whenever it occurs, an actual fact, having a certain *analogy of structure* [...] with the fact which makes it true or false.' In this respect, he follows, the intuition of Wittgenstein's (1913, p. 105) famous claim that 'one must not say "The complex sign '*aRb*'" says that *a* stands in the relation *R* to *b*; but that "*a*" stands in a certain relation to "*b*" says that *aRb*'. As Wittgenstein explains:

What constitutes a picture is that its elements are related to one another in a determinate way. (Wittgenstein 1922, p. 2.14) The essence of a propositional sign is very clearly seen if we imagine one composed of spatial objects (such as tables, chairs, and books) instead of written signs. Then the spatial arrangement of these things will express the sense of the proposition.

(Wittgenstein 1922, p. 3.1431) In the proposition, the world is as it were put together experimentally. (Wittgenstein 1914-1916: 7)

The very idea that we can think propositional thoughts in images is questionable to start with (cf. Dennett 1991). A further problem of the picture theory is related to the intensionality of the meaning of natural language. Pictures are purely extensional, language is not. The picture theory, for example, cannot explain the difference in meaning between *A is left of B* and *B is right of A*. In the following I argue that the picture theory is no advance in overcoming the dichotomy between unity and productivity, even if these two problems are disregarded. This becomes particularly clear in Russell's version of the theory; it is this version, therefore, on which I focus.

Like the Multiple Relations Theory of Judgement (which Russell abandoned in 1914), Russell's version of the picture theory takes propositions as psychological entities; but unlike in this former theory, in the picture theory, propositions are not composed of objects, relations etc. but of mental representations of objects. Russell distinguishes between propositions 'expressed in words', which he calls 'word-propositions', and propositions 'consisting of images', which he calls 'image-propositions'. He argues: 'as a general rule, a word-proposition "means" an image-proposition' (Russell 1919: 308) – whatever this is exactly supposed to mean. The central aspect of the theory is that 'an image-proposition has an objective reference dependent upon the meanings of its constituent images' (Russell 1919: 309). In brief, an image is iconic. In the image of the fire being left of the window, the relation *being left of* is represented by the spatial relation between A and B. According to Russell, the iconic relation determines reference. 'But such idyllic simplicity of correspondence is rare. It is already absent in the word-propositions which mean such simple visual image-propositions' (Russell 1919: 316). In general, Russell (1923: 67) argues,

words which mean relations are not themselves relations, but just as substantial or unsubstantial as other words. In this respect a map, for instance, is superior to language, since the fact that one place is to the west of another is represented by the fact that the corresponding place on the map is to the left of the other; that is to say, a relation is represented by a relation.

Russell notes that we could have conventions in language which represent 'a few specially important relations [...] by relations between words. For instance, "*AB*" might have meant "A is to the left of B"' (Russell 1919: 316). But he has to admit that 'the practical possibilities of this method of symbolizing relations are obviously very limited [...]. Hence the linguistic statement of a fact is a more complex fact than that which it asserts' (Russell 1919: 316).

Picture theorists hardly ever talk about relations other than spatial relations when discussing their theory – and it is unclear for many other kinds of relations as to how they could be represented pictorially. As Stevens (2006: 119) points out:

Russell faces a stern challenge in explaining how certain relations are to be constituents of mental images. Can I for example, have a mental *image* of the fact that Wittgenstein wrote the *Tractatus* before I was borne, or an image of the fact that my friend prefers playing darts to watching football?

In respect to unity, there is another, and perhaps even more pressing, problem: How can we bridge the gap between the word-proposition and the image-proposition? Why, according to this theory, is the meaning of *A is left of B* not a complex image consisting of A, B, and something's being left of something else? Ensuring that the sentence corresponds to the image-proposition by adding a further constituent gives rise to Bradley's regress. Assuming a primitive one-to-one correlation between sentences and image-propositions leaves the productivity of language unexplained.

In order to explain 'how I know the relation between an object-word and its meaning' (Russell 1938: 47), Russell adopts a 'quasi-causal' (Russell 1938: 46) approach to language. He argues: 'It is quite possible that between sensation and motor impulse there are no intermediate links. [...] I am inclined to think that, whenever I notice a horse, I have an impulse to say "horse", though the impulse may be inhibited' (Russell 1938: 47). This reflex-like relation between mental-images of something and linguistic expression might be thought to bridge the gap between word-propositions and mental pictures. Russell (1948: 117) writes:

Suppose that, when I am walking with a friend, he says: "There was an explosion here yesterday." [...] The most important word in the sentence is "explosion". This word, when I am actively understanding it, rouses in me faint imitations of the effects of hearing an actual explosion – auditory images, images of nervous shock, etc. Owing to the word "here", these images are combined in my mental picture with the surrounding scenery. Owing to the word "yesterday", they are combined with recollections of yesterday's experiences.

However, it is very hard to see how a combination of my recollections from yesterday's experiences (say, going shopping, writing a paper, giving a lecture, etc.), in combination with my mental picture of the surrounding scenery (say, the courtyard of Durham Cathedral), the auditory images of an explosion and images of nervous shock are supposed to give rise to anything coherent at all, rather than a random collection of images; and it remains completely unclear how they are supposed to give rise to a proposition. Even if they do, Russell says nowhere how they do (or how they could do), which is what the unity problem is all about.

Thus, it is not the case that ‘Russell finally had a substantial answer to Bradley’s insistent questions about unities’, as Stevens (2006: 119) claims.⁴⁴

2.5.3 A Proposal

Despite the failure of the picture theory to account for the productive nature of language, there is something we can learn from it (and from wholistic theories more generally): Relations have to be inherently relating for unity to be secured – if it is accidental to relations whether they actually relate or not, there is always the possibility of ‘duplicating’ a proposition with a non-unified aggregate of objects. The relevant intuition is clearly expressed in Read (2005: 319):

Just as *a* is common to the facts that *a* is *F* and *a* is *G*, so too *F* is common to the facts that *a* is *F* and that *b* is *F*. But seen that way, *F* becomes an object, a property robbed of its character as a property. A property or relation is by its nature a property of something, a relation between things. Once we treat it as an object, as a constituent of the fact, it loses that character, and we are simply left with a list: *a* and *F*, or *a*, *R* and *b*.

The intuition behind the picture theory is that in a picture, the representations of the objects stand in certain relations, without a need of introducing the relation in addition to the representations.⁴⁵ As Stevens (2006: 107) argues: ‘Propositions, construed as pictures, [...] have their unity written into them.’ A similar point is behind Davidson’s claim that if predicates are not taken to contribute entities towards the meaning of the wholes in which they feature, Bradley’s regress is avoided. As mentioned above, the strength of translational semantic theories is precisely that they represent the meanings of syntax by a relating relation: a syntactic relation of the metalanguage which actually relates the meanings of the terms.

The same intuition also plays an important role in some metaphysical accounts of unity. Lowe (2006: 167) argues in respect to the relation between an object (e.g. a particular rubber ball) and the ‘mode’ characterizing it (e.g. the ball’s particular yellowness):

⁴⁴ Wittgenstein’s version of the picture theory differs from Russell’s in that Wittgenstein remains an anti-psychologist. Consequently, he rejects Russell’s talk of mental images and the distinction between image- and word-propositions. Yet, this aspect does not make the account any more explanatory. Mental images are the way in which Russell attempts to bridge the gap between words and pictures. Where Russell’s bridge does not meet the other end, in Wittgenstein’s theory, there is no bridge in the first place. As Stevens (2006: 117) summarizes: ‘The interpretation of the picture theory in the *Tractatus* as assimilating propositions to sentences yielded a theory with no account of how words make the shift from being concrete terms in a sentence to being the “relating-relations” of a picture.’

⁴⁵ For a recommendation of Wittgenstein’s theory in light of this, see Linsky (1992) and Johnston (2007). Cf. Collins (2011b, chapter 3.5) for discussion of their approach. To the extent to which Linsky and Johnston are right in assimilating Wittgenstein’s proposal to Frege’s, the charges levelled against Frege in section 2.3.3 also apply to Wittgenstein.

The only way [to avoid Bradley's regress] is to deny that the characterization "relation" is any type of *entity* or *being* whatever, [...] characterization is an *internal* relation and as such, in Armstrong's useful phrase, "no addition of being". In order for an internal relation to hold between two or more entities, it is sufficient for those entities to exist.

If we think of modes (i.e. ways things are) in such a way that they can only characterize the very object they characterize, that is, if they 'depend for their very existence and identity upon the objects which possess or "bear" them' (Lowe 2006: 167), Bradley's regress is avoided: there is no need for an additional (external) relation relating the mode and the object. Rather, the mode, if it exists, is intrinsically related to its bearer.⁴⁶

Yet, this metaphysical proposal cannot directly be employed to the linguistic case, for, as it stands, it does not provide an account of productivity. In the case of language, two conditions have to be reconciled. First, in order to account for unity, (the meanings of) predicates (when used as predicates) have to be inherently relating, that is, it has to be impossible for them to fail to apply to whatever they apply to. Second, inherently relating predicates cannot be primitives of the theory, since in this case productivity would remain unexplained. I argue in the following chapters that these two demands can be met – even though they may initially sound incompatible. What turns the meaning of a lexical item into a predicative predicate is the grammatical configuration it enters. If and only if a lexical item occupies a particular place in a certain grammatical structure, it acts as a predicative predicate. This proposal, obviously, is in some sense wholistic: it depends upon the grammatical structure whether one of its parts is predicative. It might thus be thought that the proposal falls prey to the very same problems which the other wholistic accounts do. However, what makes the difference between the present account and the other wholistic accounts discussed in this chapter is that grammatical structure can be accounted for independently. And their derivation is, in comparison, relatively simple and well understood.

My proposal has another nice feature. Natural languages allow for most lexical items to occur both predicatively and referentially:

- (9) I am free.
- (10) Freedom is desirable.

⁴⁶ Maurin (2010; 2012) uses the same idea of avoiding Bradley's regress, but spells it out, not with the help of modes, but with the help of a special kind of relational tropes. A similar strategy is employed by Peacock (2012) – although he originally criticises this kind of approach as stipulative.

As Davidson (2005: 158) admits: ‘If some (second level) predicates are true of abstract objects, those objects must exist, but their existence does not explain the role of such predicates.’ But then it remains unclear what the relation between the meaning of a predicate when used as a predicate and the meaning of a predicate when used as a referential expression consists in. As Burge (1973) argues, they clearly seem to be related; and a theory that captures this relation is preferable to one that does not (cf. also Wiggins 1984). However, neither Davidsonian nor Montagovian semantics can capture this relation, as they have to define different lexical entries for both cases (or, alternatively, have to employ arbitrary type-shifting functions). The present approach, in contrast, derives both referential and predicative uses from the same lexical entry, which is neither inherently predicative nor referential.

The Irreducibility of Grammar

The discussion in chapter 2 has suggested that a central problem in accounting for the unity of linguistic meaning consists in the fact that structural meaning cannot be reduced to non-structural meaning – in particular, grammatical meaning cannot be reduced to lexical meaning. This is the insight behind both translational theories and picture theories. In both cases, the meaning of a grammatical relation is given by a different relating relation: a spatial relation in the case of the picture theory, a grammatical relation of the meta-language in the case of translational theories. However, I have also argued that these two kinds of theories cannot answer the unity questions discussed in section 1.2, as they don't give an account of how meanings are united, or how else unity is achieved. Unity, thus, remains unexplained.

The aim of this chapter is to inquire deeper into the nature of grammatical meaning and its relation to the unity problem. In section 3.1, I argue that the distinction between referential and predicative expressions is grammatical, not lexical: whether a certain lexical item functions predicatively or referentially does not depend upon its intrinsic properties, but on the grammatical relations it enters. I review semantic and linguistic evidence in favour of this claim and demonstrate the difference it makes in respect to explaining the unity of meaning. However, grammar is a certain structure; and structures of any kind are usually not regarded as inherently meaningful. Instead, they have to be interpreted in terms of something else if they are meaningful at all. If so, using grammar in order to explain a semantic phenomenon is not very promising an endeavour. This problem has surfaced in recent work on structured propositions, which I discuss in section 3.2. I argue that there is good reason to assume that grammar is inherently meaningful. If so, it should be possible to explain in grammatical terms what traditionally is explained in semantic terms. An example of how such a grammatical explanation of semantic facts could work is given in section 3.3, where I argue that aspects of natural logic may be accounted for with the help of grammar.

3.1 A Grammarist Account of Reference and Predication

3.1.1 Lexical Roots, Parts of Speech, and Grammar

Strawson (1950: 337) argues:

The distinction [between referential and predicative expressions] is primarily one between different rôles or parts that expressions may play in language, and not primarily one between different groups of expressions; for some expressions may appear in either rôle.

Consider the sentences below. In (1), *radium* is a mass-term that can be quantified over. It is thus used predicatively. In (2), however, *radium* is used to refer to a natural kind, and hence acts as a name. Also *Alfred* can be used predicatively as in (3) and referentially as in (4).

- (1) We discovered (some) *radium* in this lake.
- (2) *Radium* was discovered by Madame Curie. (Longobardi 1994)
- (3) No *Alfred* likes his name.
- (4) *Alfred* dislikes his name.

Referential and predicative expressions are most commonly distinguished in lexical terms; that is, whether a word is a name or a predicate is part of its lexical specification. I will call this position *lexicalism*. Given the examples in (1) to (4), lexicalism entails that *radium* and *Alfred* (as well as most other nouns) are ambiguous: there are two lexical entries associated with *radium* – one with a predicative and one with a referential meaning. An alternative to lexicalism is *grammarism*. On this conception, grammar determines whether a particular expression functions as a predicative or referential expression in a particular context. That is, the grammarist is free to assume that the same lexical root *radium* features in (1) and (2). Yet, since it occurs in different grammatical roles, it is used predicatively in (1) and referentially in (2).

Furthermore, parts of speech can be treated in a lexicalist and a grammarist way: On the lexicalist conception, it is part of the lexical entry of an expression whether it is a noun (N), verb (V) or adjective (A). A lexicalist, thus, has to assume separate lexical entries for _A*human* and _N*humanity*, for _V*feed* and _N*food* and for _V*walk* in *I walk* and _N*walk* in *this is a nice walk*. The grammarist, by contrast, can assume that each of these pairs of expressions share a lexical root as common conceptual content. The differences between different parts of speech are then taken as an effect of the grammatical configurations in which the roots enter. On a grammarist approach, parts of speech are thus a first grammatical layer, narrowing down, but not always determining, the grammatical roles an expression can play in the grammatical configuration it enters: whereas nouns can become both predicates and referential expressions, verbs, for

example, can only take a predicative role within a sentence. A fully grammatist architecture of grammar, then, is as summarized in (5)-(7) (cf. Hinzen and Sheehan 2014, chapters 2-4): a lexical root (5) can enter the grammatical derivation as different parts of speech (6). Some parts of speech (nouns) can be used in both referential and predicative functions (7).¹

- (5) **Lexical root** (conceptual content)
√HUMAN
- (6) **Parts of speech** (first layer of grammaticalization)
 - a. John is _Ahuman.
 - b. _NHumanity is not respected.
- (7) **Grammatical Role/Function** (second layer of grammaticalization)
 - a. Referential: [_{DP} Humanity] is not respected (in the treatment of prisoners).
 - b. Predicative: There is no [_{NP} humanity] (in the treatment of prisoners).

In this section, I argue that the unity of linguistic meaning can be accounted for on the grammatist, but not on the lexicalist approach. I use Plato's theory of the unity of meaning to demonstrate the difference grammatism can make in this respect (section 3.1.2). Yet, the grammatist approach presupposes structure and thus seems to include a wholistic element. In section 3.1.3, I argue that grammatism is nonetheless compatible with the productivity of natural language. In sections 3.1.4 and 3.1.5, I review additional linguistic evidence in favour of grammatism.

3.1.2 Lexicalism, Grammatism, and Unity

Plato's treatment of the unity of meaning is embedded in a discussion of how 'false speech or mere opinion' (Sophist 236e) is possible. The problem is that a false sentence apparently picks out a state of affairs which does not exist. This 'seems to presuppose that there *is* something which does not have being' (237a), which is a contradiction. To solve the problem, Plato suggests that a sentence does not have to correspond to a state of affairs to be meaningful – it is enough if its meaningful parts are combined in the right way. Yet, this raises the question of how the meanings of words can be combined to make up a unitary sentential meaning. Plato

¹ This tripartite architecture goes back to Modistic grammar in the Middle Ages (cf. Leiss 2009, chapter 2) and can arguably be traced back to Aristotle (cf. Reichard 2013b). However, in contrast to the central importance that Modistic grammar attributes to parts of speech, I treat them like any other aspect of grammar. A similar architecture can be found in Husserl's *Logical Investigations*, in particular in part IV, where he develops what he calls a 'pure grammar' in the first and a 'purely logical grammar' in the second edition. Husserl distinguishes between a 'kernel' or 'nuclear matter' (lexical root), 'nuclear form' or 'syntactic matter' (part of speech) and 'syntactic form' (grammatical function). Cf. Bianchin (2013) for discussion.

observes that neither a sequence of ὀνόματα like *lion, deer, horse* nor a sequence of ῥήματα like *walks, runs, sleeps* yields an assertion (λόγος) (262b). In the simplest case, an assertion has to contain both an ὄνομα and a ῥήμα, as in *Theaetetus sits*.

Plato's account of the unity of meaning relies on a functional distinction between ὀνόματα (referential expressions) and ῥήματα (predicates): referential expressions pick out objects, and predicates say something about (or 'attribute a quality' (262e) to) the objects picked out by the referential expression.² Thus, the meaning of a sentence does not consist in two independent objects, which then have to be combined to make up a unity. Rather, (at least in the simplest case) there is only one object: the object picked out by the referential expression. The predicate gives information about this object. It does not need to refer to an object.

Whether the distinction between the different functions of referential and predicative expressions contributes anything towards an account of the unity of meaning, however, depends on whether it is understood in a lexicalist or grammarist way. On the lexicalist interpretation, some lexical items are inherently referential, others inherently predicative. However, given such an interpretation, Plato's theory cannot account for unity, as Davidson's and Gaskin's critiques of Plato's theory show, which are both based on lexicalist interpretations.³

First, if lexical items are referential or predicative lexically, there is nothing which prevents us from 'duplicating' a sentence by a list comprising the very same expressions, as Gaskin (2008) points out (cf. chapter 1.2.2 for discussion). Yet, whereas the meaning of the sentence exhibits the unity we are looking for, the meaning of the list does not. Any attempt to fix the problem in a lexicalist way ends in Bradley's regress. This shows that the unity of meaning cannot be explained with the help of intrinsic features of lexical items. As Gaskin argues:

Nothing prevents us from compiling lists of (type) words (referring to aggregates of objects) which are of the right grammatical category to constitute a sentence (proposition), but which do not, as it happens, do so [...]. What unifies a sentence and its corresponding proposition is not an ingredient of the sentence or proposition, in the sense of a component that is

² This is the reason for translating ὄνομα and ῥήμα as 'referential expression' and 'predicate' respectively, instead of the more common translation as 'noun' or 'name' and 'verb' (cf. chapter 1.2.2).

³ Gaskin (2008: 23), who treats Plato as an adherent of the thesis 'that the problem of unity can be solved by merely advertent to the fact that a sentence is composed of words which are syntactically of the right form to compose one, and which are concatenated (in general: ordered) in an appropriate way.' Davidson (2005: 81) summarizes his reconstruction of Plato in the following way: 'A sentence must contain both a noun and a verb. [...] A sentence must have a word that picks out an object, and a verb that picks out a general form.'

antecedently available to be configured with other, similarly available ingredients, but a structural property. (Gaskin 2008: 299) The moment of propositional unity must be something over and above the mere suitability and availability of objects to be combined in the right way to form a proposition. (Gaskin 2008: 314)

Davidson (2005, chapter 4) makes a similar point when he argues against Plato that the mere difference in the kind of the denotation of lexical items is not sufficient to explain unity: on the lexicalist interpretation, it is not clear how the object mentioned by *Theaetetus* and the quality which *sits* stands for are supposed to be more than an aggregate of disparate objects when put together.

Second, according to Davidson (2005: 82), second-order predication challenges Plato's theory. Many lexical roots which are usually used as predicates can also occur referentially, like *health* in *Health is important* (Plato (254b-556e) discusses the example *Motion is not rest*). Thus it seems that predicates can be used to pick out an (abstract) object, rather than to say something about an object picked out by another word. Yet, given that this function is part of the lexical entry of the root (and also assuming that it is the same lexical item HEALTH which features in *Health is important* and *John is healthy*), it follows that *health* and its grammatical derivations pick out an object in every context. But then it remains mysterious how it could also serve as a predicate that says something about another object, rather than just adding a further object to it.

The problem can be overcome if the lexicalist interpretation of Plato's distinction is given up. On a grammarist interpretation, grammar determines whether a word is used referentially or predicatively. In principle, the same lexical root can function as referential expression in some grammatical contexts and as predicate in others.⁴ On the grammarist interpretation, the problem from second order predication does not arise, as it depends on the assumption that a lexical root cannot be used as a predicate in some and as a referential expression on other contexts. The grammarist interpretation also fixes the first problem: if words are referential and predicative expressions only in virtue of playing a particular grammatical role in a sentence, then a sentence cannot be 'duplicated' by a list of referential expressions and predicates. As the list lacks the

⁴ Compare Burge's (2007: 598) claim that 'the key to understanding why sentences are not strings of names lies not in distinguishing the entities that names and predicates bear semantical relations to. The key lies in distinguishing the relevant semantical relations themselves.' Unfortunately, Burge spells out the difference in the semantic relations in terms of function application, which is problematic, as argued in chapter 2.3.

grammatical structure which makes a referential expression referential and a predicate predicative, referential expressions and predicates cannot as such be part of a list.⁵

In sum, Plato's account of the unity of meaning relies on a functional distinction between referential and predicative expressions: referential expressions pick out objects, and predicates say something about the objects picked out by the referential expression.⁶ Yet, functional explanations of unity only work if the distinction between referential expressions and predicates is grammatical, rather than lexical, since a lexical specification fails to account for the difference between a sentence and a list. Arguably, lexicalist accounts also face a problem with second-order predications.

However, assuming that the distinction is grammatical implies presupposing the grammatical structure of sentences. The distinction between referential and predicative expressions, then, is wholistic in the sense discussed in chapter 2. Thus, the question arises whether it is compatible with the productivity of language. It is this question which I turn to now.

3.1.3 The Origin of Grammatical Structure

Gaskin (2008: 299) argues: 'There is no purely grammatical solution to the unity problem.' In this section, I argue that as far as Generative Grammar is concerned, Gaskin's arguments towards this conclusion miss their target.

Gaskin's first argument concerns morphological accounts of unity, that is, accounts according to which, for example, the morphology of the verb (say, the third person marker *-s* in *John loves Mary*) unites the sentence. The problem of such approaches is that words can be listed including their morphology; that is, in addition to the sentence *John loves Mary*, there is a list of words consisting of *John*, *loves* and *Mary* (cf. Schnieder 2004). Morphology, therefore, cannot make the difference between a sentence and a list containing the same expressions including the same morphology. Yet, as Gaskin (2008: 21, my emphasis) admits, this argument does not touch grammatical explanations of unity that are not purely based on morphology: 'In saying that the criterion for the unity of a type sentence cannot be merely syntactic, I mean that

⁵ Cf. Reichard (2013b) for discussion of whether a grammarist interpretation of Plato is historically plausible. I don't touch this issue here, as my current concern is not historical.

⁶ By referring to the difference in grammatical function, I do not mean to imply that the unity problem could be solved by defining the meaning of predicates in terms of their use, as Tugendhat (1976, lecture 11) suggests.

the criterion cannot be a mere matter of *superficial linguistic form*, given that the superficial linguistic form of a sentence is not, as such, distinct from that of a mere list'.⁷

However, Gaskin notes that there is a further notion of syntax, where syntax is understood in structural terms. Gaskin (2008: 21-22) writes, 'on *that* conception of syntax, it is indeed open to us to say that sentences enjoy internal syntactic relations lacked by mere lists: for certainly, a phrase marker appropriate to a sentence (at some level of syntactic analysis) will look quite different from one appropriate to a list': in contrast to the syntactic structure of a list, the sentence is hierarchically structured and has a root. Yet according to Gaskin this does not solve the problem, as it

simply pushes the question one stage back: what *is* it for us, confronting a bunch of words that might *prima facie* be analysed either as a sentence or as a list, to apply the one kind of syntactic analysis rather than the other – to associate the words with one kind of representation at the level of LF, say, rather than with another kind? In pursuing this question [...] it is plainly not a solution to have one's attention directed to intrasentential relations at some level of syntactic analysis, but rather a placeholder for a solution. For our question precisely is: in virtue of what are those intrasentential syntactic relations in place at the relevant level of syntactic analysis? (Gaskin 2008: 22)

One interpretation of this quote is that Gaskin worries why a certain sound, gesture or mark on paper is mapped to a hierarchical structure, rather than to a paratactic one. This problem is a special case of the question of how natural language is parsed, that is, why a certain string of sounds is mapped to one syntactic structure rather than to another. Yet, this problem is not a problem peculiar to questions concerning unity. The same problem arises in respect to the question of why we understand an ambiguous sentence in one way rather than in another. For example, if you say to me 'every boy danced with a girl' in a certain situation, I may intuitively understand the universal quantifier as outscoping the existential one. It is a very interesting question why in this situation I understand the sentence in this way but not in another. An answer will probably have to make reference to the context of the utterance, to statistical knowledge regarding this expression or expressions of this kind and many other pragmatic features. Yet, given the generality of the question, a theory of unity in particular would not have to answer it.⁸

⁷ Gibson (2004: 68-69) provides an argument to the same effect: the difference between a list and a sentence cannot be an intrinsic part of an inscription, as the inscription could be accidental. Since my notion of grammar is independent of typography, Gibson's argument does not affect my account.

⁸ In case Gaskin does indeed think there is a problem at this point, it may be homemade by adopting too broad a notion of linguistic items: Gaskin writes that for him, sentences are individuated 'phonologically or orthographically' (Gaskin 2008: 14) in addition to semantically. To the extent that phonological and

A second interpretation of the quote above is that Gaskin is concerned about the origin of grammatical structure. Given that the distinctions which are claimed to explain unity are structural, the account of unity has to presuppose the respective structures. And, thus, the question arises where they come from. As argued in chapter 2, since natural languages are productive, a theory of unity should not rely on taking sentences (or sentence-meanings) as primitives.

However, Collins (2011b) offers an answer to the question of where the structure of natural language comes from: according to him, it is generated by a grammatical operation called ‘Merge’; and Merge is supposed to be ‘psychologically real’ (p. 116).⁹ My suspicion is that when Gaskin raises the problem above, he does not appreciate that a syntactic representation in Generative Grammar represents a derivation of the expression in question – the syntactic structure is not just a way of representing the structural relations which the parts of a sentence exhibit. Rather, the derivation is a way of explaining why the respective lexical items are in the structural relations they are, from a psychological point of view. The answer to the question of where the structures originate that determine whether a lexical item is used referentially or predicatively is thus that it is derived with the help of grammatical principles. Indeed, in Minimalist syntax, Merge is supposed to create the sentential structure out of a lexical array – the set of lexical expressions which will be featuring in the respective sentence. So, Merge can be taken to be responsible for the difference between a set of lexical items and a sentence formed from them; and the question of where the structures that determine whether a lexical root is used predicatively or referentially come from is not an obstacle to a grammatical theory of unity.

3.1.4 The Grammar of Reference and Predication

Grammatism is not only suggested by the unity problem, but has recently also been defended on independent grounds. To back up my position, I now outline a grammarist theory of the distinction between referential and predicative nominals and review some evidence in its favour.

The most common notion of proper names is lexicalist. According to it, *Alfred*, for example, is a proper name however it is used. Proper names in this sense are often used referentially as in

orthographic features matter to sentencehood, it is clear that sentences cannot be the objects the unity of which we want to explain, since orthographic features can be listed. What cannot be listed are the grammatical structures in the minds of real people. It is here, therefore, that we can expect a solution to the problem, if anywhere; but I shall leave this point now.

⁹ The properties of Merge are irrelevant for my current concern. In chapter 6.2, I define Merge formally and discuss the role it could play in an explanation of unity, with a focus on Collins’s proposal.

derived from a single lexical root. Motivated by this thought, but still remaining within the lexicalist framework, a number of philosophers and linguists have argued that names are inherently predicative and that the referential use of proper names can be derived from its predicative one with the help of quantification (cf. Burge 1973; 1974; Larson and Segal 1995; Geurts 1997; Recanati 1997; Matushansky 2008; Fara 2012; cf. also Russell 1918; Quine 1953; Kneale 1962). However, none of these accounts is able to overcome the problems of quantificational analyses of referential uses of names pointed out by Kripke (1972): whatever the descriptive content is taken to be, a sentence with a name as subject and the description as predicate is always more informative than a tautology, and, unlike a tautology, could be false. This is the case even if the description mentions the name as in (19). When used referentially, names refer independently of descriptive content, that is, they are *rigid* (to use a term of Kripke's).¹³

(19) Gödel is named 'Gödel'.

Thus, rigid uses of proper names cannot be explained in terms of predicative uses and quantification (for discussion see Hinzen 2007, chapter 5; Kirkby 2012b).¹⁴ But also the prospects of explaining predicative uses of names in terms of referential ones are dim, and I don't know of any worked out attempts of doing so.

A grammarist alternative, in accordance with the intuition that predicative and referential uses of names are derivationally related, is to think of lexical roots as neither inherently predicative nor as inherently referential. What determines their referential or predicative properties, on this account, is the grammatical role they play. In current grammatical theory, the nominal domain splits into a noun (N) and a number of functional projections. The most important one is the determiner phrase (DP). Longobardi (1994; 2005; cf. also Sheehan and Hinzen 2011; Hinzen and Sheehan 2014) argues that rigidity correlates with movement of the

¹³ According to Kripke's original proposal, a term refers rigidly if it refers to the same thing in every possible world (Kripke 1972: 48). I follow Hinzen (2007, ch. 5) in setting the modal aspect aside and defining rigidity in terms of independence of descriptive content, as this definition is better suited for the point I want to make. The extension of rigid terms is thereby restricted to terms that are rigid *de jure*. Terms, such as *the smallest prime number*, which are rigid *de facto* in Kripke's terminology are excluded on my definition (cf. Kripke 1972: 21, n. 21).

¹⁴ Higginbotham (1988: 37) offers a further argument against attempts to explain rigidity with the help of hidden demonstratives: as is evident from the contrast between (i) and (ii), demonstratives in natural languages are restrictive, whereas rigidity is the effect of an un-restricted reading of the name.

- (i) Alfred wrote the *Principles of Mathematics*.
- (ii) This Alfred wrote the *Principles of Mathematics*.

noun to the determiner position (N-to-D movement). Alternatively, in some languages (like Italian and spoken German) the determiner position can be occupied by an expletive determiner that acts as a place-holder of the name.¹⁵ This proposal explains that rigid reference is independent of descriptive content and that it cannot be restricted: The name, when used rigidly, acts itself as a determiner, and hence cannot be quantified over (cf. Hinzen 2007, chapter 5 for discussion).

The grammarist thesis is supported by the fact that not only names but also common nouns follow the same paradigm. As is evident from (20), if they occupy a certain grammatical position, they can only receive a rigid interpretation.

(20) Cat/*cat came.

(Borer 2005a: 73)

As Borer (2005a: 76-77) concludes: ‘Aside from social conventions which may favour the interpretation of some nouns as proper names and others as common names, it appears that a noun will be interpreted as a proper name or as a common name (or, at times, as ambiguous between the two) solely on the basis of structural information.’ The lexicalist alternative to assume that *Cat* and *cat* are two different lexical items is not only uneconomical, but also deprives us of the only way to explain the fact that certain expressions are usually used rigidly whereas others are not. Borer (2005a: 77) argues:

That *John* indeed is conventionally a proper name and *cat* a common name is information, we suggest, that is associated with the encyclopedic entry of such a listeme, and it is precisely that information which can be overridden grammatically, [...] provided that outstanding oddity does not ensue.

Thus, we can explain that some lexical roots are names (that is, that they are usually used rigidly) and others are common nouns (that is, that they are usually used non-rigidly) only if the rigid and non-rigid uses of nouns are uses of the same lexical item. Otherwise it is unclear how this statistical information enters language.¹⁶

¹⁵ Longobardi provides three kinds of evidence in favour of the expletive determiner. The first is morphological: in a number of languages (e.g. Catalan and some Frisian dialects), the expletive determiner is morphologically distinct from the substantive determiner used for definite descriptions. The second kind of evidence is syntactic: expletive determiners cannot scope over a conjunction of a rigid name and a predicative noun, even if the substantive and the expletive determiners are not morphologically distinct. Finally, constructions with expletive determiner and those with N-to-D movement are not semantically distinct.

¹⁶ According to ‘use theories’ of language, knowing a language is equivalent to knowing when it is appropriate to use which linguistic expression. If the above is correct, such a statistical knowledge about

3.1.5 Generalizing the Approach: Grammatical Phases

In recent grammatical theory, linguistic expressions are not assumed to be derived in one go, but in smaller chunks called ‘phases’. In the following, I will assume that DP (Determiner Phrase), *v*P (Voice Phrase) and CP (Complementizer Phrase) are phases. With the help of phase theory, the grammatical account of the distinction between predicative and referential expressions can be formulated on a more principled ground. It can thereby also be generalized to the clausal domain.

A general rationale for phases is that they reduce the computational burden of producing and comprehending language: if linguistic expressions are computed in phases, the derivational engine does not have to remember the complete structure it is computing, but only the phase which is currently being computed. But there is also grammatical evidence for phases: first, phases are islands from extraction.¹⁷ Furthermore, phases ‘are reconstruction sites, and they have a degree of phonetic independence’ (Chomsky 2001: 12).

Phases are usually taken to consist of two parts: a body and a left edge:

$$(21) \text{ [Phase-edge } \dots \text{ [Phase-body } \dots \text{]}]}$$

The function of the phase-body is to build up the descriptive content of an expression, whereas the phase-edge determines its referential properties. It is thus clear that the functional distinction between N and D in the nominal domain described in section 3.1.4 is an instance of the general phasal architecture: N is (part of) the body of the nominal phase and D is (part of) the nominal phase-edge. Yet, whereas these functions have remained primitives in the explanations given in section 3.1.4, they can to some extent be derived from phase theory: once a phase is complete, it is ‘sent off’ the computational workspace and receives both a phonological and semantic interpretation. The internal complexity of the body of the phase is then gone and cannot be accessed anymore. Phases are ‘impenetrable’ in this sense. However, it is not as if the phase had never existed; once it is complete, all the information still relevant for further derivation is contained in the left edge, which remains in the derivation until it is spelled out with the next phase. All the descriptive properties built up during the computation of the phase, thus, ‘shrink together’ to a referent, which stands for the whole phase as a single unit.

usage is crucial for the distinction between proper names and common nouns in the traditional sense. Yet, such statistical knowledge is impossible without presupposing a rigid notion of grammar: the statistical knowledge about the use of a lexical item is (in part) knowledge of which role or roles the lexical item usually plays in grammatical configuration – which, in turn, presupposes the notion of grammar.

¹⁷ For a brief discussion of syntactic islands see chapter 4.2.1.

If this is correct, then we predict that where the left edge is empty, the denotation is determined purely by its descriptive content. If both the left edge and the body of the phase are active (like in the case of definite descriptions),¹⁸ the denotation depends on descriptive content but can also be referential. If the phase body is empty, reference is independent of descriptive content, that is, rigid.¹⁹ In the nominal domain, these predictions are borne out, as is evident from the discussion in section 3.1.4. Yet, as Sheehan and Hinzen (2011) argue, this finding generalizes to the clausal domain as well. According to Sheehan and Hinzen, matrix sentences are referential, whereas fully intensional clauses (for example clauses embedded under believe-type verbs) are descriptive. Factive clauses (such as *it is raining* in *John regrets that it is raining*), which are presupposed to be true, exhibit both referential and descriptive properties. Sheehan and Hinzen provide evidence that these different interpretations correspond to grammatical differences: in the case of intensional clauses, the phase edge (C) is weak.²⁰ It follows that the denotation is primarily determined with the help of the descriptive content. The phase edge of factives is stronger; hence, factives exhibit both referential and descriptive properties. In matrix clauses, finally, the TP (Tense Phrase) moves to the C-position. Hence, the body of the phase is empty. Therefore, matrix clauses are only referential. The T-to-C movement in matrix clauses corresponds to N-to-D movement in rigidly referring nominals.

In sum, a grammarist theory of the distinction between referential and predicative expressions is not only suggested by the problems in accounting for the unity of meaning, but is also supported by more general semantic considerations and grammatical evidence. Furthermore, the grammatical explanation of some properties of rigidly referring expressions is a first taster of a grammatical explanation of semantic facts – a topic which I come back to in section 3.3 and in chapter 5.1. Before that, however, I discuss how any kind of structure could in principle explain aspects of meaning (section 3.2) – according to an influential intuition in philosophy, ‘no structure is self-interpreting’ (Collins 2013, section 2). If so, grammatical (and hence structural) explanations of meaning don’t reach very far. Since this thesis has recently

¹⁸ Whereas some definite descriptions, for example, *the bus* in *I take the bus home* are clearly quantificational, others are used referentially – for example incomplete definite descriptions which pick out a salient discourse referent (for discussion see Strawson 1961; Elbourne 2008; Mukherji 2010). Donnellan’s (1966; 1970) ‘referential definite descriptions’ are an instance of this latter class.

¹⁹ Indeed, in the case of pronouns, the complement is obligatorily absent, strengthening this line of reasoning, since pronouns in the relevant uses are deictic.

²⁰ Cf. Hinzen, Sheehan and Reichard (2013) for a defence of the thesis that intensionality is a grammatical phenomenon.

been discussed and defended in the framework of structured propositions, this is the framework I now focus on.

3.2 Can Structure be Inherently Meaningful?

Current theories of structured propositions are derived from a revitalisation of Russell's (1903) theory in the 1980s, following a suggestion of Kaplan's (1977). The currently most influential version has been developed by Soames (1985; 1987; 1989) and Salmon (1986a; 1986b). In this tradition, propositions are taken to be structured entities, the constituents of which are objects, properties and relations. In the formal semantics offered by Soames and Salmon, propositions are set-theoretic objects (ordered n-tuples, or concatenations of ordered n-tuples).²¹ Yet, as King (1995) and Jubien (2001) note, it remains unclear how these set-theoretic expressions are supposed to have truth-conditions or modal properties, and what ensures the special kind of unity which propositions as opposed to mere lists exhibit.²² There does not seem to be an inherent relation between, say, the structure of a set-theoretic expression like *{the property of swimming, Dara}* and the meaning of *Dara swims*. Such a relation can only be provided by interpreting the structure in a certain way. But then it is the interpretation which gives meaning to the structure; its meaningfulness is, thus, not an inherent property of the structure. As Soames (2010b: 31) formulates the point: None of the structures we may produce trying to capture the predicational structure of any sentence or proposition is such that it, 'by its very nature, indicates that anything is predicated of anything. Hence, there is nothing intrinsic to such structures that makes them representational, and so capable of being true or false.'

Some advocates of structured propositions, therefore, suggest that the origin of meaning should not be sought in abstract or concrete objects which are independent of human minds, as in the tradition of Frege and Russell. Rather, the source of meaning is taken to be language in the case of King and cognition in the case of most others (section 3.2.1). However, in section

²¹ The main motivations for adopting a semantics based on structured propositions as opposed to truth-conditions are a number of problems which truth-conditional semantics (including possible worlds semantics) faces. According to advocates of structured propositions, truth-conditions are not fine-grained enough to account for linguistic meaning. For example, two sentences which differ in meaning may have the same truth-conditions (Soames 1987; Soames 2010b, chapter 3; King 2013a; Speaks 2013). I will not be concerned with this debate. My current interest in structured propositions regards mainly the recent discussion of the meaning of structure in this tradition.

²² Cf. Hanks (2009) and Moltmann (2013, ch. 4) for a recent review of problems that theories of structured propositions face, including, but not limited to, the ones discussed here.

3.2.2, I argue that King's way of spelling out this suggestion does not yield a theory that gets us any closer to solving the unity problems discussed in chapter 1.2, although King presents his theory as an account of the unity of linguistic meaning. In section 3.2.3, I turn to theories that appeal to cognition in order to overcome the above problems. Focussing on Soames's and Hanks's accounts, I argue that these approaches face a problem in respect to the relation between types and tokens which makes them incapable of explaining any structural aspect of meaning. In section 3.2.4, I therefore reconsider the idea that grammar is an inherently meaningful structure – a proposal which, I argue, gets us closer to an explanatory account of grammatical meaning (section 3.2.5).

3.2.1 The Origin of Meaning

Let us call the meaning of a sentence a *proposition* (without making any commitments as to what propositions are). Frege urged that propositions (which he called 'thoughts') have to be mind-external entities. Otherwise, he maintained, it would not be possible to explain how two people could ever have the same thought, or that expressions in two different languages could mean the same (e.g. Frege 1892: 46, n. *). Yet, propositions also cannot be physical entities (Frege 1884: 33). Frege, therefore, thought of propositions as abstract, eternal objects (Frege 1918: 353). Although Russell (1903) rejects Frege's distinction between sense and reference, he maintains that propositions have to be mind-independent entities, for much the same reasons as Frege (cf. chapter 2.2.1). In addition to being the meanings of sentences, advocates of propositions argue that propositions are also needed as bearers of truth and falsity, as bearers of modal properties and as objects of propositional attitudes (for reviews of recent developments in this area see Hanks 2009; Schiffer 2006).

However, philosophers have often been concerned about the existence of such abstract entities. Regarding Fregean thoughts, Bell (1979: 109), for example, argues that 'such doctrines [...] represent the tip of an ugly ontological iceberg.' Furthermore, current advocates of propositions (Jubien 2001; King 2007; Soames 2010b) have themselves identified a central problem with the traditional notion of propositions: propositions represent the world as being a certain way. The proposition that Socrates sits, for example, represents Socrates as sitting (or the world as being such that Socrates sits). Intuitively, this is why propositions can be true or false – if the world is the way that the proposition represents it to be, the proposition is true, if not, the proposition is false. But why do propositions have the power to represent the world as being a certain way? Neither Russell nor Frege give an answer. Indeed, for Russell (1903), truth is a

primitive property of propositions (cf. Sosa 1993). Thus, according to Soames (2010b: 106-07), ‘the real problem’ for the advocate of propositions is to explain

how propositions can be representational, and so have truth-conditions. To the extent that the traditional account even recognizes the problem, it fails to offer a solution. Worse, it takes the mysterious, unexplained, and supposedly intrinsic representational properties of propositions to be the source from which the cognitive states of agents, and the sentences they employ, inherit their representational properties, thereby ensuring the impossibility of explaining the intentionality of anything.

As a consequence, King and Soames both suggest reversing the classical order of explanation. King argues that propositions are a certain kind of linguistic fact, and Soames claims that propositions can be identified with types of cognitive events, the instances of which consist in an agent’s predicating something of something else.

Whilst I follow King, Soames and others in the suggestion that the origin of propositional meaning has to be sought in our minds and language, I argue in sections 3.2.2 and 3.2.3 that the way in which they spell out this idea fails to provide an account compatible with a solution to UP1 and UP2.

3.2.2 King’s Theory of Propositions and Bradley’s Regress²³

Following the neo-Russellian tradition, King (1995; 2007; 2009; 2013b; 2013a) heuristically takes singular terms to stand for objects (e.g., the semantic value of *Dara* is Dara) and predicates for properties and relations (the semantic value of *swim* is the property of swimming and the semantic value of *love* is the relation of loving). In the context of a sentence, words stand in certain syntactic relations. There is, for example, a certain syntactic relation between *Dara* and *swims* in the sentence *Dara swims*, and a different syntactic relation between *red* and *house* in the phrase *red house*. According to King, speakers of English interpret the syntactic relation between *Dara* and *swims* in *Dara swims* as ascribing the semantic value of *swims* to the semantic value of *Dara*.²⁴ King’s theory of propositions is based on this observation. According to him, the proposition that Dara swims is a certain fact about languages,²⁵ namely that there is a

²³ I am grateful to Thomas Hodgson for many helpful discussions on the topic of this and the following sub-section, as well as very useful comments on an earlier draft of parts of it.

²⁴ I omit context sensitivity for the purpose of exposition.

²⁵ Collins (2013, section 2) offers four prima facie reasons for assuming that the structure of propositions is linguistic. First, he argues that this is the most parsimonious option; second, the structure of propositions and that of language correspond at least partially; third, the syntactic and lexical information in the sentence at least constrains the proposition that can be expressed in the sentence; fourth, syntax provides the right kind of structures for predication, whereas set-theory, for example, doesn’t.

language in which a lexical item with *Dara* as value (*Dara*) and a lexical item with the property of swimming as value (*swims*) stand in a syntactic relation which encodes ascription.²⁶ If King is right, facts like the above can be identified with the respective propositions, because these facts do all the work which advocates of structured propositions want propositions to do.²⁷

Although King (2009; 2013b) says that the central motivations for developing his account are problems concerning the unity of the proposition, it cannot answer UP1 or UP2. The problem lies in King's Russellian heritage. For him, properties and relations are not inherently relating: the property of swimming or the relation of loving exist independently of whether anyone in particular swims or loves someone. Why should this be different in the case of the relation of ascription? Yet, if ascription is not inherently a relating relation, King's theory faces Bradley's regress: in order to ensure that the values of *Dara*, *swims* and the syntactic relation (ascription) are actually related, a further relation is needed, and so on *ad infinitum*.

In light of this, it is surprising that King (2007: 36-38) argues that his theory can explain the difference between the meaning of the sentence *Dara swims* and the list (or set) consisting of *Dara*, ascription and swimming. According to King, the difference consists in the fact that, in the sentence, the syntax 'encodes' ascription and in the list it 'refers' to ascription. He illustrates this in a tree-representation with the difference between a dotted and a continuous line:

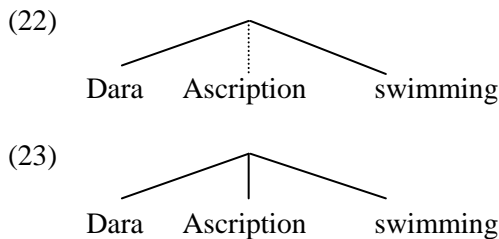

However, this is not more than a graphic trick, as it raises the question of what the difference between an encoding relation and a reference relation is. Since for King relations are not inherently relating, we could replace (22) by (24); that is, we could have only one kind of line, but specify that in one case the line stands for an encoding relation and in the other it stands for

²⁶ A problem of this account is that the thesis that propositions are facts sounds very much like a category mistake. Propositions are generally accepted as the bearers of truth and falsehood; but, despite King's attempts to explain how the facts that he identifies with propositions come to have truth-conditions, it remains unclear how a fact could be false (irrespective of what its constituents are).

²⁷ There has been some debate as to whether this claim is correct (Collins 2007; 2013; Hodgson 2012; Caplan and Tillman 2012; King 2013a). However, my interest in the following does not concern this question. Rather, I shall ask whether King's thesis provides a solution to the unity problems, as defined in section 1.2.

a reference relation. But then, what we took to be the meaning of the sentence *Dara swims* is again ‘duplicated’ by a list (Dara, swimming, ascription, encoding relation, reference relation) and we would have to specify that the relations labelled *Code* and *Reference* respectively are encoding rather than reference relations, and so on *ad infinitum*. So, King’s approach does not solve the unity questions discussed in chapter 1.2.²⁸

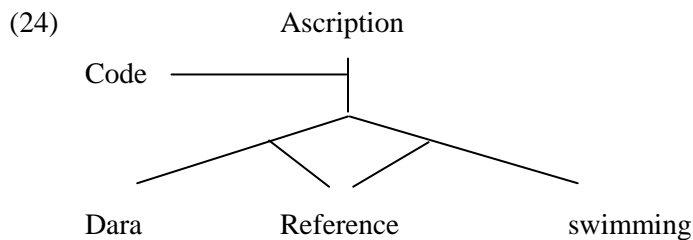

The problem is familiar from chapter 2. The grammatical aspect of meaning cannot be reduced to a lexical or non-structural aspect of meaning. King’s differentiating between a dotted and a continuous line indicates that he implicitly likes to think about the meaning of the spines of the syntactic representation in ways that are different in kind from those of terminal nodes. In this sense, he seems to admit that grammatical meaning cannot be reduced to lexical meaning. However, admitting this is not giving an account of grammatical meaning.

One reason for why this problem arises in the first place is that, according to King, structures are not inherently meaningful. Hence, it is a ‘contingent’ fact about English that the syntactic relation relating *Dara* and *swims* in the sentence *Dara swims* is interpreted as encoding ascription. As King (2007: 36-38) argues, the very same syntactic relation which encodes ascription in English could encode different relations (such as reference or the negation of ascription) in other languages. Hence, in order to say what the meaning of the syntax consists in, it has to be mapped to something else. The problem is that it cannot be mapped to entities like those which lexical items are mapped to; for in that case the unity of meaning cannot be explained without evoking Bradley’s regress. Thus, either we have to give an account which explains the meaning of syntax without inducing Bradley’s regress, or we have to ground the meaning of sentences in something inherently meaningful. I return to the former strategy in

²⁸ King’s official answer to the question ‘what holds the constituents of propositions together’ is that if propositions are a special kind of facts, then the question of the unity of the proposition becomes the question of the unity of the fact (cf. Higginbotham 2009). King does not answer how facts are united; rather, he argues that this is a more general problem which his account does not have to solve. The problem is that King’s Russellianism about propositions (and hence facts) always entails Bradley’s regress and thus makes it impossible to explain the unity of the fact, and hence of the proposition (cf. chapter 2.2.1).

chapter 4, arguing that, as far as grammatical meaning is concerned, such a move is not explanatory. In this chapter, I explore what, if anything, could be inherently meaningful. I begin with a discussion of recent proposals according to which cognitive act- or event-tokens are inherently meaningful.

3.2.3 Propositions Cannot be Abstracted from Cognitive Acts or Events

When Sue says that John is smart, she predicates smartness of John. Predicating something of something else is a cognitive act. Since acts are events, whenever someone predicates something of something else, there is also a cognitive event. Soames (2010b; 2010a, chapter 5.2; 2013b) identifies propositions with types of cognitive events.²⁹ For example, the proposition that snow is white is an event type such that its tokens are all the predications of whiteness of snow (Soames 2010b: 103).

In many respects, the general outline of Hanks's (2011) theory of propositions is reminiscent of Soames'.³⁰ Hanks takes propositions to be types of complex acts. For example, if Sue asserts that John is smart, Sue refers to John and predicates smartness of him. Yet in order to predicate smartness of anything, Sue first needs to 'express' it. So Sue's assertion that John is smart involves a complex action consisting of an act of reference, an act of expressing a property and an act of predication. Hanks identifies the proposition that John is smart with the type of the complex act consisting of these three basic acts.³¹

According to Soames and Hanks, the origin of representationality has to lie in cognitive act-tokens with inherent semantic properties. Propositions, that is, types of cognitive acts or events, are taken to inherit their semantic properties from their respective tokens. As Soames (2010b: 107) argues, 'propositions are representational *because* of their intrinsic connection to the inherently representational cognitive events in which agents predicate some things of other things.' In the same vein, Soames (2013b: [9]) writes that 'the representationality, and hence truth-conditions, of the proposition are due to the representational features of these possible

²⁹ Whereas in earlier publications, Soames has explicitly argued against identifying propositions with act-types, he recently contended: 'I now am more inclined to identify propositions with cognitive acts than with event types' (Soames 2013a, n. 16). This change of mind, however, does not bear on the following discussion.

³⁰ For a critical review of Hanks's approach see Jespersen (2012).

³¹ The main difference between Hanks's and Soames's theory is that Hanks, unlike Soames, insists that propositions always come with declarative, interrogative or some other kind of force. Cf. Hom and Schwartz (2013) for a critique of this aspect of Hanks's theory.

instances'.³² Hanks (2011: 41) makes a similar move when he argues that 'linguistic tokens are the primary bearers of semantic properties, and linguistic types inherit their semantic properties from their tokens.' For example, 'the reason the proposition that Le Carré is a novelist is true if and only if Le Carré is a novelist is that tokens of this proposition, particular assertions that Le Carré is a novelist, are true if and only if Le Carré is a novelist.'

Cognitive act- or event-types are supposed to be ontologically cheap. According to Soames (2010b: 3), cognitive act types are *abstracted* from their tokens. Indeed, if they were supposed to be more independent entities, they could not simply inherit their semantic properties from their instances; and we would again face the puzzle of why they are endowed with representational properties. However, taking types to be no more than abstractions from their tokens introduces a problem that stands in the way of any serious semantic explanation: any explanation of why a certain cognitive act- or event-token has the representational content it does, in effect, has to rely on the type it falls under. For, there has to be a certain feature that renders the act the kind of thing it is (or a number of features that collectively do so). Without such a requirement, every cognitive act-token could just have any representational content, which is clearly unwarranted. Yet, if we assume a feature that all instances share, we have, in effect, assumed the type. I shall discuss three aspects of this problem.

First, assume that at time t_1 Sue says that John loves Mary and that at t_2 she again says that John loves Mary. Why is it that we regard both of these acts as instances of the same type? Part of the answer is presumably that both acts involve the same constituents: John, Mary and the loving relation (or referring to John, referring to Mary and mentioning the loving relation, for Hanks). Yet, this cannot be all, since Sue's assertion that Mary loves John at t_3 , sadly, does not fall under the same type as the other two acts, despite involving the same constituents. In addition to having the same constituents, the relevant tokens also need to say the same thing about the constituents: in the first two acts, John is said to love Mary and not vice versa. This, it seems, is an aspect of the structure of the acts in question. Thus, a structural criterion has to be part of any account of which acts fall under the same type and under different types. What makes a certain cognitive act an instance of the proposition that John loves Mary, then, is that it has John, Mary and the loving relation as constituents and that these constituents stand in a certain structural relation to one another. And this already is the definition of a type – the type of things falling under the proposition that John loves Mary. Thus, in order to say which things are

³² At the SPE Conference in June 2013, Soames indicated that he has recently changed his mind on this issue: in line with my critique, he now regards the types as inherently meaningful, not the tokens. For the purpose of this dissertation, however, I will be concerned with the position that he has defended in print.

to constitute a certain type, the type has, in effect, to be presupposed. If tokens are taken as the primitive, it has to remain a mystery why there are the types there are, and any investigation into the question of why a cognitive act has specific representational properties and not others becomes impossible.³³

Second, if Sue asserts that John loves Mary and also believes that Mary is a Scotswoman, she is thereby committed to John loving a Scotswoman. As has been noted since antiquity, inferences like these are independent of the particular constituents of sentences: if we replace *Mary* by *Jane* or *John* by *Bill*, the inference is still valid. Yet, in order to formulate such rules, acts of asserting must have a certain structure and mean what they mean partly because they have this structure. Of course, every single cognitive act exhibits such inferential properties. But this is no reason to base one's logic on tokens; for, we can only explain why the tokens have the inferential properties they have if we accept that they fall into certain types and that these types are related in a law-like way. If this was not the case, logic would be impossible: the inferential role of every sentence-token would have to be specified independently of the type and other sentences – a conclusion that not even a pragmatist could accept. Furthermore, this problem does not only concern inferential behaviour, but also the explanation of all respects in which, for example, tokens of *John loves Mary*, *Bill loves Mary* and *Bill loves everyone* are similar or different.

Third, not all cognitive acts or events are instances of propositions; other cognitive events that Soames (2010b: 129) mentions are applying functions to arguments, negating, conjoining, and disjoining. Yet there cannot be a criterion which separates, say, predicatings from conjoinings (or from any other cognitive act type) if act types are abstractions from tokens. How could we tell that some cognitive events are predications whereas others are not? It seems that an answer to these questions has to be structural: a certain act-token is a predication as opposed to a negation or conjunction because it has a certain structure. But this implies that the type is explanatorily prior to the token and, thus, cannot be a mere abstraction from its tokens. As Collins (2011b: 156) formulates the point, 'mere abstractions from predications do not explain why the instances realize the predication features they do.' Replying that what distinguishes the different kinds of event-types is that some are acts of predication whilst others are acts of conjoining would be circular.

³³ Crawford (2013), who identifies propositions with types of predication acts, admits the explanatory importance of types, but nonetheless argues that 'predication act-types are ways of typing act-tokens on the basis of the latter's content, that is, on the basis of what is predicated of what in the various token acts of predication being typed together,' without noting that such a 'typing together' de facto presupposes the assumption of the types in question.

To be fair, although Hanks does not discuss how to derive propositions from cognitive act-tokens, he does discuss how to define reference types. So, let us have a brief look at how reference types are defined and whether this method could be generalized. According to Hanks, semantic reference types are defined with the help of a relation *R* that holds between two reference tokens iff (under ideal circumstances) anyone who is semantically competent with the names used realizes that they have the same referent (Hanks 2011: 27). This condition is met if the two acts of reference involve the same name or if they involve two different names which are conventional translations of one another (Hanks 2011: 46). Two names are distinct if they are ‘syntactically different or they have different referents (or both)’ (Hanks 2011: 29). That is, two tokens of acts of reference fall under the same semantic reference type if the reference is identical and if the names used are syntactically similar or conventional translations of each other. In some contexts, more finely (Hanks 2011: 36) or more coarsely grained reference types (Hanks 2011: 39) than semantic reference types are relevant; but for the present purpose, we can leave this complication aside.

Note that this criterion only works if two kinds of types are already presupposed. First, a criterion is needed to determine which tokens count as syntactically similar; that is, in effect, we have to assume syntactic types. Second, a criterion is needed to determine which acts count as acts of referring, as opposed to acts of mentioning, for example. It is not clear what, other than a structural criterion, could be used for this purpose. Nonetheless, in the case of individuating semantic reference types, the referent also does some work. Since the referent is taken to be independent of the acts of reference, defining semantic reference types with the help of tokens is not completely circular. However, in the case of Hanksian propositions, there is nothing taking an analogous role to the referent in acts of reference: after all, the approach has been developed as an alternative to the classical notion of propositions, according to which they are more substantial abstract entities that have their representational properties inherently. Hanks’s recipe for defining semantic reference types can thus not be used for propositions.

Jubien (2001) has adopted a different strategy to avoid the problem that it is unclear how mind-independent entities could have semantic properties inherently. According to him, there are no propositions, strictly speaking (cf. also Moltmann 2003a; 2003b; and, with some intricate qualifications, 2013). Following Russell’s Multiple Relations Theory of Judgement, he maintains that if Sue believes that John loves Mary, Sue stands in a multigrade relation to John, Mary and loving. This relation is thought of as a psychological one. Hence, ‘the burden of intentionality’ is placed ‘squarely on the shoulders of agents with intentional capacities.’ Subjects are credited ‘with, first, the intentional ability to hook together the constituents in the

right way, and second, the capacity to have a variety of different attitudes toward the same constituents' (Jubien 2001: 56). Having a belief, that is, standing in a particular multigrade relation to the constituents of the would-be proposition, is a relational property people can have or fail to have. This allows Jubien to account for quantification over would-be propositions. For example, if Sue believes that John loves Mary, she has a certain multigrade property which Bob can also have. Therefore, even though the source of intentionality is taken to be psychological, it is possible for Sue and Bob to have the same belief. So, when Bob believes everything Sue believes, Bob has all the belief-properties that Sue has.

Nonetheless, the account faces similar difficulties as the theories discussed above: what is it that makes a certain mental/cognitive state a belief rather than anything else? It seems that the answer has to rely on structural properties of the mental state: if the particular state instantiates a certain structure, it is a belief, and if it doesn't, it is not a belief. Furthermore, what distinguishes the belief that John loves Mary from the belief that Mary loves John? Again, the answer has to be structural. Finally, what is it that makes two judgements instances of the same type? Again an appeal to the structure and the constituents of the judgements seems unavoidable.

In sum, we find ourselves in a paradoxical situation: when propositions are abstract, mind-independent entities, it is unclear how they could be endowed with intrinsic semantic properties. Yet, grounding representationality in tokens of cognitive acts or events makes any serious semantic explanation impossible. In the following sections, I therefore speculate on what kinds of types could plausibly be taken to be inherently meaningful.

3.2.4 Grammar is Inherently Meaningful

The thesis that structures are not inherently meaningful but require interpretation is closely related to the divide of language into a syntactic and a semantic component. The division between syntax and semantics is central to formal languages. In formal languages, the syntax defines the set of primitive expressions and rules of combining them into well-formed complex expressions. Given a syntax, it is possible to define an interpretation function that determines what the basic expressions stand for and what the syntactic rules contribute towards the meaning of a complex expression. The relations defined by the interpretation function are arbitrary. In analogy, for a natural language, we may assume that syntax defines which sounds are well-

formed expressions of a particular language. The semantics can then be seen as determining what the well-formed sounds stand for.³⁴

However, even though the syntax-semantics divide is very useful in respect to formal languages, there is no necessity for it to apply to natural languages, given that they are natural rather than stipulated objects. Indeed, Mukherji (2010: 77-78), for example, argues that for natural languages,

the form of a sentence is intrinsically connected to its interpretation [...] if you know that a given string is, say, an English sentence, then you cannot fail to attach some semantic interpretation to it. [...] It follows that the conception of a phonological form as a representation of “noise” is without any clear sense.

One argument towards this conclusion consists in considerations concerning the question of how we can determine the syntactic structure of a given sound in a certain language, given that this is an empirical matter and not subject to stipulation. The sounds of natural languages (or the signs of natural sign-languages) do not come in clearly separated units – it was a central finding already of the Structuralist tradition that sounds can only be broken up into separate units by considering the difference they make for meaning. Although the two sentences in (25) are perceived as phonologically clearly distinct, the sounds associated with them are not physically distinct:

- (25) a. Have you looked at this guy yet?
 b. Have you looked at the sky yet? (Jackendoff 1997: 56)

Jackendoff (1997: 53) summarizes:

One of the primary intuitions we have about language is that it comes divided into words, and that the words can be neatly divided into syllables and individual speech sounds. [...] It turns out that this sequence is a considerable abstraction of what physically takes place in speech. The acoustic stream we hear as speech shows no such neat divide.

Also a morpheme is defined as the smallest unit which is independently *meaningful*. As for syntax, a structure containing the same words in the very same order may nonetheless be assigned two or more different syntactic structures which account for different possible interpretations. Consider (26):

- (26) The president called the senator from Texas. (Pietroski 2005b: 257)

³⁴ As Collins (2013, section 2) stresses, ‘syntactic organisation appears to be only contingently or even arbitrarily associated with truth-conditions.’

There are two possible structures for this expression which correspond to the two possible interpretations in which *from Texas* either modifies *the senator* or *called*. But there is no third possible reading according to which *from Texas* modifies *the president*. The assumption of grammatical principles is often motivated by the possibility of the possible readings and the impossibility of the infinitely many impossible readings of the sentence. Therefore, grammar is also able to *explain* both the positive and the negative facts about the part of meaning which relies on structure (as opposed to the lexicon). A sentence means what it does inter alia because it has the syntactic structure it has. An explanation of the above facts has to be grammatical, rather than say logical or semantic, since from a logical or semantic point of view, it is not impossible for *from Texas*, for example, to modify *the president*.³⁵

In sum, differences in meaning are part of the motivation for assuming certain grammatical structures, as opposed to others. As Higginbotham (1989: 159) argues, ‘the theory of meaning and the theory of form do not proceed along separate tracks.’ Furthermore, the grammatical structures are assumed in order to *explain* the differences in meaning. There is, thus, no notion or theory of syntax for a natural language which is independent of meaning. Or, put in Mukherji’s terms, the grammar of natural languages never only concerns noise.³⁶

One may be tempted to object that the argument presented here is primarily epistemological. In what way does the fact that we cannot figure out the syntax of a language without considering what it means imply that there is no syntax-semantics divide in natural languages? But such an objection would miss the target. The point is not about how we can find out what the syntactic structure of a natural language construction is – it is about what explains that a certain

³⁵ Similar examples can be given in respect to many phenomena in language: already the interpretation of words which consist of more than one morpheme are sensible to their syntactic structure. Consider the difference between (i) and (ii):

- (i) an un[lockable] door
- (ii) an [unlock]able door

The former door is one that cannot be locked but it is not specified whether it can be unlocked. In contrast, the latter door can be unlocked – whether it can be locked is not specified.

As a further example concerning syntactic structure, consider quantifier scope. As noted in the Preface, May (1977) famously argues that quantifiers raise to their proper scope position. And, indeed, in some languages, this is the place where we find them (Kiss 1991).

³⁶ Mukherji (2010, ch. 3) gives a second argument towards the same conclusion: in current grammatical theory, phonological and semantic structures are the result of a single derivation. That is, the derivation of a sentence produces both a phonological and a logical form (PF and LF), whereby most aspects of the derivation are relevant for both. In this sense, PF and LF are derivationally rather than arbitrarily related. Furthermore, according to the phasal model of grammatical structure-building, both PF and LF are derived in ‘chunks’. Strictly speaking, there is, thus, no single level of phonological and semantic representation.

expression means what it does. In many cases, grammatical structures are posited to explain the structural aspects of meaning, that is, the aspects of meaning which go beyond the meanings of lexical items. Of course, we could in addition assume a semantic structure which the grammatical one is mapped to. But since such an additional structure would in the relevant respects have to be isomorphic to the grammatical one, it does not add anything to our understanding of these aspects of meaning. I will come back to this point in sections 4.3-4.4.

3.2.5 Naturalizing Grammatical Meaning

We still haven't answered the question in virtue of what grammatical structures are supposed to be inherently meaningful, rather than mere theoretical devices of describing facts about meaning. I only know of one answer which has the desired result: the relation between the structure and its meaning is a biological one – grammatical structures themselves, then, have to be taken as natural objects. Such a view is, of course, in conflict with what is probably the most popular view in philosophy, namely that language is a conventional system. Soames (1989: 589) speaks for the philosophical mainstream when he says that 'coming to understand the sentence is a matter of satisfying conventional standards regarding their use.' In chapter 1.1.1, I have listed some reasons for studying language, and hence grammar, as a natural object – and I shall not add a defence of this thesis at this point. Yet, if taking grammatical form to be a natural object is indeed the only way of providing a solution to what Soames calls 'the real problem', this finding could itself serve as an argument in favour of thinking of grammar in this, from a philosophical point of view, untraditional way.

In what way can meaning become an inherent feature of a grammatical structure if grammar is thought of as a natural object? Hinzen argues that if grammar is a natural object, its structures are on a par with other natural structures, like that of the DNA. If so, the relation between a grammatical structure and its meaning is equivalent to that between the DNA of an organism and the role the DNA plays for the development of the organism. In principle, a DNA sequence could be mapped to anything. 'You can map any DNA sequence of an organism to bottles and pancakes. The question is why you should' (Hinzen 2006: 229), since the DNA serves a very particular and clearly defined biological function: 'The DNA codes for the proteins it codes for, playing a particular causal role in an organismic process' (Hinzen 2006: 229). Similarly, grammatical structures have such a biological function, if they are natural objects. 'An LF/SEM is, equally, a particular organismic structure' (Hinzen 2006: 229). Due to structural differences, 'expressions will play a different causal role in our mental life and behaviour' (Hinzen 2006: 228). The link between structure and meaning is then a functional biological one.

We may, of course, ask further why the grammatical structures give rise to the meanings they give rise to. I address aspects of this question in sections 3.3 and 5.1: the meaning of complex grammatical structures can often be predicted with the help of basic grammatical principles. On the other hand, every empirical theory will have to adopt some notions as primitive. For these primitives, there is usually no conceptual necessity.³⁷ Further research may always be able to push the limits of our understanding further backwards; yet, even if such an attempt is successful, there will be another such limit. Thus, perhaps it is possible to explain the linguistic primitives in terms of more general biological or cognitive principles. But then the question what these principles follow from will probably still be open.³⁸ This picture is not very far off Soames' account (insofar as Soames' account is spelled out) in that it naturalizes propositions by binding them to cognition; at the same time it repairs what seem to be a central problem in this account by attributing a central explanatory status to grammatical structure.³⁹

In sum, some theorists in the tradition of structured propositions rightly dispense with propositions as mysterious third-realm entities; taking these entities as meanings of sentences and contents of thoughts ensures 'the impossibility of explaining the intentionality of anything' (Soames 2010b: 107). Yet, King's strategy of explaining meaningfulness, which implies that nothing is inherently meaningful, is problematic in that it gives rise to a regress similar to Bradley's regress. The attempt to ground the meaning of language in cognitive act- or event-

³⁷ In *this* respect, my proposal does not differ much from that of King's (2009: 263), who argues that 'it seems very likely that [...] due to [our] biological endowment, we come hard-wired to interpret syntactic concatenation in a small handful of ways.' The difference between King's proposal and the one I'm defending in this thesis, then, mainly concerns the question of where exactly grammar is located: King assumes that the relation between grammatical structure and its meaning is arbitrary, whereas I argue that it is not. Correspondingly, even though King subscribes to many aspects of Generative Grammar, he nonetheless seems to think of important aspects of grammar as conventional, whereas I don't.

³⁸ According to Poeppel and Embick (2005), the unification of linguistics with the rest of biology is still not in sight and, if it is not forever out of the reach of human understanding (Chomsky 2010), the unification of these domains may well require a fundamental revision of biological or even physical theory (Chomsky 2000).

³⁹ My proposal also accommodates the productive nature of language (and cognition more generally) which is present in the following quote – radicalizing and structuralizing it by getting rid of Soames' conventionalism about language:

In the case of many sentences, we do not grasp the propositions they express prior to understanding the sentences themselves. [...] Coming to understand the sentences [...] is counted not only as understanding new sentences, but also as grasping new propositions. As a result, learning a language is not just a matter of acquiring a new tool for manipulating information one already possesses; it is also a means of expanding one's cognitive reach. (Soames 1989: 589)

It should be noted, though, that for Soames the difference language makes is restricted to providing access to objects 'with which no one is, or could be, in direct epistemic contact' (Soames 1989: 590).

tokens is no less problematic, since in order to explain why certain cognitive events are predications whereas others are not, we have to rely on structural differences between the two kinds of events. In that case, assuming that structures are mere abstractions from their tokens would be circular. The way out of this dilemma that I have pointed out is to reconsider the contention that structures have to be arbitrarily related to their meanings. Certain structures like the DNA of a certain organism simply bear a certain functional role in the development of this organism and something similar may be true of certain cognitive structures. I have reviewed some reasons for assuming that grammar is equally inherently meaningful.⁴⁰ But, what kind of meaning is grammatical meaning? In the following chapter, I propose an answer to this question which also helps in answering UQ2. Before that, however, I turn to one example where grammar can do work that is usually associated with semantics.

3.3 Grammar and Entailment

The relation between different sentences, in particular relations of entailment, consistency etc., have always been a central aspect of philosophical inquiry. Thus, when I claim that grammar is inherently meaningful, there should be some way of explaining those aspects of entailment etc. that are due to structural (as opposed to lexical) information in grammatical terms. Indeed,

⁴⁰ It might be objected that this account renders propositions linguistic entities. Yet Soames thinks of propositions explicitly in more general terms:

Although language is the locus of our ordinary and theoretical talk about meaning, [...] propositions [...] are understood in [...] all forms of cognition. For this reason, I reject the pervasive “language of thought” fantasy, which wrongly takes linguistic meaning as the fundamental model [...]. By contrast, I start with perception. One who sees an object *x* as *red* and tastes it as *sweet* thereby predicates redness and sweetness of it. (Soames 2010b: 7-8) There is nothing in our notions of knowledge, belief, and other cognitive attitudes that restricts them to human agents. (Soames 2010b: 81)

The thesis that there is no qualitative difference between human and non-human cognition is not uncontroversial in philosophy, and empirical evidence seems to speak rather in favour of a qualitative difference (cf. e.g. Csibra and Gergely 2011; Penn, et al. 2008; Tomasello 2008; compare also the discussion in section 4.3). However, whether or not the thesis that predication is such a general notion that also applies to perception is correct or not does not bear on my proposal in this section. What is important is the question of whether perception is structured. You may either think ‘seeing something *as red*’ is completely unstructured. In that case, there is no sense in which it could be true or false and, more importantly, in that case, it is not clear what is predicated of what. Predication, it seems, has to rely on structure. Yet if ‘seeing something *as red*’ does have structure, a position which has become more popular in recent philosophical approaches (e.g. McDowell 1994) and which Soames (2013b: 6-7) seems to adopt, there is no a priori reason why this should not be the cognitive structure which linguists describe in their grammatical theories. In that case, what has been called ‘grammar’, or at least aspects of it, is simply a more general cognitive phenomenon than originally anticipated (cf. chapter 1.1.3).

Ludlow (2002), drawing on Sánchez (1991; 1994) and Dowty (1994), has done much to bring medieval syllogistic logic into the reach of grammatical theory (section 3.3.1). In Reichard (2012a; 2013a), I have developed a grammatical theory of intersective and subjective modification and the respective entailment relations, which syllogistic logic does not cover (sections 3.3.2-3.3.4). Hinzen and Reichard (2011) have outlined how grammar can be used to explain entailment relations between ontological categories.⁴¹ Summarizing these accounts in this section, I develop some ideas of how grammatical principles can be used to explain the validity and invalidity of inferences.⁴²

The grammatical explanation of the validity of inferences is, evidently, limited to inferences that depend purely on grammatical as opposed to lexical information. However, formal logical systems face a similar limitation: modern formal logic presupposes a strict distinction between the form and content of sentences and thoughts. In respect to modern logic, it has been argued that the notion of formality assumed in these theories – a notion which goes back to Kant’s transcendental philosophy – is not well motivated if the Kantian framework is not taken on board, which it usually isn’t (MacFarlane 2000).⁴³ However, a theory of implication which is based on grammar does not face this problem, since the distinction between grammatical structure and lexical items, on which I rely, is an empirically well supported and theoretically well defined one (cf. chapter 5.3).⁴⁴ A second advantage of the grammatical explanation of the

⁴¹ Some passages in this section are adapted from these three articles.

⁴² Such a close relation between grammar and formal validity of inferences has been proposed by Quine (1970: 17), who argues: ‘It is a general practice, in intellectual pursuits, to argue from the truth of one sentence to the truth of another. Some such arguments are the business of logic, others not. They belong to logic if they hinge purely on the structure of the sentences concerned, rather than depending on content. But the structure of sentences consists in grammatical constructions. Here, then, is the intimate connection between grammar, truth and logic.’

⁴³ Pragmatists have argued that the distinction between form and content has to rely on the individual inference rather than on a general form. According to them, what is part of the logical form of a sentence in respect to one inference may not be part in respect to another (cf. e.g. Whiteley 1951). I argue in chapter 5 that the relation between form and content in respect to natural language is, although complex, much more systematic. The complexity is due to the different layers of formal ontological classification and the fact that from the point of view of a higher layer, the ontology of the lower layer becomes part of the content rather than form.

⁴⁴ MacFarlane (2000: 44, n. 19) argues that

linguistics and cognitive science may give good grounds for preferring one of two grammars that are equivalent in the set of meaningful expressions they generate, on the grounds that it corresponds more closely with the psychological mechanisms responsible for speakers’ linguistic competence. However, it is doubtful that the psychologically “real” grammar would yield a notion of formality useable for demarcating logic, and I am not aware of any recent proposals along these lines. In the early 1970s, there was a proposal (“generative semantics”) to meld grammatical form with logical form by letting the goals of each constrain the other [...]. But this program seems to have self-destructed by the late 1970s.

formal validity of judgements over a formal logical explanation of the same fact is that grammar is an empirical discipline, whereas logic is not. Due to the stipulated nature of formal logical systems, nothing in the logical system necessitates that humans use one formal system rather than another as basis for their judgements. Grammar does not face this problem; grammatical theory describes a human cognitive capacity.⁴⁵

3.3.1 Natural Logic and Generative Grammar

Aristotle's logic covers mainly the interrelation between negative and affirmative existential and universal statements. Its original formulation is restricted in that it does not cover all possible cases; it is also *ad hoc* in that it does not show in what sense the valid inferences form a natural class. The medieval logicians have tried to improve classical logic in both respects: they widened coverage and tried to reduce the principles of valid inferences to two. The latter is what Ludlow (2002) calls 'the Holy Grail of natural logic'. The two rules are to be used in different environments: *dicto de omni* and *dicto de nullo*. They correspond to upward entailing (monotone increasing) and downward entailing (monotone decreasing) environments in modern terminology – though as Sánchez (1994) observes, *dicto de nullo* and downward entailing environments don't match perfectly. Let ' $A < B$ ' indicate that (all) A(s) are/is B. Then the two rules are as follows (Ludlow 2002: 136):

- (27) An environment α in a sentence ϕ is a *dictum de omni* environment iff
 $[\phi \dots [\alpha \dots A \dots] \dots]$ entails $[\phi \dots [\alpha \dots B \dots] \dots]$ iff $A < B$
- (28) An environment α in a sentence ϕ is a *dictum de nullo* environment iff
 $[\phi \dots [\alpha \dots A \dots] \dots]$ entails $[\phi \dots [\alpha \dots B \dots] \dots]$ iff $B < A$

The classic example is (29). The quantifier *all* elicits a *dictum de omni* environment. The second premise specifies that *animal < mortal*. Therefore, *mortal* can replace *animal* in the original sentence.

- (29) All men are animals
All animals are mortal
 All men are mortal

It is the purpose of this section to suggest the opposite conclusion. The separation between the formal and the non-formal aspect of language is not stipulated but empirically discovered. The breakdown of generative semantics was in part caused by the urge to overcome a clear distinction between lexical and grammatical meaning (cf. Bagha 2011 for a recent review), that is, a refusal to accept the limits of possible grammatical explanation of inferential behaviour.

⁴⁵ This paragraph was inspired by Kirkby (2012a).

(27) and (28) cover more instances than the original Aristotelian logic. If you take ‘If A then B’ to be an instance of ‘A < B’ even *modus ponens* and *modus tollens* are included. Thus, unlike in modern logic, we do not need different inference rules for different kinds of inferences. Negation turns an environment from *dictum de omni* into *dictum de nullo* or vice versa. Quantifiers can exhibit different entailment environments in their first and second position: ‘Some’ has *dictum de omni* in both positions, ‘no’ has *dictum de nullo* in both positions, ‘every’ has *dictum de nullo* in the first, *dictum de omni* in the second position.

Ludlow (2002: 139) argues: ‘If all of natural logic can be reduced to cases of the *dicta de omni et nullo* and if those paradigms can in turn be identified as features of clearly identifiable syntactic forms, then the natural logic project becomes a chapter in the syntax of natural language’. He sketches how it is possible to integrate the environments into a minimalist derivation. Quantifiers can be defined in terms of *dicta de omni et nullo* environments: if determiners are so defined, they ‘control structure-building and have no interpretation of their own’ (Ludlow 2002: 153); or, to put it in other terms, determiners are the morphological realization of certain structural configurations. The environments, in turn, can be defined in terms of negations: a positive number of negations scoping over an expression yields *dictum de omni*, a negative number of them yields a *dictum de nullo* environment.⁴⁶ Ludlow stresses that even ‘most’ can be handled this way.⁴⁷ The reader is referred to Ludlow’s article for the technical details. What is important for my current purposes is that natural logic can be reduced to syntax and that it can therefore be integrated into a grammatical theory.

⁴⁶ Ludlow assumes a template for the nominal domain which has as its highest projection a Polarity Phrase (Pol_IP). It follows a Proportion Phrase (PropP) for phrases like *half* or *all* in *all the man*. This is followed by the DP, NumP, and NP. *No*, for example, has three features {_{-scope}, _{-restrict}, _v}. _{-restrict} triggers movement to the specifier of Pol_IP negating it. It then moves to IP (Inflection Phrase) for case reasons. Above IP, there are two relevant projections: a sentential Polarity Phrase (Pol_SP) and a Conjunction Phrase (ConjP). _{-scope} triggers movement to Pol_SP turning it negative, and _v triggers movement to ConjP. So, for *no man is mortal* we get: _{ConjP}[-man [_v _{Pol_SP}[-man [-_{IP}[-man [_I _{VP}[_{Pol_IP}[-man [-_{DP}[no [NP]]][mortal]]]]]]]]].

⁴⁷ Some independent support for the thesis that the two kinds of environments are aspects of grammar comes from the distribution of negative polarity items like ‘any’ and ‘ever’. These expressions have long been thought to be triggered by semantic features, since they are correlated with downward entailing environments. This is problematic, as it is not clear how holistic semantic features could have an influence on syntax. However, if the syntactic account of *dicta de omni et nullo* is correct, there can be a syntactic account of the distribution of negative polarity items. Furthermore, syntactic constraints can be placed upon the class of possible determiners in natural languages. If determiners are restricted to a certain class of feature settings involving only conjunction, disjunction and negation, then we also can give a syntactic explanation of their conservativity.

3.3.2 Intersective and Non-Intersective Modification

In many cases, the second premise of a syllogism that (all) A(s) is/are B(s) is based on the hierarchical structure of the lexicon or general world knowledge. Yet, in other cases, one may feel, it is due purely to the form of the expression. This is in particular the case in respect to modified nouns. Consider (30):

- (30) Socrates is a white man.
(All) white men are men.
 Socrates is a man

In this case *white man* < *man* may be thought to be guaranteed by the form of the expression alone, without consideration of the lexicon or general world knowledge. In both syllogistic logic and modern predicate logic, adnominal modification has usually been analyzed in terms of conjunctions. Consider the inferential relations between the sentences (31)-(34). (31) entails (32)-(34), (32) and (33) separately entail (34), but a conjunction of (32) and (33) does not entail (31), since we might talk about different houses in (32) and (33).

- (31) There is a blue house in London.
 (32) There is a blue house.
 (33) There is a house in London.
 (34) There is a house.

Grammatically, *blue* and *in London* modify *house* in (31). However, being mainly concerned with inferential behaviour and not with grammatical structure, in standard predicate logic, *house*, *blue* and *in London* are taken to be predicates of an underlying variable which the sentence is an existential quantification of. The logical form of (31), then, is (35). This accounts for the inferential behaviour observed in (31)-(34), since then the entailments can be explained as instances of conjunction reduction. The fact that a conjunction of (32) and (33) does not entail (31) is accounted for by the different existential quantifiers which scope over the variables of the respective predicates.

- (35) $\exists x \text{ house}(x) \ \& \ \text{blue}(x) \ \& \ \text{in London}(x)$
There is an object x , such that x is a house, x is blue, and x is in London.

Davidson (1967b) has famously proposed to extend this analysis to events and adverbial modification. The main motivation for this proposal was the parallel inferential behaviour of sentences like (36)-(39) and (31)-(34): (36) entails (37)-(39), (37) and (38) separately entail

(39), but their conjunction does not entail (36), since Shem may have boiled the soup at nine o'clock in Edinburgh and at five o'clock in London.

- (36) Shem boiled the soup at nine o'clock in London.
- (37) Shem boiled the soup at nine o'clock.
- (38) Shem boiled the soup in London.
- (39) Shem boiled the soup.

Grammatically, *at nine o'clock* and *in London* modify *Shem boiled the soup*. However, the most straightforward way of capturing the inferential behaviour of these sentences in logical terms is again to disregard the grammatical structure and to assume that *Shem boiled the soup*, *at nine o'clock*, and *in London* are predicates of an underlying event variable *e* introduced by the action verb. Action sentences, then, can be analyzed as existential quantifications over events. Under this analysis, the logical form of (36) is (40).

- (40) $\exists e$ boil(Shem, the soup, *e*) & at nine o'clock(*e*) & in London(*e*)
There exists an event e such that e is Shem's boiling of the soup, e happened at nine o'clock and e happened in London.

The analysis was quickly generalized from sentences involving action verbs to many other kinds of sentences (Davidson 1969). In particular, it has been argued that also copula sentences can be analyzed in a similar way, if (in parallel to event variables) state variables are admitted as implicit arguments of the copula and stative verbs (Parsons 1990; 2000). The logical form of (41) is (42) under such an analysis.

- (41) Some years ago, John was in love.
- (42) $\exists s$ in love(John, *s*) & some years ago(*s*)
There exists a state s, such that s is John's being in love, and s held some years ago.

Finally, Moltmann (2013, ch. 2.5) has proposed an analysis of adverbial modification of adjectives in terms of implicit quantification over tropes. The logical form of (43) is then as given in (44).

- (43) The rose is deeply red.
- (44) $\exists t$ red(*t*, the rose) & deep(*t*)
There exists a trope t such that t is the redness of the rose and t is deep.

However, analyses of modification in terms of predicate conjunction face a limitation. As already Aristotle (*de Int.*, ch. 11) noted, many modifiers are not intersective and hence do not

allow for the full range of inferences. For example, although a skilful surgeon is a surgeon, John may not be a skilful violinist, even if he is a violinist in addition to being a skilful surgeon. However, if adnominal modification is analyzed as predicate conjunction in the way described above, then the conjunction of (45) and (46) should entail (48), which, by conjunction reduction, should entail (47).

- (45) John is a skilful surgeon.
- (46) John is a violinist.
- (47) John is a skilful violinist.
- (48) skilful(John) & surgeon(John) & violinist(John)

Adjectives like *skilful* have been called ‘subsective’ since the denotation of the combination of adjective and noun is a subset of the denotation of the noun, but not of the denotation of the adjective (Kamp and Partee 1995). In contrast, adjectives are called intersective when the denotation of the combination of adjective and noun is a subset of both the denotation of the adjective and the denotation of the noun taken for themselves. A third class of adjectives has been dubbed ‘non-subsective. *Former* is one adjective which belongs to this class: The former president is not a president anymore, thus an inference from the combination of noun and adjective to the adjective is not valid. I shall disregard this class of modifiers in this section. They are not very frequent and usually use one of the grammatical ways of deferring reference.

In the early Montagovian tradition (Clark 1970; Montague 1970; Parsons 1970), a uniform treatment of parts of speech (which were taken to be lexical categories) was standard. To allow for this, all adjectives were treated as non-subsective. In order to capture the different inferential properties of the different classes of adjectives, additional specifications may be part of the lexical entry. These may be formulated as ‘meaning postulates’ (Kamp and Partee 1995; Partee 2007). An alternative way of capturing the data is to give up the aim of providing a unified treatment of lexical classes. In this case, the denotation of intersective adjectives, for example, can be treated as standard sets (Siegel 1976).

In both cases, the difference between intersective and subsective modification is taken to be a lexical one. However, many adjectives that are traditionally classified as subsective also have an intersective reading, and most, if not all, adjectives that are traditionally classified as intersective also have a subsective reading – even if in many cases one of the readings is marginal for pragmatic reasons (Reichard 2013a). If this conjecture is correct, the lexicalist account of adjective classes introduces a high redundancy into the lexicon and misses out on an explanation for the systematicity of the phenomenon. Furthermore, in the semantic literature, there has been

considerable disagreement about which adjectives belong to which of the classes mentioned above. Even though this is not a decisive point – different speakers may have different lexicons –, it could already put some initial doubt on the idea that adjectives belong to inferential classes qua their lexical entry.

3.3.3 Two Ambiguities

As first noted in Bolinger (1967), deverbal adjectives exhibit an ambiguity when combined with a noun: they can either be used as attributing a temporal or as attributing a non-temporal property. This contrast seems to coincide with the distinction between stage-level and individual-level predicates, discussed in Carlson (1980). According to one reading of the adjective *visible* in (49), for example, Cappella is one of the stars that are in principle visible but perhaps not now. The sentences could in this sense truthfully be asserted at daytime when actually no stars are visible at all. In this case, the adjective tells us something about a general property of the referent of the phrase; it concerns the individual referred to irrespective of the current situation and is thus an individual-level predicate. However, (49) can also be used to say something about the current properties of Cappella. According to this reading, the sentence can only be truthfully asserted if Cappella is visible at the time of the assertion. Used in this way, the speaker is not committed to the claim that the predicate denoted by the adjective holds of the referent of the phrase in general. According to this reading, (49) would be true even if Cappella was not generally visible but only at the time of the assertion. Used in this way, the adjective is therefore called a stage-level predicate. In Germanic languages, only the stage-level reading is available for post-nominal adjectives, as shown in (50). Post-nominal and pre-nominal occurrences can be combined. In this case the pre-nominal adjective has to be an individual-level predicate (see (51)). Furthermore, if the same (deverbal) adjective appears twice in pre-nominal position, the first occurrence has a stage-level and the second an individual-level reading, as in (52). In the examples (50) to (52), the stage-level predicates are italicised.

- (49) The visible stars include Cappella.
- (50) The stars *visible* include Cappella.
- (51) The visible stars *visible* include Cappella.
- (52) The *visible* visible stars include Cappella.

Stage-level readings are taken to be intersective, but individual-level readings are not. Thus, the denotation of *stars visible* in (50) can be correctly described as the intersection between all stars and all visible things. However, this is not the case for the individual-level reading of (49).

Interpreted in this way, (49) does not imply that Cappella is (currently) visible. If *visible* has an individual-level reading, the denotation of *visible star* can therefore not be a mere intersection. However, it can hardly be questioned that visible stars are stars. The individual-level readings of adjectives, thus, seem to follow the pattern of subsective adjectives.⁴⁸

A close correlate to the individual-/stage-level distinction can also be found in adjectives which are not deverbal. Indeed, there is a close correlation between the relation between objects and their temporal ‘slides’ on the one hand and that of kinds and their instances on the other. Thus, in this case, the individual-level reading of the deverbal adjectives corresponds to a kind-level reading of the non-deverbal adjective, and the stage-level interpretation of the deverbal adjective corresponds to an individual-level interpretation of the non-deverbal adjective. The most obvious interpretation of (53) is intersective. According to this reading, I assert that I own an object which is both a car and big (compared to other cars). And if I owned a Mercedes, for example, the sentence would be true. However, there is another reading such that I could truthfully assert (53) if the car I owned is just a small model (or version) of a Mercedes. Now *big* doesn’t modify the individual car I own, but the kind of car I own. In this reading, the truth of (53) is compatible with that of (54). Germanic languages don’t allow the intersective adjective to appear post-nominally in this case, as shown in (55). However, both uses of the adjectives can appear prenominally. In this case the first has an intersective and the second a subsective reading (see (56) and (57)). This parallels exactly the case discussed above (52).

- (53) I have a big car.
- (54) I have a *small* car.
- (55) *I have a car *small*.
- (56) I have a *small* big car.
- (57) I have a *big* small car.

Subsective kind-level readings can be found for most adjectives usually treated as intersective. When presented with a tepid cup of tea in a café, you may say to the waiter that you were hoping for a *hot* hot drink (if you are not too English an Englishman, anyway). And when you find tomatoes sorted in two boxes, one for the red and one for the green ones, you can ask for the *reddest* green tomato. Finally, when you find out that the truffles you have bought are made following a French recipe, but are actually produced in the UK, you may wish you had

⁴⁸ Larson (1998; 1999; 2000b; 2000a; 2002) argues that the distinction between stage-level and individual-level predicates should be captured in terms of differences in genericity. If he is right, there is a rather trivial grammatical explanation for the differences in interpretation, as I point out in Reichard (2012a).

bought *French* French truffles.⁴⁹ In sum, the distinction seems to be a genuine one, even if the situations in which a kind reading of these adjectives is required are rather pragmatically special.⁵⁰

If this is correct, most adjectives can be used both intersectively and subsectively, which suggests that the difference is a structural rather than a lexical one. This conclusion is supported by the fact that the different readings are associated with grammatical differences: many intersective, but no subsective modifiers can occur postnominally in English. Nonetheless, in English, the grammatical differences are not very clear cut. Indeed, adjectives in postnominal position such as (52) are marked for some speakers.⁵¹ However, the difference in word order which corresponds with the intersective and subsective usage of adnominal modifiers is much clearer in other languages, particularly in Romance languages.⁵² And there are a number of other grammatical phenomena which coincide with this distinction, too.⁵³ The grammatical differences in combination with the differences in meaning have motivated an analysis according to which the grammatical structure of the two kinds of expression is indeed fundamentally different. Most recently, Cinque (2010; see also Alexiadou, et al. 2007; Sproat and Shih 1988) has argued that intersective adnominal modifiers originate in reduced relative clauses, whereas subsective modifiers lack a clausal origin.

3.3.4 The Grammar of Intersective and Subsective Modification

My grammatical explanation of the difference between the inferential behaviour of intersective and subsective modifiers begins with the observation that there is a non-standard way of describing the inferential difference between intersective and subsective modification discussed

⁴⁹ Larson (2000b) notes that in expressions like ‘I missed the *Thursday* Thursday lecture’, the second instance of *Thursday* gets a generic interpretation and the first a deictic one: what I missed in this case is *this* Thursday’s Thursday lecture. This seems to be yet another instance of the kind discussed here.

⁵⁰ There are additional ambiguities to the same effect, the most general one being the ambiguity between adverbially and adjectively modifying adjectives, which appears when deverbal nouns are modified (Kamp 1975).

⁵¹ In addition, the difference in position is closely tied to the heaviness of the modifier.

⁵² For evidence from Chinese, Maltese, Bosnian, Croatian, Serbian, Romanian, Greek, Russian and German see the Appendix in Cinque (2010). See also Sproat and Shih (1988) for additional support from Japanese, Kannada, Arabic, Thai, Mokilese and Irish. Compare Alexiadou et al. (2007) for review.

⁵³ Sproat and Shih (1988) note that in Chinese, adjectives with the suffix *-de* do not obey the ordering restrictions of adjectives found in most languages (cf. Cinque 2010; Scott 2002). They argue that this finding is not restricted to Chinese but is characteristic of intersective modification in all languages which they review. Furthermore, Bosnian, Croatian and Serbian require different agreement morphology in the two cases (Leko 1988 and subsequent work). Moreover, Greek allows to ‘spread’ the determiner only in cases of intersective modification (Kolliakou 2004).

in section 3.3.2: we may say that there are two kinds of implicational relations. First, the denotation of the combination of adjective and noun may or may not imply the denotation of the noun. Second, the denotation of the combination may or may not imply that of the adjective. Intersective and subsective uses of adjectives are similar in that both allow for the first kind of implication. They differ, however, in that intersective adjectives do, but subsective adjectives do not allow for the second kind. As noted above, in formal semantics the inferential behaviour of expressions involving adjectives is often taken to be part of the lexical entry of the adjective. If this is the case, then all kinds of implications of expressions involving the relevant adjective trivially have the same source: the lexical entry of the adjective.⁵⁴ However, if it is correct that the difference between intersective and subsective adjectives is grammatical, then it is possible that the different kinds of implications which adjectives allow for have different grammatical sources. I shall argue in the following that this is the case.

From a grammatical point of view, it is not surprising that the first kind of implication holds (in the absence of expressions which involve negation and certain quantifiers, which change the environment from *dictum de omni* to *dictum de nullo* or vice versa), that is, that it is possible to drop the modifier in both the intersective and the subsective cases, whilst preserving the truth value. Traditionally, modifiers have been treated as adjuncts. Yet, a grammatical object is complete without an adjunct added to it: adjectives, on this view, are not selected for (Svenonius 1994: 442-43). It is thus natural to assume that whatever semantic value an object has after specification by an adjunct (or specifier), it has already had before the addition of the adjunct. It follows that the modified expression entails the unmodified one. However, as a result of Kayne's (1994) antisymmetry-thesis which assimilates specifiers and adjuncts, Scott (2002) and Cinque (2010), for example, assume adjectival modifiers to have more structure: in the extended projection of the noun, APs feature in the Specifier position of functional heads, which ensures the proposed universal order in which adjectives occur.⁵⁵ If this view is correct, modifiers are part of the structural grammatical part of language. As I point out in chapter 4.3 and 6.3, the meaning of grammatical structure is ordered in part-whole relations: Corresponding to the grammatical structure of (58), if I ate these three lambs, I ate three lambs; if I ate three lambs, I

⁵⁴ An alternative developed in Larson and Segal (1995) and Larson (1998) is to treat the ambiguity (at least as far as the adjectival/adverbial distinction is concerned) as a matter of the lexical structure of the noun modified. Note that this is still a lexicalist solution to the problem. The approach considered here takes the ambiguity to be one in grammatical structure.

⁵⁵ Cf. chapter 6.3 for further discussion of the Cartographic tradition.

ate lambs and if I ate lambs, I ate lamb. Similarly, if I bought beautiful little kittens, I bought little kittens and if I bought little kittens I bought kittens.⁵⁶

(58) I ate [_{DP} these [_{NumP} three [_{CIP} -s [_{NP} lamb]]]]

(59) I bought [_{SubjectiveCommentP} beautiful [_{SizeP} little [_{CIP} kittens]]]

This rather trivial explanation relies on the asymmetry of all grammatical operations (cf. chapter 6 for discussion).⁵⁷ The host is what provides the semantic value, whereas the modifier only specifies this value and is thus always interpreted relative to its host. Such an asymmetry, which will turn out to be crucial for my account of UP1, is unexpected if modification is essentially conjunction, which is a symmetrical relation. Given the asymmetry, however, subsectivity of the modifier is expected. What is puzzling from a grammatical point of view, then, is intersectivity, not subsectivity. But the assumed clausal nature of intersective adjectives may be taken to explain this fact in the light of current syntactic theory.

As discussed in chapter 3.1.5, Chomsky (2001; 2008) proposes that the computational device of human language constructs syntactic representations in units which he calls phases. When the edge of a phase is reached in the computational derivation, the complement of the phase head is ‘sent’ to the conceptual-intentional interface, where it receives an interpretation, and to the phonological interface, where it is spelled out; the derivational device now can ‘forget’ about the complex structure of the expression generated. Phases are in this sense ‘impenetrable’. What is important for our current purposes is that phases are, *inter alia*, taken to be units of semantic valuation. If indirect modifiers are clausal and thus CPs (Complementizer Phrases), they are phases and therefore such units of valuation. In this case, the semantic value of an indirect modifier is already fixed when it modifies its host. The host can, thus, not relativize the modifier in any way. And if the modifier is not interpreted relative to its modiffee, then intersectivity is the only possible interpretation left.

To conclude, logical calculi are arbitrary: we can define whatever logic seems useful for a certain purpose. Yet, natural logic is a different, and essentially empirical, project in that it asks

⁵⁶ A further possible entailment which I have not mentioned here is that if I bought beautiful little kittens, I bought beautiful kittens. The reason for the validity of this inference is that even if no particular size is specified, the abstract Size Head is nonetheless projected. As I point out in chapter 6.3, adjectives are located in the Specifier position of the respective functional heads, indicating in what way the functional head of the phrase specifies the ontological category of its complement. If no Specifier is present, the ontology is specified generically.

⁵⁷ Even in cases which seem symmetrical, a certain asymmetry seems to be necessary for a compositional interpretation. See Moro (2000) and Sheehan (2011) for small clauses and Bauke (2011) for compounds.

for an explanation of why we are naturally inclined to think of certain inferences as valid, but not of others. I wish to emphasize that a natural logic describes a competence (very much like grammatical theory). It is therefore not falsified by the fact that we sometimes reason differently. Yet, some reflection will in most cases tell us whether the inference was a good one or not. Thus, when I have claimed in this section that aspects of our ability to draw valid inferences is due to our grammatical competence, I do not mean to claim that a strong, 35 valued Kleene logic, for example, can be derived from a theory of grammar. It cannot, as far as I know. What my claim amounts to is that natural logic, to the extent to which it is structural, can be explained in, or at least illuminated by, grammatical terms.

As I have argued at the beginning of this section, Ludlow has shown how to integrate the two environments, *de omni* and *de nullo*, of medieval natural logic into a Minimalist syntax. In the main part of this section, I have then argued that the difference between intersective and subsective modification can be explained with the help of grammatical principles: First, most adjectives have both intersective and subsective readings, even if often one of the two readings is marginal for pragmatic reasons. The different readings are, furthermore, systematically available. This suggests that the distinction is grammatical, rather than lexical. Otherwise, the lexicon has to be taken as highly redundant and there is no explanation for the systematicity of the phenomenon. A further argument for this conclusion has been the consistent problems of classifying adjectives into the relevant semantic classes. Second, I have pointed out that the differences in meaning correspond closely to their syntactic position. In accordance with recent syntactic theories, I have assumed that intersective modifiers are reduced relative clauses, whereas subsective ones don't have a clausal origin. In a third step, I have demonstrated that, if this thesis is correct, there is a grammatical explanation for the difference in interpretation. Whereas, due to the inherent asymmetry of language, subsectivity is expected, intersectivity follows from the clausal nature of the relevant occurrences of the modifiers: in current syntactic theory clauses are taken to be phases and phases are units of semantic valuation. If, because it is already fixed at the time of modification, the semantic value of the modifier cannot be relativized to that of the modifiee, the only available interpretation left is intersective.

Grammatology: A Solution to UP2¹

When grammatical structure is built up, the formal ontology of the meaning of linguistic expressions changes. For example, when the meaning of *Socrates* is combined with that of *sits*, the result is a proposition, evaluable for truth and falsity, whereas neither *Socrates* nor *sits*, taken on their own, has a proposition as meaning or is so evaluable. The second unity problem (UP2) asks for an explanation of this change in formal ontology.

In chapter 3, I have argued that grammar is meaningful and that the meaning of grammar is structural and cannot be reduced to something non-structural, for example to the meaning of lexical items. Yet, what is the meaning of grammar? In this chapter, I argue that UP2 receives a straightforward solution if the picture of language developed as part of the ‘Un-Cartesian Linguistics’ project is on the right track.² According to it, grammatical distinctions determine the referential properties of linguistic expressions. The different modes of reference that grammar enables give rise to the formal ontology of language we seek to explain. Thus, in effect, grammar contributes to linguistic meaning that these meanings fall into different formal ontological categories. The most extensive systematic defence of this view can be found in Hinzen and Sheehan (2014).³ An outline of the present chapter can be found at the end of section 4.1.1.

¹ I’m indebted to James Miller for many helpful comments on an earlier draft of this chapter and chapter 5.2.

² Led by Wolfram Hinzen and Elisabeth Leiss, the project Un-Cartesian Linguistic (2009-2012) was located in the philosophy department of Durham University and the linguistics department of LMU Munich. It was funded by the AHRC and the DFG. Cf. chapter 1.1.3 for an exposition of some of the central Un-Cartesian claims.

³ The roots of the version of Un-Cartesian Linguistics that I will draw on can be found in Hinzen (2006; 2007), who has since developed this framework in many articles, partially in collaboration with Boban Arsenjevic, Michelle Sheehan, Txuss Martin and myself.

4.1 Grammar and the Formal Ontology of Language

4.1.1 Grammar and Ontology

Ontological categories are categories such as property, object, event, proposition, fact and state of affairs. According to my terminology, also the distinctions between, for example, genericity and individuality, objectivity and mass, or telicity and atelicity concern ontology.

I will call those ontological categories which, purportedly, carve nature at its joints, irrespective of human cognition and language, *metaphysical categories*. In principle, these categories may or may fail to be equivalent to *conceptual ontological categories*, the categories which we employ in our thought. For example, whereas there is evidence that objects are conceptually basic (cf. Carey 2009), metaphysicians may still argue that, metaphysically, objects reduce to, for example, bundles of tropes (e.g. Williams 1953; Campbell 1990; Paul 2012). In addition to metaphysical and conceptual ontological categories, the meanings of different linguistic expressions may fall into different *semantic categories*, such as (on one popular conception) objects, truth-values, and functions of various types (cf. chapter 2.3 for exposition and discussion). The semantic categories, again, may or may fail to correspond to metaphysical and/or conceptual ones. Finally, linguistic expressions themselves fall into different *grammatical* (or lexical) *categories* such as noun, verb, sentence, etc. and (in accordance with chapter 3) referential expression and predicate. These last categories, again, may correspond to semantic categories, or fail to do so. There is, thus, the following hierarchy of categories:⁴

- (1) Grammatical categories
 - Semantic categories
 - Conceptual categories
 - Metaphysical categories

⁴ Within the hierarchy, the relation between semantic and conceptual categories is probably the most controversial one. Externalists argue that there is a direct connection between semantics and metaphysics; on this conception, however, semantics may depart radically from psychology (cf. the literature departing from Kripke 1972; Putnam 1975). Internalists, by contrast, argue that semantics is independent of metaphysics, but related to conceptual distinctions (cf. e.g. Pietroski 2005b; Burton-Roberts 2009; Collins 2011a). Nonetheless, often all four different kinds of categories are distinguished, as, for example, in the following passage of Maienborn (2003: 42):

The following thoughts aim at ontology, understood as the basic categories of our cognition. Accordingly, ontological commitments concern the organisation of our knowledge of the world, not reality itself. [...] Distinctions of natural language provide helpful evidence of the basic conceptual categories, and should be taken seriously. [...] Yet, they also bear the danger of confusing distinctions of single languages with ontological distinctions.

In general, it is assumed that the kinds of categories further down in (1) are more fundamental than those at the top. For example, to the extent to which conceptual categories reflect metaphysical ones, the latter are often taken to determine and explain the availability of the former, but not vice versa. Similarly, semantic categories are usually taken to be available independently of grammatical distinctions, even though grammatical distinctions may express and correspond to semantic ones.

The main thesis I defend in this chapter is that grammatical categories determine and explain the availability of semantic categories rather than vice versa. If this thesis is correct, the second unity problem (UP2) dissolves: if grammar gives rise to a formal ontology, grammatical changes inevitably evoke changes in the formal ontology of the meaning of linguistic expressions (section 4.4). A first argument in favour of the thesis that the formal ontological distinctions of language are grammatical distinctions is provided in section 4.1.2, where I show that ontology can only contribute towards a solution of unity problems when ontology has a structural nature, very much like grammar. A second line of argument begins with the observation that, from an evolutionary point of view, the availability of the respective ontological categories in human cognition requires an explanation. Yet, semantic categories cannot be derived from metaphysical ones, since the most central semantic categories arguably don't have a metaphysical correlate and since the semantic categories relevant for unity problems are formal in a way in which metaphysical categories are arguably not. Furthermore, even when semantic categories are taken to reflect metaphysical ones, the question arises how we cognize them (section 4.2). I also argue that independently given conceptual categories cannot account for semantic ones: many conceptual categories are uniquely human and arise more or less simultaneously with language in human evolution – a fact that cannot be explained if they are themselves taken as explanatory primitives (section 4.3). My suggestion is to think of grammatical, semantic and some conceptual categories as three ways of describing the same thing. This relaxes the burden placed on evolution, in that only one system had to evolve rather than two or three. It also provides the possibility to use a relatively well understood theory of grammar in order to explain more obscure semantic and conceptual facts.

4.1.2 Intrinsic and Relational Ontological Categories

Entities possess properties intrinsically iff they have them irrespective of any other entity. The mass of an object, for example, does not depend on anything but the object itself; mass is thus an intrinsic property. In contrast, entities possess properties relationally iff they have them in virtue of some other entity. Whether a man is a grandfather, for example, depends on there being

something else, a child, whose grandfather he is; being a grandfather is thus a relational property.

Similarly, entities may fall under a particular ontological category irrespective of the relations to other entities they stand in, or they may fall under the ontological category only in virtue of standing in a particular relation to another entity. In analogy with the case of properties above, I will call ontological categories where membership is determined relationally ‘relational ontological categories’ and those where membership is fixed ‘intrinsic ontological categories’. If ‘object’ and ‘property’ are relational ontological categories, it depends on the relations an entity stands in whether it is an object, a property or neither. If these ontological categories are intrinsic ones, a property remains a property in all circumstances in which it exists.⁵

Unlike intrinsic ontological categories, relational ones can be used in an account of unity. If a property, say, is only a property insofar as it plays a particular role within a proposition, fact or state of affairs, there has to be a proposition, fact or state of affairs if there is a property. The unity of the proposition is secured and Bradley’s regress does not arise. In contrast, if a property is a property intrinsically, there being a proposition, fact or state of affairs which it is a part of is not guaranteed by the property. Therefore, intrinsic ontological categories are of no help in an account of unity.

The relational nature required for ontological categories to bear on questions regarding unity fits well with my proposal that grammar is responsible for determining the formal ontological categories of the meaning of linguistic expressions, given that grammatical categories are relational categories. As argued in chapter 3.1, a lexical item functions as a predicate, or referential expression respectively, only within a particular grammatical context. Thus, if grammar determines the formal ontology of natural language, these ontological categories trivially guarantee unity.

As an example of relational ontological categories, consider (my interpretation of) Fregean concepts and objects.⁶ Frege (1892: 54) motivates the assumption of these categories with reference to the unity problem, arguing that without a distinction analogous to his distinction between concepts and objects, it remains unexplained how ‘all parts of a thought [...] hold together.’ Given that only relational ontological distinctions can account for unity, this on its

⁵ As I discuss below, the inherent-relational distinction I draw here is not equivalent to the necessary-contingent distinction.

⁶ In chapter 5.3.2, I come back to the purported paradox of the concept *horse*, which such an approach faces.

own is reason to assume that Frege's distinction between objects and concepts is a relational one. Furthermore, Frege argues that concepts are derived by abstraction from a whole:

‘Instead of putting a judgement together from an individual thing as subject and an already previously formed concept as predicate, we do the opposite and arrive at a concept by having the judgeable content fall into pieces [zerfallen]. However, for it to be possible to fall into pieces, the expression of the judgeable content has to be structured. [...] Yet, it does not follow that the ideas of these properties and relations are formed independently of the objects [to which they apply.]’ (Frege 1880-1881: 18-19)

Thus, Fregean concepts seem to be concepts only in virtue of being derived in a particular way from a thought, dependent on the other parts of the thought. Concepts are thus ‘unsaturated’ or ‘incomplete’, which again suggests that they are what they are in virtue of standing in a relation to something else that makes them complete.

The relational nature of Frege's ontological categories is independent of whether something is a concept necessarily or contingently, that is, whether a concept always ceases to exist if it fails to play the role within a thought that makes it a concept, or whether, under these conditions, it could still exist, but fail to be a concept. There are some passages where Frege seems to suggest that the distinction is contingent. For example, Frege (1884: X) argues that ‘it is a mere illusion to suppose that a concept can be made an object without altering it,’ which suggests that Frege assumes that a concept can in principle be made an object. Also in ‘On Concept and Object’, Frege (1892: 46) writes that, before it can be made the referent of a subject, ‘the concept [...] must first be converted into an object,’ which seems to support the thesis that Fregean concepts can be turned into objects. However, in ‘On Concept and Object’, Frege relativizes this commitment by adding ‘or speaking more precisely, [the concept must be] represented by an object.’ This relativization can be taken to suggest that Frege takes his concepts and objects to fall under their ontological category necessarily. Yet, in respect to unity questions it only matters that the concept-object distinction is a relational one, not whether it is necessary or contingent.

Frege's distinction between concepts and objects resembles the distinction I want to draw not only in being relational, but also in being tied to the syntactic distinction between (logical) singular terms and (logical) predicates. Frege (1892: 43) argues, for example: ‘The concept (as I understand the word) is predicative;’ and he adds in a footnote ‘It is, in fact, the reference of a grammatical predicate’, before continuing: ‘On the other hand, a name of an object, a proper name, is quite incapable of being used as a grammatical predicate.’ As Collins (2011b: 37)

concludes, ‘for Frege, logic or semantics has priority over any metaphysical conception of objects and properties.’

In turn, the logical distinction between predicates and their arguments follows largely the corresponding grammatical distinction. For example, Frege restricts his discussion of functions to the meanings of what could be predicates in natural language, even though his (1879: 13) definition of functions is independent of distinctions that natural languages make:

Suppose that a simple or complex symbol occurs in one or more places in an expression [...]. If we imagine this symbol as replaceable by another (the same one each time) at one or more of its occurrences, then the part of the expression that shows itself invariant under such replacement is called the function; and the replaceable part, the argument of the function.

This definition is consistent with grammatical singular terms such as *Socrates* in *Socrates sits* and *Socrates sleeps* being functions, mapping sits, sleeps and so on to the respective propositions. However, Frege never considers such predicates – in line with the impossibility of treating *Socrates* in these sentences as grammatical predicates (cf. Gaskin 2008). In sum, Frege’s most basic ontological distinction, the distinction between objects and concepts, is essentially a grammatical distinction.

4.2 Formal Ontological Distinctions and the Ontological Productivity of Language

Ontological categories are usually taken to be independent of linguistic ones. The distinction between objects and properties, say, is seen as a metaphysical or perhaps as a conceptual distinction, more or less well reflected in language, but in principle independent of it. Nonetheless, for some theorists there is a close relation between semantic and metaphysical categories. For example, Higginbotham (2009: 154) argues that semantic theory inevitably comes with ontological commitments: ‘It’s no good to take referential semantics on board for the purpose of linguistic explanation, and then to say, “No, well, I don’t really mean it, it’s all syntax.” That won’t go, in my opinion.’ In line with this general thesis, since Quine (1953), it is often assumed that quantification over objects, for example, generates an ontological commitment to objects. Similarly, Davidson (1993: 42) argues in respect to events: ‘If an ontology of events were the only way to give a satisfactory semantic analysis of [action sentences] and the relations between such sentences, it would, in my opinion, provide a very strong argument for the claim that there are events’. Also advocates of propositions are often

motivated by semantic considerations: propositions are needed as the meanings of sentences, objects of attitudes, etc. A semantic analysis generating ontological commitments to propositions is taken to be necessary, since the ontologically sparser alternative, according to which the meanings of sentences are truth-conditions, fails.⁷

In the following, I argue both against the position that formal ontological categories of language are independent of language and against the thesis that language generates metaphysical commitments (in a non-trivial sense): the formal-ontological categories relevant to my present concern are determined by the way we refer to the world, rather than by the objects referred to themselves. They are therefore independent of metaphysics. Furthermore, language is arguably ontologically productive, that is, there are ontological categories essential to language and thought, but hard to motivate from an independent metaphysical point of view. They also correspond closely to grammatical categories, which opens the possibility of explaining their availability to humans in grammatical terms.

I call an ontological category *formal* if it does not depend on what is categorized, but how it is categorized.⁸ The ontology of natural language is formal in this sense: whether you describe a situation with the help of a sentence as *Joana smiles* or whether you refer to *Joana's smile* makes a formal ontological difference. In the first case, the meaning of the expression is a proposition (or state of affairs), whereas the meaning of the second expression is an object (or event). Yet, the situation described or referred to may be exactly the same – the only difference being that the situation is asserted in the first and referred to in the second case. Similarly, you may assert the proposition that *Joana is beautiful* or refer to *Joana's beauty*, an object (or property); but the situation again may be exactly the same. Furthermore, whether you say *I had coffee this morning* or *I had a cup of coffee this morning* makes an ontological difference: coffee is a mass (something unbounded), whereas a cup of coffee is an individual (something bounded). Yet, again, the situation referred to may be exactly the same. Since these ontological differences, thus, do not depend on *what* is referred to or asserted, but *whether* it is referred to or asserted (and in which way it is referred to or asserted), they are formal: they concern the mode of reference, rather than the way the world is.⁹

⁷ See chapter 3.2 for discussion and references.

⁸ This use of *formal ontology* is borrowed from Wolfram Hinzen (cf. Hinzen and Sheehan 2014). It is distinct from more standard uses according to which a formal ontology is a mathematical definition of the properties and relations of certain entities (e.g. Zalta 1983).

⁹ This thesis goes back at least to the Modistic grammarians in the 14th century. Cf Leiss (2009) for discussion.

In all these cases, the formal ontological difference relies on a grammatical one: corresponding to the difference in formal ontological category, both *Joana smiles* and *Joana is beautiful* are sentences, whereas *Joana's smile* and *Joana's beauty* are possessive determiner phrases. The formal ontological distinction between masses and individuals is closely related to classification: in *I had coffee*, *coffee* acts as a mass noun. Yet, when it is classified, for example by *a cup of*, it acts as a fully individuated object. These observations are in line with the general thesis of chapter 3.1, namely that the difference between these different modes of reference is due to differences in the functional grammatical structure (as opposed to the lexicon).¹⁰

In sum, the formal ontological categories we find in language are grounded in different ways of referring (or asserting), and at least in part independent of the things asserted or referred to. If metaphysics concerns the way things are independently of how we refer to them in language or otherwise, the formal ontological categories in question are not metaphysical categories.

However, one might object to this conclusion that the respective ontological categories have to be metaphysical categories: what, if not facts or states of affairs, could make sentences and thoughts true (Armstrong 2004)? Ontological categories like ‘proposition,’ ‘fact’ or ‘state of affairs’ certainly play a central role in our mental and social life. We believe that the earth is round, tell our neighbour that the lecture is boring and we disagree with our student whether the mark in her Metaphysics essay is appropriate. Our beliefs, fears, and assertions are true if things are as we believe, fear or say, and false otherwise. Whether these ontological categories are metaphysical ones is much more controversial (Dodd 1999). Indeed, it is questionable that the central role that formal ontological categories such as propositions, facts and states of affairs play in cognition entails anything about the metaphysical reality of propositions, facts and states of affairs (cf. Iacona 2003; Betti 2006; Crawford 2013).¹¹ If so, language and thought may be ontologically productive, that is, at least not all ontological categories we employ in language can be derived from independently given metaphysical ones. Hence, the formal ontological

¹⁰ I provide further examples of the correspondence between linguistic ontology and grammatical differences in chapter 5, where I also discuss the extent to which linguistic ontology can be an aspect of the lexicon.

¹¹ These considerations, even if correct, don't render propositions, facts or states of affairs unreal in any non-technical sense of the term. Tables, chairs and doorknobs are things we have made, and they are as real as anything. Also positive law is binding, despite being made up by human beings. When accused of drink-driving, it is unlikely that even the best metaphysician could get her driving licence back by arguing that the law prohibiting this doesn't have metaphysical reality. Correspondingly, even if propositions or facts are categories that owe their existence to the way we think and speak, they are still real things which we can refer to, talk about and have true or false beliefs about. Given that most metaphysicians like ‘desert landscapes’ (Quine 1953) as far as ontology is concerned, it is indeed not surprising if not all of the many linguistic categories turn out to reflect metaphysical ones.

categories of language cannot be explained with reference to independently established metaphysical categories (or at least not all of them).

Furthermore, as noted in chapter 1.3, even in case language reflects metaphysics, there remains a further cognitive question: it has to be explained how the metaphysical categories are cognized, or how we have cognitive ‘access’ to these metaphysical categories.¹² Either way, the question arises how the cognitive system works that determines the respective formal ontological categories. I have suggested that they are determined and explained by grammar. Yet, since language is often taken to be merely expressive of independently given thought, I now turn to language and thought and the relation between them.

4.3 Language and Thought

In particular within the formal semantic tradition, often no metaphysical commitment is associated with semantic theory. For those who follow Strawson’s (1974) idea of a ‘descriptive metaphysics’ or Bach’s (1989) notion of ‘natural language metaphysics’, the aim of semantics is to determine the ontological commitments we would have if we took language metaphysically seriously, although we ultimately may not. On this conception, natural language metaphysicians are particularly concerned with what Montague (1969) calls ‘philosophical entities’, that is entities which ‘are routine in language, but routinely suspect in metaphysics’ (Higginbotham 2000: 50). As Maienborn (2003: 42) stresses, ‘according to this conception, ontological commitments concern the organisation of our knowledge about the world, not reality itself.’ Thus, the right semantic analysis of *there is a flaw in your argument* may include quantification over flaws, and that of *the average American owns two cars* reference to the average American, without anyone who uses such expressions being committed to there being flaws or the average American, metaphysically speaking.¹³ Yet, semantic models could not only include metaphysically suspect entities, but also metaphysically suspect kinds of entities. Thus, even if

¹² Assume, for the sake of an analogy, that it is established that colours are metaphysically fundamental entities. There still remain cognitive and neurophysiological questions about how we are able to perceive them. If we didn’t have eyes, for example, we, probably, could not perceive colours, whatever they are metaphysically. Similarly, even if it was established that facts are metaphysically fundamental categories, this does not explain that humans can also employ them in their thought and language.

¹³ Cf. e.g. Chomsky (2000), Kennedy and Stanley (2009) and Collins (2011a) for a discussion of the relation between expressions such as *the average American* and the limits of formal semantics.

generic events, say, are perfectly good entities to refer to linguistically, they may lack a metaphysical correlate.¹⁴

This conception of semantics offers the possibility of taking the ontological categories of semantics to originate in the human mode of thought, without taking a commitment as to whether thought reflects metaphysical principles. Theories of language, therefore, often presuppose thought and the ontological categories of thought, with the help of which linguistic expressions are interpreted. However, assuming that a linguistic expression is not inherently meaningful but interpreted with the help of another system does not provide an answer to the question of where meaning comes from and how something is meaningful, but merely defers the primary locus of meaning to another system, which then is called ‘semantic’. The puzzle remains of how and why the structures generated by the semantic system are meaningful, and the fact that we understand and produce meaningful linguistic expressions remains as mysterious as ever. The mere fact that a structure which is called ‘syntactic’ is mapped to one which is called ‘semantic’ therefore does not add any explanatory value per se.

Based on this thought, I argue that both findings in comparative psychology (section 4.3.2-3) and archaeology (4.3.4) suggest that grammar comes with a new mode of thought. At its centre are formal ontological categories, closely related to grammatical categories and probably unique to our species. However, in the Generative tradition, the very tradition I draw upon in the following, the relation between grammar and thought is standardly seen to be much looser than I am suggesting here. I begin the section with a critical examination of arguments that have traditionally led to this conclusion (section 4.3.1).

4.3.1 Language and Thought in the Generative Tradition

Generative grammar is often interpreted as a purely formal science, concerned primarily with the generation of well-formed expressions. Such an interpretation is suggested by the way in which the project has often been presented. Chomsky (1965: 3), for example, formulates his project as follows:

This study [...] will be concerned with the syntactic component of a generative grammar, that is, with the rules that specify the well-formed strings of minimal syntactically functioning units (*formatives*) and assign structural information of various kinds both to these strings and to strings that deviate from well-formedness in certain respects.

¹⁴ For discussion of the nature of events see e.g. Montague (1969), Chisholm (1970), Davidson (1969; 1970; 1971), and Kim (1969; 1976). Cf. Pianesi and Varzi (2000) for an overview.

Radford (1981: 167) argues that ‘the question [...] of what the syntactic structure (underlying or superficial) of a sentence [is] is *entirely independent* of the question of what its semantic structure may be.’ Generative grammarians also often stress the ‘modular character’ (Chomsky 1981: 7) of syntax. The syntactic module is taken to interface with ‘systems of belief, of pragmatic competence, of speech production and analysis, and so on’ (Chomsky 1981: 18), but to operate in an autonomous way. Chomsky (1993: 48; 2000: 27), for example, argues that the computational system of language could be just the way it is for a certain speaker, but be used for locomotion rather than language. According to this understanding of grammar, the ‘meaning’ of a syntactic structure, thus, radically depends upon the system which interprets it. If the syntactic structure feeds into a semantic system, it is interpreted as a thought, if it feeds into a motor system, the syntactic structure gives an instruction for a movement. Perhaps the same computational system could also be used for the regulation of hormones, or be implemented in the central computer system of Royal Mail to speed up the distribution of letters and parcels.

A main motivation for assuming that the relation between syntax and meaning is arbitrary consists in constraints on syntactic operations which don’t seem to be motivated from a semantic point of view. For example, there is no straightforward semantic rationale for many constraints on syntactic movement. In order to transform the sentence in (2) into a question about the THEME of the embedded CP, the wh-word *what* has to be moved to the front of the matrix sentence, leaving behind a trace *t* (which is not pronounced in English). The resulting construction also requires do-support of the verb in the matrix sentence. The result is as in (3). However, if the same strategy is used for a sentence like the one in (4), the syntax of which seems to differ only slightly from that of the sentence in (2), the result is hardly comprehensible, as is evidenced by the virtual impossibility of parsing (5). The intended thought, however, seems fine and can be paraphrased as in (6). The difference between the grammatical structures in (2) and (4) is that in the first one the verb *know* embeds a CP and in the second it embeds a DP. It was a substantial linguistic discovery that DPs are islands of movement (Ross 1967), that is, that you cannot move expressions out of a DP, disregarding exceptional circumstances, whereas movement out of a CP is unproblematic in many cases.¹⁵ Yet, such a rule seems arbitrary from a semantic point of view. Thus, ‘island conditions [...] make certain thoughts inexpressible, except by circumlocution’ (Chomsky 2009: 28).

¹⁵ Factive clauses are weak islands. In particular emotive factives only allow extraction of direct objects, as is evident from the fact that it is very hard to parse questions like **When do you mind that he arrived?* (Sheehan and Hinzen 2011).

- (2) You know [_{CP} that a man photographed the house].
- (3) What do you know [_{CP}that a man photographed _{t_{what}]}?
- (4) You know [_{DP} a man [_{CP} who photographed the house]].
- (5) *What do you know [_{DP} a man [_{CP} who photographed _{t_{what}]]]?}
- (6) Which thing is such that you know a man who photographed it?

On the other hand, as far as I know, there is no evidence that, in our empirical minds, we ever form a thought that has the structure of (5). Being a biological object, the computational system generating thoughts (in this biological sense) is, in all likelihood, restricted in respect to the structures it can generate. To what extent the structures thus computed coincide with those that can be generated by grammar is an empirical question, not easy to tackle directly. Hence, the coherence of the thought expressed in (5) from an abstract, logical point of view does not provide any evidence regarding the structures of our *empirical* thoughts. It may well be that in order to actually form this thought (or a thought that is similar enough for its counting as equivalent), we have to rely on a paraphrase like (6). The inference from the fact that a thought is coherent from an abstract, logical point of view to the thesis that, in our empirical minds, we can actually form a thought with this very structure presupposes that thoughts are not biological objects. However, although we can abstract from biological constraints in many variants of philosophical or logical inquiry, it is hard to deny that there is such an empirical notion of thought (cf. also chapter 3.3). Only under such an empirical notion of thought does it make sense to inquire into the evolution of thought; and it is this empirical notion of thought that is thus relevant to the current discussion.

A similar point can be made in respect to Chomsky's claim about locomotion. It is close to a truism that a structure can serve for nearly any purpose if considered at a level which is abstract enough. Yet, this simply means that we have abstracted over all the features which make the structure a genuinely linguistic one. And so far, I don't know of any evidence that a genuinely linguistic structure could be used for any other purpose than linguistic ones (although it may well play a role in other cognitive domains which are uniquely human like mathematics and music, cf. Mukherji 2010, ch. 6; Katz and Pesetsky 2011).

An additional argument in favour of the thesis that grammar is modular and autonomous of interpretive processes comes from the possibility of nonsensical, but grammatical, expressions. Consider Chomsky's (1957) famous sentence (7) or Lewis Carroll's (8) from 'Jabberwocky'. What sentences like these are taken to show is that syntax is independent from interpretation, since these expressions are perfectly grammatical, but nonetheless nonsensical.

- (7) Colourless green ideas sleep furiously.

(8) All mimsy were the borogoves.

However, the conclusion should be quite the opposite: in order to determine that a certain expression is nonsense as opposed to mere noise, it is necessary to interpret it. As Mukherji (2010: 77) stresses, it is quite impossible to understand a string of sounds as a sentence (which may or may not make sense) without interpreting it. In this sense, the examples above differ crucially from pure noise like *ffufalrolauhivnocaseisyiligsduhacosnovksury*.¹⁶ As Roeper (p.c.) argues, using his (2007) notion of a ‘strict interface’:

It is misleading to claim that there is a definable object syntax if its interface is obligatory. [...] We are forced to generate an interpretation for a nonsense sentence, which we then determine fails to meet other criteria for interpretation. If that were not the case, it would be like not being able to hear something [well] enough to form phonemes and words. We would not know any characteristics of the spoken phrase because we did not quite hear it. This is clearly not true for nonsense.

Only by interpreting (7) can we determine what is wrong with the sentence, that is, that, poetry aside, nothing is both green and colourless, that ideas don’t have colours and hence are not green, that they cannot sleep and so on. That is, when we put the meanings of the lexical items together in the way the syntax of the sentence tells us to, we run into contradictions. But we don’t run into these contradictions unless we do interpret the sentence, so it is hard to avoid the conclusion that the sentence is meaningful. Furthermore, only granting meaning to nonsensical expressions makes it possible to distinguish between the degrees of deviance of (7) and (8). Whereas all lexical items that enter into (7) have lexical meaning, we don’t know what *mimsy* means or what borogoves are. We therefore don’t get as far in interpreting (8) as in interpreting (7). Yet again, how meaningful the sentence is can only be determined once we interpret it. Meaning, thus, becomes a matter of grade. This is unproblematic unless we presuppose that the absolute distinction between well-formed and not well-formed expressions, familiar from logic, carries over to natural language.

In many passages, Chomsky, indeed, seems to regard interpretation very much as part of grammar. He argues, for example, that if sentences are grammatical, ‘the generative rules of the language assign an interpretation to them’ (Chomsky 1965: 11). Moreover, the generativity of our linguistic capacity is restricted to the syntactic component. The conceptual-intentional (C-I) systems only execute the commands received from syntax. Chomsky (1995: 168, cf. p. 2) thus classifies the C-I systems, that language is taken to interface with, as ‘performance systems’,

¹⁶ Husserl (1913, Investigation IV) makes very much the same point.

very much like the articulatory-perceptual (A-P) systems. As Uriagereka (2002: 275) formulates the thesis: it is ‘as if syntax carved the path interpretation must blindly follow.’

Furthermore, at least Chomsky has never axiomatically insisted on the distinction between syntax and semantics. Already in *Aspects*, he writes that ‘it should not be taken for granted, necessarily, that syntactic and semantic considerations can be sharply distinguished’ (Chomsky 1965: 77). For this reason, ‘a decision as to the boundary separating syntax and semantics (*if there is one*) [...] will clearly remain open until these fields are much better understood’ (Chomsky 1965: 159, my emphasis). Since the inception of Generative Grammar, the main purpose of grammar was taken to be that it relate sound (or sign) and meaning: ‘the goal of a grammar is to express the association between representations of form and representations of meaning’ (Chomsky 1981: 17). Yet in many passages, Chomsky and others have gone far beyond this thesis. Chomsky (2000: 62, my emphasis), for example, argues that ‘the principles of universal grammar [...] provide the framework for thought *and* language.’ ‘The systems of thought [...] use linguistic expressions for reasoning, interpretation, organizing action, and other mental acts’ (Chomsky 2009: 19). Moreover, in recent years, Chomsky has repeatedly suggested that UG is ‘optimized relative to the CI interface’ (e.g. Chomsky 2007) – according to this picture, grammar is thus designed for thought rather than its expression: ‘Mapping to the sensorimotor interface appears to be a secondary process [...]. If so, then it appears that language evolved, and is designed, primarily as an instrument of thought’ (Chomsky 2009: 28-29). Hauser (2009: 74) makes much the same point: ‘Language evolved for internal thought and planning and only later was co-opted for communication.’ Chomsky (2009: 31-32) even writes: ‘It seems to me no longer absurd to speculate that there may be a single internal language, effectively yielding the infinite array of expressions that provide a language of thought.’ Furthermore, in his most recent article, Chomsky (2013) stresses that the Generative tradition has always been concerned with aspects of meaning including compositionality and scope.¹⁷

¹⁷ It might be thought that the Un-Cartesian hypothesis, according to which rational thought is structured by grammatical principles, is in conflict with contextualist approaches to semantics (cf. the literature mentioned in n. 37 of chapter 1). It is generally assumed that thoughts carry truth conditions. However, contextualists believe that the sentences we utter, just taken for themselves, are too underspecified to determine truth conditions. The sentence *it is raining*, for example, fails to determine the cases in which it is true, unless further parameters such as time and place are fixed. What we want to say when asserting that it is raining, thus, is usually something like *it is raining here and now*. Hence, the logical form of sentences does not coincide with thoughts. Rather, with the help of contextual information, sentences have to be mapped to thoughts, which exhibit a richer structure. However, nothing in the contextualist framework rules out that the richer structure of thoughts is produced by grammar. If both Un-Cartesian linguistics and contextualism are right, the logical forms of sentences are mapped to structures equally

Nonetheless, in particular recent considerations about the evolution of language in the Generative tradition might be taken to suggest a separation between syntax and semantics. The Minimalist Program (Chomsky 1995) urges to reduce the complexity of the faculty of language which was suggested in the Principles and Parameters framework.¹⁸ The Minimalist Program was motivated by considerations concerning the evolution of language: if the faculty of language is a natural organic object, it must have evolved. The evolution of complex systems usually takes a very long time and presupposes an evolutionary advantage of every step of the evolution of the respective system. However, language evolved extremely quickly in evolutionary terms¹⁹ and it is not clear what the evolutionary advantage of parts of this system would consist in.²⁰ In light of these considerations, Chomsky and the linguists following him try to reduce as much of grammar as possible to the two systems which language is taken to interface with (sensory-motor and conceptual-intentional systems) as well as third factor principles, that is, principles which apply more generally in computational systems, biological systems, or even physics.²¹ Given that both the conceptual-intentional systems, that is, the systems of thought, and the sensory-motor systems are presupposed as given in this framework,

produced by grammatical principles. This assumption, indeed, is *prima facie* plausible, given that you can always make the relevant contextual information explicit by linguistic means. So even if ‘what is said’ by *it is raining* really is *it is raining here and now*, the latter may still be a grammatical structure. Furthermore, if the Cartographic tradition, which I have drawn on in chapter 3.3, is on the right track, most, if not all, information of which contextualists assume that it is not part of the sentence in fact is specified in the grammatical structure of the sentence (cf. Reichard and Kirkby 2011). The room for contextualist worries may thus be rather small anyway.

¹⁸ The Minimalist Program is a research program within the framework of Principles and Parameters (P&P). Yet, whereas the initial formulation of P&P suggested that the language faculty is of great complexity, the Minimalist Program drives to reduce this complexity by explaining as many aspects of it in terms of other non-grammatical factors. An alternative way of reducing complexity which sticks closer to the notions of principles and parameters is being developed in a project led by Ian Roberts and Anders Holmberg (Roberts 2012; Biberauer, et al. 2013; Sheehan 2013).

¹⁹ Our species originates about 150.000-200.000 years ago. There is first evidence for the presence of language from about 80.000-100.000 years ago (see the discussion below). Language must have been present in its current form no less than 40.000 years ago, since at that time, humans spread over the whole world, with some populations (for example in central Australia) not being in contact with the rest of humanity. Yet, neither their linguistic nor their rational capacities differ from those of other humans, as far as we know.

²⁰ Both assumptions are far from universally accepted. For alternative pictures see for example Bickerton (1990; 2000) and Arbib (2005). Cf. Clark (2013) for a recent comparison. Compare also n. 22. For an overview of recent considerations about evolutionary theory concerning language, see Fitch (2005) and the articles in Tallermann and Gibson (2012).

²¹ Chomsky argues: ‘If it’s ever going to be possible to say something sensible about the evolution of language, it’ll be because linguistic computations are *not* cognitively provincial. If they turn out to be so, too bad, but it seems to me a desideratum to reduce that element’ (quoted in Hornstein 2013, 401).

grammar (core syntax) seems to be no more than a bridge between thought and its externalization. This suggests that, in principle, the same kind of thought can inhabit a linguistic and a non-linguistic being.

Hauser, et al. (2002) spell out the Minimalist account by drawing a distinction between what they call ‘the language faculty in the broad sense’ (FLB) and ‘the language faculty in the narrow sense’ (FLN).²² FLB consists of every cognitive and sensory-motor capacity which is involved in language, whereas FLN comprises only those capacities which are unique to language. What is part of FLN is ultimately an empirical issue; Hauser, et al. stress that FLN may be empty. The tongue, for example, is part of FLB, as it plays quite a crucial role in spoken language. Yet, many species which don’t communicate by linguistic means have tongues. It is, hence, not very plausible to assume that tongues evolved to support language. Tongues are, therefore, not part of FLN. Hauser, et al. suggest that only the operation of recursion is part of FLN, whereas both the sensory-motor and the conceptual-intentional systems are part of FLB and hence pre-grammatical in evolution. That the conceptual-intentional systems are supposed to be part of FLB again suggests that rational thought was possible before grammar was around – non-linguistic hominids may have been Platos in the privacy of their minds (although their thought will have faced the limitation of being non-recursive). Whereas the distinction between FLN and FLB is clearly a useful one, I shall take issue with the idea that rational thought predates grammar. I also suggest that FLN is more substantial than recursion (which may not be uniquely human anyway, cf. n. 24).

In the remainder of this section, I argue that both the archaeological record and findings in comparative psychology suggest a stronger correlation between rational thought and grammatical competence than this picture does. I point out that there is a striking correlation between the absence of grammatical capacities in non-human communication and the absence of the corresponding mode of thought: whereas some animals can learn a remarkable number of

²² The main disagreement associated with this paper concerns the question of whether language evolved in a saltation or rather as an adaptation in small steps (Pinker 2003; Pinker and Jackendoff 2005; for a reply see Chomsky, et al. 2005). This debate is not directly relevant to the current discussion. I therefore shall not draw on it, although the sudden cultural change which I describe below speaks against a slow evolution of language and thought in many adaptive steps. One point where the debate is relevant, however, is that in the adaptationist literature, language is usually seen as an adaptation for communicating propositional thought. As Pinker (2003: 27) writes: ‘The system appears to have been put together to encode propositional information’. Yet, as I argue below, this means presupposing the most puzzling aspect of language: the origin of the propositional thoughts which are to be expressed. Explaining the evolution of language as an adaptation for the expression of propositional thought, therefore, comes close to begging the question.

symbolic labels, they systematically fail to acquire a grammatical system. Correspondingly, animals never use symbolic labels for referential or propositional purposes. Yet, reference and propositionality are at the top of grammatical complexity, as we have, in part, already seen in chapter 3.1. A similar correspondence is suggested by the archaeological record, to which I turn after discussing some findings about the grammatical and rational capacities of non-extinct species. I suggest that the main puzzle in the evolution of our species is the origin of rational thought, that is, a mental format based on reference and propositionality, not the externalization of such thought. If grammar provides the cognitive structures that give rise to this new rational mode of thought, not only the correlation between grammar and rationality is explained, but also a first step for explaining the origin of the rational format of thought is taken.

4.3.2 Monkey Talk

Many animals communicate. Yet, their calls are usually innate reflexes to stimuli in the environment and lack grammar (cf. Tomasello and Zuberbühler 2002, cf. also n. 185 and 187). In the current respect more interesting than the natural calls of animals is the remarkable amount of symbolic labels which some animals can learn. This capacity comes in two aspects: First, the great apes (and possibly other primates) use some conventional gestures naturally. Second, apes and some other animals can be trained in aspects of sign-languages or other language-like systems. Remarkable as these capacities are, however, they exclude the grammatical elements which are so characteristic of human language. I discuss the two aspects in turn.

Primates, in particular the great apes, use a number of gestures, bodily postures and facial expressions in order to communicate with conspecifics. Many of these are innate, but some are conventional. The conventional postures concern in particular social situations like nursing, begging, grooming and play. Summarizing his previous research, Tomasello (2008: 20) argues that these ‘gestures are individually learned, intentionally and flexibly produced communicative signals.’ Evidence towards this conclusion consists in, first, the large differences between individuals in respect to these gestures; second, the invention or learning of new gestures; third, that these gestures are only produced if the recipient is attentive; and fourth, that the reaction of the recipient is observed. According to Tomasello, some of these gestures, like making noise, poking, ground slapping and throwing stuff are pure ‘attention getters’, others are ontogenetically ritualized movements which are usually abbreviations of full actions. These ‘intention movements’ are used to initiate play, grooming and other social activities. Attention getters and intention movements can be combined, and if the intention movement does not have the intended effect, the gesture is repeated or other gestures to the same effect are displayed.

However, ‘based on all available analyses, the gesture sequences of great apes seem to contain basically no relational or grammatical structuring of any kind’ (Tomasello 2008: 249). They remain independent gestures.²³

However, a number of animals have been trained in human languages, and it is here that we might expect the greatest success in respect to the acquisition of grammatical knowledge. Some birds (in particular parrots) have mastered to respond appropriately to a large number of commands (Pepperberg 1999). The most successful non-human language learners, however, are great apes who have been trained in sign languages and lexigrams. Yet, despite extensive training over many years, the grammatical aspects of human language is absent in these language-trained apes (cf. Terrace, et al. 1979). I restrict the discussion to Kanzi, who is, so far, the most gifted non-human language learner (Savage-Rumbaugh, et al. 1998). The aim of the discussion is to show that even he systematically failed to acquire a command of grammatical structure.

Whereas Kanzi marginally outperformed a three-year-old child in some respects (Savage-Rumbaugh, et al. 1993) and developed a clear sensitivity for word order, his performance drops to a level of accuracy of 22,2% when dealing with conjunction (as opposed to 72% overall) (Truswell 2009). This indicates that he is not sensitive to two central aspects of human grammar: its hierarchical nature and its functional structure. In order to correctly understand the sentence in (9) and to act according to it, it is necessary to understand that *the water and the doggie* is a constituent, as indicated in (10). Otherwise chaos results as in (11): since *giving* is a binary predicate, the problem is that there are too many nominal expressions which ‘fight’ for the two argument positions. The failure of understanding the hierarchical order (as opposed to the mere linear order) could be in part overcome by a sensitivity to functional structure, indicated by the English function words *and* and *to*. Yet, Kanzi, it seems, was unable to use the information provided by these functional markers.

- (9) Give the water and the doggie to Rose
- (10) Give [the water and the doggie] to Rose
- (11) Giving, water, doggie, Rose

²³ Note, however, that there is considerable disagreement to what extent these gestural signs are communicative signs (cf. Cheney and Seyfarth 1997). The answer to this question has no bearing on my current argument. What I would like to point out here is that to the extent to which it is accepted that these gestures are indeed communicative signs, they cannot be combined in a grammatical way, nor are they used referentially, strictly speaking.

Since even Kanzi's linguistic abilities are quite exceptional for a non-human animal, we can, tentatively, conclude that non-human animals do not seem capable of learning or acquiring a human-style grammar. Their natural signs, to the extent to which they are not genetically fixed, don't contain any structural information. Furthermore, whereas Kanzi is sensitive to a linear order, his performance breaks down when the hierarchical nature of language plays an important role, as in the case of conjunction. This is in line with the suggestion of Hauser, et al (2002) that recursion, an abstract property of certain structures, is absent in the cognition of non-human animals.²⁴ However, the same examples also reveal Kanzi's lack of sensitivity to functional grammatical structure more generally.²⁵ This suggests that not only an abstract structural property and the mechanism generating it should be part of FLN, but also the more concrete functional grammatical elements.

4.2.3 Monkey Thoughts

In chapter 3.1, I have argued that the most complex grammatical structure in the nominal domain is associated with a referential use of the nominal and that propositionality is associated with the most complex grammatical structure in the clausal domain. In both cases, the grammatical complexity is mainly due to functional structure rather than to the lexicon. If animals cannot learn the functional aspect of human language and if this is also not part of their natural communication systems, we expect that, correspondingly, apes lack the ability to refer to objects in the sense in which humans naturally do and that they also fail to entertain propositional thought. In the following, I argue that the available evidence suggests that these expectations are borne out: the kinds of thoughts of non-human animals, revealed in their communication either with conspecifics or with human trainers, differ in significant ways from the kinds of thoughts which humans communicate.

One in respect to the current discussion particularly striking difference concerns the inability of non-human animals to refer to objects in the world. Thus, whereas children from a very early

²⁴ It is not so clear that there is indeed no recursion in the animal world, as Hauser, et al. argue. In particular, bird song is a good candidate for recursivity. And in the biological and physical domains recursion is nearly omnipresent. Think of parsley, fern, seaweed, etc. on the one hand and the universe at the other, which contains galaxies, which contain solar systems, which in turn contain planetary systems. However, language is probably unique in the animal kingdom in being a system used for communication which exhibits recursive features.

²⁵ Although an inability to comprehend hierarchical structures and an inability to deal with functional structure are two closely related aspects of our linguistic competence, they are not equivalent. Indeed, it is in part possible to lexicalize functional structure with the help of propositions or case-marking which mirrors thematic roles.

age onwards use language to draw the attention of someone else to an object or event, or to ask for information,

there is no evidence that apes used any of the symbols they learned to *refer* to objects or events or that those symbols had any function other than to request whatever food or drink its trainer could provide (e.g., *please, me, more*, etc.). This was true even of the symbols that apes used to obtain particular rewards (e.g., *apple, Coke, banana*, etc.). (Terrace 2005: 98)

A chimpanzee can learn to sign *dog* in the presence of a dog. ‘It should be clear, however, that the function of the utterance *dog* is to obtain some reward and not to initiate a conversation with the trainer about the presence of a dog. To think otherwise is sheer projection’ (Terrace 2005: 99). Correspondingly, the chimpanzee stops the ‘conversation’ as soon as the trainer stops supplying food and drink as a reward. The chimpanzee, thus, does not aim at communicating propositional information. Rather, he has learned that signing certain signs in certain circumstances is a way of getting food or other kinds of rewards. This is in stark contrast to human infants, who do not expect to be rewarded for a conversation.

The same is true of the gestures of the great apes. Intention movements are never referential or propositional.

Because intention-movements are simply ritualizations (abbreviations) of initial steps in intentional actions, their ‘meaning’ is built in; it is simply what the communicator intends the other to do in the interaction, which was already present in some preexisting act in the social interaction before the signal was ritualized. (Tomasello 2008: 51-52)

There is, thus, no question of how the ape learns the connection between the gesture and its meaning. But more important for our current purpose is that, although intentional, the intention movement is a direct expression of the emotional state of the producer; there is no entity, abstract or concrete referred to, no claim made. The communicational act is expressive and imperative. Tomasello argues that attention getters get somewhat closer to the referential mode. The sole function of the attention getter is to focus the attention of a conspecific towards some bodily gesture. This may be the display of an intention movement or a non-intentionally controlled posture (e.g. a male chimpanzee who is in the mood of having sex may aim to direct the attention of a female towards his erect penis). Yet, it is clear that this kind of reference is not very much alike the human kind of reference associated with a grammatical DP. There is a crucial difference between attracting attention to oneself by shouting ‘Hello!’ on the one hand and referring to an object as ‘Paul’ or ‘the ball’ on the other.

In sum, non-human animals don't use words referentially or in order to provide information, irrespective of whether they are natural calls,²⁶ bodily positions, or the signs of linguistically trained animals. This is in line with Csibra and Gergely's (2009; 2011) finding that, although many animals teach their offspring and other conspecifics, the knowledge that animals teach is not the generalizable, propositional knowledge which human infants expect to be taught. Furthermore, based on different data than I have discussed above, Penn, et al (2008: 110) argue:

The profound biological continuity between human and nonhuman animals masks an equally profound functional discontinuity between the human and nonhuman mind. [...] The functional discontinuity between human and nonhuman minds pervades nearly every domain of cognition.

If it is accepted that there is a qualitative difference between the thoughts of human and non-human animals, the question arises what could account for the difference between the two different modes of thought. The close correlation between grammatical capabilities and rational thought suggests that the two are more closely related than traditionally assumed. Indeed, since grammar can be studied by empirical means, the hypothesis that grammar is not only the structuring principle of our utterances but also of rational thought attacks the central problem head on and may serve to naturalize aspects of human rationality. On the other hand, presupposing the existence of rational thought in an explanation of the evolution of language merely shifts the burden of the problem: accounting for the evolution of the new kinds of meaning which humans are capable of producing and grasping is, it seems, the central challenge, and the key of what makes linguistic structures genuinely linguistic. As long as no theory of the origin of the new mode of thought is provided, a theory of its externalization lacks its central component. Since it is unclear what if not grammatical structure could be used for an empirical

²⁶ Alarm calls might initially be thought to provide a counterexample to this generalization. Yet, our closest non-human kin, the great apes, do not call for alarm. Monkeys call for alarm, but these calls are at best functionally referential. There is no evidence that alarm calls are ever made in order to warn other animals, as opposed to a mere expression of the present mental state of the animal. This is even true in respect to false alarm calls or of suppressed alarm calls in the absence of close kin (cf. Bickerton 1995: 12-15). Indeed, in experimental situations, macaque mothers who see their offspring approached by a predator don't give an alarm call, as long as they are not in danger themselves (Cheney and Seyfarth 1990). Tomasello (2008: 53-54) concludes: 'For all mammals, including nonhuman primates, vocal displays are mostly unlearned, genetically fixed, emotionally urgent, involuntary, inflexible responses to evolutionary important events that benefit the vocalizer in some more or less direct way. They are broadcast mostly indiscriminately, with little attention to potential recipients.'

explanation of rational thought, thinking of grammar as a bridge between thought and sound, in effect, defers an explanation of the origin of language out of the reach of empirical science.²⁷

Conversely, the thesis that grammar provides the structure of rational thought makes sense of the findings reviewed above. According to the above, the two parallel uniquely human capacities are the capacity of acquiring grammatical knowledge and the ability to use expressions referentially or propositionally. As Terrace (2005: 101) stresses, ‘like grammatical ability, referential ability is uniquely human’. In particular, even the most linguistically skilled animals seem to be insensitive to hierarchical organisation and functional structure, the hallmark of human language, no less after intense training. The insensitivity of animals to functional grammatical structure and their inability to use expressions referentially or propositionally match up perfectly, since, as already indicated above, it is the functional structure which is responsible for building up referents and propositions.

4.3.4 The Evolution of Language and Thought

The difference that language and the rational format of thought make to primate cognition can also be seen in the archaeological record. The hominid lineage separated from that of the chimpanzee about 7 million years ago. Yet, as far as we know, there was no big difference between the behaviour of the early hominids and other great apes, apart from the fact that all hominids were bipeds (Gibbons 2006). It was not before about 2.6 million years ago that the first important technological innovation occurred in hominid history: it is from this time onwards that hominids have produced and used Oldowan stone tools. Yet, according to Tattersall (2004), the inventors of these tools have not had a brain much larger than an ape of similar size would have had, nor did they behave in a way that differed much from the behaviour of the other great apes.

The technological progression was very slow, compared to modern standards. It indeed took another million years until, about 1.6 million years ago, the next technical innovation appeared and *Homo ergaster* invented Acheulean hand axes. Whereas the only characteristic of Oldowan stone tools is that they possess a cutting edge, Acheulean hand axes resemble each other in many respects, as if they had been made following a ‘mental template’ which was not only

²⁷ As Higginbotham (1989: 171) argues, in an admittedly different context: a central philosophical interest in the study of language is ‘getting at the nature of thought and rationality by inquiring into the nature of language’. However, ‘if language is made available to us only because we can think, and therefore form hypotheses about meaning, then the very power has been presupposed that linguistic investigation was intended to clarify.’

determined by functionality (Tattersall 2010: 195). It again took about a million years until a new hominid species, *Homo heidelbergensis*, invented a new kind of stone tool about 600.000 years ago.

The speciation of *Homo sapiens* happened between 150.000 and 200.000 years ago in Sub-Saharan Africa (White, et al. 2003). It was possibly based on a single genetic change (Crow 2008). Since language does not fossilize, it is impossible to determine when exactly language first appeared. Yet, language is a symbolic system, and the first fossilized symbolic representations appear only about 80.000-100.000 years ago (Henshilwood, et al. 2002). It is therefore plausible to assume that language was around at the time when the first cave art, sculpture, music, trade, the sophisticated tools which *homo sapiens* introduced etc. can be found.²⁸ There is, of course, no absolute certainty that other hominid species did not talk. Yet, the archaeological record suggests that only modern humans were linguistically gifted.²⁹ Whereas already *Homo heidelbergensis* domesticated fire and built shelters, and whereas *Homo neanderthalensis* was a very gifted toolmaker and buried his dead (at least sometimes), there are no clearly symbolic representations associated with these hominids.³⁰ Moreover, the advent of language had a dramatic effect. Whereas *Homo sapiens* and *Homo neanderthalensis* had coexisted for many ten thousands of years, in part interbreeding with one another, the Neanderthals and all other by then non-extinct hominids disappeared relatively quickly after the first symbolic representations can be found. ‘Once *Homo sapiens* had begun to behave in a “modern” way, [...] the rules of the game changed entirely, and our species became an irresistible force in Nature, intolerant of competition and able to indulge that intolerance’ (Tattersall 2010: 197). Tattersall (2008: 101) concludes: ‘the difference in cognitive capacity

²⁸ The delay between the genetic change which defines *Homo sapiens* as a species and the realization of the new potential which comes with it is expected and actually rather short, given that it often took several hundred thousand years until a new species invented new technology. *Homo ergaster*, who invented the Acheulean hand axe, had existed several hundreds of thousand years prior to this invention. It took *Homo heidelbergensis* between 300.000 and 400.000 years before inventing Mousterian stone tools. And, although it is not known which species invented the Oldowan stone tools, it is very likely that they had been around for a long time before making their big invention. Tattersall (2010: 195) concludes: ‘Biological and technological advances do *not* go hand in hand. And this disconnect between anatomical and behavioral innovation actually makes eminent sense. For there is quite obviously no place that any innovation can arise, except *within* a species.’

²⁹ The issue is far from settled. Cf. e.g. the recent exchange in *Biolinguistics* on this topic (Barceló-Coblijn and Benítez-Burraco 2013; Johansson 2013b; Johansson 2013a).

³⁰ A flute which has long been thought to have belonged to Neanderthals, and which has been the main empirical evidence for the purported musical capacity of Neanderthals (Mithen 2005), has recently been shown to have belonged to a group of modern humans (Benazzi, et al. 2011).

between *Homo sapiens* and even its closest extinct relatives is a huge one. And it is not just a difference in degree. It is a difference in kind, [...] a qualitative, discontinuous one.’

The thesis that grammar may be used to explain the difference between rational and non-rational thought, then, is supported by the archaeological record, even if this support comes more from a methodological than from an empirical point: Since language does not fossilize, it is only the artefacts and cultural changes which the new mode of thought gave rise to as well as the consequences for the human and non-human populations at that time that can give evidence of the presence and absence of language. Thus, to the extent to which archaeology is relevant at all to the study of the evolution of language, the equivalence between language and rational thought, then, has to be taken for granted.

To conclude, whereas considerations in current linguistic theory concerning the evolution of grammar led to considering many aspects of human rationality as evolutionary prior to language, both the archaeological record and findings in comparative animal psychology suggest a very close correlation between the human ability to think in a rational way and the human grammatical competence, since, first, both are universal within the human species but absent in every non-human species, and second, they have to have evolved at about the same time. Furthermore, the hallmarks of grammar are the hallmarks of rational thought: the most complex grammatical structures are associated with referentiality and propositionality which, in turn, are central ingredients of judgements, and hence rational thought. As a result, taking grammar as a (perhaps optimal) bridge between rational thought and its externalization leaves out the most puzzling aspect of language as long as no corresponding theory of the evolution of rational thought is provided. On the other hand, given the close correlation observed in this section, the empirically studied grammatical structures may well serve to explain the origin of our rational thought and thereby to naturalize aspects of rationality.

4.4 Grammatical Structure Building and Ontological Change

4.4.1 The Second Unity Problem

As argued in chapter 1.2, the second problem associated with the unity of meaning (UP2) is that if linguistic expressions are combined in a grammatical way, this is often associated with an ontological change. Thus, if we put the two words *Socrates* and *sits* together, the complete expression *Socrates sits* has a proposition as meaning and is evaluable for truth, although the meaning of *Socrates* is an object and that of *sits* is a property and none of these two meanings is

evaluable for truth. This ontological change is not only the clearest sign for the qualitative difference between the meaning of a sentence and the meaning of a list, but, more importantly, the new ontological categories are impossible without grammatical complexity. As already Aristotle (Met 1027b) noticed, grammatical complexity is inevitable for asserting a truth.³¹ Strikingly, even the truth predicate on its own is not enough to assert a truth (Hinzen 2011).³² Yet, the phenomenon is not restricted to predicate-argument concatenation, but occurs in all instances of grammatical structure building: if a classifier is added to a NP, the mass denotation of the NP turns into a count interpretation. And even in the case of adjunction, the question arises of why, given that the meaning of *brown* is a colour, that of *brown cow* is an animal, not a colour.

If the formal ontological category of the meaning of an expression is part of the lexical entry of that expression, these puzzles cannot be addressed in an illuminating way. Given a lexicalist understanding of ontology, UP2 could be paraphrased as: ‘what kind of thing do we need to add to an entity to receive a truth value?’ or ‘what kind of thing do we need to add to a mass in order to receive an individual?’ But there is no *thing* which we could add to a mass which would then turn it into an individual. With standard semantic theory, we could, of course, assume that classifiers, sentential predicates and many other expressions denote functions. The classifier, then, is a function from masses to individuals, and a sentential predicate is a function from objects to truth values. Yet, as Davidson remarks (cf. chapter 2.4), as an explanation of the ontological shifts at issue, this strategy is vacuous: we simply postulate as the meaning of a predicate and classifier respectively what we know predicates and classifiers do. Davidson (1967c: 20) argues:

³¹ This is not to deny that there are one-word sentences in many languages. In Arabic, for example, the sentence *I love you* can be expressed in one word: *uhibu-ki* if the addressee is female or *uhibu-ka* if the addressee is male. Yet, this does not mean that the sentence in Arabic is grammatically less complex than in English. As in English, there is a first person subject, a second person object, a specification for tense, aspect, force etc. The difference is just that in Arabic all these specifications are realized by the morphology of the verb, whereas in English some of them (the person specifications) require additional words. Others, like aspect and tense, are part of the morphology of the verb in English, too.

³² In the course of a conversation, it is, of course, sometimes possible to assert something just by using the truth predicate. If someone says: ‘Aristotle was clever’, someone else may answer ‘true’, or ‘yes’. This is no counterevidence for Aristotle’s thesis that grammatical complexity is necessary for asserting a truth. First, there is pervasive evidence that, despite appearance, these expressions are not grammatically simple, but ellipses (Holmberg 2013). Second (and in support of the first point), these expressions are only possible if a truth-evaluable statement has already been made and thus presuppose that grammatical complexity is already part of the discourse.

Ask, for example, for the meaning of ‘Theaetetus flies’. A Fregean answer might go something like this: given the meaning of ‘Theaetetus’ as argument, the meaning of ‘flies’ yields the meaning of ‘Theaetetus flies’ as value. The vacuity of this answer is obvious. We wanted to know what the meaning of ‘Theaetetus flies’ is; it is no progress to be told that it is the meaning of ‘Theaetetus flies’.

If, however, the formal ontology of natural language is a grammatical phenomenon, as I have argued in this chapter, grammatical changes are ontological changes and the problem dissolves. Indeed, the question of how the formal ontological category can change with the grammatical structure is only a problem as long as we think of the meanings of linguistic expressions as falling under formal ontological categories intrinsically: in that case, two formal ontological categories would have to be combined to give rise to a new one. And it is not clear how this could work. However, if ontology is a structural phenomenon, ontology necessarily changes with the structure; *mutatis mutandis*, if ontology is a grammatical phenomenon, ontology necessarily changes with grammar, and UP2 is solved.

In chapter 3.2, I have taken the first step of my argument that the formal ontology of language is a grammatical phenomenon by pointing out that there is reason to assume that grammar is inherently meaningful. In the current chapter, I have then argued that a central aspect of the meaning of grammar consists in its determining a formal ontology. I summarize both parts of the argument in the remainder of this section.

4.4.2 The Meaning of Grammar

There is a long tradition in philosophy according to which meanings are some kind of metaphysical entities. Thus, Frege reasoned that the meanings of sentences are propositions (he called them *thoughts*), which he took to be abstract entities in a third realm. These abstract entities were taken to provide a link between our private thought on the one hand and the world on the other. They were also taken to account for the intuition that several people could have the same thought. However, as Fodor (1998) points out, if there is a problem about the relation between thought/language and the world, the same problem is bound to appear in respect to the relation between thought/language and these abstract entities which were taken to bridge the gap. Furthermore, as discussed in section 3.2.1, the question arises where these third realm entities are supposed to get their content from (King 2007; Soames 2010b). Finally, many philosophers are worried about the existence and identity of abstract objects. Following Fodor, King, Soames and others, I have therefore suggested seeking the locus of meaning not in some third realm entities, but in the cognitive domain. For Frege, such a psychologistic move would have been impossible, since he was worried about how, in such a case, we could ensure that two

different people ever talk and think about the same things – psychologizing meaning, he thought, would make successful communication impossible. However, to the extent to which the relevant forms of thought are part of our genetic endowment, this worry is without any bite. Indeed, as Fodor suggests, the solipsistic conclusion which Frege seems to associate with psychologism can be avoided if the individual thoughts of people are tokens of types which can be tokened by others.

There is, however, one complication to this idea. Seemingly, the ontologically least costly way of talk about types is to think of them as abstractions from their tokens. And this is indeed a common proposal within the tradition of structured propositions. Yet, abstractions are completely unconstrained: we can abstract from just anything we want. Therefore, if propositions are taken to be act- or event-types abstracted from their tokens, there is no motivated way in which we could arrive at the relevant distinctions both in respect to what counts as a predication and in respect to what counts as the same predication. The types would be open to stipulation, which presupposes a theorist who stipulates them, and, hence, the cognitive act-tokens which were supposed to be inherently meaningful are not so, since what they mean depends upon something else: the abstracting theorist. In other words, if we want to explain why a certain cognitive act is a predication (as opposed to, say, a property conjunction), this explanation will have to presuppose a (probably structural) criterion which every act has to satisfy in order to count as a predication. Similarly, the difference between different predications (say, the difference between the two propositions expressed by the sentences *John loves Mary* and *Mary loves John*) can only be explained with the help of general rules concerning their structure. In this sense, the types have an explanatory priority over their tokens.

I have therefore suggested giving up the thesis that there are no inherently meaningful structures. For certain cognitive structures, the ‘relation’ between the structure and its meaning is ensured by biological laws (which may either be primitives or be reduced to more fundamental ones). These structures are then on a par with other inherently meaningful structures, like that of DNA. Although there is no conceptual necessity for the role the DNA plays for the development of an organism, it does play this role. This view is supported by recent considerations in the philosophy of grammar according to which the relation between grammar and its meaning is not arbitrary: the radical divide between syntax and semantics, familiar from formal languages, does not apply to natural languages. In many cases, considerations concerning meaning play an important role in determining linguistic structure and, conversely, a grammatical analysis of a sentence already explains the structural aspects of the meaning of the sentence. Any post-grammatical representation which is supposed to give an

interpretation of a grammatical representation would simply have to reiterate the relevant grammatical information.

An aspect of the meaning of grammar consists in the formal ontological categories into which linguistic expressions fall. My argument towards this conclusion has been that simply assuming these ontological categories, which are so central to thought and language, is not an explanatory way to go. Yet, it is unclear what, if not grammar, has given rise to these ontological categories in human cognitive evolution.

In section 4.2 I have argued that assuming these categories to be of a metaphysical origin, independent of our cognition, faces three difficulties. First, the relevant ontological categories are formal ones, that is, they concern primarily the mode of referring to the things in the world, not the things in the world themselves. Second, the most central ontological categories for human thought and language are those which we have no language-independent reason to assume. Language is in this sense ontologically productive. Finally, even if the categories at issue turn out to be of a metaphysical kind, we still face the question of how they are cognized.

In section 4.3, I have also rejected the idea that the formal ontology of language originates in a pre-grammatical mode of thought. Whereas abilities to refer and think in a propositional format are universal among *Homo sapiens*, the evidence from the archaeological record and comparative animal psychology suggests that reference and propositionality (and hence the rational mode of thought which crucially presupposes reference and predication) is not shared even with our closest non-human relatives. Furthermore, although there was some progression in the cognitive abilities of hominids in the last three million years, the change from a non-rational to a rational mode of thought, which is closely associated with our species, was probably quite rapid and happened relatively recently. Therefore, the question arises where this new propositional mode of thought, and hence the ability to grasp the novel ontological categories associated with reference and predication, comes from.

I have suggested that there are a number of reasons that make grammar a good candidate for being the cognitive ability that gives rise to this new mode of thought. First, like rationality, grammar is universal in human populations, but not shared with non-human species, including our closest hominid relatives, *Homo neanderthalensis*. Furthermore, the time of the first evidence for the presence of language and that for the presence of the rational mode of thought coincide. Second, the hallmark of grammar consists in exactly those functions which give rise to the new mode of thought: what requires the highest grammatical complexity are reference and propositionality (in the nominal and clausal domains respectively). Hence, the functions of grammar and the categories of the new mode of thought coincide. Third, in chapter 5.1, I will

provide some examples of how grammatical principles can be used in order to explain why the denotations of certain expressions have the ontological category they do, whereas the reverse direction of explanation is elusive. In sum, grammatical theory can be used in order to explain the ontological aspects of linguistic meanings and thoughts. Since grammar is an empirical discipline, the formal ontology of natural language can be naturalized in this way.

A further argument towards the conclusion that ontology is a grammatical phenomenon consists in the implication relations that exist between formal ontological categories which exactly mirror the grammatical organisation. If you ate these three lambs, you ate three lambs. If you ate three lambs, you ate lambs, and if you ate lambs, you ate lamb. As I discuss in chapter 6, the grammatical structure of the phrase *these three lambs*, given in (58), predicts just that (cf. also chapter 3.3.1). Similar implicational relations hold in the verbal and clausal domain.

(12) [_{DP} these [_{NumP} three [_{CIP -S} [_{NP} lamb]]]]

The fact that some ontological kinds include others, for example that objects always include masses, already suggests that ontology is a structural phenomenon. The close correlation between the ontological inclusions and the grammatical structure supports the thesis that the formal ontology of language is grammatical. Given that, as argued above, the fact that human beings are capable of making the respective formal ontological distinctions has to be explained, the close correlation between the formal ontology and grammatical structure again suggests that it is grammar which provides this explanation.

If the thesis that grammar and the formal ontology of language coincide is correct, UP2 dissolves. However, the thesis that the formal ontology of language is grammatical faces the challenge that at least some aspects of ontology can be part of lexical items. Consider constructions such as *the proposition that John loves Mary*, *the property of being red* or *the event of eating*. Each of these expressions is grammatically a DP, but, given their lexical content, they have a proposition, a property and an event as their respective meanings. It thus seems that grammar and ontology can come apart in at least some cases. Furthermore, a number of ontological categories seem to be available prior to language already. Arguably, already our visual cognition makes an implicit distinction between objects, properties and events. In the following chapter, I will take up these challenges by providing a theory of the relation between grammatical and lexical ontology. I also discuss what language adds to the ontology already implicit in evolutionary more ancient cognition. In the course of these discussions, I furthermore provide some examples of grammatical explanation of the ontological category of the meaning of linguistic expressions.

Grammatical, Lexical, and Perceptual Ontology

In chapter 4, I have argued that the full ontology we employ in language and thought only becomes available with grammar. This also opens the possibility of explaining facts concerning the ontology of language with the help of grammatical theory. In section 5.1, I give an example of how such an explanation could work. In section 5.2, I discuss the relation between grammatical ontology and the ontology of perception. I suggest that grammar gives rise to an additional layer of formal ontological classification. Aspects of pre-grammatical ontology may enter into the specifications of lexical items. In section 5.3, I discuss the possibility of lexicalizing grammatical ontology. I argue that the generalized version of Frege's paradox of the concept *horse*, which this possibility gives rise to, is not in fact problematic for the account developed.

5.1 A Case Study in Grammatology¹

I begin with some thoughts about the relation between grammatical and ontological categories, given that they correspond neatly (section 5.1.1). In sections 5.1.2-5.1.4, I discuss a project of Friederike Moltmann's, who proposes to use ontology to explain facts about the meaning and the distribution of certain grammatical categories. I aim to show that the reverse strategy, that is, explaining ontology in terms of grammar, yields a more explanatory theory.

5.1.1 Grammar and Ontology: A Chicken-Egg Problem

The thesis that grammar is meaningful is widely accepted. According to Partee (2007: 148), the Montagovian notion of compositionality entails a 'homomorphism' of syntax and semantics: 'syntactic and semantic rules come in pairs [...] in this sense compositional semantics concerns "the semantics of syntax".' Furthermore, King (2007: 34) emphasizes: 'Semantic approaches

¹ Parts of this section are adapted from Reichard and Hinzen (2012).

differ only on what they claim *is* the instruction that a given bit of syntax provides. They are all stuck with the idea of syntax providing instructions.’

The homology between ontological and grammatical distinctions, however, is not always recognized. Despite his assertions that structures are arbitrary, many ontological differences which Soames (2010b) discusses, for example, seem to be tied to grammatical distinctions. For instance, Soames argues that propositions are to be identified with event types rather than act types. The distinction is motivated on metaphysical grounds: ‘Act types [...] are either themselves a certain kind of property, or something closely akin to properties’ (Soames 2010b: 102). Propositions are by definition not properties. Hence, propositions are not act-types. However, all act-types Soames mentions are grammatically gerunds which lack an agent: ‘kissing Martha or predicating incompleteness of arithmetic’ (Soames 2010b: 102), ‘running, opening a door, talking to John, and predicating brilliance of someone’ (Soames 2010b: 102, n. 3). Propositions like ‘that snow is white’, on the other hand, seem to be primarily that-clauses, that is, CPs (complementizer phrases).² Gaskin (2008: 15) makes this point explicit when he argues that the different functions of propositions are ‘guaranteed by grammar’ via the distributional properties of that-clauses: The functions of propositions are that propositions can be true and false, that they are the bearers of modal properties and that they are the objects of propositional attitudes. These functions are guaranteed by grammar, since predicates like *it is true*, *it is necessary*, and *John believes* all take that-clauses as complements.

Yet, if grammar ‘guarantees’ the functions of propositions, we get something like a chicken-egg problem in respect to the explanatory priority of grammar and ontology. Is grammar the way it is *inter alia* because propositions simply have all these functions? That is, do predicates like *it is true*, *it is necessary*, *(I) believe*, *(I) want* and *(I) doubt* take that-clauses as complements because propositions can be true, are the bearers of modal properties and are the objects of our beliefs, desires, and doubts? Or is it rather the other way round: propositions have the relevant functions because CPs, the designators of propositions, function as complements of predicates like *it is true*, *it is necessary* and *I doubt*?

In the current philosophical and semantic literature, it is the first answer which is nearly universally accepted (irrespective of whether the respective ontological categories are taken to

² Propositions can also be DPs (determiner phrases), but only if they embed a that-clause, as in the phrase ‘the proposition that John is brilliant’ (Soames 2010b: 101), or if they somehow ‘stand for’ CPs, as in ‘Goldbach’s Conjecture’ or ‘your claim’ (Soames 2010b: 3). In this sense, propositionality seems to be clearly associated with CPs. For a discussion of the relation between meta-grammatical vocabulary and their structural counterparts see section 5.3.2.

be metaphysical or cognitive ones). It is thus no wonder that semantic analyses usually employ ontological vocabulary. However, as I have pointed out in chapter 4, the fact that human beings are capable of applying a formal ontology in their thought and speech is itself in need of explanation. I have suggested that the grammatical capacities of humans may account for this – and it is unclear what else could.

The idea that grammatical categories could be used to explain ontological intuitions is not unheard of in semantics. Higginbotham (1993) suggests something along these lines concerning the ontological status of sakes.³ Among many other expressions, flaws and sakes have often been taken to show that referential semantics is deeply problematic (e.g. Chomsky 1981: 324; Hornstein 1984, ch. 7), since, given a referential semantics, they draw a certain divergence between grammatical form and meaning. Whereas expressions like *for x's sake* suggest that there are sakes, most philosophers would not be willing to admit that sakes are real objects like tables and chairs. However, Higginbotham (1993: 177) notes that the distribution of expressions like *sake* and *behalf* is severely restricted. *The sake* in isolation is not very good an expression, *for a sake* is also bad, etc. Sakes, thus, seem to be restricted to a relatively small class of phrases, and this restricted productivity of this lexical item, Higginbotham argues, may explain our hesitation in admitting that there are sakes, metaphysically speaking. He concludes:

The metaphysical oddity of sakes is nothing but a projection from the syntax of the word “sake”. It is not surprising that one projects syntactic defectiveness first of all in metaphysical terms [...]. What would be unfortunate is to let the first, metaphysical terms also be the last terms of the discussion. For then one could get the idea that the syntax really is divorced from the semantics in a radical way.

However, the syntax of the word *sake* is, unfortunately, not very well understood. To what extent a principled explanation of the metaphysical oddity of sakes in grammatical terms is possible, thus, remains unclear until the relevant advances in syntactic theory have been made. However, there are some areas where the syntax is better understood and where such a grammatical explanation of metaphysical intuitions seems more promising given the current state of syntactic theory. To exemplify how such an explanation may work, I now discuss the ontological difference between the denotations of a certain kind of gerundive constructions and corresponding adjective nominalizations.

³ For a somehow related thesis see Higginbotham's (2006) sententialism concerning the meaning of CPs.

5.1.2 The Grammar of Tropes and States

Moltmann (2003a; 2004; 2005; 2007; 2013) accepts a homology between grammatical categories and ontological ones; but whereas I propose that grammatical distinctions can illuminate and explain the ontology which human language and thought exhibit, Moltmann argues for the reverse relation: according to her, ontology explains aspects of grammar. Her general strategy is to identify grammatical categories (for example, adjective nominalizations) with certain ontological categories (for example, tropes) and then to argue that this explains certain facts about the distribution of the respective grammatical category (for example, that adjective nominalizations cannot be negated). To give the following discussion focus, I will concentrate on two particular pairs of grammatical/ontological categories, adjective nominalizations, which Moltmann argues correspond to tropes,⁴ and gerundive constructions, which she takes to refer to ‘states’. I briefly consider other constructions in section 5.1.4.

Moltmann (2007: 368) argues:

Adjective nominalizations like *wisdom* are best considered general terms for particularized properties or tropes (or at least entities closely related to them), whereas gerundive constructions like *John’s being tired* describe entities quite different from tropes, namely what I will call states (given that they can be straightforwardly expanded into terms like *the state of John’s being tired*).

Tropes are defined as particularized properties. A common example is the colour of a particular object, say the redness of a particular rose. Whereas properties, for example the shade of red of this particular rose, can be taken to be universals that may be instantiated by different objects, a trope is a particular, which only one object can possess (at a time). In addition to being particulars, for Moltmann at least some tropes are concrete in the sense of being perceivable. The particular redness of a particular rose can be seen in case you are close enough and the light is good etc. The claim that adjective nominalizations refer to tropes, therefore, renders their denotations (potentially) concrete particulars.

What Moltmann calls ‘states’, on the other hand, are not concrete entities. She argues that ‘states are “above” concrete manifestations’ and that they are ‘beyond any type-token distinction’ (2007: 371); Moltmann also calls states ‘abstract – in a certain sense of “abstract”’ (Moltmann 2013: 18). Unlike tropes, states are also not particulars, strictly speaking, but

⁴ In Moltmann (2013), she has changed a central part of her theory: whereas in 2007 she thought of tropes as truthmakers of the corresponding expressions, she now regards them as implicit arguments of adjectives (cf. chapter 3.3). Significant as this change is, it will not bear on the issue I want to discuss in the following, and I shall therefore set it aside.

‘Russellian definite description[s]’ (Moltmann 2007: 370). Thus, if gerundive constructions denote states, their denotation is abstract and general.

A grammatical explanation of the ontological categories of the meanings of these expressions may run along the following lines: The grammar of natural languages provides two sources of particularity, one in the nominal domain, the other in the verbal domain. In the former, a general term such as *lamb*, occurring as a bare NP as in (1) below, lacks any particularity: no particular lamb is or can be referred to, and insofar as reference is established, it is solely via the descriptive content of the predicate involved. Where a weak determiner is added, as in (2), particularity is now derived: unlikely as it may a priori be, (2) entails that I ate an individual lamb. But it is still not possible to refer to a determinate particular lamb already established in the discourse, as in (3), where *the lamb* is used anaphorically. Where the nominal moves into the determiner position, reference is ‘rigid’ – in the sense that how the referent is picked out becomes independent of whether or not any identifying description applies. This process comes to a culmination in (5), where even the last residue of such an identifying description is removed,⁵ which is still involved in (4), simply insofar as any speaker using a proper name presupposes that the referent is a bearer of that name. And at this stage, adding an NP-restriction with a descriptive content becomes ungrammatical:

- (1) I ate [_{NP} lamb]
- (2) I ate [_{DP} a [_{NP} lamb]]
- (3) I ate [_{DP} the [_{NP} lamb]]
- (4) I ate [_{DP} Gina [_{NP} Gina]]
- (5) I ate [_{DP} her/it]

In the verbal domain, the source of particularity is finiteness. The event denoted by the verb phrase is a particular only if it possesses finite tense (T), as in (7). Finite tense locates an event in time in relation to the point of speech and in this sense makes it temporally a particular (Hinzen and Reichard 2011). An expression lacking sufficiently specified tense, like (6), only has a generic denotation:

- (6) [_{TP}Coming home] is wonderful.
- (7) I [_{TP}came home].

These facts enable us to explain the peculiar genericity of gerundive constructions (‘states’). The relevant syntactic structure of (8) is given in (9):

⁵ To the extent to which the grammatical number and gender features that pronouns exhibit can be seen as contributing descriptive content this is an idealization.

- (8) Mary's being beautiful
 (9) [_{DP} Mary's [_{NP} be-ing [_{TP} **be** [beautiful]]]]

The most embedded part of the expression is the phrase *be beautiful*. This phrase is then nominalized with the help of the suffix *-ing*, which, due to its enclitic nature, triggers movement of *be*. *Mary* functions as a specifier of the possessive clitic 's, which is in the D-position. Since the expression has a tense projection (T), it possesses temporal aspect. Yet, since the TP is not specified for finiteness (Past or Present in relation to the point of speech), its denotation remains generic. As a nominal, however, it is specific, as all possessive constructions of this type are. This gives (8) the intermediate status between specificity and generality that Moltmann describes. It may also be the source for 'states' being, in Moltmann's words, 'beyond a type token distinction': The expression is generic in the temporal respect, which is an aspect of types. Yet it is tied to a particular possessor, due to its possessive determiner, which renders it a token rather than a type.

The particularity of adjective nominalizations can also be explained with the help of the principles above. The adjective is nominalized with the help of the suffix *-dom*, which triggers movement of the adjective, due to its enclitic nature. *John's* acts again as a possessive determiner of the nominalized adjective:

- (10) John's wisdom
 (11) [_{DP} John's [_{NP} wis-dom [_{AP} **wise**]]]

This time there is no verb and no TP, and, for this reason, the expression does not possess temporal aspect. Thus, it is neither specific nor non-specific temporally. Yet, the expression is definite, since the possessive determiner triggers specificity. It is therefore expected that adjective nominalizations denote particulars.

In addition, tropes are said to be concrete rather than abstract. Yet, as Moltmann (2007: 371) notes, the standard notion of tropes cannot be applied to the linguistic case: can John's wisdom really be perceived? Certainly, John's wisdom does not occupy a certain space-time region. Aristotle is long gone, but part of his wisdom is still around, and, indeed, visible, when you read his works. Thus, there does not seem to be an aspect in which the concreteness of Moltmannian tropes exceeds the grammatically induced definite specificity discussed above. In sum, the

ontological differences between adjective nominalizations and gerundive constructions can be explained with the help of basic grammatical principles.⁶

5.1.3 The Distribution of Tropes and States

Let us follow Moltmann's argument further. Given that the denotations of adjective nominalizations occurring as complements of possessive determiners are particulars, whereas those of gerundive constructions are universals, we may expect that adjective nominalizations can act as arguments of predicates of change, whereas gerundive constructions cannot. This expectation is borne out, as Moltmann argues: (12) is fine, whereas (13) is odd.

- (12) John's wisdom increased over time.
- (13) ??John's being wise increased over time.

Furthermore, given that the denotation of gerundive constructions is 'beyond concrete manifestation', it is perhaps expected that they, unlike the concrete adjectival nominalizations, cannot be the subject of a predicate of measurement. This may be taken to explain the contrast between (14) and (15): something can only be extreme in comparison with other things of the same kind – but if there is no kind-token distinction in respect to the denotation of gerundive constructions, they cannot be compared to other instances of their kind.

- (14) John's tiredness was extreme.
- (15) ?? John's being tired was extreme.

Similar contrasts can be found in respect to verbs of description, examination and admiration. Whereas adjective nominalizations can act as complements of these verbs, Moltmann stresses that gerundive constructions cannot. Compare the following contrasts:

- (16) John described Mary's beauty.
- (17) ?? John described Mary's being beautiful.
- (18) John examined/investigated/took a closer look at Mary's illness.
- (19) ?? John examined/investigated/took a closer look at Mary's being ill.
- (20) John admired Mary's beauty.
- (21) ?? John admired Mary's being beautiful.

⁶ This result is not incompatible with Moltmann's main aims: Moltmann wants to use the ontological categories to explain the distribution of the respective expressions. That the categories are predicted by the grammar of the respective expressions does not affect this thesis, at least not directly.

In many cases, I'm not sure how the oddity of the gerundive constructions as complements of these verbs is supposed to follow from their denoting states. For example, what is it about the abstractness or generality of states that prevents them from being described? In general, describing something general or abstract is not a problem at all. Why is it a problem in the present case? Moltmann (2007: 368) argues that the possibility of describing tropes, but not states, follows from the fact that 'tropes can act as arguments of predicates that care about the internal structure or complexity of an argument; states cannot.' Unfortunately, no reason is given for how this follows from the nature of tropes and states.

Moltmann is clear that she does not use the terms 'trope' and 'state' in the sense standard in current metaphysics. Thus, perhaps it is simply a primitive fact about the kinds of entities which Moltmann calls 'tropes' that they can be described, examined and admired, whereas this is not the case in respect to what she calls 'states'. Yet, if this is the case, the question arises how independent the ontological category is from the grammatical one. If the grammatical features and the distribution of the respective grammatical category determine the properties of the ontological category, then it seems that the grammatical category has an explanatory primacy. For example, if the only reason for thinking that tropes can, but states cannot be described is that verbs of description take trope-referring, but not state-referring expressions as complements, then the features of the ontological categories are not established independently of grammar. Rather, the properties of the relevant ontological classes are inferred from the distribution of the respective grammatical configuration, which, in turn, should have a grammatical explanation.

Consider again the difference between (22) and (23) (from (18) and (19) above).

- (22) John investigated Mary's illness.
- (23) John investigated Mary's being ill.

Note that also (23) is acceptable in certain specific circumstances. Imagine that John is not a doctor but Mary's boss. And Mary has been absent from work a couple of times, claiming that she is ill. But John doubts that she is indeed ill. In that case he may well decide to investigate Mary's being ill.

The difference between (22) and (23), then, is not so much that the former is good and the latter isn't, but that the two expressions have different meanings and that, for pragmatic reasons, the latter kind of sentence is one we wouldn't use as often as the former. The question which Moltmann raises, then, is mainly why (22) cannot mean what (23) means. The answer to this question is straightforwardly grammatical. Compare the grammatical structures in (24) and (25).

What is investigated is in both cases encoded as the head of the nominal phase which *investigate* takes as its complement, *illness* in (24) and *being* in (25). The reason for why *ill* cannot be what is investigated in (25) is that the head *being* is also a candidate for being investigated, and it is closer to the matrix verb, intervening between its relation with the more deeply embedded head *ill*:

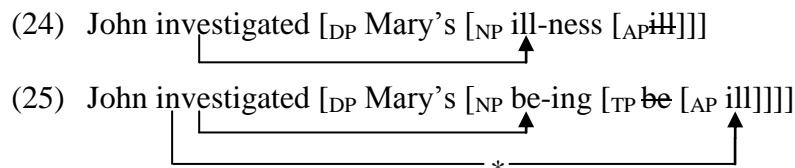

Similar points can be made in respect to the other examples mentioned so far.

Another difference between adjective nominalizations and gerundive constructions is even more clearly grammatical. Moltmann argues that adjective nominalizations cannot be negated. That is, according to her, there is no adjective nominalization corresponding to expressions like (26). And it is indeed correct that expressions like (27) are ungrammatical. The reason for this is that *not* applies only to sufficiently verbal expressions and *readiness* is not verbal in any sense. It is, however, possible to use a different negation as in (28) which applies to adjectives and thus also to adjective nominalizations.^{7 8}

⁷ It should be noted, though, that prefixes which in English function as negations like *un-*, *a-*, *in-*, *dis-*, and *non-* are often less productive than *not*. *Unreadiness* is ok, but not very good, *unwillingness* is much better. *Non-compliance* is good, whereas *non-realization* is bad. The acceptability of these negations, thus, seems to be partially determined lexically.

⁸ As additional differences between the two kinds of constructions, Moltmann argues that terms referring to states, but not terms referring to tropes, allow for disjunction. There, thus, should not be an adjective nominalization corresponding to *John's being either jealous or insecure*. Yet, the following passage seems fine to me:

- (i) The meeting was difficult due to John's being either jealous or insecure. Indeed, his jealous- or insecureness persisted even when he was appointed president of the society.

Moltmann furthermore argues that adjective nominalizations, but not gerundive constructions, allow for demonstrative determiners and mass quantification. Thus, there are supposed to be no gerundive correlates to expressions like (ii) and (iii).

- (ii) this tiredness
(iii) more anger

However, (iv) and (v) seem fine to me.

- (iv) This constantly being tired is the downside of having little children.
(v) Being more angry would hardly have been possible.

Yet, as Moltmann (p.c.) points out, (iv) does not capture the reading of *this* which she is after: the reading of *this* she requires is a contrastive demonstrative:

- (vi) *this* tiredness as opposed to *that* tiredness

- (26) John's not being ready
 (27) *John's not readiness
 (28) John's unreadiness

In sum, the differences in meaning between adjective nominalizations and gerundive constructions are explained by their respective grammatical structure, given some basic grammatical principles. Furthermore, also aspects of their distribution can be traced back to how they are made up grammatically.

5.1.4 The Grammar and Distribution of Events and Facts

Moltmann sees her theory of adjectival nominalizations and gerundive constructions supported by the existence of a (largely) parallel distinction between verb nominalizations and clausal constructions. Verb nominalizations like *John's jump*, she argues, refer to events which are concrete particulars, whereas constructions like *the fact that John jumped*, that is CPs embedded in the noun phrase *the fact*, refer to facts, which, according to Moltmann, are abstract and not particulars.

A syntactic analysis of a verb nominalization is given in (29). The verb *jump* projects up to VP, it is then nominalized and becomes the complement of the determiner of a possessor head and its specifier:

- (29) [_{DP} John's [_{NP} [_{VP} jump]]]

Verb nominalizations are neither specific nor non-specific in a temporal respect, even though they have a verbal origin. This is because their verbal part does not project a tense phrase. Evidence for this comes from a variety of phenomena, including adverbial modification (Fu, et al. 2001). They are, however, definite in the nominal sense, due to the possessive determiner, which accounts for their particularity.

The grammar of the relevant clausal expressions is as given in (30). A full clause (CP) functions as a complement of *the fact*.

- (30) [_{DP}the fact [_{CP} that [_{TP} John jumped]]]

Intuitions may fail me here, but I don't get the difference in acceptability between (vi) and (vii). Both are rather bad.

- (vii) *this* being tired as opposed to *that* being tired

Moltmann argues that the difference in acceptability between sentences like (31) and (32) is due to the proposed ontological differences. Only concrete particulars can be measured, whereas abstract universals cannot.

- (31) John's jump was high.
 (32) ?The fact that John jumped was high.

However, from a grammatical point of view, it is clear that the difference in acceptability has to do with the fact that the matrix predicate *high* attaches to the whole subject of the respective expressions. And it is the head of these subjects that determines their reference (e.g. 'John's jump' ultimately refers to a jump, not to John, though it is John's jump; and the 'the fact that...' construction will always ultimately refer to a fact, not to anything named in its modifying relative clause).⁹ The question, thus, reduces to the question of why jumps but not facts can be high – which is just as mysterious as the question of why ideas cannot eat or be tired.

To conclude, complex ontological categories of linguistic expressions can be explained on grammatical grounds, given some basic assumptions about the workings of grammar.¹⁰ This supports the thesis that grammar gives rise to a new formal ontology in the evolution of thought, and contributes to an explanation of why we can make the many intricate ontological distinctions we can make. By contrast, Moltmann's strategy of explaining facts about grammar and distribution in ontological terms cannot provide an answer to the question why these particular ontological distinctions are available in human language and thought (although, to be fair, this question is not one she attempts to answer). Furthermore, as I have argued, in many cases it is unclear whether the ontological distinctions she stipulates actually can do the explanatory work Moltmann argue they do.

5.2 Pre-Grammatical Ontology and the Lexicalization of Onto-Grammatical Categories

I have argued that grammar gives rise to a formal ontology. Yet, some ontological distinctions seem to be pre-grammatical. Pre-grammatical ontology comes in three different aspects. First, some ontological distinctions, for example the distinction between objects and events, may be

⁹ Cf. chapter 6 for a discussion of grammatical heads.

¹⁰ All that is needed as a primitive, arguably, is that phases progress from non-specific to specific modes of reference and that the first phase is associated with objects, the second with events. A systematic account of this, however, remains to be worked out.

traced back to perception. It is, therefore, a distinction which already animals can make, and thus should not be tied to grammar. Second, even though noun phrases are associated with objecthood, expressions like *the war* and *the concert*, for example, intuitively denote events. In this case, ontological and grammatical categories do not seem to match up. Third, there are a number of lexical items that denote ontological categories. Examples of expressions that denote ontological categories are *mass*, *individual*, *event*, *property*, *proposition*, *truth* etc.

I discuss the three cases in turn. I accept that there are aspects of ontology which precede grammar, but I argue that this kind of ontology is much more limited than the ontology that grammar gives rise to: Even though perceptual ontological categories already are formal categories (section 5.2.1), grammar adds a further formal layer (section 5.2.2). This further ontological layer gives rise to ontological categories which are not part of a perceptual ontology and makes the pre-grammatical ones more flexible. I discuss challenges posed by expressions where grammatical and lexical ontological categories do not match up in section 5.2.3, and problems that are due to expressions which denote ontological categories in section 5.2.4.

5.2.1 The Formal Ontology of Perception

According to the classical empiricist picture, only perceptual cognitive capacities of humans are innate. Every aspect of non-perceptual cognition was taken to rely on copies or abstractions from sensory input. Concepts have, thus, been taken to be mental images usually called ‘ideas’. Following Locke (1689), Hume draws a distinction between simple and complex ideas. Simple ideas, he argues, ‘mimic or copy the perceptions of the senses; but they never can entirely reach the force and vivacity of the original sentiment’ (Hume 1748: 17). Several primitive ideas which are mere copies of sensory impressions may be combined. For example, the ideas GOLD and MOUNTAIN, which both have been acquired via the senses, may be combined into GOLDEN MOUNTAIN. And this is why, according to the classical Empiricists, we can think and talk about things we have never seen before. ‘All this creative power of the mind amounts to no more than the faculty of compounding, transposing, augmenting, or diminishing the materials afforded us by the senses and experience.’ Hence, ‘when we analyse our thoughts or ideas, however compounded or sublime, we always find, that they resolve themselves into such simple ideas as were copied from a precedent feeling or sentiment’ (Hume 1748: 19).

If this picture was correct, conceptual and linguistic ontological categories like *mass*, *object*, *event*, *property*, or *proposition* also have to be explained as abstractions from perceptions. Yet, as Quine points out, the difference between objects and masses, for example, cannot be abstracted from perceptions: since perceived objects always have a (perceived) mass, it seems

possible for someone to take objects as special kinds of masses. Quine (1960: 93) argues that a child ‘may at that point have learned “apples” as another mass term, applicable to just so much apple as is taken up in apple heaps’. Since Quine wants to keep an overall empiricist picture of the human mind, he argues that only advanced quantificational linguistic devices can force a language learner to draw the distinction between masses and objects; and language acquisition is, according to Quine, explicable in behaviourist terms.

However, there is considerable empirical evidence against the thesis that the category of objects is a purely linguistic one. If Quine was right, children could not distinguish between masses and objects before they are two or three years old; and, in any case, non-human animals could never represent anything as an object. However, human infants, and indeed also other primates, take objects to be permanent (Baillargeon, et al. 1985) and spatio-temporally continuous (Spelke, et al. 1995). Moreover, young human infants and non-human primates alike can track up to three objects, but not more. As Feigenson and Carey (2003; 2005) report, if an infant sees up to three items being placed in a box and is then allowed to search for the items in the box without being able to retrieve the complete number of items that she has seen being placed there, the infant will search much longer for more items than when she is able to find all the items that have been placed in the box. However, performance breaks down if the infant sees four items being placed in a box: even if she can retrieve only one, she will not search for more items. The same pattern can be observed in non-human primates (e.g. Hauser and Carey 2003). Since four objects have more mass than one object of the same kind, these experiments speak against Quine’s thesis that non-linguistic primates lack the category of objects. Carey (2009, ch. 3) argues that creating ‘object files’ is part of the innate ‘core cognition’ of primates, and also other animals. Such an object file allows the animal to track an object, even if the object moves, changes colour, size or form or if it disappears from sight. There is, however, an upper limit to how many object files can be ‘open’ at the same time, and this limit is three in the case of human infants and non-human primates.¹¹ If Carey is on the right track, the conceptual category of an object, then, is a formal category which animals use in order to structure their perception rather than a category abstracted from perceptions.

The same may be true of events. Yet, whereas object perception and representation has been studied for many years in some depth, ‘the field of action or event perception is in its infancy’ (Shipley 2008: 11). It is, nonetheless, plausible to assume that events play a crucial role in animal cognition. As Gibson (1979) argues, many features of objects can only be perceived with

¹¹ This hypothesis is also supported by findings concerning the visual tracking of objects (e.g. Pylyshyn 2001) and the perception of change over time (cf. Nakayama, et al. 1995).

the help of motion. Thus, whether an object is animate, which intentions it has, etc. can only be perceived with the help of its actions and, hence, presupposes sensitivity to events. Indeed, the ability to perceive objects which are not in motion is restricted to primates (Kandel and Mason 1996: 452). The perception of movement (or moving objects) is thus evolutionary the more ancient visual function. The reason for this is probably, as Shipley (2008: 7) argues, that in order to coordinate our own behaviour with the world, we have to be sensible to events: ‘We perceive events in order to anticipate the future, and we use information available in the present to guide future action; in this way we attempt to maintain a perfect coordination of our actions with the world.’ This suggests that being sensitive to events is central for the survival of animals, and therefore an adaptive feature for all animals, not only for humans. However, it does not in itself give any evidence of how information about events is processed and whether animal cognition provides for a formal category of events.

Is event perception a system of Careyian core cognition? Some recent findings and theories suggest so. *First*, object and event perception is often taken to be parallel to a large degree (Shipley 2008). *Second*, Bauer (2008) surveys evidence to the effect that event (or rather action) memory develops very early in human infants, which suggests that innate capacities play an important role. And it is indeed not clear how categories which are used to structure event perception, like the trajectory of a motion, its manner etc., could be learned based on experience. Rather, these categories, which appear early in the development, seem to be a condition for such learning to take place. Interestingly, it has been argued that the same categories also play a crucial role in the acquisition of lexical items that concern actions and events (for a recent overview see Pruden, et al. 2008; Maguire and Dove 2008). *Third*, Hommel (2004) hypothesizes that in parallel to object files, the ability of creating event files is part of our perceptual endowment. Zacks, et al. (2007) indeed suggest that sensory input triggers an event model of a currently perceived individual event with the help of an event schema. Whereas event models are particulars, event schemata are schemata of certain types of events. According to Zacks, et al., event models serve two purposes. First, they help to predict what might happen next. Second, they serve to individuate events with the help of a mechanism that compares the prediction to what is actually perceived. In case the difference between prediction and perception increases, the event model is reset. This is perceived as the end of the old and the beginning of a new event.

If these theories are on the right track, the relevant notion of events is primarily a psychological or cognitive category that may be independent of metaphysical ones. How events are individuated is due to the way our cognition works. As Schwartz (2008: 60) argues:

The universe does not come parceled into events, and the events individuated do not arrive with 'natural' boundaries among their parts that simply await inspection, perception, recognition, and description. So not only the events themselves but the theoretically significant concepts of 'event' and 'event perception,' which hope to go beyond loose, unreflective, everyday talk, also require construction.

The picture that both events and objects are formal ontological categories that we use in order to structure our perception of and thought about the world, rather than categories that are inherent in the world perceived and thought about, is also supported by the anatomy of vision. Objects and events do not seem to be part of the stimulus that meets the eye; rather, object- and event-representations are constructed out of diverse sensory data. In this sense, our visual system shares probably more properties with a modern artist than with a camera. Already the cells in the retina are sensitive nearly exclusively to contrasts. Bipolar-cells and ganglion cells (the latter are the sole output from the retina) are most sensitive to light or dark spots at the centre of their receptive fields. The information that reaches the visual cortex, thus, is restricted to such contrasts. This information can only be used to produce object- and event-representations if the system presupposes these categories. Many visual illusions, but also our ability to see three-dimensional objects in pictures and movements in films, rely on this.

Furthermore, the organisation of the visual cortex provides neurophysiological evidence for an implicit ontological distinction between events and objects in vision. Visual information is processed in two interacting but clearly distinguishable pathways: one stream is located in the parietal, the other in the temporal lobe. Beginning with direction-sensitive neurons in layer 4B of V1, the parietal lobe stream (including area MT and MST) is mainly concerned with event perception, and, as such, closely related to action planning (Milner and Goodale 2006). The temporal lobe stream (including area V4 and IT), on the other hand, is specialized on perceiving objects and relate closely to visual memory.¹²

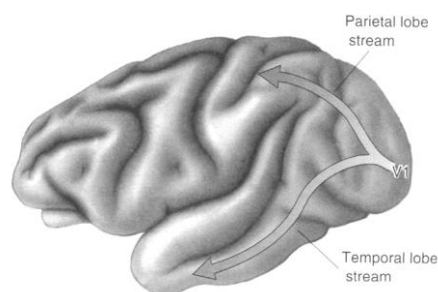

Parietal and temporal lobe visual processing streams (Bear, et al. 1996: 267)

¹² For a recent overview of the neuro-anatomy and neurology of vision see Bear, et al. (2007, chapters 9-10).

One way one might think to be able to avoid the rationalist conclusion that the cognitive categories of object and event are not abstracted from features of the world but rather constitutive of our perception of it and our thought about it is by appealing to the causal function of evolution (Quine 1969a: 90; 1969b: 126-28). Carey (2009: 116) formulated the point as follows: ‘The requisite causal connection between entities in the world and symbols in the head is guaranteed by natural selection. Thus, we have the beginnings of a theory of how the symbols in core cognition come to have the content they do.’ However, evolution does not provide a short-cut from cognition to metaphysics, since what matters from an evolutionary point of view is that our cognition functions well in the environment in which we live. It does not aim for truth. And as we know from the history of science, many theories work well (or at least well enough), even though they are not correct given the view from modern science. In parallel, perceiving the world in terms of objects and events may be an adaptive cognitive feature even if, metaphysically, nothing corresponds to these formal ontological categories.

5.2.2 Grammatical Ontology and Perceptual Ontology

Does the evidence that pre-linguistic cognition is structured in formal ontological categories falsify the thesis that grammatical structure gives rise to ontological categories, as argued in chapter 4? I think it does not; for, there are two aspects where grammatical ontology goes far beyond pre-linguistic ontology. First, the grammatical difference between reference and predication adds a further formal layer to the already formal ontological categories of perception. Second, there are ontological categories like *proposition* which don’t have an evolutionary more ancient correlate in perception. I address these two points in turn.

Although the different pathways where visual information is processed in the brain interact to some degree, in perception, a certain kind of information is bound to play a certain role. Information about colour, for example, will always serve as a property of an object, and the trajectory of an object will never itself be treated as an object. Language, on the other hand, is much freer in this respect. Whereas a colour can function as the property of an object, as in (33) and (34), it can also be made the subject of a sentence and thus be treated like an object, as in (35) and (36). Finally, a lexical item like *red* can also be verbalized and then denotes an event (37). The ontological distinctions which grammar gives rise to, thus, add a formal layer to the (already formal) ontological distinctions which are part of perception.

- (33) The red statue
- (34) The statue is red.
- (35) The red of the statue is beautiful.

- (36) Red is a beautiful colour.
 (37) The face reddened.

Grammatical ontology is, therefore, independent of the perceptual pre-grammatical ontology. How a lexical item is ontologically specified before it enters into the grammatical derivation does not determine which role it can play grammatically and, hence, of which onto-grammatical category its denotation is. The reason for this is that pre-grammatical ontological distinctions are specified only in the lexicon and that lexical information does not play a role in the grammatical derivation. The difference between ontological form and content in respect to the formal ontologies at issue, then, is a relative one: from the viewpoint of grammar, those formal distinctions which are already part of the object that enters into the syntactic derivation are not treated as part of the formal ontology. Rather, it is part of the lexical content which gets its form in the process of the grammatical derivation.¹³

The second novelty of grammar is the distinction between reference and predication, exemplified in the difference between (33) and (34): Whereas (33) only contains a referential expression which includes the meaning contributed by the adjective, (34) contains a real predication and can, thus, be asserted. This difference cannot be spelled out in perceptual terms. We can attend to events which have participants which, in turn, have properties. We can also attend to objects with their properties, disregarding the events in which they participate. And we are highly selective in respect to what we ‘see’. However, our perception does not refer to something or perceive something as a referent as opposed to a predicate. On the other hand, this difference is the hallmark of grammar. And this grammatical distinction gives rise to new ontological categories like propositions, facts and truth in the clausal domain and to the difference between reference and quantification in the nominal domain. The difference between

¹³ The relativity of the distinction between content and form is in accordance with Aristotle’s distinction between ὕλη and εἶδος. Summarizing the account of change developed in his *Physics*, Aristotle (*Met.* 1033b, 12-13) argues: ‘Everything that changes (γιννόμενον) has to be divisible: one part has to be this, the other something else: I mean, one has to be matter (ὕλη), the other form (εἶδος).’ If there is a change, matter is what stays constant and takes a new form. Yet, in different kinds of changes (e.g. a change in size vs. a change in location), different aspects remain constant. Which ‘part’ of an object counts as matter and which as form is, hence, relative to the kind of change in question. Buchheim (1999: 103) argues that for Aristotle

those properties which are neither given up nor established are the material properties as opposed to the changing form. The concept of matter in Aristotle means what remains constant within a movement including all the constant properties. Matter is, hence, a relative concept (it can always be something different, depending on the process taking place), and only that which cannot transform ever is form in every case.

reference and quantification gives again rise to new ontological distinctions, as exemplified by the difference between (35) and (36): whereas in (36), *red* functions as an abstract object, in (35) grammar treats it as a general term. This gives rise to a distinction between red as such and different shades of red – a distinction which, again, perception cannot make.

5.2.3 Mismatches Between Lexical and Grammatical Ontology

The additional formal ontological layer which grammar adds to perception can be used to make sense of an otherwise surprising fact: that the grammatical and the ontological categories can in some cases *fail* to match up perfectly. Consider for example the expression *the concert*. This expression is a definite nominal, but it still seems to denote an event rather than an object. Expressions like this have played an important role in philosophy. In Davidsonian event semantics, for example, it is often pointed out that these expressions (along with nominalizations of verbs) can be used to refer to events or to quantify over them, which generates an ontological commitment to events (Davidson 1967b). To what extent these expressions contain a verbal aspect is unclear. First, event-denoting nouns without a direct verbal correlate are rather rare. Many nouns which denote events can also be used as verbs: *the war – to war*, *dinner – to dine* etc. And *concert* can at least etymologically be traced back to the French verb *concertare*. The eventive interpretation may, thus, be due to a verbal core in these expressions.

However, whether or not these expressions have a verbal core, the reason for the mismatch is just the one pointed out above: grammar adds a *further* layer of ontology, and it is often not the case that the initial ontological category is thereby completely wiped out. Nonetheless, it should also be clear that there is a significant difference in meaning between nouns and their verbal correlates which concerns the mode of reference: *the war* can be used to refer to the subject of a predication, whereas *to war* cannot without being turned into a nominal first.¹⁴ That is, grammar can treat something as an object, even if it is lexically not specified as an object but rather as an event, or property, or something else. The denotation of such an expression will correspondingly formally be an object, and yet exhibit aspects of eventhood or propertyhood.

This is also true of lexical items which pick out objects that have a propositional format, e.g. *the sentence of the excluded middle* or *Goldberg's theorem*, *Tarski's theory of truth*, etc. That is, also ontological categories which grammar gives rise to can be lexicalized. Nonetheless, lexicalized aspects of grammatical ontology don't play an active role within a grammatical derivation: grammar treats expressions like *Goldberg's theorem* as objects. If lexicalized,

¹⁴ This is also true of quotations, since quotation is a nominalizing device.

grammatical ontology thus becomes part of the lexical content rather than the grammatical form of the expression.

Although aspects of ontology can in this way be lexicalized, lexical ontology is limited in a number of respects, very much like the ontology of perception. *First*, lexical ontology is not as rigid as its grammatical counterparts. It is, for example, not clear whether *Christmas* is an event, or a time, or something else. Furthermore, lexical ontology can often be overridden grammatically: whereas *stone* is lexically an object, *stoning* is an event. Indeed, in general, only nominal projections leave the flavour of a lexical ontological category intact. *Second*, not all aspects of grammatical ontology can be lexicalized. Whereas it is possible to refer to a proposition with the help of a name of that proposition (say *Goldberg's theorem*) or a demonstrative, it is impossible to assert a truth without grammatical complexity. Only a matrix clause can be used for this purpose. *Third*, reference and quantification require grammatical complexity: a bare lexical item is never referential on its own. Even proper names have to undergo movement in order to become rigidly referring expressions (cf. chapter 3.1).¹⁵

To sum up, perception and the lexicon exhibit certain ontological distinctions. These distinctions are formal ontological distinctions in the sense that they are categories which we use in order to structure our perception and thought about the world, rather than categories inherent in the world perceived. Grammar, however, adds a further layer of ontological categories: these categories arise around the grammatical difference between reference and predication. They are again formal in that they are independent of pre-grammatical ontological categories; that is, grammar may treat something as an object which is pre-grammatically specified as an event or vice versa. Furthermore, the grammatical distinctions which arise around reference and predication give rise to novel ontological categories which are not present in perception. Although aspects of these new ontological categories can be lexicalized, reference, predication and the assertion of truth cannot. Finally, the notion of form at issue is a relative rather than an absolute one. Ontology that enters language as part of the lexical specifications is not part of the formal ontology which the grammatical derivation gives rise to when the lexical item is fed into the derivative engine; rather, it is treated as part of the lexical meaning, which grammar is not sensitive to.

¹⁵ This paragraph is adapted from Reichard and Hinzen (2012).

5.2.4 The Paradox of the Concept *Horse* Generalized

So far, I have considered one way in which grammatically specified aspects of ontology and lexically specified aspects of ontology can come into an apparent conflict: Grammar adds an additional formal ontological layer in cognition and therefore can, for example, treat items which are lexically or perceptually specified as events as objects. Now, I discuss a second case where the relation between grammatical and lexicalized ontology becomes problematic: lexical items that pick out ontological classes themselves, like *object*, *event*, *proposition*, etc.

Consider expressions like *the property of being red*, *the proposition that John loves Mary*, *an event of jumping* etc. Grammatically, they are all nominals embedding other grammatical categories. They, thus, should have objects as meanings. On the other hand, the lexical content of their head renders them a property, a proposition, and an event, respectively. How can something be both an object and a proposition? We seem to face a generalized version of Frege's (1892) paradox of the concept *horse*. As noted in chapter 4.1.2, Frege's ontological distinction between concepts and objects is a formal distinction which mirrors the grammatical distinction between referential and predicative expressions: grammatical predicates have concepts as *Bedeutung*, whereas referential expressions have objects as *Bedeutung*.¹⁶ It follows that expressions like 'the concept *horse*' have an object as *Bedeutung*, given that they are referential rather than predicative. However, the lexical content specifies that its *Bedeutung* is a concept. Given that Frege also assumes that there is an absolute distinction between concepts and objects, we face an apparent paradox: the concept *horse* both is and is not a concept.¹⁷

Frege (1892: 46, n. †) suggested comparing expressions like *the concept 'horse'* with more clearly grammatical expressions like *the predicate 'is red'*. Following this suggestion, we may, in parallel, compare expressions like *the proposition that John loves Mary* with expressions like *the sentence that John loves Mary*. The expression is not a sentence but a nominal phrase. As such, it can be used to refer to a certain entity, and with its help, something can be predicated about its referent. The entity it picks out, it seems, is the sentence *John loves Mary*. Yet, referring to a sentence (as a sentence or as something else) by embedding it into a nominal

¹⁶ The Fregean notion of *Bedeutung* cannot be equated with the standard notion of reference. You simply cannot refer to a Fregean concept in the normal sense of *referring*, since the difference between a concept and its objectual correlate is precisely that something is an object iff it is referred to in the normal sense, but a concept when it plays a predicative role.

¹⁷ The paradox of the concept *horse* is often taken to be devastating for Frege's philosophy (e.g. Davidson 2005, chapter 6; Lowe 2006: 84; Soames 2010b: 21). For discussion and attempts to solve the problem on Frege's behalf compare e.g. Geach (1961), Dummett (1973, chapter 7), Wiggins (1984), Parsons (1986), Higginbotham (1990), Textor (2010), and MacBride (2011). For a more detailed discussion of my own take on Frege's paradox of the concept *horse* see Reichard (2014).

expression deprives the sentence of something which is very closely associated with sentencehood: the fact that a sentence can be used to assert something. On the other hand, the expression exhibits the central features of a nominal expression: it can be used to pick out the subject matter of a predication, which an asserted sentence cannot. In this sense, a sentence which is referred to as a sentence is grammatically not a sentence but a nominal. Should we, therefore, regard expressions like *The sentence that John loves Mary* as contradictions, strictly speaking?

I think the answer is that we should not. A grammatical analysis of (38) is as given in (39). The most embedded expression *that John loves Mary* is a CP and, hence, a sentential expression. However, the clause is embedded in the expression *the sentence*.¹⁸ Grammatically, *the sentence* is a normal nominal expression. Lexically, however, it is a meta-grammatical expression, standing for a certain grammatical configuration, namely the sentential one. From a grammatical point of view, the possibility of a nominal's denoting a sentence is not surprising, given that grammatical categories are independent of the content of the lexical item. If it is possible to lexicalize a grammatical structure – and there is no reason for why this should not be possible – and if the normal grammatical rules apply, there is no reason for why the lexical root SENTENCE should not be used as a nominal. Since the nominal *sentence* is the head of the expression,¹⁹ the whole expression *the sentence that John loves Mary* becomes a nominal expression, too.

- (38) the sentence that John loves Mary
 (39) [_{DP} the sentence [_{CP} that John loves Mary]]

What the referential expression presupposes is not that the whole expression *the sentence that John loves Mary* is a sentence, which would be incorrect, it only presupposes that *John loves Mary* is a sentence, which is right. That is, as shown in the diagram in (40), the category denoted by the lexical item *sentence* (*a*) has to comply with the grammatical category of the embedded expression *John loves Mary* (*c*). As exemplified in (41), if they don't, the expression is contradictory. For the coherence of the expression, the grammatical category of the embedding expression (*b*) and the whole expression (*d*) is quite irrelevant.

¹⁸ The grammatical fine structure of this kind of expression (e.g. whether *the sentence* is a constituent or whether *sentence* is merged with the CP before the definite article is attached) is not relevant to my current discussion, and I shall therefore ignore it (cf. Matushansky 2012 for a recent overview of the syntactic literature on close apposition).

¹⁹ I discuss the grammatical notion of headedness in more detail in chapter 6.

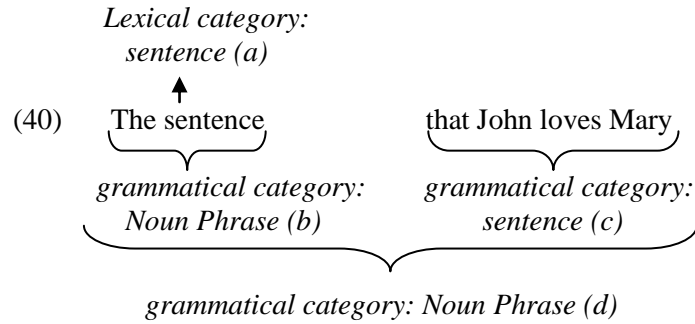

(41) The word/VP/DP that John loves Mary

Such a ‘mismatch’ between the grammatical form of an expression and the ontological category which the expression denotes lexically is not restricted to expressions which embed the respective grammatical form. For example, *the sentence of the excluded middle* is not a sentence grammatically speaking; nor does it embed a sentence. Still, if you write down the sentence of the excluded middle, it will have a sentential form. In this sense, grammatical form can be lexicalized. Furthermore, you can refer to a certain sentence which someone just uttered as *this sentence* (which again is not a sentence). Finally, it is possible for the lexical expression *sentence* to be turned into a kind-name, as for example in *the sentence is a certain grammatical structure*. Again, *the sentence* is not a sentence, grammatically speaking.

To the extent to which ontology is linked to grammar, it is no wonder that what can happen on the grammatical side has its effect on ontological possibilities. In *the proposition that John loves Mary*, the CP (*that*) *John loves Mary* is a proper part of the expression. Furthermore, (*that*) *John loves Mary* is (or expresses) a proposition. Yet, it is embedded in a larger, nominal structure. This turns the meaning of the whole expression formally into an object: it is now impossible to assert the proposition expressed by the embedded clause; instead, it is possible to assert something about it. Yet, the propositionhood which is due to the embedded CP still remains intact to a certain degree and becomes part of the content rather than the formal aspect of the expression and its denotation.

Like in the case of meta-grammatical expressions, the central point for the explanation of ontological expressions is the formal character of grammatical ontology. Whereas *John loves Mary* is onto-grammatically a proposition, *the proposition* is so only lexically. The coherence of the expression, again, depends upon the compatibility of the lexical ontological category (*a*) in the schema in (42) and the onto-grammatical category of position (*c*). On the other hand, *the proposition (b)* is grammatically a definite nominal and hence onto-grammatically an object. This renders the whole expression (*d*) objective and ensures that it can be used as a referential

expression, but cannot be asserted. In this way of recursive embedded ontological categories, grammar achieves something which otherwise would be impossible: referring to something which *prima facie* cannot be referred to.

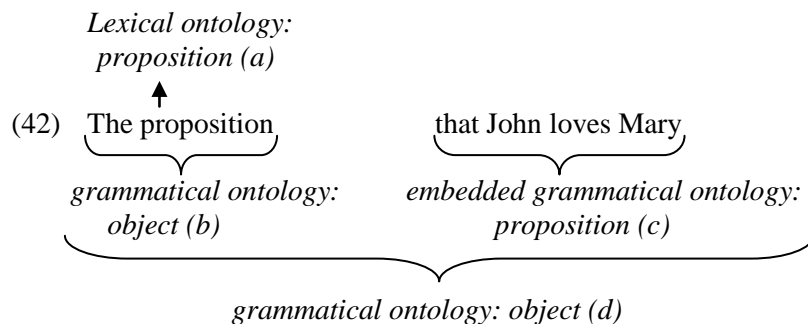

In sum, it is crucial to distinguish between the different layers of ontology. As suggested in section 5.2.2, grammar gives rise to new ontological categories, for example propositions. These categories can in part be lexicalized, either as lexical ontological categories or in meta-onto-grammatical vocabulary like *proposition*, *reference* etc. The onto-grammatical category of these expressions does not need to fit with the onto-grammatical category lexicalized, since lexicalized ontology does not have an effect on grammatical processes. Grammatically, the referents of these expressions are, hence, treated as objects. Not every aspect of onto-grammatical categories can be lexicalized, though. In particular, assertive force or reference, which the respective grammatical configurations give rise to with biological necessity, cannot be mimicked lexically, but requires active grammatical structure. The interplay between lexical and grammatical ontology is intricate. On the one hand, the two are quite independent. On the other, the possibility of embedding one structure in another or lexicalizing aspects of grammatical structure enables combinations of aspects of ontological categories which otherwise would be impossible, e.g. reference and propositionality.

Productivity without ‘Building Blocks’: A Solution to UP1

In the previous two chapters, I have argued that UP2 dissolves if we think of the formal ontology of natural language and thought in grammatical rather than in lexical terms. If the formal ontology of language is a grammatical phenomenon, ontological changes are expected when grammatical structure is built up. Based on this insight, I now address the first unity problem (UP1) delineated in chapter 1.2.2 of how the meanings of different lexical items can be combined grammatically so as to give rise to a new and unitary meaning, rather than to just an aggregate of disparate objects. Recall that simply naming a semantic relation which is supposed to hold the constituents of a proposition together is not sufficient for answering this question (cf. chapters 1.2.2 and 3.2.2); nor is identifying a syntactic operation which combines lexical items, a point that I will come back to in section 6.2. The question is not so much which operation puts linguistic expressions together or which semantic relation holds between the meanings of subsentential parts, but rather how we can understand that the respective operation or relation ensures the particular kind of unity which we seek to explain. A more detailed outline of the chapter can be found at the end of section 6.1.

6.1 The Paradox of the Unity of Meaning

Every attempt at answering UP1 faces a dilemma. On the one hand, not all meanings that we are able to produce and understand can be primitive, since language is productive: despite the finiteness of our brains, we can produce and understand a potential infinity of different linguistic expressions with different meanings. We can also easily produce and understand expressions we have never heard before, as long as we understand their components. This strongly suggests that there is a finite number of basic meanings and a finite number of ways they can be combined, which together give rise to an infinite number of complex (for example sentential) meanings. So, meanings combine, giving rise to ‘bigger’ (for example sentential) meanings.

However, there is a compelling argument that the meaning of a sentence is not just the sum or a set of the meanings of its parts, but something qualitatively different from the meanings of

its parts or a mere sum of them. The clearest sign of this difference is that a sentence can be true or false, whereas its parts, or a mere collection of them, cannot. Yet, as Bradley's regress argument shows, every attempt to combine meanings in such a way that they give rise to sentential meanings, as opposed to mere collections, necessarily fails, as the mode of combination can always be regarded as just an additional member of the collection, and as such does not play the unifying function it is supposed to play. Hence, sentential meanings have to be primitive – but, according to the above, they cannot all be, and, as pointed out in previous chapters, there is good evidence that they indeed never are. The paradox is perfect.

Any attempt to resolve this paradox has to make sure that the relations between the constituents of the meaning of the sentence cannot also be regarded as not actually relating relations. For, in this case, sentential meanings can always be 'duplicated' by mere collections of the meanings of their parts. As noted in section 2.5.2, Russell's picture theory tries to satisfy this requirement by thinking of propositions in terms of mental images, since in images, relations are always actually relating ones. However, this feature is also a limitation of Russell's account, as it is not only unclear how most of the propositions we can think about could correspond to images, it is also unclear how the link between Russell's word-propositions and image-propositions is supposed to be established. Either image-propositions are primitive, in which case the productivity of language remains unaccounted for, or we need an account of how the images that are the meanings of the constituents of the sentence give rise to the proposition, rather than mere collections of unrelated images.

A different strategy of ensuring that the relation 'holding together' the meaning of the sentence actually relates the constituents of the sentential meaning is to do away with non-linguistic meanings altogether. Indeed, as discussed in chapters 2.3 and 2.4, in effect, a significant part of the philosophical and formal semantic tradition can be interpreted as analyzing the meanings of sentences not in terms of extra-linguistic entities, but with the help of other sentences in a meta-language. Davidson (1967c: 23), for example, suggests that a truth-conditional theory of meaning

will have done its work if it provides, for every sentence *s* in the language under study, a matching sentence [...] that, in some way yet to be made clear, 'gives the meaning' of *s*. One obvious candidate for matching sentence is just *s* itself, if the object language is contained in the metalanguage; otherwise a translation of *s* in the metalanguage.

The first unity problem does not arise in this case: since the meaning of the meta-language sentence is united, so is the meaning of the object-language sentence which the meta-language sentence is supposed to 'give'. Yet, it is obvious that this strategy only moves the problem one

step back, and in order to understand the unity of the meaning of the object-language sentence we now have to explain the unity of the meaning of the meta-language sentence. However, explaining the unity of the meaning of the meta-language sentence is not significantly different from explaining that of the object-language sentence. Thus, no real progress has been made with this move.

My suggestion will be that modern grammatical theory not only provides a way of addressing the second unity problem, but also leads towards a solution of UP1. A similar point has already been made by Collins (2011b), who argues that a theory of unity based on grammar makes it possible to separate to some extent the account of productivity from that of unity, by separating the generation from the interpretation of grammatical structures (cf. chapter 3.1.3). However, as I argue in sections 6.2, this move only gives rise to the question of how and why grammatical expressions are interpreted as unities by post-linguistic cognitive modules, and the first unity problem remains unaddressed. If we want an answer to UP1 (which, to be fair, is different from the question Collins seeks to answer), we cannot separate syntax and semantics in this way.¹

In section 6.3, I argue that we should give up the idea that meanings combine, strictly speaking. Instead, we should think of linguistic meaning as ‘growing’ out of one lexical meaning. I have already argued that the meaning of grammar is of a very different kind, compared to lexical meaning: grammar leaves the lexical content as it is, but determines the formal ontological category of the meanings of linguistic expressions. Further lexical roots, phrases or phases can only serve to indicate in which way grammar specifies the ontology of a meaning contributed by a lexical root; they influence the meaning that grows in the grammatical soil only ‘from the outside’. If meanings don’t combine, if they are not made up from ‘building blocks’, to use a metaphor of Davidson’s (cf. Ramberg 1989), the question of how they combine to make up a unitary meaning does not arise and Bradley’s regress is avoided.

¹ Also Hinzen and Sheehan (2014) propose that the unity of meaning can be explained in grammatical terms. They argue that Case should not be viewed as a meaningless grammatical feature, but as a grammatical relation that ensures that in sentences like *He was kicked*, ‘there are not *two* referents, an event and an object (a kicking and a male person), in these constructions, but *one* referent, an event of kicking, of which the object has become an inherent part’ (Hinzen and Sheehan 2014: [207]). Although I’m not unsympathetic towards interpreting Case in this way, it is clear that this cannot be taken to be a full account of the unity of linguistic meaning: what would additionally be required is an explanation of how the argument becomes a participant of the event. Only saying that there is a grammatical relation which ensures that is not enough.

6.2 Why Merge is not Enough

In section 3.1.3, I have discussed a worry which one might have concerning my claim that the unity of linguistic meaning can be explained in grammatical terms. The worry is that grammatical relations are only in place if there already is a structure. Thus, the question arises where the respective grammatical structures come from. As Gaskin (2008) argues, without an answer to this question, the unity problem is not solved but just pushed back one step. Yet, as Collins (2011b) points out, according to current linguistic theory these structures are produced by Merge, which Collins takes to be a psychologically real operation. I shall devote this section to a discussion of Collins's proposal. In section 6.2.1, I argue that, whereas Collins's theory provides the key for overcoming this particular difficulty, it does not help much to progress in UP1. In section 6.2.2, I explore one way of how Collins's proposal could be used to answer UP1. Although this answer fails, it carries an important insight which I use for my own proposal, presented in section 6.3.

6.2.1 Collins's 'Combinatorial Unity' and UP1²

The main question that Collins attempts to answer is called 'combinatorial unity':

- (1) Given lexical items with their semantic properties, what principle or mechanism combines the items into structures that are interpretable as a function of their constituent parts? (Collins 2011b: 28)

This question is ultimately an empirical one. Therefore, Collins appeals to linguistic theory in answering it: the basic combinatorial principle in current linguistic theory is Merge. Merge is a binary set-forming operation; that is, Merge does nothing apart from forming binary sets of linguistic expressions. The operation can be applied recursively; that is, the result of a Merge operation can be merged again. The motivation for assuming Merge as the basic combinatorial principle in linguistics is that it is the simplest operation sufficient to explain linguistic structure building: a unitary operation is evidently incapable of combining different linguistic items, but empirical evidence is lacking that there are ever more than two expressions combined at any one time.

One may complain that taking Merge as a primitive amounts to presupposing unity, since a set already exhibits a certain kind of unity. And the unity of a set is indeed something which Collins accepts as a primitive (p.c.). Yet, as pointed out in chapter 1.2, the unity of a set is not

² Parts of this section are adapted from Hinzen and Reichard (2012).

the kind of unity we are looking for. Indeed, the unity of a set is what the unity of sentences contrasts with. As Collins (2011b: 1) stresses: ‘unlike mereological unities, our unities are not immediately explicable simply by the existence of the relevant constituents.’ Therefore, if the assumption of Merge allows explaining the kind of unity characteristic of sentences, this would be a big step ahead. According to Collins, the trick is that recursive Merge defines a hierarchical structure via the resulting sub-set relation. Merge, thus, introduces structure without the assumption of further entities, and in this way avoids Bradley’s regress. ‘Because the principle [Merge] is indifferent to interpretation, it need not be specified as part of the interpretation of any structure’ (Collins 2011b: 127). Merge is ‘unconstrained’ (Collins 2011b: 118), and probably not even specific to linguistic cognition (Collins 2011b: 117). In interpretive terms, it therefore also produces ‘lots of garbage’ (Collins 2011b: 126). But this is not problematic, as long as a suitable filter weeds the unusable (uninterpretable) expressions out. In Collins’s theory, this filter is, ultimately, a lexical one, depending on feature specifications of lexical items and how these match or fail to match when they are merged. A verb like ‘love’ comes with a specification of the argument-structure that it will eventually have to have: without a lover (Agent) and a lovee (Patient), the structure is not interpretable.

For example, starting with the lexical array *John, love* and *Mary, love* and *Mary* may be merged first forming the set $\{love, Mary\}$. This set may be merged with *John*, forming the set $\{John, \{love, Mary\}\}$. The asymmetric relation between John and Mary is thus encoded structurally and does not have to be taken as a further element to be added to the three expressions. It is also possible that an expression which has already been merged is merged again with the very set that it already is a member of. This operation is called ‘internal Merge’. As a result of internal Merge, an asymmetry can be introduced between the two members of a set created by Merge. The set $\{love, Mary\}$, for example, may be remerged with *love* forming the set $\{love, \{love, Mary\}\}$. Of course, as a linguistic expression *love love Mary* is ungrammatical, but since *love* is now both part of the subset and a member of the superset, an asymmetry between *love* and *Mary* is introduced. This mirrors the asymmetry between the roles that the two expressions play: semantically, Mary is a participant in a loving-event, and syntactically, *love Mary* is VP, that is, a projection of *love*, not of *Mary*. The structure $\{love, \{love, Mary\}\}$ may be taken to express just this asymmetry.

However, Collins’s combinatorial unity does not directly address UP1: whereas (1) asks why there are the structures there are, UP1 aims at uncovering why the respective structures give rise to a unitary meaning. Furthermore, Collins’s question seems to presuppose that we already know that there is a certain operation which is responsible for linguistic structure building, and

we only need to determine which operation it is. The answer to this question is an empirical issue; and Merge may be a good candidate, given the current state of linguistic theory. Yet, on its own, it will not tell us much about why or how the particular kind of unity arises that we seek to explain.

In respect to this point, Collins's diagnosis of the problem is telling. Concerning Russell's (1903, §54) formulation of the unity problem that unity cannot be restored once a linguistic structure has been analyzed into its constituents, Collins argues that the problem consists in the symmetry of the analysis, 'leaving no way to restore the structure or asymmetry of the whole' (Collins 2011b: 99). The symmetry is problematic, since then it is impossible to determine the difference between two sentences which have the same constituents. For example, given a symmetric analysis, it will be impossible to distinguish *John loves Mary* and *Mary loves John*, which is a disastrous result for a theory of linguistic meaning. In the following passage, Collins (2011b: 109, my emphasis) makes very much the same point :

Our problem is not so much how many things can be counted as one thing, but how many things can be structured one in relation to another to form one thing *such that it is interpretable one way rather than another*, or not at all, where such interpretation is a brute empirical fact.

Asymmetry clearly is a crucial component for any account of the unity of linguistic meaning. But it is not clear how the asymmetry created by Merge on its own could explain how the meanings of lexical items combine such as to give rise to phrasal and sentential meanings. If we wanted to use Collins's account towards answering UP1, we would have to answer the question of why the meanings of *love* and *Mary*, which initially just formed a set of two separate objects, suddenly exhibit the relevant kind of unity when *love* is merged again.

Despite this being not part of the question that Collins tries to answer with his theory, he goes some way towards addressing UP1 when he argues that in $\{love, \{love, Mary\}\}$, *love* 'stands proxy' (Collins 2011:115) for $\{love, Mary\}$, pointing out that this is what gives rise to the unity. An expression can stand proxy for a structure of which it is a part because language is headed; that is, if two expressions of different grammatical types are combined, say a noun and a verb, the resulting category is usually a projection of one of these categories. The parallel effect can be found in respect to the meanings of the expressions. As Collins stresses, a 'red ball is a kind of thing, not a kind of property' (Collins 2011:113); in parallel, *love Mary* is an event, not a thing. If anything, it might be thought, it is this what gives rise to the required unity of complex phrases like *red ball* or *love Mary*. Since internal Merge can be used to represent the head-

complement relation, Collins (2011b: 115) argues that internal Merge is the key to the unity problem:

Internal Merge establishes an asymmetry between a pair of identical elements and that new relation has an ontological reflex. [...] Such a new relation – being a head – allows us to consider the one object as both an element of a structure and also as a proxy for the collection of elements it heads; this is because the elements headed [...] function as if a single object relative to all other potentially merged objects. The selection of a head insulates the objects in the head’s domain as a unit by way of the creation of an asymmetry of containment, with the objects being members of the subset of the head superset. Unity, therefore, is possible because of a head relation formed via the creation of an asymmetry between identical elements.

However, although I agree that it is possible to express headedness with the help of internal Merge, there is nothing in its set-theoretic definition which explains or necessitates such an interpretation, as Collins (p.c.) is happy to admit. Furthermore, even on the syntactic framework that Collins adopts, not all internally merged elements head the resultant structure (e.g. *wh*-expressions). To add to the problem, headedness can also not be specified lexically. Therefore, it is not Merge together with lexical specifications that explains the unity at issue.

6.2.2 A Syntactic Answer to UP1

Even though nothing in set-theory necessitates an interpretation of expressions produced by Merge in terms of headedness, there is one way one may think that headedness could be explained with the help of Merge;³ this explanation also goes some way towards a syntactic answer to UP1. Since Merge is a general operation which can be applied to any two linguistic expressions, the computational system needs information about which linguistic expressions can be meaningfully combined (or, alternatively, the combination of which linguistic expressions is interpretable). Collins, like many others, takes this information to be lexical.⁴ Yet, it is also clear that the computational system is not sensitive to all aspects of the respective expressions. It is, for example, insensitive to the difference in meaning between *John* and *Bill*. Thus, assume that the information which is relevant for the computational system is stored at a special place, the *label* of the expression; and that the label is all the computational system can ‘see’. It now so happens that if two linguistic expressions are combined, only one of the two labels will be

³ Collins does not make this move explicitly, but it may be the motivation behind his approach.

⁴ There remains the question, however, what for Collins gives unity to a lexical item. For his approach to work, the primitives (lexical items) already have to be complex (cf. Collins 2008, ch. 5.4). But then the question arises where the unity of the primitives comes from. According to standard linguistic theory, they are just bundles of features – but they also exhibit the unity characteristic of linguistic expressions. So, there is the worry that a theory like Collins’s which relies on complex lexical items does not get off the ground when it comes to providing an account of UP1.

relevant for the further derivation: the complex expression thus only has one single label, which it inherits from one of its constituents.⁵ For example, if you combine a noun and a verb, say *Theaetetus* and *sit*, the result *Theaetetus sits* is usually a verbal projection and not a nominal one, despite the fact that the expression also contains a noun; that is, the whole expression behaves syntactically rather like a verb than like a noun. The computational system of natural language, thus, treats complex expressions as units similar to non-complex expressions.

What explains the special kind of unity that we find in grammatical expressions of natural language, then, could be taken to be the fact that, in natural languages, syntactic structure building is only sensitive to the labels of the expressions and that, when two expressions have been combined, the whole expression inherits only one of the labels. In this sense, the generative engine of language treats complex expressions not as mere sets but as non-complex entities, or as one of the expressions themselves. Furthermore, labelling can be expressed in terms of internal Merge (Chomsky 1995), although, again, nothing in set-theory necessitates such an interpretation.

There is still a syntactic difficulty to be resolved: it is obvious that even though *John loves Mary* is a verbal projection, at least one of its syntactically relevant properties differs from those of *loves Mary*. Whereas *loves Mary* can be meaningfully combined with a further nominal, *John loves Mary* cannot. This problem can technically be handled relatively straightforwardly. It is standardly assumed that labels contain ‘features’ which have to be ‘checked’. Such an unchecked feature in the label of *sit* licenses, for example, that *sit* be combined with a nominal. But once it is combined with a nominal, the feature has been checked and thus does not license another argument. *John loves Mary*, thus, inherits its label from *love Mary* (and therefore ultimately from *love*) – but Merger of *loves Mary* with *John* changes the label in at least one respect, and this is where the syntactic difference between the two expressions comes from.⁶

However, labelling cannot provide a complete solution to UP1. Consider the original question: How is it that the meanings of *John*, *love* and *Mary*, when combined, form a unity that goes beyond the unity of a list or set? The current answer is that, from a syntactic point of view, *love* stands proxy for *love Mary* and hence is a single unit, not just a list. But in which sense does this solution say anything about the unity we find in the *meaning* of the complex

⁵ In most current theories, not every expression has to have a label, but we can ignore this complication for the purpose of this argument. It is standardly assumed that if an expression *A* which has no label is merged with an expression *B* that does have a label, the complex expression will get the label of *B* (e.g. Hornstein and Pietroski 2009).

⁶ It should be noted, though, that this is non-canonical: in Chomsky (1995), the label stays as identical as the lexical item itself.

expression?⁷ A straightforward extension of the syntactic explanation to the semantic case does not seem possible, since there is a crucial difference in meaning between *love Mary* and *John loves Mary*. Hence, *John* needs to contribute something towards the meaning of *John loves Mary* which goes beyond the fact that *John loves Mary* cannot be combined with a further noun. But then the question arises again how the two meanings are so combined or in which other way the unity is established.

6.3 The Growth of Linguistic Meaning

UP1 is the question which concerns unity most directly. Sets exhibit some kind of unity. Yet, the unity which the meaning of a linguistic expression characterizes is of a different nature: a blue house is not a set of blueness and a house, but a house which is blue. Also, an event does not exist independently of and in addition to its participants, as they, although being objects in themselves, become inherent parts of it. The question, thus, arises how such unity is possible. A central challenge for any answer to this question is that it has to avoid Bradley’s regress,⁸ but also be compatible with an explanation of the productivity of language. On any ‘building-block’ model of semantics, Bradley’s regress is sure to arise, as when every meaningful part has its meaning independent of the whole, meaning that is actually relational is impossible, and the unity of meaning remains inexplicable. On the other hand, wholistic semantics, that is, semantic theories taking the meanings of the complexes (e.g. sentences) as primitives, cannot account for the productivity of linguistic meaning.

In this section, I make an attempt at delineating a semantic theory that answers both constraints. The core idea of my proposal is that, as far as grammatical structure building is concerned, strictly speaking, it is never the case that two meanings are combined. Rather, when put in grammatical soil, a sentential (or referential) meaning grows out of a lexical root. Other

⁷ Perovic (2012) points out an issue that might be mistaken for the one I have in mind here. She argues that Collins’s theory is in trouble because neither Merge nor the syntactically relevant aspects of lexical specifications can rule out nonsense sentences like *Alice is raining* or Chomsky’s *Colourless green ideas sleep furiously*. I don’t think that examples such as these should be ruled out, neither on Collins’s approach nor on the one I shall propose in the following section. Unlike *seflokstrultsgadbn*, these sentences clearly are interpretable – only given such an interpretation can we judge that they are paradoxical, in contradiction to world knowledge or nonsense, if you want. And if they are thus interpretable as unities, they should have the characteristic unity of sentences (cf. chapter 4.3.1).

⁸ As noted, Gaskin (2008) argues that Bradley’s regress is not problematic and actually provides part of a solution to the unity problem. Yet, as argued in chapter 1.3, at least if the unity question is thought of as a psychological rather than a metaphysical problem, this way out is not available.

lexical, phrasal or phasal expressions can influence its growth ‘from the outside’, but do not combine with them. In section 6.3.1, I present the basic idea in an informal and metaphorical way, and in the remainder of this chapter, I spell it out, employing technical grammatical vocabulary. I demonstrate how the mechanics of my proposal work by a detailed discussion of the Classifier projection in the nominal domain, focussing on functional heads in section 6.3.2 and on Specifiers in section 6.3.3. I then point out how this proposal can be extended beyond classification, to accommodate all functional projections in the nominal and verbal domain, as well as adjuncts and argument structure (section 6.3.4).

6.3.1 Growing Linguistic Meaning in Grammatical Soil

Is there a puzzle about the unity of an oak tree? Initially it might seem that there is, as the oak consists of roots, a stem, limbs, twigs and leaves. We, thus, may wonder how all these combine to make up the unified oak. However, although the disparate parts of the oak may be lying around or be piled up, waiting to be taken away or burned, there is no pile of roots, limbs, twigs and leaves, unless a tree has been hewn. Nothing is a stem (in the relevant sense), unless it belongs or has belonged to a tree, which suggests a wholistic attitude towards trees: ontologically, the whole tree is prior to its parts. However, trees do not miraculously come into existence. Our oak has grown from a small acorn. Growing is not a compositional process, in the sense that roots, stem, limbs, twigs and leaves are not just added to the acorn, but grow out of it. If this is so, there is no question about how the parts of the oak combine to make up the tree, as there is never more than one object; there is only the acorn that gradually becomes the tree.

In the following, I will take no stance on the unity of the oak; for me, nothing hinges on the adequacy of the above account with respect to organic objects. However, I would like to suggest that the derivation of sentential meaning is very much like growth. Where the tree begins as acorn, linguistic meaning begins with a lexical root. Where growth of plants is determined by general organic rules, the growth of a linguistic meaning is determined by the architecture of the grammatical phase. If a lexical root takes the role of a verbal phase head, a sentence can grow out of it. Yet, the growth of our oak does not only depend on the acorn and natural laws, but also on environmental aspects. Nutrition, the availability of water, light and shadow, wind and many other things have an influence on how the oak grows and thus its final appearance. In the linguistic case, the role of the environment is played by other lexical (or phrasal) material in the sentence, such as modifiers and arguments. It thus becomes clear why thinking of linguistic meaning in terms of growth avoids Bradley’s regress, as the growing meaning never combines with the meanings of its modifiers or arguments. Rather, these meanings can only influence the

growth of the meaning of the phrase head ‘from the outside’, so to speak: by putting obstacles in its way or by pushing and pulling it in certain directions. As in the syntactic account discussed in section 6.2.2, the influence of other expressions on the meaning of the head is by leaving their mark on it, not by combining with it, strictly speaking. Of course, the meanings of arguments and those of most modifiers are not ‘just there’, but have grown themselves in a grammatical process. However, this is irrelevant for the role they play in this growth. In the remainder of this chapter, I shall spell out the account in theoretical grammatical, rather than metaphorical, terms.

6.3.2 The Meaning of Phrase Heads

I would like to begin my proposal with an observation about grammatical structure building. Consider the following examples, which follow an analysis of Borer’s (2005a) and which have already been mentioned in chapter 4.3:

- (2) I ate_{NP}[lamb].
- (3) I ate_{CIP[-S NP[lamb]]}. (read: ‘lamb’s’)
- (4) I ate_{NumP[three CIP[-S NP[lamb]]]}.
- (5) I ate_{DP[these NumP[three CIP[-S NP[lamb]]]]}.

The noun phrase (NP), the grammatically least complex expression in the nominal domain considered here, is interpreted as a mass term (2).⁹ If a Classifier (CI) is added, the mass term becomes a count term (3). Borer (2005a: 110) stresses ‘that mass interpretation does not derive from a particular feature, but rather, from the absence of a dividing structure. In the absence of a dividing structure [...], nouns will always be interpreted as mass.’ That is, the distinction between mass and count nouns is not a lexical distinction, but relies on grammatical structure. A nominal lacking a Classifier will always be interpreted as mass. The Classifier ‘divides’ the mass into portions or individuals which then can be counted. The plural inflection *-s* is a possible morphological realization of the abstract Classifier Head in English.

Evidence for the grammaticality of the mass-count distinction comes from the fact that most predominantly mass nouns can be used as count nouns (as in (6)) and vice versa (7).

- (6) a. a wine, a love, a thread, a salt, a stone
b. wines, loves, threads, salts, stones
 - (7) a. there is dog/stone/chicken on this floor
b. that’s quite a bit of table/carpet for the money
- (Borer 2005a: 102).

⁹ As I suggest below, there is a more primitive syntactic projection which transforms a bare lexical item into a nominal in the first place.

Whereas the bias of taking a certain lexical item as either a mass or a count term can in this way be grammatically overridden in most cases, the same is not true of grammatical specification. Thus, even though the plural inflection of *pluralia tanta* like *trousers* or *scissors* is usually seen as morphological rather than conceptual, their grammatical complexity cannot be overcome by grammatical or other means. They, thus, don't allow for singular agreement (8) or mass readings (9). This asymmetry with respect to the possibility of coercion supports the contention that mass terms are grammatically simpler than count terms and that plural morphology is a morphological realization of the grammatical element that is responsible for dividing the mass into individual portions.

(8) My trousers tear(*s) easily.

(9) *There's too much scissors around this house. (Borer 2005a: 105)

A further argument towards the conclusion that mass terms are grammatically simpler than count terms derives from the fact that count terms in most languages require additional morphology. In classifier languages, such as Chinese, this work is usually done by a number of highly grammaticalized, but non-cliticizing elements, whereas in languages like English, the grammatical function which divides the mass into countable units is associated with plural inflection or the indefinite article. Borer (2005a: 108) argues:

I suggested that listemes [that is, lexical roots] do not have any formal properties, and are, in this sense, tantamount to raw material, 'stuff' which is poured into the structural mould to be assigned grammatical properties. If this metaphor has any formal substance to it, it follows that nouns, by themselves, are stuff, and that stuff, as such, is simply the absence of any grammatical specification. Should this stuff be divided, it would be, so to speak, cast into mould(s) which would in turn make counting possible.

In addition to acting as a classifier, the indefinite determiner also acts as a number term, assigning range to the abstract number head *Num*. The same is true of *one*, whereas the other numerals only act as counters, and therefore require plural morphology which makes the denotation countable in the first place.¹⁰ Thus, adding the numeral *three* to a classified expression orders the denotation provided by the classified expression into sets of three;

¹⁰ Evidence for the claim that the difference between singular and plural morphology is not a metaphysical or purely conceptual difference, but is rather the result of two different ways of Classification, is that whereas *one apple* is singular, the mathematically equivalent *1.0 apples* has to be plural. Similarly, *0.2 apples*, although not even denoting one complete apple, has to exhibit plural morphology (cf. Borer 2005a: 115). This is unexpected if singular and plural reflected non-grammatical principles. As Andrew Woodard (p.c.) has pointed out, however, an alternative explanation for this finding could be that in the case of 1.0 apples, the units at issue are the decimals rather than the complete apples.

compare example (4) above. We can pick out one of these sets with the help of a determiner or demonstrative (5).

6.3.3 The Meaning of Specifiers

Let us have a closer look at the fine structure of syntactic representation. Recall the X' structure discussed in chapter 1.1.2, repeated in (10). The head of a phrase X^0 first takes a Complement (Comp) and thus projects an intermediate projection X' . The Complement of X^0 is referred to as $[Comp, X]$. A further projection which makes the structure a phrase (XP) gives rise to a Specifier position (Spec). I refer to this position as $[Spec, X]$. In the X' -schema, X^0 can stand for any functional syntactic head (e.g. Cl, Num, D etc.).

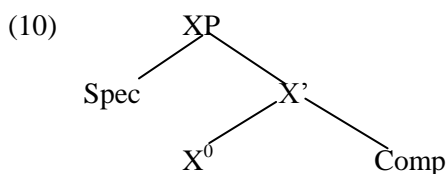

For the following explanation of UP1, I will make two assumptions which, I think, follow from standard syntactic practice in conjunction with the considerations in the previous chapters, but which, nonetheless, are far from standard. The first one is that a phrase head (X^0) is not a lexical item of any kind. Rather, X^0 , as well as X' and XP , is a way of representing grammatical structure. (Following standard practice, I will not label the X' node below.) This move is motivated by the fact that the grammatical structure of a phase is very much fixed, it is like a template or schema, although more or less of such structure can be projected. For example, there is no way in which a Num-head and a D-head could swap places. Lexical roots, on the other hand, where they can enter grammatical structures, are very free. In principle, *blue* can occupy the same grammatical positions that *stone* or *walk* can. Furthermore, grammatical structure, as we shall see below, doesn't add 'content', it only specifies the ontological category of the meaning that is being derived. In terms of the metaphor from section 6.3.1, X^0 -nodes represent the growth of the meaning that is being derived.

Second, a phrase head is never a phrase head, but rather always in Complement position (not all complements are phrase heads, though). In the standard case, the phrase head is a bare lexical item. For example, the phrase head of *these three lambs* is the lexical root $\sqrt{\text{lambda}}$. Phase heads, not phrase heads, is what I have usually called 'heads' in the more informal discussions of previous chapters (an exception being section 6.2.2). Calling both phrase heads and phase heads

‘heads’ is potentially misleading, given that they follow quite different principles of grammatical organization and serve very different semantic functions. Whereas phrase heads are purely structural notions containing no lexical content whatsoever, phase heads usually contain lexical content¹¹ and, indeed, are lexical items in the most typical cases. It follows that phases are not just like big phrases, but follow a very different principle of grammatical organisation.

Consider the phrase structure tree in (11), which is a more detailed analysis of the DP from (5). Derivation starts with a lexical root *LAMB*. As such, a root is of no particular grammatical form, nor is it any particular part of speech, as I have argued in chapter 3. Lexical roots can surface as such in compounds like *lamb meat*, *truck driver*, *stone lion* or *swing door*. That is, as roots they can be used in order to modify nominal (or verbal) expressions.¹² In (11), the root is first nominalized.¹³ When taken on its own, a Part of Speech Phrase (PosP) has a mass reading, as argued above.

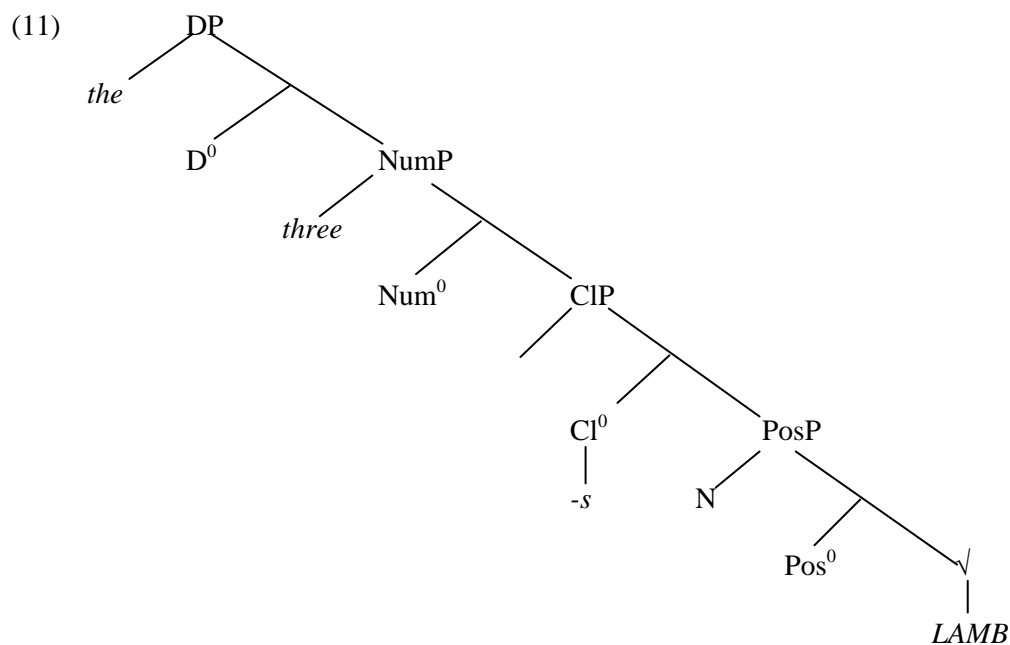

As also mentioned above, I follow Borer’s proposal that the plural *-s* in English is a morphological realization of the abstract Classifier head. Since I take these abstract heads to be

¹¹ The copula may be an exception in that it can serve as a phase head without contributing lexical content. In this respect, it functions as a verbal expletive.

¹² Bare roots have, thus, many features of adjectives. Therefore, it has sometimes been suggested that adjectives are simply lexical roots which are neither nominalized nor verbalized.

¹³ This proposal roughly follows Marantz (1997), Marvin (2002) and Arad (2005). Cf. Armoskaite (2011) for discussion and critique.

representations of structure, rather than genuine lexical items, the presence of the plural morpheme in English in a certain nominal expression is a morphological reflex purely of grammatical structure. In the standard case of English, no lexical items are inserted in [Spec, CI]. Instead, the noun from PosP moves there, since the plural morpheme is a clitic in English. Yet, [Spec, CI] cannot remain empty in classifier languages like Chinese. In such a language, plural marking is absent. Instead, there are a number of highly grammaticalized elements which divide the mass into individuals. Cf. the grammatical analysis of (12) in (13). The difference between different classifiers is that they divide the mass in different ways, as is evident from comparing (12) and (14): dividing a mass into grains requires a different classifier from dividing a mass into persons.¹⁴

(12) y 1 mi (Chinese, Borer 2005a: 86)
 one CL rice
 ‘one grain of rice’

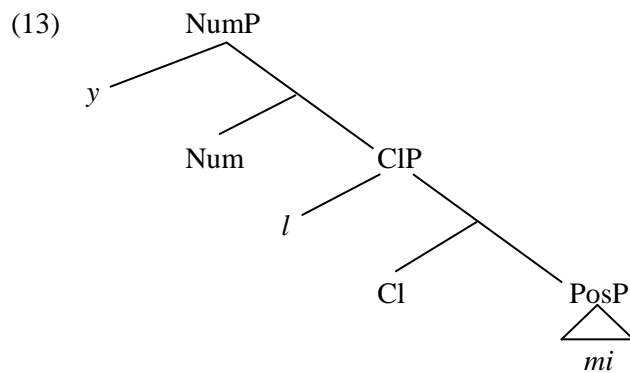

(14) yi ge ren (Chinese, Borer 2005a: 86)
 one CL person
 ‘one person’

¹⁴ I shall remain agnostic as to whether languages like English have silent but essentially similar classifiers as Chinese in [Spec, CI]. In case they do, a longstanding puzzle about the relation between the lexicon, grammar and metaphysics could be solved: Chomsky (2000: 37) argues that referential theories of meaning are on the wrong track, since there is no possible referent which could account for the meaning of lexical items, not even of proper names. The problem is that even a proper name like London can have so many different meanings: it can be used to refer to a certain area, to the people living in a certain city, to the air above a city etc., but none of these features is necessary for calling something *London*.

(i) London is so unhappy, ugly, and polluted that it should be destroyed and rebuilt 100 miles away.

Yet, many of these differences are specified by classifiers in classifier languages. Hence, if languages that lack overt classifiers have them covertly, the differences between the meanings of these different uses of the same lexical item could be explained in a grammatical way.

Classifiers in Chinese, thus, serve two functions. First, like the plural morpheme in English, they mark morphologically that the grammatical structure which divides masses into objects is projected. Second, they indicate in which way such a divide takes place: whether the objects to be counted in NumP are grains, bottles or persons. Although English and other Germanic languages lack the highly grammaticalized elements which do this job in classifier languages, also in these languages, it is not impossible to explicitly specify the way in which a mass is divided. This requires a lexical item to be inserted in [Spec, CI]. Such an insertion requires the presence of the classifier; that is, the presence of either plural morphology or of an indefinite determiner. In English, a pseudo-partitive *of* is also obligatory. The resulting constructions (cf. (15)) are expressions like *three bottles of wine*, *a cup of coffee*, or *five pieces of lamb*. As can be seen in the syntactic analysis (17) of (16), which is the German translation of (15), in case a lexical item serves as a Specifier of CI, the cliticizing plural morphology is attached to the Specifier and the NP complement can stay in situ.¹⁵

- (15) [NumP Three [CIP bottles of [NP wine]]]
 (16) Drei Flaschen Wein

¹⁵ I use the example from German rather than English, since German does not require the pseudo-partitive *of*, which adds a complication irrelevant for my current point. It could indeed be thought that examples like (i) provide counterevidence to the analysis in (17), since in this case it is clear that more grammatical structure (at least NumP) is projected by the complement introduced by *of* than a bare NP; and since expressions like it look otherwise very much like those exemplified in (15), one could conclude that these also contain more structure than I assume. Yet, note the difference between (ii) on the one hand and (iii) and (iv) on the other. In German, Genitive case plays the partitive role which *of* plays in English. Whereas in German, Genitive case is required if the complement projects up to NumP (see iv), this is not the case if the complement is a bare NP (ii). This indicates that the two cases may be different. An archaic sounding variant of (ii) is *drei Scheiben Brots*, which is very much like a Genitive – yet a construction with modern Genitive morphology (*Drei Scheiben Brotes*) sounds ungrammatical to my ears.

- (i) three slices of a bread
 (ii) Drei Scheiben Brot
 three slices bread
 ‘three slices of bread’
 (iii) Drei Scheiben eines Brotes
 three slices one.Gen bread.Gen
 (iv) *Drei Scheiben ein Brot
 three slices one.Nom bread.Nom

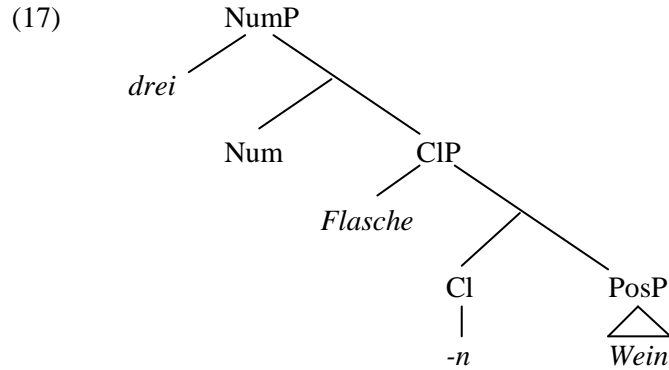

To return to the questions concerning unity, both the Head and the Classifier contribute meaning to the whole expression: there is, evidently, a difference in meaning between *rice* and *grain of rice*. On the other hand, it is also clear that, as long as the derivation follows the X'-schema and as long as heads are taken to be representing structure rather than lexical content, there is no point in the derivation where lexical items are directly combined. Rather, the lexical content in the Specifier position specifies the particular grammatical function represented by the Head: [Spec, CI] specifies in which way the abstract Classifier Head divides the denotation of PosP. Specifiers, thus, never combine directly with the complement of the respective phrase Head, but provide additional information about the role of the grammatical structure. As the Complement becomes part of a larger structure, meaning changes: whereas the meaning of a PosP is a mass, say *lamb meat*, the meaning available at this point of the derivation is further specified, or divided, by the Classifier. As a result, the denotation of CIP consists in individuals, *lambs*. More specifically, the change in meaning is a change in formal ontology, which in chapter 4 has been argued to be a structural rather than a lexical change. If the Specifier position is occupied by some lexical item, the Classifier can also divide the *lamb mass* differently, as, for example, in *pieces of lamb* or *packs of lamb* or *kinds of lamb*. In this way, it becomes clear that neither the structure which is usually represented as a Classifier nor the lexical content which can be inserted at [Spec, CI] contributes an entity towards the meaning of the whole. Rather, the meaning which the Classifier contributes consists in changing or specifying the formal ontology of the meaning contributed by the complement. And the element in [Spec, CI] indicates the criterion according to which the Classifier specifies the ontology of its complement; that is, whether the individuals are grains, persons, packs or kinds. Similarly, the Num head is

responsible for ordering the individuals derived in CIP into sets. [Spec, Num] specifies whether these sets consist of some, few, many, one, or nine items.¹⁶

Derivations of linguistic meaning, thus, start with a lexical root, the phase head. The meaning which this phase head contributes towards the derivation is then successively modified and specified with the help of grammatical structure. The grammatical structure gives rise to specific ontological changes, whereby a concept is turned into a mass, which is divided into individuals, which are ordered in sets. If a phase edge is projected, it specifies the referential properties of the expression. Additional lexical content can only appear in Specifier positions. Its meaning is never directly combined with that of the lexical root or the meaning of a phrase. Rather, the Specifiers serve to specify aspects of how the grammatical structure is to be applied to the Complement of the respective head. That is, the Specifier determines the criterion according to which a Classifier divides a mass into objects, or how big the sets are in which Num orders its complement, etc. This thought is in accordance with the fact that all the categories in (11) are usually treated as ‘extended projections’ of the noun (cf. e.g. Haegeman 1994, ch. 11.6).

6.3.4 Adjuncts and Arguments

The picture delineated in the previous section can also be applied to adjuncts and arguments. As a result of Kayne’s (1994) antisymmetry-thesis, Specifiers and adjuncts have been assimilated. As a consequence, Scott (2002) and Cinque (2010), for example, assume adjectival modifiers to feature in the Specifier position of functional heads. These functional heads are usually not defined in formal terms, but in terms where the relevance for meaning is directly visible. The respective heads are responsible for modifying the *Size, Length, Height, Speed, Temperature* etc. of their respective Complement (Scott 2002: 102). The central motivation for this thesis is that it explains the universal order in which (unmarked) modifiers occur. The hierarchy is taken to be equivalent in the nominal and in the verbal domain (Cinque 1999). Adjuncts thus employ the very same mechanisms of grammatical structure building as the functional categories discussed above do. Indeed, one of Cinque’s main aims is to integrate the adjunct system into the system of other functional projections. A phrase head, then, specifies, for example, that its Complement is extended, whereby the lexical item in [Spec, Size] specifies whether the size attributed to

¹⁶ The reason for taking N to be in [Spec, Pos] rather than being a head itself is mainly theoretical: if phrase heads stand for purely structural information, there should not be different heads competing for the same position. It should be noted, though, that on some accounts the different parts of speech are derived successively (Boeckx 2010; Marantz 2013). Such a view is also compatible with my philosophical theses developed here, and in such a case, a PosP is not required.

[Comp, Size] is big or small. This procedure predicts the asymmetric relation between an adjunct and its phase head, noted earlier. A blue house is an object that has a certain colour, not a colour that has a certain form or function. This is a result of the fact that in *blue house*, *house* is the phase head and *blue* is in [Spec, Colour]. Although I’m not completely sure what *house blue* could be, it is relatively certain that it would be a certain kind of colour. The reason for this is that in this case *blue* is the phase head, and *house* some adnominal modifier.¹⁷

The thesis can be straightforwardly extended to the verbal domain, which also contains functional structure that is responsible for ontological changes. Aspect, or *v*, for example, is responsible for turning an atelic event into a telic one.¹⁸ Cf. for example, the difference between (18) and (19). Whereas the latter has a natural end point or *telos* (when the soup is empty), the former does not.

- (18) (John) eats.
 (19) (John) eats the soup.

This ontological shift is closely related to the ontological shift which the Classifier in the nominal domain is responsible for. The difference between the Classifier and Aspect is that Aspect individuates events in a temporal respect, whereas the Classifier individuates objects in a, broadly speaking, spatial respect. Given these parallelisms, the functional structure in the nominal and verbal domain has often been argued to be (more or less) the same, the only difference being that the nominal domain is associated with a spatial and the verbal domain with a temporal ontological specification (cf. Borer 2005b; Hinzen and Uriagereka 2006).

Finally, also arguments are not simply combined with a lexical head or a phrase. Rather, arguments are inserted in Specifier positions and have to take thematic roles like AGENT, PATIENT, THEME, etc. Therefore, argument structure can be subsumed under the general mechanism described above: the functional head, standing for a certain structure, modifies or specifies the ontology of its Complement. Specifiers, and hence also arguments, provide additional information about the ontological specification. This is particularly clear if Baker’s (1997) Universal Thematic Assignment Hypothesis (UTAH) is correct. According to UTAH, every thematic role is represented in the syntactic structure as a unique functional head.

¹⁷ Compare the discussion of adjunction in chapter 3.3.

¹⁸ I will not provide a detailed theory of the grammar of telicity here, given that the issue is highly complex and involves probably, apart from the presence or absence of a *v* head, the grammar of some (but not all) arguments, certain adjuncts and perhaps case (for discussion see e.g. Arsenijević 2006; Borer 2005b; Ramchand 2008; Verkuyl 1993).

Thematic roles then follow the schema in (20), where θ represents any thematic role; in the example below, $\theta = \text{THEME}$. θ , then, specifies the presence of a particular thematic role, and thus causes an ontological change. The argument in [Spec, θ] specifies what, in particular, takes the role.

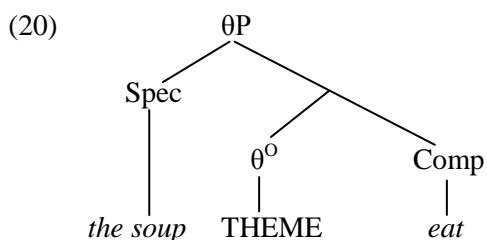

UTAH is, in a sense, cartography for thematic roles rather than adjuncts. Also the empirical motivation for UTAH is very similar to that for Cinque's cartography of the adjunct system: the hierarchical order of thematic roles is crosslinguistically uniform. If UTAH is correct, this fact is explained. However, unlike in the case of adjuncts, there are also different ways of guaranteeing that thematic order is fixed. Baker's proposal is, thus, far from being universally accepted. For my proposal, it does not make much of a difference if θ is identified with different functional heads. In Borer's (2005b) framework, for example, the THEME of a verbal Phase is inserted in [Spec, Aspect]. This makes eminent sense of the fact that it is (usually) the THEME which provides the temporal 'boundary' of the event. In (19), for example, it is the soup which has to be emptied in order for the telos to be reached. In sum, however the exact details may turn out to be, participants don't contribute objects to the event in question; rather, they help modifying certain aspects of it – contra the standard formal semantic tradition, *as* participants they are inherently predicative (cf. Pietroski 2005a). The only requirement for this proposal to come out true is that arguments occupy Specifier positions of functional heads. And this is currently generally accepted (cf. e.g. Borer 2005b; Ramchand 2008; Adger 2013).¹⁹

To end with a different metaphor that relates in particular to the case of arguments, we can think of the derivation of a sentential meaning as analogous to that in which a statue is carved. The process begins with a single stone that is given a certain form. It is clear that at no point in this process, two things are combined, so Bradley's regress does not arise. We can think of the functional heads as something like the tools used to modify the form of the meaning contributed by their complement. If you use a tool to manipulate an object, it is not that you just add the tool

¹⁹ In contrast, in the literature until about ten years ago, it was standard to assume that arguments (in particular internal arguments) can occupy complement positions.

to the object. Rather you use the tool to change the form of the object. Arguments (and adjuncts) can be thought of as objects which have been carved in a separate phase. Yet, they are not simply added to the meaning of the verb. Rather, the functional grammatical heads turn them into tools which can then modify a particular aspect of the meaning already in place. What all kinds of Specifiers contribute towards the meaning of the phrase they are a part of is the particular 'mark' which they leave as a tool in the form of the object which is derived step by step from the phase head.

In sum, why is the meaning of *John loves Mary* a unity which goes beyond the unity of a mere set? I have suggested that there is a grammatical solution to this question: the meanings of *John* and of *Mary* are not added to that of *love*; rather, via thematic roles, their meanings are used to modify the event denoted by *love*, very much in the way in which functional grammatical structure modifies the form of the content that is provided lexically. I would like to stress the similarity of this approach with the syntactic one described in section 5.2.3: in both cases, unity follows because an entity is modified by, rather than combined with, another entity. The two approaches may thus well be seen as the two sides of one coin. Yet, it is also clear that the current extension of the syntactic proposal to meaning presupposes a rich notion of grammar according to which grammatical structure is responsible for building up the structural aspects of meaning, in particular its formal ontology. Pace Collins (2011b), a notion of grammar which takes Merge to be the only grammatical operation will not do.

Conclusion

7.1 Concluding Remarks

Although the philosophy of language has been central to analytic philosophy, advances in grammatical theory have had very little influence on mainstream philosophy, as it is generally assumed that grammar does not bear on philosophical problems.¹ However, the results of this dissertation suggest that the opposite is the case, in that grammatical theory can help us in understanding and addressing philosophical problems that have been discussed for centuries. My proposals with respect to both unity questions are based on current grammatical theory. In addition, I have demonstrated how aspects of natural logic and natural language ontology can be systematically derived from grammatical principles (cf. chapters 3.3 and 5.1, respectively). In this sense, contrary to common assumptions, grammar, as Hinzen (2012) puts it, is ‘philosophically significant’.

The first of the two puzzles concerning the unity of linguistic meaning, introduced and discussed in chapter 1.2, concerns the question of how the meanings of, for example, sub-sentential linguistic expressions can combine in such a way as to give rise to the meaning of a sentence, as this is a unity, rather than a mere aggregate of the meanings of its parts. This question is, however, not restricted to the unity of sentential meanings, but to the unity of all grammatically complex expressions. The second puzzle concerns the question of why and how the formal ontology changes when expressions are combined grammatically. The two questions are closely related, as the change in formal ontology is the clearest sign of the unity of linguistic meaning.

There are two constraints that any adequate solution to the two unity problems has to meet when it is concerned with the meaning of natural language. First, the proposed solution should not give rise to Bradley’s regress: assuming that a certain relation holds between constituents only gives rise to the question of how the relation is related to its constituents, and if another relation is needed to ensure this relatedness, we never get to the actual explanation. The second

¹ This is also reflected in the fact that text-books in the philosophy of language such as Lycan (2008) and Morris (2006) hardly ever mention grammatical theory.

constraint is that an adequate theory also has to explain, or at least be compatible with, the productivity of natural language and human thought.

I have argued that both questions concern the meaning of grammar, and this inquiry is thus an inquiry into grammatical meaning. It has become clear that grammatical meaning cannot be reduced to lexical meaning (chapter 2). I have further argued on this basis that grammar should be taken to be inherently meaningful, that is, grammatical structures have their meaning ensured by biological necessity (chapter 3). A central aspect of grammatical meaning, which is evolutionary novel in our species, is that grammar specifies the referential properties of linguistic expressions which give rise to a formal ontology (chapters 4 and 5). The second unity problem, thus, dissolves, as formal ontology changes when grammatical structure is built up, because it is itself a grammatical phenomenon. For a more detailed summary of the second unity problem and my proposed solution see chapter 4.4.

To solve the first unity problem, I have argued that, strictly speaking, we should not think of meanings as combining; instead, we can think of them as growing and thereby taking form. This is already suggested by the idea that grammatical meaning concerns the formal ontology of the meaning of natural language expressions. If a classifier is added to a PosP, the meaning changes from mass to individual. However, there is nothing we could add to a lamb mass (say, lamb meat) such that the combination is individual. Instead, we need to divide the mass into individual portions (lambs, packs of lamb meat, etc.). The entity, then, remains the same, but the formal ontology changes. I have argued that all additional grammatical and lexical material that enters into a sentence – functional heads, arguments, and modifiers – can be thought of as determining in which way the growing meaning of the lexical root changes. Since, according to this theory, meanings do not combine, Bradley's regress does not arise. Nonetheless, we can understand the productivity of meaning in that the meanings we start with can 'grow' in novel and potentially infinite, yet systematic, ways, constrained 'from the outside' by the meanings of the other expressions that are part of the sentence. The conditions of adequacy are thus met. A more detailed analysis of the first unity problem can be found in chapter 6.1. I present a more detailed account of my proposal informally in chapter 6.3.1 and spell the account out in formal terms in the remainder of chapter 6.3.

7.2 Further Directions in Grammatology

What I have called ‘Grammatology’ is the attempt to explain aspects of linguistic meaning in grammatical terms, instead of assuming that grammar produces structures that have to be interpreted by another, semantic module, and the current study is an essay in grammatology in this sense. As argued in chapter 4.3, if they are possible, grammatological explanations are preferable to traditional semantic explanations, as they explain what makes human cognition stand out within the animal-world, and as they give an empirical account of the evolution of human-specific cognition. In addition, they assume less redundancy in the human brain, which makes them attractive from a theoretical point of view.

There already are grammatological explanations of particular semantic phenomena, such as the referential properties of expressions determined by the phasal organisation of grammar (Hinzen 2007; Hinzen and Reichard 2011; Sheehan and Hinzen 2011; Hinzen and Sheehan 2014), some aspects of intensionality (Reichard 2012b; Reichard 2013a; Hinzen, et al. 2013), the meaning of Case (Hinzen and Sheehan 2014, chapter 6), and some case studies of the meaning and referential properties of complex expressions (Reichard and Hinzen 2012). Aspects of these have been summarized in chapters 3-5. The present study enriches this inventory by offering a grammatical account of the unity of meaning. However, to demonstrate the credibility of the grammatological strategy, a systematic semantic presentation, dealing with all or most of the semantic phenomena that classical semantic theories address, would be needed, although unfortunately such a presentation is not available to date.

References

- Adger, D. 2013. *A Syntax of Substance*. Cambridge, MA: MIT Press.
- Alexiadou, A., L. Haegeman and M. Stavrou 2007. *Noun Phrase in the Generative Perspective*. Berlin: Mouton de Gruyter.
- Arad, M. 2005. *Roots and Patterns*. Dordrecht: Springer.
- Arbib, M. A. 2005. From Monkey-Like Action Recognition to Human Language: An Evolutionary Framework for Neuroscience. *Behavioral and Brain Sciences* 28, 105-67.
- Aristotle. *Hermeneutica (de Interpretatione)*. In: *Organon Graece. Pars Prior*, ed. by T. Waitz, 123-143. Leipzig: Sumtibus Hanii (1844).
- Aristotle. *Metaphysica*. Ed. by W. Christ. Leipzig: B. G. Teubner (1934).
- Armoskaite, S. 2011. *The Destiny of Roots in Blackfoot and Lithuanian*. PhD-dissertation: University of British Columbia, Vancouver.
http://www.academia.edu/3986118/The_destiny_of_roots_in_Blackfoot_and_Lithuanian.
- Armstrong, D. M. 1997. *A World of States of Affairs*. Cambridge: CUP.
- 2004. *Truth and Truthmakers*. Cambridge: CUP.
- Arnauld, A. and C. Lancelot 1660. *A General and Rational Grammar, Containing the Fundamental Principles of the Art of Speaking, Explained in a Clear and Natural Manner. With the Reasons of the General Agreement, and the Particular Differences of Languages*. Transl. by A. Arnauld and C. Lancelot. London: J. Nourse (1753).
- Arsenijević, B. 2006. *Inner Aspect and Telicity: The Decompositional and the Quantificational Nature of Eventualities at the Syntax-Semantics Interface*. Utrecht: LOT.
- Bach, E. 1989. *Informal Lectures on Formal Semantics*. New York: State University of New York Press.
- Bagha, K. N. 2011. Generative Semantics. *English Language Teaching* 4, 223-31.
- Baillargeon, R., E. S. Spelke and S. R. Wasserman 1985. Object Permanence in 5-months-old Infants. *Cognition* 20, 191-208.
- Baker, M. 1997. Thematic Roles and Grammatical Categories. In: *Elements of Grammar*, ed. by L. Haegeman, 73-137. Dordrecht: Kluwer.
- Barceló-Coblijn, L. and A. Benítez-Burraco 2013. Disentangling the Neanderthal Net: A Comment on Johansson (2013). *Biolinguistics* 7, 199-216.
- Bauer, P. J. 2008. Event Memory in Infancy and Early Childhood. In: *Understanding Events: From Perception to Action*, ed. by T. F. Shipley and J. M. Zacks, 130-59. Oxford: OUP.
- Bear, M. F., B. W. Connors and M. A. Paradiso 1996 and 2007. *Neuroscience: Exploring the Brain*. Philadelphia: Lippincott Williams and Wilkins.
- Bell, D. 1979. *Frege's Theory of Judgement*. Oxford: Clarendon.
- Benazzi, S., K. Douka, C. Fornai, C. C. Bauer, O. Kullmer, J. Svoboda, I. Pap, F. Mallegni, P. Bayle, M. Coquerelle, S. Condemi, A. Ronchitelli, K. Harvati and G. W. Weber 2011. Early Dispersal of Modern Humans in Europe and Implications for Neanderthal Behaviour. *Nature* 479, 525-28.
- Berwick, R. C., P. Pietroski, B. Yankama and N. Chomsky 2011. Poverty of the Stimulus Revisited. *Cognitive Science* 35, 1207-42.
- Betti, A. 2006. Against Facts. *Manuscript*. http://www.academia.edu/252444/Against_Facts.
- Bianchin, M. 2013. Husserl on Meaning and Grammar. *Manuscript*.

- Biberauer, T., A. Holmberg, I. Roberts and M. Sheehan 2013. Complexity in Comparative Syntax: The View from Modern Parametric Theory. *Manuscript*. <http://ling.auf.net/lingbuzz/001827>.
- Bickerton, D. 1990. *Language and Species*. Chicago: University of Chicago Press.
- 1995. *Language and Human Behaviour*. London: UCL Press.
- 2000. How Protolanguage Became Language. In: *The Evolutionary Emergence of Language: Social Functions and the Origins of Linguistic Form*, ed. by C. Knight, M. Studdert-Kennedy and J. R. Hurford, 264-84. Cambridge: CUP.
- Black, M. 1949. *Language and Philosophy*. Ithaca: Cornell University Press.
- Boeckx, C. 2010. Defeating Lexicocentrism: Outline of Elementary Syntactic Structures. *Manuscript*. <http://ling.auf.net/lingbuzz/001130>.
- Bolinger, D. 1967. Adjectives in English: Attribution and Predication. *Lingua* 18, 1-34.
- Borer, H. 2005a. *In Name Only*. Oxford: OUP.
- 2005b. *The Normal Course of Events*. Oxford: OUP.
- Borg, E. 2004. *Minimal Semantics*. Oxford: OUP.
- 2010. *Persuing Meaning*. Oxford: OUP.
- Brabanter, P. D. 2011. Tutorial on Quotation. Delivered at *SPE 4*, University of Bochum, 26.9.-1.10.2011.
- Bradley, F. H. 1883. *The Principles of Logic*. London: OUP (1922).
- 1893. *Appearance and Reality: A Metaphysical Essay*. Oxford: Clarendon Press (1930).
- Brandom, R. 1994. *Making it Explicit*. Cambridge, MA: Harvard University Press.
- 2000. *Articulating Reasons: An Introduction to Inferentialism*. Cambridge, MA: Harvard University Press.
- Buchheim, T. 1999. *Aristoteles*. Freiburg (Brsg.): Herder.
- Burge, T. 1973. Reference and Proper Names. *The Journal of Philosophy* 70, 425-39.
- 1974. Demonstrative Constructions, Reference, and Truth. *The Journal of Philosophy* 71, 205-23.
- 2007. Predication and Truth. *The Journal of Philosophy* 104, 580-608.
- Burton-Roberts, N. 2009. On the Grounding of Syntax - and More. *Newcastle Working Papers in Linguistics* 15, 22-39.
- Cameron, R. P. 2008. Turtles All the Way Down: Regress, Priority, and Fundamentality. *The Philosophical Quarterly* 58, 1-14.
- Campbell, K. 1990. *Abstract Particulars*. Oxford: Basil Blackwell.
- Candlish, S. 2007. *The Russell/Bradley Dispute and its Significance for Twentieth-Century Philosophy*. London: Palgrave Macmillan.
- Caplan, B. and C. Tillman 2012. Benacerraf's Revenge. *Philosophical Studies* doi: 10.1007/s11098-012-0064-8.
- Cappelen, H. and E. Lepore 2005. *Insensitive Semantics: A Defence of Semantic Minimalism and Speech Act Pluralism*. Oxford: Blackwell.
- Carey, S. 2009. *The Origin of Concepts*. Oxford: OUP.
- Carlson, G. 1980. *Reference to Kinds in English*. New York: Garland.
- Carnap, R. 1947. *Meaning and Necessity: A Study in Semantics and Modal Logic*. Chicago: University of Chicago Press.
- Carston, R. 2002. *Thoughts and Utterances*. Oxford: Blackwell.
- Cheney, D. L. and R. M. Seyfarth 1990. Attending to Behaviour versus Attending to Knowledge: Examining Monkey's Attribution of Mental States. *Animal Behaviour* 40, 742-53.
- 1997. Why Animals Don't Have Language. *The Tanner Lectures on Human Values* 19, 173-210.
- Chisholm, R. M. 1970. Events and Propositions. *Nous* 24, 15-24.

- Chomsky, N. 1957. *Syntactic Structures*. Berlin: Mouton de Gruyter.
- 1959. Review of B. F. Skinner's *Verbal Behavior*. *Language* 35, 26-58.
- 1965. *Aspects of Theory of Syntax*. Cambridge, MA: MIT Press.
- 1966. *Cartesian Linguistics: A Chapter in the History of Rationalist Thought*. New York: Harper and Row (2009).
- 1975. *Reflections on Language*. New York: Pantheon.
- 1980. *Rules and Representations*. Oxford: Blackwell.
- 1981. *Lectures on Government and Binding. The Pisa Lectures*. Berlin: Mouton de Gruyter (1993).
- 1986. *Knowledge of Language: Its Nature, Origin, and Use*. New York: Praeger.
- 1993. *Language and Thought*. Wakefield, RI: Moyer Bell (2004).
- 1995. *The Minimalist Programme*. Cambridge, MA: MIT Press.
- 2000. *New Horizons in the Study of Language and Mind*. Cambridge: CUP.
- 2001. Derivation by Phrase. In: *Ken Hale. A Life in Language*, ed. by M. Kenstowicz, 1-52. Cambridge, MA: MIT Press.
- 2005. Three Factors in Language Design. *Linguistic Inquiry* 36, 1-22.
- 2006. *Language and Mind*. Cambridge: CUP.
- 2007. Approaching UG from Below. In: *Interfaces + Recursion = Language? Chomsky's Minimalism and the View from Syntax-Semantics*, ed. by U. Sauerland and H.-M. Gärtner, 1-29. Berlin: Mouton de Gruyter.
- 2008. On Phases. In: *Foundational Issues in Linguistic Theory: Essays in Honor of Jean-Roger Vergnaud*, ed. by R. Freidin, C. P. Otero and M. L. Zubizarreta, 133-66. Cambridge MA: MIT Press.
- 2009. Opening Remarks. In: *Of Minds and Language: A Dialogue with Noam Chomsky in the Basque Country*, ed. by M. Piatelli-Palmarini, J. Uriagereka and P. Salaburu, 13-43. Oxford: OUP.
- 2010. The Mysteries of Nature: How Deeply Hidden? In: *Chomsky Notebook*, ed. by J. Bricmont and J. Franck, 3-33. New York: Columbia University Press.
- 2013. Problems of Projection. *Lingua* 130, 33-49.
- Chomsky, N., M. D. Hauser and W. T. Fitch 2005. *Appendix. The Minimalist Program*. <http://www.wjh.harvard.edu/%7Emnkylab/publications/languagespeech/EvolAppendix.pdf>.
- Cinque, G. 1999. *Adverbs and Functional Heads: A Cross-linguistic Perspective*. Oxford: OUP.
- 2010. *The Syntax of Adjectives: A Comparative Study*. Cambridge MA: MIT Press.
- Clark, B. 2013. Syntactic Theory and the Evolution of Syntax. *Biolinguistics* 7, 169-97.
- Clark, R. 1970. Concerning the Logic of Predicate Modifiers. *Nous* 4, 311-35.
- Collins, J. 2007. Syntax, More or Less. *Mind* 116, 805-50.
- 2011a. Semantic Theory and 'Sensible Ontology'. Delivered at *Truth be Told: Workshop on Formal and Philosophical Theories of Truth*, Amsterdam, 23-25 March 2011.
- 2011b. *The Unity of Linguistic Meaning*. Oxford: OUP.
- 2013. Cutting it (Too) Fine. *Philosophical Studies* doi: 10.1007/s11098-013-0163-1.
- Cottingham, J. 1998. 'The Only Sure Sign'... Thought and Language in Descartes. In: *Thought and Language*, ed. by J. Preston, 29-50. Cambridge: CUP.
- Crain, S. and D. Khlentzos 2008. Is Logic Innate? *Biolinguistics* 2, 24-56.
- 2010. The Logic Instinct. *Mind & Language* 25, 30-65.
- Crain, S. and P. Pietroski 2001. Nature, Nurture, and Universal Grammar. *Linguistics and Philosophy* 24, 139-86.
- Crawford, S. 2013. Propositional or Non-Propositional Attitudes? *Philosophical Studies* DOI: 10.1007/s11098-013-0126-6.

- Crow, T. 2008. The 'Big Bang' Theory of the Origin of Psychosis and the Faculty of Language. *Schizophrenia Research* 102, 31-52.
- Csibra, G. and G. Gergely 2009. Natural pedagogy. *Trends in Cognitive Sciences* 13, 148-53.
- 2011. Natural pedagogy as evolutionary adaptation. *Philosophical Transactions of the Royal Society B* 366, 1149-57.
- Davidson, D. 1963. The Method of Extension and Intension. In: *The Philosophy of Rudolph Carnap*, ed. by A. Schilpp. La Salle, IL.: Open Court.
- 1965. Theories of Meaning and Learnable Languages. In: *Inquiries into Truth and Interpretation*, 3-15. Oxford: Clarendon (1991).
- 1967a. Causal Relations. In: *Essays on Actions and Events*, 149-62. Oxford: Clarendon (2001).
- 1967b. The Logical Form of Action Sentences. In: *Essays on Actions and Events*, 105-22. Oxford: Clarendon (2001).
- 1967c. Truth and Meaning. In: *Inquiries into Truth and Interpretation*, 17-36. Oxford: Clarendon (1991).
- 1969. The Individuation of Events. In: *Essays on Actions and Events*, 163-80. Oxford: Clarendon (2001).
- 1970. Events as Particulars. In: *Essays on Actions and Events*, 181-88. Oxford: Clarendon (2001).
- 1971. Eternal vs. Ephemeral Events. In: *Essays on Actions and Events*, 189-203. Oxford: Clarendon (2001).
- 1973. Radical Interpretation. In: *Inquiries into Truth and Interpretation*, 125-39. Oxford: Clarendon (1991).
- 1991. Three Varieties of Knowledge. In: *Subjective, Intersubjective, Objective*, 205-20. Oxford: Clarendon (2001).
- 1992. The Second Person. In: *Subjective, Intersubjective, Objective*, 107-21. Oxford: Clarendon (2001).
- 1994. The Social Aspect of Language. In: *Truth, Language, and History*, 109-25. Oxford: Clarendon (2005).
- 1996. The Folly of Trying to Define Truth. In: *Truth, Language, and History*, 19-37. Oxford: Clarendon (2005).
- 1997a. The Emergence of Thought. In: *Subjective, Intersubjective, Objective*, 123-34. Oxford: Clarendon (2001).
- 1997b. Seeing Through Language. In: *Truth, Language, and History*, 127-41. Oxford: Clarendon (2005).
- 1997c. Truth Rehabilitated. In: *Truth, Language, and History*, 3-17. Oxford: Clarendon (2005).
- 2001. What Thought Requires. In: *Problems of Rationality*, 135-49. Oxford: Clarendon (2004).
- 2005. *Truth and Predication*. Cambridge, MA: Belknap Press of Harvard University.
- Dennett, D. C. 1991. *Consciousness Explained*. Boston: Little, Brown.
- Descartes, R. 1637. Discourse on the Method. In: *The Philosophical Writings of Descartes, Vol. I*, transl. by R. Stoothoff, ed. by J. Cottingham, R. Stoothoff and D. Murdoch, 109-76. Cambridge: CUP (1985).
- Dodd, J. 1999. Farewell to States of Affairs. *Australasian Journal of Philosophy* 77, 146-60.
- Donnellan, K. S. 1966. Reference and Definite Descriptions. *The Philosophical Review* 75, 281-304.
- 1970. Proper Names and Identifying Descriptions. *Synthese* 21, 335-58.

- Dowty, D. R. 1994. The Role of Negative Polarity and Concord Marking in Natural Language Reasoning. In: *Proceedings of SALT IV*, ed. by M. Harvey and L. Santelmann, 114-44. Ithaca, NY: Cornell University Press.
- Dummett, M. 1973. *Frege: Philosophy of Language*. London: Duckworth.
- 1978. Truth. In: *Truth and Other Enigmas*, 1-24. London: Duckworth.
- 1991. *Frege: Philosophy of Mathematics*. Cambridge, MA: Harvard University Press.
- Eklund, M. 2009. Regress, Unity, Facts, and Propositions. *Manuscript*.
- Elbourne, P. 2008. Demonstratives as Individual Concepts. *Linguistics and Philosophy* 31, 409-66.
- Fara, D. G. 2012. "Literal" Uses of Proper Names. *Manuscript*.
<http://www.princeton.edu/~dfara/papers/fara-literal.pdf>.
- Feigenson, L. and S. Carey 2003. Tracking Individuals Via Object Files: Evidence from Infants' Manual Search. *Developmental Science* 6, 568-84.
- 2005. On the Limits of Infants' Quantification of Small Object Arrays. *Cognition* 97, 295-313.
- Fiocco, M. 2012. Fundamentality, Unity, and Simple Facts. Delivered at University of Durham, 24 May 2012.
- Fitch, W. T. 2005. The Evolution of Language: A Comparative Review. *Biology and Philosophy* 20, 193-230.
- Fodor, J. 1975. *The Language of Thought*. New York: Crowell.
- 1998. *Concepts: Where Cognitive Science Went Wrong*. Oxford: Clarendon.
- 2001. Language, Thought and Compositionality. *Mind and Language* 16, 1-15.
- Fodor, J. and E. Lepore 1991. Why Meaning (Probably) Isn't Conceptual Role. In: *The Compositionality Papers*, 9-26. Oxford: Clarendon (2002).
- 1992. *Holism: A Shopper's Guide*. Oxford: Blackwell.
- 1996. The Red Herring and the Pet Fish: Why Concepts Still Can't be Prototypes. In: *The Compositionality Papers*, 27-42. Oxford: Clarendon (2002).
- 2001. Why Compositionality Won't Go Away: Reflections on Horwich's 'Deflationary' Theory. In: *The Compositionality Papers*, 43-62. Oxford: Clarendon (2002).
- Frege, G. 1879. Begriffsschrift: A Formalized Language of Pure Thought Modelled upon the Language of Arithmetic. In: *Translations from the Philosophical Writings of Gottlob Frege*, transl. by P. T. Geach, ed. by P. T. Geach and M. Black, 1-20. Oxford: Basil Blackwell (1966).
- 1880-1881. Booles rechnende Logik und die Begriffsschrift. In: *Gottlob Frege: Nachgelassene Schriften*, ed. by H. Hermes, F. Kambartel and F. Kaulbach, 9-52. Hamburg: Meiner (1969).
- 1884. *The Foundations of Arithmetic: A Logico-Mathematical Enquiry into the Concept of Number*. Transl. by J. L. Austin. Oxford: Basil Blackwell (1950).
- 1892. On Concept and Object. In: *Translations from the Philosophical Writings of Gottlob Frege*, transl. by P. T. Geach, ed. by P. T. Geach and M. Black, 42-55. Oxford: Basil Blackwell (1966).
- 1918. Logische Untersuchungen. Erster Teil: Der Gedanke. In: *Gottlob Frege: Kleine Schriften*, ed. by I. Angelelli, 342-62. Hildesheim: Georg Olms (1967).
- 1923a. Compound Thoughts. *Mind* 72, 1-17 (1963).
- 1923b. Logische Untersuchungen. Dritter Teil: Gedankengefüge. In: *Gottlob Frege: Kleine Schriften*, ed. by I. Angelelli, 378-94. Hildesheim: Georg Olms.
- Fu, J., T. Roeper and H. Borer 2001. The VP within Process Nominals: Evidence from Adverbs and the VP Anaphor Do-So. *Natural Language & Linguistic Theory* 19, 549-82.
- Gabriel, G., H. Hermes, F. Kambartel, C. Thiel and A. Veraart (eds.) 1976. *Gottlob Frege: Wissenschaftlicher Briefwechsel*. Hamburg: Meiner.

- Gaskin, R. 1995. Bradley's Regress, The Copula and the Unity of the Proposition. *The Philosophical Quarterly* 45, 161-80.
- 2008. *The Unity of the Proposition*. Oxford: OUP.
- 2010a. Précis of The Unity of the Proposition. *Dialectica* 64, 259-64.
- 2010b. The Unity of the Proposition: Replies to Vallicella, Schnieder, and García-Carpintero. *Dialectica* 64, 303-11.
- Geach, P. T. 1961. Frege. In: *Three Philosophers*, ed. by G. E. M. Anscombe and P. T. Geach, 127-62. Oxford: Basil Blackwell (1973).
- Geurts, B. 1997. Good News about the Description Theory of Names. *Journal of Semantics* 14, 319-48.
- Gibbons, A. 2006. *The First Human: The Race to Discover Our First Ancestors*. New York: Doubleday.
- Gibson, J. J. 1979. *The Ecological Approach to Visual Perception*. Boston: Houghton Mifflin.
- Gibson, M. I. 2004. *From Naming to Saying: The Unity of the Proposition*. Oxford: Blackwell.
- Goldin-Meadow, S. and C. Mylander 1998. Spontaneous Sign Systems Created by Deaf Children in Two Cultures. *Nature* 391, 279-81.
- Gomila, A. 2011. *Verbal Minds: Language and the Architecture of Cognition*. Amsterdam: Elsevier.
- Green, T. H. 1874. Introductions to Hume's 'Treatise of Human Nature'. In: *Works of Thomas Hill Green, Vol. I: Philosophical Works*, ed. by R. L. Nettleship, 1-371. London: Longmans, Green, and Co. (1894).
- Grossmann, R. 1983. *The Categorical Structure of the World*. Bloomington: University of Indiana Press.
- Hacking, I. 1986. The Parody of Conversation. In: *Truth and Interpretation: Perspectives on the Philosophy of Donald Davidson*, ed. by E. Lepore. Cambridge, MA: Blackwell.
- Haegeman, L. 1994. *Introduction to Government and Binding Theory*. Oxford: Blackwell.
- Hanks, P. W. 2007. How Wittgenstein Defeated Russell's Multiple Relation Theory of Judgment. *Synthese* 154, 121-46.
- 2009. Recent Work on Propositions. *Philosophy Compass* 4, 469-86.
- 2011. Structured Propositions as Types. *Mind* 120, 11-52.
- Hauser, M. D. 2009. Evolvingo: The Nature of the Language Faculty. In: *Of Minds and Language: A Dialogue with Noam Chomsky in the Basque Country*, ed. by M. Piatelli-Palmarini, J. Uriagereka and P. Salaburu, 74-84. Oxford: OUP.
- Hauser, M. D. and S. Carey 2003. Spontaneous Representations of Small Numbers of Objects by Rhesus Macaques: Examinations of Content and Format. *Cognitive Psychology* 47, 367-401.
- Hauser, M. D., N. Chomsky and W. T. Fitch 2002. The Faculty of Language: What is it, Who has it, and How did it Evolve? *Science* 298, 1569-79.
- Heil, J. 2006. *From an Ontological Point of View*. Oxford: OUP.
- Heim, I. and A. Kratzer 1998. *Semantics in Generative Grammar*. Oxford: Blackwell.
- Henshilwood, C. S., F. d'Errico, R. Yates, Z. Jacobs, C. Tribolo, G. A. T. Duller, N. Mercier, J. C. Sealy, H. Valladas, I. Watts and A. G. Wintle 2002. Emergence of Modern Human Behavior: Middle Stone Age Engravings from South Africa. *Science* 295, 1278-80.
- Higginbotham, J. 1988. Contexts, Models, and Meaning. In: *Mental Representations*, ed. by R. Kempson, 29-48. Cambridge: CUP.
- 1989. Knowledge of Reference. In: *Reflections on Chomsky*, ed. by A. George, 153-74. Oxford: Basil Blackwell.
- 1990. Frege, Concepts and the Design of Language. In: *Information, Semantics, and Epistemology*, ed. by E. Villanueva, 153-71. Cambridge, MA: Basil Blackwell.
- 1993. Grammatical Form and Logical Form. *Philosophical Perspectives* 7, 173-96.

- 2000. On Events in Linguistic Semantics. In: *Speaking of Events*, ed. by J. Higginbotham, F. Pianesi and A. C. Varzi, 49-79. Oxford: OUP.
- 2006. Sententialism: The Thesis that Complement Clauses Refer to Themselves. *Philosophical Issues* 16, 101-19.
- 2009. Review of Jeffrey King: 'The Nature and Structure of Content'. *Philosophical Books* 50, 29-37.
- Hinzen, W. 2006. *Mind Design and Minimal Syntax*. New York: OUP.
- 2007. *An Essay on Names and Truth*. New York: OUP.
- 2010. An Argument Against Compositionality. *Manuscript*.
- 2011. Deflationism, Truth, and Grammar. Delivered at *Truth be Told: Workshop on Philosophical and Formal Theories of Truth*, Amsterdam, 23-25 March 2011.
- 2012. The Philosophical Significance of Universal Grammar. *Language Sciences* 34, 635-49.
- Hinzen, W. and U. Reichard 2011. The Event-Argument Hypothesis: In Search of Evidence. *Manuscript*.
- 2012. Review of John Collins's 'The Unity of Linguistic Meaning'. *Mind* 121, 788-93.
- Hinzen, W. and M. Sheehan 2014. *The Philosophy of Universal Grammar*. Oxford: OUP (forthcoming).
- Hinzen, W., M. Sheehan and U. Reichard 2013. Intensionality, Grammar, and the Sententialist Hypothesis. In: *Minimalism and Beyond: Radicalizing the Interfaces*, ed. by P. Kosta, S. Franks and T. Radeva-Bork. Amsterdam: John Benjamins (forthcoming).
- Hinzen, W. and J. Uriagereka 2006. On the Metaphysics of Linguistics. *Erkenntnis* 65, 71-96.
- Hodges, W. 2012. Formalizing the Relationship between Meaning and Syntax. In: *The Oxford Handbook of Compositionality*, ed. by M. Werning, W. Hinzen and E. Machery, 245-61. Oxford: OUP.
- Hodgson, T. 2012. Structured Propositions and Shared Content. In: *Philosophical and Formal Approaches to Linguistic Analysis*, ed. by P. Stalmaszczyk, 177-95. Frankfurt a. M.: Ontos.
- Hofweber, T. 2005. Number Determiner, Number, and Arithmetics. *The Philosophical Review* 114, 179-225.
- Holmberg, A. 2013. The Syntax of Answers to Polar Questions in English and Swedish. *Lingua* 128, 31-50.
- Hom, C. and J. Schwartz 2013. Unity and the Frege-Geach Problem. *Philosophical Studies* 163, 15-25.
- Hommel, B. 2004. Event Files: Feature Binding in and across Perception and Action. *Trends in Cognitive Sciences* 8, 494-500.
- Hornstein, N. 1984. *Logic as Grammar: An Approach to Meaning in Natural Language*. Cambridge, MA: MIT Press.
- 2013. Three Grades of Grammatical Involvement: Syntax from a Minimalist Perspective. *Mind & Language* 28, 392-420.
- Hornstein, N. and P. Pietroski 2009. Basic Operations: Minimal Syntax-Semantics. *Catalan Journal of Linguistics* 8, 113-39.
- Horwich, P. 2008. What's Truth got to do with it. *Linguistics and Philosophy* 31, 309-22.
- Hrachovec, H. 2008. Ganze Sätze: Davidson über Prädikation. *Conceptus* 91, 11-31.
- Hume, D. 1739-40. *A Treatise of Human Nature*. New York: Barnes and Noble (2005).
- 1748. *An Enquiry Concerning Human Understanding*. Oxford: OUP (2007).
- Husserl, E. 1913. *Logische Untersuchungen. Zweiter Band. Erster Teil: Untersuchungen zur Phänomenologie und Theorie der Erkenntnis*. The Hague: Kluwer (1984).
- Hylton, P. 1990. *Russell, Idealism, and the Emergence of Analytic Philosophy*. Oxford: Clarendon.
- Iacona, A. 2003. Are There Propositions? *Erkenntnis* 58, 325-51.

- Jackendoff, R. 1997. *The Architecture of the Language Faculty*. Cambridge, MA: MIT Press.
- Janssen, T. M. V. 2001. Frege, Contextuality and Compositionality. *Journal of Logic, Language, and Information* 10, 115-36.
- 2012. Compositionality: Its Historical Context. In: *The Oxford Handbook of Compositionality*, ed. by M. Werning, W. Hinzen and E. Machery, 19-46. Oxford: OUP.
- Jespersen, B. 2012. Recent Work on Structured Meaning and Propositional Unity. *Philosophy Compass* 7, 620-30.
- Johansson, S. 2013a. Neanderthals between Man and Beast: A Comment on the Comments by Barceló-Coblijn & Benítez-Burraco (2013). *Biolinguistics* 7, 217-27.
- 2013b. The Talking Neanderthals: What Do Fossils, Genetics, and Archeology Say? *Biolinguistics* 7, 35-74.
- Johnston, C. 2007. The Unity of a Tractarian Fact. *Synthese* 156, 231-51.
- Jubien, M. 2001. Propositions and the Objects of Thought. *Philosophical Studies* 104, 47-62.
- Kamp, H. 1975. Two Theories about Adjectives. In: *Formal Semantics of Natural Language*, ed. by E. L. Keenan, 123-55. Cambridge: CUP.
- Kamp, H. and B. H. Partee 1995. Prototype Theory and Compositionality. *Cognition* 57, 129-91.
- Kandel, E. E. and C. Mason 1996. Wahrnehmung von Form und Bewegung. In: *Neurowissenschaften: Eine Einführung*, ed. by E. E. Kandel, J. H. Schwartz and T. M. Jessell, 431-58. Heidelberg: Spectrum.
- Kant, I. 1787. *Kritik der reinen Vernunft. Nach der ersten und zweiten Originalausgabe*. Hamburg: Meiner (1998).
- Kaplan, D. 1977. Demonstratives: An Essay in the Semantics, Logic, Metaphysics, and Epistemology of Demonstratives and Other Indexicals. In: *Themes from Kaplan*, ed. by J. Almog, J. Perry and H. K. Wettstein, 481-564. Oxford: OUP.
- Katz, J. and D. Pesetsky 2011. The Identity Thesis for Language and Music. *Manuscript*. <http://ling.auf.net/lingBuzz/000959>.
- Kennedy, C. and J. Stanley 2009. On 'Average'. *Mind* 118, 583-646.
- Kim, J. 1969. Events and their Descriptions: Some Considerations. In: *Essays in Honor of Carl G. Hempel*, ed. by N. Rescher, 198-215. Dordrecht: Reidel.
- 1976. Events as Property Exemplifications. In: *Action Theory. Proceedings of the Winnipeg Conference on Human Action*, ed. by M. Brand and D. Walton, 159-77. Dordrecht: Reidel.
- King, J. C. 1995. Structured Propositions and Structured Predicates. *Nous* 29, 516-35.
- 2007. *The Nature and Structure of Content*. Oxford: OUP.
- 2009. Questions of Unity. *Proceedings of the Aristotelian Society* 109, 257-77.
- 2013a. On Fineness of Grain. *Philosophical Studies* 163, 763-81.
- 2013b. Propositional Unity: What's the Problem, Who Has it and Who Solves it? *Philosophical Studies* 165, 71-93.
- Kirkby, D. 2012a. The Formality of Logic. Delivered at the *Language and Mind Research Group*, Durham, 17.5.2012.
- 2012b. Proper Names: Denying Semantic Uniformity. In: *Philosophical and Formal Approaches to Linguistic Analysis*, ed. by P. Stalmaszczyk. Frankfurt a. M.: Ontos.
- Kirkby, D. and U. Reichard 2013. Developing the Linguistic Analogy: The Implications of Minimalist Linguistics. *Manuscript*.
- Kiss, K. É. 1991. Logical Structure in Syntactic Structure: The Case of Hungarian. In: *Logical Structure and Syntactic Structure: Cross-Linguistic Perspectives*, ed. by C.-T. J. Huang and R. C. May, 111-48. Cambridge, MA: MIT Press.
- Klein, P. 2003. When Infinite Regresses Are Not Vicious. *Philosophy and Phenomenological Research* 66, 718-29.

- Kneale, W. 1962. Modality De Dicto and De Re. In: *Logic, Methodology and Philosophy of Science: Proceedings of the 1960 International Congress*, ed. by E. Nagel, P. Suppes and A. Tarski, 622-33. Stanford: Stanford University Press.
- Kolliakou, D. 2004. Monadic Definites and Polydefinites: Their Form, Meaning, and Use. *Journal of Linguistics* 40, 263-323.
- Kripke, S. A. 1972. *Naming and Necessity*. Oxford: Blackwell (1980).
- Larson, R. K. 1998. Events and Modification in Nominals. In: *Semantics and Linguistic Theory VIII (SALT8)*, ed. by D. Stolovitch and A. Lawson, 145-68. Ithaca, NY: Cornell University.
- 1999. The Semantics of Adjectival Modification. Delivered at *the Dutch National Graduate School (LOT)*, Amsterdam.
[http://semlab5.sbs.sunysb.edu/~rlarson/LOT\(99\)/Contents.html/index.html](http://semlab5.sbs.sunysb.edu/~rlarson/LOT(99)/Contents.html/index.html).
- 2000a. ACD in AP. Delivered at *19th West Coast Conference on Formal Linguistics (WCCFL 19)*, Los Angeles, CA. <http://semlab5.sbs.sunysb.edu/~rlarson/wccfl19.pdf>.
- 2000b. Temporal Modification in Nominals. Delivered at *The Syntax of Tense and Aspect*, Paris, 15.-18.11.2000. <http://semlab5.sbs.sunysb.edu/~rlarson/ParisHandout.pdf>.
- 2002. The Grammar of Intensionality. In: *Logical Form and Language*, ed. by G. Preyer and G. Peter, 228-62. Oxford: Clarendon.
- 2010. *Grammar as a Science*. Cambridge, MA: MIT Press.
- Larson, R. K. and G. Segal 1995. *Knowledge of Meaning: An Introduction to Semantic Theory*. Cambridge, MA: MIT Press.
- Lasnik, H. 2000. *'Syntactic Structures' Revisited: Contemporary Lectures on Classic Transformational Theory*. Cambridge, MA: MIT Press.
- Leckie, G. 2013. The Double Life of Names. *Philosophical Studies* 165, 1139-60.
- Leiss, E. 2009. *Sprachphilosophie. Eine Einführung in ihre Axiomatik*. Berlin: Walter de Gruyter.
- Leko, N. 1988. X-bar Theory and Internal Structure of DPs. *Lingua* 75, 135-69.
- Lepore, E. and K. Ludwig 2005. *Donald Davidson: Meaning, Truth, Language, and Reality*. Oxford: OUP.
- 2007. *Donald Davidson: Truth-Theoretic Semantics*. Oxford: Clarendon.
- 2011. Truth and Meaning Redux. *Philosophical Studies* 145, 251-77.
- Lerdahl, F. and R. Jackendoff 1983. *A Generative Theory of Tonal Music*. Cambridge, MA: MIT Press.
- 2006. The Capacity for Music: What is It, and What's Apeial About It? *Cognition* 100, 33-72.
- Levine, J. 2009. Review of Stewart Candlish's *The Russell/Bradley Dispute and its Significance for Twentieth-Century Philosophy*. *Notre Dame Philosophical Reviews* 2009.02.20.
- Lewis, D. K. 1991. *Parts of Classes*. Oxford: Blackwell.
- Lidz, J., S. Waxman and J. Freedman 2003. What Infants Know about Syntax But Couldn't Have Learned: Experimental Evidence for Syntactic Structure at 18 Months. *Cognition* 89, B65-B73.
- Lightfoot, D. 1982. *The Language Lottery: Toward a Biology of Grammars*. Cambridge, MA: MIT Press.
- Linsky, L. 1992. The Unity of the Proposition. *Journal of the History of Philosophy* 30, 243-73.
- Locke, J. 1689. *An Essay Concerning Human Understanding*.
- Longobardi, G. 1994. Reference and Proper Names. A Theory of N-Movement in Syntax and Logical Form. *Linguistic Inquiry* 25, 609-65.
- 2005. Towards a Unified Grammar of Reference. *Zeitschrift für Sprachwissenschaft* 24, 5-44.
- Lowe, E. J. 2006. *The Four-Category Ontology. A Metaphysical Foundation for Natural Science*. New York: Clarendon.

- Ludlow, P. 2002. LF and Natural Logic. In: *Logical Form and Language*, ed. by G. Preyer and G. Peter, 132-68. Oxford: Clarendon.
- Lycan, W. G. 2008. *Philosophy of Language. A Contemporary Introduction*. London: Routledge.
- MacBride, F. 2011. Impure Reference: A Way Around the Concept Horse Paradox. *Philosophical Perspectives* 25, 297-312.
- MacFarlane, J. G. 2000. *What does it Mean to Say that Logic is Formal*. PhD-dissertation: University of Pittsburgh. <http://johnmacfarlane.net/dissertation.pdf>.
- Maguire, M. J. and G. O. Dove 2008. Speaking of Events: Event Word Learning and Event Representation. In: *Understanding Events: From Perception to Action*, ed. by T. F. Shipley and J. M. Zacks, 193-218. Oxford: OUP.
- Maienborn, C. 2003. *Die logische Form von Kopula-Sätzen*. Berlin: Akademie Verlag.
- Marantz, A. 1997. No Escape from Syntax: Don't Try Morphological Analysis in the Privacy of Your Own Lexicon. *University of Pennsylvania Working Papers in Linguistics* 4, 201-25.
- 2013. Phases and Words. *Manuscript*.
https://files.nyu.edu/ma988/public/Phase_in_Words_Final.pdf.
- Marvin, T. 2002. *Topics in the Stress and Syntax of Words*. PhD-dissertation: MIT, Cambridge, MA.
- Matushansky, O. 2008. On the Linguistic Complexity of Proper Names. *Linguistics and Philosophy* 21, 573-627.
- 2012. What's Proper? Delivered at *Workshop on Binominal Denominative Noun Phrases*, Paris I, 2 June 2012.
<http://www.hum.uu.nl/medewerkers/o.m.matushansky/Downloads/CAParis.pdf>.
- Maurin, A.-S. 2010. Trope Theory and the Bradley Regress. *Synthese* 175, 311-26.
- 2012. Bradley's Regress. *Philosophy Compass* 7, 794-807.
- May, R. C. 1977. *The Grammar of Quantification*. PhD-dissertation: MIT, Cambridge, MA.
- McDowell, J. 1994. *Mind and World*. Cambridge, MA: Harvard University Press.
- Mellor, D. H. 2006. On Wholes and Parts: The Limits of Composition. *South African Journal of Philosophy* 25, 138-45.
- Milner, A. D. and M. A. Goodale 2006. *The Visual Brain in Action*. Oxford: OUP.
- Mithen, S. 2005. *The Singing Neanderthals. The Origins of Music, Language, Mind and Body*. London: Weidenfeld & Nicolson.
- Moltmann, F. 2003a. Nominalizing Quantifiers. *Journal of Philosophical Logic* 32, 445-81.
- 2003b. Propositional Attitudes Without Propositions. *Synthese* 135, 77-118.
- 2004. Properties and Kinds of Tropes: New Linguistic Facts and Old Philosophical Insights. *Mind* 113, 1-41.
- 2005. Two Kinds of Universals and Two Kinds of Collections. *Linguistics and Philosophy* 27, 739-76.
- 2007. Events, Tropes, and Truthmaking. *Philosophical Studies* 134, 363-403.
- 2013. *Abstract Objects and The Semantics of Natural Language*. Oxford: OUP.
- Montague, R. 1969. On the Nature of Certain Philosophical Entities. In: *Formal Philosophy: Selected Papers of Richard Montague*, ed. by R. H. Thomason, 148-87. New Haven: Yale University Press (1974).
- 1970. English as a Formal Language. In: *Formal Philosophy: Selected Papers of Richard Montague*, ed. by R. H. Thomason, 189-224. New Haven: Yale University Press (1974).
- 1974. *Formal Philosophy: Selected Papers of Richard Montague*, ed. by R. H. Thomason. New Haven: Yale University Press.
- Moore, G. E. 1899. The Nature of Judgement. *Mind* 8, 176-93 (1993).
- Morris, M. 2006. *An Introduction to the Philosophy of Language*. Cambridge: CUP.

- Mukherji, N. 2010. *The Primacy of Grammar. Explorations in the Philosophy of Linguistics*. Cambridge MA: MIT Press.
- Nakayama, K., Z. J. He and S. Shimojo 1995. Visual Surface Representation: A Critical Link between Lower-Level and Higher-Level Vision. In: *Visual Cognition: An Invitation to Cognitive Science*, ed. by S. M. Kosslyn and D. Osherson, 1-70. Cambridge, MA: MIT Press.
- Orilia, F. 1991. Type-free Property Theory, Bradley's Regress and Meinong and Russell Reconceiled. *Grazer philosophische Studien* 39, 103-25.
- 2006. States of Affairs: Bradley vs Meinong. *Meinongian Studies* 2, 103-25.
- Pagin, P. 1999. Radical Interpretation and Compositional Structure. In: *Donald Davidson: Truth, Meaning and Knowledge*, ed. by U. M. Zeglen, 59-72. London: Routledge.
- Pagin, P. and D. Westerståhl 2010. Compositionality II: Arguments and Problems. *Philosophy Compass* 5, 265-82.
- Palmer, A. 1988. *Concept and Object: The Unity of the Proposition in Logic and Psychology*. London: Routledge.
- Parsons, T. 1970. Some Problems Concerning the Logic of Grammatical Modifiers. *Synthese* 21, 320-34.
- 1986. Why Frege Should Not Have Said "The Concept Horse is Not a Concept". *History of Philosophy Quarterly* 3, 449-65.
- 1990. *Events in the Semantics of English: A Study in Subatomic Semantics*. Cambridge, MA: MIT Press.
- 2000. Underlying States and Time Travel. In: *Speaking of Events*, ed. by J. Higginbotham, F. Pianesi and A. C. Varzi, 81-93. Oxford: OUP.
- Partee, B. H. 1984. Compositionality. In: *Compositionality in Formal Semantics: Selected Papers by Barbara H. Partee*, 153-81. Malden, MA: Blackwell (2004).
- 2007. Compositionality and Coercion in Semantics: The Dynamics of Adjective Meaning. In: *Cognitive Foundations of Interpretation*, ed. by G. Bouma, I. Krämer and J. Zwarts, 145-61. Amsterdam: Royal Netherlands Academy of Arts and Sciences.
- Partee, B. H., A. ter Meulen and R. Wall 1990. *Mathematical Methods in Linguistics*. Dordrecht: Kluwer.
- Paul, L. A. 2012. Building the World from its Fundamental Constituents. *Philosophical Studies* 158, 221-56.
- Peacock, H. 2011. Is there a Problem about Propositional Unity? *Dialectica* 65, 393-418.
- 2012. Bradley's Regress, Truthmaking, and Constitution. *Grazer Philosophische Studien* 86.
- Pelletier, F. J. 2012. Holism and Compositionality. In: *The Oxford Handbook of Compositionality*, ed. by M. Werning, W. Hinzen and E. Machery, 149-74. Oxford: OUP.
- Penn, D. C., K. J. Holyoak and D. J. Povinelli 2008. Darwin's Mistake: Explaining the Discontinuity Between Human and Nonhuman Minds. *Behavioral and Brain Sciences* 31, 109-30.
- Pepperberg, I. M. 1999. *The Alex Studies*. Boston: Harvard University Press (2002).
- Perovic, K. 2012. Review of John Collins's *The Unity of Linguistic Meaning*. *Notre Dame Philosophical Reviews*.
- Pianesi, F. and A. C. Varzi 2000. Events and Event Talk: An Introduction. In: *Speaking of Events*, ed. by J. Higginbotham, F. Pianesi and A. C. Varzi, 3-47. Oxford: OUP.
- Pietroski, P. M. 2005a. *Events and Semantic Architecture*. Oxford: OUP.
- 2005b. Meaning Before Truth. In: *Contextualism in Philosophy: Knowledge, Meaning, and Truth*, ed. by G. Preyer and G. Peter, 255-302. Oxford: OUP.
- 2011. Minimal Semantic Instructions. In: *The Oxford Handbook of Linguistic Minimalism*, ed. by C. Boeckx, 472-98. Oxford: OUP.

- 2012. Semantic Monadicity with Conceptual Polyadicity. In: *Oxford Handbook of Compositionality*, ed. by W. Hinzen, M. Werning and E. Machery, 129-48. Oxford: OUP.
- Pinker, S. 1994. *The Language Instinct*. London: Penguin (1995).
- 2003. Language as an Adaptation to the Cognitive Niche. In: *Language Evolution: The States of the Art*, ed. by M. H. Christiansen and S. Kirkby. Oxford: OUP.
- Pinker, S. and R. Jackendoff 2005. The Faculty of Language: What's Special About It? *Cognition* 95, 201-36.
- Plato. Sophistes. In: *Platonis Opera, Tomus I*, ed. by I. Burnet. Oxford: Clarendon (1961).
- Poeppel, D. and D. Embick 2005. Defining the Relation between Linguistics and Neuroscience. In: *Twenty-First Century Psycholinguistics: Four Cornerstones*, ed. by A. Cutler, 103-20. Hillsdale, NJ: Lawrence Erlbaum.
- Poole, G. 2002. *Syntactic Theory*. Basingstoke: Palgrave Macmillan.
- Preyer, G. (ed.) 2012. *Donald Davidson on Truth, Meaning, and the Mental*. Oxford: OUP.
- Pruden, S. M., K. Hirsh-Pasek and R. M. Golinkoff 2008. Current Events: How Infants Parse the World and Events for Language. In: *Understanding Events: From Perception to Action*, ed. by T. F. Shipley and J. M. Zacks, 160-92. Oxford: OUP.
- Pullum, G. K. and B. C. Scholz 2010. Recursion and the infinitude claim. In: *Recursion in Human Language*, ed. by H. v. d. Hulst, 113-38. Berlin: Mouton de Gruyter.
- Putnam, H. 1975. The Meaning of 'Meaning'. In: *Mind, Language and Reality. Philosophical Papers, Volume 2*, 215-71. Cambridge: CUP.
- Pylyshyn, Z. W. 2001. Visual Indexes, Preconceptual Objects, and Situated Vision. *Cognition* 80, 127-58.
- Quine, W. v. O. 1953. On What There Is. In: *From a Logical Point of View: Logico-Philosophical Essays*, 1-19. New York: Harper & Row (1963).
- 1960. *Word and Object*. Cambridge, MA: MIT Press (1993).
- 1969a. Epistemology Naturalized. In: *Ontological Relativity and Other Essays*, 69-90. New York: Columbia University Press.
- 1969b. Natural Kinds. In: *Ontological Relativity and Other Essays*, 114-38. New York: Columbia University Press.
- 1970. Philosophical Progress in Language Theory. *Metaphilosophy* 1, 2-19.
- 1987. Indeterminacy of Translation Again. *Journal of Philosophy* 84, 5-10.
- Radford, A. 1981. *Transformational Syntax*. Cambridge: CUP.
- 1997. *Minimalist Syntax: Exploring the Structure of English*. Cambridge: CUP.
- Ramberg, B. T. 1989. *Donald Davidson's Philosophy of Language. An Introduction*. Oxford: Blackwell.
- Ramchand, G. C. 2008. *Verb Meaning and the Lexicon. A First Phase Syntax*. Cambridge: CUP.
- Read, S. 2005. The Unity of the Fact. *Philosophy* 80, 317-42.
- Recanati, F. 1997. *Direct Reference: From Language to Thought*. Oxford: Blackwell.
- 2004. *Literal Meaning*. Cambridge: CUP.
- 2010. *Truth-Conditional Pragmatics*. Oxford: OUP.
- Reichard, U. 2012a. Making Events Redundant: Adnominal Modification and Phases. In: *Philosophical and Formal Approaches to Linguistic Analysis*, ed. by P. Stalmaszczyk, 429-55. Frankfurt a. M.: Ontos.
- 2012b. Rigid and Yet Descriptive: On Binominal Denominative Noun Phrases. Delivered at *Binominal Denominative Noun Phrases*, IHPST Paris, 2 June 2012.
- 2013a. Inference and Grammar: Intersectivity, Subsectivity and Phases. In: *Microvariation, Minority Languages, Minimalism and Meaning: Proceedings of the Irish Network in Formal Linguistics*, ed. by C. S. Rhys, P. Iosad and A. Henry, 222-44. Newcastle upon Tyne: Cambridge Scholars.
- 2013b. Onoma and Rhema: Plato and Aristotle and the Unity of Meaning. *Manuscript*.

- 2014. Object, Concept, Unity. In: *Philosophy of Language and Linguistics: The Legacy of Frege, Russell, and Wittgenstein*, ed. by P. Stalmaszczyk. Frankfurt a. M.: Ontos (forthcoming).
- Reichard, U. and W. Hinzen 2012. Grammar and Ontology: What is the Connection? *Manuscript*.
- Reichard, U. and D. Kirkby 2011. Comment on Guglielmo Cinque. Delivered at *The Past and Future of Universal Grammar*, University of Durham, 15-18 December 2011.
- Roberts, I. G. 2012. On the Nature of Syntactic Parameters: A Programme for Research. In: *Parameter Theory and Linguistic Change*, ed. by C. Galves, S. Cyrino, R. Lopes, F. Sandalo and J. Avelar, 319-34. Oxford: OUP.
- Roeper, T. 2007. *The Prism of Grammar: How Child Language Illuminates Humanism*. Cambridge, MA: MIT Press.
- Ross, J. R. 1967. *Constraints on Variables in Syntax*. PhD-dissertation: MIT, Cambridge, MA.
- Russell, B. 1899. The Classification of Relations. In: *The Collected Papers of Bertrand Russell, vol. 2: Philosophical Papers 1896-99*, ed. by N. Griffin and A. Lewis. London: Routledge (1990).
- 1903. *Principles of Mathematics*. London: Routledge (2010).
- 1905. On Denoting. *Mind* 14, 479-93.
- 1912. *Problems of Philosophy*. Oxford: OUP.
- 1918. The Philosophy of Logical Atomism. In: *Logic and Knowledge: Essays 1901-1950*, 177-281. London: George Allen & Unwin (1956).
- 1919. On Propositions: What they are and How they Mean. In: *Bertrand Russell: Logic and Knowledge: Essays 1901-1950*, ed. by R. C. Marsh, 283-320. London: George Allen & Unwin (1956).
- 1923. Vagueness. *Australasian Journal of Philosophy and Psychology* 1, 84-92.
- 1938. The Relevance of Psychology for Philosophy and Logic. *Aristotelian Society Supplementary Volume* 17, 42-53.
- 1948. *Human Knowledge: Its Scope and Limits*. London: Allen and Unwin.
- Sainsbury, R. M. 1996. How Can We Say Something? In: *Bertrand Russell and the Origins of Analytical Philosophy*, ed. by R. Monk and A. Palmer, 137-53. Bristol: Thoemmes.
- Salmon, N. U. 1986a. *Frege's Puzzle*. Cambridge, MA: MIT Press.
- 1986b. Reflexivity. *Notre Dame Journal of Formal Logic* 27, 401-29.
- Sánchez, V. 1991. *Studies on Natural Logic and Categorical Grammar*. PhD-dissertation: University of Amsterdam.
- 1994. Monotonicity in Medieval Logic. In: *Language and Cognition* 4, ed. by A. De Boer, H. De Hoop and H. De Swart, 161-74. Groningen: Rijksuniversiteit Groningen.
- Saussure, F. d. 1916. *Grundfragen der allgemeinen Sprachwissenschaft*. Berlin: Walter de Gruyter (1967).
- Savage-Rumbaugh, E. S., J. Murphy, R. Sevcik, K. Brakke, S. Williams, D. Rumbaugh and E. Bates 1993. Language Comprehension in Ape and Child. *Monographs of the Society for Research in Child Development* 58.
- Savage-Rumbaugh, E. S., S. G. Shanker and T. Taylor 1998. *Apes, Language, and the Human Mind*. New York: OUP.
- Schaffer, J. 2010. Monism: The Priority of the Whole. *Philosophical Review* 119, 31-76.
- Schiffer, S. 2006. Propositional Content. In: *The Oxford Handbook of Philosophy of Language*, ed. by E. Lepore and B. C. Smith, 267-94. Oxford: OUP.
- Schnieder, B. 2004. Once More: Bradleyan Regresses. In: *Relations and Predicates*, ed. by H. Hochberg and K. Mulligan, 219-56. Frankfurt a. M.: Ontos.
- 2010. Propositions United. *Dialectica* 64, 289-301.

- Schwartz, R. 2008. Events are What We Make of Them. In: *Understanding Events. From Perception to Action*, ed. by T. F. Shipley and J. M. Zacks, 54-60. Oxford: OUP.
- Scott, G.-J. 2002. Stacked Adjectival Modification and the Structure of the Nominal Phrases. In: *Functional Structure in DP and IP*, ed. by G. Cinque, 91-120. New York: OUP.
- Searle, J. R. 2007. What is Language: Some Preliminary Remarks. In: *Explorations in Pragmatics: Linguistic, Cognitive and Intercultural Aspects*, ed. by I. Kecskes and L. R. Horn, 7-37. Berlin: Mouton de Gruyter.
- Senghas, A. and M. Coppola 2001. Children Creating Language: How Nicaraguan Sign Language Acquired a Spatial Grammar. *Psychological Science* 12, 323-28.
- Sheehan, M. 2013. Towards a Parameter Hierarchy for Alignment. *Proceedings of WCCFL* 31, (forthcoming).
- Sheehan, M. and W. Hinzen 2011. Moving Towards the Edge: The Grammar of Reference. *Linguistic Analysis* 37, 405-58.
- Shipley, T. F. 2008. An Invitation to an Event. In: *Understanding Events. From Perception to Action*, ed. by T. F. Shipley and J. M. Zacks, 3-30. Oxford: OUP.
- Siegel, M. E. A. 1976. *Capturing the Adjective*. PhD-dissertation: University of Massachusetts, Amherst, MA.
- Soames, S. 1985. Lost Innocence. *Linguistics and Philosophy* 8, 59-71.
- 1987. Direct Reference, Propositional Attitudes and Semantic Content. *Philosophical Topics* 15, 47-87.
- 1989. Semantics and Semantic Competence. *Philosophical Perspectives* 3, 575-96.
- 2008. Truth and Meaning: In Perspective. *Midwest Studies In Philosophy* 32, 1-19.
- 2010a. *Philosophy of Language*. Princeton: Princeton University Press.
- 2010b. *What is Meaning?* Princeton: Princeton University Press.
- 2013a. Clarifying and Improving the Cognitive Theory to Meet its Explanatory Burden. In: *New Thinking about Propositions*, ed. by J. C. King, S. Soames and J. Speaks. Oxford: OUP.
- 2013b. Propositions as Cognitive Event Types. In: *New Thinking about Propositions*, ed. by J. C. King, S. Soames and J. Speaks. Oxford: OUP.
- Sosa, E. 1993. Epistemology, Realism, and Truth: The First Philosophical Perspectives Lecture. *Philosophical Perspectives* 7, 1-16.
- Speaks, J. 2013. What's Wrong With Semantic Theories Which Make No Use of Propositions. In: *New Thinking about Propositions*, ed. by J. C. King, S. Soames and J. Speaks. Oxford: OUP (forthcoming).
- Spelke, E. S., R. Kerstenbaum and D. J. Simons 1995. Spatiotemporal Continuity, Smoothness of Motion and Object Identity in Infancy. *British Journal of Developmental Psychology* 13, 113-42.
- Sperber, D. and D. Wilson 1986. *Relevance: Communication and Cognition*. Oxford: Blackwell (1995).
- Sproat, R. and C. Shih 1988. Prenominal Adjectival Ordering in English and Mandarin. In: *Proceedings of NELS 18*, ed. by J. Blevins and J. Carter, 465-89. Amherst: GSLA.
- Stanley, J. 2000. Context and Logical Form. *Linguistics and Philosophy* 23, 391-424.
- Stevens, G. 2005. *The Russellian Origins of Analytic Philosophy: Bertrand Russell and the Unity of the Proposition*. London: Routledge.
- 2006. Russell's Repsychologising of the Proposition. *Synthese* 151, 99-124.
- Strawson, P. F. 1950. On Referring. *Mind* 59, 320-44.
- 1961. Singular Terms and Predication. *The Journal of Philosophy* 58, 393-412.
- 1974. *Individuals: An Essay in Descriptive Metaphysics*. London: Methuen.
- Summers, S. 2012. *Lexical Meaning and Propositional Representation: An Investigation into the Problem of the Unity of the Proposition*. PhD-dissertation: University of East Anglia.

- Szabò, Z. G. 2004. Review of Fodor and Lepore's *The Compositionality Papers*. *Mind* 113, 340-44.
- Tallerman, M. and K. R. Gibson (eds.) 2012. *The Oxford Handbook of Language Evolution*. Oxford: OUP.
- Tarski, A. 1936a. The Concept of Truth in Formalized Languages. In: *Logic, Semantics, Metamathematics*, transl. by J. H. Woodger, 152-278. Oxford: Clarendon (1956).
- 1936b. The Establishment of Scientific Semantics. In: *Logic, Semantics, Metamathematics*, transl. by J. H. Woodger, 401-08. Oxford: Clarendon (1956).
- 1944. The Semantic Conception of Truth: and the Foundations of Semantics. *Philosophy and Phenomenological Research* 4, 341-76.
- Tattersall, I. 2004. What Happened in the Origin of Human Consciousness? *The Anatomical Record. Part B, New Anatomist* 276B, 19-36.
- 2008. *The World from Beginnings to 4000BCE*. Oxford: OUP.
- 2010. A Putative Role for Language in the Origin of Human Consciousness. In: *The Evolution of Human Language*, ed. by R. K. Larson, V. Deprez and H. Yamakido, 193-99. Cambridge: CUP.
- Terrace, H. S. 2005. Metacognition and the Evolution of Language. In: *The Missing Link in Cognition*, ed. by H. S. Terrace and J. Metcalfe, 84-115. Oxford: OUP.
- Terrace, H. S., L. A. Pettito, R. L. Sanders and T. G. Brever 1979. Can an Ape Create a Sentence? *Science* 206, 891-902.
- Textor, M. 2010. Frege's Concept Paradox and the Mirroring Principle. *The Philosophical Quarterly* 60, 126-48.
- Tomasello, M. 2008. *The Origins of Human Communication*. Cambridge, MA: MIT Press.
- Tomasello, M. and K. Zuberbühler 2002. Primate Vocal and Gestural Communication. In: *The Cognitive Animal: Empirical and Theoretical Perspectives on Animal Cognition*, ed. by M. Bekoff, C. Allen and G. Burghardt. Cambridge, MA: MIT Press.
- Travis, C. 2008. *Occasion-Sensitivity*. Oxford: OUP.
- Truswell, R. 2009. Constituency and Bonobo Comprehension. *Manuscript*.
<http://www.lel.ed.ac.uk/~rtruswel/kanzi3.pdf>.
- Tugendhat, E. 1960. Tarskis semantische Definition der Wahrheit und ihre Stellung innerhalb der Geschichte des Wahrheitsproblems im logischen Positivismus. (Ein kritischer Überblick im Anschluß an Wolfgang Stegmüller: *Das Wahrheitsproblem und die Idee der Semantik. Eine Einführung in die Theorien von A. Tarski und R. Carnap*. Wien 1957. Springer Verlag. X, 328 S). In: *Wahrheitstheorien. Eine Auswahl aus den Diskussionen über Wahrheit im 20. Jahrhundert*, ed. by G. Skirbekk, 189-223. Frankfurt a. M.: Suhrkamp (1977).
- 1976. *Vorlesungen zur Einführung in die sprachanalytische Philosophie*. Frankfurt a. M.: Suhrkamp.
- Uriagereka, J. 2002. *Derivations: Exploring the Dynamics of Syntax*. London: Routledge.
- Vallicella, W. F. 2000. Three Conceptions of States of Affairs. *Nous* 34, 237-57.
- 2002a. *A Paradigm Theory of Existence: Onto-Theology Vindicated*. Dordrecht: Kluwer.
- 2002b. Relations, Monism, and the Vindication of Bradley's Regress. *Dialectica* 56, 3-36.
- 2010. Gaskin on the Unity of the Proposition. *Dialectica* 64, 265-77.
- Verkuyl, H. J. 1993. *A Theory of Aspectuality*. Cambridge: CUP.
- Werning, M. 2005. Right and Wrong Reasons for Compositionality. In: *The Compositionality of Meaning and Content*, ed. by M. Werning, E. Machery and G. Schurz, 285-309. Frankfurt a. M.: Ontos Verlag.
- White, T. D., B. Asfaw, D. DeGusta, H. Gilbert, G. D. Richards, G. Suwa and F. Clark Howell 2003. Pleistocene Homo sapiens from Middle Awash, Ethiopia. *Nature* 423, 742-47.
- Whitehead, A. N. and B. Russell 1910-13. *Principia Mathematica*. Cambridge: CUP.

- Whiteley, C. H. 1951. The Idea of Logical Form. *Mind* 60, 539-41.
- Wiggins, D. 1984. The Sense and Reference of Predicates: A Running Repair to Frege's Doctrine and a Plea for the Copula. *The Philosophical Quarterly* 34, 311-28.
- 1997. Meaning and Truth-Conditions: From Frege's Grand Design to Davidson's. In: *A Companion to the Philosophy of Language*, ed. by B. Hale and C. Wright, 3-18. Oxford: Blackwell.
- Williams, D. C. 1953. The Elements of Being. In: *Principles of Empirical Realism*, 74-109. Springfield: Charles C. Thomas (1966).
- Wittgenstein, L. 1914-1916. *Notebooks 1914-1916*. Oxford: Basil Blackwell (1979).
- 1922. *Tractatus Logico-Philosophicus*. London: Routledge (1961).
- Zacks, J. M., N. K. Speer, K. M. Swallow, T. S. Braver and J. R. Reynolds 2007. Event Perception: A Mind-Brain Perspective. *Psychological Bulletin* 133, 273-93.
- Zalta, E. N. 1983. *Abstract Objects: an Introduction to Axiomatic Metaphysics*. Dordrecht: Reidel.