



Thermo-mechanical electricity storage

Elmegaard, Brian; Pedersen, Allan Schrøder; Petersen, Aksel Hauge ; Petersen, Tage; Reinholdt, Lars; Bang-Møller, Christian

Published in:
DTU International Energy Report 2013

Publication date:
2013

Document Version
Publisher's PDF, also known as Version of record

[Link back to DTU Orbit](#)

Citation (APA):
Elmegaard, B., Pedersen, A. S., Petersen, A. H., Petersen, T., Reinholdt, L., & Bang-Møller, C. (2013). Thermo-mechanical electricity storage. In H. Hvidtfeldt Larsen, & L. Sønderberg Petersen (Eds.), DTU International Energy Report 2013: Energy storage options for future sustainable energy systems (pp. 29-36). Technical University of Denmark (DTU).

DTU Library

Technical Information Center of Denmark

General rights

Copyright and moral rights for the publications made accessible in the public portal are retained by the authors and/or other copyright owners and it is a condition of accessing publications that users recognise and abide by the legal requirements associated with these rights.

- Users may download and print one copy of any publication from the public portal for the purpose of private study or research.
- You may not further distribute the material or use it for any profit-making activity or commercial gain
- You may freely distribute the URL identifying the publication in the public portal

If you believe that this document breaches copyright please contact us providing details, and we will remove access to the work immediately and investigate your claim.

DTU International Energy Report 2013

Technical University of Denmark



ENERGY STORAGE OPTIONS FOR FUTURE SUSTAINABLE ENERGY SYSTEMS

Edited by Hans Hvidtfeldt Larsen and Leif Sønderberg Petersen / DTU National Laboratory for Sustainable Energy / November 2013



ENERGY STORAGE OPTIONS FOR FUTURE SUSTAINABLE ENERGY SYSTEMS

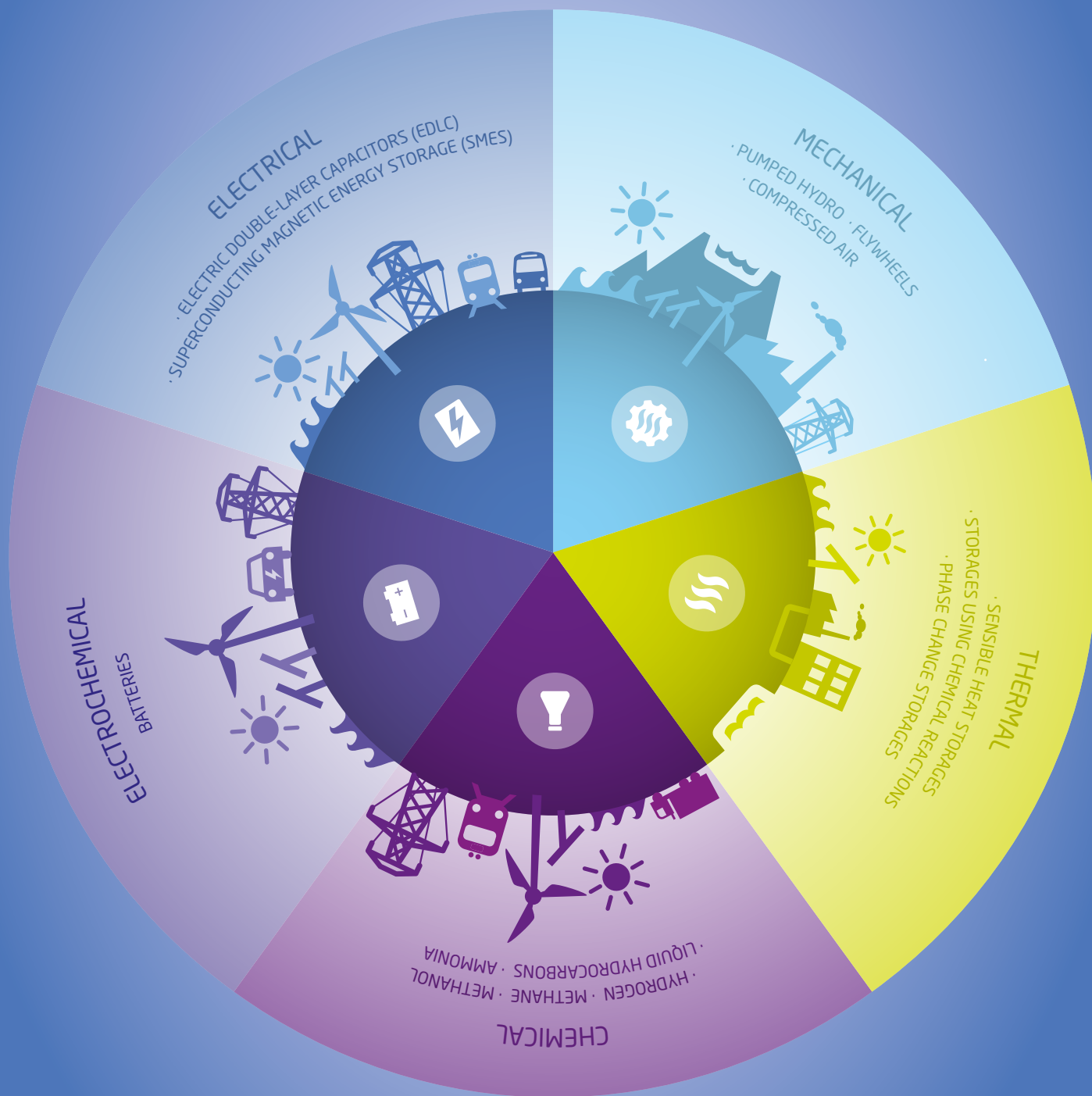

DTU International Energy Report 2013

Energy storage options for future sustainable energy systems

EDITED BY

Hans Hvidtfeldt Larsen and Leif Sønderberg Petersen, DTU National Laboratory for Sustainable Energy

REVIEWED BY

Professor Peter Hall, Department of Chemical and Biological Engineering, University of Sheffield, UK

EDITORIAL CONSULTANT

Charles Butcher, Science Journalist, UK

COPYRIGHT

Technical University of Denmark, November 2013

ISBN 978-87-550-3968-1

Contents

1	Preface	3
2	Summary and recommendations	5
3	Global energy development trends - Role of storage in future sustainable energy systems	6
4	Energy storage in the future energy system	12
5	Energy storage initiatives and strategies	18
6	Stochastic power generation	24
7	Thermo-mechanical electricity storage	29
8	Electromagnetic and electrostatic storage	37
9	Electrochemical storage: batteries	42
10	Chemical energy storage	47
11	Thermal storage	53
12	Storage in distributed generation systems	58
13	Grid storage and flexibility	64
14	Synthesis	72
15	Index	77
16	References	79
17	Recent volumes of DTU International Energy Report	87

Preface

One of the great challenges in the transition to a non-fossil energy system with a high share of fluctuating renewable energy sources such as solar and wind is to align consumption and production in an economically satisfactory manner. Energy storage could provide the necessary balancing power to make this possible. This energy report addresses energy storage from a broad perspective: It analyses smaller stores that can be used locally in for example heat storage in the individual home or vehicle, such as electric cars or hydrogen cars. The report also addresses decentralized storage as flywheels and batteries linked to decentralized energy systems. In addition it addresses large central storages as pumped hydro storage and compressed air energy storage and analyse this in connection with international transmission and trading over long distances. The report addresses electrical storage, thermal storage and other forms of energy storage, for example conversion of biomass to liquid fuel and conversion of solar energy directly into hydrogen, as well as storage in transmission, grid storage etc. Finally, the report covers research, innovation and the future prospects and addresses the societal challenges and benefits of the use of energy storage.

DTU International Energy Report series

The series deals with global, regional and national perspectives on current and future energy issues. The individual chapters are written by DTU researchers in cooperation with leading Danish and international experts.

Each report is based on internationally-recognised scientific material and is fully referenced. Furthermore the reports are refereed by independent international experts. Finally the reports are edited, produced and published in accordance with the highest international quality standards.

The target group is colleagues, collaborating partners and customers, as well as funding organisations, institutional investors, ministries and authorities as well as international organisations such as the EU, the IEA and the UN.

ELECTRICAL

Electromagnetic energy can be stored in the form of an electric field or a magnetic field, the latter typically generated by a current-carrying coil. Practical electrical energy storage technologies include electrical double-layer capacitors (EDLCs or ultracapacitors) and superconducting magnetic energy storage (SMES).

MECHANICAL

The most common mechanical storage systems are pumped hydroelectric power plants (pumped hydro storage, PHS), compressed air energy storage (CAES) and flywheel energy storage (FES).

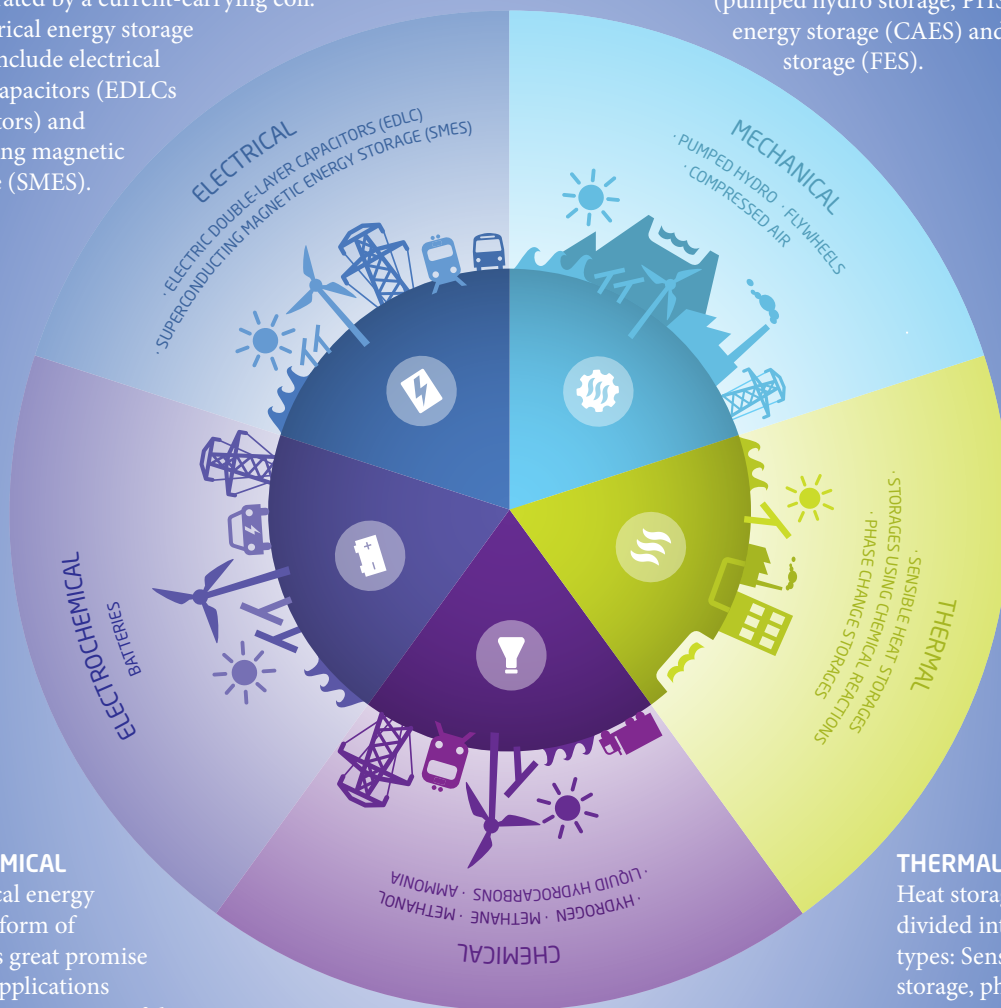

ELECTROCHEMICAL

Electrochemical energy storage in the form of batteries holds great promise in a range of applications which cover many aspects of the future needs for energy storage, both in Denmark and abroad.

CHEMICAL

Energy stored in chemical fuels can be used for power generation and for transport, since chemical fuels are readily converted to mechanical or electrical energy.

THERMAL

Heat storage can be divided into three main types: Sensible heat storage, phase change storage and storage using chemical reactions.

Summary and recommendations

Energy storage technologies can be defined as technologies that are used to store energy in the form of thermal, electrical, chemical, kinetic or potential energy and discharge this energy whenever required. Energy storage technologies and systems are diverse and provide storage services at time-scales from seconds to years.

One of the great challenges in the transition to a non-fossil energy system with a high share of fluctuating renewable energy sources, such as solar and wind, is to align consumption and production in an economically satisfactory manner. This Report provides convincing evidence that energy storage can provide the necessary balancing power to make this possible.

Energy storage systems can contribute to grid stability and reliability. Utilities can also employ them to integrate and optimise all types of renewable and distributed energy resources.

The investment costs of energy storage are considerable. However, these costs will partly be offset by the ability of energy storage to reduce the cost of upgrading the transmission and distribution infrastructure to keep pace with the expansion of the share of renewable energy.

Energy storage is currently the most expensive solution for balancing consumption and production, but this situation is likely to change as storage costs fall and emphasis on grid stability increases. Storage also brings the widest spectrum of benefits – which currently are only partly monetised – to the electricity system as a whole.

Improved access to clean and efficient energy services for the world's poorest people is a priority for both the affected countries and the global community. Storage technologies can potentially play an important role in this context.

Recommendations

To stimulate development in energy storage technologies and their integration in energy systems, a series of initiatives is recommended to be taken over the next two decades:

Research initiatives

- Since energy storage must be expected to be a cornerstone of future renewable energy systems, it should be supported as a separate field of research.
- Strong and focused support for materials R&D relevant to energy storage technologies should be prioritised.
- In the longer term, to realise a future 100% renewable-based energy system, research and innovation must ensure development of the flexibility and associated solutions needed to ensure a reliable and economic energy system.

Pilot and demonstration projects

- The increased research efforts should be accompanied by demonstration projects in grid integration of energy storage, thermal management and industrial waste heat storage, grid-connected battery storage, and heat storage (including underground technology).
- Demonstration of connections between grids, such as the power-to-gas concept in which electricity is converted to synthetic methane or hydrogen.

Market initiatives

- Design of market terms for integrating energy storage in electricity markets.
- Development of a market-based approach to the allocation of flexibility so as to provide flexibility in an economical manner.

System initiatives

- Sizing and positioning of storage in power systems should account for the variability and predictability of stochastic power generation, network topology and network usage, and the economics of storage operations.
- Regulatory settings should be developed to favour the effective coupling of the power, heat and gas infrastructures.

3

Global energy development trends – Role of storage in future sustainable energy systems

John Christensen, UNEP Risø Centre, DTU Management Engineering; Mark Radka, UNEP, Paris

Energy development trends

Energy storage is gaining prominence largely due to projected changes in energy systems around the world. Before diving into the technical aspects of the various storage technologies and energy systems changes, this section will therefore briefly discuss the underlying global trends in energy development and the major drivers for future energy development, such as:

- Climate change
- Energy security
- Green growth and job creation.

Improved access to clean and efficient energy services for the poorest people in the world is also a priority for both the affected countries and the global community. In this context storage technologies can potentially play an important role which will be addressed in a separate section.

Climate change concerns are usually presented in one of two ways. As a global issue, climate change can be seen in terms of the political target set by the Copenhagen Accord to limit the average temperature rise to 2°C by the end of the century. At the national level in terms of the need to address specific reduction targets for greenhouse gases (GHGs) for both the country as a whole and individual sectors of the economy.

Global energy demand and its associated GHG emissions continue to grow, while at national and regional levels there may be marked shifts in both supply and demand structures. The International Energy Agency (IEA) analysis from the World Energy Outlook 2012 [3] shows current and projected growth in primary energy demand according to three different scenarios (Figure 1). One reflecting a Business as Usual path (current policies), one assuming full implementation of already existing policies and the most ambitious one aimed at limiting annual global GHG emissions to reach a stabilization level of the concentration of GHGs in the atmosphere below 450 ppm (referred to as the “450 Scenario”). This level is normally associated with a 50% chance of staying within the political target of a max 2°C global temperature increase at the end of this century.

Even the 450 ppm scenario allows for considerable growth in world energy demand, so it is clear that the various scenarios assume marked changes in the sources of supply and strong assumptions about increased energy efficiency. A recent report by the IEA [5] states that the world is currently not anywhere close to the 450ppm scenario and current trends risk leading to average temperature increases in the order of 3.6 to 5.3°C, which according to the Intergovernmental Panel on Climate Change [7] and the World Bank [11] would have dramatic consequences for many parts of the world.

Energy security and green growth priorities are more diverse and harder to assess analytically. One key parameter for many countries is the import ratios of fossil fuels, and it is a distinct cause for concern in many OECD countries but also in major emerging economies like China and India. Figure 2 from the IEA shows the current and projected import ratios for oil and gas in the EU, the USA, Japan, China and India. While Japan’s strong import dependency has prevailed for years and is not expected to change, the trends for the EU, China and India are of concern to these countries. A very distinct exemption is the USA, which in just the last year has seen a remarkable shift towards energy independence thanks to domestic shale gas, which is expected to keep on growing, although predictions about shale gas resources are generally uncertain. At the same time the USA is increasing domestic oil production and putting in place stricter fuel efficiency standards, which together are projected to reduce oil imports significantly.

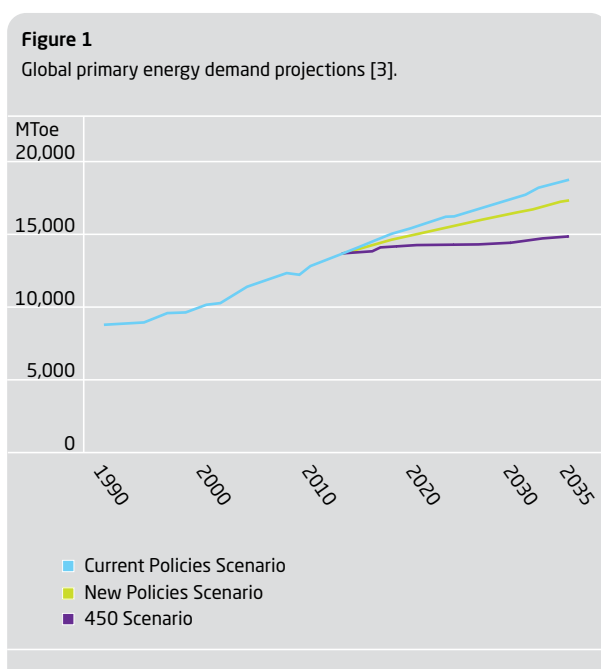
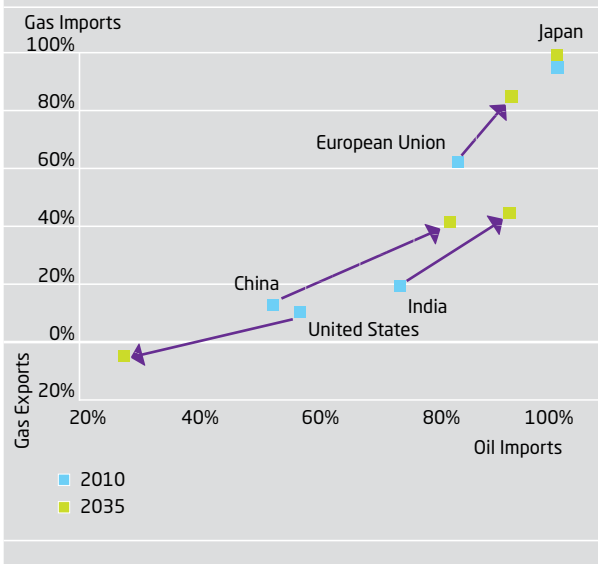

Figure 2
Net oil & gas import dependency in selected countries [1].



Changes in global distribution of demand and supply are also key factors when considering future security of supply and energy prices. Some of the macro level changes can be illustrated by the following Figure 1 from BP [1] showing how the global energy demand is gradually shifting from being dominated by OECD countries to gradually reflect the growing populations and increased economic activity in the developing world, dominated by the BRIC countries. Consumption by non-OECD countries has surpassed the

OECD some years ago and the projection indicates that non-OECD countries in 2030 will consume more than the double of the OECD countries. A single number exemplifying this trend is the IEA's projection [3] that by 2035 almost 90% of all Middle East oil production will be consumed in Asia, where China and India will surpass Japan and Korea, while the USA will import almost nothing from this region.

The right-hand part of Figure 3 shows another important trend: electricity is accounting for an increasing share of primary energy use. This is the situation in a large number of countries, both industrialized and developing, reflecting the versatility of electricity and the ease of transporting it over long distances.

Renewable energy expansion in electricity supply

Many countries have adopted policies that rapidly increase their share of energy from renewable energy (RE) sources, especially in electricity production. This reflects a combination of concerns about macro level energy security and climate change plus the fact that many renewable energy technologies have become much more competitive compared with fossil based production due to technological advancements and increasing fossil fuel prices. In many countries, national interest in green growth and employment opportunities is also a short-term policy driver for renewables expansion. This trend is illustrated by the quote below from a report on global trends in renewable energy investment [2].

Figure 3
(Left) Regional share of global energy demand, and (right) changes in primary energy use, projected to 2030 [1].

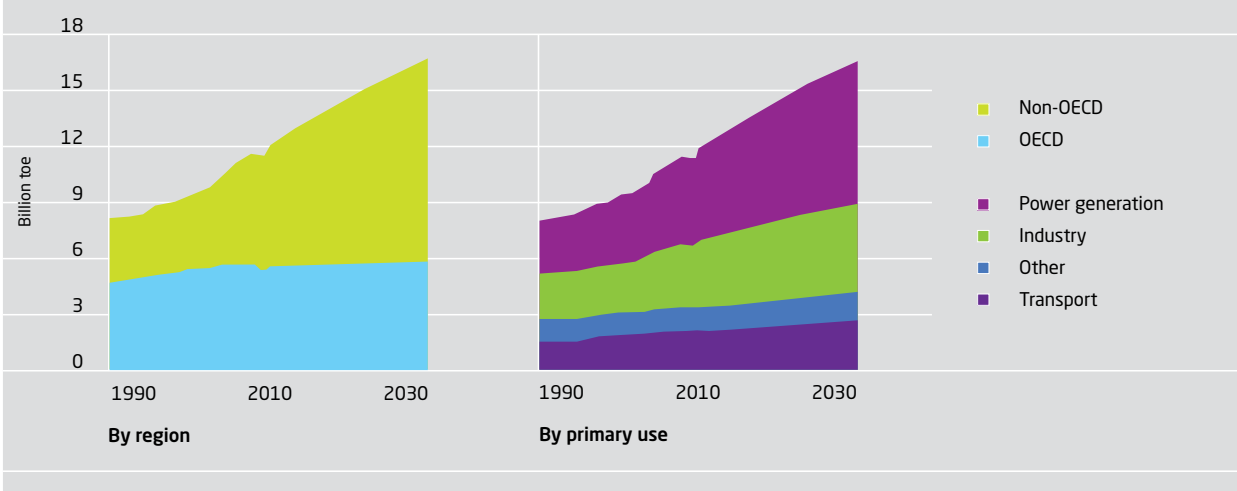

Renewable power, excluding large hydro-electric, accounted for 44% of new generation capacity added worldwide in 2011, up from 34% in 2010, and 31% of actual new power generated due to the intermittency of the wind and solar capacity added.

The proportion of power generated by renewables excluding large hydro rose to 6% in 2011 from 5.1% the previous year, the low figure reflecting the huge amount of non-renewable capacity already existing.

Gross investment in fossil-fuel generating capacity in 2011 was \$302 billion, compared to \$237 billion for that in renewables excluding large hydro.

However, if spending on replacement plant is excluded, and investment in large hydro included, then net investment in renewable power capacity was about \$262.5 billion, some \$40 billion higher than the same measure for fossil fuel.

GLOBAL TRENDS IN RENEWABLE ENERGY INVESTMENT 2012

Bloomberg New Energy Finance & Frankfurt School - UNEP Collaborating Centre

Expectations for the possible future pace of expansion of renewables in the power sector vary between different institutions and actors representing different energy sector interests. Figure 4, showing a set of different scenarios analyzed by REN21, illustrates the spread in projections.

The spread of estimates is considerable, but the trend is clear.

In spite of noticeable differences between the various scenarios, the overall trend towards a significantly larger share of renewables in power supply is quite uniform, with all scenarios expecting more than 50% renewables by 2050.

Figure 4
Projected share of Renewable Energy in electricity production in recent global scenarios [4].

Scenario	By Year	Electricity
By 2030-3040		
ExxonMobil Outlook for Energy: A View to 2040 (2012)	2040	16%
BP Energy Outlook 2030 (2012)	2030	25%
IEA World Energy Outlook (2012) "New Policies"	2035	31%
IEA World Energy Outlook (2012) "450"	2035	48%
Greenpeace (2012) Energy [R]evolution	2030	61%
By 2050		
IEA Energy Technology Perspectives (2012) "2DS"	2050	57%
GEA Global Energy Assessment (2012)	2050	62%
IEA Energy Technology Perspectives (2012) "2DS High Renewables"	2050	71%
Greenpeace (2012) Energy [R]evolution	2050	94%
WWF (2011) Ecofys Energy Scenario	2050	100%

Figure 5
Changes in power generation technologies for the world's main economic regions, 2010-2035 [5].

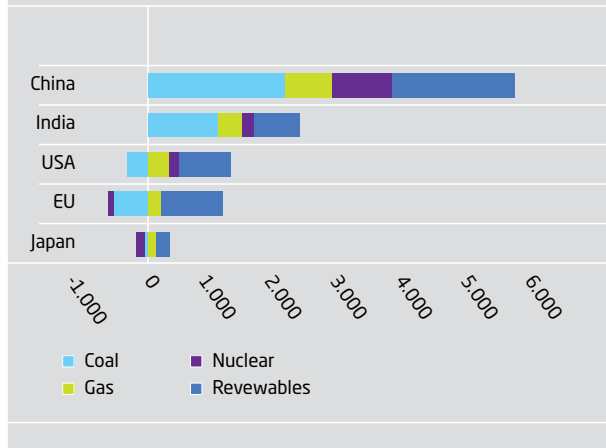

The short- and medium-term perspectives are more varied and evidently depend on the assumptions embedded in the different scenarios both about the rate and speed of renewable energy penetration and changes in global demand, as a result of very different expectations for efficiency improvements.

The IEA World Energy Outlook figures for 2035, disaggregated for some of the major economies and country groups (Figure 5), show that the global trend includes significant national and regional variations. For all the countries listed, however, the expansion of renewables will be very significant.

According to REN21 [9], renewables in 2012 produced approximately 21% of the world's power, with 16% coming from large hydro plants and a little over 5% from other renewable energy sources. Hydro will remain important in the global power production mix and will expand in some regions, especially Africa. But the major global expansion of renewable energy is expected to come from wind, solar and biomass technologies, with geothermal energy playing a smaller part. The actual expected shares for the different technologies vary between scenarios, but most studies expect that wind and solar power will approach or even overtake hydro over the next couple of decades. There will be significant regional variations, and the OECD countries will have the highest percentage of power based on renewables. In Denmark, for instance, wind energy contributes around 30% of the national power supply.

Addressing intermittency, variability and distributed generation

With this increasing share of renewable energy sources in the power systems around the world there is an increasing focus on how these new sources can be integrated and how electricity systems will gradually move from having a relatively few and large point sources to having a much more decentralised structure with potentially hundreds of sources with a significant geographical spread. IPCC in the special report on Renewable Energy Sources and Climate Change Mitigation [8] identifies three main characteristics that need to be taken into consideration in the process of integrating increased RE based power supply:

- Variability and predictability (uncertainty), which are important for scheduling and dispatch (continuously optimizing) operations in the power system
- Location, relevant for the network design
- Capacity factor, capacity credit and power plant characteristics, which are important when comparing the RE sources with thermal fossil or nuclear plants.

Common to most renewable energy sources is that their location is resource dependent and transmissions systems need to be developed to accommodate this constraint. Variability and predictability on the other hand varies significantly between the different renewable sources. Large-scale hydro with reservoirs, geothermal and biomass combustion plants generally have a high degree of predictability and dispatchability. PV and wind systems have a higher degree of variability both short term and seasonal and therefore are only partially dispatchable.

With the expected expansion of solar and wind based power generation described above, the major challenge will therefore be to develop the national and regional grid structures and back-up systems to ensure that security of supply remains high in spite of increased variability of part of the supply sources. Solutions will include a number of different options depending on local circumstances, flexibility of the existing grid structure and possible inter-connections to other national or regional power systems.

The IEA has in the Energy Technology Perspectives report [4] analysed various approaches for dealing with electricity system development. The analysis shows that storage has potentially an important role to play, but many of the relevant technologies are not fully mature and cost effective, so whether storage will be a niche application or a game changer will depend strongly on the rapid development of a number of the most promising technologies. A summary

of the IEA findings are included in Figure 6 where the different options for addressing increased variability and more limited dispatchability are compared.

Overall system design including enhanced interconnections regionally, efficiency improvements and regulated consumer behaviour are other measures which may either be in competition with storage options or depending on design make storage more attractive.

The IPCC Special Report on Renewable Energies and Climate Change (SRREN) also provided a detailed analysis of integration options, examining improved infrastructure, increased generation flexibility, demand-side measures, improved operational and planning approaches – including short term forecasting to increase predictability – and energy storage. As with the IEA study summarized in Figure 6, the IPCC does not offer any conclusions or recommendations about what may be the “best” approach, instead it is stressed that RE can be integrated into all types of electrical power systems and the challenges will relate to a number of factors including the current system design, demand patterns, generation mix, geographical location of renewable energy sources, or amount to be integrated etc.

These factors will all be discussed further in the following chapters, in terms of both the Danish energy system and the status and potential of individual storage technologies. The discussion here focuses on electricity systems, since this is the major issue worldwide, but at national and regional levels the ability to use storage in heating and cooling systems may also be important.

Similarly the specific role that renewable energy sources and storage technologies may play in relation to decentralised power grids or off-grid applications, typically in developing countries and island communities, is in the global context a niche application, but as it may have significant implications for the more than 1 billion people without electricity access, it will be discussed briefly in the next section.

Autonomous electricity grids

Autonomous electricity systems are typically relative small scale and used in remote locations where central grid expansion is not economically viable or technically feasible or on small islands with no outside connection. In principle, the integration of renewable energy into autonomous systems faces issues similar to those that relate to large-scale integration, as discussed above. With the technical supply options typically being restricted and local manage-

Figure 6
Technology choices in electricity system flexibility [4].

	Application by response timeframe										Discharge time/ duration
	Hours					Minutes			Seconds		
	Energy arbitrage	Generation capacity deferral	(T&D) investment deferral	Congestion management	Voltage support	Black start	Spinning reserve/load following	Renewable ramp reduction	Regulation	Power quality	
Generation											
Conventional generation		M	M		M	M	M	M	M		> Hours
Generation re-dispatch			M	M							> Hours
Hydro generation			M	M	M	M	M	M	M		> Hours
Distributed generation					D	D	D	D	D	D	Minutes/hours
Demand response											
Industrial	M	M		D	D		M				Hours
Commercial/residential				D	D	D	D	D	D	D	Minutes/hours
Network/interconnection											
Interconnection	M	M	M	M		M	M	M			Hours
Transmission	M	M	M	M	M	M			M	M	> Hours
Static compensation devices			M		M						> Hours
Power electronics										M	Seconds
Storage technologies											
Pumped hydro	M	M	M	M	M	M	M	M	M		Hours
CAES	C	C	C	C	C	C	C	C			Hours
Flywheel						D	D	D	D	D	Minutes
Super capacitor										D	Seconds
Battery technology						C/D	C/D	C/D	C/D	C/D	Hours/minutes
Operational measures											
Protection measures			M	M							Seconds
Dynamic line rating			C	C							Hours
Forecasting	M										Hours
Technology maturity key: M Mature C Commercial D Demonstration											

ment capacity of integration issues weaker, the role of storage is normally larger than what is the case in the centralized systems at present.

In many parts of the world many small-scale systems are powered by diesel but with the increased fuel and transport costs, interest in using locally available renewable sources has increased significantly in many countries. Off-grid electrification based on renewable sources has been dominated for the last decade by small-scale solar systems for individual households and institutional buildings, plus lanterns and other direct-use appliances. While these systems have provided useful energy services typically for lighting and communication there are clear limitations on the level of energy they can deliver. Combining the small scale supply systems in mini grids does, however, provide opportunity for more robust systems with opportunity to rely on multiple sources. Such a move will also provide opportunities for increased energy provision to cover cooking and productive uses and in many cases facilitate a shift from direct current to three phase electricity required for power intensive devices. The interest in mini-grid systems with RE supply has therefore been increasing in many developing regions stemming both from interest in substituting expensive diesel in existing local systems and moving from individual household PV systems to integrating these into a community level system possibly in combination with other local RE sources.

These new mini-grids are often based on significant amounts of intermittent generation (mostly PV but also wind and run-of-river small hydro). The resulting limited dispatchability. It is usually not economically feasible to install the sophisticated supervisory control systems used in central grids or to pay for network operators to manage the system on a continuous basis. Energy storage is therefore often included for stabilising power supply as the fluctuations in customer loads and variability in generation will affect small and weak system more direct than is the case for large integrated systems. Several storage options may be relevant but so far battery systems are dominating this market [6], but as the experiences vary between countries and local systems and it is still an emerging market where other storage technologies may become relevant with further commercialisation. This will be further discussed in the rest of this report.

Conclusions and reflections

1. Energy security and climate change remain the major driving factors for energy policy in most countries around the world
2. GHG emissions from the energy sector is still increasing and if the political 2 degree target shall remain achievable this situation needs to change rapidly
3. A gradual transition towards increased use of renewable energy sources has started especially in the power sector and all projections expect between 50 and 100% of power supply in 2050 will be based on renewable energy
4. Variability and intermittence aspects associated with especially large shares of wind and solar power will need to be addressed. Several options exists and the role of storage will depend on several factors like overall power system design, increased ability to project short and medium term variations, demand flexibility etc. plus evidently on further technical improvements for most storage technologies and associated cost efficiency improvements.
5. Storage technologies are likely to play a distinct role in the increasing number of RE based mini-grid systems being established in the off grid areas of developing countries and for isolated island systems.

4

Energy storage in the future energy system

Lars Henrik Nielsen, DTU Management Engineering; Tom Molinski, Manitoba Hydro, Canada

Storage needs are much an overall energy system issue and trade-offs exist between future storage needs and other system development options.

To eliminate greenhouse gas (GHG) emissions and improve energy security, Denmark is phasing out fossil fuels: from the power system by 2035 and completely by 2050. Renewables will form the basis of the future Danish energy system, aided by energy efficiency improvements and new enabling technologies.

Energy systems that make large-scale use of wind power and other intermittent renewable energy sources (RESs) have limited capacity for balancing and regulation. It can therefore be expected that system balancing technologies, including energy storage, will become increasingly important in the future. By synchronising energy supplies and demands, energy storage can improve system reliability, and by enabling the large-scale use of renewables it can improve energy the security of energy supply.

The term “storage” covers a wide range of technologies, many of which are essential to the working of today’s energy systems: storage is an integral part of our systems for power, district heating, natural gas, biogas and transport. The interplay between these storage elements, with their different characteristics, creates a balance which underlies the effective functioning of our energy systems.

Energy storage, however, is only one of several ways to promote system balance and reliability in electricity systems. The following sections focus on how storage interact and competes with other options.

Heat and hydro storage in the present power system

Two well-known storage elements of the existing energy system are heat storage in combined heat and power (CHP, or cogeneration) systems, and water reservoirs in hydro power systems.

A CHP plant must meet demand profiles for both heat and electricity. This is often achieved by including heat storage, reducing the operating constraints on the power side of the system and allowing it to be dispatched as required by the electrical needs. Heat storage capacity thus alleviates regulation constraints that otherwise may build up in the power system.

Hydro power systems that include reservoirs can supply storage services on timescales ranging from seconds to months, or even years, depending on the site in question. This form of storage can meet demand peaks, balance variations in other forms of generation, or stabilise output from

the hydro plant as rainfall varies between seasons or consecutive years. This is especially valuable in systems that are otherwise characterised by low flexibility.

Strengthening inter-regional power transmission capacity will allow for more efficient use of existing storage, production and regulation capacity. Interconnecting regional power grids to form larger systems yields mutual benefits (to varying extents), such as covering local imbalances and improving security of energy supplies, at the expense of increased investment and greater reliance on grids. The expanded electricity markets will permit regulation exchange among subsystems and regions.

The Scandinavian power system is an example of this. The Norwegian power system is dominated by hydro power, while Denmark has mainly thermal power plants. In dry years, when hydro power is in short supply, Danish thermal power can help to conserve water in Norway; in wet years, excess Norwegian hydro power can be exported to Denmark and beyond. This is an example of mutual energy balancing on a timescale of years.

Large-scale inclusion of uncontrolled variable power production, notably wind and solar plants, requires imbalances between demand and production to be levelled out by other parts of the power system, on either the supply or the demand side. In the Scandinavian power system, reservoir-based hydro power supply such regulation on a large scale, - e.g. to the Danish system.

System integration, reinforced grids and gas storage

The demand for storage much depends on how technologies interact in energy systems, and the need to introduce or extend storage capacity is a function of how the overall energy system is configured. Appropriate or “smart” planning and configuration of an energy system may minimise the demand for conventional storage and regulation capacity, and reduce overall system costs.

An example would be the use of PV alongside wind power in Denmark. Compared to wind alone, the production profile of wind and PV in combination is a better fit to the existing electricity demand profile. Adding PV could therefore reduce the need for backup energy and regulation capacity.

More power transmission capacity linking different geographic regions will likely level out wind power produced in the larger interconnected system, and may reduce the

need for backup power and storage. And enlarged electricity markets, due to increased interregional transmission capacity, can be instrumental to distribute the increased available regulation assets to the entire market area.

Very large gas storage facilities may form an important part of future regional energy storage needs, for instance in relation to biomass gasification or e.g. in case of a widespread use of hydrogen as an energy carrier. Denmark currently has two large storage facilities for natural gas: the Stenlille aquifer and the salt dome caverns in Lille Torup (Figure 7).

The Danish energy system is connected to the interregional European NG-grids and Danish natural gas fields in the North Sea have been in operation for more than 30 years. In the future, depleted gas fields may constitute a huge storage potential.

The Danish NG pipeline system covers most of the country, and may thus contribute to level out geographic (regional, national and even local) energy system imbalances. Such an extended network for gas is complementary to the power grid and may allow for distributed renewable power developments and also attain high security of energy sup-

plies. Thus system developments of geographically distributed power production based on renewables and sustained by gas supplies, become options.

Emerging options for distributed electricity generation, storage and flexible consumption

Demand-side management (DSM), which mobilises flexibility in energy consumption, is another important technical regulation option. As a way of balancing energy systems, demand-side flexibility is equivalent in its effects to conventional supply-side regulation options at the corresponding time scales. Demand-side flexibility aggregated into larger-scale regulation assets are essential to future smart grid and energy system developments. DSM in combination with supply-side management may provide flexible and robust systems. An example is heat pumps that include heat storage, which can be very efficient in providing flexibility to potentially constrained CHP systems.

A virtual power plant (VPP) is a group of smaller generators or storage systems, possibly widely distributed, which is able to act as a single unit via power electronics, IT and

Figure 7

Stenlille Gas Storage Facility is an aquifer storage facility. The gas is stored in water filled sand beds which lie approximately 1,500 metres below the ground surface. Over the sand beds there are approximately 300 metres of gas tight clay beds, which have a slightly domed structure forming a basin. The clay layer ensures that the gas does not penetrate up to the surface. Source: DONG Energy.

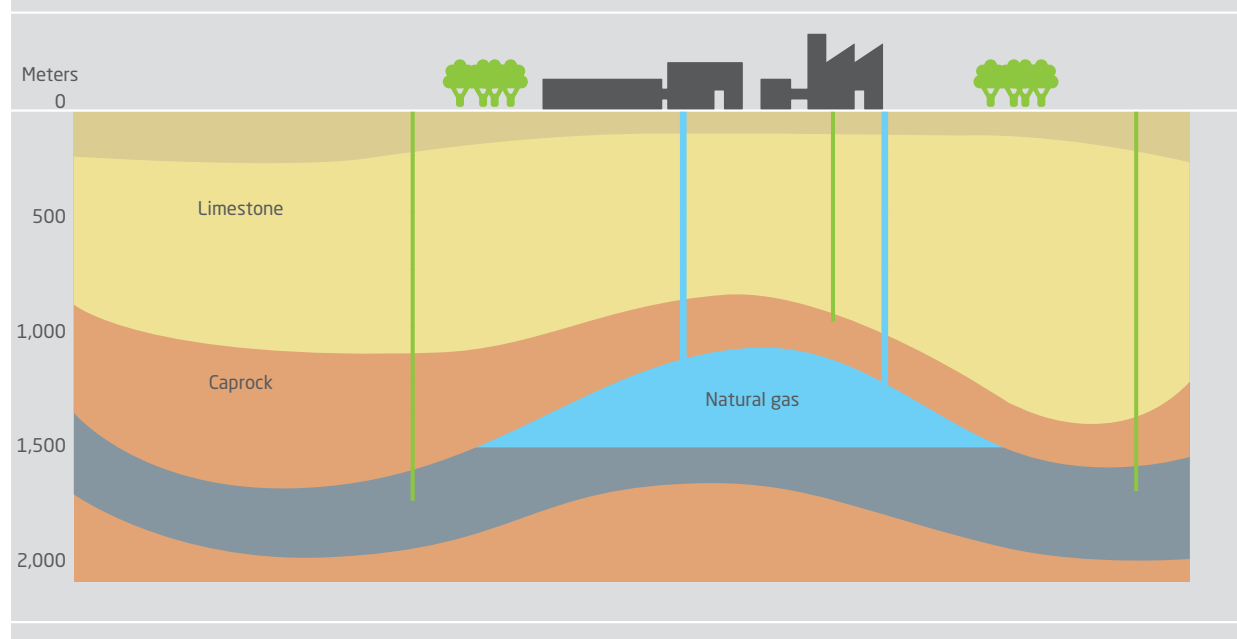

communication systems. One example is a VPP based around the batteries in a fleet of electric vehicles.

Electric vehicles (EVs) and plug-in hybrid electric vehicles (PHEVs) are potential game-changers in future power systems due to their great flexibility in interacting with the power grid. Properly organised, a fleet of EVs can constitute a large and very flexible power store over timescales from seconds to hours. For instance, a future fleet of 1 million EVs, each grid connected at 10 kW, could transfer 10 GW to or from the Danish grid. This may be compared to the Danish peak power demand of about 6.5 GW in a country of around 5.5 million people.

Future EV batteries with higher capacities than those of today, and increased numbers of EVs, could extend the regulating ability of a vehicle fleet to higher peak capacity and longer timescales. "Second life" EV batteries when no longer useful for transport applications may furthermore be aggregated into stationary units dedicated to power system regulation.

Another example of a battery-based VPP is a collection of uninterruptible power supply systems (UPSs). These small autonomous often battery-based systems provide reliable power to IT systems, hospitals and other applications where even a short power interruption is unacceptable. Since UPSs are idle for much of their lives, they could in principle be designed to provide regulating services to the grid without compromising their prime purpose.

Wind and solar power based power systems and other variable power supplies, with limited regulation capability, may benefit from these potential power balancing sources.

Storage to improve energy security

Besides handling natural fluctuations in demand and supply, the overall energy system must be able to cope with the risks of failing components and maintain the desired levels of reliability, robustness and security of supply.

Strengthening and interconnecting regional power grids can bring benefits in terms of system balance, power support and consequently also security of supply. However, dependence on enlarged grids may also increase exposure to the risk of grid failures.

Energy security may become compromised in large interconnected systems where the consequences of a failure may propagate over long distances. And the economic consequences to society of large-scale power failure may be huge. For many businesses, though the actual cost of energy makes up only a small part of the budget, a power cut lasting more than a few minutes may effectively shut down the operation.

To reduce the risks and consequences of grid failure it would be helpful if large grids could be designed with the ability to split into smaller autonomous subsystems or even micro-grids. The ability to isolate sections of the grid following a fault could reduce the risk of country-wide or regional blackouts.

Smart grids able to split into stand-alone sections may require considerable reserves and storage services may be in high demand, especially when intermittent renewables account for a large fraction of the generating capacity. Further investments in generating capacity may be needed to allow such grid sections to operate autonomously for a sufficient period of time.

Future demands for power regulation are expected to increase due to large-scale integration of fluctuating generation from wind and solar power plants. The actual storage requirement will, however, depend on a number of factors that together will shape our future energy systems.

Future electricity grids, for example, are likely to cover wider geographical areas. As well as the commercial benefits of expanded trade, competition and flexibility in siting power generation units, these larger grids may support the development of new markets in energy flexibility, storage and regulation, taking advantage of increased spare capacity on both the supply and the demand sides.

Multiple options and consequences

From the above it is seen that considerable untapped power regulation assets exist in conventional power systems, on both the supply and the demand side. Such potential regulating capacity may not be economic to exploit in today's power systems, typically because conventional power systems already provide ample regulating capacity. In future systems that rely increasingly on renewables, however, regulation assets may be in demand, encouraging untapped regulation capacity to find a market.

Figure 8

Operational benefits monetising the value of energy storage [1].

Figure 8 shows the many ways in which energy storage can supply quantifiable benefits to future smart power grids. These benefits span a wide range of capacities, power outputs and timescales, and cover the spectrum of power users, carriers, generators and regulators. In addition, demand-side management and virtual power plants - two options for mobilising latent flexibility in present and future energy systems - may supplement conventional storage solutions. New solutions may arise through integration of the power, heat, gas and transport sectors.

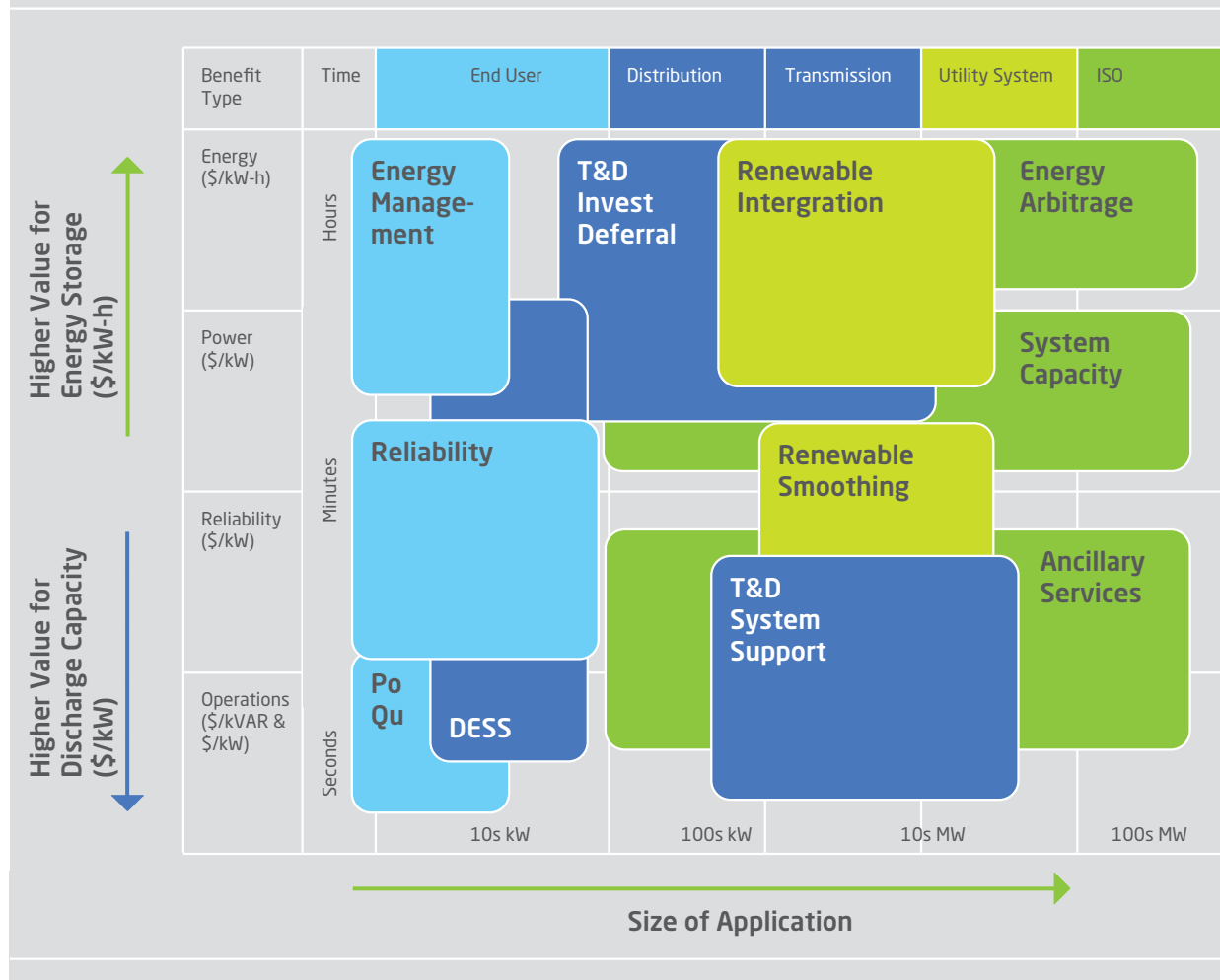

Demands for storage and regulation services can be met by diverse and competing means, not all of which involve particular storage technologies. These approaches may interact, have multiple consequences for energy systems, and may affect many stakeholders (Figure 8 and Figure 9).

Potential benefits of storage and regulation, however these are achieved, go beyond support for expanded renewable generation to include improved system operation, grid stability and reliability. New storage and regulation capacity

may furthermore make it possible to postpone costly investments in transmission and distribution capacity.

Thorough economic studies are important in untangling the system-wide consequences of different approaches to storage and regulation. A proper analysis of the consequences – for individual stakeholders and society as a whole – can require detailed modelling of planned developments and scenarios.

Table 1

Energy storage for utility transmission and distribution grid support. The megawatt- and kilowatt-scale energy storage systems listed here have the potential to affect areas including transmission and distribution substation grid support, peak shaving, capital deferral, reliability and frequency regulation [1].

Technology option	Maturity	Capacity (MWh)	Power (MW)	Duration (hours)	% Efficiency (total cycles)	Total cost (\$/kW)	Cost (\$/kWh)
CAES (aboveground)	Demo	250	50	5	(>10,000)	1950-2150	390-430
Advanced Pb-acid	Demo	3.2-48	1-12	3.2-4	75-90 (4500)	2000-4600	625-1150
Na/S	Commercial	7.2	1	7.2	75 (4500)	3200-4000	445-555
Zn/Br flow	Demo	5-50	1-10	5	60-65 (>10,000)	1670-2015	340-1350
V redox	Demo	4-40	1-10	4	65-70 (>10,000)	3000-3310	750-830
Fe/Cr flow	R&D	4	1	4	75 (>10,000)	1200-1600	300-400
Zn/air	R&D	5.4	1	5.4	75 (>4500)	1750-1900	325-350
Li-ion	Demo	4-24	1-10	2-4	90-94 (>4500)	1800-4100	900-1700

Market development

Mobilising untapped assets in regulation and storage may require changes in the power markets. Markets should be able to monetise existing flexibility in power systems and prompt investment where necessary to increase the supply of storage and regulation capability. This may result in the emergence of new actors, perhaps focusing on particular untapped assets.

Examples include owners of heat pumps and electric vehicles, who could offer commercial storage and regulation services geographically dispersed across the power system. Existing power markets may expand to support certified actors marketing system flexibility – via both new and existing, untapped, means – to distribution system operators (DSOs) and transmission system operators (TSOs). Smart metering and price signals may help distributed (and often small-scale) storage and regulation assets to reach the market.

Storage can operate on both the demand side and the supply side of energy systems. Demand side flexibility solutions may deliver fast regulation benefits, and extend untapped assets at the lower time scales for use by the system operator. At the supply end, within the portfolio of conventional power companies, smaller scale and dispersed storage and regulation options may make its way to the market. It may be relevant to modify market structures so as to create broader access to untapped flexibility in the system as a whole (including demand-side management, UPSs, virtual power plants and electric vehicles).

System flexibility and efficiency may be increased by improving structures being able to monetise these assets in the overall system.

Storage technologies are diverse, yielding their services at power ratings from kW to GW and over periods from seconds to months or even years (Figure 9 and Table 1). Storage systems and power regulation markets operating on a timescale of hours will be especially important for the large-scale integration of fluctuating renewable power sources with limited regulation capability.

Figure 9

Energy storage technologies classified according to storage capacity and operating timescale [1].

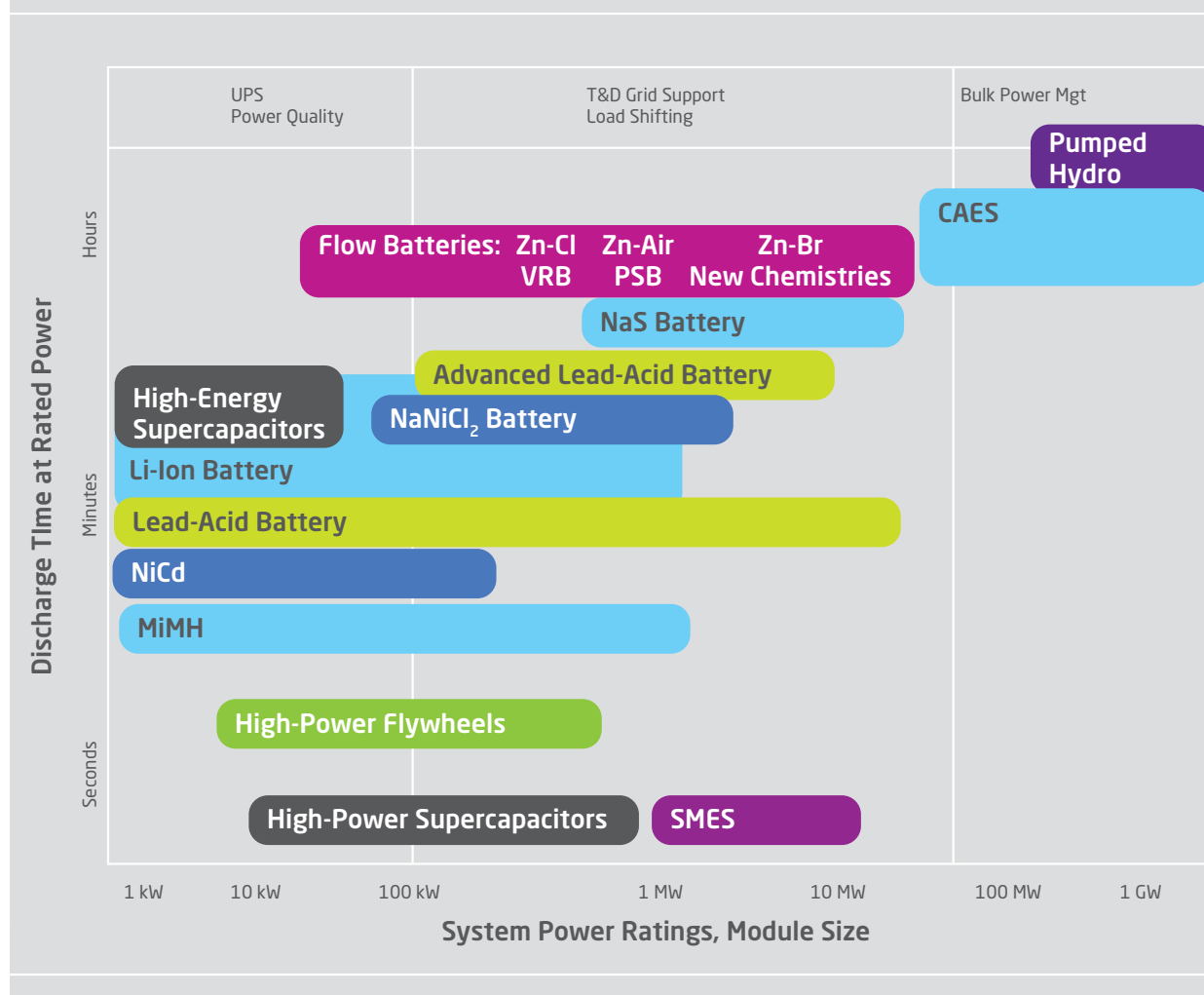

Conclusion

The requirements for storage are to a large extent an issue for the overall energy system, and trade-offs exist between future storage needs and other system development options.

Hydro power reservoirs and heat storage are widely used in to-day's energy systems. In the future, concepts such as smart grids, demand-side management and virtual power plants – all ways of mobilising latent flexibility – may extend the options for storage and balancing. New solutions may combine options across the power, heat, gas and

transport sectors. And as physical or virtual storage capacity increases, new market mechanisms able to mobilise such flexibility will become increasingly important.

5

Energy storage initiatives and strategies

Rainer Saliger, Siemens AG; Allan Schrøder Pedersen, DTU Department of Energy Conversion and Storage

Strategic planning of energy storage in the future sustainable energy system

During the coming decades the energy landscape in Europe will be increasingly dominated by primary supply from renewable sources, as decided by the governments of the EU member states and the European Commission itself. However, wind and solar power are inherently variable and cannot be dispatched like the conventional, fossil energy sources we have relied on for more than a century. These uncontrollable renewable sources will pose severe problems in terms of the relative timing of supply and demand.

In the worst case, a situation with 100% renewable energy will be characterised by serious mismatches: sometimes far too much power will be available, yet at other times there will be drastic shortages. Meeting our renewable energy targets thus requires shifting part of the excess generation to other time periods. To address these problems, the European authorities responsible for planning the future energy system are focusing their attention on a series of technical steps:

Energy storage is currently the most expensive solution, but this is likely to change as new technology reduces costs, while emphasis on grid stability makes these costs easier to justify. Storage also brings the widest spectrum of benefits to the complete electricity system; at present these benefits are only partly monetised.

Flexible conventional backup power plants, notably gas turbines and gas or diesel engines, fit very well with fluctuating renewables. They can only fill the gaps in power supply, however. They cannot solve the problem of oversupply, and they still emit CO₂ if powered by fossil fuels.

Demand-side management (DSM) is often the first and cheapest way to cope with variable renewables. "Classic" DSM has been used for a long time to manage consumption by factories and other large users. More recently, new types of DSM have emerged to suit private households. Examples of the latter include tariffs which vary with time or market price, and the ability of households with their own PV generation to adjust their consumption depending on how much power they are producing. Although DSM is conventionally thought of as a way to optimize power demand, a system that converts electricity to heat can also be used to absorb excess wind power. With the addition of heat storage, the same system can then reduce power demand at times of low wind production.

Improved electricity transmission and distribution capacity are today the second-highest priorities behind DSM.

Extensions to the distribution system go along with the trend towards decentralised supply structures, while investments in transmission grids aid long-distance transport of fluctuating renewable power to balance over- or under-supply.

Timeline for energy storage within the electricity grid

Several attempts have been made to predict when energy storage will become an inevitable requirement.

Relative to total generation, 40–50% of fluctuating renewable energy is sometimes considered the limit that can be handled in a conventional electricity system without dedicated storage [1]. Europe as a whole is still a long way from this limit: currently 20% of electricity production in the EU comes from renewables [2], and as well as wind and solar power this includes the more stable, predictable and storable resources like biomass, waste and hydro power. On the other hand, certain regions of the EU – notably Denmark, north Germany and Catalonia – already have quite high proportions of renewable electricity and are doing well without dedicated local storage.

However, these regions have good electrical connections with surrounding areas which serve as buffers. In Denmark, for example, about 30% of the electricity supply was generated by wind turbines in 2011 [3], but it can be argued that this high level of wind power is facilitated by Norwegian hydro power, which acts as a buffer for Danish wind production. Thus the 30% figure for Denmark does not prove that another country could achieve the same amount of wind power without storage.

In any case, the frequency and duration of periods requiring special measures to stabilise the grid depend to a considerable extent on local grid quality (for example, tolerance to voltage variations, reactive power compensation needs and short-circuit capability) and the strength of connections to neighbouring regions. There are extensive plans to expand the European electricity transmission grid [4], though these are unlikely to solve all future problems and a balance based on economy and feasibility of different solutions must be set.

At the moment, much of the balancing capacity needed to stabilise the grid comes from conventional thermal power plants burning fossil fuels. As these are increasingly phased

out in parts of Europe, however, the ancillary services they now supply (e.g. frequency and voltage control) will not be available for grid stabilisation to the extent we have been used to. At the same time, the presence of a high level of wind and solar generating capacity that relies on power electronics (inverters) to connect to the grid will tend to create problems with grid stability and lack of short-circuit capability.

Energy storage is an option in tackling these issues, and in fact a recent publication [5] concluded that the delivery of ancillary services will become the first commercial application for new energy storage technologies. (It should not be forgotten that an older form of storage, pumped hydro power, is already used commercially in many places in Europe serving this specific purpose among others – see also below.)

Europe's existing grid architecture was historically constructed for one-way supply of electricity from central generators to decentralised users. Such a system reaches its limits with high levels of renewables because most small

renewable generators connect at medium (below 72 kV) or low (below 1 kV) voltages, right down to 220–240 V in the case of household PV. As the distribution grid reaches its limits, short-term, fast-reacting storage devices like batteries will help consumers maximise the fraction of their PV generation that they are able to use locally. With storage times typically up to 4 hours, such systems will allow distribution grids to operate autonomously for part of the time. This application of energy storage is already beginning to find commercial application but economy is still uncertain; Figure 10 shows an example of such an installation.

Over the next 10–20 years large-scale energy storage is very likely to become an integral part of the energy system, used for both short-term time shifting (energy arbitrage) and seasonal storage. A good example of the latter is thermal energy storage: heat collected in the summer is stored for use during the winter.

Figure 10

Siemens has commissioned a 300kW Li-Ion battery storage system as one component of a Smart Grid project in Southern Germany where the 2500 people community generates with renewables 3 times the electricity it consumes. [6].



Storage linking different energy sectors

Energy storage is likely to play an important role in inter-linking the various sectors of the energy system: power, gas, heat and transport. This role is important because it adds flexibility and robustness to the entire system, while also securing efficiency in terms of economy and resources.

In the short term (within the next 10 years), cross-sector energy transfer will take place mainly through the transformation of electricity into heat (see the discussion of demand-side management above), plus maybe to some extent the use of electric vehicles for mobility. Heat storage has considerable potential to integrate large amounts of wind or solar power by storing heat when renewable generation is high, to be used subsequently in periods of low renewable production.

Converting electricity to synthetic methane – the power-to-gas concept (see Figure 11 and the following section) – is a way to link the electricity and gas systems. This tech-

nology would let us continue to use gas even when supplies of natural gas have been exhausted, and could take advantage of the large gas storage facilities existing in many European countries. It would also allow the continued use of the extensive and more or less depreciated European natural gas distribution infrastructure, plus gas-fired boilers, turbines, heaters and ovens in households and industry.

Last but not least, the goal of a fossil-free energy supply for Europe means that transport too must ultimately rely on renewable sources. Transport accounts for about 30% of the total European energy demand; storing this much energy from wind and solar in forms suitable for mobile applications will require a substantial R&D effort for a considerable number of years yet. Effective and economic renewables-based transport is probably the most challenging new application for energy storage. It is likely to be several decades before we see a complete transformation of vehicles, trucks, ships and aircraft to renewable energy.

Figure 11

How different sectors of the energy system can be interconnected via electrolysis/power-to-gas [7].

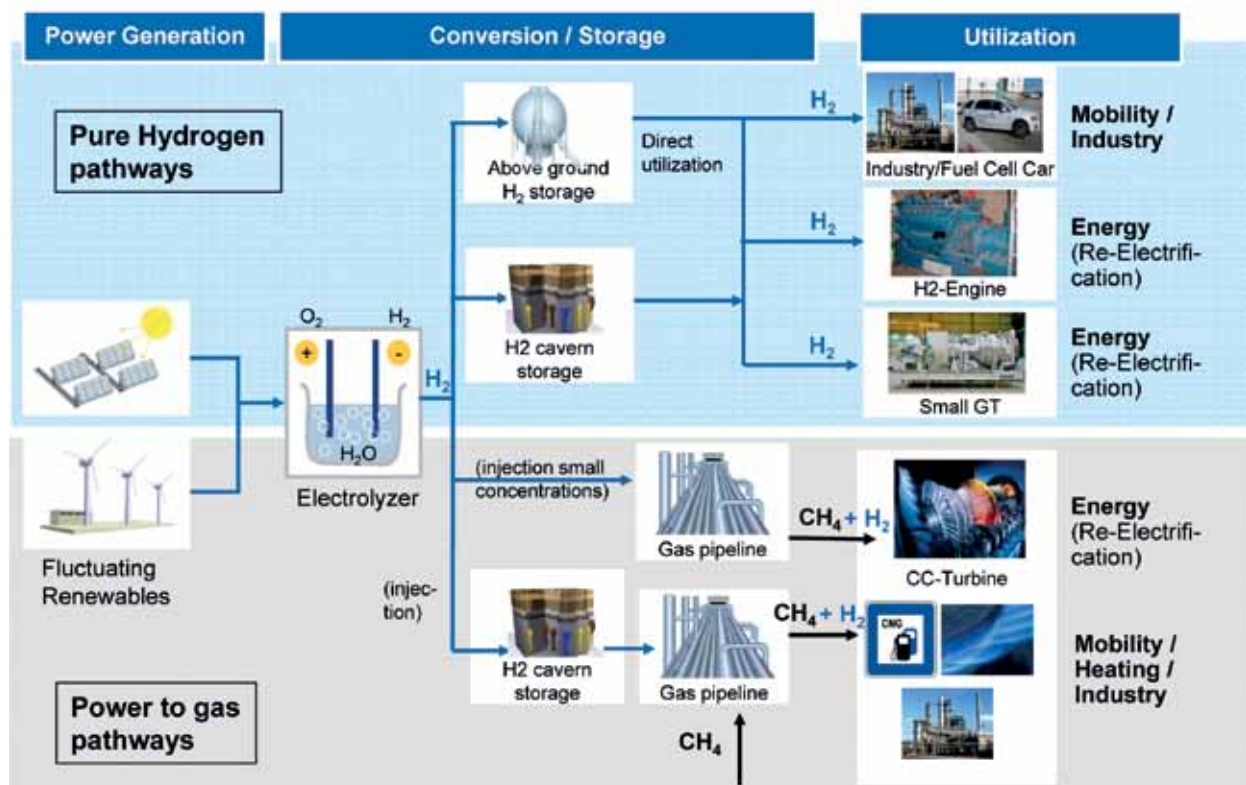

Energy storage activities and trends in Europe

With the prominent exception of pumped hydro (see below), energy storage activities in Europe are currently at pilot or demonstration plant scale, or even still in the laboratory. Large-scale energy storage (GW) has not yet been realised. However, joint European research plans as well as national plans within EU member states clearly show that energy storage is considered an essential element of the future energy infrastructure, and must be developed now so that it is available when market demand emerges.

The following subsections outline the most commercially advanced energy storage technologies, with a focus on Europe. Not included here, though discussed in other chapters, are storage technologies designed to operate over very short timescales, such as superconducting magnetic energy storage (SMES), flywheels and ultracapacitors. Although these have the potential to improve power quality in regions with high shares of fluctuating renewables, unlike the technologies discussed here they would never be able to help transform our energy systems towards very high shares of fluctuating sources.

Pumped hydro storage (PHS) has been used commercially as a grid component for almost a century and accounts for 99% of the world's 140 GW of installed electricity storage capacity. The market for new PHS systems is quite significant, with 6 GW being added every year, of which 1.5 GW is in Europe (Figure 12).

Despite being a mature technology, PHS still holds considerable potential for improvement. The main areas for development are to increase the range of heads (water lev-

Figure 12

Pumped hydro storage facility in Spain illustrating the topographical requirements for traditional PHS installations [9].



els) over which PHS can operate efficiently, add the ability to use underground reservoirs (such as abandoned mines), seawater operation, variable turbine/pump speeds, increasing the power range in turbine mode, and cutting reaction time. Taken together, these aims will increase flexibility and storage efficiency as well as expanding the physical application potential, which is currently limited by local geography.

On the negative side, PHS brings serious – and perhaps increasing – concerns about environmental damage, as shown by protests in various Alpine countries and in Norway. New PHS technologies now being developed (such as underground reservoirs and the “energy membrane” concept – a huge water-filled bag covered with soil [8]) could in the future mitigate some of the environmental issues and allow PHS to be used independently of local geographic conditions.

Battery storage of electricity has a history as long as that of PHS, but batteries have still not yet found widespread applications in larger electricity grids. Pilot-scale trials of grid-scale systems are now under way, however, based on a large variety of battery chemistries.

Battery storage is of special interest in regions with weak grids and high renewable penetration, such as the French territories of the Caribbean, Corsica, Sardinia and the Canaries. Battery systems are also being tested in continental Europe at locations where the grid is weak, as in some places in Italy.

Other pilot projects include batteries in distribution grids very close to final consumers, in areas where local solar generation is installed, to prevent grid congestion and control voltage variations.

Finally, wind and solar equipment manufacturers are experimenting with large battery installations to stabilise the output of wind farms and large PV installations. One example is the Sol-Ion project [10], where Li-ion batteries (5–15 kWh, 170–350 V) are used to level out mismatches between power demand and solar production.

Compressed air energy storage (CAES) is another technology dating back more than a hundred years, but only two modern CAES installations are in operation: one in Alabama in the USA and the other at Huntorf in Germany. The Huntorf plant is owned by E.ON and has been running since 1978.

The main disadvantage of CAES is its low “round-trip” efficiency, which is only about 40% (Huntorf) due to heat loss

during the compression phase. CAES research therefore focuses on increasing efficiency by storing the heat of compression, and later using this to re-heat the air during the heat-absorbing expansion phase. Such “adiabatic CAES” is the aim of the ADELE project in Germany, which will use large ceramic assemblies to store sensible heat at temperatures up to about 600°C (Figure 13). The aim is to increase CAES round-trip efficiency to about 75% [11].

Power-to-gas stores energy by converting electricity to gas – most often hydrogen or methane – via electrolysis (for hydrogen), optionally followed by methanation (for methane).

The chemical fuel produced in this way is versatile, energy-dense and can be stored indefinitely without losses. Both methane and hydrogen can easily be used directly as fuels for cars, trucks, ships and aircraft. The established gas distribution infrastructure can handle synthetic methane and low hydrogen concentrations and – certainly with some modifications – pure hydrogen too.

It is also possible to convert the chemical energy in the stored gas back into electricity, but the round-trip conversion efficiency is relatively low, at around 35%.

Many European resources are being put into improving the economics of electrolysis by reducing equipment costs, increasing life time and conversion efficiency. Germany in particular is carrying out a great deal of hydrogen research funded by the government and the car industry.

Heat storage – or more correctly thermal energy storage, because it includes cooling as well – is sometimes a little overlooked in discussions about the need for energy storage. However, more than 50% of final energy use in Europe takes the form of heat, and all energy conversion processes are associated with the release of heat. Good management of heat, including thermal energy storage, should therefore be strongly prioritised in the future energy system, via both efficient use of energy (utilisation of waste heat) and the general management of energy supply (time shifting).

Figure 13

The planned ADELE CAES facility in Germany will store heat in ceramic materials housed on the surface, while the compressed air itself is contained in underground caverns. The installation will generate several hundred MW [12].



R&D in thermal energy storage concentrates on:

Low temperature sensible heat storage in district heating systems (ground-level water tanks as well as certain underground technologies);

High temperature sensible heat storage for CAES technology (see above); and heat storage for concentrated solar power.

Researchers are also developing new materials for heat storage: phase-change materials and thermochemical heat storage systems. The latter are of special interest because of their potentially high energy storage density.

Conclusions and recommendations

There is little doubt that the transition to a fossil-fuel-free European energy system is under way. Political arguments based on economics, security of supply and climate change have resulted in firm targets for decarbonisation, and several EU member states are committed to reducing their fossil fuel dependency to close to zero by 2050.

Nevertheless it is difficult to predict the pace at which the penetration of renewables will approach 100% – or more, if we think in terms of installed capacity versus instantaneous production. Should we expect linear progress or asymptotic behaviour, the latter reflecting the fact that the last steps towards the target are likely to be the most difficult and expensive?

Looking at the present European electricity system we can already see the outline of future balancing problems. When the wind blows strongly, some wind turbines need to be shut down because surplus power threatens the stability of the grid. The same problem is reflected in occasional negative electricity prices – as an example the Scandinavian market in December 2012 hit –€200/MWh during a one-hour period. Negative power prices are short-lived, but the underlying problem of balancing the European electricity grid is going to get worse unless we act to fix it.

We believe that the short-term electricity balancing market is where energy storage will be first applied, based on commercial business cases, and that the need for additional balancing power will be confirmed within the next five years. However, only a few energy storage applications are commercially justifiable at the moment, and this is why many energy storage technologies have not yet spread into the market.

Nevertheless, now is the time to prepare effective and economic storage technologies for future applications. For this to take place we recommend a series of initiatives to be taken over the next two decades:

1. Support demonstration and pilot programmes focusing on grid integration of energy storage.
2. Encourage grid-connected battery storage experiments at different voltage levels.
3. Model large underground heat storage systems.
4. Set up pilot projects for thermal management and industrial waste heat storage.
5. Design the financial and regulatory structures needed to integrate energy storage into the electricity markets.
6. Create market incentives to encourage the integration of energy storage with the electricity grid.
7. Begin heat storage experiments, including underground technology.
8. Study the interaction of gas and electricity grids to minimise total cost and CO₂ emissions.
9. Support large-scale demonstration projects for energy storage.
10. Study communications and interactions between different storage assets supplying ancillary and load shifting services to the grid.

In parallel we should maintain strong support for materials R&D in areas relevant to energy storage.

The above conclusions and recommendations are in line with the recommendations of the EASE roadmap [5], to which both authors have contributed.

6

Stochastic power generation

Pierre Pinson, DTU; Robin Girard, MINES ParisTech, Centre for Processes, Renewable Energies and Energy Systems;
Patrick McSharry, Smith School for Enterprise and the Environment, University of Oxford

Introduction

Our path towards decarbonisation involves the large-scale use of renewable sources – the most prominent contributions being from wind and solar, followed by biomass – to gradually replace fossil fuels for energy production, mainly in the form of heat and electricity. By June 2012, cumulative installed wind power capacity worldwide had reached 254 GW and was still increasing rapidly [1]. Ref. [2] gives an extensive introduction to various forms of renewable energy sources among our potential options for the future.

Of the various forms of renewable energy sources, some are similar to conventional fuels. Biomass, for instance, includes straw and other waste materials that can be burned in more-or-less conventional furnaces and boilers. Given enough fuel, biomass power plants can be operated and dispatched like their gas or coal equivalents. Dispatchable power generation units are able to follow market signals and schedule their power production to meet demand. They may also provide ancillary services to the grid, such as support for stabilising voltage and frequency.

In contrast, some other forms of renewable energy are not dispatchable. Indeed, wind farms and solar power plants can be scheduled and controlled only to the extent that their power output can be curtailed if necessary. Renewable energy sources such as wind, solar, wave and tidal power are characterised as variable and of limited predictability. They are formally known as stochastic power sources, meaning that the variation of power production over time can be predicted only partially; it also contains a random component that is inherently uncertain.

The increased share of stochastic power generation in the electricity system certainly is one of the drivers for looking at the various forms of energy storage, which can compensate for the limited predictability of wind and solar power.

Changing consumption patterns can magnify the issues associated with stochastic power generation. For instance, it is likely that in the future the transport sector will come to rely increasingly on electricity, and this will create a degree of exposure to variations in electricity supply that does not exist in this sector at the moment. Another example is the increasing tendency of households to generate power via PV panels, or other local generation means, as well as consuming it from the grid. Such “producers/consumers” (“prosumers”) may be less predictable in their consumption patterns than traditional consumers, especially since they are more likely to participate in demand

management programmes that encourage them to dynamically schedule their use of power and heat.

After a brief overview of the system and market structure, our main emphasis in this chapter is on the issues surrounding the variability and predictability of stochastic power generation. Examples are given for wind only, though other stochastic sources of renewable energy would yield qualitatively similar results. We conclude by discussing the implications for the planning and operation of energy storage facilities.

System and market setup

This section does not aim to give a full overview of the context of power system operations in a market environment. Instead we use it to support our choice of the topics most relevant to energy storage and the optimal integration of stochastic power sources. These subjects are then covered in more detail in the sections that follow.

Ref. [3] gives an extensive overview of the challenges in the case of wind energy. Most of these challenges are similar for other forms of stochastic power generation, though some may be technology-specific. In this chapter the main emphasis is on the daily scheduling and operation of power systems, ignoring the role of storage on timescales that are either very short (for example frequency support) or very long (such as smoothing out seasonal variations in wind, sunshine or rainfall).

At present, for most electricity markets, a daily schedule for production and consumption is obtained through a single auction mechanism in the day-ahead market, based on production and consumption offers characterised by quantity and price (Figure 14). On the production side, offers are ranked in terms of their short-run marginal costs. This favours stochastic renewable energy sources like wind and solar, since their short-run marginal cost is zero, or even negative if they are subsidised.

The day-ahead market is cleared early in the afternoon before the day of operation. Predictions of power demand and stochastic power generation are therefore needed up to 36 hours ahead so that the corresponding consumption and production offers can be defined. The variability of the electric load is pretty well understood in connection to human activity and the influence of the weather. In contrast, the variable nature of stochastic power generation is more difficult to appraise. In the past, market and system operators were used to highly accurate load forecasts,

Figure 14

Timeline for the daily operation of power markets and systems.

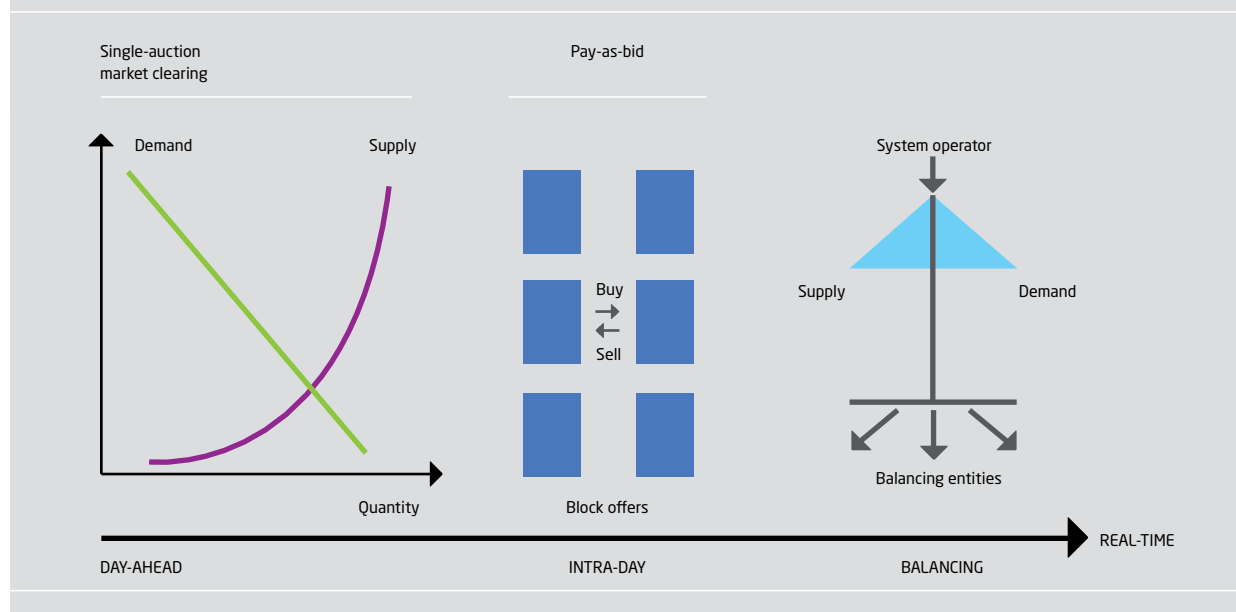

whereas they now have to deal with renewable energy forecasts that are less accurate and more variable. Forecast accuracy has improved considerably over the last 10–15 years [4]. The importance of accurate power generation forecasts from renewables is highly dependent on the market, the regulatory setup, and the actual penetration of renewable energy.

Electricity production and consumption must be constantly balanced to avoid power outages. During the day of operation, any deviations from the day-ahead schedule therefore have to be corrected through the balancing market. In most cases this means using thermal power plants that are more expensive to run and more polluting than either renewable or conventional baseload plants. As a result, the total operating costs of the power system are influenced by the variability and predictability of renewable sources (see for instance Ref. [5]).

While the grid itself transports energy in space, we can view storage as a way to transport energy in time. The hope is that storage, in smoothing the variability of stochastic power generation, could also help to correct imbalances originating from forecasting errors. We need to account for variability in space as well as in time, since power that is available at the right time but in a different place may cause

congestion on the grid. Storage located at strategic nodes on the transmission network might alleviate such problems.

Variability of stochastic power generation

Stochastic power generation takes potential energy from the atmosphere, the sun and the oceans, and converts it to electricity via devices such as wind turbines, solar panels, tidal current turbines and wave energy machines. The resulting power output is a direct function of the appropriate atmospheric and ocean variables. These in turn have their own natural variability on various scales in time and space, as dictated by complex geophysical phenomena.

The power generated by a solar plant, for instance, shows a clear daily cycle. Starting at dawn, solar irradiance increases gradually up to mid-day and then decreases until twilight. On top of this smooth variation may be more abrupt fluctuations as clouds pass across the sun. The hours of daylight and the maximum height of the sun follow an annual pattern, while changing seasonal temperatures may also introduce their own variability by affecting the efficiency of the energy conversion process. Similarly, for wind turbines, wind speed is the dominant factor affecting power

output. Wind speed fluctuations are either magnified or dampened through the turbines' power curves, yielding complex wind power fluctuations. These are better described in the frequency domain. A reference study is that in Ref. [6], where the spectrum of the power output from wind turbines is analyzed, allowing to jointly look at temporal and spatial scales of such fluctuations. Another relevant study is that in Ref. [7], which more specifically focused on the fluctuations of wind speed over the North Sea, a region where it is expected that substantial offshore wind power capacities will be deployed and operated over the coming few decades.

Wind speeds can vary greatly from one day to the next, depending on the local wind climate, which in turn is influenced by both large-scale weather patterns and local thermal effects, for instance sea breezes. Where thermal effects dominate, wind patterns tend to be very similar from one day to the next, as for example on Mediterranean islands and the Red Sea coast. Where winds are driven mainly by larger-scale weather phenomena, as in northern Europe, wind patterns may be totally different from one day to the next. Terrain can also influence wind regimes and wind speed variability over quite small distances. Off-shore wind turbines, for instance, experience generally higher wind speeds, but also stronger swings in output, compared to their counterparts onshore.

Besides the fluctuations in wind speed and power output for periods ranging from seconds to days, it is not yet clear whether wind speeds are changing over the long term as a result of global warming or changes in land use, and if so, whether wind speeds are increasing or decreasing [8]. In any case, any such variation would be too slow to be relevant to energy storage.

Figure 15 shows wind power generation in Denmark on five randomly chosen days in December 2011. Total Danish wind generating capacity was 3,956 MW at the time. On several of these winter days the wind was very strong at night, yielding wind power generation close to the nominal capacity, and then decreased during the day. On other days, wind power production was low at night but then picked up early in the afternoon. Finally, there were also some days with almost no wind power generation.

As well as temporal variability, spatial variability is also relevant because it may require grids to transport large quantities of power over long distances. An example is Texas in the USA, which has a large amount of wind power capacity in the western part of the state. Since the main load centres are in the east, Texas requires strong transmission links to

Figure 15

Daily patterns of hourly wind power generation for the whole of Denmark on five randomly chosen days in December 2011.

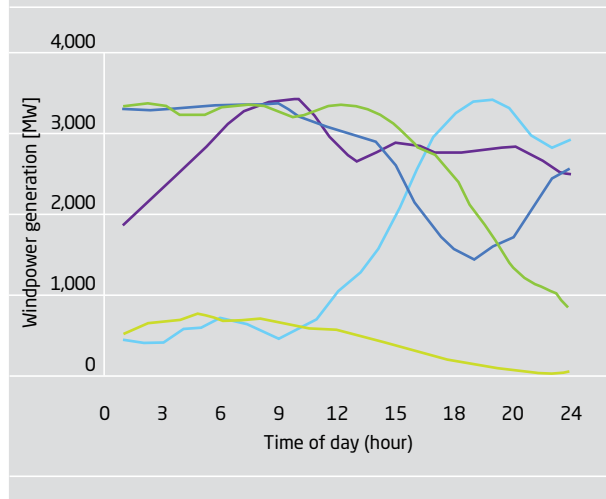

make effective use of its wind resources. Even in less extreme cases, where renewable energy capacity and load centres are spread more evenly across the map, the spatial variability of stochastic generation creates additional power flows on the grid.

Given this variability in space and time, it should not be surprising if aggregating stochastic power generation over wider geographical areas – country, region or even continent – reduces variability, at least in the short term. A number of studies have confirmed this [9] [10]. As long as there is sufficient transmission capacity, the ability to harvest power from wider areas will reduce the need for storage and result in slower rates of charge and discharge. This comes at the expense of potentially prohibitive investment in required transmission capacities.

Finally, the various types of stochastic power generation show different types of variability. For example, ocean swell varies more smoothly than wind speed over short time-scales and distances, though at larger scales it may show greater variation than wind speed. As a result, a combination of, say, wind and wave generation may result in a smoother power output than either technology could achieve on its own.

Predictability of stochastic power generation

Besides damping fluctuations in power generation induced by the natural spatial and temporal variability of stochastic sources, storage could help to accommodate errors in the predictions required by energy markets. As an example we will look at the situation in Denmark on 25 December 2011 (Figure 16).

The forecast issued the previous day indicated that wind power generation would be very high in the morning (at one point even higher than consumption), before falling steadily during the rest of the day. In the event, this is not what happened. The actual power generation was significantly less than expected, and it reached a minimum earlier than predicted. Over that day, the market required 18,684 MWh from conventional power plants to balance the wind power that did not materialise. This is equivalent to 45% of the wind power predicted for that day, and is also roughly equivalent to the yearly consumption of 4,000 Danish households.

Forecasting errors are not always as extreme as in the above example, but the predictability of stochastic power generation is highly variable. Predictability is influenced by several factors, notably the type of renewable energy source,

geographic location, generating plant sizes and size distribution, time of day, and weather. As intuitively expected, predictability degrades with increasing forecast lead times. Forecasts for a few minutes to a few hours ahead can be extremely accurate, while predictions with lead times of more than 4–5 days will clearly be of lower quality.

Continuing with the example of Denmark, Figure 17 summarises the accuracy of 2011 wind power forecasts in western and eastern Denmark as a function of the time of day (corresponding to the hourly divisions of the electricity market). Forecast accuracy is measured in terms of the mean absolute error (MAE): the average absolute percentage difference between forecast and measurement (so the lower the better).

Since the day-ahead market is cleared at noon on the previous day, the various times on the horizontal axis correspond to lead times between 12 and 36 hours. The error increases slowly but surely with the lead time, in the range 4.0–5.5% of the nominal capacity.

Forecast accuracy is higher for Denmark as a whole than for either of the two regions, thanks to the spatial smoothing effect discussed above [10]. For 2011, the total absolute error in wind power forecasts for the whole of Denmark

Figure 16

Predicted and actual Danish wind power generation for 25 December 2011. The area between the forecast and observation curves represents the quantity of energy to be balanced throughout that day.

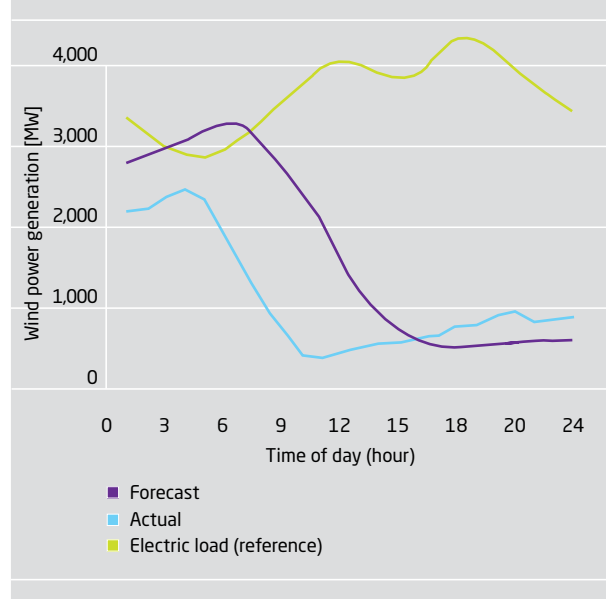
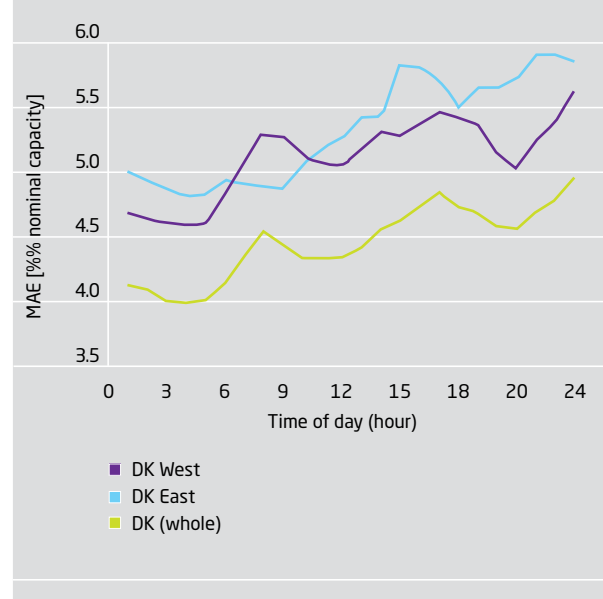

Figure 17

Wind power forecast accuracy (mean absolute error) for Denmark in 2011.



was 1.34 TWh, which is roughly equivalent to the yearly consumption of 300,000 Danish households. It fell to the Danish system operator to balance the grid by adjusting thermal power generation either upwards or downwards, and potentially international power exchange, depending on the direction of the forecast error at any particular time. The characteristics of forecast errors are fairly complex to appraise, and this is the reason why optimally operating the electric power system with significant wind power penetration comprises a real challenge.

Challenges for operation and planning

The variability and predictability of stochastic power generation, as described above, present a number of operational and planning challenges when applied to real power systems and markets – whatever technologies are chosen for power generation and storage.

Optimal use of storage requires that we account for the dynamics and uncertain nature of stochastic power generation. This applies both at the time of clearing the market and later, in near real time, when storage is actually called upon to balance deviations from the forecast.

Optimal operating policies first require advanced forecasts in the form of predictive densities or space-time scenarios. These are then used as inputs to purpose-designed stochastic optimisation models. If the network has enough storage, in terms of both power output and energy content, one could argue that such complex decision-making is unnecessary. However, this would result in sub-optimal use of storage assets, perhaps with additional operational costs and shorter life expectancy. The optimal integration of storage will also be highly dependent on the type of storage technology, whether it is centralised or distributed, and who operates it (system operator, market participants or final consumers).

Sizing and locating storage in a power system is a complex planning problem which needs to account for the variability and predictability of stochastic power generation, the topology and other characteristics of the network, and the cost of building and operating storage. Storage methods proposed in the literature have most often focused on particular power sources (notably wind and solar), rather than integrated methodologies for the power system as a whole (see, e.g., Refs. [11] and [12]).

One challenge of great relevance is to work out how storage will actually alter the market and the dynamics of the power system, potentially affecting its economic value. An example is energy arbitrage: it is often thought that you can estimate the economic value of storage by simply looking at price differentials in the market. However, if every market participant used storage to maximise the profits from arbitrage, these price differentials could shrink and eventually vanish.

Overall, we recommend that storage should be part of a portfolio of solutions supporting the integration of diverse sources of stochastic power generation.

Thermo-mechanical electricity storage

Brian Elmegaard, DTU Department of Mechanical Engineering; Allan Schrøder Pedersen, DTU Department of Energy Conversion and Storage; Aksel Hauge Petersen, DONG Energy, Denmark; Tage Petersen and Lars Reinholdt, Danish Technological Institute; Christian Bang-Møller, Topsoe Fuel Cell, Denmark

Thermal, mechanical and thermo-mechanical technologies underly the great bulk of electricity storage in use today in connection with electric power. In fact, 99% of current electricity storage capacity is based on pumped hydro storage (PHS), for which the market is still significant and growing [1]. An alternative technology, compressed air energy storage (CAES), has been in limited operation for some decades [2].

Bulk electricity storage is presently used mainly to fill gaps between supply and demand arising from the requirements of the grid, power plants or consumers. A common use of storage is to meet evening demand peaks in grids based on power plants which require constant load, such as nuclear plants. In contrast, we do not yet have bulk storage methods that are economic when the driver is variations in electricity price.

When evaluating the performance of electricity storage technology, the most important parameters are:

Power

1. Charging rate [MW]
2. Discharging rate [MW]

Energy

1. Storage capacity [MWh]

Footprint

1. Volumetric capacity [MWh/m³]
2. Area capacity [MWh/m² land]

Efficiency

Cycle electric storage efficiency (or round trip efficiency) [MWh electricity produced/MWh electricity stored]

Efficiency is sometimes defined in other ways: for thermo-mechanical systems such as CAES, for instance, the need to transfer heat to or from the storage plant could allow integration with heat distribution networks, so efficiency based purely on electrical output may not be the best measure. In any case, determining the correct measure of storage efficiency requires the application of thermodynamics, in the form of exergy analysis [3]. Where the power grid is concerned, however, electrical storage efficiency is important to quantify independently of other measures.

Principles of thermo-mechanical electricity storage

Many methods of storing electricity based on thermo-mechanical technology exist [4]. In this section we describe

three established technologies: PHS, CAES and flywheels.

Pumped hydro

Pumped hydro storage (PHS) is based on the principle of storing potential energy by pumping water from a lower to a higher level (Figure 18). To return power to the grid, the water flow is reversed and used to drive turbines. In practice, the same machines – reversible pump-turbines – are used for both phases of operation. Storage at both upper and lower levels takes the form of open reservoirs. PHS is characterised by relatively high efficiency (up to 80%) and large footprint. The volumetric capacity depends mostly on the height difference between the two reservoirs.

Compressed air energy storage

CAES is in operation at two sites worldwide: Huntorf in northern Germany and McIntosh in Alabama, USA. In both cases the compressed air occupies a large underground cavern created by solution mining of a salt dome. To charge the cavern with air at pressures up to about 100 bar, an electric motor drives an axial compressor. To generate power, the compressed air is allowed to expand through an axial turbine (Figure 19).

Compression increases the enthalpy and thus the temperature of the air. Injecting hot air into the cavern is undesirable since it causes thermal stresses in the surrounding rock, and also lowers the storage capacity significantly because hot air is less dense than cold. For this reason, the compressor train incorporates intercoolers and aftercoolers to reduce the temperature.

Figure 18

Pumped hydro storage uses reversible pump-turbines to move water to a high reservoir for energy storage. When power is required, the water is allowed to flow back down to the lower reservoir.

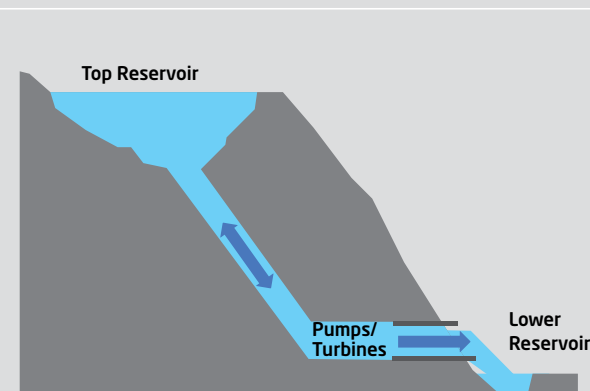

Similarly, expansion reduces the temperature of the air and limits the power available from the turbine. To maintain output, natural gas burners therefore add heat to the air stream. In fact, the burners add so much heat that in practice they supply around two-thirds of the system's power output, the remaining one-third coming from the pressurized air stream.

The large proportion of energy supplied by the burning gas complicates the calculation of efficiency, and the CAES literature defines efficiency in several different ways. Based on exergy analysis, however, traditional CAES has a rather low electrical efficiency (~40%), though its volumetric capacity is larger than that of pumped hydro.

Flywheels

Flywheels are another way to store electricity based on mechanical principles, this time using the kinetic energy and moment of inertia of a rotating mass instead of the potential energy that characterises PHS and CAES. Again in contrast to PHS and CAES, flywheels are typically considered for short-term applications combining high power with relatively low storage capacity.

Flywheels have been used since the birth of the steam engine. Modern designs take advantage of polymer composites and other advanced materials to give strength and density, plus magnetic bearings and operation in vacuum to reduce losses [5].

Historically the major development centre has been the USA and in particular Beacon Power, which has had flywheels in commercial operation with grid operator ISO New England and elsewhere since November 2008. However, European manufacturers are also in the market for flywheel electricity storage. Germany-based Piller Power Systems, for example, sells UPS systems capable of delivering 2.4 MW for 8 seconds (approximately 5 kWh). Interesting tests are also going on in the UK, Spain, and elsewhere in Germany (for a complete list see [1]). One example is a flywheel being tested at a tram terminus in the German city of Freiburg. The flywheel stores the braking energy of arriving trams and gives it back to departing trams, and is expected to save up to 250,000 kWh of electricity annually [5].

In principle, flywheels can be produced in a wide range of sizes (and used in parallel if necessary), from multi-megawatt utility applications down to small systems for cars,

Figure 19

Compressed air energy storage uses an electrically driven compressor with intercoolers to compress air into an underground cavern. During energy recovery, natural gas burners replace the enthalpy that is lost as the air expands through a turbine.

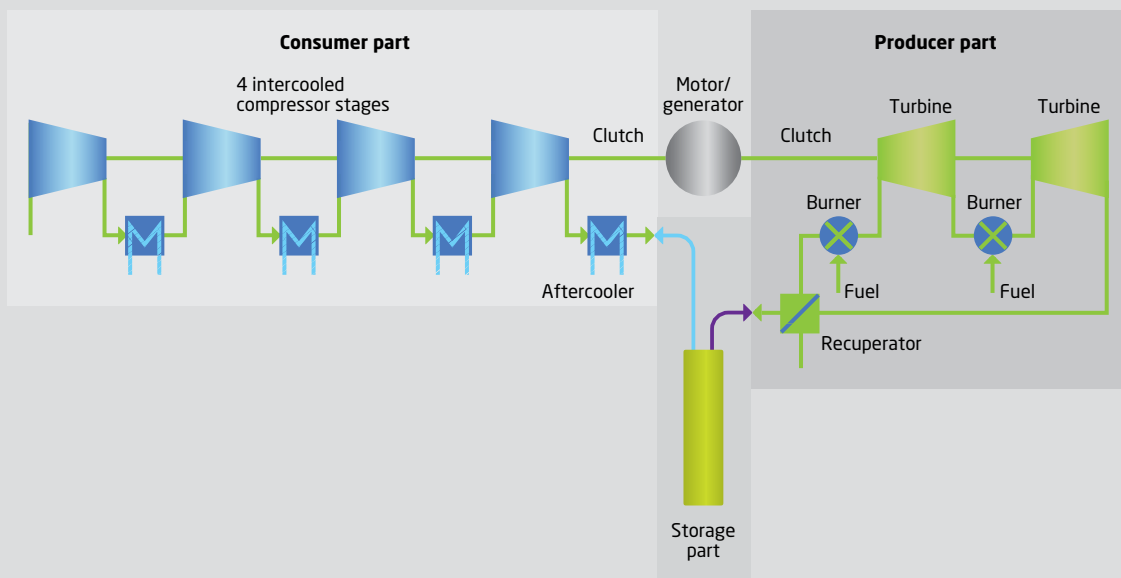

buses and ferries. Beacon Power, the dominant producer of large flywheels, manufactures single modules each rated at 100 kW/25 kWh. These are then combined into groups to provide the necessary capacity; the standard unit contains 10 flywheels, giving a capacity of 1 MW/250 kWh (Figure 20).

Like any electricity storage technology, flywheels carry an element of risk. In 2011, a serious accident destroyed one of the 200 flywheels at Beacon's new 20 MW frequency regulation plant in Stephentown, NY [6]. Further development of high-power flywheel technology needs to focus on safety and reliability as well as operating costs.

New ideas in thermo-mechanical bulk electricity storage

As mentioned above, both PHS and CAES have a scale and a level of technical maturity that make them attractive for bulk electricity storage. However, they also involve some disadvantages which have triggered ideas for further research and development into thermo-mechanical storage technologies.

The main obstacles to conventional pumped hydro storage are the need for large areas of land and large volumes of water. As a result, the number of new sites where this technology can be built is probably limited [7], and expanding hydro power of any kind involves issues of environmental impact and public acceptance [8]. A shorter-term solution is to add pumps and low-level reservoirs to existing hydro power plants wherever possible, and to make best use of

Figure 20

10 flywheel modules lowered into the ground (five on each side of the container). Each flywheel can supply 100 kW for 15 minutes (25 kWh capacity). Source: Beacon Power.



existing PHS facilities. In addition to the specific new PHS technologies mentioned below, general PHS development trends focus on methods to [1]: expand the range of site types amenable to PHS, including both very high heads (requiring multiple stages) and very low heads (with new types of pump-turbines), increase the flexibility of PHS by developing variable-speed motor-generators, increasing the capacity rate and range over which water turbines function effectively and stably.

The most important challenge for the extended use of current CAES technology purely for electricity storage is the need to burn fuel during the discharge phase. Potentially greener alternatives to natural gas include biogas and hydrogen produced by electrolysis based on renewable energy sources. However, neither of these fuels is presently available in sufficient quantity, and in any case the overall electrical storage efficiency of CAES will remain low. A better solution would be to store the heat removed from the compression process and use it to re-heat the air during the discharge phase.

Below we describe some ideas for variations on PHS and CAES that are currently being investigated. Their maturity varies considerably; some are little more than sketches at

Figure 21

Underground pumped hydro storage, typically using an abandoned mine as the lower reservoir.

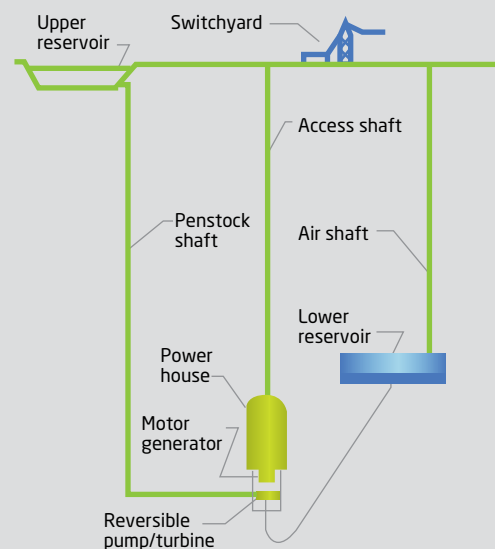

present, while others have been demonstrated, at least at small scale.

Underground pumped hydro storage

To get around the shortage of sites for conventional PHS, some researchers are investigating the potential for operating between an upper reservoir at ground level and a lower reservoir beneath the surface (Figure 21) [9]. The lower reservoir is typically an abandoned mine, in which case the storage capacity per unit of ground area will depend mainly on the depth of the mine. A technological challenge is the operation and maintenance of the underground pump-turbine.

Another solution currently being investigated is to store water in flexible tanks located 25 m below ground level [10]. As seawater is pumped into the tanks the ground above them lifts, before falling again as the tanks empty. The proposed plant has a volume of 1.75 million m³, giving a storage capacity of 30 MW/200 MWh with 80% electrical efficiency.

Gravity Power suggests underground PHS in only one cylindrical reservoir by moving a piston vertically [1].

Offshore pumped hydro storage

Another way to build PHS in more locations is the proposals termed Green Power Island [11] and Seahorn energy [12], an offshore reservoir created by building a continuous

dam around an artificial island. The power for the reservoir charging pumps may come directly from nearby offshore wind farms, perhaps with turbines mounted directly on the dam. Power is recovered by discharging the water back to sea level; since the heights involved would be much lower than those used in standard PHS plants, special low-head pump-turbines would have to be tailored to the application. Suggested capacities are in the range 400 MWh to 50 GWh, based on surface areas of 1.5–65 km².

Adiabatic CAES

An obvious way to reduce or eliminate the need to burn fuel in a CAES plant is to store the heat of compression and recover it during the expansion phase (Figure 22). This idea has been investigated extensively in a large EU-funded project [13]. The heat could be stored in a solid, liquid or phase-change material. A crucial part of the design of such an “adiabatic CAES” facility lies in minimising efficiency losses due to irreversibilities in the heat transfer to and from the heat storage and the pressure losses due to flow through piping. In addition, careful thermal management of the stored heat will be required to reduce losses between cycles.

Isothermal CAES

Another approach to managing heat in a CAES plant is to avoid generating it in the first place. Such a plant would use isothermal (constant-temperature) processes for both compression and expansion. Isothermal operation has the

Figure 22

In adiabatic CAES the heat of compression is extracted, stored, and used to re-heat the air during expansion

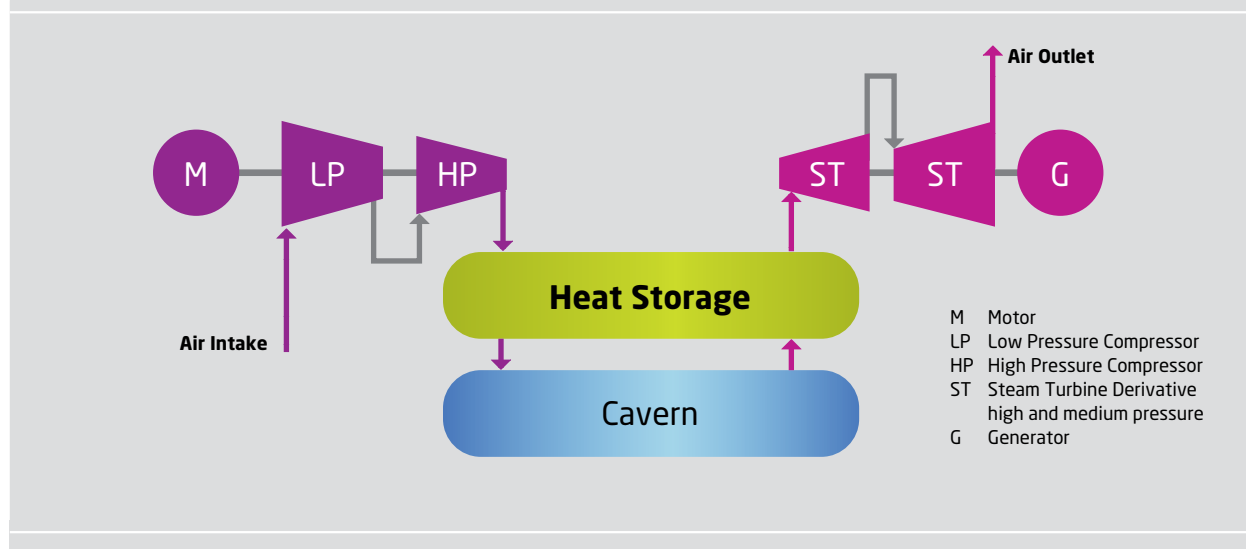

advantage of being thermodynamically efficient – it requires the lowest specific work to compress a gas, but it is hard to do on a practical scale, and the development of workable isothermal processes would be a breakthrough for many applications besides CAES.

This idea is being investigated commercially by companies including LightSail [14], Sustain [15], and General Compression [16]. These firms have patented solutions which involve adding a liquid to absorb heat during the compression phase and thus keeping the temperature of the air more or less constant, storing the heated water and using this as a source of heat during the expansion phase. LightSail's approach, for instance, is to spray a water mist into the cylinder of a piston compressor/expander (Figure 23).

Liquid-piston CAES

One recent project investigated a combination of underground PHS and CAES [17]. Air stored in a sub-surface cavern is compressed not directly, as with conventional CAES, but instead by pumping water into the closed space, so reducing the volume available for the air to occupy. On discharge, the turbine is driven by water, as with conventional PHS, rather than air as in conventional CAES (Figure 24).

Because water is essentially incompressible, it experiences only a very small rise in temperature as it is pressurised by the pump. Heat transfer between the water and the air in the cavern will limit the temperature variation of the air during the cycle.

Figure 23

Isothermal compressed air energy storage as patented by LightSail Inc. Heat is removed by spraying water into the compressor cylinder. The heated water is stored, and during the generating phase it is used to heat the air being expanded in the same cylinder.

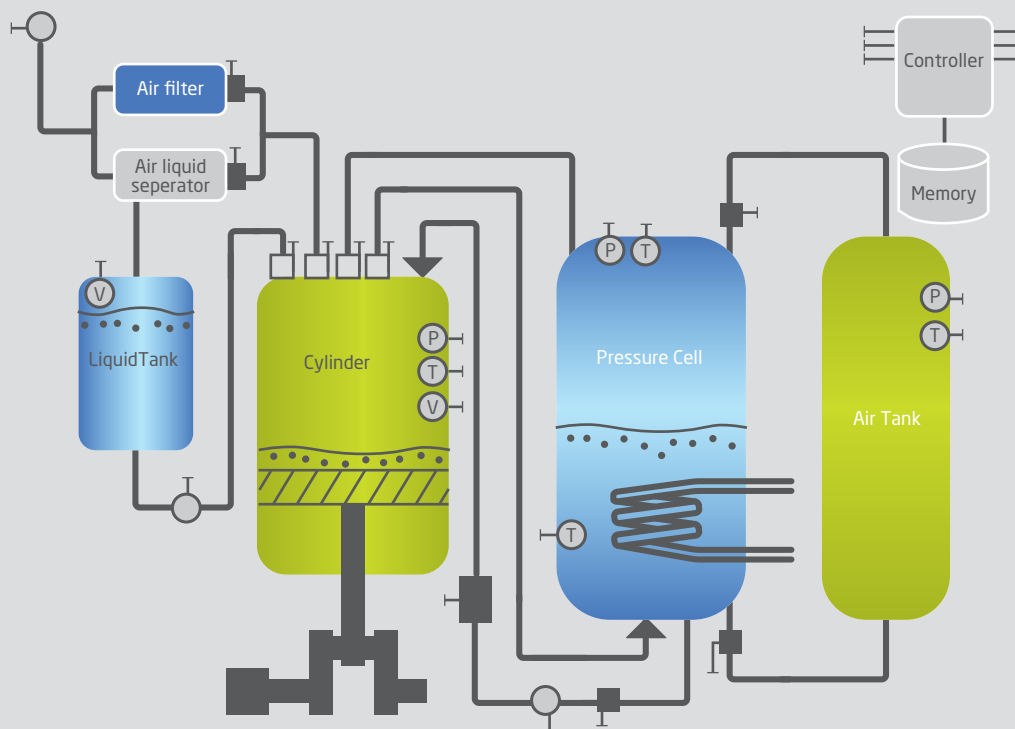
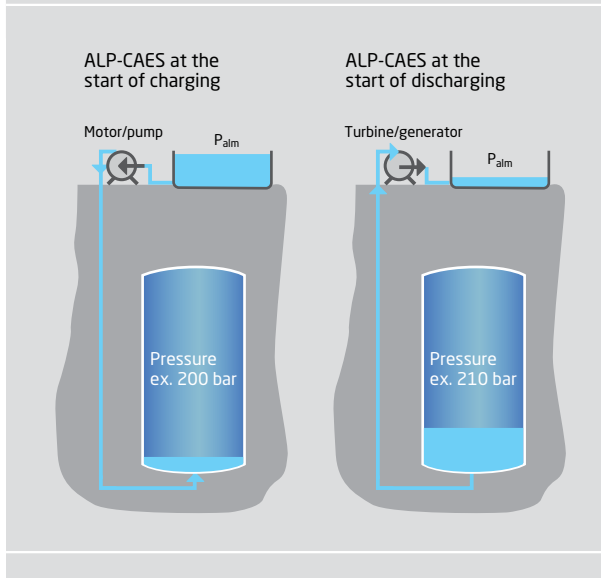

Figure 24

In adiabatic liquid piston CAES, air is compressed by injecting water into an underground cavern.



One important characteristic of this method is that if it is based around a solution-mined salt cavern, the water will become saturated with salt. This means that the ground-level reservoir cannot take the form of a conventional freshwater lake, nor can the water be discharged to a river or the sea.

Another issue compared to a conventional PHS plant is that the water must be lifted to the upper reservoir during the discharge phase instead of the charging phase. Depending on the depth of the cavern, this may significantly reduce the head available to drive the turbine.

For smaller scale applications CAEStorage is developing a similar technology. Air is stored in metal cylinders and is compressed by pumped hydraulic oil into the cylinder [3].

Liquid air thermo-mechanical storage

The Highview Power Storage concept is based on technology used to produce liquid air (Figure 25) [18]. During the charging process, electricity is used to compress air, which is then cooled and expanded until it liquefies. The liquid air is stored in tanks, which need to withstand only modest pressures compared to those required for CAES.

During discharge, the stored liquid air is pumped at high pressure through an evaporator where it absorbs heat from the atmosphere or a source of low-temperature waste heat. The resulting high-pressure gas is then expanded through a turbine to produce power.

The technology is currently being tested at pilot scale. The working fluid could be nitrogen instead of air, but in either case the gas liquefaction process involves significant thermodynamic irreversibilities which lower the storage efficiency. It is therefore important to develop highly integrated heat recovery if this technology should reach high efficiency.

Transcritical CO₂ thermo-mechanical storage

Another idea based on transferring technology from other fields uses a reversing, transcritical heat pump cycle with carbon dioxide as the working fluid (Figure 26) [4]. Carbon dioxide has recently received significant attention for heat pumps, but the idea of using it for electricity storage dates back to the early 20th century [19].

The technology uses a transcritical CO₂ cycle and thus involves evaporation at subcritical pressure, followed by compression, and then gas cooling at supercritical pressure. The evaporation accordingly occurs at constant temperature, which matches well with the use of a water-ice mixture for heat storage. The supercritical cooling step, on the other hand, occurs with temperature glide and is therefore integrated with a water tank which stores sensible heat. This method will require large and highly efficient components for the reversible compressor/expander unit. Such technology is not yet commercially available.

Figure 25
Liquid air electricity storage system developed by Highview Power.

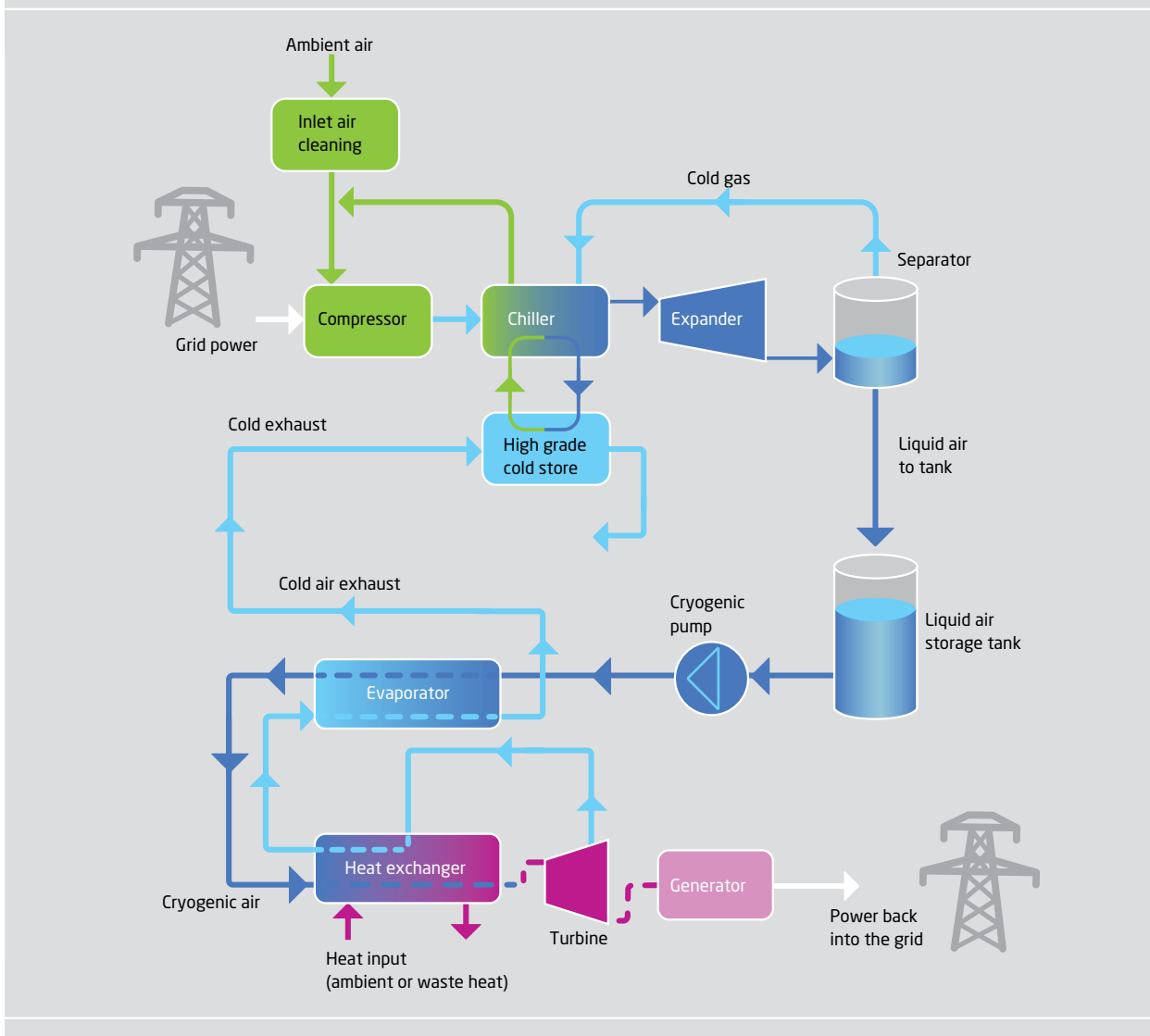
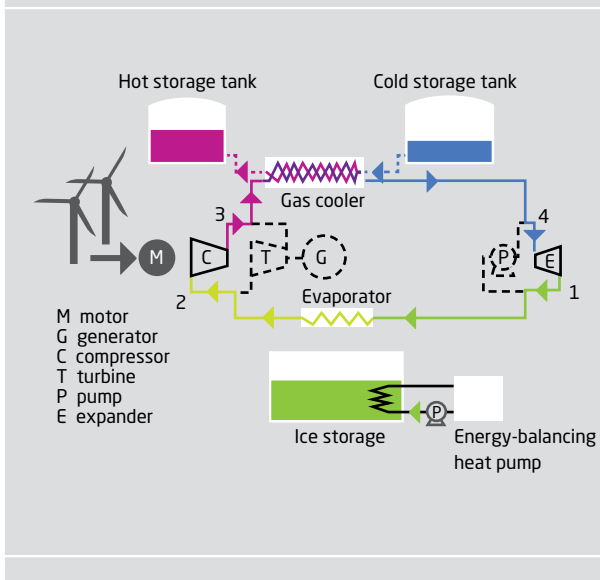

Figure 26

A heat pump using transcritical CO₂ as the working fluid stores thermal energy in the form of ice and hot water.



Summary

Thermo-mechanical electricity storage is the type used most extensively today. Pumped hydro storage (PHS), with an installed capacity of more than 100 GW, accounts for more than 99% of current global electricity storage capacity. Compressed air energy storage (CAES) is a workable, if low-efficiency, technology which so far has not been widely adopted. Flywheels have made limited commercial progress for short-term regulation.

Both PHS and CAES have been in operation for several years, but it is clear that they face some challenges to further expansion. As a result, several innovative ideas for variants on these technologies, plus new ones, have been suggested. The broad spectrum of these ideas shows that new forms of thermo-mechanical technology have the potential to be used extensively in a future which sees significantly increased demand for electricity storage to match the introduction of more intermittent energy sources.

Electromagnetic and electrostatic storage

Claus Nygaard Rasmussen and Argyrios Altiparmakis, DTU; Manfred Däumling, Germany

Introduction

Electromagnetic energy can be stored in the form of an electric field or as a magnetic field generated, for instance, by a current-carrying coil. Technologies which can store electrical energy directly include electrical double-layer capacitors (EDLCs) and superconducting magnetic energy storage (SMES). The basic designs of these two technologies are relatively simple: an EDLC stores energy in an electric field between two charged electrodes separated by an electrically insulating material, whereas a SMES stores energy in a magnetic field generated by a current running through a superconducting wire. Both of these storage technologies are characterised by high power density, low energy density, high efficiency and little or no degradation after repeated cycles of charging and discharging.

Electrical double-layer capacitors (EDLCs)

Theoretical background

An ordinary capacitor consists of two electrically conducting electrodes separated by a dielectric. Opposing charges on the two electrodes generate an electric field (E) in the dielectric and a voltage difference (U). The energy (W) stored in the dielectric is proportional to the square of the voltage difference:

$$W = \frac{1}{2} CU^2, C = \epsilon \frac{A}{d} \quad (1)$$

where C is the capacitance, A is the electrode surface area, d is the dielectric thickness and ϵ is the permittivity of the dielectric. This leads to the following expression for energy density in the dielectric (W_{vol}):

$$W_{\text{vol}} = \frac{1}{2} \epsilon E^2 \quad (2)$$

The energy density of an ordinary capacitor is therefore determined by the permittivity and the breakdown electric field strength of the dielectric material.

Electrical double-layer capacitors differ from ordinary capacitors by having an electrolyte between the electrodes instead of a solid dielectric. An EDLC consists of two electrodes with a porous separator between them. The separator is a polymer membrane approximately 100 μm thick which provides electrical insulation between the electrodes. It is impregnated with an electrolyte – a liquid solvent in which a salt has been dissolved – to allow conduction of ions but prevent electronic conduction. Double-layer capacitors are also known as supercapacitors or ultracapacitors, due to their very high capacitance compared to other capacitor types.

The electrodes and impregnated separator are rolled up and placed in a sealed container. When a voltage is applied to the electrodes, the corresponding electric field will cause ions in the electrolyte to move towards the electrode surfaces. These surfaces consist of porous carbon, which does not react with the ions. Ionic layers therefore form at the electrode surfaces, resulting in the effective double layer of charges which has given the double-layer capacitor its name (Figure 27).

The maximum voltage that can be applied to a single EDLC is only 1–3 V [1], but the effective distance across the two layers of separated charges is in the range of a few nanometers. This results in intense electric fields in the two surface layers ($E \approx 10^9$ V/m) and hence very high energy densities.

Characteristics of electrical double-layer capacitors

There are no chemical reactions taking place in the dielectric of a double-layer capacitor. Charge/discharge cycle degradation is therefore basically non-existent, and the expected lifetime is more than 1 million cycles. This makes EDLCs suitable for applications involving continuous rapid cycling.

The temperature range over which EDLCs can operate is generally larger than for batteries. The large surface area results in low internal resistance and hence low losses. The cycle efficiency is therefore also high (95–99% depending on the cycling pattern) and internal heating is low.

Figure 27

An electrical double-layer capacitor, (a) uncharged and (b) charged.

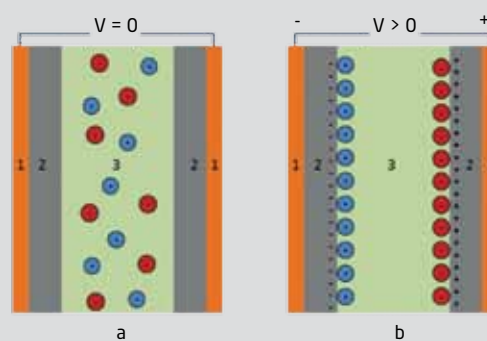

1. Metal electrodes
2. Porous carbon
3. Polymer separator (impregnated with electrolyte)

The high efficiency and low heat production allow high power density (10 kW/kg) [2], even though the volumetric energy density is modest (5 Wh/kg) [1]. The combination of high power density and low energy density results in a short operating timescale (τ):

$$\tau = \frac{W_{max}}{P_{max}} \quad (3)$$

where W_{max} is the energy storage capacity and P_{max} is the maximum power output. This equation applies to any electrical storage device; for an EDLC the timescale of operation typically ranges from a few seconds to a few minutes.

Low energy density makes EDLCs impractical for high-energy applications due to size limitations. Another drawback is that the large surface area results in a relatively high self-discharge rate which restricts useful storage times to a matter of weeks or months. The very low internal resistance can also be a disadvantage: if the electrodes are accidentally short-circuited, the resulting very high discharge current can destroy the device and may be dangerous.

Construction and operation of an EDLC storage unit is also complicated by the low voltage of the individual “cells”. To obtain a practical working voltage it is often necessary to put many EDLCs in series and this may lead to problems of uneven charging, and thereby a reduction of the effective capacity.

The voltage across a capacitor varies a lot with the charge level. This means that a DC converter is needed to maintain a constant output voltage from an EDLC storage system, but in any case it is impossible to extract the entire energy content from the capacitor while keeping the output voltage within practical limits. This further reduces the effective energy density of EDLCs.

Application areas

A combination of a battery and an EDLC in parallel can be smaller, cheaper and longer-lasting than a battery alone. During discharge, the EDLC’s ability to deliver short bursts of high power may allow a smaller battery to be used. When charging, the EDLC can prolong the life of the battery by smoothing out potentially damaging current pulses.

Besides supplementing batteries, EDLCs can also be used for applications where the power-to-energy ratio is high and the storage timescale is short. These could include transport applications requiring frequent acceleration, such as city buses, trams and local trains. The EDLCs can absorb the high currents produced by regenerative braking and use this stored energy to improve acceleration. EDLCs are

also useful as a way to provide short bursts of power in industrial applications and scientific test equipment.

When it comes to power systems, the short operating timescale limits EDLCs to applications such as power quality improvement and voltage support in relation to large, sudden load changes and other transient phenomena. EDLCs from companies such as Maxwell Technologies are already on the market for applications such as backup power, burst power and regenerative power. The cost of EDLCs is roughly 350 \$/kWh [7] and it is expected to stay at that level in the coming decade.

Future possibilities

At present the energy density of an EDLC is a roughly 1% of that of a typical Li-ion battery. This low energy density is the main factor preventing the widespread use of EDLCs for energy storage. Ongoing research aims to combine the best properties of capacitors and batteries. This could result in high-power storage devices with large energy capacities, little cycling degradation and a wide range of operating temperatures.

EDLCs using various forms of nanostructured carbon-based electrodes, such as carbon nanotubes or nanoparticles, have shown very promising results [3]. Another example is a graphene-based lithium capacitor which combines the properties of an ultracapacitor and a Li-ion battery [2]. Initial tests of such devices have shown energy densities up to 160 Wh/kg – not far off those of existing Li-ion batteries.

The potential uses of EDLCs will grow dramatically if materials research leads to commercially available devices with significantly increased energy density. The prospect of high capacity, long operating life and low price will open up applications in transport (electric vehicles) and utility-scale energy storage in the power system on timescales up to hours.

Superconducting magnetic energy storage (SMES)

Superconducting magnetic energy storage (SMES) systems store energy in a magnetic field created by the flow of direct current through a superconducting coil.

Their primary advantage compared to other types of energy storage is their very short reaction time and ability to provide high power for short periods. Because they can be switched on with virtually no time delay, SMES systems can counteract abrupt changes in demand for applications

where even the shortest interruptions are unacceptable. Ignoring cooling losses (but see below) they have a high round-trip efficiency: typically 95% [5] or higher for the superconducting coil itself, minus a few percent lost in the power electronics converter. This gives SMES systems an advantage for applications involving many charge/discharge cycles.

Theoretical background

The energy (E) stored in a current-carrying coil is:

$$E = \frac{1}{2} LI^2 \quad (4)$$

where L is the inductance of the coil and I is the current. This applies to any coil, but in practice only coils made from superconducting materials can sustain currents high enough to provide useful energy storage capacity.

A SMES coil needs to be cooled to a temperature below the “critical temperature” (T_c) of the superconducting material used to make the wire. The critical temperature depends on the type of material. Low-temperature superconductors (LTSCs) are either basic metallic elements or alloys, and they have critical temperatures of 20 K (-253°C) or below. High-temperature superconductors (HTSCs) are complex ceramics with critical temperatures up to 133 K (-140°C) [4].

The current (I) is limited by the critical current density (J_c) of the superconducting material: if the current exceeds this critical level the material will move out of its superconducting state, either abruptly or gradually depending on the type of material. To sustain currents high enough for practical SMES devices, modern ceramic superconductors are engineered to obtain higher critical current densities by creating inhomogeneities in the material.

The coil inductance (L) depends on the number of turns and the coil geometry. Two specific coil geometries are worth mentioning: solenoids and toroids. The simplest geometry is the solenoid, in which the wire is wound as a straight tube-shaped coil. A toroid is a solenoid that has been bent into a circle to form a doughnut shape. Smaller SMES devices are usually made as solenoids because these are easy to wind, but they exhibit a considerable exterior magnetic field which may be hazardous. Larger SMES devices are usually based on toroidal coils, since this geometry constrains the strong magnetic field within the doughnut.

The main factor limiting the energy density of SMES devices is the magnetic force acting on the wires of the coil. The coil configuration and tensile strength of the superconducting material are therefore important. Superconducting magnets also typically contain steel reinforcements to limit the conductor strain to a tolerable value. A toroidal SMES device with a storage capacity of 100 MWh would be at least 100 m in diameter.

A SMES installation connected to the power system includes a superconducting coil, a power-electronic converter and a cryogenic cooling system (Figure 28). The superconducting coil is “charged” by applying a DC voltage which causes the current through the coil to increase. When the current reaches its working value an electronic switch isolates the DC supply and short-circuits the coil. Because the coil has zero resistance, the current continues to circulate without losses and with no heat generation. To release the stored energy, the switch is opened and the coil discharges through the converter, yielding AC power which can be fed to the grid.

Characteristics of SMES

Cooling is a major issue for SMES. The losses in the superconducting coil itself are negligible under steady-state conditions, but a cryogenic refrigerator is needed to keep the superconductor cool, and efficiency calculations must take account of this. The choice of cooling medium depends on the type of superconductor: LTSC coils are typically cooled with liquid helium at a temperature of 4.2 K, whereas HTSC coils can be cooled using liquid nitrogen at 77 K. The capacity of the cooling system is determined by the amount of heat to be removed, including conduction and thermal radiation through the cryostat walls, small electrical losses in the superconductor during charge and discharge, as well as losses and thermal conduction through the current leads that connect the cold SMES coil to the room-temperature part of the system. Conduction and radiation losses can be reduced by the use of vacuum insulation, but the heat inflow through the current leads is significant and unavoidable.

Figure 28

A SMES system comprises a superconducting coil in a cryogenic enclosure, an electronic converter to match the DC power in the coil to the AC on the grid, and an electronic switch to control the flow of current into and out of the coil.

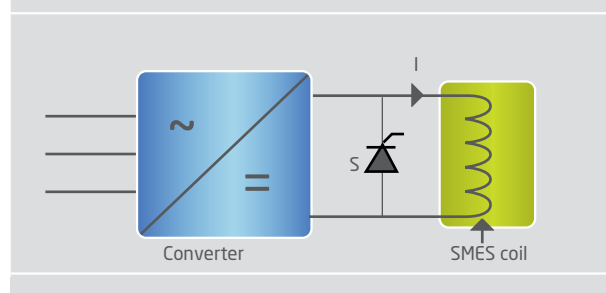

The efficiency of a cryogenic refrigerator is typically a few percent and decreases with temperature. The heat influx to the cryostat also increases with decreasing coil temperature, so the cooling requirements are much higher for LTSCs than for HTSCs. The cooling requirement is to a large extent independent of the amount of current flowing through the SMES coil.

Other factors to consider when comparing low- and high-temperature SMES systems are mechanical stresses, cryogenic insulation, reliability and costs. A large part of the equipment cost is associated with the superconductor, and here a careful engineering evaluation is needed to decide which type of conductor to use.

LTSC materials are more developed than HTSCs, far cheaper, and available in longer piece lengths. Since LTSCs are metal alloys, their mechanical properties are superior to those of the complex ceramic HTSC materials.

HTSCs are more expensive than LTSCs because of the complexity involved in manufacturing them. However, HTSC materials can carry higher currents at higher magnetic fields than LTSC materials are capable of, and their higher operating temperatures reduce the cost of refrigeration.

There are advantages to operating HTSCs at temperatures well below the threshold of superconductivity. Reducing the operating temperature to, say, 4.2 K increases the current capacity dramatically, though this may not be enough to compensate for the much higher cooling losses.

With no moving parts, a SMES coil experiences virtually no degradation from charge cycling, though a strong support structure is needed to control the large forces generated by the magnetic field. The ancillary equipment (vacuum chamber and cryogenic cooler) will degrade over time, though ways that are largely independent of charge cycling.

Application areas

The effective energy density of SMES systems is low. Given their high power density, this results in very short operating timescales (τ), typically 1 second or less.

SMES systems have so far only been made in relatively small sizes, with energy storage capacities up to approximately 100 MJ (28 kWh) [6]. The lack of actual implementation of large SMES units can likely be attributed to such factors as their high technological complexity, the energy requirements for refrigeration, and the high cost and man-

ufacturing complexity of the superconducting wires. SMES systems are presently used only for applications involving storage covering very short timescales, such as improving power quality and voltage support in relation to load transients [7].

There are several test projects and small SMES units available for commercial use. The cost of SMES is not well-defined since only a relatively small number of custom made units have been produced. The German company Bruker, for example, has supplied SMES built to customers' specifications (Figure 29) [8].

A few SMES units in the power range around 1 MW, with energy capacities of 1–30 MJ, are used for power quality applications around the world [6], for example to ensure top-grade power for highly sensitive manufacturing or scientific measurement equipment.

Future possibilities

SMES systems have so far remained a curiosity within energy storage. Their use is restricted to small sizes and very short timescales, for applications where other solutions are insufficient or in cases where the opportunity to study a working SMES system helps to justify the cost.

The superconducting material itself is a big issue in relation to SMES. Although materials development has yielded increases in the critical magnetic field and hence the current density that SMES devices can sustain, this has still not been enough to increase the effective energy density of SMES systems beyond that of other storage technologies. Given the high costs of superconducting materials and cryogenic cooling it is hard to see how an economically viable commercial SMES facility can be achieved using existing materials.

Figure 29

A 2 MJ SMES unit supplied by Bruker. So far, practical SMES systems have been limited to niche applications.



Research has also aimed to improve the mechanical properties of high-temperature superconductors and reduce the cost of wire manufacturing. Finding techniques that allow continuous production of extended lengths of superconducting wire is very difficult, so research has therefore focused on how to apply thin films of ceramic superconducting material onto stable substrates.

The use of small-scale SMES in power systems is now possible, but a SMES system providing utility-scale storage capacity (1 MWh or more) and based on currently known materials and technologies would be unrealistically large and commercially non-viable, due to the costs of materials, refrigeration and thermal insulation.

Large commercial SMES systems will require one or more technological breakthroughs, such as room-temperature superconductivity or cheap, flexible superconductors. The ultimate limits of superconducting materials are unknown, but no major advances have been made since the discovery of high-temperature superconductivity in the late 1980s. The most probable future use of SMES is therefore small-scale, for extremely demanding power quality or specialised scientific applications, rather than utility-scale bulk energy storage.

Conclusions

Electricity can be stored directly in an electrical double-layer capacitor (EDLC) or superconducting magnetic energy storage (SMES) system. Both technologies avoid the need to convert electricity to other forms of energy; the result is high efficiency and short reaction time, but also low volumetric energy density. Apart from these shared characteristics, the two technologies are different in almost every other respect.

The EDLC is a fundamentally simple and robust technology. The main limiting factor in relation to power system applications is its low energy density, but high power density and the effective absence of cycle degradation still make EDLCs very interesting for power quality applications. EDLC research is very active, and major improvements in energy density might well be around the corner. EDLCs are therefore a promising storage technology for power system applications, and this makes feasibility studies and prototype testing of this technology highly recommendable.

SMES is a more complex technology in the sense that it demands advanced ancillary equipment to operate. Its main advantage is its very short reaction time, but this feature is necessary only for a few highly specialised applications. Further development of SMES technology depends on research on superconducting materials. Commercialisation and widespread use in power systems will not be possible without major advances such as room-temperature superconductors.

SMES can therefore best be regarded as an interesting and slightly exotic technology, with little or no relevance to energy storage in power systems. Our recommendation would therefore be to follow the materials research related to this technology with an open mind, and to perform feasibility studies in case research leads to new possibilities.

Tejs Vegge and Poul Norby, DTU Energy Conversion; Kristina Edström, Uppsala University

Introduction

Electrochemical energy storage in the form of batteries holds great promise in a range of applications, which cover many of the future needs envisioned both in Denmark and abroad [1]. These range from portable consumer electronics such as mobile phones and tablet computers, through mobile applications including urban transport, boats and forklift trucks, to large-scale grid-based applications for stabilisation and short-term load balancing of fluctuating, renewable sources like wind and solar energy.

Areas such as aviation, long-range transport of goods and seasonal energy storage clearly lie well beyond the capabilities of existing batteries, and it will not be possible to address these without radical improvements in technology. Even in near-term battery applications, the diversity of uses yields a similarly wide range of requirements – and potential obstacles – in terms of energy and power density, charge and discharge rates, durability, price and safety [2].

The success of the ambitious Danish Energiplan 2050 [3] in moving towards a society that relies increasingly on renewable energy depends on R&D in novel battery technologies among other energy storage solutions. Several national and international research projects on the development of novel, high-energy-density batteries (ReLiable [4]) and improving emerging and existing technologies (Hi-C [5],

ALPBES [6]) have recently begun, but more are needed to meet the expected demands of the future energy infrastructure. A Danish test facility to investigate the viability of lithium batteries for grid-scale storage in connection with wind power has recently been established [7].

This chapter presents the requirements for current and future battery technologies to be used in portable, mobile and stationary applications, and the corresponding challenges. Denmark's needs in this respect are generally very similar to those of the rest of the world. We emphasise the role of batteries in the energy sector and the challenges in terms of energy and power density, charge and discharge rates, efficiency, durability and safety. The discussion includes fundamental materials challenges for a number of promising battery chemistries, including lithium-ion and metal-air batteries.

As described in Chapter 8, electrical double-layer capacitors (EDLCs, or ultracapacitors) are also of considerable interest in future energy applications. Although their specific energy is very small compared to lithium batteries, their high power density may allow the development of efficient systems based on combinations of batteries and ultracapacitors [8].

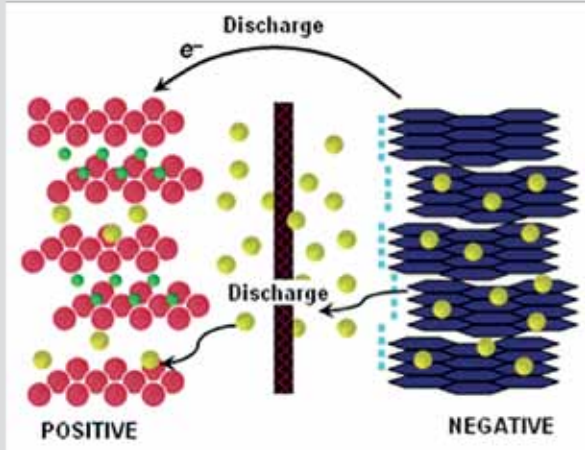

Oxygen

Lithium Ion

Metal Ion

Carbon

Separator

SEI

Battery facts: Lithium-ion batteries

A rechargeable lithium cell consists of a positive and a negative electrode separated by an electrolyte. Normally there is also a separator membrane to avoid short-circuiting the cell. The charge is carried by lithium cations in the membrane and by electrons in the outer circuit.

As the cell is discharged, electrons move from the negative electrode (anode) to the positive electrode (cathode). During charging the process is reversed.

The positive electrode, usually referred to as the cathode, typically consists of a transition metal oxide (such as LiCoO_2 or LiMn_2O_4) or another transition metal compound (such as LiFePO_4). The negative electrode is usually carbon (graphite), which may intercalate lithium up to LiC_6 . Lithium titanate ($\text{Li}_4\text{Ti}_5\text{O}_{12}$) is a newer anode material used especially for long-life-time, high power density batteries. One of the promising new anode materials is silicon, which allows more than four lithium atoms to be intercalated per silicon atom.

Energy storage applications

Batteries are an essential component in the development of a society based increasingly on sustainable energy. Present-day rechargeable lithium-ion (Li-ion) batteries have been very successful since they were commercialised around 1990 [9], largely due to their higher energy density compared to competing battery chemistries like nickel-metal hydride (NiMH) (Figure 30). Li-ion batteries now dominate the market for consumer electronics, and the technology is also gaining market share in high-power applications such as power tools, electric vehicles and boats. The most promising expanding markets for high-power batteries are within transportation (electric vehicles) and as storage for intermittent renewable sources such as wind and solar energy, where they can help with frequency- and voltage stabilisation and balancing the grid on a timescale of minutes to hours.

In the near future, the use of battery-powered portable devices is expected to continue to grow and expand into new applications. This will create a demand for new and specialised battery types, but Li-ion technologies are likely to continue to dominate this market in the foreseeable future [12]. The Li-ion chemistry is well suited to moderate energy density applications, and in particular the low power density requirements of typical portable applications.

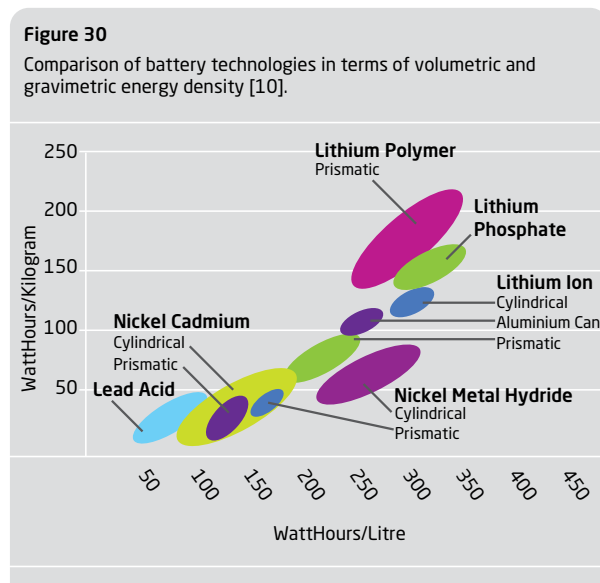

As Figure 31 shows, it is possible to make lithium batteries with high power densities, but the energy density typically decreases significantly when high currents are needed. Also the efficiency due to, e.g., higher over-potentials, decreases with high current rates. Although lithium-based batteries for transportation and mobility have the potential to become the largest market for batteries in Denmark and abroad, a number of fundamental challenges remain to be resolved, especially relating to power density (Figure 32), lifetime/durability and price [2].

More investment in the development of batteries with high energy densities and high power densities is needed to meet the future requirements for transportation; electric vehicles may also ultimately play a role in providing decentralised grid-scale storage to balance daily fluctuations in electricity generation and consumption. Significant efforts are now being made to improve energy density while at the same time reducing materials costs and the dependence on scarce materials, increasing battery durability and cycle life, and improving safety [1].

The largest potential for electrochemical storage in a future sustainable energy infrastructure is probably for frequency and voltage stabilisation in connection with sustainable energy sources as well as in dealing with hourly and daily

Figure 31

Specific power as a function of specific energy for a range of battery chemistries and ultracapacitors. All systems show a decrease in energy density when high currents are drawn, illustrating the challenges of optimising both simultaneously [11].

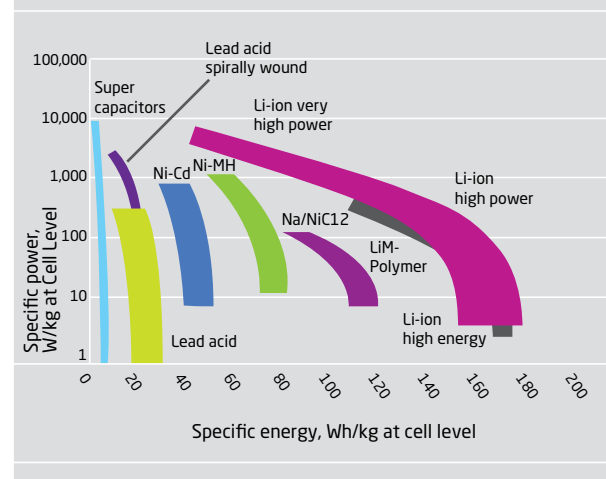

fluctuations caused by variations in production from wind and solar power. This requires very fast and reversible energy storage with low energy losses and high durability, which in turn means that batteries used for large-scale storage face quite different challenges compared to those in portable and mobile applications.

For large centralised storage applications, the important considerations are cost, volume, fast charge/discharge rates, short response times, durability (both shelf-life and cycle-life) and low maintenance requirements. Commercial systems based on highly durable lithium batteries, such as those with lithium titanate anodes, are already in limited operation; one such storage facility is currently being tested in Denmark [7]. For these applications, lithium batteries face competition from alternative technologies such as flow batteries [13].

Technological and materials challenges

Lithium batteries now dominate the market in powering consumer electronics such as mobile phones, tablets and computers, but even here they continue to face significant challenges related to materials, durability/life time, interfaces, raw materials cost and production. Before Li-ion batteries see widespread introduction in the transport and energy sectors it is critical that we overcome limitations on storage capacity, degradation, cyclability and stability, and the safety issue of fires caused by uncontrolled chemical reactions. Interfaces and interface reactions in batteries play an important role in controlling battery performance and safety, and it is important to understand interface

transport properties, structure and formation at an atomic and molecular level.

One of the largest obstacles to large-scale use of today's Li-ion batteries is their high price per kWh, which is a combination of the cost of materials and processing. Mass production is expected to yield some cost savings, but a significant reduction in materials price is still required through research into alternative materials. Other challenges concern the availability of resources and the environmental impact of the materials, including toxicity. Limited resources of certain key elements such as cobalt may restrict production or increase battery prices [2]. Future batteries should ideally use abundant and reusable resources; batteries based on iron and manganese, for example, are very attractive from a resource and environmental perspective.

Specific energies (Wh/kg) and volumetric energy densities (Wh/L) must be improved, especially for future applications in transport, where the batteries needed for a reasonable driving range are simply too heavy [2] as illustrated in Figure 32. While the energy density of lithium batteries is high compared to earlier battery technologies (Figure 31), it has increased only modestly in the last two decades. Promising high-energy-density materials include new NMC (nickel-manganese-cobalt) Li-rich high-voltage materials for cathodes, and silicon nanoparticles in anodes. However, even the medium-term goal of boosting energy density by a factor of 3–5 can only be achieved by a paradigm change in the way lithium is stored in the electrodes. Alternative emerging battery technologies offer the potential of a many-fold increase in energy density; these include lithium-sulphur batteries [14], metal-air batteries, magnesium (Mg) batteries and other conversion battery types such as Fe/LiF [15, 16].

The **power density** of a battery naturally affects the recharge time for electric vehicles: higher power density means faster charging for the same battery capacity. However, high currents are even more important in connection with storage systems for intermittent renewable energy plants, which must accommodate large currents (in both directions) with very low energy losses, no decrease in capacity or lifetime, and no compromises in safety. This can be achieved by using larger batteries or by improving the specific power density of the batteries. Figure 32 compares power density and specific energy for various electrochemical storage solutions; ultracapacitors have the highest power densities, but with very low energy densities, and – as with all the storage technologies shown – the energy

Figure 32

Estimated battery weights and sizes for an electric vehicle with a 200 km driving range between charges (50 kWh). The lithium-air battery has not yet been realized as a commercial battery, and the values for the volumetric and gravimetric energy density are optimistic estimates.



density falls as the specific power increases. Existing lithium-ion batteries can also achieve high power densities, but at the expense of energy density: for a given size of battery, as the current increases the available capacity decreases significantly. In addition, the energy efficiency decreases by increasing current.

The challenges related to improving batteries are to a very large extent associated with materials and interface properties, as reflected in issues pertaining to ionic and electronic transport, reactivity, degradation, stability, kinetic barriers and phase mobility. Solving these challenges will require a better understanding of the fundamental mechanisms at the atomic scale. This requires dedicated effort based on a combination of experimental and theoretical work – a synergy between computational chemistry, materials synthesis, electrode preparation and advanced structural and electrochemical characterisation [17].

Below we discuss a few examples of promising future battery technologies, including metal-sulphur and metal-air batteries for high energy densities; conversion batteries; robust low-cost batteries such as sodium batteries; and novel flow-type batteries.

Materials development

Different applications place very different demands on the battery performance. Grid-scale storage can accept batteries that are heavier than those needed for mobile applications (lower energy density), but high power operation and long-term stability (a high number of charge/discharge cycles) are mandatory to allow many years of operation with minimum maintenance.

The solutions to present and future challenges in battery research will therefore depend specifically on the applications targeted. A key requirement for widespread introduction of Li-ion batteries in the transport and energy sectors is the ability to solve the significant challenges related to price, storage capacity, degradation, cyclability, stability and safety.

High-energy batteries: At present, the gravimetric energy density of lithium batteries is limited by the use of transition metals. The cell voltage is determined at the positive electrode by a single-electron oxidation/reduction, for example of cobalt or iron, and at the negative electrode by the redox potential of lithium or a lithium compound. Future needs call for a significant increase in energy density, but this can happen only in a limited number of ways.

All of these are currently under investigation, though they have different potential impacts:

Lighter electrode materials: novel battery chemistries without transition metals now under development include the reaction of lithium with oxygen (lithium-air) or sulphur (lithium-sulphur) [14]. This could increase the energy density by 5–10 times.

Higher cell voltages will increase energy density. Substantial research is put into developing cathode materials for high voltages (approaching 5 V) [18]. However, big challenges in terms of electrolyte stability, safety and cyclability still have to be overcome. This could increase the energy density by 1.2–1.3 times.

Transferring more than one electron per active transition metal atom could increase the energy density; this might be done by using several oxidation states of iron or manganese. In addition, conversion type batteries involving, for example, iron fluoride are of increasing interest [16], as are other metal-air batteries such as zinc-air [19]. This could increase the energy density by 1.5–2.5 times.

The use of thin solid electrolytes may also improve energy density, for instance by enabling the use of metallic lithium anodes. However, this requires the lithium-ion conductivity of the solid electrolytes to be improved significantly [20]. This could increase the energy density by 1.5–2 times. However, solid electrolytes are most frequently used in thin film batteries, where the energy density is not as high as in conventional lithium batteries.

High-power batteries: The increasing demand for high power densities in batteries has led to intensified research into battery interfaces and optimisation of transport properties. Much of the power density limitation in batteries is caused by electronic and ionic transport issues in the bulk and across interfaces [21]. Optimisation of transport properties relies on knowledge of structures and defects in external and internal interfaces in the active electrodes, and of reactions between solids and the electrolyte. In addition, nanostructuring of materials and optimising the 3-D structure of batteries are important for high-power operations [22].

Low-energy-density and robust solutions: For grid-scale storage, land-based operational storage systems and sea transport, energy density is not as important as robustness and long life. Here, alternative battery chemistries such as

flow batteries are of interest; examples are vanadium in aqueous electrolyte solutions, and cerium-zinc [13, 23]. In addition, development of cheap and robust sodium batteries is of considerable interest [24], but further developments are still needed for both technologies.

Recommendations for electrochemical storage solutions

As outlined in this chapter, battery technologies are expected to play an increasing role at multiple levels of the future energy infrastructure:

Electrification of the transport sector will require efficient and inexpensive energy storage solutions, and existing lithium-ion and next-generation batteries will be a key factor in this development.

Grid-scale storage for load balancing in connection with renewable energy sources may be based in part on electrochemical storage.

Highly application-specific demands in terms of parameters including energy/power density, charge/discharge rates, durability and safety, as well as reduced cost, will, however, dictate substantial improvements in existing battery technologies and the development of novel high-performance batteries, if sustainable battery solutions are going to become competitive for transport and stationary applications. Researchers across the world are increasingly focusing on better batteries for electric vehicles and large-scale storage. Denmark also needs substantial investments in fundamental battery research, materials development and the implementation of new battery technologies to facilitate the ongoing transition to a society based on sustainable energy.

A battery is only one form of chemical energy storage, and as the next chapter describes, synthetic fuels produced from sustainable energy are also expected to compete with/complement batteries in the transportation sector. Examples are hydrogen, the electrochemical fixation of CO₂ to produce methane or methanol [25], and the conversion of nitrogen to ammonia [26].

Figure from ref 27.

Battery facts: lithium-air batteries

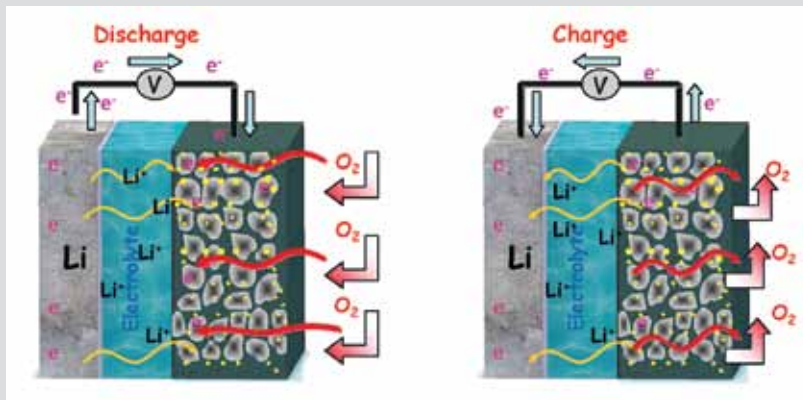

The lithium-air (or lithium-oxygen, Li-O₂) battery exploits a reversible reaction between lithium and oxygen which potentially yields an extremely high energy density [27].

The maximum energy content is obtained by oxidation to lithium oxide:

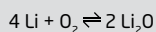

In practice, however, only the reaction to lithium peroxide is reversible [28]:

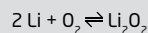

It is realistic to imagine lithium-air batteries with ten times the energy density of today's lithium-ion batteries. If they could provide the same safety and performance figures as existing lithium-ion batteries, they would revolutionise transport and grid-scale storage. However, though the reversibility of the lithium-air battery has been proven, numerous challenges remain in creating a viable lithium-air battery [29, 30].

Chemical energy storage

Jakob Munkholt Christensen, DTU Chemical Engineering; Peter Vang Hendriksen, DTU Energy Conversion; Jan-Dierk Grunwaldt, Institute for Chemical Technology and Polymer Chemistry and Institute of Catalysis Research and Technology, KIT, Germany; Anker Degn Jensen, DTU Chemical Engineering

With the finite nature of fossil resources and the concern about global climate change it is expected that the energy sector of the future to a large extent will be based on renewable resources such as sun and wind [1, 2]. A major challenge in an energy infrastructure relying heavily on electricity production from renewable resources is the fluctuating productivity. As an example the power generation from an offshore wind farm like Horns Rev can fluctuate between essentially no output and the rated output in less than an hour [3]. To stabilise the system against fluctuating imbalances between supply and demand of electricity it is necessary to store large amounts of energy from periods with high renewable electricity output to periods with low output. Currently the direct storage of electricity produced by wind turbines and solar cells is very challenging at the necessary scale, and a more promising approach seems to be energy storage in the form of chemicals [1, 4]. This is illustrated in figure 33, which shows how the energy density in chemicals is much greater than the energy density of current battery technologies. The produced chemicals would not only be useful for subsequent electricity production, but also as fuels for the transportation sector and as raw materials for the chemical industry, substituting fossil oil.

A way to stabilize the energy sector could be to use water electrolysis to produce hydrogen in periods with excess electricity production. The hydrogen could be used as an energy storage molecule in itself or used in the synthesis of other storage molecules. Another contribution to a stabili-

sation of the fluctuating electricity production could be to have a significant capacity for gasification of renewable resources (biomass and carbon containing waste fractions) in the energy sector. Gasification is the reaction of carbonaceous raw materials with steam at high temperature to produce syngas (mainly CO, CO₂ and H₂) [10]. When electricity is in short supply the syngas can be combusted to produce electricity, and when electricity demands are supplied by e.g. sun and wind the syngas can in a range of catalytic processes be converted into various fuels and chemicals (e.g. methane, methanol and synthetic gasoline and diesel) [4, 10, 11, 12, 13]. There are obvious synergies between electrolysis and gasification, as the syngas immediately produced in gasification typically is deficient in hydrogen compared to the requirements of the syngas conversion [14, 15]. It would therefore be beneficial to boost the hydrogen content of the syngas with hydrogen from water electrolysis. This approach is illustrated in the diagram in figure 34.

Many types of biomass are characterized by a low energy density that makes transport to a central conversion unit a challenge. Some proposed biomass utilization strategies focus on performing a local pyrolysis of the biomass, which yields a bio-oil with 7–8 times higher energy density than the original biomass [16]. The bio-oil can then at a central facility be gasified [17, 18] or upgraded to fuels (see figure 34) [16]. The upgrading is typically a treatment with hydrogen, which in turn could come from water electrolysis.

Figure 33

Energy densities of various storage chemicals (on a lower heating value basis) and battery technologies [1, 5, 6, 7, 8, 9]. For N-ethylcarbazole, Mg(NH₃)₆Cl₂ and liquid ammonia the energy content is that of the contained H₂.

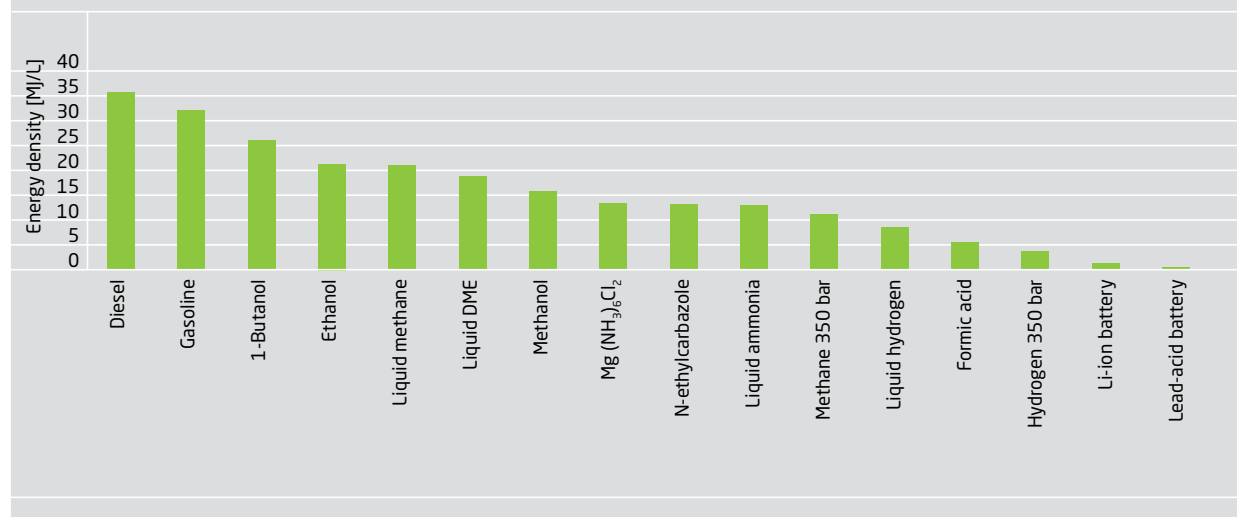
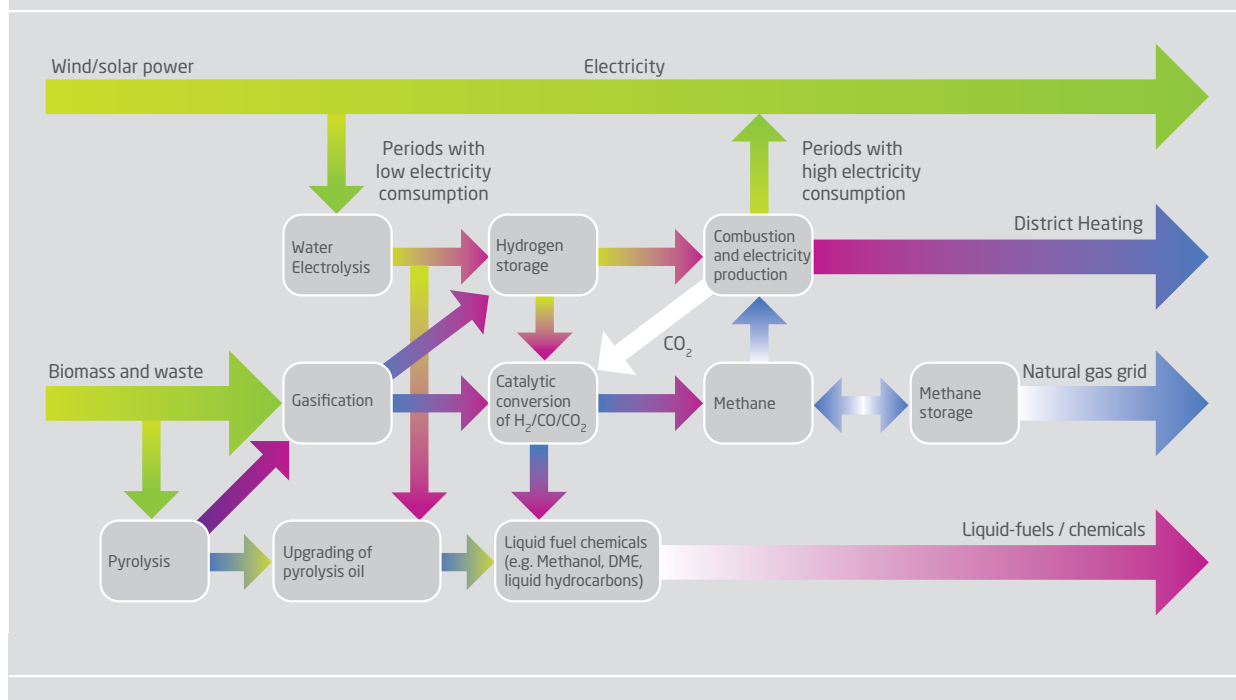

Figure 34

The concept of an energy infrastructure utilizing the storage of renewable energy in chemicals through water electrolysis and biomass gasification.



For most of the potential energy storage chemicals catalysis is one of the keys for improvement of the production technologies, and it is still necessary with research into and improvements of the catalytic synthesis of the chemicals. Since 2009 the Catalysis for Sustainable Energy (CASE) Initiative at DTU funded by a 16 mio. € grant from the Danish Ministry for Science, Technology and Development has focused on the development of catalytic processes for storage of energy from renewable resources. The CASE project has contributed substantially to the understanding of the storage solutions described in this text [19].

Storage compounds and production technologies

This section discusses a number of possible chemical storage compounds, their pros and cons and related production technology.

Hydrogen

Many factors make hydrogen an ideal energy carrier, and the concept of a widespread hydrogen economy was already suggested in Jules Verne's 1874 novel *The Mystery-*

ous Island. Hydrogen has a very high weight based energy content of 120 MJ/kg (based on the lower heating value – the energy if the heat of water condensation is not utilised) and its only combustion product is water. Hydrogen can be converted into electricity by means of a fuel cell or a gas turbine [20, 21]. Contemporary fuel cells can achieve 50–55 % efficiency [22, 23], and a similar efficiency can be achieved with a gas and steam turbine [21, 22].

Hydrogen can be produced from water electrolysis using renewable electricity or produced directly from sunlight by photocatalytic water splitting [24]. However, as it is easier to collect electricity produced from an array of photovoltaic cells at a central electrolysis unit, than it is to collect the hydrogen produced from an array of photocatalytic cells [1], research is required to enable photocatalytic systems relying on inexpensive, earth-abundant materials [1, 25]. Here the CASE initiative at DTU has made considerable progress [25].

Electrolysis

Hydrogen can be produced from renewable electricity by for example water electrolysis. Electrolysis is an established technology, but due to unfavourable economics only

around 4 % of the global hydrogen production is currently derived from water electrolysis [20, 26]. The increased demand for energy storage following from an increased extent of irregular production on the electricity grid of the future has led to renewed interest in the application of electrolysis in the energy sector. Different technologies for electrolysis exist (or are under development) with key ones being: alkaline electrolysis, Proton Exchange Membrane (PEM) electrolysis and solid oxide electrolysis (SOE) cells. In Denmark development of all three technologies is being pursued [27]. In Ref. [28] Hendriksen et al. outlines characteristics of the different electrolysis technologies and points to suitable application areas and scales in the energy system.

Alkaline electrolysis is a mature technology used in industry since the 1920s and scaled up to multi MW plants [29, 30]. Electrolysis systems based on PEM cells are less mature than the alkaline counterpart, but kW scale systems are available from commercial suppliers [29, 31]. Efficiencies are on the level of alkaline plants [30]. The PEM technology has virtues in terms of flexibility of operation and in allowing production of high pressure hydrogen, but the cell life time needs to be improved [30]. SOE is the least mature of the three technologies being so far demonstrated on kW scale only and with maximal test durations on the scale of 1 year [32, 33]. However, the technology is promising in the sense that it may become inexpensive (no noble metals involved) and potentially may reach high efficiency [33, 34]. In addition there is an obvious synergy between this technology and upgrading technologies for production of synthetic fuels from the produced hydrogen (or syngas). Such reactions are typically high temperature, exothermic processes and the “waste” heat of these can be used to boost the efficiency of the electrolysis process.

The energy efficiency in the conversion of water to hydrogen depends on the system, the scale, and on which of the above technologies that is applied. The efficiency for the electrolyser itself may reach up to 68–80 % on the basis of the lower heating value (80–95 % on the basis of the higher heating value) [26, 35]. When considering the whole electrolysis system the best current system efficiencies are in the range of 62 % (with alkaline electrolysers) [26, 35, 36]. The values in this text are generally based on the lower heating value, since the heat from condensation of formed water cannot be utilized in most applications of the studied fuels. The energy efficiency in the synthesis of a fuel determines how large a fraction of the primary, renewable energy that can be utilized by the consumers and is a determining factor for the economics of the fuel synthesis process.

Storage and transport of hydrogen

On the negative side, a major challenge for the direct use of hydrogen as an energy carrier is the low volumetric energy density (see figure 33). This is especially a problem for mobile applications. To attain a range of around 500 km for a typical vehicle it is necessary to compress the hydrogen to 350–700 bar, but this generally requires a compression duty corresponding to 10–15 % of the energy content in the hydrogen [37]. A higher energy density can be achieved by liquefying the hydrogen, but the cooling duty required for the liquefaction corresponds to about 30 % of the energy contained in the hydrogen [37]. These energy penalties further decrease the fraction of the primary energy that can be utilised by the consumer. Research into alternative hydrogen storage solutions with easier handling and higher volumetric energy density is on-going. This involves storage in solid metal hydrides [37], liquid formic acid [38] or liquid carbazoles [37]. It is also an issue that large scale transport of hydrogen requires a dedicated infrastructure with special requirements in terms of pipeline materials and safety considerations [2, 39, 40] and that road transport of hydrogen suffers from low efficiency due to the low energy density [40]. It could therefore in some cases be advantageous to store the hydrogen by a conversion into chemicals with greater energy density and easier handling.

Methane

Methane (CH₄) is an interesting storage molecule. At identical pressures the volumetric energy density of gaseous methane is more than 3 times the volumetric energy density of gaseous hydrogen. In many countries, including Denmark, there is already a widespread infrastructure for transportation and handling of natural gas. Gas stations for fuelling vehicles running on natural gas are now also appearing in Denmark.

Methane can, typically with the use of a nickel catalyst, be produced from syngas by hydrogenation of CO and CO₂ (R1 and R2) [41]. In parallel to the synthesis reactions the so-called water-gas shift reaction (R3) takes place as well.

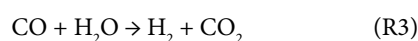
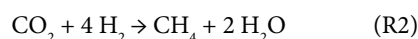
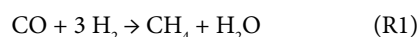

It has been estimated that the energy efficiency in conversion of biomass to methane via gasification can reach the

60–65 % range [41, 42]. Methane rich bio-gas can also be produced by anaerobic digestion of biomass [43]. It has been reported [44] that the biogas contains 20–40 % of the energy content in the biomass. In Germany the concept of “power-to-gas” has recently attracted attention [45, 46]. In this suggested concept stored methane is combusted to generate electricity in periods with insufficient renewable electricity production. The CO₂ produced in the methane combustion is then, by means of electrolysis derived H₂, hydrogenated into CH₄ with an estimated energy efficiency of around 75–80 % [1, 45]. The methane can then be stored in the natural gas grid and in salt caverns. A downside to this concept is the necessary storage of significant amounts of H₂ and perhaps also CO₂ between methane synthesis and methane combustion. There are also challenges related to the use of methane. The energy density of gaseous methane is lower than that of liquid fuel chemicals, there are safety aspects to be considered in the handling of methane [39], and methane has a greenhouse gas potential approximately 25 times (mol/mol) higher than CO₂, which means that leakages from a large scale methane infrastructure must be avoided [47, 48].

Methanol and higher alcohols

Another potential storage molecule is methanol [26, 39, 49]. Methanol can be produced from syngas by hydrogenation of CO and CO₂ over a copper based catalyst (R4 and R5) [50]. Along with the methanol synthesis reactions the water-gas shift reaction (R3) takes place as well.

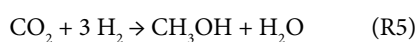
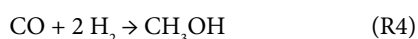

It has been discussed elsewhere [51, 52] how rational design of improved catalysts for this process requires structural characterization during exposure to relevant operating conditions. The energy efficiency in the conversion of biomass to methanol via gasification is estimated to be in the range of 57–59 % [42, 53]. Estimates show that the energy efficiency could be increased by combining the gasifier and synthesis plant with a high temperature electrolysis unit [54].

Methanol is a liquid, and this is an advantage as our current energy infrastructure with its heavy reliance on oil largely is geared towards liquid fuels. Methanol is a highly efficient fuel for gasoline vehicles [55]. In the long term methanol could also be used in vehicles powered by a direct methanol fuel cell, although research is needed for example to alleviate the need for expensive noble metal catalysts in the fuel

cell [56]. Methanol, which is easily transported, can also be reformed locally to produce hydrogen [57]. Additionally methanol can be converted into dimethyl ether (DME, an alternative to oil-derived diesel fuel) [15, 58, 59]. The energy efficiency in the synthesis of DME from biomass via gasification is estimated to 58 % [42]. Estimates of energy efficiencies are generally for larger, centralized plants. For both methanol and DME it has been estimated that small decentralized plants would have a 6–8 % lower efficiency than what can be achieved in a large centralized plant [13]. There are also well established processes for converting methanol into synthetic gasoline (reportedly at around 90 % energy efficiency) [11, 60], as well as into acetic acid, formaldehyde and olefins [26]. Methanol is thus also useful as a platform molecule for the chemical industry. There are however also challenges associated with the use of methanol. The volumetric energy density of liquid methanol is, although higher than that of hydrogen and gaseous methane, nevertheless considerably lower than that of higher alcohols and liquid hydrocarbons (see figure 33). In the presence of water there are also issues with the miscibility of methanol and gasoline (a phase separation creates a corrosive methanol-rich phase), which makes it difficult to phase in the fuel use of methanol [61]. A mixture of methanol and higher alcohols (ethanol, propanol, butanol) can also be prepared directly from syngas [62, 63, 64, 65], although the energy efficiency in the mixed alcohol synthesis currently is lower than in methanol synthesis [66]. In the presence of water the mixed alcohols are more compatible with the existing infrastructure, since they have a better miscibility with oil-derived gasoline than pure methanol [61], and the mixed alcohol synthesis might therefore be advantageous during a transition to an energy infrastructure with methanol as a significant energy carrier. Ethanol could, just like methanol, be an important platform chemical for the future chemical industry [67]. A catalytic process that yields ethanol from syngas with high selectivity remains a goal for research [63, 64], but ethanol can be produced by fermentation, and the fermentation based ethanol production also has synergies with power production [68].

Liquid hydrocarbons

Liquid hydrocarbons form the backbone of our current energy infrastructure, and liquid hydrocarbons produced from renewable resources would thus be completely compatible with the existing energy infrastructure. Additionally, synthetic gasoline and diesel fuels produced from renewables have significantly higher energy densities than methanol, ethanol, methane and hydrogen (see figure 33). It is also expected that for example the aviation sector will

rely on liquid hydrocarbon fuels far into the future [1]. Liquid hydrocarbons can be produced from syngas in the so-called Fischer Tropsch synthesis, which is a well-established technology [15]. The Fischer Tropsch reaction, which occurs along with the water-gas shift reaction (R3), can be expressed as:



Where CH_2 represents the basic building block in the liquid hydrocarbons.

As previously discussed gasoline range hydrocarbons can also be produced from methanol and/or DME over a zeolite catalyst [11, 60]:

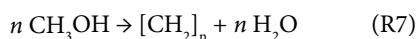

A disadvantage is that the synthesis of liquid hydrocarbons from syngas generally occurs with a lower thermal efficiency than the syntheses of for example methanol, DME or methane. So a lower fraction of the primary energy is stored in the synthesized hydrocarbon fuels. The energy efficiency for the conversion of biomass to synthetic Fischer Tropsch diesel via gasification is estimated to be in the range of 40 % [42, 69, 70]. Estimates place the energy efficiency for the conversion of biomass to synthetic gasoline via gasification and methanol synthesis in the same range (around 43 %) [69, 71]. It is also possible to produce liquid hydrocarbon fuels directly from a catalytic conversion of the sugars in biomass [72, 73] or from treatment of pyrolysis derived bio-oil with hydrogen [16]. These processes require hydrogen, which could be derived from for example water electrolysis.

Ammonia

Another potential storage compound is ammonia (NH_3). Ammonia can be formed from hydrogen and nitrogen over an iron catalyst:



The energy efficiency of the process (from natural gas) can be up to 70 % [74]. Due to the widespread use of ammonia as a fertilizer there is already some infrastructure for transportation of ammonia [5], and ammonia can be stored at a relatively high density as metal amines (such as $\text{Mg}(\text{NH}_3)_6\text{Cl}_2$) – a technology developed at DTU [5, 75]. Research is ongoing to develop catalysts of cheap, earth-abundant elements for the catalytic decomposition of NH_3

into H_2 and N_2 , whereby the hydrogen is unlocked [2, 5, 76]. A disadvantage is that the ammonia release from the metal amine complex and the subsequent decomposition of NH_3 into N_2/H_2 in the ideal case requires approximately 31 % of the energy content in the stored hydrogen [75].

Concluding remarks

A future energy sector relying heavily on power production from renewable resources will most likely require substantial energy storage in the form of chemicals. Figure 34 illustrates the concept of such an energy infrastructure. Here we have discussed a range of possible storage chemicals, and each of these chemicals has both advantages and disadvantages. A future energy infrastructure could therefore easily involve several or indeed all of these energy carriers, and local opportunities and requirements may determine the energy carrier that is preferred in a given situation. Another important parameter will be cost, but as several of the described technologies still are relying on anticipated technological improvements, it is at the moment difficult to provide a comparison of the costs associated with the different energy storage options. A thing that seems clear is that catalysis and electrolysis will play pivotal roles in all of the described storage routes.

For Danish conditions a 2010 report from Energinet.dk analysed various scenarios for the development in the Danish energy infrastructure towards 2050 [77]. In all of the considered scenarios energy storage in the form of gaseous chemicals (hydrogen or methane) was found to be a vital part. In the analysis it was found that storage in the form of methane was most consistent with the existing storage capacity, whereas the use of hydrogen with its lower energy density would necessitate an expansion of the storage capacity [77]. As part of a gas mediated energy infrastructure it is expected that there will be facilities for conversion of syngas and electrolysis derived hydrogen into methanol, DME, liquid hydrocarbons etc. to supply the applications that continue to require liquid fuels [77]. Sectors such as aviation and heavy road transport would be expected to require liquid hydrocarbon fuels far into the future.

A question will be how the limited biomass resource is utilized. The Danish Energy Agency estimates that the amount of biomass currently (anno 2006) available for energy production corresponds to 165 PJ per year (half of which is currently utilized) [78]. This has to be compared to a Danish electricity consumption of 113 PJ, an energy consumption of 210.7 PJ in the transportation sector and a total energy consumption of 792 PJ (in 2011) [79]. Similar

ratios between biomass resources and energy demands are seen on a global scale. Global biomass fuel resources have been estimated to around 100 EJ/year [80], which corresponds to about 20 % of the current global energy consumption [81]. Each one of the biomass conversion options described in this text entails an energy loss in the conversion process. From the perspective of covering the electricity demand during periods of insufficient electricity production from sun and wind the greatest energy efficiency and hence the greatest CO₂ replacement would therefore arise from burning the biomass and producing electricity directly. There could however also be advantages to a gasification of the biomass followed by a conversion of the produced syngas to fuel chemicals. In this case the biomass derived syngas could be supplemented by electrolysis derived hydrogen, whereby the energy content of the biomass could be boosted with the energy from hydrogen produced during periods with excess electricity production from sun and wind. By a catalytic conversion to methane the energy could be stored at a relative high density. Elec-

tricity production from a gaseous fuel (syngas, methane, hydrogen) would have some advantages in dealing with rapidly fluctuating imbalances between consumption and renewable electricity production, as the start-up of gas turbines is relatively rapid [82]. Electricity production from gas is therefore more suitable than electricity production from solid fuels such as biomass or coal when compensating for rapidly fluctuating imbalances between electricity demands and power production from wind and sun [83]. Another factor that merits consideration is that some commentators have argued that the oil price is already entering an era where the production is unable to keep up with the growing demand [84]. If this is the case, then it would from a supply safety perspective be necessary to consider alternative sources of transportation fuels. Here the conversion of biomass and electrolysis derived hydrogen into fuel chemicals would be a way to lessen the reliance on oil and to channel excess electric power into the transportation sector. How the biomass resources are utilized will be a trade-off between all of these considerations.

Thermal storage

Simon Furbo, DTU Civil Engineering and Brian Elmegaard, DTU Mechanical Engineering

Introduction

In principle, heat storage can be divided into three main types: Sensible heat storage, phase change storage and storage using chemical reactions.

In sensible heat storage, the stored energy increases the temperature of a chosen material. To achieve a high heat storage capacity per unit volume the heat storage material should have a high specific heat and a high density. Water scores highly in this respect and has the further advantages of being cheap, safe and easy to handle, so today it is almost always the storage material of choice for sensible heat storage systems operating at temperatures in the range 0–100°C.

Phase change storage are heat storage where a large part of the accumulated heat is released or taken up during the phase change of the heat storage material. In such heat storages it is possible to store large energy quantities at a constant temperature. The heat storage capacity of phase change storages is higher than the heat storage capacity of sensible heat storages if a limited temperature interval is available for the heat storage. In connection with energy systems operating in the temperature interval from about 0°C to 100°C the phase change solid-liquid, where the heat of fusion of the solidification/melting process is utilized, is of specific interest since a number of suitable materials melt in this temperature interval.

Chemical heat storage systems rely on the fact that all chemical reactions either absorb or release heat, so a reversible reaction which absorbs heat when it runs in one direction will release heat in the other direction. The high strength of chemical bonds means that a chemical heat storage system can store much more energy than one based on sensible heat or phase change. Heat loss is not an issue, so a suitably-chosen chemical system can store energy for long periods.

The following sections discuss the status and development of the three different types of heat storage in more detail.

Sensible heat storage

Today almost all marketed heat stores for energy systems operating in the temperature interval from 0°C to 100°C are hot water stores with water contained in a steel, stainless steel, concrete or plastic tank. The tank is insulated with an insulation material with a low thermal conductivity in order to reduce the tank heat loss.

Heat loss from the tank is caused by thermal conduction through the insulation material. Besides the transmission loss from the tank, there is, especially for small tanks, a considerable heat loss through thermal bridges in the insulation.

Thermal bridges can, e.g., be caused by poor insulation work, small insulation thickness in certain places, and by penetrations of the insulation of any kind.

Measurements have shown that the placement of the thermal bridges is of great importance to the magnitude of the heat loss. If a thermal bridge is placed in the bottom of the tank, the water at the thermal bridge will be cooled relatively quickly and form a cold, stagnant, insulating layer above the thermal bridge, so that the heat loss will be low. If a thermal bridge is placed in the top of the tank, the thermal bridge will remain hot, as the water cooled by the thermal bridge is replaced by warmer water from the storage tank because of density differences. Natural convection in the storage tank therefore keeps the temperature of the thermal bridge high, and the heat loss from the thermal bridge will therefore be high.

The piping is also of vital importance for the heat loss from a heat storage. A pipe connection through the insulation is the type of thermal bridge that can cause the largest heat loss, as internal fluid circulation can occur in the pipe, as the density of the fluid is temperature dependent. This internal fluid circulation will heat larger or smaller parts of the piping system resulting in larger or smaller storage heat loss. It is therefore important that the pipe connection is placed in the bottom of the storage tank and that the pipes are carried downwards from the tank so that internal circulation in the piping system is prevented, [1].

If a pipe is connected to the tank top or tank side the heat loss of the pipe connection is high. The heat loss can be somewhat reduced by means of a so called heat trap connected to the pipe just outside the tank. A heat trap is a pipe system with one pipe going downwards close to the tank connection, a horizontal pipe at a lower level connecting the downwards pipe with an upwards going pipe in the other end of the horizontal pipe. A sketch of a heat store with a pipe connected to the top without and with a heat trap is shown in Figure 35.

Figure 35

Sketch of a tank with a pipe connected to the top without and with a heat trap.



Further, if a pipe, which is connected to a tank, is a part of a pipe loop there is a risk that thermosyphoning will occur in the pipe loop resulting in high heat losses from the tank. It is important that a valve which is closed in periods without flow in the loop prevents unwanted thermosyphoning.

During operation of the energy system, thermal stratification can be established in the tank, that is the temperature in the upper part of the tank is high and the temperature in the lower part of the tank is low. If this is compared with the above mentioned conditions, it is essential that:

- the upper part of the solar tank is well insulated with no kind of thermal bridges
- all thermal bridges, e.g. pipe connections, tank securings etc. are placed in the bottom of the tank
- Pipe loops going through the solar tank are equipped with a valve to prevent thermosyphoning.

Figure 36

Schematic sketch of a water pond heat storage.

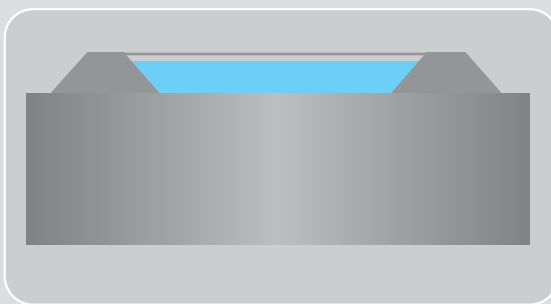

Experience from laboratory tests of marketed solar domestic hot water systems has shown that these are the most important design rules on small heat storages for solar heating systems and that they are of vital importance in order to achieve a high performance solar heating system [2].

For large hot water stores the heat loss from thermal bridges is of minor importance. Further, for increasing volume of the hot water tank the percentage heat loss of the tank is decreasing, because the surface/volume ratio of the heat storage is decreasing for increasing heat storage volume. Consequently, long term or seasonal heat storage is possible if the heat storage volume is high. One possibility of seasonal heat storage is water ponds placed in soil with a sealing consisting of a membrane of clay covered with rubber, see Figure 36. Insulation is built into a floating cover in order to reduce the heat loss from the top of the water pond. The water ponds need no other insulation, as, after a number of years operation, the surrounding earth masses takes active part in the heat storage. Several water ponds are today used as long term heat storages for solar heating systems in Denmark, see Figure 37. Experience from these water ponds will elucidate if seasonal heat storage is possible and economically attractive.

Another long term sensible heat storage type being investigated for the moment is a borehole heat storage, where soil is used as heat storage material instead of water. Pipes with circulating heat transfer fluid is placed in the soil and used to transfer heat to and from the soil. These types of heat storages have also relatively small heat losses if they are large and they are also used for solar heating plants. As the heat capacity per volume of soil is about 35% lower than the heat capacity per volume of water, the volume of a

Figure 37

75000 m³ water pond under construction at Marstal solar heating plant.



borehole heat store should be about 50% larger than the volume of a water pond with the same heat content.

It must be mentioned that thermal stratification in hot water tanks, which is possible because the density of water is decreasing for increasing temperature, can improve the efficiency of some energy systems such as solar heating systems. Thermal stratification can be established during operation of the heat storage in different ways, both during charge and discharge periods. The design of the hot water tank determine how well thermal stratification is utilized to improve the energy system efficiency. In [3] and [4] the suitability related to thermal stratification for differently designed hot water storages for solar heating systems are described.

Future improvements of hot water storage are possible by use of the smart tank principle. The water in a smart tank is heated from the top and the water volume heated in the top of the tank is fitted to the expected future heat demand. In periods with a high heat demand the volume is large, in period with a low heat demand the volume is small. Investigations have shown that smart tanks are suitable as solar tanks, where the lower part of the tank is reserved for heat produced by solar collectors and the upper smart part of the tank is reserved for heat produced by an auxiliary energy supply system, see Figure 39, [5].

Furthermore, in the future flat vacuum insulation panels can be used as insulation material resulting in heat storages with strongly reduced heat losses [6].

Figure 38

19000 m³ borehole heat storage under construction at Brædstrup solar heating plant.



Figure 39

Schematic sketch of (left) a traditional hot water tank with the top of the tank heated to a high temperature by the auxiliary energy supply system and (right) a smart hot water tank with variable volume at the top of the tank heated to a high temperature by the auxiliary energy supply system.

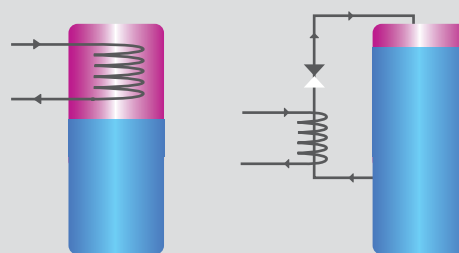

Phase change material storage

Several phase transitions can be used for phase change heat storages. Large energy quantities are connected to transitions from solid or liquid to gaseous state. The use of transitions including gaseous states is normally not feasible due to difficulties with the large volume of the gas phase.

Transitions within purely solid or purely liquid phases, that is order-disorder transitions, are other possibilities. However, the energy quantities connected to the transitions for materials undergoing such transitions are normally relatively small.

The most promising transitions is from solid to liquid phase. A heat storage based on this phase change is a heat of fusion storage and the heat of fusion of the solidification/melting process is utilized.

Heat of fusion storage material candidates are inorganic salt hydrates, organic compounds and organic and inorganic eutectic mixtures. As a rule the organic compounds have small densities compared with the inorganic salt hydrates resulting in a small heat storage density per volume. This makes the inorganic salt hydrates favourable as heat storage materials. A number of harmless inexpensive salt hydrates with high heat of fusions and melting points in the interval from 0°C to 100°C are available as candidates for heat storage materials for heat of fusion heat storages for energy systems with heat storage in this temperature interval.

Heat of fusion storage is attractive for systems operating in a small temperature interval. For instance, phase change materials can with advantage be built into building con-

structions, where they can stabilize the indoor temperature and decrease the heat demand of the building, [7].

Heat of fusion storages for energy systems operating in a large temperature interval are today not competitive with traditional hot water stores. For instance, for solar heating systems the heat storage volume can be reduced about 2-3 times if a heat of fusion storage is used instead of a hot water storage, but hot water stores results in the best system from an economy point of view.

Heat of fusion storage based on stable supercooling of the heat storage material offer a potential for a compact seasonal heat storage. The heat storage principle can for instance be based on the advantage of stable supercooling of the salt hydrate sodium acetate trihydrate with a melting point of 58°C. By using this principle the heat storage will have no heat loss for a long period making seasonal heat storage possible. If the salt hydrate has been fully melted it can cool down in its liquid phase to the surrounding temperature and still preserve the latent heat related to the heat of fusion. The heat storage module can be left in this state with no heat loss until a heat demand is required, in which case solidification is activated, the heat of fusion is released, and the heat storage temperature increases almost immediately to the melting point. The principle of supercooling is described in [8]. The principle is already utilized commercially [9]. An ongoing EU supported project COMTES [10] will elucidate if such heat storages are attractive seasonal heat storage solutions. If that is the case the total yearly heat demand of houses can in the future be covered only by means of relatively small solar heating systems. In this way solar heating systems might play a very important role in our efforts to create a fossil free future. It should however be noticed that a lot of technical problems related to the technology must be solved before reliable and economically attractive solutions will be available on the market.

Sorption and chemical storage

A thermo-chemical heat storage system consists of a working fluid and a sorption material. The working fluid is in most cases water and the sorption material can for instance be a porous solid or a salt hydrate solution. The heat storage principle is based on the fact that the sorption material releases water vapour during charge and releases heat when water vapour is adsorbed or absorbed. Adsorption is the bonding of a gas on the surface of a solid. In an absorption process a new compound is formed by the sorption material and the working fluid. The heat storage type offer the potential advantages of compact long term heat storage

with a low heat loss and a higher heat storage density per volume than heat of fusion heat storages.

However, many problems related to the design of these heat storages must be solved before the heat storages can be introduced on the market. Research, both basic material research and technical research, is needed in order to elucidate which materials are most suitable as heat storage materials, which heat storage designs will result in sufficiently high heat exchange capacity rates to and from the heat storage, which heat content per m³ can be obtained in practice for the heat storages inclusive all tanks, equipment and insulation materials and which solutions will result in reliable, safe, economically attractive and long term stable heat stores. A number of research and development projects are going on in order to solve these problems, among other things, four research projects supported by EU within the Seventh Framework Programme, SAM.SAA, COMTES, MERITS and SOTHERCO [10], [11] and [12]. Further, a number of projects are going on within the Task 42 project of the IEA (International Energy Agency) SHC Programme [13].

If the problems are solved the heat storage type can in the future be an attractive seasonal heat storage solution. Even relatively small solar heating systems making use of such heat storage solutions can in the future cover the total yearly heat demand of houses. Consequently, solar heating systems can play an essential role in our future energy system, if the heat storage research is successful.

Conclusions

The importance of thermal storage will increase in the future since an increasing part of our heat demand in the future will be covered by renewable energy sources where there is a time difference between the heat production and the heat demand.

Today, due to reliability and economy issues, hot water stores are used in almost all energy systems requiring heat storage in the temperature interval between 0°C to 100°C. Both short term hot water stores for individual buildings and long term hot water stores for collective heating systems can be improved in the future. The improvements can be achieved due to better devices establishing thermal stratification in the stores, due to smart tank designs and smart control strategies and due to improved thermal insulation materials.

Further, there is still need for development work before it is possible to introduce attractive phase change storages and chemical heat storages on the market. A high number of research projects on phase change storages and on chemical heat storages are ongoing. If this research is successful it will be possible in the future to introduce attractive compact seasonal heat stores on the market making it possible for even relatively small solar heating systems to fully cover the yearly heat demand of our buildings. Consequently, solar heating systems can play an important role in a future fossil free energy system.

Storage in distributed generation systems

Guangya Yang and Seyedmostafa Hashemi Toghroljerdi, DTU Electrical Engineering, DTU; Francesco Marra, Statoil ASA; Arne Ravndal Finnby, Solvind Prosjekt AS

Distributed generation, notably in the form of wind and solar power, is rapidly gaining ground in power networks because of its potential to significantly reduce emissions and ultimately to provide cheaper energy [1] [2].

Denmark now has around 3,600 MW of installed wind generating capacity, and this figure is expected to reach 6,000 MW by 2030. Solar power is growing even faster, with predictions of 7,000–8,000 MW of installed photovoltaic (PV) capacity by 2030. On top of this, renewables-based combined heat and power (CHP) plants will provide district heating as well as electricity. Since Danish maximum electrical demand by 2030 is forecast to be around 7,000 MW, we could imagine that the future power system will run solely on renewables for much of the time [3].

Such rapid growth in distributed generators (DGs) brings up predictable challenges to system operation and control, and not just in Denmark. The issue has attracted much attention from power engineers worldwide, who have proposed “smart grids” – featuring information and communications technologies (ICT), demand-side management, and active use of different energy carriers – as one way to address the challenges.

Among the many different ideas for managing DGs, one of the most attractive is the “Microgrid”. By extending the grid concept down to a smaller and more local scale than at present, Microgrids combine DGs and local energy carriers to smooth their overall power output, improve energy efficiency, and actively support the grid by providing ancillary services.

Fundamental changes are happening in the power industry, ranging from large-scale investments in infrastructure, through new methods of operation and control, down to new ways of manufacturing equipment and components. To allow an orderly transition to the new energy era it is important to set suitable standards for the grid interconnection characteristics of DGs, especially wind and PV plants.

Upcoming grid regulations

Current work on grid connection standards aims to keep abreast of the trend towards greater use of DGs, with particular emphasis on the ancillary services required by the grid.

In the USA, 2003 saw the release of the IEEE 1547 standard, which defines requirements for the performance, operation, testing, safety and maintenance of interconnections between DGs and power grids [4]. In Europe, ENTSO-E (the European Network of Transmission System Operators for Electricity) is currently revising the regulations covering system operation, planning and security [5]. In this section we explain how the new ENTSO-E grid code aims to take advantage of the storage capacity offered by DGs and to make best use of the availability of different energy carriers at the level of the power distribution network [6].

The ENTSO-E draft grid code aims to set clear and objective requirements for how every power generation module – both individual units and groups of installations – should link to the internal electricity market and play its part in ensuring system security. As well as general requirements, ENTSO-E has defined rules governing the performance of different sizes of generating plants.

Most individual DGs have capacities below 10 MW, so they are usually connected to distribution grids or sub-transmission systems rather than to the high-voltage transmission grid used by central power stations. Generators below a certain limit – ENTSO-E recommends 0.8 kW – require only limited control functions. As generating capacity increases, more requirements are introduced to provide the ancillary services needed for a strong and reliable grid.

Larger DGs (for example, above 1.5 MW in the Nordic area) are expected to contribute to frequency containment reserve. This means that they must vary their output, if possible, to help correct imbalances between power demand and supply. If demand is greater than supply, the system frequency (50 Hz in Europe) will drop; to correct this, all generating plants are required to increase production. If supply is greater than demand, the system frequency rises and generators must cut production. This “frequency support” makes the grid more stable by increasing the system’s inertia.

The required change in output is proportional to the frequency deviation, up to a certain limit (Figure 40).

Figure 40

To correct drift in system frequency (Δf), grid codes require generators to alter the amount of power they produce at any given time (ΔP) [6].

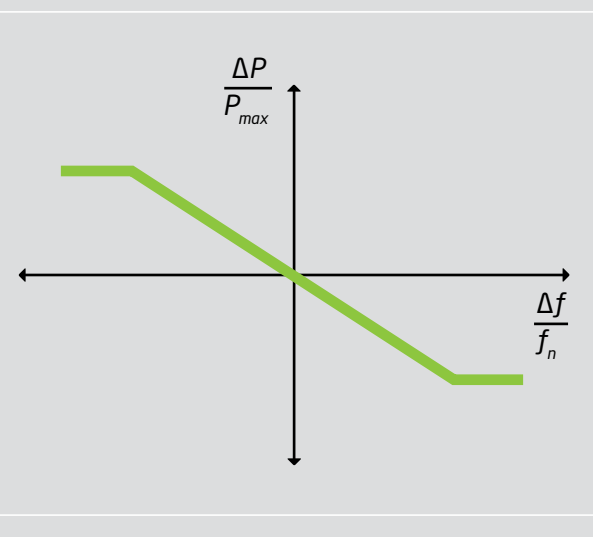

P_{max} is the maximum or rated capacity of the generator.

ΔP is the required change in the active power output.

f_n is the nominal system frequency (50 Hz in Europe).

Δf is the frequency deviation caused by the imbalance between demand and generation.

Equation 13 defines the ratio sl of the frequency deviation to the required production change. The values of sl recommended by ENTSO-E are in the range 2–12%.

$$sl = \frac{\Delta f / f_n}{\Delta P / P_{max}} \times 100\% \quad (13)$$

This function previously applied only to large synchronous generation units, since these have traditionally provided the only way to maintain grid stability and power delivery. Nowadays, with the growth in DGs and the corresponding retirement of thermal power plants, this service is being transferred to DGs.

At the moment most DGs can provide over-frequency response: that is to say, when the system frequency is too high they can reduce their output proportionally to help bring it back to its nominal value. Under-frequency response is more difficult. As most DGs are based on renewables, increasing their power output depends on the availability of resources such as wind or sunshine, as well as suitable control systems.

To meet the need for under-frequency response the assumption is that DGs, especially wind and solar power plants, will need to interact with energy storage devices. In this chapter we describe how this might be done using batteries, electric boilers/heat pumps and electric vehicles, in turn.

Battery storage with renewables

In recent years power engineers have come to realise that energy storage systems could be an effective way to meet the challenges associated with a high penetration of renewables. Most energy storage projects to date have matched battery storage to renewable power generation. Well-designed storage systems can provide the ancillary services needed to satisfy the grid codes, especially in terms of frequency response. Other desirable functions of storage include smoothing out fluctuations in renewable generation, shaving peak loads, and reducing congestion and power quality issues in the network. Below we discuss briefly the role of battery storage with wind and solar power.

Batteries with wind power

The increasing penetration of wind power and its non-dispatchable nature increase the need for storage in the power system. Even when power demand is steady, the variability of wind generation creates various operational issues for the system operators. Storage which could enable wind power to be dispatched like other generating sources would be a great tool in ensuring secure and efficient operation of the system.

Worldwide there have been various industrial and demonstration projects using battery storage with distributed wind power plants:

In Germany, an Enercon 6 MW wind turbine is connected to a 1 MW sodium-sulphur (NaS) battery.

Japan has several large-scale applications of NaS batteries with both wind and solar power; the largest is the 34 MW/245 MWh NaS battery system at the 51 MW Rokkasho wind farm [7].

In Dublin, California, a 2 MWh lithium-ion phosphate battery is installed in a smart microgrid together with a 1.2 MW solar photovoltaic (PV) plant, a 1 MW fuel cell and five 2.3 kW wind turbines [8].

Also in California, utility company Palmdale Water District has added a 450 kW superconducting magnetic energy storage system (SMES) to a microgrid containing a 950 kW wind turbine, a 200 kW gas-fired generator and a 250 kW water turbine. The objective is to maintain grid stability during power fluctuations and power interruptions [9].

The planned Pillar Mountain Wind Project in Kodiak, Alaska, will contain a 3 MW lead-acid battery which will enable Kodiak Electric Agency to increase its wind power capacity from 4.5 MW to 9 MW.

Alongside effective weather forecasts and proper market design, storage helps to mitigate the problems caused by the intermittency of wind. Energy storage systems can also enable wind farms to deliver ancillary services to the grid at various timescales. This may also reduce the need to install additional dedicated units to provide ancillary services in the future.

Batteries with PV

Photovoltaic (PV) power is one of the most rapidly growing renewable energy technologies worldwide. Annual growth of PV has reached more than 44% in the last decade, with installed capacity rising from 1,000 MW in 2000 to 18.2 GW by the end of 2010. Like wind, PV is a non-dispatchable power source whose output is volatile.

Storage linked to PV power plants may be required to overcome bottlenecks in the medium-voltage distribution network to which the plants are connected. High-capacity storage that can be recharged directly by PV systems may also offer a convenient solution for powering stand-alone industrial processes. Current projects include:

In the Hawaiian archipelago, the Kaua'i Island Utility Cooperative is using a 1.5 MW/1 MWh lead-acid battery with a 3 MW solar PV plant. Lanai Sustainability Research on the tiny island of the same name has a 1.125 MW/0.5 MWh lead-acid battery and a 1.5 MW PV plant.

In Berlin, a smart grid facility is testing NaS batteries with a solar PV plant.

In Japan, the city of Wakkanai has a 1.5 MW NaS battery connected to a 5 MW solar plant [10].

In New South Wales, Australia, two zinc-bromine redox flow batteries (200 kW/400 kWh and 100 kW/200 kWh

respectively) are connected to a smart grid together with solar PV and small wind turbines [11]. At the University of Queensland another zinc-bromine flow battery (90 kW/240 kWh) operates together with the university's 340 kW solar panels.

Trends show that in the near future the majority of new PV installations are likely to be grid-connected residential systems. PV systems of this type are connected to the low-voltage (LV) networks, and are normally below 100 kW in size. An LV network typically has a radial configuration, with power flowing traditionally in one direction: from the upstream transmission grid toward the loads. With high levels of PV, however, current flows in the LV system can reverse. This can cause operational problems such as voltage rise and power quality issues.

Battery storage could help to solve such problems by storing energy when PV production is high and demand is low, and releasing it when the opposite conditions apply. System operators anticipate that customers with battery storage will have smoother and more predictable load profiles, ensuring better network operation and control and allowing grids to host more PV capacity. In addition, storage can be used to facilitate the participation of PV power plants in the electricity markets by providing committed power production during certain periods of the day.

Future outlook

From the viewpoint of the grid operator, the use of batteries together with DGs can help to provide the frequency regulation required by the upcoming grid codes.

A further benefit is increased energy efficiency. DGs are normally connected to low-voltage networks, which have higher percentage losses than medium- and high-voltage lines over the same distance (because lower voltage requires higher current for power transmit, and therefore creates higher resistive losses). Batteries allow more of the power from DG systems to be consumed locally, so overall losses are lower.

Various strategies have been proposed for the design of storage systems and their interaction with DGs. From a practical aspect, there is still a lack of business cases and appropriate rules from the grid operators to attract investment in battery storage. As the development of battery technologies continues to bring down costs and prolong battery life, however, the attractions of battery storage for DGs will increase.

DGs with other distributed energy resources

One concept proposed to get the most benefit from the emerging potential of DGs is a “Microgrid” of DGs and their associated loads as a subsystem of the main grid [12]. A Microgrid is a low-voltage distribution system containing DGs, storage devices and controllable loads, the whole thing operated in a coordinated way to provide consumers with reliable and affordable electricity and heat (Figure 41). This type of cooperation offers distinct advantages to customers and utilities: improved energy efficiency, minimisation of overall energy cost, improved reliability and resilience, network operational benefits, and more cost-efficient replacement of electricity infrastructure [12].

The size of a Microgrid is a function of the capacity of the feeder, and can vary from a few kilowatts to several megawatts.

Electric boilers and heat pumps

Electric boilers and heat pumps are both devices for converting electrical energy into heat.

An electric boiler generates steam or hot water using electricity rather than by burning fuel directly. The boiler uses resistance- or immersion-type heating elements to convert electrical energy into thermal energy at very high efficiency.

A heat pump uses a relatively small amount of electricity to capture a larger amount of low-temperature heat from the environment and boost its temperature to the point where it can be used to heat a building. Heat pumps can also be used in the reverse direction to cool buildings.

Figure 41

A typical Microgrid with distributed generators, a low-voltage distribution system, heat and electricity storage, energy consumers and a communication network.

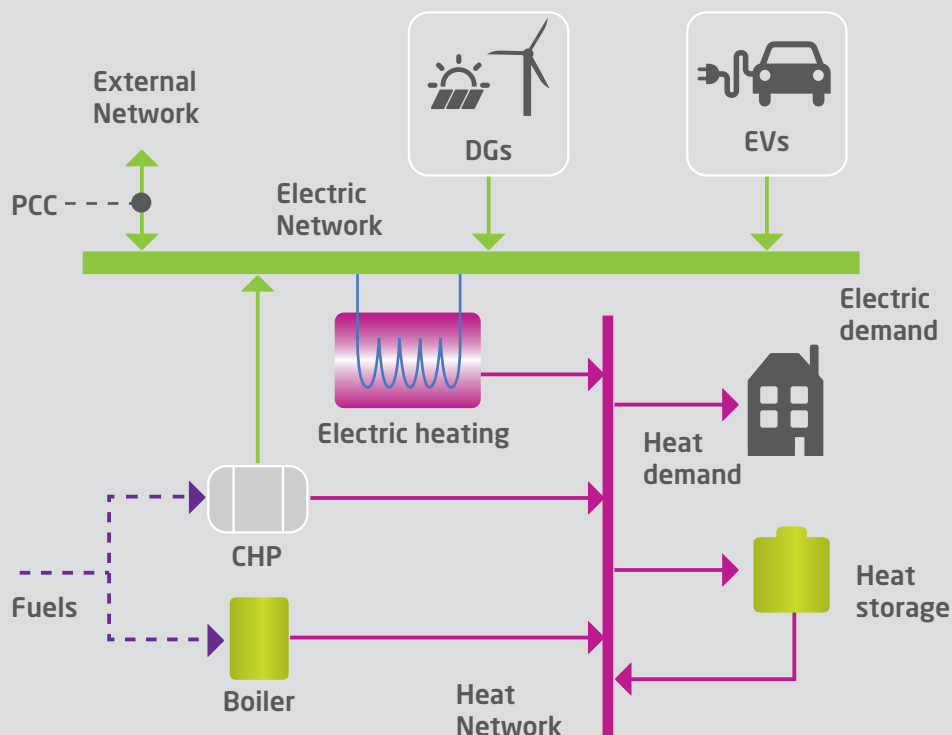

The sizes of boilers and heat pumps depend on the heating demand, which varies with geographical area and building type. Electric heating has different demand characteristics compared to other forms of electricity use, notably because the large thermal mass of buildings makes heating and cooling rather slow. This can be exploited to advantage in the control of electricity demand.

If the power system has surplus electricity, for example, heating systems can be used as storage devices, absorbing the extra energy and avoiding grid control problems. The extra energy can either be transferred directly to end-users or stored in heat reservoirs. When power is in short supply, heating systems can continue to draw on central heat storage facilities or simply be switched off for short periods, relying on the large time constants created by bricks and concrete.

With the help of smart control systems, DGs and heating devices can also work together to support system operation, for instance by providing the frequency response characteristics required by the new grid codes. For renewables-based DGs, good control strategies can mitigate the intermittency of generation.

In Denmark it is expected that a large portion of the future electrical load will comprise individual heat pumps, and residential PV installations are forecast to surge in the coming years [3]. The development of smart grids will extend the possibilities for cooperation between PV and heating devices. On the other hand, efficient cooperation will also mitigate the burden caused by the presence of DGs on the low-voltage grids and further increase the penetration of renewable energy.

Electric vehicles

Denmark and many other countries consider battery-powered vehicles to be the future of road transport, so electric vehicles (EVs) cannot be neglected as a component of the power system.

Today the most competitive battery technology is lithium-ion, thanks to its better performance compared to lead-acid and nickel-based batteries. An average vehicle battery has a capacity of 20–24 kWh, giving an average range of about 150 km. A full charge takes 6–7 hours.

As well as providing sustainable transport with zero emissions, battery EVs are interesting because of their intrinsic energy storage capacity. EVs need to be connected to the grid for charging, and in this state they have the potential to act as a distributed storage system comparable to the storage solutions now being investigated for PV and wind power.

The main issue with EVs compared to static storage systems lies in knowing where and when they will be available. A typical EV will be driven for an hour or two every day and will spend the rest of the time plugged into the grid, either at a public charging point or at home. As yet we cannot define the market penetration of EVs, but as they gradually replace conventional cars in the coming years the EV fleet will almost certainly come to be seen as a source of grid services and a way to store surplus PV or wind power.

Among the various EV projects, several have already considered the use of EVs to provide grid stabilisation and even longer-term storage. Such “vehicle-to-grid” (V2G) storage is an advanced concept at the moment. With future advances in battery power density and operating life, however, and business models that are attractive to EV owners, it seems an attractive long-term option for countries with high levels of renewable energy.

Summary

Renewable energy brings clean energy to the power system, but also creates a range of operational challenges. New grid codes due to come into force in the next few years will help to ensure a smooth transition to this new energy era.

The suppliers of grid services, in future energy systems, may be more diverse than today. Renewable generation plants, along with traditional plants, operate together to ensure the supply security. As DGs are replacing traditional fossil-fuelled thermal power plants, the grid services – voltage and frequency support – now provided by traditional generators will need to be transferred to these new units. To meet these requirements, the outputs of DGs must be sufficiently controllable in terms of both active and reactive power. From this point of view, the cooperation of DGs with other devices is a handy option to maintain the operational security of the grid, especially when the new DGs are based on intermittent renewable energy sources.

One of the options for DGs is to equip them with battery storage. Although many battery technologies are still limited by high investment and operational costs, some of them are already in use with DGs. For example, some PV inverter manufacturers have started to provide composite units which include storage. For the future, the potential of batteries to compensate for the intermittency of renewable generation is clear. Direct operational advantages obtained by incorporating battery storage include smoothing output, load shaping, frequency reserve and voltage control. Storage can also help DGs succeed in the power markets by allowing them to guarantee output schedules and respond to price variations.

The concept of the Microgrid further extends the possibilities for cooperation among distributed energy resources. A microgrid may contain renewable generation units, district or individual heating systems, electric vehicles, combined heat and power, storage units and other devices. Such a diverse network creates a range of possibilities for cooperation among different devices as well as across the entire microgrid. Opportunities to link power and heat are created by electric boilers, heat pumps and hot water storage tanks. Heating systems can provide storage for DGs by absorbing electricity when there is a surplus and temporarily reducing power consumption when necessary.

A Microgrid can also act as a single larger unit at the point where it connects to the rest of the distribution grid, opening up opportunities to support the operation of the main grid and participate in the electricity market. Within a Microgrid, the harmonisation of different technologies and control algorithms supports the overall goal of ensuring that the Microgrid is a “good citizen” within the main grid. Smart grid technologies, including the communications infrastructure, are important here.

The electrification of the transport sector runs the risk of creating stress on distribution grids, whose load profiles may have to change significantly to satisfy new demand from electric vehicles. Since a battery lies at the heart of every EV, however, the storage capability of EVs can be exploited to cooperate with DGs (vehicle-to-grid, or V2G). Battery technologies for EVs are still in their infancy, with drawbacks including high cost and slow charging, and the whole V2G concept depends on the availability of EVs in sufficient numbers. As a result, the use of EVs for storage, though potentially attractive, is further off than many other storage solutions.

In practice there are still some issues which restrict the development of above solutions. For example, the grid codes applicable to small and medium-size DGs are still under development. Incentives are also necessary to encourage investment in new solutions.

Jacob Østergaard and Kai Heussen, DTU Electrical Engineering

This chapter addresses the energy infrastructures and their intrinsic storage capability. The chapter describes how the concept of flexibility can be used as a framework for applying storage technologies in the energy infrastructures and as a way of formalising integration of the energy infrastructures, so they can act as storage resources for each other.

The energy system consists of a number of energy infrastructures characterised by different energy carriers. The main energy infrastructures in Denmark are electricity, heat and gas. Oil and cooling are other examples of energy infrastructures.

The various energy resources, e.g. wind and coal, are converted into energy carriers and distributed via their respective infrastructures. When it reaches the end users the energy carriers are then transformed into energy services. The Danish government plans to transform the Danish energy system into one based on renewable energy [1], an objective which is possible from the perspective of energy resources (Table 2).

Transforming the Danish energy system into one without fossil fuels will require the electricity infrastructure to handle a higher proportion of our total energy, since most renewable energy sources generate electricity. Electricity also has the advantages of being easy to use and often providing higher energy efficiency than other energy carriers. Today approximately 20% of Danish energy use is in the form of electricity. In an energy system without fossil fuels electricity is expected to account for at least 40% of all energy use, and up to 70% if electric transport becomes significant [1].

The various energy infrastructures are closely coupled (Figure 42). Examples on the generation side are cogeneration of electricity and heat, and on the demand side, heat pumps and electric heating. The energy infrastructures are also coupled with other infrastructures, notably transport (through petrol and diesel vehicles, electric vehicles and railways), and water supply (through electric pumps and hydro power).

A 100% renewable energy system will be based largely on stochastic and partly unpredictable energy resources: wind, solar and wave (Table 2). In Denmark, wind energy will be the largest of these three.

A high share of stochastic energy resources requires substantial flexibility (Chapter 6). There are four ways to achieve this:

- flexible generation based on storable resources (biomass)
- flexible demand
- intrinsic flexibility within the energy infrastructure
- flexibility through conversion across energy infrastructures.

Table 3 shows how much flexibility the different energy infrastructures possess, and how much they require. The stochastic energy resources will feed mainly into the electricity grid, which is also the energy infrastructure with the lowest intrinsic flexibility. Ensuring sufficient flexibility in the electricity infrastructure is therefore crucial. Electricity demand flexibility and the ability to convert energy between infrastructures will also be important.

Demand response has the potential to provide flexibility, especially over shorter timescales (seconds, minutes and hours). Efficient use of biomass to provide flexible generation, and flexibility between infrastructures, can play an important role at longer timescales. The gas system is especially noteworthy for its storage potential, which is large enough to provide flexibility over hours, days, weeks and even months.

Table 2

Current generation from renewable energy resources in Denmark, and corresponding resources (in PJ) [2].

	Current production	Total resource	How much of consumption in 2050 can the energy resource technically cover?
Wind	26	1,220	>250%
Wave power	0	40	<10%
Solar electricity and heating	1	250	<50%
Biofuels and waste	89	250*	<50%
Total renewables **	123	1,760	<300%

* Incl. 20 PJ fossil fuel waste

** Heat from geothermal installations and heat pumps is not included in the estimate, as the potential is hard to determine

Figure 42

Interactions between the various energy infrastructures help to provide the flexibility required in a fully renewable energy system [2].

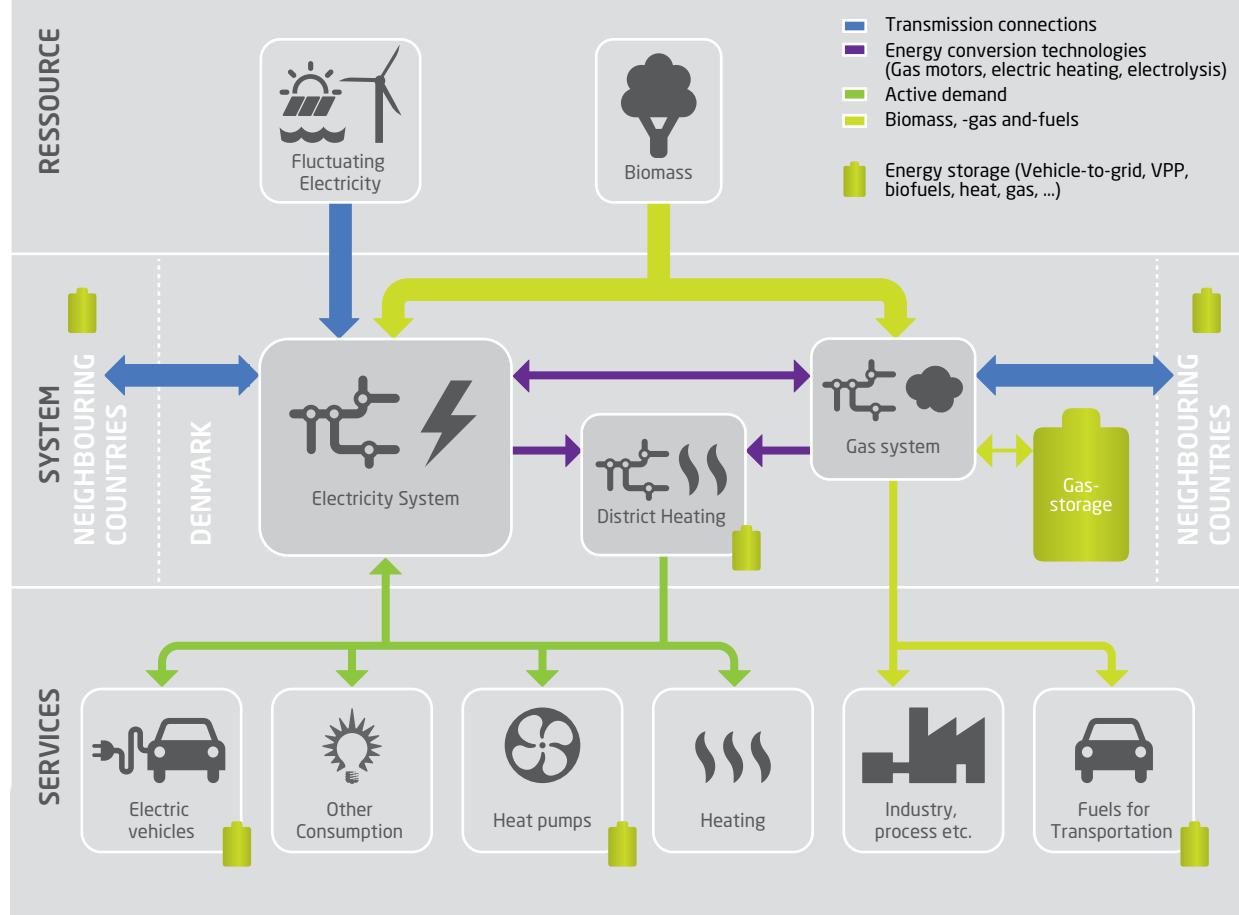

Table 3

Different energy infrastructures have different levels of intrinsic flexibility and different needs for flexibility.

Energy infrastructure	Properties	Intrinsic flexibility	Flexibility need
Electricity	<ul style="list-style-type: none"> Long-distance transport Low losses Easy to generate from renewable energy sources Easy conversion to other energy carriers 	Very low (seconds)	High
Heating	<ul style="list-style-type: none"> Local/district Medium losses Difficult to convert to other energy carriers 	Medium (days)	Medium
Gas	<ul style="list-style-type: none"> Long-distance transport Low transmission losses Intrinsic losses during conversion at the point of use Easy to convert to heat, but more difficult to convert to other energy carriers 	High (months)	Low

Flexibility services

In a conventional electricity infrastructure the required flexibility is provided on the generation side in the form of large thermal and hydroelectric power plants. When wholesale power markets were introduced and the operation of the electricity grid became separated from power generation, this production flexibility became associated with a trade value for the ability to deliver energy at a specific point in time. In other words, power price differences at different points in time implicitly reward flexibility without requiring a specific flexibility service.

Flexibility services that are more direct are based on the availability of units to respond to an operator's request (control signals). These "ancillary services" can be rewarded based on their availability, the size of the response, or both. As such services are needed to keep the system stable, special requirements apply to the organisations which supply them, who are known as balancing responsible parties (BRPs) in the electricity system. At present each market area has only a single buyer of ancillary services – the transmission system operator (TSO) who has a monopoly on grid operation – but in the future distribution system operators (DSOs) are also expected to request ancillary services. Table 4 summarises the services requested in Denmark, while Ref. [3] gives an international overview.

The demand for ancillary services is defined by the grid operator and driven by momentary imbalances in the grid, taking into account operating constraints such as transmission bottlenecks. With increased penetration of fluctuating renewable energy, imbalances tend to increase and so too does the demand for ancillary services.

In principle, flexibility services can also be employed in distribution grids. Increasing amounts of solar PV generation and additional loads such as heat pumps and electric vehicles force the distribution grid operators to increase the hosting capacity of their grids. Flexibility services from resources within the distribution grid could therefore be traded off against grid investments such as additional cables and substations. Ongoing research at DTU within the iPower and EcoGrid EU projects aims to help specify and develop such services.

Flexibility that is useful for the grid is usually directly associated with the experience of grid needs from the operator's perspective. Here the relevant parameters are:

- response time
- scale (minimum bid size)
- ramping speed, duration, availability and reliability
- location with respect to the grid
- ownership (the organisation providing the services).

Organisations gain access to the power market through a pre-qualification test which proves their capabilities.

Table 4

Active power flexibility services at in Denmark.

Flexibility service	Operating scheme	Pricing scheme	Delivered to
Regulating power	Active power request; delivery within 15 min	Marginal bid-based price (energy)	TSO (ancillary service)
Secondary control (regulation)	Reservation control signal delivery; delivery within 5 min	Bid-based reservation + energy markup	TSO (ancillary service)
Primary frequency control	Decentralised control loop with fixed participation factor (delivery within 30 s)	Bid-based reservation payment	TSO (ancillary service)
Balancing power - removing imbalance with respect to market schedule	Change of production after BRP request	Energy price driven by imbalance penalty - bi-lateral contracts	BRP
DSO flexibility services (under development; see [14], and references therein)	Examples are long-term bilateral contracts, and time-based or signal-based demand shifting	Single buyer; pricing unclear	DSO

Flexibility provision

With increasing renewable energy generation, fewer thermal power plants are available to deliver flexibility services. Flexibility from fluctuating renewables is technically feasible but very limited, and usually requires undesirable curtailment of production.

Other important changes to the electricity system are driven by the introduction of new types of flexibility providers. Whereas conventional power plants place energy provision first and flexibility second, the new flexibility providers:

- often operate on the demand side
- interact with the electricity system as a secondary concern, at most, and/or
- face constraints which limit the length of time for which they can supply flexibility services.

Favourable economics for flexibility provision can be anticipated when the flexibility is a by-product of other processes – such as district heating combined heat and power (CHP) plants or industrial processes – which have a degree of freedom in their energy consumption (Chapters 10 and 11).

Even further down the electricity value chain, consumers may also be flexible with respect to the timing and quality of the energy services they enjoy. Consumers can even become small dispatchable electricity producers by installing their own generating units such as micro-CHP plants.

Such flexibility from the bottom end of the electricity value chain implies a huge change in the number of units to be managed; the flexibility provided by a conventional 500MW power plant, for instance, could be substituted by 200,000 customers units rated at 2.5 kW each. Even if the actual capacity of distributed energy resources (DERs) never matches that of today's power plants, the implications for access to this flexibility are clearly provoking a paradigm shift in power system control.

On a larger scale, somewhere on the road to a 100% renewable energy supply it will be necessary to introduce additional energy conversion units to balance large amounts of surplus electricity, such as electrolysis and gasification systems (Chapters 4 and 9) [4]. Such units imply the effective large-scale coupling of energy infrastructures.

Flexibility access

One cannot expect the direct operator of an energy conversion device to be proactively concerned with providing flexibility to the grid when this is only a secondary purpose of the device. Instead, other entities need to exploit the available flexibility by representing it to the electricity system operators.

For example, the flexibility of DERs often cannot be bid directly into the transmission-level markets. The fact that distributed resources occupy locations conventionally associated with the demand side bears technical, organisational and regulatory challenges. To enable access to these new resources a corresponding organisational, control and ICT infrastructure therefore has to be developed.

A key concept in integrating DERs into energy markets and system operation is “aggregation”. Here a single entity, the aggregator, represents a large number of small units, bidding their flexibility resources into energy and ancillary service markets and controlling their collective behaviour accordingly [5]. A number of control strategies have been developed for aggregators, each with different trade-offs in terms of communication requirements and precision of control (Table 5).

New market-based solutions require the reorganisation of regulatory frameworks to enable small units to provide and sell flexibility services without having to participate in the bulk energy and ancillary service markets. Figure 43 shows how a small regulatory change allows DERs to provide an ancillary service known as manual regulating power (MRP). Here the aggregator is subordinate to the BRP, and a new flexibility contract and control interface between the DERs and the BRP is introduced. The required regulatory change is that the TSO allows the BRP to choose the appro-

Table 5
Classification of aggregator control strategies, based on [10].

	Direct (no price signals)	Indirect (market-driven)
Unidirectional	Conventional demand response, e.g. load shedding	Incentive signals, e.g. real-time pricing [6], [8]
Unidirectional with indirect observation	Cluster estimation with grid observations [9]	Constraint-driven, e.g. Olympic Peninsula, USA
Bidirectional	Direct control, e.g. Power Hub (DONG) [7]	Double-sided auction, e.g. PowerMatcher (TNO)

Figure 43

(A) The current setup, under which a TSO accepts contributions from a BRP which operates its own power plants directly. The TSO monitors these power plants, which are large and few in number, using special equipment (dashed line). This setup of direct validation does not scale well to a future scenario with large numbers of diverse service providers.

(B): Distributed energy resources (DERs) such as household heat pumps gain access to the ancillary services markets through a different monitoring setup, under which the service validation is organised through a separate entity responsible for metering. Source: [11].

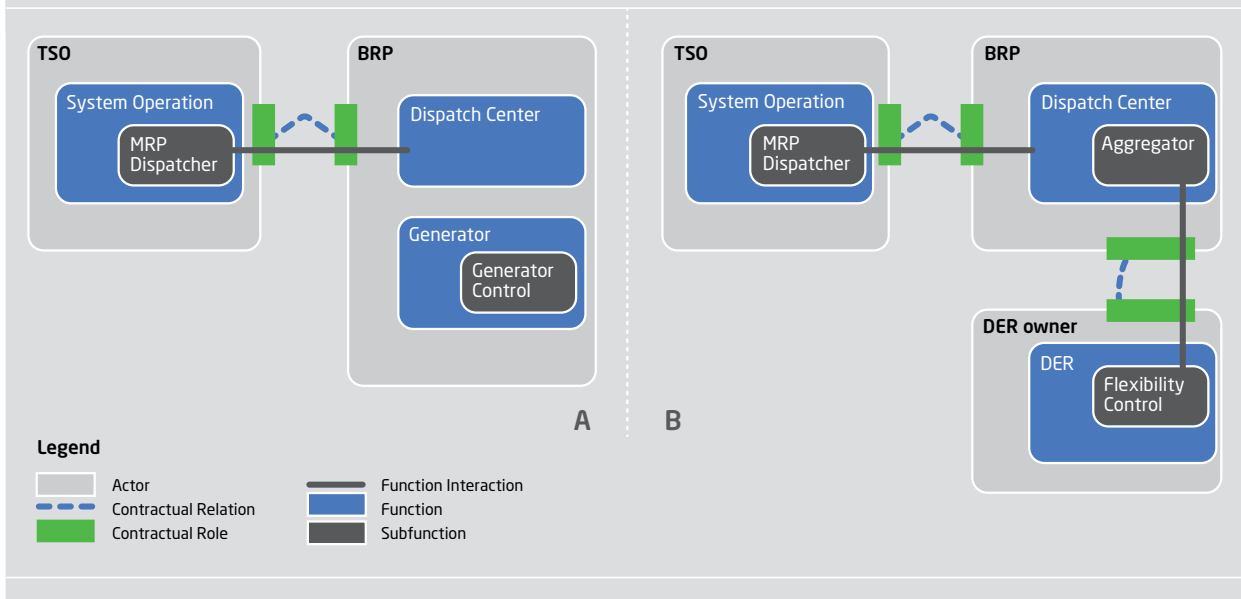

appropriate monitoring technology and to enable pre-qualification of DERs. This is an example of new stakeholder concepts being developed within the Danish iPower project (www.ipower-net.dk).

Access to flexibility is not only an issue on the supply side. As the value of individual flexibility transactions falls, the transaction cost need to be reduced. Access to the new types of resources should therefore be facilitated by appropriately scalable IT solutions, low-cost communications and standardised business transactions. The grids must also become smarter if they are to accommodate increasingly price-driven behaviour from distributed resources.

Flexibility analysis

Studies of the dynamic behaviour of the power system are essential for power system analysis, in particular with respect to system stability and short timescales. Ramping flexibility has also been of concern previously, though more in terms of how restrictions on unit scheduling affect market operations. Table 6 gives an overview of flexibility and how it is analysed at different timescales from a system perspective.

With the introduction of distributed energy storage technologies for system balancing, the energy limitations associated with new flexibility technologies become a new concern.

Power Nodes

The new perspective on flexibility and how it may be provided by integrating different energy infrastructures requires a new layer of modelling to be added to the classical analysis of power systems. A novel approach known as Power Nodes has been developed by DTU in collaboration with ETH Zurich [12]. In the future it will be possible to combine the Power Nodes methods with stochastic approaches describing fluctuating renewable energy sources (Chapter 6). Ongoing projects in this area include Balancing Power in The European System (BPES) [13].

In the new approach, the electro-mechanical domain of the electric grid interfaces with a domain of Power Nodes representing energy storage and energy conversion processes (Figure 44). A third domain accounts for the demand and supply processes which transfer energy to and from the Power Node domain. As Figure 44 shows, these processes

Table 6

Flexibility timescales and their associated analysis tools, phenomena and storage technologies.

Timescale	Analysis tools and concerns	Phenomena	Relevant storage technologies
Nanoseconds to milliseconds	Electromagnetic transients and finite-element methods	Lightning, switching and wave propagation	-
Milliseconds to seconds	Transient stability	Faults and protection systems;	Capacitors/inductors, inertia (system inherent storage)
Seconds to minutes	Voltage and wide area stability	Propagation of faults; Inter-area swings; cloud passing; frequency disturbances	Generator primary controllers, batteries, thermal loads
Minutes to hours	System operation, including balancing and reserves, ancillary services, decision support	Plant outages, wind fluctuations and forecast errors, fast demand ramps, shifts in market schedules	Demand response and building thermal storage, electric vehicles, batteries, district heating, etc.
Hours to days	Energy markets	Forecast errors, daily and week-scale fluctuations	Pumped hydro, compressed air storage, gas network, heat network
Days to seasons	Energy futures markets	Seasonal weather patterns; social crises	Hydro; seasonal heat storage
Seasons to several years	Investment and asset management	Market price development; regulatory change; climate change	Electrolysis; gaseous, liquid and solid fuels

Figure 44

(A) The "extended" power system as described by the Power Nodes framework: the conventional grid model interfaces with the Power Nodes domain, a generic buffer or storage model which in turn interfaces with the actual demand/supply process. This approach ensures that the system model takes energy constraints into consideration, while the clear definition of the Power Node (B) enforces consistent modelling practice. Source: [10].

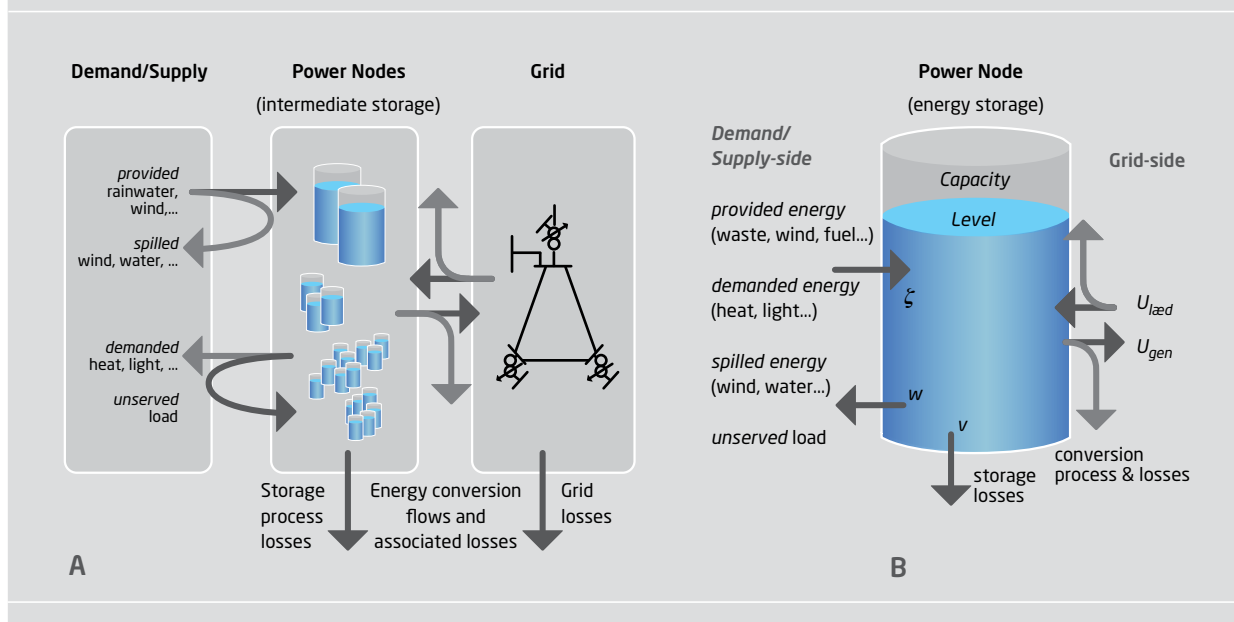

may be thought of as either externally driven (such as a supply of intermittent renewable energy) or fully controllable (such as a supply of fuel to a dispatchable generator).

To ensure consistency it is important to define unambiguous interfaces between the domains. These interfaces generally take the form of exchanges of energy, or power, in continuous time. For instance, the exchange between the Power Node domain and the grid domain is defined as the active power being fed into or consumed from the grid. When we make the model dynamic, the inertia of any synchronous generators running at a given time is taken to be part of the grid domain. So far as these generators are concerned, therefore, the active power interface is equivalent to the mechanical power being provided by their prime movers. Grid losses are modelled inside the electro-mechanical grid domain, while pre-grid losses, such as those associated with storage and conversion, fall into the Power Nodes domain. This clear separation allows the Power Nodes framework to integrate with a number of different physical network representations common in power systems modelling.

All supply and demand processes are connected to the electricity grid via a Power Node. Consequently, the total energy provided to or demanded from the grid may differ from the actual energy served to or used by external processes. The arrows in Figure 44 cover all possible modes of energy flow; this mathematically redundant choice of flow modes establishes a formalised interpretation of real-world effects which cause supplied energy to be lost, or demanded energy to remain unserved. For example, energy conversion implies conversion losses, power in-feed from wind turbines may be curtailed, or a load may become disconnected from the grid. To evaluate the overall system performance Power Node flows track these losses and account for the value of energy associated with each respective domain.

Energy storage technologies introduce duration constraints to the modelling problem. The combined effect of these constraints and uncertainty creates tough challenges for the coordination and decision support systems needed to operate the energy system. Further research is needed to establish appropriate ways to capture flexibility and uncertainty for different coordination and decision problems, such as trading of flexibility in energy markets and dispatch during system operation.

The introduction of generic models, such as Power Nodes, aids the analysis and improvement of operational decision-making and new decision support tools which are technology-agnostic, yet capable of accounting for new flexibility resources and interactions with other energy domains.

Future outlook

This chapter has provided an overview of the role of flexibility in relation to the different energy infrastructures. The technical characteristics of the electric power system and other energy systems are complementary. However, to access to this flexibility we need new interfaces and frameworks, both technically and in a regulatory sense. Finally, new analytical methods and tools are required to plan, design and operate these future infrastructures.

In the medium term, capabilities spanning the different energy systems need to be demonstrated and a regulatory setting developed to favour the effective coupling of the electricity infrastructure with both the heat and gas infrastructure. In the longer term, to realise a future energy system based entirely on renewables, research and innovation must ensure the development of the necessary flexibility and associated solutions to ensure a reliable and economic system. In particular, coupling of the electricity and gas infrastructures has significant potential to balance longer breaks in the supply of wind power and to capture temporary oversupply.

Flexibility can evolve through many stages, starting as a market niche and toward a good that is tradable in a standardised way. A market-based approach to the allocation of flexibility is a complex setting involving trade-offs in both technical and market terms:

- the specification of a flexibility service product must be relevant to operators who request the flexibility, but it should also be technically meaningful to the owners of flexibility resources,
- there should be a market – a sufficient number of flexibility providers capable of supplying the product, and
- it must be technically feasible to provide the flexibility in an economic manner.

All of these three aspects are highly interrelated. The link between these aspects is established by the identification of "control points", as gateways where technical service delivery is matched with contractual responsibility and a feasible service validation.

As there are no straightforward solutions at hand, in the medium term, a combination of "bottom-up" experimental development and "top-down" reconciliation of results seems to be the way forward. An example for the experimental development of such new control points is the flexibility clearinghouse (FLECH), which is currently under development in the Danish iPower project [14].

In the context of the longer-term transition to an energy supply based on renewables, both the needs for flexibility and the ways of providing it are changing. With these changing requirements, the ways of handling and activating flexibility also have to be updated – in several iterations rather than one big step. Over time, flexibility services need to evolve (in terms of technology development and flexibility characterisation, for instance) along with aggregation methods, marketplaces for flexibility services and an increasingly integrated view of our energy systems.

To support this development we need to develop appropriate tools for analysing and simulating the systemic interactions with respect to flexibility. In the medium term this will include, for instance, simulation of coupled energy systems, starting with a focus on proper representation of neighbouring infrastructures, including storage and uncertainty. In the longer term, new methods for handling interdependencies across infrastructures, analysing resilience and supporting operators are needed. These methods will need to address not only the conventional energy infrastructures but also increasingly the communications infrastructure.

While we can draw analogies with other production and control systems, knowledge gained in modelling energy flexibility may also hold lessons for more sustainable and effective alignment of other engineering and business processes.

14

Synthesis

Energy storage technologies can be defined as technologies that are used to store thermal, electrical, chemical, kinetic or potential energy and discharge this energy whenever required. Energy storage technologies and systems are diverse and provide storage services at different timescales, from seconds up to years.

Energy storage systems can provide grid stability and reliability. They can also be used by utilities to integrate and optimise all types of renewable and distributed energy resources.

The investment costs of energy storage technologies and systems are considerable. However, they will partly be offset by lower investment costs for upgrading the transmission and distribution infrastructure in step with the expansion of the share of renewable energy.

Energy storage: a cornerstone of future renewable energy systems

Greenhouse gas (GHG) emissions from the energy sector are still increasing. If the political target of a 2°C global average temperature rise is to remain achievable, this situation needs to change rapidly.

One of the great challenges in the transition to a non-fossil energy system with a high share of fluctuating renewable energy sources such as solar or wind is to align consumption and production in an economically satisfactory manner. Energy storage could provide the balancing power needed to make this possible.

Improved access to clean and efficient energy services for the world's poorest people is also a priority for both the affected countries and the global community. Storage technologies can potentially play an important role in this context.

Storage technologies are likely to play a distinct role in the increasing number of renewables-based mini-grid systems being established in the off-grid areas of developing countries and on isolated islands.

The existing grid architecture in Europe was historically constructed for one-way supply, from central generators to decentralised demand reaches users, and will reach its limits as the proportion of renewables increases. This is because most renewable generators connect to the distribution grid at low or medium voltages – or even down to the local level, in the case of domestic solar power.

With the prominent exception of pumped hydro storage, energy storage activities in Europe are currently confined to pilot or test plants, or even the laboratory. Large-scale energy storage has not yet been realised. However, joint European research plans as well as national plans in the EU member states clearly show that energy storage is considered an essential element of the future energy infrastructure and must be developed now to be available when market demand emerges.

In the medium perspective (10–20 years), large-scale energy storage used both over short timescales (energy arbitrage) and for seasonal storage must be foreseen as an integral part of the energy system.

Energy storage is likely to play an important role in linking different sectors of the energy system: power, gas, heat and transport. This interlinking is important because it adds flexibility and robustness to the entire system, while also securing efficiency in terms of economy and resources.

The various energy infrastructures are already closely coupled on both the generation side and the demand side. Examples of this are cogeneration of electricity and heat (on the generation side), and heat pumps and electric heating (on the demand side). Energy infrastructures are also coupled with other infrastructures, notably transport (through fuel-powered vehicles, electric vehicles and railways), and water supply (through power-hungry pumping operations).

Flexible conventional backup power plants based on gas turbines, gas engines and diesel engines fit very well with fluctuating renewables. These can only fill the gaps when renewables are unable to meet demand, however. They cannot solve problems with electricity oversupply.

Demand-side management (DSM) is often the first and cheapest way to cope with variable renewables. The classic forms of DSM used in industry are now being joined by new types better suited to private households.

Good economics for the provision of flexibility can be anticipated when flexibility is a side-effect of a process rather than its main function. Examples include district heating with combined heat and power (CHP) plants, and industrial processes which have a degree of freedom in their energy consumption.

System balance and reliability

Energy storage can close the gap between energy supply and demand, and can improve security of supply. In this

role, energy storage competes with a number of other technologies.

Combined heat and power (CHP) production must meet demand profiles for both heat and electricity. This is often achieved by including heat storage, allowing heat demand to be met while electricity production varies.

Hydro power with reservoirs may supply storage services on a range of timescales ranging from seconds to weeks and months, or even years, depending on the site in question.

The Scandinavian power system provides mutual benefits between Norway, whose power system is dominated by hydro, Sweden (nuclear and hydro), and Denmark (thermal and wind).

Strengthening inter-regional power transmission capacity may imply more efficient use of existing storage, production and regulation capacity.

Very large gas storage volumes may be an important asset in covering future regional energy system storage needs, such as those related to biomass gasification or the large-scale use of hydrogen as an energy carrier. The Danish natural gas grid covers nearly all of the country, and may thus help to level out geographic energy system imbalances at regional, national and even local levels.

Demand-side management

There are many ways to take advantage of energy storage in power grids and smart grids, depending on location and other factors. These include demand-side management (DSM) and virtual power plants (VPPs).

DSM – the ability to mobilise flexibility in consumption – is an important technical option in power system regulation. In its ability to maintain energy and power system balance, demand-side flexibility is equivalent to conventional supply-side regulation.

Flexibility services

In principle, flexibility services can be employed in distribution grids. Here the increasing popularity of solar photovoltaic generation and additional loads such as heat pumps and electric vehicles is forcing the distribution grid operators to increase the hosting capacity of their grids.

The issue of access to flexibility is not confined to the supply side. As the value of individual flexibility transactions decreases, transaction costs also need to be reduced. Access

to the new types of resources should therefore be facilitated by appropriately scalable IT solutions, low-cost communications and standardised business transactions. Grids also need to become smarter so that they can accommodate increasingly price-driven behaviour from distributed resources.

Storage for the transport sector

Effective and economic storage of energy for mobility is probably the most challenging new application for energy storage. The complete transformation of cars, trucks, ships and aircraft to electric power is estimated to take decades.

Electric vehicles (EVs) and plug-in hybrid electric vehicles (PHEVs) could provide huge regulating capacity over short timescales. If the storage capacity of EV batteries or the number of PHEVs increases, a future road transport system based on EVs could supply regulation over longer timescales and help to meet demand at peak times.

Regulating markets

Existing regulating power markets may expand to support certified actors in marketing new, untapped, flexibility options for distribution system operators (DSOs) and transmission system operators (TSOs). Smart metering and price signals may help to pave the way for distributed (and often small-scale) storage and regulation assets to reach the market.

New market-based solutions require the reorganization of regulatory frameworks, enabling small units to provide and sell flexibility services without having to participate in the bulk energy and ancillary service markets.

Overview of energy storage technologies

Energy storage systems can be broadly classified as mechanical, electrical, electrochemical, chemical or thermal.

Mechanical storage

The most common mechanical storage systems are pumped hydroelectric power plants (pumped hydro storage, PHS), compressed air energy storage (CAES) and flywheel energy storage (FES).

PHS has been used commercially in power grids for almost a century and accounts for 99% of the world's 140 GW of installed electricity storage capacity. The PHS market is quite significant: it is growing at 6 GW a year, of which 1.5 GW a year is in Europe.

Geographical factors currently limit the potential for PHS. One way to allow PHS to be used more widely is the Green Power Island concept, based on offshore reservoirs surrounded by continuous dams. Offshore wind farms would provide power to pump seawater into the dam to create a PHS system.

CAES technology is more than a hundred years old, but only two modern CAES installations are in operation. One is in Alabama in the USA. The other, at Huntorf in Germany has operated since 1978.

Flywheels are the third promising type of electricity storage technology based on mechanical principles, in this case using a rotating mass as the energy storage medium. Compared to PHS and CAES, flywheels are most promising for short-term applications requiring relatively low energy but high power.

The maturity of these three technologies ranges from ideas that currently may be little more than sketches, through to proven commercial applications.

Electrical storage

Electromagnetic energy can be stored in the form of an electric field or a magnetic field, the latter typically generated by a current-carrying coil. Practical electrical energy storage technologies include electrical double-layer capacitors (EDLCs or ultracapacitors) and superconducting magnetic energy storage (SMES). Both are characterised by high power density, low energy density, high efficiency and little or no degradation due to charge/discharge cycling.

The opportunities for ultracapacitors will increase dramatically if materials research leads to commercially available devices with significantly increased energy density.

SMES systems store energy in magnetic fields created by the flow of direct current through superconducting coils. Cooling is a major issue in relation to SMES. The primary advantages of SMES compared to other types of energy storage are that the reaction time is very short and high power can be provided for short periods.

Due to the high costs of superconducting materials and cooling systems, however, it is hard to see how general-purpose commercial SMES systems can be built using existing materials.

SMES is therefore best regarded as an interesting and slightly exotic technology with little or no relevance to power grids. The recommendation is to follow supercon-

ducting materials research with an open mind and perform feasibility studies in case research leads to new possibilities.

Electrochemical storage

Electrochemical energy storage in the form of batteries holds great promise in a range of applications which cover many aspects of the future needs for energy storage, both in Denmark and abroad.

Present-day rechargeable lithium-ion (Li-ion) battery technology has been very successful since it was commercialised around 1990, largely due to its increased energy density compared to competing battery chemistries like nickel-metal hydride (NiMH).

In the near future, the use of battery-powered portable devices is expected to continue to grow and expand into new application areas, creating a demand for specialised battery solutions. Li-ion technologies are, however, likely to continue to dominate this market in the foreseeable future.

Although lithium-based batteries for transport and mobility have the potential to become the largest market for batteries both in Denmark and internationally, a number of fundamental challenges remain to be resolved. In particular these relate to power density, lifetime/durability and price.

Large battery systems such as those needed for grid-scale storage in connection with intermittent sustainable energy sources face quite different challenges compared to the small batteries used in portable and mobile applications. For large systems the most important factors are cost, volume, durability, low maintenance requirements, and especially fast charge/discharge rates.

Commercial systems based on highly durable lithium batteries, such as those with lithium titanate anodes, are already operating in connection with wind energy and solar power stations. The number of existing facilities is still limited, though one is currently being tested in Denmark.

Another challenge is the availability, toxicity and other environmental impacts of the materials used to manufacture batteries.

An absolutely key point before Li-ion batteries can be introduced on a massive scale in the transport and energy sectors is the need to overcome significant challenges related to price, storage capacity, degradation, cyclability, stability, and safety issues concerning uncontrolled chemical reactions.

Chemical storage

Energy stored in chemical fuels can be used for power generation and for transport, since chemical fuels are readily converted to mechanical or electrical energy.

Hydrogen (H₂) can be used as an energy storage molecule in itself, or as a feedstock for the synthesis of other storage molecules. Especially in mobile applications, however, a major issue for the direct use of hydrogen as an energy carrier is its low volumetric energy density.

Hydrogen can be produced by water electrolysis during periods of excess electricity production. Electrolysis is an established technology, but due to its unfavourable economics only around 4% of global hydrogen production uses this route.

Another way to stabilise fluctuating electricity production is by producing hydrogen and carbon monoxide through the gasification of renewable resources such as biomass and carbon-rich wastes.

Hydrogen can also be produced directly from sunlight by photocatalytic water splitting. However, a major challenge for the direct use of hydrogen as an energy carrier is the low volumetric energy density. This is especially a problem for mobile applications.

Methane (CH₄) is an interesting storage molecule because natural gas distribution networks are already in wide use, and the volumetric energy density of gaseous methane is more than three times that of gaseous hydrogen. In the **Power-to-gas** concept, electricity is first converted to hydrogen by electrolysis, followed by a methanation step to produce methane. As the name makes clear, power-to-gas connects the electricity system and the gas system.

Methanol is another potential storage molecule. Methanol can be produced from syngas or by hydrogenating carbon dioxide over a copper-based catalyst. Methanol can be converted into **dimethyl ether (DME)**, an alternative to oil-derived diesel fuel.

Liquid hydrocarbons form the backbone of our current energy infrastructure, so liquid hydrocarbons produced from renewable resources would thus be completely compatible with the existing energy infrastructure.

Ammonia (NH₃) is another potential storage compound. Due to the widespread use of ammonia as a fertiliser there is already some infrastructure for transporting it, and it can be stored at a relatively high energy density.

Heat storage

Heat storage – or rather thermal energy storage – is sometimes a little overlooked in discussions about the need for energy storage. However, more than 50% of Europe's final energy demand is in the form of heat.

In principle, heat storage can be divided into three main types: sensible heat, phase changes, and chemical reactions.

Sensible heat storage makes use of a temperature increase of the heat storage material. To achieve a high volumetric storage capacity the material should have a high specific heat and/or a high density. As water has high heat storage capacity per volume compared to other potential heat storage materials, it is suitable as heat storage material. Today almost all marketed heat storage systems operating in the temperature interval 0–100°C are based on hot water contained in a steel, stainless steel, concrete or plastic tank. The tank is insulated with an insulation material with a low thermal conductivity in order to reduce heat loss.

Phase change storages are heat storages where a large part of the accumulated heat is given off or taken up during the phase change of the heat storage material. In such heat storages it is possible to store large energy quantities at a constant temperature. The most promising transitions are from solid to liquid phase.

Heat storages using chemical reactions make use of a process where heat is transferred to the heat storage when a chemical process is going in one direction. During discharge of the heat storage the process goes in the opposite direction and heat is liberated. By means of this heat storage method heat can be stored without losses in periods without charge or discharge.

The importance of thermal storage will increase in the future as more and more of our heat demand is met by renewable energy sources characterised by a time difference between production and demand. Phase-change storage systems need further development before they can be marketed, while chemical heat storage systems are still at the R&D stage.

System aspects

System operators expect customers equipped with battery storage to have smoother and more predictable load profiles, thus allowing better grid control and higher levels of renewable generating capacity on the grids.

Storage can also be used to facilitate the participation of PV and wind power plants in the electricity markets by allowing them to commit to power production during certain periods of the day.

Worldwide, various industrial and demonstration projects have combined battery storage with distributed wind power plants. In Germany, an Enercon 6 MW wind turbine is connected to a 1 MW NaS battery. In Japan, large NaS batteries have been used with both wind and solar power; the largest is a 34 MW/245 MWh NaS battery system connected to the 51 MW Rokkasho wind farm.

From the point of view of the grid operator there are various benefits in using batteries together with distributed generators (DGs), including the ability to provide frequency regulation as required by upcoming grid codes.

A further point is that DGs normally connect to the distribution grid at relatively low voltages, where energy transfer is less efficient than in the high-voltage transmission grids. The ability of batteries to reduce the average distances over which power needs to be moved can therefore bring efficiency gains.

Since most DGs are renewable-based, their power output depends on the availability of resources as well as how they are controlled. It is therefore expected that it will increasingly become necessary for DGs, especially wind and solar power plants, to have associated energy storage.

Heating systems have characteristics that differ from those of electric systems; in particular, they usually have larger time constants. This fact can be exploited in relation to electricity demand management. For example, if the power system has a surplus of electricity, the heating system can absorb this and so prevent operational issues such as over-frequency, over-voltage and congestion on the power grid. The extra heat can either be supplied directly to customers, reducing the need to burn fuel, or stored for future use.

In the medium term, links between energy systems need to be demonstrated and regulatory settings developed to favour the effective coupling of infrastructures with respect to both the heat and gas sectors. In the longer term, to realise a future energy system based entirely on renewables, research and innovation must ensure that we develop the flexibility and associated solutions needed for a reliable and economic energy supply. In particular, coupling between the electricity and gas sectors has significant potential to balance longer breaks in the wind power supply and to capture temporary oversupply.

With the electrification of the transport sector, distribution grids may become increasingly stressed as they try to satisfy the new demand from EVs. Since EVs are equipped with large batteries, however, their storage capability can be exploited to cooperate with DGs. As with most conventional cars, EVs will be driven for an hour or two per day and will remain parked for the rest of the time. When they are plugged into the grid, their batteries may be used as a distributed storage system providing several useful grid services.

Index

- Adiabatic CAES, 22, 32
- Adiabatic Liquid Piston CAES, 34
- ammonia, 46, 51, 75, 82, 84
- biomass, 3, 8, 9, 13, 18, 24, 47, 48, 49, 50, 51, 52, 64, 73, 75
- borehole heat storage, 54, 55
- CAES, 4, 10, 16, 21, 22, 23, 29, 30, 31, 32, 33, 34, 36, 73, 74
- CASE, 48, 82
- CHP, 12, 13, 58, 67, 72, 73
- Demand Side Management, 13, 14, 16, 17, 18, 20, 58, 72, 73, 86
- DGs, 58, 59, 60, 61, 62, 63, 76
- dimethyl ether, 50, 75, 84
- Distributed Generation, 9, 10, 58
- DME, 50, 51, 75, 82, 84
- DSM, 13, 18, 72, 73
- DSO, 16, 66, 73
- EDLC, 4, 37, 38, 41, 42, 74
- electric boiler, 59, 61, 63
- electric double layer capacitors, 37, 42, 74
- Electrolysis, 22, 31, 47, 48, 49, 50, 51, 52, 67, 69, 75, 83
- energy density, 37, 38, 39, 40, 41, 43, 44, 45, 46, 47, 49, 50, 51, 74, 75
- ENTSO-E, 58, 59, 85
- EVs, 14, 62, 63, 73, 76
- fluctuations, 11, 14, 25, 26, 27, 43, 44, 59, 60, 69, 79, 82
- Flywheel Storage, 30, 73
- gasification of renewable resources, 47, 75
- grid-scale storage, 42, 43, 45, 46, 74
- heat pumps, 13, 16, 34, 59, 61, 62, 63, 64, 66, 72, 73
- Heat storages, 53, 54, 55, 56, 57, 75, 85
- High power batteries, 43, 45
- hot water stores, 53, 54, 56
- Hydro power, 12, 17, 18, 19, 31, 64, 73
- Hydrogen, 3, 5, 13, 22, 31, 46, 47, 48, 49, 50, 51, 52, 73, 75, 82, 83, 84
- IEEE, 58, 79, 80, 82, 83, 85, 86
- intermittent sustainable energy sources, 74
- Li-ion, 16, 43, 74, 81
- Li-ion battery, 19, 38, 81
- Liquid Air Thermo-Mechanical Storage, 34
- Liquid hydrocarbons, 50, 51, 75
- lithium capacitor, 38
- methane, 5, 20, 22, 46, 47, 49, 50, 51, 52, 75, 83
- Methane, 59
- Methanol, 46, 47, 50, 51, 75, 83, 84
- NG, 13
- NG grids, 13
- PEM, 49
- Phase change material storage, 55
- phase change storages, 53, 57, 75
- PHEVs, 14, 73
- PHS, 4, 21, 29, 30, 31, 32, 33, 34, 36, 73, 74
- power density, 37, 38, 40, 41, 42, 43, 44, 45, 46, 62, 74
- Power-to-Gas, 5, 20, 22, 50, 75, 83

predictability, 5, 9, 24, 25, 27, 28

prosumers, 24

Proton Exchange Membrane, 49

Pumped Hydro Storage, 3, 4, 21, 29, 31, 32, 36, 72, 73

RESs, 12

Sensible heat storages, 53

SMES, 4, 21, 37, 38, 39, 40, 41, 60, 74, 80

SOE, 49

solid oxide electrolysis, 49

Sorption and chemical storage, 56

stochastic power generation, 5, 24, 25, 26, 27, 28

storages using chemical reactions, 75

superconducting magnetic energy storage, 4, 21, 37, 38, 41, 60, 71, 81

thermal energy storage, 4, 19, 22, 23, 75, 80, 85

thermo-chemical heat storage system, 56

Thermo-Mechanical Electricity Storage, 29, 36

Transcritical Carbon Dioxide Thermo-Mechanical Storage, 34

ultra-capacitor, 4, 21, 37, 38, 42, 44, 74

UPS systems, 30

variability, 5, 9, 11, 24, 25, 26, 27, 28, 59

Virtual Power Plants, 14, 16, 17, 73

VPP, 13, 14, 73

References

Chapter 3

1. BP Energy Outlook 2030, London 2013
2. Global Trends in Renewable Energy Investments 2012, FSF in cooperation with Bloomberg New Energy Finance, Frankfurt 2012.
3. International Energy Agency: World Energy Outlook 2012, IEA, Paris
4. Energy Technology Perspectives 2012, IEA, Paris
5. Redrawing the energy-climate map. World Energy Outlook Special report, IEA 2013, Paris
6. Photovoltaic Power Systems Program – The role of energy storage for mini-grid stabilisation. Report IEA-PVPS T11-02:2011, Paris 2011
7. Climate Change – Synthesis Report, IPCC, Geneva 2007
8. Special Report on Renewable Energy Sources and Climate Change Mitigation (SRREN), IPCC, Geneva 2012.
9. Global Status Report, REN21, Paris 2013
10. Renewables Global Futures Report 2013, REN21, Paris 2013
11. Turn Down the Heat: Climate Extremes, Regional Impacts, and the Case for Resilience. World Bank, Washington 2012.

Chapter 4

1. Electric Energy Storage Technology Options: A White Paper Primer on Applications, Costs and Benefits. EPRI, Palo Alto, CA, 2010. 1020676.
2. Smart Grid Strategi - fremtidens intelligente energisystem. Klima-, Energi- og Bygningsministeriet. April 2013. ISBN: elektronisk 978-87-7844-993-1 / trykt 978-87-7844-994-8.
3. Risø Energy Report 10. Energy for smart cities in an urbanised world. Risø-R-1778(EN) November 2011. Edited by Hans Larsen and Leif Sønderberg Petersen

Chapter 5

1. Storage and balancing synergies in a fully or highly renewable pan-European power system, M.G.Rasmussen, G.B.Andresen and M.Greiner, Energy Policy, Vol.51 (2012), 642-651
2. EU in Figures (ISBN 978-92-79-22555-7), European Commission, Brussels, 2012.
3. Energy Statistics 2011 (ISBN 978-87-7844-94), Danish Energy Agency, Copenhagen, 2012.
4. <https://www.entsoe.eu/major-projects/ten-year-network-development-plan/>, 2013. [Online].
5. Joint EASE/EERA recommendations for a European Energy Storage Technology Development Roadmap towards 2030., European Association for Storage of Energy and EERA, JP Energy Storage, Brussels, 2013.

6. [http://www.projekt-irene.de/downloads/netzpraxis_irene.pdf] [Online].
7. http://www.dwv-info.de/aktuelles/Pressemeldungen/2012/pm1201_wai.pdf [Online].
8. http://godevelopment.dk/?page_id=576. [Online].
9. http://www.store-project.eu/en_GB/current-situation-in-the-target-countries-spain, Spanish Ministry of Environment. [Online].
10. <http://www.sol-ion-project.eu/sites/en/>. [Online].
11. <http://www.rwe.com/web/cms/mediablob/en/399030/data/0/2/ADELE-Adiabatic-Compressed-Air-Energy-Storage-for-electricity-supply.pdf>, [Online].
12. <http://www.rwe.com/web/cms/en/364260/rwe-power-ag/innovations/adele/>, RWE. [Online].

Chapter 6

1. World Wind Energy Association, “2012 – Half-year report”, WWEA, Bonn, Germany, 2012.
2. T. M. Letcher, Future Energy: Improved, Sustainable and Clean Options for our Planet, Amsterdam, The Netherlands: Elsevier, 2008.
3. T. Ackermann, Wind Power in Power Systems, New York: Wiley, 2012.
4. B. Ernst, B. Oaklef, M. Ahlstrom, M. Lange, C. Moehrlen, B. Lange, U. Focken and K. Rohrig, “Predicting the wind”, IEEE Power and Energy Magazine, vol. 5, no. 6, pp. 78–89, 2007.
5. P. Meibom, C. Weber, R. Barth and H. Brand, “Operational costs induced by fluctuating wind power production in Germany and Scandinavia”, IET Renewable Power Generation, vol. 3, no. 1, pp. 75–83, 2009.
6. J. Apt, “The spectrum of power from wind turbines”, Journal of Power Sources, vol. 169, no. 2, pp. 369-374, 2007.
7. C. L. Vincent, P. Pinson, G. Giebelm, “Wind fluctuations over the North Sea”, International Journal of Climatology, vol. 31, no. 11, pp. 1584-1595, 2011.
8. G. Giebel, “A variance analysis of the capacity displaced by wind energy in Europe”, Wind Energy, vol. 10, no. 1, pp. 69–79, 2007.
9. B. Hasche, “General statistics of geographically dispersed wind power”, Wind Energy, vol. 13, no. 8, p. 773–784, 2010.
10. U. Focken, M. Lange, K. Mönnich, H.-P. Waldl, H. Beyer and A. Luig, “Short-term prediction of the aggregated power output of wind farms—a statistical analysis of the reduction of the prediction error by spatial smoothing effects”, Journal of Wind Engineering and Industrial Aerodynamics, vol. 90, no. 3, pp. 231–246, 2002.

11. M. Korpaas, A. T. Holen, R. Hildrum, "Operation and sizing of energy storage for wind power plants in a market system", *International Journal of Electrical Power and Energy Systems*, vol. 25, no. 3, pp. 599–606, 2003.
12. T. K. A. Brekken, A. Yokochi, A. von Jouanne, Z. Z. Yen, H. M. Hapke, D. A. Halamay, "Optimal energy storage sizing and control for wind power applications", *IEEE Transactions on Sustainable Energy*, vol. 2, no. 1, pp. 69–77, 2011
11. Gottlieb Paludan, "Green Power Island", December 2009. [Online]. Available: http://www.greenpowerisland.dk/BlueBattery_96dpi.pdf.
12. Seahorn Energy, "Technology", [Online], <http://www.seahorn.dk/technology.htm>, Last visited 1 October 2013.
13. C. Bullough, C. Gatzen, C. Jakiel, M. Koller, A. Nowi and S. Zunft, "Advanced Adiabatic Compressed Air Energy Storage for the Integration of Wind Energy", i *Proceedings of the European Wind Energy Confer*, London, 2004.

Chapter 7

1. EASE and EERA Joint Programme on Energy Storage, "Joint EASE/EERA recommendations for a European Energy Storage Technology Development Roadmap towards 2030", EASE and EERA JP Energy Storage, Brussels, 2013.
2. F. Crotochino, K.-U. Mohmeyer and R. Scharf, "Huntorf CAES: 20 Years of Successful Operation", *Proceedings of SMRI Spring 2001 Meeting*, Orlando, Florida, USA, 2001.
3. B. Elmegaard and W. Brix, "Efficiency of Compressed Air Energy Storage", i *Proceedings of ECOS 2011*, Novi, Sad, Serbia, 2011.
4. Y. M. Kim, "Novel concepts of compressed air energy storage and thermo-electric energy storage", *École Polytechnique Fédérale de Lausanne*, Lausanne, 2012.
5. A.E. Tønnesen, A. H. Pedersen, A. H. Nielsen, A. Knöpfli, B. Elmegaard, J. Rasmussen, J. H. Vium, L. Reinholdt, P. B. Thøgersen, A. S. Pedersen, "Electricity Storage Technologies for Short Term Power System Services at Transmission Level", Report for ForskEl Project 10426, October 2010
6. D. Flint, "A Mishap At The Beacon Power Frequency Flywheel Plant", 29 July 2011, <http://eastwickpress.com/news/2011/07/a-mishap-at-the-beacon-power-frequency-flywheel-plant/>, [Last visited 1 October 2013]
7. R. B. Schainker, "Executive overview: energy storage options for a sustainable energy future", i *Power Engineering Society General Meeting*, 2004, 2004.
8. International Energy Agency, "Technology Roadmap, Hydropower", International Energy Agency, Paris, 2012.
9. W. Pickard, "The History, Present State, and Future Prospects of Underground Pumped Hydro for Massive Energy Storage", i *Proceedings of the IEEE*, 2012.
10. M. Kirchgässner, "Energilagring i underjordisk vandreservoir", 26 September 2009. [Online]. Available: <http://ing.dk/infografik/energilagring-i-underjordisk-vandreservoir-102512>.
11. J. E. P. Berlin, S. E. Crane and D. A. Fong, "Compressed air energy storage system utilising two-phase flow to facilitate heat exchange". USA Patent US 8037677 B2, 2011.
15. B. R. Bollinger, »System and Method for Rapid Isothermal Gas Expansion and Compression for Energy Storage«. USA Patent US 7802426 B2, 2010
16. M. Blieske, "Systems and methods for optimising thermal efficiency of a compressed air energy storage system". USA Patent US8272212 B2, 2012.
17. T. Petersen, B. Elmegaard and A. S. Pedersen, "Adiabatic Liquid Piston Compressed Air Energy Storage", 2013.
18. The Centre for Low Carbon Futures, "Liquid Air in the energy and transport systems", 2013.
19. M. Mercangöz, J. Hemrle, L. Kaufmann, A. Z'Graggen and C. Ohler, "Electrothermal energy storage with transcritical CO₂ cycles", *Energy*, 45, pp. 407–415, 2012.

Chapter 8

1. M. F. El-Kady, V. Strong, S. Dubin and R. B. Kaner, "Laser Scribing of High-Performance and Flexible Graphene-Based Electrochemical Capacitors", *SCIENCE*, vol. 335, pp. 1326–1330, 2012.
2. Bor Z. Jang, et. al., "Graphene Surface-Enabled Lithium Ion-Exchanging Cells: Next-Generation High-Power Energy Storage Devices", *Nano letters*, American Chemical Society, vol. 11, p. 3785–3791, 2011.
3. L. Wei and G. Yushin, "Electrical double layer capacitors with activated sucrose-derived carbon electrodes", *Carbon*, vol. 49, pp. 4830–4838, 2011.
4. A. Schilling, M. Cantoni, J. Guo and H. Ott, "Superconductivity above 130 K in the Hg–Ba–Ca–Cu–O system", *Nature*, vol. 363, pp. 56–58, 1993.
5. M. Hasan Ali, B. Wu and R. Dougal, "An Overview of SMES Applications in Power and Energy systems", *IEEE TRANSACTIONS ON SUSTAINABLE ENERGY*, vol. 1, pp. 38–47, 2010.

6. J. Wen, Jian X. Jin, You G. Guo and Jian G. Zhu, "Theory and Applications of Superconducting Magnetic Energy Storage", in Proceedings of the Australasian Universities Power Engineering Conference, Melbourne, 2006.
7. Z. Styczynski, et. al., "Electric Energy Storage Systems", CIGRE Working group C6.15, Paris, 2011.
8. Bruker Corporation, "http://www.bruker.com/" 2013.
9. F. J. Blatt, Modern Physics, McGraw-Hill College, 1992.
16. A. Reddy and M. Fichtner, Batteries based on fluoride shuttle", *J. Mater. Chem.*, vol. 21, pp. 17059–17062, 2011.
17. J. Mýrdal, D. Blanchard, D. Sveinbjörnsson, T. Vegge and T. Vegge, Li-ion conduction in the LiBH₄:LiI system from Density Functional Theory calculations and Quasi-Elastic Neutron Scattering", *J. Phys. Chem. C*, vol. 117, p. 9084, 2013.
18. T. Ohzuku and Y. Makimura, Layered lithium insertion material of LiCo_{1/3}Ni_{1/3}Mn_{1/3}O₂ for lithium-ion batteries", *Chemical letters*, vol. 7, p. 642, 2001.
19. V. Tripković, S. Siahrostami, K. Lundgaard, K. Jensen, H. Hansen, J. Hummelshøj and et al., First Principle Investigation of Zinc-anode Dissolution in Zinc-air Batteries", *Phys. Chem. Chem. Phys.*, vol. 15, p. 6416, 2013.

Chapter 9

1. M. Armand and J. Tarascon, Building Better Batteries", *Nature*, vol. 451, p. 652, 2008.
2. J. Goodenough and Y. Kim, Challenges for Rechargeable Li Batteries", *Chemistry of Materials*, vol. 22, p. 587, 2010.
3. 2050", [Online]. Available: http://www.ens.dk/sites/ens.dk/files/forbrug-besparelser/energisparreraadet/moeder-energisparreraadet/moede-energisparreraadet-16-marts-2011/Energistrategi2050_sammenfatning.pdf.
4. ReLiab", [Online]. Available: <http://www.reliable.dk>.
5. Hi-C: Novel in situ and in operando techniques; improving rechargeable batteries and super-capacitors (FP7-Energy, 2013–2017).
6. ALPBES", [Online]. Available: <http://www.energiforskning.dk/node/7274>.
7. Altairnano", 21 3 2013. [Online]. Available: <http://www.altairnano.com/press-releases/?id=1743927>.
8. P. Simon and Y. Gogotsi, Materials for electrochemical capacitors", *Nature Materials*, vol. 7, p. 845, 2008.
9. M. S. Whittingham, Lithium Batteries and Cathode Materials", *Chemical Reviews*, vol. 104, p. 4271, 2004.
10. Electropaedia", Woodbank Communications Ltd., [Online]. Available: <http://www.mpoweruk.com/chemistries.htm>.
11. Int. Energy Agency, Tech. Roadmaps, Electric and Plug-in Hybrid Electric Vehicles", 2009.
12. C. Pillot, The worldwide battery market 2011–2025", Avicenne Energy, 2012.
13. B. Dunn, H. Kamath and J. Tarascon, Electrical Energy Storage for the Grid: A Battery of Choices", *Science*, vol. 334, p. 6058, 2011.
14. P. Bruce, S. Freunberger, L. Hardwick and J.-M. Tarascon, Li-O₂ and Li-S batteries with high energy storage", *Nature Materials*, vol. 11, p. 19, 2012.
15. R. Prakash, C. Wall, A. Mishra, C. Kuebel, M. Ghafari, H. Hahn and M. Fichtner, Modified synthesis of [Fe/LiF/C] nanocomposite, and its application as conversion cathode material in lithium batteries", *J. Power Sources*, vol. 196, pp. 5936–5944, 2011.
20. D. Sveinbjörnsson, J. Mýrdal, D. Blanchard, J. Bentzen, T. Hirata, M. Mogensen and et al., The effect of heat treatment on the lithium ion conduction of the LiBH₄-LiI solid solution", *J. Phys. Chem. C*, vol. 117, p. 3249, 2013.
21. K. Edström, T. Gustafsson and J. Thomas, The cathode-electrolyte interface in the Li-ion battery", *Electrochimica Acta*, vol. 50, p. 397, 2004.
22. S. Cheah, E. Perre, M. Rooth, M. Fondell, A. Harsta, L. Nyholm and et al., Self-Supported Three-Dimensional Nanoelectrodes for Microbattery Applications", *Nano Lett.*, vol. 9, p. 3230, 2009.
23. J. Halls, A. Hawthornthwaite, J. Russell, R. Hepworth, N. Roberts, J. Kevin et al., Empowering the smart grid: can redox batteries be matched to renewable energy systems for energy storage?", *Energy Environ. Sci.*, vol. 6, p. 1026, 2013.
24. J. Whitacre, A. Mohammad, S. Snehbag, T. Wiley, E. Weber, D. Blackwood et al., Large-Format Asymmetric Sodium-Ion Functional Energy Storage Devices for Stationary Applications", *Journal of Power Sources*, vol. 213, pp. 255–264, 2012.
25. A. Peterson, F. Abild-Pedersen, F. Studt, J. Rossmeisl and J. Nørskov, "How copper catalyses the electroreduction of carbon dioxide into hydrocarbon fuels", *Energy Environ. Sci.*, vol. 3, p. 1311, 2010.
26. J. Howalt, T. Bligaard, J. Rossmeisl and T. Vegge, "DFT based study of transition metal nano-clusters for electrochemical NH₃ production", *Phys. Chem. Chem. Phys.*, vol. 15, p. 7785, 2013.
27. G. Girishkumar, "Lithium–Air Battery: Promise and Challenges", *J. Phys. Chem. Lett.*, vol. 1, p. 2193, 2010.
28. J. Hummelshøj, J. Blomqvist, S. Datta, T. Vegge, J. Rossmeisl, K. Thygesen et al., "Elementary oxygen electrode reactions in the aprotic Li-air battery", *J. Chem. Phys.*, vol. 132, p. 071101, 2010.

29. S. Younesi, S. Urbonaitė, F. Björefors and K. Edström, "Influence of the cathode porosity on the discharge performance of lithium-oxygen batteries", *J. Power Sources*, vol. 196, p. 9838, 2011.
 30. J. Garcia-Lastra, J. Myrdal, R. Christensen, K. Thygesen and T. Vegge, "DFT +U study of polaronic conduction in Li₂O₂ and Li₂CO₃: Implications for Li-air batteries", *J. Phys. Chem. C*, vol. 117, p. 5568, 2013.
- ### Chapter 10
1. F. Schüth, "Chemical Compounds for Energy Storage", *Chem. Ing. Technol.*, vol. 83, pp. 1984-1993., 2011.
 2. R. Schlögl, "The role of chemistry in the energy challenge", *ChemSusChem*, vol. 3, pp. 209-222, 2010.
 3. P. Sørensen, N. Cutululis, A. Viguera-Rodríguez, L. Jensen, J. Hjerrild and M. M. H. Donovan, "Power fluctuations from large wind farms", *IEEE Transactions on Power Systems*, vol. 22, pp. 958-965, 2007.
 4. R. Schlögl, "Chemical Energy Storage", Berlin: De Gruyter, 2012.
 5. A. Klerke, C. Christensen, J. Nørskov and T. Vegge, "Ammonia for hydrogen storage: challenges and opportunities", *J. Mater. Chem.*, vol. 18, pp. 2304-2310, 2008.
 6. T. Semelsberger, R. Borup and H. Greene, "Dimethyl ether (DME) as an alternative fuel", *J. Power Sources*, vol. 156, pp. 497-511, 2006.
 7. J.-M. Tarascon and M. Armand, "Issues and challenges facing rechargeable lithium batteries.", *Nature*, vol. 414, pp. 359-367, 2001.
 8. S. Szwaja and J. Naber, "Combustion of n-butanol in a spark-ignition IC engine", *Fuel*, vol. 89, pp. 1573-1582, 2010.
 9. J. Yang, A. Sudika, C. Wolverton and D. J. Siegel, "High capacity hydrogen storage materials: attributes for automotive applications and techniques for materials discovery", *Chem. Soc. Rev.*, vol. 39, pp. 656-675, 2010.
 10. C. Higman and M. van der Burgt, "Gasification", USA: Gulf Professional Publishing, 2003.
 11. F. Joensen, P. Højlund Nielsen and M. Sørensen, "Biomass to green gasoline and power", *Biomass Conv. Bioref.*, vol. 1, pp. 85-90, 2011.
 12. J. Rostrup-Nielsen, P. Højlund Nielsen, F. Joensen and J. Madsen, "Polygeneration – Integration of Gasoline Synthesis and IGCC Power Production Using Topsøe's TIGAS Process", in *Proc. Risø Int. Energy Conference*, 2007, pp. 56-68.
 13. J. Ahrenfeldt, T. Thomsen, U. Henriksen and L. Clausen, "Biomass gasification cogeneration—A review of state of the art technology and near future perspectives", *Appl. Therm. Eng.*, vol. 50, pp. 1407-1417, 2013.
 14. J. Christensen, P. Jensen and A. Jensen, "Effects of Feed Composition and Feed Impurities in the Catalytic Conversion of Syngas to Higher Alcohols over Alkali-Promoted Cobalt–Molybdenum Sulfide", *Ind. Eng. Chem. Res.*, vol. 50, pp. 7949-7963, 2011.
 15. I. Wender, "Reactions of synthesis gas", *Fuel. Proc. Technol.*, vol. 48, pp. 189-297, 1996.
 16. P. Mortensen, J.-D. Grunwaldt, P. Jensen, K. Knudsen and A. Jensen, "A review of catalytic upgrading of bio-oil to engine fuels", *Appl. Catal. A*, vol. 407, pp. 1-19, 2011.
 17. K. Raffelt, E. Henrich, A. Koegel, R. Stahl, J. Steinhardt and F. Weirich, "The BTL2 process of biomass utilization entrained-flow gasification of pyrolyzed biomass slurries", *Appl. Biochem. Biotechnol.*, vol. 129, pp. 153-164, 2006.
 18. N. Dahmen, E. Dinjus, T. Kolb, U. Arnold, H. Leibold and R. Stahl, "State of the art of the bioliq® process for synthetic biofuels production", *Env. Prog. Sust. Energy*, vol. 31, pp. 176-181, 2012.
 19. For a list of publications from the CASE project see: www.case.dtu.dk.
 20. P. Edwards, V. Kuznetsov, W. David and N. Brandon, "Hydrogen and fuel cells: Towards a sustainable energy future", *Energy Policy*, vol. 36, pp. 4356-4362, 2008.
 21. P. Chiesa, G. Lozza and L. Mazzocchi, "Using Hydrogen as Gas Turbine Fuel", *J. Eng. Gas Turbines Power*, vol. 127, pp. 73-80, 2005.
 22. M. I. Hoffert, K. Caldeira, G. Benford, D. R. Criswell, C. Green and H. Herzog et al., "Advanced Technology Paths to Global Climate Stability: Energy for a Greenhouse Planet", *Science*, vol. 298, pp. 981-987, 2002.
 23. C. Song, "Fuel processing for low-temperature and high-temperature fuel cells: Challenges, and opportunities for sustainable development in the 21st century", *Catal. Today*, vol. 77, pp. 17-49, 2002.
 24. T. Bak, J. Nowotny, M. Rekas and C. Sorrell, "Photo-electrochemical hydrogen generation from water using solar energy. Materials-related aspects", *Int. J. Hydrogen Energy*, vol. 27, pp. 991-1022, 2002.
 25. Y. Hou, B. Abrams, P. Vesborg, M. Björketun, K. Herbst, L. Bech, A. Setti, C. Damsgaard, T. Pedersen, O. Hansen, J. Rossmeisl, S. Dahl, J. Nørskov and I. Chorkendorff, "Bioinspired molecular co-catalysts bonded to a silicon photocathode for solar hydrogen evolution", *Nature Materials*, vol. 10, pp. 434-438, 2011.

26. G. Olah, G. Prakash and A. Goepfert, "Anthropogenic chemical carbon cycle for a sustainable future", *J. Am. Chem. Soc.*, vol. 133, pp. 12881-12898, 2011.
27. Partnerskabet for Brint og Brændselsceller, "Elektrolyse i Danmark, Strategi for F, U & D 2010-2018", <http://www.energinet.dk/SiteCollectionDocuments/Danske%20dokumenter/Forskning/Brint%20-%20Elektrolyse%20i%20Danmark.pdf>, 2009.
28. P. V. Hendriksen, B. V. Mathiesen, A. S. Pedersen and S. Linderth, "The role of fuel cells and electrolyzers in future efficient energy systems", in H.H. Larsen, L.S. Petersen (Eds.) DTU Energy report, Technical University of Denmark, 2012, pp. 95-101.
29. J. Turner, G. Sverdrup, M. K. Mann, P.-C. Maness, B. Kroposki, M. Ghirardi, R. J. Evans and D. Blake, "Renewable hydrogen production", *Int. J. Energy Res.*, vol. 2008, pp. 379-407, 2008.
30. G. Gahleitner, "Hydrogen from renewable electricity: An international review of power-to-gas pilot plants for stationary applications", *Int. J. Hyd. Energy*, vol. 38, pp. 2039-2061, 2013.
31. A. Ursúa, L. M. Gandia and P. Sanchis, "Hydrogen Production From Water Electrolysis: Current Status and Future Trends", *Proceedings of the IEEE*, vol. 100, pp. 410-426, 2012.
32. J. Schefold, A. Brisse and F. Tietz, "Nine Thousand Hours of Operation of a Solid Oxide Cell in Steam Electrolysis Mode", *J. Electrochem. Soc.*, vol. 159, pp. A137-A144, 2012.
33. M. A. Laguna-Bercero, "Recent advances in high temperature electrolysis using solid oxide fuel cells: A review", *J. Power Sources*, vol. 203, pp. 4-16, 2012.
34. A. Hauch, S. D. Ebbesen, S. Højgaard Jensen and M. Mogensen, "Highly efficient high temperature electrolysis", *J. Mater. Chem.*, vol. 18, pp. 2331-2340, 2008.
35. J. Ivy, "Summary of Electrolytic Hydrogen Production Milestone Completion Report", NREL Report NREL/MP-560-36734, 2004.
36. J. Turner, "Sustainable hydrogen production", *Science*, vol. 305, pp. 972-974, 2004.
37. U. Eberle, M. Felderhoff and F. Schüth, "Chemical and physical solutions for hydrogen storage", *Angew. Chem. Int. Ed.*, vol. 48, pp. 6608-6630, 2009.
38. S. Enthaler, J. von Langermann and T. Schmidt, "Carbon dioxide and formic acid—the couple for environmental-friendly hydrogen storage?", *Energy Environ. Sci.*, vol. 3, pp. 1207-1217, 2010.
39. G. Olah, A. Goepfert and G. Prakash, "Beyond Oil and Gas: The Methanol Economy", Germany: Wiley-VCH, 2006.
40. U. Bossel, B. Eliasson and G. Taylor, "The future of the hydrogen economy: bright or bleak?", *Cogen. Competitive Power J.*, vol. 18, pp. 29-70, 2003.
41. J. Kopyscinski, T. Schildhauer and S. Biollaz, "Production of synthetic natural gas (SNG) from coal and dry biomass—A technology review from 1950 to 2009", *Fuel*, vol. 89, pp. 1763-1783, 2010.
42. C. Hamelinck and A. Faaij, "Outlook for advanced biofuels", *Energy Policy*, vol. 34, pp. 3268-3283, 2006.
43. R. Raven and K. Gregersen, "Biogas plants in Denmark: successes and setbacks", *Renew. Sust. Energy Rev.*, vol. 11, pp. 116-132, 2007.
44. P. McKendry, "Energy production from biomass (part 2): conversion technologies", *Bioresource Technol.*, vol. 83, pp. 47-54, 2002.
45. T. Trost, S. Horn, M. Jentsch and M. Sterner, "Erneuerbares Methan: Analyse der CO₂-Potenziale für Power-to-Gas Anlagen in Deutschland", *Z. Energiewirtschaft*, vol. 36, pp. 173-190, 2012.
46. R. Winkler-Goldstein and A. Rastetter, "Power to Gas: The Final Breakthrough for the Hydrogen Economy", *Green*, vol. 3, pp. 69-78, 2013.
47. J. Lelieveld, S. Lechtenböhmer, S. Assonov, C. Brenninkmeijer, C. Dienst, M. Fischeidick and T. Hanke, "Greenhouse gases: Low methane leakage from gas pipelines", *Nature*, vol. 434, pp. 841-842, 2005.
48. IPCC, "Working Group I Fourth Assessment Report 'The Physical Science Basis'", <https://www.ipcc-wg1.unibe.ch/publications/wg1-ar4/wg1-ar4.html>, 2007.
49. G. Olah, "After Oil and Gas: methanol economy", *Catal. Lett.*, vol. 93, pp. 1-2, 2004.
50. M. Behrens, F. Studt, I. Kasatkin, S. Kühl, M. Hävecker, F. Abild-Pedersen, S. Zander, F. Girgsdies, P. Kurr, B. Knief, M. Tovar, R. Fischer, J. Nørskov and R. Schlögl, "The Active Site of Methanol Synthesis over Cu/ZnO/Al₂O₃ Industrial Catalysts", *Science*, vol. 336, pp. 893-897, 2012.
51. J.-D. Grunwaldt, A. M. Molenbroek, N.-Y. Topsøe, H. Topsøe and B. S. Clausen, "In Situ Investigations of Structural Changes in Cu/ZnO Catalysts", *J. Catal.*, vol. 194, pp. 452-460, 2000.
52. J.-D. Grunwaldt, "In situ Analysis of Heterogeneous Catalysts in Chemical Energy Conversion", in R. Schlögl (Ed.), *Chemical Energy Storage*, Berlin, De Gruyter, 2012, pp. 311-328.
53. C. N. Hamelinck and A. P. C. Faaij, "Future prospects for production of methanol and hydrogen from biomass", *J. Power Sources*, vol. 111, pp. 1-22, 2002.
54. Danish Technological Institute, "GreenSynFuels Final Project Report", http://www.hydrogennet.dk/fileadmin/user_upload/PDF-filer/Partnerskabet/Strategier/GreenSynFuels_report_final.pdf, 2011.

55. R. Nichols, "The methanol story: a sustainable fuel for the future", *J. Sci. Ind. Res.*, vol. 62, pp. 97-105., 2003.
56. S. Wasmus and A. Küver, "Methanol oxidation and direct methanol fuel cells: a selective review", *J. Electroanal. Chem.*, vol. 461, pp. 14-31, 1999.
57. D. Palo, R. Dagle and J. Holladay, "Methanol steam reforming for hydrogen production", *Chem. Rev.*, vol. 107, pp. 3992-4021, 2007.
58. J. B. Hansen and F. Joensen, "High Conversion of Synthesis Gas into Oxygenates", *Stud. Surf. Sci. Catal.*, vol. 61, pp. 457-467, 1991.
59. T. H. Fleisch, A. Basu and R. A. Sills, "Introduction and advancement of a new clean global fuel: The status of DME developments in China and beyond", *J. Nat. Gas Sci. Eng.*, vol. 9, pp. 94-107, 2012.
60. A. Y. Kam, M. Schreiner and S. Yurchak, "Mobil Methanol-to-Gasoline (MTG) Process", in R.A. Meyers (Ed.), *Handbook of Synfuels Technology*, USA, McGraw-Hill, 1984, pp. 2-75-2-111.
61. J. Keller, "Alcohols as motor fuel?", *Hydrocarbon Process.*, vol. 58, pp. 127-138, 1979.
62. J. Christensen, P. Mortensen, R. Trane, P. Jensen and A. Jensen, "Effects of H₂S and process conditions in the synthesis of mixed alcohols from syngas over alkali promoted cobalt-molybdenum sulfide", *Appl. Catal. A*, vol. 366, pp. 29-43, 2009.
63. V. Subramani and S. Gangwal, "A Review of Recent Literature to Search for an Efficient Catalytic Process for the Conversion of Syngas to Ethanol", *Energy Fuels*, vol. 22, pp. 814-839, 2008.
64. J. Spivey and A. Egbebi, "Heterogeneous catalytic synthesis of ethanol from biomass-derived syngas.", *Chem. Soc. Rev.*, vol. 36, pp. 1514-1528, 2007.
65. J. Christensen, P. Jensen, N. Schiødt and A. Jensen, "Coupling of Alcohols over Alkali-Promoted Cobalt-Molybdenum Sulfide", *ChemCatChem*, vol. 2, pp. 523-526, 2010.
66. S. Phillips, "Technoeconomic Analysis of a Lignocellulosic Biomass Indirect Gasification Process to Make Ethanol via Mixed Alcohol Synthesis", *Ind. Eng. Chem. Res.*, vol. 46, pp. 8887-8897, 2007.
67. P. Vennestrøm, C. Osmundsen, C. Christensen and E. Taarning, "Beyond petrochemicals: the renewable chemicals industry", *Angew. Chem. Int. Ed.*, vol. 50, pp. 10502-10509, 2011.
68. J. Larsen, M. Petersen, L. Thirup, H. Li and F. Iversen, "The IBUS process—lignocellulosic bioethanol close to a commercial reality", *Chem. Eng. Technol.*, vol. 31, pp. 765-772, 2008.
69. F. Trippe, M. Fröhling, F. Schultmann, R. Stahl, E. Henrich and A. Dalai, "Comprehensive techno-economic assessment of dimethyl ether (DME) synthesis and Fischer–Tropsch synthesis as alternative process steps within biomass-to-liquid production", *Fuel Process. Technol.*, vol. 106, pp. 577-586, 2013.
70. M. J. A. Tijmensen, A. P. C. Faaij, C. N. Hamelinck and M. R. M. van Hardeveld, "Exploration of the possibilities for production of Fischer Tropsch liquids and power via biomass gasification", *Biomass Bioenergy*, vol. 23, pp. 129-152, 2002.
71. S. Phillips, J. Tarud, M. Bidy and A. Dutta, "Gasoline from woody biomass via thermochemical gasification, methanol synthesis, and methanol-to-gasoline technologies: A technoeconomic analysis", *Ind. Eng. Chem. Res.*, vol. 50, pp. 11734-11745, 2011.
72. E. Kunkes, D. Simonetti, R. West, J. Serrano-Ruiz, C. Gärtner and J. Dumesic, "Catalytic conversion of biomass to monofunctional hydrocarbons and targeted liquid-fuel classes", *Science*, vol. 322, pp. 417-421, 2008.
73. G. Huber, J. Chheda, C. Barrett and J. Dumesic, "Production of liquid alkanes by aqueous-phase processing of biomass-derived carbohydrates", *Science*, vol. 308, pp. 1446-1450, 2005.
74. R. Schlögl, "Catalytic Synthesis of Ammonia—A Never-Ending Story?", *Angew. Chem. Int. Ed.*, vol. 42, pp. 2004-2008, 2003.
75. C. Christensen, R. Sørensen, T. Johannessen, U. Quaade, K. Honkala, T. Elmøe, R. Köhler and J. Nørskov, "Metal ammine complexes for hydrogen storage", *J. Mater. Chem.*, vol. 15, pp. 4106-4108, 2005.
76. S. Simonsen, D. Chakraborty, I. Chorkendorff and S. Dahl, "Alloyed Ni-Fe nanoparticles as catalysts for NH₃ decomposition", *Appl. Catal. A*, vol. 447, pp. 22-31, 2012.
77. Energinet.dk, "Energi 2050 Udviklingsspor for energisystemet", 2010.
78. Energistyrelsen, "Biomasseressourcer", <http://www.ens.dk/undergrund-forsyning/vedvarende-energi/bioenergi/biomasseressourcer>, 2013.
79. Energistyrelsen, "Energistatistik 2011", <http://www.ens.dk/sites/ens.dk/files/info/tal-kort/statistik-noegletal/aarlig-energistatistik/Energistatistik%202011.pdf>, 2011.
80. M. Parikka, "Global biomass fuel resources", *Biomass Bioenergy*, vol. 27, pp. 613-620, 2004.
81. U. E. I. Administration, "EIA International Energy Outlook 2013", <http://www.eia.gov/forecasts/ieo/>, 2013.
82. U. C. Colpier and D. Cornland, "The economics of the combined cycle gas turbine—an experience curve analysis", *Energy Policy*, vol. 30, pp. 309-316, 2002.

83. H. Weigt, "Germany's wind energy: The potential for fossil capacity replacement and cost saving", *Appl. Energy*, vol. 86, pp. 1857-1863, 2009.
84. J. Murray and D. King, "Oil's tipping point has passed", *Nature*, vol. 481, pp. 433-435, 2012.

Chapter 11

1. Int. J. Solar Energy, Test procedures for heat storages for solar heating systems, S. Furbo, 1983.
2. EuroSun 2012 Conference Proceedings, Thermal performance of marketed SDHW systems under laboratory conditions, Rijeka, Croatia, S. Furbo, E. Andersen, J. Fan, Z. Chen, B. Perers, 2012.
3. Proceedings of Conference on Thermal Storage, Heat storage for solar heating systems – Now and in the future, Prague, Czech Republic, S. Furbo, E. Andersen, 2008.
4. Proceedings of Conference on Thermal Storage, Stratification devices, Prague, Czech Republic, E. Andersen, S. Furbo, 2008.
5. *Solar Energy* vol. 78/2, Smart solar tanks for small solar domestic hot water systems, S. Furbo, E. Andersen, S. Knudsen, N.K. Vejen, L.J. Shah, 2005.
6. International Energy Agency Solar Heating and Cooling Programme, Thermal energy storage for solar and low energy buildings, state of the art by the IEA Solar Heating and Cooling Task 32, J.-C. Hadorn, 2005.
7. "BASF website," [Online]. Available: http://www.micronal.de/portal/basf/ien/dt.jsp?setCursor=1_290829. [Accessed 05 2013].
8. Solar Heating & Cooling Programme, Compact Thermal Energy Storage: Material Development for System Integration, Development of Space Heating and Domestic Hot Water Systems with Compact Thermal Energy Storage, a report of the IEA Solar Heating and Cooling/Energy Conservation through Energy Storage programme - Task 42/Annex 24, W. van Helden, 2013.
9. "Thermobatterie website," [Online]. Available: <http://www.thermobatterie.net/thermobatterie.html>. [Accessed 07 2013].
10. "COMTES website," [Online]. Available: <http://comtes-storage.eu>. [Accessed 07 2013].
11. "MERITS website," [Online]. Available: <http://www.merits.eu>. [Accessed 07 2013].
12. "SOLTHERCO website," [Online]. Available: <http://sotherco.eu>. [Accessed 07 2013].
13. "IEA Task 42 website," [Online]. Available: <http://task42.iea-shc.org/>. [Accessed 05 2013].

Chapter 12

1. N. Hatzigiorgiou, H. Asano, R. Iravani and C. Marnay, "Microgrids: an overview of ongoing research, development and demonstration projects", *IEEE Power and Energy Magazine*, vol. 5, no. 4, pp. 78–94, 2007.
2. M. Pehnt, M. Cames, C. Fischer, B. Praetorius, L. Schneider, K. Schumacher and e. al, *Micro Cogeneration: Towards Decentralised Energy Systems*, Springer, 2006.
3. G. Y. Yang and O. J. Olesen, "Future Scenario Description, System in Context and Specifications", Work package report of the Project 'Secure Operation of Sustainable Power Systems', Kgs. Lyngby, Denmark, 2013.
4. IEEE Standard for Interconnecting Distributed Resources with Electric Power Systems", IEEE, 2003.
5. ENTSO-E, "Latest Updates & Milestones – March 2013", ENTSO-E, 2013. [Online]. Available: <https://www.entsoe.eu/major-projects/network-code-development/latest-updates-milestones/>. [Accessed 26 May 2013].
6. ENTSO-E, "Network Code on Requirements for Grid Connection applicable to all Generators (RfG)", ENTSO-E, 2013. [Online]. Available: <https://www.entsoe.eu/major-projects/network-code-development/requirements-for-generators/>. [Accessed 26 May 2013].
7. J. Leadbetter and L. G. Swan, "Selection of battery technology to support grid-integrated renewable electricity", *Journal of Power Sources*, vol. 216, pp. 376–386, 15 October 2012.
8. "Project Overview", Alameda County, CA, 2011. [Online]. Available: <http://www.acgov.org/pdf/SRJSmartGridOverview.pdf>. [Accessed 26 May 2013].
9. "Microgrid Energy Storage Demonstration", CEC/DOE Energy Storage Collaboration, 2013. [Online]. Available: <http://energystoragedemo.epri.com/cec/microgrid/microgrid.asp>. [Accessed 26 May 2013].
10. "NAS Battery System", NGK Insulators, LTD, 2011. [Online]. Available: <http://www2.ademe.fr/servlet/getBin?name=EA7316C69FBD6C4A1AF9FD685A474A941260277923999.pdf>. [Accessed 26 May 2013].
11. "DOE Energy Storage Database", Sandia National Laboratories, 2013. [Online]. Available: <http://www.energystorageexchange.org/projects>. [Accessed 26 May 2013].
12. "Community energy generation and storage", 2011. [Online]. Available: <http://www.smartgridsmartcity.com.au/Trial-progress-and-results/Community-energy-generation-and-storage.aspx>.
13. R. Lasseter, "MicroGrids", in *IEEE Power Engineering Society Winter Meeting*, New York, NY, USA, 2002.

Chapter 13

1. The Government, Vores Energi (in Danish), November 2011, (<http://www.ens.dk/politik/dansk-klimatenergipolitik/regeringens-klimatenergipolitik/vores-energi>)
2. limakommissionen, Grøn Energi – vejen mod et dansk energisystem uden fossile brændsler (in Danish), September 2010 (<http://www.ens.dk/politik/dansk-klimatenergipolitik/klimakommissionen/gron-energi>).
3. Yann Rebours and Daniel Kirschen. A survey of definitions and specifications of reserve services. Technical report, University of Manchester, 2005.
4. Peter Vang Hendriksen, Brian Vad Mathiesen, Allan S. Pedersen and Søren Linderøth, “The role of fuel cells and electrolyzers in future efficient energy systems”, In DTU Energy Report 2012, Ch.13A , pp. 95, (http://www.natlab.dtu.dk/~media/Andre_Universitetsenheder/Nationallab_for_Baeredygtig_Energi/NatLabDocs/dtu_energy_report_2012.ashx)
5. D. Pudjianto, C. Ramsay, and G. Strbac. Virtual power plant and system integration of distributed energy resources. IET Renew. Power Gener., 1(1):10{16, 2007.
6. Yi Ding; Nyeng, P.; Ostergaard, J.; Maj Dang Trong; Pineda, S.; Koen Kok; Huitema, G.B.; Grande, O.S., Ecogrid EU – a large scale smart grids demonstration of real time market-based integration of numerous small DER and DR, Innovative Smart Grid Technologies (ISGT Europe), 2012 3rd IEEE PES International Conference and Exhibition on , vol., no., pp.1,7, 14–17 Oct. 2012
7. Biegel, B. (2012). Flexibility Interface – Information Modelling for Direct Control. Aalborg University. Copenhagen: iPower.
8. Jónson, T. (2012). Flexibility Interface – Indirect Control by Prices. DTU, DTU Compute. iPower.
9. D. Callaway, “Tapping the energy storage potential in electric loads to deliver load following and regulation, with application to wind energy”, Energy Conv. Manage., vol. 50, no. 9, pp. 1389–1400, 2009.
10. Heussen, K., You, S., Biegel, B., Hansen, L. H., & Andersen, K. B. (2012). Indirect Control for Demand Side Management – A Conceptual Introduction. Innovative Smart Grid Technologies. Berlin: IEEE .
11. Daniel E. M. Bondy, Kai Heussen, Germán Tarnowski, Lars Henrik Hansen, Operational Scenario: Manual Regulating Power, Technical report, Copenhagen, iPower, (www.iPower-net.dk)
12. Heussen, K.; Koch, S.; Ulbig, A. & Andersson, G. ‘Unified System-Level Modelling of Intermittent Renewable Energy Sources and Energy Storage for Power System Operation’ Systems Journal, IEEE, 2012, 6, 140–151
13. Project Homepage, ([http://orbit.dtu.dk/en/projects/optimal-sizing-and-control-of-balancing-power-in-the-future-european-system-considering-transmission-system-constraints\(8899cf62-e1dd-4e6a-abfd-6b21f5355c9b\).html](http://orbit.dtu.dk/en/projects/optimal-sizing-and-control-of-balancing-power-in-the-future-european-system-considering-transmission-system-constraints(8899cf62-e1dd-4e6a-abfd-6b21f5355c9b).html))
14. Heussen, Bondy, Hu, Gehrke, Hansen, A Clearing-house Concept for Distribution-Level Flexibility Services, ISGT 2013, Copenhagen.

Recent volumes of DTU International Energy Report

Energy efficiency improvements - a key element in the global transition to non-fossil energy, 2012

Increasing energy efficiency, much of which can be achieved through low-cost measures, offers huge potential for reducing CO₂ emissions during the period up to 2050. With this background the report addresses the global, regional and national challenges in pursuing energy efficiency improvements, together with the main topics in research and development for energy efficiency. The report also analyses a selection of barriers hindering the broader implementation of energy efficiency improvements. Finally it gives examples of how more stringent performance standards and codes, as well as economic incentives, can unlock energy efficiency potential and scale up the financing of energy efficiency improvements.

November 2012. ISBN 978-87-550-3965-0

Energy for smart cities in an urbanised world, 2011

Volume 10 takes as its point of reference the rapid urbanisation of the world. The report addresses energy related issues for smart cities, including energy infrastructure, onsite energy production, transport, economy, sustainability, housing, living and governance, including incentives and barriers influencing smart energy for smart cities.

November 2011. ISBN 978-87-550-3905-6

Non-fossil energy technologies in 2050 and beyond, 2010

The report analyses the long-term outlook for energy technologies in 2050 in a perspective where the dominating role of fossil fuels has been taken over by non-fossil fuels, and CO₂ emissions have been reduced to a minimum. Against this background, the report addresses issues like: How much will today's non-fossil energy technologies have evolved up to 2050? Which non-fossil energy technologies can we bring into play in 2050, including emerging technologies? What are the implications for the energy system? Further the report analyses other central issues for the future energy supply: The role of non-fossil energy technologies in relation to security of supply and sustainability; System aspects in 2050; Examples of global and Danish energy scenarios in 2050.

November 2010. ISBN 978-87-550-3812-7

The intelligent energy system infrastructure for the future, 2009

The report takes its point of reference in the need for the development of a highly flexible and intelligent energy system infrastructure which facilitates substantial higher amounts of renewable energy than today's energy systems. The report presents a generic approach for future infrastructure issues on local, regional and global scale with focus on the energy system.

September 2009. ISBN 978-87-550-3755-7

An overview of the complete report series is available at www.natlab.dtu.dk/english/Energy_publications/Report_series

The expert team behind DTU International Energy Report 2013

The individual chapters in DTU International Energy Report 2013 are written by DTU researchers in cooperation with leading Danish and international experts. The report is edited and published in accordance with the highest international quality standards. Finally the report was refereed by an independent international expert.



Aksel Hauge Petersen
DONG Energy, Denmark



Allan Schrøder Pedersen
DTU Department of
Energy Conversion and
Storage



Anker Degn Jensen
DTU Chemical Engineering



Argyrios Altiparmakis
DTU
DTU Electrical Engineering



Arne Ravndal Finnby
Solvind Projekt AS



Brian Elmegaard
DTU Mechanical
Engineering



Christian Bang-Møller
Topsoe Fuel Cell Denmark



**Claus Nygaard
Rasmussen**
DTU Electrical Engineering



Francesco Marra
Statoil ASA



Guangya Yang
DTU Electrical Engineering



Hans Hvidtfeldt Larsen
DTU National Laboratory
for Sustainable Energy



Jacob Østergaard
DTU Electrical Engineering



**Jakob Munkholt
Christensen**
DTU Chemical Engineering



Jan-Dierk Grunwaldt
Karlsruhe Institute of
Technology, Germany



John Christensen
UNEP Risø Centre DTU
Management Engineering



Kai Heussen
DTU Electrical Engineering



Kristina Edström
Uppsala University



Lars Henrik Nielsen
DTU Management
Engineering



Lars Reinholdt
Danish Technological
Institute



**Leif Sønnderberg
Petersen**
DTU National Laboratory
for Sustainable Energy



Manfred Däumling
Germany



Mark Radka
UNEP Paris



Patrick McSharry
Smith School for Enterprise
and the Environment,
University of Oxford



Peter Hall
Department of Chemical
and Biological Engineering
University of Sheffield, UK



Peter Vang Hendriksen
DTU Energy Conversion



Pierre Pinson
DTU Electrical Engineering



Poul Norby
DTU Energy Conversion



Rainer Saliger
Siemens AG



Robin Girard
MINES ParisTech Centre
for Processes Renewable
Energies and Energy
Systems



**Seyedmostafa Hashemi
Toghroljerdi**
DTU Electrical Engineering



Simon Furbo
DTU Civil Engineering



Tage Petersen
Danish Technological
Institute



Tejs Vegge
DTU Energy Conversion



Tom Molinski
Manitoba Hydro Canada

DTU International Energy Report 2013

Energy storage options for future sustainable energy systems

Edited by Hans Hvidtfeldt Larsen and Leif Sønnderberg Petersen,
DTU National Laboratory for Sustainable Energy

Reviewed by
Professor Peter Hall, Department of Chemical and Biological Engineering,
University of Sheffield, UK

Editorial consultant
Charles Butcher, Science Journalist, UK

Design by Bysted A/S

Cover illustration Bysted A/S

Printed by Centertryk A/S

Copyright: Technical University of Denmark, 2013

ISBN 978-87-550-3968-1

