

Technical University of Denmark



## A Research on Wind Farm Micro-sitting Optimization in Complex Terrain

**Xu, Chang; Yang, Jianchuan; Li, Chenqi; Shen, Wen Zhong; Zheng, Yuan; Liu, Deyou**

*Published in:*

Proceedings of the 2013 International Conference on aerodynamics of Offshore Wind Energy Systems and wakes (ICOWES2013)

*Publication date:*  
2013

*Document Version*  
Publisher's PDF, also known as Version of record

[Link back to DTU Orbit](#)

*Citation (APA):*

Xu, C., Yang, J., Li, C., Shen, W. Z., Zheng, Y., & Liu, D. (2013). A Research on Wind Farm Micro-sitting Optimization in Complex Terrain. In W. Shen (Ed.), Proceedings of the 2013 International Conference on aerodynamics of Offshore Wind Energy Systems and wakes (ICOWES2013) (pp. 669-679). Technical University of Denmark (DTU).

## DTU Library

Technical Information Center of Denmark

---

### General rights

Copyright and moral rights for the publications made accessible in the public portal are retained by the authors and/or other copyright owners and it is a condition of accessing publications that users recognise and abide by the legal requirements associated with these rights.

- Users may download and print one copy of any publication from the public portal for the purpose of private study or research.
- You may not further distribute the material or use it for any profit-making activity or commercial gain
- You may freely distribute the URL identifying the publication in the public portal

If you believe that this document breaches copyright please contact us providing details, and we will remove access to the work immediately and investigate your claim.

# A Research on Wind Farm Micro-sitting Optimization in Complex Terrain

Chang Xu<sup>1</sup>, Jianchuan Yang<sup>1</sup>, Chenqi Li<sup>1</sup>, Wenzhong Shen<sup>2</sup>, Yuan Zheng<sup>1</sup>, Deyou Liu<sup>1</sup>

<sup>1</sup>Hohai University, College of Energy and Electrical Engineering, Nanjing, Jiangsu Province, 211100, China, [zhuifengxu@hhu.edu.cn](mailto:zhuifengxu@hhu.edu.cn), [yefeng1t@hhu.edu.cn](mailto:yefeng1t@hhu.edu.cn)

<sup>2</sup>Technical University of Denmark, Department of Wind Energy, Nils Koppels Alle, Building 403, 2800, Lyngby, Denmark, [wzsh@dtu.dk](mailto:wzsh@dtu.dk)

## ABSTRACT

Wind farm layout optimization in complex terrain is a pretty difficult issue for onshore wind farm. In this article, a novel optimization method is proposed to optimize the layout for wind farms in complex terrain. This method utilized Lissaman and Jensen wake models for taking the terrain height and the wake loss from the upstream turbines into the wind turbine power output calculation. Wind direction is divided into sixteen sections, and the wind speed is processed using the Weibull distribution. The objective is to maximize the total wind farm power output and the free design variables are the wind turbines' park coordinates which subject to the boundary and minimum distance conditions between two wind turbines. A Cross Particle Swarm Optimization (CPSO) method is developed and applied to optimize the layout for a certain wind farm case. Compared with the uniform and experience method, results show that the CPSO method has a higher optimal value, and could be used to optimize the actual wind farm micro-sitting engineering projects.

**Keywords:** wind farm micro-sitting, complex terrain, wake model, probability density, cross particle swarm optimization (CPSO)

## 1 Introduction

In the past few years there is a growing energy demand with the worldwide economic development, where fossil fuel almost accounts for all of the energy consumption. It's well known that the fossil fuel is nonrenewable and could generate all kinds of emissions which pollute the environment as well as affect human's health<sup>[1]</sup>. Global people's minds are being awakened to develop and utilize renewable energy which covers wind energy, solar energy, wave energy, hydrogen energy, etc. Nevertheless, with the current technology status, wind energy is almost the lowest-cost in all the renewable energy utilization fields and can be installed on a large scale or distributed power. It is promising to be the third energy supply in addition to fossil energy and hydro energy in China.

During the last 10 years, the total installed wind turbines capacity in China has reached 65 000MW which is the top one position in the world, most of them are scaled wind farm utilizations and at the same time, are located on flat terrain with good wind energy resources. The zone in addition to flat terrain is called complex terrain. The next stage in wind farm development will be focused on complex terrain<sup>[2]</sup>. There are often a few advantages for the decision maker to exploit the wind energy resources in complex terrain on the lower land, operation and environment costs. At the same time this kind of projects often creates many high quality job opportunities and incents the local economic as well. However, it is difficult to predict the wind energy distribution and layout the wind farm due to the detouring flow in the complex terrain and the wakes in the wind farms are very hard to be modeled. Currently, how to make full use of the wind energy and lay out the wind farms are both academic and engineering issues.

Many factors will affect the wind power output of a wind farm, such as wind turbines selection, layout method, grid connection, etc. However, the layout of a wind farm is one of most effective ways to improve wind energy utilization efficiency<sup>[3-5]</sup>.

There are some studies or software applied in the actual wind farm micro-sitting. Common software include WAsP, Windfarm, Windsim, Meteodyn WT, etc. WAsP from Danish Risø National Laboratory is the most widely used software up to now, however WAsP itself has some drawbacks, such as, WAsP can't optimize the placement of wind turbines independently without the help of other necessary techniques and is proved to be not accurate enough from the practical data in complex terrain<sup>[6]</sup>. The CFD can simulate the flow field in complex terrain accurately and the velocities in front of each wind turbine can be determined. On the other hand CFD computations are excessive computational costly, with a considerable long process runtime and it is unsuitable to implement in the practical use of the optimization issue<sup>[7]</sup>. Rasoul rahmani<sup>[8]</sup>, Alireza Emami<sup>[9]</sup>, C. Szafron<sup>[10]</sup> and Chunqiu Wan<sup>[11]</sup> presented a simplified wake model accompanied with Weibull wind speed distribution in their studies, but the model didn't consider the wind direction and elevation which had great influences on the turbine wake. Liu<sup>[12]</sup> applied the Genetic Algorithm (GA) to the wind farm layout optimization, but the efficiency of the overall algorithm was not discussed and the power calculation was too rough to predict accurately the energy production. Furthermore, the above mentioned methods are all based on the rectangular and flat topography. However, most of the wind farms are located on irregular and uneven topography which increases the difficulties in wind farm modeling and calculation of the optimal results.

In this paper, a novel methodology is used to optimize the wind turbines' park coordinates for maximizing the wind farm's power production in a specified irregular zone wind farm with knowing the number of turbines. In the proposed approach, Lissaman wake model and Jenson wake model are established that can be applied in complex terrain with different wind directions. The calculation of the power output based on the probability density method by wind speed Weibull distribution combined with wind speed-power curve. The CPSO algorithm is implemented for the optimization problem, and compared with uniform distribution method and experienced distribution method. The feasibilities and reliabilities are analyzed for the wind farm layout optimizations as well.

## 2 Mathematical Models

### 2.1 Wake model

Wind turbine in a wind farm extracts energy from atmosphere, reducing the wind velocity and producing swirling eddies behind the rotor which is called wind turbine wake<sup>[13]</sup>. The mean velocity and turbulence intensity in the wake zone are different from that in the free stream. If a turbine locates behind an upstream turbine in the wind direction, the turbine will be affected by the wake created by the upstream turbine, which will reduce its power output. The wind speed has the stochastic characters in both direction and magnitude<sup>[14]</sup>. In order to calculate wind power production under different speeds, different directions and different layouts in the wind farm should be transformed and wind speed distribution should be modeled.

In this paper, the wind directions are divided into 16 intervals with  $22.5^\circ$  for each interval from  $0^\circ$  to  $360^\circ$ . The angular bisector of the interval can be deemed to the direction of each interval.

The statistical characteristic of the wind speed at a certain height has been approximated by the two-parameter Weibull distribution function which is proved to

be appropriate enough distribution pattern for the wind energy field [15-16]. For a given wind speed  $v$  in the direction interval  $\theta_{iv}$ , with a shape parameter  $K_{iv}$  and a scale parameter  $C_{iv}$  of the Weibull distribution function, its frequency  $g(v, \theta_{iv})$  can be calculated as:

$$g(v, \theta_{iv}) = \frac{K_{iv}}{C_{iv}} \left(\frac{v}{C_{iv}}\right)^{K_{iv}-1} \exp\left(-\left(\frac{v}{C_{iv}}\right)^{K_{iv}}\right) T(\theta_{iv}) \quad (1)$$

where  $T(\theta_{iv})$  is the probability in the wind direction interval  $iv$ ,  $iv$  is from 1 to  $n$  ( $n=16$ ).

$$T(\theta_{iv}) = \frac{\varepsilon_{iv}}{\varepsilon_{sum}} \quad (2)$$

where  $\varepsilon_{iv}$  is the count statistics that the wind speed direction within the range of  $(iv-1)*22.5^\circ$  and  $iv*22.5^\circ$ ,  $\varepsilon_{sum}$  is the total count statistics of wind speed.

According to Lissaman wake model [17], wind speed varies with elevation by index relationship. Suppose that a set of wind data is measured at a certain height  $z_0$  (Fig.1), the wind speeds at turbine  $i$  and  $j$  can be calculated by equations (3) ~ (4):

$$v_i = v_0 \left(\frac{z(i) + h}{z_0}\right)^\alpha \quad (3)$$

$$v_j = v_0 \left(\frac{z(j) + h}{z_0}\right)^\alpha \quad (4)$$

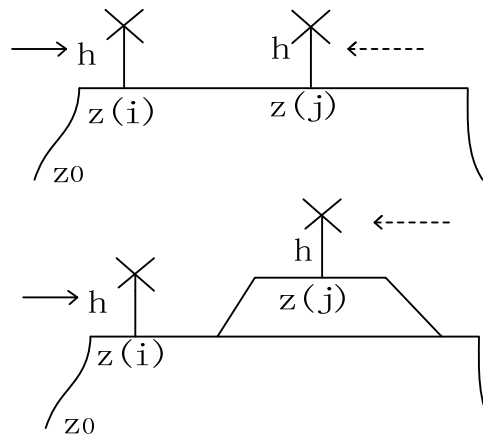


Fig.1 Lissaman wake mode

where  $z(i)$  and  $z(j)$  are the elevations of turbine  $i$  and turbine  $j$ , respectively,  $h$  is the wind turbine tower height,  $v_0$  is the wind speed measured at  $z_0$ , and  $\alpha$  is the friction coefficient which is determined by the terrain ( $\alpha=1/7$  for the paper). the actual wind speeds of turbine  $i$  and  $j$  are:

$$v'_i = v_i(1 - d_i) \quad (5)$$

$$v'_j = v_j(1 - d_j) \quad (6)$$

Where  $d_i$  and  $d_j$  are wind speed deficits, in this paper, we apply Jensen wake model to calculate the value.

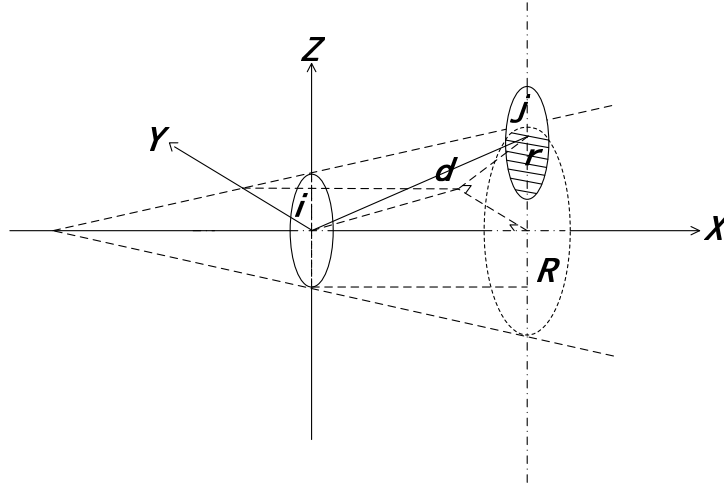


Fig.2 Jensen wake mode

When the wind blows from left to right, the turbine  $i$  is the upstream turbine, it will not be affected by any other turbine, so the speed deficit of two turbines are<sup>[12]</sup>:

$$d_i = 0 \quad (7)$$

$$d_j = [1 - (1 - C_T)^{1/2}] \left(\frac{r}{R}\right)^2 \left(\frac{h}{h + \Delta Z}\right)^{2\alpha_1} \frac{A_w}{\pi r^2} \quad (8)$$

Where  $C_T$  thrust coefficient,  $r$  is the blade radius,  $R$  is the wake radius and  $A_w$  swept area of a turbine's rotor.

When the wind blows from right to left, the wind speed deficit of two turbines can be calculated as :

$$d_j = 0 \quad (9)$$

$$d_i = [1 - (1 - C_T)^{1/2}] \left(\frac{r}{R}\right)^2 \left(\frac{h + \Delta Z}{h}\right)^{2\alpha_1} \frac{A_w}{\pi r^2} \quad (10)$$

Suppose there are  $N$  turbines in a wind farm and the kinetic energy deficit keeps conservation due to all the wakes, the inlet velocity of a turbine for a certain wind speed and a wind direction interval can be obtained by equation (11):

$$v'_i = \sqrt{v_i^2 + \sum_{\substack{j=1 \\ j \neq i}}^N [v_{ij}^2 - v_i^2]} \quad (11)$$

Where  $v_{ij}$  represents the turbine  $i$ 's inlet velocity after the effects of the turbines  $j$ .

## 2.2 Power model

The power that a turbine obtained from the wind is associated with the wind speed, and the power curve could be linearly approximated<sup>[18]</sup>:

$$f(v) = \begin{cases} 0, & v < v_{in} \\ \lambda v + \eta, & v_{in} \leq v \leq v_{rated} \\ P_{rated}, & v_{rated} \leq v \leq v_{out} \end{cases} \quad (12)$$

Where  $v_{in}$ ,  $v_{out}$  and  $v_{rated}$  are wind turbine's cut-in, cut-out and rated wind speeds respectively.  $P_{rated}$  is the rated power.  $\lambda$  and  $\eta$  are the coefficients of the wind turbine power curve.

Combined with the equation (1) and (12), a wind turbine power output can be calculated by:

$$E(p) = \sum_{iv=1}^n \int_0^{+\infty} \frac{360^\circ}{n} g(v, \theta_{iv}) f(v) dv \quad (13)$$

The total power that all wind turbines produced the of the wind farm is:

$$E(P_{sum}) = \sum_{l=1}^N E(P_l) \quad (14)$$

$E(P_l)$  is the power of function of turbine  $l$  and  $E(P_{sum})$  is the power function of the total wind farm.

### III Algorithms for the turbine placement optimization Cross Particle Swarm Optimization (CPSO) algorithm

In this paper, the target of the optimization issue is the maximization of the wind farm total power production, which means the minimization of the power loss due to wind direction and turbines coordinates. The objective function of an individual for the evolutionary algorithms is the logarithmic of total power production's multiplicative inverse:

$$f = \ln(1/E(P_{sum})) \quad (15)$$

The fitness value of an individual for evolutionary algorithms is:

$$F = \frac{1}{f + \psi} \quad (16)$$

Where  $\psi$  is a small positive value to ensure the fitness value be a positive value.

The basic steps of standard PSO algorithm can be simplified as<sup>[19]</sup>:

$$x_i^{t+1} = x_i^t + v_i^{t+1} \quad (17)$$

$$v_i^{t+1} = \omega v_i^t + \beta_1 r_1 (p_i - x_i^t) + \beta_2 r_2 (p_g - x_i^t) \quad (18)$$

Where:  $v_i^{t+1}$ , velocity of agent  $i$  at iteration  $t$ ;  $\omega$ , inertia weight;  $\beta_1, \beta_2$ , positive weighting constants;  $r_1, r_2$ , random number between 0 and 1;  $x_i^t$ , current position of individual at iteration  $t$ ;  $p_i$ , local best of the individual  $i$ ;  $p_g$ , global best of all the individuals.

The standard PSO algorithm would be easily trapped into local optimal point compared with other population based algorithms for lacking of population diversities<sup>[20]</sup>. In this paper, some operators are designed to overcome this drawback. Firstly the strategy is inertia weight is gradually decreased. In the standard PSO, the inertia weight is a fixed constant, while the inertia weight  $\omega$  is responsible for the searching area. A big  $\omega$  means search the optimization solution in the large space, and A small  $\omega$  means small local searching space<sup>[21]</sup>. Therefore, The big  $\omega$  is efficient at the beginning of the iterations and the small  $\omega$  will be better to get the optimization result at the later stage of the iterations. The inertia weight in the paper is defined:

$$\omega = \omega_{max} (\omega_{max} / \omega_{min})^{\frac{1}{1+10t/T_{sum}}} \quad (19)$$

Where  $\omega_{max}$  and  $\omega_{min}$  are max and min inertia weights,  $t$  is the current generation or inertia time and  $T_{sum}$  is the total generations or inertia times.

Secondly, the inferior particles will be eliminated. In the behavior of the swarm, there will always be some particles far from the optimal results, which affect the overall optimization efficiency. The improved algorithm introduces some new particles that

based on cross operator to replace the bad ones. The new particle's positions and corresponding speeds are:

$$x_r^t = q_1 x_g + (1 - q_2) x_{b_1}^t \quad (20)$$

$$v_r^t = q_3 v_g + (1 - q_4) v_{b_2}^t \quad (21)$$

Where  $t$  is the current generation,  $x_r^t$  and  $v_r^t$  are the inferior particle and its speed,  $x_g$  and  $v_g$  are the global best particle and its speed,  $x_{b_1}^t$  and  $v_{b_2}^t$  are random selected particle and speed from other particles respectively.  $q_1$ ,  $q_2$ ,  $q_3$  and  $q_4$  are random numbers from 0 to 1.

Thirdly, individual optimal position and global optimal position mutate. During the iteration, particles gradually approach the local optimal and global optimal, and the search efficiency may be trapped into stagnation. In order to keep the search ability at this time, individual optimal position and global position both mutate if the particles' position close to optimal over the limitation.

$$p_i' = c_1 p_i + (1 - c_2) p_i \quad (22)$$

$$\text{If } |x_i - p_i| < \nabla$$

$$p_g' = c_3 p_g + (1 - c_4) p_g \quad (23)$$

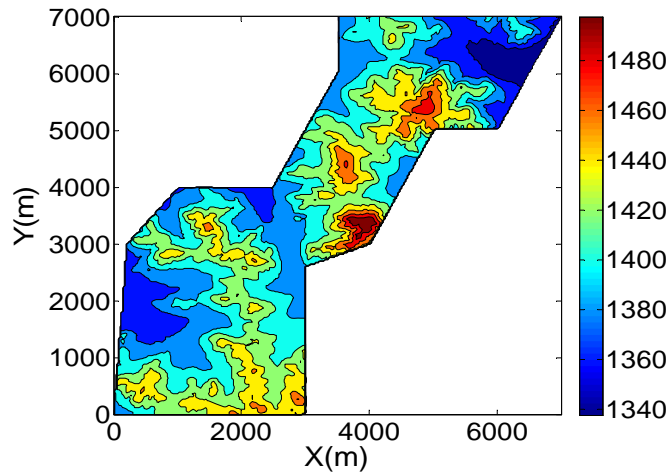
$$\text{If } |x_i - p_g| < \nabla_1$$

Where  $c_1$ ,  $c_2$ ,  $c_3$ ,  $c_4$  are random numbers from 0 to 1,  $\nabla$  and  $\nabla_1$  are the limitation constants.

## 4 Case study

### 4.1 Wind farm description

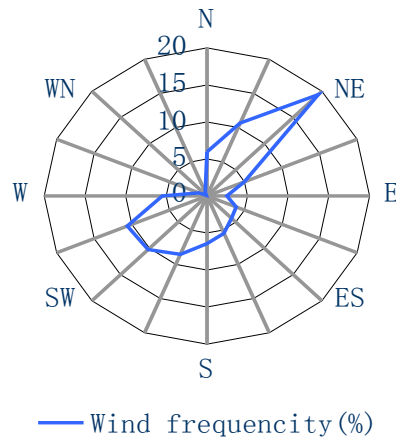
In order to compare the reliability and feasibility of the proposed method. The efficiencies of the three evolutionary algorithms are checked in the same wind farm of north China. The wind farm is the complex terrain shown as *Fig. 3*. The wind farm is an irregular graphic with  $X$ -axis and  $Y$ -axis both from 0 m to 7000 m, and elevation from 1337.5 m to 1517.5 m.



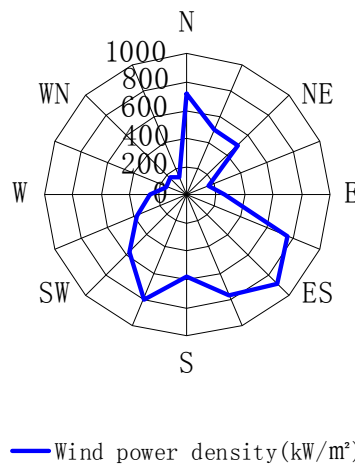
*Fig.3* Wind farm topographic contour

The wind farm locates in the rich wind resource zone. *Fig.4* and *Fig.5* describe the wind's frequency and power density distribution. *Tab.1* shows the Weibull

distribution parameters,  $K$  value,  $C$  value, probability, and power density of 16 wind direction sections.



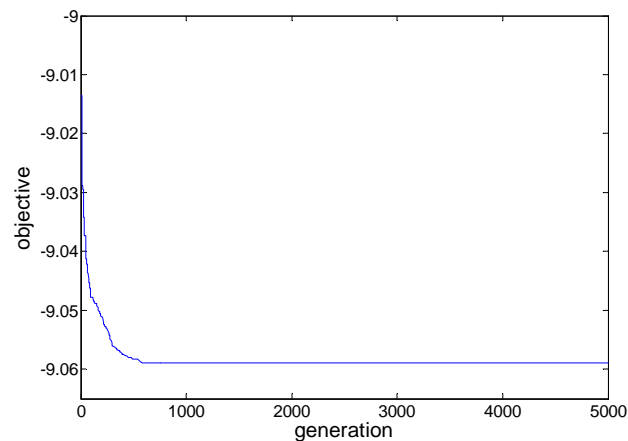
**Fig.4** Wind direction rose chart



**Fig.5** Wind power density rose chart

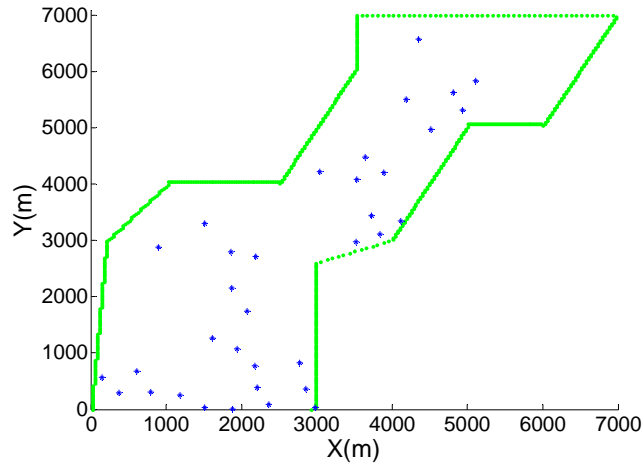
### 4.2 Results and analysis

Objective function convergence curves and optimal placement distributions are checked and analyzed for the three evolutionary algorithms applied in the wind farm layout optimization. Objective function convergence curve for CPSO is shown as Fig.6, Optimal placement distribution results for CPSO is shown as Fig.7.



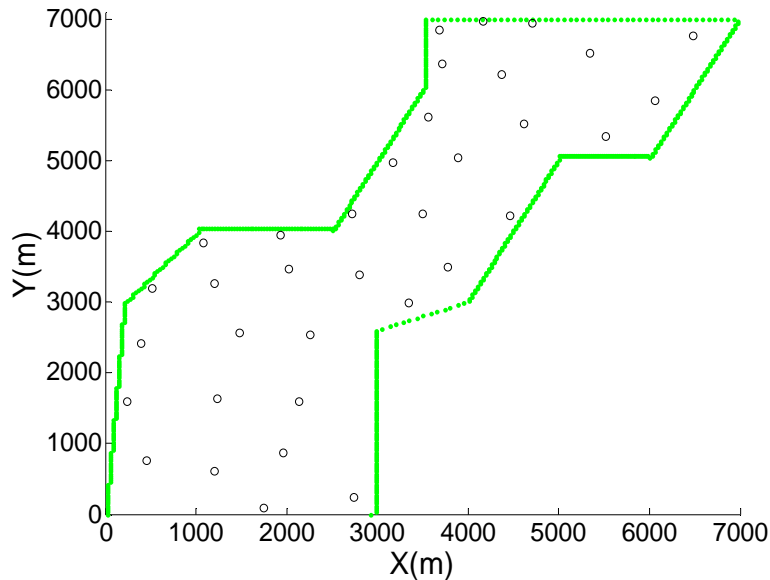
**Fig.6** Objective function convergence curve (CPSO)



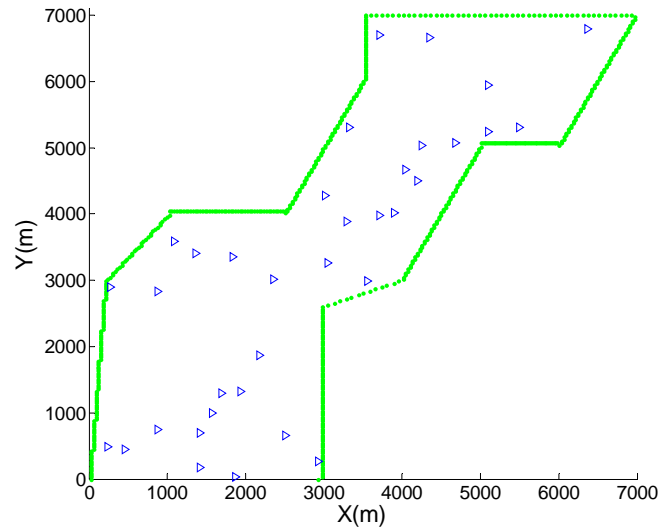


**Fig.7 Optimal placement distribution (CPSO)**

Wind turbine uniform layout scheme (Uniform distribution) is often applied for the flat terrain wind farm. Higher elevation positions with good wind energy resource are also usually chose to place the wind turbine by the experienced engineer for the complex terrain (Experience distribution). The regulations of these two schemes are the turbines are required to keep 5 to 9 diameters in the prevail direction and 3 to 5 diameters in the direction perpendicular to the prevail direction, and wind turbines configurate plum blossom<sup>[22]</sup>. Uniform layout scheme for the wind farm is shown as Fig.7. Distribution scheme by choosing high elevation is shown as Fig.8 for the complex terrain wind farm. Data of wind speeds, wind directions, topography and wind turbine parameters can be loaded into WASP, and WASP can exports wind turbines power outputs for these two layout methods<sup>[23]</sup>.



**Fig.7 Placement of uniform distribution**



**Fig.8 Optimal placement of experience distribution**

The result comparisons of the five layout methods are shown as in Tab.1, where the power is wind farm annual average power production for all turbines.

**Tab.1 Optimization results comparison**

|                         | Optimal objective | Power(kW) | Converge Time(h) |
|-------------------------|-------------------|-----------|------------------|
| Uniform distribution    | -9.0141           | 8218.3    | 2.1              |
| Experience distribution | -9.0346           | 8388.4    | 2.1              |
| CPSO                    | -9.0589           | 8594.7    | 7.2              |

From the Tab.3, the uniform distribution and experience distribution methods get the lower power production and the lower time than the three proposed evolutionary algorithms because of no optimization computation process. After testing, the coordinate distributions of the three algorithms meet the requirements of distance and boundary restrictions at the same time. The layouts of the three optimization algorithms concentrate on the high position (compare the layout with the wind farm topographic contour in Fig.2) where the power density is higher than the others. The CPSO have improved the total power production by 2.46% compare with the experience distribution method. The uniform distribution and experience distribution methods concentrate on the prevail wind direction and distance from each other, without considering the effect of elevation and optimizing distribution, so the schemes of these two methods are both not competent.

## 5. Conclusion

In this paper, a wake model was established which could be implemented in calculating wind farm power output of the complex terrain. The wake model utilized the Lissaman model and Jensen model which process the wind speeds of different elevation in the wind farm, and consider the effect of the wake intersection area with the rotor on the wind turbine power output. The wind direction was divided into 16 sections and the wind speed was processed by Weibull distribution. The probability density of each section was used to calculate of wind turbine power output. A optimization algorithm called CPSO is proposed in the paper. Results from the CPSO optimization were compared with the uniform and experience method. Results show the CPSO optimization methods perform better than the uniform and experience method in the wind farm layout optimization. CPSO proposed by the paper shows the

best performance in the distribution problem and can be used to optimize the wind farm layout engineering issue.

**Acknowledgements:** This paper is partially supported by the National Key Basic Research Development Program of China (973), project number is 2010CB227102-1); the Scientific Research Foundation for the Returned Overseas Chinese Scholars from State Education Ministry, project number is 2012-940; and the Six Personnel Field Peak Projects in Jiangsu Province, project number is 2012-XNY-12.

## References:

- (1) Carlos M. Ituarte-Villarreal and Jose F. Espiritu. Wind turbine placement in a wind farm using a visual based optimization algorithm [J]. Computers and Industrial Engineering, 2008 (41):672-677.
- (2) Han, X. Guo, J. Wan, p. Adequacy study of a wind farm considering terrain and wake effect [J]. Journals and Magazines.2012, 10(06):1001-1008.
- (3) Li ling, Zeng Xiang Jun, Zhang Ping. Wind farms reactive power optimization using genetic/tabu hybrid algorithm[C]. Chang'sha, China, ICICTA, 2008:1272-1276.
- (4) J.M. Morales, R.Minguez, A.J. Conejo. A methodology to generate statistically dependent wind speed scenarios [J]. Applied Energy, 2010(87):843-855.
- (5) Zhang Changshui, Hou Guangdong, Wang Jun. A fast algorithm based on the submodular property for optimization of wind turbine positioning [J]. Renewable Energy, 2011(36): 2951-2958.
- (6) Xu Guobin, Peng Xiufang, Wang Haijun. Micro-siting of Complex Terrain for Wind Power Station [J]. Water Resources and Power, 2010, 28(4): 157-160.
- (7) Rajai Aghabi Rivas, Jens Clausen, Kurt S.Hansen, et al. Solving the turbine position problem for large offshore wind farms by simulated annealing [J]. Wind Engineering, 2009,3(33):287-298.
- (8) Rasoul Rahmani, A.Khairuddin, Sam M.Cherati, et al. A novel method for optimal placing wind turbines in a wind farm using particle swarm optimization (PSO) [C]. Johor, Malaysia, IEEE, 2010:134-139.
- (9) Alireza Emami, Pirooz Noghreh. New approach on optimization in placement of wind turbines within wind farm by genetic algorithms [J]. Renewable Energy, 2010,35:1559-1564.
- (10) C.Szafron. Off shore wind farm layout optimization[C]. Janiszewskiego, Poland, IEEEIC, 2010:542-545.
- (11) Chunqiu Wan, Jun Wang, Geng Yang, et al. Optimal micro-siting of wind turbines by genetic algorithms based on improved wind and turbine models[C]. Shang'hai, China, IEEE, 2009:5092-5096.
- (12) Feng-Jiao Liu, Pai-Hsun Chen, Shyi-Shium Kuo. Wind characterization analysis incorporating genetic algorithm: A case study in Taiwan Strait[J]. Energy, 2011(36):2611-2619.
- (13) Moskalenko, N. Otto-von-Guericke-Univ, Magdeburg, et al. Study of wake effects for offshore wind farm planning[C]. Magdeburg, Germany, MEPS, 2010:1-7.
- (14) Yunus Eroglu, Serap Ulusam Seckiner. Design of wind farm layout using ant colony algorithm[J]. Renewable Energy.2012(44):53-62.
- (15) Mathaba. T, Mpholo. M, Letuma. M. Velocity and power density analysis of the wind at Lefeng-la-terae in Lesotho[J]. Renewable Energy, 2012(46):210-217.
- (16) Shi. LB, Wang. C, Yao, LZ. Optimal power flow solution incorporating wind power[J]. IEEE Systems Journal.2011(6)233-241.
- (17) Tai-Her Yeh, Li Wang, Senior Member. A study on generator capacity for wind turbines under various tower heights and rated wind speeds using Weibull distribution [C]. Tainan, China, Energy Conversion, IEEE, 2008,2(23):592-602.
- (18) C. Kongnam, S. Nuchprayoon. Decision analysis on generation capacity of a wind park[J]. Renewable and Sustainable Energy Reviews, 2009,8(13): 2126- 2133.

- (19) Marcela Martinez-Rojas, Andreas Sumper, Oriol Gomis-Bellmunt, et al. Reactive power dispatch in wind farms using particle swarm optimization technique and feasible solutions search[J]. Applied Energy 2011(88)4678-4686.
- (20) Chunqiu Wan, Jun Wang, Geng Yang, et al. Wind farm micro-siting by Gaussian particle swarm optimization with local search strategy[J].Renewable Energy,2012 (48) 276-288.
- (21) Chen Guo-Chu, Yang Wei, Zhang Yan-chi, et al. Simplified classification PSO and its application in wind farm modeling[J].Control and decision,2011,3(26):381-386.
- (22) WU Qing-yuan, He De-xin, Sun Ru-lin, Wu Yun-dong. Wind powerengineering technical manual[M], Beijing: Machinery industry press, 2004.
- (23) Dunsic, Zejko, Mikulovic,et al. A model for vertical wind speed data extrapolation for improving wind resource assessment using WASP [J] .Renewable Energy,2011 (41):407-411. 8.1031e+03