

REVISION OF *BLEDIUS* AND  
RELATED GENERA  
PART I. THE *AEQUATORIALIS*,  
*MANDIBULARIS*, AND  
*SEMIFERRUGINEUS* GROUPS  
AND TWO NEW GENERA  
(COLEOPTERA, STAPHYLINIDAE,  
OXYTELINAE)

LEE H. HERMAN, JR.

BULLETIN  
OF THE  
AMERICAN MUSEUM OF NATURAL HISTORY  
VOLUME 149 : ARTICLE 2 NEW YORK : 1972



*REVISION OF BLEDIUS AND RELATED GENERA*



PART I. *THE AEQUATORIALIS,*  
*MANDIBULARIS, AND SEMIFERRUGINEUS*  
*GROUPS AND TWO NEW GENERA*  
(*COLEOPTERA, STAPHYLINIDAE, OXYTELINAE*)

LEE H. HERMAN, JR.

*Assistant Curator, Department of Entomology*  
*The American Museum of Natural History*

BULLETIN

OF THE

AMERICAN MUSEUM OF NATURAL HISTORY

VOLUME 149 : ARTICLE 2

NEW YORK : 1972

BULLETIN OF THE AMERICAN MUSEUM OF NATURAL HISTORY

Volume 149, article 2, pages 111-254, figures 1-451, maps 1-17, tables 1-5

*Issued November 20, 1972*

*Price: \$5.55 a copy*

## CONTENTS

ABSTRACT . . . . .	115
INTRODUCTION . . . . .	115
TAXONOMY . . . . .	118
Key to the Genera . . . . .	118
<i>Microbledius</i> , New Genus . . . . .	118
Key to the Species of <i>Microbledius</i> in the United States . . . . .	120
<i>Psamathobledius</i> , New Genus . . . . .	136
Key to the Species of <i>Psamathobledius</i> . . . . .	140
Genus <i>Bledius</i> . . . . .	153
Key to the Species-groups of <i>Bledius</i> from the New World . . . . .	154
Key I. The Species of the <i>aequatorialis</i> Group . . . . .	154
Key II. The Species of the <i>mandibularis</i> Group . . . . .	154
Key III. The Species of the <i>semiferrugineus</i> Group . . . . .	154
<i>aequatorialis</i> Group . . . . .	156
<i>mandibularis</i> Group . . . . .	173
<i>semiferrugineus</i> Group . . . . .	204
APPENDIX: MATERIAL EXAMINED . . . . .	247
LITERATURE CITED . . . . .	252
INDEX . . . . .	254

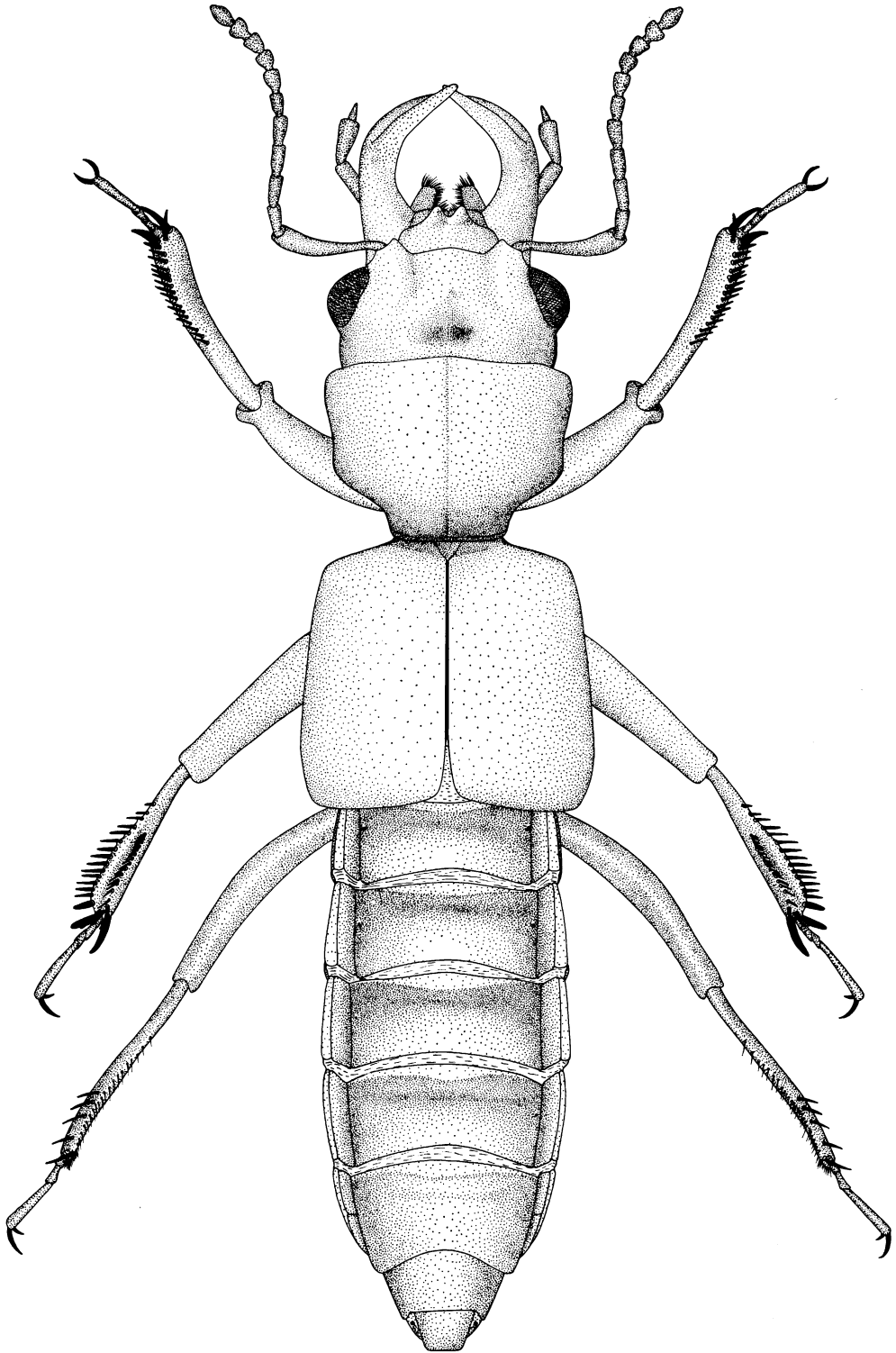

FIG. 1. General aspect of *Bledius pallipennis*; male.

## ABSTRACT

*BLEDIUS* IS REDESCRIBED, and a key to the species-groups of the New World is presented. The species of the *aequatorialis*, *mandibularis*, and *semiferrugineus* groups of *Bledius* Leach from the Nearctic and West Indian areas and two new genera, *Microbledius* and *Psamathobledius*, are described. Illustrations, keys, diagnoses, and distributional and habitat data are presented for each species. Three new species *Microbledius playanus*, *Microbledius actitus*, and *Microbledius litoreus* are described and *M. forcipatus* (Le Conte), *M. albidus* (Sharp), *M. albipennis* (Bernhauer), *M. bifasciatus* (Sharp), *M. miles* (Bernhauer), *M. minutissimus* (Bernhauer), and *M. weiseri* (Bernhauer) are transferred from *Bledius*. *Psamathobledius* contains *P. caribbeanus* (Blackwelder), *P. microcephalus* (Fauvel) and *P. punctatissimus* (Le Conte) (*B. esposus* Blackwelder is a new synonymy); all are transferred from *Bledius*.

*Bledius aequatorialis* Mutchler, *B. beattyi* Blackwelder, and *B. ceratus* Blackwelder are included in the *aequatorialis* group. *Bledius mandibularis* Erichson, *B. pallipennis* Say (*B. gularis* Le Conte is a new synonymy), *B. fortis* Le Conte, *B. ferratus* Le Conte, and *B. jacobinus* Le Conte (*B. actus* Herman is a new synonymy) are in the *mandibularis* group. *Bledius semiferrugineus* Le Conte (*B. canaliculatus* Notman is a new synonymy), *B. foraminosus* Casey (*B. relictus* Fall and *B. deceptivus* Fall are new synonymies), *B. tallaci* Fall, *B. gravidus* Casey (*B. missionensis* Hatch is a new synonymy), *B. rotundicollis* Le Conte, *B. rubiginosus* Erichson, *B. fumatus* Le Conte, *B. philadelphicus* Fall (*B. dickersoni* Notman and *B. mixtus* Notman are new synonymies), and *B. analis* Le Conte, *B. nitidicollis* Le Conte, *B. assimilis* Casey, and *B. coulteri* Hatch are included in the *semiferrugineus* group.

## INTRODUCTION

THE PRESENT PAPER is the first of a three-part monograph that will discuss the taxonomy, classification, phylogeny, zoogeography, and biology of the rove-beetle genus *Bledius* and related genera. It contains descriptions, keys, illustrations, habitats, and distributions of the species in the *aequatorialis*, *mandibularis*, and *semiferrugineus* groups of *Bledius* and two new genera. Part II will consider the remaining groups in a similar fashion, and the third part will discuss the phylogeny, zoogeography, and ecology of *Bledius* and will expand the infra-generic classification given in the first two papers.

*Bledius* is an almost cosmopolitan group of species that burrows into moist sand or mud and eats algae and diatoms. *Bledius* and *Microbledius* live on the shores of oceans, lakes, rivers, and streams, on salt flats, and in temporarily moist soil. Where species are sympatric they are often microgeographically separated. The species of *Psamathobledius* are known only from the seashore. Adults and larvae of all three genera burrow into the ground to depths varying from about 5 to nearly 200 mm. The eggs are laid in an egg chamber beside and connected to the

main tunnel. The site of the tunnel is identified by either a hemispherical pile of dry, agglutinated sand at the entrance (figs. 307, 308) or by a meandering, molelike tunnel. Burrows of a dense population may be so numerous and close that the surface of the ground is soft and powdery.

The most effective technique for collecting the species is to place the soil containing a burrow into a bucket of water. The soil sinks to the bottom, and the adults and larvae float to the surface. Two other less effective methods are: pouring water over the casts to drive the animals to the surface; and treading on the habitat, thereby forcing the beetles out.

In addition to using conventional light microscopes, I studied some specimens with the scanning electron microscope. The beetles were first cleaned, either for 10 to 30 seconds in an ultrasonic cleaner or for 10 to 30 minutes in a solution of lactophenol. Then they were air-dried, cemented to the specimen stub with aluminum paint, coated with 200 to 400 angstroms of gold, and examined with a Cambridge Stereoscan Mark II scanning electron microscope at 20,000 volts.

Measurements were made with the stereoscopic microscope and an ocular reticule. The range in length, obtained by measuring the smallest, most contracted specimen, and largest most extended one, is approximate because adult staphylinids in contrast to other beetles have a loosely jointed head, prothorax and mesothorax, and a telescoping abdomen. The width of the head is measured across the widest part of both eyes, the interocular width across the narrowest width between the eyes. The pronotal width is the widest transverse breadth of the pronotum, and the pronotal length the longest midlongitudinal distance. The elytral length is the distance from the posterior margin of the scutellum to the greatest longitudinal length of the elytron.

Adequate taxonomic conclusions for *Bledius* are possible only after studying long series of specimens for which microhabitat data are known. Often characters separating species of *Bledius* are slight, variable, and difficult to describe. As larger samples and knowledge of the microhabitats of phenetically similar, sympatric species are obtained, the consistency of slight anatomical differences becomes more evident.

Generally, characteristics of the mandibular denticulation, relative size, shape, convexity, punctation and sculpturing of the head and pronotum, size of the eyes, color—particularly of the elytra—the seventh sternite of the abdomen of the males, and other more rarely modified structures are important for identification of the species. For delimitation of monophyletic species-groups important characters are found on the labral lobes, hypopharynx of the labium, labial palps, pronotum, elytra, aedeagus and spermatheca.

#### HISTORY

*Bledius* was described by Leach (1819) and based on one European species. Other Europeans described species, but when Say (1823, 1834) described six species in *Oxytelus* and Erichson (1840) transferred them to *Bledius*, they were the first species of *Bledius* recorded from the United States. Erichson also described five other species in the United States. Maeklin (1852, 1853) described the first two species from western North America. In 1863 Le Conte described 15 species in *Bledius* from many parts of the country, then in 1877 revised the genus

and described 20 more. Le Conte (1877) provided the first infrageneric classification of the North American species in which, with some notable exceptions, the species-groups are the same as the subgeneric classification used in Europe. Casey (1889) described 27 species from the United States, Fall (1901, 1910), Blatchley (1910), and Notman (1920, 1922) added 19, one, and five species, respectively. Blackwelder (1943) described seven West Indian species, and Hatch (1957) described 12 species and re-described all the other species of *Bledius* from the Pacific Northwest. Herman (1970) re-described *Bledius*, gave a checklist of the species of the world, and discussed the phylogenetic relationship of *Bledius* and other genera of the Oxytelinae.

#### ACKNOWLEDGMENTS

I am indebted to the following for the loan of specimens: Dr. Robert T. Allen (University of Arkansas), Mr. J. Balfour-Browne, British Museum (Natural History), Dr. George Ball (University of Alberta), Dr. Edward Balsbaugh (South Dakota State University), Dr. Horace Burke (Texas A & M), Dr. J. Milton Campbell (Canadian National Collection), Mr. Oscar Cartwright and Dr. Paul Spangler (National Museum of Natural History, Smithsonian Institution), Dr. Robert Gordon (United States Department of Agriculture), Mr. Don Larson (University of Alberta, personal collection), Dr. John Lawrence (Museum of Comparative Zoology, Harvard University), Mr. Hugh Leech (California Academy of Science), Dr. Carl Lindroth (Zoological Institute, Lund, Sweden), Mr. Ian Moore (personal collection), Dr. Milton Sanderson (Illinois Natural History Survey), Dr. Rupert Wenzel and Mr. Henry Dybas (Field Museum of Natural History), Dr. Harold Willis (Wisconsin State University, personal collection), and Dr. Robert Woodruff (Florida Department of Agriculture).

The following people kindly lent holotypes: Dr. Roger Damoiseau and Dr. Gaston Fagel (Institut des Parcs Nationaux du Congo Belge), Dr. Peter Hammond (British Museum [Natural History]), Dr. F. Hieke (Institut für Spezielle Zoologie und Zoologisches Museum), and Dr. J. Milton Campbell, who is listed in the preceding paragraph.

I owe particular thanks to Hugh Leech, who



sent many separate shipments of specimens as he and others collected them.

An essential component of this study is the scanning electron microscope photographs of the adoral surface of the labium. These would have been impossible without the generosity of Drs. Vincent Palladino and John Duffy and Mr. Frederick Miller of the Meadowbrook Hospital. I am further indebted to Mr. Miller for the many hours of his time used to prepare and photograph the specimens and for many other

personal favors.

Mr. Robert Logan of the Photography Department at the American Museum of Natural History printed the photographs that appear in the present paper. Mrs. Thelma Nirou conscientiously, patiently, and carefully typed and proofread this manuscript and organized the locality data, and Ms. Veronica Picchi helped plot the distributional maps and spent many hours hovering over a computer analyzing the measurements.

## TAXONOMY

### KEY TO THE GENERA

IN A KEY to the genera of the Oxytelinae (Herman, 1970, pp. 360-362) both *Microbledius* and *Psamathobledius* run to couplet 16. To include these two genera and separate them from *Bledius*, a modification of couplets 15, 16, and 17 is presented below:

MODIFIED FROM HERMAN, 1970, p. 361

- 15 (14). Tarsal formula 3-3-3 (figs 68, 80) . .16  
 Tarsal formula 4-4-4 (figs. 388-390) or  
 5-5-5 . . . . .17
- 16a (15). Prosternum with small, densely setigerous pit (figs. 41, 52, 70, 71, 85-88, 137, 138, 140) . . . . .16c  
 Prosternum without small, densely setigerous pit . . . . .16b
- 16b (16a). Seventh abdominal tergum with posterior margin serrate; Neotropical . . . . .*Parosus* (part)  
 Seventh abdominal tergum with posterior margin fimbriate; Holarctic . . . . .*Aploderus*
- 16c (16a). Pronotal lateral marginal bead absent (figs. 40-43) . . . . .*Microbledius*  
 Pronotal lateral marginal bead present (figs. 85, 86) . . . . .*Psamathobledius*
- 17 (15). Tarsal formula 4-4-4 (figs. 1, 388-390); procoxal fissure distinct and well developed (figs. 175, 209, 369); cosmopolitan . . . . .*Bledius*  
 Tarsal formula 5-5-5; procoxal fissure reduced . . . . .18

### **MICROBLEDIUS**, NEW GENUS

Figures 2-71; Maps 1, 2; Table 1

**TYPE-SPECIES:** *Microbledius playanus* Herman, designated herein.

**DIAGNOSIS:** This genus can be distinguished from *Bledius* by the presence of the setigerous pit on the prosternum (figs. 41, 52, 70, 71), a truncate posterior margin of the eighth tergum (fig. 39), and three tarsomeres (figs. 68, 69) and by the absence of the protergosternal suture (figs. 40-43), pronotal lateral marginal bead (figs. 40-43), elytral epipleural ridge, and parameres of the aedeagus (figs. 54-57). The most striking visual feature of the genus is the small, slender appearance.

**DESCRIPTION:** Length 1.5 to 4.0 mm. Body form subcylindrical. Body with moderately dense pubescence. Color variable from black to pale yellowish brown.

**HEAD:** Epistomal suture present; suture straight or nearly so (figs. 2, 3, 6, 7). Supra-antennal ridge of male and female with anteriorly directed horn (figs. 2, 3, 6, 7, 10-17, 29-32); horn of male (figs. 2, 3, 6, 7, 10, 12, 13, 16) more strongly developed than of female (figs. 11, 14, 15, 17, 29-32), that of female occasionally obsolete; supra-antennal ridge with one horn. Clypeal tubercle absent (figs. 2, 3, 6, 7). Gular sutures confluent to submentum and sharply divergent at base (fig. 53). Labrum (fig. 33) with anterior margin broadly sinuate; mid-longitudinal groove absent; anterior margin not reflexed; surface with broad, median transversely hemispherical depression on dorsal surface (fig. 66); membranous lobe large and well developed (fig. 33). Labial palpus (fig. 38) with second segment shorter than first or third; articles each slightly narrower than preceding article; basal and second article each with one seta; second article without numerous setae on mesial surface. Adoral surface of labium as in figures 58-60, 62-65. Mentum as in figures 34, 36. Submentum as in figure 55. Maxillary palpus (fig. 18) with fourth segment subulate; second segment strongly curved. Galea with numerous spinelike setae and without distinctive, more prominent, spinelike seta. Mandible denticulate (figs. 19-28) and prominent. Antenna geniculate (fig. 35).

**THORAX:** Pronotum wider than long and of pentagonal shape (figs. 4, 5, 8, 9). Pronotal horn absent. Pronotal lateral marginal bead absent (figs. 40-43). Protergosternal suture absent (figs. 40-43) or evident as broad, shallow depression; depression extending in arcuate line from procoxal fissure to anterior margin. Procoxal fissure short and open (figs. 40, 42, 43) or closed (fig. 41). Protrchantin concealed (fig. 41) or slightly exposed (figs. 40, 42, 43). Post-procoxal lobe present (figs. 40-43). Prosternal process present (fig. 41). Prosternum with small, densely setigerous pit anterior to procoxa (figs. 41, 52, 70, 71); broad, shallow, pubescent depression anterior to procoxa absent.

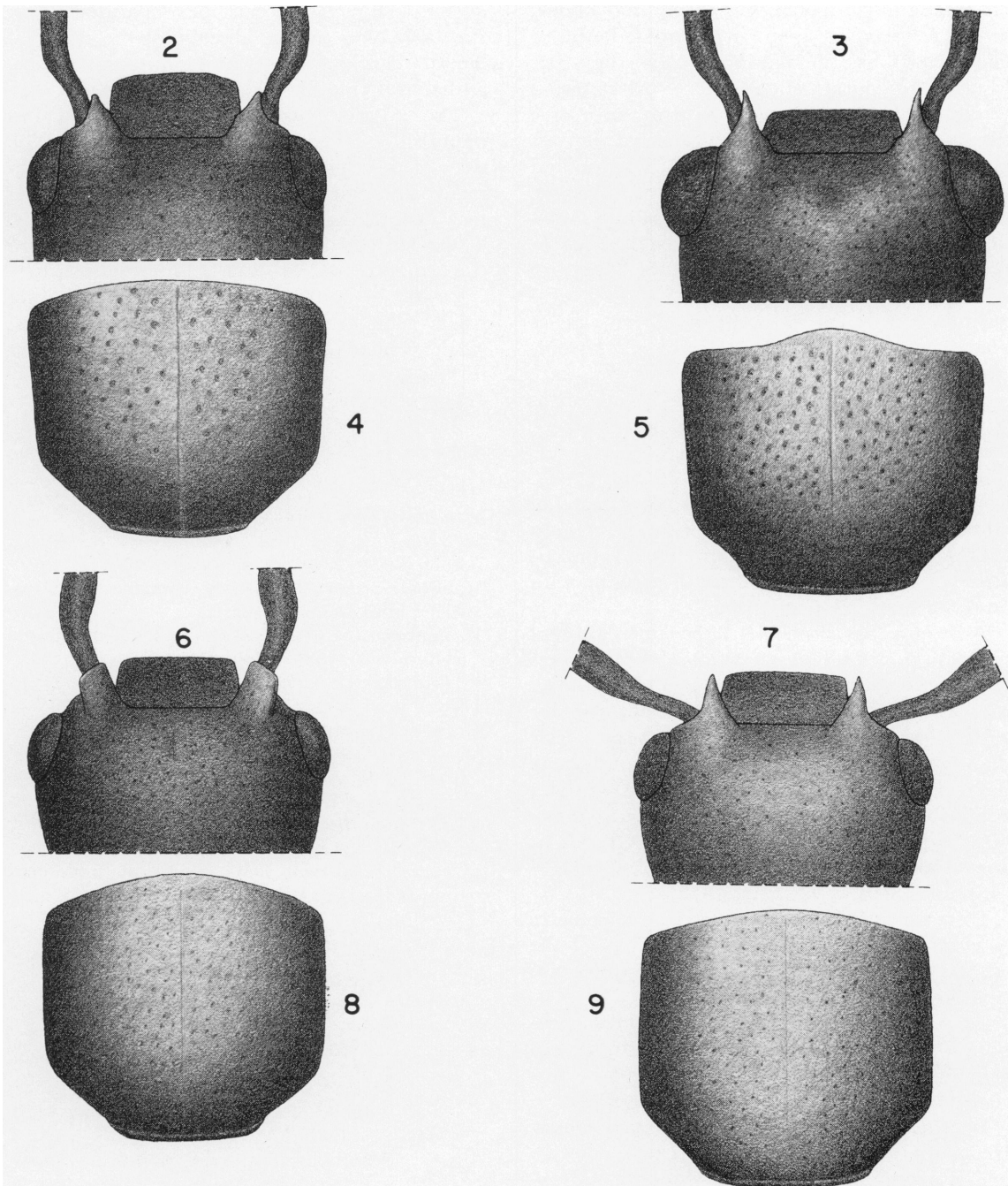

FIG. 2. *Microbledius litoreus*; head, dorsal view; male.  
 FIG. 3. *Microbledius forcipatus*; head, dorsal view; male.  
 FIG. 4. *Microbledius litoreus*; prothorax, dorsal view; male.  
 FIG. 5. *Microbledius forcipatus*; prothorax, dorsal view; male.  
 FIG. 6. *Microbledius actitus*; head, dorsal view; male.  
 FIG. 7. *Microbledius playanus*; head, dorsal view; male.  
 FIG. 8. *Microbledius actitus*; prothorax, dorsal view; male.  
 FIG. 9. *Microbledius playanus*; prothorax, dorsal view; male.

Scutellum concealed by pronotum. Elytral suture dehiscent at apex (as in fig. 1). Posterior margin without membranous lobe (fig. 37). Elytral epipleural ridge absent. Mesosternal process prominent and carinate at apex (see Herman, 1970, fig. 34). Metasternal process absent; metasternum with low longitudinal carina between coxae (see Herman, 1970, fig. 34). Mesocoxae contiguous. Protibia and mesotibia with longitudinal rows of spines (as in fig. 1); metatibia with longitudinal row of weakly developed spinules (as in fig. 1). Tarsal formula 3-3-3 (figs. 68, 69); basal two articles small, third elongate, slender and apically in-crasstate.

**ABDOMEN:** Second sternite well developed. Terga and sternites without midlongitudinal, basal carina. Terga without basolateral ridges; basal transverse ridge present (as in fig. 1). Segments II to III each with two pairs of laterosternites (as in fig. 1). Seventh tergum with posterior margin fimbriate (fig. 61); fimbriation of varying length. Eighth tergum with posterior margin truncate (fig. 39).

**Aedeagus** (figs. 54-57) with parameres absent but with possible remnant of base of parameres covering median foramen on ventral surface. Median lobe heavily sclerotized and tubular with basal end slightly swollen and distal end slightly constricted; surface smooth and shiny. Basal end with round membranous cupule; cupule with sclerotized disk; disk with many muscles attached to inner surface. Ostium at apex and large.

**Spermatheca** as in figures 48-51.

**DISCUSSION:** The presence of three tarsomeres in combination with unique characters of the labium, spermatheca, and aedeagus require generic recognition of this taxon.

*Microbledius* should be placed in the Coprophilini as defined by Herman (1970). Phylogenetic relationships of the genus will be discussed in Part III of this revision of *Bledius*.

In a key to the genera of the Oxytelinae by Herman (1970), *Microbledius* runs to couplet 16 which includes *Parosus* and *Aploderus*. *Microbledius* is readily separated from these two genera by the presence of the prosternal setigerous pits (figs. 41, 52, 70, 71). *Microbledius* can be further separated from *Aploderus* by the absence of the pronotal lateral marginal bead (figs. 40-43) and from *Parosus* by the presence of tibial spines. For other characters, see the Diagnosis of *Micro-*

*bledius*. *Microbledius* can be separated from *Psamathobledius* by the absence of the pronotal lateral marginal bead, protergosternal suture, and elytral epipleural ridge.

The internal surface of the aedeagus has many ridges. The resulting depressions and the sides of the ridges are points of muscle attachment. The other end of the muscles is attached to a disk at the posterior end of the aedeagus. There may be differences among the species on the armature and struts of the internal sac.

**ETYMOLOGY:** From the Greek *mikros*, meaning small. The name *Microbledius* refers to some small, slender, *Bledius*-like beetles once included in *Bledius*.

**DISTRIBUTION:** New World.

**SPECIES INCLUDED:** The following species are included in this genus, but only those from the United States are described herein.

- M. actitus*, new species; United States
- M. albidus* (Sharp), new combination, transferred from *Bledius*; Brazil, Argentina
- M. albipennis* (Bernhauer), new combination, transferred from *Bledius*; Argentina
- M. bifasciatus* (Sharp), new combination, transferred from *Bledius*; Guatemala
- M. forcipatus* (Le Conte), new combination, transferred from *Bledius*; United States, Mexico
- M. litoreus*, new species; United States
- M. miles* (Bernhauer), new combination, transferred from *Bledius*; Argentina
- M. minutissimus* (Bernhauer), new combination, transferred from *Bledius*; Argentina
- M. playanus*, new species; United States
- M. weiseri* (Bernhauer), new combination, transferred from *Bledius*; Argentina

#### KEY TO THE SPECIES OF *MICROBLEDIUS* IN THE UNITED STATES

1. Mandible with large and prominent dorsal (or basal) denticle (figs. 23-28); eyes small (figs. 2, 6, 7, 12-17, 29, 31, 32); range of head width/interocular width = 1.2 to 1.4 . . . . . 2  
Mandible with small dorsal (or basal) denticle (figs. 19-22); eyes large (figs. 3, 10, 11, 30); range of head width/interocular width = 1.4 to 1.7 . . . *forcipatus*<sup>1</sup>
- 2 (1). Horn of supra-antennal ridge distinct (figs. 2, 3, 6, 7, 10-17, 29-32) . . . . 3  
Horn of supra-antennal ridge indistinct . . . 4
- 3 (2). Horn of supra-antennal ridge (figs. 6, 16)

<sup>1</sup>See also the Diagnosis of *M. bifasciatus*.

- with dorsal surface broad from base to apex; apexobliquely truncate to rounded . . . . . *actitus*
- Horn of supra-antennal ridge (figs. 2, 7, 11-15, 17, 29, 31, 32) with dorsal surface broad at base and converging to apex; apex acute . . . . . 4
- 4 (2, 3). Procoxal fissure closed or open only slightly and protrochantin concealed or slightly exposed (figs. 42, 43); elytra with basal half or more brown (figs. 45, 47) . . . . . 5
- Procoxal fissure widely open, exposing protrochantin (fig. 40); elytra with less than basal half brown (fig. 46). . . . . *playanus*
- 5 (4). Head bright reddish brown and with apex of elytra yellow . . . . . *litoreus*
- Head blackish brown or dark reddish brown with infusions of black and with apex of elytra yellow. . . . . *actitus*

***Microbledius playanus*, new species**

Figures 7, 9, 12, 15, 25, 26, 31, 40, 46, 58-61;  
Map 1; Table 1

ORTENBURGER AND BIRD, 1933, pp. 61, 62, figs. 36, 37, 40 (cited as *Bledius*, "probably n. sp.").

TYPE LOCALITY: Oklahoma, Alfalfa County, 6 miles east, 3 miles south of Cherokee, Great Salt Plains National Wildlife Refuge, on the salt flats.

HOLOTYPE: Collected by Lee H. Herman, Jr. on June 11, 1968; deposited in the American Museum of Natural History, New York.

PARATYPES: One hundred males and females, unsexed, with same collection data as holotype. Two males and two females will be deposited at the Field Museum of Natural History, Chicago, Illinois; National Museum of Natural History, Smithsonian Institution, Washington, D.C.; and at the British Museum (Natural History), London, England. The remaining paratypes are deposited with the holotype.

DIAGNOSIS: *Microbledius playanus* is readily separated from the males of *M. actitus* by the form of the supra-antennal horn (figs. 7, 12, 15, 31; cf. figs. 6, 16), and from the females of *M. actitus* and the males and females of *M. litoreus* by the color pattern of the elytra (fig. 46; cf. figs. 45, 47), the open procoxal fissure (fig. 40, cf. figs. 42, 43), and the geographical distribution (maps 2, 3). *Microbledius forcipatus* can be separated from *M. playanus* by the elytral color pattern (fig. 44, cf. fig. 46), by the larger eyes

(fig. 3, cf. fig. 4), and closed procoxal fissure (fig. 41, cf. fig. 40).

DESCRIPTION OF HOLOTYPE: Male.

Length approximately 2.6 (range 2.0 to 3.3) mm.

Dorsum of head, clypeus, and labrum dark reddish brown. Venter of head reddish brown. Maxilla, labium, and antenna yellowish brown. Mandible reddish brown. Prothorax reddish brown. Elytron pale brownish yellow with narrow transverse, pale reddish brown strip along base (fig. 46). Pterothoracic pleura and sterna reddish brown. Legs pale reddish brown. Abdomen dark reddish brown.

Dorsum of head shining dully, not polished, with distinct microgranulate ground sculpturing (as in figs. 66, 67), and with moderately dense setigerous punctation (fig. 7); pubescence absent from midlongitudinal region; pubescence moderately long; midlongitudinal groove absent (fig. 7); median portion of head broadly and shallowly convex (fig. 7). Supra-antennal horn broad (figs. 7, 12) at base, apically acuminate and moderately long; surface with microgranulate ground sculpturing and pubescence; apex glabrous and polished. Epistomal suture (fig. 7) straight between supra-antennal ridges and sharply angulate at juncture with ridges. Clypeus shining, and with weak, microgranulate ground sculpturing (as in fig. 66), and shallow, setigerous punctation; anterior margin without tubercles. Eyes small (figs. 7, 12). Lateral side of head with broad, glabrous strip extending from base of head to posterior margin of eye. Venter of head with microreticulate ground sculpturing. Width of head 0.4 (0.3 to 0.5) mm.; interocular width 0.3 (0.3 to 0.4) mm.; head width/interocular width 1.3 (1.2 to 1.4) mm. (table 1). Labrum with microgranulate ground sculpturing (as in fig. 66) and shallow, setigerous punctation. Mandible bidentate (figs. 25, 26); ventral (or apical) denticle longer and stouter than dorsal (or basal) denticle; dorsal denticle large.

Pronotum 0.4 (0.3 to 0.4) mm. long; 0.4 (0.3 to 0.5) mm. wide; pronotal width/pronotal length 1.0 (1.0 to 1.1) (table 1); surface moderately strongly convex (fig. 9); shape as in figure 9. Pronotum with microgranulate ground sculpturing; sculpturing increasingly obsolete laterally and basally; anterior surface shining, but not polished; posterior surface polished and with dense, moderately deep, setigerous puncta-

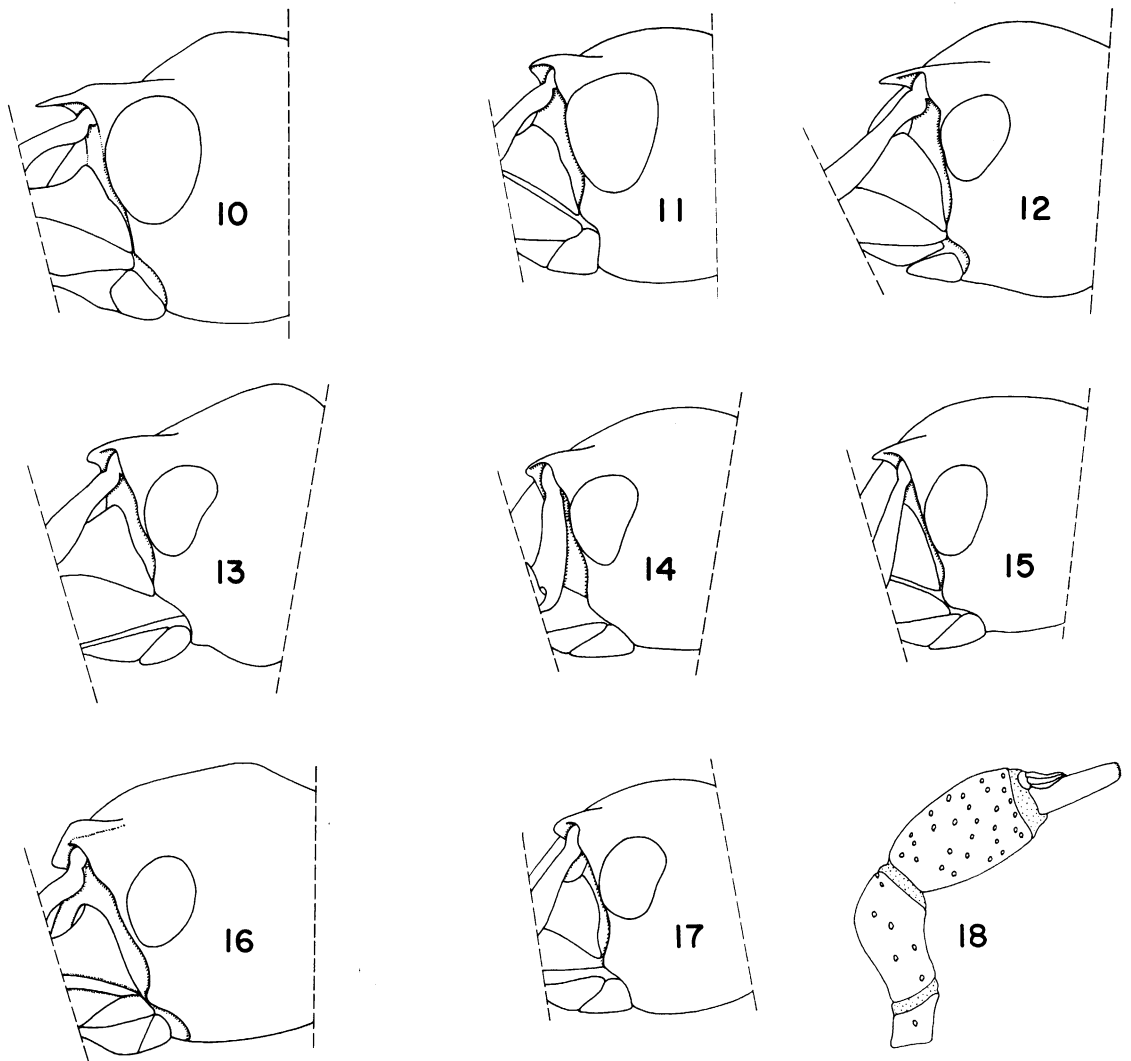

FIG. 10. *Microbledius forcipatus*; head, lateral view; male.  
 FIG. 11. *Microbledius forcipatus*; head, lateral view; female.  
 FIG. 12. *Microbledius playanus*; head, lateral view; male.  
 FIG. 13. *Microbledius litoreus*; head, lateral view; male.  
 FIG. 14. *Microbledius litoreus*; head, lateral view; female.  
 FIG. 15. *Microbledius playanus*; head, lateral view; female.  
 FIG. 16. *Microbledius actitus*; head, lateral view; male.  
 FIG. 17. *Microbledius actitus*; head, lateral view; female.  
 FIG. 18. *Microbledius forcipatus*; maxillary palpus; setae removed.

tion (fig. 9); midlongitudinal groove weakly developed but distinct (fig. 9); pubescence moderately long. Prohypomeron and prosternum with obsolete, microrugose ground sculpturing; prohypomeron with pubescence along dorsal

edge; prosternum with scattered pubescence. Procoxal fissure short but widely open, exposing part of protrochantin (fig. 40). Elytra 0.3 (0.3 to 0.5) mm. long; elytral length/pronotal length 0.8 (0.8 to 1.3) (table 1); surface shining dully,

TABLE 1  
 MEASUREMENTS (IN MILLIMETERS) OF THE HEAD, THORAX, AND ELYTRA OF ADULTS OF THE SPECIES OF THE *microbletidus* GROUP  
 (The mean, standard deviation, and sample size are given in that order for each species.)

	Head Width			Interocular Width			Pronotal Width			Pronotal Length			Elytral Length			Head Width			Pronotal Width			Elytral Length								
	Mean	SD	n	Mean	SD	n	Mean	SD	n	Mean	SD	n	Mean	SD	n	Mean	SD	n	Mean	SD	n	Mean	SD	n	Mean	SD	n			
<i>actitus</i> ♀	0.38	0.01	20	0.28	0.01	20	0.37	0.01	20	0.35	0.02	20	0.33	0.02	19	1.34	0.02	20	1.05	0.04	20	0.93	0.06	19						
<i>actitus</i> ♀, winged	0.38	0.01	2	0.28	0.02	2	0.37	0.01	2	0.35	0.03	2	0.45	0.02	2	1.36	0.04	2	1.06	0.05	2	1.26	0.05	2						
<i>actitus</i> ♂	0.40	0.02	20	0.30	0.02	20	0.38	0.01	20	0.37	0.01	20	0.31	0.03	20	1.33	0.03	20	1.04	0.03	20	0.85	0.07	20						
<i>bifasciatus</i> ♀ and ♂	0.41	0.04	7	0.27	0.03	7	0.40	0.03	7	0.36	0.02	7	0.47	0.02	7	1.53	0.04	7	1.11	0.03	7	1.30	0.03	7						
<i>forcipatus</i> ♀	0.40	0.02	20	0.26	0.02	20	0.39	0.03	20	0.34	0.02	20	0.49	0.03	20	1.57	0.05	20	1.14	0.03	20	1.42	0.07	20						
<i>forcipatus</i> ♂	0.45	0.04	20	0.32	0.04	20	0.42	0.04	20	0.36	0.03	20	0.49	0.03	20	1.49	0.05	20	1.19	0.04	20	1.36	0.06	20						
<i>litoreus</i> ♀ and ♂	0.41	0.03	8	0.31	0.02	8	0.41	0.02	8	0.36	0.02	8	0.33	0.04	7	1.33	0.04	8	1.61	0.04	8	0.89	0.07	7						
<i>playanus</i> ♀, Kansas	0.40	0.02	20	0.30	0.01	20	0.38	0.01	20	0.37	0.01	20	0.31	0.01	20	1.32	0.04	20	1.02	0.02	20	0.84	0.02	20						
<i>playanus</i> ♂, Kansas	0.43	0.02	20	0.33	0.02	20	0.41	0.02	20	0.39	0.02	20	0.33	0.02	20	1.32	0.03	20	1.04	0.03	20	0.83	0.05	20						
<i>playanus</i> ♀ and ♂, New Mexico	0.46	0.03	20	0.36	0.02	20	0.44	0.02	20	0.43	0.02	20	0.37	0.02	20	1.29	0.03	20	1.02	0.02	20	0.86	0.02	20						
<i>playanus</i> ♀, winged, Oklahoma	0.40	0.02	7	0.30	0.01	7	0.38	0.01	7	0.37	0.01	7	0.44	0.03	7	1.31	0.04	7	1.01	0.01	7	1.19	0.08	7						
<i>playanus</i> ♂, Oklahoma	0.39	0.03	20	0.30	0.02	20	0.37	0.03	20	0.36	0.03	20	0.30	0.02	20	1.31	0.03	20	1.02	0.02	20	0.82	0.03	20						

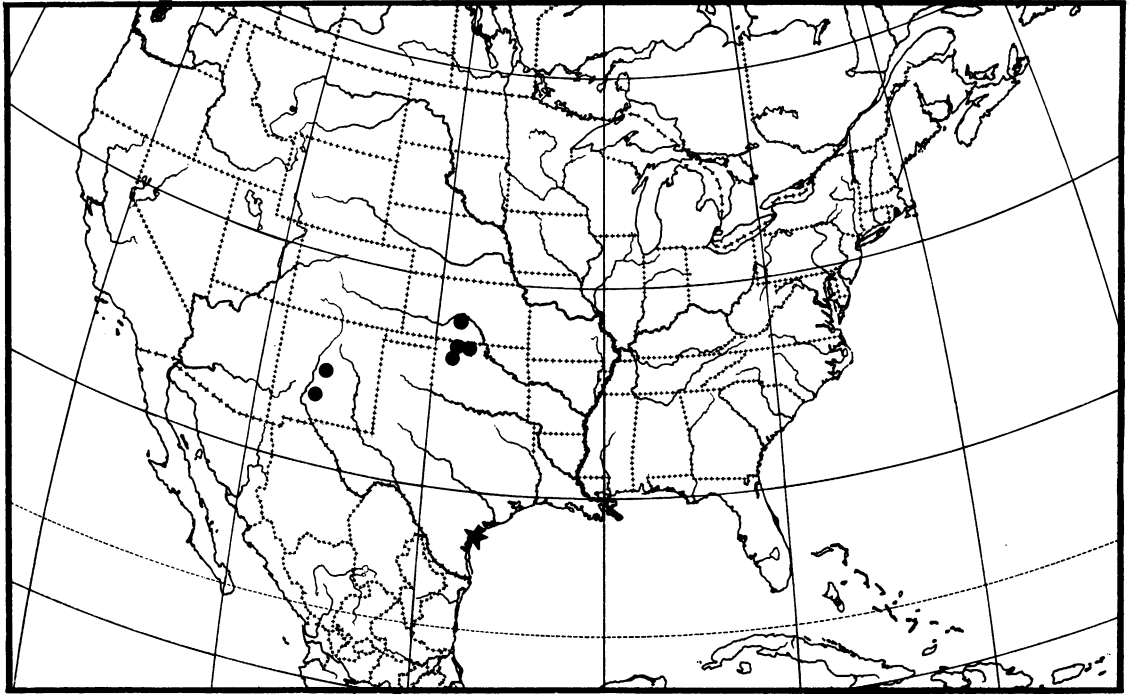

MAP 1. Distribution of *Microbledius playanus* (black dots) and *M. actitus* (stars).

not polished, with dense, microrugose ground sculpturing and moderately deep and dense setigerous punctation; suture weakly dehiscent at apex; posterior margin transversely arcuato-truncate; humeral angle moderately well developed (fig. 46). Metathoracic wing reduced; metathorax reduced.

Abdominal segments unmodified.

**SEXUAL DIMORPHISM:** The sexes are not readily distinguishable. The horn of the supra-antennal ridge is slightly longer in the male than in the female (compare figs. 7, 12, 15, 31). The spermatheca is similar to that in figure 48.

**VARIATION:** The known populations can be distinguished from one another by color. The base of the elytra of the population around Cherokee, Oklahoma, has only a very small, pale, often indistinguishable brown spot, and a pale reddish brown prothorax. Specimens from a population near Willard, New Mexico, have a large (about one-third of length), dark reddish brown transverse, basal strip on the elytra, and the individuals are more melanistic. Those from Stafford, Kansas, are intermediate but closer in appearance to the Oklahoma population. They are darker than individuals from Oklahoma,

and the elytral spot is larger, but they are neither so dark nor is the elytral spot so large as in the New Mexico population. Individuals from New Mexico are largest.

Most of the 329 specimens studied have brachypterous metathoracic wings and a reduction of the metathorax and elytra. Seven females have a fully developed metathorax and metathoracic wings with concomitantly longer elytra and larger elytral spot. These females were collected from the Salt Fork of the Arkansas River near the Great Salt Plains National Wildlife Refuge and represent 19.4 percent of the *M. playanus* collected from the river and about 37 percent of the females.

**HABITAT AND DISTRIBUTION:** *United States:* Kansas, New Mexico, Oklahoma (map 1). (See Appendix for localities.)

*Microbledius playanus*, with a scattered distribution (map 1), is known from salt flats in Oklahoma, Kansas, and New Mexico. It is known from only two rivers, the Salt Fork of the Arkansas River within a mile of the Great Salt Plains near Cherokee, Oklahoma, and the Cimarron River at Cleo, Oklahoma.

The species apparently is found almost ex-



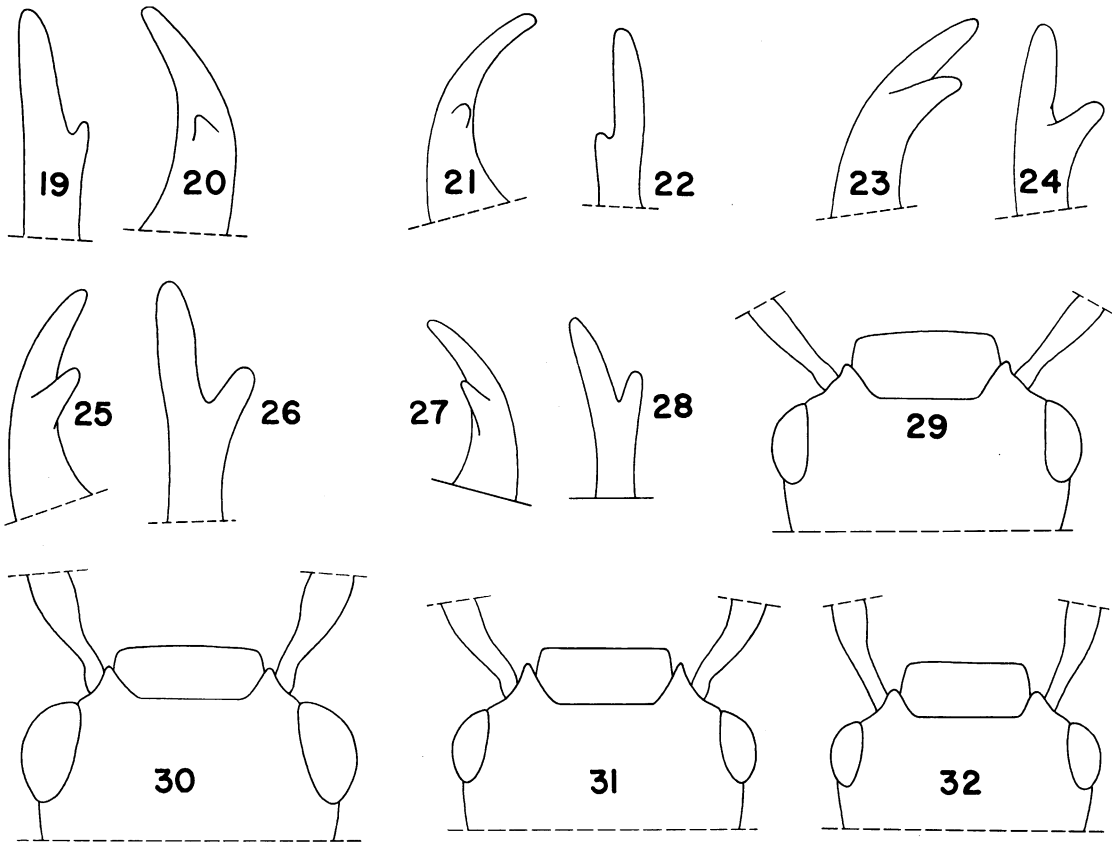

- FIG. 19. *Microbledius forcipatus*; left mandible, anterolateral view; male.  
 FIG. 20. *Microbledius forcipatus*; right mandible, dorsal view; male.  
 FIG. 21. *Microbledius forcipatus*; left mandible, dorsal view; female.  
 FIG. 22. *Microbledius forcipatus*; right mandible, anterolateral view; female.  
 FIG. 23. *Microbledius actitus*; left mandible, dorsal view; male.  
 FIG. 24. *Microbledius actitus*; left mandible, anterolateral view; male.  
 FIG. 25. *Microbledius playanus*; left mandible, dorsal view; male.  
 FIG. 26. *Microbledius playanus*; left mandible, anterolateral view; male.  
 FIG. 27. *Microbledius litoreus*; right mandible, dorsal view; male.  
 FIG. 28. *Microbledius litoreus*; left mandible, anterolateral view; male.  
 FIG. 29. *Microbledius litoreus*; head, dorsal view; female.  
 FIG. 30. *Microbledius forcipatus*; head, dorsal view; female.  
 FIG. 31. *Microbledius playanus*; head, dorsal view; female.  
 FIG. 32. *Microbledius actitus*; head, dorsal view, female.

clusively in saline habitats. At the salt flats near Stafford, Kansas, and Cherokee, Oklahoma, the beetles burrow into moist, firm, unvegetated sand, one or two inches below the surface, leaving a small hemispherical cast at the entrance. Shortly after a rain the casts look, at first, like grains of sand uniformly distributed over the surface; later the cast is enlarged. On the salt flats near Willard, New Mexico, the beetle

burrows in similar situations, but the burrow is like that of a mole.

On the Salt Fork of the Arkansas River and where Clay Creek enters the Great Salt Plains, *M. playanus* lives in the drier sand near the vegetated parts of the shore.

In general, *M. playanus* is extremely abundant on salt flats and uncommon along rivers. On the salt flat near Cherokee it is most numerous near

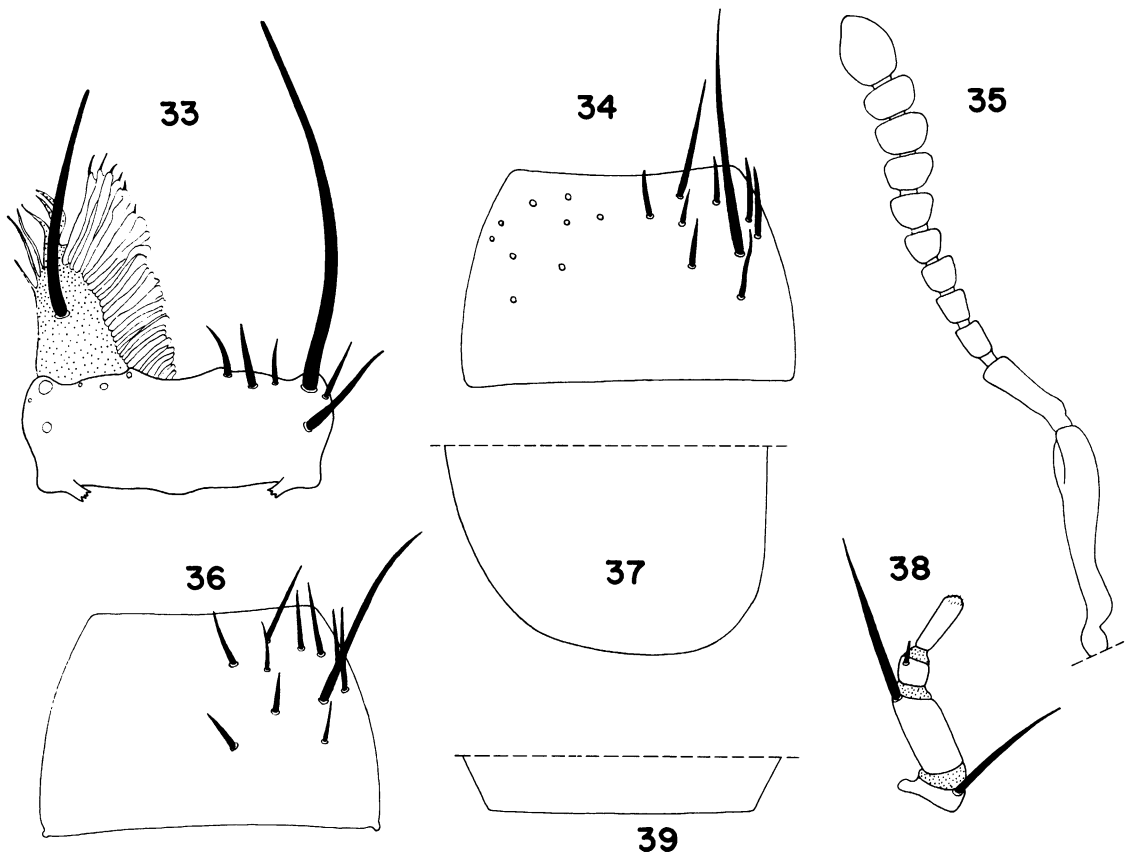

FIG. 33. *Microbledius forcipatus*; labrum.  
 FIG. 34. *Microbledius forcipatus*; mentum.  
 FIG. 35. *Microbledius forcipatus*; antenna.  
 FIG. 36. *Microbledius forcipatus*; mentum.  
 FIG. 37. *Microbledius forcipatus*; left elytron, apex.  
 FIG. 38. *Microbledius forcipatus*; labial palpus.  
 FIG. 39. *Microbledius forcipatus*; tergum VIII, apex.

the periphery. According to Ortenburger and Bird (1933), there are 285 burrow casts per square foot in densely inhabited areas. As the Great Salt Plains cover about 43 square miles and *M. playanus* is on many parts of the salt flats, the numbers of individuals must be stupendous. At Stafford, Kansas, the species is abundant, but the populations are not so dense as those at Cherokee. The population on the salt flats near Willard, New Mexico, is small and restricted.

The species was collected in Oklahoma and Kansas during June, and New Mexico in May and August. The species probably can be found

throughout the year in Oklahoma and Kansas.

DISCUSSION: On the playas where there is little or no vegetation or relief to obstruct the wind, all individuals have brachypterous metathoracic wings. Fully developed metathoracic wings apparently occur only on females and only when they live along rivers, but most females on rivers have brachypterous metathoracic wings. In no instances were fully winged *M. playanus* attracted to a black light even where they were known to occur.

ETYMOLOGY: Playa, geological term, meaning salt pan or a flat-floored bottom of an undrained, desert basin, becoming at times a shallow lake

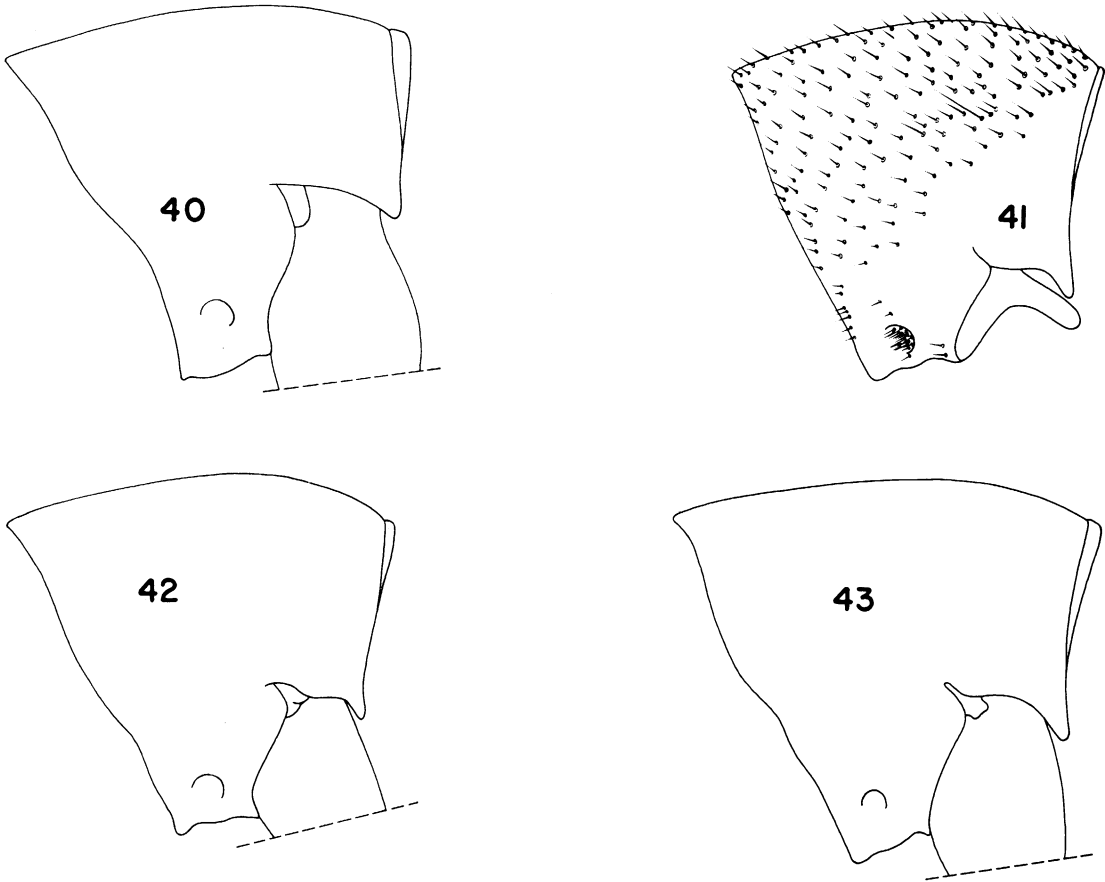

FIG. 40. *Microbledius playanus*; prothorax, lateral view, setae and punctures removed.

FIG. 41. *Microbledius forcipatus*; prothorax, lateral view.

FIG. 42. *Microbledius litoreus*; prothorax, lateral view; setae and punctures removed.

FIG. 43. *Microbledius actitus*; prothorax, lateral view; setae and punctures removed.

which on evaporation may leave a deposit of salt or gypsum. The word is applied to this species because it lives on salt flats.

***Microbledius actitus*, new species**

Figures 6, 8, 16, 17, 23, 24, 32, 43, 45, 57, 62, 63;  
Map 1; Table 1

TYPE LOCALITY: Texas, 9 miles north of Rockport, Aransas County, Copano Bay, from a sand flat near the beach.

HOLOTYPE: Collected by Lee H. Herman, Jr. on May 30, 1968; deposited in the American Museum of Natural History, New York.

PARATYPES: 40 females and 33 males, with same collection data as holotype. A male and female paratype will be deposited at the Cali-

fornia Academy of Sciences, San Francisco, California; at the Field Museum of Natural History, Chicago, Illinois; at the National Museum of Natural History, Smithsonian Institution, Washington, D. C.; at the Canadian National Collection, Ottawa, Ontario; and at the British Museum (Natural History), London, England. The remaining paratypes will be deposited with the holotype.

DIAGNOSIS: The males of *Microbledius actitus* can be distinguished from all the other species of the genus in the United States by the broad, flattened supra-antennal horn (figs. 6, 16) and the color pattern of the elytra (fig. 45). The females of *M. actitus* can be separated from *M. forcipatus* by the smaller eyes (compare figs. 3, 10, 11, 17, 30, 32) and color pattern of the

elytra (compare figs. 44, 45). The females of *M. actitus* can be separated from *M. litoreus* by the dark, blackish brown head and from *M. playanus* by the color pattern of the elytra (compare figs. 45, 46), the closed procoxal fissure, and the presence of *M. actitus* on the seashore, and *M. playanus* on playas.

DESCRIPTION OF HOLOTYPE: Male.

Length approximately 2.2 mm. (range 1.7 to 2.5 mm.).

Dorsum of head brownish black. Clypeus, labrum, venter of head, submentum, and mentum dark reddish brown. Antenna, mandible, maxilla, and labial palp pale reddish brown. Prothorax dark reddish brown. Elytron with basal three-fifths dark reddish brown, apical two-fifths pale brownish yellow (fig. 45). Pterothoracic pleura and sterna dark reddish brown. Legs dark yellowish brown. Abdomen dark reddish brown.

Dorsum of head shining dully, not polished, with distinct microgranulate ground sculpturing (as in figs. 66, 67), and with moderately dense (fig. 6) and deep, setigerous punctation; pubescence absent from midlongitudinal region; pubescence moderately long; midlongitudinal groove or fovea present (fig. 6) or absent; median portion broadly and shallowly convex (fig. 6). Supra-antennal horn broad (figs. 6, 16) with mesiodorsal surface flat; apical margin oblique and truncate; surface with microgranulate ground sculpturing and with pubescence on all but apex. Epistomal suture straight between supra-antennal ridges (fig. 6); suture sharply angulate at juncture with supra-antennal ridge. Clypeus with microgranulate ground sculpturing (as in fig. 66) and shallow, setigerous punctation; anterior margin without tubercles (fig. 6). Eye small (figs. 6, 16). Lateral side of head with broad glabrous strip extending from base of head to posterior margin of eyes. Venter of head with weakly developed, microgranulate ground sculpturing. Width of head 0.4 (0.35 to 0.45) mm.; interocular width 0.3 (0.26 to 0.33) mm.; head width/interocular width 1.3 (1.3 to 1.4) (table 1). Labrum (as in fig. 66) with microgranulate ground sculpturing and shallow, setigerous punctation. Mandibles (figs. 23, 24) bidentate; ventral (or apical) denticle longer and stouter than dorsal (or basal) denticle; dorsal denticle large.

Pronotum 0.4 (0.3 to 0.4) mm. long; 0.4 (0.3 to 0.4) mm. wide; pronotal width/pronotal

length 1.0 (1.0 to 1.1) (table 1); surface moderately strongly convex (fig. 8); shape as in figure 8. Pronotum with weak, microgranulate ground sculpturing; surface with high luster but not polished, with dense, shallow, setigerous punctation (fig. 8); midlongitudinal groove weakly developed, evident as polished, slightly depressed line; pubescence moderately long. Prosternum and prohypomeron with microreticulate ground sculpturing; prohypomeron without pubescence except on dorsal edge; prosternum with scattered pubescence. Procoxal fissure closed (as in fig. 41). Elytra 0.4 (0.3 to 0.5) mm. long; elytral length/pronotal length 1.0 (0.8 to 1.3) (table 1); surface shining but not polished, with distinct, microrugose ground sculpturing, and with dense, moderately deep, setigerous punctation; suture weakly dehiscent at apex; posterior margin obliquely arcuatotruncate; humeral angle moderately well developed. Metathoracic wings reduced; metathorax reduced.

Abdominal segments unmodified.

SEXUAL DIMORPHISM: The supra-antennal horn of the female (figs. 17, 32) is shorter and the apex more pointed than that of the male. The median portion of the head is more convex on the female than on the male. The spermatheca is similar to those shown in figures 48 and 50.

VARIATION: The ground sculpturing is more prominent on some individuals than on others, and some individuals have the band of yellow on the elytra as large as one-half of the length of the elytra. The posterior margin of the elytra is most often transversely arcuatotruncate. Most known individuals have brachypterous metathoracic wings, but three females (3.3 percent of population, 6.2 percent of females) have the metathorax and metathoracic wings fully developed.

In few cases, the procoxal fissure may be slightly open (fig. 43), exposing the pro-trochantin slightly.

DISTRIBUTION AND HABITAT: *Microbledius actitus* is known only from a moist, saline sand flat at the type locality (map 1). It may live in similar circumstances on many parts of the Gulf of Mexico.

The species was collected in May.

ETYMOLOGY: From the Greek, *aktites*, meaning shore dwelling, applied to this species because it lives on the ocean shore.

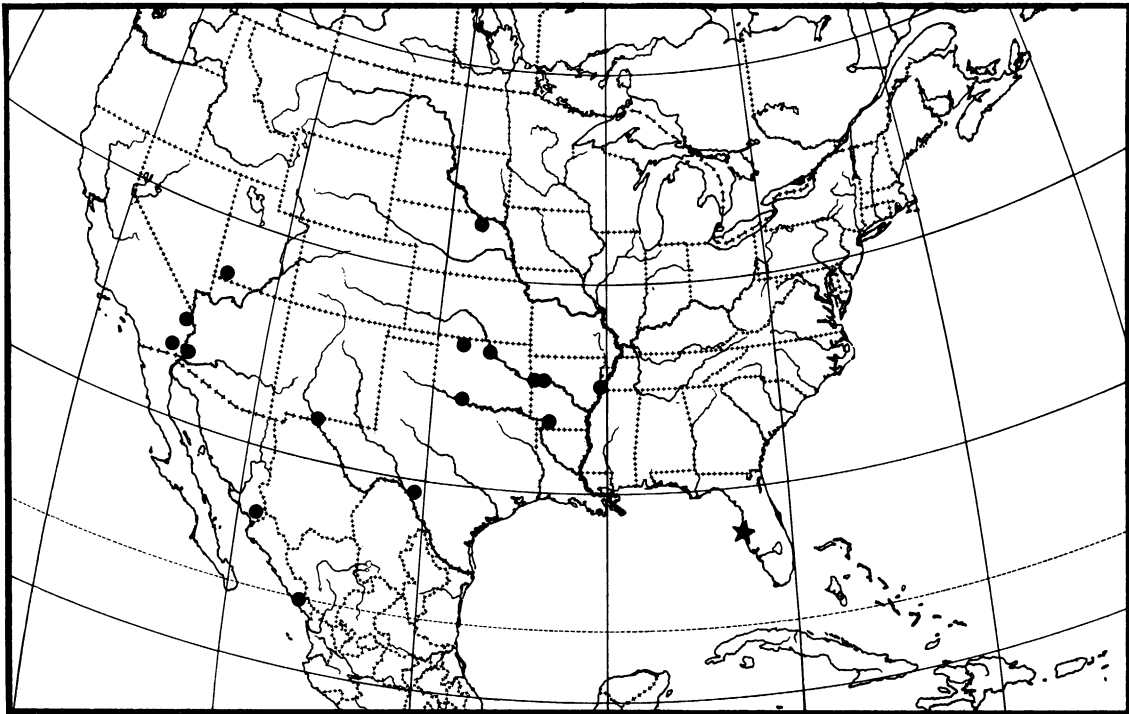

MAP 2. Distribution of *Microbledius forcipatus* (black dots) and *M. litoreus* (stars).

***Microbledius litoreus*, new species**

Figures 2, 4, 13, 14, 27–29, 42, 47, 49, 50;  
Map 2; Table 1

TYPE LOCALITY: Florida, Passe Grille, in beach sand.

HOLOTYPE: Collected by J. C. Bradley on February 26, 1937; deposited in the Cornell University Department of Entomology, Ithaca, New York.

PARATYPES: Seven specimens, same data as holotype; six are deposited with the holotype and one at the American Museum of Natural History.

DIAGNOSIS: The species is readily separated from *Microbledius forcipatus* by the smaller eyes (compare figs. 2, 13, 14, 29 with figs. 3, 10, 11, 30), less acute, shorter supra-antennal ridge (compare figs 2, 13, with figs. 3, 10), and color pattern of the elytra (compare fig. 47 with fig. 44). The reddish brown color, elytral color pattern, the closed procoxal fissure and broader supra-antennal ridge will distinguish *M. litoreus* from *M. playanus*. Differences in the shape of the

supra-antennal ridge will separate the males (compare fig. 2 with fig. 6) of *M. litoreus* and *M. actitus*. The polished elytra of *M. actitus* and color will separate the females of the last two species.

DESCRIPTION OF HOLOTYPE: Male.

Length approximately 2.2 mm. (range 1.7 to 2.5 mm.).

Dorsum of head, clypeus, labrum, venter of head, and mandibles bright reddish brown. Antenna, maxilla, and labium pale reddish brown. Pronotum bright reddish brown. Propyteron and prosternum pale reddish brown. Elytron with basal two-thirds bright reddish brown; apical third pale brownish yellow (fig. 47). Pterothoracic pleura and sterna reddish brown. Legs pale reddish brown. Abdomen bright reddish brown.

Dorsum of head shining, not polished, with prominent, microgranulate ground sculpturing, and shallow, moderately dense setigerous punctation (fig. 2); punctation absent from midlongitudinal region; pubescence moderately long; short midlongitudinal groove present;

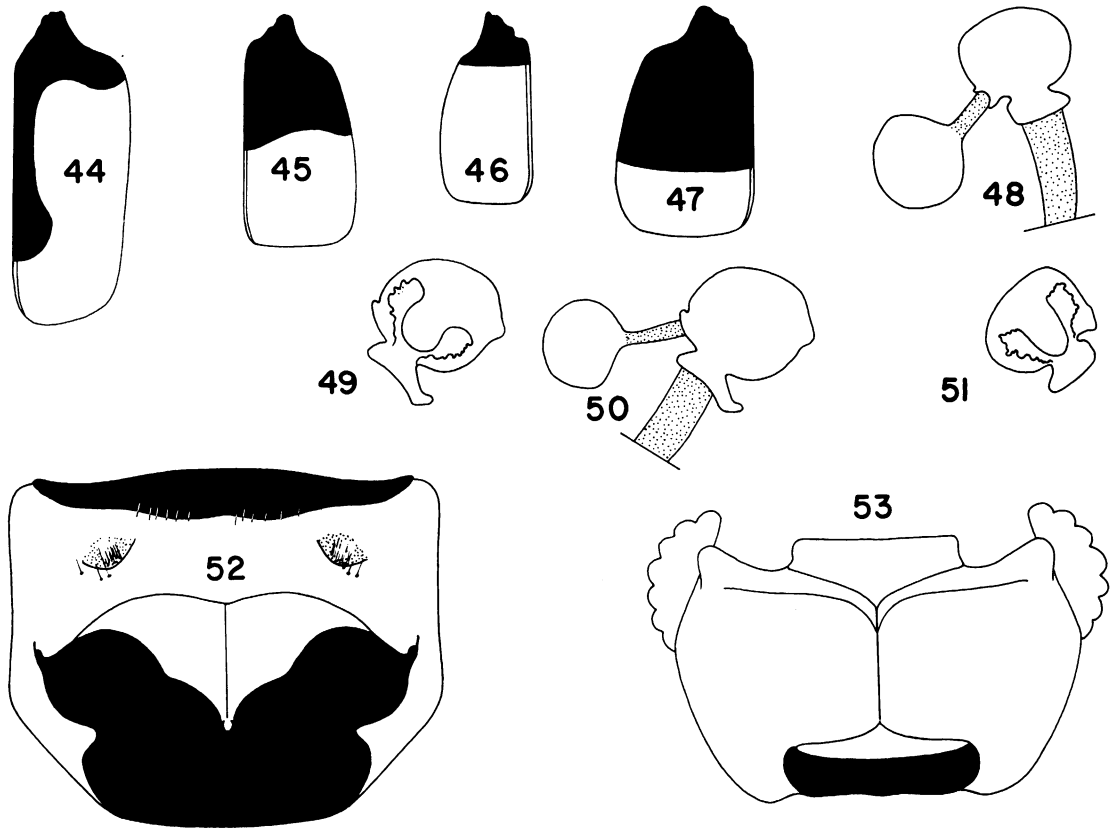

- FIG. 44. *Microbledius forcipatus*; right elytron; color pattern.  
 FIG. 45. *Microbledius actitus*; right elytron; color pattern.  
 FIG. 46. *Microbledius playanus*; left elytron; color pattern.  
 FIG. 47. *Microbledius litoreus*; left elytron; color pattern.  
 FIG. 48. *Microbledius forcipatus*; spermatheca.  
 FIG. 49. *Microbledius litoreus*; cross section of part of spermatheca.  
 FIG. 50. *Microbledius litoreus*; spermatheca.  
 FIG. 51. *Microbledius forcipatus*; cross section of part of spermatheca.  
 FIG. 52. *Microbledius forcipatus*; prothorax, ventral view.  
 FIG. 53. *Microbledius forcipatus*; head, ventral view.

median portion broad and slightly convex. Supra-antennal ridge prominent (fig. 2); apical horn short, broad, and with lateral margin convergent to bluntly pointed apex; basal and lateral surfaces with microgranulate ground sculpturing and pubescence; dorsal surface polished to apex. Epistomal suture (fig. 2) straight between supra-antennal ridges; suture sharply angulate at juncture with supra-antennal ridge. Clypeus with microgranulate (as in fig. 66) ground sculpturing and shallow, setigerous punctation; anterior margin without tubercles (fig. 2). Eye small (fig. 2). Lateral side of head

with broad, glabrous strip extending from base of head to posterior margin of eyes. Venter of head with obsolete microgranulate ground sculpturing. Width of head 0.4 (0.36 to 0.45) mm.; interocular width 0.3 (0.27 to 0.34) mm.; head width/interocular width 1.3 (1.3 to 1.4) (table 1). Labrum with dense, microgranulate ground sculpturing (as in fig. 66) and shallow setigerous punctation. Mandible bidentate (figs. 27, 28); ventral (or apical) denticle longer and stouter than dorsal (or basal) denticle; dorsal denticle large.

Pronotum 0.4 (0.3 to 0.4) mm. long; 0.4 (0.38

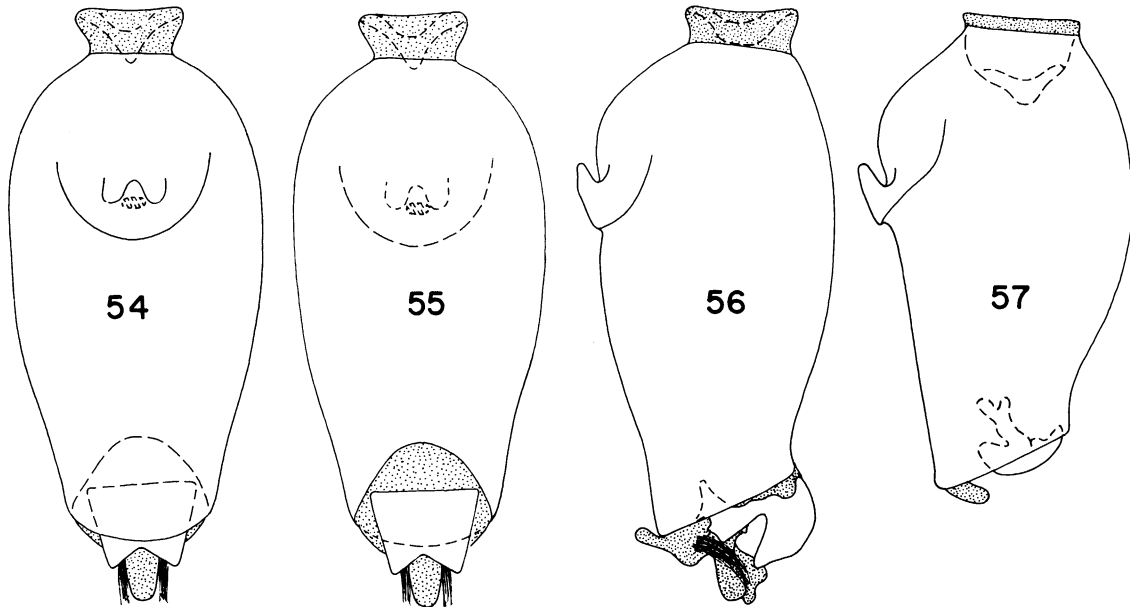

FIG. 54. *Microbledius forcipatus*; aedeagus, ventral view.

FIG. 55. *Microbledius forcipatus*; aedeagus, dorsal view.

FIG. 56. *Microbledius forcipatus*; aedeagus, lateral view; internal sac partially extruded.

FIG. 57. *Microbledius actitus*; aedeagus, lateral view; internal sac withdrawn.

to 0.44) mm. wide; pronotal width/pronotal length 1.2 (1.1 to 1.2) (table 1); surface strongly convex (fig. 4); shape as in figure 4. Pronotum polished, with obsolete microgranulate ground sculpturing, and moderately dense, moderately deep, setigerous punctation (fig. 4); pubescence moderately long; midlongitudinal groove moderately deep (fig. 4). Prosternum and prohypomeron with microreticulate ground sculpturing; prosternum with pubescence; prohypomeron devoid of pubescence except on dorsal edge. Procoxal fissure closed or slightly open (fig. 42). Elytra 0.3 (0.3 to 0.4) mm. long; elytral length/pronotal length 0.8 (0.8 to 1.0) (table 1); surface strongly shining or nearly polished, with obsolete microrugose, ground sculpturing, with moderately dense, moderately deep setigerous punctation; suture only slightly dehiscent at apex; posterior margin transversely truncate; humeral angle well developed (fig. 47). Metathoracic wings fully developed; metathorax fully developed. Abdominal segments unmodified.

**SEXUAL DIMORPHISM:** The supra-antennal horn of the female is shorter and the apex less acute than that of the male. The spermatheca is

shown in figures 50 and 51.

**VARIATION:** A few specimens have strong microgranulate ground sculpturing, and a few have a yellow elytral band larger than one-third of the elytral length, but not greater than one-half of its length. Rarely, the procoxal fissure is slightly open, exposing the protochantin slightly (fig. 42).

**HABITAT AND DISTRIBUTION:** *Microbledius litoreus* is known only from beach sand at the type locality.

**DISCUSSION:** The eight specimens examined have fully developed, apparently functional metathoracic wings; there is no evidence of the brachypterous condition found in *Microbledius actitus* and *M. playanus*.

**ETYMOLOGY:** From the Latin *litoreus*, meaning "of the seashore," applied to this species because it was collected on the seashore.

*Microbledius forcipatus* (Le Conte),  
new combination

Figures 3, 5, 10, 11, 18-22, 30, 33-39, 41, 44, 48,  
51-56, 64-71; Map 2; Table 1

*Bledius forcipatus* LE CONTE, 1863, p. 54. LE CONTE

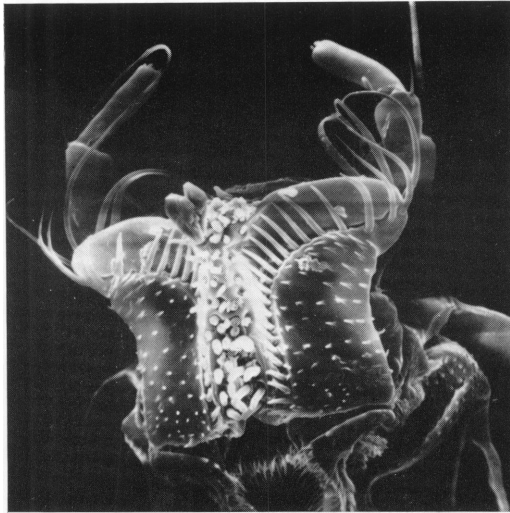

58

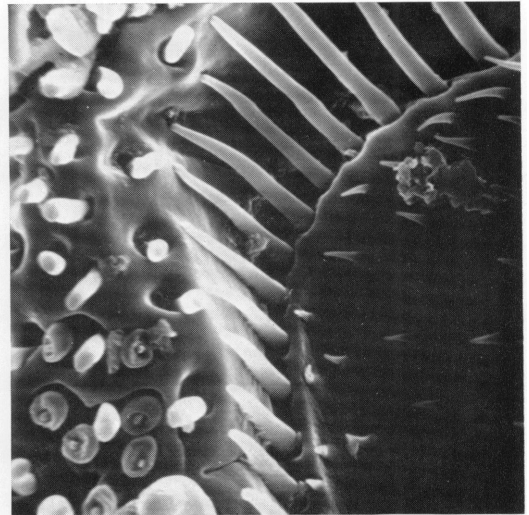

59

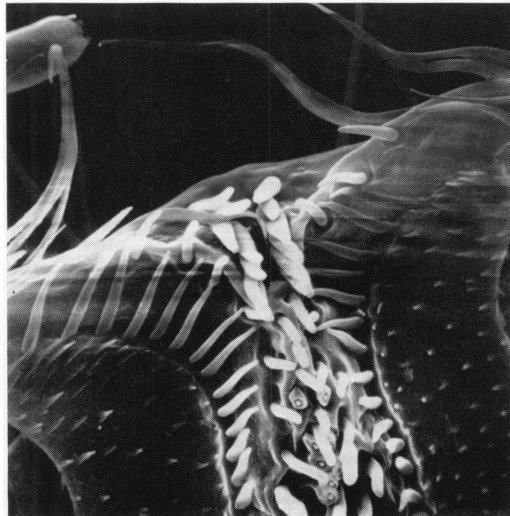

60

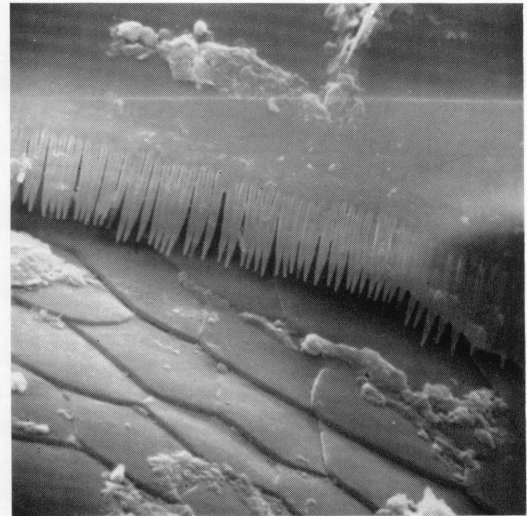

61

FIG. 58. *Microbledius playanus*; adoral surface of labium.  $\times 400$ .

FIG. 59. *Microbledius playanus*; median portion of adoral surface of labium.  $\times 1600$ .

FIG. 60. *Microbledius playanus*; adoral surface of labium, showing more of anterior portion.  $\times 800$ .

FIG. 61. *Microbledius playanus*; tergite VII, posterior margin.  $\times 1440$ .

1877, pp. 232, 233. CASEY, 1889, p. 67. FALL, 1901, p. 75 (type locality: California, Fort Yuma; holotype: deposited at the Museum of Comparative Zoology, Harvard University, Cambridge, Massachusetts; type examined, male).

DIAGNOSIS: *Microbledius forcipatus* can be distinguished from all other species in the genus in

the United States by the large eyes (compare fig. 3 and figs. 2, 67), small dorsal, mandibular denticle (figs. 19–22), and color pattern of the elytra (fig. 44). The supra-antennal horn of the male (figs. 3, 10) is longer and more acuminate than that of any of the other species of the genus in the United States.





62



63

FIG. 62. *Microbledius actitus*; adoral surface of labium.  $\times 400$ .

FIG. 63. *Microbledius actitus*; median portion of adoral surface of labium.  $\times 800$ .

**DESCRIPTION:** Length 1.7 to 2.6 mm.

Dorsum of head black to pale reddish brown. Horn of supra-antennal ridge reddish brown. Clypeus, labrum, venter of head dark to pale reddish brown. Mentum and submentum reddish brown to yellowish brown. Maxilla, labial palpus, and antenna yellowish brown. Mandibles reddish brown to yellowish brown. Pronotum dark reddish brown to reddish brown. Prohypomeron and prosternum reddish brown to pale reddish brown. Elytron (fig. 44) pale yellowish brown with transverse, basal brown stripe; basal stripe continuous with narrow brown sutural stripe; sutural stripe sharply expanded into hemispherical, brown subapical spot; spot extending from point about one-fourth of elytral length from posterior margin to point about one-half elytral length from posterior margin; sutural, subapical spot occasionally not connected to transverse basal stripe by sutural stripe, but connecting stripe often less distinct; sutural, subapical spot occasionally absent; spot occasionally spreading posterolaterally. Pterothoracic pleura and sterna dark reddish brown to reddish brown. Legs yellowish brown. Abdomen black to reddish brown.

Dorsum of head shining dully, not polished, with prominent, dense, microgranulate ground

sculpturing (figs. 66, 67), and very shallow, moderately dense, setigerous punctation (fig. 3); pubescence present on midlongitudinal region; pubescence moderately long; midlongitudinal groove absent but middorsal region occasionally with punctiform fovea; midbasal portion of head of male broadly tumescent (fig. 3); anterior portion of head of male strongly declivous from tumescence to clypeus between supra-antennal ridge; occasionally declivous region broadly depressed; dorsum of head of female broadly and shallowly convex and not modified in manner of male. Supra-antennal horn of male (figs. 3, 10) with large, strongly convex, broad base; horn elongate and attenuate anteriorly; horn of male longer and more prominent than that of female (figs. 11, 30); female with base less strongly convex than on male; female with apex of horn less strongly pointed (figs. 11, 30); female occasionally lacking horn; base of horn with dense microgranulate ground sculpturing, and setigerous punctation; apex of horn glabrous and polished. Epistomal suture straight between supra-antennal ridges and sharply angulate at juncture with ridges (figs. 3, 30). Clypeus shining dully; with dense, microgranulate ground sculpturing (fig. 66); with very shallow, setigerous punctation; anterior margin



64



65

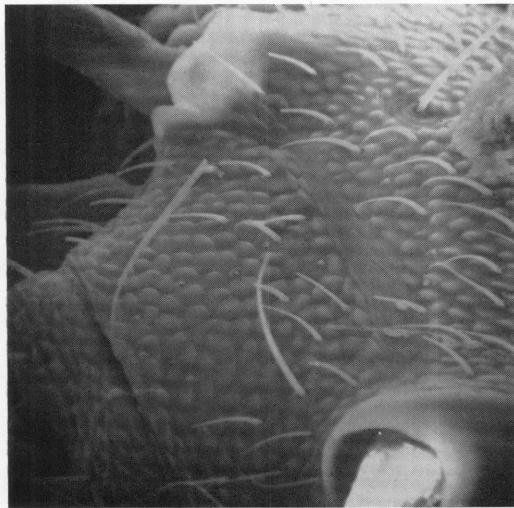

66

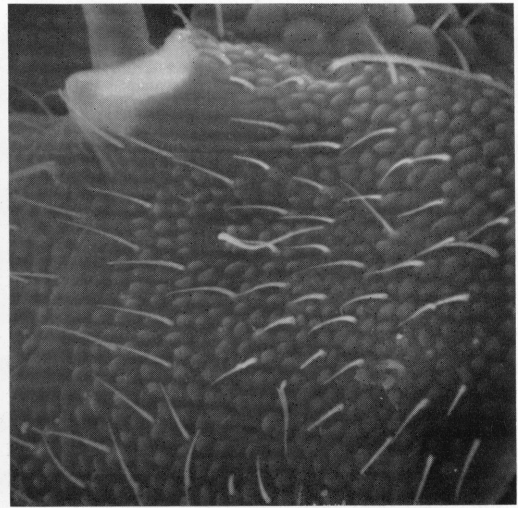

67

FIG. 64. *Microbledius forcipatus*; adoral surface of labium.  $\times 880$ .

FIG. 65. *Microbledius forcipatus*; adoral surface of labium.  $\times 1600$ .

FIG. 66. *Microbledius forcipatus*; dorsum of head; clypeus and labrum.  $\times 370$ .

FIG. 67. *Microbledius forcipatus*; dorsum of head.  $\times 320$ .

without tubercles. Eyes large (figs. 3, 10, 11, 30). Lateral side of head with broad, glabrous strip extending from base of head to posterior margin of eye. Venter of head with microreticulate ground sculpturing. Width of head 0.3 to 0.4 mm.; interocular width 0.2 to 0.4 mm.; head width/interocular width 1.4 to 1.7 (table 1).

Labrum with microgranulate ground sculpturing and shallow, setigerous punctation. Mandible bidentate (figs. 19-22); ventral (or apical) denticle longer and stouter than dorsal (or basal) denticle (figs. 19-22); dorsal denticle small (figs. 19-22); male (figs. 19, 20) with base more stout than that of female (figs. 21, 22).

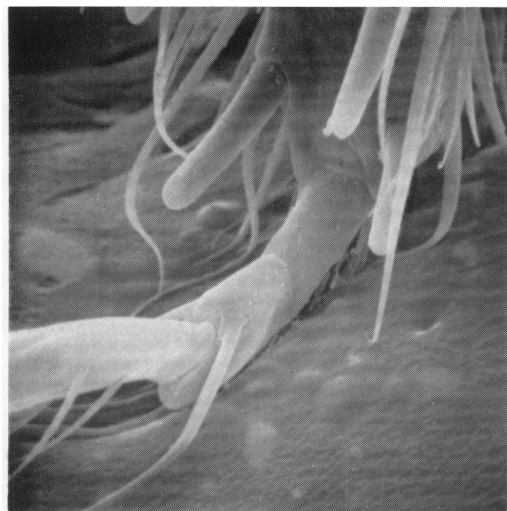

68



69

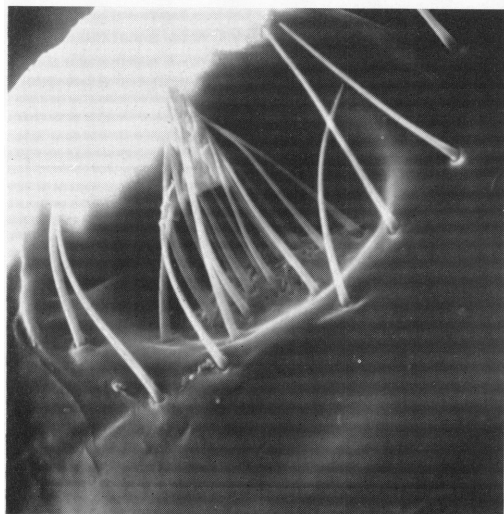

70

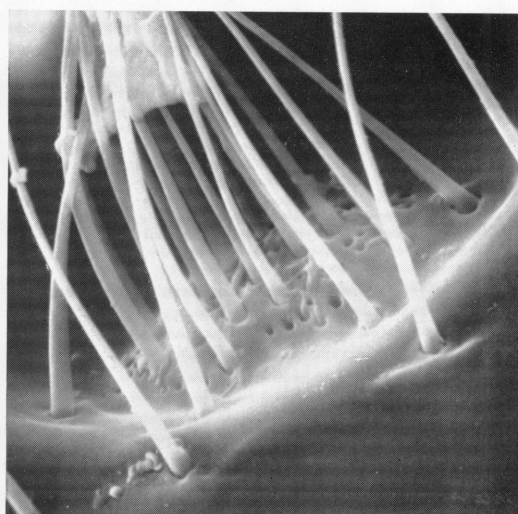

71

FIG. 68. *Microbledius forcipatus*; mesotarsus.  $\times 800$ .

FIG. 69. *Microbledius forcipatus*; mesotarsus, joint of apical and subapical article.  $\times 1920$ .

FIG. 70. *Microbledius forcipatus*; prosternal setigerous pit.  $\times 960$ .

FIG. 71. *Microbledius forcipatus*; prosternal setigerous pit.  $\times 1920$ .

Pronotum 0.2 to 0.4 mm. long; 0.3 to 0.5 mm. wide; pronotal width/pronotal length 1.1 to 1.3 (table 1); surface moderately strongly convex (fig. 5); shape as in figure 5. Pronotum with microgranulate ground sculpturing; sculpturing uniformly distributed; surface shining but not polished with moderately dense, moderately

deep to more shallow setigerous punctation (fig. 5), and midlongitudinal groove distinctly and prominently but finely developed (fig. 5); pubescence moderately long. Prohypomeron and prosternum with microreticulate ground sculpturing; prohypomeron with pubescence along dorsal edge; prosternum with scattered

pubescence. Procoxal fissure usually closed (fig. 41), occasionally with ventral edge slightly open, exposing protrochantin slightly. Elytra 0.4 to 0.6 mm. long; elytral length/pronotal length 1.2 to 1.5 (table 1); surface shining dully, with microrugose ground sculpturing and dense, shallow setigerous punctation; suture strongly dehiscent at apex; posterior margin transversely arcuatotruncate; humeral angles well developed (fig. 44). Metathoracic wings and metathorax fully developed.

Abdominal segments unmodified.

Spermatheca shown as in figures 48 and 51.

**SEXUAL DIMORPHISM:** The males have the dorsum of the head tumescent near the base with the anterior region strongly declivous (fig. 5), and the supra-antennal horn long, slender anteriorly, and prominent (figs. 5, 10). The dorsum of the head of the female is more shallowly and broadly convex than that of the male, and the anterior region is not sharply declivous. The supra-antennal horn of the female (figs. 11, 30) is shorter, stouter, less attenuate and the apex less pointed than that of the male. Some females entirely lack the supra-antennal horn.

The base of the mandibles of the male (figs. 19, 20) is stouter than that of the female (figs. 21, 22), and the dorsal denticle is often, but not always, longer on the male than on the female.

**VARIATION:** The subapical, brown sutural spot of the elytra is occasionally enlarged posterolaterally into a triangular, obliquely transverse stripe. Increased size of the elytral spot is more prevalent in the populations from Yuma, Arizona, and Needles, California, than in the populations from Oklahoma and Arkansas. A specimen from the Mississippi River is completely devoid of the elytral sutural spot.

**HABITAT AND DISTRIBUTION:** *Mexico:* Sinaloa, Sonora. *United States:* Arizona, Arkansas, California, Nebraska, Oklahoma, Texas, Utah. (See Appendix for localities.)

*Microbledius forcipatus* occurs in the southwestern two-thirds of the United States (map 2) as far east as the Mississippi River and into Mexico. The species is collected on the shores of the Colorado, Rio Grande, Red, Arkansas, Cimarron, and Mississippi rivers, and Verdigre Creek.

On the Red River near Hugo, Oklahoma, the species burrows into moderately moist sand flats. It has not been collected in sufficient numbers

or localities to deduce its microhabitat. Most collections were by black light.

The species was collected during April in California, August in Arizona, August and September in Sinaloa and Sonora, and during June through September in the central parts of the United States.

**DISCUSSION:** Specimens I identified as *Microbledius bifasciatus* (Sharp) from San Blas and Ixtlan del Rio in Mexico are similar in most respects to *M. forcipatus*. They can be separated by the elytral luster. The elytra of *M. bifasciatus* are shiny, those of *M. forcipatus* dull. *Microbledius bifasciatus* has a large triangular, transversely oblique, brown subapical sutural spot on the elytra in place of the small, hemispherical, brown subapical sutural spot of *M. forcipatus*. Some individuals of *M. forcipatus* have a small, triangular elytral spot, which with individuals of *M. bifasciatus* having a small spot bridge the gap between the two nominate species.

I am uncertain of the status of these nominate species, but until more individuals and microhabitat data are available, they are retained as separate species.

The following species is included because I am designating the lectotype and because it is so similar to *M. forcipatus*.

*Microbledius bifasciatus* (Sharp), new combination

*Bledius bifasciatus* SHARP, 1887, p. 686 (type locality: Guatemala, Rio Naranjo, 450 feet; lectotype: deposited in the British Museum [Natural History], London, England. The specimen designated herein as the lectotype is mounted on a card with a female. The lectotype, a male, is on the left side of the card, has the left elytron missing, and has the humeral angle of the right elytron partly chewed by dermestid beetles. Type examined).

**DIAGNOSIS:** The species is similar to *Microbledius forcipatus*, except that the elytra are polished between the punctures in *M. bifasciatus*. (See also Discussion under *M. forcipatus*.)

**PSAMATHOBLEDIUS, NEW GENUS**

Figures 72-140; Maps 3, 4; Table 2

**TYPE-SPECIES:** *Psamathobledius punctatissimus* (Le Conte), designated herein; species transferred from *Bledius*.

**DIAGNOSIS:** This genus can be distinguished from *Bledius* by the presence of the prosternal

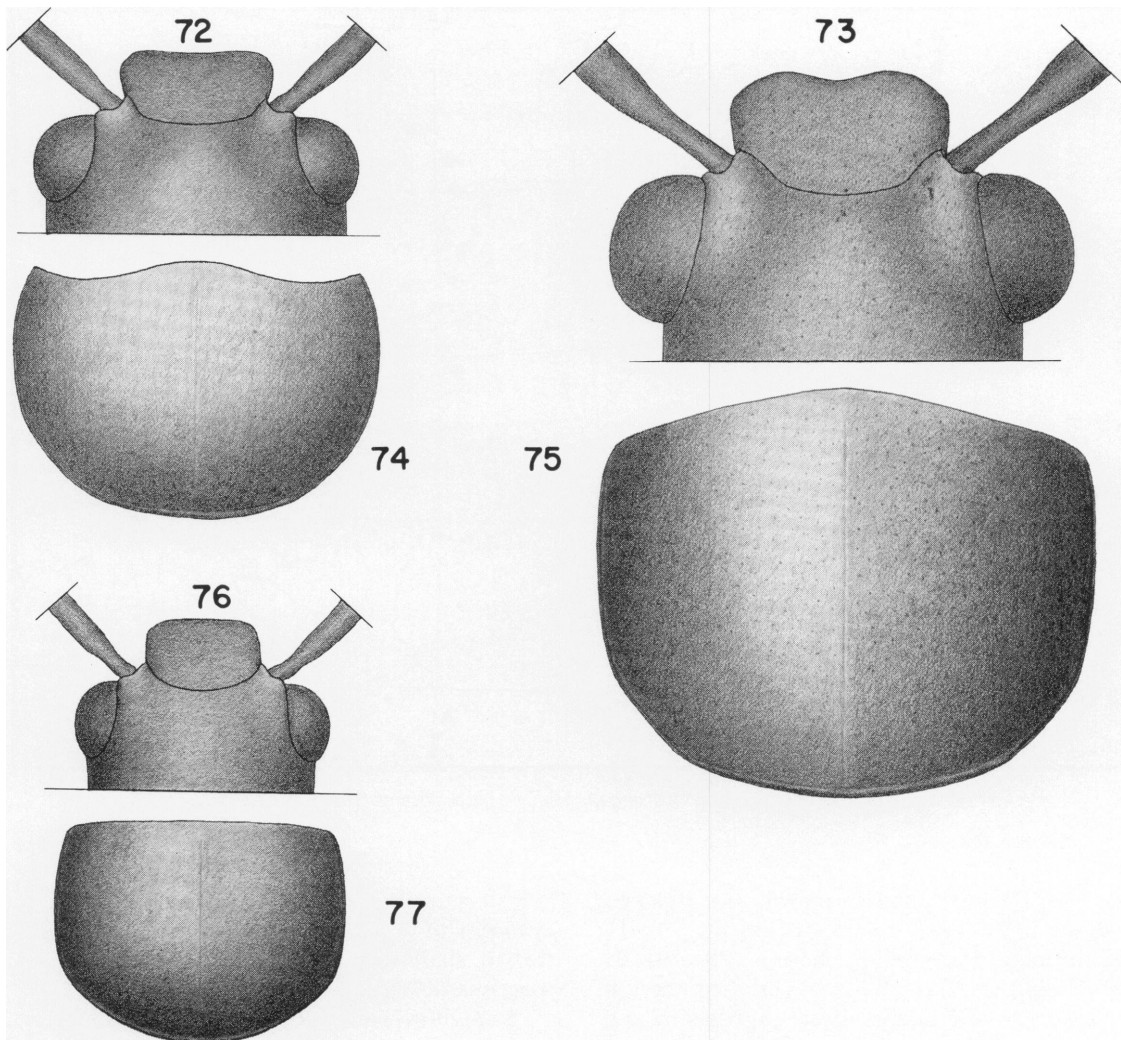

FIG. 72. *Psamathobledius caribbeanus*; head, dorsal view.  
 FIG. 73. *Psamathobledius punctatissimus*; head, dorsal view.  
 FIG. 74. *Psamathobledius caribbeanus*; prothorax, dorsal view.  
 FIG. 75. *Psamathobledius punctatissimus*; prothorax, dorsal view.  
 FIG. 76. *Psamathobledius microcephalus*; head, dorsal view.  
 FIG. 77. *Psamathobledius microcephalus*; prothorax, dorsal view.

setigerous pit (figs. 85–88, 137, 138, 140) and the presence of only three tarsomeres (fig. 80) on each leg. From *Microbledius*, *Psamathobledius* can be separated by the presence of the pronotal lateral marginal bead (compare figs. 85, 86 with fig. 41), the protergosternal suture (compare figs. 85, 86 with fig. 41) and the elytral epipleural ridge (figs. 97, 100).

DESCRIPTION: Length 1.5 to 3.7 mm. Body

form subcylindrical. Body with dense pubescence. Color black to yellowish brown.

HEAD: Epistomal suture present and broadly arcuate (figs. 72, 73, 76). Supra-antennal ridge without horns (figs. 72, 73, 76). Clypeal tubercles absent (figs. 72, 73, 76). Gular sutures of variable length (figs. 89–91); sutures confluent but sharply divergent near base of head (figs. 89–91). Labrum with anterior margin sinuate

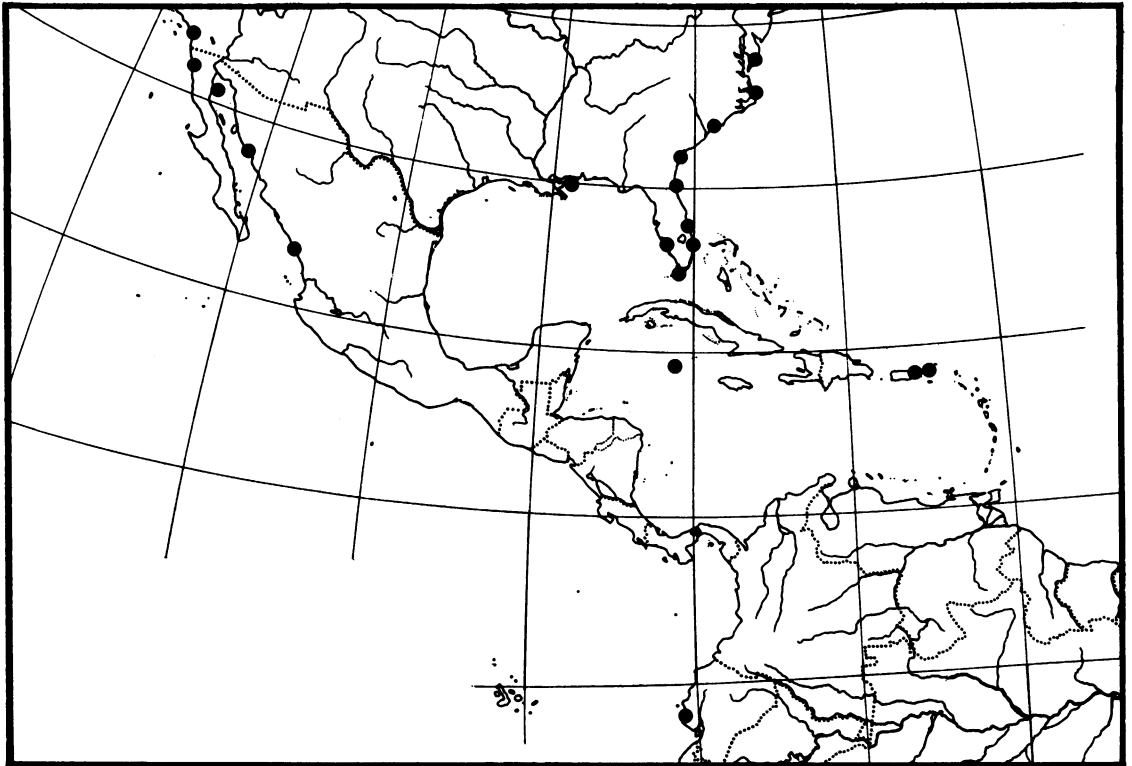

MAP 3. Distribution of *Psamathobledius punctatissimus* (black dots).

(figs. 78, 79, 81); anterior margin not reflexed; midlongitudinal groove absent (figs. 78, 79, 81); membranous lobes as in figures 78, 79, 81. Labial palpus (figs. 82, 83) with segments of variable size and shape; basal and second segments each with only one seta. Adoral surface of labium as in figures 125–130, 132, 133, 135, 136. Mentum as in figures 92, 95. Submentum extending onto venter of head, posterior margin strongly to slightly V-shaped (figs. 89–91). Maxillary palpus as in figure 38. Galea with numerous rows of curved spinelike setae. Mandibles prominent and denticulate (fig. 114). Antenna geniculate (as in fig. 1).

**THORAX:** Pronotum wider than long; shape as in figures 74, 75, 77. Pronotal horn absent. Pronotal lateral marginal bead present and complete (figs. 85, 86). Protergosternal suture present (figs. 85, 86). Procoxal fissure open (fig. 86) or closed (fig. 85). Protrochantin exposed (fig. 86) or concealed (fig. 85). Post-procoxal lobe present (figs. 85, 86). Prosternal process reduced to low carina (figs. 85, 86).

Prosternum with small, densely setigerous pit anterior to procoxa (figs. 85–88, 137, 138, 140); broad, shallow, pubescent depression anterior to procoxa absent.

Scutellum concealed by pronotum. Elytral suture dehiscent at apex (as in fig. 1). Elytral epipleural ridge present and complete (figs. 97, 100). Elytron without membranous lobe on posterior margin (figs. 96, 97). Mesosternal process prominent and carinate at apex (see Herman, 1970, fig. 34). Metasternal process absent; metasternum with low, longitudinal carina between coxae (see Herman, 1970, fig. 34). Mesocoxae contiguous. Protibia and mesotibia with longitudinal rows of spines (as in fig. 1); metatibiae with longitudinal row of weakly developed spinules (as in fig. 1). Tarsal formula 3–3–3 (fig. 80); basal two articles reduced; third article elongate, apically incarsate and slender.

**ABDOMEN:** Second sternite well developed. Terga and sternites without midlongitudinal, basal carina. Terga without basolateral ridges

TABLE 2  
 MEASUREMENTS (IN MILLIMETERS) OF THE HEAD, THORAX, AND ELYTRA OF ADULTS OF THE SPECIES OF *Psamathobletius*  
 (The mean, standard deviation, and sample size are given in that order for each species.)

	Head Width	Interocular Width	Pronotal Width	Pronotal Length	Elytral Length	Head Width		Pronotal Width		Elytral Length											
						Interocular Width	Pronotal Length	Interocular Width	Pronotal Length	Interocular Width	Pronotal Length										
<i>caribbeanus</i> ♀ and ♂	0.43	0.02	20	0.27	0.01	20	0.49	0.02	20	0.34	0.02	20	1.58	0.04	20	1.42	0.04	20	1.28	0.03	20
<i>microcephalus</i> ♀ and ♂	0.35	0.01	20	0.23	0.01	20	0.40	0.02	20	0.31	0.01	20	1.54	0.06	20	1.29	0.04	20	1.42	0.04	20
<i>punctatissimus</i> ♀ and ♂, Baja California	0.56	0.02	20	0.35	0.02	20	0.64	0.02	20	0.52	0.02	20	1.62	0.05	20	1.23	0.03	20	1.51	0.05	20
<i>punctatissimus</i> ♀ and ♂, Florida	0.56	0.01	20	0.32	0.01	20	0.62	0.02	20	0.50	0.02	20	1.71	0.04	20	1.24	0.03	20	1.38	0.03	20
<i>punctatissimus</i> ♀ and ♂, Puerto Rico	0.58	0.02	20	0.33	0.01	20	0.64	0.02	20	0.51	0.02	20	1.75	0.04	20	1.27	0.02	20	1.42	0.06	20

(as in fig. 1); basal transverse ridge present (as in fig. 1). Segments II to III each with two pairs of laterosternites (as in fig. 1). Seventh tergum with posterior margin fimbriate (as in fig. 61); fimbriation of varying length. Eighth tergum with posterior margin truncate (fig. 98).

Aedeagus (figs. 122-124) trilobed. Parameres short, with one or two setae at apex. Median lobe bulbous; apex of ventral surface attenuate (fig. 124); dorsal surface (fig. 122) and base with long, narrow membranous strip; apex of dorsal surface longitudinally divided and partially separated from basal half of median lobe by ventrally extended membranous strip; ostium at apex of median lobe; internal sac attached to longitudinally divided apex of median lobe; when internal sac retracted, apex of dorsal surface of median lobe longitudinally infolded.

Spermatheca as in figures 115 and 119.

DISCUSSION: The three-segmented tarsi in combination with unique characteristics of the labium, spermatheca, and aedeagus demand generic recognition of this taxon.

*Psamathobledius* should be included in the Coprophilini as defined by Herman (1970). The phylogenetic relationships of the genus will be discussed in Part III of the present revision. The species included are those described below. If a few others are discovered, the transfers will be made in Part III of this revision of *Bledius* and related genera.

In the key to the genera of the Oxytelinae by Herman (1970), *Psamathobledius* runs to couplet 16, which includes *Aploderus* and *Parosus*. The presence of the prosternal setigerous pit (figs. 85-88, 137, 138, 140) on *Psamathobledius* will separate this genus from *Aploderus* and *Parosus*.

ETYMOLOGY: From the Greek, *psamathos*, meaning sand of the seashore. The name *Psamathobledius* refers to the *Bledius*-like beetle found in sand of the seashore, which is where all the species have been collected.

DISTRIBUTION: New World (maps 3 and 4). (See Appendix for localities.)

KEY TO THE SPECIES OF PSAMATHOBLEDIUS

- 1. Procoxal fissure closed (fig. 85) . . . . .
- . . . . . *punctatissimus*
- Procoxal fissure open (fig. 86) . . . . . 2
- 2 (1). Elytra rough, with coarse microtuberculate ground sculpturing; punctuation not readily visible . . . . . *caribbeanus*

Elytra smooth, without microtuberculate ground sculpturing; punctuation distinct. . . . . *microcephalus*

*Psamathobledius punctatissimus* (Le Conte), new combination

Figures 73, 75, 78, 80, 82, 85, 88, 90, 99-114, 119, 125-128, 137-140; Map 3; Table 2

*Bledius punctatissimus* LE CONTE, 1877, pp. 226, 227. CASEY, 1889, p. 56. FALL, 1901, p. 75. NOTMAN, 1920, p. 698. MOORE, 1964, pp. 273, 274, 276, 277, 281, 282 (type locality: Southern California; holotype: deposited in the Museum of Comparative Zoology, Harvard University, Cambridge, Massachusetts. Type examined).

*Bledius esposus* BLACKWELDER, 1943, pp. 113, 114; 1947, p. 119 (new synonym. Type locality: West Indies, Antigua, St. Johns; holotype: deposited at the National Museum of Natural History, Smithsonian Institution, Washington, D.C. Type examined).

DIAGNOSIS: This species is easily separated from the other known congeneric species by the closed procoxal fissure (fig. 85). The seventh sternite of the male does not have a membranous lobe (see figs. 93, 94), the submentum does not extend very far onto the venter of the head (compare fig. 90 with figs. 89, 91), and the head and prothorax are large (see measurements and table 2).

DESCRIPTION: Length 2.6 to 3.7 mm.

Dorsum of head and clypeus black. Supra-antennal ridge black to blackish brown. Labrum black. Venter of head black to brownish black. Mentum, submentum, and maxilla brownish black to blackish brown. Antenna brown to dark yellowish brown. Mandible reddish brown. Pronotum black with infusions of brownish black along lateral and basal margin. Prohypomeron and prosternum black with some infusions of dark brown to dark reddish brown. Elytron entirely black or bicolored (figs. 102-111); disk black to dark reddish brown; when bicolored, apex and epipleuron yellowish brown (figs. 102-111); apical spot of variable size with numerous intergrades between extremes (figs. 102-111); spot often reduced to small area adjacent to epipleuron (figs. 106, 111) and often enlarged to cover area from epipleuron, across apex to suture (figs. 102, 107); epipleuron black, brown, or brownish yellow; when epipleuron yellowish brown then apical spot usually present. Pterothoracic pleura and sterna black to dark



reddish brown. Legs dark to pale yellowish brown. Abdomen black.

Dorsum of head shining dully, not polished, with dense, microtuberculate ground sculpturing (fig. 139), and moderately dense, shallow, and very fine, setigerous punctation (fig. 73); punctation visible only at high magnification; pubescence absent from narrow midlongitudinal strip; pubescence moderately long; mid-dorsal region broadly and shallowly convex and without longitudinal groove or punctiform fovea (fig. 73). Supra-antennal ridge low and moderately well developed and without horns (fig. 73); surface with dense, microtuberculate ground sculpturing and shallow, very fine, setigerous punctation. Epistomal suture broadly and shallowly arcuate with suture more sharply angulate at intersection with supra-antennal ridge (fig. 73). Clypeus shining dully, not polished; coarse, dense, microtuberculate ground sculpturing (fig. 139) and moderately dense pubescence present; punctation not readily visible; anterior margin sinuate with median portion broadly and shallowly emarginate (fig. 73); anterior margin without tubercles (fig. 73). Eye large (fig. 73). Lateral side of head with glabrous strip extending from base of head toward but not reaching posterior margin of eye; glabrous strip broad at base and strongly attenuated anteriorly. Venter of head with microgranulate ground sculpturing. Submentum extending only slightly onto venter and strongly attenuate basally (fig. 90); with numerous setae (fig. 90). Labial palpus with second segment shortest and apical segment shorter than third (fig. 82). Gular sutures of nearly normal length (fig. 90). Width of head 0.5 to 0.6 mm.; interocular width 0.3 to 0.4 mm.; head width/interocular width 1.6 to 1.8 (table 2). Labrum with microgranulate ground sculpturing and very shallow, fine, setigerous punctation; anterior margin broadly sinuate and with broad, moderately deep, median emargination (fig. 78); anterior margin not reflexed. Mandibles tridentate (figs. 112-114); basal and second denticles on mesial mandibular surface very short and evident as swellings (figs. 112-114) to more elongate and spiniform.

Pronotum 0.5 to 0.6 mm. long; 0.6 to 0.7 mm. wide; pronotal width/pronotal length 1.2 to 1.3 (table 2); surface moderately strongly convex (fig. 75); anterior margin broadly arcuate to nearly truncate (fig. 75); lateral margin broadly

and strongly arcuate from anterior to basal angles (fig. 75); basal margin broadly but very slightly arcuate (fig. 75); anterior angles not anteriorly produced (fig. 75); basal angles moderately well defined (fig. 75). Pronotum with surface shining dully, not polished; microtuberculate ground sculpturing present; dense, fine, very shallow, setigerous punctation present (fig. 75); punctation visible only at high magnification; fine, shallow, midlongitudinal groove present (fig. 75); pubescence moderately long. Prohypomeron with microreticulate ground sculpturing; prosternum with microgranulate ground sculpturing. Procoxal fissure closed (fig. 85). Protrochantin concealed (fig. 85). Elytra 0.6 to 0.8 mm. long; elytral length/pronotal length 1.4 to 1.6 (table 2); surface shining dully, not polished; dense, moderately deep, distinct, setigerous punctation present; pubescence moderately short; apex (figs. 99-101) with sclerotized projection; membranous lobe absent from apex. Metathoracic wings fully developed.

Abdominal segments of males and females unmodified.

Spermatheca as shown in figure 119.

VARIATION: The elytron, including the epipleuron, may be entirely black (or reddish brown) or the disk of the elytron may be black (or reddish brown) with the apex and the epipleuron yellowish brown (figs. 102-105, 107-110). The size of the apical spot varies, with many intermediates, from small and restricted to the area adjacent to the epipleuron (figs. 105, 110) to a wide transverse band extending from the epipleuron to the suture (figs. 102, 107). Generally, the elytral disk is entirely black without an apical spot in populations from Florida and Mississippi, Baja California, and California. Individuals from these areas may have a yellowish or reddish brown epipleuron. A few specimens from Florida have a poorly delimited, slightly paler region near the apex, adjacent to the epipleuron. Specimens from the West Indies and Ecuador all have a black or reddish brown disk with a yellowish brown epipleuron and apex. The large apical spot is associated with the southern part of the geographical range, and it is here that most of the intergrades are found. Further collecting in Mexico may result in discovery of intergrading individuals.

SYNONYMY: The only character separating *Bledius esposus* from *Psamathobledius punctatissimus* is the presence or absence of the variable spot on

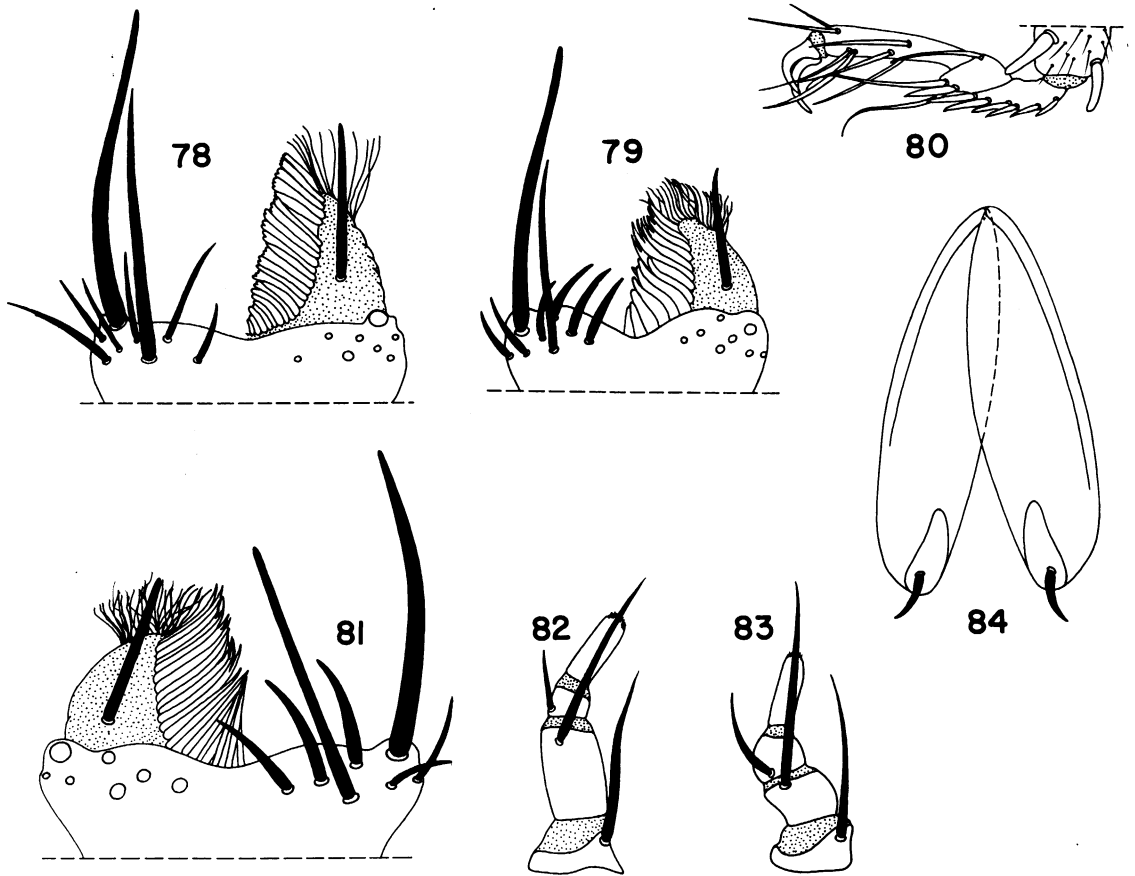

FIG. 78. *Psamathobledius punctatissimus*; labrum.  
 FIG. 79. *Psamathobledius microcephalus*; labrum.  
 FIG. 80. *Psamathobledius punctatissimus*; metatarsus.  
 FIG. 81. *Psamathobledius caribbeanus*; labrum.  
 FIG. 82. *Psamathobledius punctatissimus*; labial palpus.  
 FIG. 83. *Psamathobledius caribbeanus*; labial palpus.  
 FIG. 84. *Psamathobledius caribbeanus*; sternite IX; female.

the apex of the elytron. As there are many intermediates between the two extremes, I consider *B. esposus* and *P. punctatissimus* to be synonymous.

HABITAT AND DISTRIBUTION: *Ecuador*: Guayas. *Mexico*: Baja California, Sinaloa. *United States*: California, Florida, Georgia, Maryland, Mississippi, North Carolina, South Carolina. *West Indies*: Little Cayman Island, Puerto Rico, St. Thomas. (See Appendix for localities.)

I have seen additional specimens from Rio de Janeiro and Ceara Beach, Brazil, that, except for elytral color pattern, are inseparable from *P. punctatissimus*.

*Psamathobledius punctatissimus* occurs along the

Atlantic coast of the United States from Maryland to Florida, along the Gulf of Mexico to Alabama, and on several islands in the Gulf of Mexico. In the western United States it extends on the Pacific coast from southern California into Baja California and on the coast of the mainland of Mexico as far south as Mazatlan, Sinaloa (map 3). The species is also known from coastal Ecuador. It probably occurs on most of the Mexican, Central American, and northern South American coasts.

The species is known only from coastal regions, where it is found in saline habitats. On Puerto Rico at Loquillo Beach, *P. punctatissimus* lives on

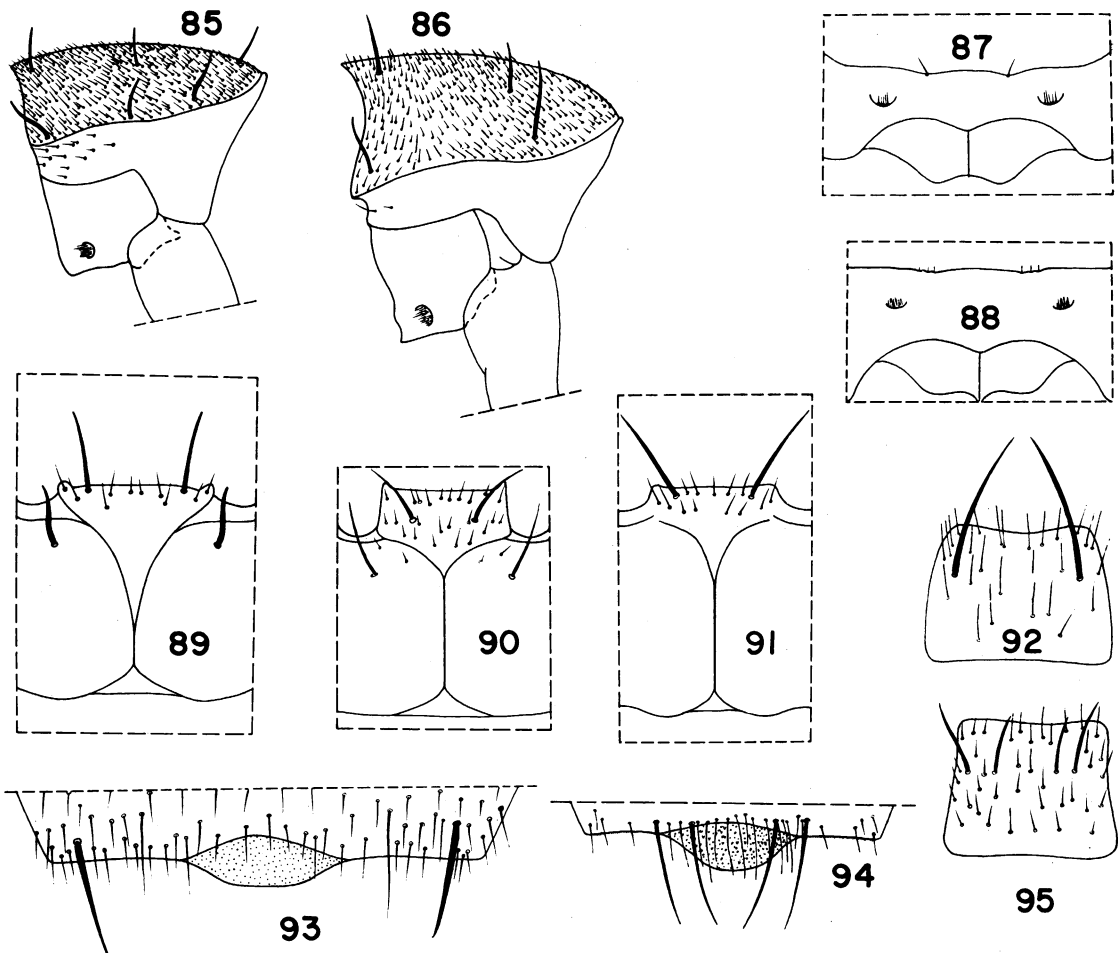

FIG. 85. *Psamathobledius punctatissimus*; prothorax, lateral view.

FIG. 86. *Psamathobledius caribbeanus*; prothorax, lateral view.

FIG. 87. *Psamathobledius caribbeanus*; prosternum.

FIG. 88. *Psamathobledius punctatissimus*; prosternum.

FIG. 89. *Psamathobledius caribbeanus*; gular region and submentum.

FIG. 90. *Psamathobledius punctatissimus*; gular region and submentum.

FIG. 91. *Psamathobledius microcephalus*; gular region and submentum.

FIG. 92. *Psamathobledius caribbeanus*; mentum.

FIG. 93. *Psamathobledius caribbeanus*; sternite VII; apex; male.

FIG. 94. *Psamathobledius microcephalus*; sternite VII; apex; male.

FIG. 95. *Psamathobledius punctatissimus*; mentum.

the leeward side of a sand bar in a lagoon and burrows in sand near the vegetation. Near Grove City, Florida, it is found on open, moist, sand flats on the leeward side of a peninsula. At La Misión de San Miguel, Baja California, Moore (1964) reported the species in muddy sand that lacked a salt crust and had sparse vegetation, near the water of a lagoon. Some

labels on specimens from Pablo Beach, Florida, indicate the species was taken above the high-tide mark and under debris. The species is abundant in Puerto Rico, North Carolina, Florida, and Baja California and uncommon in Maryland.

The species was collected in Baja California in May, in Sonora and Sinaloa during July and

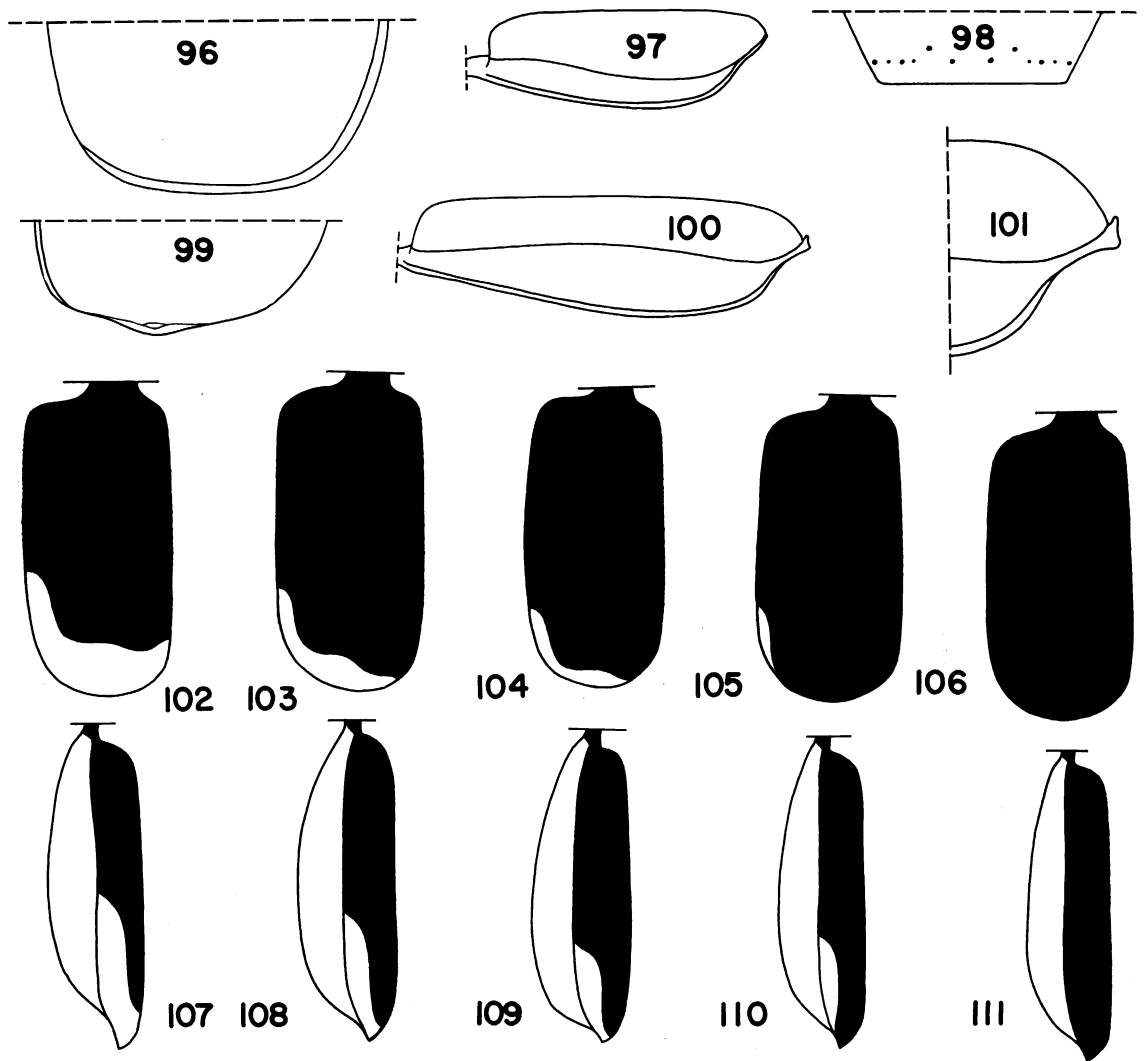

FIG. 96. *Psamathobledius caribbeanus*; left elytron; apex.

FIG. 97. *Psamathobledius caribbeanus*; left elytron; lateral view.

FIG. 98. *Psamathobledius caribbeanus*; tergum VIII; apex; setae removed.

FIG. 99. *Psamathobledius punctatissimus*; right elytron; apex.

FIG. 100. *Psamathobledius punctatissimus*; left elytron; lateral view.

FIG. 101. *Psamathobledius punctatissimus*; left elytron; lateral view; apex.

FIG. 102. *Psamathobledius punctatissimus*; left elytron; color pattern; dorsal view; Puerto Rico.

FIG. 103. *Psamathobledius punctatissimus*; left elytron; color pattern; dorsal view; Puerto Rico.

FIG. 104. *Psamathobledius punctatissimus*; left elytron; color pattern; dorsal view; Puerto Rico.

FIG. 105. *Psamathobledius punctatissimus*; left elytron; color pattern; dorsal view; Puerto Rico.

FIG. 106. *Psamathobledius punctatissimus*; left elytron; color pattern; dorsal view; Florida.

FIG. 107. *Psamathobledius punctatissimus*; left elytron; color pattern; lateral view; Puerto Rico.

FIG. 108. *Psamathobledius punctatissimus*; left elytron; color pattern; lateral view; Puerto Rico.

FIG. 109. *Psamathobledius punctatissimus*; left elytron; color pattern; lateral view; Puerto Rico.

FIG. 110. *Psamathobledius punctatissimus*; left elytron; color pattern; lateral view; Puerto Rico.

FIG. 111. *Psamathobledius punctatissimus*; left elytron; color pattern; lateral view; Florida.

August, in Ecuador during January, in Florida and the West Indies during November through April. In Maryland and South Carolina the species was collected in June, and at Horn Island, Mississippi, during May, June, and September. At most localities the species can probably be collected throughout the year.

DISCUSSION: Le Conte (1877, p. 226) remarked that the presence of this species on both the Atlantic and Pacific coasts of the United States was unusual. The few records of the species in Mexico indicate that there are probably connecting populations in Central America.

When Le Conte described *Bledius punctatissimus* he mentioned that it might be a separate species-group. He included it as a member of the *annularis* group of *Bledius* where, even if it were a *Bledius*, it was incorrectly placed because the procoxal fissure is closed rather than open. Further study of the species demonstrates conclusively that it is not a member of *Bledius* and is more correctly associated with other species included in *Psamathobledius*.

*Psamathobledius caribbeanus* (Blackwelder),  
new combination

Figures 72, 74, 81, 83, 84, 86, 87, 89, 92, 93, 96-98,  
115-118, 131, 133-136;  
Map 4; Table 2

*Bledius caribbeanus* BLACKWELDER, 1943, pp. 113, 114  
(type locality: West Indies, Tobago, 3 miles southwest of Scarborough, on seashore, collected on January 1, 1936; holotype: deposited in the National Museum of Natural History, Smithsonian Institution, Washington, D.C. Type examined, female).

DIAGNOSIS: *Psamathobledius caribbeanus* is readily separated from *P. punctatissimus* by the open procoxal fissure (compare fig. 86 with fig. 85), the deeply angulate submental suture (compare fig. 89 with fig. 90), and the smaller eyes (fig. 72). The male of *P. caribbeanus* has a membranous lobe (fig. 93) on the seventh sternite, the male of *P. punctatissimus* does not. The coarse, microtuberculate sculpturing of the elytra, the small, membranous lobe on the seventh sternite of the male (compare fig. 93 with fig. 94), the more deeply angulate submental suture (compare fig. 89 with fig. 91), and the more shallowly emarginate labrum (compare fig. 81 with fig. 79) will separate *P. caribbeanus* from *P. microcephalus*.

Note also the range of variation for the measurements of the head, prothorax and elytra (table 3 and Descriptions).

DESCRIPTION: Length 1.7 to 2.5 mm.

Dorsum of head and clypeus black. Venter of head and labrum dark reddish brown often with infusions of black. Labium, maxilla, mandibles, and antenna yellowish brown to dark yellowish brown. Mandibles usually with infusions of reddish brown. Antenna in most cases more brownish apically. Pronotum black. Prohypomeron and prosternum pale reddish brown, generally with infusions of black and yellowish brown. Elytron black, in most cases with brown to yellowish brown epipleuron, in some cases with yellowish brown lateroapical spot. Pterothoracic sterna and pleura black to brownish black. Legs with coxae and femora pale reddish brown, tibiae and tarsi yellowish brown. Abdomen black to brownish black.

Dorsum of head shining dully, not polished, with dense, microtuberculate ground sculpturing (as in fig. 139) and moderately dense pubescence; punctation not readily visible (fig. 72); pubescence absent from narrow midlongitudinal strip; pubescence moderately long; middorsal region broadly and shallowly convex and without longitudinal groove, punctiform fovea or impression (fig. 72). Supra-antennal ridge very low and poorly developed (fig. 72); horns absent (fig. 72); surface with sculpturing similar to dorsum. Epistomal suture broadly and very slightly arcuate; suture more strongly angulate at intersection with supra-antennal ridge (fig. 72). Clypeus shining dully, not polished; coarse, dense microtuberculate ground sculpturing present (as in fig. 139), and moderately dense pubescence present; punctation not readily visible (fig. 72); anterior margin truncate to slightly sinuate (fig. 72); anterior margin without tubercles (fig. 72). Eye small (fig. 72). Lateral side of head with glabrous strip extending from base anteriorly toward but not reaching eye; glabrous strip broad at base and strongly attenuate anteriorly. Venter of head with microreticulate ground sculpturing. Submentum extending prominently onto venter of head, nearly reaching posterior margin (fig. 89); submentum extremely attenuate basally (fig. 89); with seta along anterior portion, none on basal portion (fig. 89). Labial palpus with second segment longest on lateral side and shortest on mesial side (fig. 83); second segment



MAP 4. Distribution of *Psamathobledius caribbeanus* (black dots) and *P. microcephalus* (stars; large star indicates record for country only).

(at longest point) approximately equal to length of basal segment but shorter than apical segment (fig. 83); basal and second segment each with one seta (fig. 83). Gular sutures (fig. 83) very short (gular suture begins at approximately basal of submental suture). Width of head 0.4 to 0.5 mm.; interocular width 0.2 to 0.3 mm.; head width/interocular width 1.5 to 1.6 (table 2). Labrum with microgranulate ground sculpturing and shallow, fine, setigerous punctation; anterior margin broadly sinuate and with broad, moderately deep, median emargination (fig. 81); anterior margin not reflexed. Mandibles tridentate, basal and second denticles short and poorly developed to more elongate and slender (figs. 116–118); basal and second denticle, when mesial surface of mandible viewed, on nearly same dorsoventral plane (fig. 116).

Pronotum 0.3 to 0.4 mm. long; 0.4 to 0.5 mm. wide; pronotal width/pronotal length 1.4 to 1.5 (table 2); surface strongly convex (fig. 74); anterior margin strongly sinuate (fig. 74); anterior angles strongly produced (figs. 74, 86); lateral margin broadly arcuate from anterior angle to basal margin (fig. 74); basal angles poorly developed (fig. 74); basal margin broadly

arcuate (fig. 74). Pronotum with surface shining dully, not polished, with dense, microtuberculate ground sculpturing, and dense pubescence; punctation not readily visible (fig. 74); fine, shallow, midlongitudinal groove present (fig. 74); pubescence moderately long. Prohypomeron and prosternum with microreticulate ground sculpturing. Procoxal fissure open (fig. 86). Protrochantin exposed (fig. 86). Elytra 0.4 to 0.5 mm. long; elytral length/pronotal length 1.2 to 1.3 (table 2); surface shining dully, not polished; with dense pubescence; pubescence short; punctation not readily visible; dense, coarse, microtuberculate ground sculpturing present; apex without membranous lobe or sclerotized projection (figs. 96, 97). Metathoracic wings fully developed.

Abdominal segments of females unmodified; seventh sternite of males with small, median, membranous lobe on posterior margin (fig. 93).

Spermatheca as shown in figure 115.

**SEXUAL DIMORPHISM:** The males can be differentiated from the females by the presence on the males of a membranous lobe on the posterior margin of the seventh sternite (fig. 93).

**HABITAT AND DISTRIBUTION:** *West Indies:*

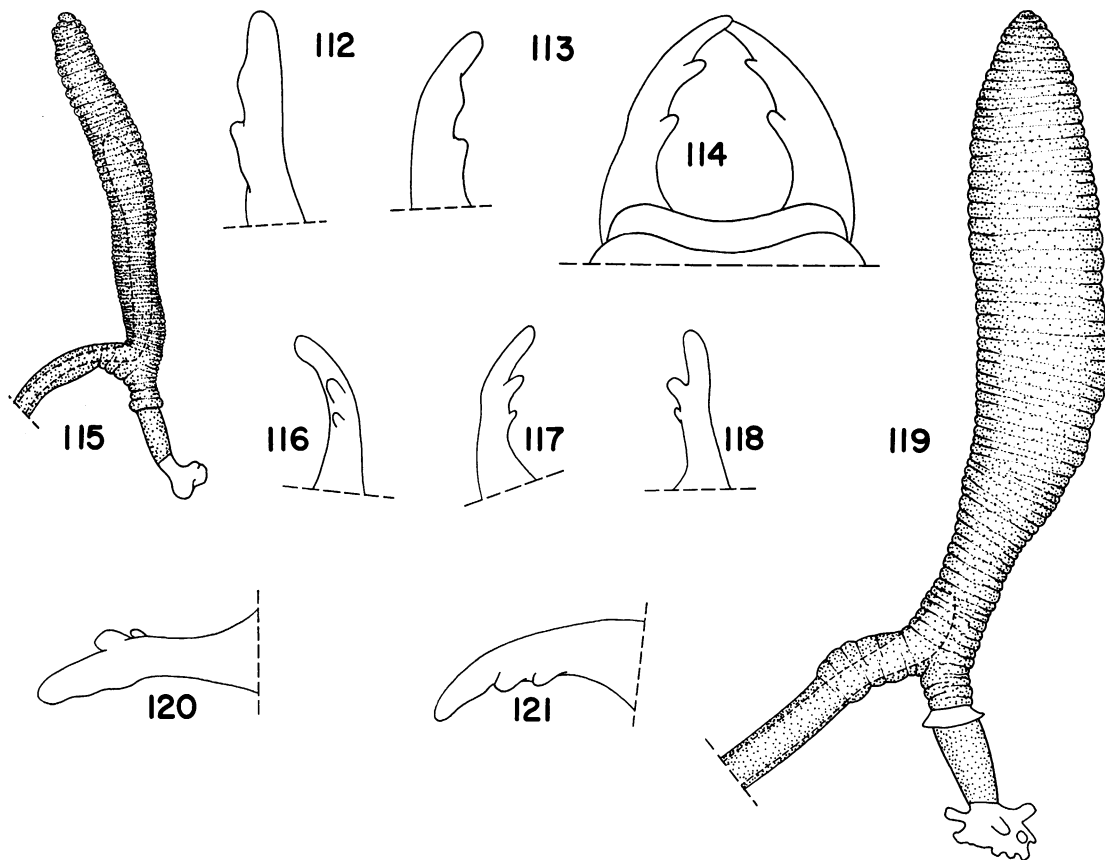

- FIG. 112. *Psamathobledius punctatissimus*; right mandible; anterolateral view; apex.  
 FIG. 113. *Psamathobledius punctatissimus*; left mandible; dorsal view; apex.  
 FIG. 114. *Psamathobledius punctatissimus*; mandible, labrum, and apex of clypeus; dorsal view.  
 FIG. 115. *Psamathobledius caribbeanus*; spermatheca.  
 FIG. 116. *Psamathobledius caribbeanus*; right mandible; mesial view; apex.  
 FIG. 117. *Psamathobledius caribbeanus*; left mandible; dorsal view; apex.  
 FIG. 118. *Psamathobledius caribbeanus*; right mandible; anterolateral view; apex.  
 FIG. 119. *Psamathobledius punctatissimus*; spermatheca.  
 FIG. 120. *Psamathobledius microcephalus*; left mandible; anterolateral view; apex.  
 FIG. 121. *Psamathobledius microcephalus*; right mandible; dorsal view; apex.

Puerto Rico, Dominica (the following are records from Blackwelder, 1943, p. 114), Hispaniola, Montserrat, Guadeloupe, Grenada, Tobago. (See Appendix for localities.)

*Psamathobledius caribbeanus* occurs in large numbers on the coasts of islands in the West Indies (map 4). Blackwelder (1943) collected the species under seaweed on the beach and on the muddy bank of a tidal lagoon. Two species, one of which may have been *P. caribbeanus*, were collected by Kirkpatrick (1957) on the intertidal

zone in Trinidad (see Habitat and Distribution of *P. microcephalus*). In Puerto Rico I found the species on the leeward side of a sand bar in a lagoon, just above the high-tide mark.

The species was collected during February, June, and July and can probably be taken throughout the year.

DISCUSSION: I examined some specimens from Trinidad that are very similar to *Psamathobledius caribbeanus* but differ by having yellowish brown elytra and a slightly more deeply emarginate

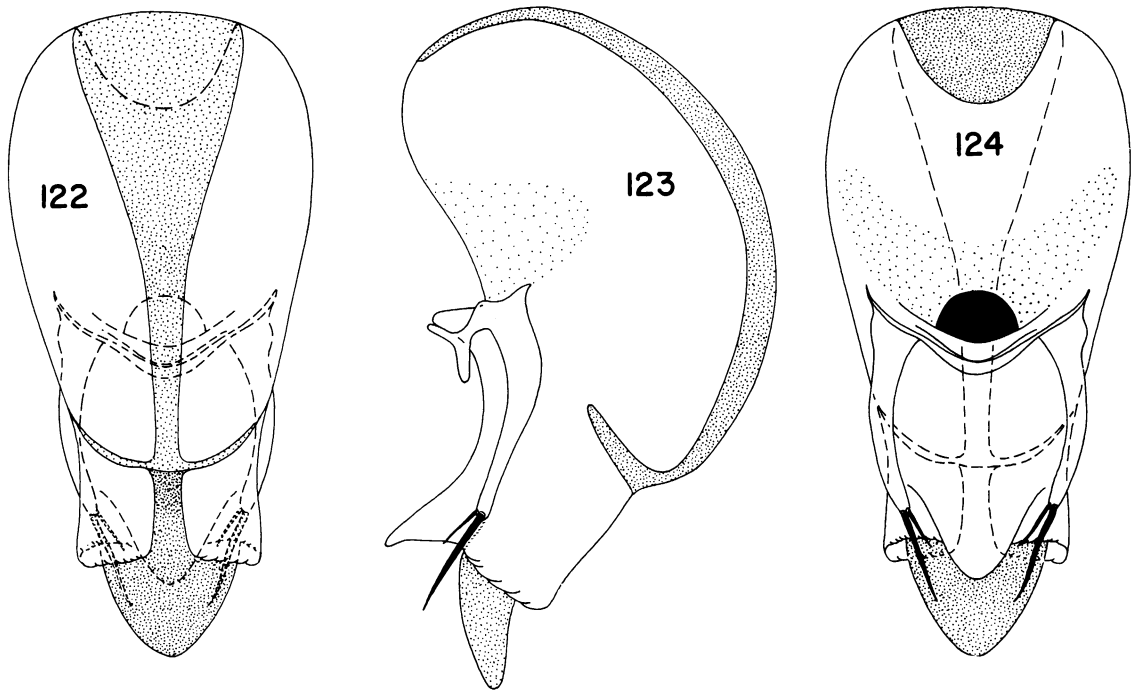

FIG. 122. *Psamathobledius microcephalus*; aedeagus; dorsal view.

FIG. 123. *Psamathobledius microcephalus*; aedeagus; lateral view.

FIG. 124. *Psamathobledius microcephalus*; aedeagus; ventral view.

labrum. Further study and collection of habitat data are needed before the status of that population can be resolved.

*Psamathobledius microcephalus* (Fauvel),  
new combination

Figures 76, 77, 79, 91, 94, 120–124, 130, 132;  
Map 4; Table 2

*Bledius microcephalus* FAUVEL, 1901, p. 72, pl. 1, fig. 1  
(type locality: Colombia. [No further data]; holotype: deposited in the Institut Royal des Sciences Naturelles de Belgique, Brussels, Belgium. Type examined, female; collected in March, 1896, by E. Bugnion).

DIAGNOSIS: This species is easily separated from *P. punctatissimus* by the open procoxal fissure (as in fig. 86). *Psamathobledius microcephalus* is readily distinguished from *P. caribbeanus* by the more deeply emarginate labrum (compare fig. 79 with fig. 81), the less deeply angulate submental suture (compare fig. 91 with fig. 89), and the strongly punctured elytra that lack microtuberculate ground sculpturing.

DESCRIPTION: Length 1.5 to 1.6 mm.

Dorsum of head, clypeus and labrum black to reddish brown. Venter of head and mouthpart dark to pale reddish brown. Antennae reddish brown. Pronotum black to reddish brown. Prohypomeron and prosternum reddish brown. Elytra dark reddish brown to reddish brown, occasionally with apex yellowish brown. Pterothoracic sterna and pleura black to reddish brown. Legs with coxae and femora reddish brown, tibiae and tarsi yellowish brown. Abdomen black to reddish brown.

Dorsum of head shining dully, not polished; with dense, very fine, microgranulate ground sculpturing (as in fig. 139), and moderately dense pubescence; punctation not readily visible (fig. 76); pubescence absent from narrow median strip; pubescence moderately long; middorsal region broadly and shallowly convex and without longitudinal groove or median fovea or impression (fig. 76). Supra-antennal ridge obsolete (fig. 76); horns absent (fig. 76); surface with sculpturing similar to dorsum. Epistomal suture (fig. 76) broadly and shallowly arcuate;



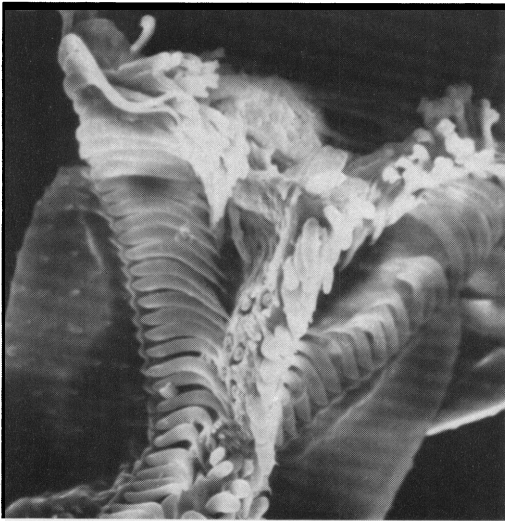

125

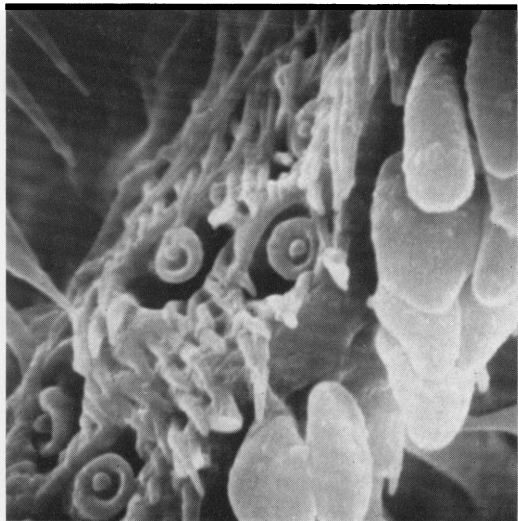

126

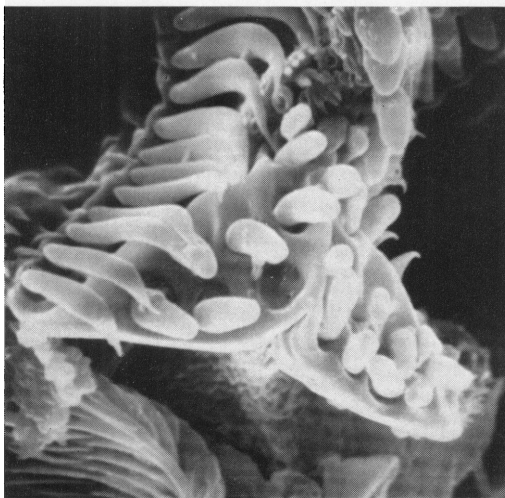

127

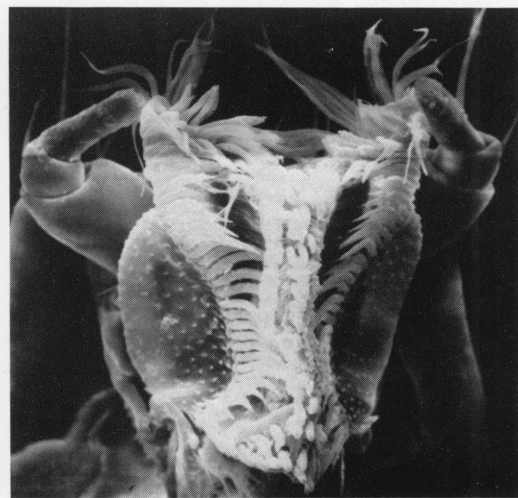

128

FIG. 125. *Psamathobledius punctatissimus*; adoral surface of labium.  $\times 800$ .

FIG. 126. *Psamathobledius punctatissimus*; median portion of adoral surface of labium.  $\times 4000$ .

FIG. 127. *Psamathobledius punctatissimus*; base of median portion of adoral surface of labium.  $\times 1600$ .

FIG. 128. *Psamathobledius punctatissimus*; adoral surface of labium.  $\times 400$ .

suture strongly angulate at supra-antennal ridge. Clypeus shining dull, not polished, with dense, microtuberculate ground sculpturing (as in fig. 139), and fine, shallow, setigerous punctation; pubescence moderately dense; anterior margin slightly sinuate and without tubercles (fig. 76). Eye small (fig. 76). Lateral side of head with broad glabrous strip extending from base of

head toward but not reaching eye. Venter of head with microreticulate ground sculpturing. Submentum extending strongly onto venter of head (fig. 91); submentum extremely attenuate basally (fig. 91), and setae along anterior margin, setae absent from basal portion (fig. 91). Labial palpus (as in fig. 83) with second segment longest on lateral side and shortest on

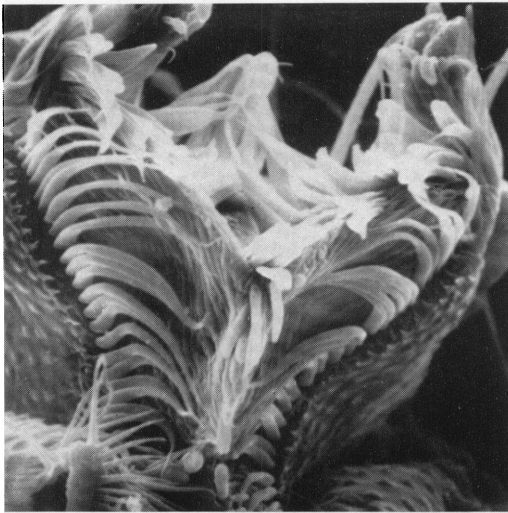

129



130

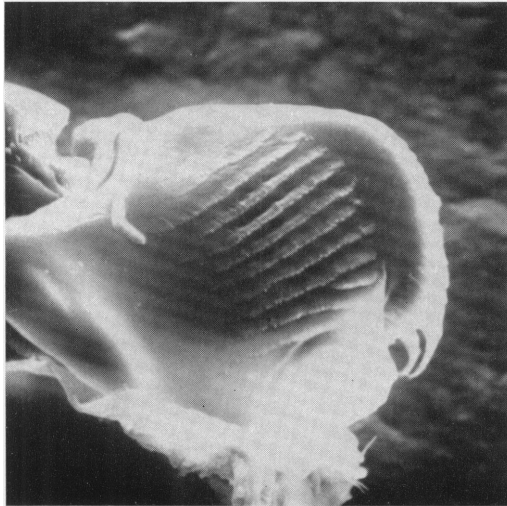

131



132

FIG. 129. *Psamathobledius microcephalus*; adoral surface of labium.  $\times 980$ .

FIG. 130. *Psamathobledius microcephalus*; median portion of adoral surface of labium.  $\times 1840$ .

FIG. 131. *Psamathobledius caribbeanus*; base of mandible, adductor side.  $\times 800$ .

FIG. 132. *Psamathobledius microcephalus*; median portion of adoral surface of labium.  $\times 4400$ .

mesial side; second segment (at longest point) approximately equal to basal segment but shorter than apical segment; basal and second segment each with one seta. Gular sutures short (fig. 91) (gular sutures begin approximately at basal angle of submental suture). Width of head 0.3 to 0.4 mm.; interocular width 0.2 to 0.25 mm.; head width/interocular width 1.4 to

1.6 (table 2). Labrum with microgranulate ground sculpturing and shallow, fine setigerous punctation; anterior margin sinuate and with deep, broad, median emargination (fig. 79); anterior margin not reflexed. Mandibles tridentate (figs. 120, 121); basal and second denticles short to more elongate; when mesial surface of mandible viewed, then second and

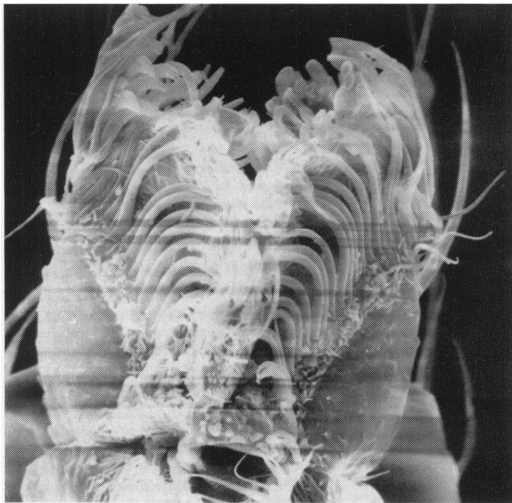

133

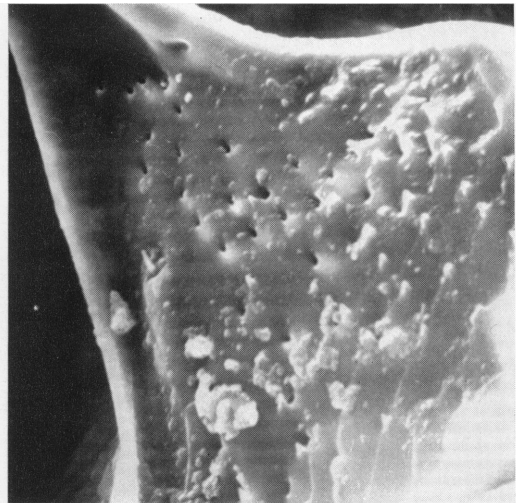

134

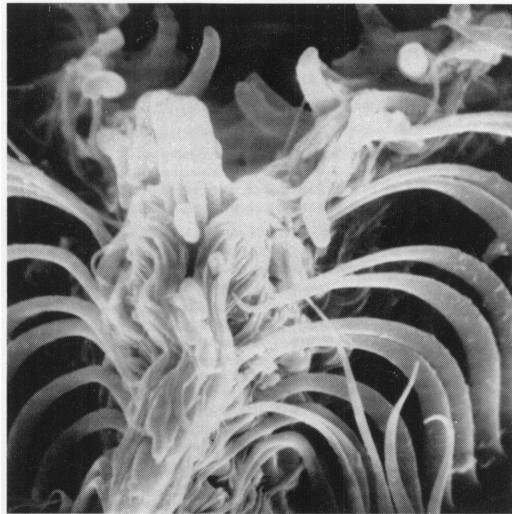

135

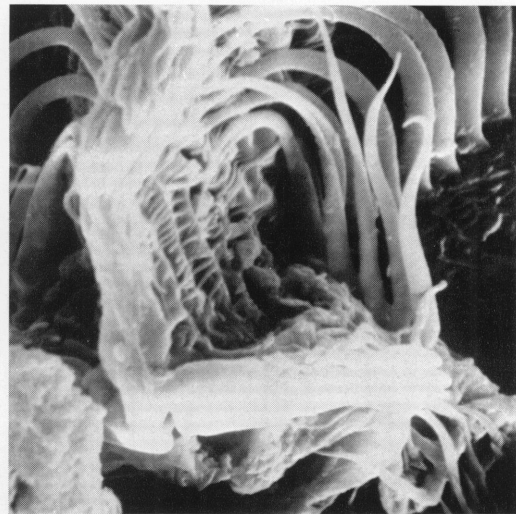

136

FIG. 133. *Psamathobledius caribbeanus*; adoral surface of labium.  $\times 800$ .

FIG. 134. *Psamathobledius caribbeanus*; basal of mandible, lateral side.  $\times 800$ .

FIG. 135. *Psamathobledius caribbeanus*; anterior median portion of adoral surface of labium.  $\times 1600$ .

FIG. 136. *Psamathobledius caribbeanus*; basal median portion of adoral surface of labium.  $\times 1600$ .

basal denticles on nearly same dorsoventral plane.

Pronotum 0.28 to 0.3 mm. long; 0.38 to 0.44 mm. wide; pronotal width/pronotal length 1.2 to 1.4 (table 2); surface moderately strongly convex (fig. 77); anterior margin truncate (fig. 77) to weakly sinuate; anterior angles usually not produced (fig. 77), occasionally

slightly produced; lateral margin with anterior two-thirds slightly arcuate, posterior one-third more strongly arcuate to broadly arcuate basal margin (fig. 77); basal angles poorly developed (fig. 77). Pronotum with surface shining dully, not polished, with fine, dense, microtuberculate ground sculpturing, and dense pubescence; punctation not readily visible (fig. 77); fine,

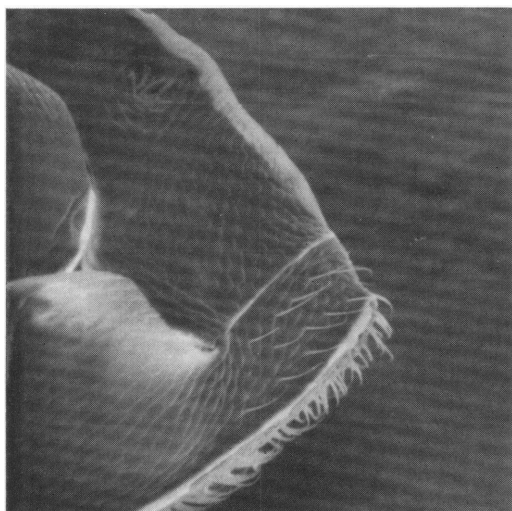

137

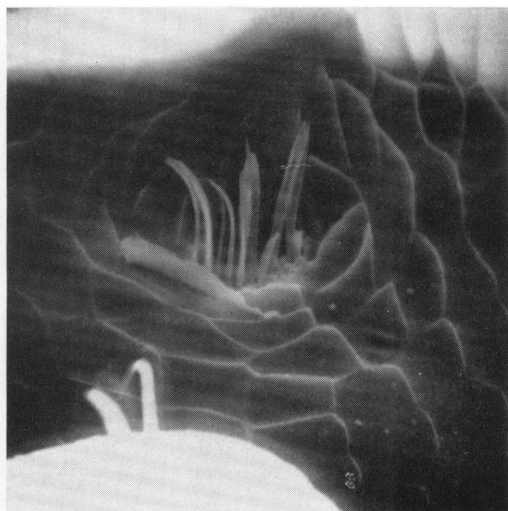

138

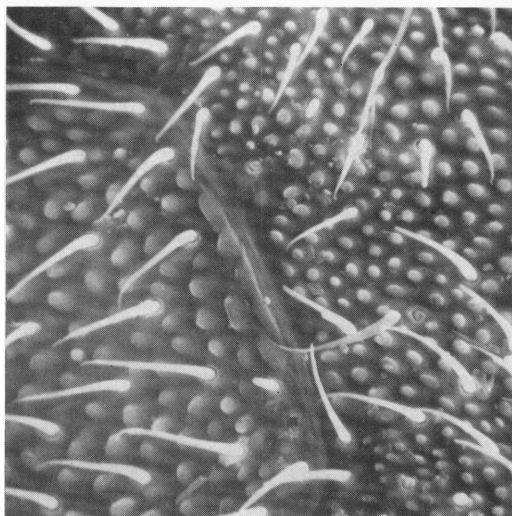

139

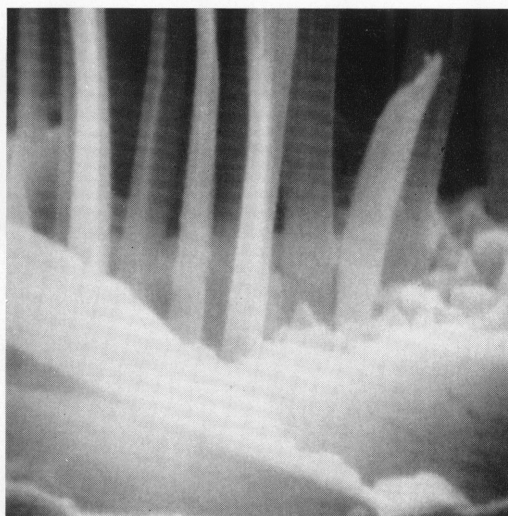

140

FIG. 137. *Psamathobledius punctatissimus*; prosthema and prohypomeron.  $\times 136$ .

FIG. 138. *Psamathobledius punctatissimus*; prosternal pit.  $\times 720$ .

FIG. 139. *Psamathobledius punctatissimus*; epistomal area.

FIG. 140. *Psamathobledius punctatissimus*; prosternal pit.  $\times 3600$ .

shallow, midlongitudinal groove present (fig. 77); pubescence moderately long. Prohypomeron and prosthema with microreticulate ground sculpturing. Procoxal fissure open (as in fig. 86); protrochantin exposed (as in fig. 86). Elytra 0.41 to 0.46 mm. long; elytral length/pronotal length 1.4 to 1.5 (table 2); surface strongly shining but roughened by coarse, dense

setigerous punctation; pubescence moderately long; microtuberculate ground sculpturing absent; apex without membranous lobe or sclerotized projection (as in fig. 96). Metathoracic wings fully developed.

Abdominal segments of female unmodified; seventh sternite of males with large, median, membranous lobe on posterior margin (fig. 94).

Spermatheca as in figure 115.

**SEXUAL DIMORPHISM:** The male has a large membranous lobe on the posterior margin of the seventh sternite (fig. 94). This sternite of the female is unmodified.

**HABITAT AND DISTRIBUTION:** *Colombia. West Indies:* Trinidad (map 4). (See Appendix for localities.)

Kirkpatrick (1957, pp. 110–111) reported two unidentified species of *Bledius* from Trinidad beaches a few yards below the high-tide mark. Apparently, as the water recedes to the low-tide point the beetles follow the water line. The illustration he made of one of the species is similar in appearance to *B. microcephalus*, so this may have been the species he saw. The species was collected in March and November.

#### GENUS *BLEDIUS*<sup>1</sup>

Figures 1, 141–451; Maps 5–17; Tables 3–5

**TYPE-SPECIES:** *Bledius armatus* (Panzer).

**DIAGNOSIS:** This genus is readily recognized by the subcylindrical form (fig. 1), the geniculate antennae (fig. 1), the presence of the procoxal fissure (figs. 175, 209, 369), the spinous tibiae (fig. 1), and the four tarsomeres (figs. 1, 388–390).

**DESCRIPTION:** Length 2.0 to 7.5 mm. Body form subcylindrical. Body with sparse to dense pubescence. Color variable from black to pale testaceous.

**HEAD:** Epistomal suture present (figs. 141, 146, 192, 327); suture straight (fig. 192) or broadly arcuate (figs. 143, 147, 327). Supra-antennal ridge obsolete to prominent and well developed; horns present (figs. 141, 143) or absent (figs. 146, 147, 192, 327). Clypeal tubercle present (figs. 192, 193, 197, 199, 327) or absent (figs. 146, 147). Gular sutures confluent to near posterior margin of neck, then sharply divergent (figs. 156, 219–228, 375). Labrum with anterior margin truncate or with acute, median notch or broadly and shallowly emarginate (figs. 164, 229, 374) or bilobed; midlongitudinal groove present (figs. 229, 374) or absent (fig. 164); anterior margin reflexed or unmodified (fig. 164). Labral lobes variable (figs. 164, 229, 374). Labial palpus with segments of variable size and variably pubescent (figs. 154, 155, 231, 373). Adoral surface of labium variable (figs. 183–191, 309–318, 424–437, 439–441). Mentum variable

(figs. 162, 163, 230, 372). Submentum variable (figs. 156, 219–228, 375). Maxillary palpus with fourth segment subulate (fig. 232); second segment strongly curved (fig. 232). Galea variable but generally with numerous rows of curved spinelike setae (figs. 289, 293–296). Mandibles prominent (fig. 1) or not and denticulate or edentate. Antennae geniculate (fig. 1).

**THORAX:** Pronotum usually wider than long, shape variable (figs. 142, 144, 145, 148, 149, 202–205, 341–343). Pronotal horn present (fig. 142) or absent (figs. 207, 329). Pronotal lateral marginal bead present and entire (figs. 175, 369), incomplete (figs. 172, 209), or absent (fig. 171); bead usually not on hypomeron. Protergosternal suture present (figs. 175, 369), absent (figs. 209, 212), or obsolete. Procoxal fissure present and open (figs. 171, 172, 175), or closed (figs. 209, 369). Protrochantin concealed (figs. 209, 369) or exposed (fig. 175). Postprocoxal lobe present and usually well developed (figs. 175, 209, 369). Prosternal process present (fig. 175) or absent; process when present, elongate and slender and extending completely between coxae (fig. 175) or short and carinate and not extending between coxae. Prosternum with (figs. 170, 175, 213, 369) or without broad patch of pubescence anterior to procoxa; prosternum with (as in fig. 41) or without (figs. 170, 175, 213, 369) small, densely setigerous pit anterior to procoxa.

Scutellum concealed by pronotum. Elytral suture dehiscent at apex (fig. 1). Elytral epipleural ridge present (fig. 371) or absent; ridge entire (fig. 371) or incomplete (figs. 161, 236) when present. Elytron with (figs. 166, 370) or without (fig. 235) membranous lobe on apex. Mesosternal process prominent and carinate at apex (see Herman, 1970, fig. 34). Metasternal process absent; metasternum with low, longitudinal carina between coxae (see Herman, 1970, fig. 34). Mesocoxae contiguous. Protibia and mesotibia with longitudinal rows of spines (fig. 1); metatibiae with longitudinal row of weakly developed spinules (fig. 1). Tarsal formula 4–4–4 (figs. 388–390); basal article reduced; fourth article elongate, slender, and apically incrasate.

**ABDOMEN:** Second sternite well developed. Terga and sternites without midlongitudinal, basal carina. Terga without basolateral ridges (fig. 1); basal, transverse ridge present (fig. 1). Segments II to VI each with two pairs of

<sup>1</sup>Modified from Herman, 1970.

laterosternites (fig. 1). Seventh segment with posterior margin fimbriate (fig. 319); fimbriation of varying length. Eighth tergum with posterior margin truncate or emarginate (fig. 174).

Aedeagus trilobed. Parameres of variable size and shape (figs. 176-178, 304-306). Median lobe bulbous at base, more slender apically (figs. 176-178, 304-306, 421-423); other details variable.

Spermatheca variable (figs. 179-182, 297-303, 406-420).

DISCUSSION: For the synonyms and subgenera of *Bledius* and a list of the species included, see Herman, 1970, page 375. In the present paper some of these species are removed from *Bledius* and placed in two new genera.

DISTRIBUTION: Cosmopolitan.

KEY TO THE SPECIES-GROUPS OF *BLEDIUS* FROM THE NEW WORLD

- 1. Prosternum with small, well-defined, setigerous pit anterior to procoxa (as in figs. 41, 70, 85, 86, 137, 138) . . . See Part II . . . . . *basalis*  
 Prosternum without small, setigerous pit anterior to procoxa; prosternum with, at best, shallow, setigerous, poorly defined depression anterior to procoxa (figs. 170, 171, 175, 213, 369) . . . . . 2
- 2 (1). Elytral epipleural ridge present only on apex of elytron (figs. 161, 236) . . . . . 3  
 Elytral epipleural ridge present along entire length of elytron (fig. 371) . . . . . 4
- 3 (2). Procoxal fissure open, protrochantin exposed (figs. 171, 172, 175) . . . See Key I . . . . . *aequatorialis*  
 Procoxal fissure closed, protrochantin concealed (figs. 209, 211) . . . See Key II . . . . . *mandibularis*
- 4 (2). Procoxal fissure closed, protrochantin concealed (fig. 369) . . . . . 5  
 Procoxal fissure open, protrochantin exposed (as in figs. 86, 171) . . . See Part II . . . . . *annularis*
- 5 (4). Protergosternal suture present (figs. 369) . . . See Key III . . . . . *semiferrugineus*  
 Protergosternal suture absent (as in fig. 209) . . . . . See Part II . . . . . *armatus*

KEY I. THE SPECIES OF THE *aequatorialis* GROUP

- 1. Mandibles bidentate (figs. 165, 167) . . . 2  
 Mandibles tridentate (figs. 168, 169) . *beattyi*
- 2 (1). Pronotal lateral marginal bead present at least on the anterior half (figs. 152, 172) . . . . . *aequatorialis*

Pronotal lateral marginal bead absent (fig. 171) . . . . . *ceratus*

KEY II. THE SPECIES OF THE *mandibularis* GROUP

- 1. Submental suture strongly angulate (figs. 221, 224); mandibles with dorsal denticle nearly as long as ventral denticle (figs. 288, 290-292) . . . . . *pallipennis*  
 Submental suture sinuate to weakly angulate (figs. 219, 220, 222, 223, 225-228); mandibles with dorsal denticle variable but never nearly so long as ventral denticle (figs. 237-287) . . . . . 2
- 2 (1). Submental excavation evident as single, round depression of varying depth (figs. 225, 226); pubescence moderately long, never short and bristle-like (fig. 211) . . . . . *jacobinus*  
 Submental excavation variable but usually with broad to narrow median ridge or raised region (figs. 219, 220, 222, 223, 228) or entirely flat and not prominently excavated (fig. 227); pubescence of varying length (figs. 214-218) . . . . . 3
- 3 (2). Elytra and pronotum with short, inconspicuous bristle-like pubescence (fig. 218) . . 4  
 Elytra and pronotum with pubescence of varying length but never short and bristle-like (figs. 214-218) . . . . . 6
- 4 (3). Submental excavation modified and narrow median ridge with deep depression on each side (fig. 218) . . . . . *fortis*  
 Submental excavation with large, broadly round tumescence occupying most of surface (figs. 220, 222) or surface nearly flat (fig. 223) . . . . . 5
- 5 (4). Elytra red; remainder of body black to reddish black . . . . . *fortis*  
 Elytra yellow to reddish yellow; remainder of body brownish black to brown to yellow . . . . . *mandibularis*
- 6 (3). Prohypomeron with arcuate, polished ridge anterior to procoxal fissure (fig. 206), ridge with sculpturing incomplete and weakly developed (fig. 206); submentum slightly excavated under gular region (figs. 222, 223) . . . . . *mandibularis*  
 Prohypomeron lacking polished arcuate ridge anterior to procoxal fissure or if present only weakly developed but distinctly sculptured (fig. 208); submentum not excavated under gular region (figs. 227, 228) . . . . . *ferratus*

KEY III. THE SPECIES OF THE *semiferrugineus* GROUP

- 1. Metatarsus in dorsal view with last article

- abruptly swollen at base (fig. 391) or middle to apex (fig. 392) . . . (males and females) . . . . . *rotundicollis*
- Metatarsus in dorsal view with last article gradually expanded to apex (fig. 393) . 2
- 2 (1). Sternite VII with posterior margin emarginate or possessing membranous lobe (figs. 396-405) . . . (males) . . . 3
- Sternite VII with posterior margin truncate . . . (males and females) . . . 13
- 3 (2). Sternite VII with emargination (figs. 396-400, 403, 404) . . . . . 4
- Sternite VII with membranous lobe (figs. 401, 402, 405) . . . . . 11
- 4 (3). Mandibles bidentate (figs. 358, 359, 362, 363, 366) . . . . . 5
- Mandibles tridentate (figs. 354-357, 360, 361, 364, 365, 367, 368) . . . . . 8
- 5 (4). Sternite VII deeply emarginate (figs. 398, 399); pronotal midlongitudinal groove deeply impressed (figs. 333, 334) . . . 6
- Sternite VII shallowly emarginate (figs. 403, 404); pronotal midlongitudinal groove shallow, incomplete or absent (figs. 350, 352) . . . . . 7
- 6 (5). Eyes large (fig. 332), range of head width/interocular width = 1.59-1.69; eastern species (map 11) . . . . . *fumatus*
- Eyes smaller (fig. 331), range of head width/interocular width = 1.41-1.52; western species (map 11) . . . *gravidus*<sup>1</sup>
- 7 (5). Abdomen bicolored, segments III to VI reddish orange, segments VII to X black . . . . . *analis*
- Abdomen nearly concolorous, if bicolored not in pattern described above, segments reddish orange to reddish brown . . . . . *nitidicollis*
- 8 (4). Sternite VII with deep, prominent emargination of posterior margin (figs. 396, 397, 399) . . . . . 9
- Sternite VII with shallow, nearly indistinguishable emargination of posterior margin (fig. 400) . . . . . *foraminosus*
- 9 (8). Pronotum without prominent microgranulate ground sculpturing (fig. 450), surface highly polished . . . *semiferrugineus*
- Pronotum with prominent, microgranulate ground sculpturing (as on vertex, fig. 448) on all or some of surface, surface with or without polished areas. . . . 10
- 10 (9). Last metatarsomere swollen abruptly at middle to apex (fig. 392); sternite VII with deeper emargination of posterior margin (as in fig. 396); lateral margins of pronotum more strongly rounded (fig.

- 337) . . . . . *rotundicollis*
- Last metatarsomere gradually expanded from base to apex (as in fig. 390); sternite VII with more shallow emargination of posterior margin (figs. 397, 399); lateral margins of pronotum less strongly rounded (figs. 333, 341) . . . . . *tallaci* and *gravidus*<sup>2</sup>
- 11 (3). Sternite VII with spiniform process laterad of emargination (fig. 402). . . *assimilis*
- Sternite VII without spiniform process laterad of emargination (figs. 401, 405) . . . . . 12
- 12 (11). Pronotum without midlongitudinal groove (fig. 348) . . . . . *coulteri*
- Pronotum with midlongitudinal groove (fig. 350) . . . . . *philadelphicus*
- 13 (2). Mandible tridentate (figs. 354, 355) . . . . . *foraminosus*<sup>3,4</sup>
- Mandible bidentate (figs. 358, 359) . . 14
- 14 (13). Pronotal midlongitudinal groove absent (figs. 348, 353) . . . . . 15
- Pronotal midlongitudinal groove present (figs. 338, 352) . . . . . 19
- 15 (14). Abdomen bicolored; segments III to VII reddish orange; segments VIII to X black . . . . . *analis*
- Abdomen usually concolorous or nearly so, if bicolored, pattern not as described above; segments reddish orange to reddish brown to black . . . . . 16

<sup>2</sup>The male of *B. tallaci* runs to *B. gravidus* in couplet 10. To separate these two species, consult the Diagnosis under *B. tallaci*.

<sup>3</sup>The specimens of *Bledius foraminosus* that run to this couplet are males that have a very shallow emargination of sternite VII.

<sup>4</sup>Seven nominal species belonging to the *armatus* group run to *Bledius foraminosus* in couplet 13 because they possess a feebly to well-developed protergosternal suture. Five of the species, *B. piceus*, *B. condonensis*, *B. specularis*, *B. regularis*, and *B. opacifrons*, can be distinguished from *B. foraminosus* by the finer, more sparse punctation of the dorsum of the head and the pronotum. The elytra of *B. specularis*, *B. condonensis*, and *B. regularis* are highly polished between the punctures. *Bledius strenuus* can be separated by the bituberculate tumescence on the dorsum of the head and the sparse, fine punctation of the dorsum. The posterior margin of the eighth tergum of each of these seven species is more strongly serrate than on *B. foraminosus*. *Bledius nitidiceps* is easily distinguished by the long, prominent pronotal pubescence and the ridge encircling the apex of antennomeres 3 to 7.

*Bledius turgidus* belongs to the *annularis* group but, as it possesses the protergosternal suture, will run also to couplet 13 where it can be separated by the distinctly rectangular basal angles of the pronotum.

The separation of these seven species from *Bledius foraminosus* will be elaborated further in Part II of this revision.

<sup>1</sup>Basal (third) denticle is often difficult to see on *B. gravidus* (fig. 364), so it is brought here through couplet 4.

- 16 (15). Pronotum opaque (as on vertex, fig. 448) with no polished spots . . . . .17  
 Pronotum polished (fig. 450), or with at least some polished spots . . . . .18
- 17 (16). Eastern species (map 17) . . . . .*assimilis*  
 Western species (map 16) . . . . .*coulteri*
- 18 (16). Pronotum opaque (as on vertex, fig. 448) on most of surface but with polished midlongitudinal strip . . . . .*assimilis*<sup>1</sup>  
 Pronotum polished over most of surface, or with scattered polished spots not confined to midlongitudinal strip . . . . .*nitidicollis*
- 19 (14). Pronotum with most or all of surface polished (fig. 450), microgranulate ground sculpturing if present not prominent .20  
 Pronotum with most or all of surface opaque (as on vertex, fig. 448), microgranulate ground sculpturing prominent, often with some polished spots .27
- 20 (19). Head distinctly darker than pronotum; head black, reddish black or dark reddish brown; pronotum reddish orange; head punctation very shallow . . . . .*rubiginosus*  
 Head and pronotum concolorous or nearly so; head and pronotum black to dark reddish brown; head punctation various . . . . . .21
- 21 (20). Abdomen bicolored, segments III to VI reddish orange, segments VII to X black . . . . .*analisis*  
 Abdomen concolorous or nearly so, if bicolored pattern not as described above . . . . . .22
- 22 (21). Head width less than 0.80 mm. . . . .23  
 Head width more than 0.80 mm. . . . .24
- 23 (22). Dorsum of head and prothorax coarsely and densely punctate; midlongitudinal groove deep and well developed (figs. 328, 330) . . . . .*semiferrugineus*  
 Dorsum of head and prothorax more finely and less densely punctate; midlongitudinal groove shallow and poorly developed (figs. 344, 346) . . . . .*nitidicollis*
- 24 (22). Pronotum with no prominent microgranulate ground sculpturing (fig. 450); dorsum of head coarsely punctate (fig. 329) . . . . .*semiferrugineus*  
 Pronotum with at least (on anterior portion) some prominent microgranulate ground sculpturing; dorsum of head finely to moderately coarsely punctate (figs. 327, 331, 332) . . . . . .25
- 25 (24). Dorsum of head with shallow, fine punctation (figs. 331, 332); pronotum with large areas of microgranulate ground sculpturing; eastern and western species . . . . . .26  
 Dorsum of head with deeper, more coarse punctation (fig. 327); pronotum usually with more small spots of microgranulate ground sculpturing; western species (map 10) . . . . .*foraminosus*
- 26 (25). Eyes large (fig. 332); range of head width/interocular width = 1.54-1.68; eastern species (map 11) . . . . .*fumatus*  
 Eyes small (fig. 331); range of head width/interocular width = 1.42-1.54; western species (map 11) . . . . .*gravidus*
- 27 (19). Head with less than 0.87 mm. . . . .28  
 Head width greater than 0.88 mm. . . . .29
- 28 (27). Prothorax with deep, distinct, well developed midlongitudinal groove (fig. 350) . . . . .*philadelphicus*<sup>2</sup>  
 Pronotum with shallow, less distinct, poorly developed midlongitudinal groove (fig. 346) . . . . .*nitidicollis*<sup>2</sup>
- 29 (27). Metatarsus in dorsal view abruptly swollen from near middle, and then nearly parallel-sided to apex (fig. 392) . . . . .*rotundicollis*  
 Metatarsus in dorsal view gradually expanded from base to apex, middle to apex with sides gradually divergent (fig. 393) . . . . . .30
- 30 (29). Dorsum of head with dense, moderately coarse punctation (fig. 327); western species (map 10) . . . . .*foraminosus*  
 Dorsum of head with fine, shallow, moderately dense punctation (figs. 331, 332); eastern and western species . . . . . .31
- 31 (30). Eyes large (fig. 332); range of head width/interocular width = 1.54-1.68; eastern species (map 11) . . . . .*fumatus*  
 Eyes small (fig. 331); range of head width/interocular width = 1.42-1.54; western species (map 11) . . . . .*gravidus*

#### AEQUATORIALIS GROUP

Figures 141-191; Maps 5, 6; Table 3

DIAGNOSIS: Superficially, the supra-antennal and pronotal horns (figs. 141-145) of the males will distinguish the males of this group from all the other groups in the New World. The group can be separated from other New World groups by the absence of a complete elytral epipleural

<sup>2</sup>Some individuals of *B. analis* with stronger granulate sculpturing may run to this couplet but can be distinguished by the bicolored abdomen.

<sup>1</sup>See discussion under description of *B. assimilis*.



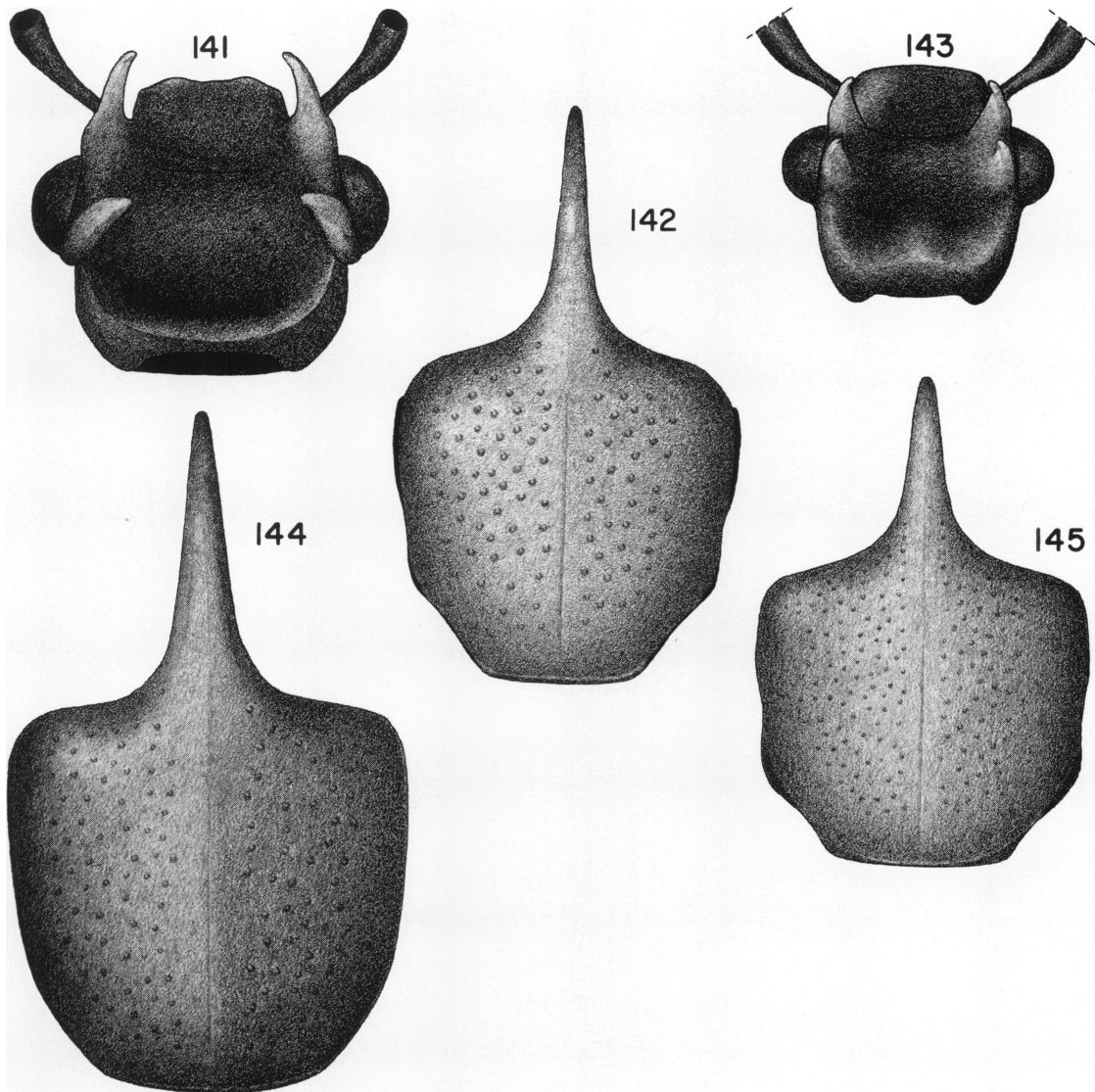

FIG. 141. *Bledius beattyi*; head, dorsal view; male.

FIG. 142. *Bledius aequatorialis*; prothorax, dorsal view; male.

FIG. 143. *Bledius ceratus*; head, dorsal view; male.

FIG. 144. *Bledius beattyi*; prothorax, dorsal view; male.

FIG. 145. *Bledius ceratus*; prothorax, dorsal view; male.

ridge (fig. 161) and the presence of an open procoxal fissure (figs. 171, 172, 175).

**DESCRIPTION:** *Bledius*. Males usually with pair of supra-antennal horns (figs. 141, 143, 150-152, 157); females without horns (figs. 146, 147, 153). Clypeus with (fig. 141) or without low, rounded tumescence on anterior margin (figs. 142, 146, 147). Gular sutures of normal length

(fig. 156), confluent to submentum and sharply divergent at base. Labrum with anterior margin sinuate (fig. 164); anterior margin not reflexed; midlongitudinal groove absent (fig. 164); membranous lobes as in figure 164. Labial palpus (figs. 154, 155) with second article longer than first and approximately equal to length of third; first and second articles with few, scattered setae

TABLE 3  
 MEASUREMENTS (IN MILLIMETERS) OF THE HEAD, THORAX, AND ELYTRA OF ADULTS OF THE SPECIES OF THE *aequatorioides* GROUP  
 (The mean, standard deviation, and sample size are given in that order for each species.)

	Head Width		Interocular Width		Pronotal Width		Pronotal Length		Elytral Length		Head Width		Pronotal Width		Elytral Length									
	Mean	SD	Mean	SD	Mean	SD	Mean	SD	Mean	SD	Mean	SD	Mean	SD	Mean	SD								
<i>aequatorioides</i> ♀	0.77	0.02	20	0.51	0.02	20	0.80	0.03	20	0.78	0.03	20	1.01	0.03	20	1.50	0.04	20	1.02	0.02	20	1.31	0.02	20
<i>aequatorioides</i> ♂	0.76	0.04	10	0.50	0.03	10	0.84	0.07	10	1.33	0.18	10	0.99	0.07	10	1.50	0.04	10	0.63	0.04	10	0.76	0.06	10
<i>beatlyi</i> ♀	0.87	0.04	6	0.61	0.03	6	0.92	0.05	6	0.88	0.05	6	1.08	0.06	6	1.43	0.06	6	1.05	0.02	6	1.23	0.04	6
<i>beatlyi</i> ♂	0.86	0.05	20	0.58	0.04	20	0.94	0.08	20	1.46	0.24	20	1.04	0.06	19	1.47	0.04	20	0.66	0.08	20	0.74	0.12	19
<i>ceratus</i> ♂	0.69	—	1	0.43	—	1	0.70	—	1	1.04	—	1	0.86	—	1	1.62	—	1	0.68	—	1	0.83	—	1



MAP 5. Distribution of *Bledius beattyi* (black dots).

(figs. 154, 155). Adoral lobes of labium as shown in figures 183–191. Mentum as in figures 162, 163. Maxillary palpus as in figure 234. Galea with numerous rows of curved, spinelike setae. Mandibles moderately prominent.

Pronotal shape as in figures 142, 144, 145, 148, 149, 173. Pronotal horns present on midanterior margin of males (figs. 142, 144, 145, 150, 152, 157, 171, 172, 175); pronotal horn of female absent (figs. 148, 149, 153) (or present, see Discussion below and under *Bledius ceratus*); pronotal horn of male anteriorly directed and ventrally deflexed (figs. 142, 144, 145, 150, 152, 157, 171, 172, 175). Pronotal lateral marginal bead present and complete (fig. 175) or incomplete (fig. 172) or absent (fig. 171). Protergosternal suture present (figs. 171, 172, 175). Procoxal fissure large and widely open (figs. 171, 172, 175). Protochantin exposed (figs. 171, 172, 175). Prosternal process present (fig. 171). Prosternum with large patch of pubescence in broad depression anterior to procoxae (fig. 170); without small, setigerous pit anterior to procoxae (compare fig. 170 with figs. 52, 137).

Elytron with membranous lobe on posterior

margin (fig. 166); epipleural ridge present on apical portion (fig. 161).

Abdomen with posterior margin of eighth tergum broadly emarginate (fig. 174); margin entire, not serrulate (fig. 174).

Aedeagus trilobed (figs. 176–178). Paramere long and slender (figs. 176, 177); posterior edge of basal portion partially fused to ventral surface posterior to median foramen (fig. 178); paramere extending around sides to dorsal side of median lobe (figs. 176, 178); apex of paramere with seta (figs. 176–178). Median lobe bulbous basally and broad but dorsoventrally flattened apically (fig. 177); base membranous (figs. 176–178); dorsal surface mostly membranous (fig. 176); sides of apical half and apex of dorsal side sclerotized (fig. 176); apex of dorsal side longitudinally divided (fig. 176); base of ventral surface of median lobe membranous (fig. 178); ventral side nearly completely sclerotized (fig. 176); sclerotized portion of ventral surface longitudinally divided for nearly entire length (fig. 176); lateral, median region of ventral side weakly sclerotized (figs. 177, 178). Ostium at apex (fig. 177).

Spermatheca as in figures 179–182.

DISCUSSION: There are three Neotropical species, *Bledius aequatorialis*, *B. beattyi*, and *B. ceratus* and one undescribed species from Texas known in this group. The species from Texas is represented by a female with a short, slender pronotal horn but without the supra-antennal horns; the spermatheca indicates that it belongs in or near the *aequatorialis* group.

In the New World this is the only group in which the males have a pronotal horn, and the only group in the world in which the males have two pairs of supra-antennal horns.

*Bledius beattyi* Blackwelder

Figures 141, 144, 146, 148, 150, 153, 154, 157, 160, 161, 163, 166, 168, 169, 170, 173–175, 179, 180, 183–185; Map 5; Table 3

*Bledius beattyi* BLACKWELDER, 1943, pp. 113, 117 (type locality: West Indies, St. Croix, along a stream 1 mile northeast of Sprat Hill Estate, collected under a stone at the edge of a small stream in the woods; holotype: deposited in the National Museum of Natural History, Washington, D.C. Type examined, female).

DIAGNOSIS: This species can be separated from the others in the species-group by the presence of three mandibular denticles (figs. 168, 169) and the uninterrupted pronotal lateral marginal bead (fig. 175).

DESCRIPTION: *aequatorialis* group.

Length 4.2 to 5.7 mm.

Dorsum of head, clypeus and labrum reddish brown, often with infusions of black; venter of head pale reddish brown. Mentum, submentum, labial palpus, maxilla, mandibles, and antenna pale reddish brown. Pronotum reddish brown. Prohypomeron and prosternum paler reddish brown. Elytra dark reddish brown with large yellowish brown humeral spot (fig. 160), or orangish brown with reddish brown epipleuron. Pterothoracic sterna and pleura reddish brown. Legs yellowish brown. Abdomen dark reddish brown; apical segments (apex of VII, VIII, IX, and X) yellowish brown in some populations.

Dorsum of head shining dully, not polished, but male more shiny than female and with dense, coarse, microgranulate ground sculpturing (as in fig. 448); male without pubescence on dorsum between supra-antennal ridges, individuals with small supra-antennal horns with sparse pubescence on basal region behind supra-antennal

ridges; dorsum of male without punctation or small tuberculi (fig. 141); dorsum of female with moderately dense setigerous tuberculi (fig. 146), punctation absent; tuberculi of dorsum absent from median strip on female (fig. 146); pubescence moderately long on dorsum of female; male with area between supra-antennal ridges convex from front to rear (fig. 141), possessing large supra-antennal horns with deep, transverse depression posterior to supra-antennal ridges (fig. 141); depression not bi-impressed and without a broad midlongitudinal ridge (fig. 141); base of head of males possessing deep depression with sharply rounded U-shaped ridge extending from one eye posteriorly to along basal margin then to other eye (fig. 141); males with smallest supra-antennal horns (fig. 150) with very shallow, transverse depression behind supra-antennal ridge and without U-shaped ridge along margin of base of head; female with anterior portion of dorsum of head depressed (fig. 146), with median portion shallowly concave to nearly flat (fig. 146); region posterior to supra-antennal ridge with slight transverse depression to flat (fig. 146), occasionally with shallow, median, punctiform impression on female. Supra-antennal ridge of male with pair of horns (figs. 141, 157); horns poorly developed (fig. 150) to well developed (figs. 141, 157); when poorly developed, anterior margin of supra-antennal ridge (fig. 150) slightly pointed and base of ridge with small dorsally directed, acute tubercle, surface of ridge with setigerous tuberculi and microgranulate ground sculpturing; when supra-antennal horns well developed (figs. 141, 157), cylindrical at base and compressed from just above base to apex; anterior horn anterodorsally directed (figs. 141, 157) and with flattened axis set in anteromedially oblique plane (fig. 141), lateroanterior surface without setigerous tuberculi (fig. 157) and surface polished, mesioposterior surface and base with sparse setigerous tuberculi and with microgranulate ground sculpturing, horn curved mesially and gradually tapered to apex (figs. 141, 157); posterior horn dorsally directed (figs. 141, 157) and with flattened axis only slightly set in anteromedially oblique plane (fig. 141), horns slightly curved toward middle (fig. 141), lateral surface with sparse setigerous tuberculi (fig. 157), mesial surface with one setigerous tuberculi near apex; female with unmodified, well-developed supra-antennal ridge (figs. 146,

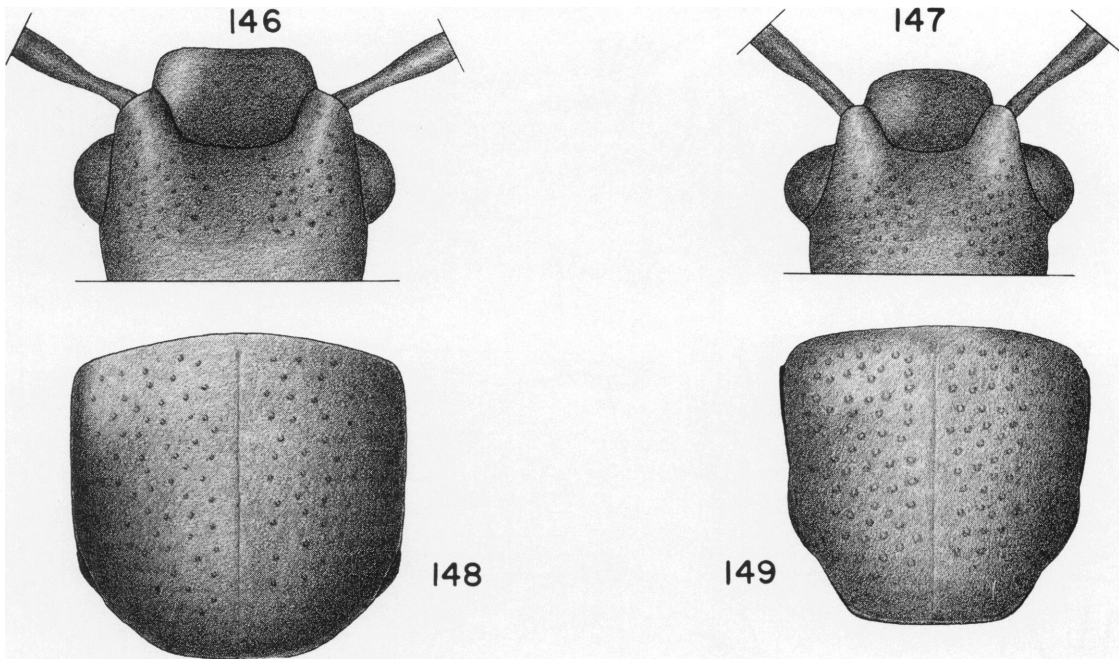

FIG. 146. *Bledius beattyi*; head, dorsal view; female.

FIG. 147. *Bledius aequatorialis*; head, dorsal view; female.

FIG. 148. *Bledius beattyi*; prothorax, dorsal view; female.

FIG. 149. *Bledius aequatorialis*; prothorax, dorsal view; female.

153), ridge with setigerous tuberculi (fig. 146) and microgranulate ground sculpturing. Epistomal suture deeply impressed (figs. 141, 146); suture broadly arcuate and sharply angulate at intersection with supra-antennal ridge (figs. 141, 146). Clypeus shining dully, not polished; with dense, coarse microgranulate ground sculpturing (as in fig. 448); with sparse pubescence on lateral sides; pubescence absent from median stripe; anterior margin often with pair of slight tumescences (fig. 141). Eyes of moderate size (figs. 141, 146). Lateral side of head with glabrous strip extending from base of head to posterior margin of eye and becoming attenuated from broad base anteriorly to apex. Venter of head with microreticulate ground sculpturing. Width of head 0.8 to 0.9 mm.; interocular width 0.5 to 0.7 mm.; head width/interocular width 1.4 to 1.6 (table 3). Labrum with microgranulate ground sculpturing (as in fig. 325) and shallow setigerous punctation with shallow midlongitudinal impression; anterior margin sinuate (as in fig. 164); anterior half strongly deflexed. Mandibles tridentate (figs. 168, 169).

Pronotum 0.8 to 1.8 mm. long,<sup>1</sup> 0.8 to 1.1 mm. wide; pronotal width/pronotal length 0.6 to 1.1 (table 3); surface strongly convex on males with large pronotal horn (fig. 144); surface of males with small pronotal horn and of females only moderately strongly convex (fig. 148); shape as in figures 144, 148, 173; basal angles indistinct (figs. 144, 148, 173); anterior margin of males with median portion produced into long (figs. 144, 157) to short (figs. 150, 173), anteriorly directed, ventrally recurved horn; males possessing large supra-antennal horns with large pronotal horns (fig. 157); males possessing short supra-antennal horns with short pronotal horn (fig. 150); females with anterior pronotal margin truncate (fig. 148); anterior angles strongly rounded (figs. 144, 148); anterior two-thirds of lateral margins straight and parallel to one another or nearly so (figs. 144, 148); posterior one-third becoming rounded gradually to broadly arcuate posterior margin (figs. 144,

<sup>1</sup>The length of the pronotum of the male includes the pronotal horn.

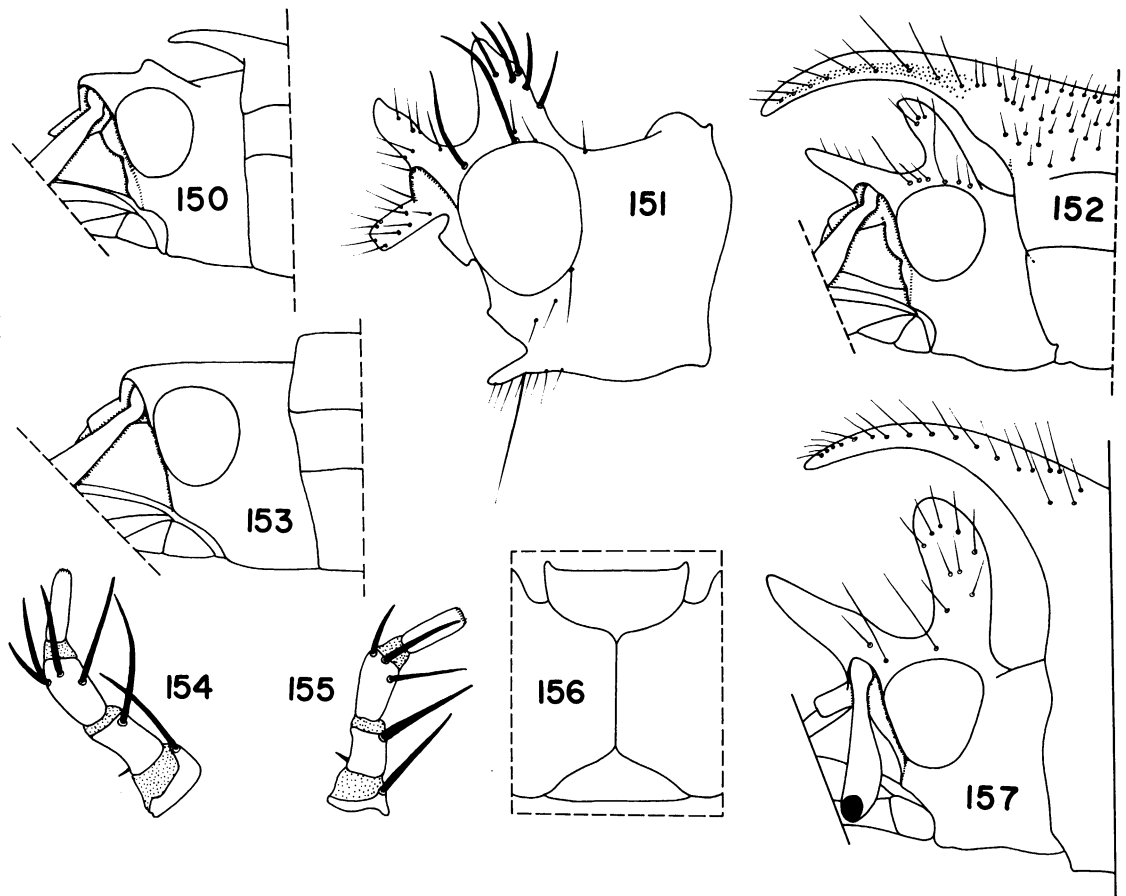

- FIG. 150. *Bledius beattyi*; head and apex of prothorax, lateral view; male.  
 FIG. 151. *Bledius ceratus*; head, lateral view; male; mouthparts and antenna removed.  
 FIG. 152. *Bledius aequatorialis*; head and apex of prothorax, lateral view; male.  
 FIG. 153. *Bledius beattyi*; head and apex of prothorax, lateral view; female.  
 FIG. 154. *Bledius beattyi*; labial palpus.  
 FIG. 155. *Bledius ceratus*; labial palpus.  
 FIG. 156. *Bledius ceratus*; gular region and submentum.  
 FIG. 157. *Bledius beattyi*; head and apex of prothorax, lateral view; male.

148); prohypomeron visible in dorsal view at point about two-thirds from anterior margin on female (fig. 148) and some males (fig. 173). Pronotum of males with surface polished, and with moderately strong, microgranulate ground sculpturing (as in fig. 448). Pronotum with surface of females shining dully, not polished and with strong, microgranulate ground sculpturing (as in fig. 448). Pronotum with moderately dense, setigerous tuberculi (figs. 144, 148); tuberculi small but distinct. Midlongitudinal groove present (figs. 144, 148); groove well developed in female and extending to near

anterior margin (fig. 148); groove of male less distinct and extending only to base of horn (fig. 144). Horn of male with anterolaterally directed setae arising from groove on lateral side (fig. 175); dorsal surface of horn polished. Pronotal lateral marginal bead present and entire (fig. 175). Prohypomeron and prosternum with microreticulate ground sculpturing; prosternum with scattered setae (fig. 170); anterior margin of prosternum of males with deep to shallow, rounded incision anterior to procoxa (fig. 170), males possessing larger supra-antennal and pronotal horns with deeper incision; anterior

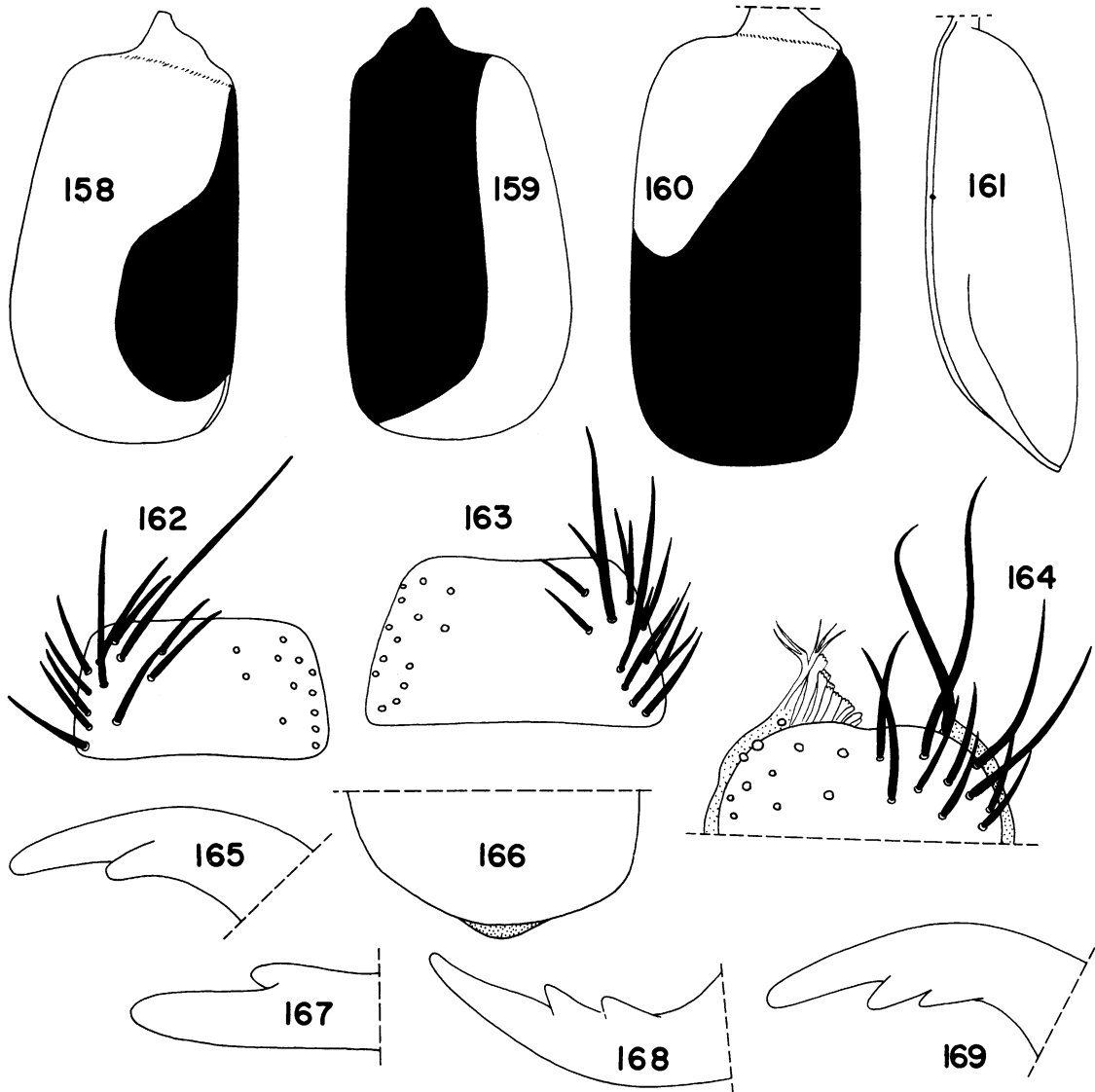

- FIG. 158. *Bledius ceratus*; left elytron; color pattern; dorsal view.  
 FIG. 159. *Bledius aequatorialis*; right elytron; color pattern; dorsal view.  
 FIG. 160. *Bledius beattyi*; left elytron; color pattern; dorsal view.  
 FIG. 161. *Bledius beattyi*; left elytron, lateral view.  
 FIG. 162. *Bledius ceratus*; mentum.  
 FIG. 163. *Bledius beattyi*; mentum.  
 FIG. 164. *Bledius ceratus*; labrum.  
 FIG. 165. *Bledius aequatorialis*; right mandible; apex, dorsal view.  
 FIG. 166. *Bledius beattyi*; left elytron; apex.  
 FIG. 167. *Bledius aequatorialis*; left mandible, anterolateral view; apex.  
 FIG. 168. *Bledius beattyi*; left mandible, dorsal view; apex.  
 FIG. 169. *Bledius beattyi*; right mandible; apex, dorsal view.

margin of prosternum of females without incision. Elytra 1.0 to 1.2 mm. long; elytral length/pronotal length 0.6 to 1.3 (table 3); surface polished, with or without obsolete ground sculpturing, and dense, moderately deep, setigerous punctation. Metathoracic wings fully developed.

Abdominal segments unmodified.

Spermatheca as shown in figures 179, 180.

**SEXUAL DIMORPHISM:** The males have supra-antennal and pronotal horns (cf. figs. 153, 157) and lack setigerous tuberculi on the dorsum of the head (cf. figs. 141, 146). The anterior margin of the prosternum of the males has a rounded incision anterior to the procoxa (fig. 170). At a point about two-thirds from the anterior margin, the prohypomeron is more easily visible in dorsal view on the female than on the male (compare fig. 144 with fig. 148).

The females lack pronotal and supra-antennal horns, lack the emargination of the anterior margin of the prosternum but possess setigerous tuberculi on the dorsum of the head.

**HABITAT AND DISTRIBUTION:** *Colombia:* Magdalena. *West Indies:* Cuba, St. Croix, St. Thomas, Vieques. (See Appendix for localities.)

The holotype was collected under a stone at the edge of a small stream in the woods (Blackwelder, 1943) on St. Croix. The collection from Yucatan was made along the beach, but the collections in Colombia and Cuba apparently were made near inland streams or rivers. The microhabitat for the species is not known.

The species has been collected from April through July and during October and November.

**DISCUSSION:** The sizes of the supra-antennal and pronotal horns (extremes shown in figs. 144, 150, 157, 173) vary from large and well developed to smaller and less conspicuous. Males with large horns also have the head deeply impressed across the base, the pronotum strongly convex, and a deep incision on the anterior margin of the prosternum. Males with small horns have each of the other three characters less prominently modified, and between the extremes are numerous intergrades which have not been illustrated.

Six Cuban specimens with orangish brown elytra that lack a humeral spot were studied. All the other specimens of the species have the elytra reddish brown and a large yellowish brown humeral spot (fig. 160). There are no other differences between the Cuban specimens

and the remainder of the material studied, so I consider them to be conspecific with the holotype even though I found no intergradations of the color differences.

*Bledius ceratus* Blackwelder

Figures 143, 145, 151, 155, 156, 158, 162, 164, 171, 181, 186-188; Map 6; Table 3

*Bledius ceratus* BLACKWELDER, 1943, pp. 113, 118 (type locality: Haiti, Port-au-Prince, collected on November 1, 1934; holotype: deposited in the National Museum of Natural History, Smithsonian Institution, Washington, D.C. Type examined, male).

**DIAGNOSIS:** The presence of bidenticate mandibles separate this species from *Bledius beattyi* (compare figs. 165, 167 with figs. 168, 169), and the absence of the pronotal lateral marginal bead (compare fig. 171 with fig. 172) will distinguish the species from *B. aequatorialis*. *Bledius ceratus* can be further separated from *B. aequatorialis* by the bi-impressed depression on the base of the head of the male (fig. 143) and by the difference of overall coloration and the pattern of the elytral coloration (compare fig. 158 with fig. 159). The prothorax of *B. ceratus* is less elongated (compare fig. 145 with fig. 142) than that of *B. aequatorialis*.

**DESCRIPTION:** *aequatorialis* group.

Length 3.5 to 5.0 mm.

Dorsum of head, clypeus, supra-antennal ridge, labrum, venter of head, labium, maxilla, and mandibles pale reddish brown to reddish brown. Antenna yellowish brown. Prothorax yellowish brown. Elytra yellowish brown and with (fig. 158) or without reddish brown sutural stripe; stripe of variable width. Pterothoracic sterna and pleura and legs yellowish brown. Abdomen yellowish brown; males with segments VII and VIII dark reddish brown.

Dorsum of head shining dully, not polished, and with microgranulate ground sculpturing (as in fig. 448); male without pubescence, punctation or setigerous tuberculi between supra-antennal ridges (fig. 143); dorsum of female with moderately dense setigerous punctation, tuberculi absent, punctation absent from narrow median stripe, pubescence moderately long; male with area between supra-antennal ridges convex from front to rear (fig. 143), convexity greater with increased size of supra-antennal horns; male with transverse depression posterior to supra-antennal ridges (fig. 143), depression



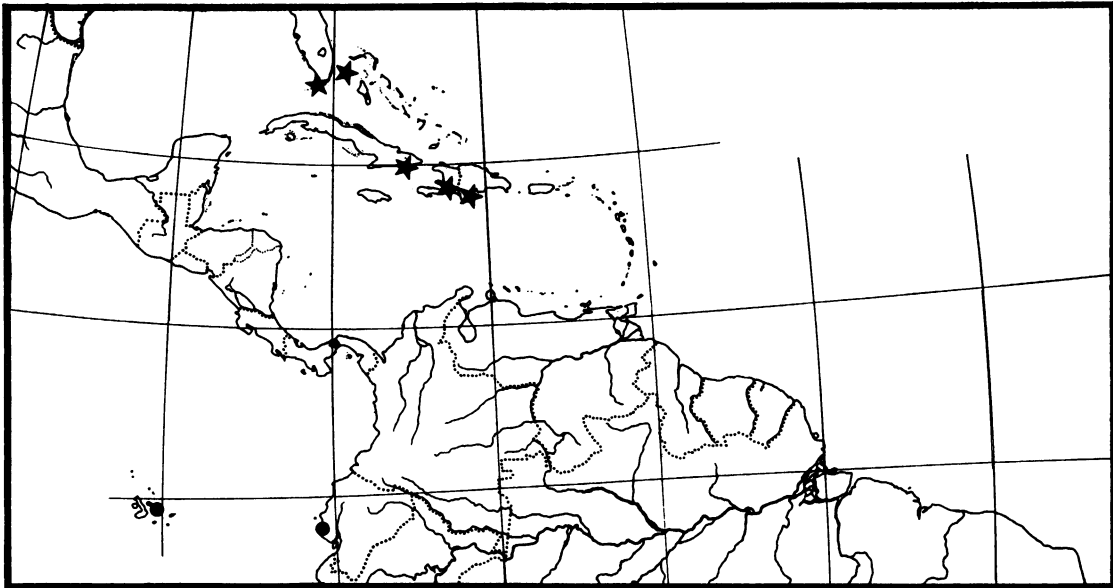

MAP 6. Distribution of *Bledius ceratus* (stars) and *B. aequatorialis* (black dots).

deeper with increased size of supra-antennal horns; depression bi-impressed and divided longitudinally by broad, low, midlongitudinal ridge (fig. 143); male with broadly rounded U-shaped ridge extending from one eye along lateral margin to, and then along, the posterior margin, then to the other eye (fig. 143); ridge increasingly well developed on males with large supra-antennal horns; female with anterior portion of dorsum of head depressed and with median portion shallowly concave, region posterior to supra-antennal ridge slightly impressed; supra-antennal ridge of male with pair of well developed (figs. 143, 151), to more poorly developed, to obsolete horns; surface of ridge with small setigerous tuberculi (fig. 151) and microgranulate ground sculpturing; horns cylindrical at base and weakly compressed from just above base to apex (fig. 143); anterior horn anterodorsally directed (figs. 143, 151) and with flattened axis set in anteromedially oblique plane (fig. 143), lateroanterior surface polished and without pubescence (fig. 151), mesio-posterior surface with sparse pubescence and microgranulate ground sculpturing; anterior horn curved mesially and tapered to apex (figs. 143, 151); posterior horn dorsally directed (figs. 143, 151) and with flattened axis set in antero-

medially oblique plane (fig. 143), horns slightly curved toward middle (fig. 143), lateral surface with sparse pubescence (fig. 151), mesial surface without pubescence; female with unmodified well-developed supra-antennal ridge, ridge with setigerous punctation and granulate ground sculpturing on lateral and dorsal surfaces; epistomal suture deeply impressed (fig. 143); suture broadly arcuate and sharply angulate at intersection with supra-antennal ridge (fig. 143). Clypeus shining dull, not polished, with microgranulate ground sculpturing (as in fig. 325) and with sparse pubescence on lateral sides and absent from median strip; anterior margin often with pair of slight tumescences. Eyes of moderate size (fig. 143). Lateral side of head with glabrous strip extending from base of head to posterior margin of eye and becoming attenuated from base to apex. Venter of head with microreticulate ground sculpturing. Width of head 0.7 mm.; interocular width 0.4 mm.; head width/interocular width 1.6. Labrum with microreticulate ground sculpturing (as in fig. 325) and shallow, setigerous punctation; with slight, shallow, midlongitudinal impression; anterior margin sinuate; anterior half strongly deflexed. Mandibles bidentate (as in figs. 165, 167).

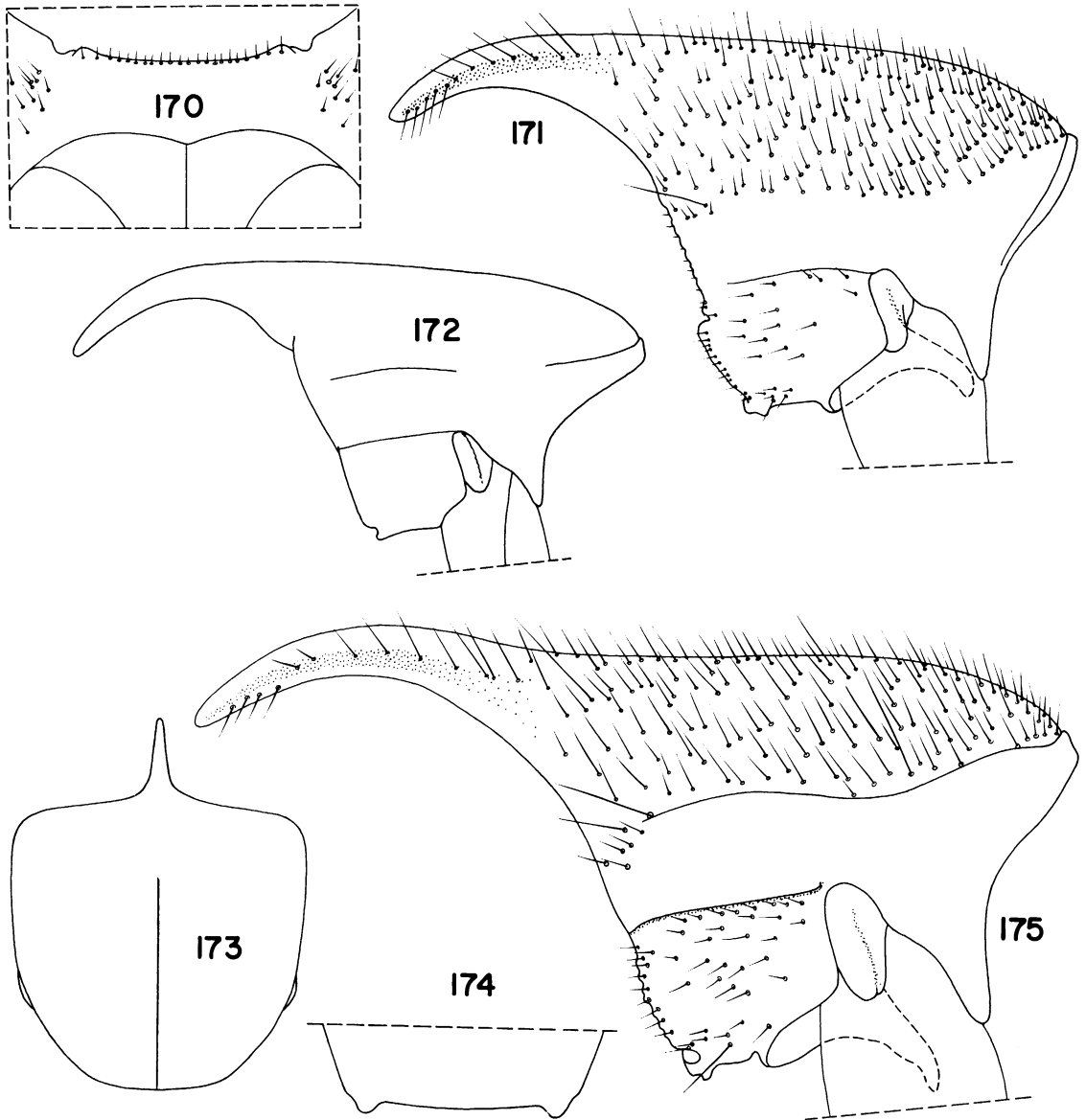

FIG. 170. *Bledius beattyi*; prosternum, anterior view; male.

FIG. 171. *Bledius ceratus*; prothorax, lateral view; male.

FIG. 172. *Bledius aequatorialis*; prothorax, lateral view; male; setae and punctures removed.

FIG. 173. *Bledius beattyi*; pronotum, dorsal view; male; setae and punctures removed.

FIG. 174. *Bledius beattyi*; tergum VIII; apex.

FIG. 175. *Bledius beattyi*; prothorax, lateral view; male.

Pronotum 1.1 mm. long,<sup>1</sup> 0.7 mm. wide; pronotal width/pronotal length 0.7; surface of male strongly to moderately strongly convex

<sup>1</sup>The length of pronotum of the male includes the pronotal horn.

(fig. 145), convexity increasingly strong with increasing size of pronotal horn; shape as in figure 145; surface of female moderately strongly convex; basal angles distinct (fig. 145); anterior margin of males with median portion produced

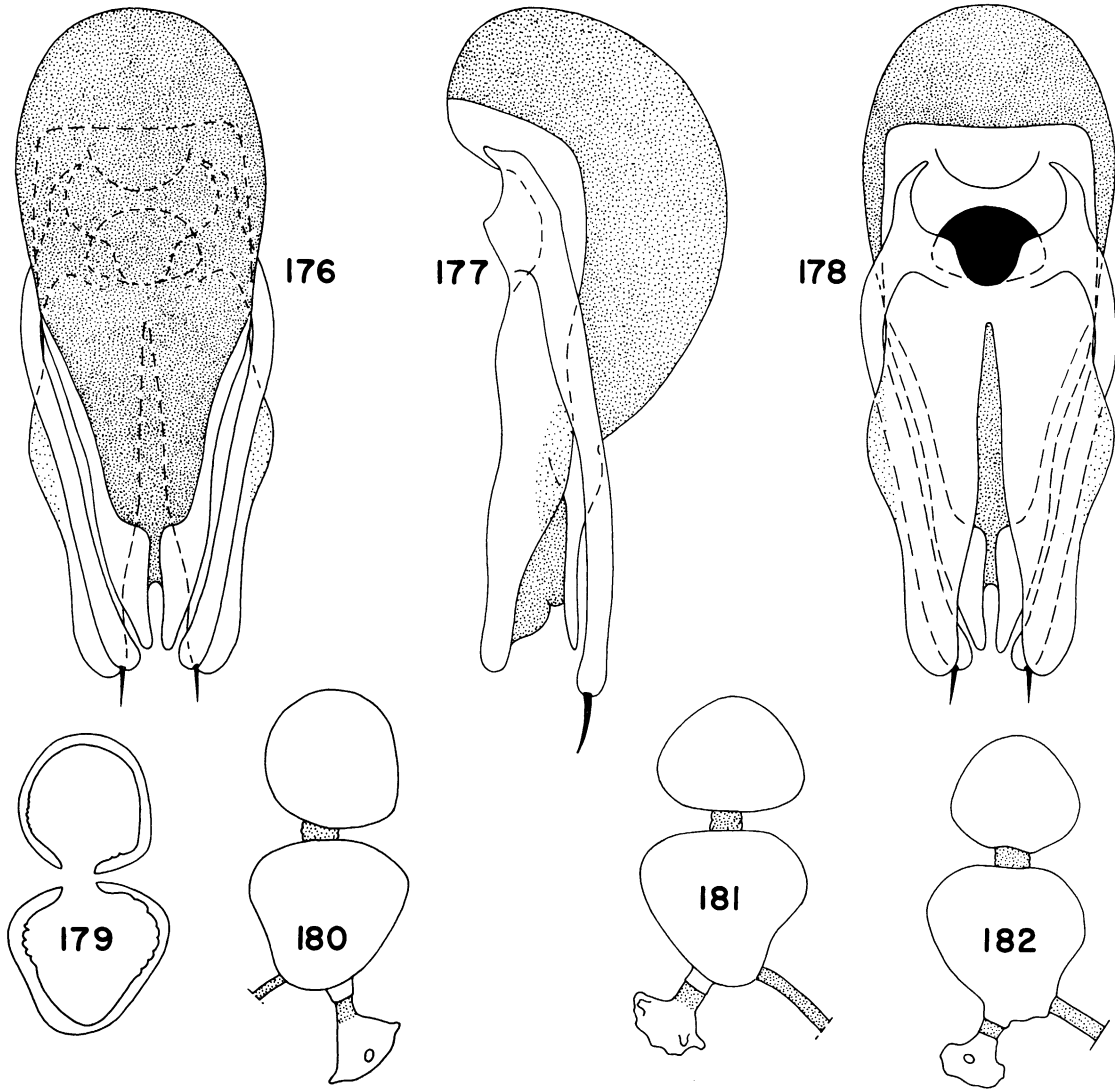

FIG. 176. *Bledius aequatorialis*; aedeagus, dorsal view.  
 FIG. 177. *Bledius aequatorialis*; aedeagus, lateral view.  
 FIG. 178. *Bledius aequatorialis*; aedeagus, ventral view.  
 FIG. 179. *Bledius beattyi*; spermatheca, cross section.  
 FIG. 180. *Bledius beattyi*; spermatheca.  
 FIG. 181. *Bledius ceratus*; spermatheca.  
 FIG. 182. *Bledius aequatorialis*; spermatheca.

into long to short anteriorly directed, ventrally recurved horns (fig. 145); pronotal horn increasingly large with increasing size of supra-antennal horns; female with anterior pronotal margin truncate; anterior angles strongly rounded (fig. 145); lateral margins straight and nearly parallel (fig. 145); apical one-third

strongly convergent to basal margin (fig. 145); basal margin truncate (fig. 145); prohypomeron visible in dorsal view at point about two-thirds from anterior margin (fig. 145). Pronotum with surface shining dully, not polished, with dense microgranulate ground sculpturing and with dense, setigerous tuberculi (fig. 145); tuberculi



183



184



185

FIG. 183. *Bledius aequatorialis*; adoral surface of labium.  $\times 720$ .

FIG. 184. *Bledius aequatorialis*; adoral surface of labium.  $\times 1440$ .

FIG. 185. *Bledius aequatorialis*; median region of adoral surface of labium.  $\times 3600$ .

very small (fig. 145); midlongitudinal groove present (fig. 145); groove of male well developed and extending to base of pronotal horn (fig. 145). Horn of male with anterolaterally directed setae arising from groove on lateral side (fig. 171); dorsal surface of horn polished. Pronotal lateral marginal bead absent (fig. 171). Prohypomeron and prosternum with microreticulate ground

sculpturing; prosternum with scattered setae; anterior margin of prosternum of male with small rounded incision anterior to procoxae (as in fig. 170); incision increasingly shallow with reduction of length of pronotal and supra-antennal horns of male.

Elytra 0.9 mm. long; elytral length/pronotal length 0.8; surface strongly shining, not polished

and with fine microrugose ground sculpturing, and with dense, moderately deep, setigerous punctation. Metathoracic wings fully developed.

Abdominal segments unmodified.

Spermatheca as shown in figure 181.

**SEXUAL DIMORPHISM:** The male has supra-antennal horns (figs. 143, 151), lacks setigerous punctation or tuberculi on the dorsum of the head between the supra-antennal ridges (fig. 143), has a pronotal horn (figs. 145, 171), has an emargination on the anterior margin of the prosternum anterior to the procoxa (as in fig. 170), and has a bicolored abdomen with segments VII and VIII reddish brown and the remaining segments yellowish brown. The female lacks supra-antennal horns, has setigerous punctation on the dorsum of the head between the supra-antennal ridges, lacks a pronotal horn, lacks a prosternal emargination and has a concolorous yellowish brown abdomen.

**HABITAT AND DISTRIBUTION:** *West Indies:* Bahama Islands, Haiti (Blackwelder, 1943), Dominican Republic, Cuba. *United States:* Florida (map 6). (See Appendix for localities.)

The species can be collected on Big Pine Key on mud flats near coastal mangrove swamps and occurs there with *B. mandibularis*. The species has been collected in May, July, September, and December.

**DISCUSSION:** On the coast of Texas I collected a specimen of a species of *Bledius* that apparently belongs in or near the *aequatorialis* group. This specimen is a female, has tridentate mandibles, lacks a pronotal lateral marginal bead, and has a pronotal horn on the anterior margin. Because of the absence of the pronotal lateral marginal bead, a condition also found in *B. ceratus*, the two species may be nearer each other ancestrally than to the other species of the group.

*Bledius aequatorialis* Mutchler

Figures 142, 147, 149, 152, 159, 165, 167, 172, 176-178, 182-185; Map 6; Table 3

*Bledius aequatorialis* MUTCHLER, 1925, p. 225, 226, fig. 43 (type locality: Ecuador, Galapagos Island, South Seymour, collected from under stones in moist mud around pools in April, 1923; holotype: deposited in the American Museum of Natural History, New York. Type examined, male).

**DIAGNOSIS:** The bidentate mandibles (compare figs. 165, 167 with figs. 168, 169) will separate this species from *Bledius beattyi*. *Bledius*

*aequatorialis* has a pronotal lateral marginal bead that is well developed on the anterior half (fig. 172), absent or obsolete near the middle (fig. 172), and distinct on the posterior portion (fig. 172). On *B. beattyi* the pronotal lateral marginal bead is distinct the entire length of the pronotum (fig. 175) although it may be slightly less prominent near the middle. The presence of the pronotal lateral marginal bead (fig. 172) on *B. aequatorialis* separates it from *B. ceratus* which lacks the bead (fig. 171). Other characters useful for separation of the two species are discussed under the Diagnosis of *B. ceratus*.

**DESCRIPTION:** *aequatorialis* group.

Length 4.0 to 5.2 mm.

Dorsum of head and clypeus black to dark reddish brown. Supra-antennal ridge dark reddish brown to reddish brown. Labrum reddish brown. Venter of head, mentum, submentum, maxilla, and antenna reddish brown to pale reddish brown. Pronotum dark reddish brown to reddish brown. Prohypomeron and prosternum reddish brown to pale reddish brown. Elytra with dark reddish brown sutural stripe extending from base to near apex (fig. 159); remainder dark yellowish brown to yellowish brown. Pterothoracic pleura and sterna dark reddish brown to pale reddish brown. Legs pale reddish brown to yellowish brown. Abdomen dark reddish brown to pale reddish brown; occasionally with apical segments paler reddish brown.

Dorsum of head shining dully, not polished, but male slightly more shiny than female, with coarse, dense, microgranulate ground sculpturing (as in fig. 448); male without pubescence on dorsum between supra-antennal ridges; male individuals possessing very short supra-antennal horns with several setae near base of supra-antennal ridge; male without punctation or tuberculi on dorsum (as in figs. 141, 143); female with moderately dense, setigerous tuberculi (fig. 147), punctation absent, tuberculi absent from narrow median stripe, pubescence moderately long; male with area between supra-antennal ridges convex from front to rear (as in fig. 141), convexity greater with increased size of horn; male with transverse depression posterior to supra-antennal ridges (as in fig. 141), depression deeper with increasing size of supra-antennal horn, and on individuals with extremely small horn (e.g., holotype) depression obsolete; depression not bi-impressed, and with-

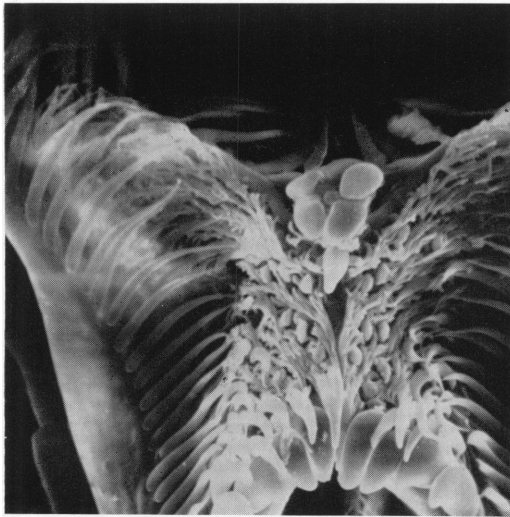

186

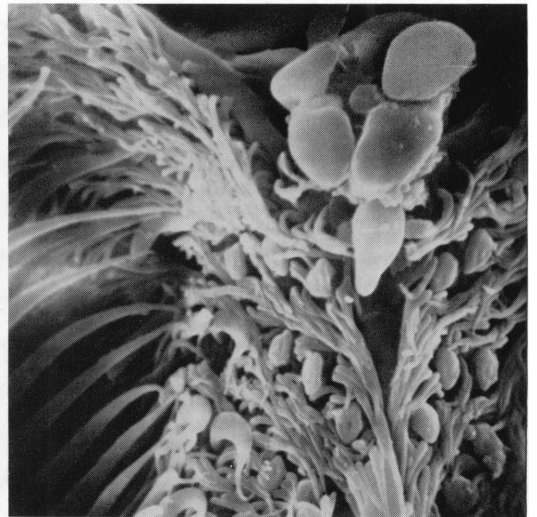

187

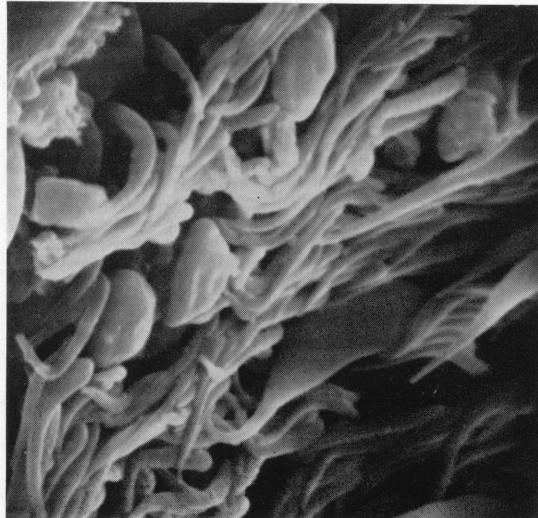

188

FIG. 186. *Bledius ceratus*; adoral surface of labium.  $\times 800$ .

FIG. 187. *Bledius ceratus*; median portion of adoral surface of labium.  $\times 1600$ .

FIG. 188. *Bledius ceratus*; median portion of adoral surface of labium.  $\times 4000$ .

out broad midlongitudinal ridge (as in fig. 141); male with broadly rounded, U-shaped ridge extending from one eye posteriorly along lateral margin, then along posterior margin, then to other eye (as in fig. 141), ridge increasingly well developed on male with large supra-antennal horns and deep basal depression, male with small supra-antennal horns with obsolete ridge;

female with anterior portion of dorsum depressed and median portion slightly concave to nearly flat, region posterior to supra-antennal ridge with slight transverse depression to nearly flat (fig. 147), usually with shallow, median, punctiform impression. Supra-antennal ridge of male with pair of well-developed (fig. 152) to poorly developed horns; when horns poorly

developed, anterior margin and base of ridge each with small, acute tubercle, surface of ridge with setigerous tuberculi and microgranulate ground sculpturing; when horns well developed, horns cylindrical at base and compressed from just above base to apex (as in fig. 141); anterior horn anterodorsally directed and with flattened axis set in anteromedially oblique plane (as in fig. 141), lateroanterior surface polished and without setigerous tuberculi (fig. 152), mesio-posterior surface with sparse, setigerous tuberculi and with microgranulate ground sculpturing, horn curved mesially (as in fig. 141) and tapered to apex (fig. 152); posterior horn dorsally directed (fig. 152) and with flattened axis set in anteromedially oblique plane (as in fig. 141), horns slightly curved toward middle (as in fig. 141), lateral surface with sparse, setigerous tuberculi (fig. 152), mesial surface with sparse, very scattered setigerous tuberculi; female with unmodified, well-developed supra-antennal ridge (fig. 147), ridge with setigerous tuberculi and microgranulate ground sculpturing. Epistomal suture deeply impressed (fig. 147); suture broadly arcuate and sharply angulate at intersection with supra-antennal ridge (fig. 147). Clypeus shining dully, not polished with dense, coarse, microgranulate ground sculpturing (as in fig. 325) with sparse pubescence on lateral sides; pubescence absent from median strip; anterior margin often with pair of slight tumescences. Eyes of moderate size (fig. 147). Lateral side of head with glabrous strip extending from base of head to posterior margin of eye and becoming attenuated from broad base anteriorly to apex. Venter of head with microreticulate ground sculpturing. Range of width of head 0.7 to 0.8 mm.; range of interocular width 0.5 to 0.6 mm.; range of head width/interocular width 1.4 to 1.6. Labrum with microgranulate ground sculpturing (as in fig. 325) and shallow setigerous punctation, without midlongitudinal impression; anterior margin sinuate; anterior half strongly deflexed. Mandibles bidentate (figs. 165, 167).

Pronotum 0.7 to 1.6 mm. long,<sup>1</sup> 0.7 to 0.9 mm. wide; pronotal width/pronotal length 0.6 to 1.1; surface of male strongly to moderately strongly convex (fig. 142), convexity increasingly strong with increasing size of pronotal horn; females with surface moderately strongly convex (fig.

<sup>1</sup>The length of the pronotum of the male includes the pronotal horn.

149); shape as in figures 142, 149; basal angles moderately distinct (figs. 142, 199); anterior margin of males with median portion produced into long to short anteriorly directed, ventrally recurved horn (figs. 142, 152); pronotal horn increasingly large with increasing size of supra-antennal horns; females with anterior margin truncate (fig. 149); anterior angles strongly rounded (figs. 142, 149); lateral margins gradually and slightly convergent to basal margin (figs. 142, 149); lateral margin of males occasionally sinuous at about two-thirds from anterior margin (fig. 142); posterior margin nearly truncate (figs. 142, 149); prohypomeron visible in dorsal view at point about two-thirds from anterior margin on males (fig. 142) and females (fig. 149). Pronotum with surface shining, not polished, with dense, microgranulate ground sculpturing, with moderately dense, setigerous tuberculi (figs. 142, 149); tuberculi small but distinct. Midlongitudinal groove present (figs. 142, 149); groove well developed on female and extending to near anterior margin (fig. 149); groove of males less distinct and extending only to base of pronotal horn (fig. 142). Horn of male with anterolaterally directed setae arising from groove on lateral side (fig. 152); dorsal surface of horn polished. Pronotal lateral marginal bead present but incomplete (fig. 172); bead not attaining anterior margin (fig. 172) and short section absent or obsolete at point about two-thirds from anterior margin (fig. 172). Prohypomeron and prosternum with microreticulate ground sculpturing; prosternum with scattered setae; anterior margin of prosternum of male with (fig. 170) or without small, rounded incision anterior to procoxa, size and presence or absence of incision dependent on length of pronotal horn, male with largest horns with deepest incision, males with smallest horns with incision shallow or absent; anterior margin of prosternum of females without incision. Elytra 0.8 to 1.1 mm. long; elytral length/pronotal length 0.6 to 1.4; surface strongly shining, not polished, with fine, microrugose ground sculpturing, with dense, moderately deep, setigerous punctation. Metathoracic wings fully developed.

Abdominal segments unmodified.

Spermatheca shown in figure 182.

**SEXUAL DIMORPHISM:** The males all have supra-antennal horns and an anteriorly directed pronotal horn, lack setigerous tuberculi between the supra-antennal ridges on the dorsum of the

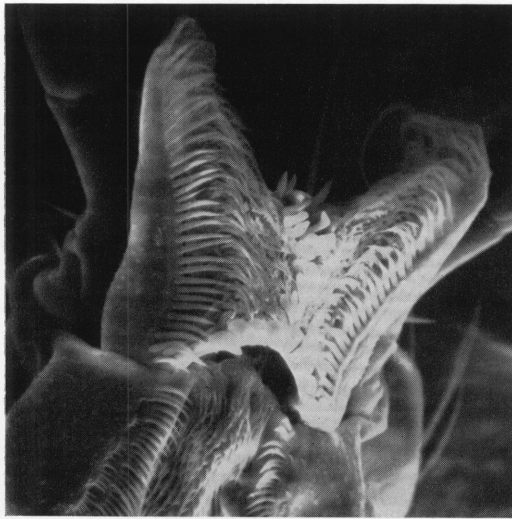

189

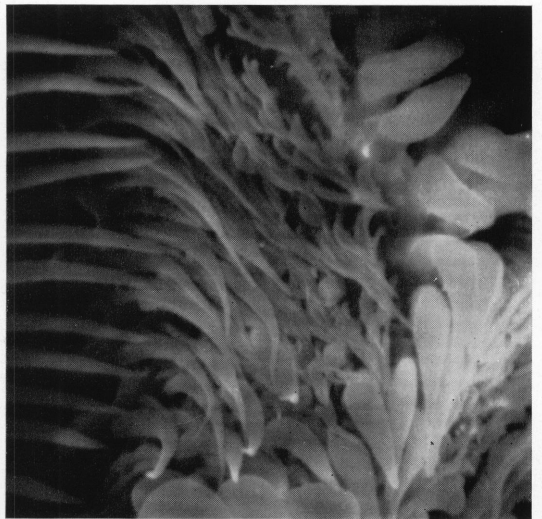

190

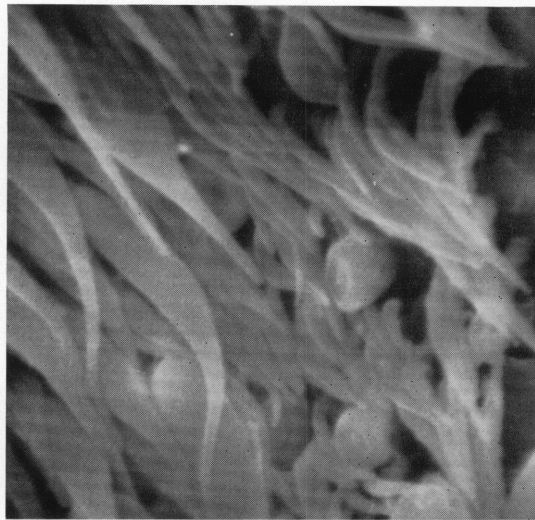

191

FIG. 189. *Bledius beattyi*; adoral surface of labium.  $\times 352$ .

FIG. 190. *Bledius beattyi*; median region of adoral surface of labium.  $\times 1360$ .

FIG. 191. *Bledius beattyi*; near median region of adoral surface of labium.  $\times 3600$ .

head and have a small, rounded incision on the anterior margin of the prosternum anterior to the procoxa. The female has no supra-antennal or pronotal horns, no incision of the anterior margin of the prosternum, but has setigerous tuberculi on the dorsum of the head.

HABITAT AND DISTRIBUTION: *Ecuador*: Guayas,

Galapagos Islands (map 6). (See Appendix for localities.)

The species was collected on South Seymour Island under stones in moist mud around pools (Mutchler, 1925, p. 226). It was collected on the Galapagos during April and January, and in Ecuador during January.



DISCUSSION: The sizes of the supra-antennal and pronotal horns of the males vary from large and well developed (fig. 142) to small and less conspicuous (as in figs. 150, 173; also see Mutchler, 1925, fig. 43). The size of the supra-antennal horns correlates with the size of the pronotal horns, the depth of the transverse depression behind the supra-antennal ridges, the convexity of the dorsum of the head between the supra-antennal ridge, and the depth and presence of the incision of the anterior margin of the prosternum. The larger the supra-antennal horn the larger or more strongly modified the other characters listed above. Between the extremes are numerous intergrades.

The holotype of *Bledius aequatorialis*, with small supra-antennal and pronotal horns, has the dorsum of the head more shallowly convex, has the base of the head less deeply impressed, and lacks an incision of the anterior margin of the prosternum. The holotype and allotype of this species are testaceous, but this apparently is because they are teneral adults.

#### MANDIBULARIS GROUP

Figures 1, 192–326; Maps 7–9; Table 4

DIAGNOSIS: This group is separable from all the New World groups by the absence of a small, setigerous prosternal pit (fig. 213), the reduction of the pronotal lateral marginal bead (fig. 209) and elytral epipleural ridge (fig. 236), and the closed procoxal fissure (fig. 209).

DESCRIPTION: *Bledius*. Supra-antennal horns absent in males and females (figs. 192–201). Clypeal tubercles present (figs. 192, 193) or absent (figs. 194–201). Gular sutures confluent to submentum and sharply divergent at base (figs. 219–228). Labrum with broad, shallow, median emargination (fig. 229); midlongitudinal groove (fig. 229) continuous with emargination but shallow and poorly developed; anterior margin not reflexed (fig. 229); membranous lobes as in figure 229. Labial palpus (fig. 231) with second article much longer than first or third; articles each slightly narrower than preceding article; basal article with one long seta on mesal side; second article with numerous setae on mesal surface and additional scattered setae on remaining surface (fig. 231). Mentum as in figure 230. Adoral surface of labium as in figures 309–318, 320. Maxillary palpus as in

figures 232, 233, 323. Galea with few to numerous spinelike setae (figs. 289, 293–296); each species with more distinctive, spinelike seta separated from others (figs. 289, 293–296). Mandibles prominent, variable, and well developed (figs. 1, 237–287).

Pronotum of pentagonal shape (figs. 202–205, 207). Pronotal horns absent in males and females (figs. 202–205, 207). Pronotal lateral marginal bead incomplete, present only at apex (figs. 209, 212). Protergosternal suture absent (figs. 209, 212). Procoxal fissure short and closed (figs. 209, 212). Protrochantin concealed (figs. 209, 212). Prosternal process present (as in fig. 175). Prosternum with large patch of scattered pubescence in slight depression laterad of and anterior to procoxae (fig. 213) and without small densely setigerous pit anterior to procoxae (fig. 213).

Elytron without membranous lobe on posterior margin (fig. 235); epipleural ridge incomplete, present only at apex (fig. 236).

Abdomen with posterior margin of eighth tergum emarginate; margin entire, not serrulate (fig. 210).

Aedeagus trilobed (figs. 304–306). Parameres long, slender and posterior margin of base free, not fused to ventral surface of median lobe (figs. 305, 306); parameres without setae (figs. 304, 305); parameres not fused to median lobe (figs. 304, 305). Median lobe bulbous (figs. 304–306); base membranous (figs. 304–306); median and apical portions of dorsal surface lightly sclerotized (fig. 304); apex of ventral surface slightly divided longitudinally (fig. 304); ventral surface with base and area surrounding median foramen membranous, remainder sclerotized (fig. 306); ventral surface with apical two-thirds divided longitudinally into broad, flat lobes that overlap partially along midline (fig. 306).

Spermatheca as shown in figures 297–303.

DISCUSSION: The only five species in this group are *Bledius mandibularis*, *B. ferratus*, *B. jacobinus*, *B. fortis*, and *B. pallipennis*, all of which occur in the United States and Mexico.

#### *Bledius pallipennis* (Say)

Figures 1, 192, 193, 207, 221, 224, 234, 288, 290–292, 296, 300, 301, 315, 316, 319, 323–326;  
Map 7; Table 4

*Oxytelus pallipennis* SAY, 1823, p. 155. ERICHSON, 1840, p. 779.

*Bledius pallipennis* (Say): ERICHSON, 1840, p. 779. LE CONTE, 1877, p. 218. BERNHAUER AND SCHUBERT,

1911, p. 133 (listed *B. mandibularis* Er. as a junior synonym; type locality: "on banks of the Missouri below the confluence of the Platte River"; holotype: apparently, the holotype has been lost or destroyed).

*Bledius gularis* LE CONTE, 1877, p. 218 [new synonym]; (type locality: middle states, Illinois; holotype: deposited in the Museum of Comparative Zoology, Cambridge, Massachusetts. Type studied, male).

**DIAGNOSIS:** This species is easily separated from nearly all individuals of all species of the *mandibularis* group by the color pattern of the elytra (fig. 234); the apex and suture are black to reddish black, the remainder yellowish brown to pale reddish brown. Additional characters useful for recognition of the species are the tubercles on the anterior margin of the clypeus (figs. 192, 193), the deeply angulate gular sutures (figs. 221, 224), and the long dorsal denticle of the mandibles (figs. 281, 290-292).

**DESCRIPTION:** *mandibularis* group.

Length 8.0 to 11.0 mm.

Dorsum of head, clypeus and labrum black to reddish black. Venter of head dark reddish brown. Mandibles dark reddish brown. Labium, maxilla, and antenna reddish brown. Pronotum reddish brown with infusions of black to dark reddish brown to reddish brown. Prohypomeron reddish brown to yellowish brown. Elytron bicolored yellowish brown to pale reddish brown with suture and apex black to reddish black (fig. 234). Pterothoracic sterna and pleura and legs yellowish brown. Abdomen of male with segments II to VI yellowish brown to pale reddish brown, segments VII to X darker; terga VII to X black; sternites VII to X dark reddish brown. Abdominal segments of female concolorous yellowish brown to pale reddish brown; apex not differentially pigmented.

Dorsum of head opaque, not polished but with a few polished spots near middle, with dense, microgranulate ground sculpturing (fig. 325), and with moderately dense, moderately deep, setigerous punctation, punctation present along base and lateral sides of dorsum, absent from middle to epistomal suture (figs. 192, 193); pubescence moderately long; male with dorsum of head broad and flat (figs. 1, 192); male with large, deep, transverse, crescent-shaped, postocular depression (figs. 1, 192); dorsum of male with midlongitudinal groove beginning anterior to, and extending posteriorly onto, crescent-shaped depression (figs. 1, 192); female with

dorsum narrower than that of male and strongly convex (fig. 193); female with distinct middorsal tumescence (fig. 193); tumescence with mid-longitudinal groove (fig. 193); groove occasionally dividing median tumescence into two smaller tumescences. Supra-antennal ridge low to moderately prominent (figs. 1, 192, 193), with distinct microgranulate ground sculpturing on base and sides, and dorsal surface with less distinct microgranulate ground sculpturing. Epistomal suture straight between supra-antennal ridges (figs. 192, 193); suture obsolete but sharply angulate at juncture with supra-antennal ridge (figs. 192, 193). Clypeus with microgranulate ground sculpturing (fig. 325) and shallow, setigerous punctation; anterior margin with tubercle laterad of middle (figs. 192, 193); male with tubercles large and joined on mesial surface (fig. 192); female with tubercles smaller and separated (fig. 193). Lateral side of head with narrow, glabrous strip extending from base of head anteriorly to posterior margin of eye. Venter of head with dense, microgranulate ground sculpturing (fig. 324). Gular sutures short (figs. 221, 224). Submental suture deeply angulate (figs. 221, 224); male (fig. 221) with suture more deeply angulate than in female (fig. 224). Width of head 1.5 to 2.1 mm.; interocular width 0.9 to 1.4 mm. Head width/interocular width 1.5 to 1.6 (table 4). Labrum with microgranulate ground sculpturing (figs. 325, 326) and shallow, setigerous punctation. Mandible of male and female bidentate (figs. 288, 290-292); denticles long, slender, and separated (figs. 288, 290-292); denticles of male (figs. 288, 290) more stout than those of female (figs. 291, 292); apical denticle slightly but noticeably more stout than basal denticle; apical denticle approximately one-third to one-fourth longer than basal denticle (figs. 288, 290-292). Galea with prominent, spinelike seta on lateral side of apex (fig. 296); spinelike setae stout and strongly curved mesally (fig. 296); galea with remainder of apex covered densely with numerous more slender, mesally curved setae (fig. 296). Submentum of triangular shape with sides sinuate and angles rounded (figs. 221, 224); submentum of male (fig. 221) longer than that of female (fig. 224); submentum of male deeply excavated under gular region (fig. 221); submentum of female impressed at juncture with gular region but not excavated under gular region (fig. 224).

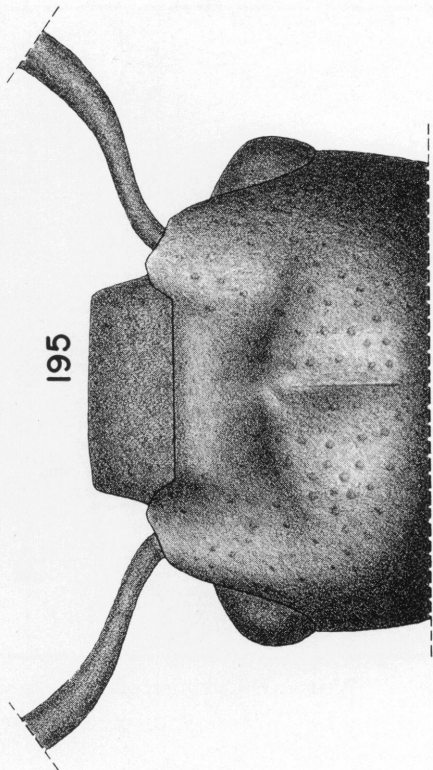
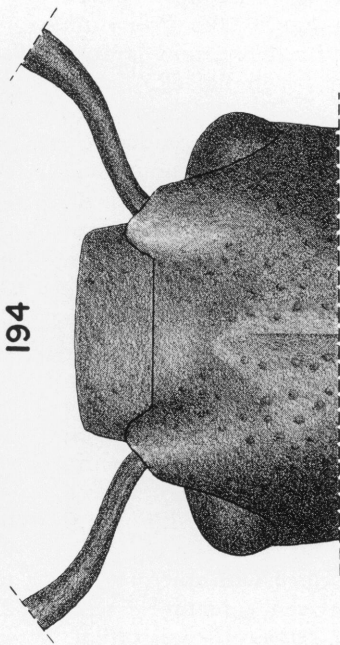
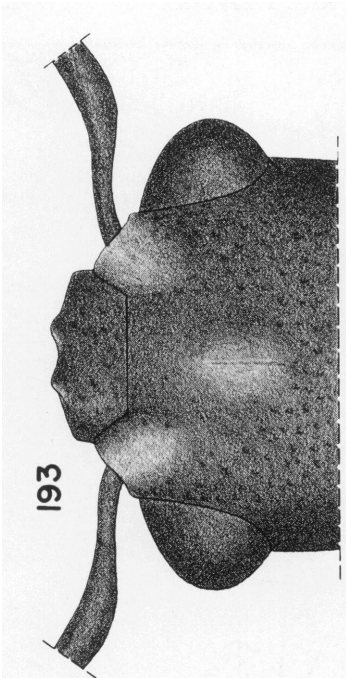
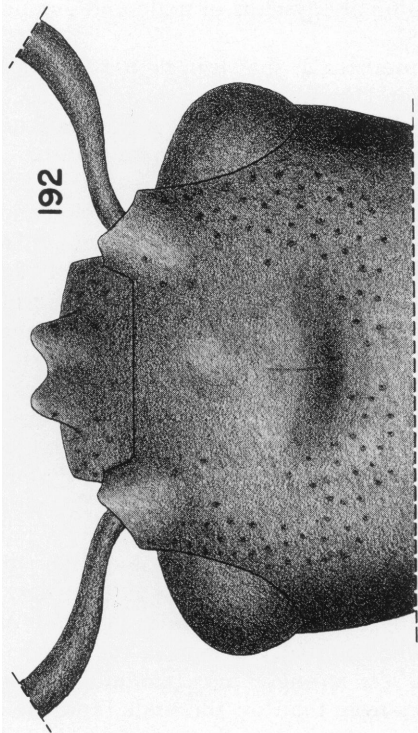
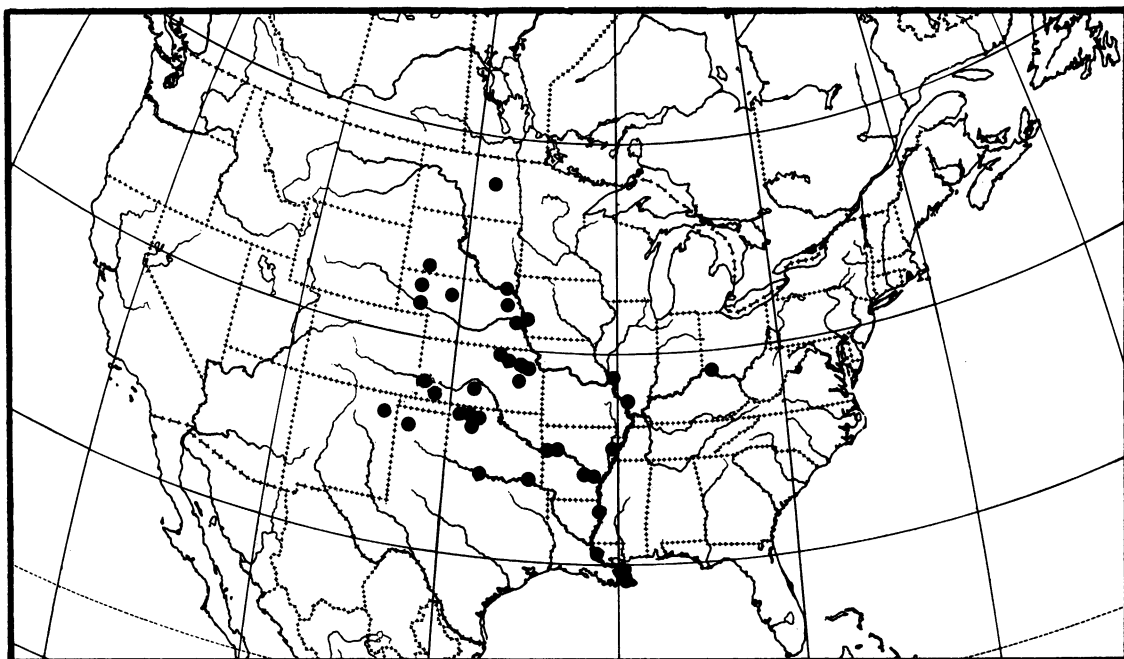

FIG. 192. *Bledius pallipennis*; head, dorsal view; male.  
FIG. 193. *Bledius pallipennis*; head, dorsal view; female.  
FIG. 194. *Bledius fortis*; head, dorsal view; female.  
FIG. 195. *Bledius fortis*; head, dorsal view; male.



MAP 7. Distribution of *Bledius pallipennis* (black dots).

Pronotum 1.2 to 1.7 mm. long, 1.5 to 2.3 mm. wide; pronotal width/pronotal length 1.2 to 1.4 (table 4); surface moderately strongly convex (fig. 207); shape as in figure 207. Pronotum opaque, not polished; with dense, microgranulate ground sculpturing (as in fig. 325), with moderately dense, moderately deep, setigerous punctation (fig. 207); pubescence moderately long and with moderately deep midlongitudinal groove (fig. 207). Pronotal lateral marginal bead not quite reaching posteriorly to projected dorsal extension of procoxal fissure. Prohypomeron with ridge anterior to procoxal fissure; ridge weakly developed; surface of ridge opaque; not polished, with microreticulate ground sculpturing. Prohypomeron and prosternum (as in fig. 324) with microreticulate ground sculpturing and pubescence; pubescence more dense on prosternum than prohypomeron and prosternum with slightly more dense patch on broad area anterior to procoxae (as in fig. 213). Elytra 1.6 to 2.2 mm. long; elytral length/pronotal length 1.2 to 1.4 (table 4); surface with microrugose ground sculpturing between punctures; with dense, moderately deep, setigerous punctation; pubescence moderately long.

Abdominal segments of male and female unmodified.

Spermatheca as shown in figures 300, 301.

**SEXUAL DIMORPHISM:** The male (fig. 192) has a depression on each side of a midlongitudinal groove near the base of the dorsum of the head. The anterior margin of the clypeus (fig. 192) has a pair of large, mesially fused, tubercles, and the dorsal denticle of the mandible is long and stout (figs. 288, 290). The submental suture is deeply angulate with a concomitant shortening of the gular sutures (fig. 221), and the submentum is deeply excavated under the gular region (fig. 221). The apex of the abdomen is black, the remainder reddish brown to yellowish brown.

The female (fig. 193) has a median tumescence on the dorsum of the head that has a midlongitudinal groove bisecting it. The anterior margin of the clypeus (fig. 193) has a pair of small, separated tubercles, and the dorsal denticle of the mandible of the female (figs. 291, 292) is shorter and more slender than that of the male. The submental suture of the female (fig. 224) is less strongly angulate and the gular sutures longer than on the male, and the submentum is not excavated under the gular region

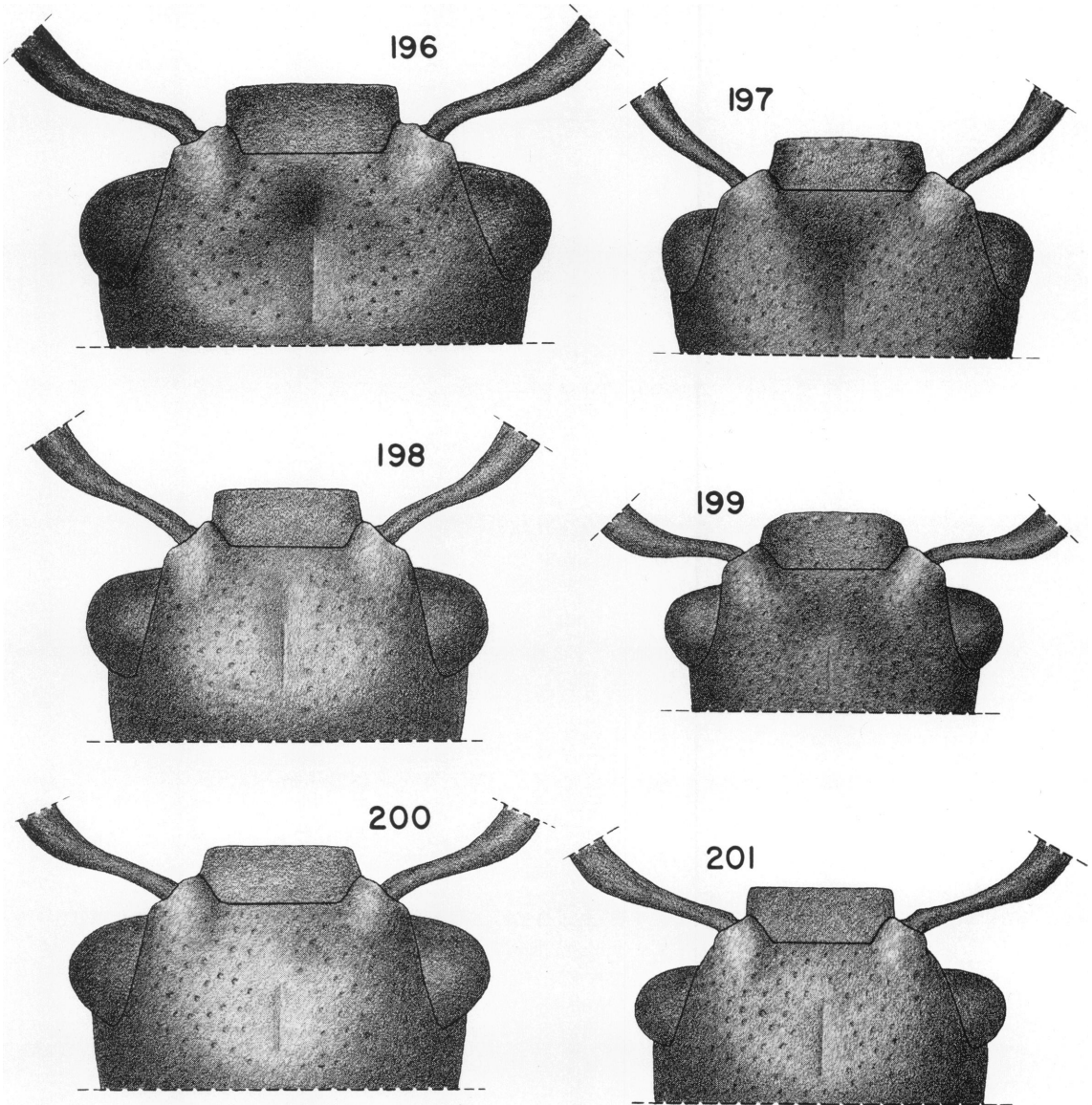

FIG. 196. *Bledius mandibularis*; head, dorsal view; male.  
 FIG. 197. *Bledius jacobinus*; head, dorsal view; male.  
 FIG. 198. *Bledius mandibularis*; head, dorsal view, female.  
 FIG. 199. *Bledius jacobinus*; head, dorsal view; female.  
 FIG. 200. *Bledius ferratus*; head, dorsal view; Sonora, Mexico.  
 FIG. 201. *Bledius ferratus*; head, dorsal view; New Mexico.

(fig. 224). The apex of the abdomen of the female is concolorous with the remainder of the abdomen.

SYNONYMY: As *Bledius pallipennis* and *B. gularis* are simply the female and male of the same species, they are herein synonymized. Le Conte

(1877) described the male as *B. gularis* and re-described the female as *B. pallipennis* (see Sexual Dimorphism).

HABITAT AND DISTRIBUTION: Arkansas, Illinois, Iowa, Kansas, Louisiana, Mississippi, Missouri, Nebraska, New Mexico, North Dak-

TABLE 4  
 MEASUREMENTS (IN MILLIMETERS) OF THE HEAD, THORAX, AND ELYTRA OF ADULTS OF THE SPECIES OF THE *mandibularis* GROUP  
 (The mean, standard deviation, and sample size are given in that order for each species.)

	Head Width		Interocular Width		Pronotal Width		Pronotal Length		Elytral Length		Head Width		Pronotal Width		Elytral Length									
	Mean	SD	Mean	SD	Mean	SD	Mean	SD	Mean	SD	Mean	SD	Mean	SD	Mean	SD								
<i>ferratus</i> ♀ and ♂, California	1.15	0.10	20	0.77	0.06	20	1.16	0.10	20	0.98	0.08	20	1.28	0.09	20	1.50	0.05	20	1.18	1.02	20	1.30	0.05	20
<i>ferratus</i> ♀ and ♂, Mexico	1.04	0.07	20	0.68	0.04	20	1.04	0.07	20	0.91	0.06	20	1.16	0.06	20	1.54	0.03	20	1.14	1.02	20	1.28	0.04	20
<i>ferratus</i> ♀ and ♂, New Mexico	0.97	0.06	20	0.67	0.04	20	1.01	0.08	20	0.88	0.06	20	1.17	0.08	20	1.46	0.04	20	1.14	1.03	20	1.33	0.05	20
<i>fortis</i> ♀	1.60	0.05	20	1.14	0.04	20	1.85	0.06	20	1.52	0.05	20	1.78	0.08	20	1.40	0.02	20	1.22	1.02	20	1.17	0.04	20
<i>fortis</i> ♂	1.85	0.09	20	1.33	0.07	20	2.11	0.10	20	1.67	0.07	20	1.90	0.08	20	1.39	0.02	20	1.26	1.04	20	1.13	0.04	20
<i>jacobinus</i> ♀	1.23	0.06	20	0.79	0.04	20	1.24	0.07	20	1.05	0.06	20	1.40	0.08	20	1.56	0.04	20	1.19	1.03	20	1.34	0.02	20
<i>jacobinus</i> ♂	1.35	0.12	20	0.87	0.08	20	1.38	0.15	20	1.14	0.11	20	1.45	0.12	20	1.56	0.03	20	1.22	1.03	20	1.27	0.05	20
<i>mandibularis</i> ♀ and ♂, Florida	1.69	0.08	20	1.05	0.06	20	1.81	0.10	20	1.45	0.07	20	1.83	0.06	20	1.61	0.04	20	1.25	1.02	20	1.27	0.05	20
<i>mandibularis</i> ♀ and ♂, New Jersey	1.50	0.08	20	0.97	0.06	20	1.61	0.10	20	1.29	0.08	20	1.70	0.09	20	1.53	0.03	20	1.24	1.02	20	1.32	0.04	20
<i>mandibularis</i> ♀ and ♂, New Mexico	1.33	0.14	20	0.88	0.09	20	1.42	0.15	20	1.16	0.13	20	1.42	0.13	20	1.49	0.03	20	1.22	1.04	20	1.23	0.04	20
<i>mandibularis</i> ♀ and ♂, Oklahoma	1.22	0.08	20	0.80	0.05	20	1.35	0.09	20	1.11	0.07	20	1.36	0.08	20	1.52	0.04	20	1.22	1.02	20	1.23	0.03	20
<i>mandibularis</i> ♀ and ♂, Texas	1.64	0.07	20	1.05	0.05	20	1.81	0.09	20	1.46	0.06	20	1.82	0.07	20	1.57	0.03	20	1.25	1.02	20	1.25	0.04	20
<i>mandibularis</i> ♀ and ♂, Utah	1.34	0.07	20	0.92	0.04	20	1.49	0.07	20	1.17	0.06	20	1.52	0.07	20	1.46	0.03	20	1.27	1.03	20	1.30	0.06	20
<i>pallipennis</i> ♀	1.68	0.09	20	1.04	0.06	20	1.76	0.11	20	1.35	0.07	20	1.86	0.08	20	1.59	0.02	20	1.29	1.02	20	1.38	0.04	20
<i>pallipennis</i> ♂	1.92	0.17	20	1.25	0.11	20	2.04	0.21	20	1.50	0.12	20	1.96	0.14	20	1.54	0.03	20	1.36	1.03	20	1.31	0.04	20

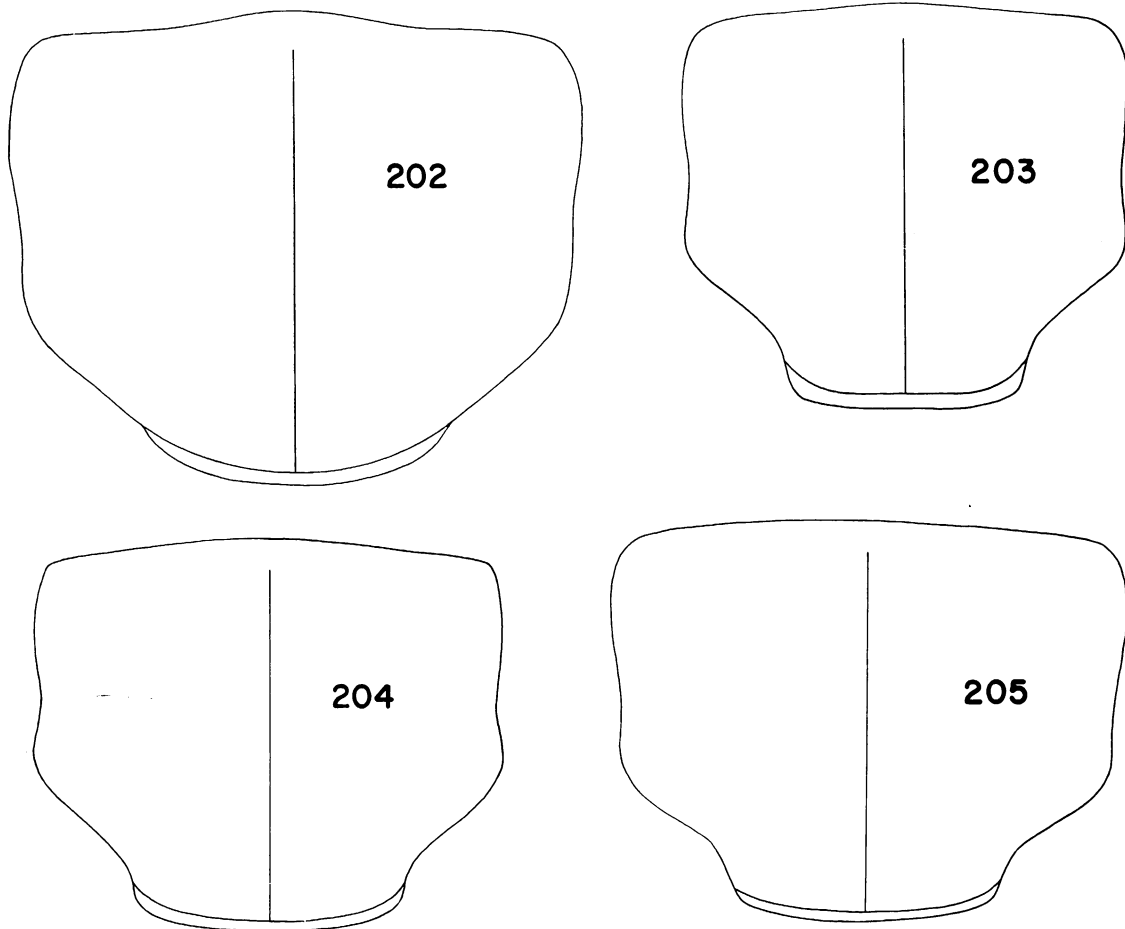

FIG. 202. *Bledius fortis*; pronotum; male.  
 FIG. 203. *Bledius ferratus*; pronotum.  
 FIG. 204. *Bledius jacobinus*; pronotum; male.  
 FIG. 205. *Bledius mandibularis*; pronotum, male.

ota, Ohio, Oklahoma, South Dakota, Texas. (See Appendix for localities.)

*Bledius pallipennis* occurs on the Mississippi drainage basin from the Mississippi west to eastern New Mexico and western Kansas, Nebraska, and South Dakota (map 7). The species is commonly found on the open, flat, moist sandy shores of large rivers of central Oklahoma, Kansas, eastern Nebraska, and the westernmost localities. At areas such as the Mississippi River at West Memphis, Arkansas, where the species is very abundant, it is also found in sand that was once wet but has dried, and even in vegetated sand banks. Generally, the species is associated with fresh water, but on

the Salt Fork of the Arkansas River at Cherokee, Oklahoma, the species was taken where some salt encrustation was evident. At the Sand Hills region of Nebraska it was collected near an alkali lake, one of the few known collections on isolated lakes. From the Mississippi River west to about central Oklahoma and Kansas and eastern Nebraska, the species is extremely to moderately abundant. Farther west the species is infrequent. The southern populations are larger and more widely distributed over the habitat than are the northern populations.

It should be recognized that, although abundant along the Mississippi River and many of its tributaries, the species has not been collected

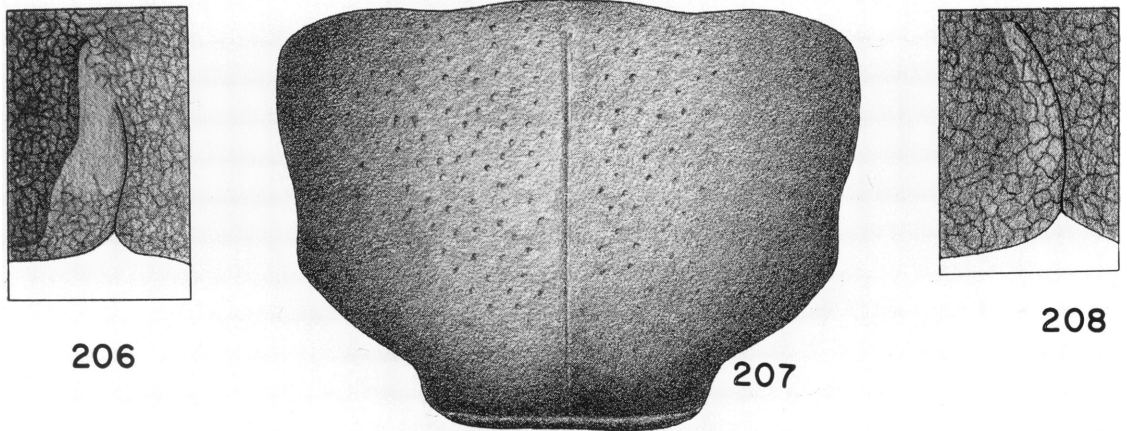

FIG. 206. *Bledius mandibularis*; procoxal fissure with preceding ridge and surrounding ground sculpturing, lateral view.

FIG. 207. *Bledius pallipennis*; pronotum; male.

FIG. 208. *Bledius ferratus*; procoxal fissure with preceding ridge and surrounding ground sculpturing, lateral view.

along the Tennessee River even though the author made several attempts to do so.

The species has been collected from June through early September at most of the localities. It is probable that the species is active throughout the year in some parts of its range, particularly in the southern United States.

The species is attracted to black lights.

**DISCUSSION:** Based on Say's (1823) description of *Bledius pallipennis*, there is no question that he was describing the species discussed above and only slight doubt that he was describing the female. The only species of the size and elytral color from the Platte and Missouri rivers juncture that Say could have found is *B. pallipennis*. Say mentioned the presence of tubercles on the anterior margin of the clypeus; these are small and might be difficult to see on a female. The clypeal tubercles of the male are larger and easier to see, but since Say does not mention the black-tipped abdomen that is characteristic of the male, the specimen studied by Say was probably a female with well-developed clypeal tubercles.

#### *Bledius fortis* Le Conte

Figures 194, 195, 202, 210, 218, 219, 222, 229, 231, 235, 276-278, 282-284, 289, 297, 298, 317, 318, 320-322; Map 8; Table 4

*Bledius fortis* LE CONTE, 1877, p. 219 (type locality: Texas, Galveston; holotype: deposited in the

Museum of Comparative Zoology, Cambridge, Massachusetts. Type examined, male).

**DIAGNOSIS:** This species is the only one in the *mandibularis* group that is black with bright brownish red elytra. The setae on the dorsum of the head, pronotum, and elytra are short and bristle-like (fig. 218). The surface of the submentum of the male is modified into a narrow, midlongitudinal ridge (fig. 219).

The characteristic of the submentum will allow easy separation of both the male and female of *Bledius fortis* (figs. 219, 222) from *B. pallipennis* (figs. 221, 224) and *B. jacobinus* (figs. 225, 226). The male of *B. fortis* is separated from *B. mandibularis* and *B. ferratus* by characters of submentum (compare fig. 219 with figs. 220, 223, 227, 228) with the support of the color and pubescence (compare fig. 218 with figs. 214-217). The female of *B. fortis* can be separated from the two last species by the color and pubescence.

**DESCRIPTION:** *mandibularis* group.

Length 9.0 to 12.0 mm.

Dorsum of head, clypeus, labrum, and venter of head dark blackish red. Lateral sides of head black. Mandible, maxilla, labium, and antenna dark reddish brown. Pronotum reddish black. Prohypomeron and prosternum dark reddish brown. Elytron concolorous bright brownish red. Pterothoracic sterna and pleura and legs dark reddish brown. Abdominal terga, paratergite,



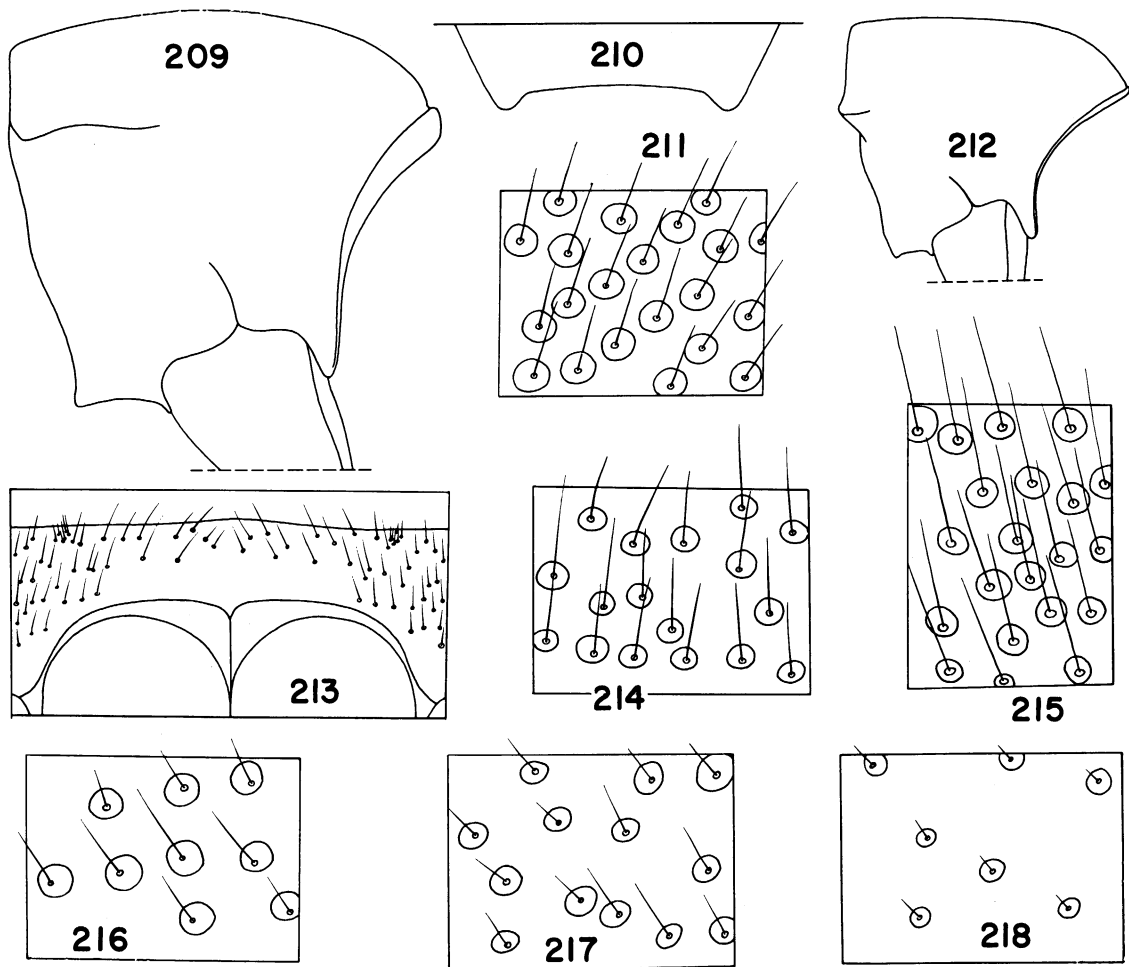
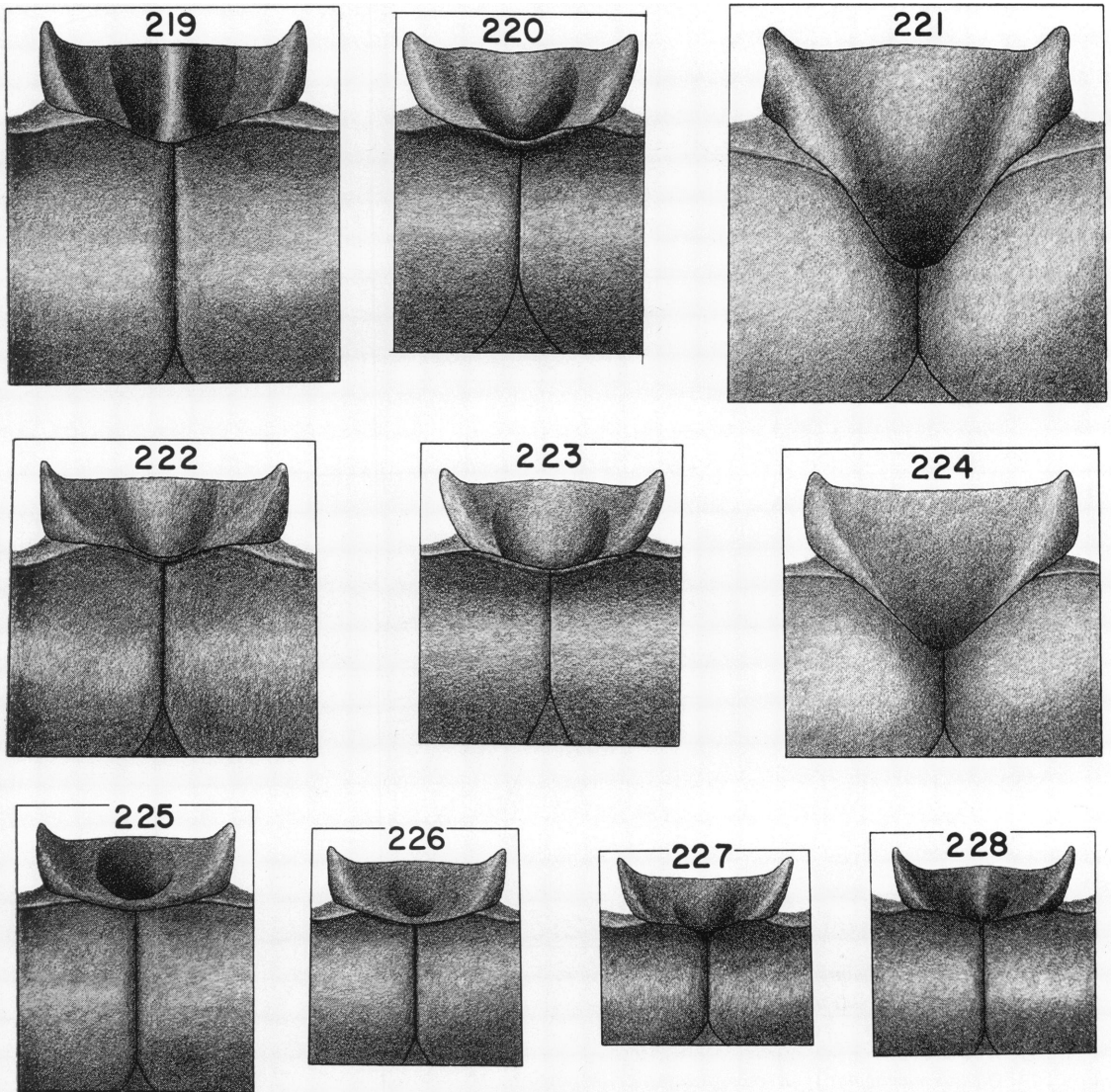

FIG. 209. *Bledius mandibularis*; prothorax; lateral view.  
 FIG. 210. *Bledius fortis*; tergum VIII; apex.  
 FIG. 211. *Bledius jacobinus*; pronotal setae.  
 FIG. 212. *Bledius ferratus*; prothorax, lateral view.  
 FIG. 213. *Bledius mandibularis*; prosternum, anterior portion.  
 FIG. 214. *Bledius ferratus*; pronotal setae; coastal Sonora, Mexico.  
 FIG. 215. *Bledius ferratus*; pronotal setae; New Mexico.  
 FIG. 216. *Bledius mandibularis*; pronotal setae; New Mexico.  
 FIG. 217. *Bledius mandibularis*; pronotal setae; coastal Texas.  
 FIG. 218. *Bledius fortis*; pronotal setae.

and parasternite black; abdominal sternites dark reddish brown.

Dorsum of head opaque, not polished, with dense microgranulate ground sculpturing (as in fig. 325), and with moderately dense, moderately deep, setigerous punctation (figs. 194, 195); punctation absent along midlongitudinal strip from depression anteriorly to epistomal suture (figs. 194, 195); punctation denser laterally and

basally than anteriorly and medially (figs. 194, 195); pubescence short and bristle-like (fig. 218); dorsum of head of male broad and depressed (fig. 195); male with midlongitudinal groove, groove shallow to deep (fig. 195); male with broad, oblique, ovoid depression anterior to and laterad of midlongitudinal groove (fig. 195); female with dorsum of head broad but less depressed (fig. 194) than that of male; female



- FIG. 219. *Bledius fortis*; submentum and gular region; male.  
 FIG. 220. *Bledius mandibularis*; submentum and gular region; male.  
 FIG. 221. *Bledius pallipennis*; submentum and gular region; male.  
 FIG. 222. *Bledius fortis*; submentum and gular region; female.  
 FIG. 223. *Bledius mandibularis*; submentum and gular region; female.  
 FIG. 224. *Bledius pallipennis*; submentum and gular region; female.  
 FIG. 225. *Bledius jacobinus*; submentum and gular region; male.  
 FIG. 226. *Bledius jacobinus*; submentum and gular region; female.  
 FIG. 227. *Bledius ferratus*; submentum and gular region; not sexed.  
 FIG. 228. *Bledius ferratus*; submentum and gular region; not sexed.

with shallow midlongitudinal groove (fig. 194); female with shallow, rounded depression anterior to and laterad of midlongitudinal groove (fig. 194). Supra-antennal ridge low to moderately

prominent (figs. 194, 195) and with distinct, microgranulate ground sculpturing on lateral and basal sides; dorsal surface with less distinct ground sculpturing. Epistomal suture straight

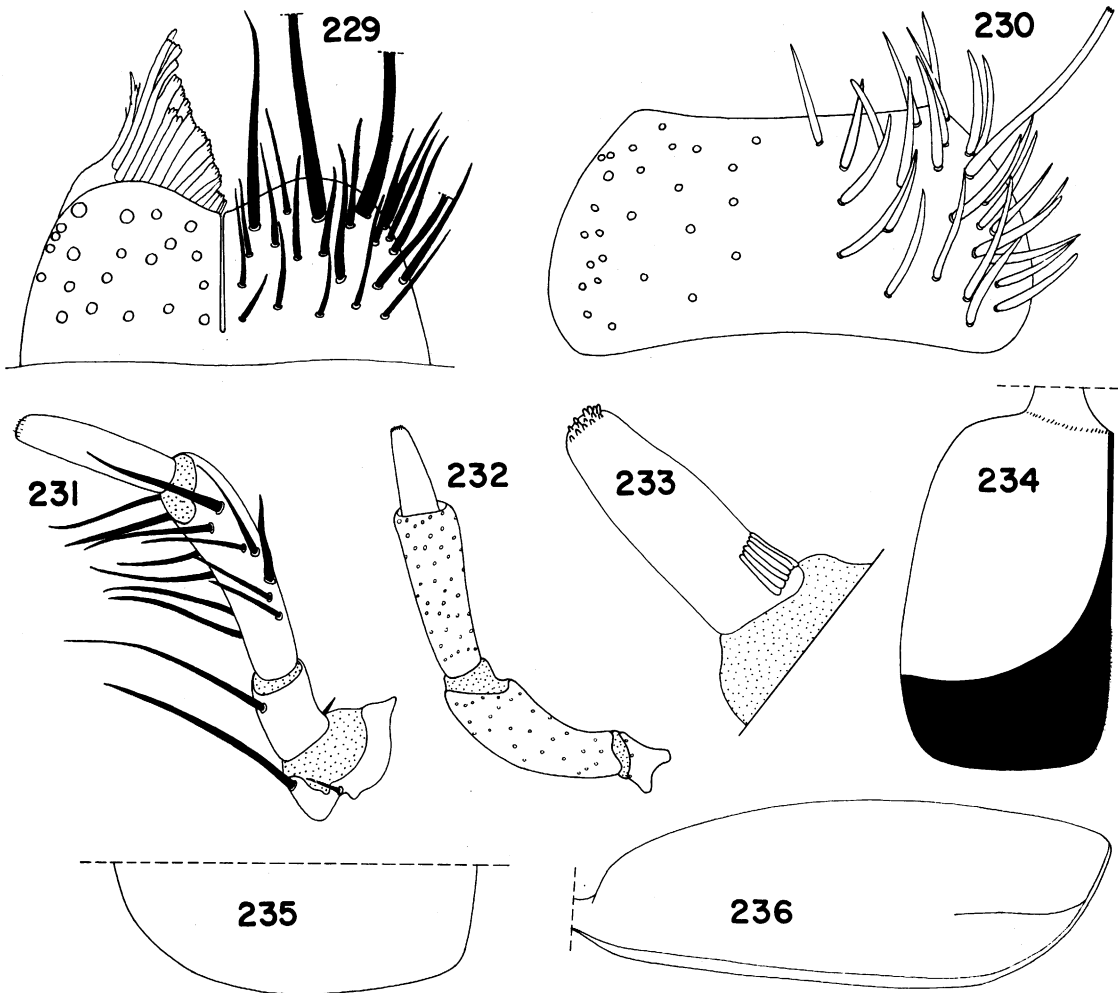

- FIG. 229. *Bledius fortis*; labrum.  
 FIG. 230. *Bledius jacobinus*; mentum.  
 FIG. 231. *Bledius fortis*; labial palpus.  
 FIG. 232. *Bledius mandibularis*; maxillary palpus; setae removed.  
 FIG. 233. *Bledius jacobinus*; fourth segment of maxillary palpus.  
 FIG. 234. *Bledius pallipennis*; left elytron; color pattern.  
 FIG. 235. *Bledius fortis*; left elytron; apex.  
 FIG. 236. *Bledius mandibularis*; left elytron, lateral view.

between supra-antennal ridges (figs. 194, 195); suture sharply angulate at juncture with supra-antennal ridge. Clypeus with microgranulate ground sculpturing (as in fig. 325) and shallow setigerous punctation; anterior margin without tubercles (figs. 194, 195). Lateral side of head with moderately broad, glabrous strip extending from base of head to posterior margin of eye. Venter of head with dense, microreticulate

ground sculpturing. Gular sutures of normal length (figs. 219, 222). Submental suture sinuate, not deeply angulate (figs. 219, 222). Width of head 1.5 to 2.0 mm.; interocular width 1.1 to 1.5 mm.; head width/interocular width 1.35 to 1.44 (table 4). Labrum with dense, microgranulate ground sculpturing (as in fig. 325) and shallow, setigerous punctation. Mandible of male (figs. 276-278) and female (figs. 282-284)

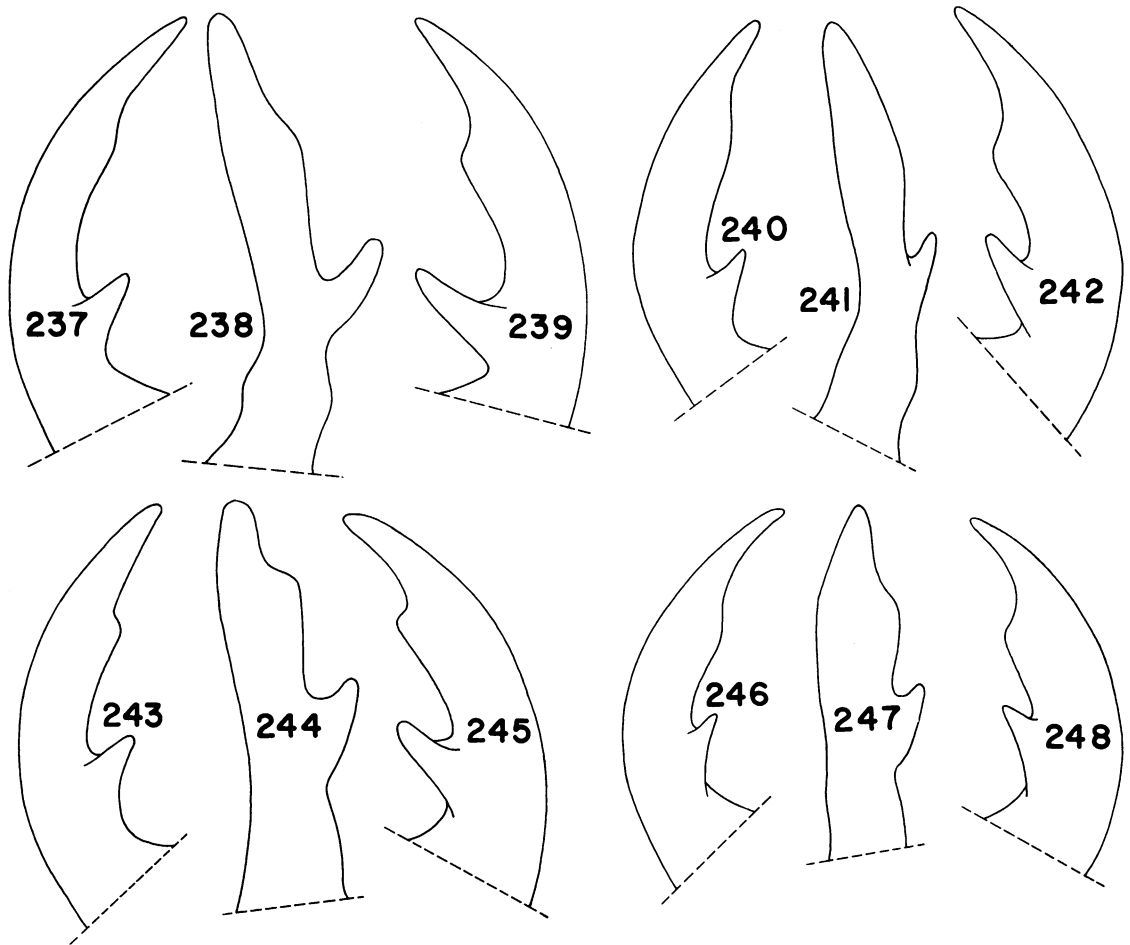

- FIG. 237. *Bledius mandibularis*; left mandible, dorsal view, male; New Jersey.  
 FIG. 238. *Bledius mandibularis*; left mandible, anterolateral view, male; New Jersey.  
 FIG. 239. *Bledius mandibularis*; right mandible, dorsal view; male; New Jersey.  
 FIG. 240. *Bledius mandibularis*; left mandible, dorsal view; female; New Jersey.  
 FIG. 241. *Bledius mandibularis*; left mandible, anterolateral view; female; New Jersey.  
 FIG. 242. *Bledius mandibularis*; right mandible, dorsal view; female; New Jersey.  
 FIG. 243. *Bledius mandibularis*; left mandible, dorsal view; male; Florida.  
 FIG. 244. *Bledius mandibularis*; left mandible, anterolateral view; male; Florida.  
 FIG. 245. *Bledius mandibularis*; right mandible, dorsal view; male; Florida.  
 FIG. 246. *Bledius mandibularis*; left mandible, dorsal view; female; Florida.  
 FIG. 247. *Bledius mandibularis*; left mandible, anterolateral view; female; Florida.  
 FIG. 248. *Bledius mandibularis*; right mandible, dorsal view; female; Florida.

bidentate; basal denticle shorter than apical (figs. 276–278, 282–284); basal denticle separated from or fused to apical denticle; apical denticle of right (figs. 278, 284) mandible broader than that of left (figs. 276, 282); male with basal denticle stout but short and not fused to apical denticle (figs. 276, 278); male with apical denticle one-half to three-fourths longer

than basal denticle (figs. 276–278); male with apical denticle broad, flattened, and bladelike (figs. 276, 278); male with mesial edge of apical denticle sinuate, right (fig. 278) more strongly sinuate than left (fig. 276); female with basal denticle more slender and shorter (figs. 282–284) than in male; female with basal denticle fused to apical denticle, but with small portion

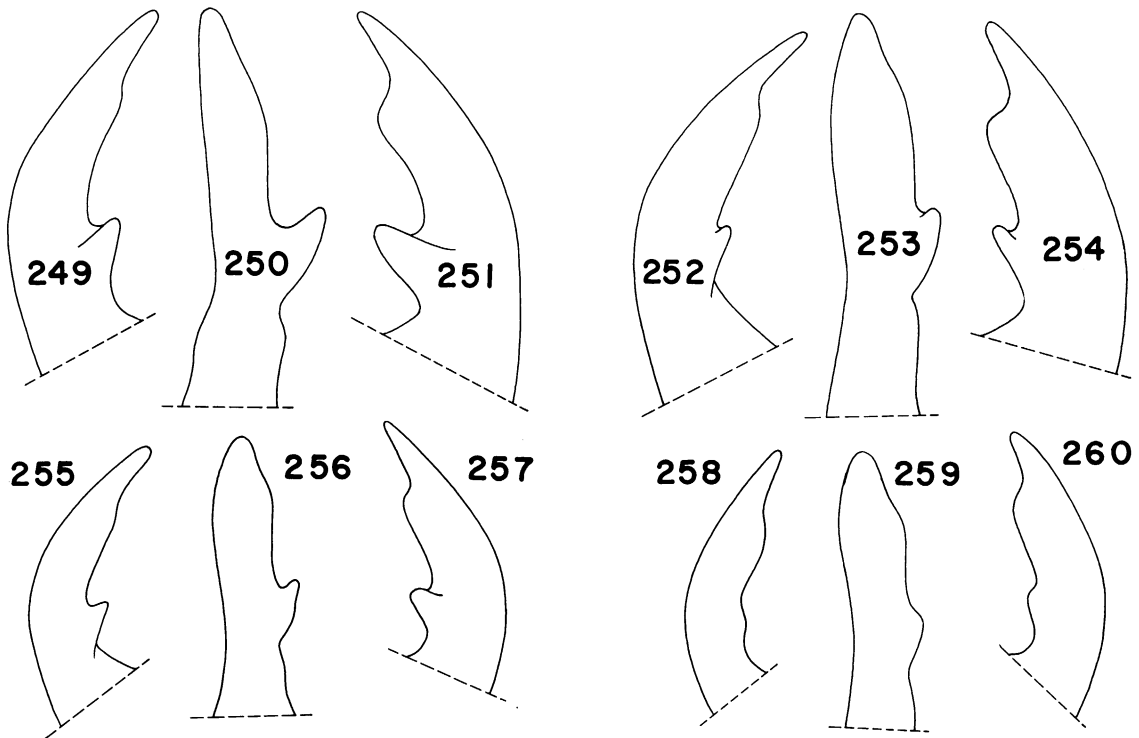
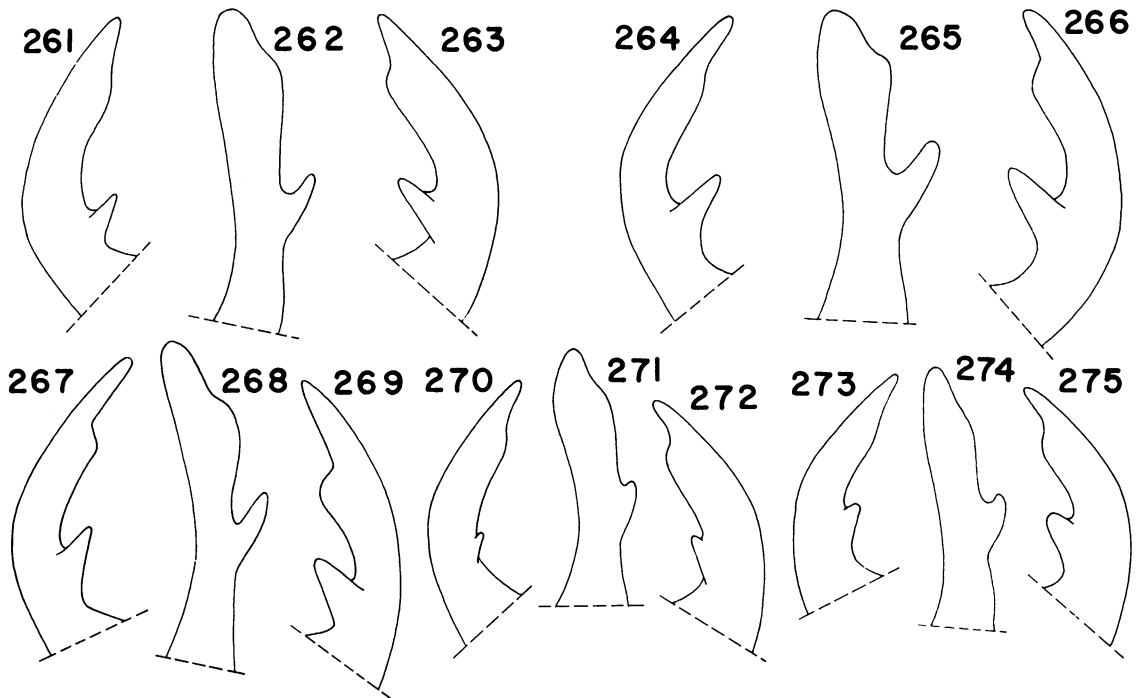

FIG. 249. *Bledius mandibularis*; left mandible, dorsal view; male; Texas.  
 FIG. 250. *Bledius mandibularis*; left mandible, anterolateral view; male; Texas.  
 FIG. 251. *Bledius mandibularis*; right mandible, dorsal view; male; Texas.  
 FIG. 252. *Bledius mandibularis*; left mandible, dorsal view; female; Texas.  
 FIG. 253. *Bledius mandibularis*; left mandible, anterolateral view; female; Texas.  
 FIG. 254. *Bledius mandibularis*; right mandible, dorsal view; female; Texas.  
 FIG. 255. *Bledius mandibularis*; left mandible, dorsal view; male; Oklahoma.  
 FIG. 256. *Bledius mandibularis*; left mandible, anterolateral view; male; Oklahoma.  
 FIG. 257. *Bledius mandibularis*; right mandible, dorsal view; male; Oklahoma.  
 FIG. 258. *Bledius mandibularis*; left mandible, dorsal view; female; Oklahoma.  
 FIG. 259. *Bledius mandibularis*; left mandible, anterolateral view; female; Oklahoma.  
 FIG. 260. *Bledius mandibularis*; right mandible, dorsal view; female; Oklahoma.

of apex separated (figs. 282, 284); right mandible of female (fig. 284) with greater length of basal denticle fused to apical denticle than on left denticle (fig. 282); female with apical denticle broad, flattened, and bladelike (figs. 282, 284); female with mesial edge of apical denticle sinuate, right (fig. 284) more strongly sinuate than left (fig. 282). Galea (fig. 289) with prominent, spinelike seta on lateral half of apex but not on or near edge; seta long and slender and slightly mesially curved; seta surrounded by and separated from more numerous, more slender, setae on dorsal, lateral, and ventral edges of lateral half; mesial half with numerous,

densely packed, mesially curved, shorter setae. Submentum of trapezoidal shape with posterior edge sinuate (figs. 219, 222); male with submentum excavated under gular region (fig. 219); submentum of male with prominent, midlongitudinal ridge (fig. 219); ridge of male with dorsal surface rounded to more acutely carinate (fig. 219); submentum of female (fig. 222) slightly excavated under gular region; excavation of female more shallow than in male; submentum of female with median, broadly rounded tumescence; tumescence in most cases nearly flat to broadly convex; base of tumescence generally modified to ridge; some



- FIG. 261. *Bledius ferratus*; left mandible, dorsal view; female; Panamint Mountains, California.  
 FIG. 262. *Bledius ferratus*; left mandible, anterolateral view; female; Panamint Mountains, California.  
 FIG. 263. *Bledius ferratus*; right mandible, dorsal view; female; Panamint Mountains, California.  
 FIG. 264. *Bledius ferratus*; left mandible, dorsal view; male; Panamint Mountains, California.  
 FIG. 265. *Bledius ferratus*; left mandible, anterolateral view; male; Panamint Mountains, California.  
 FIG. 266. *Bledius ferratus*; right mandible, dorsal view; male; Panamint Mountains, California.  
 FIG. 267. *Bledius ferratus*; left mandible, dorsal view; New Mexico.  
 FIG. 268. *Bledius ferratus*; left mandible, anterolateral view; New Mexico.  
 FIG. 269. *Bledius ferratus*; right mandible, dorsal view; New Mexico.  
 FIG. 270. *Bledius ferratus*; left mandible, dorsal view; female; Kino Bay, Mexico.  
 FIG. 271. *Bledius ferratus*; left mandible, anterolateral view; female; Kino Bay, Mexico.  
 FIG. 272. *Bledius ferratus*; right mandible, dorsal view; female; Kino Bay, Mexico.  
 FIG. 273. *Bledius ferratus*; left mandible, dorsal view; male; Kino Bay, Mexico.  
 FIG. 274. *Bledius ferratus*; left mandible, anterolateral view; male; Kino Bay, Mexico.  
 FIG. 275. *Bledius ferratus*; right mandible, dorsal view; male; Kino Bay, Mexico.

females with ridge as in male; ridge of female lower and more broadly rounded than in male.

Pronotum 1.4 to 1.8 mm. long; 1.8 to 2.2 mm. wide; pronotal width/pronotal length 1.2 to 1.4 (table 4); surface moderately strongly convex; shape as in figure 202. Pronotum opaque, not polished, with dense microgranulate ground sculpturing (as in fig. 325), and with moderately dense, moderately deep, setigerous punctation; pubescence short and bristle-like (fig. 218); surface with moderately deep, midlongitudinal groove. Pronotal lateral marginal head not quite reaching posteriorly to projected dorsal

extension of procoxal fissure. Prohypomeron with ridge anterior to procoxal fissure (as in fig. 206); ridge broad, flat, and well developed; surface of ridge opaque, not polished, with microreticulate ground sculpturing. Prohypomeron and prosternum (as in fig. 324) with microreticulate ground sculpturing and pubescence; prosternum with pubescence more dense than on prohypomeron; prosternum with broad, more densely pubescent patch anterior to procoxa (as in fig. 213). Elytra 1.6 to 2.0 mm. long; elytral length/pronotal length 1.1 to 1.2 (table 4); surface with microrugose ground

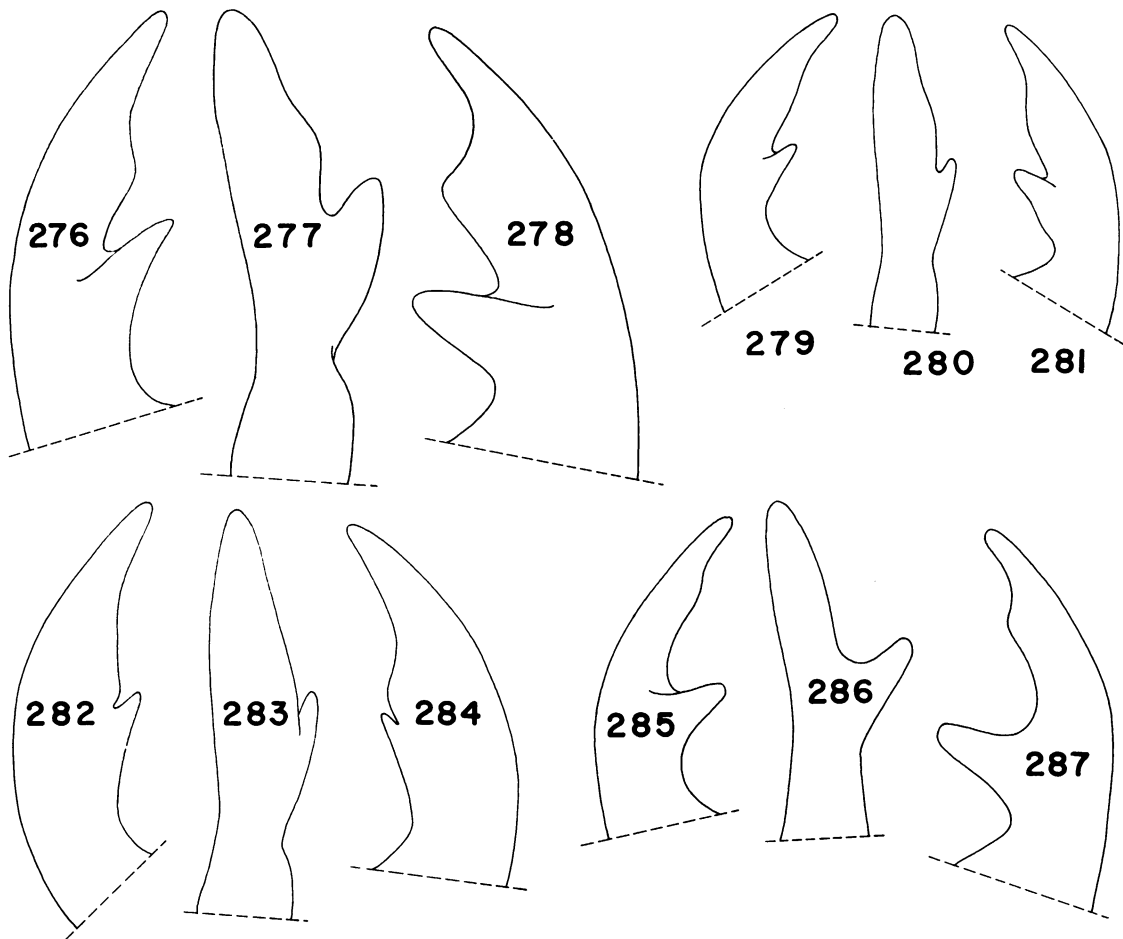

- FIG. 276. *Bledius fortis*; left mandible, dorsal view; male.  
 FIG. 277. *Bledius fortis*; left mandible, anterolateral view; male.  
 FIG. 278. *Bledius fortis*; right mandible, dorsal view; male.  
 FIG. 279. *Bledius jacobinus*; left mandible, dorsal view; female.  
 FIG. 280. *Bledius jacobinus*; left mandible, anterolateral view; female.  
 FIG. 281. *Bledius jacobinus*; right mandible, dorsal view; female.  
 FIG. 282. *Bledius fortis*; left mandible, dorsal view; female.  
 FIG. 283. *Bledius fortis*; left mandible, anterolateral view; female.  
 FIG. 284. *Bledius fortis*; right mandible, dorsal view; female.  
 FIG. 285. *Bledius jacobinus*; left mandible, dorsal view; male.  
 FIG. 286. *Bledius jacobinus*; left mandible, anterolateral view; male.  
 FIG. 287. *Bledius jacobinus*; right mandible, dorsal view; male.

sculpturing; with moderately dense, shallow setigerous punctation; pubescence short but longer and less bristle-like than that of dorsum of head and pronotum.

Abdominal segments of male and female unmodified.

Spermatheca as shown in figures 297, 298.

SEXUAL DIMORPHISM: The male has a large,

stout, strongly mesially directed dorsal denticle that is joined only by the base to the rest of the mandible (figs. 276-278). The female has a smaller, more slender, more anteriorly directed dorsal denticle that has most of its anterolateral side fused to the rest of the mandible so only the very apex is free (figs. 282-284).

The dorsum of the head of the male (fig. 195)

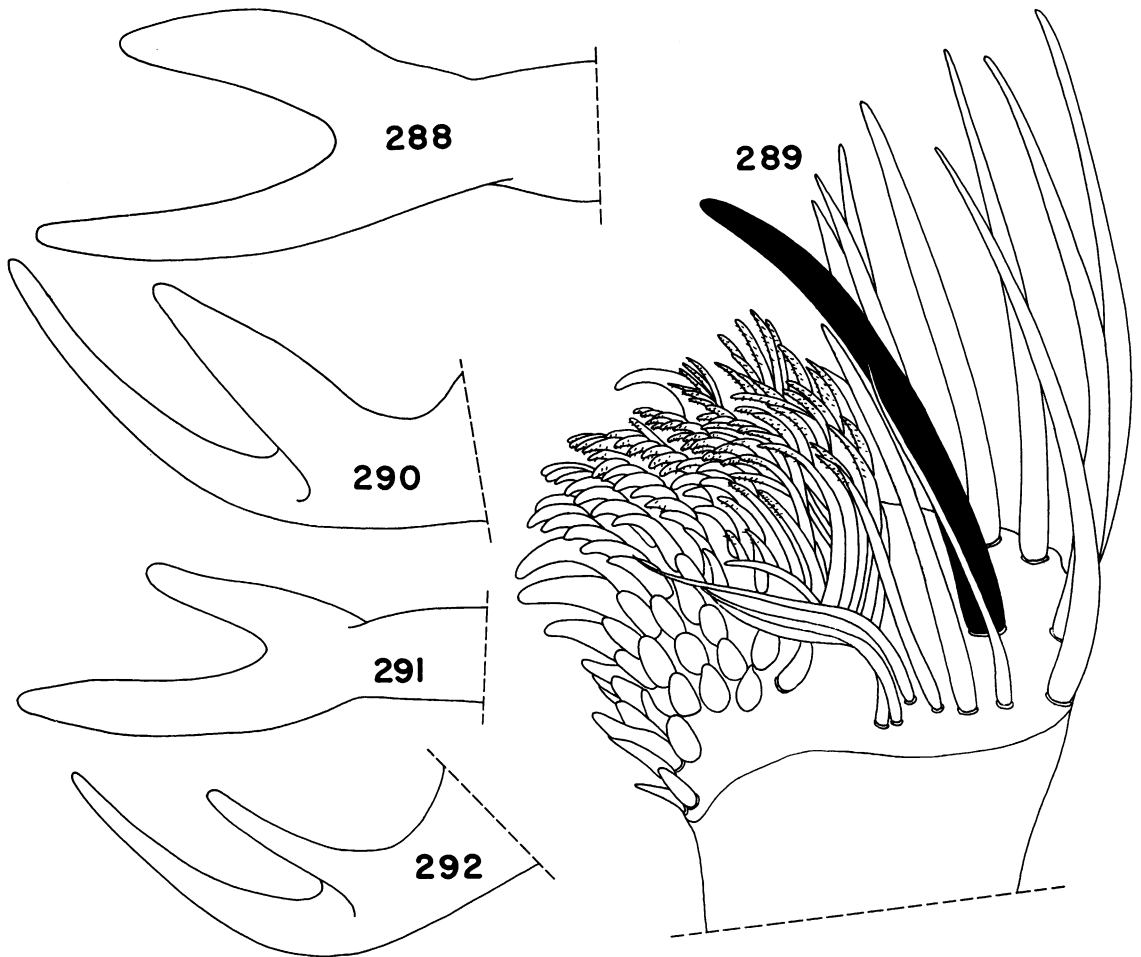

FIG. 288. *Bledius pallipennis*; left mandible, anterolateral view; male.

FIG. 289. *Bledius fortis*; galea, apex.

FIG. 290. *Bledius pallipennis*; left mandible, dorsal view; male.

FIG. 291. *Bledius pallipennis*; left mandible, anterolateral view; female.

FIG. 292. *Bledius pallipennis*; left mandible, dorsal view; female.

is usually more deeply depressed than on the female (fig. 194), and the midlongitudinal groove usually more prominent.

The submentum of the male is deeply excavated on each side of a midlongitudinal ridge (fig. 219). The ventral surface of the ridge is narrow and rounded (fig. 219). The submentum of the female is not so deeply excavated as that of the male and the median region is flat or occupied by a broad tumescence that is low and has a broadly rounded surface (fig. 222). The base of the tumescence is in most cases ridgelike (fig. 222). Some females have a midlongitudinal

ridge, but it is not so narrow or as high as on the male.

**HABITAT AND DISTRIBUTION:** *Bledius fortis* is known only from coastal Texas (map 8), and few collections have ever been made. When the present study was started only two specimens were known. Since then I have collected 128 specimens, two other collectors got 28, and a few specimens were found in other collections. Unfortunately, the specimens were all taken in the same general vicinity, and the collections were by black light or there was no collection data on the labels.



The species apparently is associated with the coastal habitat, and might occur farther south along the eastern coast of Mexico; Texas may be the northern part of its range.

DISCUSSION: In June, 1968, an effort to collect and locate the habitat of *B. fortis* at Goose Island State Park, Texas, was partially successful in that specimens were attracted to a black light; the habitat was not found after an intensive search of the sand flats and other moist sand areas of the sea beaches.

*Bledius ferratus* Le Conte

Figures 200, 201, 203, 208, 212, 214, 215, 227, 228, 261-275, 295, 303, 311, 312; Map 8; Table 4

*Bledius ferratus* LE CONTE, 1877, p. 220. FALL, 1901, p. 75. MOORE, 1964, pp. 273-277, 280-282 (type locality: California, San Diego; holotype: deposited in the Museum of Comparative Zoology, Harvard University, Cambridge, Massachusetts. Type examined, male).

DIAGNOSIS: The submental depression is evenly and shallowly impressed (figs. 227, 228). The narrow, elliptical depression most often has a broad, rounded, low midlongitudinal ridge (fig. 228). The depression does not excavate under the gular region (figs. 227, 228). It might be possible to confuse this species with *Bledius mandibularis* occasionally. The pubescence of *B. ferratus* is longer (compare figs. 214, 215 with figs. 216, 217) and the pronotal lateral marginal bead shorter (compare fig. 212 with fig. 209) than on *B. mandibularis*. On *B. ferratus* the broad flat ridge anterior to the procoxal fissure is not distinctly developed, and the surface has a dull shine because it is sculptured (fig. 208). Occasionally the dorsal edge is polished on *B. ferratus*. On *B. mandibularis* the broad, flat ridge anterior to the procoxal fissure is distinctly developed, and the surface is polished because the ground sculpturing is usually entirely absent (fig. 206).

For separation of *Bledius jacobinus* and *B. ferratus* see the Diagnosis under *B. jacobinus*.

DESCRIPTION: *mandibularis* group.

Length 4.0 to 8.0 mm.

Dorsum of head and clypeus pale reddish brown to dark reddish brown to reddish black. Labrum reddish brown. Venter of head pale reddish brown to dark reddish brown with infusions of black. Mandibles dark reddish brown. Maxilla, labium, and antenna reddish brown. Pronotum dark yellowish brown to pale

reddish brown to dark reddish brown with infusions of black. Prohypomeron and prosternum reddish brown. Elytron pale to dark yellowish brown to pale reddish brown to dark reddish brown with infusions of black. Pterothoracic sterna and pleura pale reddish brown to reddish black. Legs yellowish brown to reddish brown. Abdominal terga yellowish brown to reddish brown to dark reddish brown with infusions of black; occasionally tip of abdomen paler than remainder; abdominal sternites yellowish brown to reddish brown.

Dorsum of head opaque, not polished, with microgranulate ground sculpturing (as in fig. 325) and shallow, moderately dense, setigerous punctation (figs. 200, 201); pubescence moderately long (fig. 214) to long (fig. 215); punctation absent from midlongitudinal strip (figs. 200, 201); punctation uniformly dense; dorsum of head broad and flat (figs. 200, 201) to slightly depressed to more narrow and strongly convex, and with midlongitudinal groove (figs. 200, 201) occasionally with slight depression anterior to and laterad of midlongitudinal groove; dorsum of head of male and female not distinctly dimorphic. Supra-antennal ridge low to slightly prominent (figs. 200, 201); dorsal surface, base and sides with microgranulate ground sculpturing; apex of dorsal surface with only slight ground sculpturing. Epistomal suture straight between supra-antennal ridges (figs. 200, 201); suture sharply angulate at juncture with supra-antennal ridge. Clypeus with microgranulate ground sculpturing (as in fig. 325), shallow, setigerous punctation, and with apical or subapical tubercles or with slight, subapical, tumescence laterad of midline. Lateral side of head with narrow glabrous strip extending from base of head to posterior margin of eye. Venter of head with microreticulate ground sculpturing. Gular sutures of normal length (figs. 227, 228). Submental suture sinuate, not deeply angulate (figs. 227, 228). Width of head 0.8 to 1.4 mm.; interocular width 0.6 to 0.9 mm.; head width/interocular width 1.4 to 1.6 (table 4). Labrum with microgranulate ground sculpturing (as in fig. 325); with shallow, setigerous punctation. Mandible bidentate (figs. 261-275); basal denticle short and slender; apical denticle broad, strongly flattened, and bladelike; right mandible (figs. 263, 266, 269, 272, 275) with apical denticle broader than left (figs. 261, 264, 267, 270, 273); apical denticle with mesial

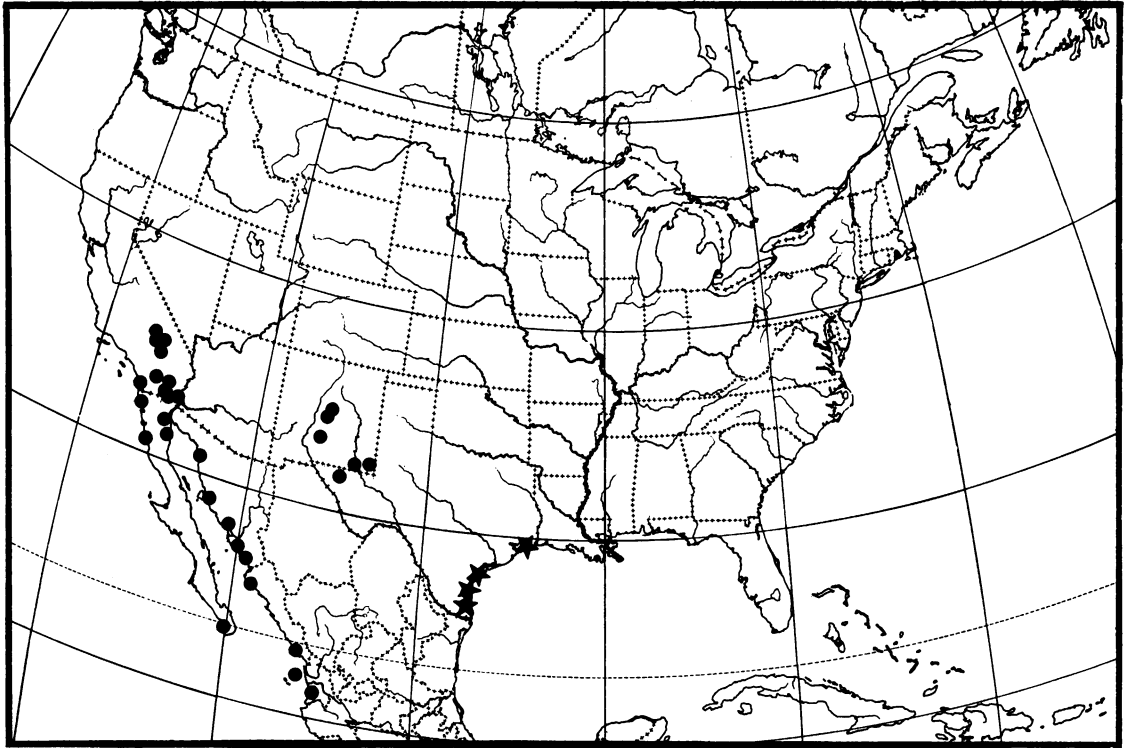

MAP 8. Distribution of *Bledius fortis* (stars) and *B. ferratus* (black dots).

surface sinuate; male with basal denticle more distinctly separated from apical denticle than in female. Galea (fig. 295) with prominent, spine-like seta on lateral half of apex; prominent spinelike seta long and slender but more stout and more mesially curved than remaining spines; lateral half of apex with numerous, long, slender spinelike setae on dorsal edge, these setae nearly straight or sinuate; mesial half of apex with numerous, small, slender, mesially curved seta in central region and some thick, short, mesially curved setae on dorsal edge. Submentum of trapezoidal shape, with posterior margin sinuate (figs. 227, 228); surface with narrow, elliptical depression (figs. 227, 228); surface with distinct midlongitudinal ridge (fig. 228); ridge with dorsal surface rounded; ridge well developed (fig. 228) to obsolete (fig. 227); submentum not excavated under gular region or even under submental suture, although suture often well developed ridge posterior to submental depression (figs. 227, 228); male and female not obviously dimorphic.

Pronotum 0.7 to 1.1 mm. long; 0.8 to 1.4 mm.

wide; pronotal width/pronotal length 1.1 to 1.2; surface moderately strongly convex; shape as in figure 203. Pronotum opaque, not polished, with microgranulate ground sculpturing (as in fig. 325), and dense, moderately deep, setigerous punctation; pubescence moderately long (fig. 214) to long (fig. 215); surface with moderately deep, midlongitudinal groove. Pronotal lateral marginal bead short (fig. 212); bead not reaching posteriorly to projected dorsal extension of procoxal fissure (fig. 212). Prohypomeron with poorly to moderately well developed, broad, flat ridge anterior to procoxal fissure (fig. 208); surface of ridge opaque and with microreticulate ground sculpturing or in some cases polished on dorsal edge and without ground sculpturing (fig. 208). Prohypomeron and prosternum (as in fig. 324) with microreticulate ground sculpturing and pubescence; pubescence longer and more dense on prosternum than on prohypomeron; prosternum with broad patch of more dense pubescence anterior to procoxae (as in fig. 213). Elytra 1.0 to 1.5 mm. long; elytral length/pronotal length 1.2 to 1.4; surface with

microrugose ground sculpturing and with moderately dense, weak, setigerous punctation; pubescence moderately long.

Abdominal segments of male and female unmodified.

Spermatheca as shown in figure 303.

**SEXUAL DIMORPHISM:** This species appears to have no externally visible sexually dimorphic characteristics.

**HABITAT AND DISTRIBUTION:** *Mexico:* Baja del Norte, Nayarit, Sinaloa, Sonora. *United States:* California, New Mexico, Texas. (See Appendix for localities.)

*Bledius ferratus* is known from coastal California, from coastal Baja California, and from coastal Mexico as far south as Nayarit. Two inland areas have large populations of the species, one in southern California and the other in central and southeastern New Mexico (map 8). The populations are treated under the Discussion.

On the coast of northern Baja California on a salt marsh in the vicinity of a lagoon, *Bledius ferratus* occurs in salt-encrusted muddy sand which supports a lush growth of *Salicornia* sp. Adults and larvae are found between 1 and 4 inches below the surface. The species is less common in the areas without *Salicornia* (Moore, 1964, pp. 273-274). A specimen was collected by Hugh Leech near Ballarat, California, near a warm sulfur spring.

At salt flats and lakes near Willard and Loving, New Mexico, I collected *Bledius ferratus* from very moist, open, unvegetated sand flats. At Willard the soil has an encrustation of salt, but at Loving the collection site of *B. ferratus* has no encrustation. At both areas the species is abundant in the wettest part of the habitat.

At Loving, one of only two places where *Bledius mandibularis* and *B. ferratus* are found together, the microhabitat of *B. ferratus* is more moist, in softer soil, closer to water, and unvegetated. The salt pan, if present, is deeper than that where *B. mandibularis* is found.

At Willard, New Mexico, *Bledius ferratus* is the most abundant species of *Bledius*, but at Loving *B. mandibularis* is equally numerous. Moore (1964) mentioned that *B. ferratus* is one of the most abundant species at La Misión de San Miguel, Baja California.

The species has been collected in New Mexico in May through August, and in Death Valley and on the Salton Sea during March through

July. The species is collected in Baja California from May through October, in Sonora and Sinaloa from May through August, and in Nayarit April through September.

**DISCUSSION:** As the external sexual dimorphism of this species is not distinct, it has been described under only one name. On the other hand, there is a good deal of distinct geographical variation, but until now the species has been known only from one locality.

The individuals from the populations along the Pacific and Gulf of California coasts are darkly colored. The head is reddish brown to black, the pronotum is light to dark reddish brown, the elytra reddish brown to pale reddish brown, and the abdomen is dark reddish brown to reddish brown to pale reddish brown. The pubescence is moderately long. The mandibles have reduced denticles (figs. 270-275).

The individuals from the inland populations of southern California and Baja del Norte are lightly pigmented. The head is reddish brown to light reddish brown, the pronotum is reddish brown to dark yellowish brown, the elytra are pale reddish brown to yellowish brown, and the abdomen reddish brown to yellowish brown. The pubescence is moderately long. The mandibles have large basal denticles (figs. 261-266).

The individuals of the inland populations from New Mexico and Texas are darkly pigmented. The head is nearly black to dark reddish brown, the pronotum is nearly black to dark reddish brown, the elytra are dark reddish brown to brown to yellowish brown, and the abdomen is nearly black to dark reddish brown. The pubescence is long. The mandibles have moderately large basal denticles (figs. 267-269).

Although the above characters apply in general to the populations described, there are individuals in each population that have the characteristics of another population. The only exception appears to be the absence, in the New Mexican populations, of individuals as pale as those from inland, southern California. Only in the populations from New Mexico is the pubescence long.

#### *Bledius mandibularis* Erichson

Figures 196, 198, 205, 206, 209, 213, 216, 217, 220, 223, 232, 236, 237-260, 293, 299, 304-310;  
Map 9; Table 4

*Bledius mandibularis* ERICHSON, 1840, p. 765. LE

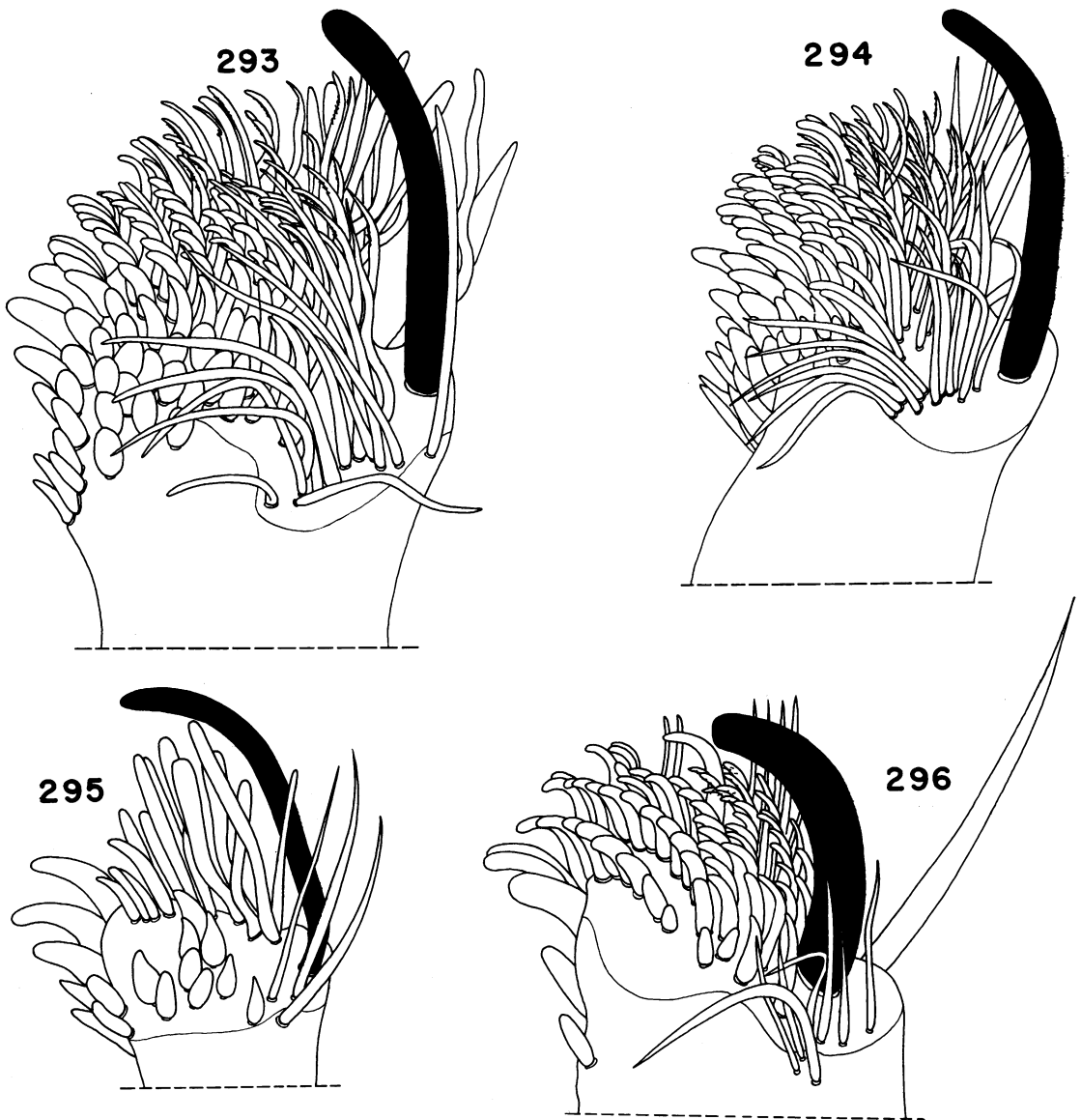

FIG. 293. *Bledius mandibularis*; galea, apex.

FIG. 294. *Bledius jacobinus*; galea, apex.

FIG. 295. *Bledius ferratus*; galea, apex.

FIG. 296. *Bledius pallipennis*; galea, apex.

CONTE, 1877, pp. 218, 219. CASEY, 1889, p. 42. BERNHAUER AND SCHUBERT, 1911, p. 133 (cited as junior synonym of *B. pallipennis* [Say]). LENG, 1920, p. 97 [cited as junior synonym of *B. pallipennis*]. BLACKWELDER, 1947, pp. 119–121 (not McLeay, 1873) (type locality: “America Septentrionali (?)”); holotype: I have not been able to locate the type or any type material. The specimens in the Institut

für Spezielle Zoologie und Zoologisches Museum are labeled such that it appears that the collector is Schaum rather than Chevrolat as stated in Erichson, 1840, p. 765. This material is, therefore, apparently not that used by Erichson).

*Bledius brevidens* LE CONTE, 1877, p. 218, 219, 220. Duvivier, 1883, p. 186. CASEY, 1889, p. 42. BLACKWELDER, 1947, p. 119 (cited as junior synonym of

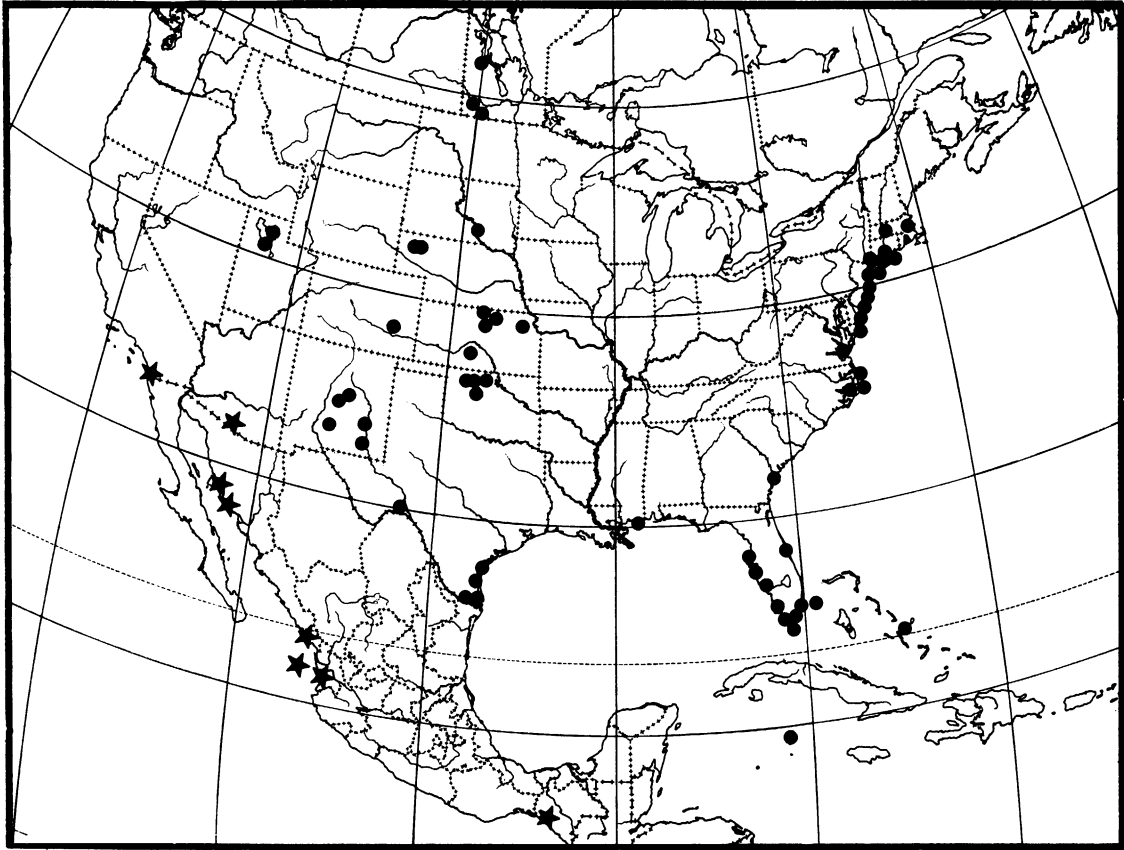

MAP 9. Distribution of *Bledius jacobinus* (stars) and *B. mandibularis* (black dots).

*B. mandibularis*) (type locality: New York; holotype: deposited in the Museum of Comparative Zoology, Cambridge, Massachusetts. Type examined, female).

**DIAGNOSIS:** The broad excavation of the submentum (figs. 220, 223) with the surface broadly tumescent to flat will separate *B. mandibularis* from the other species of the *mandibularis* group.

The submental depression of *B. mandibularis* (figs. 220, 223) and the females of *B. fortis* (fig. 222) are similar, but the species can be separated by the color patterns. The females of *B. jacobinus* (fig. 226) have a narrower more "scooped-out" submental depression than *B. mandibularis*. The character useful for separation of *B. ferratus* and *B. mandibularis* are listed in the Discussion under *B. ferratus*.

**DESCRIPTION:** *mandibularis* group.

Length 6.0 to 11.0 mm.

Dorsum of head reddish brown to dark red-

dish brown to black. Clypeus and labrum reddish brown to dark reddish brown. Venter of head reddish brown. Mandible, maxilla, labium, and antenna reddish brown. Pronotum reddish brown to dark reddish brown with infusions of black. Prohypomeron and prosternum yellowish brown to pale reddish brown. Elytron pale reddish brown to yellowish brown with disk broadly infused with brown. Pterothoracic sterna and pleura pale reddish brown to dark reddish brown with infusions of black. Legs pale reddish brown to dark reddish brown. Abdomen reddish brown to dark reddish brown with broad infusions of black.

Dorsum of head opaque, not polished, with microgranulate ground sculpturing (as in fig. 325), and with moderately dense, moderately deep, setigerous punctation (figs. 196, 198); punctation absent from broad strip around and anterior to midlongitudinal groove (figs. 196,

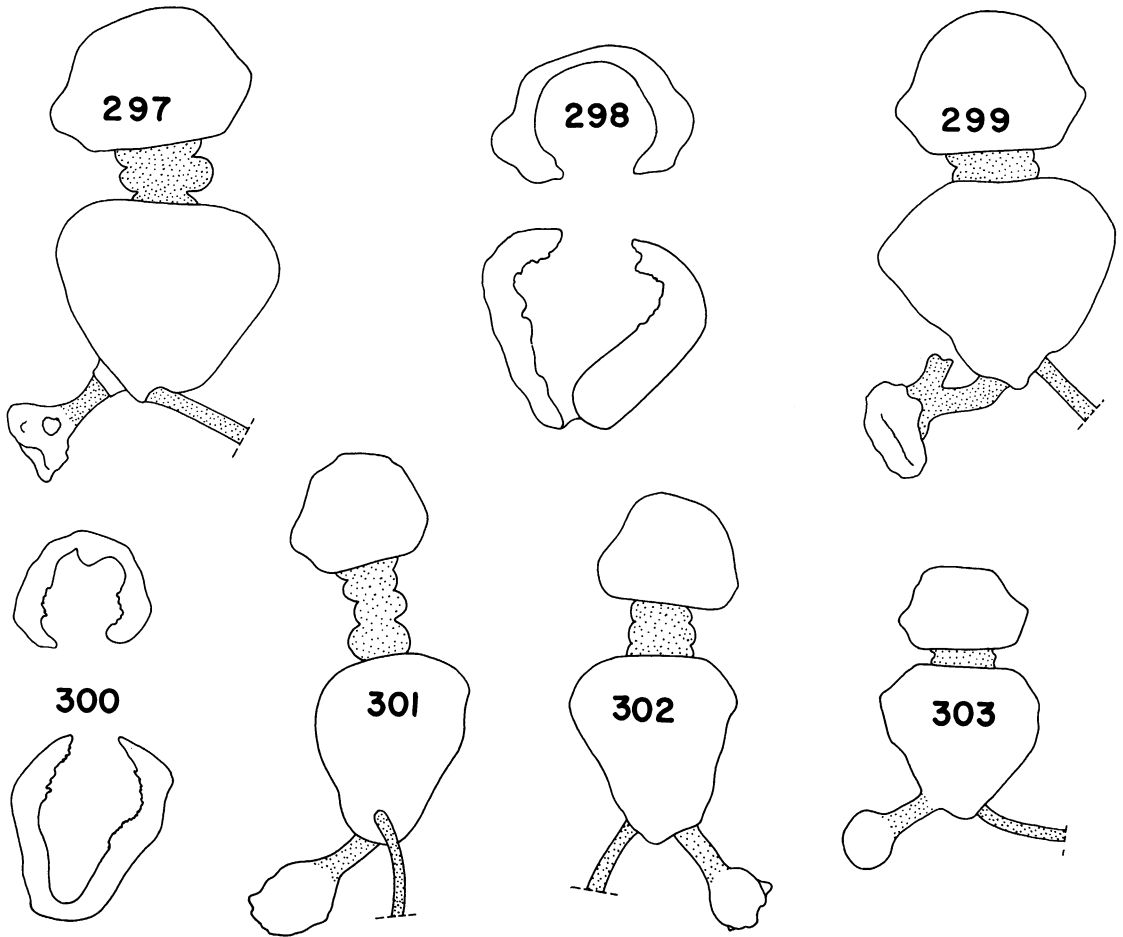

FIG. 297. *Bledius fortis*; spermatheca.  
 FIG. 298. *Bledius fortis*; spermatheca, cross section.  
 FIG. 299. *Bledius mandibularis*; spermatheca.  
 FIG. 300. *Bledius pallipennis*; spermatheca, cross section.  
 FIG. 301. *Bledius pallipennis*; spermatheca.  
 FIG. 302. *Bledius jacobinus*; spermatheca.  
 FIG. 303. *Bledius ferratus*; spermatheca.

198); pubescence short to moderately long (figs. 216, 217); surface with well-developed midlongitudinal groove (figs. 196, 198); males in most cases with broad, moderately deep to shallow, oblique depression anterior to midlongitudinal groove (fig. 196); female with region anterior to midlongitudinal groove flat, obsoletely depressed (fig. 198) or obsoletely convex. Supra-antennal ridge low to moderately prominent (figs. 196, 198); basal and lateral surfaces with microgranulate ground sculpturing; dorsal surface with or without micro-

granulate ground sculpturing and with surface opaque or polished. Epistomal suture straight between supra-antennal ridges (figs. 196, 198); suture sharply angulate at juncture with supra-antennal ridge. Clypeus with microgranulate ground sculpturing (as in fig. 325) and shallow, setigerous punctation, and often with apical or subapical tubercles. Lateral side of head with narrow, glabrous strip extending from base of head to posterior margin of eyes. Venter of head with microreticulate ground sculpturing. Gular sutures of normal length (figs. 220, 223). Sub-

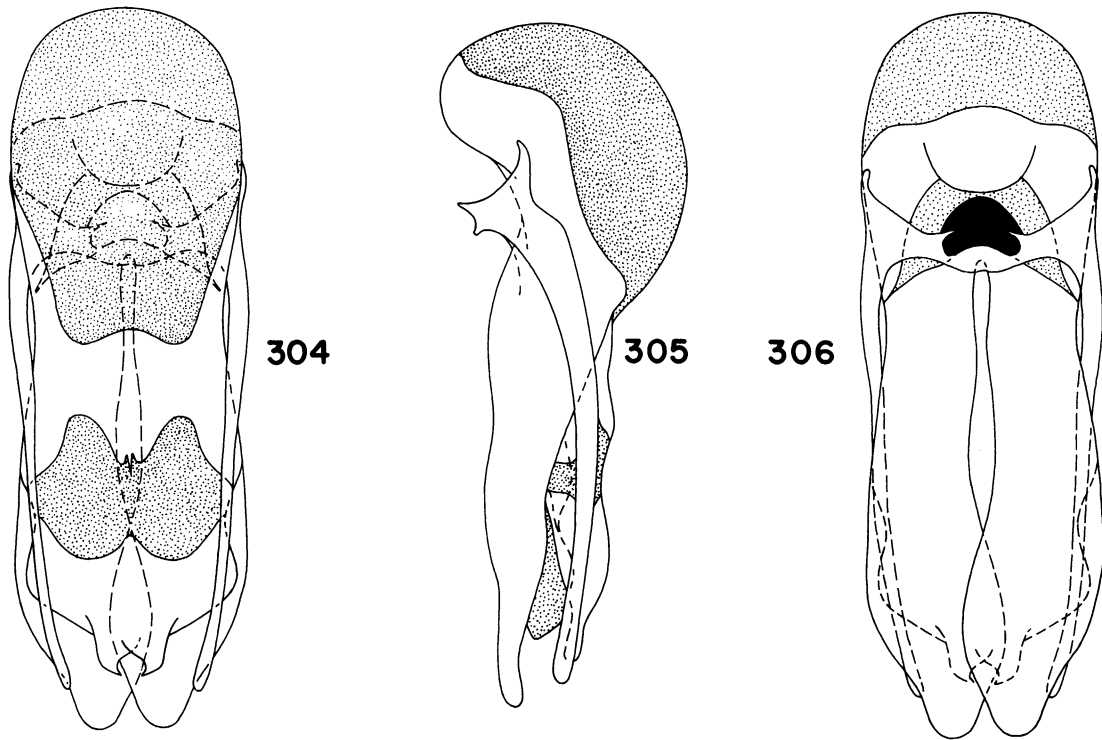

FIG. 304. *Bledius mandibularis*; aedeagus, dorsal view.  
 FIG. 305. *Bledius mandibularis*; aedeagus, lateral view.  
 FIG. 306. *Bledius mandibularis*; aedeagus, ventral view.

mental suture broadly sinuate, not deeply angulate (figs. 220, 223). Width of head 1.4 to 1.9 mm.; interocular width 0.7 to 1.2 mm.; head width/interocular width 1.4 to 1.7 (table 4). Labrum with microgranulate ground sculpturing (as in fig. 325) and shallow, setigerous punctation. Mandibles of male and female bidentate (figs. 237–260); basal denticle shorter than apical; apical denticle broad, flattened and bladelike; apical denticle of right mandible broader than that of left; apical denticle with mesial edge sinuate; basal denticle of male short, but stout and separated from apical denticle (figs. 237–239, 243–245, 249–251, 255–257); basal denticle of female shorter, more slender and more acute than male and fused to or separated from apical denticle (figs. 240–242, 246–248, 252–254, 258–260). Galea (fig. 293) with prominent spinelike seta on lateral edge of apex; seta long, stout, and mesially curved; dorsal edge of apex with numerous long, slender, straight setae on lateral half; mesial half of apex

with numerous, short, mesially curved setae. Submentum of trapezoidal shape with posterior margin broadly rounded (figs. 220, 223), and with broad, shallow depression; depression with surface broadly and distinctly convex to flat; male (fig. 220) with tumescence well developed usually; female (fig. 223) with submentum flat or with tumescence poorly developed; depression distinctly excavated under submental ridge (figs. 220, 223).

Pronotum 0.9 to 1.6 mm. long, 1.2 to 2.0 mm. wide; pronotal width/pronotal length 1.2 to 1.3 (table 4); surface moderately strongly convex; shape as in figure 205. Pronotum opaque, not polished with microgranulate ground sculpturing (as in fig. 325), and dense, moderately deep, setigerous punctation; pubescence short to moderately long (figs. 216, 217); with moderately deep, midlongitudinal groove. Pronotal lateral marginal bead reaching posteriorly to or nearly to projected dorsal extension of procoxal fissure (fig. 209). Prohypomerone with broad, flat



307

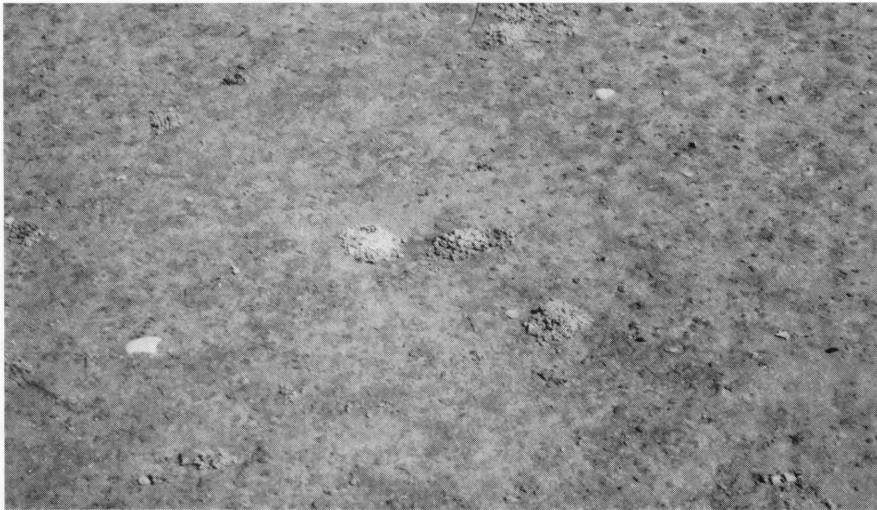

308

FIG. 307. Habitat and burrows of *Bledius mandibularis*, sand flats, Dewey Beach, Delaware.

FIG. 308. Burrows of *Bledius mandibularis*, Dewey Beach, Delaware.

ridge anterior to procoxal fissure (fig. 206); ridge distinct and well developed and surface usually polished (fig. 206), in some cases surface only shining and with weak, microreticulate ground sculpturing. Prohypomeron and prosternum with microreticulate ground sculpturing (as in fig. 324) and pubescence; pubescence more dense on prosternum than on prohypomeron; prosternum with patch of more dense

pubescence anterior to procoxae (fig. 213). Elytra 1.2 to 2.0 mm. long; elytral length/pronotal length 1.2 to 1.4 (table 4); surface with microrugose ground sculpturing; with moderately dense, shallow, setigerous punctation.

Abdominal segments of male and female unmodified.

Spermatheca as shown in figure 299.



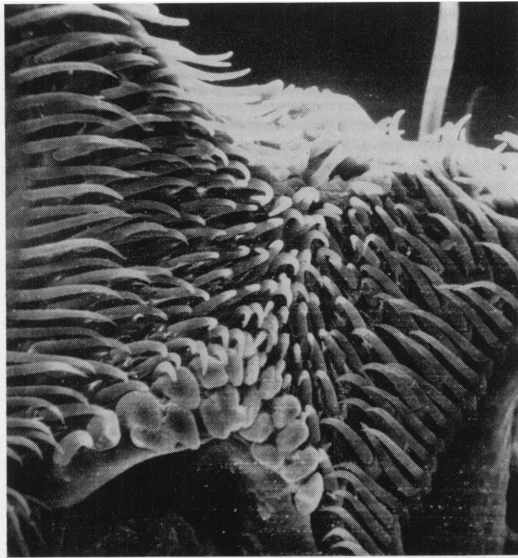

309



310

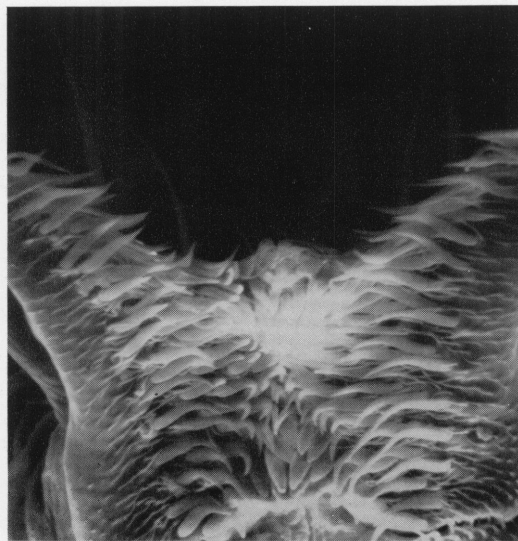

311

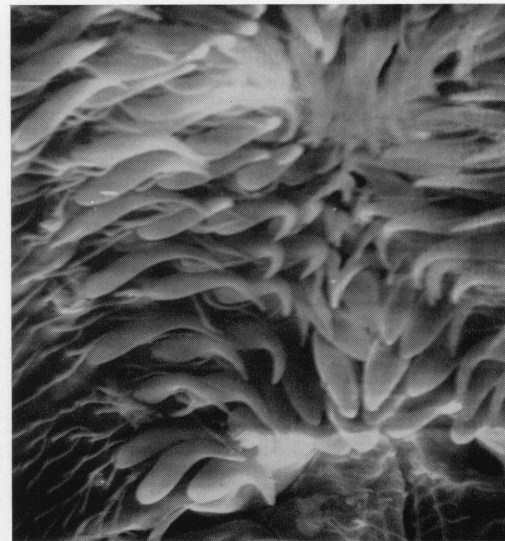

312

FIG. 309. *Bledius mandibularis*; adoral surface of labium.  $\times 400$ .

FIG. 310. *Bledius mandibularis*; median region of adoral surface of labium.  $\times 4000$ .

FIG. 311. *Bledius ferratus*; adoral surface of labium.  $\times 360$ .

FIG. 312. *Bledius ferratus*; median region of adoral surface of labium.  $\times 7600$ .

**SEXUAL DIMORPHISM:** The dorsum of the head of the male (fig. 196) is usually more deeply impressed than that of the female (fig. 198). The male (figs. 237–239) has the dorsal (or basal) mandibular denticle more stout and more

mesially directed than the female, in which the denticle is slender and more anteriorly directed (figs. 240–242) or reduced to a swelling or tubercle (figs. 258–260). The mesial surface of the dorsal denticle of the male is separated from

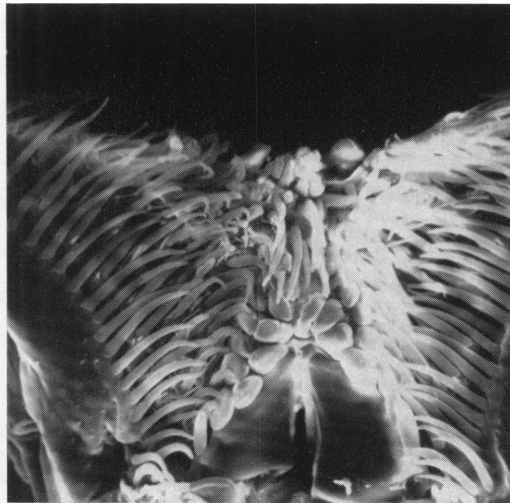

313

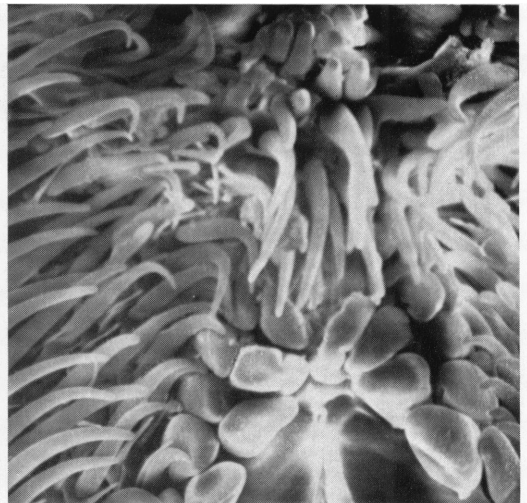

314

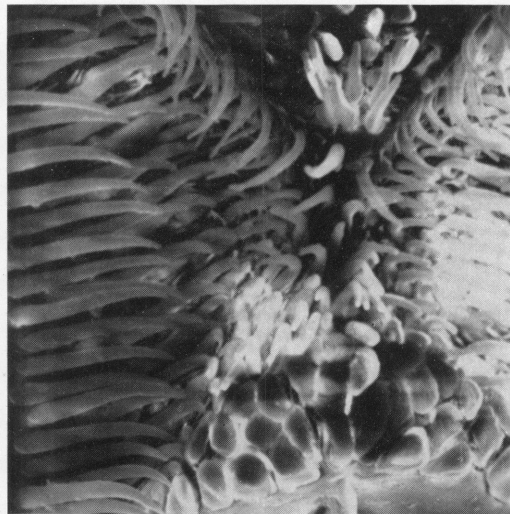

315



316

FIG. 313. *Bledius jacobinus*; adoral surface of labium.  $\times 480$ .

FIG. 314. *Bledius jacobinus*; median region of adoral surface of labium.  $\times 960$ .

FIG. 315. *Bledius pallipennis*; adoral surface of labium.  $\times 504$ .

FIG. 316. *Bledius pallipennis*; median region of adoral surface of labium.  $\times 1000$ .

the apical denticle; the mesial surface of the dorsal denticle of the female is fused partly or entirely to the apical denticle. The submentum of the male (fig. 220) is more deeply impressed and the broad, flat tumescence more strongly developed than in the female (fig. 223) where the submentum is evenly excavated and often flat or the tumescence not so strongly developed

as in the males from the same population.

Because of geographical variation of the characters, the features useful for distinguishing the sexes can only be applied to individuals within the same population (for example, compare the mandibles in figures 237-260 between sexes from the same locality, then compare the same sex between localities).

**VARIATION:** The species exhibits variation of color, sculpturing, size, and mandibular denticulation. Individuals of populations from inland salt lakes and salt flats tend to be darker, more coarsely sculptured, and smaller than those from coastal populations. Individuals from New Jersey are smaller than those from Texas and Florida and larger than those from inland localities (table 4). Individuals from Florida and Texas are almost the same size (table 4). Individuals from Utah and New Mexico are almost the same size but larger than those from Oklahoma (table 4). The mandibular denticles of males (figs. 237–239) and females (figs. 240–242) from New Jersey are longer than those of males (figs. 243–245, 249–251) and females (figs. 246–248, 252–254) from Florida and Texas. The mandibular denticles of individuals from Oklahoma are small (figs. 255–260).

**SYNONYMY:** Although Blackwelder (1947) listed *Bledius brevidens* as a junior synonym of *B. mandibularis* without giving any reasons, I have studied the holotype of *B. brevidens* and concur for the following reasons. The two were separated by slight differences of the submental excavation (Le Conte, 1877). This excavation is subject to sexually dimorphic modifications and also considerable individual variation. The flat submental excavation of *B. brevidens* falls within the limits of variation of *B. mandibularis* and suggests that the holotype of *B. brevidens* is a female.

**HABITAT AND DISTRIBUTION:** *Canada:* Manitoba. *United States:* Colorado, Connecticut, Delaware, Florida, Georgia, Kansas, Maryland, Massachusetts, Mississippi, Nebraska, New Jersey, New Mexico, New York, North Carolina, Oklahoma, South Dakota, Texas, Utah, Virginia. *West Indies:* Bahamas, Little Cayman Island. (See Appendix for localities.)

*Bledius mandibularis* occurs in saline habitats on coastal regions of the United States from Massachusetts to Texas, and on the coasts of the islands of the West Indies. The species lives on salt flats and the margins of salt lakes in the central interior United States in a broad strip from Texas to southern Manitoba and at the Great Salt Lake in Utah (map 9). I collected specimens from salt lakes or salt flats in New Mexico, Oklahoma, southern Kansas, Colorado, and Utah and on alkali lakes and alkali flats in the Sand Hills region of Nebraska.

Both coastal and inland populations prefer

bare, moist spots surrounded by vegetation, but individuals from the inland localities may be found among the vegetation. On the coastal areas *B. mandibularis* is generally on the leeward side on an island or peninsula and behind beach dunes (fig. 307) of moist flats near calm ocean water. At Little Cayman Island the species was collected near a dead mangrove swamp. On inland salt flats and along salt lakes *B. mandibularis* is sometimes close to the water, sometimes far away.

In New Mexico at the only two localities that I know of where *B. mandibularis* and *B. ferratus* overlap geographically, the latter species is the most abundant. At Loving, New Mexico, *B. mandibularis* is most commonly on the drier, vegetated parts of the saline mud flats where the salt pan is about 6 inches from the surface, and the soil is more compacted than in the areas where *B. ferratus* is found. George Ball collected it from the lower slope of an alkali dome near a trickle of water from a sulfur spring on the Herman Chandler Ranch in Texas.

At most coastal and inland localities the species burrows deeply, 5 to 10 inches, but at Shelter Island where the sand is rocky, the burrows are shallow and molelike.

The populations are often enormous. At Little Cayman Island, Blackwelder (1947) reported the collection of 25,000 specimens in 2 hours on each of two successive nights. I collected in inland areas where the population size must have been in the hundreds of thousands. The coastal populations were moderately large from Texas north to New Jersey, but at Shelter Island they were small.

On the coastal northeastern United States *Bledius mandibularis* can be collected from at least May through October. In Florida and the West Indies it can be collected all year. The species has been collected May through October in Texas and from June to September at the inland localities. It is possible that the species is active at most localities throughout the year, but most collectors are not.

The species is attracted to black lights.

**DISCUSSION:** *Bledius mandibularis* has been considered a junior synonym of *B. pallipennis* by Bernhauer and Schubert (1911) and Leng (1920). Blackwelder (1947) removed *B. mandibularis* from synonymy with *B. pallipennis*. No explanation was given for either action.

Without types there is only circumstantial

evidence suggesting that these names represent two species. Erichson's description of *B. mandibularis* stated that the mandibles are dilated and the color testaceous, without mention of black elytral apices. The apex of the mandible of *B. pallipennis* is gradually tapered and the elytral apices are black. Since there is no contradictory evidence, *B. mandibularis* and *B. pallipennis* should be considered species.

The groove on the abdominal segment IX mentioned by Le Conte as a male sexual character is simply the groove leading to the abdominal gland found in both sexes and in most genera of the Oxytelinae (Herman, 1970, pp. 350, 359, 360, fig. 72).

*Bledius jacobinus* Le Conte

Figures 197, 199, 204, 211, 225, 226, 230, 233, 279–281, 285–287, 294, 302, 313, 314; Map 9; Table 4

*Bledius jacobinus* LE CONTE, 1877, pp. 218, 220. SHARP, 1887, p. 685. FALL, 1901, p. 75. MOORE, 1964, p. 275 (type locality: California, San Diego; holotype: deposited in the Museum of Comparative Zoology, Cambridge, Massachusetts. Type studied, female).

*Bledius actus* HERMAN, 1970, p. 376 (proposed as a new name to replace *B. lecontei* Sharp; new synonym).

*Bledius lecontei* SHARP, 1887, p. 685, tab. XVIII, fig. 7. CASEY, 1889 (1889, 1890), p. 71. BLACKWELDER, 1943, p. 106; 1947, p. 120 (preoccupied by Duvivier, 1883, or Bernhauer, 1905; new synonym; type locality: Mexico, Tres Marias Islands; lectotype: designated here and so labeled on the specimen; the specimen, figured in Sharp [1887, tab. XVIII, fig. 7], has infusions of brown on the elytra and abdominal tergites. Type examined, male).

**DIAGNOSIS:** The male of this species is easily separated from all the species of the *mandibularis* group by the deep, rounded, submental depression (fig. 225). The female is usually readily recognized by the submental depression that is similar to that of the male but is more shallow and less distinctly rounded (fig. 226). When the female has a particularly shallow submental depression, the individual might be confused with *Bledius ferratus* or *B. mandibularis*. The latter species is separated by the broader submental depression that excavates under the gular region and which usually has a broad tumescence on the surface (figs. 220, 223). *Bledius ferratus* can be separated by the narrow, shallow submental depression that often has a low, rounded mid-

longitudinal ridge (fig. 228). The submental depression of *B. jacobinus* has a "scooped-out" appearance (fig. 226) whereas that of *B. ferratus* is more evenly, flatly, and shallowly impressed (fig. 227). Additional characters useful for recognition of *B. jacobinus* are the moderately long remnant of the pronotal lateral marginal bead, the moderately long pubescence (fig. 211), and the nearly flat (fig. 199) to broadly depressed dorsum (fig. 197) of the head. This last group of characters is particularly useful for separation of females of *B. jacobinus* from *B. ferratus* when confusion arises from the use of the submental depression (compare figs. 197, 199 with figs. 200, 201).

**DESCRIPTION:** *mandibularis* group.

Length 5.5 to 8.0 mm.

Dorsum and venter of head, clypeus, and labrum dark reddish brown to pale reddish brown. Mandible dark reddish brown. Maxilla and labium yellowish brown. Antenna reddish brown to yellowish brown. Pronotum, prohypomeron, and prosternum reddish brown. Elytron yellowish brown; suture reddish brown and disk with infusions of brown. Pterothoracic sterna and pleura yellowish brown. Legs yellowish brown. Abdomen pale reddish brown, occasionally with infusions of brown.

Dorsum of head opaque, not polished, with dense, microgranulate ground sculpturing (as in fig. 325), and moderately dense, moderately deep, setigerous punctation (figs. 197, 199); pubescence moderately long (fig. 211); punctation absent from midlongitudinal strip, where present more or less evenly distributed; dorsum of head of male broad and depressed (fig. 197); male with midlongitudinal groove (fig. 197); male with broad, median, moderately deep depression anterior to midlongitudinal groove (fig. 197); female with dorsum of head broad and flat to slightly depressed (fig. 199); female with shallow midlongitudinal groove (fig. 199); female with shallow, median depression anterior to midlongitudinal groove (fig. 199). Supra-antennal ridges low and not well developed (figs. 197, 199) and with microgranulate ground sculpturing on side, base, and dorsal surface but not apex. Epistomal suture straight between supra-antennal ridges (figs. 197, 199). Suture sharply angulate at intersection with supra-antennal ridge. Clypeus with microgranulate ground sculpturing (as in fig. 325), shallow, setigerous punctation, and low, rounded, subapical tubercle



317

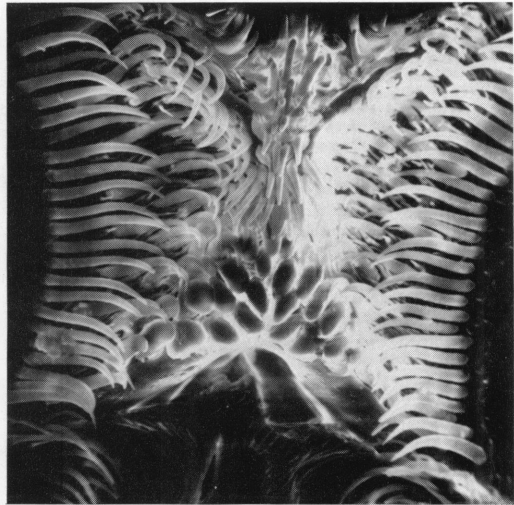

318

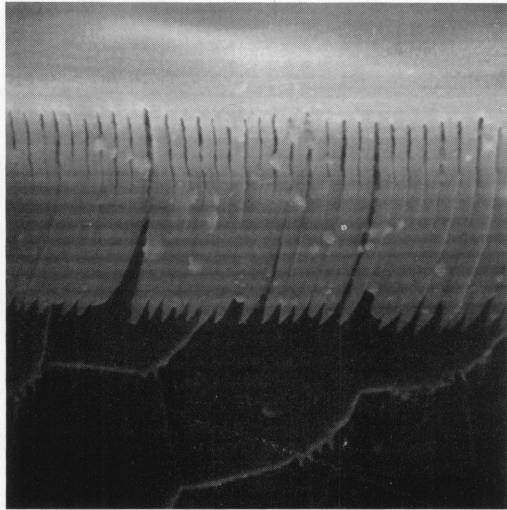

319

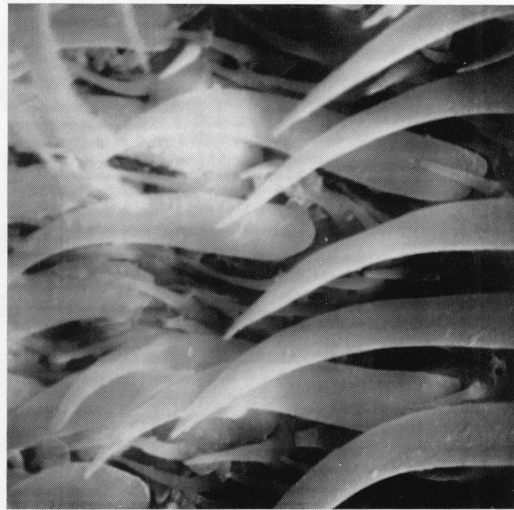

320

FIG. 317. *Bledius fortis*; adoral surface of labium.  $\times 160$ .

FIG. 318. *Bledius fortis*; adoral surface of labium.  $\times 400$ .

FIG. 319. *Bledius pallipennis*; sternite VII, posterior margin.  $\times 1440$ .

FIG. 320. *Bledius fortis*; near median region of adoral surface of labium.  $\times 1920$ .

laterad of midline (figs. 197, 199). Lateral side of head with narrow, glabrous strip extending from base of head to posterior margin of eye. Venter of head with microreticulate ground sculpturing. Gular sutures of normal length (figs. 225, 226). Submental suture sinuate, not deeply angulate (figs. 225, 226). Width of head 1.1 to 1.6 mm.; interocular width 0.7 to 1.0 mm.; head width/

interocular width 1.5 to 1.7 (table 4). Labrum with dense, microgranulate ground sculpturing (as in fig. 325) and moderately deep, setigerous punctation. Mandible of male (figs. 285–287) and female (figs. 279–281) bidentate; basal denticle shorter than apical (figs. 279–281, 285–287); basal denticle separated from or partially fused to apical denticle; male with basal denticle

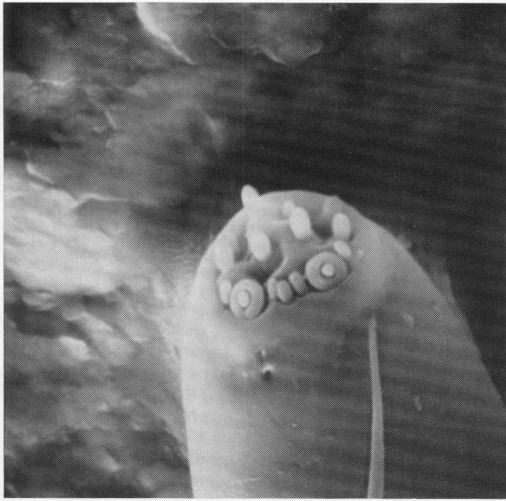

321

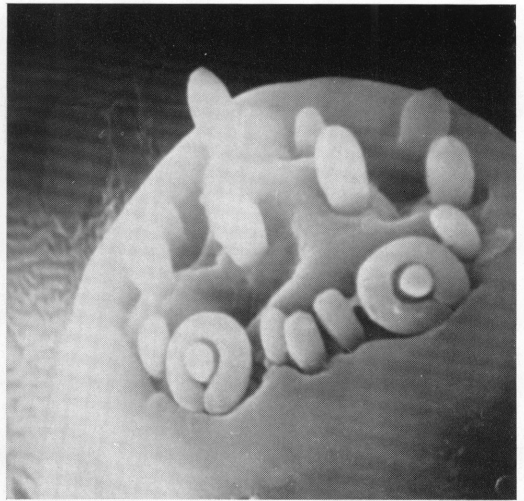

322

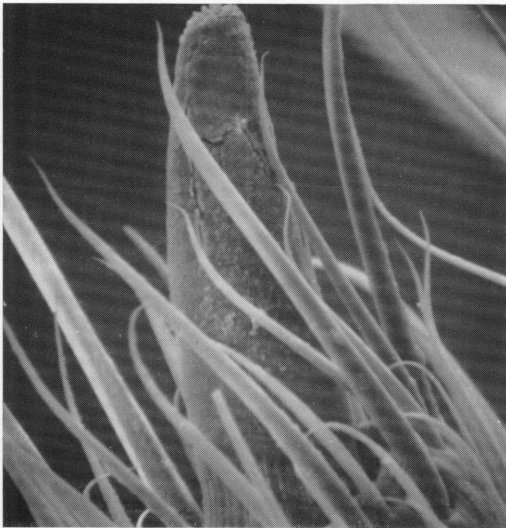

323

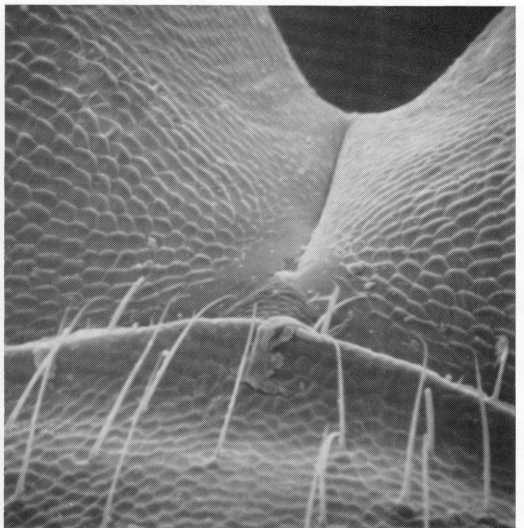

324

FIG. 321. *Bledius fortis*; third segment of labial palpus, apex.  $\times 1600$ .

FIG. 322. *Bledius fortis*; third segment of labial palpus, apex.  $\times 4000$ .

FIG. 323. *Bledius pallipennis*; fourth segment of labial palpus.  $\times 360$ .

FIG. 324. *Bledius pallipennis*; gular region and anterior portion of prosternum.  $\times 69$ .

less than one-half the length of apical denticle (figs. 285–287); male with basal denticle stouter (figs. 285–287) than that of female; male with mesial portion of apical denticle slightly flattened; male with apical denticle of right mandible (fig. 287) broader than left (fig. 285) and with mesial edge sinuate, the sinuation greater on right (fig. 287) than left (fig. 285);

female with basal denticle less than one-third as long as apical denticle (figs. 279–281); female with basal denticle fused to basal denticle with only small portion of apex free (figs. 279–281); female with apical denticle of right (fig. 281) mandible slightly broader than left (fig. 279); female with apical denticle slightly flattened and with mesial edge sinuate, that of right (fig. 281)

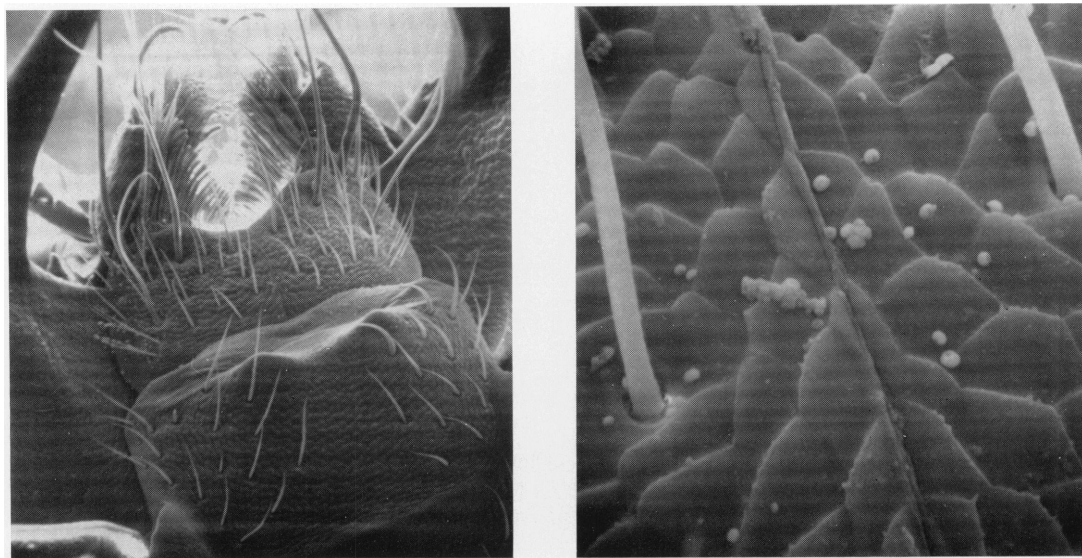

325

326

FIG. 325. *Bledius pallipennis*; clypeus and labrum.  $\times 80$ .

FIG. 326. *Bledius pallipennis*; median portion of labrum.  $\times 800$ .

mandible more than left (fig. 279). Galea (fig. 294) with stout, prominent, spinelike seta on lateral side of apex; seta long and strongly curved mesially; remainder of apex with numerous, short, mesially curved setae. Submentum of trapezoidal shape (figs. 225, 226); submentum of male with deep, prominent, round depression (fig. 225); depression of male strongly excavating under gular region (fig. 225); submentum of female with smaller, rounded, less prominent depression that excavates under gular region only slightly (fig. 226).

Pronotum 0.9 to 1.3 mm. long, 1.1 to 1.7 mm. wide; pronotal width/pronotal length 1.2 to 1.3; surface moderately strongly convex; shape as in figure 204. Pronotum opaque, not polished, with microgranulate ground sculpturing (as in fig. 325) and moderately dense, moderately deep, setigerous punctation; pubescence moderately long (fig. 211); surface with moderately deep, midlongitudinal groove. Pronotal lateral marginal bead not quite reaching projected dorsal extension of procoxal fissure. Prohypomerone with broad, flat ridge anterior to procoxal fissure; ridge poorly developed, surface opaque, not polished, and surface with microreticulate ground sculpturing (as in fig. 208); prophypo-

meron and prosternum (as in fig. 324) with microgranulate ground sculpturing and pubescence; prosternum with pubescence more dense than on prohypomerone and with broad patch of slightly more dense pubescence anterior to procoxae (as in fig. 213). Elytra 1.2 to 1.7 mm. long; elytral length/pronotal length 1.2 to 1.4; surface with microrugose ground sculpturing; with shallow, setigerous punctation; pubescence moderately long.

Abdominal segments of male and female unmodified.

Spermatheca as shown in figure 302.

**SEXUAL DIMORPHISM:** The dorsal denticle of the male is long, stout, and anteromesially directed (figs. 285–287). The submentum of the male has a deep, round depression that slightly excavates under the gular region (fig. 225).

The dorsal denticle of the female is short, slender, and mesioanteriorly directed (figs. 279–281). The submentum has a more shallow, rounded depression that only barely, if at all, excavates under the gular region (fig. 226).

**SYNONYMY:** *Bledius actus* was proposed (Herman, 1970) to replace *B. lecontei* Sharp which is preoccupied by *B. lecontei* Duvivier (1883). Duvivier proposed the name for *B. phytosinus* Le

Conte, which he mistakenly thought to be pre-occupied.

The holotype of *Bledius actus* (= *B. lecontei* Sharp) is simply the male of *B. jacobinus*. Sharp (1887) separated *B. lecontei* and *B. jacobinus* by the fact that the former has a deeper submental (fig. 225) excavation than the latter (fig. 226).

HABITAT AND DISTRIBUTION: *Mexico*: Chiapas, Nayarit, Sinaloa, Sonora. *United States*: Arizona, California. (See Appendix for localities.)

*Bledius jacobinus* is known only from San Diego, California, south along the mainland of Mexico to Chiapas, Mexico, and from one locality in southern Arizona (map 9). With further collecting it will probably be found in coastal Baja California. Ian Moore, who collected the southern California coasts intensively, never found the species and suspected the type locality was an error (Moore, 1964, p. 275). I have studied a few specimens from San Diego, but since it is rarely collected there the species may be near the northern extent of its geographical range and therefore found in a restricted microhabitat. A few hundred miles south in Mexico, *B. jacobinus* is abundant and attracted to black lights in large numbers. Patricia Vaurie (in conversation) informs me that the light to which hordes were attracted in Mazatlan, Mexico was set up on moist sand flats not far from the ocean beach. The species has been collected at this locality by a number of collectors all using lights.

The only habitat data I have is from George Ball (in a letter) who collected the species near Puerto Arista, Chiapas, Mexico. The specimens were collected a mile or so from the sea beach, on a moist, muddy, saline, sand flat that was unencrusted with salt. A small, shallow body of water was on the flat, but the species was not particularly near the water.

The species has been collected from May to September in Sinaloa and Sonora, and during March in Chiapas. The species is probably active throughout the year in Mexico.

#### SEMIFERRUGINEUS GROUP

Figures 327–451; Maps 10–17; Table 5

DIAGNOSIS: The closed procoxal fissure (fig. 369), the absence of the small, setigerous, prosternal pit (fig. 369), the presence of the pronotal lateral marginal bead (fig. 369), elytral epi-

pleural ridge (fig. 371), and protergosternal suture will distinguish this group from most of the species in the other groups. The species that pose exceptions to these characters run to couplet 13 in Key III and are discussed and separated there.

DESCRIPTION: *Bledius*. Supra-antennal horns absent in males and females (fig. 327). Clypeal tubercles only moderately developed (figs. 327, 328, 340, 344, 347). Gular sutures confluent to submentum and sharply divergent at base (fig. 375). Labrum with slight, acute, median emargination and with midlongitudinal groove continuous with emargination (fig. 374); anterior margin not or only slightly reflexed and sinuate (fig. 374). Labial palpus with second article longer than first or third (fig. 373); articles each slightly narrower than preceding article (fig. 373); basal and second article each with one seta; second article not densely pubescent on mesial surface. Premental lobes as in figures 424–437, 440, 441, 443, 444, 445, 447. Maxillary palpus as in figure 232. Galea with numerous spinelike setae (figs. 293, 296). Mandibles moderately well developed.

Pronotal shape variable (figs. 329, 330, 333, 334, 337, 338, 341–343). Pronotal horns absent in males and females (figs. 341–343). Pronotal lateral marginal bead present and entire (fig. 369). Protergosternal suture present and complete; suture and lateral marginal bead convergent apically (fig. 369). Procoxal fissure entirely closed (fig. 369). Protrochantin concealed (fig. 369). Prosternal process present (as in fig. 175). Prosternum with large patch of scattered pubescence laterad of and anterior to procoxae (fig. 369) and without small, densely setigerous pit anterior to procoxa.

Elytra with small, membranous lobe on posterior margin (fig. 370); epipleural ridge present and complete (fig. 371).

Abdomen with posterior margin of eighth tergum emarginate (fig. 394) and margin serrulate (figs. 394, 395).

Aedeagus trilobed (figs. 421–423). Median lobe acuminate apically and dorsoventrally flattened (fig. 422); base bulbous (figs. 421–423); dorsal surface of base membranous (fig. 421); median foramen on ventral surface (fig. 423); apical half of ventral surface of median lobe with apex longitudinally bisected and with membranous strip extending anteriorly from end of split (fig. 423); lateral and apical sides of



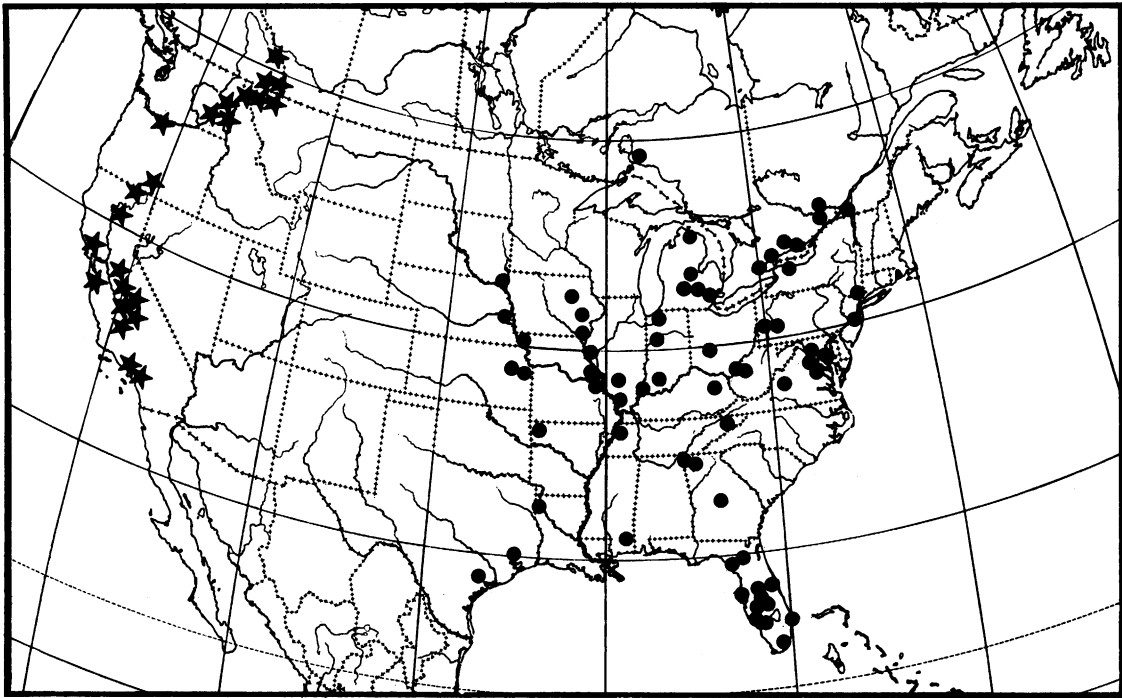

MAP 10. Distribution of *Bledius semiferrugineus* (black dots) and *B. foraminosus* (stars).

apical half of median lobe strongly sclerotized; ostium at apex. Parameres extending from ventral surface (fig. 423), anterior to median foramen, around to dorsal surface (fig. 421), enveloping dorsal surface of median lobe; parameres broad (figs. 420–423); median surface with membrane capable of inflation (fig. 423) (when parameres dried, median surface scooped out); parameres apically acuminate and longer than median lobe (figs. 421–423).

Spermatheca composed of two hatlike structures connected by membrane; one hatlike structure with deep to shallow, conical depression, other hatlike structure with small sclerite attached by membranous tube; sclerite of variable shape (figs. 406–420).

DISCUSSION: This group contains other species in the Palearctic and Neotropical regions, but in the United States and Canada includes only the following 12 species: *Bledius semiferrugineus*, *B. gravidus*, *B. fumatus*, *B. foraminosus*, *B. rotundicollis*, *B. tallaci*, *B. rubiginosus*, *B. analis*, *B. nitidicollis*, *B. philadelphicus*, *B. assimilis*, and *B. coulteri*. Superficially, *Bledius turgidus*, *B. nitidiceps*, *B. strenuus*, *B. regularis*, *B. specularis*, *B. condonensis*, *B. piceus*, and *B. opacifrons* appear to belong to

the *semiferrugineus* group, and all but *B. strenuus* were included before now because they have a protergosternal suture and a closed procoxal fissure. They are removed herein and placed in the *armatus* and *annularis* groups; their descriptions and a discussion of the characters demonstrating their phylogenetic affinities will be discussed in Parts II and III of this monograph.

#### *Bledius semiferrugineus* Le Conte

Figures 328, 330, 343, 360, 361, 374, 376, 390, 393, 396, 412, 424, 426, 427, 450, 451; Map 10; Table 5

*Bledius semiferrugineus* LE CONTE, 1863, p. 52; 1877, p. 223. CASEY, 1889, p. 52. FALL, 1910, p. 108. BLATCHLEY, 1910, p. 464. NOTMAN, 1920, p. 697 (type locality: "Middle States"; holotype: deposited in the Museum of Comparative Zoology, Harvard University, Cambridge, Massachusetts. Type examined, male).

*Bledius canaliculatus* NOTMAN, 1920, pp. 697, 698 (new synonym; type locality: Florida, Fort Myers; holotype: deposited in the American Museum of Natural History, New York. Type examined, female).

DIAGNOSIS: *Bledius semiferrugineus* can be sep-

TABLE 5  
 MEASUREMENTS (IN MILLIMETERS) OF THE HEAD, THORAX, AND ELYTRA OF ADULTS OF THE SPECIES OF THE *semiferrugineus* GROUP  
 (The mean, standard deviation, and sample size are given in that order for each species.)

	Head Width	Interocular Width	Pronotal Width	Pronotal Length	Elytral Length	Head Width		Pronotal Width		Elytral Length														
						Interocular Width	Pronotal Length	Interocular Width	Pronotal Length	Interocular Width	Pronotal Length													
<i>analis</i>	0.69	0.04	20	0.48	0.01	20	0.80	0.05	20	0.76	0.04	20	0.95	0.05	20	1.46	0.03	20	1.04	0.02	20	1.24	0.04	20
<i>assimilis</i> , northeastern United States	0.67	0.02	20	0.46	0.02	20	0.72	0.04	20	0.68	0.04	20	0.86	0.02	20	1.45	0.04	20	1.08	0.03	20	1.28	0.03	20
<i>assimilis</i> , Quebec, Ontario, New York (red elytra)	0.72	0.02	12	0.50	0.01	12	0.75	0.02	12	0.70	0.05	12	0.90	0.05	12	1.42	0.02	12	1.08	0.02	12	1.30	0.04	12
<i>coulteri</i> , Manitoba <i>coulteri</i> , western United States and British Columbia	0.71	0.04	20	0.48	0.01	20	0.78	0.04	20	0.71	0.04	20	0.96	0.04	20	1.48	0.03	20	1.08	0.02	20	1.34	0.03	20
<i>foraminosus</i>	0.69	0.02	15	0.49	0.01	15	0.75	0.04	15	0.69	0.05	15	0.92	0.05	14	1.44	0.05	15	1.08	0.02	15	1.33	0.04	14
<i>fumatus</i>	1.04	0.04	20	0.69	0.04	20	1.14	0.06	20	1.04	0.06	20	1.29	0.06	20	1.51	0.04	20	1.10	0.02	20	1.25	0.04	20
<i>gravatus</i>	1.11	0.02	20	0.70	0.02	20	1.18	0.05	20	1.04	0.04	20	1.36	0.04	20	1.61	0.04	20	1.12	0.03	20	1.31	0.03	20
<i>nitidicollis</i>	1.06	0.04	20	0.71	0.02	20	1.20	0.06	20	1.09	0.05	20	1.32	0.06	20	1.49	0.02	20	1.11	0.04	20	1.22	0.04	20
<i>philadelphicus</i>	0.65	0.02	27	0.41	0.02	27	0.72	0.04	27	0.68	0.04	27	0.89	0.05	27	1.58	0.06	27	1.08	0.02	27	1.31	0.04	27
<i>rotundicollis</i>	0.76	0.04	25	0.52	0.04	25	0.84	0.62	25	0.76	0.05	25	0.99	0.05	24	1.47	0.03	25	1.10	0.02	25	1.29	0.06	24
<i>rubiginosus</i>	1.19	0.04	20	0.75	0.02	20	1.34	0.06	20	1.12	0.05	20	1.48	0.04	20	1.59	0.02	20	1.19	0.02	20	1.30	0.04	20
<i>semiferrugineus</i>	0.99	0.05	20	0.59	0.02	20	1.04	0.08	20	0.94	0.06	20	1.19	0.06	20	1.68	0.04	20	1.11	0.02	20	1.26	0.04	20
<i>tallaci</i>	0.95	0.04	20	0.59	0.02	20	1.02	0.08	20	0.95	0.09	20	1.19	0.04	20	1.61	0.03	20	1.09	0.03	20	1.25	0.10	20
	0.96	0.08	2	0.68	0.05	2	1.10	0.08	2	1.01	0.04	2	1.28	0.04	2	1.40	0.00	2	1.06	0.00	2	1.28	0.00	2

arated from all the other members of the *semiferrugineus* group by the combination of the following characters: The dorsum of the head (fig. 328) and pronotum (figs. 330, 343) are coarsely and deeply punctate, and the integument of the pronotum is polished between the punctures (fig. 450) because it lacks microgranulate ground sculpturing. The pronotal midlongitudinal groove is well developed (figs. 330, 343). *Bledius foraminosus* is the only other species of this group with coarse punctation on the dorsum of the head (compare fig. 327), but the species is readily separated from the males of *B. semiferrugineus* by the more shallow emargination of the seventh sternite (compare fig. 396 with fig. 400), and from the females by the presence of microgranulate ground sculpturing between the punctures of the pronotum.

DESCRIPTION: *semiferrugineus* group.

Length 4.0 to 7.0 mm.

Dorsum of head and clypeus black to dark reddish brown. Venter of head black to reddish brown. Labrum, maxilla, labium, and antenna reddish brown. Pronotum black to dark reddish brown. Prohypomeron and prosternum dark reddish brown to reddish brown. Head and prothorax basically concolorous. Elytra basically red with black infusions along suture and base, but color varying from dark red with many infusions of black to bright red to yellowish brown with dark brown base and suture. Pterothoracic sterna and pleura dark reddish brown to yellowish brown. Legs reddish brown to yellowish brown. Abdomen reddish brown to yellowish brown.

Dorsum of head shining to polished between punctures (figs. 450, 451), microgranulate ground sculpturing absent (figs. 450, 451), obsolete, or distinct but sparse, with dense, coarse, deep, setigerous punctation between supra-antennal ridges (figs. 328), and with prominent middorsal tumescence (fig. 328); tumescence shining to polished (fig. 451) and without punctation except for fovea on posterior margin (fig. 328); tumescence not longitudinally divided; postocular groove weakly developed (fig. 328). Supra-antennal ridge moderately prominent (fig. 328), base and sides with setigerous punctation (fig. 328), and weak or obsolete microgranulate ground sculpturing, dorsal surface polished and impunctate. Epistomal suture broadly and moderately deeply arcuate (fig. 328); suture sharply angulate at

intersection with supra-antennal ridge. Clypeus shining; punctation strongly evident or obsolete, and with dense, distinct microgranulate ground sculpturing; surface sharply depressed from dorsum at epistomal ridge; anterior margin with small, rounded tubercle near lateral margin (fig. 328). Lateral side of head with glabrous polished strip extending from base of head to posterior margin of eye. Venter of head with dense microreticulate ground sculpturing. Width of head 0.9 to 1.0 mm.; interocular width 0.55 to 0.65 mm.; head width/interocular width 1.6 to 1.7 (table 5). Labrum with dense microgranulate ground sculpturing (as in fig. 325), with moderately dense, setigerous punctation, and with median portion of anterior margin strongly reflexed, reflexed portion narrow; anterior margin truncate. Mandibles of female bidentate (as in figs. 362, 363); denticles connate. Mandibles of male tridentate (figs. 360, 361); apical and middle denticle connate; basal denticle separated, smaller, and acute (figs. 360, 361). Antennomeres without apical encircling ridges.

Pronotum 0.8 to 1.1 mm. long, 0.9 to 1.2 mm. wide; pronotal width/pronotal length 1.0 to 1.4 (table 5) and strongly convex (figs. 330, 343); lateral margin broadly rounded from anterior margin to basal margin (figs. 330, 376) or with anterior three-fifths nearly parallel and basal two-fifths rounded (fig. 343); basal margin broadly rounded (figs. 330, 343); lateral margin of males with anterior half apically convergent and posterior half basally convergent (figs. 330, 376); basal angles obsolete (figs. 330, 340). Pronotum polished (fig. 450); microgranulate ground sculpturing absent or obsolete (fig. 450); surface with very dense to more scattered, large, coarse, setigerous punctation (figs. 330, 343); punctures larger and coarser medially and anteriorly (figs. 330, 343); punctures absent beside midlongitudinal groove (figs. 330, 343); midlongitudinal groove deep and distinct from anterior to posterior marginal beads (figs. 330, 343). Pronotal lateral marginal bead entirely visible in dorsal aspect (figs. 330, 343); bead slightly deflexed anteriorly. Prohypomeron shining with microreticulate ground sculpturing. Prosternum with microreticulate ground sculpturing. Elytra 1.1 to 1.2 mm. long; elytral length/pronotal length 1.1 to 1.4 (table 5); surface polished between punctures and with dense, coarse, setigerous punctation.

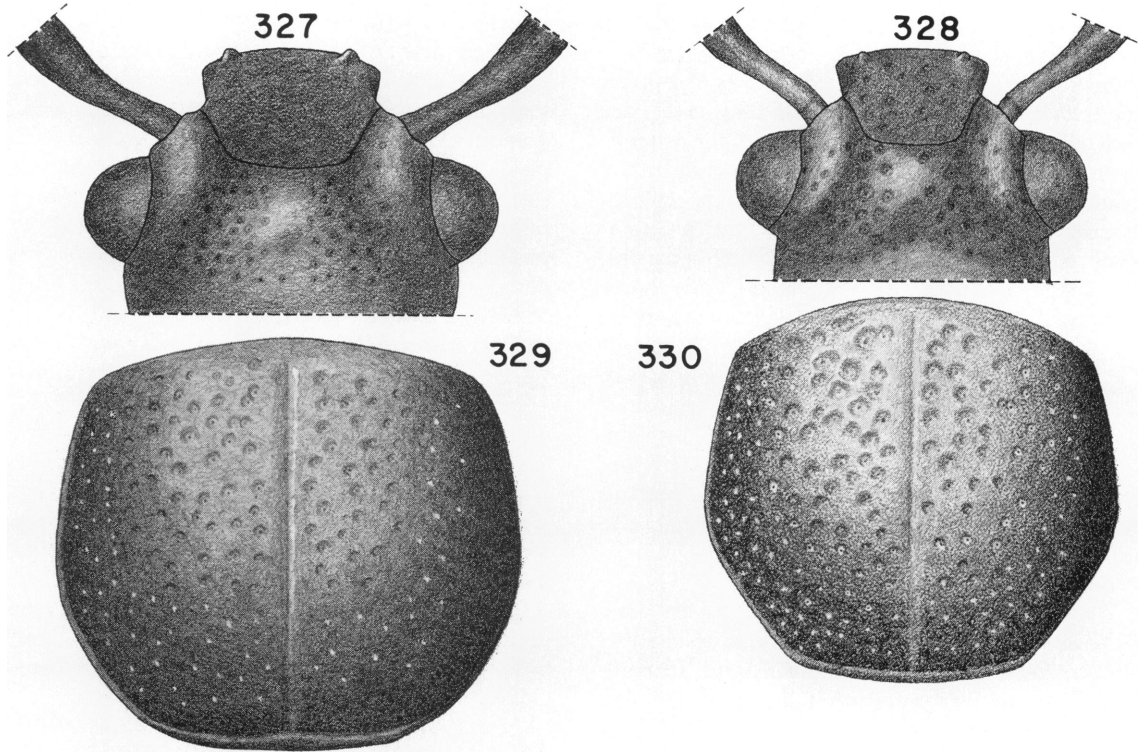

FIG. 327. *Bledius foraminosus*; head, dorsal view; male.

FIG. 328. *Bledius semiferrugineus*; head, dorsal view; male.

FIG. 329. *Bledius foraminosus*; prothorax, dorsal view; male.

FIG. 330. *Bledius semiferrugineus*; prothorax, dorsal view; male.

Metatarsus with last article gradually expanded toward apex (fig. 390, 393).

Abdomen with posterior margin of seventh sternite of males broadly and moderately deeply emarginate (fig. 396); emargination margined with many long setae (fig. 396); setae near lateral edge of emargination mesially curved (fig. 396); emargination not enclosed by membrane (fig. 396); emargination without spiniform process on lateral angle (fig. 396); seventh sternite of female unmodified. Eighth sternum of male with dense patch of setae behind emargination of seventh sternite; eighth sternum of female unmodified.

Spermatheca as shown in figure 412.

**SEXUAL DIMORPHISM:** The male has tridentate mandibles (figs. 360, 361) and an emargination of the seventh abdominal sternite (fig. 396) bordered by setae. The female has bidentate mandibles (as in figs. 362, 363), and the seventh abdominal sternite is not emarginate. The pro-

thorax of the males tends to be robust and have the lateral margins strongly rounded from the anterior to the posterior margin (figs. 330, 376). The female has a less robust prothorax with the lateral margins less strongly rounded and the anterior three-fifths parallel to one another (fig. 343). Some males, particularly small individuals, have the prothorax similar to that of the females and some females, particularly large ones, have a prothorax similar to that of the males.

**HABITAT AND DISTRIBUTION:** *Canada:* Ontario, Quebec. *United States:* Arkansas, Florida, Georgia, Illinois, Indiana, Iowa, Kansas, Kentucky, Louisiana, Maryland, Michigan, Mississippi, Missouri, Nebraska, New Jersey, New York, Ohio, Pennsylvania, South Dakota, Tennessee, Texas, Virginia, West Virginia. (See Appendix for localities.)

*Bledius semiferrugineus* is known from the eastern half of the United States from New York to

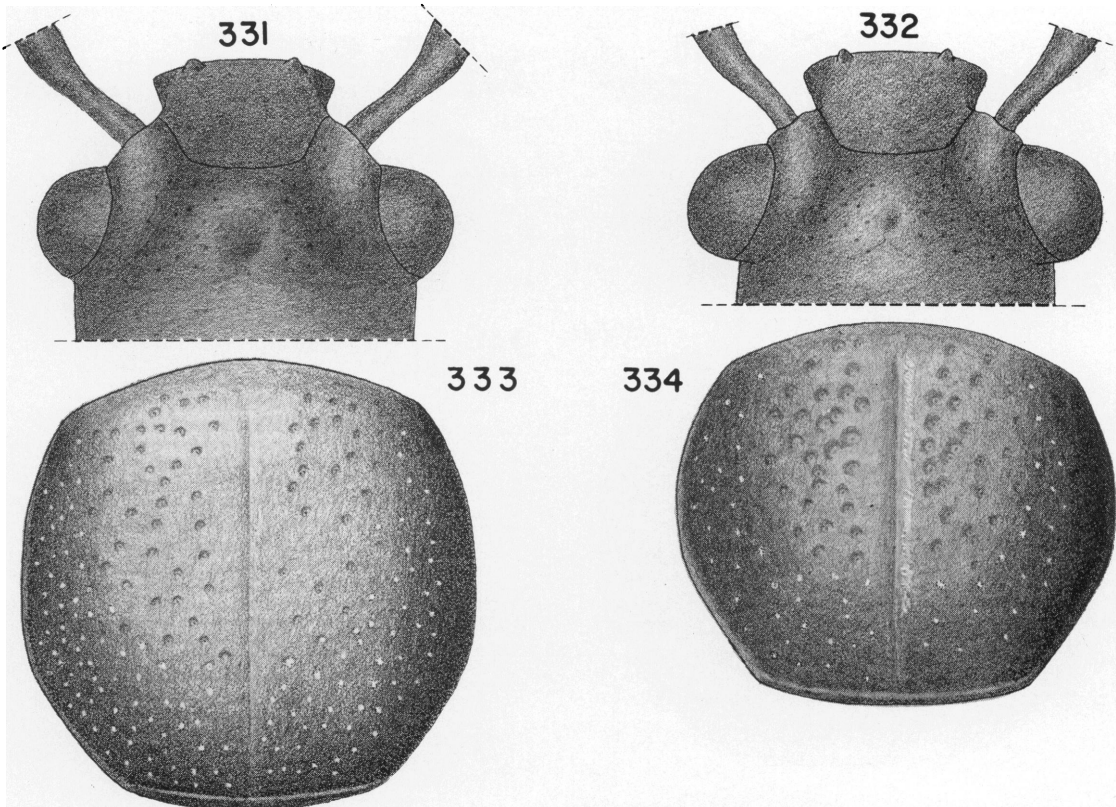

FIG. 331. *Bledius gravidus*; head, dorsal view; male.

FIG. 332. *Bledius fumatus*; head, dorsal view; male.

FIG. 333. *Bledius gravidus*; prothorax, dorsal view; male.

FIG. 334. *Bledius fumatus*; prothorax, dorsal view; male.

Florida west to east Texas through eastern Kansas, Nebraska, and South Dakota and from several localities in southern Ontario (map 10).

The species was collected in moist, sandy clay on shaded, vegetated banks of the Patauxent River in Maryland and along the White River in northwestern Arkansas.

The species is collected throughout the year in Florida, and from April through October in the rest of the United States and Canada.

DISCUSSION: Notman (1920) proposed the separation of *Bledius canaliculatus*, with the "sides of thorax slightly rounded, nearly parallel in front" from *B. semiferrugineus*, with the "sides of the thorax very much rounded." The female (fig. 343) (of *B. semiferrugineus*) usually has a less robust prothorax than the male (figs. 330, 376). The type of *B. canaliculatus* is a female and cannot be separated from the females of *B. semiferrugineus*.

#### *Bledius foraminosus* Casey

Figures 327, 329, 342, 354, 355, 377, 380, 400, 414, 419, 432-435, 449; Map 10; Table 5

*Bledius foraminosus* CASEY, 1889, p. 53. FALL, 1901, p. 76, 1910, p. 107. NOTMAN, 1920, p. 697. HATCH, 1957, p. 99 (type locality: California, Lake County; holotype: deposited at the National Museum of Natural History, Smithsonian Institution, Washington, D.C. Type examined, female).

*Bledius deceptivus* FALL, 1901, pp. 227, 228. NOTMAN, 1920, pp. 697 (new synonym; type locality: California, Kern County; holotype: deposited in the Museum of Comparative Zoology, Harvard University, Cambridge, Massachusetts. Type examined, female).

*Bledius relictus* FALL, 1901, p. 228. NOTMAN, 1920, p. 697 (new synonym; type locality: California, Pomona; holotype: deposited at the Museum of Comparative Zoology, Harvard University, Cambridge, Massachusetts. Type examined, female).

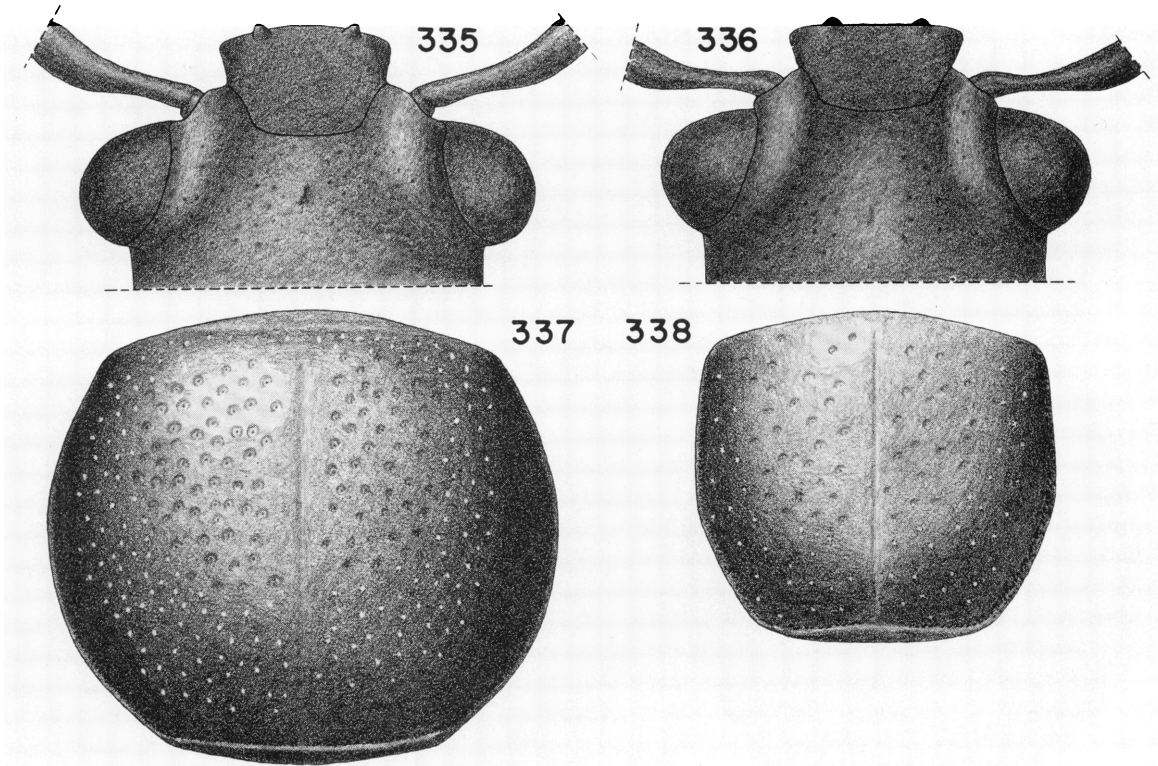

FIG. 335. *Bledius rotundicollis*; head, dorsal view; male.  
 FIG. 336. *Bledius rubiginosus*; head, dorsal view.  
 FIG. 337. *Bledius rotundicollis*; prothorax, dorsal view; male.  
 FIG. 338. *Bledius rubiginosus*; prothorax, dorsal view.

DIAGNOSIS: *Bledius foraminosus* can be separated from all the members of the *semiferrugineus* group in the United States by the combination of the following characters: The dorsum of the head has small, moderately coarse punctation (fig. 327) and microgranulate ground sculpturing (fig. 327), the head is wide (fig. 327), the head and pronotum are nearly concolorous, the pronotum has microgranulate ground sculpturing and a prominent midlongitudinal groove (fig. 329), the fourth metatarsomere is gradually expanded to the apex (figs. 390, 393), and the posterior margin of the seventh abdominal sternite of the male is slightly emarginate (fig. 400). *Bledius foraminosus* might be confused with *B. semiferrugineus*, but the species are easily separated by the presence of a polished surface of the dorsum of the head and pronotum of the latter species (figs. 450, 451) and by the deeper emargination of the posterior margin of the seventh abdominal sternite of the males of *B.*

*semiferrugineus* (fig. 396). *Bledius foraminosus* might be confused with *B. gravidus* or possibly *B. fumatus*, but both of the last two species have very fine punctation of the dorsum of the head (compare fig. 327 with figs. 331, 332) and a deeper emargination of the posterior margin of the seventh abdominal sternite of the male (compare fig. 400 with figs. 398, 399).

DESCRIPTION: *semiferrugineus* group.

Length 4.5 to 6.5 mm.

Dorsum of head, clypeus, and labrum black to pale reddish brown. Lateral and ventral portions of head reddish black to reddish brown. Antennae, labium, maxillae, and mandibles reddish brown. Pronotum black to reddish brown. Prohypomeron and prosternum dark to pale reddish brown. Elytra with disk bright reddish brown to yellowish brown; basal and sutural regions with diffuse black or dark brown on individuals with reddish brown elytra. Pterothoracic sternite and pleura black to yellow-

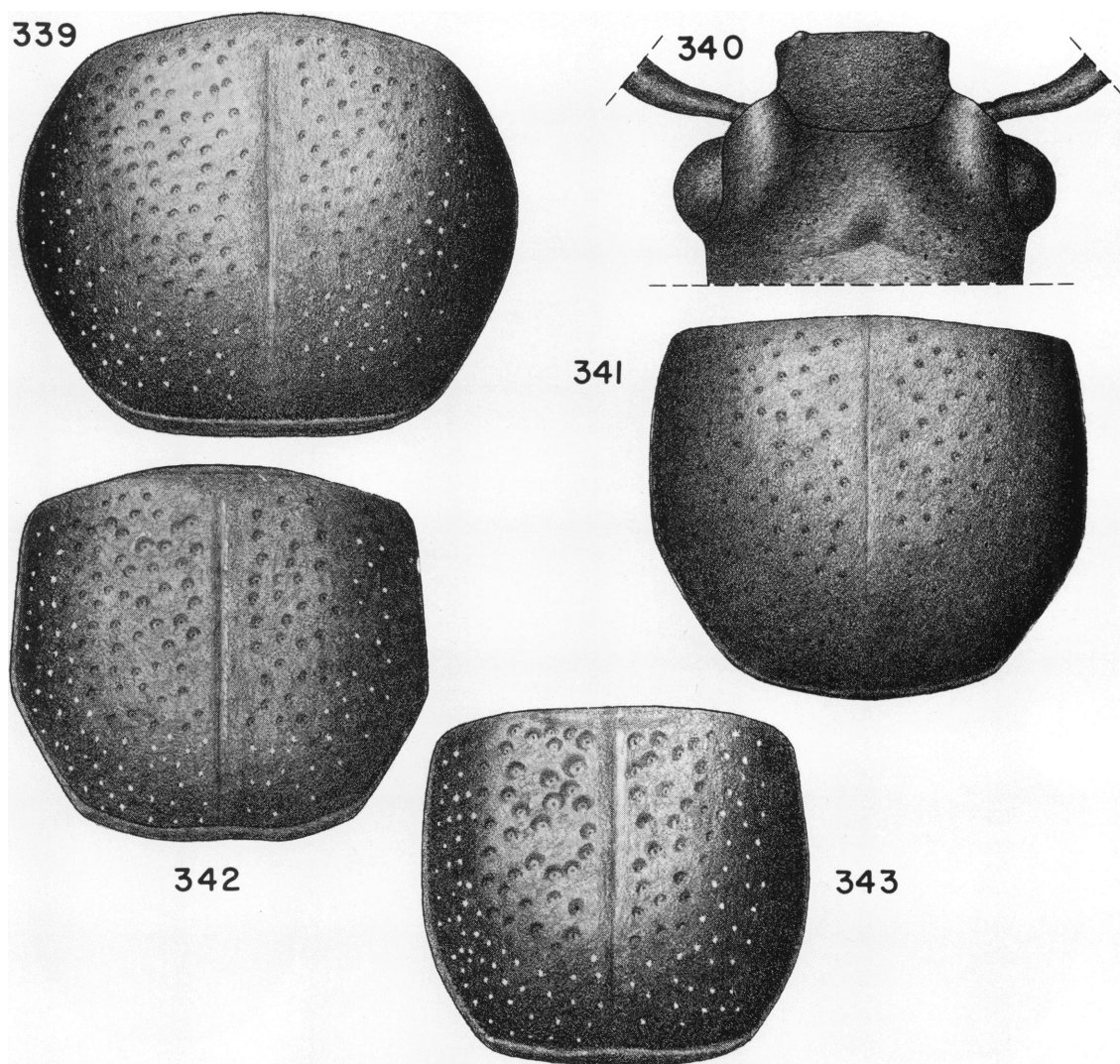

FIG. 339. *Bledius rotundicollis*; prothorax, dorsal view; female.

FIG. 340. *Bledius tallaci*; head, dorsal view; male.

FIG. 341. *Bledius tallaci*; prothorax, dorsal view; male.

FIG. 342. *Bledius foraminosus*; prothorax, dorsal view; female.

FIG. 343. *Bledius semiferrugineus*; prothorax, dorsal view; female.

ish brown. Legs reddish brown to yellowish brown. Abdomen black to pale reddish brown.

Dorsum of head, but for one median polished spot, opaque, not polished (fig. 449), with dense microgranulate ground sculpturing (fig. 449), with dense, distinct, moderately deep, setigerous punctation between supra-antennal ridges (fig. 327), and with distinct, convex, midlongitudinal ridge between supra-antennal ridges (fig.

327); ridge often with dorsal surface polished (fig. 449) and with small fovea behind polished portion (fig. 327); postocular transverse groove absent (fig. 327). Supra-antennal ridge with some scattered punctures on basal half of dorsal surface (fig. 327); dorsal surface polished; lateral and basal surfaces with microgranulate ground sculpturing. Epistomal suture broadly and deeply arcuate (fig. 327); suture strongly

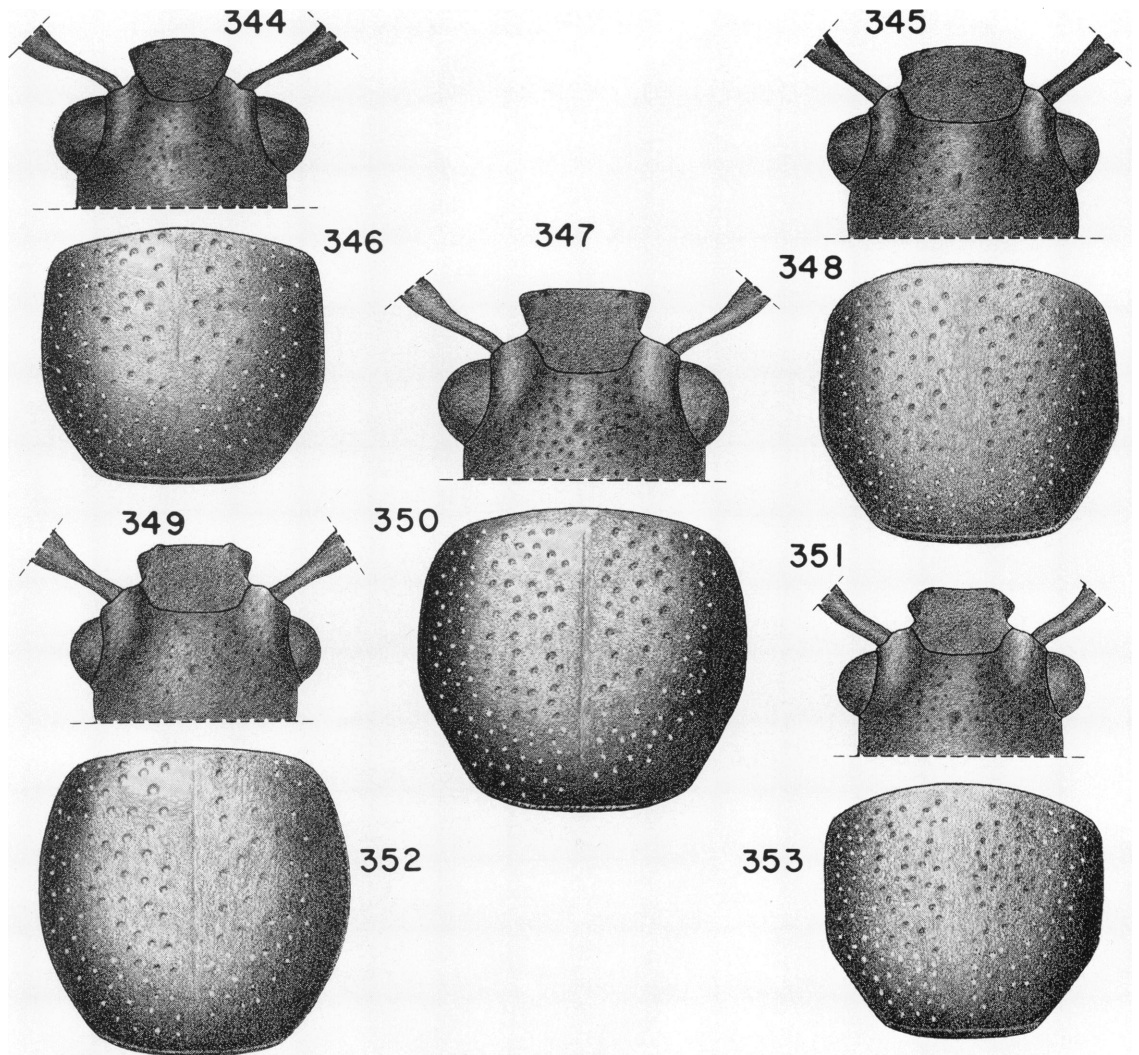
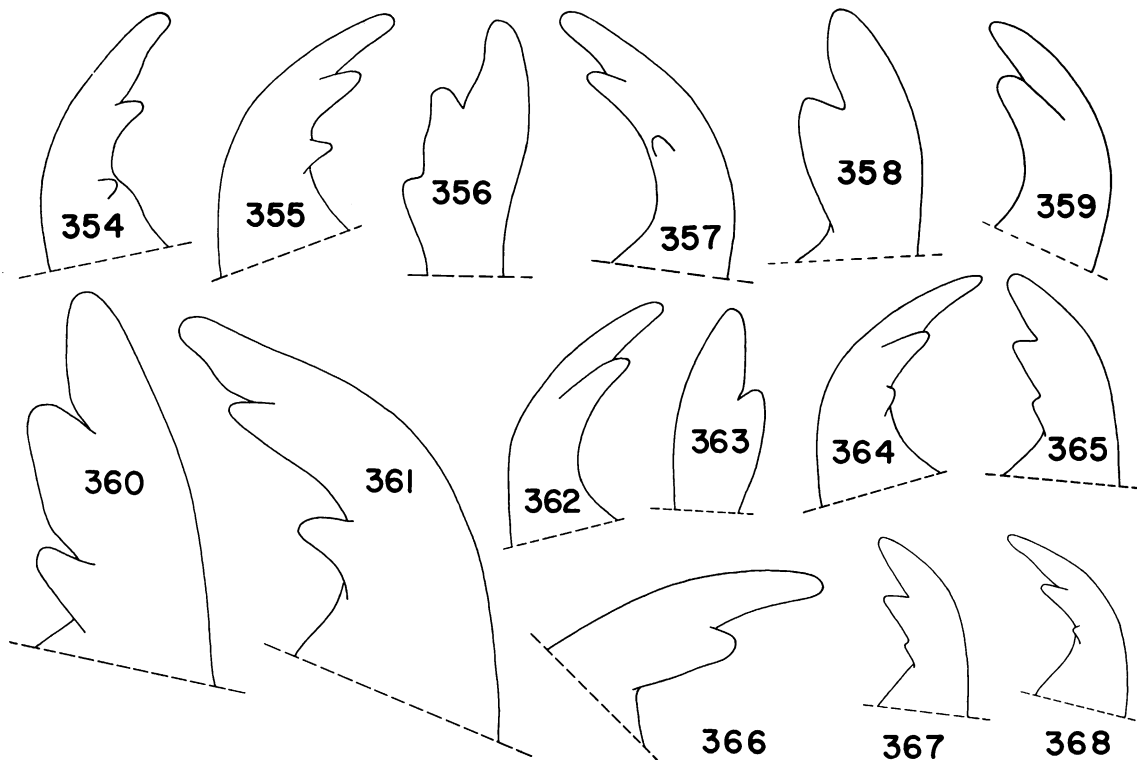

FIG. 344. *Bledius nitidicollis*; head, dorsal view; male.  
 FIG. 345. *Bledius coulteri*; head, dorsal view; male.  
 FIG. 346. *Bledius nitidicollis*; prothorax, dorsal view; male.  
 FIG. 347. *Bledius philadelphicus*; head, dorsal view; male.  
 FIG. 348. *Bledius coulteri*; prothorax, dorsal view; male.  
 FIG. 349. *Bledius analis*; head, dorsal view; male.  
 FIG. 350. *Bledius philadelphicus*; prothorax, dorsal view; male.  
 FIG. 351. *Bledius assimilis*; head, dorsal view; male.  
 FIG. 352. *Bledius analis*; prothorax, dorsal view; male.  
 FIG. 353. *Bledius assimilis*; prothorax, dorsal view; male.

angulate at juncture with supra-antennal ridges. Clypeus with dense, microgranulate ground sculpturing (fig. 449); anterior margin with small, round tubercles near lateral margin (fig. 327). Lateral side of head with polished, gla-

brous, postocular strip extending from base of head to posterior margin of eye. Venter of head with dense microreticulate ground sculpturing. Width of head 1.0 to 1.1 mm.; interocular width 0.6 to 0.8 mm.; head width/interocular width





- FIG. 354. *Bledius foraminosus*; left mandible, apex, dorsal view; male.  
 FIG. 355. *Bledius foraminosus*; left mandible, apex, anterolateral view; male.  
 FIG. 356. *Bledius rotundicollis*; right mandible, apex, anterolateral view; male.  
 FIG. 357. *Bledius rotundicollis*; right mandible, apex, dorsal view; male.  
 FIG. 358. *Bledius coulteri*; right mandible, apex, anterolateral view; male.  
 FIG. 359. *Bledius coulteri*; right mandible, apex, dorsal view; male.  
 FIG. 360. *Bledius semiferrugineus*; right mandible, apex, anterolateral view; male.  
 FIG. 361. *Bledius semiferrugineus*; right mandible, apex, dorsal view; male.  
 FIG. 362. *Bledius rubiginosus*; left mandible, apex, dorsal view; female.  
 FIG. 363. *Bledius rubiginosus*; left mandible, apex, anterolateral view; female.  
 FIG. 364. *Bledius gravidus*; left mandible, apex, dorsal view; male.  
 FIG. 365. *Bledius gravidus*; right mandible, apex, anterolateral view; male.  
 FIG. 366. *Bledius nitidicollis*; left mandible, apex, anterolateral view; male.  
 FIG. 367. *Bledius philadelphicus*; right mandible, apex, anterolateral view; male.  
 FIG. 368. *Bledius philadelphicus*; right mandible, apex, dorsal view; male.

1.4 to 1.6 (table 5). Labrum with dense, microgranulate ground sculpturing, and moderately dense, setigerous punctation; anterior margin truncate and weakly reflexed near midlongitudinal groove. Mandibles of females bidentate (as in figs. 362, 363); denticles connate (as in fig. 364). Mandibles of males tridentate (figs. 354, 355); apical and middle denticles largest and connate (figs. 354, 355); basal denticle separated, acute, and smallest (figs. 354, 355). Antennomeres without carina encircling apex.

Pronotum 1.0 to 1.2 mm. long, 1.1 to 1.3 mm. wide; pronotal width/pronotal length 1.1 to 1.2 (table 5) and weakly to moderately strongly convex (figs. 329, 342); lateral margin with anterior three-fifths anteriorly convergent and gradually rounded to more strongly rounded basal two-fifths (figs. 329, 377), or lateral margins with anterior three-fifths nearly parallel to basal two-fifths, basal two-fifths strongly convergent (figs. 342, 380); basal margin broadly rounded. Pronotum usually opaque with dense,

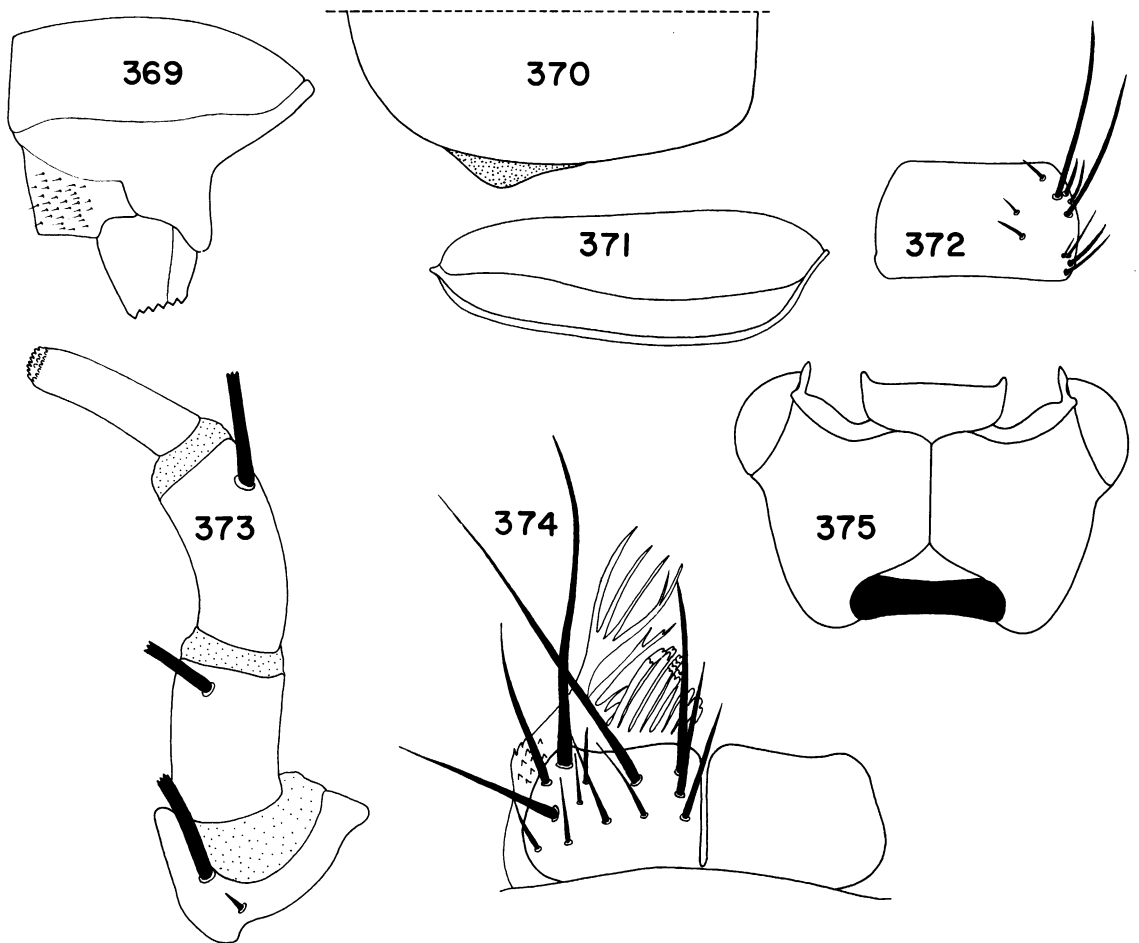

- FIG. 369. *Bledius analis*; prothorax, lateral view; setae and punctures removed from notum.  
 FIG. 370. *Bledius rubiginosus*; left elytron, dorsal view; apex.  
 FIG. 371. *Bledius analis*; left elytron, lateral view.  
 FIG. 372. *Bledius rubiginosus*; mentum.  
 FIG. 373. *Bledius fumatus*; labial palpus.  
 FIG. 374. *Bledius semiferrugineus*; labrum.  
 FIG. 375. *Bledius rubiginosus*; head and submentum, ventral view.

microgranulate ground sculpturing; surface often with numerous small, polished spots, occasionally large areas polished; sculpturing more distinct near anterior and middle regions; notum with dense, setigerous punctation (figs. 329, 342); punctation distinct and moderately deep (figs. 329, 342); punctures larger medially and anteriorly (figs. 329, 342); midlongitudinal groove deep with anterior half slightly deeper than posterior half (figs. 329, 342); groove reaching to anterior and posterior marginal beads. Pronotal lateral marginal bead visible in

dorsal aspect along entire length (figs. 329, 342); anterior portion slightly deflexed. Prohypomeron shining, with dense microreticulate ground sculpturing. Prosternum with dense microreticulate ground sculpturing.

Elytra 1.2 to 1.4 mm. long; elytral length/pronotal length 1.2 to 1.3 (table 5); surface with dense, setigerous punctation.

Metatarsus with fourth article gradually expanded to apex (as in figs. 390, 393).

Abdomen of males with posterior margin of seventh sternite obsolete emarginate (fig. 400);

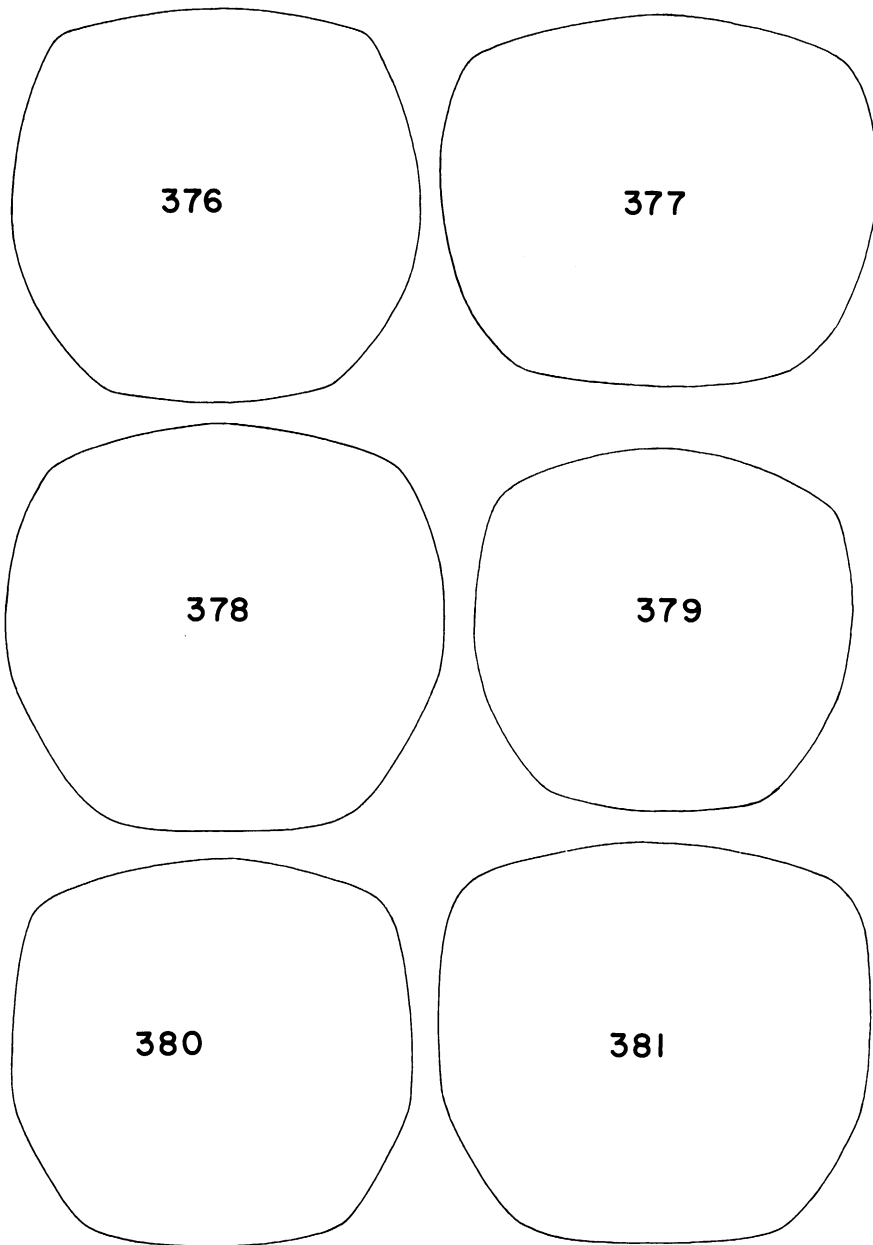

FIG. 376. *Bledius semiferrugineus*; variation of pronotal shape; male.

FIG. 377. *Bledius foraminosus*; variation of pronotal shape; male.

FIG. 378. *Bledius fumatus*; variation of pronotal shape; female.

FIG. 379. *Bledius rubiginosus*; variation of pronotal shape.

FIG. 380. *Bledius foraminosus*; variation of pronotal shape; female.

FIG. 381. *Bledius gravidus*; variation of pronotal shape; female.

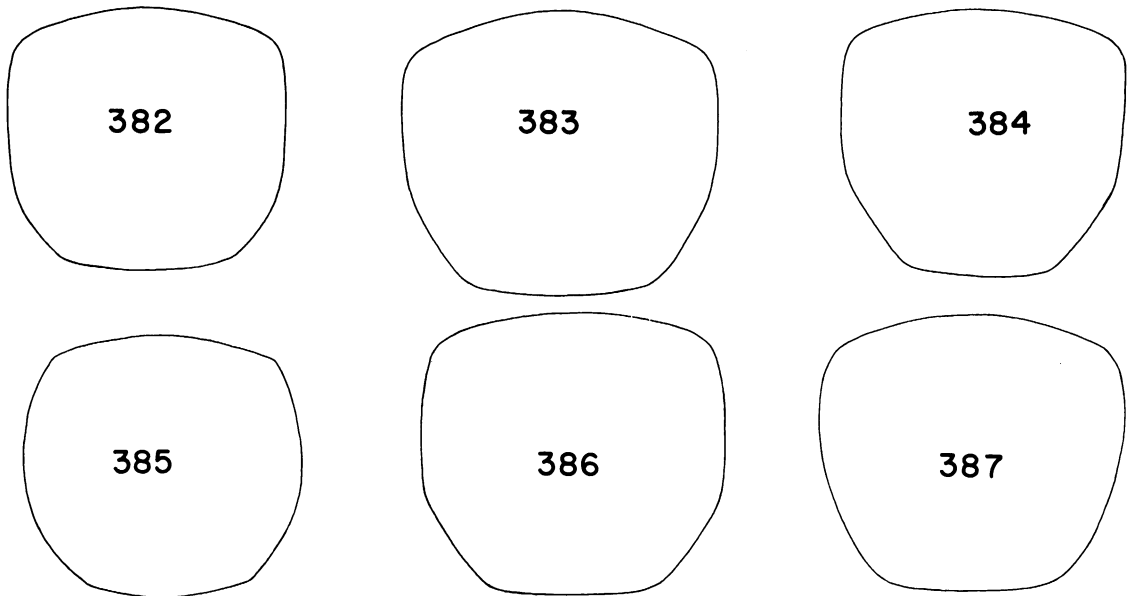

FIG. 382. *Bledius nitidicollis*; variation of pronotal shape; female.

FIG. 383. *Bledius philadelphicus*; variation of pronotal shape; female.

FIG. 384. *Bledius assimilis*; variation of pronotal shape; female.

FIG. 385. *Bledius nitidicollis*; variation of pronotal shape; male.

FIG. 386. *Bledius philadelphicus*; variation of pronotal shape; female.

FIG. 387. *Bledius coulteri*; variation of pronotal shape; male.

emargination without membranous filling and without spiniform process on lateral angle (fig. 400); emargination lined with long setae (fig. 400); seventh sternite of female unmodified. Eighth sternum of male and female without distinct, well-developed patch of setae behind emargination of seventh sternite.

Spermatheca as shown in figures 414, 419.

**SEXUAL DIMORPHISM:** The male has tridentate mandibles (figs. 354, 355), the female bidentate (as in figs. 362, 363). The posterior margin of the seventh sternite of the male has a slight emargination and a slightly more dense pubescence near the emargination (fig. 400). The female has no modification of the seventh sternite.

**SYNONYMY:** When Fall (1901) described *Bledius deceptivus* and *B. relictus* he did not discuss their separation from *B. foraminosus*. I can find no characters that even suggest separation of *B. deceptivus* from *B. foraminosus* and, therefore, synonymize them.

*Bledius relictus* at first glance appears to have distinctly shorter elytra, but measurements of the elytral length and pronotal length demon-

strate that the absolute measurements and comparisons of them (as a ratio) fall within the range of variation of *B. foraminosus*. The width of the head is slightly smaller than that actually measured for *B. foraminosus*, but the other measurements of the holotype of *B. relictus* simply indicate that it is a small female of the species. As the elytral length is within the range of variation of *B. foraminosus* and no other characters were found to support recognition of *B. relictus* distinct from *B. foraminosus*, the two names are synonymized.

**HABITAT AND DISTRIBUTION:** *Canada:* British Columbia. *United States:* California, Idaho, Montana, Oregon, Washington. (See Appendix for localities.)

*Bledius foraminosus* occurs in the western United States from southern California north to British Columbia and into eastern Montana (map 10).

The species is collected near Libby, Montana, along Fisher River and along the Pack River near Sandpoint, Idaho, on the drier, sparsely vegetated portions of the shore. Near Ritzville, Washington, on the shore of Lake McElroy, *B.*

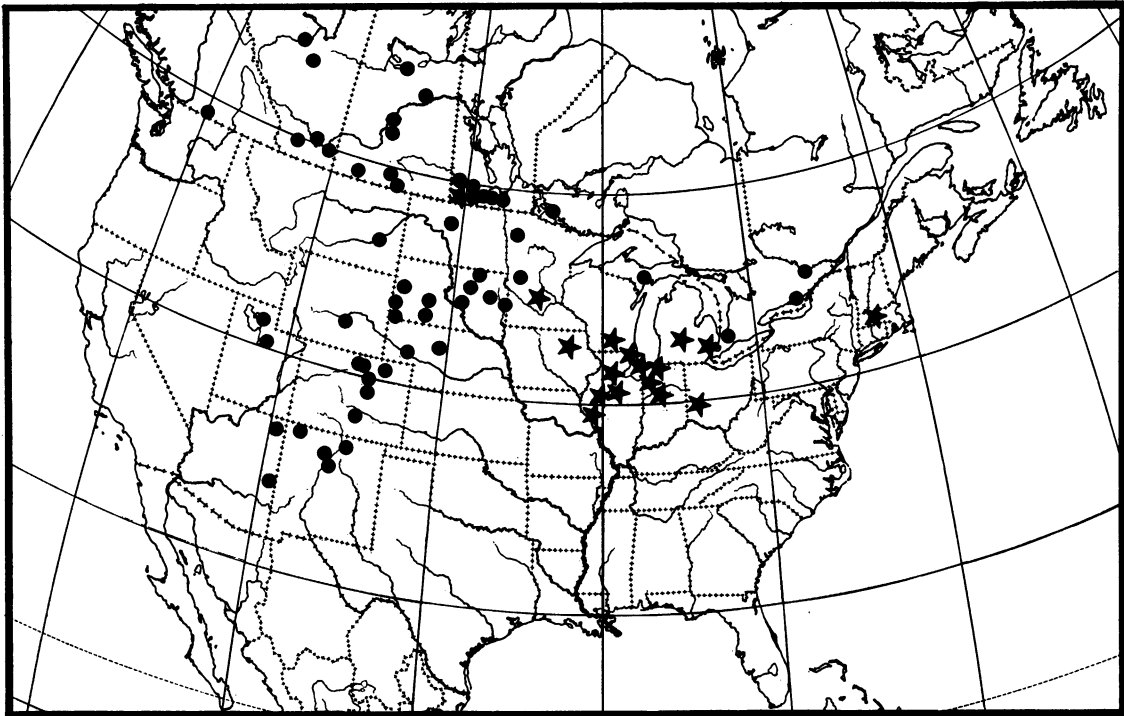

MAP 11. Distribution of *Bledius gravidus* (black dots) and *B. fumatus* (stars).

*foraminosus* burrows into moist sand that lacks vegetation or alkali encrustations.

The species is collected from April through October in California and from May through September in Washington, Montana, and Canada.

*Bledius gravidus* Casey

Figures 331, 333, 364, 365, 381, 399, 411, 421-423; Map 11; Table 5

*Bledius gravidus* CASEY, 1889, p. 54. FALL, 1910, p. 107, 108. NOTMAN, 1920, p. 697 (type locality: New Mexico, Albuquerque; holotype: deposited in the National Museum of Natural History, Smithsonian Institution, Washington, D. C. Type examined, male).

*Bledius missionensis* HATCH, 1957, p. 99 (new synonym; type locality: British Columbia, Mission Flats; holotype: deposited in the Canadian National Collection, Ottawa, Ontario. Type examined, female).

DIAGNOSIS: *Bledius gravidus* can be easily separated from all the members of the *semiferrugineus*

group in the United States except *B. fumatus* by the following characters: The dorsum of the head has fine punctation (fig. 331) with prominent microgranulate ground sculpturing (as in fig. 448), the head is wide (fig. 331), the head and pronotum are nearly concolorous, the pronotum has prominent microgranulate ground sculpturing (as on vertex, fig. 448), and a prominent midlongitudinal groove (fig. 333), the fourth metatarsomere is gradually expanded to the apex, the seventh abdominal sternite of the male has a prominent emargination (fig. 399) rather than a membranous lobe. *Bledius gravidus* can be separated from *B. fumatus* by the smaller eyes (compare figs. 331, 332, see measurements and table 5) and more broadly rounded lateral margins of the pronotum (compare fig. 333 with fig. 334). The punctation of the dorsum of the head of *B. gravidus* (fig. 331) is finer than that of *B. foraminosus* (fig. 327). (See also the Diagnosis under *B. rotundicollis*.)

DESCRIPTION: *semiferrugineus* group.

Length 5.0 to 6.5 mm.

Dorsum of head and clypeus black to dark

reddish brown. Venter of head dark to pale reddish brown. Maxilla, labium, and antennae reddish brown to dark yellowish brown. Labrum black to reddish brown, concolorous with clypeus. Mandibles dark reddish brown. Pronotum black to reddish brown, lateral margin often paler. Prohypomeron and prosternum dark reddish brown to dark yellowish brown. Elytra dark reddish brown to yellowish brown; suture black to dark reddish brown; disk usually paler than base or area along suture. Pterothoracic sterna and pleura black to reddish brown. Legs dark reddish brown to dark yellowish brown. Abdomen dark reddish brown to pale reddish brown; posterior margin of terga often darker.

Dorsum of head opaque, not polished, with dense, microgranulate ground sculpturing (as in fig. 448), with fine, distinct but shallow setigerous punctation near base between supra-antennal ridges (fig. 331) and with moderately convex midlongitudinal ridge (fig. 331); ridge impunctate and not longitudinally divided (fig. 331); with large, foveate, median depression (fig. 331); postocular transverse groove absent (fig. 331). Supra-antennal ridge with dorsal surface impunctate (fig. 331); apex of dorsal surface polished; sides punctate and with microgranulate ground sculpturing. Epistomal suture broadly and deeply arcuate (fig. 331); suture at junction with supra-antennal ridge more strongly angulate. Clypeus with dense, microgranulate ground sculpturing (as in fig. 448); anterior margin with small, rounded tubercles near lateral margin (fig. 331). Lateral portion of head with polished, glabrous, postocular strip extending anteriorly from base of head to posterior margin of eye. Venter of head with dense, microreticulate ground sculpturing. Width of head 1.0 to 1.1 mm.; interocular width 0.7 to 0.8 mm.; head width/interocular width 1.4 to 1.5 (table 5). Labrum with moderately dense, setigerous punctation; with dense, microgranulate ground sculpturing (as in fig. 325). Mandibles of females bidentate (as in figs. 362, 363). Mandibles of males tridentate (figs. 364, 365); apical and second denticles connate; basal denticle of male small and often evident only as small tuberculate swelling at base of second denticle (figs. 364, 365). Antennomeres without carina encircling apex.

Pronotum 1.0 to 1.2 mm. long, 1.1 to 1.3 mm. wide; pronotal width/pronotal length 1.0 to 1.2 (table 5) and moderately strongly convex (fig.

333); lateral margin broadly rounded to basal angles (fig. 333), often with basal two-fifths slightly more convergent to basal angles (fig. 381); basal angles indistinct; basal margin broadly and evenly rounded. Pronotum opaque and usually not polished and with dense, microgranulate ground sculpturing (as on vertex, fig. 448); sculpturing more distinct near middle and anterior region, posterior and lateral areas often with sculpturing feeble or absent, in which case surface more shining or polished, surface with moderately dense, setigerous punctation (fig. 333); punctation larger and deeper mesially and anteriorly (fig. 333); pubescence short; surface with deep midlongitudinal groove (fig. 333); groove deepest near middle, becoming obsolete anteriorly and posteriorly (fig. 333), and not reaching anterior or posterior margins. Pronotal lateral marginal bead visible in dorsal aspect except for small part of apex (fig. 333); anterior portion slightly deflexed. Prohypomeron shining, with microreticulate ground sculpturing. Prosternum with dense microreticulate ground sculpturing.

Elytra 1.2 to 1.4 mm. long; elytral length/pronotal length 1.1 to 1.3 (table 5); surface polished and with dense, setigerous punctation.

Metatarsus with fourth tarsomere gradually expanded apically (as in figs. 390, 393).

Abdomen of males with posterior margin of seventh sternite moderately deeply emarginate (fig. 399); emargination not filled by membrane (compare fig. 399 with fig. 405); emargination with patch of long setae at lateral angles and along margin (fig. 399); emargination without spiniform process on lateral angle (compare fig. 399 with fig. 402); seventh sternite of female unmodified. Eighth sternum of male with dense patch of setae behind emargination of seventh sternite; eighth sternum of female with setae but not arranged in dense patch.

Spermatheca as shown in figure 411.

**SEXUAL DIMORPHISM:** The male has tridentate mandibles (figs. 364, 365), and the large emargination of the posterior margin of the seventh sternite (fig. 399) is bordered by setae. The female has bidentate mandibles (as in figs. 362, 363), and the abdominal segments are unmodified.

**SYNONYMY:** Melville Hatch (1957) correctly recognized that the species he described as *Bledius missionensis* was not recorded in the literature from the Pacific Northwest. He did not

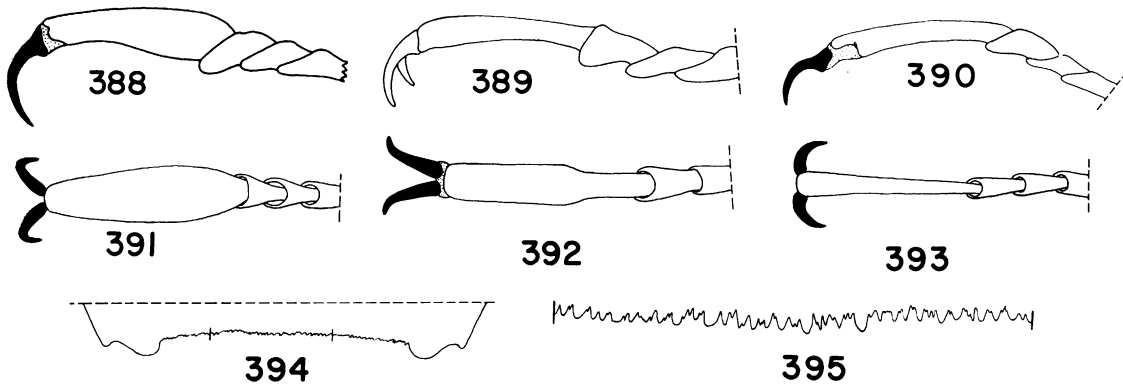

FIG. 388. *Bledius rotundicollis*; metatarsus, lateral view; male; Brookings, South Dakota.  
 FIG. 389. *Bledius rotundicollis*; metatarsus, lateral view; male; Brandon, Manitoba.  
 FIG. 390. *Bledius semiferrugineus*; metatarsus, lateral view; male.  
 FIG. 391. *Bledius rotundicollis*; metatarsus, dorsal view; male; Brookings, South Dakota.  
 FIG. 392. *Bledius rotundicollis*; metatarsus, dorsal view; male; Brandon, Manitoba.  
 FIG. 393. *Bledius semiferrugineus*; metatarsus, dorsal view; male.  
 FIG. 394. *Bledius rubiginosus*; tergum VIII, apex.  
 FIG. 395. *Bledius rubiginosus*; tergum VIII, posterior margin enlargement of median portion.

know that *B. gravidus*, until now known only from New Mexico, has a geographical range extending up the eastern side of the Rockies to Canada and west in Canada to the Pacific Northwest. There is no question that the type of *B. missionensis* is a male of *B. gravidus*.

**HABITAT AND DISTRIBUTION:** *Canada:* Alberta, British Columbia, Manitoba, Ontario, Saskatchewan. *United States:* Arizona, Colorado, Michigan, Minnesota, Montana, Nebraska, New Mexico, North Dakota, South Dakota, Utah, Wyoming. (See Appendix for localities.)

*Bledius gravidus* is known from central Alberta and Saskatchewan south to New Mexico and Arizona, and from Michigan west to Utah in the United States and across Canada from Ontario to British Columbia (map 11).

The species was collected from temporarily moist, vegetated sand on the roadside near Crookston, Minnesota. The species was 2 to 3 inches below the surface, and one or two eggs were in each egg chamber.

Near Brush, and Greeley, Colorado, on the South Platte River the species lives in slightly moist, heavily vegetated, and heavily shaded sand on the margins but not the shore of the river. In these areas the species is found in large numbers.

The species is collected from April through September.

#### *Bledius fumatus* Le Conte

Figures 332, 334, 373, 378, 398, 420;  
Map 11; Table 5

*Bledius fumatus* LE CONTE, 1863, p. 52; 1877, p. 224. CASEY, 1889, pp. 53, 54. BLATCHLEY, 1910, p. 464. NOTMAN, 1920, p. 697. HATCH, 1957, p. 99 (type locality: "Western States"; holotype: deposited in the Museum of Comparative Zoology of Harvard University, Cambridge, Massachusetts. Type examined, female).

**DIAGNOSIS:** The fine shallow punctation of the dorsum of the head will separate *Bledius fumatus* (fig. 332) from both *B. semiferrugineus* (fig. 328) and *B. foraminosus* (fig. 327). *Bledius semiferrugineus* can be further separated by the polished pronotum (fig. 450) and the tridentate mandibles (figs. 360, 361) of the male. *Bledius foraminosus* is further separated by the shallow emargination of the seventh sternite of the male (compare fig. 398 with fig. 400). *Bledius rotundicollis* can be separated by the peculiar fourth metatarsomere (figs. 391, 392). *Bledius fumatus* has a range of 1.54 to 1.67 for the ratio of the head width/interocular width, and *B. gravidus* has a range of 1.45 to 1.54. The eyes of *B. gravidus* are smaller (fig. 331) than those of *B. fumatus* (fig. 332). There are geographical distributional differences (map 11) and some difference in the shape of the prothorax of the two

species (figs. 333, 334). Color differences and the lack of modification of the seventh abdominal sternite will separate *B. rubiginosus* from *B. fumatus*. The smaller head and differences of the seventh abdominal sternite will separate *B. philadelphicus*, *B. coulteri*, *B. assimilis*, *B. analis*, and *B. nitidicollis* from *B. fumatus*.

DESCRIPTION: *semiferrugineus* group.

Length 5.2 to 6.8 mm.

Head and labrum black to reddish brown. Supra-antennal ridge black with apex reddish brown. Mandibles, labrum, maxillae, and antennae dark to pale reddish brown. Prothorax with dorsal surface black to reddish brown, often with small reddish brown spot on lateral margin about three-fifths from anterior margin. Prohypomeron and prosternum reddish brown to yellowish brown. Elytra reddish brown; with large paler reddish brown spot on lateromedian region; with base and suture darker reddish brown to black. Pterothoracic sterna and pleura reddish brown. Legs reddish brown to yellowish brown. Abdomen dark to paler reddish brown.

Dorsum of head opaque, not polished, with dense, prominent microgranulate ground sculpturing (as in fig. 448) and with fine distinct, but shallow, setigerous punctation between and on side and base of supra-antennal ridges (fig. 332); median, longitudinal region without setigerous punctation but with large, prominent median fovea on slightly convex median ridge (fig. 332); ridge not longitudinally divided (fig. 332); postocular transverse ridge absent (fig. 332). Supra-antennal ridge moderately well developed (fig. 332) and without setigerous punctation on dorsal surface (fig. 332); dorsal surface polished apically; sides and base with setigerous punctation (fig. 332) and microgranulate ground sculpturing. Epistomal suture broadly and deeply arcuate (fig. 332); suture at junction with supra-antennal ridge more strongly angulate. Clypeus with dense, microgranulate ground sculpturing (as in fig. 448) and with setigerous punctation but punctures very fine, shallow, and very indistinct; anterior margin with small, rounded tubercles near lateral margin (fig. 332). Lateral portion of head with polished, glabrous, postocular strip extending anteriorly from base of head to compound eye; polished strip sometimes not reaching eye. Lateral sides and venter of head with dense, microreticulate ground sculpturing. Width of head 1.0 to 1.2 mm.; interocular width 0.6 to 0.7 mm.; head width/

interocular width 1.5 to 1.7 (table 5). Labrum with dense, microgranulate ground sculpturing (as in fig. 325), with moderately dense, setigerous punctation, and with median portion of anterior margin weakly reflexed. Mandibles of males and females bidentate (as in figs. 362, 363); denticles connate (figs. 362, 363). Antennomeres without carina encircling apex.

Pronotum 1.0 to 1.1 mm. long, 1.0 to 1.2 mm. wide; pronotal width/pronotal length 1.1 to 1.2 (table 5), and moderately convex (fig. 334); lateral margin with anterior three-fifths broadly and shallowly rounded and anteriorly convergent (figs. 334, 378) with posterior two-fifths straight and strongly convergent to strongly round basal angles (figs. 334, 378); basal margin, broadly rounded. Pronotum with dense, distinct, microgranulate ground sculpturing (as on vertex, fig. 448); surface with some opaque, unpolished regions and some polished areas near middle, base, and lateral margins; microgranulate sculpturing indistinct or absent on polished regions, and with dense, distinct setigerous punctation (fig. 334); punctation larger and deeper mesially and anteriorly (fig. 334); pubescent short; median longitudinal strip impunctate and with deep midlongitudinal groove (fig. 334); groove more shallow posteriorly and deepest anteriorly. Pronotal lateral marginal bead entirely visible in dorsal aspect (fig. 334); anterior portion slightly deflexed. Prohypomeron shining, and with dense, microreticulate ground sculpturing. Prosternum with dense, microreticulate ground sculpturing.

Elytra 1.3 to 1.4 mm. long; elytral length/pronotal length 1.3 to 1.4 (table 5); surface polished, with dense, distinct setigerous punctation. Metatarsus with fourth article gradually expanded apically (as in figs. 390, 393).

Abdomen with posterior margin of seventh sternite moderately, deeply emarginate (fig. 398); emargination without posteriorly directed spiniform process on lateral angle (fig. 398); emargination with patch of long setae along middle and lateral angles, setae near lateral angles longest and mesially curved (fig. 398); emargination not enclosed by membrane (fig. 398); seventh sternite of female unmodified. Eighth sternum of male with dense patch of setae behind emargination of seventh sternite; eighth sternum of female unmodified.

Spermatheca as shown in figure 420.

SEXUAL DIMORPHISM: The male of *Bledius*



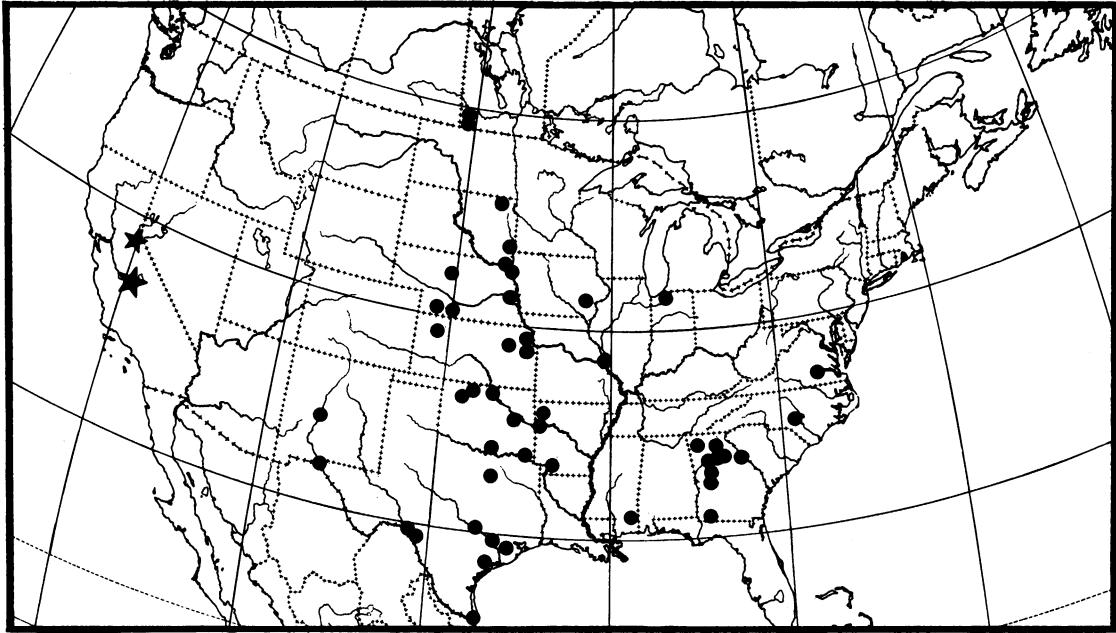

MAP 12. Distribution of *Bledius rubiginosus* (black dots) and *B. tallaci* (stars; large star indicates only found county).

*fumatus* has a deep emargination bordered with long setae on the seventh abdominal sternite (fig. 398). The seventh sternite of the female is unmodified.

**HABITAT AND DISTRIBUTION:** *Canada:* Manitoba, Ontario. *United States:* Illinois, Indiana, Iowa, Massachusetts, Michigan, Minnesota, Ohio, Wisconsin. (See Appendix for localities.)

Most specimens of *Bledius fumatus* were collected in the midwestern United States with one collected in Massachusetts and one in southern Manitoba (map 11).

The species is known from few specimens, and there is no information concerning its habitat. The species may inhabit temporarily moist soil that is not necessarily near permanent bodies of water.

The species is collected from May through August.

#### *Bledius tallaci* Fall

Figures 340, 341, 397; Map 12; Table 5

*Bledius tallaci* FALL, 1910, pp. 106, 107. NOTMAN, 1920, p. 697 (type locality: California, Lake Tahoe, Tallac; holotype: deposited at the Museum of

Comparative Zoology, Harvard University, Cambridge, Massachusetts. Type examined, male).

**DIAGNOSIS:** The tridentate mandibles (as in figs. 364, 365), the emargination of the seventh abdominal sternite (fig. 397), the dense punctation and ground sculpturing of the pronotum, and the gradually expanded fourth metatarsomere (as in figs. 390, 393) will separate the males of *Bledius tallaci* from the males of all other North American species in this group.

In the key to the species of the *semiferrugineus* group, *B. tallica* runs to *B. gravidus* at couplet 10. The more dense punctation and more prominent granulate ground sculpturing of the pronotum (compare fig. 341 with fig. 333) will separate *B. tallaci* from *B. gravidus*. *Bledius tallaci* is smaller, and the ratio of the head width/interocular width is less than on *B. gravidus* (table 5). The lateral margins of the anterior half of the pronotum are parallel to each other on *B. tallaci* (fig. 341) and more evenly rounded on *B. gravidus* (fig. 333). The punctation of the head of *B. tallaci* (fig. 340) is slightly deeper than on *B. gravidus* (fig. 331). The emargination of the seventh sternite is deeper on *B. gravidus* (fig. 399) than on *B. tallaci* (fig. 397) and the pubescence

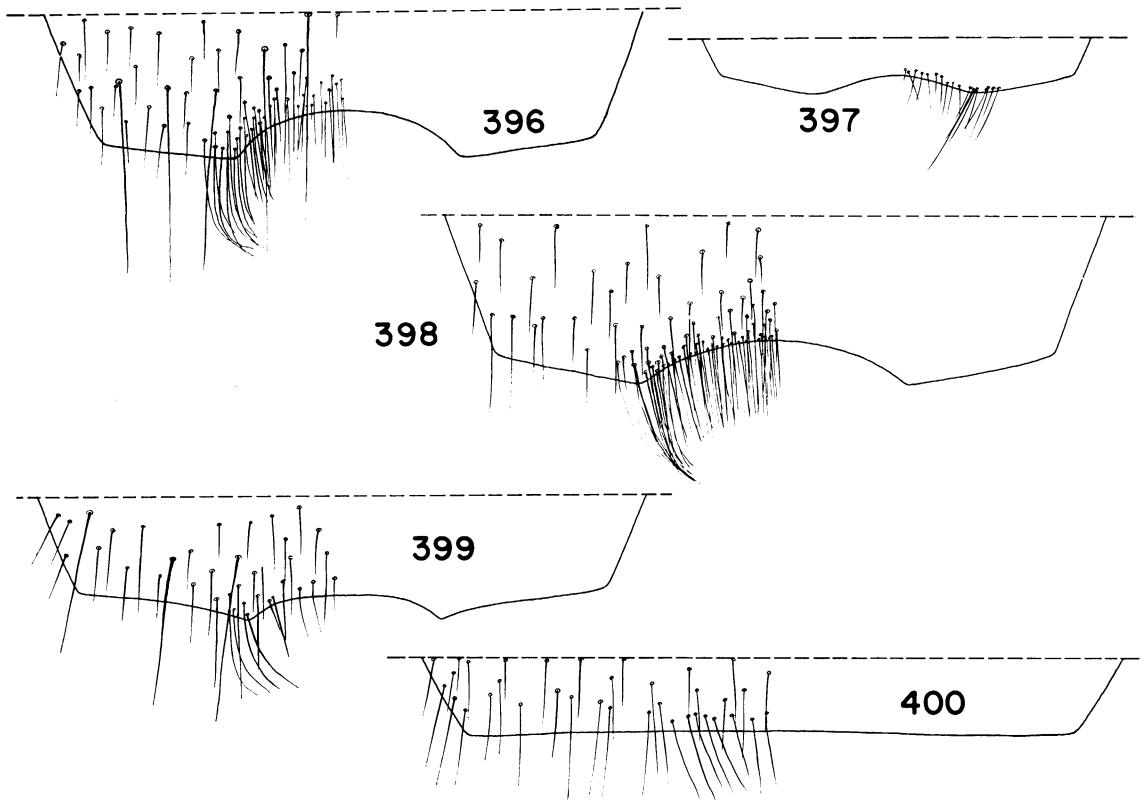

FIG. 396. *Bledius semiferrugineus*; apex of tergum VII; male.  
 FIG. 397. *Bledius tallaci*; apex of tergum VII; male.  
 FIG. 398. *Bledius fumatus*; apex of tergum VII; male.  
 FIG. 399. *Bledius gravidus*; apex of tergum VII; male.  
 FIG. 400. *Bledius foraminosus*; apex of tergum VII; male.

of the body longer on the latter than on the former.

The female is unknown, but see the Discussion of this species below.

DESCRIPTION: *semiferrugineus* group.

Length 5.0 to 5.9 mm.

Dorsum of head and clypeus black. Venter of head dark reddish brown. Maxilla, labium, and mandibles reddish brown. Antenna dark reddish brown. Labrum black. Pronotum black with elongated reddish brown spot on lateral side. Prohypomeron reddish brown. Prosternum dark reddish brown. Elytra reddish brown with blackish infusion at base of suture. Pterothoracic sterna and pleura dark brownish black. Legs reddish brown. Abdomen brownish black.

Dorsum of head opaque, not polished, with dense microgranulate ground sculpturing (as in fig. 448), with distinct but moderately fine,

moderately deep, setigerous punctation between supra-antennal ridges (fig. 340), with slightly elongated, median tumescence and with small elongated depression behind tumescence (fig. 340); tumescence impunctate and not longitudinally divided (fig. 340); postocular transverse groove obsolete and present only posterior to median tumescence (fig. 340). Supra-antennal ridge with dorsal surface impunctate, glabrous, and polished; sides punctate and with microgranulate ground sculpturing. Epistomal suture broadly and shallowly arcuate (fig. 340); suture sharply angulate at juncture with supra-antennal ridge. Clypeus with dense microgranulate ground sculpturing (as in fig. 448); anterior margin with moderately large, rounded tubercles near lateral margin (fig. 340). Lateral portion of head with polished, glabrous, post-ocular strip extending from base of head to

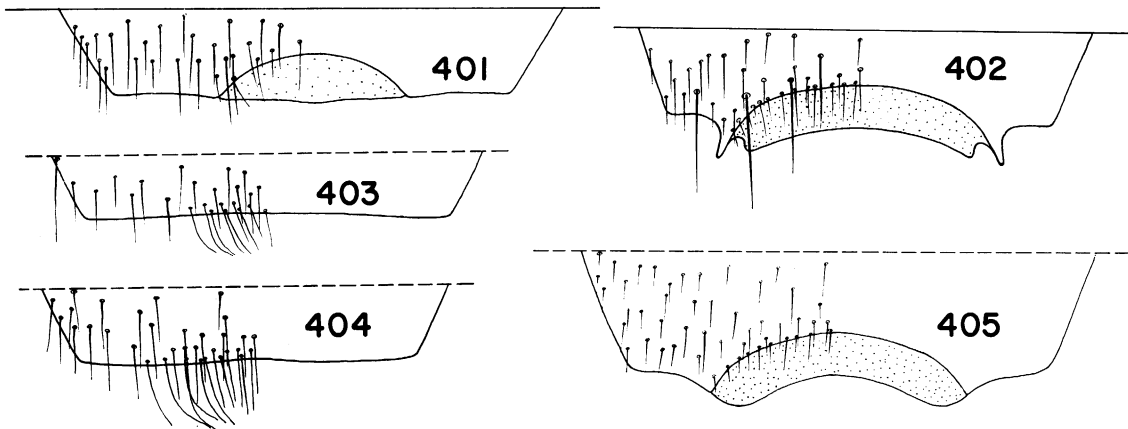

FIG. 401. *Bledius philadelphicus*; apex of tergum VII; male.

FIG. 402. *Bledius assimilis*; apex of tergum VII; male.

FIG. 403. *Bledius nitidicollis*; apex of tergum VII; male.

FIG. 404. *Bledius analis*; apex of tergum VII; male.

FIG. 405. *Bledius coulteri*; apex of tergum VII; male.

posterior margin of eye. Venter of head with microreticulate ground sculpturing. Width of head 0.9 to 1.0 mm.; interocular width 0.6 to 0.7 mm.; head width/interocular width 1.4 mm. (table 5). Labrum with moderately dense, setigerous punctation, and with dense microgranulate ground sculpturing (as in fig. 325). Mandibles of male tridentate (as in figs. 364, 365); apical and second denticles connate and large, basal or third denticle connate but reduced to small tumescent swelling (as in figs. 364, 365); basal denticle of right mandible smaller than that of left. Antennomeres without carina encircling apex.

Pronotum 1.0 mm. long, 1.0 to 1.2 mm. wide; pronotal width/pronotal length 1.1 (table 5); surface moderately strongly convex (fig. 341); lateral margins of anterior half nearly parallel to each other (fig. 341); lateral margin of posterior half strongly convergent to basal angles (fig. 341); basal angles distinct but strongly round (fig. 341); posterior margin broadly and evenly rounded. Pronotum opaque, not polished, and with dense, microgranulate ground sculpturing (as on vertex, fig. 448); sculpturing less distinct or absent on lateral margin and surface often polished; sculpturing more distinct on disk; surface with dense setigerous punctation (fig. 341); punctation large and deeper on disk and anterior portion of pronotum and becoming more shallow, smaller and less distinct laterally

and posteriorly (fig. 341); pubescence moderately long; midlongitudinal groove present and deepest near middle (fig. 341); groove reaching to anterior and posterior marginal beads. Pronotal lateral marginal bead entirely visible in dorsal aspect (fig. 341); anterior portion slightly deflexed. Prohypomeron and prosternum with dense microreticulate ground sculpturing.

Elytra 1.2 to 1.3 mm. long; elytral length/pronotal length 1.3 (table 5); surface polished; with dense, setigerous punctation.

Metatarsus with fourth tarsomere gradually expanded apically (as in figs. 390, 393).

Abdomen of males with posterior margin of seventh sternite broadly, and moderately deeply emarginate (fig. 397); emargination not filled with membrane (fig. 397); emargination with patch of long setae at lateral angles and along margin (fig. 397); emargination without spiniform process on lateral angle (fig. 397). Eighth sternum of males without dense patch of setae posterior to emargination of seventh sternite.

Spermatheca unknown.

SEXUAL DIMORPHISM: The female of this species is not known.

HABITAT AND DISTRIBUTION: *United States: California* (map 12). (See Appendix for localities.)

I did not collect the species and know nothing of its habitat or where it is found.

DISCUSSION: The female of *Bledius tallaci* is not

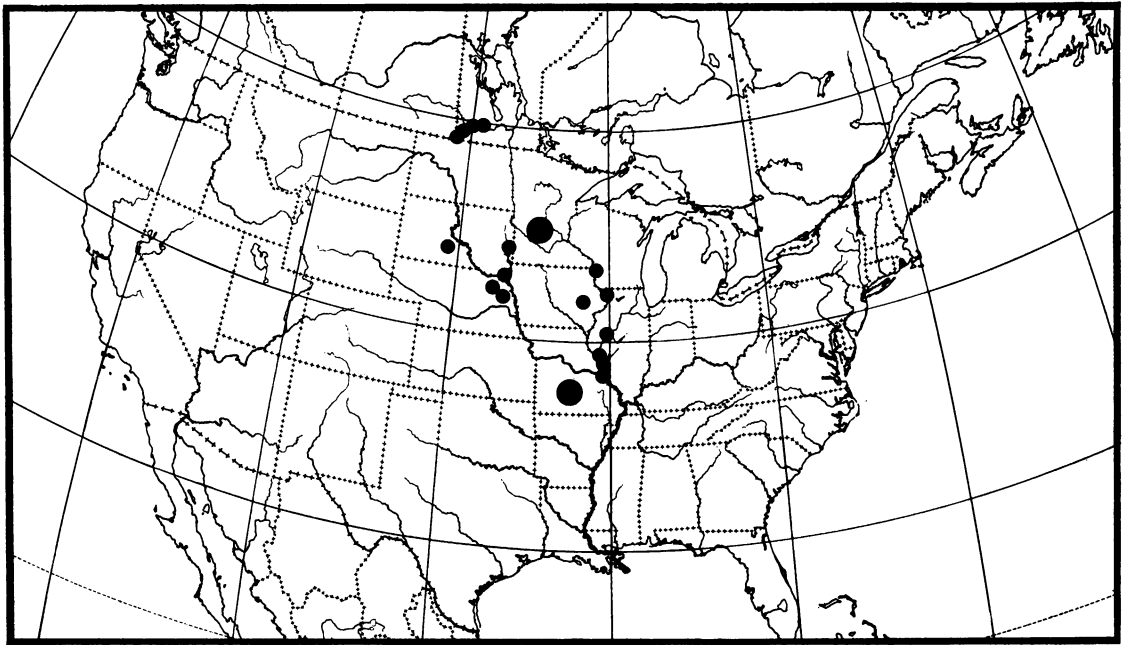

MAP 13. Distribution of *Bledius rotundicollis* (black dots; large dot indicates state record only).

known. If we can extrapolate from information known about the females of similar species (i.e., *B. gravidus*, *B. foraminosus*, *B. fumatus*), then the female of *B. tallaci* probably has bidentate mandibles, lacks an emargination of the seventh sternite, and has punctation and ground sculpturing of the head and pronotum similar to that of the male. If the females are as such, then they will run to couplet 31 to *B. gravidus* and can be separated by the prothoracic characters given in the Diagnosis of *B. tallaci*.

*Bledius rubiginosus* Erichson

Figures 336, 338, 362, 363, 370, 372, 375, 379, 394, 395, 418, 438, 442; Map 12; Table 5

*Bledius rubiginosus* ERICHSON, 1840, p. 765. LE CONTE, 1877, p. 223, 224. CASEY, 1889, p. 55. NOTMAN, 1920, p. 697 (type locality: Carolina meridionali; lectotype: designated herein and a label placed on the specimen. Deposited at the Institut für Spezielle Zoologie und Zoologisches Museum der Humboldt-Universität zu Berlin, Deutsche Demokratische Republik. Type examined).

DIAGNOSIS: *Bledius rubiginosus* is the only species of the *semiferrugineus* group in the United

States that has the head notably darker than the pronotum. The head is reddish black to reddish brown and the pronotum usually reddish orange or occasionally reddish brown. In instances where the pronotum is reddish brown the head is invariably much darker, almost black. A few other characters helpful for recognition of *B. rubiginosus* are the fine punctation (fig. 336) and fine microgranulate ground sculpturing of the head, the wide head (fig. 336), presence of a midlongitudinal groove on the pronotum (fig. 338), the gradually expanded fourth metatarsomere (as in figs. 390, 393), and lack of the emargination of the posterior margin of the seventh sternite.

DESCRIPTION: *semiferrugineus* group.

Length 4.0 to 6.5 mm.

Dorsum of head reddish black to reddish brown. Venter of head dark to light reddish brown or reddish orange. Clypeus and dorsum concolorous. Epistomal suture often outlined in black. Maxilla, labium, and antennae reddish brown. Mandibles dark reddish brown. Pronotum usually reddish orange, occasionally dark reddish brown, but in all instances dorsum of head darker than pronotum. Prohypomeron and

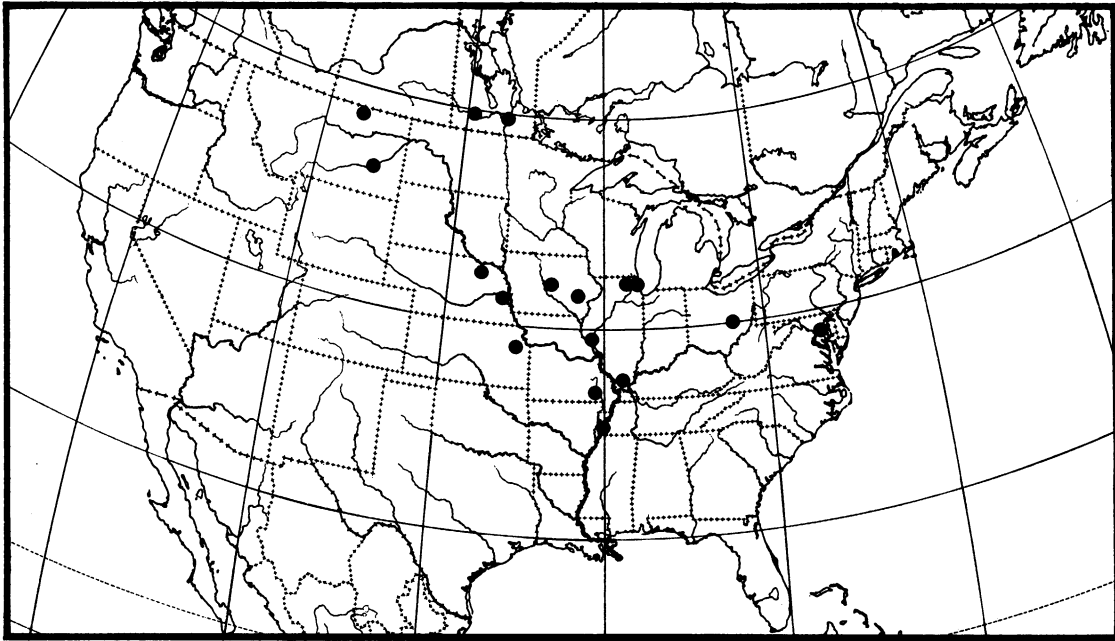

MAP 14. Distribution of *Bledius nitidicollis* (black dots).

prothorax nearly concolorous with pronotum but slightly paler. Elytra pale reddish orange, invariably paler than pronotum. Pterothoracic sterna and pleura reddish orange, darker than elytra. Legs pale reddish brown or reddish orange. Abdomen reddish orange, intermediate between pronotum and elytra.

Dorsum of head opaque, and shining but not polished, with dense microgranulate ground sculpturing (as in fig. 448), with dense, distinct but shallow setigerous punctation at base of head (fig. 336), and with median, longitudinal slightly convex, impunctate ridge (fig. 336); central fovea usually present (fig. 336), sometimes absent; postocular groove absent (fig. 336). Supra-antennal ridge moderately prominent (fig. 336), with shallow, setigerous punctation on base and side, dorsal surface impunctate (fig. 336), and with microgranulate ground sculpturing on sides and base; apex of dorsal surface polished. Epistomal suture broadly arcuate and strongly angulate at intersection with supra-antennal ridge (fig. 336). Clypeus with small, rounded tubercles on anterior margin near lateral margin (fig. 336) and with dense, microgranulate ground sculpturing (as in fig. 448). Lateral portion of head with gla-

brous, postocular strip; strip reaching anteriorly nearly to posterior margin of eye. Ventral surface of head with microreticulate ground sculpturing. Width of head 0.9 to 1.1 mm.; interocular width 0.5 to 0.6 mm.; head width/interocular width 1.6 to 1.8 (table 5). Labrum with dense, microgranulate ground sculpturing, and with moderately dense, indistinct, setigerous punctation; anterior margin not reflexed. Mandibles of males and females bidentate; denticles connate. Antennomeres without carina encircling apex.

Pronotum 0.8 to 1.1 mm. long, 0.9 to 1.2 mm. wide; pronotal width/pronotal length 1.1 to 1.2 (table 5); surface moderately strongly convex (fig. 338); lateral margins divergent from base, apical three-fifths slightly rounded (fig. 338); basal two-fifths more strongly rounded to strongly rounded basal angles (fig. 338); basal margin moderately strongly rounded; lateral margins occasionally broadly rounded to basal margin (fig. 379); surface with moderately dense, setigerous punctation (fig. 338); punctation larger, deeper, and more distinct from lateral margin mesially (fig. 338); median strip impunctate (fig. 338); surface with feeble granulate ground sculpturing; surface polished (as on vertex, fig. 451); midlongitudinal groove

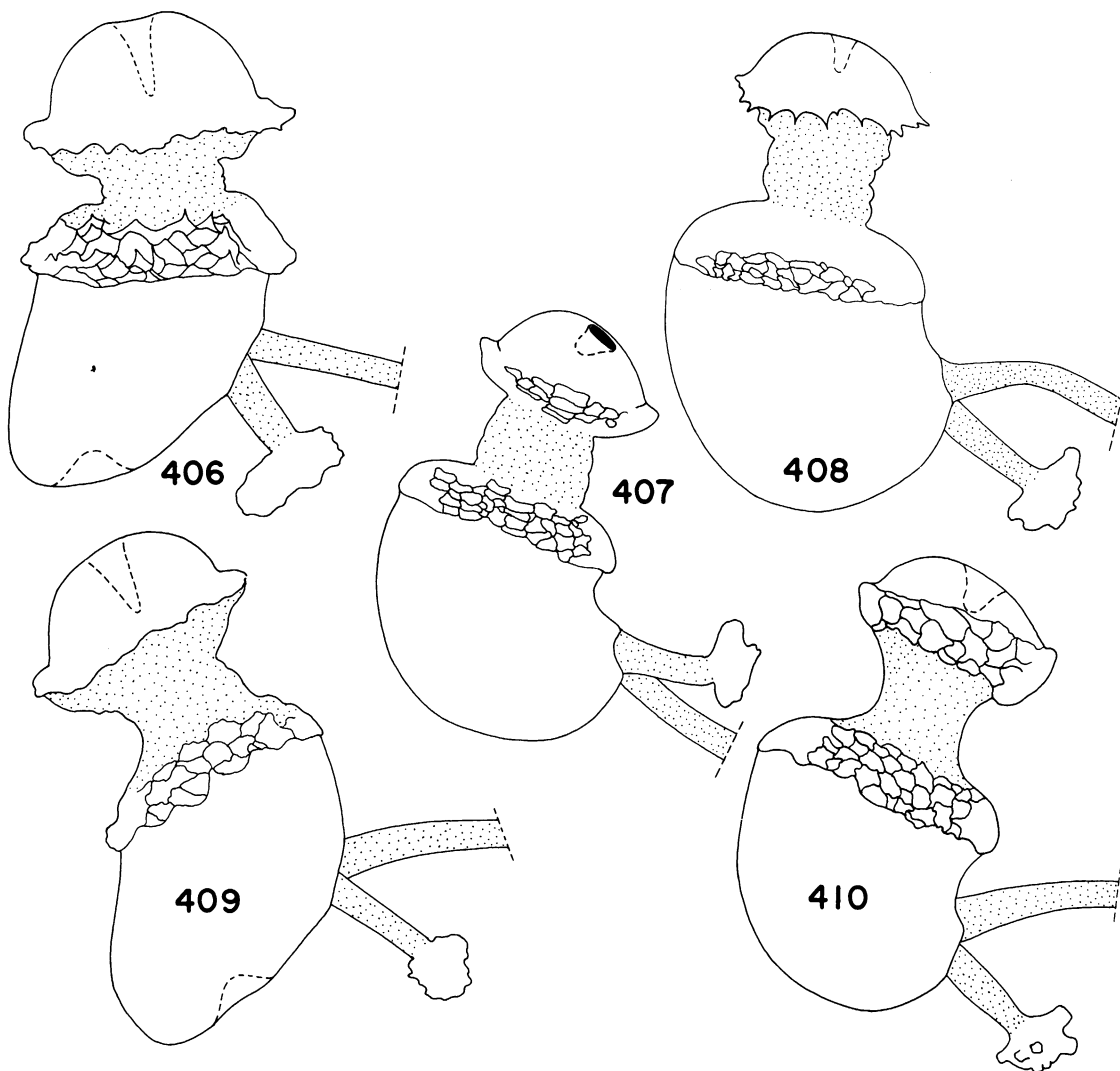

FIG. 406. *Bledius philadelphicus*; spermatheca.

FIG. 407. *Bledius assimilis*; spermatheca; Iowa.

FIG. 408. *Bledius assimilis*; spermatheca; Duparquet, Quebec.

FIG. 409. *Bledius philadelphicus*; spermatheca.

FIG. 410. *Bledius coulteri*; spermatheca.

distinct, usually deep and prominent (fig. 338), not reaching anterior or posterior margin. Pronotal lateral marginal bead visible in dorsal aspect (fig. 338); sinuate in lateral view and slightly deflexed anteriorly. Prohypomeron with microreticulate ground sculpturing. Prosternum with microgranulate ground sculpturing.

Elytra 1.1 to 1.3 mm. long; elytral length/pronotal length 1.2 to 1.3 (table 5), and with

dense, coarse, distinct, setigerous punctation; surface polished. Metatarsus with fourth article gradually expanded to apex (as in figs. 390, 393).

Abdomen with posterior margin of seventh sternite of males and females unmodified. Eighth sternum of males and females unmodified.

Spermatheca as shown in figure 418.

**SEXUAL DIMORPHISM:** There is no way of distinguishing the males and females externally.

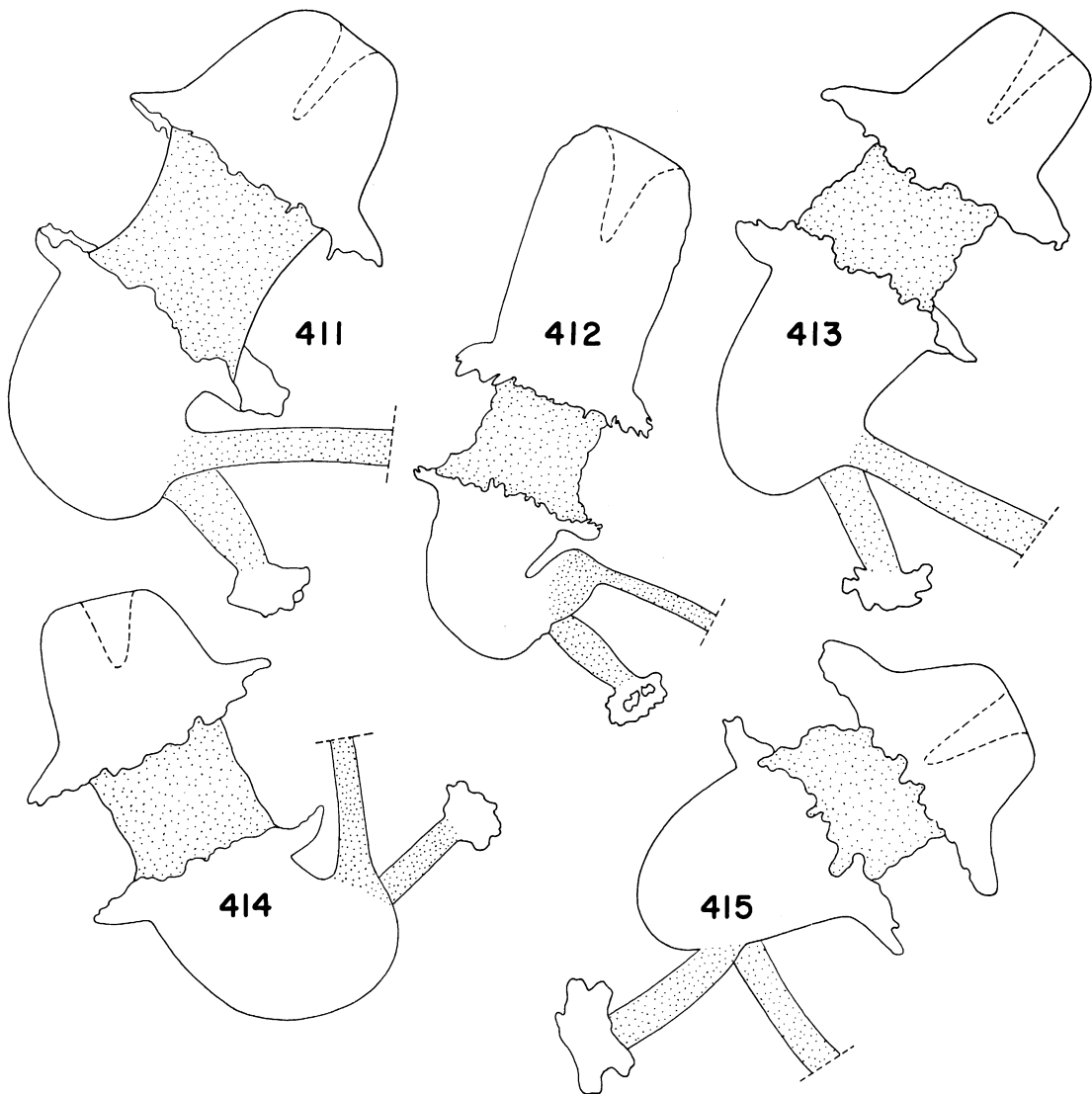

FIG. 411. *Bledius gravidus*; spermatheca.

FIG. 412. *Bledius semiferrugineus*; spermatheca.

FIG. 413. *Bledius rotundicollis*; spermatheca; Iowa.

FIG. 414. *Bledius foraminosus*; spermatheca.

FIG. 415. *Bledius rotundicollis*; spermatheca; South Dakota.

**HABITAT AND DISTRIBUTION:** *Canada:* Manitoba. *United States:* Arkansas, Georgia, Indiana, Iowa, Kansas, Mississippi, Missouri, Nebraska, New Mexico, North Carolina, Oklahoma, South Dakota, Texas, Virginia, Wyoming. (See Appendix for localities.)

*Bledius rubiginosus* is known from the southeastern United States but not Florida and from

many localities in the midwestern United States from southern Texas to as far north as southern Manitoba and as far west as central New Mexico and western Kansas and Nebraska (map 12).

The species was collected on moist, open, unvegetated parts of sand flats on the Arkansas River near Ponca City, Oklahoma, on the Salt

Fork of the Arkansas River near Jet, Oklahoma, on the South Fork of the Solomon River near Tasco, Kansas, on the Platte River near Wahoo, Nebraska, on the Republican River near Trenton, Nebraska, and on the Rio Grande near Belen, New Mexico.

The species is collected from April through September at most localities.

*Bledius rotundicollis* Le Conte

Figures 335, 337, 339, 356, 357, 388, 389, 415, 430, 431; Map 13; Table 5

*Bledius rotundicollis* LE CONTE, 1877, p. 223. NOTMAN, 1920, p. 697. HATCH, 1957, p. 99. MIYATAKE, 1967, p. 94 (not *rotundicollis* Miyatake, 1963) (type locality: Nebraska, Fort Pierce; holotype: deposited in the Museum of Comparative Zoology, Harvard University, Cambridge, Massachusetts. Type examined, male).

DIAGNOSIS: *Bledius rotundicollis* can be separated from all the members of the *semiferrugineus* group in the United States by the swollen fourth metatarsomere (figs. 391, 392). Some individuals from the more northern parts of the geographical range have the fourth metatarsomere swollen from the middle (fig. 392) rather than the base (fig. 391). Individuals with the tarsomere swollen from the middle might be confused with *B. gravidus* or *B. fumatus* but can be separated from these two species by the large eyes (compare fig. 335 with figs. 331, 332), more broadly rounded lateral margins of the pronotum, and the more dense pronotal punctation (compare figs. 337, 339 with figs. 333, 334). Additional characters helpful in the recognition of *B. rotundicollis* are the shallow punctation and microgranulate ground sculpturing of the head (fig. 335), the nearly concolorous head and pronotum, and deep emargination of the posterior margin of the seventh sternite of the male.

DESCRIPTION: *semiferrugineus* group.

Length 5.5 to 9.0 mm.

Dorsum of head reddish brown to reddish black with venter and supra-antennal ridge paler and more reddish. Labrum concolorous with dorsum of head. Antenna, maxilla, and labium yellowish brown to pale reddish brown. Pronotum concolorous with head; lateral margins often bright reddish brown in contrast to dark reddish brown disk; prohypomeron and prosternum usually pale reddish brown. Elytra bright reddish brown with dark reddish brown

along suture and base. Pterothoracic sterna reddish brown to brown. Legs yellowish brown to reddish brown. Abdomen bright reddish brown, approximately concolorous with elytra.

Dorsum of head opaque, not polished, with dense, microreticulate ground sculpturing (as in fig. 448), and with moderately dense, setigerous punctation (fig. 335); punctation fine and inconspicuous (fig. 335); dorsum with median depression (fig. 335); depression round and punctiform to elongate (fig. 335); postocular transverse groove absent (fig. 335). Supra-antennal ridge moderately prominent (fig. 335); base and sides with microgranulate ground sculpturing and fine shallow setigerous punctation (fig. 335); dorsal surface glabrous. Epistomal suture broadly arcuate and strongly angulate at juncture with supra-antennal ridge (fig. 335). Clypeus with dense microgranulate ground sculpturing (as in fig. 448); anterior margin with small, rounded tubercles near lateral margin (fig. 335). Lateral side of head with postocular glabrous strip reaching to posterior margin of eye. Venter of head with dense, microreticulate ground sculpturing. Width of head 1.1 to 1.2 mm.; interocular width 0.7 to 0.8 mm.; head width/interocular width 1.56 to 1.63 (table 5). Labrum with dense, microgranulate ground sculpturing (as in fig. 325) and with moderately dense, setigerous punctation; anterior margin with median portion weakly reflexed. Mandibles of female bidentate (as in figs. 362, 363); denticles connate. Mandibles of male tridentate (figs. 356, 357); denticles connate; apical and second denticles large, basal denticle small. Antennomeres without ridge encircling apex.

Pronotum 1.0 to 1.2 mm. long, 1.3 to 1.4 mm. wide; pronotal width/pronotal length 1.16 to 1.24 (table 5) and strongly convex (figs. 337, 339); lateral and basal margins broadly rounded (figs. 337, 339); basal two-fifths of lateral margin often almost straight (fig. 339); basal angles poorly developed and obsoletely angulate (figs. 337, 339). Pronotum opaque, not polished, with dense microgranulate ground sculpturing (as on vertex, fig. 448); lateral margin polished and without microgranulate ground sculpturing; setigerous punctation moderately dense and moderately prominent (figs. 337, 339); punctation less distinct laterally; middorsal groove distinct (figs. 337, 339) but not reaching anterior or basal margin. Pronotal lateral marginal bead



with apex usually visible in dorsal view (figs. 337, 339); anterior portion ventrally deflexed. Prohypomeron polished and with microreticulate ground sculpturing, devoid of punctation or pubescence. Prosternum with microreticulate ground sculpturing; punctation obsolete. Elytra 1.4 to 1.5 mm. long; elytral length/pronotal length 1.2 to 1.4 (table 5); surface polished, with dense, prominent, setigerous punctation.

Metatarsus with fourth article swollen (figs. 388, 389, 391, 392); base often sharply swollen, lateral margins parallel or broadly arcuate to apex (figs. 388, 391), or less swollen with base narrow and parallel, then sharply swollen at middle and nearly parallel to apex (figs. 389, 392).

Seventh abdominal sternite of male with broad, moderately deep emargination; emargination not filled by membrane; emargination without spiniform process at lateral angles; emargination with setae along margin and with small cluster of longer setae at lateral angles (as in fig. 396). Eighth sternum of males with patch of dense pubescence behind emargination of seventh sternite. Seventh and eighth sternal elements of female unmodified.

Spermatheca as in figure 415.

**SEXUAL DIMORPHISM:** The male has tridentate mandibles and a deep emargination of the posterior margin of the seventh sternite. The female has bidentate mandibles, and the seventh sternite is unmodified.

**HABITAT AND DISTRIBUTION:** *Canada:* Manitoba. *United States:* Illinois, Iowa, Minnesota, Missouri, Nebraska, South Dakota, Wisconsin. (See Appendix for localities.)

*Bledius rotundicollis* is known from the midwestern United States from Illinois west to South Dakota and eastern Nebraska, and from Missouri north to southern Manitoba (map 13).

The species is collected rarely, at few localities, and almost always by light trap. There is no information on its habitat.

The species has been collected from May through August.

*Bledius nitidicollis* Le Conte

Figures 344, 346, 366, 382, 403, 417, 440, 441;  
Map 14; Table 5

*Bledius nitidicollis* LE CONTE, 1863, p. 52; 1877, pp. 223, 225. CASEY, 1889, p. 56. BLATCHLEY, 1910, pp. 464, 465. NOTMAN, 1920, p. 697 (type locality:

New York; holotype: deposited in the Museum of Comparative Zoology, Harvard University, Cambridge, Massachusetts. Type examined, male).

**DIAGNOSIS:** *Bledius nitidicollis* is similar to *B. analis* in many respects including the male secondary sexual character of the seventh sternite (cf. fig. 403 to fig. 404) but is easily separated. The abdomen of *B. nitidicollis* is concolorous, and the midlongitudinal groove of the pronotum is absent or at best poorly developed (cf. fig. 346 to fig. 352). *Bledius nitidicollis* is on the average smaller than *B. analis* (table 5).

The male secondary sexual character will enable separation of *Bledius nitidicollis* (fig. 403) from *B. philadelphicus* (fig. 401), *B. coulteri* (fig. 405), and *B. assimilis* (fig. 402). The females of *B. nitidicollis* can be separated from those of *B. philadelphicus* by characteristics of the spermatheca (compare fig. 417 with figs. 406, 409) and by the lack or poor development of the pronotal midlongitudinal groove (compare fig. 346 with fig. 350). The spermathecal characters (compare fig. 417 with figs. 407, 408, 410) and feeble microgranulate ground sculpturing will allow separation of the females of *B. nitidicollis* from *B. coulteri* and *B. assimilis*. The smaller size and the combination of the above characters will permit recognition of *B. nitidicollis* from the other species of the *semiferrugineus* group.

**DESCRIPTION:** *semiferrugineus* group.

Length 3.3 to 4.5 mm.

Dorsum and venter of head, clypeus, and labrum black to reddish brown. Labium, maxilla, and antennae yellowish brown. Mandibles reddish brown. Pronotum dark to light reddish brown. Prohypomeron and prosternum reddish brown. Elytra orange with light brown infusions along suture from base to apex. Pterothoracic sterna and pleura blackish brown to reddish brown. Legs yellowish brown. Abdomen dark reddish brown to bright reddish brown; tergal elements VII to X concolorous with remainder of terga.

Dorsum of head opaque, not polished, with dense, distinct, prominent, microgranulate ground sculpturing (as in fig. 448), with dense, distinct, shallow, setigerous punctation between supra-antennal ridges (fig. 344), and with impunctate, midlongitudinal, broadly rounded ridge (fig. 344); ridge with small, shallow fovea at base (fig. 344); postocular groove absent (fig. 344). Supra-antennal ridges well developed and moderately prominent (fig. 344); base and

sides with setigerous punctation and microgranulate ground sculpturing; dorsal surface impunctate and with microgranulate ground sculpturing, apex polished and without ground sculpturing. Epistomal suture broadly arcuate (fig. 344); suture strongly angulate at intersection with supra-antennal ridge. Clypeus with dense, microgranulate ground sculpturing (as in fig. 448); anterior margin with small, rounded tubercle near lateral margin (fig. 344). Lateral side of head with large, polished, glabrous region at base of head extending anteriorly to posterior margin of eye. Venter of head with dense, microreticulate ground sculpturing. Width of head 0.6 to 0.7 mm.; interocular width 0.4 to 0.5 mm.; head width/interocular width 1.4 to 1.7 (table 5). Labrum with dense, microgranulate ground sculpturing (as in fig. 325), and with moderately dense, setigerous punctation; anterior margin truncate and with median portion slightly reflexed. Mandibles of male and female bidentate (fig. 366); denticles connate at base and free at apex. Antennomeres without apical encircling ridge.

Pronotum 0.6 to 0.7 mm. long, 0.7 to 0.8 mm. wide; range of pronotal width/pronotal length 1.0 to 1.1 (table 5). Pronotum moderately strongly convex (fig. 346); lateral margin usually broadly and evenly rounded from anterior margin to posterior margin (fig. 382); lateral margins in some cases with anterior three-fifths almost parallel and posterior two-fifths strongly convergent (fig. 346); posterior portion more strongly convergent than anterior portion (figs. 346, 382); basal angles broadly and strongly rounded (figs. 346, 382); basal margin broadly and shallowly rounded (figs. 346, 382). Pronotum polished to shining; microgranulate ground sculpturing distinct, well developed, and uniform to less distinct, less strongly developed, and unevenly distributed; setigerous punctation moderately dense, distinct, moderately deep and prominent (fig. 346); midlongitudinal strip impunctate (fig. 346); midlongitudinal groove present (fig. 346) or absent; groove when present usually incomplete, shallow, and indistinct (fig. 346). Pronotal lateral marginal bead entirely visible in dorsal aspect (fig. 346); bead deflexed anteriorly. Prohypomeron shining; with microreticulate ground sculpturing. Prosternum with dense, microreticulate ground sculpturing.

Elytra 0.8 to 1.0 mm. long; elytral length/pronotal length 1.2 to 1.4 (table 5); surface

polished between punctures and with dense, moderately coarse, setigerous punctation. Metatarsus with last article gradually expanded apically (as in figs. 390, 393).

Abdomen with posterior margin of seventh sternite of males shallowly and broadly emarginate (fig. 403); emargination not enclosed with membrane but margined with long, dense pubescence (fig. 403); apex of pubescence mesially curved (fig. 403); lateral angle of emargination without spiniform process (fig. 403); seventh sternite of female unmodified. Eighth sternum of male with dense patch of pubescence behind emargination of seventh sternite; eighth sternum of female unmodified.

Spermatheca as shown in figure 417.

**SEXUAL DIMORPHISM:** The male and female of *Bledius nitidicollis* are externally distinguishable from each other by the presence on the male of an emargination of the seventh abdominal sternite that is bordered by long, dense pubescence (fig. 403).

**HABITAT AND DISTRIBUTION:** *Canada:* Manitoba. *United States:* Arkansas, Illinois, Iowa, Kansas, Maryland, Missouri, Montana, Nebraska, Ohio. (See Appendix for localities.)

*Bledius nitidicollis* is known from the northeastern two-thirds of the United States to east of the Rocky Mountains, and in southern Manitoba (map 14).

On the Mississippi River at West Memphis, Arkansas, the species is found in large numbers in shaded, vegetated, slightly moist sand banks. The banks are covered with *Salix* sp. and various grasses. The species was collected during May through September.

*Bledius analis* Le Conte

Figures 349, 352, 369, 371, 404, 416, 444-447;  
Map 15; Table 5

*Bledius analis* LE CONTE, 1863, p. 52; 1877, pp. 223, 225. CASEY, 1889, p. 52. BLATCHLEY, 1910, p. 464. NOTMAN, 1920, p. 697 (type locality: Illinois; holotype: deposited in the Museum of Comparative Zoology, Harvard University, Cambridge, Massachusetts. Type examined, female).

**DIAGNOSIS:** *Bledius analis* is separated from *B. nitidicollis* by the bicolored abdomen with the seventh to tenth tergal elements black. The former species is slightly larger than the latter. The male secondary sexual characteristics are the same for both *B. analis* (fig. 404) and *B.*

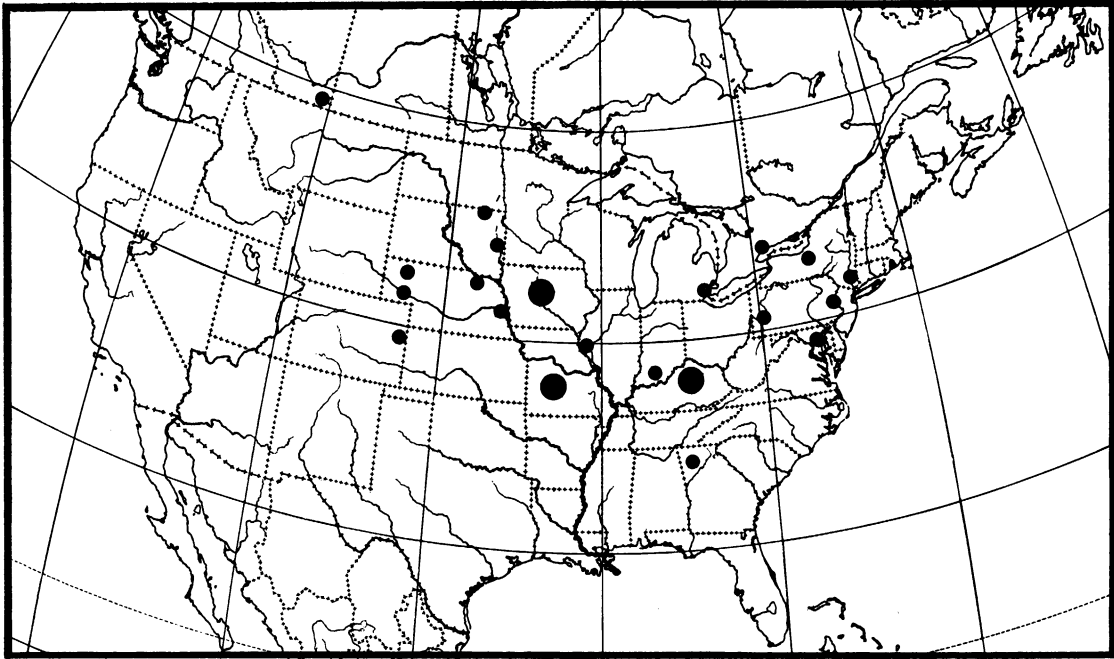

MAP 15. Distribution of *Bledius analis* (black dots; large dots indicate state records only).

*nitidicollis* (fig. 403), but *B. philadelphicus* (fig. 401), *B. coulteri* (fig. 405), and *B. assimilis* (fig. 402) all have a membranous lobe on the seventh sternite of the male. The last three species all have dense microgranulate ground sculpturing (as on vertex, fig. 448) of the pronotum, whereas *B. analis* often has a polished pronotum with the microgranulate ground sculpturing obsolete to weakly developed. The midlongitudinal groove of the pronotum is weakly to strongly developed in *B. analis* but absent in *B. assimilis* and *B. coulteri*.

*Bledius analis* is readily separable from all the other members of the *semiferrugineus* group by the bicolored abdomen and the smaller eyes.

DESCRIPTION: *semiferrugineus* group.

Length 3.5 to 4.8 mm.

Dorsum of head, clypeus, and labrum black to dark reddish brown; venter of head black to dark reddish brown. Mandibles reddish brown. Labium and maxilla reddish brown to yellowish brown. Antenna reddish brown. Pronotum black to dark reddish brown. Prohypomeron and prosternum reddish brown. Elytra with reddish orange to orange to yellowish brown disk; suture black to dark brown from base to apex. Pterothoracic sterna and pleura black to red-

dish brown. Legs reddish brown to yellowish brown. Abdominal terga bright reddish orange to yellowish brown with terga VII, VIII, IX, and X black; abdominal sternites bright reddish orange to yellowish brown.

Dorsum of head opaque, not polished, with dense, distinct microgranulate ground sculpturing (as in fig. 448), with moderately dense, distinct, shallow setigerous punctation between supra-antennal ridges (fig. 349), and with impunctate, midlongitudinal, slightly convex ridge or tumescence (fig. 349); ridge with prominent, punctiform fovea between bases of supra-antennal ridges (fig. 349); postocular groove absent (fig. 349). Supra-antennal ridges well developed, moderately prominent (fig. 349); base and sides with fine, shallow, indistinct, setigerous punctation (fig. 349) and microgranulate ground sculpturing; dorsal surface polished, with obsolete microgranulate ground sculpturing, and with a few scattered setae. Epistomal suture broadly arcuate (fig. 349); suture strongly angulate at intersection with supra-antennal ridge. Clypeus with dense, distinct, microgranulate ground sculpturing (as in fig. 448); anterior margin with small, rounded tubercle near lateral margin (fig. 349). Lateral

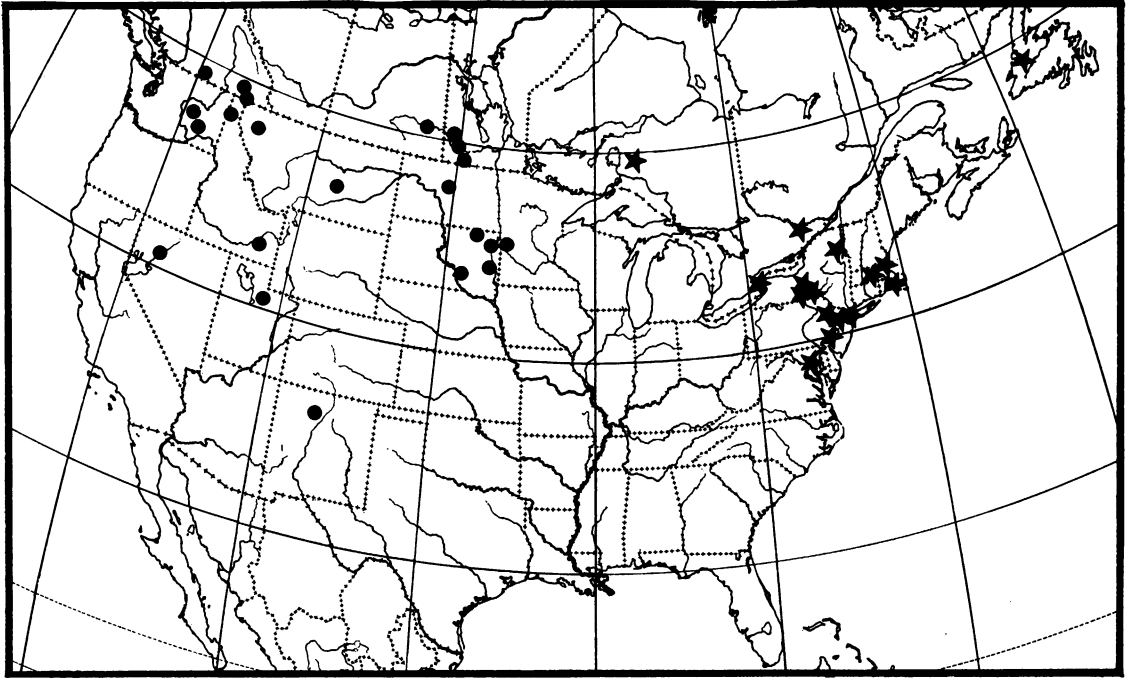

MAP 16. Distribution of *Bledius coulteri* (black dots) and *B. philadelphicus* (stars).

side of head with large, polished, glabrous region at base of head extending anteriorly to posterior margin of eye. Venter of head with dense, microreticulate ground sculpturing. Width of head 0.6 to 0.7 mm.; interocular width 0.4 to 0.5 mm.; head width/interocular width 1.4 to 1.5 (table 5). Labrum with dense microgranulate ground sculpturing (as in fig. 325) and with moderately dense, setigerous punctation; anterior margin with median portion very slightly reflexed. Mandibles of males and females bidentate (as in fig. 366); denticles connate at base and free at apex. Antennomeres without apical, encircling ridge.

Pronotum 0.7 mm. long, 0.7 to 0.9 mm. wide; pronotal width/pronotal length 1.0 to 1.1 (table 5); strongly convex (fig. 352); lateral margins generally evenly and broadly rounded from anterior margin to posterior margin (fig. 352); more strongly convergent basally than anteriorly (fig. 352); lateral margin occasionally with anterior three-fifths nearly parallel and with posterior two-fifths strongly convergent (fig. 352); basal angles strongly rounded (fig. 352); basal margin broadly and shallowly rounded. Pronotum polished; microgranulate ground

sculpturing generally absent to weakly developed, in some cases strongly developed; setigerous punctation moderately dense, distinct, moderately deep and prominent (fig. 352); mid-longitudinal strip impunctate (fig. 352); mid-longitudinal groove distinct, shallow, entire (fig. 352), and nearly reaching both anterior margin and posterior marginal bead or distinct and shallow but broken and absent or obsolete in many spots. Pronotal lateral marginal bead entirely visible in dorsal aspect (fig. 352); bead deflexed anteriorly; bead entire. Prohypomeron shining and with microreticulate ground sculpturing. Prosternum with dense, microreticulate ground sculpturing.

Elytra 0.9 to 1.0 mm. long; elytral length/pronotal length 1.2 to 1.3 (table 5); surface polished between punctures, and with dense, moderately coarse setigerous punctation.

Metatarsus with last article gradually expanded apically (as in figs. 390, 393).

Abdomen with posterior margin of seventh sternite of male shallowly and broadly emarginate (fig. 404); emargination not filled with membrane but margined with long, dense pubescence (fig. 404); apex of pubescence

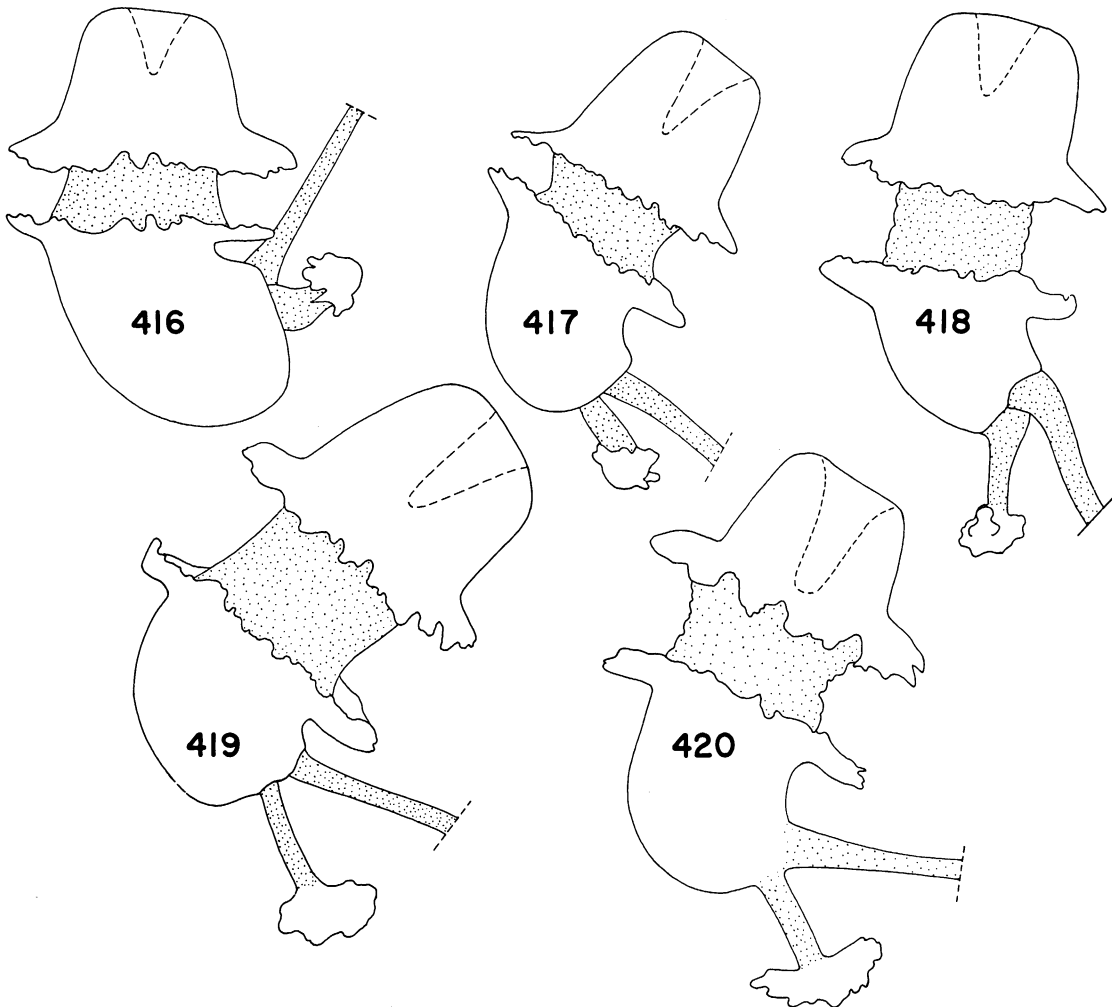

FIG. 416. *Bledius analis*; spermatheca.

FIG. 417. *Bledius nitidicollis*; spermatheca.

FIG. 418. *Bledius rubiginosus*; spermatheca.

FIG. 419. *Bledius foraminosus*; spermatheca.

FIG. 420. *Bledius fumatus*; spermatheca.

mesially curved (fig. 404); lateral angle of emargination without spiniform process (fig. 404); seventh sternite of female unmodified. Eighth sternum of male with dense patch of setae behind emargination of seventh sternite; eighth sternum of female unmodified.

Spermatheca as shown in figure 416.

**SEXUAL DIMORPHISM:** The male has an emargination of the seventh abdominal sternite (fig. 404), the female does not.

**HABITAT AND DISTRIBUTION:** *Canada:* Alberta, Ontario. *United States:* Colorado, Georgia, Il-

linois, Indiana, Iowa, Kentucky, Maryland, Michigan, Missouri, Nebraska, New York, Pennsylvania, South Dakota. (See Appendix for localities.)

*Bledius analis* is known from the northeastern two-thirds of the United States from New York to western Nebraska and eastern Colorado. The species may actually occur in isolated populations as far as the eastern side of the Rocky Mountains, as there is a specimen known from southeastern Alberta, east of the mountains (map 15).

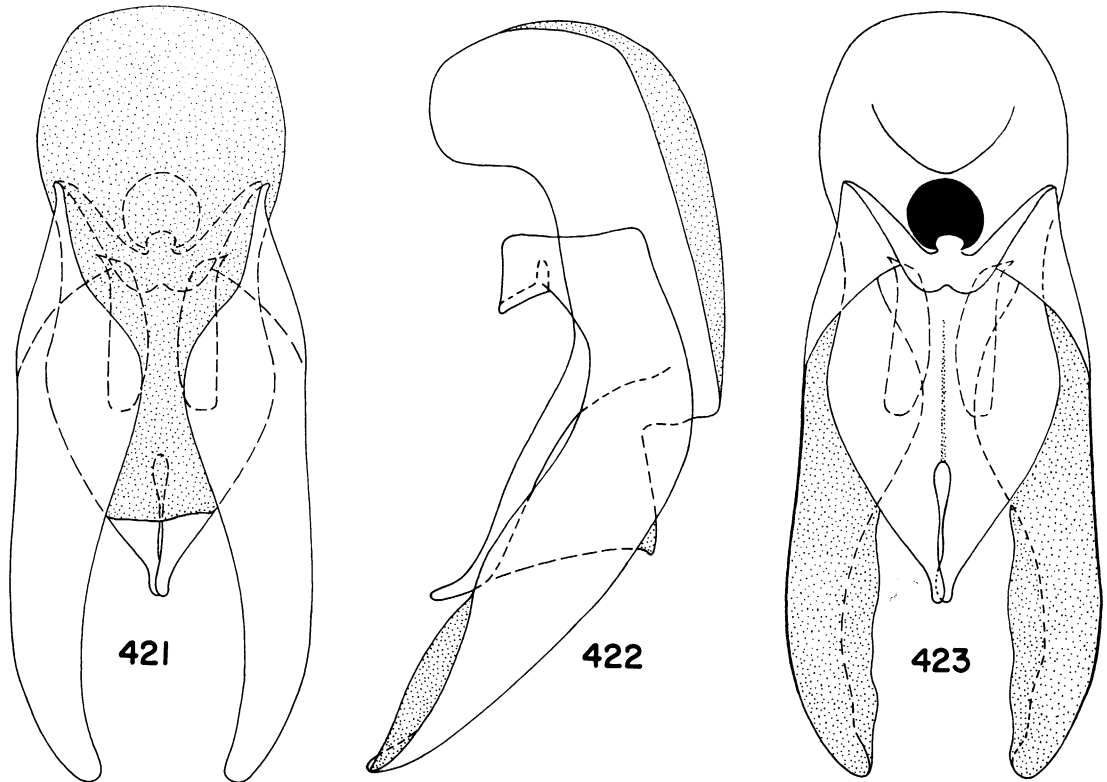

FIG. 421. *Bledius gravidus*; aedeagus, dorsal view, slightly expanded.  
 FIG. 422. *Bledius gravidus*; aedeagus, lateral view, slightly expanded.  
 FIG. 423. *Bledius gravidus*; aedeagus, ventral view, slightly expanded.

In western Nebraska on the Niobrara River near Hay Springs, on the North Platte River near Oshkosh, and on the Patauxent River in Maryland, the species is in moist, shaded vegetated sand banks. Blatchley (1910) reported the species "under cover along the banks of streams and lakes."

The species is collected during June through September.

*Bledius philadelphicus* Fall

Figures 347, 350, 367, 368, 383, 386, 401, 406, 409, 428, 429; Map 16; Table 5

*Bledius philadelphicus* FALL, 1919, p. 26. NOTMAN, 1920, p. 697 (type locality: Pennsylvania, Philadelphia; holotype: deposited at the Museum of Comparative Zoology, Harvard University, Cambridge, Massachusetts. Type examined).

*Bledius falli* WENDELER, 1928, p. 298 (objective synonym, proposed to replace *B. dissimilis* Fall).

*Bledius dissimilis* FALL, 1910, p. 107 (preoccupied, not Erichson, 1840).

*Bledius mixtus* NOTMAN, 1922, p. 104 (new synonym; type locality: New Jersey, Newark; holotype: deposited at the Staten Island Institute of Arts and Sciences, New York, New York; type examined, female).

*Bledius dickersoni* NOTMAN, 1922, p. 105 (new synonym; type locality: New Jersey, Newark; holotype: deposited at the Staten Island Institute of Arts and Sciences, New York, New York. Type examined, female).

DIAGNOSIS: The males of *Bledius philadelphicus* can be separated from all the males of the *semi-ferrugineus* group except *B. assimilis* and *B. coulteri* by the membranous lobe on the seventh sternite (fig. 401). The seventh sternite of the males of *B. philadelphicus* lacks a spine on each side of the membranous lobe, so the presence of these spines on males of *B. assimilis* allows easy separation of the species (compare fig. 401 with

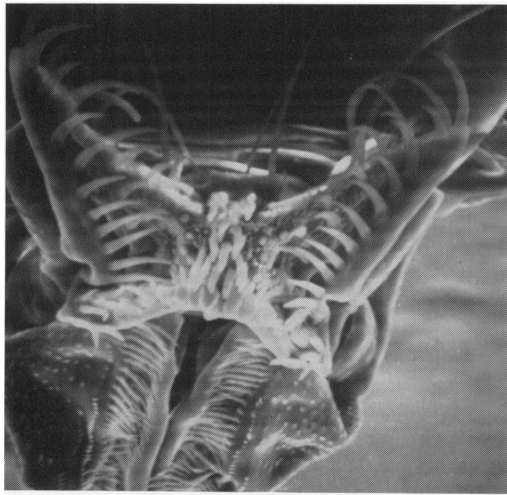

424

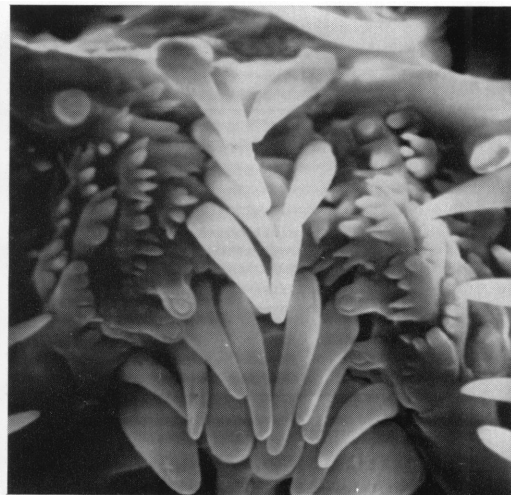

425

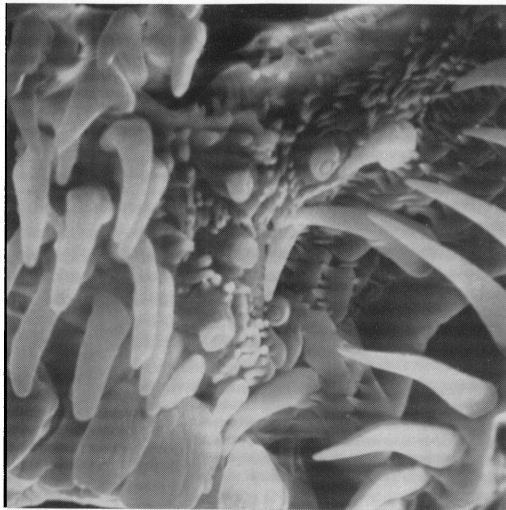

426

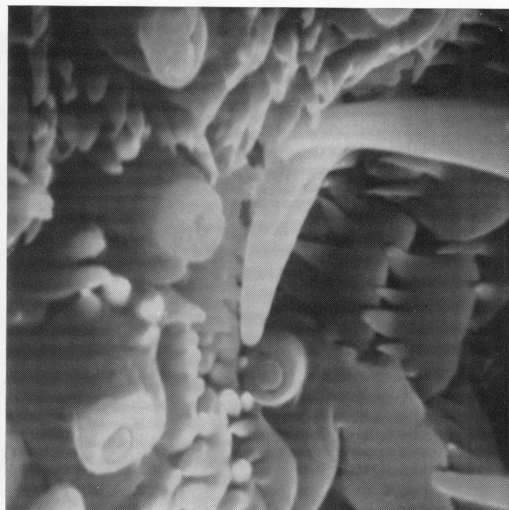

427

FIG. 424. *Bledius semiferrugineus*; adoral surface of labium.  $\times 400$ .

FIG. 425. *Bledius assimilis*; median region of adoral surface of labium.  $\times 1600$ .

FIG. 426. *Bledius semiferrugineus*; median region of adoral surface of labium.  $\times 1600$ .

FIG. 427. *Bledius semiferrugineus*; median region of adoral surface of labium.  $\times 4000$ .

fig. 402). The males of *B. philadelphicus* and *B. coulteri* can be separated by the presence of a well-developed pronotal midlongitudinal groove in the former species (compare fig. 350 with fig. 348).

The presence of a midlongitudinal pronotal groove will allow separation of the females of *B. philadelphicus* (fig. 350) from those of *B. coulteri* (fig. 348) and *B. assimilis* (fig. 353). The smaller

width of the head, finer, more shallow punctation of the head (compare fig. 347 with fig. 328) and pronotum (compare fig. 350 with fig. 330), and dense, microgranulate ground sculpturing of pronotum of the females of *B. philadelphicus* will separate them from the females of *B. semiferrugineus*. The smaller width of the head will separate the females of *B. philadelphicus* (fig. 347) from those of *B. foraminosus* (fig. 327), *B.*

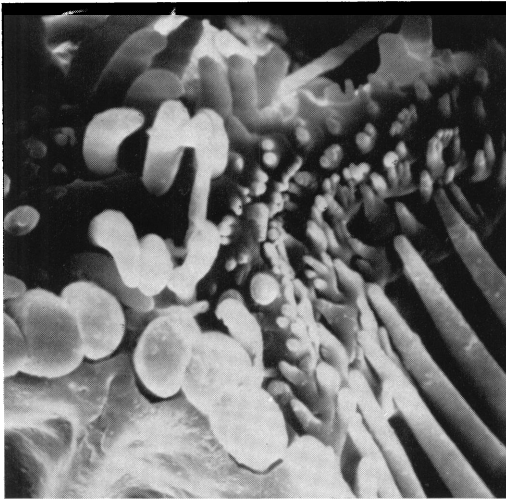

428

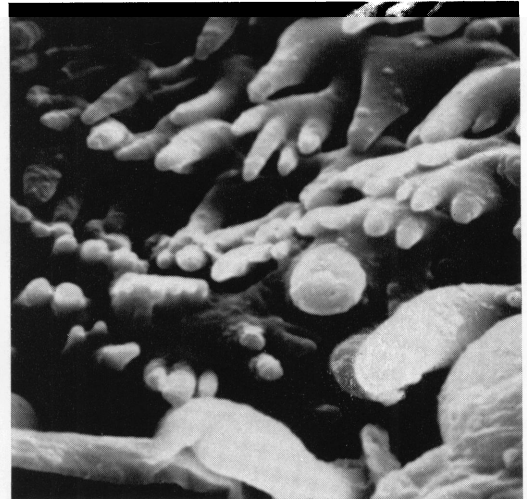

429



430

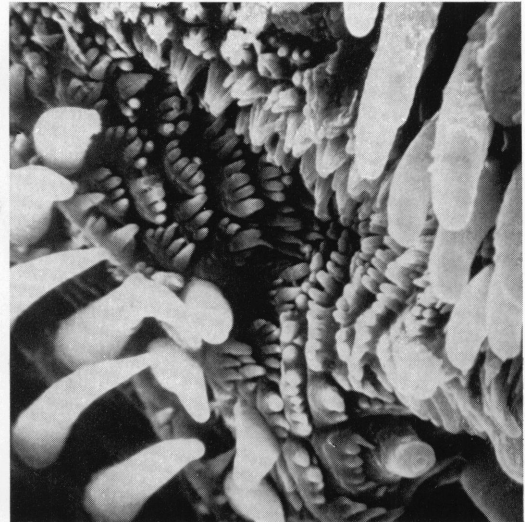

431

FIG. 428. *Bledius philadelphicus*; median region of adoral surface of labium.  $\times 1600$ .

FIG. 429. *Bledius philadelphicus*; median region of adoral surface of labium.  $\times 4000$ .

FIG. 430. *Bledius rotundicollis*; median region of adoral surface of labium.  $\times 800$ .

FIG. 431. *Bledius rotundicollis*; median region of adoral surface of labium.  $\times 1600$ .

*rotundicollis* (fig. 335), *B. gravidus* (fig. 331), *B. fumatus* (fig. 332), and *B. rubiginosus* (fig. 336). In addition, the last species and *B. philadelphicus* can be separated by color. The females of *B. philadelphicus* and *B. analis* can be separated by the color pattern of the abdomen. The shape and dense, microgranulate ground sculpturing and distinct midlongitudinal groove of the pro-

notum (compare fig. 350 with fig. 346) and coarser, denser punctation of the dorsum of the head (compare fig. 347 with fig. 344) will separate the females of *B. philadelphicus* from *B. nitidicollis*.

DESCRIPTION: *semiferrugineus* group.

Length 3.0 to 5.0 mm.

Dorsum and venter of head, clypeus, and



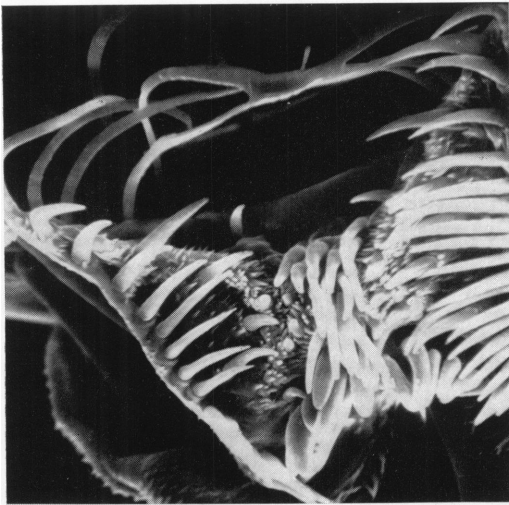

432

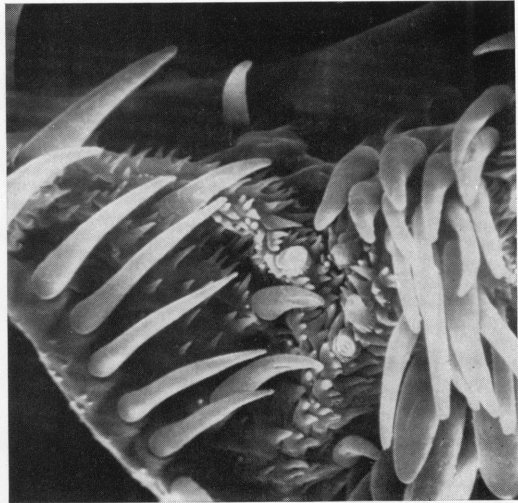

433



434

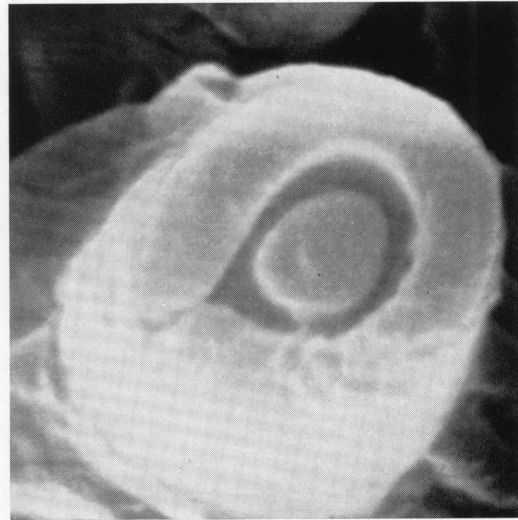

435

FIG. 432. *Bledius foraminosus*; adoral surface of labium.  $\times 400$ .

FIG. 433. *Bledius foraminosus*; adoral surface of labium.  $\times 800$ .

FIG. 434. *Bledius foraminosus*; median region of adoral surface of labium.  $\times 4000$ .

FIG. 435. *Bledius foraminosus*; campaniform-like structure of adoral surface of labium.  $\times 16,000$ .

labrum black to dark reddish brown. Antennae, mandibles, labium, and maxillae reddish brown. Pronotum black to reddish brown. Prohypomeron and prosternum reddish brown to yellowish brown. Elytra orangish brown to yellowish brown; base black to brown; sutural area often with infusions of brown or black, occasionally with broad, triangular, brown sutural stripe.

Pterothoracic sterna and pleura reddish black to bright reddish brown to yellowish brown. Legs reddish brown to yellowish brown. Abdomen dark reddish brown to bright reddish brown to dark yellowish brown.

Dorsum of head opaque, not polished, with prominent, microgranulate ground sculpturing (as in fig. 448), with moderately dense, distinct,

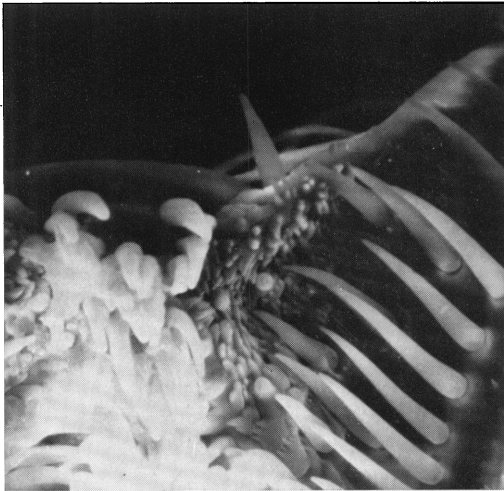

436



437

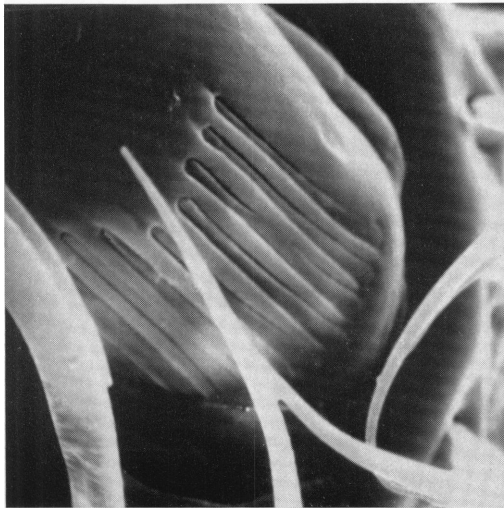

438

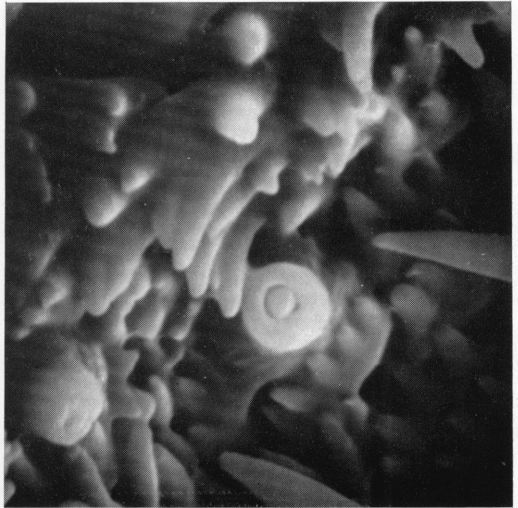

439

FIG. 436. *Bledius gravidus*; adoral surface of labium.  $\times 980$ .

FIG. 437. *Bledius gravidus*; median region of adoral surface of labium.  $\times 1760$ .

FIG. 438. *Bledius rubiginosus*; base of fourth segment of maxillary palpus.  $\times 1600$ .

FIG. 439. *Bledius gravidus*; median region of adoral surface of labium.  $\times 4000$ .

fine, shallow, setigerous punctation between supra-antennal ridges (fig. 347), with impunctate midlongitudinal strip (fig. 347), without prominent midlongitudinal ridge or tumescence (fig. 347), and with moderately deep, prominent, elongate fovea between bases of supra-antennal ridges (fig. 347); postocular groove absent (fig. 347). Supra-antennal ridge moderately promi-

nent but short (fig. 347); base and lateral sides with fine, very shallow setigerous punctation, dorsal surface impunctate (fig. 347); base, lateral, and dorsal surfaces with dense, prominent, microgranulate ground sculpturing (as in fig. 448). Epistomal suture broadly arcuate (fig. 347); suture more strongly curved at juncture with supra-antennal ridge. Clypeus

with dense, distinct, microgranulate ground sculpturing (as in fig. 448), and with shallow, fine, indistinct setigerous punctation; anterior margin with small, rounded tubercles near lateral margin (fig. 347). Lateral side of head with polished, glabrous strip at base of head and extending toward but not reaching posterior margin of eyes. Venter of head with microreticulate ground sculpturing. Head width 0.7 to 0.8 mm.; interocular width 0.5 to 0.6 mm.; head width/interocular width 1.4 to 1.5 (table 5). Labrum with dense microgranulate ground sculpturing (as in fig. 325), and with moderately dense, indistinct setigerous punctation; anterior margin with narrow median portion reflexed. Mandibles of female bidentate (as in figs. 358, 359); denticles connate at base and free at apex. Mandibles of male tridentate (figs. 367, 368); apical and middle denticle large and connate; basal denticle very small, rounded and tubercle-like (figs. 367, 368). Antennomeres without apical encircling ridges.

Pronotum 0.7 to 0.8 mm. long, 0.7 to 0.9 mm. wide; pronotal width/pronotal length 1.1 to 1.2 (table 5), and strongly convex (fig. 350); lateral margins with anterior three-fifths slightly rounded and almost parallel to each other (figs. 350, 383, 386); basal two-fifths almost straight and basally convergent to broadly rounded basal angles; basal margin broadly rounded. Pronotum opaque, not polished, with dense, microgranulate ground sculpturing (as on vertex, fig. 448), and with moderately dense, distinct, moderately deep, prominent, setigerous punctation (fig. 350); punctation absent along midlongitudinal strip (fig. 350); midlongitudinal groove present, distinct, well developed, moderately deep (fig. 350), and reaching posterior marginal bead but not anterior margin. Pronotal lateral marginal bead entirely visible in dorsal aspect; bead slightly deflexed anteriorly. Prohypomeron shining; with microreticulate ground sculpturing. Prosternum with microreticulate ground sculpturing. Elytra 0.9 to 1.1 mm. long (range); range of elytral length/pronotal length 1.2 to 1.4 (table 5); surface polished between punctures, and with dense, coarse, setigerous punctation.

Metatarsus with last article gradually expanded apically (as in figs. 390, 393).

Abdomen of males with membranous lobe on posterior margin of seventh sternite (fig. 401); lobe with long setae along margin but pubes-

cence not dense (fig. 401); lobe without lateral spiniform process (fig. 401); seventh sternite of female unmodified. Eighth sternum of males with dense patch of pubescence behind emargination of seventh sternite; eighth sternum of females unmodified.

Spermatheca as shown in figures 406, 409.

**SEXUAL DIMORPHISM:** The males have tridentate mandibles, with the basal denticle reduced (figs. 367, 369). The females have bidentate mandibles; they lack the small basal denticle (as in figs. 358, 359). The seventh abdominal sternite of males has a membranous lobe on the posterior margin (fig. 401); the seventh sternite of the female is unmodified.

**SYNONYMY:** When Notman (1922) described *Bledius mixtus* and *B. dickersoni*, he referred to his key (Notman, 1920) to the species of the *semi-ferrugineus* group. He stated that the species should be placed with *B. piceus*, and differentiated the two new species from *B. piceus*. In order to place *B. mixtus* and *B. dickersoni* near *B. piceus* in the key and at the same time differentiate them from *B. philadelphicus*, the newly described species had to have the protergosternal suture and the pronotal lateral marginal bead convergent anteriorly. All the species of the *semi-ferrugineus* group have these structures converging, so the character is useless for differentiating the species.

I can find no characters to separate *Bledius mixtus* and *B. dickersoni* from each other or from *B. philadelphicus* that are not within the range of variation of *B. philadelphicus*. The pronotal midlongitudinal groove of *B. mixtus* is more shallow than most individuals of *B. philadelphicus* studied but within the range of variation. The elytra of *B. dickersoni* are short but fall at the short end of the range of variation for *B. philadelphicus*.

**HABITAT AND DISTRIBUTION:** *Canada:* Newfoundland, Ontario. *United States:* Maryland, Massachusetts, New Jersey, New York, Pennsylvania. (See Appendix for localities.)

*Bledius philadelphicus* is known from the northeastern United States and southeastern Ontario with collections in Newfoundland and central Ontario (map 16).

The species is known from few specimens, and no habitat data are available. The species may live in temporarily wet soil that is not necessarily near a permanent body of water.

The species was collected from April through July and October.



440

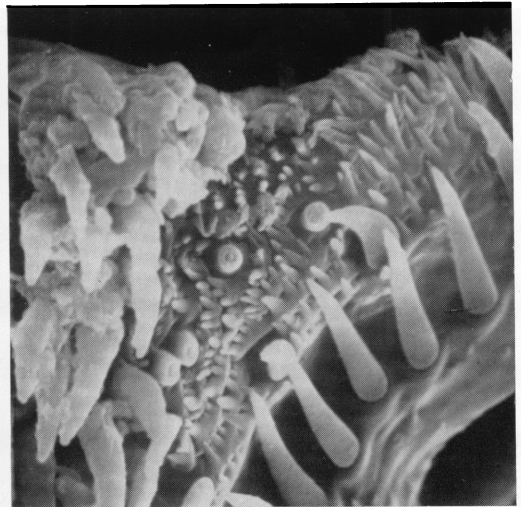

441

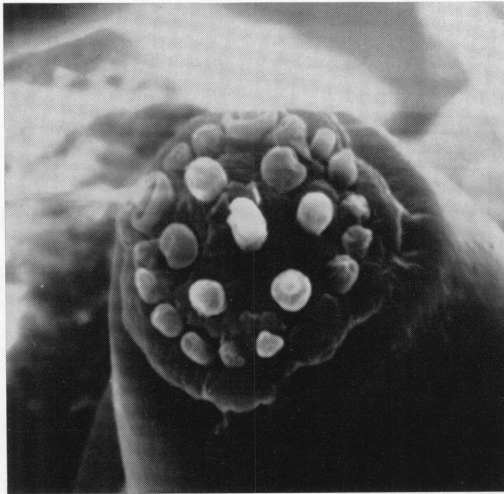

442

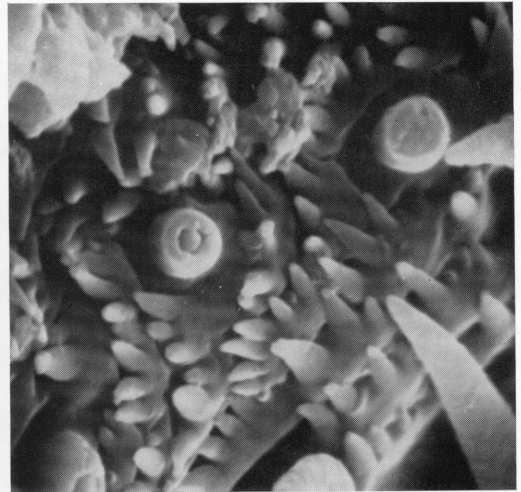

443

FIG. 440. *Bledius nitidicollis*; adoral surface of labium.  $\times 800$ .

FIG. 441. *Bledius nitidicollis*; median region of adoral surface of labium.  $\times 1600$ .

FIG. 442. *Bledius rubiginosus*; apex of fourth segment of maxillary palpus.  $\times 4000$ .

FIG. 443. *Bledius nitidicollis*; median region of adoral surface of labium.  $\times 4000$ .

*Bledius coulteri* Hatch

Figures 345, 348, 358, 359, 387, 405, 410;  
Map 16; Table 5

*Bledius coulteri* HATCH, 1957, p. 99 (type locality: Washington, Cheney, Turnbull Slough; holotype: deposited at the University of Washington, Seattle, Washington. Holotype not studied).

DIAGNOSIS: The males of *Bledius coulteri* can be

distinguished from the males of all the members of the *semiferrugineus* group except *B. philadelphicus* and *B. assimilis* by the presence of the membranous lobe on the seventh sternite (fig. 405). The lack of a spiniform process beside the lobe on *B. coulteri* (fig. 405) will distinguish the males of this species from those of *B. assimilis* (fig. 402). *Bledius coulteri* lacks a midlongitudinal groove on the pronotum (fig. 348), but *B.*

*philadelphicus* (fig. 350) has one. The females of *B. coulteri* can be separated from most other females of the *semiferrugineus* group by the absence of a midlongitudinal groove of the pronotum (fig. 348) and the presence of dense microgranulate ground sculpturing on the pronotum of *B. coulteri*. Some individuals of *B. analis* and *B. nitidicollis* may lack a midlongitudinal groove and have fairly prominent microgranulate ground sculpturing. In such instances the females of *B. coulteri* will have to be separated from *B. nitidicollis* and *B. analis* by characteristics of the spermathecae (compare fig. 410 with figs. 416, 417), the presence of microgranulate ground sculpturing on the dorsal surface of the supra-antennal ridge (as in fig. 448) and slight variations of the shape of the pronotum. The females of *B. coulteri* and *B. assimilis* can be separated only by their geographical distribution and association with the males (compare maps 16, 17).

DESCRIPTION: *semiferrugineus* group.

Length 3.3 mm. to 4.5 mm.

Dorsum of head and clypeus black to dark reddish brown. Venter of head blackish brown to reddish brown. Labrum black. Labium, maxilla, mandible, and antenna reddish brown. Pronotum brownish black to reddish brown. Prohypomeron and prosternum reddish brown to yellowish brown. Elytra red to orange to yellowish brown, in most cases concolorous or with brown infusions at base but occasionally with broad, brown sutural stripe. Pterothoracic sterna and pleura brownish black to reddish brown. Legs yellowish brown. Abdomen brownish black to reddish brown.

Dorsum of head opaque, not polished, with prominent, dense, microgranulate ground sculpturing (as in fig. 448), with moderately dense, indistinct, shallow setigerous punctation between supra-antennal ridges (fig. 345), and with impunctate midlongitudinal strip (fig. 345); midlongitudinal strip forming low, broad, convex ridge (fig. 345); dorsum with large, prominent, elongate fovea behind midlongitudinal ridge (fig. 345). Postocular groove absent (fig. 345). Supra-antennal ridges moderately prominent; base and lateral sides with fine, shallow, setigerous punctation, dorsal surface impunctate (fig. 345); base, lateral and dorsal surfaces to apex opaque, not polished and with dense, microgranulate ground sculpturing (as in fig. 448). Epistomal suture polished and broadly

arcuate (fig. 345); suture more strongly curved at junction with supra-antennal ridge. Clypeus with dense, prominent, microgranulate ground sculpturing (as in fig. 448); anterior margin without tubercles or with obsolete rounded tubercles (fig. 345). Lateral side of head with polished glabrous strip at base of head extending toward but not reaching posterior margin of head. Venter of head with microreticulate ground sculpturing. Head width 0.6 to 0.8 mm.; interocular width 0.4 to 0.5 mm.; head width/interocular width 1.4 to 1.5 (table 5). Labrum with dense, microgranulate ground sculpturing (as in fig. 325), and with moderately dense, indistinct, fine, setigerous punctation; anterior margin with median portion reflexed; reflexed portion narrow. Mandibles of male and female bidentate (figs. 358, 359); denticles connate at base and free at apex. Antennomeres without apical, encircling ridges.

Pronotum 0.6 to 0.8 mm. long, 0.6 to 0.8 mm. wide; pronotal width/pronotal length 1.0 to 1.1 (table 5), and strongly convex (fig. 348); lateral margins with anterior three-fifths slightly rounded and almost parallel to each other (figs. 348, 387); basal two-fifths sinuate and convergent to basal angles (figs. 348, 387); basal angles distinct and strongly rounded (figs. 348, 387); basal margin broadly rounded. Pronotum opaque, not polished, with dense, prominent, microgranulate ground sculpturing (as on vertex, fig. 448), and with moderately dense, distinct, moderately deep, setigerous punctation (fig. 348); punctation absent along midlongitudinal strip (fig. 348); midlongitudinal groove absent (fig. 348); midlongitudinal impunctate strip (fig. 348), often with polished spots and raised spots along midline. Pronotal lateral marginal bead entirely visible in dorsal aspect; head deflexed anteriorly. Prohypomeron shining, and with microreticulate ground sculpturing. Prosternum with microreticulate ground sculpturing. Elytra 0.8 to 1.0 mm. long; elytral length/pronotal length 1.2 to 1.4 (table 5); surface polished between punctures, and with dense, coarse, setigerous punctation.

Metatarsus with last article gradually expanded apically (as in figs. 390, 393).

Abdomen with membranous lobe on posterior margin of seventh sternite of male (fig. 405); lobe margined with long setae (fig. 405); lobe without spiniform process at lateral angle (fig. 405); seventh sternite of female unmodified.

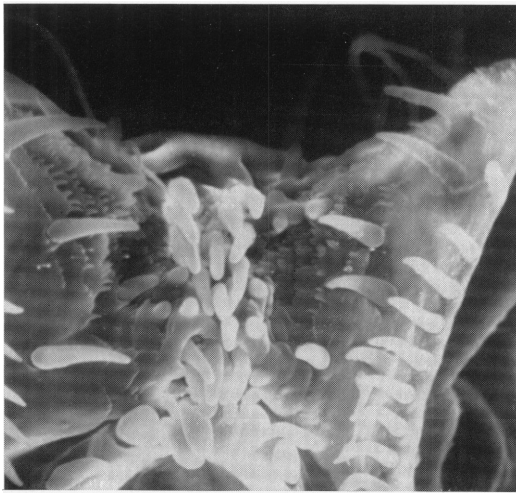

444



445

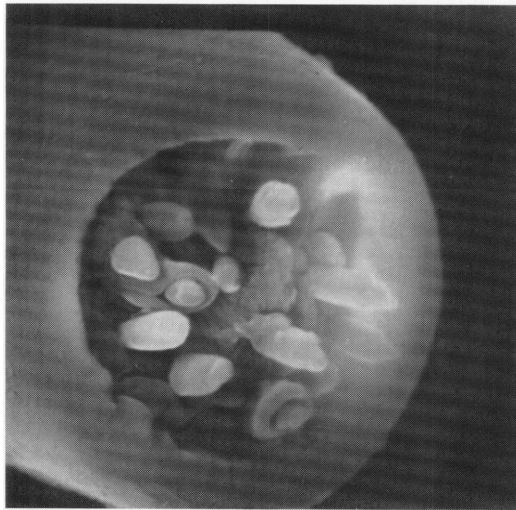

446

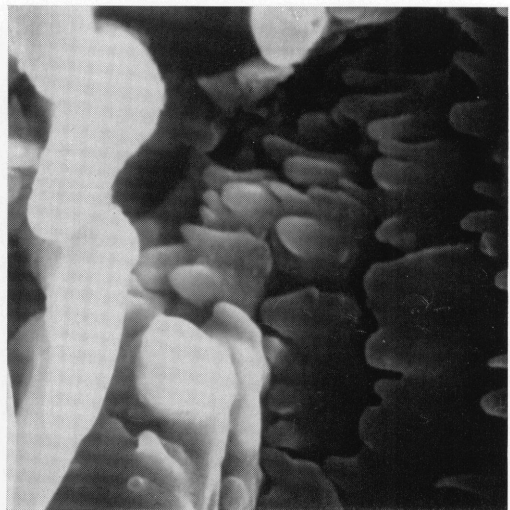

447

FIG. 444. *Bledius analis*; adoral surface of labium.  $\times 1000$ .

FIG. 445. *Bledius analis*; median region of adoral surface of labium.  $\times 1600$ .

FIG. 446. *Bledius analis*; apex of third segment of labial palpus.  $\times 4000$ .

FIG. 447. *Bledius analis*; median region of adoral surface of labium.  $\times 4000$ .

Eighth sternum of male with patch of dense pubescence posterior to emargination of seventh sternite; female with scattered pubescence on eighth sternite.

Spermatheca as shown in figure 410.

**SEXUAL DIMORPHISM:** The male of *Bledius coulteri* can be separated from the female by the presence of a membranous lobe on the seventh

sternite of the male (fig. 405) and the dense pubescence on the eighth sternum of the male.

**HABITAT AND DISTRIBUTION:** *Canada:* British Columbia, Manitoba, Saskatchewan. *United States:* Idaho, Minnesota, Montana, Nevada, New Mexico, North Dakota, South Dakota, Utah, Washington. (See Appendix for localities.)

*Bledius coulteri* is known from the western half

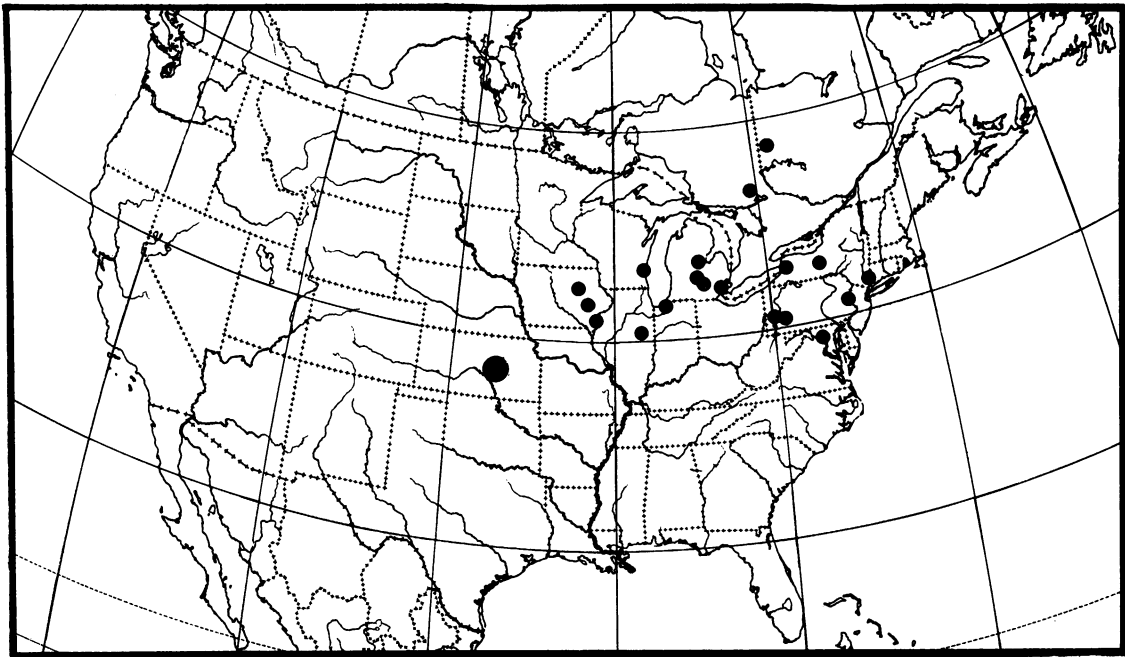

MAP 17. Distribution of *Bledius assimilis* (black dots; large dot indicates state record only).

of the United States from Washington east to eastern Minnesota and from southern Canada south to New Mexico (map 16).

The species is not commonly collected; almost all the collections were with light traps, and there are no data on its habitat. The species may live in temporarily moist soil that is not near a permanent body of water.

The species is collected from April through September.

*Bledius assimilis* Casey

Figures 351, 353, 384, 402, 407, 408, 448;  
Map 17; Table 5

*Bledius assimilis* CASEY, 1889, p. 55. FALL, 1910, p. 109. NOTMAN, 1920, p. 697. HATCH, 1957, p. 100 (type locality: Illinois and Iowa; holotype: deposited at the National Museum of Natural History, Smithsonian Institution, Washington, D.C. Type examined, male).

**DIAGNOSIS:** The male of *Bledius assimilis* is the only species in the *semiferrugineus* group that has a spine on each lateral angle of the membranous lobe of the seventh sternite (fig. 402). The female can be separated from all the species in the *semiferrugineus* group except *B. coulteri* and

some individuals of *B. analis* and *B. nitidicollis* by the absence of a midlongitudinal groove on the pronotum (fig. 353). From the females of *B. analis* and *B. nitidicollis* that have no midlongitudinal groove on the pronotum, *B. assimilis* can be separated by characteristics of the spermatheca (compare figs. 407, 408 with figs. 416, 417), by the more shallow, denser pronotal punctation (compare fig. 353 with figs. 346, 352), by the shape of the pronotum and by the more distinct and more prominent microgranulate ground sculpturing of the head and pronotum. The females of *B. assimilis* and *B. coulteri* can be separated only by distribution (compare maps 16, 17) and by association with the males.

**DESCRIPTION:** *semiferrugineus* group.

Length 3.4 to 4.1 mm.

Dorsum of head, clypeus, and venter of head black to dark reddish brown. Labrum, labium, maxilla, mandible, and antenna reddish brown. Pronotum reddish black to dark reddish brown. Prohypomeron and prosternum dark to light reddish brown. Elytra dark reddish orange with infusions of black. Pterothoracic sterna and pleura reddish black to dark reddish orange. Legs yellowish brown. Abdomen black with

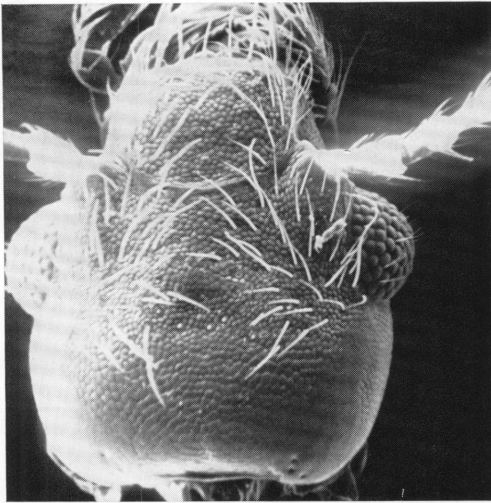

448

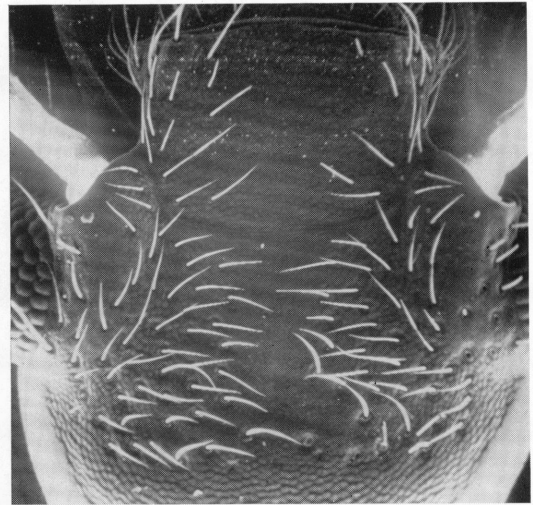

449

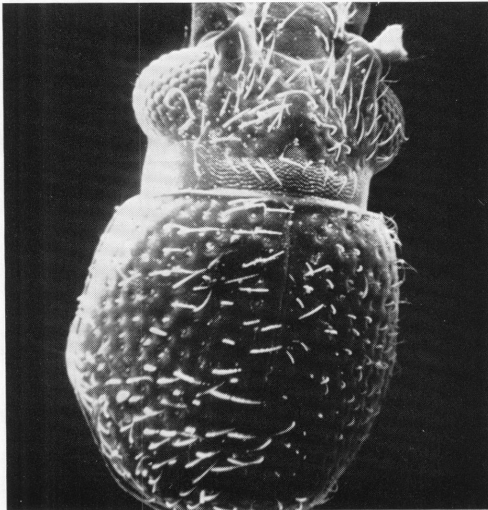

450

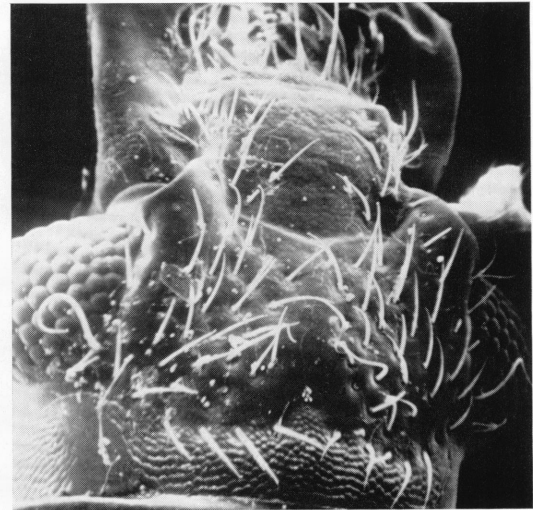

451

- FIG. 448. *Bledius assimilis*; dorsum of head.  $\times 80$ .  
 FIG. 449. *Bledius foraminosus*; dorsum of head.  $\times 80$ .  
 FIG. 450. *Bledius semiferrugineus*; head and prothorax.  $\times 40$ .  
 FIG. 451. *Bledius semiferrugineus*; dorsum of head.  $\times 80$ .

small infusions of red to dark reddish orange with infusions of black and black strips on posterior margin of most segments.

Dorsum of head opaque, not polished, with prominent microgranulate ground sculpturing (fig. 448), with moderately dense, distinct, fine, shallow setigerous punctation between supra-antennal ridges (fig. 351), and with impunctate

midlongitudinal strip (fig. 351); strip weakly convex (fig. 351); dorsum with median, postocular, punctiform fovea (fig. 351); postocular groove absent (fig. 351). Supra-antennal ridge moderately prominent (fig. 351); base and lateral sides with fine, very shallow, indistinct setigerous punctation, dorsal surface impunctate (fig. 351); base, lateral sides, and dorsal



surface with dense, prominent microgranulate ground sculpturing present to apex (fig. 448). Epistomal suture broadly arcuate (fig. 351); suture more strongly curved at juncture with supra-antennal ridge. Clypeus with dense microgranulate ground sculpturing (fig. 448); anterior margin with small, rounded tubercles near lateral margin (fig. 351). Lateral side of head with glabrous, polished postocular strip at base of head and extending toward but not reaching posterior margin of eye. Venter of head with microreticulate ground sculpturing. Width of head 0.6 to 0.7 mm.; interocular width 0.4 to 0.5 mm.; head width/interocular width 1.3 to 1.5 (table 5). Labrum with dense, microgranulate ground sculpturing (as in fig. 325), and with moderately dense, indistinct, setigerous punctation; anterior margin with narrow, median portion reflexed. Mandibles of male and female bidentate (as in figs. 358, 359); denticles connate at base and free at apex. Antennomeres without ridges encircling apex.

Pronotum 0.6 to 0.7 mm. long, 0.7 to 0.8 mm. wide; pronotal width/pronotal length 1.0 to 1.1 (table 5), and strongly convex (fig. 353); lateral margins with anterior three-fifths slightly rounded and almost parallel to each other (figs. 353, 384); basal two-fifths straight or almost so and strongly convergent to strongly rounded basal angles (figs. 353, 384); basal margin broadly rounded. Pronotum not polished, opaque, with dense, uniform, microgranulate ground sculpturing (as on vertex, fig. 448), and with dense, distinct, moderately deep, setigerous punctation (fig. 353); punctation absent along midlongitudinal strip (fig. 353); midlongitudinal groove absent (fig. 353). Pronotal lateral marginal bead entirely visible in dorsal aspect; bead slightly deflexed anteriorly. Prohypomeron shining, and with microreticulate ground sculpturing. Prosternum with microreticulate ground sculpturing.

Elytra 0.8 to 0.9 mm. long; elytral length/pronotal length 1.2 to 1.4 (table 5); surface polished, and with dense, coarse, setigerous punctation.

Metatarsus with last article gradually expanded apically (as in figs. 390, 393).

Abdomen of male with membranous lobe on posterior margin of seventh sternite (fig. 402); lobe with posteriorly directed spiniform process on lateral angle (fig. 402); lobe with row of setae on edge (fig. 402); seventh sternite of female

unmodified. Eighth sternum of male with dense patch of setae behind emargination of seventh sternite; eighth sternum of female with setae, but not arranged in dense patch.

Spermatheca as shown in figures 407, 408.

**SEXUAL DIMORPHISM:** The posterior margin of the seventh sternite of the male has a membranous lobe and an acute spiniform process on each side of the lobe (fig. 402). The eighth sternum of the male has a dense patch of setae behind the emargination of the seventh sternite. The abdominal sternal elements of the female are unmodified.

**HABITAT AND DISTRIBUTION:** *Canada:* Ontario, Quebec. *United States:* Illinois, Indiana, Iowa, Kansas, Maryland, Michigan, New York, Pennsylvania, Wisconsin. (See Appendix for localities.)

*Bledius assimilis* is found in the northeastern half of the United States and southeastern Ontario (map 17).

The species is collected infrequently, and there is no information regarding its habitat. The species may inhabit temporarily moist areas that are not necessarily near permanent bodies of water.

The species has been collected from May through July.

**DISCUSSION:** Because there is some doubt as to the status of the variants described below, they were not included in the description of *Bledius assimilis*.

Two males and 10 females from Duparquet, Quebec, a female from Sudbury, Ontario, and a female from Peekskill, New York, differ from the above description of *Bledius assimilis* in the following respects: The glabrous, polished strip on the lateral side of the head is larger but still does not reach the compound eyes. The midlongitudinal strip on the pronotum is polished with most of the microgranulate ground sculpturing missing; on the two males the ground sculpturing on this strip is more evident than on the females. The protergosternal suture and pronotal lateral marginal bead are more strongly convergent. The elytra are brighter red with a dark brown infusion on the base of the suture.

As the variations described for the Duparquet population are rather constant, and the two other individuals from different localities are similar to the Duparquet population, a case can be made for considering this variant group of specimens a separate species. In some species of

*Bledius*, variations similar to those described for the Duparquet population intergrade within the species. In this case, although I have seen almost no tendency for the characters differentiating the two groups to intergrade, I have not seen

enough specimens to have any confidence in the consistency of the characters of the Duparquet population. I am tentatively considering these two groups to represent one species.

## APPENDIX: MATERIAL EXAMINED

FOR CONVENIENCE, the species as well as the countries, states, and counties under each species, are listed alphabetically. The collectors and places of deposition of specimens are omitted, but the information is on file at the American Museum of Natural History.

### *Microbledius actitus*, new species

Map 1

Specimens: 90.

*United States*: Texas: Aransas Co., Copano Bay, 9 mi. N Rockport, on beach, May.

### *Microbledius forcipatus* (Le Conte)

Map 2

Specimens: 137.

*Mexico*: Sinaloa: Presidio River, Sept. Sonora: Alamos, Aug.

*United States*: Arizona: Yuma Co., Yuma, Aug. Arkansas: Crittenden Co., 8 mi. E West Memphis on shore of Mississippi River, Sept.; Franklin Co., Ozark, Arkansas River, Sept.; Lafayette Co., Lewisville, June; Sebastian Co., Fort Smith, Arkansas River, Sept. California: Imperial Co., Imperial Dam, July; San Bernardino Co., Needles, Apr. Nebraska: Knox Co., 6 mi. S Niobrara, Verdigre Creek, moist sand bank, June. Oklahoma: Choctaw Co., 7 mi. S Hugo, Red River, Sept.; Jefferson Co., 5 mi. S Waurika, Red River, Sept.; Kay Co., 1 mi. E Ponca City, Arkansas River, June; Major Co., 2.5 mi. S Cleo, Cimarron River and on shore, June. Texas: El Paso Co., El Paso; Val Verde Co., Del Rio, 955 ft., June. Utah: Washington Co., Rockville, Virgin River, 3700 ft., Aug.

### *Microbledius litoreus*, new species

Map 2

Specimens: 8

*United States*: Florida: Pinellas Co., Pass-a-Grille Beach, in beach sand, Feb.

### *Microbledius playanus*, new species

Map 1

Specimens: 329.

*United States*: Kansas: Stafford Co., 18 mi. N Stafford, Big Salt Marsh, on salt flats, June. Oklahoma: Alfalfa Co., Cherokee Salt Plains, June; Alfalfa Co., 6 mi. E, 3 mi. S Cherokee, on salt plain, June; Alfalfa Co., 8 mi. N Jet, from shore of Salt Fork of Arkansas River, June; Major Co., 2.5 mi. S Cleo, on shore of Cimarron River, June; Woods Co., June. New Mexico: Otero Co., 12 mi. W Alamogordo, on

shore of small salt lake, May; Torrance Co., 6.5 mi. E Willard, on salt flats, Aug.

### *Psamathobledius caribbeanus* (Blackwelder)

Map 4

Specimens: 27.

*West Indies*: Dominica: June. Montserrat: July. Puerto Rico: Loquillo, Loquillo Muni, on leeward side of beach above high-tide mark, Feb.

### *Psamathobledius microcephalus* (Fauvel)

Map 4

Specimens: 41.

*Colombia*: (no further locality), Mar.

*West Indies*: Trinidad: Mazanilla, Nov.

### *Psamathobledius punctatissimus* (Le Conte)

Map 3

Specimens: 310.

*Ecuador*: Guayas, Alto, 8 mi. S Manglar, Jan.

*Mexico*: Baja California: La Misión de San Miguel, edge of salt pond, May. Gulf of California, San Carlos Bay, taken on ship, July. Sinaloa: Mazatlan, near beach, Aug.

*United States*: California: San Diego Co., Carlsbad, Oct. Florida: Charlotte Co., 6.5 mi. SSE Grove City, open sand flat, Mar.; Duval Co., Pablo Beach, under debris on beach just above high-tide mark, Nov.; Monroe Co., Lower Matecumbe Key, on beach just above high-tide mark, Dec.; Palm Beach Co., Lake Worth; Indian River Co., Capron. Georgia: Chatham Co., Savannah. Maryland: Worcester Co., Assateague Island, June. Mississippi: Horn Island, May, June, Sept. North Carolina: Dare Co., Cape Hatteras National Seashore, Oregon Inlet, July. South Carolina: Georgetown Co., Litchfield Beach, June.

*West Indies*: Little Cayman Island: South coast of South Town, Apr. Puerto Rico: Loquillo, Loquillo Muni, on leeward beach, Feb. St. Thomas.

### *Bledius aequatorialis* Mutchler

Map 6

Specimens: 31.

*Ecuador*: Guayas, 8 mi. S Manglar Alto, Jan.

*Galapagos*: Isla Santa Cruz, Academy Bay, Darwin Research Station, Jan.; South Seymour Island, Apr.

### *Bledius analis* Le Conte

Map 15

Specimens: 110.

*Canada*: Alberta: Ranchville, June. Ontario: Toronto.

*United States*: Colorado: Yuma Co., 32 mi. S Wray, South Fork of Republican River, Sept. Georgia: Floyd Co., Rome, Armuchee Creek, Apr. Illinois: Pike Co., Pine Lake, near Pittsfield, Aug. Iowa: Indiana: Orange Co., West Baden, July. Kentucky: Maryland: Anne Arundel Co., Patauxent River and U. S. Route 50, May. Michigan: Wayne Co., Detroit. Missouri: Nebraska: Douglas Co., Platte River, 14 mi. E Wahoo along edge of drying pools, June; Garden Co., Oshkosh, near North Platte River on shore of small pond, Sept.; Garden Co., Oshkosh, North Platte River, vegetated area, Sept.; Knox Co., Verdigre Creek, 6 mi. S Niobrara, in moist sand bank, June; Sheridan Co., 14 mi. S Hay Springs, Niobrara River, in vegetated sand, Sept. New York: Oneida Co., Sylvan Beach, June; Westchester Co., Peekskill. Pennsylvania: Allegheny Co., Pittsburgh, Sept.; Northampton Co., Easton, June. South Dakota: Brookings Co., Brookings, July; Brown Co., Hecla, Aug.

*Bledius assimilis* Casey

Map 17

Specimens: 68.

*Canada*: Ontario: Sudbury. Quebec: Duparquet, May.

*United States*: Illinois: Champaign Co., Urbana, May. Indiana: La Porte Co., La Porte. Iowa: Buchanan Co., Independence; Des Moines Co., Burlington; Johnson Co., Iowa City, July. Kansas: Maryland: Montgomery Co., Glen Echo, July. Michigan: Eaton Co., Grand Ledge, July; Midland Co.; Wayne Co., Detroit. New York: Erie Co., Buffalo; Tompkins Co., Ithaca; Westchester Co., Peekskill, June. Pennsylvania: Allegheny Co., Pittsburgh; Northampton Co., Easton, June; Westmoreland Co., Jeannette. Wisconsin: Milwaukee Co., July.

*Bledius beattyi* Blackwelder

Map 5

Specimens: 30.

*Colombia*: Magdalena, Rio Frio.

*Mexico*: Yucatan, Progreso, along beach, July.

*West Indies*: Cuba: Almendare, Havana, May. Puerto Rico: Ponce, June; Vieques Island, Apr. St. Croix, Oct. St. Thomas, Nov.

*Bledius ceratus* Blackwelder

Map 6

Specimens: 51.

*Cuba*: Oriente, Boqueron, July.

*United States*: Florida: Monroe Co., Big Pine Key, 2 mi. E. Big Pine, Dec.

*West Indies*: Dominican Republic, Barahona, Sept. Bahama Islands, South Bimini, May.

*Bledius coulteri* Hatch

Map 16

Specimens: 245.

*Canada*: British Columbia: Creston, July; Rykerts, S Creston, July; 16 mi. W Osoyoos, June. Manitoba: Aweme, July; Brandon, June, Aug.; Bald Head Hills, 13 mi. N Glenboro, July; Ninette, Apr., May; 5 mi. SW Shilo, June. Saskatchewan: Burgis, June.

*United States*: Idaho: Bannock Co., Pocatello; Bonner Co., Priest River, June. Minnesota: Big Stone Co., Artichoke Lake. Montana: Flathead Co., Kalispell, June; Musselshell Co., 38 mi. E Roundup, Musselshell River, on shore, in vegetated sand, Aug. Nevada: Humboldt Co., Winnemucca, Humboldt River, 4400 ft., June. New Mexico: Jemez Mountains, Aug. North Dakota: Ward Co., 2 mi. SE Minot, near Souris River, July. South Dakota: Brookings Co., Brookings, May, June, July, Aug.; Brown Co., Hecla, Aug.; Buffalo Co., Fort Thompson, Aug., Sept.; Grant Co., Big Stone, Aug. Utah: Utah Co., Provo, June. Washington: Adams Co., Paha, Lake McElroy, May, July; Grant Co., Soap Lake, July.

*Bledius ferratus* Le Conte

Map 8

Specimens: 403.

*Mexico*: Baja del Norte: Hamilton Ranch, Aug.; La Misión de San Miguel, May, June, Sept.; Km. 88, 60 mi. S Mexicali, June; 5 mi. N San Felipe, June; Santa Maria, Sept. Baja del Sur: San Venancio, Oct.; Isabela Island, July. Nayarit: San Blas, April, Sept. Sinaloa: Mazatlan, May, Aug.; 5 mi. N Mazatlan, July, Aug. Sonora: Estero de Sargente, 25 km. S Desemboque, Aug.; 18 mi. SE Guaymas, Aug.; Kino Bay, July, Aug.; San Carlos Bay, July; near San Jose Beach, 40 mi. SW Ciudad Obregon, May; Yavaros, July.

*United States*: California: Imperial Co.: 15 mi. E Calexico, June; Imperial Co., Calipateria, July; Imperial Co., Imperial, July; Imperial Co., Winterhaven, July; Inyo Co., 5 mi. N Ballarat, warm sulfur spring, 1200 ft., Mar.; Inyo Co.: Death Valley, Saratoga Springs, June; Inyo Co., Panamint Mountains, Apr.; Inyo Co., Panamint Valley, Apr.; Salton Sea. New Mexico: Eddy Co.: 5 mi. E Loving, salt lake, May; Eddy Co., 9 mi. E Loving, salt lake, May; Lea Co., 25 mi. W Hobbs, alkali flat, June; Otero Co., 12 mi. W Alamogordo, salt lake, May; Torrance Co.: E Estancia, salt flat, Aug.; Torrance Co., 3.7 mi. E Willard, June; Torrance Co., 6.5 mi. E Willard, salt flat, Aug. Texas: Hudspeth Co., Salt Flat, Aug.

*Bledius foraminosus* Casey

## Map 10

Specimens: 148.

*Canada*: British Columbia: Fernie, reared from larva found in soil, Aug.; Mt. Revelstoke, July; Rykerts, S Creston, July.

*United States*: California: Calaveras Co., Murphys, 2500 ft., May; Kern Co., Bakersfield, Aug.; Madera Co., Raymond, May; Los Angeles Co.: Azusa, Apr., May; Los Angeles Co., Pasadena, Apr., Oct.; Santa Clara Co., Los Gatos; Shasta Co., Hat Creek, July; Siskiyou Co., Cole, July; Sonoma Co.: Duncan Mills, July; Sonoma Co., Guerneville, May; Tulare Co.: El Mirador, May; Tulare Co., Kaweah, Apr.; Tulare Co., Lindsay, June; Tulare Co., Visalia, June; Tulare Co., Woodlake, June. Idaho: Bonner Co., Sandpoint, July; Bonner Co., 11 mi. N Sand Point, in temporarily wet soil, July. Montana: Flathead Co., Kalispell, June; Lincoln Co., 40 mi. SE Libby, Fisher River near Loon Lake, July; Salmon Lake, Apr. Oregon: Hood River Co., Mt. Hood, Sand Creek, July; Lake Co., 17 mi. N Lakeview, on Crooked Creek, Aug. Washington: Adams Co., Cow Creek, 11 mi. SE Ritzville, July; Adams Co., McElroy Lake, 8 mi. S Ritzville, July; Spokane Co., Medical Lake, July; Whitman Co., Pullman, May; Yakima Co., Yakima River, July.

*Bledius fortis* Le Conte

## Map 8

Specimens: 127.

*United States*: Texas: Aransas Co., Goose Island State Park, 9 mi. N Rockport, sea beach, June; Galveston Co., Galveston, Apr.; Kenedy Co., Armstrong, King Ranch, Sept.; Kleberg Co., Riviera, July.

*Bledius fumatus* Le Conte

## Map 11

Specimens: 187.

*Canada*: Manitoba: Aweme. Ontario: Strathroy, June.

*United States*: Illinois: Calhoun Co., Kampsville, June; Cook Co., Chicago, July; Mason Co., Havana, May; McHenry Co., Algonquin, May, June, July, Aug.; McLean Co., Bloomington, June; Putnam Co. Putnam, Lake Senachwine, July; Illinois River. Iowa: Buchanan Co., Independence. Indiana: LaPorte Co., LaPorte; Tippecanoe Co., Lafayette, June, July. Massachusetts: Worcester Co., Petersham. Michigan: Eaton Co., Grand Ledge, July; Lapeer Co., May; Wayne Co., Detroit. Minnesota: Wright Co., Buffalo, July, Aug. Ohio: Clark Co., Springfield, Aug. Wisconsin: Dane Co., June.

*Bledius gravidus* Casey

## Map 11

Specimens: 441.

*Canada*: Alberta: Bilby, May; Edmonton, Sept.; Lethbridge, June; Medicine Hat, June, July; One-four, June; Scandia, July; Pembina River, near Flatbush, June. British Columbia: Crawston, July; Keremeos, June. Manitoba: Aweme, July; Brandon, June, July; Holland, June; Ninette, Maple-Elm Floodplain comm., Apr., May, June; Ninette, Pelican Lake, May; Reynolds, June; Rosebank, June; 5 mi. SW Shilo, July. Ontario: Fort Frances, June; Ottawa; Trenton, July. Saskatchewan: Assiniboia, June; Rock Glen, Aug.; Saskatoon, July; Val Marie, June; Warman, May; Waskesiu Lake, July; White Fox, Aug.

*United States*: Arizona: Apache Co., Chinle, July; Leukachuka Mountains, July; White Mountains, July. Colorado: Adams Co., Watkins, July; Morgan Co., 5 mi. N Brush, South Platte River, in vegetated sand, Sept.; Pueblo Co., Pueblo, Aug.; Weld Co.: Greeley, April; 7 mi. E Greeley, South Platte River, heavily vegetated sand, Sept. Michigan: Delta Co., Escanaba, July. Minnesota: Douglas Co., Camp Carlos, Alexandria, June; Polk Co., 10 mi. E Crookston, temporarily moist soil, July. Montana: Rosebud Co., Forsyth, Yellowstone River, Aug. Nebraska: Garden Co., Oshkosh: near North Platte River, shore of small pond, Sept.; Garden Co., Oshkosh, North Platte River, Sept.; Thomas Co., Halsey, July. New Mexico: Bernallilo Co., Albuquerque, University of New Mexico campus; Bernallilo Co., Albuquerque, Sandia Mountains; San Juan Co., Aztec, July; Taos Co., near Taos, Rio Grande, June. North Dakota: Ward Co., 2 mi. SE Minot near Souris River, July. South Dakota: Beadle Co., Huron, May; Bennett Co., Martin, June; Brookings Co., Brookings, May; Brown Co., Hecla, May, Aug.; Buffalo Co., Fort Thompson, July, Sept.; Fall River Co., Ardmore, Aug.; Hyde Co., Highmore, May, July; Jones Co., Capa, June; Lawrence Co., Spearfish, July; Pennington Co., Hills City, June, Aug. Utah: Utah Co., Vineyard, July; Weber Co., Ogden, June; Weber Co., Roy, July; Bellevue, June. Wyoming: Natrona Co., 4 mi. SW Alcova, 5500 ft., Aug.

*Bledius jacobinus* Le Conte

## Map 9

Specimens: 347.

*Mexico*: Chiapas: 1.7 mi. N Puerto Arista, salt flats, 40 ft., Mar. Nayarit: San Blas, Sept. Sinaloa: Mazatlan, at sea level, near beach, Mar., May, July, Aug.; 5 mi. W Mazatlan, July. Sonora: near San Jose Beach, 40 mi. W Ciudad Obregon, May; Kino Bay, July; Port Guatulca, Dec.; San Carlos Bay, Aug.; Tres Marias Islands.

*United States*: Arizona: Pima Co., between Gun-

sight and Covered Wells, July. California: San Diego Co., San Diego.

*Bledius mandibularis* Erichson

Map 9

Specimens: 812.

Canada: Manitoba: Baldur, July; Strathclair, Aug.; Winnipegosis, July.

United States: Colorado: Crowley Co., 9 mi. N La Junta, Cheraw Lake (saline), Sept. Connecticut: New Haven Co., Guilford, June. Delaware: Sussex Co., Bethany Beach, July; Sussex Co., 3 mi. S Dewey Beach, from burrows on broad flat, May. Florida: Brevard Co., Sand Point, Jan.; Brevard Co., Titusville, Mar.; Charlotte Co., 6.5 mi. SSE Grove City, open sand flat, Mar.; Collier Co., Marco, Mar.; Dade Co., Coconut Grove, Mar.; Dade Co., Miami, Apr.; Lee Co., Cape Coral, May; Manatee Co.: Palmetto Key, June; Manatee Co., Tampa Bay, Palmetto, Mar.; Monroe Co.: Big Pine Key, May, Dec.; Monroe Co., Flamingo, Everglades National Park, Mar., May; Monroe Co., Key Largo, Mar.; Pinellas Co., Tarpon Springs, Mar. Georgia: Chatham Co., Savannah. Kansas: Republic Co., 4 mi. NW Jamestown, salty ditch, Sept.; Republic Co., 4 mi. W, 1 mi. S Kackley, small salt flat, June; Republic Co., 1 mi. S,  $\frac{1}{2}$  mi. E Talmo, Sept.; Shawnee Co., Topeka, June; Stafford Co., Big Salt Marsh, 11 mi. NE Hudson, Sept.; Stafford Co., Big Salt Marsh, 18 mi. N Stafford, salt flat, June. Maryland: Worcester Co., Ocean City, July. Massachusetts: Hampden Co., Springfield (doubtful record); Suffolk Co., Revere, May (doubtful record). Mississippi: Horn Island, June. Nebraska: Sheridan Co., 15 mi. ESE Alliance, alkali flat, Sept.; 23 mi. E Alliance, edge of alkali lake, Sept. New Jersey: Atlantic Co., Atlantic City, Aug.; Alco; Cape May Co., Anglesea, July, Sept.; Cape May Co., Five Mile Beach, Aug.; Cape May Co., Seven Mile Beach, July; Cape May Co., Ocean City, May, June, July; Cape May Co., Sea Isle City, May, July, Aug.; Cape May Co., Wildwood, June, Aug.; Ocean Co., Lakehurst, July; Ocean Co., 3 mi. SE Tuckertown, Mystic Islands, May. New Mexico: Chaves Co., 10 mi. E Roswell, Bottomless Lake State Park, June; Eddy Co., 4 mi. N Loving, salt lake, May; Eddy Co., 4 mi. NE Loving, on shore of Pecos River at Route 31, May; Eddy Co., 5 mi. E Loving, salt lake, May; Eddy Co., 9 mi. E Loving, salt lake, May; Otero Co., 12 mi. W Alamogordo, near salt lake; Torrance Co., E Estancia, salt flat, Aug.; Torrance Co., 6.5 mi. E Willard, Aug.; Torrance Co., 4 mi. SE Willard, June. New York: Kings Co., Rockaway Beach, June; Nassau Co., Long Beach, July; Suffolk Co., Shelter Island, Ram Island Peninsula, on vegetated flat near beach, Aug.; Suffolk Co., Wading River, on beach, May; Westchester Co., New Rochelle, Aug. North Carolina: Dare Co., Cape

Hatteras, Aug.; Dare Co., Kill Devil Hills, June, July; Hyde Co., Swanquarter, July. Oklahoma: Alfalfa Co., Cherokee, Salt Plains, stream, June; Alfalfa Co., 8 mi. N Jet, Great Salt Plains, Salt Fork of Arkansas River, June; Major Co., 2.5 mi. S Cleo, Cimarron River, June, July; Woods Co., Freedom, Cimarron River, on shore. South Dakota: Brule Co., Chamberlain, June. Texas: Aransas Co., Goose Island State Park, 9 mi. N Rockport, near sea beach, sand flat, May, June; Calhoun Co., Port O'Connor, May; Cameron Co., Brownsville, Mar., June, Aug.; Hidalgo Co., Texas Experimental Station, May, June; Kenedy Co., Armstrong King Ranch, Sept.; Terrell Co., Herman Chandler Ranch, alkali dome, July. Utah: Box Elder Co., 10 mi. W Brigham City, Aug.; Box Elder Co., Utah Hot Springs, July; Great Salt Lake, July. Virginia: Hampton, June.

West Indies: Bahamas: Rum Cay near Port Nelson, Mar.; South Bimini Island, May, June, July, Aug. Little Cayman Island: South Town, south coast, June.

*Bledius nitidicollis* Le Conte

Map 14

Specimens: 143.

Canada: Manitoba: Aweme, July; Winnipeg, June.

United States: Arkansas: Crittenden Co., 8 mi. E West Memphis, Mississippi River, from vegetated bank, Sept. Illinois: McHenry Co., Algonquin, July; Pike Co., near Pittsfield, Pine Lake, Aug.; Union Co., Pine Hills Field Station, May; Winnebago Co., Rockford, Camp Grant, June. Iowa: Johnson Co., Iowa City, July; Story Co., Ames, May. Kansas: Douglas Co., Lawrence. Maryland: Calvert Co., Chesapeake Beach. Missouri: Wayne Co., Williams-ville, July. Montana: Hill Co., Assiniboine; Rosebud Co., Forsyth, Yellowstone River, Aug. Nebraska: Douglas Co., 14 mi. E Wahoo, Platte River, June; Knox Co., 6 mi. S Niobrara, Verdigre Creek, in moist sand bank, June. Ohio: Muskingham Co., 5 mi. SE Zanesville, Sept.

*Bledius pallipennis* (Say)

Map 7

Specimens: 347.

United States: Arkansas: Arkansas Co., Arkansas River, June; Crittenden Co., 8 mi. E West Memphis, Mississippi River, Sept.; Franklin Co., Ozark, Arkansas River, Sept.; Jefferson Co., 8 mi. NE Pine Bluff, Sept.; Sebastian Co., Fort Smith, Arkansas River, Sept. Illinois: Jackson Co., Grand Tower, June. Iowa: Pottawattamie Co., Council Bluffs, June. Kansas: Clay Co., 1 mi. S Clay Center, Republican River, Aug.; Douglas Co., Lawrence, June; Geary Co., Manhattan, June; Hamilton Co., Cincinnati; Leavenworth Co., July; Meade Co., Meade, July;

Osage Co., Osage; Shawnee Co., Topeka, June; Stafford Co., 18 mi. N Stafford, Big Salt Marsh, shore of Rattle Snake Creek, June. Louisiana: East Baton Rouge Par., Baton Rouge, Apr.; Orleans Par., New Orleans, Sept. Mississippi: Mississippi River; Warren Co., Vicksburg, at ferry crossing, Sept. Missouri: St. Louis Co., St. Louis, June. Nebraska: Cuming Co., West Point, June; Douglas Co., 14 mi. E Wahoo, Platte River, June; Douglas Co., near Venice, Platte River, June; Garden Co., near North Platte River, Oshkosh, on small pond, and North Platte River, open sand flat, Sept.; Knox Co., 6 mi. S Niobrara, Verdigre Creek, June; Sheridan Co., 23 mi. E Alliance, on shore of alkali lake, Sept.; Thomas Co., Halsey, July; Thomas Co., 2.5 mi. W Halsey, Nebraska National Forest, July. New Mexico: Quay Co., Logan, Canadian River, Sept. North Dakota: Nelson Co., Stump Lake, July. Oklahoma: Alfalfa Co., Cherokee Salt Plains; Alfalfa Co., 8 mi. N Jet, Great Salt Plains State Park, Salt Fork of Arkansas River, June; Grant Co., 2 mi. N Pondcreek, Salt Fork of Arkansas River, June; Major Co., 2.5 mi. S Cleo, Cimarron River, June; Woods Co., Freedom, Cimarron River, July. South Dakota: Bennett Co., Martin, June. Texas: Oldham Co., 42 mi. S Dalhart, Canadian River, sand flats, Sept.; Wichita Co., Burkburnett, Red River, June.

*Bledius philadelphicus* Fall

Map 16

Specimens: 56.

Canada: Newfoundland: Steady Bank; Humber, July. Ontario: Arnprior, May; St. Catherine, Apr.; Dirleton, Oct.

United States: Maryland: Prince Georges Co., College Park, in soil, Oct. Massachusetts: Bristol Co., Somerset; Hampshire Co., Amherst, July; Norfolk Co., Brookline, Apr.; Suffolk Co., West Roxbury, June. New Jersey: Essex Co., Orange; Warren Co., Phillipsburg, May. New York: Broome Co., Windsor; Essex Co., Keene Valley, June; New York Co., New York; Queens Co., Rosedale, May; Thompsons Co., Ithaca, Apr., May, July; Tioga Co., Nichols, May. Pennsylvania: Northampton Co., Belfast, May; Northampton Co., Easton, June; Philadelphia Co., Philadelphia.

*Bledius rotundicollis* Le Conte

Map 13

Specimens: 204.

Canada: Manitoba: Aweme, June, July; Brandon, June, July; 5 mi. SW Shilo, July.

United States: Illinois: Calhoun Co., Kampsville, June; Carroll Co., Savanna, at light, July; Mason Co., Havana, Aug.; Pike Co., Pine Lake, near Pitts-

field, Aug. Iowa: Johnson Co., Iowa City, May, June, July. Minnesota. Missouri: St. Louis Co., Howard Bend, June. Nebraska: Cuming Co., West Point; Pierce Co., Fort Pierce. South Dakota: Brookings Co., Brookings, May, June, July, Aug.; Clay Co., Vermillion, July; Jones Co., Capa, June; Union Co., Elk Point, July. Wisconsin: Vernon Co., Victory, Aug.

*Bledius rubiginosus* Erichson

Map 12

Specimens: 305.

Canada: Manitoba: Aweme, May, July; Onah, May.

United States: Arkansas: Lafayette Co., Lewisville, June; Sebastian Co., Fort Smith, Arkansas River, Sept.; Washington Co., Fayetteville, June, August. Georgia: Crawford Co., Roberta, Apr.; Decatur Co., Spring Creek, Aug.; DeKalb Co., Panthersville, June; Floyd Co., Mt. Berry, May; Fulton Co., Bolton, June; Lamar Co., Milner, tangle foot trap posts, May; Richmond Co., Augusta, May; Taylor Co., Butler, Apr.; Walton Co., Monroe, June. Indiana: La Porte Co., La Porte. Iowa: Johnson Co., Iowa City. Kansas: Atchison Co., Atchison, May; Clay Co., 1 mi. S Clay Center, Republican River, Aug.; Douglas Co., Lawrence, May, July, Aug.; Riley Co., July; Sheridan Co., Tascos, south fork of Solomon River, on shore, Aug. Mississippi: George Co., Lucedale, June, July. Missouri: St. Charles Co., St. Charles, Aug.; St. Louis Co., Howard Bend, June. Nebraska: Douglas Co., 14 mi. E Wahoo, Platte River, June; Douglas Co., Venice, Platte River, June; Furnas Co., Cambridge, July, Aug.; Hitchcock Co., Trenton, Republican River, open sand flat, Sept.; Thomas Co., 2.5 mi. W Halsey, Nebraska National Forest, July. New Mexico: Dona Ana Co., Las Cruces, July; Socorro Co., 17 mi. S Belen, Rio Grande River, on shore, Aug. North Carolina: Moore Co., Southern Pines. Oklahoma: Alfalfa Co., 8 mi. N Jet, Great Salt Plains, salt fork of Arkansas River, June; Choctaw Co., 7 mi. S Hugo, Red River, Sept.; Creek Co., Sapulpa, June; Kay Co., 1 mi. E Ponca City, Arkansas River, on shore, June; Major Co., 2.5 mi. S Cleo Springs, Cimarron River, June; Marshall Co., June. South Dakota: Brookings Co., Brookings, June; Brown Co., Hecla, May, June; Clay Co., Vermillion, Sept.; Union Co., Elk Point, June, Aug. Texas: Austin Co., near Sealy, S. F. Austin State Park, May; Cameron Co., Brownsville, Jan., Feb., May, June, Nov.; Colorado Co., Columbus, July, Aug.; Dallas Co., Dallas; El Paso Co., El Paso, May, July; Fort Bend Co., Richmond, Brazos River, June; Val Verde Co., Del Rio, 900 ft., July; Val Verde Co., Devils River, May; Victoria Co., Victoria. Virginia: Chesterfield Co., Petersburg, Camp Lee, Apr. Wyoming: Bridger Basin.

*Bledius semiferrugineus* Le Conte

## Map 10

Specimens: 321.

*Canada*: Ontario: Ancaster, July, Sept.; Dirleton, Oct.; near Bourget, La Rose Forest, June; Marmora, June; Toronto; Trenton, May, June, July. Quebec: 1 mi. SW Meach Lake, Gatineau Park, Berlese sample from lining of deserted beaver nest, June; St. Remi, April, May.

*United States*: Arkansas: Washington Co., Fayetteville, June, July, Aug. Florida: Alachua Co., Archer, Mar.; Alachua Co., Gainesville, May; Charlotte Co., Punta Gorda, Apr.; Dade Co., Coconut Grove, Mar.; DeSoto Co., Arcadia, Mar., Apr.; Hendry Co., La Belle, May, July; Highlands Co., Lake Placid, Archbold Biological Station, Jan., Feb., Mar., Apr., May; Highlands Co., 6 mi. S Lake Placid; Highlands Co., Sebring, Jan., Mar., Aug., Sept., Dec.; Levy Co.; Orange Co., Winter Park, May; Palm Beach Co., Lake Worth; Pinellas Co., Dunedin; Brevard Co., Sand Point, Feb. Georgia: Bibb Co., Macon; Bartow Co., Cassville; Floyd Co., Mt. Berry, May. Illinois: Clinton Co., Carlyle, Sept.; Pike Co., near Pittsfield, Pine Lake, Aug.; Union Co., Pine Hill Field Station, May; Homer Park, June. Indiana: La Porte Co., La Porte; Orange Co., West Baden, July; Posey Co., Hovey Lake, Aug.; Tippecanoe Co., Lafayette, June. Iowa: Buchanan Co., Independence; Des Moines Co., Burlington; Johnson Co., Iowa City. Kansas: Douglas Co., Lawrence; Shawnee Co., Topeka, July. Ken-

tucky: Rowan Co., Morehead, Sept. Louisiana: Caddo Par., Shreveport; Camp Plauche, May, Sept. Maryland: Anne Arundel Co., at intersection of highway U.S. Route 50, Patauxent River, shaded mud bank, May; Montgomery Co., Plummers Island. Michigan: Cheboygan Co., June; Eaton Co., Grand Ledge, July; Livingston Co.; Midland Co.; Wayne Co., Detroit. Mississippi: George Co., Lucedale, May. Missouri: Atchison Co., Langdon, Sept.; St. Charles Co., St. Charles, July; St. Louis Co., 2 mi. W St. Louis, Apr. Nebraska: Douglas Co., 14 mi. E Wahoo, Platte River, on edge of drying pool, June. New Jersey: Burlington Co., Atsion, June. New York: Orleans Co., Barre, June; Westchester Co., Peekskill. Ohio: Clark Co., Springfield. Pennsylvania: Allegheny Co., Pittsburgh; Westmoreland Co., Jeannette, July, Aug.; Allegheny. South Dakota: Union Co., Elk Point, July. Tennessee: Gibson Co., Central, Mar.; Green Co., June. Texas: Liberty Co., Dayton, July; Victoria Co., Victoria, Sept. Virginia: Fairfax Co., June; Nelson Co., July; Falls Church, July. West Virginia: Jackson Co., Millwood, July; Jackson Co., Ripley, June; Brush Creek mouth, July.

*Bledius tallaci*

## Map 12

Specimens: 2

*United States*: California: El Dorado Co., Lake Tahoe, Tallac, July; Fresno Co., Paradise, Kings River, July.

## LITERATURE CITED

- BERNHAEUER, MAX  
1905. Neue exotische Staphyliniden. Deutsche Ent. Zeitschr., Heft 1, pp. 9-21.
- BERNHAEUER, MAX, AND KARL SCHUBERT  
1911. Coleopterorum catalogus, pars 29, Staphylinidae II. Berlin, pp. 87-190.
- BLACKWELDER, RICHARD E.  
1943. Monograph of the West Indian beetles of the family Staphylinidae. Bull. U.S. Natl. Mus., no. 182, 658 pp.  
1947. The staphylinid beetles of the Cayman Islands. Proc. U.S. Natl. Mus., vol. 97, no. 3213, pp. 117-123.
- BLATCHLEY, WILLIS S.  
1910. An illustrated descriptive catalogue of the Coleoptera or beetles (exclusive of the Rhynchophora) known to occur in Indiana with bibliography and descriptions of new species. Bull. Indiana Dept. Geol. Nat. Res., no. 1, pp. 1-1386, illus.
- CASEY, THOMAS L.  
1889. Coleopterological Notices I. Ann. New York Acad. Sci., vol. 5 (1889), pp. 39-96.
- DUVIVIER, ANTOINE  
1883. Énumération des Staphylinides décrits depuis la publication du catalogue de MM. Gemminger & de Harold. Ann. Soc. Ent. Belgique, vol. 27, pp. 91-215.
- ERICHSON, WILHELM F.  
1840. Genera et species Staphylinorum insectorum Coleopterorum familiae. Berlin, pt. 2, pp. 401-954.
- FALL, HENRY C.  
1901. List of the Coleoptera of southern California, with notes on habits and distribution and descriptions of new species. Occas. Papers California Acad. Sci., vol. 8, pp. 1-282.  
1910. Miscellaneous notes and descriptions of North American Coleoptera. Trans. Amer. Ent. Soc., vol. 36, no. 2, pp. 89-197.  
1919. A change of names (Coleoptera). Ent. News, vol. 30, p. 26.
- FAUVEL, ALBERT  
1901. Voyage de M. le Dr. Ed. Bugnion au Venezuela, en Colombie et aux Antilles.



- Staphylinides. Rev. Ent., vol. 20, pp. 69-91, pls. 1, 2.
- HATCH, MELVILLE H.  
1957. The beetles of the Pacific Northwest, Part II: Staphyliniformia. Seattle, 384 pp.
- HERMAN, LEE H., JR.  
1970. Phylogeny and reclassification of the genera of the rove-beetle subfamily Oxytelinae of the world (Coleoptera, Staphylinidae). Bull. Amer. Mus. Nat. Hist., vol. 142, art. 5, pp. 343-454, figs. 1-73, table 1.
- KIRKPATRICK, T. W.  
1957. Insect life in the tropics. New York, Longmans, Green and Co., Inc., 311 pp.
- LEACH, WILLIAM E.  
1819. [New genera.] In Samouelle, George, The entomologist's useful compendium. London, 496 pp.
- LE CONTE, JOHN L.  
1863. New species of North American Coleoptera. Smithsonian Misc. Coll., vol. 6, art. 4, no. 167, pp. 1-86.  
1877. On certain genera of Staphylinidae Oxytelini, Piestidae, and Micropeplidae, as represented in the fauna of the United States. Trans. Amer. Ent. Soc., vol. 6, pp. 213-252.
- LENG, CHARLES W.  
1920. Catalogue of the Coleoptera of America, north of Mexico. Mt. Vernon, New York, 470 pp.
- MACLEAY, WILLIAM  
1873. Notes on a collection of insects from Gayndah. Trans. Ent. Soc. New South Wales, vol. 2, pp. 79-205.
- MAEKLIN, FREDRICO G.  
1852. [New species and notes.] In Mannerheim, Zweiter Nachtrag zur Kaefer-Fauna der Nord-Amerikanischen Laender des Russischen Reiches. Bull. Soc. Imp. Nat. Moscou, vol. 25, pt. 2, pp. 283-372.  
1853. In Mannerheim, Dritter Nachtrag zur Kaefer-Fauna der Nord-Amerikanischen Laender des Russischen Reiches. *Ibid.*, vol. 26, no. 3, pp. 95-269.
- MIYATAKE, MUTSUO  
1963. Two new species of the genus *Bledius* s.str. from Shikoku, Japan (Coleoptera: Staphylinidae). Trans. Shikoku Ent. Soc., vol. 7, no. 4, pp. 106-111.
1967. New name for a Japanese staphylinid, *Bledius* (s.str.) *rotundicollis* Miyatake (Coleoptera). *Ibid.*, vol. 9, no. 3, p. 94.
- MOORE, IAN  
1964. The Staphylinidae of the marine mud flats of southern California and northwestern Baja California (Coleoptera). Trans. San Diego Soc. Nat. Hist., vol. 13, no. 12, pp. 269-284.
- MUTCHLER, ANDREW J.  
1925. Coleoptera from the Williams Galapagos expedition. Zoologica, vol. 5, no. 20, pp. 219-240, illus.
- NOTMAN, HOWARD  
1920. Staphylinidae from Florida in the collection of the American Museum of Natural History, with descriptions of new genera and species. Bull. Amer. Mus. Nat. Hist., vol. 42, art. 17, pp. 693-732.  
1922. New species of Carabidae, Staphylinidae and Elateridae. Bull. Brooklyn Ent. Soc., vol. 17, no. 4, pp. 99-108.
- ORTENBURGER, A. I., AND R. D. BIRD  
1933. The ecology of the western Oklahoma salt plains. Publ. Univ. Oklahoma Biol. Surv., vol. 5, pp. 48-64, figs. 20-22; pp. 81-87, figs. 34-42.
- SAY, THOMAS  
1823. Descriptions of coleopterous insects collected in the late expedition to the Rocky Mountains, performed by order of Mr. Calhoun, Secretary of War, under the command of Major Long. Jour. Acad. Nat. Sci. Philadelphia, vol. 3, pt. 1, pp. 139-216.  
1834. Descriptions of new North American insects and observations on some already described. Trans. Amer. Phil. Soc., vol. 4, pp. 409-470.
- SHARP, DAVID  
1887. Insecta, Coleoptera. In Godman, F. D., and O. Salvin, Biologia Centrali-Americana. London, Zoology, vol. 1, pt. 2, pp. 673-824, illus.
- WENDELER, HANS  
1928. Bemerkungen über Staphyliniden. 9-14. (Col.). Deutsche Ent. Zeitschr., p. 298.

## INDEX OF SCIENTIFIC NAMES

Page numbers in boldface type refer to the description or main reference for each name.

- actitus, *Microbledius*, 115, 119–125, **127**–131, 133, 247
- actus, *Bledius*, 115, **200**, 203, 204
- aequatorialis, *Bledius*, 115, 154, 157, 158, 160–167, **169**, 173, 247  
 group, 115, 154, **156**, 160, 169
- albidus, *Microbledius*, 115, **120**
- albipennis, *Microbledius*, 115, **120**
- analis, *Bledius*, 115, 155, 205, 206, 212, 214, 220, 223, 229, **230**, 231, 233, 236, 241–243, 247
- annularis group, 154, 155, 205
- Aploderus, 118, 120, 140
- armatus, *Bledius*, 153  
 group, 154, 155, 205
- assimilis, *Bledius*, 115, 155, 156, 205, 206, 212, 216, 220, 223, 226, 229, 231, 234, 235, 240, 241, **243**–245, 248
- basalis group, 154
- beattyi, *Bledius*, 115, 154, 157–159, **160**–164, 166, 167, 169, 172, 248
- bifasciatus, *Bledius*, **136**  
*Microbledius*, 115, 120, 123, **136**
- Bledius*, 115, 116, 118, 120, 121, 136, 140, 145, **153**, 154, 157, 169, 191, 204
- brevidens, *Bledius*, 199, **192**
- canaliculatus, *Bledius*, 115, **205**, 209
- caribbeanus, *Bledius*, **145**  
*Psamathobledius*, 115, 137, 139, 140, 142–144, **145**–148, 151, 247
- ceratus, *Bledius*, 115, 154, 157–160, 162–**164**, 165–167, 169, 170, 248
- condonensis, *Bledius*, 155, 205
- Coprophilini, 120, 140
- coulteri, *Bledius*, 115, 155, 156, 205, 206, 212, 213, 216, 220, 223, 226, 229, 231, 232, 234, 235, **240**–243, 248
- deceptivus, *Bledius*, 115, **209**, 216
- dickersoni, *Bledius*, 115, **234**, 239
- dissimilis, *Bledius*, **234**
- esopus, *Bledius*, 115, **140**–142
- falli, *Bledius*, **234**
- ferratus, *Bledius*, 115, 154, 173, 177–182, 186, **189**–194, 197, 199, 200, 248
- foraminosus, *Bledius*, 115, 155, 156, 205–208, **209**–211, 213, 215–217, 219, 222, 224, 227, 233, 235, 237, 244, 249
- forcipatus, *Bledius*, 131  
*Microbledius*, 115, 119–123, 125–127, 129, 130, **131**, 132, 134–136, 247
- fortis, *Bledius*, 115, 154, 173, 175, 179, **180**–183, 187–190, 193, 194, 201, 202, 249
- fumatus, *Bledius*, 115, 155, 156, 205, 206, 209, 210, 214, 215, 217, **219**–222, 224, 228, 233, 236, 249
- gravidus, *Bledius*, 115, 155, 156, 205, 206, 209, 210, 213, 215, **217**, 219, 221, 222, 224, 227, 228, 234, 236, 238, 249
- gularis, *Bledius*, 115, **174**, 177
- jacobinus, *Bledius*, 115, 154, 173, 177–179, 181–183, 187, 189, 192–194, 198, **200**, 203, 249
- lecontei, *Bledius*, **200**, 203
- litoreus, *Microbledius*, 115, 119, 120, 122, 123, 125, 127, 128, **129**, 130, 131, 247
- mandibularis, *Bledius*, 115, 154, 169, 173, 174, 177–185, 189, **191**–197, 199, 200, 250  
 group, 115, 154, **173**, 174, 189, 193, 200
- Microbledius*, 115, **118**, 120, 123, 136
- microcephalus, *Bledius*, **148**  
*Psamathobledius*, 115, 137, 139, 140, 142, 143, 145–147, **148**, 150, 153, 247
- miles, *Microbledius*, 115, **120**
- minutissimus, *Microbledius*, 115, **120**
- missionensis, *Bledius*, 115, **217**–219
- mixtus, *Bledius*, 115, **234**, 239
- nitidiceps, *Bledius*, 155, 205
- nitidicollis, *Bledius*, 115, 155, 156, 205, 206, 212, 213, 216, 220, 223, 225, **229**–231, 236, 240, 241, 243, 250
- opacifrons, *Bledius*, 155, 205
- Oxytelinae, 116, 118, 120, 200
- Oxytelus, 116
- pallipennis, *Bledius*, 114, 115, 154, **173**, 175–180, 182, 183, 188, 192, 194, 198–203, 250  
 Oxytelus, 173
- Parosus, 118, 120, 140
- philadelphicus, *Bledius*, 115, 155, 156, 205, 206, 212, 213, 216, 220, 223, 226, 229, 231, 232, **234**–236, 239–241, 251
- phytosinus, *Bledius*, 203
- piceus, *Bledius*, 155, 205, 239
- playanus, *Microbledius*, 115, 118–120, **121**–132, 247
- Psamathobledius*, 115, 118, 120, **136**–140, 145
- punctatissimus, *Bledius*, **140**, 145  
*Psamathobledius*, 115, 136, **140**–145, 147–149, 152, 247
- regularis, *Bledius*, 155, 205
- relictus, *Bledius*, 115, **209**, 216
- rotundicollis, *Bledius*, 115, 155, 156, 205, 206, 210, 211, 213, 217, 219, 224, 227, **228**, 229, 236, 251
- rubiginosus, *Bledius*, 115, 156, 205, 206, 210, 213–215, 219–221, **224**, 227, 233, 236, 238, 240, 251
- Salicornia, 191
- Salix, 230
- semiferrugineus, *Bledius*, 115, 155, 156, **205**–211, 213–215, 219, 222, 227, 235, 252  
 group, 115, 154, **204**, 205, 207, 210, 217, 220, 222, 224, 228, 229, 231, 236, 241, 243
- specularis, *Bledius*, 155, 205
- strenuus, *Bledius*, 155, 205
- tallaci, *Bledius*, 115, 155, 205, 206, 211, **221**–224, 252
- turgidus, *Bledius*, 155, 205
- weiseri, *Microbledius*, 115, **120**



