

University of Nebraska - Lincoln

DigitalCommons@University of Nebraska - Lincoln

Historical Materials from University of
Nebraska-Lincoln Extension

Extension

2006

2006 Guide for Weed Management in Nebraska

Mark L. Bernards

University of Nebraska - Lincoln, ML-Bernards@wiu.edu

Follow this and additional works at: <https://digitalcommons.unl.edu/extensionhist>



Part of the [Agriculture Commons](#), and the [Curriculum and Instruction Commons](#)

Bernards, Mark L., "2006 Guide for Weed Management in Nebraska" (2006). *Historical Materials from University of Nebraska-Lincoln Extension*. 61.

<https://digitalcommons.unl.edu/extensionhist/61>

This Article is brought to you for free and open access by the Extension at DigitalCommons@University of Nebraska - Lincoln. It has been accepted for inclusion in Historical Materials from University of Nebraska-Lincoln Extension by an authorized administrator of DigitalCommons@University of Nebraska - Lincoln.



Guide for Weed Management

in Nebraska



2006

Authors

One of the major thrusts of all University of Nebraska–Lincoln weed science faculty is the *Guide for Weed Management in Nebraska*. This guide is not just the work of one or two people, rather it is a joint effort of all the authors to produce a comprehensive, information-packed resource. Each weed science faculty member is responsible for particular sections of the guide. The process of reviewing the current content, checking labels and research data and updating the content can be an extensive process. Each year new herbicide active ingredients and trade names are introduced and figuring out what a herbicide is and what it can control can be a sizeable task. The authors also meet twice a year to discuss feedback from readers, how the current guide is being used, and what changes should be made in the future. The individuals listed below wrote and prepared this year's Guide. Their areas of responsibility for the Guide are listed.

Mark L. Bernards

Extension Weed Specialist
Department of Agronomy and Horticulture
Lincoln – 402-472-1534
Areas of Responsibility: Corn, herbicide mode of action

Roch E. Gaussoin

Extension Turfgrass Specialist
Department of Agronomy and Horticulture
Lincoln – 402-472-8619
rgaussoin1@unl.edu
Area of Responsibility: Turf

Brady F. Kappler

Extension Educator – Weed Science
Department of Agronomy and Horticulture
Lincoln – 402-472-1544
bkappler1@unl.edu
Areas of Responsibility: General editing, dictionary, glyphosate comparison, using preemergence herbicides POST

Robert N. Klein

Extension Cropping Systems Specialist
West Central Research and Extension Center
North Platte – 308-696-6705
rklein1@unl.edu
Areas of Responsibility: Ecofallow, wheat, sprayer calibration and setup

Stevan Z. Knezevic

Extension Integrated Weed Management Specialist
Haskell Agricultural Laboratory
Concord – 402-584-2808
sknezevic2@unl.edu
Areas of Responsibility: Soybean, IWM, troublesome weeds and replant options

Drew J. Lyon

Extension Dryland Cropping Systems Specialist
Panhandle Research and Extension Center
Scottsbluff – 308-632-1266
dlyon1@unl.edu
Areas of Responsibility: Wheat, ecofallow

Alex R. Martin

Extension Weed Specialist
Department of Agronomy and Horticulture
Lincoln – 402-472-1527
amartin2@unl.edu
Areas of Responsibility: Sorghum, additives, herbicide resistance

Fred W. Roeth - retired October 2005

Extension Weed Specialist
Department of Agronomy and Horticulture

Robert G. Wilson

Extension Weed Specialist
Panhandle Research and Extension Center
Scottsbluff – 308-632-1263
rwilson1@unl.edu
Areas of Responsibility: Sugarbeet, potato, specialty crops, range and pasture

Other contributing authors to the *Guide for Weed Management in Nebraska* are:

Robert A. Masters

Adjunct Rangeland Scientist
Department of Agronomy and Horticulture
Dow Agrosciences

Patrick J. Shea

Environmental Chemist
School of Natural Resources
Lincoln – 402-472-1533
pshea1@unl.edu
Area of Responsibility: Environmental considerations of applying herbicides

Larry D. Schulze

Extension Pesticide Coordinator
Department of Agronomy and Horticulture
Lincoln – 402-472-1632
lschulze1@unl.edu
Areas of Responsibility: Pesticide education, environmental considerations

Emergency Contacts

In case of pesticide poisoning contact:

Nebraska Regional Poison Center

(800) 222-1222

University of Nebraska Medical Center

For large or hazardous pesticide spills contact:

Chemtrec (Chemical Transportation Emergency Center) (800) 424-9300

Changes in the 2006 Weed Management Guide

Each year we strive to provide a publication that is updated, informative, and easy to use. Last year's edition has been revised to include the latest research-based information and several new sections outlined below. We hope you find these revisions useful and that they make this guide an even better resource than the previous edition.

Additions and Improvements

- ❖ New information on setting up a wet boom sprayer. See page 23.
- ❖ New section on how to ensure that your fields are sprayed correctly. See page 28.
- ❖ An updated *Glyphosate Comparison Table* contrasts many of the common glyphosate herbicides registered for Roundup Ready® corn and soybeans. See page 146.
- ❖ New and updated entries in the *Herbicide Dictionary*. See page 154.

Tell us What You Think

In preparing this *Guide for Weed Management in Nebraska*, one of our key goals is to respond to the information needs of our readers. We would appreciate your feedback on what information you use the most and what suggestions you might have for future editions. After you've had a chance to adequately use this guide, please tear out and complete the evaluation form at the back of the book, then fold, tape and mail it back. We'll pay the postage. Please mail your suggestions as soon as you can fully evaluate the guide. Suggestions received by Aug. 31, 2006 will be considered for the 2007 Guide.

Ongoing Updates

For the latest and most up-to-date version of the *Guide for Weed Management in Nebraska*, go to the following Web site:

<http://weedscience.unl.edu/weedguide/>

This circular deals principally with herbicides as an aid for crop production. The suggestions for use are based on research at University of Nebraska–Lincoln Research and Extension Centers and elsewhere. Consult product labels for additional information. Reference to commercial products or trade names is made with the understanding that no discrimination is intended and no endorsement by Nebraska Extension is implied.

Cover: This guide provides unbiased, research-based weed management information for over 15 crops, turf, range, and numerous other situations. The cover is a representation of the extensive information available to you all in one place.

Contents

	Page
Abbreviations	185
Additives for Postemergence Corn Herbicides	36, 37
Additives for Postemergence Soybean Herbicides	36, 38
Additives for Postemergence Sorghum Herbicides	36, 38
Alfalfa	98
Algae in Stock, Nurse, Spray, and Other Water Tanks	109
Application Pointers	21, 28
Aquatic Weeds.....	108
Barley	75
Bean Bar/Wiper Application	67
Burndown Tables for No-till	41, 56
Calibration of Sprayers.....	26
Carryover of Herbicides.....	33
Chicory	91
Classification of Herbicides	9
Cleaning the Sprayer	34
Combination Herbicides	148
Compatibility of Herbicides	19
Conservation Tillage	32
Conversion Tables	180
Corn, Popcorn, Sweet Corn	47-55
Critical Period of Weed Control	5
CRP Acres.....	104
CRP Burndown, Sod Burndown.....	40
Cucurbits and Melons	93
Cut Stump Treatments	112
Dictionary of Herbicides	154
Drift of Herbicide	28
Dry Edible Bean.....	90
Ecofarming-Ecofallow	32, 79-85
Environmental Considerations When Applying Herbicides	13
Evaluation Form.....	183
Feed Restrictions for Row Crop Herbicides.....	140
Fertilizer-Herbicide Compatibility	19
Forage, Feed and Grazing Restrictions for Row Crop Herbicides.....	140
Garbanzo Beans.....	90
Glyphosate Comparison Table.....	146
Glyphosate-resistant Cropping Systems Research	11
Grazing Restrictions for Pasture Herbicides.....	103
Grazing Restrictions for Row Crop Herbicides.....	140
Groundwater Contamination.....	18
Growth Regulator Herbicides	144
Herbicide Applications	21
Herbicide Carryover	33
Herbicide Classification	9

Herbicide Dictionary	154
Herbicide Drift.....	32
Herbicide-Fertilizer Compatibility	19
Herbicide Resistance.....	11
Herbicide Resistant Crop Management.....	11
Herbicide Terminology	17, 21
Herbicides, Human and Environmental Risks	13
Human Hazards When Applying Herbicides	13
Integrated Weed Management.....	5
Interpreting Herbicide Residue Analysis	33
Measurements and Conversions.....	180
Melons and Cucurbits	93
Minimizing Water Contamination	18
Mixing Herbicides.....	18
Moss in Stock, Nurse, Spray, and Other Water Tanks	111
No-till Burndown Tables	41, 56
Nonchemical Weed Control	16
Noncrop Acres.....	110
Noxious Weeds.....	105
Oat	75
Onion	94
Organic Weed Control	7
Pasture and Range	101
Potato	88
Preemergence Herbicides Used After Crop Emergence	39
Preharvest Intervals	129
Prices of Selected Herbicides.....	152
Proso Millet.....	77
Rainfast Table	128
Range	101
Replant Options.....	130
Residue Analysis.....	33
Resistance	11
Restricted Use Herbicides	178
Restrictions of Herbicides for Feed, Forage and Grazing	140
Ridge-till	32, 49, 63, 71
Soil Persistence and Retention of Herbicides.....	15
Sorghum, Forage Sorghum.....	41, 68-73
Soybean.....	56-67
Spot Treatment	181
Spray Boom Set-up	23
Sprayer Calibration.....	26
Sprayer Nozzles	21
Sprayer Operation Tips	28
Sprayer Set-up	21

Sugarbeet.....	91
Sunflower	78
Surfactants.....	36-38
Terminology.....	10, 21
Trees and Shrubs, Christmas and Fruit Trees.....	108
Troublesome Weeds and Woody Plants.....	113-127
Turfgrass, Commercial.....	95
Volunteer Herbicide Resistant Crop Control.....	12
Water Contamination	18
Weed Management in Herbicide-Resistant Crops.....	11
Water Solubility of Herbicides.....	14
Weed Competition.....	5
Weed Science Resources	179
Weed Response Charts.....	41-46, 56-60, 68-69, 74, 86-87, 95-97, 100
WeedSOFT 2006	iii
Weights and Measures	180
Wheat, Spring	75
Wheat, Winter.....	76

Weed Competition

Weeds compete with crops for water, mineral nutrients, sunlight, and infrequently for carbon dioxide and oxygen. Weed species differ in competitiveness based largely on their growth rate, size, canopy shape, and emergence date. Competitive index (CI) is a term used to describe the relative competitiveness of weed species, and is expressed as a range of 1-10. A plant with a CI of 1.0 is 1/10 as competitive as a plant with a CI of 10.0. The **CI of common weeds is listed in parentheses "()" in the weed response tables in this publication.** Competitive load is a term used to describe the total competitive effect of a weed population (community) and is a summation of the number of individual weeds multiplied by the CI of each. If there are five individuals of pigweed (CI 2.5) and two individuals of shattercane (CI 3.5) per 100 sq ft, the competitive load is 5 (pigweed) X 2.5 (CI of pigweed) + 2 (shattercane) X 3.5 (CI of shattercane) = 19.5. This equation plus the table can be used to estimate yield loss. Crop yield reductions due to weed competition are directly related to the competitive load. Crops vary in their competitiveness with weeds based on their growth characteristics. Therefore, a specific competitive load may cause a larger yield reduction in one crop than another. A more precise estimate of yield loss due to weeds is available from WeedSOFT, decision-support software for weed management (see color pages inside from cover).

Competitive Load Required for a 5% Yield Reduction for Weeds Normally Found With Crop

Crop	Competitive Load per 100 ft ²	Relative Competitiveness*
Corn	39	10.0
Soybean	10	2.5
Sorghum	10	2.5
Sugarbeet	10	2.5
Wheat, winter	50	—

CL = CI X # spp.

*Relative competitiveness of the crop in competition with the weeds common to that crop, assuming that the weeds emerge with the crop.

Integrated Weed Management (IWM)

Integrated weed management (IWM) has been defined in many ways. Some describe it as a combination of mutually supportive technologies to control weeds, while others call it a multi-disciplinary approach to weed control utilizing the application of numerous alternative control measures. In practical terms, it means developing a weed management program using a combination of preventive, cultural, mechanical and chemical practices. It does not mean abandoning chemical weed control, but relying on it less.

IWM advocates the use of all available weed control options such as: plant breeding, fertilization, crop rotation, tillage practices, planting pattern, cover crops, and mechanical, biological and chemical control. A single weed control measure is not feasible due to the number of weed species, their highly variable life cycles and survival strategies. In addition, if only one or two control methods are used, weeds can adapt to those practices. Applying the principles of IWM can help minimize the overall economic impact of weeds, reduce herbicide use, and provide optimum economic returns to the producers.

In essence, the development of an integrated weed management program is based on a few general rules that can be used at any farm:

- use agronomic practices that limit the introduction and spread of weeds, preventing weed problems before they start;
- help the crop compete with weeds; and
- use practices that keep weeds off balance and do not allow weeds to adapt.

Combining agronomic practices based on these rules will allow you to design an IWM program for your farm. Remember that there isn't a single recipe for all conditions and years. Your plan will need to be changed and adjusted to a particular farming operation and season. The goal is to manage not eradicate weeds.

Prevent Weed Problems Before They Start

The best method of weed control is to keep the weeds out of the field. **Field sanitation** involves practices that prevent weeds from entering or spreading across your field. Planting weed-free crop seed is a good starting point to reduce weed infestations. Planting weed-free, **certified seeds** will produce vigorous seedlings and good crop emergence and establishment, which are important for weed competition and yields. **Control of volunteer weeds** along field edges, fence lines, and ditches is useful in preventing the spread of weeds. **Cleaning equipment**, especially combines, before moving from field to field will further reduce the spread of weeds. **Tarping grain trucks** prevents introduction of weeds on road sides, which in turn can invade neighboring fields. **Manure** can be a problem by increasing weed numbers and introducing new weed species to a field, especially if the animals or livestock feed were imported from a

different region. Aging or composting manure for at least a year before spreading on the field will reduce weed seed viability. Control patches of **new invading weeds or herbicide-resistant weeds** before they spread. In general, preventive weed control techniques are usually the least expensive but routinely the most overlooked.

Help the Crop Compete Against Weeds

Several things can be done to give the crop an advantage over weeds. For example, **fertilizer placement** affects the crop's ability to compete with weeds. Placing the fertilizer where the crop, but not the weeds, has access allows the crop to be more competitive with weeds. Studies indicate that banding nitrogen fertilizer reduced competitiveness and population density of many weed species. **Adjusting row spacing** also will allow the crop to be more competitive. Indications are that soybean planted at 7 inches or 15 inches are more competitive against weeds than soybean planted at 30 inches or 38 inches. Certain **crop varieties** can be more competitive than others. For example, taller wheat and soybean varieties close their canopy more completely than shorter types, which helps shade out weeds. Taller varieties may still need to be sprayed, but weed control will be better due to added crop competition

Keep Weeds Off Balance — Don't Give Them a Chance to Adapt

Crop rotation is the first step to keeping weeds off balance. Diversified crop rotation will allow weeds to be managed in different ways and at different times over the growing season. For example, using forage crops (perennial or annual) allows weeds to be cut before they set seeds, which is an important form of weed removal. Crops also differ in their **competitive ability**. For example, winter cereals are generally better competitors against summer annual weeds than spring cereals. Rotating **crops with different life cycles** will help prevent weeds from adapting. Annual weeds are more common in annual crops while biannual and perennial weeds are mostly found in perennial crops. For example, winter annual weeds adapt well in the fields of winter annual crops (e.g. downy brome in winter wheat), and perennial weeds are more common in perennial crops (e.g. dandelion in alfalfa). Rotating crops with different life cycles will prevent weeds with specific life cycles from adapting and establishing.

Rotating crops also will allow for **rotating herbicide practices**. Rotating herbicides with different modes of action and application times will help delay weed adaptation and reduce the chance of resistance development. Selecting herbicides for a particular application window (e.g. pre-plant incorporated, pre-emergence, post-emergence) will help keep weeds off balance too. For example, widespread use of post-emergence herbicides may shift weed populations toward late emerging weeds (e.g. fall panicum, crabgrass and morning glory). **Rotating herbicide-tolerant**

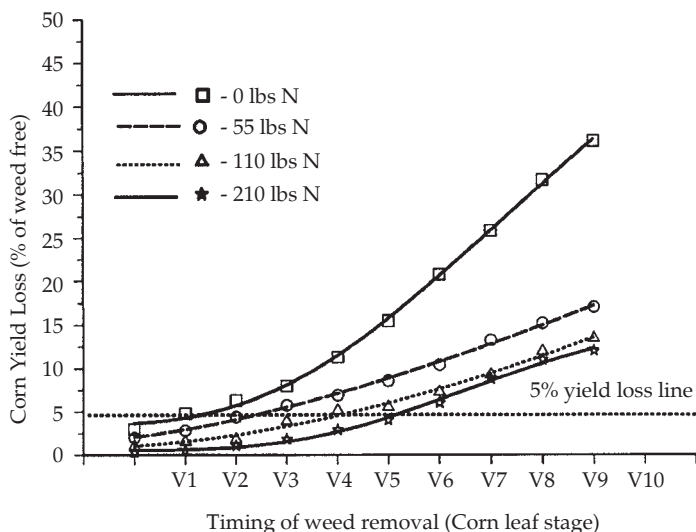

Figure 1. Corn yield loss and beginning of the critical period of weed control as influenced by the timing of weed removal and nitrogen rate.

crops also will be beneficial. Herbicide-tolerant crops are not “silver bullets” and should be viewed as just another tool for weed control.

Crops also can be selected to vary the **planting date**, which can be used to help manage a particular weed species. Planting early may give a crop a better chance against late emerging weeds such as waterhemp, morning glories, and fall panicum. Planting late may allow the use of a burndown herbicide or a tillage operation to control early-emerging weeds such as winter annuals (field pennycress, shepherds purse, mustards, henbit), velvetleaf, lambsquarters, and green foxtail. Changing the planting date from year to year will not allow a specific weed to adapt.

Using **cover crops** and their residues also can keep weeds off balance. They help manage weeds through competition, physical suppression and allelopathic effects. **Biological control of weeds** also has the potential for weed management through the use of grazing animals and natural enemies (insects, pathogens). It is a more suitable method of weed control in perennial crops (e.g. pastures) than in annual crops. Annual crops require more rapid weed control and the site disturbance often prevents long-term establishment of a biocontrol agent. In general, keeping weeds off balance and not allowing them to adapt to your cropping practices will allow you to maintain and use a variety of tools for weed control.

Making a Spray Decision

One of the most common questions that farmers ask about herbicide use is when to spray. Before deciding whether to spray, consider the following general guidelines:

Scout your field. Assessing the type and number of weeds will help you determine if a spray operation is necessary. The entire field should be walked in an inverted “W” pattern and weed density assessed (see *Field Scouting*). Some weeds are not distributed uniformly, and can be found in patches or in low spots of the field. These areas should be sprayed separately, as fieldwide spraying may not be required. Mapping weed patches also will help assess the effectiveness of the control program over time.

Consider **timing of weed emergence** relative to the crop growth stage. Studies of crop-weed competition show that yield loss is very sensitive to small differences in the period between crop and weed emergence. Use the concepts of critical period of weed control and economic thresholds.

Critical period of weed control (CPWC) is a period in the crop growth cycle when weeds must be controlled to prevent yield losses. Weeds that emerge before or after this period may not represent a threat to crop yields. This information is essential in determining the need for and timing of weed control and in achieving efficient herbicide use.

UNL research has shown that each crop has a critical period of weed control, the length of which is influenced by cropping practices (e.g. nitrogen level in corn and row spacing in soybean). Reducing the N-fertilizer level in corn resulted in a longer critical period of weed control, thus making corn a less competitive crop. The critical period of weed control ranged from the 1st-10th, 3rd-9th, 4th-9th and 6th-9th leaf stages of

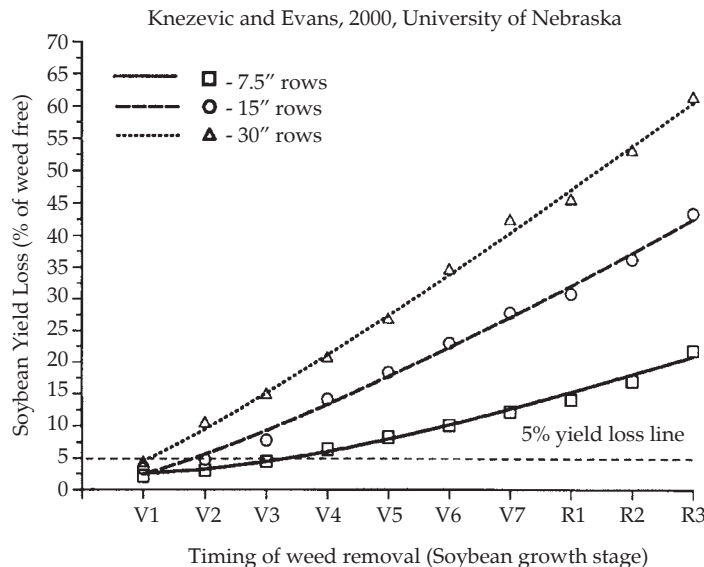

Figure 2. Soybean yield loss and beginning of the critical period of weed control as influenced by the timing of weed removal and row spacing.

corn for N-levels of 0, 55, 110 and 210 lb/A, respectively. Reducing the row spacing in soybean delayed the timing of weed control, thus increasing the crop tolerance to weed presence early in the season. In wide row (30-inch) soybeans the beginning of the critical period of weed control was at the first trifoliate stage, suggesting that in wide-row soybeans control measures should start early in the season (at the first trifoliate stage). With 15-inch rows, the beginning of the critical period of weed control was delayed and corresponded approximately to the second trifoliate stage. With 7.5-inch row soybeans, the control period was at the third trifoliate stage.

Cost of delaying weed control: Delaying weed removal beyond the start of the identified period for weed control will cost a producer an average of 2 percent in yield loss per every leaf stage of delay in both corn and soybean. From a practical standpoint, an arbitrary level of, for example, 2 percent, 5 percent or 10 percent yield loss can be used to signify the beginning of the critical period (time of weed removal). This range will allow a producer to make adjustments depending on the level of risk he or she is willing to take. To illustrate the point, an arbitrary level of 5 percent yield loss was used to determine the beginning of the critical period of weed control for corn and soybeans (see *Figures 1 and 2*).

To determine the cost of delaying weed control, use the curve above the arbitrarily selected point (the beginning of the critical period of weed control). For example, if an arbitrarily selected point is 5 percent, the 5 percent yield loss will occur if the weeds are removed at the second leaf stage in 0-N-level (*Figure 1*). Delaying weed control to the third leaf stage will cause about 7 percent yield loss, in essence costing the producer a 2 percent yield loss. A similar trend is observed for the later leaf stages at each of the four curves (*Figure 1*).

Delaying weed control in soybean resulted in similar yield losses as in corn and was significantly influenced by crop row spacing. For example, 5 percent yield loss in drilled soybeans (7.5-inch rows) occurred at the third trifoliate stage compared to a 7 percent yield loss at the fourth trifoliate. This indicates a 2 percent yield loss. Similar costs in delaying weed control in soybeans were observed for the later leaf stages at each of the three curves (*Figure 2*).

To determine the actual economics of delaying control, the producer can convert the percentage yield loss of the actual target yield on his farm. For example, if a target yield for corn is 100 bushels per acre, delaying weed control for every leaf stage of crop will cost producers about 2 bushels per acre of yield (thus 2 percent of 100 bushels per acre). In terms of actual economic loss, it will be about \$4 per acre for every crop leaf stage of delay, assuming a price of \$2 per bushel for corn. The loss in soybean will be about one bushel (2 percent of a 40 bu/A target yield). Considering current prices of soybean (about \$5 per bushel), the economic loss will be about \$5 per acre for every leaf stage of delay.

Economic threshold is the level of weed infestation at which the cost

of weed control equals the increased return on crop yield in the current year. The threshold values will vary with time of weed emergence, weed species competitiveness and commodity prices. A list of competitive indices for major weeds is on page 5. The bottom line is: Spray only when it pays. Spraying for annual weeds that are below threshold level is not necessary from both biological and economical perspectives.

Computer models also have been developed to aid with spray decisions. University of Nebraska weed scientists developed the decision support software, WeedSOFT. This software can help you select the most economical herbicide based on the various weed species present, their densities and the soil type in your field.

Field scouting to determine weed density: Crop producers are well aware of the effect of high weed densities on crop yields; however, it is at low weed densities that they must make weed management decisions, comparing the economic benefits of controlling weeds with the costs. Field scouting is an important part of deciding whether to spray. Accurately determining the types of weeds, their density and relative times of emergence in the field will help determine if a spray operation is necessary.

One of the major constraints to using weed thresholds at the farm level is a lack of practical sampling methods for estimating weed density over larger field scale. We suggest that the entire field should first be walked to get a feel for the “weed pressure” and then sampled. While several sampling methods are available, we recommend using an inverted “W” pattern as illustrated in *Figure 3*.

The scout should walk for about 100 paces along the edge of the field and then turn at a right angle and walk 100 paces into the field. The sampling begins at this point. A wooden or wire “quadrant” enclosing a 2-by 2-foot area can be used to determine weed density at every sampling spot along the inverted “W” pattern. At each sampling spot the quadrant should be placed to the ground and the number of weeds present in the quadrant counted and recorded. A minimum of 20 sampling units, each at least 20 paces apart, should be taken across the field and an average weed density calculated. The average weed density can be used to estimate yield loss using WeedSOFT or some other yield loss estimator.

Many times weeds are not uniformly distributed and may be more heavily concentrated in patches, low spots, and along field edges. These areas should be considered separately from the rest of the field.

Documentation and Record Keeping

Documentation and record keeping are essential to an IWM program. Field histories and information on cropping practices will help you evalu-

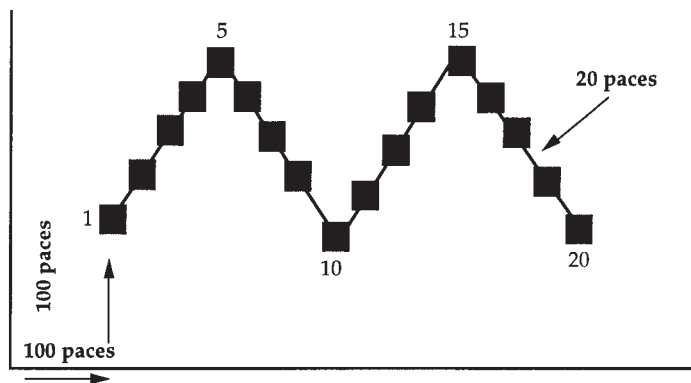

Figure 3. Field scouting pattern for determining weed thresholds.

ate your weed control program over time. Information can be recorded on paper or in computerized forms which can be developed as a database application. Data forms should have basic information such as: site description, field monitoring and evaluation, records of herbicide applications and other methods of weed control. Generally, knowing the weeds on your farm, taking notes and watching for possible shifts in weed species may prevent you from costly surprises.

Integrated Weed Management — Making It Work

Since there are many kinds of weeds with very different life cycles, no single IWM program is best under all circumstances. Obviously you can not use all of the described techniques at once; however, if new methods are implemented in a systematic manner, significant advances in weed control can be achieved. Use the best combination of techniques for your needs.

There are many ways to start developing an integrated weed management program. The easiest way is to try one or two techniques, adding more each year. After a few years, you will have developed an integrated weed management program that works well for your operation. Using a variety of weed control tools reduces the reliance on any tool, which means that those tools will still be effective in the years to come. Using various methods keeps weeds off-balance and prevents them from adapting to your management strategy. And remember, there is no such a thing as a “silver bullet” when it comes to weed control.

Nonchemical Weed Control

Nonchemical weed control can be used exclusively or integrated with chemical control. In either case, nonchemical methods can play a major role in weed management. The major nonchemical weed control techniques include: biological, cultural, and mechanical approaches. Successful nonchemical control is best achieved through an integrated approach based on the biology of the weeds and the crop. The following discussion highlights some of the major elements of nonchemical weed control.

Weed Biology

Seed Banks

Seed banks are reservoirs of weed seeds that may, under favorable conditions, germinate and emerge to compete with crops. Most agricultural soils contain large reservoirs of weed seeds, with up to 12,500 seeds/ft². The number and composition of weed seeds in soils vary greatly but are closely associated with climatic factors, soil characteristics, cropping, cultivation and weed management practices. Seed banks have a number of similarities. Generally, they consist of numerous species, although several species may comprise 70-90 percent of the total seed bank. This large set may be followed by a second smaller subset of species that may comprise 10-20 percent of the seed reserve. A final group, accounting for only a small percentage of the total seed reserve, consists of species that are remnants of past crops.

The depth of seed burial and the amount and intensity of soil cultivation are important in seed longevity. In general, weed seed longevity

will be less in cultivated soils than in noncultivated soils. Only a portion of the weed seed in the seed bank emerges each year and many annual weeds have well-defined periods of emergence. For example, common lambsquarters and redroot pigweed have major peaks of emergence from mid-spring until early summer, whereas downy brome emergence peaks from late summer through fall.

In cultivated soils, most seeds are found in the upper 6 inches, although they may be found as deep as the soil is cultivated. As the intensity of tillage declines, the seed bank moves closer to the soil surface. Seeds are then in a better position to germinate and interfere with crop production; while conversely, under good weed management, the seed bank could be more easily reduced. Design of planting and weed control systems in crops that capitalize on the shallow seed bank can improve the effectiveness of the cropping system. It is important to design weed management programs that limit the renewal of seed banks. Programs incorporating the most suitable crop rotations, herbicides and cultivation practices play an important role in limiting the number and diversity of seeds in the seed bank.

Weed species that infest cropped fields vary greatly in their potential seed production capacity. Some examples of the potential seed production capacity per plant for several annual weeds are 250 for wild oat, 7,160 for barnyardgrass, 72,450 for common lambsquarters, and 117,400 for redroot pigweed. The actual production per plant varies greatly from year to year and depends upon factors such as plant competition, environmental conditions, the suppressive effect of weed control techniques and the time of emergence.

The longevity of the seed bank depends on the percentage of seeds that germinate and the number of weeds that produce seeds. Clearly, increasing the rate of germination, coupled with prevention of seed production, can shorten the time needed to reduce weed populations to non-competing levels.

Nonchemical Approaches

Biological

Biological weed control is the control of weeds by parasites, predators or pathogens. Biological control reduces weed density but does not eliminate the target weed, as the biocontrol agent often requires the weed as a host or food source. In some instances biological control can be permanent as the biocontrol agent may be self-perpetuating and not require additional management. The target organism may then be controlled indefinitely without further human effort, an advantage particularly in certain geographically or environmentally limiting settings. Most biocontrol agents have no deleterious environmental effects since candidate organisms are rigorously evaluated prior to approval and release. The effect of biocontrol agents is limited to the target weed and perhaps a few close relatives. The economics of successful biocontrol can be favorable since following release the organism perpetuates itself indefinitely and often disperses on its own.

The response to a biocontrol program is often slow since the population of the organism must increase from the level of the initial release. As a result, most biocontrol agents are best suited to a stable long-term environment, i.e., grazing land or natural areas rather than an annual cropping system. Most biocontrol agents, by virtue of their specificity, control only a single species and are not well suited to address the complex of weeds normally found in cropland. Since most biocontrol agents by themselves do not reduce weed populations to an acceptable level, they must be used in conjunction with other approaches in an integrated weed management (IWM) program.

An often cited example of biological control success is the use of the imported cactus moth and several secondary insects to control prickly pear in Australia. A large scale biocontrol program in the United States used the Klamath beetle and other species to control the Klamath weed in Oregon. Varying degrees of success have been realized in Nebraska with biocontrol efforts targeting Canada thistle, diffuse knapweed, leafy spurge, musk thistle and purple loosestrife. Research continues at the national and state level to develop biocontrol agents.

Cultural

A variety of cultural practices can be used to improve crop competitiveness. *Crop rotation and crop selection* are two of the easiest and most effective practices. Crop rotation permits diversified management, which allows less opportunity for an individual weed to become dominant. For example, the use of forage crops (perennial or annual) provides an opportunity to cut weeds before they set seeds, which is an important form of weed removal. Most crops do differ in their competitive ability. For example, winter cereals are generally better competitors than spring cereals against summer annual weeds. Rotating crops with different life cycles will help to prevent a single weed, or small group of weeds, from dominating and having an economic impact on crop production. Annual weeds are more common in annual crops while biennial and perennial weeds are found mostly in perennial crops. For example, winter annual weeds adapt well in fields of winter annual crops (e.g., downy brome in winter wheat), and perennial weeds are more common in perennial crops (e.g., dandelion in alfalfa).

Crop and cultivar selection provide a variety of *planting date options* to aid in the management of a particular weed species. Planting early will give the crop an edge against late emerging weeds such as waterhemp, morningglories, and fall panicum. Planting late may allow the use of a pre-planting tillage operation to control early emerging weeds such as winter annuals (field pennycress, shepherdspurse, mustards, henbit), velvetleaf, lambsquarters, and green foxtail. Changing the planting date from year to year can reduce the buildup of specific weeds.

Adjusting crop population density and row spacing influences plant competition for water and nutrients, canopy closure, and crop shading effects on weeds. To a point, higher crop population densities generally are more competitive with weeds than lower population densities. The

time to canopy closure can be altered by changing row spacing. Generally, narrow row spacings result in earlier canopy closure than wider row spacings. Canopy shading is a major means by which crop plants suppress weeds, but the crop must develop rapidly to stay ahead of the weeds. Nebraska's research showed that soybean is more competitive when planted in narrow rows than in wide rows. Crop selection, population density, and row spacing should be considered in any cropping system. These cultural practices are especially important for crops with shorter stature.

Cover crops and their residues also may provide a means to keep weeds in check. Cover crops are generally planted in closely spaced rows to provide good ground cover, thus the name cover crops. They help manage weeds through competition, physical suppression, and allelopathic effects.

Mechanical

Mechanical weed control is one of the most commonly used nonchemical methods of weed control. *Tillage, mowing, cutting, and for small areas, hoeing, hand removal, and physical barriers* are common mechanical weed control techniques. A variety of implements can be used, depending on the crop and the system. Tillage destroys emerged weeds but also plants seeds that are on the soil surface. Depending on the depth of weed seed burial, tillage often tends to encourage large seeded broadleaf weeds and discourage small seeded broadleaves and grasses.

Primary tillage includes moldboard plowing, chiseling, heavy disking, rototilling and similar operations. Tillage will destroy annual and biennial weeds and disrupt the root systems and other vegetative reproductive structures of perennials. Primary tillage also buries crop residue, leaving the soil subject to erosion.

Secondary tillage is performed after primary tillage and is intended to prepare a weed-free seedbed for crop planting. Commonly used implements are disks, field cultivators and harrows. Tertiary tillage is performed after crop planting and is intended to keep weeds from becoming established in the growing crop. Commonly used implements include harrows, rotary hoes and various row cultivators. Many specialized implements have been designed for mechanical in-crop weed control.

Ridge planting is a system that incorporates mechanical weed control in that the crop is planted on an existing ridge where a sweep on the planter removes any growing weeds from the row area ahead of the planter unit and also moves weed seeds to the row middles. Subsequent cultivation and ridging controls weeds between the rows and buries small weeds growing in the crop row.

Successful weed control with secondary and tertiary tillage is highly dependent on timing, the weather and soil moisture before and after the operation. Soil moisture must permit tillage while the weeds are in the small vulnerable stage and drying conditions must exist for several hours after the operation to desiccate the small weeds. Delaying planting provides the opportunity to kill one or two "crops" of weeds prior to planting and allows the soil to warm up, resulting in rapid crop growth. Rapid crop growth is important in reaching a size differential between a larger crop plant and the weed. This size differential is required for success with many crop harrow, rotary hoe and cultivation operations.

Properly timed mowing or cutting will suppress weeds but with few exceptions will not kill them. Cutting cedar trees (or other plants without basal buds) below the lowest branch will kill them. Mowing tends to be more effective on broadleaf weeds than grasses since most grasses rapidly regrow from the crown. Mowing must be carefully timed to maximize damage to the weed and minimize damage to the crop.

Physical barriers include placing black plastic sheeting (mulch) either on the soil surface or beneath a surface covering of gravel or stone. This method is used in certain high value horticultural crops. The crop or plant to be grown is planted through a hole cut in the plastic. Black plastic is important because it excludes sunlight from reaching weed seeds or small plants. Plastic mulch is most common with high value horticultural crops.

Summary

Few nonchemical methods of weed control are so effective that any one can stand alone in providing acceptable weed control. An integrated weed management (IWM) program (see previous section) incorporating multiple approaches is important for success with nonchemical weed control.

Classification of Herbicides by Mode and Site of Action and Chemical Family

Herbicides can be classified into families based on their chemical similarity or grouped by how they kill plants (mode and site of action). In some cases, herbicides from different chemical families have a similar site of action. Combinations of herbicides having the same site of action can lead to problems. For example, repeated use of ALS inhibitors can result in the selection for ALS-resistant weeds. Using sulfonyleurea and imidazolinone herbicides (Classic, Pursuit, etc.) in the same growing season can result in increased carryover problems or possible crop injury. These problems can be lessened by rotating or combining herbicides with different action sites. This table lists herbicides by their broad mode of action (Roman numeral), specific action site (letter), and chemical family (number). In the table sites of herbicide uptake are indicated by: R = root uptake; S = shoot uptake; and F = foliage uptake. Letter sequence indicates the primary order of herbicide uptake. Those herbicides with a common action site pose the highest risk of an additive effect which can lead to resistant weed development, additional carryover, or more crop injury. Refer to the journal, *Weed Technology*, 11: 384-393 (1997) for additional information on herbicide classification.

Common Name—Trade Name—Site of Uptake

I. Lipid Synthesis Inhibition

A. ACCase inhibition

1. Aryloxyphenoxypyrone (FOPs)
 clodinafop propargyl—Discovery—F
 diclofop—Hoelon—F
 fenoxaprop—Acclaim Extra—F
 fluazifop-P—Fusilade DX—F
 quizalofop-P—Assure II—F
2. Cyclohexanediones (DIMs)
 clethodim—Select—F
 sethoxydim—Poast Plus—F
 tralkoxydim—Achieve—F

II. Amino Acid Synthesis Inhibition

A. ALS-AHAS inhibition

1. Imidazolinones
 imazamethabenz—Assert—R/F
 imazamox—Raptor—F/R
 imazapic—Plateau—R/F
 imazapyr—Arsenal—R/F
 imazaquin—Scepter—R/F
 imazethapyr—Pursuit—R/F
2. Sulfonyleureas
 bensulfuron—Londax—F/R
 chlorimuron—Classic—F/R
 chlorsulfuron—Glean—F/R
 ethametsulfuron—Muster—F
 foramsulfuron—Option—F
 halosulfuron—Permit/Battalion—F/R
 iodosulfuron—Equip—F
 metsulfuron—Ally/Escort—F/R
 nicosulfuron—Accent—F
 primisulfuron—Beacon—F/R
 prosulfuron—Peak—F/R
 rimsulfuron—Matrix—F/R
 sulfometuron—Oust—F/R
 sulfosulfuron—Maverick
 thifensulfuron—Harmony/Pinnacle—F/R
 triasulfuron—Amber—F/R
 tribenuron—Express—F/R
 triflurosulfuron—Upbeet—F
3. Triazolopyrimidines
 chloransulam methyl—FirstRate—F/R
 flucarbazone—Everest—F/R
 flumetsulam—Python—R/F

B. EPSP synthetase inhibition

glyphosate—Roundup/Touchdown—F

C. Glutamine synthetase inhibition

glufosinate—Liberty—F

III. Seedling Growth Inhibition

A. Microtubule assembly inhibition

1. Dinitroanilines
 benfluralin—Balan—S/R
 ethalfluralin—Curbit/Sonalan—S
 oryzalin—Surflan—S
 pendimethalin—Prowl—S
 prodiamine—Barricade—S
 trifluralin—Treflan—S
2. Pyridines
 dithiopyr—Dimension—R/F
3. Benzamides
 pronamide—Kerb—S/R
4. Benzoic acids
 DCPA—Dacthal—R

B. Shoot inhibition

1. Chloroacetamides
 acetochlor—Harness/Surpass—S/R
 alachlor—Lasso—S/R
 dimethenamid—Frontier—S/R
 metolachlor—Dual—S/R
 propachlor—Ramrod—S/R
2. Oxyacetamides
 flufenacet—Define—S/R
3. Acetamides
 napropamide—Devrinol—R/S

C. Lipid synthesis inhibition (not ACC ase)

1. Benzofuranes
 ethofumesate—Nortron SC—S/R
2. Phosphorodithionates
 bensulide — Betasan — R
3. Thiocarbamates
 butylate—Sutan +—S/R
 cycloate—Ro-Neet—S/R
 EPTC—Eptam/Eradicane—S/R
 triallate—Far-Go—S/R

D. Auxin transport inhibition

1. Phthalamates
 naptalam—Alanap—R/F
2. Semicarbazone
 diflufenzopyr—Distinct—F

E. Cell wall synthesis inhibition

1. Benzamides
 isoxaben—Gallery—R/S
2. Nitriles
 dichlobenil—Casoron—R/F

IV. Growth Regulators

- A. Synthetic auxins
 - 1. Phenoxyacetic Acids
 - 2,4-D—Many—F/R
 - 2,4-DB—Butyrac—F
 - dichlorprop—Many—F
 - MCPA—Many—F/R
 - mecoprop—Many—F
 - 2. Benzoic Acids
 - dicamba—Banvel/Clarity—F/R/S
 - 3. Pyridine carboxylic acids
 - aminopyralid—Milestone—F/R
 - clopyralid—Stinger—F/R
 - fluroxypyr—Starane—F
 - picloram—Tordon—F/R
 - triclopyr—Garlon—F/R
 - 4. Quinoline carboxylic acids
 - quinclorac—Paramount—F/S

V. Photosynthesis Inhibition (Photosystem II) — Classes differ in binding behavior

- A. C₁ class
 - 1. Triazines
 - ametryn—Evik—R/F
 - atrazine—AAtrex—R/F
 - cyanazine—Bladex—R/F
 - prometon—Pramitol—R/F
 - simazine—Princep—R
 - 2. Triazinones
 - hexazinone—Velpar—R/F
 - metribuzin—Sencor—R/F
 - 3. Phenylcarbamates
 - desmedipham—Betanex—F
 - phenmedipham—Betanal—F
 - 4. Uracils
 - bromacil—Hyvar—R
 - terbacil—Sinbar—R
 - 5. Pyridazinones
 - pyrazon—Pyramin—R/F
- B. C₂ class
 - 1. Phenylureas
 - diuron—Karmex—R
 - linuron—Lorox—R/F
 - siduron—Tupersan—R
 - tebuthiuron—Spike—R
- C. C₃ class
 - 1. Benzothiadiazinones
 - bentazon—Basagran—F
 - 2. Nitriles
 - bromoxynil—Buctril—F
 - 3. Phenylpyridazine
 - pyridate—Tough—F

VI. Cell Membrane Disruption

- A. PPO inhibition
 - 1. Diphenylethers
 - acifluorfen—Blazer—F
 - fomesafen—Reflex/Flexstar—R/F
 - lactofen—Phoenix/Cobra—F
 - oxyfluorfen—Goal—R/S
 - 2. N-phenylphthalimides
 - flumiclorac—Resource—F
 - flumioxazin—Valor—S/F
 - 3. Triazolinones
 - sulfentrazone—Authority/Cover/Spartan—R
 - carfentrazone ethyl—Aim/Affinity—F
 - 4. Thiadiazoles
 - fluthiacet methyl—Action—F
- B. Photosystem I electron diversion
 - 1. Bipyridyliums
 - diquat—Reward—F
 - paraquat—Gramoxone Max—F
- C. Cellular pH alteration
 - 1. Fatty acids
 - pelargonic acid—Scythe—F

VII. Carotenoid Biosynthesis Inhibition

- A. Phytolene desaturase inhibition
 - fluridone—Avast—S/R
 - norflurazon—Zorial—S
- B. 4-HPPD inhibition
 - 1. Callistemones
 - mesotrione—Callisto—F/R
 - topramezone—Impact—F/R
 - 2. Isoxazoles
 - isoxaflutole—Balance Pro—R/F
- C. Unknown site of action
 - amitrole—Amitrole—F
 - clomazone—Command—R/S

VIII. Unclassified or Unknown

- 1. Organoarsenical
 - DSMA—many—F
 - MSMA—many—F
- 2. Other
 - endothall—Aquathol—R/F
 - difenzoquat—Avenge—F
 - fosamine—Krenite—F

Herbicide Resistance

Herbicide-resistant weeds develop as a result of repeatedly using the same herbicide or herbicides with the same mode of action. Herbicide-resistant plants are naturally present in extremely low numbers.

Repeatedly using the same herbicide allows the resistant weeds to multiply while the susceptible weeds are controlled. Over a period of time the weed population shifts to primarily herbicide-resistant weeds and weed control failures are observed. Resistant weeds cannot be controlled by increasing the herbicide rate.

Triazine-resistant kochia is common across Nebraska. Populations of triazine-resistant waterhemp also have been recorded. Resistance to sulfonyleurea herbicides such as Glean, Ally, and Amber has been confirmed in Nebraska. In addition, isolated populations of kochia showing a high tolerance to 2,4-D + dicamba have been identified in western Nebraska. Additional cases of herbicide resistance are likely to develop unless steps are taken to prevent this. An integrated weed management program is suggested to minimize the development of herbicide-resistant weeds.

Following are suggestions to minimize the development of herbicide-resistant weeds:

1. Rotate crops to keep any one weed species from dominating. Rotations including row crops, small grains and perennial forage crops are the most effective.
2. Include tillage as a component of the weed-management program. Crop rotation permits a variation in tillage timing.
3. Utilize cultural practices that enhance crop growth, thereby maximizing competitiveness with weeds. Planting crops in narrow rows improves their weed competitiveness.
4. Utilize herbicides with different sites of action in successive years and, where possible, within a year. This approach will slow the increase of a weed resistant to one site of action. See the discussion on *Classification of Herbicides*, pages 9-10.
5. Use short residual rather than persistent herbicides. Most cases of resistant weeds involve persistent herbicides. Where long residual herbicides are used, other control measures also should be employed.

Weed Management in Herbicide-Resistant Crops

Herbicide-resistant crops coupled with the appropriate herbicide have generally resulted in better weed control with less risk of crop injury than with conventional management systems. As with most things in life, there are pros and cons to using herbicide-resistant crops.

The pros include weed management that usually will be improved because herbicide rates and timings are not dictated by crop tolerance. Another pro is that the total cost of weed management is lower, even when the increased seed cost is included.

Crops that are less competitive with weeds (for example, soybean is less competitive than corn) and cropping systems that reduce crop competition (for example, skip-row corn or low population rainfed corn) benefit the most from herbicide-resistant crops.

The cons are the increased cost of seed for most varieties and hybrids and that the producer must buy new seed each year due to plant variety protection restrictions. Also, GMO crops may have a limited market and

can contaminate adjoining crops. Another con is that there is an increased potential for weeds to develop resistance to herbicides.

The first case of glyphosate resistance in a weed occurred where soybeans were planted continuously with no-till and only glyphosate was used before and after planting. (If your goal were to develop resistance in a weed rather than control it, this is probably the method to use.)

Total postemergence (POST) weed management programs have become popular with herbicide-resistant crops. Let's compare the advantages and disadvantages of total POST programs with preemergence (PRE) plus POST programs.

As you can see from the table below, a PRE + POST program is usually the best and most flexible weed management program for many producers. If weed pressure is not heavy, a two-thirds rate of PRE herbicide may be used. Remember not all companies will service reduced rates.

Weed Management Strategies

<i>Weed Control</i>	<i>Advantages</i>	<i>Disadvantages</i>	<i>Risk</i>
PRE followed by POST	<ul style="list-style-type: none"> •Excellent weed control •POST timing less critical •Tolerant/resistant weeds checked 	<ul style="list-style-type: none"> •Two operations •Higher costs unless reduced amount of PRE is used 	Low
POST 1X	<ul style="list-style-type: none"> •Single operation •Low cost 	<ul style="list-style-type: none"> •Narrow application window •Early and late competition •Incomplete control 	High
POST 2X	<ul style="list-style-type: none"> •Excellent weed control 	<ul style="list-style-type: none"> •Two operations •Two post treatments (wind) •Select tolerant/resistant weeds 	Moderate

Research Findings on Glyphosate-resistant Cropping Systems

Now let's look at the research on weed shifts in glyphosate-resistant cropping systems. Recently, a study was conducted at Scottsbluff and North Platte, Nebraska; Ft. Collins, Colorado; Torrington, Wyoming; and Colby, Kansas to examine the risks of weed spectrum shift and herbicide resistance in Roundup Ready cropping systems. The North Platte and Colby sites were rainfed while all the others were irrigated. This study included four different treatments to compare weed shifts. The first two treatments were glyphosate at a rate of 1 pint and 1 quart per acre, each applied twice a year. The third treatment in the study was 1 quart of glyphosate applied twice a year alternated with a herbicide other than glyphosate in the successive years. The fourth treatment never used herbicides containing glyphosate.

Over the seven-year period at the Scottsbluff location, no weedy plants were identified that had developed resistance to glyphosate. It took about four years before significant weed species changes became evident. The field was initially infested with large quantities of kochia (5 plants/ft²) and wild proso millet (4 plants/ft²) with smaller populations of common lambsquarters, redroot pigweed, common purslane, and longspine sandbur. The density of kochia and wild proso millet declined under all herbicide programs while the density of common lambsquarters increased to 1 plant/ft² in areas treated twice with the low rate of glyphosate. After five years there was a switch from kochia and wild proso millet being the dominant weeds to common lambsquarters being the dominant species. This trend was not as evident in areas treated with two applications of glyphosate at 1 qt/A, which continued to keep lambsquarters density at a low level. A different trend was observed in the nonglyphosate treatment where kochia and longspine sandbur density were increasing. The changes in weeds growing with the crop also were observed in the quantities

of weed seed found in the soil. About twice as many weed seeds were found in soil from plots treated with the low rate of glyphosate compared to the high rate.

Crop rotation also had an influence on weed populations. Common lambsquarters density increased to a greater degree in the corn-sugarbeet-corn rotation compared to continuous corn. While in the continuous corn rotation, hairy nightshade and kochia increased.

In year six, corn and sugarbeet yields differed between the low and high glyphosate rate and the nonglyphosate treatments. Corn yields in areas treated twice with the low rate of glyphosate were reduced by 43% by common lambsquarters competition with corn.

Results from the first seven years of the study suggest that using the high rate of glyphosate twice each year continued to provide excellent weed control and did not lead to weed resistance. Reducing the glyphosate rate allowed common lambsquarters populations to increase. Therefore, the rate of glyphosate needs to be an important consideration in Roundup Ready cropping systems. Alternating two applications of glyphosate at 1 qt with a nonglyphosate treatment the next year was similar to using the recommended rate of glyphosate every year or the nonglyphosate treatment each year. Crop rotation was also a factor in regards to common lambsquarters, where populations increased when sugarbeet and spring wheat were in the crop rotation.

Volunteer Herbicide Resistant Crop Control

The widespread adoption of herbicide-resistant crop (HRC) technology has given rise to a new weed problem -- volunteer herbicide resistant crops. An HRC is created by inserting a gene that makes the crop plant resistant to an herbicide. The gene conferring herbicide resistance is passed on to succeeding generations along with all the other genes in the plant. As a result, the volunteer plants developing the year after the HRC was grown are also herbicide resistant. The grower is then confronted with controlling the volunteer HRC the next year. The list of HRCs continues to grow but currently includes Roundup Ready (RR) corn, Roundup Ready soybean, Roundup Ready alfalfa, Liberty Link (LL) corn, Clearfield (CF) corn, Clearfield sunflower, Clearfield wheat, and SU sunflower.

Controlling these volunteer HRCs with herbicides involves selecting an effective herbicide with a site of action different than the resistant target site provided in the HRC. Refer to the Herbicide Classification section of this publication for herbicide site of action information. The herbicide selected also must be registered for the crop or site in question. Sometimes it is difficult to meet all these requirements. A problem arises when the most effective herbicide for the conventional version of the crop is the herbicide to which the volunteer crop is resistant. A common situation is controlling volunteer RR corn in RR soybean. This can be handled by using Assure II, Fusion, Poast Plus, or Select in the soybean. A more difficult

problem situation is how to control a poor stand of RR corn prior to replanting corn. Glyphosate would be ineffective on volunteer RR corn. Assure II, Fusion, Poast Plus, and Select would be good choice if the replant crop was to be soybean but not corn because the residual activity of those herbicides would damage the corn.

Many crops do not routinely volunteer as a weed. However, corn, wheat, sunflower and alfalfa may volunteer and present a problem in the following crop.

A problem with a volunteer HRC can be anticipated when high harvesting losses leave grain in the field from the preceding crop. This should be considered in selecting the next crop. Once the succeeding crop has been planted many options are no longer available.

The following table lists treatments useful in controlling common herbicide resistant crop plants. Some treatments provide suppression rather than a high degree of control of the unwanted plants. Control of the volunteer HRC would be required where an established crop is not present to compete with the volunteer crop, such as in fallow or where the next crop has not yet been planted. Suppression of the volunteer HRC may be adequate where the object is to eliminate competition from the volunteer HRC plants in a growing competitive crop as is the case with volunteer corn control in corn.

Herbicides for Control of Volunteer Herbicide-resistant Crops Treated Crop or Situation

Volunteer HRC to be controlled	Corn	Soybean	Sorghum	Wheat	Fallow	Sugarbeet	Drybean
RR Corn	Liberty ^s in LL corn Lightning in CF corn	Assure Fusion Poast Plus Select				Gramoxone ^s Liberty ^s Poast Select	Assure Poast Select
LL Corn	Glyphosate in RR corn Lightning in CF corn	Assure Fusion Poast Plus Select				Glyphosate ^s Gramoxone ^s Liberty Poast Select	Assure Poast Select
CF Corn	Glyphosate in RR corn Liberty ^s in LL corn	Assure Fusion Poast Plus Select				Glyphosate Gramoxone ^s Liberty ^s Poast Select	Assure Poast Select
RR Soybean	Dicamba		Dicamba	Dicamba	Dicamba Glyphosate	Stinger	
CF Wheat	Glyphosate in RR corn	Glyphosate in RR bean Assure Fusion Select			Glyphosate	Select	Assure Select
SF Sunflower	Many other than ALS	Many other than ALS	Many other than ALS	Dicamba 2,4-D	Dicamba 2,4-D Glyphosate	Stinger	Other than ALS

^s= Suppression plants are usually not killed.

^aALS = see *Classification of Herbicides* in this guide.

Human Hazards When Applying Herbicides

The signal words CAUTION (slightly toxic), WARNING (moderately toxic), and DANGER (highly toxic) indicate the relative toxicity of an herbicide or other pesticide active ingredient to humans. These words appear on the front of product labels, often with other Precautionary Statements. The word "Poison" and the skull and crossbones symbol

are associated with the "Danger" signal word on certain labels if the product may cause acute oral, acute dermal, and/or acute inhalation toxicity. Signal words are indications of the risk from acute oral, dermal, inhalation, or eye exposure. Signal words should be used as a guide for precautionary measures during herbicide handling, mixing, or application. Always consult the pesticide label for the requirements for personal protective equipment (PPE). In some cases, personal protective equipment for the same product will differ between the mixer/loader operator and the applicator.

Dermal exposure (skin contamination) is the most common method of exposure and potentially dangerous hazard for users of herbicides and other pesticides. It can occur any time a pesticide is handled, mixed, or applied and may go undetected initially. The potential danger from dermal exposure depends on the toxicity of the material, rate of absorption through the skin, the amount of skin area contaminated, and the amount of time the material is in contact with the skin. Rates of absorption through the skin are different for different parts of the body. The figure shows the rate of absorption for different parts of the body in relation to that of the forearm (1x). Absorption may be 12 times (12x) faster in the lower groin area than on the forearm. At this rate, absorption of pesticide through the skin into the bloodstream may be more dangerous than swallowing it. Absorption continues as long as the material remains in contact with the skin. Danger from exposure is increased if the contaminated area is large or if the material is left on the skin for prolonged periods. Contact with the eye is also a concern and protective eyewear should be used.

Other components of a formulated pesticide product also can be hazardous. Many pesticides are carried in an oil base, which may be toxic if it gets into the bloodstream. Oil penetrates the skin as rapidly as some pesticides in highly sensitive areas of the body. Nitrile or neoprene aprons should be worn to protect the lower parts of the body. Absorption continues as long as the material is left on the skin.

Agricultural pesticide handlers are permitted to wear separable glove liners beneath chemical-resistant gloves. The liners may not be longer than the chemical-resistant glove, and they may not extend outside the glove. The liners must be disposed of after 10 hours of use or whenever the liners become contaminated. Lined or flocked gloves, where the lining is attached to the inside of the chemical resistant outer glove, remain unacceptable. See *Fertilizer and Pesticide Containment Guidelines* (NebGuide G1185), *Rinsing Pesticide Containers* (NebGuide G1150), and *Safe Transport, Storage, and Disposal of Pesticides* (EC2507) for additional information on proper procedures for storage and handling of pesticides. For additional information, see *Protective Clothing and Equipment for Pesticide Applicators* (NebGuide G758) and *Signs and Symptoms of Pesticide Poisoning* (EC2505). Several Internet sites are excellent resources:

UNL Pesticide Education Resources Web site

<http://PestEd.unl.edu>

The Label newsletter

<http://pested.unl.edu/thelabel/thelabel.htm>

Pesticide-related Cooperative Extension publications

<http://www.ianr.unl.edu/pubs/pesticides>

Pesticide Information Profiles on individual active ingredients

<http://extoxnet.orst.edu/pips/ghindex.html>

Recognition and Management of Pesticide Poisonings

<http://npic.orst.edu/rmpp.htm>

National Pesticide Information Center

<http://npic.orst.edu/>

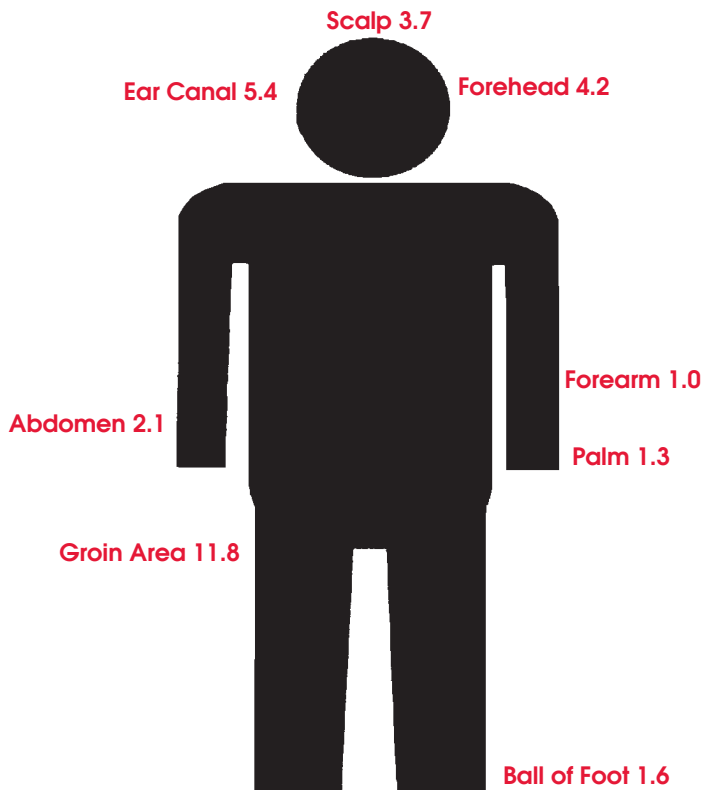

Dermal Exposure: Pesticides are absorbed at different rates by various areas of the body. Dermal skin absorption rates are compared to that of the forearm which is 1.0.

Environmental Considerations When Applying Herbicides

Maximizing herbicide effectiveness in a way that is safe for users and environmentally responsible requires awareness of possible exposure hazards and the relative potential for leaching and runoff.

Environmental Considerations

Herbicide leaching through soil can contaminate ground water, while herbicide loss in runoff can contaminate surface water. The potential for herbicide movement through runoff or leaching varies with herbicide and soil properties, as well as climatic variables and management practices. Whether herbicide residues become contaminants of ground water or surface water depends to a large extent on their retention by soil, solubility in water, and persistence. The amount of chemical applied, as well as the timing and amount of rainfall or irrigation, are important. Depth to ground water and distance to surface waters can determine the extent of herbicide contamination.

Herbicide Properties. Herbicides differ in *water solubility* and *sorption (retention)* in soil, which has a major influence on their availability for plant uptake, degradation, and movement with water. Water solubility is often given in *parts per million* (ppm). The *Koc* (*organic carbon partition coefficient*) indicates relative herbicide retention in soil. The figures that follow show comparative water solubility, soil retention, and persistence of herbicides used in Nebraska. The relative persistence of herbicides in soil is based on rates of degradation and may be evaluated by comparing their *half-lives*. A half-life is the time required to decrease the amount of herbicide present by one-half. The actual half-life of an herbicide in the

field varies among soils and with environmental conditions. More information on herbicides is available in the *Herbicide Handbook of the Weed Science Society of America, Eighth Edition — 2002*. Additional information on herbicide properties, soil behavior and potential for ground and surface water contamination can be found in the Nebraska Extension Circulars EC 94-135, *Understanding Pesticides and Water Quality in Nebraska*, and EC 96-143, *Pesticide Runoff and Water Quality in Nebraska*.

Relative Risk of Ground and Surface Water Contamination. The relative potential for herbicides to leach through soil and contaminate ground water can be determined from their soil retention (Koc values), water solubility, and persistence. The relative potential for herbicides to move off a field with runoff and potentially contaminate surface waters can be estimated from their Koc values. These properties were used to classify the mobility – the relative risk of ground water contamination from leaching and relative runoff potential — of the herbicides listed in the table.

Soil and Application Factors Influencing Herbicide Movement. Coarse-textured (sandy), porous soils tend to be highly permeable and may promote herbicide leaching, while runoff may be greater in fine-textured (high clay), less permeable soils. When the water table is shallow, the potential for ground water contamination may be high for many herbicides. The potential for contamination through runoff is high when herbicides are applied on steeply sloped land in close proximity to surface water. Excessive irrigation can promote herbicide loss through leaching and/or runoff.

Water Solubility

	<p>greater than 3000 ppm</p>	<p>Accent, Acquire, Arsenal, Banvel, Basis, Callisto, Clarity, Cyclone, Distinct, Glean, Gramoxone Extra, Gramoxone Max, Hoelon, Liberty, Matrix, Option, Peak, Plateau, Poast, Poast Plus, Python, Raptor, Rodeo, Roundup, Roundup Ultra, Roundup Ultra Max, Roundup Weather Max, Touchdown, Starane, Sterling, Ultima 160, Velpar</p>
	<p>300 to 3000 ppm</p>	<p>Ally, Amber, Authority, Basagran, Buctril, Classic, Command, Connect, Dual, Dual II Magnum, Eradicane, Frontier, Harmony GT, Hyvar, Maverick, MCPA, Outlook, Permit, Pursuit, Ramrod, Reward, Select, Sencor, Stinger, 2,4-D amine, 2,4-D ester, Tordon</p>
	<p>30 to 300 ppm</p>	<p>Aatrex, Atrazine, Axiom, Beacon, Blazer, Buctril, Connect, Define, Evik, FirstRate, Flexstar, Harness, Karmex, Lasso, Nortron, Nortron SC, Paramount, Partner, Reflex, Ro-Neet, Scepter, Surpass, Sutan+, Topnotch, Upbeet</p>
	<p>3 to 30 ppm</p>	<p>Affinity, Achieve, Aim, Balance Pro, Betamix, Casoran, Kerb, Princep, Spartan, Tupersan, Zorial</p>
	<p>less than 3</p>	<p>Acclaim Extra, Assure, Balan, Cobra, Curbit, Dimension, Fusilade DX, Gallery, Goal, Pendimax, Phoenix, Prowl, Resource, Sonalan, Surflan, Tough, Treflan</p>

Relative Soil Persistence

(half-life in days)

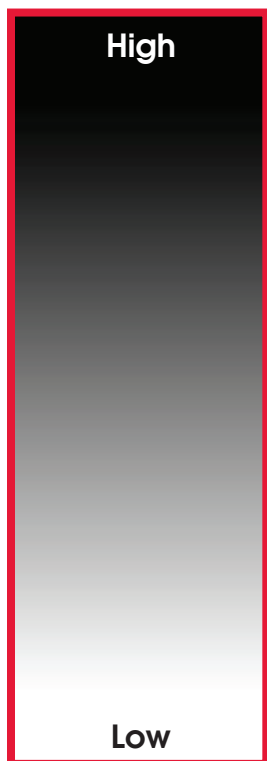

greater than 100 days	Balance Pro, Cyclone*, Gramoxone Extra*, Gramoxone Max*, Paramount, Plateau, Sinbar, Spartan
100 to 31 days	Aatrex, Acquire*, Amber, Arsenal, Assure, Atrazine, Axiom, Balan, Casoran, Classic, Curbit, Define, Devinol, Dual, Dual II, Dual II Magnum, Evik, Flexstar, Gallery, Glean, Goal, Hyvar, Karmex, Kerb, Maverick, Peak, Pendimax, Princep, Prowl, Pursuit, Python, Reflex, Rodeo*, Roundup*, Roundup Ultra*, Scepter, Sonalan, Starane, Tordon, Touchdown*, Treflan, Tupersan, Velpar, Zorial
30 to 16 days	Accent, Achieve, Ally, Assert, Avenge, Basagran, Beacon, Betamix, Command, Dimension, FirstRate, Frontier, Hoelon, Lasso, Nortron, Nortron SC, Outlook, Partner, Permit, Raptor, Ro-Neet, Sencor, Stinger, Surflan, Tough
15 to 5 days	Acclaim Extra, Action, Aim, Alanap, Banvel, Blazer, Buctril, Callisto, Clarity, Connect, Eradicane, Express, Fusilade DX, Harmony GT, Harness, Liberty, Matrix, MCPA, Option, Poast, Poast Plus, Ramrod, Resource, Reward, Spartan, Sterling, Surpass, Sutan+, 2,4-D amine, 2,4-D ester, Topnotch, Ultima, Upbeet
less than 5 days	Basis, Cobra, Distinct, Phoenix, Select

*These three classes of compounds are tightly bound to the soil and are biologically inactive soon after application, therefore rotation restrictions should not be a major concern.

Relative Soil Retention (Koc)

greater than 2000	Acclaim Extra, Acquire, Ansar 8100, Avenge, Balan, Betamix, Cobra, Curbit, Cyclone, Dacthal, Fusilade DX, Goal, Gramoxone Extra, Gramoxone Max, H-yield, Hoelon, Pendimax, Phoenix, Prowl, Resource, Rodeo, Roundup, Roundup Ultra, Sonalan, Touchdown, Treflan
500 to 2000	Assure, Axiom, Buctril, Connect, Define, Dimension, Kerb, Devinol, Ro-Neet, Surflan, Zorial
150 to 500	Casoran, Command, Dual, Dual II, Dual II Magnum, Eradicane, Evik, Gallery, Harness, Karmex, Lasso, Nortron, Nortron SC, Partner, Plateau, Starane, Surpass, Sutan+, Topnotch, Tough, Tupersan
50 to 150	Aatrex, Amber, Arsenal, Assert, Atrazine, Authority, Balance Pro, Beacon, Blazer, Callisto, Classic Poast, Distinct, FirstRate, Flexstar, Frontier, Liberty, MCPA, Outlook, Permit, Poast Plus, Princep, Ramrod, Reflex, Reward, Sencor, Sinbar, Ultima 160, Upbeet, Velpar
less than 50	Accent, Achieve, Affinity, Aim, Alanap, Ally, Banvel, Basagran, Basis, Clarity, Express, Glean, Harmony GT, Hyvar, Matrix, Maverick, Option, Paramount, Peak, Pursuit, Python, Raptor, Scepter, Select, Spartan, Sterling, Stinger, 2,4-D amine, 2,4-D ester, Tordon

Potential Human Exposure Hazard and Environmental Risks of Herbicides Used in Nebraska

Product Name	Common Name of Active Ingredient	Potential Human Exposure Hazard		Relative Use Rate ³	Relative Risk of Contamination from Leaching ⁴	Relative Runoff Potential ⁵
		Signal Word ¹	Toxicity Class ²			
Aatrex, Atrazine	atrazine	C	III	H	M*	H
Accent	nicosulfuron	C	III	L	M*	Mw
Acclaim Extra	fenoxaprop P-ethyl	C	III	L	L	Ms
Accent Gold	clopyralid (51.7%) flumetsulan (19.1%) nicosulfuron (6.5%) rimsulfuron (6.5%)	D (eye)	I	L	H*	Mw
Achieve 40 DG or SC	tralkoxydim	C	III	L	M	Mw
Aim	carfentrazone-ethyl	C	III	L	H*	Lw
Alanap, Rescue	naptalam	W	II	H	H*	Mw
Ally	metsulfuron-methyl	C	III	L	H*	Mw
Ally Extra	thifensulfuron-methyl (37.5%) tribenuron-methyl (18.75%) metsulfuron-methyl (15%)	C	III	L	H*	Mw
Amber	triasulfuron	C	III	L	H*	H
Arsenal	imazapyr	C	III	M-H	H*	H
Assert	imazamethabenz-methyl	D (eye)	I	M	H*	H
Assure II	quizalofop-P-ethyl	C	III	L	M	H
Asulox, Asulam 3.3	asulam	C	III	M-H	M*	Mw
Avenge	difenzoquat	D	I	M-H	VL	Ms
Balan DF, 2.5 G	benefin	C	III	H	L	Ms
Balance Pro	isoxaflutole	C	III	L	M	H
Banvel, Clarity, Sterling	dicamba	W, C	II, III	M	H	Lw
Basagran, Basagran T/O	bentazon	C	III	M	M	Mw
Basis	rimsulfuron (50%) thifensulfuron-methyl (25%)	C	III	L	L	Mw
Basis Gold	nicosulfuron (1.34%) rimsulfuron (1.34%) atrazine (82.44%)	C	III	M	H*	H
Beacon	primisulfuron-methyl	C	III	L	H*	Mw
Betamix	phenmedipham + desmedipham	W	II	M	L	H
Blazer, Ultra Blazer	acifluorfen	D	I	M	M	H
Buctril, Connect	bromoxynil	W	II	M	L	H
Callisto	mesotrione	C	III	L	L	L
Casoron	dichlobenil	C	III	H	M	H
Classic	chlorimuron-ethyl	C	III	L	H*	H
Cobra 25, Phoenix	lactofen	C	III	L	VL	Ms
Command 3 me, 4EC	clomazone	C, W	III, II	M	M	H
2,4-D amine, 2,4-D ester	2,4-D	D, C	I, III	M-H	M*	Mw
Define	flufenacet	W	II	M	M	Mw
Devrinol 2E, 2G or 10G or 4F	napropamide	D, C	I, III	H	M	H
Dimension 1EC, WPS	dithiopyr	C	III	L-H	L	H
Distinct	diflufenzopyr	C	III	L	M	H
DSMA Plus	DSMA	C	III	H	L	Ms
Dual, Dual II, Dual II Magnum SI	s-metolachlor	C	III	H	M	H
Eradicane	EPTC	W	II	H	L	H
Evik	ametryn	C	III	M-H	M	H
Express	tribenuron	C	III	L	H*	Mw

¹Signal Words: C = Caution, W = Warning, D = Danger. Classification may vary with formulation. V = varies by product.

²EPA Toxicity Class: I = most toxic; IV = least toxic.

³L = Low (less than 0.25 lb ai/A); M = Medium (0.25-0.99 lb ai/A); H = High (greater than 0.99 lb ai/A).

⁴VL = Very Low; L = Low; M = Medium; H = High. Asterisk (*) indicates risk of contamination from leaching increases with increasing soil pH. Salt and acid formulations generally are highly leachable. Ester formulations are less leachable, but are often rapidly hydrolyzed to corresponding acid forms that may be highly leachable.

⁵Loss with runoff when leaching also occurs: Lw = Low, primarily lost with runoff water; Ls = low, primarily lost with sediment/soil in runoff; Mw = medium, primarily lost with runoff water; Ms = medium, can be lost with displaced sediment/soil in addition to runoff water; H = high, lost in both runoff water and with displaced sediment/soil. When no leaching occurs, herbicides with Koc values less than 5000 have a high potential to be lost with runoff water.

Product Name	Common Name of Active Ingredient	Potential Human Exposure Hazard		Relative Use Rate ³	Relative Risk of Contamination from Leaching ⁴	Relative Runoff Potential ⁵
		Signal Word ¹	Toxicity Class ²			
FirstRate	cloransulam-methyl	C	III	L	H*	H
Frontier, Outlook	dimethenamid	W	II	M-H	H	H
Fusilade DX/Fusilade II	fluazifop-P-butyl	C	III	L	L	Ms
Gallery	isoxaben	C	III	M	M	H
Glean	chlorsulfuron	C	III	L	H*	Mw
Goal	oxyfluorfen	W	II	L-H	VL	L
Gramoxone Extra, Gramoxone Max, Cyclone	paraquat	D	I	M	VL	Ls
Harness, Surpass, Topnotch, Degree	acetochlor	C	III	H	M	H
Harmony GT, GT XP	thifensulfuron-methyl	C	III	L	H*	Mw
Hoelon 3E	diclofop-methyl	D	I	M-H	H*	Ms
H-Yield	MSMA	C	III	H	M	Ms
Hyvar X-L, X	bromacil	W, C	II, III	M-H	M	Mw
Karmex DL	diuron	C	III	H	M	H
Kerb 50W or T/O	pronamide	C	III	M-H	M	H
Lasso, Lsso II	alachlor	D, W	I, II	H	M	H
Liberty	glufosinate-ammonium	W	II	H	M	H
Matrix	rimsulfuron	C	III	L	M*	Mw
Maverick	sulfosulfuron	C	III	L	H*	Mw
MCPA	MCPA	D (acid, salt), C (ester)	I, III	M-H	M*	H
Nortron SC	ethofumesate	C	III	M	M	H
Option	foramsulfuron	C	III	L	M*	H
Paramount, Drive	quinclorac	C	III	M	H*	Mw
Peak	prosulfuron	C	III	L	M*	Mw
Permit, Manage	halosulfuron-methyl	C	III	L	M*	H
Plateau	imazapic	C	III	L	H*	H
Poast, Poast HC, Poast Plus	sethoxydim	C	III	M	L*	H
Princep 4L, Caliber 90	simazine	C	III	H	M	H
Prowl, Pendimax, Pendulum	pendimethalin	C	III	H	L	Ms
Pursuit, Pursuit WDG	imazethapyr	C, W	III, II	L	H*	Mw
Python WDG	flumetsulam	C	III	L	M*	Mw
Raptor	imazamox	C	III	L	H*	Mw
Reflex, Flexstar HL	fomesafen	D, W	I, II	M	H	H
Resource	flumiclorac-pentyl	W	II	L	L	Ms
Ro-Neet	cycloate	C	III	H	L	H
Roundup, Roundup Ultra, Rodeo, Acquire, Touchdown	glyphosate	V	V	M-H	VL	Ms
Scepter	imazaquin	C	III	L	H*	Mw
Select	clethodim	W	II	L	M	Mw
Sencor	metribuzin	C	III	M	M*	H
Sinbar	terbacil	C	III	M-H	H	H
Sonalan HFP or 10G	ethalfuralin	D	I	M-H	L	H
Spartan 4F	sulfentrazone	C	III	L-M	H*	H
Starane	fluroxypyr	W	II	M	M*	H
Stinger	clopyralid	C	III	L	H*	H
Surflan A.S.	oryzalin	C	III	H	L	H
Sutan+	butylate	C	III	H	M	H
Tordon 101 Mixture, 22K or K	picloram	D, C	I, III	M-H	H*	Mw
Tough 5 EC	pyridate	W	II	M-H	M	H
Treflan HFP or TRIO	trifluralin	C	III	H	L	Ms
Tupersan	siduron	C	III	H	M	H
Upbeet	triflusalufuron-methyl	C	III	L	M*	H
Valor	flumioxazin	C	III	L	L	Ms
Velpar	hexazinone	D (eye)	I	L-H	H	H
Zorial	norflurazon	C	III	M-H	M	H

Minimizing Water Contamination

Pesticide contamination of groundwater and surface water is a public concern. Contamination results from two types of sources — point and nonpoint.

Point Source Contamination

Point source contamination results from localized spills or accidents, i.e., the contamination can be traced back to an identifiable area. Point source contamination accounts for large doses being introduced into groundwater and poses a high risk of rendering the water unfit for drinking.

Spills and other mishaps which occur during the handling and mixing of pesticides are a major contributing factor. There are several steps we can take to minimize contamination.

Wells are a direct conduit to the groundwater and extra care should be taken at these sites when handling pesticides. In addition, many wells are not adequately sealed which increases the risk of contamination in the event of a spill. Mix pesticides at least 200 feet from a well. Using a nurse-tank as a water source helps avoid these problems. Prevent back-siphoning into the well. Keep the end of the filler hose above the water

level of the tank at all times. **Anti-backflow devices for hoses can be purchased from irrigation and spray equipment suppliers.** Clean up spills, especially near wells and other water supplies.

Because of the risk of a major mishap and groundwater contamination from chemigation, we do not suggest herbigation. If you need information, contact the specific chemical company or local Natural Resource District office.

Additional practices which help prevent point source contamination include triple-rinsing and the proper disposal of pesticide containers and excess pesticides.

For help in any emergency involving spills, leaks, or fires phone CHEMTREC at 800-424-9300 (chemical industry public service hotline). For assistance with human pesticide exposures, call the Poison Center, Omaha, NE at 800-222-1222.

Nonpoint Source Contamination

Contamination which occurs from nonpoint sources cannot be traced back to a specific location or event. Examples of non-point source contamination would include the leaching of pesticides through the normal course of pesticide use, or pesticides carried into streams by surface runoff. The extent of nonpoint source contamination is dependent upon herbicide, soil, geology, topography, management practices, and weather.

There are several practices which minimize nonpoint source contamination. Apply the proper amount of herbicide for the crop, weed and site. Read the label to determine the correct rate. Proper sprayer calibration assures application uniformity and more effective control. The amount of product also can be reduced by using band applications instead of broadcast treatments. These practices not only reduce the potential for groundwater contamination but also decrease the potential for crop injury and carryover problems, and make weed control more economical.

In choosing a herbicide, less mobile, short residual products are less likely to leach to the water table. Using different herbicides each year due to crop and herbicide rotation also reduces risk.

Identify high risk areas. The greatest risk for groundwater contamination exists where the water table is close to the soil surface. In addition, herbicides are more likely to contaminate groundwater when applications are made to coarse-textured soils low in organic matter. High pH soils also present concerns because some herbicides leach more readily under these conditions. Extra care should be taken when any of these situations exist.

The greatest risk for surface water contamination is on steeply sloping land that drains directly into a stream/lake. Management practices such as terraces and conservation tillage to reduce water runoff will help. Reducing herbicide rates by banding or using combinations will reduce the loading potential of that product. Untreated buffer zones next to streams/lakes and grass waterways to encourage water infiltration also may be helpful.

Mixing Herbicides

The W-A-L-E or D-A-L-E method can help you remember the mixing order for herbicides. If you have any questions about the compatibility of the herbicides and carrier, **do a jar test first** (see compatibility jar test). Some herbicides and/or some carriers require a compatibility agent and some are not compatible even with a compatibility agent. Always check the label for any special procedures.

The recommended mixing order is:

1. First fill the spray tank with one-third of the carrier (water, fertilizer, or mix) to be used. Have agitation on.
2. Add ammonium sulfate if used for glyphosate products.
3. If compatibility problems exist, the compatibility agent is usually added before the herbicides. Check the label for instructions.

If excessive foam is a problem, a de-foamer may be required. The de-foamer works best if added before foam is a problem. Check the label.

W The **W** or **D** refers to dry wettable powders, dry flowable materials or and water dispensable granules (WP, DR and WDG). These are added first to the tank. Some water soluble packets need to be allowed to soak in a small amount of water before being added to the tank. It is best to preslurry wettable powders and dry flowables at a

2:1 ratio with water before adding to the partially filled sprayer tank. With some pesticides it is recommended that they be presoaked.

- A** The **A** means agitation to disperse the herbicides added. Agitation means a rolling surface action. Do not use excessive agitation which can reduce compatibility and increase foaming.

It is best to continue the agitation until the spray solution is applied. If agitation is stopped, check that the products are back in suspension before application. After these herbicides are dispersed, add carrier to 80 percent of spray solution to be used.

- L** The **L** chemicals — liquids and flowables — are added next.

- E** The **E** chemicals are added next. These are the emulsifiable concentrates (EC). Microencapsulated formulations should be added after the emulsifiable concentrates.

Surfactants and oils are added last. Some surfactants, especially silicone-based ones, can cause excessive foaming.

If drift is a problem, consider using a drift control agent.

The last step is to add carrier to 100 percent of the spray solution to be used and check to make sure the spray solution is mixed thoroughly before starting application.

Herbicide and Fertilizer Compatibility

Most herbicides have many specific fertilizer incompatibilities and restrictions. Be sure to read the herbicide label for specific mixing or impregnation instructions. Herbicide and fertilizer combinations can increase or decrease herbicide efficacy and increase crop response. Crop response can usually be decreased by adding water to the spray solution. Compatibility agents are required for many mixes. A typical compatibility test procedure for mixing herbicides in fluid fertilizers follows.

Herbicide Compatibility with Fertilizers (not Suspensions) as Application Carriers

Herbicide	Fertilizer		Herbicide	Fertilizer	
	Fluid	Dry		Fluid	Dry
Burndown Herbicides			Small Grain Postemergence Herbicides		
2,4-D Amine	No	No	2,4-D Amine	No	No
2,4-D Ester	Yes	No	2,4-D Ester	Yes	No
Gramoxone Max	Yes	No	Achieve	No	No
Harmony Extra	Yes	No	Aim	Yes	No
Roundup	No	No	Banvel	Yes	No
Touchdown	No	No	Buctril	Yes	No
			Bronate	Yes	No
			Harmony Extra	Yes	No
			Hoelon	Yes	No
			Peak	Yes	No
			Sencor	Yes	No
Preemergence Herbicides					
Atrazine	Yes	No	Guardsman Max	Yes	Yes
Axiom	Yes	Yes	Harness	Yes	Yes
Backdraft	No	No	Harness Xtra	Yes	Yes
Balance Pro	Yes	No	Hornet	Yes	Yes
Banvel	Yes	No	Karmex	No	No
Bicep II Magnum/Cinch ATZ	Yes	Yes	Keystone	Yes	Yes
Boundary	Yes	Yes	Lariat	Yes	Yes
Bullet	Yes	Yes	Lasso	Yes	Yes
Callisto	Yes	No	Linex	Yes	Yes
Canopy XL	No	No	Lumax	Yes	No
Command	Yes	Yes	Marksman	Yes	Yes
Command Xtra	Yes	No	Outlook	Yes	Yes
Commence	Yes	Yes	Paramount	No	No
Clarity	Yes	No	Prowl/Prowl H ₂ O/Pendimax	Yes	Yes
Degree	Yes	Yes	Pursuit	Yes	No
Degree Xtra	Yes	Yes	Pursuit Plus	Yes	Yes
Domain	No	Yes	Python	Yes	Yes
Dual II Magnum/Cinch	Yes	Yes	Scepter	Yes	No
Epic	Yes	Yes	Sencor	Yes	Yes
Extreme	No	No	Sonolan	Yes	Yes
Field Master	Yes	No	Squadron	Yes	Yes
FirstRate	Yes	Yes	Surpass	Yes	Yes
Frontier	Yes	Yes	TopNotch	Yes	Yes
FulTime	Yes	Yes	Trifluralin	Yes	Yes
Gauntlet	Yes	No	Zorial Rapid	Yes	Yes

Compatibility (Jar Test)

Compatibility should always be checked before mixing large quantities of pesticides and/or fertilizers. You will need containers and measuring spoons to do the test. This example is based on an application rate of 25 gallons per acre. See *Table 1* for other rates.

- Use two quart jars. Larger containers will be needed for rates lower than 1/4 pound dry or 1/4 pint liquid (see herbicide rates and use, *Table 2*). If the carrier is water, put 1 pint of water in each of the two jars. If the carrier is fertilizer, add 1 pint of fertilizer to both jars. If a mixture of fertilizer and water, add them in the same ratio they will be used in tank. For example, with a 2:1 fertilizer to water ratio use 2/3 pint fertilizer to 1/3 pint water. Use water and fertilizer from the same source and at the same temperature as when you mix to spray.
- To one jar marked "with" add 1/4 teaspoon (1.2 ml, 1 teaspoon = about 5 ml liquid) of a compatibility agent and stir. For comparison, no compatibility agent is added to the other jar.
- To both jars add the appropriate amount of herbicide(s). Add dry herbicides first, flowables second, and emulsifiable concentrates last. Stir after adding each material for 5 to 10 seconds.

Dry herbicide: For each pound per acre to be applied, add 1 1/2 level teaspoons. For wettable powders and flowables, preslurrying of each product with water in the ratio of 2 parts product to 1 part water is recommended prior to its addition to the two jars.

Liquid herbicide: For each pint per acre to be applied, add 1/2 teaspoon or 2.5 ml. Also add crop oils, COC, etc.

- Five to 10 minutes after the final addition and mixing, observe both jars for the formation of large flakes, sludge, gels, or other precipitates.

If the incompatibility as described occurs in the jar without the compatibility agent added, the use of a compatibility agent is recommended.

If incompatibility in any of these forms occurs in the jar with the compatibility agent added, the carrier and the herbicide **SHOULD NOT BE TANK MIXED**.

Jars should be allowed to stand and be observed for 1/2 hour.

If the mixture is found to be compatible, start filling the tank. Strong agitation with a rolling effect on the surface of the carrier is recommended. Remember to preslurry the wettable powders and

flowables. Allow time for good dispersal and empty the tank as much as possible before mixing a new batch (See *Mixing Herbicides*, page 18).

Table 1. Amount of dry and liquid herbicide to add to 1 pint of carrier.

Spray Volume Rate/A Gal	Dry Herbicides tsp/lb*	Liquid Herbicides tsp/pt**
5	7 1/2	2 1/2
10	3 3/4	1 1/4
15	2 1/2	1
20	2	3/4
25	1 1/2	1/2
30	1 1/4	1/2
35	1 1/4	1/3
40	1	1/3

*For dry herbicide rates of 1/4 lb use 1/4 the amount listed and for 1/2 lb use 1/2 the amount listed.

**For liquid herbicide rates of 1/4 pint and 1/2 pint, larger containers will be needed. For 1/4 pint use 4 pints of carrier and for 1/2 pint use 2 pints of carrier and the appropriate amount of compatibility agent. Then use the amount of liquid herbicide listed in this table. If other herbicides are used in the mix at pound or pint rates, it is necessary to increase their rates by the rate the carrier was increased.

Table 2. Amount of dry and liquid herbicide to add to 2 gal of carrier.

NOTE: Add 4 teaspoons (20 ml) of compatibility agent to one jar marked "with" and stir. See Steps 2, 3, and 4, but add according to the table.

Spray Volume Rate/A Gal	Dry Herbicides tsp/oz	Liquid Herbicides tsp/oz
5	7 1/2	2 1/2
10	3 3/4	1 1/4
15	2 1/2	1
20	2	3/4
25	1 1/2	1/2
30	1 1/4	1/2
35	1 1/4	1/3
40	1	1/3

Using UAN to Keep Sprayer from Freezing

In the spring and fall when spraying, overnight temperatures may drop below 32°F causing damage to the sprayer.

What can you do to avoid damage?

One possibility would be to add 28% or 32% UAN to the sprayer tank. Make sure it is agitated because it is heavier than water. Then spray out through the booms. See *Table 1* for the amount needed for the temperature expected.

NOTE: A few herbicides may not be compatible with 28% and 32% UAN. Also UAN in the spray solution may cause injury with some herbicides, especially at higher concentrations. Surfactants plus UAN can cause crop injury. The higher UAN concentrations cause the most injury. This injury can be reduced or eliminated by adding more water and herbicide before starting to spray.

Table 1. Amount of 28% and 32% UAN to add to different amounts of water to keep sprayer from freezing.

% N	Freezing Temperature °F	28-0-0 32-0-0	
		gal/100 gallons water	
0	32	0	0
2	27	6.1	5.2
4	23	13.1	11.2
6	18	21.5	18.2
8	14	31.5	26.2
10	9	43.7	35.6
12	5	59.0	47.2
14	0	78.7	61.2

Herbicide Applications

Soil Applied

Early preplant (EPP) treatments are made 10-30 days before planting. **Preplant surface applied (PPSA)** treatments are made 0-10 days before planting. Soil disturbance by some planters may allow weed growth in rows where herbicides are applied EPP or PPSA. **Preplant incorporated (PPI)** treatments are made before planting the crop. The herbicide is then thoroughly incorporated with rototiller or two angled passes of a tandem disk, field cultivator or similar equipment. **Pre-emergence (PRE)** treatments are applied from planting time to just before crop emergence or weed seed germination. **Surface mix (SM)** is the shallow mixing of a PRE herbicide into the top 1 to 2 inches of soil using a rototiller, mulch treader, field cultivator or similar implement.

Weed control with PRE treatments may be poor if there is no rain to move the herbicide into the top inch of soil. Rainfall required for activation is generally 1/4 to 1/2 inch on coarse-textured soils and 1/2 to 1 inch on fine-textured soils. To overcome dependence on rainfall and to increase dependability, some PRE herbicides may be incorporated into the surface soil with a rotary hoe. Excessive rainfall may leach some of the more soluble herbicides into the subsoil, especially on sandy soils. Weed control with preplant herbicides is more satisfactory on surface-planted crops. Some weed species are resistant to particular herbicides. Herbicides and crops should be rotated to control a wider spectrum of weeds and to reduce the risk of herbicide carryover.

Postemergence

Early postemergence (EPOST) refers to herbicide applications made soon after the crop has emerged; control of late emerging weeds may be reduced. **Postemergence (POST)** treatments are applied after emergence of weeds or crop. **Directed POST** treatments are made to the lower portion of the crop plant.

Layby treatments are applied at last cultivation to provide an extended period of weed control.

Harvest aid treatments are applied late in the growing season to reduce weed seed production and make harvest easier.

Desiccants are applied after crop maturity to hasten drying and permit earlier harvest.

Excellent growing conditions make weeds more susceptible to POST herbicides. Likewise, crops may be more subject to herbicide damage

when growing rapidly. **Adjust herbicide and additive dosages downward** when excellent conditions for growth are present the week before application and **upward** when ideal growth is limited by one or more factors. Rate of carrier should be in accordance with label recommendations.

Mid postemergence (MPOST) refers to herbicide applications typically made approximately four weeks after the crop has emerged. Weeds may be 3-5 inches tall.

Late postemergence (LPOST) refers to herbicide applications typically made approximately six or more weeks after crop emergence. It may be combined with EPOST to provide longer weed control. If it's the only treatment, weeds are usually over 6 inches tall and control may be reduced.

Application Pointers and Sprayer Set-up

For maximum effectiveness of pesticides, they must be applied uniformly and at the correct rate. Six factors can affect application efficiency and success:

1. sprayer design,
2. nozzle type,
3. boom height,
4. boom pressure,
5. agitation, and
6. ground speed.

Pesticides applied uniformly at the proper rate will give maximum benefit while those applied incorrectly can result in wasted chemical, marginal weed, insect or disease control, excessive carryover, ground water contamination, pesticide residues in plants, and/or crop damage. New developments in application technology can help assure the proper application of pesticides. Along with these new developments, there has been a trend toward decreasing spray volumes. This is because some herbicides perform better with reduced spray volumes (especially with low quality water). Many new row crop sprayers have limited tank capacity, and water is expensive to haul. In many areas of the state it may be a great distance from the water source to the field and filling the sprayer takes time. Decreased spray volumes also may allow the use of less expensive, smaller sprayers. Larger sprayers increase soil compaction, especially if the soil is wet. More additives such as non-ionic surfactant and water conditioners may be needed with more carrier volume.

The nozzle is a major factor determining the amount of spray applied to an area, the uniformity of application, the coverage obtained on the target surface, and the potential amount of drift. Nozzles break the spray mix into droplets, form the spray pattern, and propel the droplets in the proper direction. Nozzles determine the amount of spray volume delivered at a given operating pressure, travel speed, and spacing. Drift can be minimized by selecting nozzles that produce the largest droplet size

while providing adequate coverage at the intended application rate and pressure. Do not mix nozzles of different materials, types, spray angles, or spray volumes on the same spray boom. A mixture of nozzles produces uneven spray distribution.

Nozzle Types

Nozzle types commonly used in low-pressure agricultural sprayers include: flat-fan, flood, raindrop, hollow-cone, full-cone, and others. Special features or subtypes such as "extended range, low pressure, drift guard, and turbos" are available for some nozzle types.

Flat-Fan

Flat-fan nozzles are widely used for broadcast spraying of herbicides and produce a tapered-edge spray pattern. These nozzles have several subtypes such as standard flat-fan, even flat-fan, extended range flat-fan, drift guards, Turbo TeeJet venturi type, and some special types such as off-center flat-fans and twin-orifice flat-fan.

The **standard** flat-fan normally is operated between 30 and 60 psi, with an ideal range between 30 and 40 psi. The even (E) flat-fan nozzles (nozzle number ends with E) apply uniform coverage across the entire width of the spray pattern. They are used for banding pesticide over the row and should not be used for broadcast applications. The band width can be controlled with the nozzle height, spray angle, and the orientation of the nozzles.

The **extended range** (XR or LFR) flat-fan provides excellent drift control when operated between 15 and 25 psi. This nozzle is ideal for an applicator who likes the uniform distribution of a flat-fan nozzle and desires lower operating pressure for drift control. Since extended range nozzles have an excellent spray distribution over a wide range of pressures (15-60 psi), they are ideal for sprayers equipped with flow controllers.

The **Turbo TeeJet** has the widest pressure range of the flat-fan nozzles —15 to 90 psi. It produces larger droplets for less drift and is available only in 110°.

The **drift guard** flat-fan has a pre-orifice which controls the flow. The spray tip is approximately one nozzle size larger. It produces larger droplets, reducing the number of small drift-prone droplets.

The **venturi-type** nozzle produces large air-filled drops through the use of a venturi air aspirator for reducing drift.

Flat-fan nozzles also include the **off-center** (LX) flat-fan which is used for boom end nozzles and produces a wide swath projection and the **twin-orifice** (TJ) flat-fan which produces two spray patterns — one angled 30° forward and the other directed 30° backward. The TJ droplets are small due to the atomizing by two smaller orifices. The two spray directions and smaller droplets improve coverage and penetration, a plus when applying postemergence contact herbicides. To produce fine droplets, the twin-orifice usually operates between 30 and 60 psi.

Flat-fan nozzles are available in several spray angles, the most common of which are 80° and 110°. *Table 1* provides the recommended nozzle heights for flat-fan nozzles during broadcast application.

Table 1. Suggested minimum spray heights.

Spray Angle Degrees	Spray Height (in)			
	20-inch Spacing With Overlap of		30-inch Spacing With Overlap of	
	30%	100%	30%	100%
80	17	26	26	38
110	10	15	14	25

Nozzle height is the distance from the nozzle to the target, which may be the top of the ground, growing canopy, or stubble. Use 110° nozzles when boom heights are less than 30 inches and 80° nozzles when the booms are higher.

Although wide-angle nozzles produce smaller droplets which may be more prone to drift, the reduction of boom height reduces the drift potential more than reducing droplet size. The nozzle spacing and orientation should provide for 100 percent overlap at the target height. Nozzles should not be oriented more than 30° from vertical.

Most nozzle manufacturers identify their flat-fan nozzles with a four or five digit number. The first numbers are the spray angle and the other numbers signify the discharge rate at rated pressure. For example, an 8005 has an 80° spray angle and will discharge 0.5 gallons per minute (GPM) at the rated pressure of 40 psi. An 11002 nozzle has a 110° spray angle and will discharge 0.2 GPM at the rated pressure of 40 psi. Nozzle material also may be designated: “BR” — brass material; “SS” — stainless steel; “VH” — hardened stainless steel; “VS” — stainless steel, and “VK” — ceramic. See *Table 2* for nozzle type and discharge rates.

Table 2. Nozzles types and discharge rates at rated pressure.

Nozzle Type	Discharge (gpm)	Rated Pressure (psi)	Operating Range	
			Min (psi)	Max (psi)
Regular flat-fan 8006	0.6	40	30	60
Regular flat-fan 11008	0.8	40	30	60
Extended range flat-fan 8006XR	0.6	40	15	60
Turbo TeeJet TT11005VP	0.5	40	15	90
Drift Guard DG8002VS	0.2	40	40	60
AI TeeJet AI11005-VS	0.5	40	30	100
Flood TKSS 6	0.6	10	10	40
Turbo FloodJet TF-VS2	0.2	10	10	40

Flood

Flood nozzles are popular for applying suspension fertilizers where clogging is a potential problem. These nozzles produce large droplets at pressures of 10 to 25 psi. The nozzles should be spaced less than 60 inches apart. The nozzle height and orientation should be set for 100 percent overlap.

Nozzle spacing between 30 and 40 inches produces the best spray patterns. Pressure influences spray patterns of flood nozzles more than flat-fan nozzles; however, the spray pattern is not as uniform as with the flat-fan nozzles, and special attention to nozzle orientation and correct overlap is critical. These nozzles are best used only for fertilizer suspensions.

A new flood nozzle is the Turbo FloodJet. It incorporates a pre-orifice which controls the flow and has a turbulence chamber. The tip design more closely resembles a flat fan nozzle, resulting in a much improved pattern with tapered edges. Use this turbo flood nozzle with its improved pattern when incorporating herbicides. Because of its large droplet size, do not use the turbo flood nozzle where good coverage is needed.

Cone

Hollow-cone nozzles generally are used to apply insecticides or fungicides to field crops when foliage penetration and complete coverage of the leaf surface is required. These nozzles operate in a pressure range from 40 to 100 psi. Spray drift potential is higher from hollow-cone nozzles than from other nozzles due to the small droplets produced.

Full-cone wide-angle nozzles are a good choice if drift is a concern because they produce larger droplets than flood nozzles. Full-cone nozzles usually are recommended over flood nozzles for soil-incorporated herbicides. Full-cone nozzles operate at a pressure range of 15 to 40 psi. Optimum uniformity is achieved by angling the nozzles 30° and overlapping the spray coverage by 100 percent.

Fine hollow-cone. The ConeJet (Spray Systems) offer wide-angle (80° to 120°), hollow-cone nozzles. These are used for postemergence contact herbicides where a finely atomized spray is used for complete coverage of plants or weeds under a hood for band spraying. Drift potential is great for these nozzles.

Nozzle Material

Nozzles can be made from several materials. The most common are brass, nylon, stainless steel and hardened stainless steel and ceramic. Stainless steel nozzles last longer than brass or nylon and generally produce a more uniform pattern over an extended time. Nylon nozzles with stainless steel or hardened stainless steel inserts offer an alternative to solid stainless steel nozzles and are less expensive. Thermoplastic nozzles have good abrasion resistance but swelling can occur with some chemicals, and they are easily damaged when cleaned. Ceramic has superior wear life and is highly resistant to abrasive and erosive chemicals.

Nozzle Replacement

Replace nozzles when:

- spray pattern is distorted;
- nozzles show irregular wear; and
- nozzle flow rate is 10 percent greater than with new nozzles of the same type.

Note: Each nozzle’s flow rate on the spray boom needs to be within five percent of the average flow rate of nozzles.

Nozzle Selection and Considerations

It is important to select a nozzle that develops the desired spray pattern. The specific use of a nozzle, such as broadcast application of herbicides or spraying insecticides on row crops, determines the type of nozzle needed. Examine current and future application requirements and be prepared to have several sets of nozzles for a variety of application needs. In general, do not select a nozzle with an orifice so small that it requires a nozzle screen finer than 50 mesh. Nozzles requiring 80 and 100 mesh screens plug too easily.

The standard nozzle spacing on broadcast sprayers has been 20 inches. If you’re considering a narrower or wider spacing to improve pesticide application, first consider these factors: coverage needed, spray deposition, effect on drift, row crop spacing, desired spray coverage, nozzle cost, boom height, and overlap.

Postemergence nontranslocated herbicides require adequate and uniform coverage. Preplant incorporated herbicides require the least coverage, therefore large spray droplets could be used. Nozzles which produce large spray droplets, such as Spraying Systems turbo floods, could be used effectively for preplant soil-incorporated herbicides and also would reduce drift.

Spray Deposition

Research by the University of Nebraska has demonstrated that spray pattern uniformity from 110° nozzles on 30-inch spacing was equivalent to 80° nozzles on 20-inch spacing. The 110° nozzles on 20-inch spacing did not have an advantage over 30-inch spacing if the carrier volume remained constant, for example 20 gpa for both nozzles.

Row Spacing

The most popular row spacing is 30 inches, which easily allows for the use of drop nozzles, if needed. Some pesticides should not be sprayed directly in the whorl of the plant. With 20-inch spacing it is impossible to keep from spraying directly over some of the plants. With 30-inch spacings nozzles can always be between the rows or, if needed, they can be moved directly over the rows for band spraying.

Self-Cleaning Line Strainer

A self-cleaning line strainer mounted on the discharge side of the pump minimizes nozzle clogging. This strainer uses the excess flow to bypass potential clogging particles back to the spray tank. To use the self-cleaning strainer the sprayer must have excess pump capacity. The amount of excess pump capacity depends on the size of the strainer. Minimum flow rate is 6 gpm extra for the 0.75- and 1.00-inch self-cleaning line strainers and 8 gpm for the 1.25-inch and 1.50-inch sizes.

Fresh Water Tanks

It is very common now on most sprayers to see a fresh water tank for wash-up and infield clean-up. These range from smaller, 5- to 10-gallon tanks to the farm-type sprayers which hold 100 gallons or more on the

larger floaters. In the event of a spill clean water from these tanks is the first step in self-decontamination.

Induction Tanks (Cones)

Induction tanks for adding chemical to the spray mix have been available for several years and are a great safety device. They are usually mounted at a more convenient height for adding chemicals than when you have to climb up to the main tank. Also, some carry fresh water and use that for rinsing out the sprayer after completing the job.

Application Tips

- To reduce tip plugging avoid using any tip that requires a screen smaller than 50 mesh.
- Buy quality tips. Stainless steel, stainless steel inserts in nylon tips, polyacetal, and ceramic tips are the most economical in the long run.
- Use a special tip-cleaning brush. Keep pocket knives, paper clips, and wire away from the tips as they will distort the pattern and change the flow rate. Also, before adding any herbicide, check the sprayer with water to make sure that the tips are not plugged and fittings and hoses do not leak.
- Use strainers along with tip screens before the pump and before the flow control system.
- Use a diaphragm check valve or other sprayer items to give instant on and instant off control to eliminate drip and delay when the boom is turned on and off.
- For new sprayers, flush the entire system with water before installing screens and tips.

Spray Boom Set-up on Field Sprayers

Field sprayer booms are an important part of the pesticide delivery system and can influence application accuracy and efficiency. Booms come in all shapes and sizes, depending on their use, and deliver the spray solution to the nozzles and tips at the desired pressure for the target. A small hand boom may be only a single nozzle while a large field sprayer could have a 120-foot or wider boom.

Stability and Strength — Boom Features

Two attributes to look for when selecting a boom are stability and strength. Stability, the factor of major concern, ensures that the boom

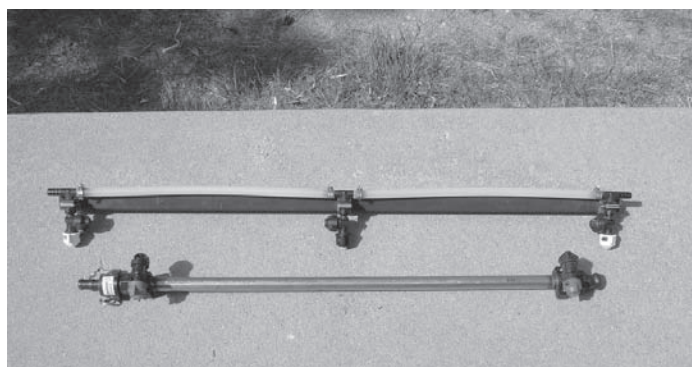

Figure 1. Sections of two booms — dry boom on top, wet boom on bottom.

maintains a constant orientation to the target. Field conditions may vary widely, but if a spray boom is expected to provide a uniform application, stability must be maintained. Also important is a boom's strength or its ability to withstand operating conditions without becoming damaged.

Two systems are used to control boom stability. Passive systems, which include trapeze suspensions, center pivots, and dampening suspensions, all use balance. They minimize the amount of deflection transferred from the sprayer to the boom through various linkage designs. Active systems, on the other hand, use sensors and actuators in stabilizing the boom. An active system will usually have a sensor on the boom which is set to distinguish any fluctuation in distance between the target and the boom. If a difference in height is observed, the sensor signals the actuator on the boom linkage and it makes the appropriate adjustment. This usually means raising or lowering the boom in relation to the original setting.

Wet and Dry Booms

There are two types of booms: wet and dry. A boom is considered a wet boom (Figure 1, bottom) if the pipe span is not only used as a support mechanism for the spray nozzles but delivers spray solution to them as well, hence the name "wet boom." A boom that is used merely as a span along which to space the nozzles, but which does not deliver the spray solution, is considered a dry boom (Figure 1, top). The solution is delivered to the nozzles via a separate hose line which runs along the boom span using it as a support mechanism to mount each nozzle.

The advantages of a wet boom are less plugging of nozzle tips since there is less area where particles could build up and the ease of flushing the boom. On the dry boom, hose and nozzle assemblies are much more



Figure 2. Angle of boom can be changed by rotating the boom within the clamps.

subject to being contaminated with residues than stainless steel tubing or pipe. Some adjuvants used with pesticides provide excellent cleaning of the tank, hose, etc. and may cause the spray solution to become contaminated. Even though the tank has been cleaned the spray booms have not.

Unless the boom is really long or a small size pipe is used, the spray boom on a wet boom needs only to be fed with the spray solution on the end. Since the nozzle assemblies on a dry boom greatly restrict the flow rate, the boom must be fed every few nozzles to prevent a pressure drop.

Another advantage of a wet boom is that the angle of the boom can be changed (Figure 2) and in most situations it is easier to change the height of a wet boom than a dry boom. Additional nozzle assemblies to accommodate various row spacings on a wet boom do not restrict the flow rate (Figure 3) nearly as much as additional nozzle assemblies on a dry boom.

The two main disadvantages of a wet boom are initial cost and its potential for damage. If the boom contacts a non-moveable object, it may break or bend, destroying part of the boom.

Cost Comparison

The costs of a modern wet boom design versus a dry boom are summarized in Table I. The cost of 1-inch outside diameter 16-gauge stainless steel tubing is approximately \$4 per foot. The ends of the tubing are compressed and 1-inch stainless steel pipe nipples (304) are welded to each end of the stainless steel tubing. The nipples cost approximately \$2 and welding each one costs about \$3. The hose that feeds the boom and the plug can be attached to these nipples. Both are quick attach couplers. Holes on the boom need to be precisely drilled at the nozzle spacing being used.

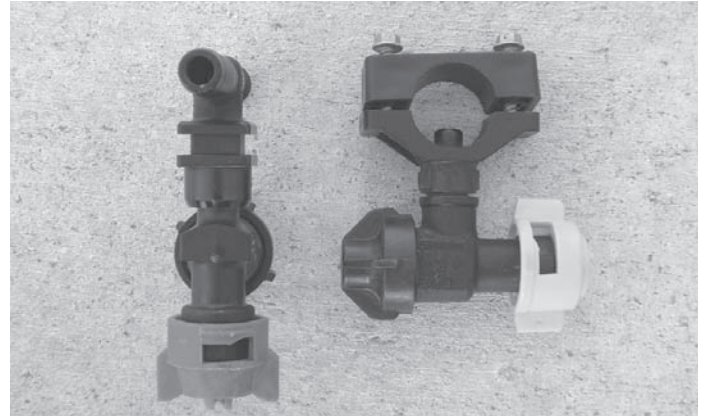

Figure 3. Nozzle assemblies for dry (left) and wet (right) booms.

Table I. Comparison of wet and dry boom costs.

20-foot wet boom:	
20 feet of 1-inch OD 16-gauge stainless steel tubing - \$4/foot	= \$ 80.00
2 nipples - \$2 each	= \$ 4.00
Welding 2 nipples - \$3 each	= \$ 6.00
Total	\$ 90.00
20-foot dry boom:	
20 feet of 3/4-inch braided hose - \$0.70/foot	= \$14.00
If 30-inch nozzle spacing, 16 stainless steel clamps - \$0.75 each	= \$12.00
To keep from losing pressure, each 10-foot section of hose is fed in the middle	
Extra hose is 7 feet + 17 feet = 24 x \$0.70	= \$16.80
4 more clamps at \$0.75 each	= \$ 3.00
Two fittings at approximately \$5 each	= \$10.00
	\$55.80

This example assumes the connectors and nozzle assemblies for the hose and stainless steel tubing will be about equal to the additional hose and fittings needed on the dry boom.

If the dry boom is left outside and unprotected, the hose may need to be replaced every two or three years. The stainless steel tubing should last for many years if not damaged.

The following photos help illustrate differences between wet and dry booms (Figures 4 - 10).



Figure 4. The bracket to hold the wet boom. The rubber hose protects the boom and the stainless steel hose clamps hold the wet boom in place.

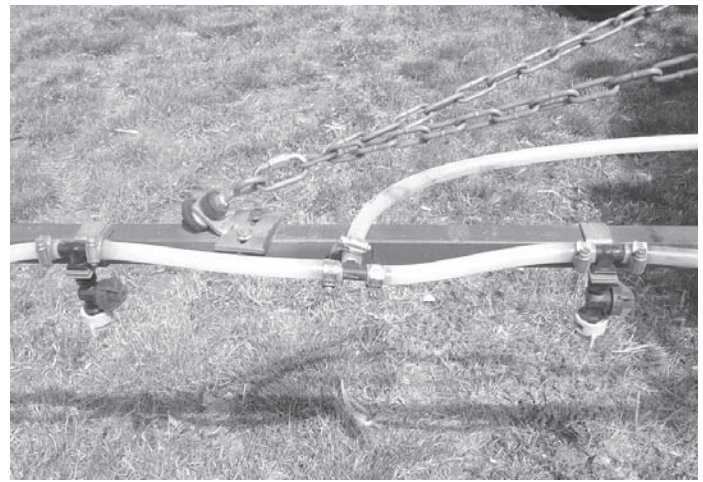

Figure 5. How dry boom is fed — note restriction to flow rate.

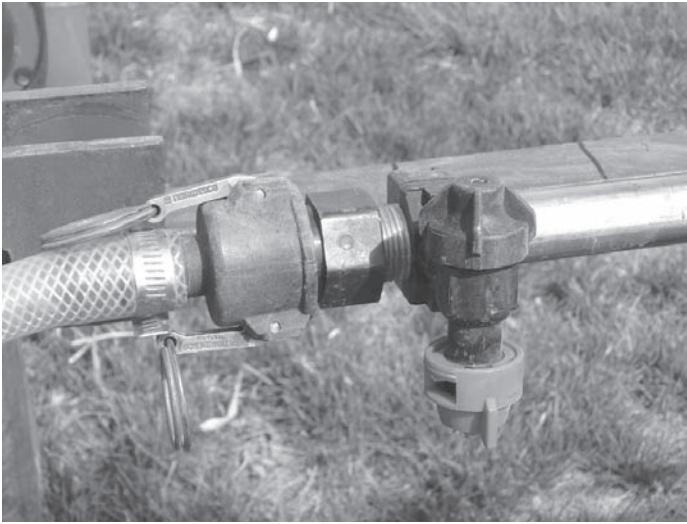

Figure 6. How wet boom is fed.

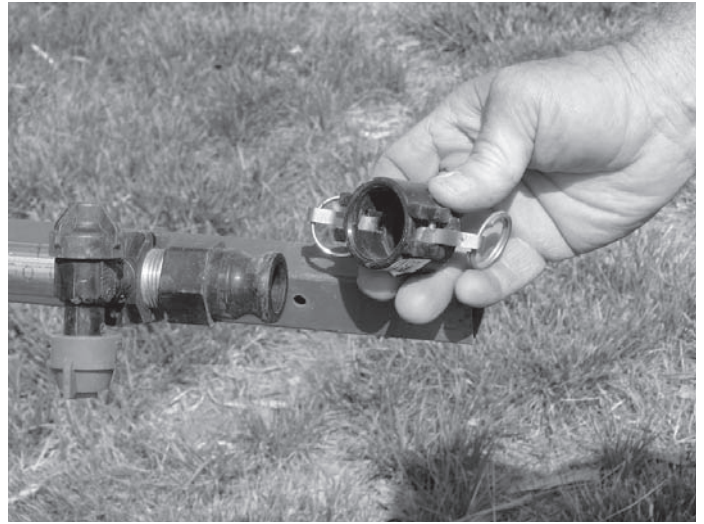

Figure 7. End cap on wet boom to drain and flush boom.

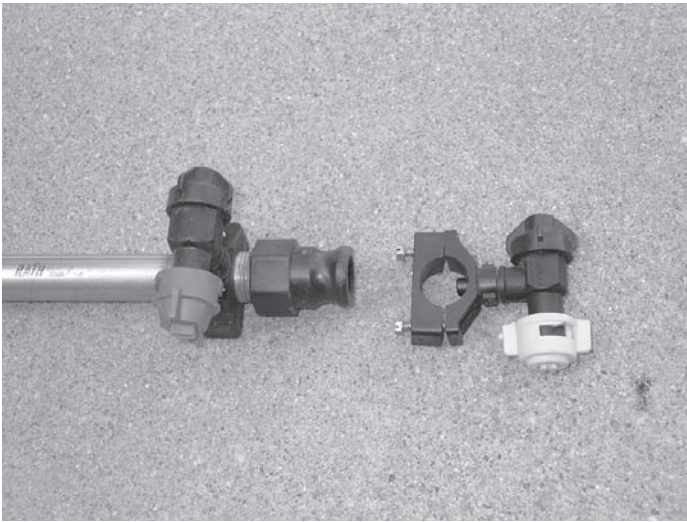

Figure 8. Wet boom nozzle body on and off boom.



Figure 9. Multiple nozzle body on wet boom.

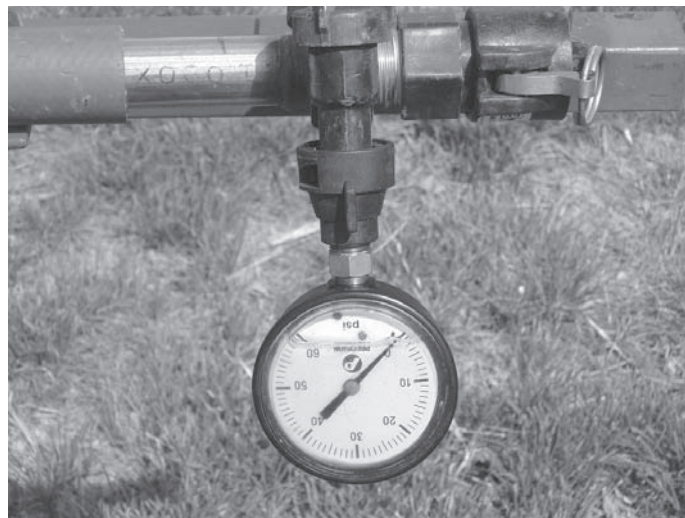

Figure 10. Gauge to check spray pressure on a wet boom.

Calibration of Sprayers

Applying the correct rate of a product is an important part of obtaining good results with pesticide sprayers. With a pesticide application, too little product can mean poor control, while too much can mean crop injury, extra costs, and possible residue on the crop and/or carryover.

Many methods can be used to calibrate sprayers, including the ounce calibration and formula-based methods. With the ounce calibration method, 128th of an acre is sprayed and the spray is collected. When measured in ounces, the amount collected would be equal to the number of gallons applied per acre since there are 128 ounces in a gallon. (For further information on this method, see NebGuide, *Fine Tuning a Sprayer with the "Ounce" Calibration Method*, G88-865). Other methods involve using formulas which need to be remembered or recorded for easy use. These methods also may require converting some of the information you have.

The methods discussed here are simple relationships and do not require remembering formulas. However, you do need a general understanding of cross multiplication. The important thing is to be consistent: if you put an item on top of an equation on one side, the same item also goes on the top on the other side.

Three factors determine sprayer application rate:

1. Speed
2. Nozzle spacing
3. Nozzle output (determined by orifice size, pressure, and density of spray solution)

Where:

Speed = Length or distance covered divided by time

Nozzle spacing = Width

Nozzle output = The quantity applied/unit time

How to determine speed in mph.

To determine speed:

1 mile per hour (mph) is:

1 mile (5280 ft) in 1 hour (60 minutes)

$$\text{Or } 1 \text{ mph} = \frac{5280 \text{ ft}}{60 \text{ min}} = 88 \text{ ft/min}$$

Example 1

If we travel 440 feet (ft) in 30 seconds (sec) what is our speed?

The objective is to determine the distance traveled in 60 seconds (1 minute) and then divide by 88 (since 88 feet/minute is equal to 1 mph).

$$\frac{30 \text{ sec}}{440 \text{ ft}} = \frac{60 \text{ sec}}{D} \quad (\text{D is the distance we are solving the equation for})$$

We cross multiply to find the value of D

$$D = \frac{60 \times 440}{30 \times D}$$

$$D = \frac{26400}{30}$$

$$D = 880 \text{ ft}/60 \text{ sec or } 880 \text{ ft/min}$$

Since every 88 ft traveled in 1 min is equal to 1 mph, we divide 880 by 88 to get 10 mph

Example 2

If we travel 297 feet in 27 seconds, what is our speed?

$$\frac{27 \text{ sec}}{297 \text{ ft}} = \frac{60 \text{ sec}}{D}$$

$$D = \frac{297 \times 60}{27 \times D}$$

$$D = \frac{17820}{27}$$

$$D = 660 \text{ ft}/60 \text{ sec}$$

Divide by 88 since 1 mph = 88 ft/60 sec (1 min)

$$\frac{660}{88} = 7.5 \text{ mph}$$

Example 3

If we travel 660 feet in 1 minute and 15 seconds, what is our speed?

First convert 1 minute and 15 seconds to seconds : 60 + 15 = 75 seconds

$$\frac{75 \text{ (sec)}}{660 \text{ (ft)}} = \frac{60 \text{ (sec)}}{D}$$

$$\frac{660 \times 60}{75 \times D}$$

$$D = \frac{660 \times 60}{75}$$

$$D = \frac{39600}{75}$$

$$D = 528$$

$$\frac{528}{88} = 6 \text{ mph}$$

How to determine rate/acre

If the sprayer is moving at 6 mph, the distance covered in one minute is 528 feet (6 mph x 88 ft/min = 528 feet).

To determine the area you cover with one nozzle in one minute if your sprayer has a 30-inch nozzle spacing:

Distance traveled:	6 x 88 = 528 ft/min
Nozzle Spacing:	30" = 2.5 ft
Area Sprayed:	1320 sq. ft. (2.5 ft x 528 ft/min)

Collect the output of several nozzles and determine the average output per nozzle. All nozzles should be within 10 percent of the manufacturer's rating for that nozzle. For example an XR11003 delivers 0.3 gpm at 40 psi. If it delivers more than 0.33 gpm or 42.24 (128 x 0.33) ounces/min at 40 psi, the nozzle should be replaced. Any nozzle delivering 5 percent above or below the *average delivery* rate for all the nozzles should be replaced.

In this next example, the average nozzle output is 32 oz per minute or 32 (oz/min), 128 (oz/gallon) = 0.25 gpm

What is the rate per acre? One way to calculate application rate without remembering a formula is to use a relationship: The amount applied and the area sprayed per minute are the same as the amount applied and the area sprayed per acre. Rate (R) = gals/acre

Minute Box	=	Acre Box
0.25 gpm	=	R

We also know...

Distance — 6 x 88 = 528 ft

Nozzle Spacing — 30 in ÷ 12 = 2.5 ft

Area sprayed / minute = Distance x Nozzle Spacing = 528ft x 2.5ft = 1320 sq. ft

$$\frac{\text{Avg. nozzle output gpm}}{\text{area sprayed/minute}} = \frac{\text{Rate (R)}}{\text{Sq ft of acre (43560)}}$$

From minute box	<table border="1"><tr><td>0.25</td></tr><tr><td>1320</td></tr></table>	0.25	1320	=	<table border="1"><tr><td>R</td></tr><tr><td>43560</td></tr></table>	R	43560	From acre box
0.25								
1320								
R								
43560								

Again we use cross multiplication to lead us to ...

$$\frac{\text{Nozzle output gpm} \times 43560}{\text{Area sprayed/minute} \times \text{Rate (R)}}$$

$$R = \frac{0.25 \times 43560}{1320 \times R}$$

$$R = \frac{10890}{1320}$$

$$R = 8.25 \text{ gals / acre}$$

How to determine the acres sprayed per minute

Travel distance in one minute = 616 ft
 Nozzle spacing = 30 inches (20 nozzles on sprayer)
 Nozzle output = 64 oz/minute
 What is travel speed? $616 \div 88 = 7$ mph (Remember 88 ft/min = 1 mph)
 What is sprayer width? 20 nozzles x 2.5 feet (30-inch spacing) per nozzle = 50 ft

What is application rate? $\frac{64 \text{ oz/minute}}{128 \text{ oz/gallon}} = 0.5 \text{ gpm}$

Minute Box		Acre Box	
0.5 gpm	=	R	

We also know...

Distance — $7 \times 88 = 616$ ft
 Nozzle Spacing — $30 \text{ in} \div 12 = 2.5$ ft
 Area sprayed / minute = Distance x Nozzle Spacing = $616 \text{ ft} \times 2.5 \text{ ft} = 1540 \text{ sq. ft}$

From minute box		From acre box	
0.5	=	R	
1540		43560	

This leads us to.....

$$\frac{\text{Nozzle output gpm} \times 43560}{\text{Area sprayed/minute} \times \text{Rate (R)}}$$

$$R = \frac{0.5 \times 43560}{1540 \times R}$$

$$R = \frac{21780}{1540}$$

R = 14.14 gals / acre

To determine the area covered in one minute:
 $\frac{1,540 \text{ sq ft/nozzle/minute}}{20 \text{ nozzles}} = (1,540 \times 20) \div 43,560 \text{ ft}^2/\text{A} = 0.71 \text{ acre/minute}$

How to determine nozzle size needed to achieve the operational goal

What nozzle size do I need to purchase with the following operational goals?

Sprayer speed = 7 mph
 Nozzle spacing = 20 inches
 Application rate desired = 17 gpa
 Nozzle flow rate = F

Minute Box		Acre Box	
F = gpm	=	17 gpa	

We also know...

Distance — $7 \times 88 = 616$ ft
 Nozzle Spacing — $20 \text{ in} \div 12 = 1.67$ ft
 Area sprayed / minute = Distance x Nozzle Spacing = $616 \text{ ft} \times 1.67 \text{ ft} = 1029 \text{ sq ft}$

From minute box		From acre box	
F	=	17	
1029		43560	

$$\frac{\text{Area sprayed/minute} \times R}{43560 \times F}$$

This leads us to.....

$$F = \frac{1029 \times 17}{43560 \times F}$$

$$1029 \times 17 = 17493$$

$$F = \frac{17493}{43560}$$

$$F = 0.40 \text{ gpm}$$

This is the output from a 0.4 gpm nozzle, such as the XR8004, at 40 psi.

How to adjust pressure (psi) to match nozzles

In the previous problem we needed 0.40 gpm, by design; however a 0.4 gpm nozzle may not always be available. Nozzle output varies by the square root of the pressure. For example if you increase the pressure from 10 psi to 40 psi (a four-fold increase), you will only double the output.

$$\sqrt{10 \text{ psi}} = 3.16 \text{ psi}$$

$$\sqrt{40 \text{ psi}} = 6.32 \text{ psi}$$

$$\sqrt{4} = 2$$

If we needed 0.4 gpm output but we only had 0.5 gpm nozzles, we would need to reduce the output by adjusting the pressure. Therefore 0.4 gpm is 80 percent of 0.5 gpm nozzle output at 40 psi.

Now we take the square root of the original psi

$$\sqrt{40} = 6.32$$

and multiply by our 80 percent reduced output need.

$$6.32 \times 0.8 = 5.056$$

$$\sqrt{P} = 5.056$$

To solve for "P" you need to take the result multiplied by itself:

$$5.056 \times 5.056 = 25.6 \text{ psi}$$

A typical 0.5 gpm nozzle at 25.6 psi will give you 0.40 gpm

How to calibrate a hand sprayer

First, fill sprayer with water to a known level, a mark you can later refill to accurately. (Best to spray test area over concrete so you can see evenness of application.)

Spray test area 100 sq ft = 10 ft x 10 ft
 or 250 sq ft = 10 ft x 25 ft
 or 500 sq ft = 10 ft x 50 ft or 20 ft x 25 ft

Refill sprayer to same level as before, measuring amount of water it takes to refill sprayer.

If the pesticide recommendation is 2 liquid ounces of product per 1000 sq ft, the amount to include per 1000 sq ft would be 1/4 cup, 4 tablespoons or 12 teaspoons. (See weights and measures conversions in this guide.)

If, during the test, 28 ounces of water were applied over 250 sq ft, how much water and pesticide should be added to a 3 gallon sprayer?

To find the volume of water applied to a 1000 sq ft area, use the following formula:

$$V = \frac{\text{Output} \times 1000 \text{ sq ft}}{\text{test area sq ft}}$$

The amount of water you applied in test area $\frac{28}{250} = \frac{V \text{ for volume}}{1000}$ How much water you will apply per 1000 sq ft

$$\frac{28 \times 1000}{250 \times v}$$

$$V = 112 \text{ ounces or } \div 32 \text{ (ounces/qt)} = 3.5 \text{ qt}$$

3.5 quarts is the amount of water you would apply per 1000 sq ft.

This indicates that 2 oz of pesticide should be added for every 3.5 qt of sprayer capacity.

With a 3-gallon sprayer, 12 qt (3 x 4 qt/gal) of water should be added to the sprayer tank.

$$\frac{2 \text{ oz}}{3.5 \text{ qt}} = \frac{P \text{ for Pesticide}}{12 \text{ qt}}$$

$$3.5 P = 24$$

$$P = 6.86 \text{ oz or } 0.86 \text{ cup}$$

You would add 6.8 oz (0.86 cups) to a 3-gallon sprayer.

How to determine the density of spray solution

The rate a fluid flows through a spray orifice varies with its density. Since all the tabulations are based on spraying water, which weighs 8.34 lbs per U.S. gallon, conversion factors must be used when spraying solutions which are heavier or lighter than water. To determine the proper size nozzle for the solution to be sprayed, first multiply the desired GPM or GPA of solution by the water rate conversion factor. The conversion factors are the square root of specific gravity. (See *Weight and Measures Conversion Chart* on page 163 for additional common fertilizers.)

For example, the specific gravity of 28% nitrogen, which weighs 10.65 lbs/gal, is:

$$\frac{10.65 \text{ (Wt of 28-0-0/gal)}}{8.34 \text{ (Wt of water/gal)}} = 1.28 \text{ specific gravity}$$

$$\sqrt{1.28} \text{ Conversion factor for 28-0-0 fertilizer or 28\% nitrogen is}$$

Weight of Solution	Specific Gravity	Conversion Factors
8.34 lbs per gallon - Water	1.00	1.00
10.65 lbs per gallon - 28% nitrogen	1.28	1.13
11.06 lbs per gallon - 32% nitrogen	1.33	1.15

Example on using conversion factor:

Desired application rate is 20 GPA of 28% nitrogen.

$$\text{GPA (solution)} \times \text{Conversion factor} = \text{GPA (water)}$$

$$20 \text{ GPA (28\%)} \times 1.13 = 22.6 \text{ GPA (water)}$$

A nozzle size should be selected that will supply 22.6 GPA of water at the desired pressure, speed, and nozzle spacing.

Using another example, the following has been recommended for an eco-fallow corn field:

75 lbs of nitrogen from 28% UAN

Density of 28% N = 10.65 lbs/gal

$$10.65 \times .28 = 2.982 \text{ lbs N/gal}$$

$$\frac{75 \text{ lbs N}}{2.982 \text{ lbs N/gal}} = 25.151 \text{ gal of 28\% solution}$$

Ingredient	Amount	Gallons
28% Nitrogen	75 lb N	25.151
Balance Pro	2.0 oz	0.016
Fultime	2.25 qt	0.563
Gramoxone Extra	2 pt	0.250
Crop Oil Concentrate	1 qt	0.250
2,4-D 6 LVE	1/2 pt	0.063

26.293 or 26.3 gal/acre

To determine how this will spray out and how many gallons of water are needed to get 26.3 gal/acre of this spray solution, three steps are required.

- To determine specific gravity weigh an equal amount of this spray solution and an equal amount of water.

Spray Solution	Water
13.08 lbs	10.3 lbs

Determine specific gravity weight of spray solution:

$$\frac{13.08 \text{ lbs (wt of spray solution)}}{10.3 \text{ lbs (wt of water)}} = 1.27 \text{ specific gravity}$$

- Determine conversion factor $\sqrt{1.27} = 1.13$
- Determine the quantity of water to calibrate sprayer:
 $\text{Spray Rate} \times \text{Conversion Factor} = \text{Water Amount Equivalent}$
 $26.3 \text{ gal/acre} \times 1.13 = 29.6 \text{ gal/acre}$
 Now you need to calibrate the equipment to apply 29.6 gallons of water.

Remember if you have a flow meter and it has been calibrated with water, it will read the same for a spray solution as with water. If connected to a rate controller it will change the pressure to adjust the output if you do not make any other adjustment such as speed.

How to Spray a Field to Prevent Overlap and Reduce Drift Injury

The method used to spray a field can affect pest control and potential crop injury to the targeted crop and adjacent crops. Start spraying a field on the side where the drift potential is greatest when wind speeds are low or blowing away from the susceptible area. Sometimes an applicator may need to return to a site later to spray when weather conditions are more favorable and would not cause spray drift. These factors should be considered and can make a difference on how you start and stop spraying a field (see *Figure 1*).

Fields With Rows

In fields with rows, usually it is best to follow the rows and set the sprayer and planter to the same row spacing. For example, with 30-inch rows and 6-, 12-, 18- and 24-row planters, sprayers with boom lengths of 30, 45, 60, 75, 90, 105, and 120 feet work best. With 30-inch rows and 8-, 16- and 24-row planters, sprayers with boom lengths of 40, 60, 80, 100 and 120 feet work best. Do watch for narrow and wide guess rows. In some situations with row widths less than 22 inches and wide sprayer tires, growers will spray perpendicular to rows so the tires cause less crop damage. In most situations two passes are needed on each end of the field to provide space for the sprayer to slow down, turn around and get back up to speed.

Fields Without Rows or When Not Following the Rows

When not using rows, start by spraying the ends and one side of the field with two initial rounds on three sides of the field. This will provide turning room for the tractor and sprayer. Spraying the ends first allows one to go around trees, power poles, guy wires and other obstructions, but requires backing into the corners for complete coverage (see *Figure 1*).

If wind is blowing in the direction of susceptible crops, avoid spraying these areas until conditions permit.

Use previous wheel tracks as an approximate marker, depending on the length of the sprayer and whether the booms are positioned on the rear of the sprayer. In most situations shut off booms as front wheels cross the previous wheel tracks.

Another method is to spray all four sides (see *Figure 2*). The disadvantage of this is that a partial boom width often occurs in the last pass and many times the foam mark or other mark has disappeared before the applicator returns to that side of the field. Also, even with GPS applicators can forget that they already made two passes on the other side of the field.

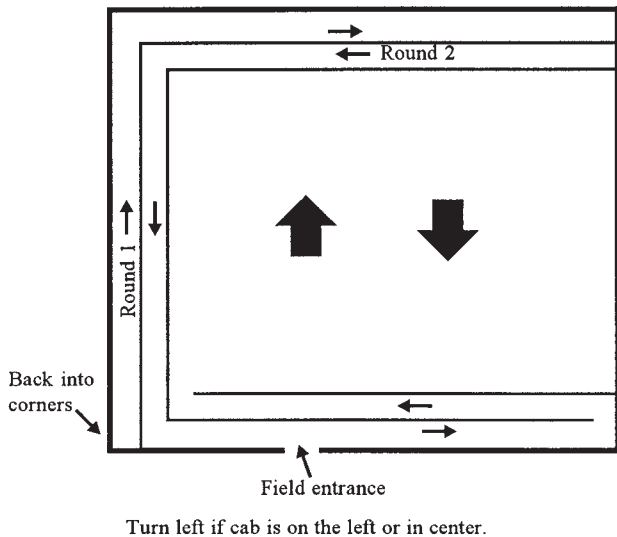
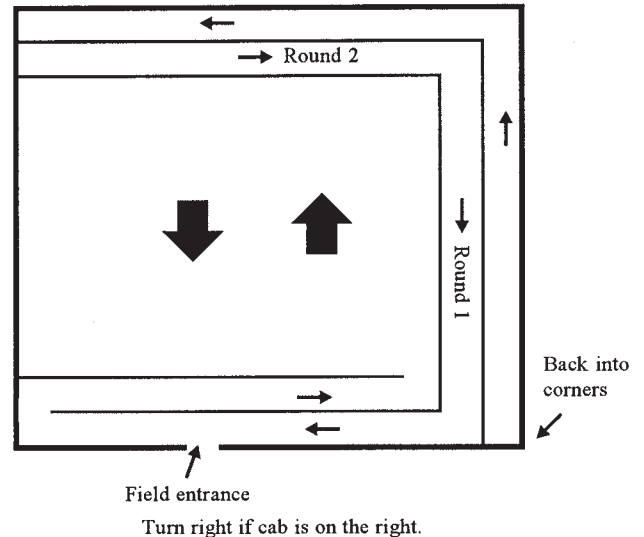

Figure 1. How to start spraying a field — spraying three sides.



Spraying Field Borders

Field borders are visible to the public and an important part of the field. The presence of poor crops, damage from weeds, herbicides, insects and pesticides or nutrient deficiencies along field borders presents a bad appearance. Many factors can increase the potential for problems in field borders, including:

- trashy conditions next to a fence line with minimum tillage;
- weed and insect pressure from fence rows;
- higher potential for overlaps and skips;
- soil compaction from turning and frequent traffic;
- high soil pH from overapplication of lime or dust from a nearby crushed limestone road (high pH increases crop injury from triazine and sulfonyleurea herbicides); and
- inconsistent sprayer application. (The outer most sprayer nozzles along the field edge will not apply a full pesticide rate (Figure 3) since most nozzles are designed for some pattern overlap. To avoid this, add a nozzle at the end of the boom (Figure 4) that can be turned on to give a full rate on field borders.

Use an off-center nozzle at the end of the boom to provide 100 percent overlap. For example, spraying systems OC-, Air Induction Underleaf Banding Spray tip (AIUB) or Underleaf Banding Spray tip (UB) could be used at the end of the boom to provide 100 percent overlap. Most sprayer tip companies have nozzle tips like these. Ideally these nozzles are one-half the size of other nozzles. Select the nozzle tip based on boom height and spray volume.

Spraying While Turning

Spraying while making sharp turns (Figure 5) can result in three to four times the desired pesticide rate along the inner boom and as high as 40 to 50 times in the pivot position. The rate of pesticide near the outer end of the turn can be 1/2 to 1/10 the desired rate. To eliminate this as much as possible, spray in a straight line and eliminate turning while spraying.

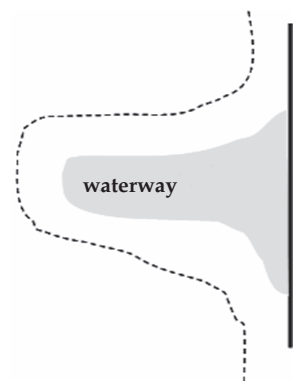

Figure 5. Problems can develop from spraying while making sharp turns. It would be better to turn off the sprayer and back into a corner.

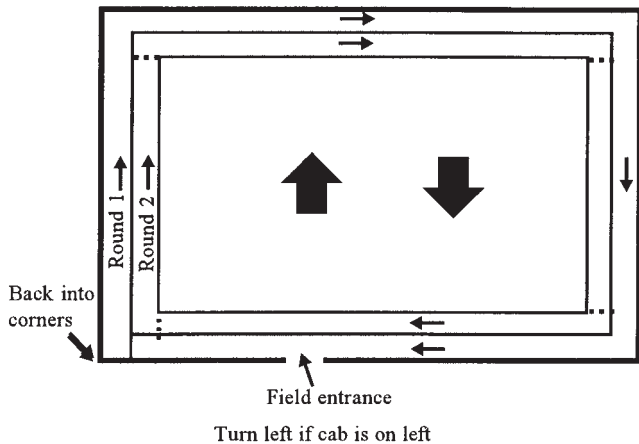

Figure 2. How to start spraying a field when spraying four sides.

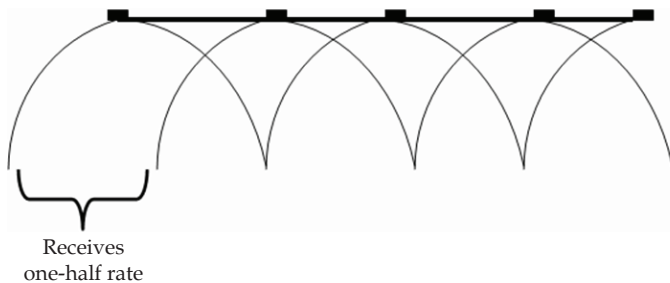

Figure 3. Shows one-half rate of pesticide from end nozzle.

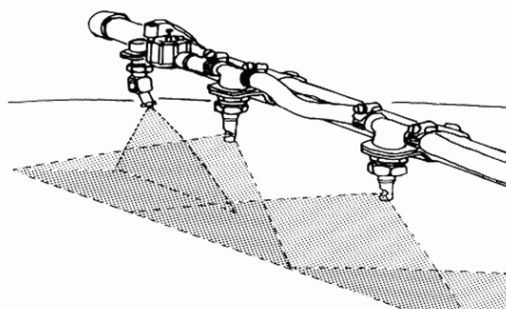

Figure 4. An additional nozzle on the end ensures that a full rate of pesticide is applied. This configuration should only be used on ends and field borders and must be turned off when swathing (spraying field).



Shut off this side of boom first.

Figure 6. Spraying uneven row lengths.

Handling Irregular Shaped Fields

Achieving pesticide coverage of point rows is difficult. Following are some guidelines for improving results.

Do you prefer to overlap applications on irregular areas or leave these areas untreated? Often these areas are difficult to cultivate and many would rather risk crop injury from overlapping pesticides than inadequate weed control. In the case of point rows or uneven row lengths (Figure 6), applicators do not always select the longest distance of travel. Consider the degree of angle into the point and minimize double spraying. Placing switches on each boom section or even on every two or three nozzles allows controlled treatment of narrow swaths on terraces, point rows and other irregular areas.

Should fence rows, waterways, terrace back slopes, and other areas be treated? Treating terraced fields can be very difficult. Farmable terraces often are sprayed as normal fields with the applicator traveling over the terraces. Other types of terraces, parallel and non-parallel, require one border along each terrace. The points between the terraces are filled in as necessary. Operating foam markers on both ends of the boom can prevent excessive double spraying.

In irregularly shaped fields avoid using pesticides that could cause carryover concerns or water quality problems if applications were overlapped.

Check Areas or "Strips"

Untreated areas (checks) are invaluable for later evaluation of a chemical or fertilizer application. Often, a planned check area provides the only means of evaluating results in terms of pest control, crop injury or fertilizer effectiveness. Checks are especially essential when using new products or the value of the treatment is uncertain.

The check area:

- should be used with the grower's consent;
- is often placed in an area not readily visible to the passerby;
- need not be large — a few feet the length of the boom or spreader is usually sufficient; and
- should be identified on the field record sheet.

Proper Swath Overlap

Nozzle pattern overlap at the end of the boom should be the same as for the rest of the nozzles along the boom (Figure 7). For example, if the overlap is 100 percent along the boom, the overlap at the edge of the swath should be 100 percent. The increased overlap of spray pattern and wider nozzle spacing increases the distance with a double rate or no rate of pesticide.

The location of a foam marker can affect the positioning of the end of the boom relative to the foam. In the following example, the marker is placed at the end of the boom, even with the last nozzle. If the nozzle spacing is 30 inches, one would move over 30 inches from the foam mark (see Figure 8).

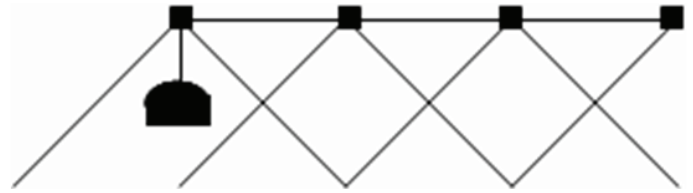

Figure 8. With a foam marker located with the last nozzle, one must move over the width of the nozzle spacing.

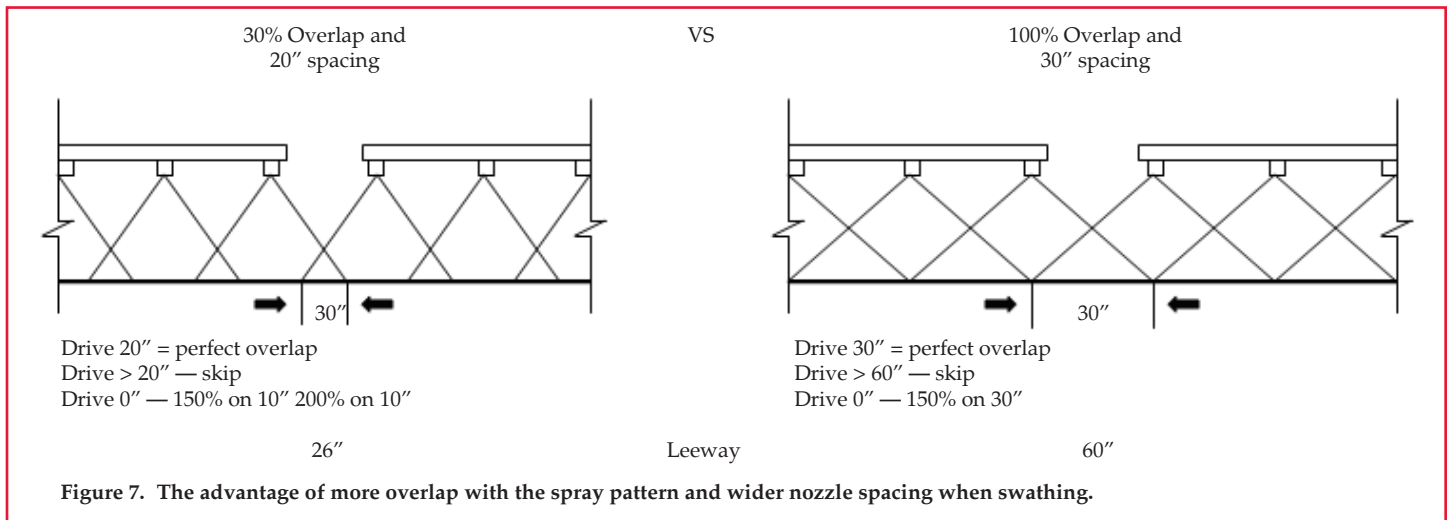

Figure 7. The advantage of more overlap with the spray pattern and wider nozzle spacing when swathing.

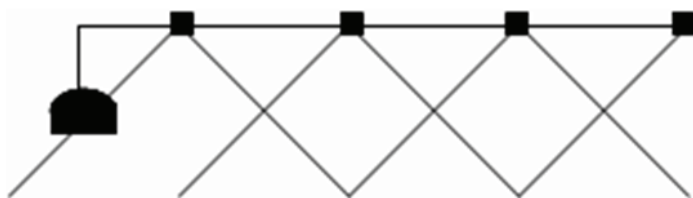

Figure 9. With a foam marker located one-half the distance between nozzles beyond the end nozzle, the marker is directly over the foam.

Some sprayers have the foam marker placed on an extension that is 50 percent of the nozzle spacing. In this situation one would have the foam marker directly above the foam on the return pass (see Figure 9).

Treating the Field

Wind Direction: Be aware of nearby crops and the drift potential of the pesticides, fertilizers, etc. Doubling the wind speed (7 to 14 mph) will increase the amount of pesticide 90 feet from the sprayer by 700 percent.

Field Speed: Base your field speed on the slowest speed that the most difficult to negotiate part of the field will permit. This will avoid wide variation in speed which makes uniform application difficult.

Driving too fast:

- increases boom bouncing and whipping;
- distorts pattern (for example, at 12 mph wind will decrease the pattern width by 15-20 percent for a nozzle placed at a height of 4-5 feet);
- creates a wind eddy behind the machine; this can be a serious problem behind large machines driven at high speeds; and
- creates more dust which deactivates certain herbicides.

Reducing Drift Injury

With a rate controller that changes output by pressure, drift may be reduced by slowing down near susceptible vegetation. For example, if an applicator is spraying at 10 mph and 40 psi and slows to 7 mph, the pressure should drop to 20 psi. One needs to stay above the minimum operating pressure for the nozzle tip being used (see Table I). This table also shows how pressure is affected as speed increases. When using the table for speeds other than 10 mph, use a percentage. For example if you travel 7 mph use 70 percent, and if you travel 12 mph use 120 percent.

The boom height also can be lowered when going slower. Boom height is the second biggest factor in drift — wind is first. These two factors, reducing pressure and lowering the boom, are two big steps in reducing drift while spraying fields. Boom height must be kept at a minimum height so that patterns will have the correct overlap.

Table I. How changing the speed of the sprayer affects pressure on sprayers with rate controllers. (Do not operate sprayer so that nozzle tips are outside their recommended pressure range.)

The example in each speed range is for 40 psi. The pressures are rounded to the nearest whole number. The $\sqrt{40} = 6.32$.

Speed Present - changed to:	Pressure Present - changed to:
10 mph to 9 mph	60 psi to 49 psi 50 psi to 41 psi
$0.9 \times \sqrt{40} = (5.69)^2 = 32.4$	40 psi to 32 psi 30 psi to 24 psi 20 psi to 16 psi
10 mph to 8 mph	60 psi to 38 psi 50 psi to 32 psi
$0.8 \times \sqrt{40} = (5.06)^2 = 25.6$	40 psi to 26 psi 30 psi to 19 psi 20 psi to 13 psi
10 mph to 7 mph	60 psi to 29 psi 50 psi to 25 psi
$0.7 \times \sqrt{40} = (4.42)^2 = 19.5$	40 psi to 20 psi 30 psi to 15 psi 20 psi to 10 psi
10 mph to 6 mph	60 psi to 22 psi 50 psi to 18 psi
$0.6 \times \sqrt{40} = (3.79)^2 = 14.4$	40 psi to 14 psi 30 psi to 11 psi 20 psi to 7 psi
10 mph to 11 mph	60 psi to 73 psi 50 psi to 61 psi
$1.1 \times \sqrt{40} = (6.95)^2 = 48.3$	40 psi to 48 psi 30 psi to 36 psi 20 psi to 24 psi
10 mph to 12 mph	60 psi to 86 psi 50 psi to 72 psi
$1.2 \times \sqrt{40} = (7.58)^2 = 57.5$	40 psi to 58 psi 30 psi to 43 psi 20 psi to 29 psi
10 mph to 13 mph	60 psi to 101 psi 50 psi to 85 psi
$1.3 \times \sqrt{40} = (8.22)^2 = 67.6$	40 psi to 68 psi 30 psi to 51 psi 20 psi to 34 psi
10 mph to 14 mph	60 psi to 118 psi 50 psi to 98 psi
$1.4 \times \sqrt{40} = (8.85)^2 = 78.3$	40 psi to 78 psi 30 psi to 59 psi 20 psi to 39 psi

Reducing Drift

It is estimated that two-thirds of pesticide drift problems involve mistakes which could have been avoided. Drift is of concern because it takes the pesticide from the intended target, making it less effective, and deposits it where it is not needed and not wanted. The pesticide then becomes an environmental pollutant in the off-target areas where it can injure susceptible vegetation, contaminate water or damage wildlife. Drift cannot be completely eliminated but the use of proper equipment and application procedures will maintain the drift deposits within acceptable limits.

There are two kinds of drift:

Particle drift is off-target movement of the spray particles.

Vapor drift is the volatilization of the pesticide molecules and their movement off target.

A Mississippi State University study analyzed data from more than 100 studies involving drift from ground sprayers. Of the 16 variables considered, three were most important.

1. **Wind speed.** When the wind speed was doubled, there was almost a 700 percent increase in drift when the readings were taken 90 feet downwind from the sprayer. Hence the recommendation of spraying in 10 mph winds or less.

2. **Boom height.** When the boom height was increased from 18 to 36 inches, the amount of drift increased 350 percent at 90 feet downwind.

3. **Distance downwind.** If the distance downwind is doubled, the

amount of drift decreases five-fold. Therefore, if the distance downwind goes from 100 to 200 feet, you have only 20 percent as much drift at 200 feet as at 100 feet and if the distance goes to 400 feet, you only have 4 percent of the drift you had at 100 feet. Check wind direction and speed when starting to spray a field. You may want to start spraying one side of the field when the wind is lower. Also it may be necessary to only spray part of a field because of wind speed, wind direction, and distance to susceptible vegetation. The rest of the field can be sprayed when conditions change.

Pesticide drift also can be reduced by using one of the new types of tips and by adjusting spray pressure. Higher spray pressures produce smaller droplets which are more susceptible to drift. If using a rate controller, be careful of increased speed. Since most rate controllers increase the pressure to maintain the same gpa when the speed increases, try to maintain the speed within +10 percent. For example, if you're applying 20 gpa at 8 mph at 40 psi and you increase the speed to 11 mph, the pressure will now be 75.5 psi which will produce a lot of small particles prone to drift. Also, this pressure will be above the operating range of most tips. Drift reduction agents may be helpful.

New spraying technology such as the "blended pulse" can decrease the risk of drift by allowing flow rate to be controlled independently of spray pressure.

Conservation Tillage Systems

No-till

Early preplant treatments generally provide the most satisfactory weed control. This involves applying residual herbicides 10 to 30 days prior to planting. The objective is to apply the herbicide prior to the germination of summer annual weeds, especially grasses. This may eliminate the need for a nonselective herbicide like Gramoxone Max or glyphosate. It is important to use treatments with adequate residual control. A split herbicide application with a portion applied early preplant and a second portion at planting can be used. This could be helpful with short residual materials or where heavy rains or delayed planting occurs following the first treatment. Properly designed early preplant treatments often can provide consistent weed control at lower cost than planting time treatments. Soil disturbance by a planter following a preplant treatment may allow weed growth in the row.

Planting time treatments of a PRE herbicide are made at or immediately after planting. When established weeds are present, a POST herbicide is combined with the PRE herbicide. Atrazine, Canopy, Preview, Pursuit Plus, glyphosate, Gramoxone Max, FallowMaster, or Landmaster BW will control established broadleaf weeds, grasses or volunteer wheat depending on plant height, density, growing conditions, weed, herbicide, and rate. Control is improved when crop oil concentrate or 28% UAN is added. In corn or soybean, 2,4-D ester also may be added for improved weed control. Gramoxone Max can be applied to grasses less than 4 inches tall. If grasses are taller than 4 inches and are growing vigorously, apply glyphosate at 24 oz/A. Kill volunteer wheat and winter annual weeds in April to prevent soil moisture loss.

Ridge-till

With the ridge plant system, the row has fewer summer annual weeds because the weed seed produced the preceding year is not worked into the soil when the seedbed is prepared. During planting, the ridge clearing device, sweeps or disks, move soil containing corn kernels and ears, sorghum seed and/or heads, and most weed seed from the ridge. A banded herbicide treatment should be used at planting time in the row. If timely cultivation is not possible, weed density is heavy, or the field contains many hard to control weeds like velvetleaf, a broadcast herbicide treatment at planting time may be necessary.

Select the herbicide treatment from the PRE treatments of soil applied herbicides. Early preplant (EPP) treatments can be applied in March to early April prior to planting to keep winter annual and early summer annual weeds from using soil water and producing seeds.

The early herbicide treatment should eliminate planting through

4-inch or taller weed growth. Weeds like kochia and Russian thistle are troublesome if not killed. The trouble arises along the cutting edge of the planter ridge clearing device, where larger broadleaf weeds may not be uprooted or covered. Most early germinating broadleaf weeds can be controlled effectively and economically with 2,4-D. If 2,4-D is to be used at planting, it is better to apply from a spray boom on the front end or underbelly of the tractor rather than after planting. If considerable grass weed growth is present before planting, Gramoxone Max or glyphosate should be used. Another option would be to preplant cultivate for row-middle tillage, leaving ridge top weed removal to the planter ridge clearing device. This works extremely well on fields where corn was ensiled. Preplant cultivation also allows for rebuilding ridges, which may be desirable if they have been damaged by harvest equipment or livestock tramping. However, preplant cultivation mixes weed seeds into the ridge.

Ecofarming

Ecofarming is a system that controls weeds after wheat harvest and throughout the fallow period by using herbicides and/or tillage with

minimum disturbance of crop residues and soils. For a more detailed discussion, see pages 79-85.

Herbicide Carryover

Certain herbicides can persist in the soil to the extent that rotational crops may be injured. The potential for herbicide carryover increases from eastern to western Nebraska. Lower rainfall and low soil organic matter increases carryover potential. Herbicide carryover potential is greater on eroded soils and may be influenced by pH. Carryover is also a function of application accuracy. Carryover will be more apparent in headlands and other areas where sprayer overlap is common. Herbicide applications made late in the season have greater carryover potential compared to earlier applications.

Carryover can restrict crop rotation options as well as limit replant options if a crop is lost due to hail or other disasters. Care should be taken when choosing herbicides to fit your rotation sequence. Consult the weed response charts for carryover restrictions and consult herbicide labels for rotation intervals (*Replant Option Tables*, pages 130-143) and carryover restrictions. Conducting a plant bioassay can be helpful in determining whether carryover will be a problem in your fields.

Testing for Herbicide Residues

The two university laboratories listed below provide herbicide residue analyses of soils. For information about their services, visit their Web sites or contact them by phone.

South Dakota State University

Oscar E. Olson Biochemistry Laboratories
Department of Chemistry and Biochemistry
ASC 133, Box 2170, Brookings, SD 57007
Phone: 605-688-6171
Fax: 605-688-6295
Web site: anserv.sdstate.edu

Montana State University

Agricultural Experiment Station (AES) Analytical Laboratory
McCall Hall, Room 10, Bozeman, MT 59717
Telephone: (406) 994-3383
Fax: (406) 994-4494
Web site: ag.montana.edu/analyticallab/

Interpreting Soil Herbicide Residue Analysis

What does a herbicide residue level of 0.3 ppm (parts per million) in the soil mean? Herbicide concentrations may be more easily visualized as lb/A rather than ppm. The tilled layer (6-7 inches deep) of an acre of loam soil weighs approximately two million pounds. Two pounds of herbicide per acre mixed in the tilled layer of soil would result in a concentration of 1 ppm (two parts herbicide per 2 million parts soil). 1 ppm = 1,000 ppb (parts per billion) which is more commonly used.

What herbicide residue levels are safe to sensitive crops? This varies with the herbicide, the environment, and the soil properties. The table below is provided as a guide. Consult the herbicide manufacturer for more specific information. Check compliance with herbicide label and follow all label guidelines.

Crop Tolerance to Herbicide Residue in the Soil (Injury Threshold Guidelines)

Herbicide concentrations equal to or greater than those listed may cause crop injury.

Herbicide	Crop	Soil	
		Silt Loam 2-3% OM pH less than 7.0	Sandy Loam 1-2% OM pH greater than 7.0
Concentration (ppb)*			
Atrazine	Alfalfa	100	40
	Oat	150	60
	Soybean	250	100
	Sugarbeet	5	< 5
	Wheat	180	75
Classic	Corn	3	1
	Wheat	5	2
Command	Corn	150	75
	Wheat	75	15
Prowl	Corn	250	150
	Sugarbeet	70	70
	Wheat	300	200
Pursuit	Corn	25	10
	Sorghum	10	4
	Sugarbeet	< 1	< 1
Scepter	Corn	10	5
	Wheat	30	10
Treflan	Corn	150	100
	Sugarbeet	70	70
	Wheat	200	150

*ppb = parts per billion of active ingredient

Cleaning the Sprayer

Herbicide residuals in the sprayer can be dissolved by herbicides, solvents and/or adjuvants.

Pesticides may settle to the bottom of the tank if agitation is not adequate. The pesticides also may settle out in the tank, hoses, boom, etc. if the sprayer is shut down. Always end the workday, if possible, with an empty tank. A tank for fresh water mounted on the sprayer will provide water to flush the system in the field and the rinsate can be sprayed on the field of the product's labeled use.

Always keep the sprayer's inside and outside clean. Sprayers with stainless steel booms, which reduce the number of hoses and fittings on the sprayer, are easier to keep clean and have less area for pesticide to build up in the spray booms. Screens and strainers need to be cleaned or replaced. Sumps and pumps along with the inside of the sprayer tank, especially the top and around baffles and plumbing, should be checked.

Select a location to clean the sprayer where any spilled rinsate will not contaminate water supplies, streams, crops or other plants and where puddles will not be accessible to children, pets, livestock, or wildlife.

Preferably the area should be impervious to water and have a wash rack or cement apron with a sump to catch contaminated wash water and pesticides. If such a facility is not available, catch or contain the rinsate and spray the rinse water or the cleaning solution on a field in a manner consistent with the intended use of the agrichemical. Avoid discharging all the cleaning solution in a small area.

The quickest and easiest way to rinse a tank and spraying equipment and dispose of waste safely is to carry a 50- to 100-gallon drum of fresh water with the spraying equipment. When spraying is finished, flush the system in the field and spray the rinsate on the field in a manner consistent with the product's intended use.

If spray material is spilled on the sprayer during loading or mixing, wash the outside of the sprayer immediately. As a general rule, plastic or polyethylene tanks and hoses tend to require more extensive cleaning than stainless steel tanks. Screens and strainers also should be cleaned or replaced frequently as they can be a major source of contamination. Residues also can accumulate in checked or cracked hoses. Inspect the inside of hoses and replace if necessary. Pay special attention to the following areas that may be missed or difficult to clean:

- sprayer surfaces or components where buildup might occur due to repeated coats of spray followed by drying
- sprayer sumps and pumps
- inside the top of the spray tank and around baffles
- irregular surfaces inside tanks caused by baffles, plumbing fixtures, agitation units, etc.

When going between crops, follow the specific cleanup procedures listed on the label. Some cleanups require special cleaning agents. Sprayer-cleaning agents (see *Table*) should be selected according to the herbicide and formulation to be removed. These agents should penetrate and dis-

solve pesticide residues which will be removed in the rinsate. Commercial tank cleaning agents are generally preferred because they do a better job than household detergents and can deactivate some herbicides. Following is the spray cleanout procedure listed in University of Missouri publication G4852, *Cleaning Field Sprayers to Avoid Crop Injury*, available on the Web at muextension.missouri.edu/xplor/agguides/crops/g04852.htm.

This procedure is recommended for all herbicides unless the label specifies a different cleanout procedure. With sensitive crops the best method to avoid herbicide injury from residual in the tank, is to use a separate sprayer for the crops. When some herbicides, such as glyphosate, are left in the tank for a period of time, they absorb products such as Banvel/Clarity/Sterling and hence crop injury can result.

1. Add one-half tank of fresh water and flush tanks, lines, booms, and nozzles for at least five minutes using a combination of agitation and spraying. Rinsate sprayed through the booms is best sprayed onto cropland for which the pesticide is labeled to avoid accumulation of pesticide-contaminated rinsate. Thoroughly rinse the inside surfaces of the tank, paying particular attention to the surfaces around the tank fill access, baffles, and tank plumbing fixtures. The use of a 360-degree nozzle, such as the TeeJet Model 27500E-TEF rinsing nozzle, permanently installed to the spray system can automate the cleaning of tops and sides of the tanks. Several nozzles may need to be carefully positioned to clean tanks with baffles. Pressure sprayers are useful for removing caked on internal and external residues. Hot water can increase penetration of dried residues, but adding a hot water rinse may cause unacceptable health hazards due to the vapors produced. Carefully review labeled safety precautions for the agrichemicals and cleaning products used.
2. Fill the tank with fresh water and the recommended cleaning solutions or a commercially available tank cleaner and agitate the solution for 15 minutes. To make a cleaning solution, add one of the following to each 50 gallons of water:
 - 2 quarts of household ammonia (let stand in sprayer overnight for growth regulator herbicides such as 2,4-D or Dicamba), or
 - 4 pounds of trisodium phosphate cleaner detergent.

Operate the spray booms long enough to ensure that all nozzles and boom lines are filled with the cleaning solution. Let the solution stand in the system for several hours, preferably overnight. Agitate and spray the solution onto areas suitable for the rinsate solution.
3. Add more water and rinse the system again by using a combination of agitation and spraying. Remove nozzles, screens, and strainers and clean separately in a bucket of cleaning agent and water.
4. Rinse and flush the system once again with clean water.

Recommended cleaning agents for selected herbicides.

Herbicide	Recommended Cleaning Solution	Sensitive Crops
2,4-D amine	ammonia + water	all broadleaf crops
2,4-D ester	kerosene or diesel fuel followed by ammonia + water	all broadleaf crops
Accent	ammonia + water	sorghum, sunflower, canola
Accent Gold	ammonia + water	sorghum, sunflower, canola, soybean
Action	ammonia or commercial tank cleaner + water	—
Aim	ammonia or commercial tank cleaner + water	sunflower, canola
Ally	ammonia + water	soybean, sunflower, corn, canola
Ally Extra	ammonia + water	corn, soybean, sorghum canola
Amber	ammonia + water	soybean, sunflower, corn, sorghum, canola
Assure II	ammonia + water	corn, sorghum, wheat, other grasses
Atrazine	detergent + water	wheat, sunflower, soybean
Authority	ammonia or commercial tank cleaner + water	corn, sorghum, canola
Axiom	commercial tank cleaner + water	—
Banvel/Clarity/Sterling	ammonia + water	all broadleaf crops
Basagran	ammonia or commercial tank cleaner + water	—

Recommended cleaning agents for selected herbicides. (continued)

Herbicide	Recommended Cleaning Solution	Sensitive Crops
Basis Gold	ammonia + water	wheat, sunflower, soybean, canola
Basis	ammonia + water	soybean, canola
Beacon	ammonia + water	sorghum, sunflower, soybean, canola
Blazer/Status	ammonia or commercial tank cleaner + water	corn, sorghum
Buctril + Atrazine	ammonia or commercial tank cleaner + water	wheat, sunflower, soybean
Buctril/Moxy/Moxynil	ammonia or commercial tank cleaner + water	—
Callisto	ammonia or commercial tank cleaner + water	sunflowers, soybean, sugarbeets, dry beans
Camix	ammonia or commercial tank cleaner + water	sunflowers, soybeans, sugarbeets, dry beans
Canopy XL	ammonia or commercial tank cleaner + water	corn, sorghum, sunflower, sorghum, canola
Caparol	ammonia or commercial tank cleaner + water	—
Celebrity	ammonia or commercial tank cleaner + water	all broadleaf crops, sorghum, wheat
Cimarron/Escort	ammonia + water	soybean, sunflower, corn, canola
Cimarron Max	ammonia + water	all broadleaf crops
Classic	ammonia or commercial tank cleaner + water	corn, sorghum, sunflower, sorghum, canola
Cobra	ammonia or commercial tank cleaner + water	corn, sorghum
Command	water	corn, sorghum, wheat, oat
Contour	ammonia or commercial tank cleaner + water	soybean, canola, sorghum, wheat, sunflower
Cotoran	ammonia or commercial tank cleaner + water	soybean
Domain	commercial tank cleaner + water	—
Dual/Dual Magnum/Cinch	ammonia or commercial tank cleaner + water	—
Epic	commercial tank cleaner + water	soybean, wheat, sorghum
Equip	ammonia + water	sorghum, sunflower, canola
Exceed/Spirit	ammonia + water	sorghum, soybean, wheat, sunflower
Expert	ammonia + water	sorghum, canola, sunflower
Express	ammonia + water	corn, soybean, sorghum, sunflower, canola
Finesse	ammonia + water	soybean, sunflower, corn, sorghum, canola
FirstRate	ammonia + water	sunflower, sorghum, canola, corn
Frontier	ammonia or commercial tank cleaner + water	—
Fusilade/Fusion	ammonia or commercial tank cleaner + water	corn, sorghum, wheat, other grasses
Glean	ammonia + water	soybean, sunflower, corn, sorghum, canola
Glyphosate	usually water; consult label	all crops
Gramoxone Max	ammonia or commercial tank cleaner + water	all crops
Harmony Extra	ammonia or commercial tank cleaner + water	canola, corn, soybean, sorghum, sunflower
Harmony GT	ammonia + water	sunflower, canola
Harness/Surpass	ammonia or commercial tank cleaner + water	—
Hornet	ammonia or commercial tank cleaner + water	soybean, sunflower
Karmex	ammonia or commercial tank cleaner + water	—
Laddok	ammonia or commercial tank cleaner + water	wheat, sunflower, soybean
Lasso/Partner/Micro-Tech	ammonia or commercial tank cleaner + water	—
Liberty	commercial tank cleaner + water	all sensitive crops
Lightning	ammonia or commercial tank cleaner + water	soybean, sorghum, wheat, sunflower, canola
Lumax/Lexar	ammonia or commercial tank cleaner + water	soybean, sunflower, sugarbeet, dry beans
Marksman/Sterling Plus	commercial tank cleaner + water	all broadleaf crops
MSMA/DSMA	ammonia or commercial tank cleaner + water	—
Northstar	commercial tank cleaner + water	all broadleaf crops, sorghum, wheat
Olympus Flex	ammonia + water	—
Optill	commercial tank cleaner + water	all broadleaf crops
Option	ammonia + water	sorghum, sunflower, canola
Option II	ammonia or commercial tank cleaner + water	corn, sorghum, wheat, other grasses
Peak	ammonia + water	soybean, sunflower, canola
Permit	ammonia + water	soybean, canola, sunflower
Phoenix	ammonia + commercial tank cleaner + water	corn, sorghum
Poast/Poast Plus	ammonia, commercial tank cleaner, or detergent + water	corn, sorghum, wheat, other grasses
Prowl H2O	commercial tank cleaner + water	—
Prowl/Pendimax	ammonia or commercial tank cleaner + water	—
Pursuit	ammonia or commercial tank cleaner + water	sunflower, canola, sorghum
Pursuit Plus	ammonia or commercial tank cleaner + water	sunflower, canola, sorghum
Python	ammonia + water	sunflower, sorghum, canola
Reflex/Flexstar	ammonia or commercial tank cleaner + water	sorghum
Resource	ammonia or commercial tank cleaner + water	—

Recommended cleaning agents for selected herbicides. (continued)

Herbicide	Recommended Cleaning Solution	Sensitive Crops
Resolve	ammonia + water	sorghum + all broadleaf crops
Roundup WeatherMax/Roundup Ultra	water	all sensitive crops
Scepter	ammonia or commercial tank cleaner + water	sunflower, canola, corn
Select	ammonia or commercial tank cleaner + water	corn, sorghum, wheat, other grasses
Sencor	detergent + water	—
Sequence	water	all sensitive crops
Shotgun	commercial tank cleaner + water	all broadleaf crops
Squadron	ammonia or commercial tank cleaner + water	sunflower, canola, corn
Staple	ammonia + water	sorghum, corn, canola, sunflower
Steadfast	ammonia + water	sorghum, sunflower, canola
Steel	ammonia or commercial tank cleaner + water	sunflower, canola, corn
Stinger	ammonia + water	sunflower, soybean
Touchdown	commercial tank cleaner + water	all sensitive crops
Treflan	ammonia or commercial tank cleaner + water	—
Tri-Scept	ammonia or commercial tank cleaner + water	sunflower, canola, corn
Turbo	detergent or commercial tank cleaner + water	—
Ultra Blazer	ammonia or commercial tank cleaner + water	corn, sorghum
Valor	ammonia + water	corn, wheat, canola, sorghum
Zorial/Rapid 80	ammonia or commercial tank cleaner + water	corn, wheat

Spray Additives

Additives are compounds added to a spray mixture to modify the characteristics of the spray solution. Activator additives increase the post-emergence activity of herbicides and include oils, surfactants and fertilizers. Modifier additives alter the application characteristics of the spray solution and include anti-foaming agents, compatibility agents and drift control agents. For a comprehensive list of additives see a Compendium of Herbicide Adjuvants, available from: Bryan Young, Southern Illinois University, 1205 Lincoln, Drive, Carbondale, IL 62901. Further information is available on the Web at www.herbicide-adjuvants.com.

Additives are commonly used with POST herbicides because they increase herbicide penetration of the treated plant surface and improve herbicide performance. Additive response varies with the herbicide, weed species, and environmental conditions. Therefore, it is important that additives not be indiscriminately added to the spray mixture.

POST herbicide activity is strongly influenced by the additives included in the spray mixture. The most commonly used spray additives (adjuvants) include oils, surfactants (surface active agents) and fertilizers. The degree of weed control and the potential for crop injury are both influenced by additives. Additive effectiveness varies with herbicide and weed species. The response to an additive will vary with environment, weed species, and herbicide. Additives that increase weed control may also increase crop injury. There may be a fine line between increased weed control and increased crop injury.

Oil concentrates include both petroleum and seed derived oils and usually are composed of at least 17% emulsifiers and 83% oil. Combining an emulsifier with the oil results in a unit, one portion of which is highly oil soluble, the other portion water soluble. Without the emulsifier, the oil would not mix with water. Methylation improves the effectiveness of seed oils as spray additives. Oil concentrates are generally used at 1 percent v/v of spray solution or 1 to 2 pt/A depending upon the herbicide, oil, and spray volume.

A material is called a surfactant if it tends to concentrate on the surface of a liquid in which it is mixed. Compounds that function in this way generally consist of two components. One portion of the molecule is hydrophilic (water soluble) and the other portion is lipophilic (oil soluble). Surfactants concentrate at the interface of two surfaces binding them together.

Surfactants are classified by the hydrophilic portion of the molecule. There are three important classes of surfactants: (1) anionic, (2) cationic, and (3) nonionic. Anionic surfactants ionize in water to form a negative ion. Cationic surfactants ionize in water to form a positively charged ion. Nonionic surfactants contain no ionizable groups and therefore carry no charge. They are by far the most commonly used surfactant type.

Organosilicone surfactants are a class of nonionic surfactants that are especially effective in reducing surface tension of water mixtures. This results in efficient wetting of very waxy surfaces. Most other nonionic surfactants interfere with the function of organosilicones and should not be used with them. Organosilicones are most stable and most effective in solutions of pH 6 to 8. In more alkaline or acidic solutions, these compounds hydrolyze with a loss in activity.

Ammonium containing fertilizers are effective spray additives with 28-0-0 and 32-0-0 UAN solutions and 21-0-0 spray grade ammonium sulfate (AMS) most commonly used. The ammonium in these fertilizers enhances the uptake of certain herbicides, especially weak acids by a mechanism not well understood. While oils and surfactants function primarily at the waxy leaf surface, the ammonium ion functions inside the cell wall. This enhanced activity due to the ammonium ion is pronounced with several POST herbicides. Fertilizers are not surfactants and do not replace the need for surfactants in the spray mixture.

AMS is the fertilizer additive that should be used with glyphosate. Calcium, magnesium and iron in spray water antagonizes glyphosate activity by reacting with glyphosate, forming salts with reduced activity. AMS added to the spray water reacts with calcium, magnesium, and iron in the water, forming insoluble sulfates that will not react with glyphosate, effectively preventing antagonism. Other nitrogen-containing fertilizers including UAN will not prevent the antagonism caused by calcium, magnesium and iron and therefore should not be used as an additive with glyphosate. AMS added at 2% by weight (17 lb/100 gallons spray) will overcome spray water antagonism of glyphosate. Liquid forms of AMS are equally effective if used at equivalent rates. Some common liquid AMS products contain approximately 3.75 lb AMS per gallon.

Surfactants exert their effect on the leaf cuticle or spray droplet to enhance penetration of foliar-applied herbicides. This results from a reduction in surface tension of the spray droplets causing them to spread out and wet the sprayed surface. Surface tension causes water to bead on a waxy surface as a result of an energy imbalance, skin effect at the surface. Plant surfaces are composed of waxes while the spray mixture is primarily water. The surfactant with the hydrophilic end associated with the spray mixture and the lipophilic portion oriented to the lipid-containing plant surface functions as a bond between the two. The result is fewer spray droplets "bounce off" on impact and they spread out more completely over the surface. This improved wetting and retention generally results in increased herbicide uptake by the plant, hence increased herbicide activity.

Additives for POST Corn Herbicides

Check the label for specific additive rates and use conditions. Weather conditions, crop and weed growth stages, and herbicide rate will determine the proper additive and use rate. A dash indicates that the additive is not labelled for use with that herbicide.

Herbicide	Nonionic Surfactant	Nonionic Surfactant + UAN ²	Crop Oil Concentrate	Crop Oil Concentrate + UAN ²	Methylated Seed Oil	Methylated Seed Oil + UAN ²
Accent	1/4%	1/4% + 2-4 qt/A	1%	1% + 2-4 qt/A	1%	1% + 2-4 qt/A
Accent + Atrazine	— ¹	— ¹	1%	1% + 2-4 qt/A	1%	1% + 2-4 qt/A
Accent + Dicamba●	1/4%	1/4% + 2-4 qt/A	—	—	—	—
Accent + Buctril	1/4%	1/4% + 2-4 qt/A	—	—	—	—
Accent + Buctril + Atrazine	1/4%	1/4% + 2-4 qt/A	—	—	—	—
Accent Gold	—	—	1 /100 gal	1 gal/100 gal + 2-4 qt/A ²	1%	1% + 2-4 qt/A
Aim	1/4%	1/4% + 2-4 qt/A	1%	1% + 2-4 qt/A	—	—
Atrazine	— ¹	—	1 qt/A	—	1 qt/A	—
Banvel/Clarity	—	—	—	—	—	—
Basis	—	1-2 qt/100 gal	—	1 gal/100 gal	—	1.25% + 1-2 qt/A
Basis Gold	—	—	1 gal/100 gal	1 gal/100 gal + 2-4 qt/A ²	1%	1% + 2-4 qt/A
Beacon	1/4%	1/4%	1 qt/A	1 qt/A + 2-4 qt/A	3/4-1 qt/A	3/4 qt/A + 2-4 qt/A
Beacon + 2,4-D	1/4%	—	—	—	—	—
Beacon + Dicamba●	1/4%	—	—	—	—	—
Beacon + Buctril	1/4%	—	—	—	—	—
Buctril	— ¹	—	— ¹	—	—	—
Buctril + Atrazine	—	—	—	—	—	—
Buctril + Dicamba●	—	—	—	—	—	—
Clarity	1/4%	—	—	—	—	—
Callisto	—	—	1%	1% + 2.5%	—	—
Callisto + Atrazine	—	—	1%	1% + 2.5%	—	—
Distinct	—	1/4% + 5 qt/100 gal	—	—	—	—
Equip	—	—	—	—	—	1.5 pt + 2 qt/A
Exceed	1/4%	1/4% + 2-4 qt/A	1 qt/A	1 qt/A + 1-2 qt/A	3/4-1 qt/A	3/4-1 qt/A + 2-4 qt/A
Glyphosate ³	<i>See page 130 for glyphosate comparison table</i>					
Hornet	1/4%	—	1%	—	1%	—
Laddok S-12	—	—	1.25%	1.25% + 2-4 qt/A	1%	1% + 2-4 qt/A
Liberty ⁴	—	—	—	—	—	—
Lightning	—	1/4% + 1-2 qt/A	—	—	—	—
Marksman	1/4%	—	1.25% ¹	—	—	—
North Star	1/4%	1/4% + 2 qt/A	3/4-1 qt/A ⁵	3/4-1 qt/A + 2 qt/A ⁵	—	—
Option	—	—	—	—	—	1.5 pt + 2 qt/A
Option + Distinct	—	—	—	—	—	1.5 pt + 2 qt/A
Permit	1/4%	1/4% + 2-4 qt/A	1%	1% + 2-4 qt/A	—	—
Permit + Dicamba●	1/4%	—	—	—	—	—
Permit + Buctril	1/4%	—	—	—	—	—
Permit + Accent or Beacon	1/4%	—	—	—	—	—
Poast Plus or POAST	—	—	1.25%	1.25% + 2-4 qt/A	1.25%	1.25% + 2 qt/A
Resolve	—	1/4% + 2 qt/A	—	—	—	—
Resource	—	—	1.25%	1.25% + 2 qt/A	—	—
Sencor + Basagran	—	—	—	—	—	—
Shotgun	—	—	—	—	—	—
Spirit	1qt/100 gal	1/4% + 2-4 qt/A	1 qt/A	1 qt/A + 2-4 qt/A	3/4-1 qt/A	3/4-1 qt + 2-4 qt/A
Steadfast	—	1/4% + 2-4 qt/A	—	1% + 2-4 qt/A	—	—
Starane	1/4%	—	—	—	—	—
Steadfast + Callisto + Atrazine	—	—	—	1% + 2-4 qt/A	—	—
2,4-D	—	—	—	—	—	1% + 2 qt/A

¹Labeled but normally not used due to crop injury.

²AMS at 2-4 lb/A can be substituted for UAN.

³Add AMS at 17 lb/100 gallon of spray mixture.

⁴Add AMS at 3 lb/A

⁵Corn 4-12" tall.

●Dicamba is the active ingredient in Banvel, Clarity, Sterling and several other herbicides. The rates and information provided here are based on the same 4 lb/gal acid equivalent formulation found in Banvel, Clarity and Sterling.

Additives for POST Soybean Herbicides

A dash indicates that the additive is not labelled for use with that herbicide.

Herbicide	Nonionic Surfactant	Nonionic Surfactant + UAN	Crop Oil Concentrate (COC)	Crop Oil + UAN	Methylated Seed Oil	Methylated Seed Oil + UAN ¹
Aim	1/4%	—	—	—	—	—
Assure II	1/4%	1/4% + 2-4 qt/A	1.25%	1.25% + 2-4 qt/A	—	—
Basagran	—	—	1.25%	1/4% + 2-4 qt/A	1.25%	1.25% + 2-4 qt/A
Basagran + Blazer	—	—	1.25% ²	—	1.25%	—
Basagran + Poast Plus	—	—	1.25%	1.25% + 1-2 qt/A	1.25%	1.25% + 1-2 qt/A
Basagran + Blazer + Poast Plus	—	—	1.25%	—	1.25%	—
Basagran + Scepter	1/4%	1% + 2-4 qt/A	1.25%	1.25% + 2-4 qt/A	1.25%	1.25% + 2-4 qt/A
Classic + Assure	1/4%	1/4% + 1-2 qt/A ²	1.25%	1.25% + 1-2 qt/A ²	—	—
Classic + Harmony GT + Assure	1/4%	1/4% + 1-2 qt/A ²	—	—	—	—
Classic	1/4%	1/4% + 2-4 qt/A ²	1/4%	1.25% + 2-4 qt/A ²	1%	1% + 2-4 qt/A
Cobra	—	—	1.25%	1.25% + 2-4 qt/A ²	1.25%	1.25% + 2-4 qt/A
Extreme	1 pt/100 gal	—	—	—	—	—
First Rate	1-2 pt/100 gal	1 qt + 2.5%	1.25%	1.25% + 2.5% ^l	1.25%	1.25% + 2 qt/A
Flexstar	—	—	0.5-1%	0.5-1% + 2-4 qt/A	0.5-1%	1.25% + 2.5%
Fusilade + Basagran	1/4%	—	1.25%	—	1 qt/A	1 qt/A + 2-4 qt/A
Fusilade or Fusion	1/4%	—	0.5-1%	0.5-1% + 2-4 qt/A	0.5-1%	—
Galaxy	—	—	1.25% ²	1.25% + 2-4 qt/A	1 qt/A	1 qt/A + 2-4 qt/A
Glyphosate ³	<i>Refer to pages 146-147 for Glyphosate Comparison Table.</i>					
Harmony GT	—	1/4% + 2-4 qt/A ²	—	—	1 qt/A ²	1 qt/A + 2-4 qt/A
Phoenix	1/4%	1/4% + 2-4 qt/A	—	—	—	—
Phoenix + Select	1/4%	1/4% + 2-4 qt/A	—	—	—	—
Poast Plus	—	—	1.25%	1/4% + 2-4 qt/A	—	—
Pursuit	—	1/4% + 1-2 qt/A	—	1.25% + 1-2 qt/A	1 qt/A	1 qt/A + 2-4 qt/A
Raptor	—	1/4% + 2-4 qt/A	—	1/4% + 1-2 qt/A	—	1% + 1-2 qt/A
Reflex	1/4%	—	0.5-1%	0.5-1% + 1-2 qt/A	—	0.5-1% + 1-2 qt/A
Resource	—	—	1.25%	1.25% + 1-2 qt/A	1.25%	1.25% + 1-2 qt/A
Rezult	—	—	1 pt/A	1 pt/A + 2-4 qt/A	1.25%	1.25% + 1-2 qt/A
Scepter	1/4%	—	1.25%	—	—	—
Scepter OT	1/4%	—	—	—	—	—
Select	—	—	1.25%	1.25% + 2 qt/A	1.25%	1.25% + 2-4 qt/A
Select Max (grasses)	—	—	1 qt/A	1 qt/A + 1-2 qts/A ¹	1 qt/A	1 qt/A + 1-2 qts/A ¹
Select Max (volunteer Roundup Ready [®] corn)	Add the necessary NIS if using a glyphosate product without a built-in adjuvant.					
Storm	1-2 pt/100 gal	—	1-2 pt/100 gal	—	1-2 pts/100 gal	—
Synchrony	—	1/4% + 2-4 qt/A	—	—	—	—
Touchdown ³	—	—	—	—	—	—
Ultra Blazer	1/4%	1/4% + 2-4 qt/A	1.25%	1.25% + 2-4 qt/A	1.25%	1.25% + 1-2 qt/A
Ultra Blazer + Poast Plus	—	—	1.25%	1 qt/A + 2-4 qt/A	—	—

Additives for Post Sorghum Herbicides

Check the label for specific additive rates and use conditions. Weather conditions, crop and weed growth stages, and herbicide rate will determine the proper additive and use rate. A dash indicates that the additive is not labelled for use with that herbicide.

Herbicide	Nonionic Surfactant	Nonionic Surfactant + UAN	Crop Oil Concentrate	Crop Oil Concentration + UAN	Methylated Seed Oil	Methylated Seed Oil + UAN ¹
Aim	1/4%	—	—	—	—	—
Atrazine	—	—	1.25%	—	—	—
Banvel/Clarity/Sterling	—	—	—	—	—	—
Buctril + Atrazine	1/4% ¹	—	—	—	—	—
Laddok S-12	—	—	1.25%	—	1.25%	—
Marksman/Sterling Plus	—	—	—	—	—	—
Paramount	—	—	1.25%	1 qt + 0.5-1 gal/A ²	1.25%	1.25% + 2-4 qt/A
Paramount + Atrazine	—	—	1.25%	1 qt + 0.5-1 gal/A ²	1.25%	1.25% + 2-4 qt/A
Peak	1/4%	1/4% + 2-4 qt/A	1 qt/A	1.25% + 2-4 qt/A	1 qt/A	1 qt/A + 2-4 qt/A
Permit	1/4%	1/4% + 2-4 qt/A	1%	1 qt/A + 2-4 qt/A	1%	1% + 2-4 qt/A
2,4-D	—	—	—	—	—	—
Shotgun	—	—	—	—	—	—
Starane	1/4%	—	—	—	—	—

¹AMS at 2-4 lb/A can be substituted for UAN.

²Labeled but not normally used due to crop injury.

³Add AMS at 17 lb/100 gallon of spray mixture.

Pre-emergence Herbicides Applied After Crop Emergence

In years when weather does not permit the normal application of pre-emergence herbicides, there are options. Several pre-emergence herbicides are labeled for broadcast application after emergence without injury to the crop. The following table lists those herbicides along with crop stage and weed height restrictions. **If the herbicide you are using is not on the list below, then consult the label to see if it can be applied broadcast after emergence. All the herbicides below are labeled for use after emergence.**

If there is concern that weed size may exceed the range of most preemergence herbicides by the time they are applied, note that many of these products contain atrazine and have burndown properties. Expect to control 4-inch broadleaf weeds at 1.5 lb and 2- to 3-inch broadleaf weeds at 0.75 – 1.0 lb of atrazine. The postemergence activity of atrazine can be increased by including an oil additive or applying with a UAN as the carrier. Do not use oil and UAN or crop injury will result. If you have planted Roundup Ready corn, then you can add glyphosate to the mixture as well. Keep in mind glyphosate activity may suffer when mixed with other herbicides or UAN so the 1 qt rate should be used. Another option with Roundup Ready corn would be to use products that contain both a pre-emergence herbicide and glyphosate as a premix. Also, if you are considering adding 2,4-D to the mixture, it is best if the entire field is in at least the spike stage to avoid injury to the corn.

Please Note:

Balance is not registered postemergence. If used postemergence, some injury may occur. DO NOT use on light sandy soils with low organic matter. Crop oil can be added with some mixtures, but be sure to check labels.

Pre-emergence Herbicides that can be Applied Postemergence

Treatment	Crop Stage	Maximum Weed Stage
Corn		
Aatrex/ Atrazine	0-12"	1.5"
Bicep II Magnum/ Cinch ATZ	0-5"	2-leaf
Bicep II Lite Magnum/ Cinch ATZ Lite	0-5"	2-leaf
Bicep II Magnum FC	0-5"	2-leaf
Callisto ¹	0-30"	5"
Contour	0-12"	3"
Define SC	Corn up to 5-leaf	
Degree	0-11"	unemerged
Degree Xtra	0-11"	2-leaf
Dual Magnum	0-40"	unemerged
Dual II Magnum/ Cinch	0-5"	unemerged
Dual + Aatrex	0-5"	2-leaf
Expert ²	0-12"	6"
Field Master ²	0-12"	6"
FulTime (after FirstRate)	0-11"	unemerged
G-MAX Lite	0-12"	1.5"
Guardsman Max	0-12"	1.5"
Harness/Confidence	0-11"	unemerged
Harness Xtra/Confidence Xtra	0-11"	2-leaf
Hornet WDG	0-20"	8"
Keystone	0-11"	unemerged
Keystone LA	0-11"	unemerged
Lasso	0-5"	2-leaf
Lightning (IMI corn)	corn < 8-leaf	weeds < 3"
Lumax/Lexar ²	0-12"	3"
Marksman	0-8"	4"
Me-Too-Lachlor II	0-40"	2-leaf
Outlook	0-12"	unemerged
Pendimax/Prowl	0-30"	1"
Prowl H ₂ O	0-36"	1"
Python	0-20"	6"
Stalwart C	0-40"	2-leaf
Stalwart Xtra	0-5"	2-leaf
Surpass	0-11"	unemerged
Topnotch	0-11"	unemerged
Trizmet II	0-5"	2-leaf
Volley/Volley ATZ/Valley ATZ Lite	0-11"	unemerged
Soybeans		
Dual II Magnum	up to 3rd trifoliolate	unemerged
FirstRate	up to 1/2 flower	see label
Outlook	1st to 3rd trifoliolate	unemerged
Pursuit	—	3"
Grain Sorghum		
Aatrex/ Atrazine	0-12"	1.5"
Bicep II Magnum	up to 5"	2-leaf
Dual Magnum	up to 5"	unemerged
Dual II Magnum	0-5"	unemerged
G-MAX Lite	0-12"	1.5"
Guardsman	0-8"	1.5"
Lasso	up to 5"	unemerged
Outlook	0-12"	unemerged

¹Severe injury may occur if Callisto is applied postemergence to corn that has been treated with Counter. Do not tank mix with any organophosphate or carbamate insecticide. Do not cultivate within seven days of application

²Do not mix this product with complex fertilizer mixtures such as 10-34-0 or flowables. Use only water or liquid nitrogen carrier.

CRP/Sod Response to Selected Herbicides

Herbicide	Treatment Time ¹	Rate/A	Alfalfa	Bluegrass	Red Clover	Smooth Brome	Sweet Clover	Tall Fescue
2,4-D + dicamba●	Spring	1.0 qt + 0.5 pt	9	1	10	2	10	2
2,4-D + dicamba●	Fall	1.0 qt + 0.5 pt	10	1	10	2	10	2
Gramoxone Max	Spring	1.3 pt	2	5	5	3	3	5
Gramoxone Max	Spring	2.7 pt	3	6	6	4	4	7
Gramoxone Max	Fall	1.3 pt	3	6	6	4	4	6
Gramoxone Max	Fall	2.7 pt	5	6	6	5	4	7
Glyphosate◆	Spring	1.0 qt	5	8	5	4	5	5
Glyphosate◆	Spring	2.0 qt	6	9	7	6	7	7
Glyphosate◆	Fall	1.0 qt	6	9	7	6	7	7
Glyphosate◆	Fall	2.0 qt	7	10	9	8	9	9
Glyphosate◆ + 2,4-D	Spring	1 qt + 1 pt	7	8	8	4	8	5
Glyphosate◆ + 2,4-D	Spring	2 qt + 1 qt	8	9	9	6	9	7
Glyphosate◆ + 2,4-D	Fall	1 qt + 1 pt	8	9	9	6	9	7
Glyphosate◆ + 2,4-D	Fall	2 qt + 1 qt	9	10	10	8	10	8
Glyphosate◆ + dicamba●	Spring	1 qt + 0.5 pt	8	8	9	4	9	5
Glyphosate◆ + dicamba●	Spring	2 qt + 1 pt	9	9	10	6	10	7
Glyphosate◆ + dicamba●	Fall	1 qt + 0.5 pt	9	9	10	6	10	7
Glyphosate◆ + dicamba●	Fall	2 qt + 1 pt	10	10	10	8	10	9
Gramoxone + atrazine	Spring	1.3 pt + 2 lb	5	9	7	7	7	7

Herbicide	Treatment Time	Rate	Warm Season Grasses	Wheatgrass
Gramoxone Max	Spring	1.3 pt	3	3
Gramoxone Max	Spring	2.7 pt	4	4
Gramoxone Max	Fall	1.3 pt	4	4
Gramoxone Max	Fall	2.7 pt	5	5
Glyphosate◆	Spring	1.0 qt	4	4
Glyphosate◆	Spring	2.0 qt	7	6
Glyphosate◆	Fall	1.0 qt	7	6
Glyphosate◆	Fall	2.0 qt	9	8
Glyphosate◆ + 2,4-D	Spring	1 qt + 1 pt	4	4
Glyphosate◆ + 2,4-D	Spring	2 qt + 1 qt	7	6
Glyphosate◆ + 2,4-D	Fall	1 qt + 1 pt	7	6
Glyphosate◆ + 2,4-D	Fall	2 qt + 1 qt	9	8
Glyphosate◆ + dicamba●	Spring	1 qt + 0.5 pt	4	4
Glyphosate◆ + dicamba●	Spring	2 qt + 1 pt	7	6
Glyphosate◆ + dicamba●	Fall	1 qt + 0.5 pt	7	6
Glyphosate◆ + dicamba●	Fall	2 qt + 1 pt	9	8
Gramoxone Max + atrazine	Spring	1.3 pt + 2 lb	3	7

Rating	Percent Control
10	— (96-100%)
9	— (90-95%)
8	— (85-90%)
7	— (80-84%)
6	— (70-79%)
5	— (60-69%)
4-2	— less than 60%
1	— 0

Ratings reflect favorable growing conditions.

¹ Response ratings assume that old growth is removed before application and 6-12 inches of new growth is present. Soil moisture affects the response. Soil moisture is usually limiting in the fall in western Nebraska. Response ratings assume the additions of AMS and appropriate surfactant. Fall applications to warm-season grasses must be made prior to dormancy, usually before September 15 to October 5, depending on area of the state. Control of warm-season grasses will decrease after a light frost. Fall applications to cool-season grasses may be made through November 1.

- ◆ Glyphosate is the active ingredient in many products. The rates provided on this page are based on a 4 lb ai or 3 lb ae formulation. See the glyphosate product comparison table on pages 146-147 for the use rate and more information on the product being used.
- Dicamba is the active ingredient in Banvel, Clarity, Sterling and several other herbicides. The rates and information provided here are based on the same 4 lb/gal acid equivalent formulation found in Banvel, Clarity and Sterling.

Weed Response to Burndown Herbicides¹

No-till Corn and Grain Sorghum

Winter annual weeds (henbit, horseweed, pennycress, etc.) can be quite susceptible to fall herbicide application. Typically herbicides such as 2,4-D, dicamba, and glyphosate all work well and inexpensively on newly germinated winter annual weeds in the fall. Herbicides can be applied in the fall, weather permitting, from late September up until early December. Before using a particular herbicide, check to see if it is labeled for fall application. Atrazine does not have a label for fall application in Nebraska.

Plant response may be altered by growing conditions, genetic variation in crops and weeds, soil type, pH, organic matter, temperature, growth stage, and application rates. Ratings may vary from season to season and geographical areas within the state. Ratings apply when herbicides are used as suggested in this publication. See pages 113-127 for additional problem weeds and their control.

Weed Response to Fall Burndown

Herbicide	Dandelion	Downy Brome	Henbit	Marestail	Pennycress	Prickly Lettuce	Shepherdspurse	Alfalfa
2,4-D Ester (1 qt)	8	1	9	9	10	9	10	7
Basis + 2,4-D (0.5 oz + 1 pt)	8	4	8	9	10	10	10	6
Glyphosate (32 oz)	6	10	9	8	9	8	10	5
Glyphosate + 2,4-D ester (4L) (24 oz + 1 pt)	8	10	9	9	10	8	10	8
Gramoxone Max (1.3 pt)	5	7	9	7	10	8	9	4

Weed Response to Spring Burndown Herbicides¹

Herbicide	Annual Bluegrass	Chickweed	Downy Brome	Dandelion	Foxtail Barley	Evening Primrose	Henbit	Horseweed (Marestail)	Field Pennycress	Prickly Lettuce	Shepherdspurse	Purslane Speedwell	Virginia Pepperweed	Tall Knotweed	Foxtail	Barnyardgrass	Lambsquarters	Longspine Sandbur	Kochia	Kochia-Triazine-resistant	Russian Thistle	Smartweed—Pennsylvania	Velvetleaf	Sunflower	Corn — volunteer	Winter Wheat or Rye	Alfalfa	Sweet Clover	Hairy Vetch	Grain Sorghum ²
2,4-D (4L) ester (1.0 pt) ³	1	7	1	5	1	7	5	7	10	9	10	7	8	6	1	1	9	1	7	4	9	7	8	10	1	1	5	7	9	Y
2,4-D (4L) ester (1.0 pt) + Dicamba [•] (0.5 pt) ³	1	10	1	7	1	8	7	8	10	9	10	7	9	9	1	1	9	2	9	9	9	9	8	10	1	1	9	8	10	N
Atrazine (2.0 qt) + COC	9	10	7	4	9	9	9	8	9	9	9	10	9	9	7	6	9	6	9	1	9	9	9	10	1	6	4	3	6	Y
Atrazine + Aim (1.1 lb + 0.5 oz)	7	10	6	4	7	9	9	8	9	9	9	10	9	9	5	4	9	4	9	6	9	9	9	10	1	4	2	2	4	Y
Atrazine + dicamba ^{•3} (2.0 qt + 0.5 pt)	10	10	8	8	10	10	10	10	10	10	10	10	10	10	9	7	10	7	10	10	9	10	9	10	2	5	7	9	10	N
Atrazine + 2,4-D (4L) ester ³ (2.0 qt + 1.0 pt)	10	10	8	6	10	10	10	10	10	10	10	10	10	10	8	7	10	7	10	6	9	10	10	10	2	7	5	8	10	Y
Balance Pro	-	8	5	2	2	-	8	8	7	8	-	-	-	-	8	8	9	8	8	8	-	8	10	7	4	3	2	1	-	N

¹This table presents burndown preplant herbicide information only. It does not reflect residual weed control.

²Treatment labeled for use in no-till grain sorghum, Y = Yes, N = No.

³A note about Using 2,4-D and dicamba Before Planting: Many times producers want to apply 2,4-D and/or dicamba (Banvel/Clarity/Sterling) prior to crop planting. The University of Nebraska recommends that the following guidelines be used when applying 2,4-D and dicamba before planting corn, soybean, and sorghum. Note that this is applicable to both ester and amine formulations of 2,4-D.

⁴Apply at least 14 days prior to planting corn.

[•] Dicamba is the active ingredient in Banvel, Clarity, Sterling and several other herbicides. The rates and information provided here are based on the same 4 lb/gal acid equivalent formulation found in Banvel, Clarity and Sterling.

Weed Response to Spring Burndown Herbicides¹ (continued)

	Annual Bluegrass	Chickweed	Downy Brome	Dandelion	Foxtail Barley	Evening Primrose	Henbit	Horseweed (Marestail)	Field Pennycress	Prickly Lettuce	Shepherdspurse	Purslane Speedwell	Virginia Pepperweed	Tall Knotweed	Foxtail	Barnyardgrass	Lambsquarters	Longspine Sandbur	Kochia	Kochia-Triazine-resistant	Russian Thistle	Smartweed—Pennsylvania	Velvetleaf	Sunflower	Corn — volunteer	Winter Wheat or Rye	Alfalfa	Sweet Clover	Hairy Vetch	Grain Sorghum ²
Balance PRO + atrazine	8	9	6	6	5	-	9	9	9	9	10	9	9	10	9	9	10	9	9	8	9	9	10	8	4	4	4	2	-	N
Distinct (4-6 oz) ⁴	1	10	1	8	1	7	8	9	9	9	7	4	7	9	1	1	7	2	9	9	9	8	7	10	1	1	9	8	10	N
Dicamba [◆] (0.5 pt) ³	1	10	1	8	1	7	7	7	9	9	7	4	7	9	1	1	7	2	9	9	9	8	7	10	1	1	9	8	10	N
Expert (3.0 qt)	10	10	10	7	9	9	9	9	10	8	10	10	9	9	10	10	9	10	9	9	9	9	10	10	10	10	5	4	6	Y
Field Master (4.5 qt)	10	10	10	7	9	10	10	10	10	10	10	10	10	10	10	10	10	10	10	9	10	10	10	10	10 [‡]	10	5	4	6	N
Gramoxone Max (1.3 pt)	9	10	7	5	7	7	9	7	10	8	9	6	9	8	6	6	7	9	9	9	6	6	8	10	4	6	4	6	8	Y
Gramoxone Max + atrazine (1.3 pt + 2.0 qt)	10	10	10	5	10	10	10	9	10	10	10	10	10	10	9	10	10	10	10	9	9	9	10	10	5	10	5	7	7	Y
LandMaster BW (54 oz)	10	10	10	8	9	9	9	9	10	9	10	10	9	9	9	10	9	10	9	9	9	9	10	10	10	10	6	5	7	Y
Radius + atrazine ⁶ (12-24 oz + 0.8-1.4 lb)	8	9	6	6	5	-	9	9	9	9	10	9	9	10	9	9	10	9	9	8	9	9	10	8	4	4	4	2	-	N
Ready Master ATZ (2.0 qt)	10	10	10	6	8	7	7	7	10	7	10	10	7	9	9	10	7	10	8	7	8	7	8	9	10	10	4	3	6	Y
Glyphosate [◆] (24 oz) ⁵	10	10	10	5	9	7	7	6	10	6	10	10	7	9	9	10	7	10	7	7	8	7	7	9	10	10	4	3	5	Y
Glyphosate [◆] (32 oz) ⁵	10	10	10	7	9	8	9	8	10	7	10	10	8	9	10	10	8	10	8	8	9	8	9	9	10	10	5	4	6	Y
Glyphosate [◆] + 2,4-D (4L) ester ⁵ (24 oz + 1.0 pt)	10	10	10	8	9	9	9	9	10	9	10	10	9	9	9	10	9	10	9	9	9	9	10	10	10	10	6	5	7	Y
Glyphosate [◆] + atrazine ⁵ (24 oz + 1.5 pt)	10	10	10	6	8	8	8	8	10	8	10	10	8	8	9	10	7	10	7	8	8	7	8	9	10	10	4	3	6	Y

Rating	Percent Control
10	— 96-100%
9	— 90-95%
8	— 85-90%
7	— 80-84%
6	— 70-79%
5	— 60-69%
4-2	— less than 60%
1	— 0

¹This table presents burndown preplant herbicide information only. It does not reflect residual weed control.

²Treatment labeled for use in no-till grain sorghum, Y = Yes, N = No.

³A note about Using 2,4-D and dicamba Before Planting: Many times producers want to apply 2,4-D and/or dicamba (Banvel/Clarity/Sterling) prior to crop planting. The University of Nebraska recommends that the following guidelines be used when applying 2,4-D and dicamba before planting corn, soybean, and sorghum. Note that this is applicable to both ester and amine formulations of 2,4-D.

⁴Apply at least 14 days prior to planting corn.

⁵During colder day/nights (less than 60°/50°F) glyphosate performance can be reduced.

⁶The rate for Radius varies with soil type. Consult the label for specific information.

[◆] Glyphosate is the active ingredient in many products. The rates provided on this page are based on a 4 lb ai or 3 lb ae formulation. See the glyphosate product comparison table on pages 146-147 for the use rate and more information on the product being used.

2,4-D Preplant Interval	Use Rate	Use Rate
Crop	1 pt	>1 pt
Corn	7 days	14 days
Soybean (use ester only)	7 days	30 days
Sorghum	10 days	21 days

Dicamba Preplant Interval	Use Rate	Use Rate
Crop	1/4 pt	1/2 pt
Corn	5 days	7 days
Soybean	DO NOT USE	DO NOT USE
Sorghum	7 days	10 days

Broadleaf Weed Response To Soil-applied Herbicides

Field Corn, Popcorn[○], Sweet Corn[□], and Silage[△]

Plant response may be altered by growing conditions, genetic variation in crops and weeds, soil type, pH, organic matter, and application rates. Ratings may vary from season to season and geographical areas within the state. Ratings apply when herbicides are used as suggested in this publication. See pages 113-127 for additional problem weeds and their control.

Weed Response Ratings: Ratings are for light to moderate weed densities, favorable conditions and weed growth stage as specified on the product label. High weed densities, adverse conditions, or large weeds will reduce control.

10 — 96-100% 9 — 90-95%
 8 — 85-89% 7 — 80-84%
 6 — 70-79% 5 — 60-69%
 4-2 — less than 60% 1 — 0%

	B. Nightshade (3.5) [§]	Cocklebur (5.5)	Kochia (2.5)	Kochia, ALS-resistant (2.5)	Kochia, Triazine-resistant (2.5)	Lambsquarters (1.5)	Morningglory species (5.5)	Pigweed (2.5)	Pigweed, Triazine-resistant (2.5)	Ragweed (4.5)	R. Thistle (2.3)	Smartweed (1.5)	Sunflower (10)	Velvetleaf (4.2)	Waterhemp (2.5)	Waterhemp, ALS-resistant (2.5)	Waterhemp, Triazine-resistant (2.5)	Crop Safety [■]
AAtrax/Atrazine ^{○□△}	9	8	10	10	1	10	8	10	1	9	9	9	7	7	9	9	1	1
Axiom [△]	7	5	5	5	2	8	4	9	7	7	5	6	6	6	7	7	6	2
Axiom + Atrazine [△]	9	6	9	9	2	9	6	10	6	8	6	8	7	7	9	9	6	2
Balance Pro	8	5	10	10	10	8	4	8	8	8	6	8	6	9	8	8	8	2
Balance Pro + Atrazine	8	7	10	10	10	9	5	9	8	8	8	9	7	10	9	9	8	2
Balance Pro + Bicep II Magnum/Cinch ATZ	9	7	9	9	9	9	5	9	9	7	8	8	7	9	9	9	9	2
Balance Pro + Define	9	5	9	9	9	9	4	9	9	9	7	8	6	9	9	9	9	2
Balance Pro + Surpass/Harness/Confidence	9	6	9	9	9	9	4	9	9	8	6	8	6	9	9	9	9	2
Bicep II Magnum/Cinch ATZ ^{○□△}	8	7	9	9	2	9	6	8	8	8	8	8	6	6	9	9	8	2
Callisto [△]	9	7	7	7	7	9	6	10	10	8	8	9	9	9	9	9	9	1
Callisto + Dual II Magnum/Cinch [△]	9	7	7	7	7	9	6	10	10	8	8	9	9	9	9	9	9	2
Camix [△]	9	7	7	7	7	9	6	10	10	8	8	9	9	9	9	9	9	2
Define [△]	7	2	2	2	2	7	1	7	7	5	3	2	2	2	7	7	7	2
Degree/Topnotch ^{○△}	8	3	2	2	2	8	1	8	8	6	5	3	2	3	8	8	8	2
Degree Xtra;r/Topnotch + atrazine [○]	9	7	9	9	2	9	6	9	7	8	8	8	6	6	9	9	7	2
Dual II Magnum/Cinch ^{○□△}	7	2	2	2	2	7	1	7	7	5	3	2	2	2	8	8	8	2
Fulltime ^{○△}	9	7	9	9	2	9	6	9	7	8	8	8	6	6	9	9	7	2
G-Max Lite ^{○□△}	9	6	7	7	5	8	5	9	8	8	8	8	6	6	9	9	7	2
Guardsman Max ^{○□△}	9	7	7	7	5	9	6	9	8	8	8	9	6	6	9	9	8	2
Harness/Confidence ^{○△}	7	2	2	2	2	7	1	7	7	5	3	2	2	2	8	8	8	2
Harness Xtra/Confidence Xtra ^{○△}	9	7	9	9	2	9	6	9	7	8	8	8	6	6	9	9	7	2
Hornet [△]	7	8	9	4	9	9	8	9	9	7	8	8	9	8	9	5	9	2
Keystone ^{○△} /Volley ATZ ^{○△}	9	7	9	9	2	9	6	9	7	8	8	8	6	6	9	9	7	2
Lumax/Lexar ^{□△}	9	7	9	9	7	9	7	10	10	8	8	9	9	9	9	9	9	2
Micro-Tech + atrazine ^{○□△}	9	7	9	9	2	9	6	9	9	8	8	8	6	6	9	9	7	2
Outlook ^{○□△}	8	2	2	2	3	7	1	8	8	5	3	2	2	2	8	8	8	2
Prowl/Prowl H20/Pendimax + atrazine ^{○□△}	9	6	9	9	5	9	6	9	7	7	7	8	6	7	9	9	6	3
Radius [△]	8	6	8	8	8	8	5	9	9	8	6	8	6	9	9	9	9	2
Stalwart C/Me-Too-Lachlor ^{○□}	7	2	2	2	2	7	1	7	7	5	3	2	2	2	8	8	8	2
Stalwart Xtra [○] /Trizmet II [○]	8	7	9	9	2	9	9	8	8	8	8	8	6	6	9	9	8	2
Surpass ^{○△}	7	2	2	2	2	8	1	8	8	5	3	2	2	2	8	8	8	2

■Crop hybrids vary in their response to herbicides. Crop safety ratings less than 3 indicate that crop yield should not be affected by any direct injury.

○Registered for popcorn.

□Registered for sweet corn.

△Registered for silage.

⊗Registered for yellow popcorn only.

§Weed Competitive Index—See page 5.

Grass Weed Response To Soil-applied Herbicides

Field Corn, Popcorn[○], Sweet Corn[□], and Silage[△]

Plant response may be altered by growing conditions, genetic variation in crops and weeds, soil type, pH, organic matter, and application rates. Ratings may vary from season to season and geographical areas within the state. Ratings apply when herbicides are used as suggested in this publication. See pages 113-127 for additional problem weeds and their control.

Weed Response Ratings: Ratings are for light to moderate weed densities, favorable conditions and weed growth stage as specified on the product label. High weed densities, adverse conditions, or large weeds will reduce control. 10 — 96-100% 9 — 90-95% 8 — 85-89% 7 — 80-84% 6 — 70-79% 5 — 60-69% 4-2 — less than 60% 1 — 0%	Weed Competitive Index [§]			Weed Response			Crop Safety [■]				
	Barnyardgrass (0.3)	Crabgrass (0.5)	Fall Panicum (0.4)	Giant Foxtail (2.0)	Green Foxtail (1.0)	Yellow Foxtail (1.0)	Sandbur (0.4)	Shattercane/Sorghum (3.5)	Shattercane, ALS-resistant (3.5)	Woolly Cupgrass (2.5)	
AAtrax/atrazine ^{○□△}	6	4	2	6	7	6	5	1	1	3	1
Axiom [△]	9	9	9	9	9	9	7	6	6	6	2
Axiom + atrazine [△]	9	9	9	9	9	9	7	6	6	6	2
Balance Pro	7	7	7	8	9	5	6	5	5	8	2
Balance Pro + atrazine	8	7	7	8	9	6	7	5	5	8	2
Balance Pro + Bicep II	8	8	8	9	9	8	7	6	5	9	2
Balance Pro + Define	9	9	9	9	9	9	7	6	5	8	2
Balance Pro + Surpass	8	7	8	9	9	9	7	6	4	9	2
Bicep II Magnum/Cinch ATZ ^{○□△⊗}	9	9	9	9	9	9	6	4	4	6	2
Callisto ^{△⊗}	1	7	1	1	1	1	1	1	1	1	1
Callisto + Dual II Magnum/Cinch ^{△⊗}	9	9	9	9	9	9	5	4	4	6	2
Camix ^{□△}	9	9	9	9	9	9	6	5	5	7	2
Define [△]	9	9	9	9	9	9	7	4	4	6	2
Degree/Topnotch ^{○△}	9	9	9	9	9	9	6	4	4	7	2
Degree Xtra/Topnotch + atrazine ^{○△}	9	9	9	9	9	9	6	4	4	7	2
Dual II Magnum/Cinch ^{○□}	9	9	9	9	9	9	5	4	4	6	2
Fultime ^{○△}	9	9	9	9	9	9	6	4	4	8	2
G-Max Lite ^{○□△}	9	9	9	9	9	9	7	4	4	8	2
Guardsman Max ^{○□△}	9	9	9	9	9	9	7	4	4	8	2
Harness/Confidence ^{○△}	9	9	9	9	9	9	6	4	4	7	2
Harness Xtra/Confidence Xtra ^{○△}	9	9	9	9	9	9	6	4	4	8	2
Hornet [△]	1	1	1	1	1	1	1	1	1	1	2
Keystone/Volley ATZ ^{○△}	9	9	9	9	9	9	6	4	4	8	2
Lumax/Lexar ^{□△⊗}	9	9	9	9	9	9	6	4	4	6	2
Micro-Tech + atrazine ^{○□△}	9	9	9	9	9	9	6	4	4	6	2
Outlook ^{○□△}	9	9	9	9	9	9	5	4	4	6	2
Prowl/Prowl H20/Pendimax + Atrazine ^{○□△}	8	9	9	9	9	9	7	3	3	7	3
Radius [△]	9	9	9	9	9	9	7	7	7	8	2
Stalwart C/Me-Too-Lachlor ^{○□}	9	9	9	9	9	9	5	4	4	6	2
Stalwart Xtra [○] /Trizmet II [○]	9	9	9	9	9	9	6	4	4	6	2
Surpass ^{○△}	9	9	9	9	9	9	6	4	4	7	2

■ Crop hybrids vary in their response to herbicides. Crop safety ratings less than 3 indicate that crop yield should not be affected by any direct injury.

○ Registered for popcorn.

□ Registered for sweet corn.

△ Registered for silage.

⊗ Registered for yellow popcorn only.

§ Weed Competitive Index—See page 5.

Broadleaf Weed Response To Postemergence Herbicides

Field Corn, Popcorn[○], Sweet Corn[□], and Silage[△]

Plant response may be altered by growing conditions, genetic variation in crops and weeds, soil type, pH, organic matter, and application rates. Ratings may vary from season to season and from one geographical area to another within the state. Ratings apply when herbicides are used as suggested in this publication. See pages 113-127 for additional problem weeds and their control.

Weed Response Ratings: Ratings are for light to moderate weed densities, favorable conditions and weed growth stage as specified on the product label. High weed densities, adverse conditions, or large weeds will reduce control.
 10 — 96-100% 9 — 90-95%
 8 — 85-89% 7 — 80-84%
 6 — 70-79% 5 — 60-69%
 4-2 — less than 60% 1 — 0%

B. Nightshade (3.5) [§]	Cocklebur (5.5)	Kochia (2.5)	Kochia, ALS-resistant (2.5)	Kochia, Triazine-resistant (2.5)	Lambsquarters (1.5)	Morningglory species (5.5)	Pigweed (2.5)	Pigweed, Triazine-resistant (2.5)	Ragweed (4.5)	R. Thistle (2.3)	Smartweed (1.5)	Sunflower (10)	Velvetleaf (4.2)	Waterhemp (2.5)	Waterhemp, ALS-resistant (2.5)	Waterhemp, Triazine-resistant (2.5)	Crop Safety [■]
----------------------------------	-----------------	--------------	-----------------------------	----------------------------------	---------------------	----------------------------	---------------	-----------------------------------	---------------	------------------	-----------------	----------------	------------------	-----------------	--------------------------------	-------------------------------------	--------------------------

Weed size influences performance—see label

AAtrax/atrazine ^{○□△}	9 9 9	9 1 9	8 9 1	9 9 4	9 8 8	8 1 1
Accent [○]	3 5 6	1 6 4	6 7 7	1 3 7	4 4 7	1 7 2
Accent + atrazine [○]	9 9 9	9 6 9	8 9 7	9 4 9	9 8 9	7 7 2
Accent + dicamba [●] or Celebrity Plus [○]	7 9 8	7 8 7	9 8 8	8 8 9	8 7 8	7 8 3
Accent + Buctril/atrazine [○]	9 9 9	9 8 9	8 9 6	9 8 9	9 8 8	8 6 2
Accent Gold	7 9 6	6 6 7	7 7 7	8 5 8	9 8 6	4 6 3
Aim/Avalanche ^{○□△}	9 7 6	6 6 9	7 8 8	6 6 8	5 10 7	7 7 2
Aim + atrazine ^{○□△}	9 8 8	8 6 9	9 9 8	7 6 8	6 10 8	8 7 2
Aim + Clarity ^{○△}	9 8 8	8 8 9	9 9 9	8 9 9	7 10 8	8 8 3
Basis	3 9 3	1 3 7	5 9 9	5 4 8	7 8 8	1 8 3
Basis Gold	9 9 8	3 5 9	8 9 6	9 9 8	8 8 8	7 6 2
Beacon ^{○△}	8 8 8	1 8 5	6 8 8	9 5 8	9 6 8	1 8 2
Buctril [○]	9 9 8	8 8 8	7 6 6	9 7 9	9 7 6	6 6 2
Buctril + atrazine ^{○□△}	9 9 9	9 8 9	8 9 6	9 8 9	9 8 8	8 6 2
Buctril + dicamba ^{●□△}	9 9 9	9 9 7	9 8 8	7 9 9	9 8 8	8 8 3
Callisto ^{△⊗}	9 9 6	6 6 9	6 9 9	6 9 9	9 9 9	9 9 1
Callisto + atrazine ^{△⊗}	9 9 8	8 6 9	8 10 9	8 9 9	9 10 10	10 9 1
Callisto + atrazine + Steadfast [⊗]	9 9 8	8 6 9	8 10 9	8 9 9	9 10 10	10 9 2
Dicamba ^{●○△}	7 9 8	8 8 8	9 8 8	8 9 9	8 6 7	7 7 3
Distinct ^{○△}	7 9 8	8 8 8	9 8 8	8 9 9	8 6 7	7 7 3
Equip	9 9 8	1 8 9	8 9 9	9 3 8	9 9 6	1 6 2
Exceed ^{○△}	8 9 8	1 8 7	7 9 9	9 4 8	9 8 8	1 8 2
Expert ^{○□△}	8 9 9	9 6 8	7 9 8	7 8 8	9 9 9	9 7 1
Glyphosate [◆] (1.0 qt) ^{○□△}	8 9 8	8 8 8	6 9 9	8 7 8	9 8 9	9 9 1
Hornet [△]	7 9 6	6 6 8	7 7 7	8 5 8	9 8 6	5 6 3
Impact	9 9 6	6 6 9	6 9 9	6 9 9	9 9 9	9 9 1
Impact + atrazine	9 9 8	8 6 9	8 10 9	8 9 9	9 10 10	10 9 1
Laddok S-12 ^{○□△}	7 9 8	8 7 7	8 8 2	9 2 9	9 9 8	8 1 1
Liberty + atrazine [△]	9 9 9	9 7 9	9 9 7	9 9 9	9 9 7	9 7 1
Lightning	8 9 8	1 8 8	8 9 9	7 5 8	8 9 6	1 6 1
Lightning + dicamba [●]	8 9 9	9 9 9	9 9 9	8 8 9	8 9 8	8 8 3
Marksman/Sterling Plus [○]	9 9 8	8 8 9	9 9 8	9 7 9	9 8 9	9 7 2
Northstar ^{* ○□△}	8 9 8	4 8 8	8 8 8	9 8 9	9 6 7	4 7 2
Option	8 7 3	1 3 6	7 7 7	5 3 3	7 8 6	1 6 2
Option + Distinct	8 9 8	8 8 8	9 8 8	8 9 9	8 8 7	7 7 2
Permit ^{○□△}	3 9 6	1 6 5	5 9 9	9 4 7	9 9 8	1 8 2
Ready Master ATZ	8 9 9	9 7 9	8 9 8	8 9 9	9 9 9	9 8 1
Resource	4 5 3	3 3 7	5 5 5	7 3 4	4 10 5	5 5 2
Spirit ^{○△}	8 8 8	1 8 6	6 8 8	9 4 8	9 7 8	1 8 2
Starane [□]	5 6 9	9 9 2	8 2 2	8 5 2	6 7 2	2 2 1
Steadfast	3 5 6	1 6 6	5 7 7	1 3 7	7 5 7	1 7 2
2,4-D ^{○□△}	6 10 5	5 5 8	9 7 7	8 4 5	7 8 8	8 8 3
Yukon [△]	6 9 7	7 7 8	8 9 9	9 7 8	9 9 8	6 8 2

[§]Weed Competitive Index—See page 5.

[■]Crop hybrids vary in their response to herbicides. Crop safety ratings less than 3 indicate that crop yield should not be affected by any direct injury.

[○]Registered for popcorn. [□]Registered for sweet corn. [△]Registered for silage. [⊗]Registered for yellow popcorn only.

[◆]Glyphosate is the active ingredient in many products. The rates provided on this page are based on a 4 lb ai or 3 lb ae formulation. See the glyphosate product comparison table on pages 146-147 for the use rate and more information on the product being used.

[●]Dicamba is the active ingredient in Banvel, Clarity, Sterling and several other herbicides. The rates and information provided here are based on the same 4 lb/gal acid equivalent formulation found in Banvel, Clarity and Sterling.

Grass Weed Response To Postemergence Herbicides

Field Corn, Popcorn[○], Sweet Corn[□], and Silage[△]

Plant response may be altered by growing conditions, genetic variation in crops and weeds, soil type, pH, organic matter, temperature, growth stage, and application rates. Ratings may vary from season to season and geographical areas within the state. Ratings apply when herbicides are used as suggested in this publication. See pages 113-127 for additional problem weeds and their control.

Weed Response Ratings: Ratings are for light to moderate weed densities, favorable conditions and weed growth stage as specified on the product label. High weed densities, adverse conditions, or large weeds will reduce control.

10 — 96-100% 9 — 90-95%
 8 — 85-89% 7 — 80-84%
 6 — 70-79% 5 — 60-69%
 4-2 — less than 60% 1 — 0%

Barnyardgrass (0.3) [§]	Crabgrass (0.5)	Fall Panicum (0.4)	Giant Foxtail (2.0)	Green Foxtail (1.0)	Yellow Foxtail (1.0)	Sandbur (0.4)	Shattercane/Sorghum (3.5)	Shattercane, ALS-resistant (3.5)	Woolly Cupgrass (2.5)	Crop Safety [■]
----------------------------------	-----------------	--------------------	---------------------	---------------------	----------------------	---------------	---------------------------	----------------------------------	-----------------------	--------------------------

Weed size influences performance—see label

AAtrex/atrazine ^{○□△}	5	4	2	5	6	6	4	2	1	5	2
Accent [○]	8	4	8	8	8	8	8	10	1	7	2
Accent + atrazine [○]	8	3	8	8	8	8	8	10	1	8	2
Accent + dicamba [●] or Celebrity Plus [○]	8	4	8	8	8	7	8	10	1	7	3
Accent + Buctril [○]	8	3	8	8	8	8	8	10	1	7	2
Accent Gold	8	7	8	8	8	7	7	10	1	6	3
Aim/Avalanche ^{○□△}	1	1	1	1	1	1	1	1	1	1	2
Aim + atrazine ^{○□△}	3	2	1	2	2	2	1	1	1	2	2
Aim + Clarity ^{○△}	1	1	1	1	1	1	1	1	1	1	3
Basis	7	7	7	7	8	7	7	10	1	4	3
Basis Gold	8	7	8	8	8	7	7	10	1	7	2
Beacon ^{○△}	2	3	7	5	4	5	4	10	1	2	2
Buctril [○]	2	2	2	1	1	1	2	2	2	1	2
Buctril + atrazine [○]	2	2	2	2	2	2	2	2	2	3	2
Buctril + dicamba ^{□△●}	2	2	2	2	2	2	2	2	2	1	3
Callisto ^{△⊗}	1	8	1	1	1	1	1	1	1	1	1
Callisto + atrazine ^{△⊗}	1	8	1	1	1	1	1	1	1	1	1
Callisto + atrazine + Steadfast [⊗]	8	9	8	8	8	8	7	10	1	7	2
Dicamba [●]	2	2	2	2	2	2	2	2	2	1	3
Distinct ^{○△}	6	2	6	4	7	5	2	6	6	3	3
Equip	8	7	8	8	8	8	8	10	1	6	2
Exceed ^{○△}	2	2	3	4	3	4	2	9	1	2	2
Expert ^{○□△}	9	9	9	9	9	9	9	9	9	8	1
Glyphosate [◆] (1.0 qt) ^{○□△}	10	9	10	10	10	10	10	10	10	9	1
Hornet [△]	1	1	1	1	1	1	1	1	1	1	3
Impact	1	8	1	1	1	1	1	1	1	1	1
Impact + atrazine	1	8	1	1	1	1	1	1	1	1	1
Laddok S-12 ^{○□}	2	2	2	2	2	2	2	2	2	2	1
Liberty + atrazine [△]	7	8	7	8	7	8	6	8	8	8	1
Lightning	8	7	8	8	7	7	8	9	1	8	1
Lightning + dicamba [●]	8	7	8	8	7	7	8	9	1	8	3
Marksman/Sterling Plus	2	2	2	2	2	2	2	2	2	2	2
Northstar ^{○□△}	2	2	2	3	2	4	2	9	2	2	2
Option	8	7	8	8	8	8	7	10	1	6	2
Option + Distinct	8	7	8	8	9	8	7	10	6	6	2
Permit ^{○□△}	1	1	1	1	1	1	1	1	1	1	2
Ready Master ATZ	9	9	9	9	9	9	9	9	9	8	1
Resource	1	1	1	1	1	1	1	1	1	1	1
Spirit ^{○△}	2	2	5	4	3	5	3	10	1	3	2
Starane	1	1	1	1	1	1	1	1	1	1	1
Steadfast	8	7	8	8	8	8	8	10	1	7	2
2,4-D ^{○□△}	2	2	2	1	1	1	2	2	2	1	3
Yukon [△]	1	1	1	1	1	1	1	1	1	1	2

[§]Weed Competitive Index—See page 5.

[■]Crop hybrids vary in their response to herbicides. Crop safety ratings less than 3 indicate that crop yield should not be affected by any direct injury.

[○]Registered for popcorn. [□]Registered for sweet corn. [△]Registered for silage. [⊗]Registered for yellow popcorn only.

[◆]Glyphosate is the active ingredient in many products. The rates provided on this page are based on a 4 lb ai or 3 lb ae formulation. See the glyphosate product comparison table on pages 146-147 for the use rate and more information on the product being used.

[●]Dicamba is the active ingredient in Banvel, Clarity, Sterling and several other herbicides. The rates and information provided here are based on the same 4 lb/gal acid equivalent formulation found in Banvel, Clarity and Sterling.

A Note about Using 2,4-D and Dicamba Before Planting

Many times producers want to apply 2,4-D and/or dicamba (Banvel/Clarity/Sterling) prior to crop planting. The University of Nebraska recommends that the following guidelines be used when applying 2,4-D and dicamba before planting corn, soybean and sorghum. Note that this is applicable to both ester and amine formulations of 2,4-D.

2,4-D Preplant Interval			Dicamba Preplant Interval		
Crop	Use Rate	Use Rate	Crop	Use Rate	Use Rate
	1 pt	>1 pt		1/4 pt	1/2 pt
Corn	7 days	14 days	Corn	5 days	7 days
Soybean (use ester only)	7 days	30 days	Soybean	DO NOT USE	DO NOT USE
Sorghum	10 days	21 days	Sorghum	7 days	10 days

When using rye as a cover crop, do not plant corn until at least 10 days after the rye has been sprayed.

Corn No-till (Burndown or Establishment)

Herbicide	Commercial Product per Acre			Application Time	Remarks and Approximate Cost/A Broadcast
	Sandy Loam < 1% OM	Silt Loam 1-2% OM	Silty-Clay Loam > 2% OM		
Cool-Season Grass Sod (including smooth brome and bluegrass)					
ATRAZINE DF ^{○□△■} + GRAMOXONE MAX	1.6 lb 1.3-2.1 pt	2.2 lb 1.3-2.1 pt	2.2 lb 1.3-2.1 pt	Apply when grass is 4-6" and before corn emerges	Cost: Atrazine DF + Gramoxone Max \$10.90-\$16.70.
GLYPHOSATE ^{○□△◆}	48-64 oz	48-64 oz	48-64 oz	Fall new growth	Use appropriate herbicide at planting. Plant RR Corn. Cost: glyphosate \$5.30-\$7.00.
Alfalfa/Clover Sod					
2,4-D ester (4L) ^{○□△}	1.5 qt	1.5 qt	1.5 qt	Fall only	Cost: \$5.50.
2,4-D ester (4L) ^{○□△} + DICAMBA ^{□△●} followed by appropriate herbicide at planting or early preplant	1 qt 0.5 pt	1 qt 0.5 pt	1 qt 0.5 pt	Apply in fall or Apr.-May to alfalfa growth and at least 10-14 days before planting	2,4-D + dicamba used to kill alfalfa. Don't apply with 28% UAN or if a triazine is present, add glyphosate. On sandy soils delay planting corn 10 days. Cost: \$8.50.
Rye or Winter Wheat					
ATRAZINE DF ^{○□△■} + BALANCE PRO ¹ + GRAMOXONE MAX	Do not use [⊙] Do not use Do not use	1.6 lb 1.9-3.0 oz 1.3 pt	1.7 lb 2.2-3.0 oz 1.3 pt	Apply when rye and wheat are 2-4" and before corn emerges	On dryland, moisture may be inadequate for corn. Cost: Atrazine + Balance + Gramoxone Max \$24.60-\$38.50.
ATRAZINE DF ^{○□△■} + GRAMOXONE MAX	1.4 lb 1.3 pt	1.6 lb 1.3 pt	1.7 lb 1.3 pt		Add appropriate annual grass herbicide. Cost: Atrazine + Gramoxone Max \$10.50-\$11.10.
FIELD MASTER ^{○△}	3.5-4 qt	4 qt	4-5 qt	PRE	If 2,4-D or dicamba is needed, they must be applied more than 7 days before planting corn. Cost: \$25.20-\$36.00.

¹Balance is not recommended on coarse-textured soils of less than 1.5% O.M. or pH greater than 7.4. If applied PRE on medium-textured soils with a pH greater than 7.5, decrease Balance rate 0.25 oz/A. Corn seed must be covered with 1.5 to 2.0 inches of soil. Avoid planting when surface soil is wet. Rates could be increased by 0.25 oz/A in fields with organic matter greater than 2.5% or with crop residues exceeding 5,000 lb/A. Do not use if water table is shallower than 25 ft.

[⊙]Rate required may pose risk of groundwater contamination.

[◆]Glyphosate is the active ingredient in many products. The rates provided on this page are based on a 4 lb ai or 3 lb ae formulation. See the glyphosate product comparison table on pages 146-147 for the use rate and more information on the product being used.

[○]Registered for popcorn. [□]Registered for sweet corn. [△]Registered for silage. [⊙]Registered for yellow popcorn only.

[■]If atrazine was applied at planting, the total amount of early and late applications cannot exceed 2.5 lb ai/A per calendar year. Use no more than 1.6 lb ai/A on highly erodible land with less than 30% crop residue. Using atrazine on soils with less than 1% organic matter increases carryover injury risk to susceptible crops, especially high pH soils. Do not use on sandy soils if water table is shallower than 30 ft.

[●]Dicamba is the active ingredient in Banvel, Clarity, Sterling and several other herbicides. The rates and information provided here are based on the same 4 lb/gal acid equivalent formulation found in Banvel, Clarity and Sterling.

Corn No-till — Burndown and Preplant (Continued)

Herbicide	Commercial Product per Acre			Application Time	Remarks and Approximate Cost Per Acre Broadcast
	Sandy Loam < 1% OM	Silt Loam 1-2% OM	Silty-Clay Loam > 2% OM		
Rye or Winter Wheat (continued)					
GLYPHOSATE ^{○□△◆}	20-24 oz	20-24 oz	20-24 oz	Apply when rye and wheat are 4-10" and before corn emerges	Use appropriate herbicide at planting. Cost: glyphosate \$2.20-\$2.60.
Continuous Corn					
If split applications are made, use 2/3 of broadcast rate 30-45 days before planting and 1/3 at planting. Products: AAtrax, Dual II Magnum, Bicep II Magnum, Bicep Lite II Magnum, Guardsman					
ATRAZINE DF ^{○□△■}	1.6 lb	2.2 lb	2.2 lb	0-45 DBP	Add 0.5-1 pt of 2,4-D ester or 0.5 pt dicamba to control broadleaf weeds. For triazine-resistant kochia add dicamba. Add Gramoxone Extra or Roundup Ultra to control emerged grass. For volunteer corn (non Roundup Ready) use Roundup Ultra1 at 12-16 oz in 5 gpa water before crop emergence. Cost: Atrazine \$3.70-\$5.10; Atrazine + Dual II Magnum/Cinch \$17.90-\$24.90; Atrazine + Aim \$6.20-\$10.10.
ATRAZINE DF ^{○□△■}	1.3-1.8 lb	1.5-2.0 lb	2.0-2.2 lb	0-45 DBP	
+ DUAL II MAGNUM/CINCH	1.0 pt	1.0-1.33 pt	1.33 pt		
ATRAZINE DF	1.0-1.5 lb	1.0-1.5 lb	1.0-1.5 lb	0-45 DBP	
+ AIM EW	0.5-1.0 oz	0.5-1.0 oz	0.5-1.5 oz		
BALANCE PRO ¹	Do not use	2.0-3.0 oz 1.5-2.0 oz	2.2-3.0 oz 2.2-3.0 oz	8-30 DBP 0-7 DBP	
BALANCE PRO ¹	Do not use	2.0-3.0 oz 1.5-2.0 oz	2.2-3.0 oz 2.2-3.0 oz	8-30 DBP 0-7 DBP	
+ ATRAZINE DF		0.90 lb	1.3 lb		
+ DUAL II MAGNUM/CINCH		1 pt	1.33 pt		
BALANCE PRO ¹	Do not use	1.5-2.0 oz	2.2-3.0 oz	0 to 7 DBP	
+ ATRAZINE DF		1.3 lb	2.0 lb		
or BICEP II MAGNUM/CINCH ATZ		1.8 qt	2.1 qt		
or FULTIME		1.5-2.0 qt	1.75-2.7 qt		
or HARNES XTRA/CONFIDENCE XTRA		1.5-2.0 qt	1.75-2.7 qt		
or SURPASS		1.5-2.0 pt	1.75-2.7 pt		
+ ATRAZINE DF [■]		1.2 lb	1.7 lb		
BICEP II MAGNUM/ CINCH ATZ ^{○□△}	1.8 qt	2.1 qt	2.1-2.6 qt	0-45 DBP	Cost: Bicep II Magnum/Cinch \$20.90-\$30.20; Bicep Lite II Magnum/Cinch \$22.10-\$32.50.
BICEP LITE II MAGNUM/ CINCH ATZ LITE ^{○□△}	1.5 qt	1.5-1.9 qt	1.9-2.2 qt	0-45 DBP	
EXPERT ^{○△}	2.5 qt	3.0 qt	3.0-3.8 qt	0-30 DBP	EPP, PPSA, PRE. Cost: \$18.75-\$28.50.

¹Balance is not recommended on coarse-textured soils of less than 1.5% O.M. or pH greater than 7.4. If applied PRE on medium-textured soils with a pH greater than 7.5, decrease Balance rate 0.25 oz/A. Corn seed must be covered with 1.5 to 2.0 inches of soil. Avoid planting when surface soil is wet. Rates could be increased by 0.25 oz/A in fields with organic matter greater than 2.5% or with crop residues exceeding 5,000 lb/A. Do not use if water table is shallower than 25 ft.

[○]Registered for popcorn.

[□]Registered for sweet corn.

[△]Registered for silage.

[◆]Registered for yellow popcorn only.

[■]If atrazine was applied at planting, the total amount of early and late applications cannot exceed 2.5 lb ai/A per calendar year. Use no more than 1.6 lb ai/A on highly erodible land with less than 30% crop residue. Using atrazine on soils with less than 1% organic matter increases carryover injury risk to susceptible crops, especially high pH soils. Do not use on sandy soils if water table is shallower than 30 ft.

Corn No-till — Burndown and Preplant (Continued)

Herbicide	Commercial Product per Acre			Application Time	Remarks and Approximate Cost Per Acre Broadcast
	Sandy Loam < 1% OM	Silt Loam 1-2% OM	Silty-Clay Loam > 2% OM		
FIELD MASTER ^{○□△}	3.5-5 qt	4-5 qt	4-5 qt	PRE	If 2,4-D or dicamba is needed, both must be applied more than 6 days before planting corn. Cost: Field Master \$25.20-\$36.00; FulTime \$21.70-\$40.30; GMax Lite \$15.00-\$26.20; Guardsman Max \$14.70-\$27.00; Harness XTRA \$24.00-\$30.60; Harness XTRA 5.6 \$14.20-\$30.40; Keystone \$21.10-\$32.60.
FULTIME ^{○△}	Do not use	2.7-4.0 qt	3.3-5.0 qt	14-40 DBP	
	2.5-3.0 qt	2.7-3.3 qt	3.0-5.0 qt	0-14 DBP	
	2.5-3.0 qt	2.7-3.3 qt	3.0-4.0 qt	DRF	
GMAX LITE	2 pt	2.5 pt	3.5 pt	0-45 DBP	
GUARDSMAN MAX ^{○□△}	2.5-3 pt	3-4 pt	4-4.6 pt	0-45 DBP	
CONFIDENCE XTRA ^{○□△}	1.8 qt	2.3 qt	2.3 qt	14 DPB	
HARNESX XTRA 5.6/ CONFIDENCE XTRA 5.6L ^{○□△}	1.4 qt	2.3-2.6 qt	2.3-3.0 qt	0-14 DBP	
KEYSTONE ^{○△}	Do not use	2.4-3.4 qt	2.8-3.4 qt	14-30 DBP	
	2.2-2.6 qt	2.4-2.8 qt	2.6-3.4 qt	0-14 DBP	
	2.2-2.6 qt	2.4-2.8 qt	2.6-3.4 qt	PRE	See label for pre and post tank-mix combinations.
LANDMASTER BW	40-64 oz	40-64 oz	40-64 oz	0-30 DBP	Use higher rates for winter annuals and bigger weeds. Add a pre-emergence herbicide for residual weed control. Add 0.5 - 1.0 oz of Aim EW to enhance burndown. Cost: Landmaster \$5.60-\$8.90; glyphosate + 2,4-D \$3.60.
GLYPHOSATE [◆]	1.0 pt	1.0 pt	1.0 pt	0-30 DBP	
+ 2,4-D LV4 ¹	1.0 pt	1.0 pt	1.0 pt		
LEXAR ^{△□■}	3.0 qt	3.0 qt	3.0 qt	0-14 DBP	Add 0.5-1.0 oz of Aim EW to enhance burndown. Cost: Lumax \$39.75-\$46.40; Lexar \$30.75.
LUMAX ^{△□■}	3.0 qt	3.0 qt	3.0-3.5 qt	0-14 DBP	
RADIUS [△]	Do not use	12-20 oz	18-24 oz	0-30 DBP	When using Radius + atrazine, use higher rates for earlier applications and lower rates at planting. Also, adjust rate based on OM content, soil pH, and crop residue cover. Cost: Radius + atrazine \$18.00-\$32.00; Topnotch + atrazine \$27.00-\$39.00; Topnotch \$24.40-\$36.10.
+ ATRAZINE		0.8-1.1 lb	1.1-1.4 lb		
SURPASS ^{○△}	1.5-2.25 pt	1.5-2.5 pt	1.5-2.75 pt	0-14 DBP	
+ ATRAZINE DF [■]	1.2 lb	1.4 lb	1.7 lb		
TOPNOTCH ^{○△}	2.5 qt	2.5-3.0 qt	3.0-3.7 qt	30-40 DBP	
TOPNOTCH ^{○△}	2.0-2.5 qt	2.5 qt	2.5-3.0 qt	10-30 DBP	Cost: Degree Xtra \$24.60-\$31.40.
+ ATRAZINE DF [■]	2.0 qt	2.0-2.5 qt	2.0-3.0 qt	0-10 DBP	
or	1.2 lb	1.4 lb	1.7 lb		
DEGREE XTRA	2.9 qt	2.9-3.7 qt	3.2-3.7 qt	0-14 DBP	

Ridge-till

Herbicide (See <i>Weed Response Charts</i> on pages 41-46 before selecting herbicides)	Commercial Product per Acre			Application Time	Remarks and Approximate Cost/A Broadcast
	Sandy Loam < 1% OM	Silt Loam 1-2% OM	Silty-Clay Loam > 2% OM		
GLYPHOSATE [◆]	24-32 oz	24-32 oz	24-32 oz	Apply 1-2 weeks preplant to prevent winter annuals and kochia from using soil water.	Glyphosate provides good control on annual grasses less than 6" tall and good to excellent control on broadleaves 6" or less. Follow with appropriate herbicide at planting. Cost: glyphosate + dicamba \$7.25; 2,4-D + dicamba \$6.60; Gramoxone Max + Atrazine \$11.00; glyphosate (generic) \$2.60-\$3.50.
GLYPHOSATE [◆] + DICAMBA ^{●1}	24 oz	24 oz	24 oz		
	0.5 pt	0.5 pt	0.5 pt		
2,4-D ester (4L) ¹ + DICAMBA ^{●1}	1 pt	1 pt	1 pt		
GRAMOXONE MAX	1.3 pt	1.3 pt	1.3 pt		
+ ATRAZINE DF	1.2 lb	1.2 lb	1.2 lb		

¹For 2,4-D preplant interval is 7 days for 1 pt and 30 days if more than 1 pt is used. For dicamba the preplant interval is 7 days for 1/2 pt.

[○]Rate required may pose risk of groundwater contamination.

[◆]Glyphosate is the active ingredient in many products. The rates provided on this page are based on a 4 lb ai or 3 lb ae formulation. See the glyphosate product comparison table on page 146-147 for the use rate and more information on the product being used.

[○]Registered for popcorn.

[□]Registered for sweet corn.

[△]Registered for silage.

[●]Registered for yellow popcorn only.

[■]If atrazine was applied at planting, the total amount of early and late applications cannot exceed 2.5 lb ai/A per calendar year. Use no more than 1.6 lb ai/A on highly erodible land with less than 30% crop residue. Using atrazine on soils with less than 1% organic matter increases carryover injury risk to susceptible crops, especially high pH soils. Do not use on sandy soils if water table is shallower than 30 ft.

Field Corn, Popcorn[○], Sweet Corn[□], and Silage[△] Tilled Seedbed — Soil-Applied

Herbicide (See <i>Weed Response Charts</i> on pages 41-46 before selecting herbicides)	Commercial Product per Acre			Application Time, Remarks and Approximate Cost Per Acre Broadcast
	Sandy Loam < 1% OM	Silt Loam 1-2% OM	Silty-Clay Loam > 2% OM	
AATREX/ATRAZINE DF ^{○□△■}	Do not use [⊗]	2.2 lb	2.2 lb	EPP, PPSA, PPI, PRE, SURFACE MIX, or EPOST— May affect sensitive crops the following year especially on high pH soils. Cost: \$5.10.
AXIOM DF [△] alone or with ATRAZINE DF [■]	13 oz 1.1 lb	15-18 oz 1.4-1.7 lb	20-22 oz 1.7-1.8 lb	EPP, PPSA, PPI, PRE, or SURFACE MIX — Tank-mix with atrazine improves broadleaf weed control and increases soil residual. Cost: Axiom \$17.80-\$30.30; Axiom + atrazine \$18.00-\$30.30.
BALANCE PRO ^{△1}	Do not use	1.5-2.0 oz	2.2-2.5 oz	PPSA, PPI, or PRE. Do not apply after corn emerges. Tank-mix Balance with a grass herbicide for improved grass control. Balance + atrazine improves cocklebur and sunflower control. Do not use Balance where water table is within 25 feet of surface and soil organic matter is less than 2%. If soil pH is greater than 7.5, reduce Balance rate by 0.25 oz/A. On a soil with less than 1.5% organic matter content, use lowest rate in column. May be applied up to 30 days preplant. Plant corn at least 1 1/2 inches deep. Cost: Balance \$13.70-\$22.40; Balance + Atrazine \$16.20-\$24.10; Balance + Bicep \$27.60-\$35.60.
BALANCE PRO ^{△1} with ATRAZINE DF [■] or BICEP II MAGNUM/ CINCH ATZ [■]	Do not use	1.5-2.0 oz 1.3 lb 1.2 qt	2.2-2.5 oz 1.5 lb 1.2 qt	
BICEP II MAGNUM/ CINCH ATZ ^{○□△■}	1.3 qt	1.6 qt	2.1 qt	
BICEP LITE II MAGNUM/ CINCH ATZ LITE ^{○□△■}	1.0 qt	1.1-1.5 qt	1.5 qt	EPP, PPSA, PPI, PRE, SURFACE MIX, or EARLY POST — Bicep Lite at 1.5 qt/A has 40% less atrazine than Bicep II Magnum at 2.1 qt/A. Both products at these rates contain 1.25 lb s-metalochlor. Cost: Bicep II Magnum \$20.90-\$24.40; Bicep Lite II Magnum \$14.80-\$32.50.
CALLISTO alone ^{○△⊗} or with DUAL II MAGNUM/CINCH or BICEP II MAGNUM/ CINCH ATZ [■] or BICEP LITE II MAGNUM/ CINCH ATZ LITE [■]	6.0 oz 1.0 pt 1.6 qt 1.5 qt	6.0 oz 1.3 pt 1.8-2.1 qt 1.5 qt	6.0 oz 1.3 pt 2.1 qt 1.5-2.2 qt	PRE. Callisto can be tank-mixed with other PRE herbicides to broaden weed control spectrum. For postemergence application, refer to post-emergence section. Cost: Callisto \$26.60; with Dual \$41.50-\$46.00; with Bicep \$50.50-\$51.00; with Bicep Lite \$48.70-\$59.10.
CAMIX ^{○□△⊗}	2.0 qt	2.0 qt	2.0 qt	PPSA, PRE, or Early Post. Do not apply more than 14 days before planting, or to corn taller than 5". Add atrazine to improve broadleaf weed control. Cost: \$29.20.
DEFINE SC [△] alone or with BALANCE PRO ¹	15 oz —	17-19 oz 1.5-2.0 oz	22-24 oz 2.2-2.5 oz	PPSA, PPI, or PRE. Define can be tank-mixed with many other PRE herbicides to broaden the weed control spectrum. Cost: Define \$15.20-\$25.30; Define + Balance \$31.40-\$46.90.
DUAL II MAGNUM/CINCH ^{○□△} or DUAL IIG MAGNUM/CINCH ^{○□△} 6-8 lb	1.0 pt	1.3 pt 8-10 lb	1.7 pt 10-12 lb	EPP, PPSA, PRE, or SURFACE MIX — Dual II Magnum and Dual II Magnum + AAtrex may be applied early post. Dual II may be applied layby. Cost: Dual II Magnum \$14.90-\$25.40; Dual II Magnum + AAtrex \$17.40-\$23.50.
DUAL II MAGNUM ^{○□△} + ATRAZINE DF [■]	1.0 pt 1.1 lb	1.3 pt 1.4 lb	1.3 pt 1.8 lb	
EXPERT ^{○△}	2.5 qt	3.0 qt	3.75 qt	EPP, PPSA, PRE. Cost: \$18.75-\$28.10.
FIELD MASTER ^{○△}	3.5-5 qt	4-5 qt	4-5 qt	PRE. Cost: \$25.20-\$36.00.
FULTIME ^{○△⊗}	2.5-2.7 qt	2.7-3.3 qt	3.0-3.5 qt	EPP, PPSA, PRE, or surface mix. Cost: \$20.10-\$28.20.
G-MAX LITE	2 pt	2.5 pt	3.5 pt	PPSA, PRE, PPI. Cost: \$15.00-\$26.20.
GUARDSMAN MAX ^{○□△■}	2.4-2.8 pt	2.8-3.4 pt	3.4-4.0 pt	PPSA, PRE, PPI or EARLY POST. Cost: \$14.10-\$23.50.

¹Balance is not recommended on coarse-textured soils of less than 1.5% O.M. or pH greater than 7.4. If applied PRE on medium-textured soils with a pH greater than 7.5, decrease Balance rate 0.25 oz/A. Corn seed must be covered with 1.5 to 2.0 inches of soil. Avoid planting when surface soil is wet. Rates could be increased by 0.25 oz/A in fields with organic matter greater than 2.5% or with crop residues exceeding 5,000 lb/A. Do not use if water table is shallower than 25 ft.

[⊗]Rate required may pose risk of groundwater contamination.

[○]Registered for popcorn.

[□]Registered for sweet corn.

[△]Registered for silage.

[■]Registered for yellow popcorn only.

[■]If atrazine was applied at planting, the total amount of early and late applications cannot exceed 2.5 lb ai/A per calendar year. Use no more than 1.6 lb ai/A on highly erodible land with less than 30% crop residue. Using atrazine on soils with less than 1% organic matter increases carryover injury risk to susceptible crops, especially high pH soils. Do not use on sandy soils if water table is shallower than 30 ft.

Field Corn, Popcorn[○], Sweet Corn[□], and Silage[△] Tilled Seedbed (continued)

Herbicide (See <i>Weed Response Charts</i> on pages 41-46 before selecting herbicides)	Commercial Product per Acre			Application Time, Remarks and Approximate Cost Per Acre Broadcast
	Sandy Loam < 1% OM	Silt Loam 1-2% OM	Silty-Clay Loam > 2% OM	
HARNESX/ CONFIDENCE XTRA ^{○△■} or DEGREE [△]	1.25-1.75 pt 2.3-3.2 pt	1.75-2.25 pt 3.2-4.0 pt	1.75-2.25 pt 3.2-4.0 pt	PPSA, PRE, SURFACE MIX, or EARLY POST. Cost: Harness/ Confidence XTRA \$13.30-\$24.00; Harness Xtra /Confidence Xtra \$24.00- \$30.70; Degree \$14.90-\$25.90; Degree Xtra \$22.90-\$29.70; Harness Xtra 5.6 L/Confidence Xtra 5.6 L \$14.20-\$26.30.
DEGREE XTRA ^{○△■} or HARNESX XTRA/ CONFIDENCE ^{○△■} or HARNESX XTRA 5.6L/ CONFIDENCE XTRA 5.6L ^{○△■}	2.7 qt 1.8 qt 1.4 qt	3.5 qt 2.3 qt 1.7-2.4 qt	3.5 qt 2.3 qt 2.3-2.6 qt	
HORNET WDG [△]	4.0 oz	4.0 oz	4.0-5.0 oz	PPSA, PRE, SURFACE MIX, or EPOST — Controls broadleaf weeds only. Hornet WDG at 3.0-4.0 oz/A can be tank-mixed with other premix herbicides containing atrazine to broaden weed control spectrum. Cost: \$14.20-\$17.80.
KEYSTONE ^{○△}	2.2-2.4 qt	2.4-2.8 qt	2.6-3.0 qt	PPSA, PRE, or Early Post. See label for pre and post tank-mix combina- tions. Cost: \$21.10-\$28.70.
KEYSTONE LA ^{○△}	1.6-1.8 qt	1.8-2.1 qt	1.9-2.2 qt	EPP, PPSA, PRE, or Early Post. Contains less atrazine than Keystone. Cost: \$18.70-\$25.70.
LEXAR ^{△⊗■}	3.0 qt	3.0 qt	3.0 qt	PPSA, PRE, EARLY POST — EARLY POST up to 12-inch corn. Cost: \$30.75.
LUMAX ^{△⊗■}	2.5 qt	2.5 qt	2.5 qt	PPSA, PRE, or EPOST. Apply preplant up to 14 days before planting. EPOST up to 12-inch corn. Cost: \$33.10.
MICRO-TECH ^{○□△}	2.0 qt	2.5 qt	3.0 qt	PPSA, PRE, or EARLY POST — Cost: Micro-Tech \$12.60-\$18.90; Micro-Tech + Atrazine \$12.30-\$18.10.
MICRO-TECH ^{○□△} + ATRAZINE DF [■]	1.5 qt 1.2 lb	2.0 qt 1.5 lb	2.2 qt 1.8 lb	
OUTLOOK ^{○□△}	10-14 oz	14-16 oz	16-18 oz	PPSA, PPI, PRE, or EPOST. Tank mix with PRE herbicides to broaden weed control spectrum. Cost: \$12.40-\$22.30.
PROWL/PROWL H20/PENDIMAX + ATRAZINE DF [■]	Do not use	1.8 qt 1.33 lb	1.8 qt 1.77 lb	PRE — Corn injury may occur if replanting is necessary. Rainfall shortly after planting required for performance. Cost: \$13.50-\$14.70.
RADIUS [△] alone or with ATRAZINE	Do not use	12-18 oz 0.8-1.1 lb	18-20 oz 1.1-1.4 lb	EPP, PPSA, or PRE. Cost: TBA.
STALWART C alone [○] or ME-TOO-LACHLOR II alone [○] or with ATRAZINE DF [■]	1.0-1.3 pt 1.0-1.3 pt 1.1 lb	1.3-1.7 pt 1.3-1.7 pt 1.4 lb	1.3-1.7 pt 1.3-1.7 pt 1.8 lb	EPP, PPSA, PRE, or SURFACE MIX. When combining with atrazine, use lower rate of Me-Too-Lachlor product. Cost: TBA.

¹Balance is not recommended on coarse-textured soils of less than 1.5% O.M. or pH greater than 7.4. If applied PRE on medium-textured soils with a pH greater than 7.5, decrease Balance rate 0.25 oz/A. Corn seed must be covered with 1.5 to 2.0 inches of soil. Avoid planting when surface soil is wet. Rates could be increased by 0.25 oz/A in fields with organic matter greater than 2.5% or with crop residues exceeding 5,000 lb/A. Do not use if water table is shallower than 25 ft.

[⊗]Rate required may pose risk of groundwater contamination.

[◆]Glyphosate is the active ingredient in many products. The rates provided on this page are based on a 4 lb ai or 3 lb ae formulation. See the glyphosate product comparison table on pages 146-147 for the use rate and more information on the product being used.

[○]Registered for popcorn.

[□]Registered for sweet corn.

[△]Registered for silage.

[⊗]Registered for yellow popcorn only.

[■]If atrazine was applied at planting, the total amount of early and late applications cannot exceed 2.5 lb ai/A per calendar year. Use no more than 1.6 lb ai/A on highly erodible land with less than 30% crop residue. Using atrazine on soils with less than 1% organic matter increases carryover injury risk to susceptible crops, especially high pH soils. Do not use on sandy soils if water table is shallower than 30 ft.

Field Corn, Popcorn[○], Sweet Corn[□], and Silage[△] Tilled Seedbed (continued)

Herbicide (See <i>Weed Response Charts</i> on pages 41-46 before selecting herbicides)	Commercial Product per Acre			Application Time, Remarks and Approximate Cost Per Acre Broadcast
	Sandy Loam < 1% OM	Silt Loam 1-2% OM	Silty-Clay Loam > 2% OM	
STALWART XTRA [○] or TRIZMET II	1.3 qt 1.3 qt	1.6 qt 1.6 qt	2.1 qt 2.1 qt	EPP, PPSA, PPI, PRE, SURFACE MIX, or EARLY POST. Cost: TBA.
SURPASS ^{○△}	1.5-2.25 pt	1.5-2.5 pt	1.5-2.75 pt	PPSA, PRE, SURFACE MIX, or EARLY POST. Cost: Surpass \$15.00-\$27.50.
TOPNOTCH ^{○△} alone or with ATRAZINE DF [■]	2.0 qt 1.1 lb	2.0-2.5 qt 1.3 lb	2.5-3.0 qt 1.5 lb	EPP, PPSA, PRE, or SURFACE MIX. Cost: Topnotch \$20.20-\$30.20; Topnotch with Atrazine \$22.70-\$33.70.

Postemergence (see page 37 for additives)

Herbicide	Rate Per Acre	Application Time	Remarks and Approximate Cost Per Acre Broadcast
ATRAZINE DF ^{○□△■}	1.4-2.2 lb	Corn less than 12" Broadleaf weeds 2-6"; grass weeds 1" or less	Lower atrazine rate controls broadleaf weeds. Atrazine maximum use rate (all uses) is 2.5 lb ai/A per year. Cost: \$3.20-\$5.90.
ACCENT [○] alone or with DICAMBA [●] or BUCTRIL + ATRAZINE [■]	0.67 oz 0.5-1.0 pt 1.5-3.0 pt	Corn 4-36" (V10), greater than 20" use drops Shattercane 4-12" Broadleaves 1-4" Grasses 1-3" Corn less than 12" if atrazine is used	Do not use if Counter was applied to the crop. Do not apply 3 days before or 7 days after foliar applied organophosphate insecticides. Corn ear pinching risk increases at V7-V10 stages. See Herbicide Resistance, page 5. Refer to Clarity label precautions. Cost: Accent \$24.10; Accent + Clarity \$30.40-\$36.80; Accent + Buctril/atrazine \$32.00-\$39.90.
ACCENT GOLD WDG	2.9 oz	Corn less than 12" (V6) Grasses 1-3" Broadleaves 1-6"	Can be tank mixed with atrazine, Banvel/Clarity, or Marksman. Apply to hybrids with maturity ratings higher than 87 days. Same restrictions as for Accent. Cost: \$23.50.
AIM EW ^{○□△} alone or with DICAMBA [●] or ATRAZINE DF [■] or ATRAZINE DF [■] + Dicamba [●]	0.50 oz 8.0 oz 0.56-1.1 lb 0.56 lb 3-4 oz	Corn less than V14, but if greater than V8, use drop nozzles Broadleaves 1-4" Velvetleaf up to 36" Corn less than 12"	Aim is a contact herbicide so thorough spray coverage is required. Aim strengthens nightshade, velvetleaf, pigweed, morningglory, and lambsquarter control in tank mixtures with other herbicides. See dicamba precautions when using with dicamba. Cost: Aim \$2.80; Aim + Atrazine \$4.10-\$5.40; Aim + dicamba \$9.20; Aim + atrazine + dicamba \$6.50-\$7.30.
BASIS	0.33 oz	Corn spike to 2-collar/4-leaf Grasses 1-2" Broadleaves 1-3"	Do not use if Counter was applied to the crop. Do not apply 3 days before or 7 days after foliar applied organophosphate insecticides. Tank-mix Basis with 4-8 oz dicamba, Marksman, or atrazine for additional broadleaf control. Can tank-mix Basis Gold with dicamba (2-4 oz) or Hornet (2 oz). Apply Basis Gold to hybrids with maturity ratings higher than 87 days. Cost: Basis \$6.00; Basis Gold \$18.40.
BASIS GOLD	14 oz	Corn less than 12" (V6) Grasses 1-3" Broadleaves 1-4"	

ⓄRate required may pose risk of groundwater contamination.

○Registered for popcorn.

□Registered for sweet corn.

△Registered for silage.

ⓄRegistered for yellow popcorn only.

■If atrazine was applied at planting, the total amount of early and late applications cannot exceed 2.5 lb ai/A per calendar year. Use no more than 1.6 lb ai/A on highly erodible land with less than 30% crop residue. Using atrazine on soils with less than 1% organic matter increases carryover injury risk to susceptible crops, especially high pH soils. Do not use on sandy soils if water table is shallower than 30 ft.

●Dicamba is the active ingredient in Banvel, Clarity, Sterling and several other herbicides. The rates and information provided here are based on the same 4 lb/gal acid equivalent formulation found in Banvel, Clarity and Sterling.

Field Corn, Popcorn[○], Sweet Corn[□], and Silage[△]

Postemergence (continued)

Herbicide	Rate Per Acre	Application Time	Remarks and Approximate Cost Per Acre Broadcast
BEACON ^{○△}	0.38-0.76 oz	Corn 4-20" Shattercane 4-12" Broadleaves 1-4" Grasses 1-3"	Do not use if Counter insecticide was applied to the crop. Do not use Beacon within 20 days of a planting or cultivation application of any organophosphate insecticide. Do not apply Beacon within 10 days of a foliar POST organophosphate insecticide. Beacon may be applied at 0.38 oz followed by a second 0.38 oz treatment if required. Can apply 0.38 oz/A Beacon with drops from 20" height to tasselling. Corn hybrids vary in tolerance. See <i>Herbicide Resistance</i> , page 5. Use only if grass herbicide has been used preplant or PRE. Beacon may be tank-mixed with atrazine, dicamba, Buctril, Marksman, or 2,4-D. Cost: Beacon \$11.00-\$22.00.
BUCTRIL [○] 2E + ATRAZINE DF [■]	1.0-1.5 pt 0.5 lb	Corn 3-leaf to 12" Broadleaf weeds 2-6" tall	Contact herbicide. Thorough coverage, correct tips, pressure, spray, volume, rate and weed size important. Cost: Buctril \$7.60-\$11.40; Buctril + atrazine \$8.90; Buctril/atrazine + dicamba \$14.60-15.20.
BUCTRIL/ATRAZINE [■]	2.0-3.0 pt		
BUCTRIL/ATRAZINE [■] + DICAMBA [●]	2.0 pt 0.5 pt		
DICAMBA [●]	0.5-1.0 pt	Spike to 36", if greater than 8", use drops	Later applications may cause brittleness and increase greensnap risk. Use lower rate for good growing conditions to reduce corn injury. Do not use dicamba within 1/2 mile of sugarbeet, fieldbean, alfalfa, soybean, gardens and ornamentals unless drop tips are used on corn over 8". Do not apply between June 20 and Sept. 1 if sensitive crops are nearby. Use higher rate of dicamba only on corn at spike to 8 inches and on silty clay loam containing more than 2.0% organic matter. Hybrids vary in sensitivity to growth regulator herbicides. Cost: dicamba \$4.75-\$9.50; 2,4-D \$0.90-\$1.80; 2,4-D + dicamba \$5.70.
2,4-D ESTER (4L) ^{○□△}	0.5-1.0 pt	Broadleaves 2-6 leaf Corn spike to 36"	
2,4-D AMINE (4L) ^{□△} or 2,4-D ESTER (4L) ^{○□△} + DICAMBA [●]	0.25 pt 0.25 pt 0.50 pt	Less risk when corn is small, over 8" use low rate and drop pipes to keep spray out of corn whorl. Weeds at 2-6"	
CALLISTO ^{○△} alone or with ATRAZINE DF [■]	3.0 oz 0.25-0.5 lb	Corn to 30" or V8 Broadleaf weeds less than 5" Corn less than 12" if atrazine used	Do not apply if Counter was applied to corn. Do not apply within 7 days of a foliar organophosphate or carbamate insecticide. Cost: Callisto \$13.30; with atrazine \$13.90-\$14.50.
CELEBRITY PLUS ^{○□△}	4.7 oz	Corn 4-24"; if over 10", use drops Weeds 2-4"	Premix of Accent and Distinct. Same restrictions as for Accent and Distinct. Use drops when possible. Cost: \$26.50.
DISTINCT ^{○△}	6 oz 4 oz	Corn 4-10" Corn 10-24"; if 25-36", use drops	Distinct contains dicamba so do not mix with products that contain dicamba, 2,4-D, or clopyralid. Observe Clarity precautions. Do not exceed 10 oz/A per season. Suppresses grass weeds that are less than 3 inches tall. Cost: \$11.20-\$16.80.
EQUIP	1.0-1.5 oz	Corn 0-36" If over 12", use drops. Weeds less than 4"	Can tank-mix with atrazine, dicamba, Distinct, Marksman, or Tough herbicides. Do not apply within 7 days of a foliar OP insecticide or in same season as a soil-applied OP insecticide except Aztec. Use with MSO + UAN. Cost: \$11.20-\$16.80.
EXCEED ^{○△}	1.0 oz	Corn 4-30" broadcast. If over than 20", use drops. Weeds 2-12"	Dicamba may be added for resistant weed management. On soil above pH 7.3 carryover may injure soybean and other sensitive crops. Eighteen month soybean rotation restriction, but 10 months if south of I-80 and STS soybean variety planted. Refer to Beacon for OP insecticide restrictions. Cost: \$12.10.
EXPERT	2.75-3.75 qt	Corn 0-12"	Do not tank-mix with other herbicides after corn emergence. Cost: \$20.60-\$28.10.

[●]Rate required may pose risk of groundwater contamination.

[○]Registered for popcorn.

[□]Registered for sweet corn.

[△]Registered for silage.

[◎]Registered for yellow popcorn only.

[■]If atrazine was applied at planting, the total amount of early and late applications cannot exceed 2.5 lb ai/A per calendar year. Use no more than 1.6 lb ai/A on highly erodible land with less than 30% crop residue. Using atrazine on soils with less than 1% organic matter increases carryover injury risk to susceptible crops, especially high pH soils. Do not use on sandy soils if water table is shallower than 30 ft.

[●]Dicamba is the active ingredient in Banvel, Clarity, Sterling and several other herbicides. The rates and information provided here are based on the same 4 lb/gal acid equivalent formulation found in Banvel, Clarity and Sterling.

Field Corn, Popcorn[○], Sweet Corn[□], and Silage[△]

Postemergence (continued)

Herbicide	Rate Per Acre	Application Time	Remarks and Approximate Cost Per Acre Broadcast
GLYPHOSATE [◆] (Roundup Ready [®] hybrid required)	32-48 oz	Corn to 30" (V12); if over 24", use drops	May apply sequentially over a preemergence herbicide. Can apply twice in crop with a 64 oz/A [◆] limit. Wait at least 10 days between applications. Check specific glyphosate label for use details. Cost: \$3.40-\$5.00.
GLYPHOSATE [◆] (Roundup Ready Corn 2 hybrid required)	up to 48 oz	Corn to 48" (V12); if over 24", use drops	Can apply twice in crop with a 12 oz/A [◆] limit. Wait at least 10 days between applications. Cost: \$5.00
<p>NOTE: This higher glyphosate application rate for corn up to 48 inches tall should be applied only to Roundup Ready Corn 2 hybrids. Check with your seed company about specific hybrid status. Not all corn hybrids are Roundup Ready Corn 2 hybrids. In addition not all glyphosate brands may be labeled for this higher application rate to taller corn. Check the specific glyphosate brand label or label supplement for compliance.</p>			
HORNET WDG [△]	2.0-5.0 oz	Corn at spike to 36", if greater than 36", use drops Broadleaf weeds less than 8"	Use higher rate for control of dense weed population, larger weeds, or when a longer residual is desired. Can tank-mix with atrazine, Buctril, dicamba, Distinct, Callisto, 2,4-D, or glyphosate. Cost: \$7.10-\$17.80.
LADDOK S-12 ^{○□△■}	1.3-2.3 pt	Corn less than 12"; Broadleaf weeds 2-4" high	Use 20 gal water and 40 psi. Increase rate according to the label on weeds 3-8" tall. Cost: \$7.90-\$14.00.
LIBERTY [△] (Liberty Link hybrid required) + ATRAZINE DF [■] or CALLISTO	32-34 oz 0.60 lb 1.5-3.0 oz	Corn less than 12" if used with atrazine or up to 30" if used with Callisto. Weeds 1-4"	Liberty is a contact herbicide without soil residual. Apply at 15-20 GPA and 35-40 psi. Use higher rate on bigger weeds. Liberty may be tank-mixed with other post corn herbicides except for Sencor and Basis. Cost: Liberty + atrazine \$16.40-\$19.70.
LIGHTNING (Clearfield hybrid required) or with DICAMBA [●]	1.28 oz	Corn to 20" (V6) Weeds to 4" Weeds to 4"	Atrazine, Buctril, Distinct, or 2,4-D also may be added to Lightning for ALS-resistant weed management. Cost: Lightning \$16.60; Lightning + dicamba \$23.00.
MARKSMAN/ STERLING PLUS ^{○■}	2.0-3.5 pt	Corn less than 8" (V5)	Observe precautions regarding dicamba use near sensitive crops specified above. Do not use more than 2.0 pt/A on sands, loamy, or sandy loam soil, or soil having less than 2.0% organic matter. Cost: \$8.30-\$14.60.
NORTHSTAR ^{○□△}	5.0 oz	Corn 4-36" (greater than V2); if greater than 20", (V6) use drops Weeds 1-4"	Observe Beacon and dicamba precautions. Controls 4-12" shattercane. Can tank-mix with Accent, atrazine (4-12" corn), Resource, or Tough. Cost: \$10.50.
OPTION alone or with DISTINCT or CALLISTO	1.25-1.75 oz 4.0 oz 1.5-3.0 oz	Corn 0-36", greater than 16" use drops Weeds less than 4"	Can also tank-mix Option with atrazine, Callisto, Clarity, Distinct, or Marksman herbicides. Do not apply within 7 days of a foliar OP insecticide or in same season as Counter insecticide. Cost: alone \$13.20-\$19.30; Option + Distinct \$24.40-\$30.50.
PERMIT ^{○□△}	0.66-1.33 oz	Corn spike-layby greater than 20" use drops Broadleaf weeds 2-6"	Dicamba may be added for resistance management. Cost: \$11.00-\$22.20.

[○]Rate required may pose risk of groundwater contamination.

[◆]Glyphosate is the active ingredient in many products. The rates provided on this page are based on a 4 lb ai or 3 lb ae formulation. See the glyphosate product comparison table on pages 146-147 for the use rate and more information on the product being used.

[○]Registered for popcorn.

[□]Registered for sweet corn.

[△]Registered for silage.

[●]Registered for yellow popcorn only.

[■]If atrazine was applied at planting, the total amount of early and late applications cannot exceed 2.5 lb ai/A per calendar year. Use no more than 1.6 lb ai/A on highly erodible land with less than 30% crop residue. Using atrazine on soils with less than 1% organic matter increases carryover injury risk to susceptible crops, especially high pH soils. Do not use on sandy soils if water table is shallower than 30 ft.

[●]Dicamba is the active ingredient in Banvel, Clarity, Sterling and several other herbicides. The rates and information provided here are based on the same 4 lb/gal acid equivalent formulation found in Banvel, Clarity and Sterling.

Field Corn, Popcorn[○], Sweet Corn[□], and Silage[△] Postemergence (continued)

Herbicide	Rate Per Acre	Application Time	Remarks and Approximate Cost Per Acre Broadcast
READY MASTER ATZ [■] (Roundup Ready [®] hybrid required)	1.5-2.0 qt	Corn less than 12" Weeds 4"	Can tank mix with Harness, MicroTech, Partner or atrazine for improved residual control. Cost: \$10.30-\$13.75.
RESOURCE	4.0-6.0 oz	Corn 2-10" leaf Broadleaf weeds less than 4"	Especially good on velvetleaf. Rate may be increased to 8 oz when using drop tips. Cost: \$5.20-\$7.80
SPIRIT [△]	1.0 oz	Corn 4-24". If greater than 20", (V6) use drops Weeds 2-8"	Soybean rotation interval is 10 months south of I-80 and 18 months north of I-80. More rotation restrictions on soils with pH greater than 7.8. Refer to Beacon for OP insecticide restrictions. Cost: \$10.60.
STARANE [□]	0.67 pt	VE-V5 corn Sweet corn up to V4 Weeds less than 8"	Can be tank-mixed with other postemergence herbicides to improve broadleaf weed control. Cost: \$8.70.
STEADFAST alone or CALLISTO + ATRAZINE DF [■]	0.75 oz 1.5-3.0 oz + 0.5 lb	Corn to 20" or V6 Weeds 2-4" Corn to 12"	Can tank-mix with atrazine, Marksman, dicamba, or Hornet to broaden weed control spectrum. Do not tank-mix with OP insecticides. Follow directions of most restrictive label. Cost: \$17.30; Steadfast + Callisto + Atrazine \$25.10-\$31.80.
STEADFAST ATZ	14 oz	Corn to 12" or V6 Weeds 2-4"	Can tank-mix with Callisto, Hornet, dicamba, Distinct, Marksman, or atrazine. Do not tank-mix with OP insecticides. Cost: \$19.30.
YUKON	4-8 oz	Spike to 36" Weeds 1-6"	Observe dicamba label precautions. Add Accent for grass control. Cost: \$10.40-\$20.80.

Layby

DUAL II MAGNUM ^{□△}	0.67-1.5 pt	Layby	Apply after furrowing or final cultivation. Cost: \$10.00-\$22.40.
OUTLOOK ^{○□△}	10-21 oz	Corn 12-36"	Apply after furrowing or final cultivation. Cost: \$12.40-\$26.00.
PROWL 3.3EC/ PROWL H ₂ O/PENDIMAX	1.8-3.6 pt	Corn spike to layby. Weeds unemerged	Cover brace roots by cultivation before application. Incorporate by tillage, irrigation, or rain within a week. Cost: \$5.80-\$10.40.
TRIFLURALIN	1.5-2.0 pt	Corn 2-leaf to layby. Weeds unemerged	Incorporate with rainfall, sprinkler irrigation water or cultivate within 24 hours. Cost: Treflan \$5.40-\$7.30.

Harvest Aid

GLYPHOSATE [◆]	1.0-3.0 qt	After black layer Corn less than 35% moisture	Allow a minimum of 7 days before harvest. Do not treat corn grown for seed. Cost: glyphosate 4ai (generic) \$3.40-\$10.10.
2,4-D ESTER (4L)	1.0 qt	After hard dough stage (dent)	For control of sunflower, cocklebur, velvetleaf and other late broadleaf weeds. Only certain brands labeled for this use. Brittleness and kernel fill not affected if silks are dry. Cost: \$3.70.

○Rate required may pose risk of groundwater contamination.

◆Glyphosate is the active ingredient in many products. The rates provided on this page are based on a 4 lb ai or 3 lb ae formulation. See the glyphosate product comparison table on pages 146-147 for the use rate and more information on the product being used.

○Registered for popcorn.

□Registered for sweet corn.

△Registered for silage.

◎Registered for yellow popcorn only.

■If atrazine was applied at planting, the total amount of early and late applications cannot exceed 2.5 lb ai/A per calendar year. Use no more than 1.6 lb ai/A on highly erodible land with less than 30% crop residue. Using atrazine on soils with less than 1% organic matter increases carryover injury risk to susceptible crops, especially high pH soils. Do not use on sandy soils if water table is shallower than 30 ft.

Winter annuals (henbit, horseweed, pennycress, etc.) and perennial weeds can be quite susceptible to fall herbicide application. Typically herbicides such as 2,4-D, dicamba, and glyphosate all work well and inexpensively on newly germinated winter annual weeds in the fall. Herbicides can be applied in the fall, weather permitting, from late September up until early December. Before using a particular herbicide, check to see if it is labeled for fall application. Atrazine does not have a label for fall application in Nebraska.

Weed Response to Burndown Herbicides¹ No-till Soybean

Plant response may be altered by growing conditions, genetic variation in crops and weeds, soil type, pH, organic matter and application rates. Ratings may vary from season to season and geographical areas within the state. Ratings apply when herbicides are used as suggested in this publication. See pages 113-127 for additional problem weeds and their control.

Weed Response to Fall Burndown Herbicides

Herbicides	Dandelion	Downy Brome	Henbit	Marestail	Pennycress	Prickly Lettuce	Shepherdspurse	Alfalfa
2,4-D Ester (1-2 pt)	7	1	9	8	10	9	10	7
Glyphosate ⁴ (32 oz)	6	10	9	8	9	6	10	5
Glyphosate ⁴ + 2,4-D (24 oz + 16 oz)	8	10	9	9	10	8	10	8
Gramoxone Max (1.3 pt)	5	7	9	7	10	8	9	4

Weed Response to Spring Burndown Herbicides

Herbicide	Annual Bluegrass	Chickweed	Dandelion	Downy Brome	Foxtail Barley	Evening Primrose	Henbit	Horseweed (Marestail)	Pennycress	Prickly Lettuce	Shepherdspurse	Purslane Speedwell	Virginia Pepperweed	Tall Knotweed	Foxtail	Barnyardgrass	Lambquarters	Sandbur, Longspine	Kochia	Kochia, Triazine-resistant	Russian Thistle	Smartweed—Annual	Velvetleaf	Sunflower	Corn—volunteer	Winter Wheat or Rye	Alfalfa	Sweet Clover	Hairy Vetch
2,4-D ester ² (1.0 pt)	1	4	7	1	1	7	4	7	8	9	8	7	7	6	1	1	9	1	6	4	9	7	8	10	1	1	5	6	7
Extreme (3.0 pt)	10	10	8	10	9	8	9	9	10	9	10	9	10	10	10	10	10	10	9	9	10	10	10	10	10	9	4	3	7
Gauntlet (co-pac)	1	7	7	1	1	7	6	9	8	7	9	7	9	8	1	1	9	1	8	8	8	8	9	10	1	1	4	4	4
Glyphosate ^{◆3,4} (24 oz)	10	10	5	10	9	7	9	6	10	6	10	10	9	9	9	10	7	10	6	6	9	7	7	9	10 ³	10	4	3	6
Glyphosate ^{◆3,4} (32 oz)	10	10	7	10	9	8	9	8	10	7	10	10	9	9	10	10	9	10	8	8	9	8	9	9	10 ³	10	5	4	6
Glyphosate ^{◆3,4} + 2,4-D ester (4L) (24 oz + 1.0 pt)	10	10	8	7	9	9	9	9	10	8	10	10	9	9	9	10	9	10	9	9	9	9	10	10	10 ³	10	6	5	7
Glyphosate ^{3,4} + Pursuit (24 oz + 4 oz)	10	10	8	10	9	8	9	9	10	9	10	9	9	10	10	10	9	10	9	9	10	10	10	10	10 ³	9	4	3	7
Glyphosate ^{◆3,4} (24 oz) + Sencor (4 oz)	10	10	7	10	9	7	9	8	10	9	10	10	9	10	9	10	8	10	8	7	10	8	8	10	10 ³	10	4	4	7
Gramoxone Max (1.3 pt)	8	10	5	7	8	7	9	7	10	8	9	6	9	9	7	7	8	7	9	9	9	6	8	10	4	6	4	4	7
Pursuit (4 oz)	5	8	4	2	7	5	7	4	9	7	9	3	3	3	8	7	5	7	6	6	6	8	9	8	3	1	1	2	2
Pursuit Plus (2.5 pt)	5	8	4	2	7	5	7	4	9	7	9	3	3	3	8	7	5	7	6	6	6	8	9	8	4	1	1	2	2
Scepter (0.66 pt)	5	9	4	1	5	5	7	4	9	6	9	3	1	3	3	3	5	5	7	7	5	7	7	8	3	1	1	1	3

Rating	Percent Control
10	— 96-100%
9	— 90-95%
8	— 85-90%
7	— 80-84%
6	— 70-79%
5	— 60-69%
4-2	— less than 60%
1	— 0

¹This guide presents burndown information only. It does not reflect residual weed control.

²For 2,4-D preplant interval is 7 days for 1 pt and 30 days if more than 1 pt is used.

³Glyphosate-based products will not control Roundup Ready volunteer corn. Refer to soybean section for listing of grass herbicides for control of volunteer Roundup Ready corn.

⁴During colder days/nights (less than 60/50°F) glyphosate performance can be reduced.

◆Glyphosate is the active ingredient in many products. The rates provided on this page are based on a 4 lb ai or 3 lb ae formulation. See the glyphosate product comparison table on pages 146-147 for the use rate and more information on the product being used.

2,4-D Preplant Interval Crop	Use Rate 1 pt	Use Rate >1 pt
Corn	7 days	14 days
Soybean (use ester only)	7 days	30 days
Sorghum	10 days	21 days

Dicamba Preplant Interval Crop	Use Rate 1/4 pt	Use Rate 1/2 pt
Corn	5 days	7 days
Soybean	DO NOT USE	DO NOT USE
Sorghum	7 days	10 days

Broadleaf Weed Response to Soil-applied Herbicides

Soybean

Plant response may be altered by growing conditions, genetic variation in crops and weeds, soil type, pH, organic matter and application rates. Ratings may vary from season to season and geographical areas within the state. Ratings apply when herbicides are used as suggested in this publication. See pages 113-127 for additional problem weeds and their control.

Weed Response Ratings: Ratings are for light to moderate weed densities, favorable conditions and weed growth stage as specified on the product label. High weed densities, adverse conditions, or large weeds will reduce control.

10 — 96-100% 9 — 90-95%
 8 — 85-89% 7 — 80-84%
 6 — 70-79% 5 — 60-69%
 4-2 — less than 60% 1 — 0%

	B. Nightshade (3.5) [§]	Cocklebur (5.5)	Kochia (2.5)	Kochia, ALS-resistant (2.5)	Kochia, Triazine-resistant (2.5)	Lambsquarters (1.5)	Morningglory species (5.5)	Pigweed (2.5)	Pigweed, Triazine-resistant (2.5)	Ragweed (3)	R. Thistle (2.3)	Smartweed (1.5)	Sunflower (10)	Velvetleaf (4.2)	Waterhemp (2.5)	Waterhemp, ALS-resistant (2.5)	Waterhemp, Triazine-resistant (2.5)	Crop Safety [□]
Authority/Blanket	8	4	9	9	9	8	6	9	9	5	9	7	3	7	8	8	8	2
Commit 3ME	4	6	9	9	9	8	2	2	2	4	5	8	4	10	2	2	2	1
Dual II Magnum	7	2	2	2	2	8	1	8	8	5	3	2	2	2	8	8	8	1
FirstRate	3	8	8	1	8	6	5	8	8	9	-	8	8	8	6	1	6	2
Gangster	9	8	8	8	8	8	5	9	8	9	7	8	8	8	8	9	9	2
Micro-Tech/Partner/Intro	7	2	2	2	2	7	2	8	8	4	2	2	2	2	8	8	8	1
Micro-Tech + Sencor	7	4	4	4	2	9	2	9	8	9	7	8	4	6	9	9	7	3
Outlook	6	2	2	2	2	7	2	8	8	5	3	2	2	2	8	8	8	1
Prowl/Prowl H20/Pendimax	2	2	7	7	7	7	2	7	7	2	7	2	2	4	7	7	7	2
Prowl/Prowl H20/Pendimax + Sencor	2	4	7	7	7	9	2	9	7	9	9	7	4	7	9	9	7	3
Pursuit DG	9	6	8	1	8	8	6	9	9	8	-	9	8	8	65	1	66	2
Pursuit + Dual II Magnum	8	6	8	2	9	9	6	9	9	9	-	9	8	8	95	7	96	2
Pursuit Plus	9	6	9	7	9	9	6	9	9	9	-	9	8	8	85	7	86	2
Python	3	5	8	1	8	8	2	8	8	3	8	8	5	7	8	1	8	1
Scepter + Dual II Magnum or Micro-Tech	8	9	6	2	4	9	7	9	9	9	-	9	8	7	9	7	9	2
Sencor (8 oz)	5	5	8	8	3	8	4	8	3	9	8	8	6	8	7	7	2	3
Squadron or Scepter + Sonalan or Treflan	8	9	7	7	7	9	7	9	9	9	7	9	8	7	9	7	9	2
Steel	9	9	8	5	8	9	8	9	9	8	-	9	9	7	9	3	7	1
Trifluralin	2	2	7	8	7	7	2	7	7	2	7	2	2	2	7	7	7	2
Trifluralin + Sencor	2	4	7	8	7	9	2	9	7	9	9	7	4	7	9	9	7	3
Valor	9	2	8	8	8	8	5	8	8	7	7	6	3	8	9	9	9	2

[□]Crop hybrids vary in their response to herbicides. Crop safety ratings less than 3 indicate that crop yield should not be affected by any direct injury. If stand is not lost, most crops will compensate for early injury. Adding surfactants, COC, or liquid nitrogen may reduce crop safety for some herbicide combinations. Refer to product label for specific information.

[§]Weed Competitive Index—See page 5.

Grass Weed Response to Soil-applied Herbicides Soybean

Plant response may be altered by growing conditions, genetic variation in crops and weeds, soil type, pH, organic matter and application rates. Ratings may vary from season to season and geographical areas within the state. Ratings apply when herbicides are used as suggested in this publication. See pages 113-127 for additional problem weeds and their control.

Weed Response Ratings: Ratings are for light to moderate weed densities, favorable conditions and weed growth stage as specified on the product label. High weed densities, adverse conditions, or large weeds will reduce control. 10 — 96-100% 9 — 90-95% 8 — 85-89% 7 — 80-84% 6 — 70-79% 5 — 60-69% 4-2 — less than 60% 1 — 0%	Barnyardgrass (0.3) [§]	Crabgrass (0.5)	Fall Panicum (0.4)	Giant Foxtail (2.0)	Green Foxtail (1.0)	Yellow Foxtail (1.0)	Sandbur (0.4)	Shattercane/Sorghum (3.5)	Shattercane, ALS-resistant (3.5)	Woolly Cupgrass (2.5)	Crop Safety [▣]
	Authority/Blanket	5	7	5	4	6	5	3	3	3	-
Boundary/Dual II Magnum + Sencor	9	9	9	9	9	9	4	4	4	6	3
Commit 3ME	9	9	9	9	9	9	6	6	6	6	1
Domain	9	9	9	8	9	9	7	6	5	5	3
Dual II Magnum	9	9	9	9	9	9	5	4	4	6	1
FirstRate	1	1	1	3	1	4	1	1	1	1	1
Gangster	6	5	7	6	6	6	3	3	3	3	2
Micro-Tech/Partner/Intro	9	9	9	9	9	9	4	3	3	6	1
Micro-Tech + Sencor	9	9	9	9	9	9	4	4	4	6	3
Outlook	9	9	9	9	9	9	4	4	4	6	1
Prowl/Prowl H20/Pendimax	9	9	9	9	9	9	8	6	6	8	2
Prowl/Prowl H20/Pendimax + Sencor	9	9	9	9	9	9	8	7	7	7	3
Pursuit DG	6	2	6	7	7	7	5	7	1	3	2
Pursuit + Dual II Magnum	9	9	9	9	9	9	7	7	3	5	2
Pursuit Plus	9	9	9	9	9	9	7	8	5	7	2
Python	1	1	1	2	1	1	1	1	1	1	1
Scepter + Dual II Magnum or Micro-Tech	9	9	9	9	9	9	4	4	4	5	2
Sencor (8 oz)	2	2	2	2	2	2	2	4	2	1	3
Squadron or Scepter + Sonalan or Treflan	9	9	9	9	9	9	7	6	5	6	2
Steel	9	9	9	9	9	9	7	9	5	4	1
Trifluralin	9	9	9	9	9	9	8	7	7	7	2
Trifluralin + Sencor	9	9	9	9	9	9	8	7	7	6	3
Valor	7	6	5	7	7	7	3	3	3	5	2

▣Crop hybrids vary in their response to herbicides. Crop safety ratings less than 3 indicate that crop yield should not be affected by any direct injury.

§Weed Competitive Index—See page 5.

Broadleaf Weed Response To Postemergence Herbicides Soybean

Plant response may be altered by growing conditions, genetic variation in crops and weeds, soil type, pH, organic matter, and application rates. Ratings may vary from season to season and geographical areas within the state. Ratings apply when herbicides are used as suggested in this publication. See pages 113-127 for additional problem weeds and their control. For generic herbicides check label to confirm site.

Weed Response Ratings: Ratings are for light to moderate weed densities, favorable conditions and weed growth stage as specified on the product label. High weed densities, adverse conditions, or large weeds will reduce control.

10 — 96-100% 9 — 90-95%
8 — 85-89% 7 — 80-84%
6 — 70-79% 5 — 60-69%
4-2 — less than 60% 1 — 0%

B. Nightshade (3.5) [§]	Cocklebur (5.5)	Kochia (2.5)	Kochia, ALS-resistant (2.5)	Kochia, Triazine-resistant (2.5)	Lambsquarters (1.5)	Morningglory species (5.5)	Pigweed (2.5)	Pigweed, Triazine-resistant (2.5)	Ragweed (3)	R. Thistle (2.3)	Smartweed (1.5)	Sunflower (10)	Velvetleaf (4.2)	Waterhemp (2.5)	Waterhemp, ALS-resistant (2.5)	Waterhemp, Triazine-resistant (2.5)	Crop Safety [¶]
----------------------------------	-----------------	--------------	-----------------------------	----------------------------------	---------------------	----------------------------	---------------	-----------------------------------	-------------	------------------	-----------------	----------------	------------------	-----------------	--------------------------------	-------------------------------------	--------------------------

Weed size influences performance—see label

Assure II	2	2	2	2	2	2	1	2	2	2	2	1	2	2	2	2	2	1
Basagran	2	9	7	7	7	7	3	2	2	7	7	9	8	9	2	2	2	1
Basagran + Ultra Blazer/Galaxy	7	9	7	7	7	7	8	8	8	9	7	9	8	9	8	8	8	2
Basagran + Cobra	7	9	4	4	4	4	5	9	9	9	7	9	8	8	9	9	9	3
Basagran + Scepter	4	10	7	7	7	7	7	9	9	7	7	9	9	9	8	3	3	1
Classic	2	10	4	1	4	4	8	8	8	9	3	9	9	8	6 ^a	1 ^a	6 ^a	3
Extreme	9	9	9	9	9	9	8	9	9	8	7	9	9	9	9	9	9	1
FirstRate	2	9	4	1	4	3	5	5	5	9	3	8	9	9	4	1	4	2
Fusilade-DX	2	2	2	2	2	2	1	2	2	2	2	2	2	2	2	2	2	1
Fusion	2	2	2	2	2	2	1	2	2	2	2	2	2	2	2	2	2	2
Glyphosate ^{♦b} (1 qt)	8	9	8	8	8	8	7	9	9	8	7	8	9	8	9	9	9	1
Glyphosate [♦] (32 oz) + Classic (0.3 oz)	8	10	10	8	10	9	8	10	10	10	10	10	10	9	10	10	10	3
Glyphosate [♦] (32 oz) + Flexstar (8 oz)	10	9	10	10	10	8	7	10	10	10	10	9	9	9	9	9	9	2
Glyphosate [♦] (32 oz) + Phoenix (5 oz)	8	9	9	9	9	6	7	10	10	10	9	10	8	9	10	10	10	3
Glyphosate [♦] (32 oz) + Raptor (3 oz)	10	10	10	10	10	10	7	10	10	8	10	8	10	10	10	10	10	1
Glyphosate [♦] (32 oz) + Scepter (1.44 oz)	8	8	9	9	9	7	6	10	10	10	10	8	9	9	10	10	10	2
Glyphosate [♦] (32 oz) + Ultra Blazer (12 oz)	10	8	9	9	9	6	7	10	10	10	10	10	8	8	9	9	9	3
Glyphosate [♦] (1 qt)—ropewicks, wipers, etc.	-	7	2	2	2	7	7	7	7	7	4	7	4	4	7	7	7	1
Harmony GT	2	6	4	1	4	8	5	8	8	4	3	8	6	8	6 ^a	1	6 ^a	3
Harmony GT + Classic	2	9	4	1	4	9	8	9	9	9	7	9	9	9	6 ^a	1	6 ^a	3
Phoenix/Cobra	8	8	4	4	4	4	8	9	9	9	5	7	4	4	9	9	9	3
Poast Plus	2	2	2	2	2	2	1	2	2	2	2	2	2	2	2	2	2	1
Poast Plus + Basagran	2	9	7	7	2	2	1	2	2	7	2	9	8	9	2	2	2	1
Pursuit	8	9	8	1	8	4	5	9	9	7	5	8	7	8	6 ^{ab}	1	6 ^{ab}	1
Pursuit + Blazer or Phoenix or Reflex	8	9	8	4	5	4	5	9	9	9	5	9	7	7	9	8	9	3
Raptor	9	9	8	1	8	8	5	9	9	7	-	7	9	9	6 ^{ab}	1	6 ^{ab}	1
Raptor + Blazer	9	9	8	4	8	8	6	9	9	9	5	9	9	9	9	9	9	1
Reflex/Flexstar	8	7	4	4	4	5	5	9	9	9	5	8	7	7	9	9	9	2
Resource	4	7	3	3	3	7	5	5	5	7	3	4	4	10	4	4	4	2
Select	2	2	2	2	2	2	1	2	2	2	2	2	2	2	2	2	2	1
Synchrony XP	2	9	6	1	6	9	5	9	9	9	7	9	9	9	6 ^{ab}	1	6 ^{ab}	1
Ultra Blazer	8	6	4	4	4	4	6	9	9	9	5	9	4	4	9	9	9	3

[¶]Varieties vary in their response to herbicides. Crop safety ratings less than 3 usually result in no yield reduction.

[♦]Glyphosate is the active ingredient in many products. The rates provided on this page are based on a 4 lb ai or 3 lb ae formulation. See the glyphosate product comparison table on pages 146-147 for the use rate and more information on the product being used.

^aNot labeled for control.

^bWarning: Repeated use of glyphosate alone can result in weed shift and weed resistance.

[§]Weed Competitive Index—See page 5.

Grass Weed Response To Postemergence Herbicides Soybean

Plant response may be altered by growing conditions, genetic variation in crops and weeds, soil type, pH, organic matter, temperature, growth stage, and application rates. Ratings may vary from season to season and geographical areas within the state. Ratings apply when herbicides are used as suggested in this publication. See pages 113-127 for additional problem weeds and their control. For generic herbicides check label to confirm site.

Weed Response Ratings: Ratings are for light to moderate weed densities, favorable conditions and weed growth stage as specified on the product label. High weed densities, adverse conditions, or large weeds will reduce control.

10 — 96-100% 9 — 90-95%
 8 — 85-89% 7 — 80-84%
 6 — 70-79% 5 — 60-69%
 4-2 — less than 60% 1 — 0%

Barnyardgrass (0.3) [§]	Crabgrass (0.5)	Fall Panicum (0.4)	Giant Foxtail (2.0)	Green Foxtail (1.0)	Yellow Foxtail (1.0)	Sandbur (0.4)	Shattercane/Sorghum (3.5)	Wolly Cupgrass (2.5)	Shattercane, ALS-resistant (3.5)	Crop Safety [¶]	Regular Corn—Volunteer (6.0)	RR Corn — Volunteer (6.0) ^a	LL Corn — Volunteer (6.0)	Clearfield Corn — Volunteer (6.0)
----------------------------------	-----------------	--------------------	---------------------	---------------------	----------------------	---------------	---------------------------	----------------------	----------------------------------	--------------------------	------------------------------	--	---------------------------	-----------------------------------

Weed size influences performance—see label

Assure II	9	9	9	8	8	6	9	10	9	10	1	10	10	10	10
Basagran	2	2	2	2	2	2	2	2	2	2	1	2	2	2	2
Basagran + Ultra Blazer or Galaxy	2	2	2	2	2	2	2	2	2	2	2	2	2	2	2
Basagran + Phoenix	2	4	4	4	5	2	4	4	2	4	3	4	4	4	4
Basagran + Scepter	2	2	2	2	2	2	2	2	2	2	1	6	6	6	0 ^b
Classic	2	2	2	2	2	1	2	2	2	2	3	3	3	3	3
Extreme	10	9	10	8	10	9	10	10	9	10	1	10	6	10	10
FirstRate	1	1	1	1	1	1	1	1	1	1	2	2	2	2	2
Fusilade DX	9	9	9	8	9	8	8	10	9	10	1	10	10	10	10
Fusion	9	9	9	9	9	9	8	10	9	10	2	10	10	10	10
Glyphosate [◆] (1 qt)	10	9	10	9	10	9	10	10	9	10	1	10	0 ^a	10	10
Glyphosate [◆] (32 oz) + Classic (0.3 oz)	10	9	10	9	10	9	10	10	9	10	1	10	0 ^a	10	10
Glyphosate [◆] (32 oz) + Flexstar (8 oz)	10	9	10	9	10	9	10	10	9	10	1	10	0 ^a	10	10
Glyphosate [◆] (32 oz) + Phoenix (5 oz)	10	9	10	9	10	9	10	10	9	10	1	10	0 ^a	10	10
Glyphosate [◆] (32 oz) + Raptor (3 oz)	10	9	10	9	10	9	10	10	9	10	1	10	0 ^a	10	10
Glyphosate [◆] (32 oz) + Scepter (1.44 oz)	10	9	10	9	10	9	10	10	9	10	1	10	0 ^a	10	10
Glyphosate [◆] (32 oz) + Ultra Blazer (12 oz)	10	9	10	9	10	9	10	10	9	10	1	10	0 ^a	10	10
Glyphosate [◆] (1 qt)—ropewicks, wipers, etc.	10	9	10	9	10	9	10	10	9	10	1	10	0 ^a	10	10
Harmony GT	1	1	1	1	1	1	1	1	2	1	2	2	2	2	2
Harmony GT + Classic	2	2	2	2	2	2	2	2	2	2	3	2	2	2	2
Phoenix/Cobra	2	4	4	1	1	1	4	4	2	4	3	2	2	2	2
Poast Plus	9	9	9	9	9	9	9	10	9	10	1	10	10	10	10
Poast Plus + Basagran	8	8	8	7	7	6	8	9	8	9	1	10	10	10	10
Pursuit	7	7	5	8	9	7	5	9	6	1	1	6	6	6	0
Pursuit + Blazer or Phoenix or Reflex	7	7	4	8	8	7	4	9	6	4	3	6	6	6	0
Raptor	8	7	9	9	9	8	7	9	5	1	1	8	8	8	0
Raptor + Blazer	8	7	9	9	9	8	7	9	5	1	1	8	8	8	0
Reflex/Flexstar	2	4	4	4	5	4	4	4	1	4	2	6	6	6	6
Resource	1	1	1	1	1	1	1	1	1	1	2	1	1	1	1
Select	9	9	9	9	9	9	9	10	9	10	1	10	10	10	10
Synchrony XP	2	2	2	2	2	2	2	2	2	2	1	6	6	6	0
Ultra Blazer	2	4	4	2	2	2	4	4	2	4	3	3	3	3	3

[¶]Varieties vary in their response to herbicides. Crop safety ratings less than 3 indicate that crop yield should not be affected by any direct injury. If stand is not lost injury, most crops will compensate for early injury. Adding surfactants, COC, or liquid nitrogen may reduce crop safety for some herbicide combinations. Refer to product label for specific information.

[§]Weed Competitive Index—See page 5.

^aGlyphosate will not control RR volunteer corn.

^bClearfield corn will not be controlled by imidazolinones and sulfonyleurea herbicides.

[◆]Glyphosate is the active ingredient in many products. The rates provided on this page are based on a 4 lb ai or 3 lb ae formulation. See the glyphosate product comparison table on pages 146-147 for the use rate and more information on the product being used.

Soybean

A Note about Using 2,4-D and Dicamba Before Planting

Many times producers want to apply 2,4-D and/or dicamba (Banvel/Clarity/Sterling) prior to crop planting. The University of Nebraska recommends that the following guidelines be used when applying 2,4-D and dicamba before planting corn, soybean, and sorghum. Note that this is applicable to both ester and amine formulations of 2,4-D.

2,4-D preplant interval	Use Rate	Use Rate	Dicamba preplant interval	Use Rate	Use Rate
Crop	1 pt	>1 pt	Crop	1/4 pt	1/2 pt
Corn	7 days	14 days	Corn	5 days	7 days
Soybean (use ester only)	7 days	30 days	Soybean	DO NOT USE	DO NOT USE
Sorghum	10 days	21 days	Sorghum	7 days	10 days

Fall Burndown Treatments

See <i>Weed Response Chart</i> on page 51 before selecting herbicides)	Sandy Loam < 1% OM	Silt Loam 1-2% OM	Silty-Clay Loam > 2% OM	Remarks and Approximate Cost/A Broadcast
2,4-D ESTER	2 pt	2 pt	2 pt	Apply before ground freezes. Cost: 2,4-D ester \$5.00; glyphosate \$3.00-\$5.00; Gramoxone Max \$10.00-\$15.00.
GLYPHOSATE♦	32 oz	32 oz	32 oz	
GLYPHOSATE♦ + 2,4-D	24 oz	24 oz	24 oz	
GRAMOXONE MAX	1 pt	1 pt	1 pt	
	1.3 pt	1.3 pt	1.3 pt	

No-till

GENERAL REMARKS

EPP treatments provide excellent early weed control; however, when the interval between herbicide application and planting is 28 days or more, split applications will generally give better control. If planting is delayed longer than planned after an EPP treatment, a PRE treatment may be needed. A non-selective herbicide such as Roundup Ultra may be needed to control emerged weeds at time of application of residual herbicides. If only non-residual PRE or POST herbicides are used, apply appropriate PRE or POST herbicides as necessary. If Roundup Ready or Liberty-Link varieties are planted, consider using a residual herbicide if a high weed density is expected. Also, Roundup Ultra does not control volunteer Roundup Ready corn. Risk of developing soybean cyst nematode can be reduced if winter annual broadleaf weeds are controlled in the fall or early spring.

Herbicide (See <i>Weed Response Chart</i> on page 51 before selecting herbicides)	Commercial Product per Acre			Application Time	Remarks and Approximate Cost/A Broadcast
	Sandy Loam < 1% OM	Silt Loam 1-2% OM	Silty-Clay Loam > 2% OM		
No-Till in Alfalfa or Clover Sod					
2,4-D ester (4L) + DICAMBA•	1.0 qt	1.0 qt	1.0 qt	Apply in fall to alfalfa with 4" new growth	Generally it is not wise to follow alfalfa with soybean. Use appropriate residual herbicide at planting. 2,4-D + Banvel/Clarity used to kill alfalfa. Cost: \$8.95.
Soybean, No-Till in Cool-Season Grass Sod					
GLYPHOSATE♦	24-32 oz	24-32 oz	24-32 oz	Apply in FALL to 6-12" of new growth	Plant RR soybean. Cost: glyphosate \$2.60-\$3.50.
Soybean, No-Till in Warm-Season Grass Sod					
GLYPHOSATE♦	32 oz	32 oz	32 oz	Apply in August to early September	Plant RR soybean. Cost: glyphosate \$3.50.
Soybean, No-Till in Corn Residue					
GLYPHOSATE♦	3 qt	3 qt	3 qt	Apply in SPRING at 4" growth	

♦Glyphosate is the active ingredient in many products. The rates provided on this page are based on a 4 lb ai or 3 lb ae formulation. See the glyphosate product comparison table on pages 146-147 for the use rate and more information on the product being used.

•Dicamba is the active ingredient in Banvel, Clarity, Sterling and several other herbicides. The rates and information provided here are based on the same 4 lb/gal acid equivalent formulation found in Banvel, Clarity and Sterling.

Soybean No-till (continued)

Herbicide <i>(See Weed Response Chart on page 56 before selecting herbicides)</i>	Commercial Product per Acre			Application Time	Remarks and Approximate Cost Per Acre Broadcast	
	Sandy Loam < 1% OM	Silt Loam 1-2% OM	Silty-Clay Loam > 2% OM			
Soybean, No-Till in Rye or Winter Wheat						
GLYPHOSATE [◆]	20-24 oz	20-24 oz	20-24 oz	Apply when rye and wheat are 4-10" and before soybean emerge	Follow with appropriate EPP treatment. Cost: glyphosate \$2.20-\$2.60.	
CANOPY EX	1.1 oz	2.0 oz	3.3 oz	45 DBP	Use east of Hwy. 281. Cost: TBA.	
EXTREME	3 pt	3 pt	3 pt	0-30 DBP	Add 2,4-D ester (1.0 pt) to enhance control of perennial weeds (e.g. swamp smartweed and hemp dogbane). If 2,4-D is used, don't plant soybean for at least 7 days after application. Cost: \$12.00.	
PURSUIT DG + DUAL II MAGNUM or MICRO-TECH or PARTNER or OUTLOOK	1.44 oz 1 pt 2.5 qt 2.3-3 lb 16-20 oz	1.44 oz 1.33 pt 2.5-3 qt 2.3-3 lb 20-25 oz	1.44 oz 1.67 pt 2.5-3 qt 2.6-3.4 lb 25-30 oz	0-30 DBP 0-30 DBP 0-30 DBP 0-30 DBP 0-30 DBP	Do not plant sorghum the following year. EPP treatments may be less effectively if rainfall does not occur within 7 days of application. Cost: Pursuit + Dual \$32.62-\$42.61; Pursuit + Micro-Tech \$33.46-\$36.61; Pursuit + Partner \$23.69-\$27.07; Pursuit Plus \$16.40; Pursuit + Outlook \$37.50-\$54.81.	
PURSUIT PLUS	2.5 pt	2.5 pt	2.5 pt	0-45 DBP		
GLYPHOSATE ^{◆2}	24-32 oz	24-32 oz	24-32 oz	0-30 DBP		Cost: glyphosate \$4.68-\$10.00.
GLYPHOSATE ^{◆2} + 2,4-D LV ester (4L) ¹	24-32 oz 1-2 pt	24-32 oz 1-2 pt	24-32 oz 1-2 pt	7-30 DBP		Use appropriate herbicide at planting. 2,4-D at 1 pt, 7 days before planting; at 2 pt, 30 days before planting. Cost: glyphosate \$2.60-\$3.50; glyphosate + 2,4-D \$4.45-\$7.20.
SENCOR 75DF + DUAL II MAGNUM or MICRO-TECH or OUTLOOK or INTRRO	0.33 lb 1 pt 2.0 qt 16 oz 2.5 qt	0.67 lb 1.33 pt 2.5 qt 20 oz 2.75 qt	0.83 lb 1.66 pt 3 qt 25 oz 2.5-2.75 qt	0-14 DBP		Add 0.25% surfactant or 1 qt/A crop oil concentrate for better burndown of small weeds up to 1.5-2. If emerged weeds are more than 2, add Gramoxone Extra, Roundup UltraMax or Touchdown/glyphosates as discussed in the pre-emergence section. Split application is not necessary except if planter causes excessive soil disturbance. Do not apply on soils with less than 0.5% OM. Reduce Sencor rate by 1/3 on calcareous soils. Do not apply Cost: Sencor with Dual II Magnum \$22.17-\$43.16; Sencor + Outlook \$27.05-\$49.18; Sencor with Micro-Tech \$19.56-\$37.16; Intrro \$6.28-\$6.90; Sequence TBA.
SEQUENCE	2.5-3.0 pts	2.5-3.0 pts	2.5-3.0 pts	0-30 DBP		
VALOR + GLYPHOSATE [◆] or 2,4-D LV ESTER (4L) ¹	1.5 oz 16-32 oz 1 pt	1.5-2.0 oz 16-32 oz 1 pt	2.0-2.5 oz 16-32 oz 1 pt	0-14 DBP 0-14 DBP 7-14 DBP	Cost: Valor + glyphosate \$8.08-\$14.05; Valor + 2,4-D \$9.29-\$14.29.	

¹Preplant interval for 1 pt 2,4-D is 7 days. If more than 1 pt of 2,4-D is used, then the preplant interval is 30 days or crop injury will result. Do not use Banvel, Clarity or Sterling preplant.

²With colder day/nights (less than 60/50°F) glyphosate performance will be reduced.

[◆]Glyphosate is the active ingredient in many products. The rates provided on this page are based on a 4 lb ai or 3 lb ae formulation. See the glyphosate product comparison table on pages 146-147 for the use rate and more information on the product being used.

Soybean Ridge-till

In crops planted after mid-May, weeds can be expected to grow vigorously before planting. In a ridge plant system these weeds may become too large to uproot and smother unless control efforts are applied in late April or early May. Two approaches can be used to control these weeds. The first would be to select an early preplant treatment from the no-till section and apply by mid to late April. Since the planting operation will destroy this herbicide barrier, a second herbicide application over the row is required at planting. A split application of two-thirds rate applied preplant and one-third banded over the row at planting should be effective. Another strategy is to apply a POST herbicide such as glyphosate to destroy weeds before growth exceeds 3 to 4 inches in height. Application is needed in late April to early May. Apply a PRE herbicide at planting. In most cases the time interval from application of the preplant knockdown herbicide to planting should not exceed three to four weeks. Weeds such as kochia, horseweed, smartweed, and winter annuals will warrant early treatment. Lambsquarters, velvetleaf, and grasses will emerge early in some years. The key to successful weed control is timely application of the herbicides. Appropriate herbicides can be selected from the no-till and tilled seedbed sections for this crop. Apply glyphosate at 1.5 to 2.0 pt/A, one to three weeks preplant. Cost: \$2.60-\$3.50.

Tilled Seedbed

Herbicide	Commercial Product per Acre			Remarks and Approximate Cost Per Acre Broadcast
	Sandy Loam < 1% OM	Silt Loam 1-2% OM	Silty-Clay Loam > 2% OM	
(See <i>Weed Response Chart</i> on page 57 before selecting herbicides)				

Soil-applied Herbicides

For cocklebur, sunflower and velvetleaf, see *Troublesome Weeds and Woody Plants*, pages 113-127.

AUTHORITY	4 oz	5.3 oz	5.3 oz	PPI, PRE. Cost: \$7.25-\$9.59.
AXIOM	7 oz	10-13 oz	13 oz	EPP, PPSA, PRE, or SURFACE MIX. Cost: \$8.75-\$16.25.
BOUNDARY 6.5	Do not use	1.5-2.0 pt	1.75-2.25 pt	PP, PRE. Cost: \$15.38-\$23.06.
COMMENCE	1.8-2 pt	2-2.5 pt	2.7 pt	Cost: \$10.00-\$12.00.
COMMIT 3ME	1.0 pt	1.6 pt	2.0 pt	Cost: \$13.00-\$26.00.
DOMAIN	Do not use	9-12 oz	10-16 oz	PPSA, PPI or PRE. For early season weed control only. Not recommended for use on sandy soils with less than 1% O.M. Use higher rates when weed pressure is heavy. Cost: \$2.76-\$13.80.
DUAL II MAGNUM/CINCH or DUAL IIG MAGNUM	1.33 pt 6-8 lb	1.33 pt 8-10 lb	1.67 pt 10-12 lb	EPP, PRE, or SURFACE MIX. Cost: \$20.11-\$25.26 for liquid.
FIRSTRATE	0.60 oz	0.60 oz	0.60 oz	To reduce injury on calcareous soil or soil with pH greater than 7.5, reduce Sencor rate by one-third. Cost: \$17.64.
GANGSTER (co-pack) GANGSTER V + GANGSTER FR	2.5 oz 0.6 oz	2.5 oz 0.6 oz	3.0 oz 0.6 oz	Do not use on sand less than 1% OM. Cost: \$16.00-\$18.00.
INTRRO/MICRO-TECH or PARTNER	2.5 qt 3.5 lb	2.5 qt 3.5 lb	2.5 qt 3.5 lb	PRE or SURFACE MIX. Cost: Intrro \$13.75; Micro-Tech \$15.75; Partner \$9.10.
OUTLOOK	12-14 oz	14-18 oz	18-21 oz	Cost: \$23.75-\$71.24.
PROWL (3.3EC)/ PROWL H ₂ O/PENDIMAX	1.2-1.8 pt	1.8-3.0 pt	2.4-3.6 pt	PPI or SURFACE MIX — Cost: Prowl \$6.65-\$10.65.
PURSUIT PLUS	2.5 pt	2.5 pt	2.5 pt	SURFACE MIX — Do not graze or feed treated soybean forage, hay, or straw to livestock. Do not plant sorghum the following year. Cost: \$16.40.
PYTHON	0.80 oz	1.0 oz	1.33 oz	Cost: \$8.24-\$13.70.
SCEPTER 70DG	1.4 oz	1.4 oz	1.4 oz	PRE. Cost: \$4.40.

Soybean

Tilled Seedbed (continued)

Herbicide (See <i>Weed Response Chart</i> on pages 57 before selecting herbicides)	Commercial Product per Acre			Remarks and Approximate Cost Per Acre Broadcast
	Sandy Loam < 1% OM	Silt Loam 1-2% OM	Silty-Clay Loam > 2% OM	
SENCOR DF + DUAL II MAGNUM/CINCH	0.33 lb 1.0 pt	.40 lb 1.0 pt	0.50 lb 1.33 pt	Cost: Sencor \$7.26-\$11.00; additional cost for combination with Dual II Magnum \$15.13-\$20.12.
SONALAN	2.0 pt	2.5 pt	3.0 pt	PPI — Incorporate within 48 hours. Increase Sonalan rate by 1/2-1 pt for black nightshade control. Sonalan may be applied to untilled residues. Cost: Sonalan \$8.10-\$ 12.10.
STEEL	3.0 pt	3.0 pt	3.0 pt	PPI or PRE—Applications can be made up to 45 days before, during, or after planting. Incorporation by tillage or rainfall needed within seven days after application to insure weed control. Labeled east of Highway 81. Do not plant corn the year following treatment north of Highway 34 unless IR/IT corn is used. Cost: \$14.70.
TRIFLURILAN	1.0 pt	1.5 pt	2.0 pt	PPI — For best results immediately incorporate. Trifluralin may be applied to untilled residue. Cost: Trifluralin \$3.65-\$7.25.
VALOR	1.5 oz	1.5-2.0 oz	2.0-2.5 oz	PRE—Cost: \$6.32-\$10.53.

Soybean

Postemergence (See page 38 for additives)

Herbicide (See <i>Weed Response Chart</i> on pages 59-61 before selecting herbicides)	Rates Per Acre	Application Time	Remarks and Approximate Cost Per Acre Broadcast
ASSURE II	7-8 oz	Grasses 4" Shattercane and corn 12-18"	Cost: \$7.10-\$8.10.
BASAGRAN alone or with ULTRA BLAZER or HARMONY GT or FLEXSTAR/REFLEX or SCEPTER	1-2 pt 0.5-1 pt 0.12 oz 0.75-1.0 pt 1.4-2.8 oz	Broadleaf weeds less than 4" tall	Split applications of Basagran at 1 pt/A may improve control of several weeds. See label for specific weed size. Cost: Basagran \$9.50-\$19.00; additional cost with Ultra Blazer \$4.25-\$8.50; Harmony GT \$1.46; Flexstar/Reflex \$9.48-\$13.70; Scepter \$4.38-\$8.75.
BASAGRAN + POAST PLUS	1.5-2 pt 1.5-2.5 pt	Use Basagran and Poast Plus guidelines	See label for rates and weed size. Cost: \$20.00-\$31.00.
CLASSIC	0.33-0.75 oz	Apply when most broadleaf weeds are less than 4" tall	May be tank-mixed with 4-6 oz Cobra or with labeled rate of Blazer or Reflex where eastern black nightshade or common waterhemp are present. Use COC only during drought conditions. Add 1 gal. of 28% UAN for velvetleaf. Refer to Classic label for recrop intervals. Cost: Classic \$3.43-\$10.28; Classic + Harmony GT \$5.09.
CLASSIC + HARMONY GT	0.25 oz 0.12 oz		
COBRA	8-12.5 oz	Apply when most broadleaf weeds are 2-6" tall	Do not use during periods of stress or weed control will be poor. See label for specific weed size. Cost: \$9.55-\$14.92.
EXTREME (Roundup Ready varieties only)	3 pt	Weeds 6-8" tall	Add NIS at 1 pt/100 gal + spray grade AMS 17 lb/100 gal. Recrop interval of 18 months for oat, sunflower, popcorn, sweetcorn and sorghum. Cost: \$12.00.
FIRSTRATE	0.30 oz	Broadleaf weeds 1-6"	Tank-mix with Blazer or Cobra or Flexstar/Reflex for waterhemp control. Also labeled for second 0.3 oz application. Cost: \$8.55.
FLEXSTAR/REFLEX	0.75-1.0 pt	Apply when most broadleaf weeds are less than 4" tall	Do not plant sorghum the following year. Do not use west of Highway 281. Do not apply Reflex or Flexstar to any field more than once every two years. Cost: \$9.48-\$13.70.
FUSILADE-DX	8-12 oz	Grasses 2-6"	Cost: \$9.43-\$14.15.
FUSION	6-10 oz	Grasses 4" Shattercane and corn 12-18"	Cost: \$7.55-\$12.58.
GALAXY	2 pt	Apply when most broadleaf weeds are less than 4" tall	See label for specific weeds. Cost: \$16.10.
GLYPHOSATE ^{♦1} (Roundup Ready variety required)	26-32 oz	Weeds less than 12" tall	Check label for maximum application amount per growing season. Cost: \$2.86-\$3.52.
GLYPHOSATE ^{♦1} + CLASSIC	32 oz 0.3 oz	Weeds 2-4"	Control of taller morningglory, velvetleaf and waterhemp can be reduced by 20-60%. Cost: \$8.00-\$10.00.

¹Warning: Repeated use of glyphosate can result in a shift in weed species and weed resistance. Six weed species have been documented to be glyphosate resistant in the United States, including: ryegrass, waterhemp, marehail, palmer amaranth, lambsquarter, and common ragweed.

[♦]Glyphosate is the active ingredient in many products. The rates provided on this page are based on a 4 lb ai or 3 lb ae formulation. See the glyphosate product comparison table on pages 146-147 for the use rate and more information on the product being used.

Soybean

Postemergence (continued) (See page 38 for additives)

Herbicide (See <i>Weed Response Chart</i> on pages 59-61 before selecting herbicides)	Rates Per Acre	Application Time	Remarks and Approximate Cost Per Acre Broadcast
GLYPHOSATE♦ ¹ + PHOENIX	32 oz 5 oz	Weeds 2-4"	Control of taller morningglory and velvetleaf can be reduced by 10-40%. Cost: \$10.00.
GLYPHOSATE♦ ¹ + RAPTOR	32 oz 3 oz	Weeds 2-4"	Control of taller morningglory can be reduced by 60%. Cost: \$15.00-\$20.00.
GLYPHOSATE♦ ¹ + FLEXSTAR	32 oz 8 oz	Weeds 2-4"	Control of taller morningglory, velvetleaf and common waterhemp can be reduced by 60%. Cost: \$10.00-\$12.00.
GLYPHOSATE♦ ¹ + SCEPTER	32 oz 1.44 oz	Weeds 2-4"	Control of taller morningglory, velvetleaf and waterhemp can be reduced by 20-60%. Cost: \$7.00-\$12.00.
GLYPHOSATE♦ ¹ + ULTRA BLAZER	32 oz 12 oz	Weeds 2-4"	Control of taller morningglory, velvetleaf and waterhemp can be reduced by 20-60%. Cost: \$8.00-\$12.00.
PHOENIX	8-12.5 oz	Apply when most broadleaf weeds are less than 4" tall	May be tank-mixed with Select (6-8 oz) + NIS. COC not required if weeds are less than 4 inches. Cost: \$9.44-\$14.75.
POAST PLUS	1.5-2.25 pt	Grasses 8" Shattercane and corn 12-18"	Use lower rate for most grasses. COC needed for effective control. UAN or AMS will improve control of some species. Refer to label. Cost: \$10.24-\$15.36.
PURSUIT DG alone or with COBRA or ULTRA BLAZER or FLEXSTAR/REFLEX	1.44 oz 4 oz 0.5-1.0 pt 0.75-1.0 pt	Weeds less than 4" Shattercane up to 6"	Do not plant sorghum the following year. Do not use during periods of stress or weed control will be poor. Add Select to improve control of volunteer corn. Use a combination for waterhemp control. Do not graze or feed treated soybean forage, hay, or straw to livestock. Cost: Pursuit alone \$14.76; additional cost with Cobra \$4.20; Blazer \$4.91-\$9.81; Flexstar/Reflex \$9.49-\$13.70.
RAPTOR or RAPTOR + ULTRA BLAZER	5 oz 4 oz 10-16 oz	Weeds 2-4" Shattercane up to 8"	Apply only once per season. Do not graze or feed treated forage to livestock. Use 4 oz rate if a pre-emergence herbicide was used. Add Ultra Blazer/Status for waterhemp and smartweed control. Cost: \$28.55.
RESOURCE	4.0-12.0 oz	Velvetleaf 4-30"	Add COC + AMS. Cost: \$5.22-\$10.44.
SYNCHRONY XP (STS variety required)	0.50 oz	Broadleaf weeds less than 6"	May be tank-mixed with 4-6 oz Cobra or labeled rates of Blazer or Reflex (where eastern black nightshade or waterhemp is present). Can be tank-mixed with POST grass herbicides under certain conditions. Synchrony STS may reduce POST grass herbicide activity. Cost: (STS variety) \$2.63-\$5.26; (any variety) \$2.18.
SYNCHRONY XP (any variety)	0.25 oz		
SELECT	6-8 oz	Grasses 6-8" Shattercane 6-18" Corn 12-24"	Add COC/MSO except when using with Phoenix. AMS is recommended. Cost: \$9.73-\$12.94.
STORM	1.5 pt	Broadleaf weeds less than 4" tall	Cost: \$16.82.

¹Warning: Repeated use of glyphosate can result in a shift in weed species and weed resistance. Six weed species have been documented to be glyphosate resistant in the United States, including: ryegrass, waterhemp, marehail, palmer amaranth, lambsquarter, and common ragweed.

♦Glyphosate is the active ingredient in many products. The rates provided on this page are based on a 4 lb ai or 3 lb ae formulation. See the glyphosate product comparison table on pages 146-147 for the use rate and more information on the product being used.

Soybean

Postemergence (continued) (See page 38 for additives)

Herbicide (See <i>Weed Response Chart</i> on pages 59-61 before selecting herbicides)	Rates Per Acre	Application Time	Remarks and Approximate Cost Per Acre Broadcast
ULTRA BLAZER	8-24 oz	Apply when most broadleaf weeds are less than 4" tall	See label for rates and specific weed size. Cost: \$4.91-\$14.72.

Harvest Aid

GLYPHOSATE♦	32 oz		14 days before harvest on Roundup Ready® varieties only. Cost: \$3.50-\$10.00.
GRAMOXONE MAX	12.8 oz	When 65% of pods are brown	Desiccant. Follow label directions on water volume and NIS additive. Do not graze for 15 days. Cost: \$4.45.

♦Glyphosate is the active ingredient in many products. The rates provided on this page are based on a 4 lb ai or 3 lb ae formulation. See the glyphosate product comparison table on pages 146-147 for the use rate and more information on the product being used.

Bean Bar/Wiper Applications

Crop	Applicator	Herbicide:Water Ratio	Remarks ¹
Soybean and Sorghum	1. Ropewick	GLYPHOSATE♦ (30% concentration)	No surfactant needed. Works best on volunteer corn and shattercane. Weeds should be 10-12" taller than soybean. Travel both directions in heavy stands. In sorghum, too wet or dripping ropes will cause droplet splash and crop injury.
Soybean	2. Bean Bar— straight stream tip	GLYPHOSATE♦ (4% concentration)	A marking dye can be added to the spray solution so it is easier to see treated plants. Add a surfactant at 0.5% v/v.
Soybean	3. Bean Bar— spreading tip	BASAGRAN 1:100 (1% concentration)	Complete coverage essential. Add 1 gal UAN to each 25 gal spray. Add Poast and COC for shattercane and volunteer corn.
		CLASSIC + PINNACLE 0.5 oz + 0.5 oz per 25 gal water	Add 1 qt COC + 1 gal 28-0-0 per 25 gal.
		POAST PLUS, FUSILADE or ASSURE 1:100 (1% concentration)	Add 1 qt COC or 1/2 pt adjuvant per 25 gal mix. Pre-harvest, intervals: Poast, 90 days; Fusilade, pre-bloom; Assure, 80 days; Fusion, Prebloom; Select, 50 days.
		SELECT 1:100 (1% concentration)	
		FUSION 1:160 (0.62% concentration)	

¹Herbicide costs per acre vary from \$1.00 with light weed infestations to \$15.00 in heavy infestations.

♦Glyphosate is the active ingredient in many products. The rates provided on this page are based on a 4 lb ai or 3 lb ae formulation. See the glyphosate product comparison table on pages 146-147 for the use rate and more information on the product being used.

Broadleaf Weed Response To Selected Herbicides

Sorghum — Grain and Forage[△]

Plant response may be altered by growing conditions, genetic variation in crops and weeds, soil type, pH, organic matter, temperature, growth stage, and application rates. Ratings may vary from season to season and geographical areas within the state. Ratings apply when herbicides are used as suggested in this publication. See pages 113-127 for additional problem weeds and their control.

Weed Response Ratings: Ratings are for light to moderate weed densities, favorable conditions and weed growth stage as specified on the product label. High weed densities, adverse conditions, or large weeds will reduce control.

10 — 96-100%	9 — 90-95%	B. Nightshade (3.5) [§]
8 — 85-89%	7 — 80-84%	Cocklebur (5.5)
6 — 70-79%	5 — 60-69%	Kochia (2.5)
4-2 — less than 60%	1 — 0%	Kochia, ALS-resistant (2.5)
		Kochia, Triazine-resistant (2.5)
		Lambsquarters (1.5)
		Morningglory species (5.5)
		Pigweed (2.5)
		Pigweed, Triazine-resistant (2.5)
		Ragweed (4.0)
		R. Thistle (2.3)
		Smartweed (1.5)
		Sunflower (10)
		Velvetleaf (4.2)
		Waterhemp (2.5)
		Waterhemp, ALS-resistant (2.5)
		Waterhemp, Triazine-resistant (2.5)
		Crop Safety [□]

Soil-applied Herbicides

Atrazine [△] ■	9	7	9	9	2	9	7	9	1	9	9	9	7	7	9	9	1	2
Bicep II Magnum/Cinch ATZ [△] ■	9	7	9	9	2	9	6	9	7	9	9	7	7	6	9	9	7	2
Bullet	9	5	9	9	2	9	6	9	7	9	7	7	6	5	9	9	7	2
Dual II Magnum/Cinch [△]	6	2	2	2	2	7	2	7	7	4	2	2	2	2	7	7	7	2
Dual II Magnum [△] / Micro-Tech + Atrazine	9	5	9	9	2	9	6	9	7	9	7	7	6	5	9	9	7	2
Guardman Max	9	7	9	9	2	9	6	9	7	8	8	8	6	6	9	9	7	2
Intrro/Micro-Tech	7	2	2	2	2	7	1	7	7	5	3	2	2	2	7	7	7	2
Lariat	9	5	9	9	2	9	6	9	7	9	7	7	6	5	9	9	7	2
Outlook	6	2	2	2	2	7	2	7	7	4	2	2	2	2	7	7	7	2

Postemergence Herbicides

Weed size influences performance—see label

AAtrex/Atrazine [△]	9	9	9	9	1	9	9	9	1	9	4	9	9	9	9	1	2
Aim/Avalanche	9	7	6	6	6	9	7	8	8	6	6	8	5	10	7	7	2
Aim + Atrazine + Dicamba [●]	9	8	8	8	7	9	9	9	9	8	8	8	6	10	8	8	2
Aim + Atrazine	9	8	8	8	6	9	9	9	8	7	6	8	6	10	8	8	2
Aim + Clarity	9	8	9	8	8	9	9	9	9	8	9	9	7	10	8	8	3
Ally + 2,4-D	4	9	9	6	9	10	9	10	10	9	8	6	10	6	9	6	2
Dicamba [●]	7	9	8	8	8	7	9	8	8	7	9	9	8	6	8	8	4
Buctril/Moxy [△]	9	9	8	8	8	7	9	6	6	9	7	9	9	8	6	6	2
Buctril + Atrazine [△]	9	9	9	9	8	9	9	9	6	9	8	8	9	9	9	9	2
Glyphosate—ropewicks, wipers, etc. [◆]	-	8	6	6	6	4	-	5	5	7	4	7	7	4	5	5	1
Marksman/Sterling Plus	9	9	8	8	7	9	9	9	8	9	8	9	9	8	9	9	2
Paramount	-	-	5	5	5	5	9	5	5	5	5	-	5	5	-	5	2
Paramount + Atrazine	9	9	9	9	5	9	9	9	5	9	7	9	9	9	9	9	2
Peak	3	9	6	1	6	5	8	8	8	9	-	7	9	8	9	1	2
Peak + Dicamba [●]	7	9	8	7	8	7	9	9	9	9	7	9	9	8	9	8	4
Permit	3	9	6	1	6	5	6	8	8	9	-	7	9	8	8	1	2
Starane	5	6	9	9	9	2	8	2	2	8	5	2	6	7	2	2	1
2,4-Dr	4	10	4	4	4	7	10	8	8	7	9	3	7	7	8	8	4

□Crop hybrids vary in their response to herbicides. Crop safety ratings less than 3 indicate that crop yield should not be affected by any direct injury.

△Registered for forage silage.

§Weed Competitive Index—See page 5.

■Glyphosate is the active ingredient in many products. The rates provided on this page are based on a 4 lb ai or 3 lb ae formulation. See the glyphosate product comparison table on pages 146-147 for the use rate and more information on the product being used.

●Dicamba is the active ingredient in Banvel, Clarity, Sterling and several other herbicides. The rates and information provided here are based on the same 4 lb/gal acid equivalent formulation found in Banvel, Clarity and Sterling.

◆If atrazine was applied at planting, the total amount of early and late applications cannot exceed 2.5 lb ai/A per calendar year. Use no more than 1.6 lb ai/A on highly erodible land with less than 30% crop residue. Using atrazine on soils with less than 1% organic matter increases carryover injury risk to susceptible crops, especially high pH soils. Do not use on sandy soils if water table is shallower than 30 ft.

Grass Weed Response To Selected Herbicides

Sorghum — Grain and Forage

Plant response may be altered by growing conditions, genetic variation in crops and weeds, soil type, pH, organic matter, temperature, growth stage, and application rates. Ratings may vary from season to season and geographical areas within the state. Ratings apply when herbicides are used as suggested in this publication. See pages 113-127 for additional problem weeds and their control. If volunteer corn is a potential problem delay planting and use Roundup to control seedlings or use tillage early to help germinate the seeds.

Weed Response Ratings: Ratings are for light to moderate weed densities, favorable conditions and weed growth stage as specified on the product label. High weed densities, adverse conditions, or large weeds will reduce control.

10 — 96-100% 9 — 90-95%
 8 — 85-89% 7 — 80-84%
 6 — 70-79% 5 — 60-69%
 4-2 — less than 60% 1 — 0%

Barnyardgrass (0.3)	Crabgrass (0.5)	Fall Panicum (0.4)	Giant Foxtail (2.0)	Green Foxtail (1.0)	Yellow Foxtail (1.0)	Sandbur (0.4)	Shattercane/Sorghum (3.5)	Shattercane, ALS-resistant (3.5)	Woolly Cupgrass (2.5)	Crop Safety [□]
---------------------	-----------------	--------------------	---------------------	---------------------	----------------------	---------------	---------------------------	----------------------------------	-----------------------	--------------------------

Soil-applied Herbicides

Atrazine [△] ■	4	4	2	6	7	6	4	2	2	3	2
Bicep II Magnum [■]	9	9	9	9	9	9	4	2	2	6	2
Bullet	9	7	7	9	9	9	4	2	2	6	2
Dual II Magnum	9	9	9	9	9	9	4	2	2	6	2
Dual II Magnum [△] /Micro-Tech + Atrazine [■]	9	7	7	9	9	9	4	2	2	6	2
Guardsman Max	9	9	9	9	9	9	4	3	3	6	2
Intro/Micro-Tech	9	9	9	9	9	9	6	4	4	6	2
Lariat	9	7	7	9	9	9	4	2	2	6	2
Outlook	9	9	9	9	9	9	4	2	2	6	2

Postemergence Herbicides

Weed size influences performance—see label

AAtrex/Atrazine + COC	2	2	2	3	4	4	2	2	2	3	2
Aim/Avalanche	1	1	1	1	1	1	1	1	1	1	2
Aim + Atrazine + Dicamba [●]	2	1	1	2	2	2	1	1	1	1	2
Aim + Atrazine	3	2	1	2	2	2	1	1	1	2	2
Aim + Dicamba [●]	1	1	1	1	1	1	1	1	1	1	3
Ally + 2,4-D	2	2	2	2	2	2	2	3	2	2	3
Dicamba [●]	2	2	2	2	2	2	2	2	2	1	4
Buctril/Moxy	2	2	2	1	1	1	2	2	2	1	2
Buctril + Atrazine [△]	2	2	2	2	2	2	2	2	2	3	2
Laddok S-12 [△]	2	2	2	2	2	2	2	2	2	2	1
Marksman	2	2	2	2	2	2	2	2	2	2	2
Paramount	7	7	-	8	8	7	5	2	2	7	2
Paramount + Atrazine	8	8	-	9	9	8	-	2	2	8	2
Peak	1	1	1	1	1	1	1	1	1	1	2
Peak + Dicamba [●]	1	1	1	1	1	1	1	1	1	1	3
Permit	1	1	1	1	1	1	1	1	1	1	2
Starane	1	1	1	1	1	1	1	1	1	1	1
Glyphosate—ropewicks, wipers, etc. [◆]	-	-	-	-	-	-	-	8	8	-	1
2,4-D	2	2	2	1	1	1	2	3	2	1	4

[□]Crop hybrids vary in their response to herbicides. Crop safety ratings less than 3 indicate that crop yield should not be affected by any direct injury.

[△]Registered for forage silage.

[§]Weed Competitive Index—See page 5.

[◆]Glyphosate is the active ingredient in many products. The rates provided on this page are based on a 4 lb ai or 3 lb ae formulation. See the glyphosate product comparison table on pages 146-147 for the use rate and more information on the product being used.

[●]Dicamba is the active ingredient in Banvel, Clarity, Sterling and several other herbicides. The rates and information provided here are based on the same 4 lb/gal acid equivalent formulation found in Banvel, Clarity and Sterling.

[■]If atrazine was applied at planting, the total amount of early and late applications cannot exceed 2.5 lb ai/A per calendar year. Use no more than 1.6 lb ai/A on highly erodible land with less than 30% crop residue. Using atrazine on soils with less than 1% organic matter increases carryover injury risk to susceptible crops, especially high pH soils. Do not use on sandy soils if water table is shallower than 30 ft.

Sorghum

No-till

When the interval between herbicide application and planting is expected to be 28 days or more, split applications will generally give better control. If a split application was not made and planting is delayed, a PRE treatment may be needed. If treatments are not applied until 14 days or less before planting, weeds likely will have emerged. Grasses should be 1.5 inches or less for control with atrazine. Adding crop oil concentrate, nitrogen fertilizer or nonionic surfactant will increase control. If grasses are more than 2 inches tall, use Gramoxone Extra at 1.5 to 2.5 pt/A or Roundup Ultra at 1.0 to 1.5 pt/A. Add 1.0 pt/A 2,4-D ester 4 lb/gal if broadleaf weeds are present and apply 10 days before planting.

A Note about Using 2,4-D and Dicamba Before Planting

Many times producers want to apply 2,4-D and/or dicamba (Banvel/Clarity/Sterling) prior to crop planting. The University of Nebraska recommends that the following guidelines be used when applying 2,4-D and dicamba before planting corn, soybean, and sorghum. Note that this is applicable to both ester and amine formulations of 2,4-D.

2,4-D Preplant Interval	Use Rate	Use Rate	Dicamba Preplant Interval	Use Rate	Use Rate
Crop	1 pt	>1 pt	Crop	1/4 pt	1/2 pt
Corn	7 days	14 days	Corn	5 days	7 days
Soybean (use ester only)	7 days	30 days	Soybean	DO NOT USE	DO NOT USE
Sorghum	10 days	21 days	Sorghum	7 days	10 days

Herbicide	Commercial Product per Acre			Application Time	Remarks and Approximate Cost Per Acre Broadcast
	Sandy Loam < 1% OM	Silt Loam 1-2% OM	Silty-Clay Loam > 2% OM		
Cool-Season Grass Sod (including smooth brome and bluegrass)					
GLYPHOSATE [◆]	48-64 oz	48-64 oz	48-64 oz	Fall or new growth	Use appropriate herbicide at planting. Cost: \$5.30-\$7.05.
Alfalfa Clover Sod					
2,4-D ester (4L) + DICAMBA [●] followed by appropriate herbicide at planting or early preplant	1.5 qt 0.5 pt	1.5 qt 0.5 pt	1.5 qt 0.5 pt	Apply in fall or April to alfalfa with 4" new growth	On dryland, moisture often not adequate for sorghum. 2,4-D + Banvel/Clarity used to kill alfalfa. Don't plant sorghum for 30 days. If smooth brome or bluegrass is present, add glyphosate. Don't apply with UAN or atrazine. Cost: \$11.60.
Rye or Winter Wheat					
ATRAZINE DF [■] + GRAMOXONE MAX	Do not use	2.3 lb 1.3-2.1 pt	2.3 lb 1.3-2.1 pt	Apply when rye and wheat are 4-10" tall and before sorghum emerges	On dryland, moisture is often not adequate for sorghum. Use safened seed with Micro-Tech or Dual II Magnum. Cost: Atrazine + Gramoxone Max \$12.50-\$17.00; Atrazine + glyphosate + Dual II Magnum \$25.40-\$30.00; Atrazine + glyphosate + Micro-Tech \$20.50-\$22.00; Intrro \$10.00-\$15.00.
ATRAZINE DF [■] + GLYPHOSATE [◆]	1.4 lb 20-24 oz	1.6 lb 20-24 oz	1.8 lb 20-24 oz		
+ INTRRO	2.0 qt	2.0 qt	2.5 qt		
+ MICRO-TECH or DUAL II MAGNUM	2.3 qt 1.3 pt	2.3 qt 1.3 pt	2.3 qt 1.5 pt		
EXPERT	2.5 qt	3.0 qt	3.75 qt		

[◆]Glyphosate is the active ingredient in many products. The rates provided on this page are based on a 4 lb ai or 3 lb ae formulation. See the glyphosate product comparison table on pages 146-147 for the use rate and more information on the product being used.

[●]Dicamba is the active ingredient in Banvel, Clarity, Sterling and several other herbicides. The rates and information provided here are based on the same 4 lb/gal acid equivalent formulation found in Banvel, Clarity and Sterling.

[■]If atrazine was applied at planting, the total amount of early and late applications cannot exceed 2.5 lb ai/A per calendar year. Use no more than 1.6 lb ai/A on highly erodible land with less than 30% crop residue. Using atrazine on soils with less than 1% organic matter increases carryover injury risk to susceptible crops, especially high pH soils. Do not use on sandy soils if water table is shallower than 30 ft.

Sorghum No-till

Herbicide	Commercial Product per Acre			Application Time	Remarks and Approximate Cost Per Acre Broadcast
	Sandy Loam < 1% OM	Silt Loam 1-2% OM	Silty-Clay Loam > 2% OM		
Continuous Row Crop					
ATRAZINE DF [△] ■	Do not use	2.3 lb	2.3 lb	April 1-15	Use safened seed with Dual II Magnum and Bicep II Magnum, and Bicep II Lite Magnum, and Bullet. Atrazine and Bicep II Magnum will damage sorghum on sandy and low organic matter soils. If weedy, add Gramoxone Extra at 1.5-2.0 pt. Cost: atrazine \$6.20; Bicep II Magnum \$18.60-\$23.25; Bicep Lite II Magnum \$23.60-\$26.55; Bullet \$16.00-\$21.30.
BICEP II MAGNUM/ CINCH ATZ [■]	Do not use	1.6 qt	2.0 qt	0-30 DBP	
BICEP LITE II MAGNUM/ CINCH ATZ LITE [■]		1.1 fb 0.5 qt 1.6 qt	1.2 fb 0.6 qt 1.8 qt	30-45 DBP fb 1 DAP 0-30 DBP	
BULLET	Do not use	3.0 qt	3-4 qt	0-7 DBP	
GUARDSMAN MAX [■]	2-4-2.8 pt	2.8-3.4 pt	3.4-4.5 pt	16-30 DBP	Seed must be treated with an appropriate sorghum seed safener to reduce injury to sorghum. Add 0.5 pt for heavy residues. Do not exceed 5.0 pt/A. Cost: Guardsman \$14.06-\$26.40.
GLYPHOSATE [◆]	24-32 oz	24-32 oz	24-32 oz	Prior to crop emergence	Add appropriate residual herbicide. If only broadleaf weeds are present, add 2,4-D (4L) ester at 1 pt/A and delay planting 10 days. Can be used preplant. Cost: \$2.65-\$3.52.

Sorghum Ridge Plant

In crops planted after mid-May, weeds can be expected to grow vigorously before planting. In a ridge plant system these weeds may become too large to uproot and smother unless control efforts are applied in late April or early May. Two approaches can be used to control these weeds. The first would be to select an early preplant treatment from the no-till section and apply by mid to late April. Since the planting operation will destroy this herbicide barrier, a second herbicide application over the row is required at planting. A split application of two-thirds rate applied preplant and one-third rate banded over the row at planting should be effective. Another strategy is to apply a POST herbicide such as Roundup Ultra or Gramoxone Extra to destroy weeds before growth exceeds 3 to 4 inches in height. Application is needed in late April to early May. Apply a PRE herbicide at planting. In most cases the time interval from application of the preplant knockdown herbicide to planting should not exceed three to four weeks. Weeds such as kochia, horseweed, smartweed, and winter annuals will warrant early treatment. Lambsquarters, velvetleaf, and grasses will emerge early in some years. The key to successful weed control is timely herbicide application. Appropriate herbicides can be selected from the no-till and tilled seedbed sections for this crop.

Herbicide	Commercial Product per Acre			Application Time	Remarks and Approximate Cost/A Broadcast
	Sandy Loam < 1% OM	Silt Loam 1-2% OM	Silty-Clay Loam > 2% OM		
GLYPHOSATE [◆]	24-32 oz	24-32 oz	24-32 oz	1-3 weeks preplant to prevent soil water loss	Glyphosate is excellent on annual grasses less than 6" tall. Both are good to excellent on broadleaves 6" or less. Follow with appropriate PRE treatment. Cost: glyphosate \$2.52-\$3.36; Gramoxone Max \$7.48-\$12.08.
GRAMOXONE MAX	1.3-2.1 pt	1.3-2.1 pt	1.3-2.1 pt		

◆Glyphosate is the active ingredient in many products. The rates provided on this page are based on a 4 lb ai or 3 lb ae formulation. See the glyphosate product comparison table on pages 146-147 for the use rate and more information on the product being used.

■If atrazine was applied at planting, the total amount of early and late applications cannot exceed 2.5 lb ai/A per calendar year. Use no more than 1.6 lb ai/A on highly erodible land with less than 30% crop residue. Using atrazine on soils with less than 1% organic matter increases carryover injury risk to susceptible crops, especially high pH soils. Do not use on sandy soils if water table is shallower than 30 ft.

Sorghum Tilled Seedbed

Herbicide	Commercial Product per Acre			Remarks and Approximate Cost Per Acre Broadcast
	Sandy Loam < 1% OM	Silt Loam 1-2% OM	Silty-Clay Loam > 2% OM	
ATRAZINE DF [■]	Do not use	2.2 lb	2.2 lb	EPP, PPSA, PP, PRE, or SURFACE MIX — Preplant applications should be made only on fine-textured soils. Do not use atrazine on sandy, high pH or calcareous soils. Rain may leach herbicides and cause sorghum injury. Cost: \$5.95.
BICEP II MAGNUM/ CINCH ATZ [■]	Do not use	1.6-2.1 qt	2.1 qt	EPP, PPSA, PRE, or SURFACE MIX — Need seed safener for Bicep and Dual. Cost: Bicep II Magnum \$18.60-\$24.41; Bicep Lite II Magnum \$17.70-\$23.60; Dual II Magnum \$19.39-\$25.35; Bullet \$15.00-\$17.50.
BICEP LITE II MAGNUM/ CINCH ATX LITE [■]	Do not use	1.2 qt	1.6 qt	
DUAL II MAGNUM/CINCH or DUAL IIG	1.3 pt 6 lb	1.3 pt 8 lb	1.7 pt 10 lb	
BULLET	Do not use	3.0 qt	3.5 qt	
INTRRO	2.0 qt	2.5 qt	3.0 qt	PRE — Seed Safener required. Cost: \$10.00-\$15.00.
OUTLOOK	13 oz	15 oz	18-21 oz	0-30 days. Add 2-5 fluid oz for heavy residues. Do not exceed 32 fluid oz/A. Need seed safener. Cost \$16.08-\$23.60.
G-MAX LITE [■]	2 pt	2.5 pt	3.5 pt	0-30- days before planting. Need seed safener. Cost: \$15.00-\$26.16.
GUARDSMAN MAX [■]	2.4 pt	2.8 pt	3.4 pt	0-30 DBP. Need seed safener. Cost: \$13.45-\$18.90.
MICRO-TECH	Do not use	2.5 qt	3 qt	PPSA, PRE, or SURFACE MIX — Need seed safener. Cost: Lariat \$16.00-\$18.65; Micro-Tech \$15.00-\$18.00.
LARIAT	Do not use	3 qt	3.5 qt	

[■]If atrazine was applied at planting, the total amount of early and late applications cannot exceed 2.5 lb ai/A per calendar year. Use no more than 1.6 lb ai/A on highly erodible land with less than 30% crop residue. Using atrazine on soils with less than 1% organic matter increases carryover injury risk to susceptible crops, especially high pH soils. Do not use on sandy soils if water table is shallower than 30 ft.

Sorghum

Postemergence (See page 38 for additives)

Herbicide	Rate Per Acre	Application Time	Remarks and Approximate Cost Per Acre Broadcast
ATRAZINE DF [■]	1.33 lb	Broadleaf weeds less than 6" Sorghum less than 12"	Atrazine may give partial control of grass weeds under 1". Do not use on sand or loamy sand. Increase Do not exceed 2.8 pounds of Atrazine DF per calendar year. Cost: Atrazine \$3.50.
AIM EW alone or with	0.5 oz	Aim alone sorghum less than 6-leaf Aim + Clarity sorghum 3-5 leaf	Aim is a contact herbicide so thorough spray coverage is required. Cost: Aim \$2.30; Aim + Atrazine \$3.20-\$4.40; Aim + Clarity \$8.20; Aim + Atrazine + Clarity \$7.90.
DICAMBA [●] or ATRAZINE DF or ATRAZINE DF + DICAMBA [●] or 2,4-D amine	8.0 oz 0.56-1.1 lb 0.56 lb 3-4 oz 6-8 oz	Broadleaves 1-4" Velvetleaf less than 36" Sorghum less than 12" Sorghum 3-5 leaf Sorghum 3-5 leaf	
ALLY + 2,4-D amine	1/20 oz 1/2 pt	Sorghum 3"-10" If broadcast greater than 11", use drops	Do not use Ally alone; always use with 2,4-D to reduce crop injury. Cost: \$2.00.
MARKSMAN/STERLING PLUS [■]	2 pt	Sorghum 2-5 leaf. Broadleaf weeds 2-4"	Cost: \$7.50.
DICAMBA [●]	0.5 pt	Sorghum 3-5 leaves	Observe label precautions when sensitive crops are nearby. Cost: \$5.85.
2,4-D AMINE (4L) or 2,4-D ESTER (4L)	1 pt 0.5 pt	After sorghum is 5" tall. 10" to early boot use drop tips	Spraying 2,4-D before 5" stage may inhibit root development. Spraying 2,4-D without drop tips after 8" through early boot may inhibit head development; use drop tips after 8" for all Banvel/Clarity treatments. Do not use 2,4-D from early boot through soft dough stage. Cost: 2,4D \$1.90; Buctril alone \$7.65-\$11.50; with Atrazine \$9.05-\$12.90, with dicamba \$8.95-\$15.30; Buctril/Atrazine + Banvel \$8.65-\$12.20.
BUCTRIL with ATRAZINE DF [■] or with DICAMBA [●]	1 -1.5 pt or 0.5-0.75 pt 0.55 lb 0.12-0.5 pt	Broadleaf weeds 2-6"; sorghum 3-leaf to 12"	
BUCTRIL/ATRAZINE DF [■]	2-3 pt	Sorghum 3-leaf to 12"	
BUCTRIL/ATRAZINE DF [■] + DICAMBA [●]	1.5-2.0 pt 0.12-0.25 pt	Sorghum 3-leaf to 12"	
PARAMOUNT	5.3-8.0 oz	Emergence to 12" sorghum	Requires COC or MSO additionally. UAN or AMS may be added. Best performance on annual grasses less than 2" tall. Works best on green foxtail. Cost: Paramount \$17.50-\$25.90; Paramount + Atrazine \$21.80-\$35.55.
PARAMOUNT + ATRAZINE DF	5.3-8.0 oz 0.5-1.0 lb		
PEAK alone or with DICAMBA [●]	0.25-1.0 oz 2.0-8.0 oz	Sorghum 5-30" Sorghum < 5 leaves	On soil above pH 7.5, carryover may injure soybean and other sensitive crops. Cost: \$2.95-\$11.80.
PERMIT	0.66 oz	Sorghum 2-leaf to layby (before head emergence)	May be tank mixed with AAtrex, Buctril, Banvel/Clarity, or 2,4-D. Cost: \$11.80.
STARANE	0.67 pt	Sorghum 3 leaf to 7 leaf; 8-leaf to boot use drop tips	Cost: \$7.60.

Harvest Aid

DIQUAT	1.5-2.0 pt	1-2 weeks before harvest.	Seed no more than 30% moisture.
GLYPHOSATE [◆]	1-2 qt	Grain moisture 30% or less. 7 days before harvest.	Not for use on seed fields. Cost: \$3.50-\$7.00.

◆Glyphosate is the active ingredient in many products. The rates provided on this page are based on a 4 lb ai or 3 lb ae formulation. See the glyphosate product comparison table on pages 146-147 for the use rate and more information on the product being used.

■If atrazine was applied at planting, the total amount of early and late applications cannot exceed 2.5 lb ai/A per calendar year. Use no more than 1.6 lb ai/A on highly erodible land with less than 30% crop residue. Using atrazine on soils with less than 1% organic matter increases carryover injury risk to susceptible crops, especially high pH soils. Do not use on sandy soils if water table is shallower than 30 ft.

●Dicamba is the active ingredient in Banvel, Clarity, Sterling and several other herbicides. The rates and information provided here are based on the same 4 lb/gal acid equivalent formulation found in Banvel, Clarity and Sterling.

Small Grain

Broadleaf Weed Response to Postemergence Herbicides

Response ratings:

Ratings are for light to moderate weed populations, favorable conditions and weed growth stage as specified on product label. High weed populations, adverse conditions, or large weeds will reduce control.

10 — 96-100% 6 — 70-79%
 9 — 90-95% 5 — 60-69%
 8 — 85-90% 4-2 — less than 60%
 7 — 80-84% 1 — 0

Herbicide	Blue Mustard (10) [§]	Knotweed (3)	Field Pennycress (10)	Horseweed (5)	Kochia (5)	Kochia, ALS-resistant (5)	Lambsquarters (5)	P. Smartweed (3)	Redroot Pigweed (2)	R. Thistle (5)	Shepherdspurse (10)	Sunflower (5)	Tansy Mustard (10)	Wild Buckwheat (4)	Prickly Lettuce (10)	Waterhemp (3)	Wild Vetch (8)	Crop Safety [□]
Aim + 2,4-D	8	7	9	-	9	9	8	-	8	8	9	8	9	8	9	8	1	2
Ally	9	4	9	7	6	1	7	4	8	6	9	7	9	5	8	7	1	1
Ally + 2,4-D	10	7	10	6	9	6	10	6	10	8	10	10	10	6	10	9	6	2
Ally + Dicamba [•]	9	7	10	6	10	7	10	9	10	9	10	9	10	7	10	9	8	3
Ally + Starane	9	4	10	7	10	8	7	4	8	6	9	7	9	5	8	7	1	1
Amber	9	4	9	7	7	1	6	5	8	6	9	8	9	8	8	7	1	1
Amber + 2,4-D	10	6	10	6	9	6	10	6	10	8	10	9	10	8	10	9	6	2
Amber + Dicamba [•]	9	7	10	6	10	7	10	9	10	9	10	10	10	9	10	9	8	3
Amber + Starane	9	4	9	7	10	8	6	5	8	6	9	8	9	8	8	9	1	1
Dicamba [•] + 2,4-D	6	8	10	6	10	10	9	10	10	9	10	10	10	7	8	9	8	4
Beyond (fall applied) ¹	1	1	9	1	1	1	1	1	1	1	9	1	9	1	1	1	1	2
Bronate Advanced	7	8	9	7	10	10	8	8	8	7	9	8	9	8	8	7	6	2
Curtail	9	9	10	9	8	8	10	10	10	8	9	10	9	9	10	9	9	2
Curtail M	7	8	9	9	8	8	8	9	8	7	9	8	9	9	8	7	8	1
Express + 2,4-D	9	7	10	6	9	6	9	6	7	8	7	7	7	7	9	8	6	1
Finesse	9	4	9	7	5	1	8	5	8	5	9	6	9	6	8	7	1	1
Finesse + 2,4-D	9	7	10	6	9	6	10	6	10	8	10	9	10	7	10	9	6	2
Finesse + Dicamba [•]	9	7	10	6	10	7	10	9	10	9	10	9	10	8	10	9	8	3
Harmony Extra+ 2,4-D	9	6	10	7	9	6	9	8	9	8	10	8	10	8	9	8	5	1
Maverick (fall applied)	5	2	9	6	3	1	3	2	4	3	9	3	9	2	8	3	1	1
MCPA	4	4	7	4	5	5	7	6	6	6	8	6	8	4	6	5	5	1
Olympus (fall applied)	8	-	9	-	-	-	-	-	5	-	9	-	9	-	-	-	-	1
Olympus Flex (fall applied)	8	-	9	-	-	-	-	-	5	-	9	-	9	-	-	-	-	1
Peak	8	6	9	7	5	1	6	8	8	6	9	8	9	6	8	7	1	1
Peak + 2,4-D	10	7	10	7	9	6	10	8	10	8	10	10	10	6	10	9	6	2
Peak + Dicamba [•]	9	7	10	7	10	7	10	9	10	9	10	9	10	9	10	9	8	3
Rave	9	7	10	6	10	7	10	9	10	9	10	10	10	9	10	9	8	3
2,4-D	7	6	9	5	6	6	9	8	9	8	9	9	9	4	9	8	7	2

¹For use in Clearfield wheat varieties only.

[§]Weed Competitive Index—See page 5.

[□]Crop ratings of 3 or less result in no yield loss; adding liquid nitrogen may considerably reduce crop safety for some herbicide combinations.

[•]Dicamba is the active ingredient in Banvel, Clarity, Sterling and several other herbicides. The rates and information provided here are based on the same 4 lb/gal acid equivalent formulation found in Banvel, Clarity and Sterling.

Winter Annual Grass Response to Selected Herbicides

(See Downy Brome in *Troublesome Weeds Section*, pages 113-127, for more information.)

10 — (96-100%) 6 — (70-79%)
 9 — (90-95%) 5 — (60-69%)
 8 — (85-90%) 4-2 — less than 60%
 7 — (80-84%) 1 — 0

Herbicide(s)	Downy Brome	Jointed Goatgrass	Feral Rye	Crop Safety [□]
Pre-emergence				
Amber	3*	1	1	1
Finesse	4*	1	1	2
Maverick	4-8*	2	1	1
Early postemergence ¹				
Beyond ²	8	9	7	3
Maverick	6-9*	3	1	1
Olympus	6-9	5	1	1
Olympus Flex	7-9	5	-	1
Late postemergence ¹				
Beyond ²	8	9	4	1
Maverick	3-5*	1	0	1
Olympus	5-8	3	0	1
Olympus Flex	6-8	3	-	1

*Requires rainfall shortly after application for best results.

¹Early postemergence = before weeds have tillered; late postemergence = after weeds have tillered.

²For use in Clearfield wheat varieties only.

[□]Crop hybrids vary in their response to herbicides. Crop safety ratings less than 3 indicate that crop yield should not be affected by any direct injury.

Small Grains (continued)

BARLEY AND SPRING WHEAT

Herbicide (See <i>Weed Response Table</i> on page 74)	Rate Per Acre	Application Time	Remarks and Approximate Cost Per Acre Broadcast
AIM EW + 2,4-D ESTER (4L)	0.5 oz 0.5 pt	2-leaf to joint stage	Add 0.25% nonionic surfactant (NIS). Cost: \$3.85.
ALLY or AMBER or FINESSE or PEAK + 2,4-D ESTER (4L)	0.10 oz 0.28 oz 0.2-0.4 oz 0.25-0.50 oz 0.25-0.50 pt	Spring 5-leaf to joint stage	Use only with small grains or a proso millet rotation. For wild buckwheat use Bronate Advanced, as listed for winter wheat. Add surfactant at 1 qt/100 gallons of spray solution. Cost: Ally + 2,4-D \$3.05-\$3.50; Amber + 2,4-D \$3.00-\$3.45; Finesse + 2,4-D \$3.60-\$7.15; Peak + 2,4-D \$3.50-\$6.95.
CURTAIL	2 pt	Spring 4-leaf to joint stage	Plant only small grain, field corn or sugarbeet the following year. Cost: \$10.00.
HARMONY EXTRA XP + 2,4-D ESTER (4L)	0.3-0.6 oz 0.25-0.50 pt	2-leaf to joint stage; weeds less than 4" tall	Add a NIS at 1 qt/100 gallons. Any crop may be planted 60 days after application. Cost: \$4.70-\$9.35.
STARANE + 2,4-D ESTER	0.5-0.67 pt 0.25-0.50 pt	Wheat 4-leaf to joint; weeds less than 8"	Provides excellent control of kochia. Cost: \$7.40-\$10.15.
2,4-D AMINE (4L) or 2,4-D ESTER (4L)	1-1.5 pt 0.50-0.75 pt	Spring 5-leaf to joint stage	Cost: \$0.95-\$2.25.

Harvest Aid

2,4-D ESTER (4L)	1 qt	Hard dough, 7 or more days before harvest	Helps desiccate large broadleaf weeds. Only certain brands labeled for this use. Cost: \$3.75.
ALLY + 2,4-D AMINE (4L)	0.1 oz 0.25-0.50 pt	After hard dough stage	Preharvest interval of 10 days. Add surfactant at 1 qt/100 gallons of spray solution. Cost: \$2.95-\$3.30.

OAT

AIM EW + 2,4-D ESTER (4L)	0.5 oz 0.5 pt	2-leaf to joint stage	Add 0.25% nonionic surfactant. Cost: \$3.85.
MCPA ESTER (4L)	0.5-1.0 pt	Fully tillered to boot	Cost: MCPA \$1.25-\$2.50.
BRONATE ADVANCED	0.8-1.2 pt	Oat 3-leaf to boot	Most broadleaf weeds should be in 2-4 leaf stage or mustards in early rosette stage. Cost: \$6.50-\$9.75.
CURTAIL M	1.75-2.3 pt	Oat 3-leaf to joint; weeds less than 3"	Cost: \$10.10-\$13.25.
HARMONY EXTRA XP or PEAK + BRONATE ADVANCED or MCPA ESTER (4L)	0.3-0.4 oz 0.25-0.5 oz 0.6-0.8 pt 0.5-0.75 pt	Oat 3-leaf to boot	Add surfactant at 1-2 qt/100 gallons of spray solution. Cost: Harmony Extra + Bronate Advanced \$9.10-\$12.15; Harmony Extra + MCPA \$5.45-\$7.50; Peak + Bronate Advanced \$7.90-\$12.55; Peak + MCPA \$4.25-\$7.90.
2,4-D AMINE (4L)	0.5-1.0 pt	3-leaf to joint	Some injury from 2,4-D may be expected at any stage. Cost: \$0.75-\$1.50.

Harvest Aid

Herbicide	Rate Per Acre	Application Time	Remarks and Approximate Cost/A Broadcast
2,4-D ESTER (4L)	1 qt	Hard dough; 7 or more days before harvest	Helps desiccate large broadleaf weeds. Only certain brands labeled for use. Cost: \$3.75.

Small Grain (continued)

RYE AND TRITICALE

Herbicide (See Weed Response Table on page 74)	Rate Per Acre	Application Time	Remarks and Approximate Cost Per Acre Broadcast
2,4-D AMINE (4L)	1.0-1.5 pt	From 4 tillers to joint stage	Do not spray until crop is well tillered. Spray broadleaf weeds as soon as good growing conditions occur. Cost: \$1.50-\$2.25.
AIM EW + 2,4-D AMINE (4L)	0.5-1.0 oz 0.5-1.0 pt	From 4 tillers to joint stage	Add UAN at 2-4 gallons/100 gallons or AMS at 4 lb/A. Cost: \$3.65-\$7.30.
DICAMBA* + 2,4-D AMINE (4L)	2-3 oz 0.50-0.75 pt	Spring, 4 tillers to joint stage	Controls most troublesome broadleaf weeds. Do not apply with fertilizer solutions. Cost: \$1.95-\$3.55.
PEAK + 2,4-D AMINE (4L)	0.25-0.50 oz 0.5-1.0 pt	From 4 tillers to joint stage	Add surfactant at 1-2 qt/100 gal. If spray solution contains liquid fertilizer, do not add surfactant. Cost: \$3.75-\$7.50.

WINTER WHEAT

Herbicide (See Weed Response Table on page 74)	Rate Per Acre	Application Time	Remarks and Approximate Cost Per Acre Broadcast
Winter Annual Grass Control			
BEYOND	4-5 oz	Wheat 3-leaf to joint, grass weeds 1-5 leaves	For use with Clearfield varieties only. For feral rye control use 5 oz/A rate and apply in fall before rye tillers. Add surfactant at 1 qt/100 gal and nitrogen based fertilizer at 2.5 gal/100 gal or AMS at 12-15 lb/100 gal. Cost: \$18.15-\$22.65.
OLYMPUS or OLYMPUS FLEX	0.9 oz 3.0-3.5 oz	In fall when weeds are actively growing	For downy brome control, best applied early postemergence. Use nonionic surfactant at 1-2 qt/100 gallons. Cost: Olympus \$9.90; Olympus Flex \$12.00-\$14.00.
MAVERICK	0.67 oz	In fall when weeds are actively growing	For downy brome control, best applied early postemergence. Use surfactant at 2 qt/100 gallons of spray solution. Cost: \$10.75.

Broadleaf Control

AIM EW + 2,4-D ESTER (4L)	0.5-1.0 oz 0.25-0.50 pt	Wheat from 4 tillers to joint stage	Add UAN at 2-4 gallons/100 gallons or AMS at 4 lb/A. Cost: \$3.40-\$6.80.
ALLY or AMBER or FINESSE or PEAK	0.10 oz 0.28-0.35 oz 0.2-0.4 oz 0.25-0.50 oz	In fall after 2-leaf stage	Effective control on mustards and pennycress. Some wheat varieties are more sensitive than others to fall application. Add surfactant. Cost: Ally \$2.55; Amber \$2.50-\$3.15; Finesse \$3.10-\$6.20; Peak \$3.00-\$6.00.
ALLY or AMBER or FINESSE or PEAK + 2,4-D ESTER (4L)	0.10 oz 0.28-0.35 oz 0.2-0.4 oz 0.25-0.50 oz 0.25-0.50pt	Early spring from 4 tillers to joint stage	Add surfactant at 1-2 qt/100 gal. If the spray solution contains liquid fertilizer, do not add surfactant. Cost: Ally + 2,4-D \$3.05-\$3.50; Amber + 2,4-D \$3.00-\$4.10; Finesse + 2,4-D \$3.60-\$7.15; Peak + 2,4-D \$3.50-\$6.95.
ALLY or AMBER + STARANE	0.10 oz 0.28-0.35 oz 0.50 pt	Spring, before boot stage; weeds less than 4" tall	Provides excellent control of kochia, including ALS-resistant kochia, with excellent crop safety. Add surfactant at 1-2 qt/100 gal. Cost: Ally + Starane \$9.45; Amber + Starane \$9.40-\$11.00.

*Dicamba is the active ingredient in Banvel, Clarity, Sterling and several other herbicides. The rates and information provided here are based on the same 4 lb/gal acid equivalent formulation found in Banvel, Clarity and Sterling.

Small Grain (continued)

WINTER WHEAT (continued)

Herbicide (See <i>Weed Response Table on page 74</i>)	Rate Per Acre	Application Time	Remarks and Approximate Cost Per Acre Broadcast
2,4-D AMINE (4L) or 2,4-D ESTER (4L)	1.0-1.5 pt 0.50-0.75 pt	Early spring, from 4 tillers to joint stage	Do not spray winter wheat until well tillered. Spray broadleaf weeds as soon as good growing conditions occur. Cost: \$0.95-\$2.25.
BRONATE ADVANCED	0.8-1.2 pt	Wheat from 3-leaf to boot	Most broadleaf weeds should be in 2-4 leaf stage or mustards in early rosette stage. Cost: \$6.55-\$9.80.
DICAMBA [•] + 2,4-D AMINE (4L)	2-3 oz 0.50-0.75 pt	Spring, 4 tillers to joint stage	Controls most troublesome broadleaf weeds. Do not apply with fertilizer solutions. Cost: \$1.95-\$3.55.
CURTAIL	2.0 pt	Before boot stage	Plant only small grain, field corn or sugarbeet the following year. Cost: \$10.00.
EXPRESS or HARMONY EXTRA XP + 2,4-D ESTER (4L)	0.25-0.33 oz 0.30-0.60 oz 0.25-0.50 pt	Wheat to joint stage; weeds less than 4" tall	Add a nonionic surfactant at 1 qt/100 gallons. Any crop can be planted 60 days after application. If the spray solution contains liquid fertilizer, do not add surfactant. Cost: Express + 2,4-D \$5.40-\$7.40; Harmony Extra + 2,4-D \$4.70-\$9.35.
STARANE + 2,4-D ESTER (4L)	0.5-0.67 pt 0.25-0.50 pt	Wheat 4-leaf to joint; weeds less than 8"	Provides excellent control of kochia. Cost: \$7.40-\$10.15.
RAVE	2.4-4.0 oz	Early spring from 4 tillers to joint stage	Add surfactant at 1-2 pt/100 gal. Cost: \$3.60-\$6.00.

Harvest Aid

ALLY + 2,4-D AMINE (4L)	0.1 oz 0.25-0.50 pt	After dough stage	Preharvest interval of 10 days. Add surfactant at 1 qt/100 gallons of spray solution. Cost: \$2.95-\$3.30.
2,4-D ESTER (4L)	1 qt	Hard dough 7 or more days before harvest	Rescue treatment for control of late broadleaf weeds. To reduce breakage with 2,4-D, all green color should be gone from joints. Only certain brands of 2,4-D labeled for this use. Cost: 2,4-D \$3.80; glyphosate \$3.40.
GLYPHOSATE [♦]	1 qt		

PROSO AND FORAGE MILLET

Herbicide	Rate Per Acre	Application Time	Remarks and Approximate Cost Per Acre Broadcast
2,4-D AMINE (4L)*	1 pt	Millet in 3- to 5-leaf stage	Coverage is essential for good control with Aim. Weeds should be less than 4". Add nonionic surfactant with Aim at 1 qt/100 gal. 2,4-D may cause significant crop injury in foxtail millet. Cost: 2,4-D \$1.50; 2,4-D + Aim EW \$4.05-\$6.95; Aim EW (without 2,4-D) \$2.90-\$5.80.
2,4-D AMINE (4L)* + AIM EW	0.75 pt 0.5-1.0 oz		
AIM EW (without 2,4-D)	0.5-1.0 oz		
2,4-D AMINE (4L)* + CLARITY or PEAK	0.75 pt 4 oz 0.38-0.50 oz	Proso in 3- to 5-leaf stage	These treatments labeled in proso only. Observe all Clarity precautions when susceptible crops are within 1/2 mile of application site. Add a nonionic surfactant with Peak at 1 qt/100 gallons of spray solution. Cost: 2,4-D + Clarity \$4.35; 2,4-D + Peak \$5.70-\$7.15.

[♦]Glyphosate is the active ingredient in many products. The rates provided on this page are based on a 4 lb ai or 3 lb ae formulation. See the glyphosate product comparison table on pages 146-147 for the use rate and more information on the product being used.

[•]Dicamba is the active ingredient in Banvel, Clarity, Sterling and several other herbicides. The rates and information provided here are based on the same 4 lb/gal acid equivalent formulation found in Banvel, Clarity and Sterling.

SUNFLOWER (See *Ecofarming* for more sunflower recommendations)

Pre-emergence

Herbicide	Commercial Product per Acre			Remarks and Approximate Cost/A Broadcast
	Sandy Loam	Silt Loam	Silt-Clay Loam	
DUAL MAGNUM PREPLANT	1.0-1.33 pt	1.33 pt	1.67 pt	Provides excellent grass weed control, but should be combined with Spartan or followed with Beyond (Clearfield varieties only) for broad-leaf weed control. Cost: \$14.25-\$23.80.
EPTAM 7E	2.5 pt	2.5 pt	2.5 pt	Apply and incorporate just before planting. Cost: Eptam + Trifluralin \$15.40; Eptam + Sonalan \$19.25.
+ TRIFLURALIN	1.5 pt	1.5 pt	1.5 pt	
or SONALAN HFP	2.0 pt	2.0 pt	2.0 pt	
PROWL/PENDIMAX (3.3EC) PPI	1.2-2.4 pt	1.8-3.0 pt	2.4-3.6 pt	PPI up to 30 days prior to planting. Prowl PRE is most effective in controlling weeds when adequate rainfall or irrigation is received 7 days after application. Otherwise, a registered POST herbicide may be required. Cost: Prowl \$3.60-\$10.80; Prowl + glyphosate \$10.70-\$12.50.
or PROWL H ₂ O	2.0 pt	2.5 pt	3.0 pt	
PROWL/PENDIMAX (3.3 EC)	3.0 pt	3.6 pt	3.6 pt	For best results immediately incorporate. Read label for carryover precautions. Cost: Trifluralin \$2.45-\$4.90.
or PROWL H ₂ O	3.0 pt	3.0 pt	3.0 pt	
with or without GLYPHOSATE♦	16 oz	16 oz	16 oz	
TRIFLURALIN	1 pt	1.25-1.5 pt	1.5-2 pt	
SPARTAN 4F	3.0-3.75 oz	3.75-6.0 oz	3.75-6.0 oz	Apply PRE up to 30 days prior to planting. Risk of crop injury increases as soil pH increases and/or soil organic matter decreases. Cost: Spartan + Prowl \$18.65-\$32.15; Spartan + Dual Magnum \$24.35-\$43.95.
+ PROWL/PENDIMAX (3.3EC) PPI	3.0 pt	3.6 pt	3.6 pt	
or PROWL H ₂ O	3.0 pt	3.0 pt	3.0 pt	
or DUAL MAGNUM	1.0-1.33 pt	1.33 pt	1.67 pt	

Postemergence

Herbicide	Rate Per Acre	Application Time	Remarks and Approximate Cost/A Broadcast
BEYOND (Clearfield varieties only)	4.0 oz	Sunflower 2-8 leaf, grasses 1-5 leaf, broadleaves 1-3"	For use with Clearfield varieties only. Add surfactant at 1-2 qt/100 gal and UAN at 2.5 gal/100 gal or AMS at 12-15 lb/100 gal. Cost: \$18.15.
POAST	1-2 pt	Most grasses less than 8", corn 12-20"	Good coverage essential. Add 2.5 lb AMS/A, 2 pt COC/A, 1.5 pt MSO/A, or 4-8 pt UAN/A. Cost: \$9.10-\$18.20.
SELECT	6-8 oz	Annual grass weeds 2-6"	Good coverage essential. Always use crop oil concentrate at 1 qt/A. May add AMS at 2.5 to 4 lb/A for difficult to control weeds. Cost: \$9.90-\$13.20.

Harvest Aid

GRAMOXONE MAX	1.0-1.33 pt	Use nonionic surfactant at 1 qt/100 gal spray solution. Apply when sunflower seeds reach physiological maturity (when seed moisture is 35% or lower). For many varieties, this corresponds to the time when the back of the heads are yellow and the bracts are turning brown. Do not graze treated areas or feed treated forage to livestock. Use the higher rate when crop stands or weed infestations are heavy. Apply at least 7 days before harvest. Cost: Gramoxone Max \$5.75-\$7.65.
---------------	-------------	--

*Only a few brands of 2,4-D are labeled for millet.

♦Glyphosate is the active ingredient in many products. The rates provided on this page are based on a 4 lb ai or 3 lb ae formulation. See the glyphosate product comparison table on pages 146-147 for the use rate and more information on the product being used.

Ecofarming

Ecofarming (ecofallow) is a system based on quality winter wheat stubble and timely weed control. Good quality stubble is the result of growing adapted winter wheat varieties competitive with weeds along with good disease and insect resistance. Proper planting date, fertilization according to needs, weed control in the growing wheat, harvest with minimum grain loss and good chaff and long straw distribution all contribute to the success of this program. Herbicides should be applied within 30 days after wheat harvest for wheat grown with a 10- to 14-month fallow period. If winter wheat is planted following soybean, corn, or grain sorghum, herbicides should be applied within 15 to 20 days after wheat harvest. Weather and weed conditions need to be correct for good results. Glyphosates (generic), Fallow Master, Gramoxone Max plus atrazine and Landmaster BW will control established broadleaf and grass weeds, and volunteer wheat depending on herbicide rate, plant height, density, and species. Check labels for use and additives. If rain is expected within six hours, Gramoxone plus atrazine is a good choice. The rainfast period required for glyphosate products can be shortened by increasing the rate and not adding atrazine to the tank-mix. Mixing atrazine with glyphosate products can create antagonism and decrease performance.

Maximum benefits from ecofarming, which includes moisture conservation and prevention of weed seed production, usually occur when treatments are timely. This is on the condition that weeds are not under drought stress, the straw has settled, dust is not present on the plants, and good coverage of the plants is possible with the spray solution. Small weeds are easier to control with the nonselective translocating herbicides containing glyphosate. Gramoxone Max plus atrazine is usually more effective in controlling small weeds as they approach maturity.

If weeds recover from initial after-harvest herbicide applications or if volunteer wheat emerges, retreat with glyphosate. More effort is needed to prevent weeds from producing seeds in the wheat stubble.

Volunteer winter wheat and/or downy brome or jointed goatgrass are not always controlled with July and early August atrazine treatments. A split after harvest treatment with an early application of Fallow Master, glyphosates or Landmaster BW followed by 1 lb/A or more of atrazine plus Gramoxone Max (if needed) applied in September can be an effective control measure. If maximum rates of atrazine are applied in the fall, do

not add additional atrazine in the spring. Lower rates of atrazine (or none at all) need to be used on eroded areas, on soils with less than 1.2% organic matter, on soils with a pH of 7.0 or greater, some terraces, Canyon and Rosebud soils, and caliche outcroppings.

High atrazine rates may carry over and destroy wheat on these areas. Total atrazine applied between wheat harvest and planting corn or sorghum should not exceed 3.25 lb 90DF or 3 qt 4 L/A.

In the spring, use glyphosate to kill volunteer wheat and annual bromes in March to prevent soil moisture loss. Consider banding over the row in weedy fields at planting for planters which disturb the soil and remove some of the preplant herbicide.

Fields not treated after harvest with herbicides are not ecofallow. Therefore, herbicides might not be as effective and grain yields may be poorer than with fields treated in late summer and fall. If moisture was present after harvest and weeds produced seeds, weed density may be great enough that weed control with herbicides at rates that do not cause crop injury may be difficult. Also, the soil moisture lost after harvest may be critical to the crop if the moisture during the winter and spring is limited.

If a producer wants to try the spring-only treatment, the following is suggested. An early spring treatment of glyphosate, Fallow Master, RT Master, Landmaster BW, or Touchdown with atrazine as soon as good growing conditions exist in the spring is an effective treatment for volunteer wheat and downy brome. Add or increase the AAtrex/Atrazine to the lower of the maximum labeled rate or the amount the crop can tolerate and still not cause damage to the succeeding crop. Be sure to add a grass herbicide. Add Gramoxone Max or glyphosate products at 1.5 to 2.0 pt/A after April 15 depending upon size of weeds. Rates suggested depend on soil type, pH, organic matter, time of application, and weed size. For corn or sorghum use 1.4-1.8 lb/A atrazine. Dual II

Magnum or Bicep II Magnum, Bullet, Fultime, or G-Max Lite should be applied 20 to 30 days before corn or sorghum planting. Balance should not be applied more than seven days before corn planting unless a planned sequential application of a POST herbicide is used. For sorghum, use a seed treatment for Dual II Magnum, Bicep II Magnum, Bullet, or G-Max Lite to prevent herbicide injury.

Planting Row Crops No-Till Into Last Year's Spring Small Grain Stubble (Oat, Spring Wheat, and Spring Barley)

The spring small grains are not as competitive with weeds as winter wheat. This is because the winter wheat is established in the fall and starts growth early in the spring before most weeds germinate. With good stands of winter wheat most weeds, except for winter annual weeds, are not a problem.

The quality and quantity of winter wheat stubble and straw is also superior and longer lasting than the spring grain crops. The winter wheat stubble and straw is more effective in suppressing weeds. While planting crops no-till into last year's small grain can be successful, it also can be a disaster if the herbicide treatments are not timely, properly selected, applied properly, and results are not evaluated to determine if retreatment or other weed control measures are necessary.

The key to this program is weed control after spring small grain harvest. Keeping the weeds from producing seeds and using stored soil

moisture is done with a timely herbicide treatment after harvest. The herbicide treatments listed for winter wheat after harvest can be used in spring small grain stubble in most situations. The higher labeled rates of herbicides are usually required. Glyphosate, Fallow Master and Landmaster BW are usually the choice nonselective herbicides for control of emerged summer annual grass weeds that are growing rapidly. As weeds approach maturity, Gramoxone Max plus atrazine may be used. If atrazine is used in the fall treatment, the next crop must be tolerant to it at the rate used (check label).

The spring herbicide treatment is necessary. Again, check the rates, etc. for the crop in the ecofarming section. Check labels and be sure to control volunteer crops. Also, do not disturb the herbicide treatment with tillage if a residual herbicide was applied last fall.

Continuous Winter Wheat and Winter Wheat Following Soybean

Continuous Winter Wheat. Select winter wheat fields that are free of downy brome, hairy chess, Japanese brome, and jointed goatgrass. Apply glyphosate, Fallow Master or Landmaster BW within 30 days after winter wheat harvest but before summer annual weeds head. Apply glyphosate about 10 days before winter wheat planting.

No-till Wheat Following Soybean Harvest. Select early maturing soybean cultivars so that winter wheat can be planted within the opti-

mum window. Plant wheat at 90 lb/A dryland and 120 lb/A irrigated with a no-till drill equipped to apply starter fertilizer in the row with the seed. Weeds such as kochia are a problem in late planted winter wheat. Therefore, a herbicide treatment is usually needed in the spring. Use Ally or Amber plus 2,4-D as 2,4-D is ineffective on triazine-resistant kochia because late seeded wheat is less competitive. Buctril or Starane may not be effective because of multiple flushes of kochia.

Ecofarming

Weed Response to Herbicides Applied After Winter Wheat Harvest

Response Ratings:

Ratings are for light to moderate weed densities, good wheat stubble, favorable conditions and weed growth stage as specified on product label. High weed density, adverse conditions, or large weeds will reduce control.

10 — 96-100% 5 — 60-69%
 9 — 90-95% 4-2—less
 8 — 85-90% than 60%
 7 — 80-84% 1 — 0
 6 — 70-79%

Herbicides¹

Herbicides ¹	Broadleaf Weeds											Summer Annual Grass								Winter Annual Grasses				
	Buckwheat, Wild	Buffalobur	Horseweed	Knotweed, Tall	Kochia	Lambsquarters	Lettuce, P.	Pigweed spp.	Smartweed, P.	Spurge, Tooth or Spotted	Sunflower, Common	Thistle, R.	Barnyardgrass	Crabgrass or Fall Panicum	Cupgrass, Prairie	Foxtail, Gr.	Foxtail, Yc.	Sandbur	Shattercane	Stinkgrass	Witchgrass	Downy Brome	Jointed Goatgrass	Volunteer Wheat
	6 inches tall or less											4 inches tall								4 inches tall				
Fallow Master ¹	10	10	10	10	10	10	10	10	10	10	10	10	10	10	10	10	10	10	10	10	10	10	10	10
Glyphosate [♦]	6	10	8	8	8	9	6	10	9	5	10	8	10	10	10	10	10	10	10	10	10	10	10	10
Glyphosate [♦] + atrazine	10	10	10	10	7	10	10	10	10	10	10	10	10	10	10	10	10	10	10	10	10	10	10	10
Gramoxone Max ¹	10	10	10	10	10	10	10	10	5	10	10	9	4	2	2	7	4	5	5	8	8	10	10	10
Gramoxone Max ¹ + atrazine	10	10	10	10	10	10	10	10	10	10	10	10	9	7	6	10	9	9	10	10	10	10	10	10
Landmaster BW	10	10	10	10	10	10	8	10	10	9	10	10	10	10	10	10	10	10	10	10	10	10	10	10
Landmaster BW + atrazine	10	10	10	10	8	10	10	10	10	10	10	10	10	10	10	10	10	10	10	10	10	10	10	10
Ready Master ATZ (4 qt)	10	10	10	10	8	10	10	10	10	10	10	10	10	10	10	10	10	10	10	10	10	10	10	10
Ready Master ATZ (2 qt)	8	10	10	10	6	10	10	10	10	10	10	10	10	10	10	10	10	10	10	10	10	10	10	10
	12 inches tall											Tillered to boot								Tillered to boot				
Fallow Master	8	10	8	9	8	10	8	8	10	7	10	8	8	8	6	10	8	8	10	10	8	10	10	10
Glyphosate [♦]	5	9	6	8	5	8	5	8	7	3	10	7	8	8	6	10	8	8	10	10	8	10	10	10
Glyphosate [♦] + atrazine + 2,4-D	10	10	10	10	8	10	8	10	10	8	10	10	5	6	4	10	5	8	10	10	8	10	10	10
Gramoxone Max	9	7	7	7	7	7	7	7	4	7	7	7	3	1	1	4	4	3	3	5	4	6	6	6
Gramoxone Max + atrazine + 2,4-D	9	10	10	10	10	10	10	10	8	10	10	10	3	2	2	4	4	3	3	7	6	9	9	9
Landmaster BW	8	10	8	9	8	10	8	8	9	7	10	8	8	8	6	10	8	8	10	10	8	10	10	10
Landmaster BW + atrazine	10	10	10	10	8	10	8	10	10	8	10	9	5	6	4	10	7	8	10	10	8	10	10	10
Ready Master ATZ (4 qt)	10	10	10	10	7	10	6	10	10	7	10	10	7	5	3	10	7	7	10	10	7	10	10	10
Ready Master ATZ (2 qt)	8	10	10	10	9	10	8	10	10	9	10	10	9	7	5	10	9	9	10	10	9	10	10	10
	24 inches tall											Headed								Headed (in spring)				
Fallow Master	6	8	8	7	6	7	8	8	8	5	7	8	8	9	6	10	8	10	10	10	10	10	10	10
Glyphosate [♦]	3	7	6	6	4	5	3	6	6	2	7	7	8	9	6	10	8	10	10	10	8	10	10	10
Glyphosate [♦] + atrazine + 2,4-D	10	10	8	8	7	9	10	10	9	6	10	8	7	8	5	10	7	9	10	10	8	10	10	10
Gramoxone Max	8	8	9	7	8	8	8	8	4	6	7	7	6	6	6	7	8	7	4	8	8	9	9	9
Gramoxone Max + atrazine + 2,4-D	10	10	10	8	10	9	10	10	7	9	10	10	8	9	7	10	10	10	6	10	10	10	10	10
Landmaster BW	5	8	8	7	5	7	8	8	8	5	7	8	8	9	5	10	8	10	10	10	8	10	10	10
Landmaster BW + atrazine	10	10	8	8	7	9	10	10	9	6	10	8	7	8	6	10	9	9	10	10	8	10	10	10
Ready Master ATZ (4 qt)	7	10	6	9	6	8	10	10	8	5	10	7	6	7	4	10	6	8	10	10	7	10	10	10
Ready Master ATZ (2 qt)	9	10	8	7	8	10	10	10	10	7	10	9	7	9	6	10	8	10	10	10	9	10	10	10

¹Rate is: 64 oz/A Fallow Master, 1.5 pt/A for Gramoxone Max, 80 oz/A for Landmaster BW, 2-4 qt/A of Ready Master ATZ, 32 oz/A for glyphosate. These rates should be helpful in preventing weeds from developing resistance to glyphosate. Atrazine rate is 2.0 qt/A and the 2,4-D amine rate (3.8 lb EC) is 1.5 pt/A when weeds are above 8 inches tall. Increasing the rate of glyphosate products will improve control of difficult weeds. For example, to control barnyardgrass, yellow foxtail, or prairie cupgrass may require 24 oz/A of glyphosate alone or 16-32 oz/A when mixed with atrazine. All ratings include the addition of the recommended additives.

[♦]Glyphosate is the active ingredient in many products. The rates provided on this page are based on a 4 lb ai or 3 lb ae formulation. See the glyphosate product comparison table on pages 146-147 for the use rate and more information on the product being used.

Ecofarming

Herbicides to use after winter wheat harvest, with winter wheat planted in 2 to 3 months (continuous winter wheat), in 12 to 14 months (fall treatment in winter wheat-fallow), or in 4-5 months (spring treatment in winter wheat-fallow). Where split treatments are listed, they give the best results.

Herbicide	Commercial Product per Acre			Application Time	Remarks and Approximate Cost Per Acre Broadcast
	Sandy Loam < 1% OM	Silt Loam 1-2% OM	Silty-Clay Loam > 2% OM		

Winter Wheat Stubble to be Seeded 2-3 Months Later to Winter Wheat (Continuous Wheat)

Herbicides to be used within 30 days after wheat harvest.

GLYPHOSATE [◆]	24-32 oz	24-32 oz	24-32 oz	POST; two or more applications required. Wait 15 days before planting wheat with Landmaster BW	If volunteer wheat develops close to planting, treat with glyphosate. To facilitate drilling stubble should be no taller than 12" with good straw and chaff distribution. Cost: glyphosate \$2.52-\$3.36; Landmaster BW \$6.49-\$9.63.
LANDMASTER BW ¹	54-80 oz	54-80 oz	54-80 oz		
2,4-D ESTER (4L)	1 qt			For common purslane when growing actively	Do not plant small grains for 15 days. Cost: \$3.75.

Winter Wheat Stubble to be Seeded 12-14 Months Later (Fallow Aid)

Single Application

ATRAZINE [■]	0.6 lb	1.1 lb	1.1 lb	Aug 10-Sept 10 (12 months or more before seeding)	Spray before weeds produce seed and not under drought stress. Volunteer wheat and downy brome control are better with late Aug. and early Sept. application. The addition of 1 pt 2,4-D ester to Atrazine + Gramoxone Max to improve control of broadleaf weeds may decrease control of grasses. Cost: atrazine + Gramoxone Max \$10.01-\$12.54; atrazine + Gramoxone Max + 2,4-D \$11.89-\$16.29; atrazine + Landmaster BW \$9.08-\$12.16; glyphosate + atrazine \$4.74-\$5.89; Ready Master ATZ \$8.50-\$17.00.
+ GRAMOXONE MAX ¹	1.5-1.7 pt	1.5-1.7 pt	1.5-1.7 pt		
ATRAZINE DF [■]	0.6 lb	1.2 lb	1.2 lb		
+ GRAMOXONE MAX ¹	1.5-1.7 pt	1.5-1.7 pt	1.5-1.7 pt		
+ 2,4-D ESTER (4L)	1 pt	2 pt	2 pt		
ATRAZINE DF [■]	0.6 lb	1.1 lb	1.1 lb		
+ LANDMASTER BW ¹ or GLYPHOSATE [◆]	32 oz	32 oz	32 oz		
READY MASTER ATZ	2 qt	3 qt	4 qt		

Two Applications — Split Treatments

LANDMASTER BW ¹ or GLYPHOSATE [◆] followed by ATRAZINE DF [■]	54-80 oz 24-32 oz 0.6-1.1 lb	54-80 oz 24-32 oz 1.1 lb	54-80 oz 24-32 oz 1.1 lb	Apply glyphosate product after harvest. Apply atrazine between Aug. 20 - Sept 10. A burndown treatment may be needed with this application.	Good for weeds that are present early. Use Gramoxone Max or Roundup Original with atrazine on weeds present in late August to early September. A burndown herbicide may be needed with this application. Cost: Landmaster BW fb atrazine \$7.87-\$12.16; glyphosate fb atrazine \$3.90-\$5.89.
--	------------------------------------	--------------------------------	--------------------------------	---	--

Winter Wheat Stubble to be Seeded to Winter Wheat 4-5 Months Later (Fallow Aid)

GLYPHOSATE [◆]	24-32 oz	4-32 oz	24-32 oz	April or before boot stage of grass weeds	Cost: Glyphosate \$2.52-\$3.36; Landmaster BW \$6.49-\$9.63.
LANDMASTER BW ¹	54-80 oz	54-80 oz	54-80 oz		
TORDON 22K + 2,4-D ester (4L)	1.5 oz 0.75 pt	1.5 oz 0.75 pt	1.5 oz 0.75 pt	May 15 to June 15	Helps control wild buckwheat. Cost: Tordon + 2,4-D \$2.58.

¹Add NIS (0.25% v/v) per 100 gal spray solution for Gramoxone Max. For Fallow Master BW and glyphosate add 17 lb ammonium sulfate (spray grade) per 100 gal and apply in 10 gpa of spray solution. Read label to determine when to add AMS or additional surfactant.

[◆]Glyphosate is the active ingredient in many products. The rates provided on this page are based on a 4 lb ai or 3 lb ae formulation. See the glyphosate product comparison table on pages 146-147 for the use rate and more information on the product being used.

[■]If atrazine was applied at planting, the total amount of early and late applications cannot exceed 2.5 lb ai/A per calendar year. Use no more than 1.6 lb ai/A on highly erodible land with less than 30% crop residue. Using atrazine on soils with less than 1% organic matter increases carryover injury risk to susceptible crops, especially high pH soils. Do not use on sandy soils if water table is shallower than 30 ft.

Ecofarming (Continued)

Commercial Product per Acre

Herbicide	Sandy Loam < 1% OM	Silty Loam 1-2% OM	Silty-Clay Loam > 2% OM	Application Time	Remarks and Approximate Cost Per Acre Broadcast
-----------	--------------------------	--------------------------	-------------------------------	---------------------	--

Winter Wheat Stubble to be Planted to Corn or Sorghum the Next Spring Check Remarks Under Ecofarming, page 79.

Herbicides to be used within 30 days after winter wheat harvest and 4 to 6 weeks later.

————— Single Application —————

GRAMOXONE MAX ¹	1.5-1.7 pt	1.5-1.7 pt	1.5-1.7 pt	July-Aug. depending upon temperature and rainfall	Spray after wheat harvest and before weeds produce seed. If weeds recover, kill weeds before they develop seed. Volunteer wheat and downy brome control is better with late Aug.-Oct. applications. Barnyardgrass and yellow foxtail control requires 86 oz/A of Landmaster BW. Cost: Atrazine + Gramoxone Max \$13.92-\$17.60; Atrazine + Landmaster BW \$12.99-\$17.45; Atrazine + glyphosate \$8.65-\$11.18; Ready Master ATZ \$8.50-\$17.00.
+ ATRAZINE DF [■]	2.3 lb	2.3-2.9 lb	2.3-3.4 lb		
LANDMASTER BW ¹ or GLYPHOSATE [◆]	64-80 oz	64-80 oz	64-80 oz		
+ ATRAZINE DF [■]	2.3 lb	2.3-2.9 lb	2.3-3.4 lb		
READY MASTER ATZ	2 qt	3 qt	4 qt		

————— Two Applications — Split Treatments —————

GLYPHOSATE [◆]	24-32 oz	24-32 oz	24-32 oz	July to Early Aug.	Spray after wheat harvest as soon as good growing conditions for the weeds occur and the crop residue does not protect the weeds from spray coverage. Cost: glyphosate \$2.52-\$3.36; Landmaster BW \$7.70-\$9.63; Fallow Master \$8.63-\$12.58.
LANDMASTER BW ¹	64-80 oz	64-80 oz	64-80 oz		
FALLOW MASTER ¹	48-70 oz	48-70 oz	48-70 oz		

followed by

GRAMOXONE MAX ¹	1.5 pt	1.5 pt	1.5 pt	Late Aug. or Early Sept.	Purpose is to control escaped weeds and volunteer wheat. The later application of atrazine is more effective in controlling volunteer wheat. Cost: Gramoxone Max + Atrazine \$12.54-\$15.30.
+ ATRAZINE DF [◆]	1.7 lb	2.3 lb	2.9lb		

Herbicides to be used within 30 days after winter wheat harvest.

Winter Wheat Stubble to be planted to soybean or sunflower the following spring (Consider soybean only in areas with over 20" rainfall)

LANDMASTER BW ¹	64-80 oz	64-80 oz	64-80 oz	2 applications with second one at lower rates	See spring treatments for soybean, pages 61-62, or sunflower on page 78. Cost: two Landmaster applications \$7.70-\$9.63; glyphosate \$2.52-\$3.36.
or GLYPHOSATE [◆]	24-32 oz	24-32 oz	24-32 oz		

¹Add NIS (0.25% v/v) per 100 gal spray solution for Gramoxone Max. For Fallow Master BW and glyphosate add 17 lb ammonium sulfate (spray grade) per 100 gal and apply in 10 gpa of spray solution. Read label to determine when to add AMS or additional surfactant.

◆Glyphosate is the active ingredient in many products. The rates provided on this page are based on a 4 lb ai or 3 lb ae formulation. See the glyphosate product comparison table on pages 146-147 for the use rate and more information on the product being used.

■If atrazine was applied at planting, the total amount of early and late applications cannot exceed 2.5 lb ai/A per calendar year. Use no more than 1.6 lb ai/A on highly erodible land with less than 30% crop residue. Using atrazine on soils with less than 1% organic matter increases carryover injury risk to susceptible crops, especially high pH soils. Do not use on sandy soils if water table is shallower than 30 ft.

Ecofarming (Continued)

Herbicide	Commercial Product per Acre			Application Time	Remarks and Approximate Cost Per Acre Broadcast
	Sandy Loam < 1% OM	Silty Loam 1-2% OM	Silty-Clay Loam > 2% OM		
Corn to be planted in winter wheat stubble treated with AAtrex/atrazine after harvest³ Herbicides to be used for ecofallow corn in the spring.					
If volunteer wheat and/or downy brome were not controlled in the fall, spray in April or control earlier with glyphosate, Fallow Master, Roundup, Landmaster BW, or Touchdown. Low rates (less than 2 lb/A active ingredient) of atrazine usually do not give satisfactory volunteer wheat and downy brome control when applied in July or early August of the previous summer. If triazine-resistant kochia is a problem, see Troublesome Weeds and Woody Plants, page 110. Adding 0.5 to 1 pt/A of 2,4-D LV4 ester improves control of broadleaf weeds.					
ATRAZINE DF [■]	1.4 lb	1.6 lb	1.8 lb	15-30 DBP	Cost: Atrazine \$3.22-\$4.14; Balance + Atrazine \$17.47-\$26.41; Ready Master ATZ \$6.38-\$8.50.
BALANCE PRO ² + AATREX/ATRAZINE DF [■]	Do not use	1.9-2.2 oz 1.4 lb	2.2-3.0 oz 1.7lb	7-21 DBP	
READY MASTER ATZ [■]	1.5 qt	2 qt	2 qt		
BALANCE PRO ² + BICEP II MAGNUM [■] or FULTIME or HARNES XTRA 5.6L [■]	Do not use	1.5-1.9 oz 1.0-1.5 qt 1.5-2.25 qt 1.2-1.8 qt	1.9-2.2 oz 1.25-1.75 qt 1.75-2.5 qt 1.5-2.0 qt	0-7 DBP	FullTime and Harness appear to reduce Balance Pro injury. If applied 8-21 DBP, increase herbicide rate 20%. Use higher rate in fields with greater grass weed density. Also lower rates can be used in fields with good stubble and sprayed timely after harvest. Rates may have to be increased if weed density was great in the wheat stubble. If soil pH is greater than 7.4, reduce Balance rate by 0.25 oz. Do not exceed and follow labeled rates. Cost: Balance + Bicep II Magnum \$22.50-\$36.19; Balance + Fulltime \$23.25-\$36.50; Balance + Harness Xtra 5.6L \$23.85-\$37.50.
BALANCE PRO ² + ATRAZINE DF [■] followed by GLYPHOSATE ^{◆1}	Do not use	1.5-1.9 oz 1.2 lb 24-32 oz	1.9-2.2 oz 1.7 lb 24-32 oz	0-7 DBP	
(Requires Roundup Ready Corn)					
ATRAZINE DF [■] + SURPASS or HARNES	0.9 lb 1.5-2.0 pt 1.5-2.0 pt	1.2 lb 2.0-2.5 pt 2.0-2.5 pt	1.2 lb 2.0-3.0 pt 2.0-3.0 pt	For 16-30 days preplant, increase rates 20%	If annual grasses produced seed in the wheat stubble or if field areas have a history of high grass density, use 20% higher rates. Do not exceed labeled rates. Cost: Harness + atrazine \$18.57-\$35.76; Surpass + atrazine \$17.45-\$33.51. atrazine \$17.45-\$33.51.
DUAL II MAGNUM/CINCH	1.3 pt	1.3 pt	1.67 pt		
BICEP II MAGNUM/CINCH ATZ [■]	1.8 qt	2.1 qt	2.4 qt	0-20 DBP	If annual grasses produced seed in the wheat stubble or if areas of field have history of high grass density, use 20% higher rates of grass herbicides. Do not exceed labeled rates. Cost: Bicep II Magnum \$20.25-\$27.00; Dual II Magnum \$19.66-\$25.27; Dual II Magnum + AAtrex \$21.43-\$28.63; Lexar \$30.75; Lumax \$33.13-\$39.75.
DUAL II MAGNUM/CINCH ATZ + AATREX DF [■]	1.25 pt 0.9 lb	1.5 pt 1.2 lb	1.67 pt 1.2 lb		
LEXAR	3 qt	3 qt	3 qt	0-14 DBP	
LUMAX	2.5 qt	2.5 qt	2.5-3.0 qt	0-10 DBP	

¹Add NIS (0.25% v/v) per 100 gal spray solution for Gramoxone Max. For Fallow Master BW and glyphosate add 17 lb ammonium sulfate (spray grade) per 100 gal and apply in 10 gpa of spray solution. Read label to determine when to add AMS or additional surfactant.

²Balance is not recommended on coarse-textured soils of less than 1.5% O.M. or pH greater than 7.4. If applied PRE on medium-textured soils with a pH greater than 7.5, decrease Balance rate 0.25 oz/A. Corn seed must be covered with 1.5 to 2.0 inches of soil. Avoid planting when surface soil is wet. Rates could be increased by 0.25 oz/A in fields with organic matter greater than 2.5% or with crop residues exceeding 5,000 lb/A. Do not use if water table is shallower than 25 ft.

[◆]Glyphosate is the active ingredient in many products. The rates provided on this page are based on a 4 lb ai or 3 lb ae formulation. See the glyphosate product comparison table on pages 146-147 for the use rate and more information on the product being used.

[■]If atrazine was applied at planting, the total amount of early and late applications cannot exceed 2.5 lb ai/A per calendar year. Use no more than 1.6 lb ai/A on highly erodible land with less than 30% crop residue. Using atrazine on soils with less than 1% organic matter increases carryover injury risk to susceptible crops, especially high pH soils. Do not use on sandy soils if water table is shallower than 30 ft.

Ecofarming (Continued)

Herbicide	Commercial Product per Acre			Application Time	Remarks and Approximate Cost Per Acre Broadcast
	Sandy Loam < 1% OM	Silty Loam 1-2% OM	Silty-Clay Loam > 2% OM		
EXPERT	2.5 qt	3.0 qt	3.75 qt	PRE 0-30 DBP	Cost: \$18.75-\$28.13.
FIELD MASTER [■]	3.5-4 qt	4 qt	4-5 qt	PRE 0-21 DBP	Cost: \$25.90-\$37.00.
GUARDSMAN MAX	2.5-3.0 pt	3.0-4.0 pt	4-4.6 pt	0-28 DBP	Cost: \$15.00-\$27.60.
G-MAX LITE	2.0 pt	2.5-3.0 pt	3.5 pt	0-28 DBP	Cost: \$15.50-\$27.13.
GLYPHOSATE ^{1♦} (Requires Roundup Ready Corn)	24-32 oz	24-32 oz	24-32 oz	POST	Excellent for fields with high grass densities. Cost: glyphosate \$2.52-\$3.36.
TOPNOTCH FULTIME	2.0 qt 2.5 qt	2.2 qt 2.7 qt	2.5 qt 2.9 qt		Cost: FulTime \$20.00-\$23.20; TopNotch \$19.50-\$24.38.

Soybean to be planted into winter wheat stubble treated with glyphosate or Landmaster BW after harvest (For areas with over 20" rainfall and fields with low weed density)

PURSUIT DG [♦] + DUAL II MAGNUM	1.4 oz 1.0 pt	1.4 oz 1.25 pt	1.4 oz 1.33 pt	0-30 DBP	Add 16-24 oz/A of glyphosate ¹ if there are emerged weeds. Control weeds when they are small to conserve moisture and improve performance. Check fields within 30 days after planting to determine if postemergence herbicides are needed. Cost without Roundup: Pursuit + Dual II Magnum \$32.77-\$37.76; with Pursuit Plus \$16.88; Canopy XL \$12.11-\$18.72; Extreme \$12.75; glyphosate \$2.52-\$3.36.
PURSUIT PLUS [♦]	2.5 pt	2.5 pt	2.5 pt		
GLYPHOSATE ^{1♦} (Requires Roundup Ready soybean)	24-32 oz	24-32 oz	24-32 oz	POST	
EXTREME (Requires Roundup Ready Soybean)	3 pt	3 pt	3 pt		

*See rotational crop restrictions on the Pursuit label.

Sunflower to be planted into winter wheat stubble treated with Landmaster BW, Roundup Ultra or Roundup Ultra RT after harvest

(Both treatments required.)					
LANDMASTER BW ¹ + PROWL/PROWL H ₂ O/ PENDIMAX (3.3EC) followed by GLYPHOSATE ^{1♦} + PROWL (3.3EC)	54-64 oz 2.0 pt 20 oz 0.4 pt	54-64 oz 2.0 pt 20 oz 1.0 pt	54-64 oz 2.0 pt 20 oz 1.6 pt	Before May 1 and a minimum of 30 days prior to planting to control volunteer wheat and downy brome. Second treatment pretreatment.	Adjust rate of Prowl depending on rainfall timing and amount after first application. Cost: Landmaster BW + Prowl \$12.49-\$15.63; glyphosate + Prowl \$3.30-\$6.90.
SPARTAN 4F + PROWL/PROWL H ₂ O/ PENDIMAX	3.0-4.0 oz 3.0 pt	4.0-4.5 oz 3.6 pt	4.0-4.5 oz 3.6 pt		Apply PRE up to 30 days prior to planting. Risk of crop injury increases as soil pH increases and/or soil organic matter decreases. Cost: Spartan + Prowl \$15.00-\$19.00.
DUAL MAGNUM	1-1.33 pt	1.33 pt	1.33 pt		Provides excellent grass control but should be combined with Spartan or followed by Beyond to extend broadleaf weed control. Apply Beyond only to Clearfield-tolerant hybrids. Cost: \$14.25-\$18.75.

¹Add NIS (0.25% v/v) per 100 gal spray solution for Gramoxone Max. For Fallow Master BW and glyphosate add 17 lb ammonium sulfate (spray grade) per 100 gal and apply in 10 gpa of spray solution. Read label to determine when to add AMS or additional surfactant.

²Balance is not recommended on coarse-textured soils of less than 1.5% O.M. or pH greater than 7.4. If applied PRE on medium-textured soils with a pH greater than 7.5, decrease Balance rate 0.25 oz/A. Corn seed must be covered with 1.5 to 2.0 inches of soil. Avoid planting when surface soil is wet. Rates could be increased by 0.25 oz/A in fields with organic matter greater than 2.5% or with crop residues exceeding 5,000 lb/A. Do not use if water table is shallower than 25 ft.

[♦]Glyphosate is the active ingredient in many products. The rates provided on this page are based on a 4 lb ai or 3 lb ae formulation. See the glyphosate product comparison table on pages 146-147 for the use rate and more information on the product being used.

[■]If atrazine was applied at planting, the total amount of early and late applications cannot exceed 2.5 lb ai/A per calendar year. Use no more than 1.6 lb ai/A on highly erodible land with less than 30% crop residue. Using atrazine on soils with less than 1% organic matter increases carryover injury risk to susceptible crops, especially high pH soils. Do not use on sandy soils if water table is shallower than 30 ft.

Ecofarming (Continued)

Herbicide	Commercial Product per Acre			Application Time	Remarks and Approximate Cost Per Acre Broadcast
	Sandy Loam < 1% OM	Silty Loam 1-2% OM	Silty-Clay Loam > 2% OM		
Winter Wheat to be planted in fall (Fallow Aid)					
Herbicides to be used in spring on corn or sorghum stubble when followed with winter wheat.					
GLYPHOSATE ¹ ◆	24 oz	24 oz	24 oz	Apr 16-May 1	Application time depends on year and weed species. If downy brome or volunteer wheat are present, they must be controlled before May 1. Early application is necessary to control winter annuals. Use glyphosate for control of downy brome before heading. Do not plant wheat for 20 days after Landmaster BW. Follow-up weed control may be necessary if one wants to go to no-till. Glean can only be used once every 36 months in western Nebraska. Cost: Landmaster BW \$7.70; glyphosate \$2.52; Amber + glyphosate \$5.01-\$7.50; Glean + glyphosate \$8.13.
LANDMASTER BW	64 oz	64 oz	64 oz		
AMBER	0.28-0.56 oz	0.28-0.56 oz	0.28-0.56 oz	Before May 1	
+ GLYPHOSATE ¹ ◆	24 oz	24 oz	24 oz		
GLEAN	0.33 oz	0.33 oz	0.33 oz		
+ GLYPHOSATE ¹ ◆	24 oz	24 oz	24 oz		
2,4-D ESTER (4L)	1 qt			Common purslane, when growing actively	Do not plant small grains for 15 days. Cost: \$3.75.

Grain Sorghum to be planted in winter wheat stubble treated with AAtrex/atrazine after harvest

If volunteer wheat and/or downy brome were not controlled in the fall, spray in April or control earlier with glyphosate, RT Master or Landmaster BW. Low rates (less than 2 lb active) of atrazine usually do not give satisfactory volunteer wheat and downy brome control when applied in July or early August of previous summer. If triazine-resistant kochia is a problem see Troublesome Weeds and Woody Plants, pages 113-127.

BICEP II MAGNUM	Do not use	1.8 qt	2.1 qt	0-30 DBP	Add 1.5-2 pt Gramoxone Extra ¹ or 54 oz Landmaster BW for emerged weeds. When using Landmaster BW wait 20 days prior to planting. Seed must be treated with approved seed safener.
BICEP LITE II MAGNUM	Do not use	1.6 qt	1.8 qt		
BULLET	3.75 qt	3.75 qt	4.0 qt	0-15 DBP	
DUAL II MAGNUM	1.25 pt	1.5 pt	1.67 pt	0-28 DBP	Use safened seed to prevent injury. Cost: Bicep II Magnum \$20.25-\$23.63; Bicep Lite II Magnum \$26.85-\$30.20; Bullet \$20.63-\$22.00; Dual II Magnum + atrazine \$20.29-\$28.03; Outlook + atrazine \$13.98-\$25.44; Guardsman \$14.40-\$20.40; Leadoff \$12.50-\$22.50; Micro-Tech + atrazine \$16.01-\$20.64; G-Max Lite \$15.50-\$27.13.
or OUTLOOK	10-14 oz	14-16 oz	16-18 oz		
+ ATRAZINE DF [■]	0.6 lb	1.2 lb	1.2 lb		
G-MAX LITE	2.0 pt	2.5-3.0 pt	3.5 pt	0-28 DBP	
GUARDSMAN MAX	2.4 pt	2.8 pt	3.4 pt	16-30 DBP	
or LEADOFF	2.5-3.0 pt	3.0-4.0 pt	4.0-4.5 pt	0-15 DBP	
MICRO-TECH	2.25 qt	2.5 qt	2.75 qt	0-15 DBP	
+ ATRAZINE DF [■]	0.6 lb	1.2 lb	1.2 lb		

Postemergence

See corn, grain sorghum, soybean, sunflower, or winter wheat sections for herbicide choices.

¹Add NIS (0.25% v/v) per 100 gal spray solution for Gramoxone Max. For Fallow Master BW and glyphosate add 17 lb ammonium sulfate (spray grade) per 100 gal and apply in 10 gpa of spray solution. Read label to determine when to add AMS or additional surfactant.

◆Glyphosate is the active ingredient in many products. The rates provided on this page are based on a 4 lb ai or 3 lb ae formulation. See the glyphosate product comparison table on pages 146-147 for the use rate and more information on the product being used.

■If atrazine was applied at planting, the total amount of early and late applications cannot exceed 2.5 lb ai/A per calendar year. Use no more than 1.6 lb ai/A on highly erodible land with less than 30% crop residue. Using atrazine on soils with less than 1% organic matter increases carryover injury risk to susceptible crops, especially high pH soils. Do not use on sandy soils if water table is shallower than 30 ft.

Weed Response to Herbicides in Selected Crops

Plant response may be altered by growing conditions, genetic variation in crops and weeds, soil type, pH, organic matter and application rates. Ratings may vary from season to season and geographical areas within the state. Ratings apply when herbicides are used at rates suggested.

Response Ratings: Ratings are for light to moderate weed densities, favorable conditions and weed growth stage as specified on product label. High weed densities, adverse conditions, or large weeds will reduce control.

10 = 96-100% 6 = 70-79%
 9 = 90-95% 5 = 60-69%
 8 = 85-90% 4-2 = less than 60%
 7 = 80-84% 1 = 0

Herbicide and application site (PPI or PRE on soil or POST on foliage)

	Annual Morningglory	Barnyardgrass	Cocklebur	Crabgrass	Fall Panicum	Foxtail	Jimsonweed	Kochia	Kochia, triazine-resistant	Lambsquarters	Nightshade (Hairy)	Pigweed	Ragweed	R. Thistle	Sandbur	Shattercane/Sorghum	Smartweed	Sunflower	Velvetleaf	W. Buckwheat	Crop Safety [□]
--	---------------------	---------------	-----------	-----------	--------------	---------	------------	--------	----------------------------	---------------	--------------------	---------	---------	------------	---------	---------------------	-----------	-----------	------------	--------------	--------------------------

Potato

Chateau-PRE	5	7	2	6	5	7	8	8	8	8	8	8	7	7	3	3	6	3	8	5	1
Chateau + Matrix-PRE	7	9	5	6	6	8	8	8	8	8	8	9	7	7	5	8	7	3	8	6	1
Dual II Magnum/ Dual Magnum-PPI/PRE	4	7	4	9	9	8	5	6	6	6	7	9	7	4	7	5	5	3	5	5	2
Eptam-PPI	7	9	4	9	9	9	4	6	6	7	7	7	6	4	9	9	4	2	4	7	2
Eptam + Sencor-PPI	6	7	6	9	7	9	4	6	6	9	8	9	7	6	7	7	6	6	6	7	3
Eptam + Treflan or Prowl-PPI	6	9	4	9	9	9	4	9	9	7	7	7	4	6	9	9	4	2	4	6	2
Matrix-PRE/POST	1	9	5	5	1	8	1	8	8	5	4	9	-	3	1	1	1	1	5	1	1
Poast-POST	1	8	1	9	9	9	1	1	1	1	1	1	1	1	9	9	1	1	1	1	1
Select-POST	1	9	1	9	9	9	1	1	1	1	1	1	1	1	9	10	1	1	1	1	1
Sencor + Dual II Magnum-PRE	4	9	6	6	9	9	7	6	2	9	7	9	9	7	6	4	7	6	7	9	2
Sencor-PRE	4	7	6	7	7	7	7	6	2	9	5	9	9	7	4	4	7	6	7	9	2
Sencor-POST	4	4	7	6	4	6	4	7	2	4	4	9	7	9	6	4	7	7	6	4	3

Dry Bean

Assure II + COC-POST	1	8	1	8	8	9	1	1	1	1	1	1	1	1	6	9	1	1	1	1	1
Basagran-POST	5	1	7	1	1	1	8	8	8	8	7	5	5	4	1	1	8	8	7	6	2
Dual II Magnum/Dual Magnum-PPI	4	8	4	9	9	9	4	4	4	7	7	8	5	4	7	7	5	1	5	2	2
Eptam-PPI	6	6	4	9	9	9	5	7	7	7	7	7	6	4	9	9	5	3	5	6	1
Eptam + Dual II Magnum-PPI	5	9	5	9	9	9	5	6	6	8	8	9	5	5	9	8	5	3	5	6	2
Eptam + Sonalan-PPI	5	9	5	9	9	9	7	9	9	9	10	9	5	5	9	9	5	1	5	6	1
Eptam + Treflan or Prowl-PPI	5	9	6	9	9	9	6	9	9	9	7	9	5	5	9	9	5	1	5	6	1
Micro-Tech + Treflan-PPI	5	7	5	9	9	9	5	9	9	8	8	9	5	5	9	7	5	1	5	5	2
Micro-Tech-PPI	4	7	4	9	9	8	5	6	6	6	7	9	7	4	7	4	4	1	4	5	2
Micro-Tech + Eptam-PPI	5	9	4	9	9	9	7	7	7	7	8	9	5	5	9	7	5	1	5	5	2
Outlook-PRE	1	8	2	8	8	9	1	2	2	7	6	8	5	3	6	3	3	1	2	1	1
Outlook + Eptam-PPI	5	9	4	9	9	9	5	7	7	9	8	9	5	5	9	9	5	1	5	5	2
Outlook + Sonalan-PPI	5	9	4	9	9	9	5	8	8	9	8	9	5	9	8	9	5	1	5	5	2
Poast-POST	1	6	1	9	9	9	1	1	1	1	1	1	1	1	9	9	1	1	1	1	1
Pursuit-POST	7	5	8	5	1	5	8	8	8	4	7	8	7	7	4	9	7	7	7	4	4
Pursuit + Basagran-POST	7	5	8	5	1	5	8	8	8	7	8	8	7	7	4	8	8	8	7	6	2
Raptor + Basagran-POST	7	5	8	7	1	7	8	8	8	8	9	9	7	7	5	8	8	8	7	7	2
Reflex + COC-POST	8	2	6	2	2	2	8	8	8	7	7	9	8	5	2	2	6	6	7	5	1
Select-POST	1	9	1	9	9	8	1	1	1	1	1	1	1	1	8	10	1	1	1	1	1

Garbanzo Beans (Chickpeas)

Assure II-POST	1	8	1	8	8	9	1	1	1	1	1	1	1	1	8	9	1	1	1	1	1
Dual Magnum-PPI	4	7	4	9	9	8	5	6	6	6	7	9	7	4	7	5	5	3	5	5	2
Outlook-PPI	1	8	2	8	8	9	1	2	2	7	6	8	5	3	6	3	3	2	2	1	2
Prowl-PPI	1	6	2	8	7	8	4	7	7	7	5	8	4	4	6	7	4	2	2	4	2
Poast-POST	1	6	1	9	9	9	1	1	1	1	1	1	1	1	9	9	1	1	1	1	1
Select-POST	1	9	1	9	9	9	1	1	1	1	1	1	1	1	9	10	1	1	1	1	1
Spartan-PRE	8	6	5	6	8	6	8	8	8	8	5	7	5	8	5	5	8	1	8	5	1
Spartan + Dual Magnum-PRE	8	8	5	8	8	8	8	8	8	8	8	8	5	8	5	7	8	1	8	5	1
Spartan + Prowl-PRE	8	8	6	7	8	8	8	9	9	8	5	8	5	8	7	8	8	1	8	6	1

[□]Crop hybrids vary in their response to herbicides. Crop safety ratings less than 3 indicate that crop yield should not be affected by any direct injury.

Weed Response to Herbicides in Selected Crops

	Annual Morningglory	Barnyardgrass	Cocklebur	Crabgrass	Fall Panicum	Foxtail	Jimsonweed	Kochia	Kochia, triazine-resistant	Lambsquarters	Nightshade (Hairy)	Pigweed	Ragweed	R. Thistle	Sandbur	Shattercane/Sorghum	Smartweed	Sunflower	Velvetleaf	W. Buckwheat	Crop Safety [□]	
Sugarbeet																						
Assure II + COC	1	9	1	9	9	9	1	1	1	1	1	1	1	1	9	10	1	1	1	1	1	1
Betamix/D+P Mix-POST	1	4	2	1	1	6	3	4	4	9	9	9	3	5	6	1	3	1	2	5	3	3
Betamix Progress-POST	1	4	2	1	1	7	3	5	5	6	8	8	3	5	7	1	3	2	2	5	3	3
Betamix + Stinger-POST	5	5	9	1	1	6	7	5	5	9	9	9	8	5	6	1	7	9	3	9	3	3
Betamix + Upbeet	1	4	6	1	1	7	3	9	9	9	9	9	6	5	6	1	6	6	7	7	3	3
Betamix + Upbeet + Stinger-POST	5	5	9	4	2	5	7	9	9	9	9	9	8	8	5	2	8	9	7	9	2	2
Betamix + Upbeet + Stinger (Micro)-POST	5	6	9	5	3	6	7	9	9	7	7	7	7	8	5	2	8	9	6	8	1	1
Dual Magnum-Layby	1	8	2	8	8	9	1	2	2	6	7	7	5	3	7	6	3	1	2	2	1	1
Eptam-layby	5	6	5	9	9	9	5	8	8	7	7	7	6	4	9	9	5	3	5	6	1	1
Glyphosate [◆] -POST	8	10	10	10	10	10	8	9	9	9	10	10	10	8	10	10	10	10	9	7	1	1
Outlook-LAYBY	1	8	2	8	8	9	1	2	2	7	6	7	5	3	6	3	3	2	2	1	1	1
Nortron/Etho SC-PPI/PRE	1	5	5	7	7	8	1	6	6	6	6	8	1	6	6	1	7	4	5	7	2	2
Poast-POST	1	6	1	7	7	9	1	1	1	1	1	1	1	1	7	7	1	1	1	1	1	1
Ro-Neet-PPI	4	7	4	8	8	9	4	3	3	8	9	9	6	4	7	7	4	2	4	4	2	2
Select-POST	1	8	1	9	9	9	1	1	1	1	1	1	1	1	9	9	1	1	1	1	1	1
Stinger/Clopyr Ag-POST	1	1	9	1	1	1	5	3	3	4	4	1	7	4	1	1	5	5	3	7	2	2
Onion																						
Buctril-POST	9	1	7	2	2	2	9	6	6	7	9	7	9	7	2	2	9	9	9	9	9	3
Dacthal 75W-PRE	4	7	4	9	4	9	4	4	4	9	6	9	4	4	7	4	4	4	4	4	2	2
Fusilade-POST	4	7	1	9	9	8	1	1	1	1	1	1	1	1	7	7	1	1	1	1	1	1
Goal 2XL-POST	4	4	7	2	4	4	1	6	6	7	6	7	1	6	4	2	1	6	1	7	3	3
Prowl-PRE	1	6	2	8	7	7	4	7	7	7	5	8	4	4	6	7	4	4	2	4	2	2
Select-POST	1	8	1	9	9	9	1	1	1	1	1	1	1	1	9	10	1	1	1	1	1	1
Vine Crop																						
Command 3ME ¹	3	6	2	6	6	6	6	7	7	5	2	2	3	-	5	5	6	6	8	-	2	2
Curbit-PRE ²	4	9	4	9	9	9	4	7	7	7	6	7	4	7	7	7	4	2	2	4	2	2
Poast-POST ²	1	6	1	9	9	9	1	1	1	1	1	1	1	1	9	9	1	1	1	1	1	1
Sandea-POST ²	5	1	9	1	1	1	-	6	6	5	9	9	9	-	1	1	7	9	9	-	2	2
Select-POST ²	1	8	1	9	9	9	1	1	1	1	1	1	1	1	9	9	1	1	1	1	1	1
Strategy ²	4	9	6	9	9	9	8	8	8	9	8	7	8	7	7	7	9	6	9	5	2	2
Treflan-PRE ³	4	9	4	9	9	9	4	7	7	7	4	7	4	7	7	7	4	2	2	4	2	2

¹Winter squash and processing pumpkins.

²Cucumber, melon, pumpkin, squash.

³Cucumber and melon.

[□]Crop hybrids vary in their response to herbicides. Crop safety ratings less than 3 indicate that crop yield should not be affected by any direct injury.

[◆]Glyphosate is the active ingredient in many products. The rates provided on this page are based on a 4 lb ai or 3 lb ae formulation. See the glyphosate product comparison table on pages 146-147 for the use rate and more information on the product being used.

Potato

Herbicide	Commercial Product per Acre			Application Time, Remarks and Approximate Cost Per Acre Broadcast
	Sandy Loam < 1% OM	Silt Loam 1-2% OM	Silty-Clay Loam > 2% OM	
CHATEAU	1.5 oz	1.5 oz	1.5 oz	PRE UP to DRAG OFF. Apply before weeds or potatoes emerge. Cost: \$5.63.
CHATEAU + MATRIX	1.5 oz 1.5 oz	1.5 oz 1.5 oz	1.5 oz 1.5 oz	PRE UP to DRAG OFF. Apply before weeds or potatoes emerge. Cost: \$26.63.
DUAL II MAGNUM/ DUAL MAGNUM/CINCH	1 pt	1.33 pt	1.67 pt	PPI, PRE, or DRAG OFF—If cool, wet soil conditions occur after application, Dual II Magnum may delay maturity or injure early maturing potato varieties. Do not harvest within 60 days of application. Cost: \$14.25-\$23.80.
EPTAM/EPTEK	3.5 pt	3.5 pt	7 pt	PPI, DRAG-OFF, or LAYBY — Apply and incorporate before planting or after potato plants have emerged. Minimum time from application to harvest is 45 days. The Superior variety potato is sensitive to Eptam and under stress conditions, early season stunting may occur. Cost: \$16.95-\$32.90.
EPTAM/EPTEK + TREFLAN	2.5 pt 1 pt	2.5 pt 1 pt	2.5 pt 1 pt	PRE UP TO and JUST BEFORE DRAG-OFF — Incorporate chemical immediately after application. Set incorporation equipment so that herbicide is not concentrated over the row. The Superior variety potato is sensitive to Eptam and under stress conditions, early season stunting may occur. Cost: Eptam + Treflan \$15.38; Eptam + Prowl \$17.15-\$18.95.
EPTAM/EPTEK + PROWL/PROWL H ₂ O	2.5 pt 1.8 pt/1.5 pt	2.5 pt 2.4 pt/2.0 pt	2.5 pt 2.4 pt/2.0 pt	
EPTAM/EPTEK + SENCOR DF	3.5 pt 0.33 lb	3.5 pt 0.33 lb	4.5 pt 0.66 lb	PPI, DRAG-OFF, or Early POST. Apply and incorporate mechanically or through an irrigation sprinkler system. Most thin-skinned varieties such as Atlantic and Shepody are sensitive to Sencor. Cost: \$23.71-\$35.67.
MATRIX	1-1.5 oz	1-1.5 oz	1-1.5 oz	Apply after hilling or drag-off but before potatoes or weeds emerge. For activation supply moisture by rainfall or sprinkle; is labeled for chemigation. Can be tank mixed with Eptam, Prowl, Dual, or Sencor; can also be applied POST after crop emergence but before the crop is 14". Maximum 2 oz/season; cannot be used on potatoes grown for seed; some varieties may show injury. Add a nonionic surfactant with post applications. Cost: \$14.00-\$21.00.
SENCOR	0.33 lb	0.5 lb	1 lb	PRE, PPI, or DRAG-OFF AS PER LABEL—Do not plant treated area to sensitive crops such as onion or sugarbeet during the next growing season. Most thin-skinned varieties such as Atlantic and Shepody are sensitive to Sencor. Cost: Dual + Sencor \$21.51-\$38.32; Sencor \$7.26-\$14.52; Prowl + Sencor \$12.66-\$21.72.
SENCOR with DUAL II MAGNUM/ DUAL MAGNUM/CINCH	0.33 lb 1 pt	0.33 lb 1.33 pt	0.66 lb 1.67 pt	
or with PROWL/PENDIMAX/ PROWL H ₂ O	1.8 pt/1.5 pt	2.4 pt/2.0 pt	2.4 pt/2.0 pt	

Postemergence

POAST	1-1.5 pt	1-1.5 pt	1-1.5 pt	POST before susceptible grasses are 4" tall. Potatoes tolerant at all growth stages. Add 2 pints of crop oil concentrate. Minimum time from application to harvest 30 days. Good coverage essential for effective control. Cost: \$9.06-\$13.58.
SELECT/ARROW + COC	6-8 oz 1 qt/A	6-8 oz	6-8 oz	POST before most grasses are 6" tall. Potatoes tolerant at all growth stages. 1 qt/A. Add COC. 30 day preharvest interval. Cost: \$9.84-\$13.13.
SENCOR DF	0.33 lb	0.5 lb	0.66 lb	POST before weeds are 1" tall. Highest rate for common sunflower and kochia; will not control triazine-resistant kochia. Do not use on red skinned or early maturing white varieties or within 60 days of harvest. Cost: \$7.26-\$14.52.

Harvest Aid

AIM	3.0-5.8 oz			Harvest aid. Preharvest interval 7 days. Use with MSO or COC. Cost: \$17.58-\$33.89.
GRAMOXONE MAX	0.7-1.3 pt			Harvest Aid—Apply when potato leaves begin to age. Preharvest interval 3 days. Not labeled for seed potatoes. Cost: \$4.03-\$7.48
REGLONE	1.0-2.0 pt			Preharvest interval 7 days. Cost: \$11.25-\$22.50.
RELY	3.0 pt			Apply at the beginning of natural senescence of potato vines. Do not harvest potatoes until 9 days after application. Not labeled for seed potatoes. Cost: \$24.75.

Dry Bean Preplant

Herbicide	Commercial Product per Acre			Application Time, Remarks and Approximate Cost Per Acre Broadcast
	Sandy Loam < 1% OM	Silt Loam 1-2% OM	Silty-Clay Loam > 2% OM	
DUAL II MAGNUM/ DUAL MAGNUM/CINCH	1 pt	1.33 pt	1.67 pt	PPI or PRE—Surface mixing will improve weed control and reduce crop injury. Cost: \$14.25-\$23.80.
EPTAM 20G or EPTAM 7E/EPTEK	11 lb 3.5 pt	20 lb 4.5 pt	— —	PPI—Apply to dry surface soil; immediately incorporate with disk or field cultivator. Apply layby at time of last cultivation as a directed spray or direct granules to the base of the plants before bean pods start to form. Do not feed or pasture vines within 45 days after application. Cost: \$16.45-\$21.15.
EPTAM/EPTEK with SONALAN or with PROWL/PROWL H ₂ O or with TRIFLURALIN	2.5 pt 2 pt 2.4 pt/2.0 pt 1 pt	2.5 pt 2 pt 2.4 pt/2.0 pt 1 pt	— — — —	PPI—Apply to dry surface soil, immediately incorporate with a disk or field cultivator. Sonalan, Treflan, or Prowl may injure fall seeded small grains, or spring seeded sugarbeet or sorghum the following year. Cost: Eptam + Dual II Magnum \$26.00; Eptam + Sonalan \$19.25; MicroTech \$19.50; Eptam + Prowl \$18.95; Emptam + Treflan \$14.19.
EPTAM/EPTEK with DUAL MAGNUM/CINCH	2.5 pt 0.8 pt	2.5 pt 1 pt	— —	
MICRO-TECH	3 qt	3 qt	—	
OUTLOOK	12 oz	14 oz	16 oz	PPI, PRE or early POST (first to third trifoliolate stage). Dry beans may be harvested 70 days or more after application. Cost: \$15.09-\$20.13.
OUTLOOK with SONALAN or with EPTAM/EPTEK	12 oz 2 pt 2.5 pt	14 oz 2 pt 2.5 pt	— — —	PPI—Apply to dry surface soil, immediately incorporate with a disk or field cultivator. Cost: Outlook + Sonalan \$22.59-\$25.14; Outlook + Eptam \$26.84-\$29.39.
MICRO-TECH + EPTAM (7E)/EPTEK or with TRIFLURALIN	2.5 qt 2.5 pt 1 pt	2.5 qt 2.5 pt 1 pt	— — —	Apply to dry surface soil, immediately incorporate. Trifluralin at 1 pt may injure fall seeded small grain or spring seeded sugarbeet or sorghum the following year. Cost: Micro-Tech + Eptam \$28.00; Micro-Tech + Trifluralin \$18.69; Trifluralin + Dual Magnum \$16.69.
TRIFLURALIN with DUAL MAGNUM	1 pt 1 pt	1 pt 1 pt	— —	

Postemergence

ASSURE II/TARGA + COC	6-12 oz 1 qt	— —	POST—Susceptible grasses less than 4" tall. Dry bean tolerant at all growth stages. Do not apply within 30 days of harvest. Cost: \$6.84-\$13.69.
BASAGRAN + COC + UAN	1-2 pt 1 qt + 2 qt	— —	POST—Unifoliolate to first trifoliolate leaf stage. Use 1 pt for dry bean in the unifoliolate leaf stage and 2 pt for beans in the first trifoliolate leaf stage. Basagran may be reapplied at the 1 pt rate 5 to 7 days after the initial application. Broadleaf weeds 1-2" tall. Weeds showing moisture stress or over 6" tall are poorly controlled. Controls hairy but not eastern black nightshade. Cost: \$10.76-\$21.53.

Dry Bean (continued) Postemergence

Herbicide	Commercial Product per Acre			Application Time, Remarks and Approximate Cost Per Acre Broadcast
	Sandy Loam < 1% OM	Silt Loam 1-2% OM	Silty-Clay Loam > 2% OM	
PURSUIT DG + NONIONIC SURFACTANT (NIS) + UAN	1.08 oz 1 qt/100 gal 2 qt/A	— — —	— — —	POST—Dry bean must have one trifoliolate leaf. Pursuit and Pursuit + Basagran require the addition of an adjuvant. Pursuit will carry over. Do not plant sugarbeet for 40 months. Allow at least 60 days between Pursuit application and harvest. Cost: Pursuit \$13.61; Pursuit + Basagran \$24.36.
PURSUIT DG + BASAGRAN + NONIONIC SURFACTANT (NIS) + UAN	1.08 oz 1 pt 1 qt/100 gal 2 qt/A	— — — —	— — — —	
POAST + COC	1-1.5 pt 1 qt	— —	— —	POST—Susceptible weeds less than 4" tall. Dry bean tolerant at all growth stages. Good coverage essential. Cost: \$9.06-\$13.59.
RAPTOR + BASAGRAN + NONIONIC SURFACTANT (NIS) + UAN	4 oz 1 pt 1 qt/100 gal 2 qt/A	— — — —	— — — —	POST—Dry bean must have at least one fully expanded trifoliolate leaf. Raptor will carry over. Do not plant sugarbeet for 18 months. Cost: \$28.88.
REFLEX + COC	1 pt 1%	Section 18 label in 2005 and applied for in 2006		POST—Susceptible weeds 1-2" tall. Do not plant sugarbeets, alfalfa, or sunflowers for 18 months following Reflex. Do not apply within 30 days of harvest. Cost: \$13.00.
SELECT/ARROW + COC	6-8 oz 1 qt	— —	— —	POST—Grasses 6" tall. Do not apply within 30 days of dry bean harvest (cutting or pulling plants from ground) Cost: \$9.84-\$13.13.

Harvest Aid

AIM	3.0-5.8 oz	—	—	Desiccant. Add MSO or COC to the spray solution. Apply when at least 80% of pods are yellowing. There is no preharvest interval. Cost: \$17.58-\$33.89.
GRAMOXONE MAX	0.8-1.3 pt	—	—	Desiccant. Add NIS (0.25% v/v) per 100 gal spray solution. Apply when at least 80% of pods are yellowing and no more than 30% of leaves are still green. Do not harvest within 7 days of application. Add 1 qt non-ionic surfactant/100 gal. Cost: \$5.75-\$8.63.

Garbanzo Beans (Chickpeas)

Herbicide	Commercial Product per Acre			Application Time, Remarks and Approximate Cost Per Acre Broadcast
	Sandy Loam < 1% OM	Silt Loam 1-2% OM	Silty-Clay Loam > 2% OM	
ASSURE II/TARGA + COC	8.0 oz + 1 qt	8.0 oz + 1 qt	8.0 oz + 1 qt	POST before susceptible grasses are 4-6" tall. Use with crop oil concentrate. Cost: \$9.12.
DUAL MAGNUM	1 pt	1.3 pt	1.3 pt	PPI or PPE—Do not cut for hay within 120 days following Dual II Magnum. Cost: \$14.25-\$18.53.
OUTLOOK	12 oz	12 oz	14 oz	PPI or PRE—Incorporation will improve weed control. Cost: \$15.09-\$17.64.
PROWL/PENDIMAX/ PROWL H ₂ O	1.8 pt/1.5 pt	2.4 pt/2.0 pt	2.4 pt/2.0 pt	PPI—Apply and incorporate before planting. Cost: \$5.40-\$7.20.

Garbanzo Beans (Chickpeas) (continued)

Herbicide	Commercial Product per Acre			Application Time, Remarks and Approximate Cost Per Acre Broadcast
	Sandy Loam < 1% OM	Silt Loam 1-2% OM	Silty-Clay Loam > 2% OM	
POAST + COC	1 pt + 1 qt	1 pt + 1 qt	1 pt + 1 qt	POST before susceptible grasses are 4" tall. Use with crop oil concentrate. Cost: \$9.06.
SELECT/ARROW + COC	6 oz 1 qt	6 oz 1 qt	6 oz 1 qt	POST before grasses are 6" tall. Cost: \$9.84.
SPARTAN 4F	3 oz	3.75 oz	4.5 oz	EPP or PRE—Use higher rate of Spartan for EPP greater than 14 days ahead of planting. Cost: Spartan \$6.72-\$10.08; Spartan + Prowl \$12.12-\$17.28; Spartan + Dual Magnam \$20.95-\$28.58.
SPARTAN 4F + PROWL/PROWL H ₂ O or with DUAL MAGNAM	3 oz 1.8 pt/1.5 pt 1.0 pt	3.75 oz 2.4 pt/2.0 pt 1.3 pt	4.5 oz 2.4 pt/2.0 pt 1.3 pt	

Chicory

Herbicide	Commercial Product per Acre		Application Time, Remarks, and Approximate Cost Per Acre Broadcast
	Sandy Loam <1% -1.5% OM		
TREFLAN	1 pt		PPI. Apply and incorporate mechanically immediately after application. Cost: \$2.44.
RAPTOR + NIS (NONIONIC SURFACTANT) + UAN	4 oz 1 qt/100 gal 6-8 oz		POST. Apply after the chicory plant has two expanded true-leaves. Cost: \$18.13.
SELECT + COC	6-8 oz 1 qt		POST. Apply when grass weeds are less than 4" tall. Cost: \$9.84-\$13.13.

Sugarbeet

Herbicide	Commercial Product per Acre						Application Time, Remarks, and Approximate Cost Per Acre Broadcast
	Sandy Loam 1% OM			Silt Loam 1-2% OM			
	Broad-cast	Product/7" Band 22" Row	Band 30" Row	Broad-cast	Product/7" Band 22" Row	Band 30" Row	
Sugarbeet, No-Till in Rye or Winter Wheat							
GLYPHOSATE [♦]	32 oz	10 oz	7.5 oz	32 oz	10 oz	7.5 oz	Apply in spring when rye or wheat are 6-10" tall and before sugarbeet have emerged. Cost: \$3.36.
PPI or PRE							
NORTRON SC/ETHO SC	35 oz	11 oz	8 oz	59 oz	19 oz	14 oz	PPI or PRE—For furrow irrigation, apply preplant and incorporate 1" to 2"; for sprinkler irrigation apply PRE at planting or shortly after and immediately irrigate with 0.5" water. Cost broadcast: \$33.91-\$57.16.
RO-NEET	32 oz	10 oz	7.5 oz	52 oz	17 oz	12 oz	PPI—Immediately mix into dry soil and incorporate with a field cultivator or roller harrow. Crop injury may occur on sandy soils below 1% organic matter or with highly saline or alkaline soil conditions. Use lower rate if POST treatments are planned. Primarily used for annual grass control. Cost broadcast: \$16.18-\$26.28.

[♦]Glyphosate is the active ingredient in many products. The rates provided on this page are based on a 4 lb ai or 3 lb ae formulation. See the glyphosate product comparison table on pages 146-147 for the use rate and more information on the product being used.

Sugarbeet (continued)

Herbicide	Commercial Product per Acre						Application Time, Remarks, and Approximate Cost Per Acre Broadcast
	Sandy Loam 1% OM			Silt Loam 1-2% OM			
	Broad- cast	Product/7" Band 22" Row	Band 30" Row	Broad- cast	Product/7" Band 22" Row	Band 30" Row	
Layby							
EPTAM 7E or EPTAM 20G	36 oz 11 lb	11.5 oz 3.5 lb	8 oz 2.5 lb	56 oz 15 lb	18 oz 4.7 lb	13 oz 3.5 lb	Apply Eptam after thinning and clean cultivation; incorporate immediately 2" deep with a cultivator. Cost broadcast: \$10.58-\$16.45.
TREFLAN	16 oz	5 oz	3.5 oz	20 oz	6 oz	4.5 oz	Sugarbeet 2" to 6" tall. Cover exposed beet roots with soil before Treflan application to reduce root girdling. Cost broad- cast: \$2.44-\$3.05.
OUTLOOK	12 oz	3.8 oz	2.8 oz	14 oz	4.4 oz	3.2 oz	Sugarbeet 4-true-leaf stage. Do not apply after the crop reaches the 8-true-leaf stage. Apply 0.5" of overhead irrigation water after application to incorporate herbicide.
DUAL MAGNUM	1 pt	5 oz	3-7 oz	1.6 pt	8 oz	6 oz	Cost broadcast: Outlook \$15.09-\$17.64; Dual Magnum \$14.25- \$22.80.

Postemergence

Herbicide	Rate per acre			Application Time	Remarks and Approximate Cost Per Acre Broadcast
	Broadcast	Product Per 7" Band 22" Row	Band 30" Row		
ASSURE II/TARGA + COC	7-8 oz	2.2-2.6 oz	1.6-1.8 oz	Grass 1-3"	Susceptible grasses less than 4" tall. Good activity on volunteer cereals. Do not apply within 45 days of harvest. Do not mix with any herbi- cide or insecticide. Cost Broadcast: \$6.84-\$7.98.
BETAMIX/D+P MIX	32 oz	10 oz	7.5 oz	Any stage of sugarbeet growth. Weeds cotyledon stage. Repeat in 5-7 days.	Treat in late afternoon to reduce injury. Cost broadcast: Betamix \$26.50; Betamix + Stinger \$43.50.
BETAMIX/D+P MIX with STINGER/CLOPYRAG	32 oz 4 oz	10 oz 1.3 oz	7.5 oz 1.0 oz	Sugarbeet 2-leaf stage. Repeat in 5-7 days	
PROGRESS	20-36 oz	6.4-11.4oz	4.7-8.4 oz	Sugarbeet cotyledon to 2-leaf stage	Use the lower rate when sugarbeet are in the cotyledon to 2-leaf stage of growth. Follow with the higher rate in 5 to 7 days when sugarbeet is in the 4-leaf stage. Cost broadcast: \$18.75- \$33.75.
ROUNDUP ULTRA MAX II (Roundup-tolerant variety required)	22 oz	7 oz	5.1 oz	Sugarbeet, 2-leaf stage Weeds 2-3" Repeat in 10-14 days	Check with your sugar company to see if they will accept Roundup Ready sugarbeet. Cost broadcast: \$11.51.
POAST + COC	16-32 oz	5-10 oz	3-7 oz	Grass 1-3"	Use higher rate for larger grass or grass under drought stress. All herbicides require the addition of an adjuvant. See label. Cost broad- cast: Poast \$9.06-\$18.12; Select \$9.84-\$13.12.
SELECT + COC/ARROW	6-8 oz	2-2.5 oz	1.4-1.8 oz	Grass 1-3"	
BETAMIX with POAST or SELECT	32 oz 24 oz 8 oz	10 oz 7.5 oz 2.5 oz	7.5 oz 5 oz 1.8 oz	Sugarbeet 2-leaf stage	Do not add crop oil to Betamix plus Poast or Betamix plus Select combinations. Grasses should be less than 2 inches. Cost broadcast: Betamix plus Poast \$39.94; Betamix plus Select \$39.62
Conventional Rate					
BETAMIX + UPBEET + STINGER/CLOPYRAG	32 oz 0.5 oz 4 oz	10 oz 0.17 oz 1.3 oz	7.5 oz 0.12 oz 1.0 oz	Weeds cotyledon to less than 1"	A minimum of two sequential applications should be utilized. Cost broadcast: \$69.50.

◆Glyphosate is the active ingredient in many products. The rates provided on this page are based on a 4 lb ai or 3 lb ae formulation. See the glyphosate product comparison table on pages 146-147 for the use rate and more information on the product being used.

Sugarbeet (continued) Postemergence

Herbicide	Rate per acre			Application Time	Remarks and Approximate Cost Per Acre Broadcast
	Broadcast	Product Per 7" Band 22" Row	30" Row		
Micro-Rate BETAMIX + UPBEET + STINGER/CLOPYRAG + Methylated Sunflower Oil 1.5%	8 oz	2.5 oz	1.7 oz	Weeds cotyledon to less than 1"	A minimum of three sequential applications should be utilized, repeat applications on a 5- to 7-day interval. Timing of applications is very important. Cost broadcast: \$18.24.
STINGER/CLOPYRAG	4-6 oz	4-10 oz	4-10 oz	Sugarbeet, 2-8 true leaves; Canada thistle rosette to pre-bud	Use lower rates for annual weeds and higher rates for Canada thistle. Do not plant or rotate for 1 year after treatment to any crop except small grains or corn. Cost broadcast: \$17.00-\$25.50.
UPBEET + MSO	0.5 oz	0.17 oz	0.12 oz	Weeds less than 2" tall	For best weed control a minimum of 2 sequential applications should be applied. Should be tank mixed with Betamix or Betamix Progress. ALS-resistant kochia will not be controlled by Upbeet. A split application of Upbeet plus MSO applied when velvetleaf is 1 to 2 inches tall provides excellent control. Cost broadcast: Upbeet \$26.00; Betamix + Upbeet \$52.50.
UPBEET + BETAMIX	0.5 oz 32 oz	0.17 oz 10 oz	0.12 oz 7.5 oz		

Vine Crops and Onion

Herbicide	Commercial Product per Acre	Application Time	Remarks and Approximate Cost Per Acre Broadcast
-----------	-----------------------------	------------------	---

Melons and Cucurbits

COMMAND (3ME) ¹	0.67-1.33 pt	Preplant	Do not use on Jack-o-lantern pumpkins. Cost: \$8.79-\$17.46.
CURBIT ²	3-4.5 pt	PRE	Apply postplant to the soil surface prior to weed emergence. Apply to seeded crop prior to crop emergence or apply as a banded spray between rows after crop emergence or transplanting. Do not preplant incorporate or do not use under plastic mulch. Cost: \$18.15-\$28.13.
STRATEGY ²	2-6 pt	PRE	Use lower rate on sandy soil. Controls many annual grasses and broadleaf weeds. Cost: \$21.00-\$63.00.
TRIFLURILAN ³	1-2.0 pt	Crop 3-4 true leaves	Direct material to soil between the rows and mechanically incorporate. Controls germinating annual grasses and some broadleaves. Use the lower rate on sandy soils. Cost: \$2.44-\$4.88.
POAST ² + COC	1-1.5 pt 1 qt	Grasses most susceptible under 4"	Do not apply within 14 days of harvest. Crop oil concentrate and good coverage essential for effective control. Cost: \$9.06-\$13.59.
SANDEA ²	0.5-1.0 oz	Crop 2-5 leaf; broadleaf weeds 1-3"	Add NIS at 1 qt/100 gallon spray mixture. Cost: \$20.50-\$41.00.
SELECT 2EC ² /ARROW + COC	6-8 oz + 1% v/v	Grasses 6" tall	Do not apply Select within 14 days of squash, cucurbit, or melon harvest. Cost: \$9.84-\$13.12.

¹Winter squash and processing pumpkin.

²Cucumber, melon, pumpkin, squash.

³Cucumber and melon.

Onion

Herbicide	Commercial Product per Acre	Application Time	Remarks and Approximate Cost Per Acre Broadcast
DACTHAL 75W	8-14 lb	PRE at seeding or transplanting and/or at layby	Preplant incorporation not recommended. Use lower rate on soils with less than 1% organic matter. Cost: \$128.00-\$224.00.
BUCTRIL	1-1.5 pt	POST; onion should have 2-5 true leaves	Water volume is important. Use 50-70 gallons of water per acre. Do not add surfactants. Cost: \$8.37-\$12.56.
GOAL 2 XL	0.5-1.0 pt	Onion, 2 fully developed true leaves; weeds, 2-4 leaves	Do not apply to onion under drought stress. Do not mix Goal with oil, surfactant or fertilizer. Cost: \$6.25-\$12.50.
FUSILADE DX + COC	6 oz 1 qt	Shattercane and corn 12-18"; other annual grasses less than 4"	Crop oil concentrate and good coverage essential for effective control. Don't tank mix with Buctril. Cost: \$7.35.
PROWL/PROWL H20/ PENDIMAX	2.4 pt/1.5 pt	PRE to weeds; onion must have 2 to 9 true leaves	Do not apply within 45 days of harvest. Cost: \$6.00-\$7.20.
SELECT 2 EC/ARROW + COC	6-8 oz 1% v/v	Grass 2-6"	Do not apply within 45 days of harvest. Crop oil concentrate and good coverage essential for effective control. Cost: \$9.84-\$13.12.

¹Winter squash and processing pumpkin.

²Cucumber, melon, pumpkin, squash.

³Cucumber and melon.

Commercial Turfgrass

Weeds are usually the most visible of turfgrass pests and are a major problem for turf managers and homeowners. Weeds are a concern principally because they compete with desirable turfgrass plants for space, light, water, and nutrients. In addition, weeds detract from the appearance and function of turfs.

Any plant can be considered a weed if it's growing where it's not wanted. For example, although tall fescue is a major turfgrass species, it is considered a weed if it infests Kentucky bluegrass.

Management and control measures will vary depending on which weeds are present. Proper identification of the weed problem is the first step in developing a management strategy.

Weeds often are grouped by life span (annuals, biennials and perennials). Determining a weed's life span can be important when developing a management strategy.

The best defense against weeds is a thick, well-managed turf. A vigorous turf will successfully compete with weeds for light, nutrients and water. Weeds become established most readily in thin, weak stands of turf. Spraying by itself does not usually produce satisfactory long-term results. Although herbicides can be used in an integrated weed control system, proper management can do much to encourage a dense, vigorous turf and discourage weeds.

Herbicides are available to control most turf weeds. Care should be used when applying any pesticide. Always read and follow label directions. Improper use can result in poor weed control, turf injury, or injury to sensitive ornamental or garden plants.

Preemergence herbicides should be applied to the turf before weeds germinate. To control most annual grasses, apply preemergence herbicides when soil temperature exceeds 50°F. A second application is sometimes needed to provide season-long control. Preemergence herbicides should be watered in immediately after application with at least 1/2 inch of water.

Postemergence herbicides are sprayed once weeds emerge and are ap-

plied to the foliage of actively growing weeds. Most postemergence herbicide control broadleaf weeds, and some are available for grasses.

Several factors influence the effectiveness of postemergence herbicide applications. Control is easiest to achieve when the weeds are small, healthy, and actively growing. As the weeds age, changes in the leaf surface, growth habit, and physiological function occur. These changes result in reduced herbicide uptake and translocation.

Avoid mowing for several days before and after postemergence herbicide application. Mowing before application reduces the amount of weed foliage available to intercept the chemical and causes stress which reduces herbicide uptake. Mowing after application may remove the treated portion and prevent translocation to the roots.

Do not apply postemergence herbicides to turfgrass and weeds under heat or drought stress. Injury may occur to the turfgrass and weed control can be less effective. Water the turf thoroughly before application to assure that the weeds are actively growing. Unlike the preemergence herbicides, don't water for several days after application. Watering can wash the herbicide off the plant. Also, avoid spraying if rain is expected within 24 hours.

Many postemergence herbicides for the control of broadleaf weeds are very volatile, and may injure sensitive plants in the area. Care should be taken to only spray when the wind is 5 mph or less and the air temperature is less than 80°F. Postemergence broadleaf herbicides are either applied early in the spring (April-May) or in the fall prior to the first frost. Fall is the preferred time to control broadleaf weeds.

Herbicides are a useful tool for controlling weeds, but they only provide short-term relief. The best approach is to use an integrated system which utilizes proper mowing, fertilizing, and irrigation management to establish a vigorous turf.

Homeowners and consumers can get more information on turfgrass weed problems from their local University of Nebraska Extension office.

Weed Response to Selected Turfgrass Herbicides

Plant response may be altered by growing conditions, genetic variation in turf and weeds, soil type, organic matter, temperature, growth stage and application rates. Ratings will vary from season to season and from area to area within the state. Ratings apply when herbicides are used as suggested in this guide. See pages 104-115 for additional problem weeds and their control.

Herbicide	Timing	Annual Weeds						
		Crabgrass*	Foxtail**	Goosegrass**	Sandbur***	Prostrate Spurge**	Henbit**	Oxalis*
Acclaim Extra	POST	9	9	8	6	0	0	0
Barricade	PRE	9	9	8	—	9	9	9
Bensumec	PRE	7-8	6-7	8	—	—	—	—
Buctril	POST	0	0	0	0	8	9	8
Confront	POST	0	0	0	0	9	9	9
Cool Power	POST	0	0	0	0	7	9	9
Dimension	PRE	9	8	7	—	6	8	—
Dimension	POST	9	7	6	—	—	—	—
Drive	POST	9	7	6-7	9	—	9	9
Gallery	PRE	4	3	2	—	9	9	9
Horsepower	POST	0	0	0	0	7	9	9
Millenium Ultra	POST	0	0	0	0	8	9	9
MSMA	POST	7	6	5	6	0	0	0
Pendimethalin	PRE	9	9	9	8	9	9	8
Ronstar G	PRE	8	8	9	8	7	7	8
SpeedZone	POST	0	0	0	0	7	9	9
Spotlight	POST	0	0	0	0	0	7	7
Surge	POST	0	0	0	0	7	9	9
Trimec Classic	POST	0	0	0	0	7	9	9
Trimec Plus	POST	7	6	5	6	7	9	9
Tripower	POST	0	0	0	0	7	9	9
Triplet	POST	0	0	0	0	7	9	9
2,4-D amine	POST	0	0	0	0	8	6	7

Response Ratings: Ratings are for light to moderate weed densities, favorable conditions and weed growth stage as specified on product label. High weed densities, adverse conditions, mature weeds or thin turf will reduce control.

9 = 90-100% 6 = 60-70% 4 = 40-50% 2 = <30%
 8 = 80-90% 5 = 50-56% 3 = 30-40% 0 = 0
 7 = 70-80%

- * Apply PRE when soil temperatures in the spring are sustained at 55oF.
- ** Apply PRE when soil temperatures in the spring are sustained at 60oF.
- *** Apply PRE when soil temperatures in the spring are sustained at 65oF.
- + POST application at early growth stage for annual weeds and fall treatments for perennial weeds will result in better control.
- ++ Apply PRE in the fall.
- +++ POST activity is limited to 1-3 leaf annual grasses.
- Efficacy data not available.

Weed Response to Selected Turfgrass Herbicides (continued)

Perennial Weeds

Herbicide	Timing	Dandelion	Clover	Ground Ivy	Violet	Plantain	Nutsedge
Buctril	POST	8	8	6	6	7	0
Certainty	POST	8	—	6	—	—	9
Confront	POST	4-8	9	8	8	9	0
Cool Power	POST	9	7	8	7	9	0
Drive	POST	9	9	6	7	—	0
Horsepower	POST	9	7	8	8	9	0
Lontrel	POST	8	9	0	—	7	0
Millenium Ultra	POST	9	8	8	7	9	0
Manage	POST	0	0	0	0	0	9
MSMA	POST	0	0	0	0	0	6
PowerZone	POST	8	9	7	7	8	0
SpeedZone	POST	9	9	7	7	8	0
Spotlight	POST	8	9	8	—	8	0
Surge	POST	9	9	6	6	8	0
Trimec Classic	POST	9	9	6	6	8	0
Trimec Plus	POST	9	9	6	6	8	6
Tripower	POST	9	9	6	6	8	0
Triplet	POST	9	9	6	6	8	0
Turflon Ester	POST	8	9	8	8	7	0
2,4-D amine	POST	9	5	5	5	7	0

— Data on efficacy not available.

Response Ratings: Ratings are for light to moderate weed densities, favorable conditions and weed growth stage as specified on product label. High weed densities, adverse conditions, mature weeds or thin turf will reduce control.

9 = 90-100% 7 = 70-80% 5 = 50-56% 3 = 30-40% 0 = 0
 8 = 80-90% 6 = 60-70% 4 = 40-50% 2 = <30%

Commercial Turfgrass Herbicide Rates and Prices

Dry Products	Rate		Costs	
	oz/1000 sq ft	\$/pound	\$/1000 sq ft	\$/A
Barricade	0.28	39.00	0.68	29.73
Drive	0.38	86.00	2.04	88.97
Gallery	0.37	133.00	3.08	133.97
Manage	0.03	1150.70	2.16	93.99
Pendimethalin	1.15	9.25	0.66	28.96
Tupersan	3.00	18.05	3.38	147.92
Liquid Products	Rate		Costs	
Product	oz/1000 sq ft	\$/gal	\$/1000 sq ft	\$/A
Acclaim Extra	0.46	495.00	1.78	77.49
Bensumec	6.5	76.15	3.87	168.45
Buctril	0.37	60.75	0.18	7.65
Confront	0.56	120.00	0.52	22.67
Cool Power	1.00	45.90	0.36	15.52
Corsair	0.065	4992.00	2.54	110.42
Dimension	1.00	118.00	0.92	40.16
Finale	0.75	62.20	0.35	15.88
Horsepower	1.00	43.50	0.34	14.80
Lontrel	0.18	476.00	0.67	29.16
Millenium Ultra	0.90	47.60	0.36	14.58
MSMA	1.00	24.50	0.19	8.34
Pendimethalin	1.50	41.50	0.49	21.18
PowerZone	1.80	60.65	0.85	37.15
Prograss	3.00	117.00	2.74	119.45
Razor (glyphosate)	0.75	39.90	0.23	9.95
Reward	0.55	124.00	0.53	23.21
RoundUp Pro	0.75	49.90	0.29	12.74
SpeedZone	1.50	52.80	0.62	26.95
Spotlight	0.75	149.00	0.58	25.35
Surge	1.30	37.50	0.38	16.60
Surflan	2.25	88.75	1.56	67.96
Trimec Classic	1.25	28.50	0.28	12.12
Trimec Plus	3.00	37.40	0.88	38.18
Tripower	1.00	32.85	0.26	11.18
Triplet	1.00	22.90	0.18	7.79
Turflon Ester	0.75	109.00	0.64	27.82
2,4-D amine	0.92	13.95	0.10	4.37

Weed Response to Selected Alfalfa Herbicides

Response Ratings: Ratings are for light to moderate weed densities, favorable conditions and weed growth stage as specified on product label. High weed densities, adverse conditions, or large weeds will reduce control.

10 = 96-100% 6 = 70-79%
 9 = 90-95% 5 = 60-69%
 8 = 85-90% 4-2 = less than 60%
 7 = 80-84% 1 = 0

	Annual Bluegrass	Black Nightshade	Barnyardgrass	Common Sunflower	Dandelion	Downy brome	Field Pennycress	Yellow Foxtail	Henbit	Kochia	Kochia, Triazine-resistant	Lambsquarters	Perennial Bluegrass	Pigweed	R. Thistle	Sandbur	Shepherdspurse	Tall Waterhemp	Tansy Mustard	Velvetleaf	Crop Tolerance [□]
--	------------------	------------------	---------------	------------------	-----------	-------------	------------------	----------------	--------	--------	----------------------------	---------------	---------------------	---------	------------	---------	----------------	----------------	---------------	------------	-----------------------------

Preplant

Trifluralin-PPI	8	1	9	1	1	7	1	9	1	8	8	8	1	7	9	7	1	6	1	1	3
Eptam-PPI	7	7	6	3	2	9	2	9	4	7	7	6	1	5	4	8	2	6	2	2	3

Seedling

Buctril /Moxy 2E (seedling only)-POST	1	6	2	6	2	1	7	2	4	7	7	10	1	6	10	1	9	6	6	7	3
Butyrac 200-POST	1	6	2	6	2	1	5	2	4	6	5	6	1	3	5	1	5	7	5	6	2
Glyphosate [◆] (Roundup Ready [®] alfalfa only)	9	9	10	10	8	10	9	10	8	9	9	7	9	10	10	10	9	8	9	9	1
Poast-POST	5	1	9	1	1	7	1	8	1	1	1	1	5	1	1	8	1	1	1	1	1
Pursuit + Buctril-POST	1	8	5	8	2	2	9	5	7	9	9	7	1	9	8	4	8	8	9	8	3
Raptor + Buctril-POST	6	9	7	9	5	8	8	7	8	9	9	8	1	9	9	4	8	9	9	8	3
Raptor + Butyrac 200-POST	6	8	7	9	5	8	8	7	8	8	8	8	1	9	8	4	8	9	8	8	2
Select	8	1	9	1	1	9	1	8	1	1	1	1	7	1	1	8	1	1	1	1	1

Established

Glyphosate [◆] -POST (conventional)	4	1	1	1	4	8	5	1	7	4	4	1	4	1	4	1	5	1	8	1	3
Gramoxone Max-POST	4	4	5	8	2	8	4	6	6	6	6	8	1	8	6	5	4	5	4	4	4
Karmex DF-PRE	6	8	9	8	3	5	7	7	5	10	1	7	4	7	8	6	10	6	10	5	2
MCP amine 4-POST	1	7	1	7	5	1	8	7	5	5	5	7	1	7	6	1	8	7	8	6	3
Pursuit-POST	1	7	5	7	2	2	8	5	7	9	9	5	1	9	7	4	7	6	8	8	2
Raptor-POST	6	8	7	8	5	8	8	7	8	8	8	5	1	9	8	4	8	8	8	8	3
Select/Arrow-POST	8	1	9	1	1	9	1	8	1	1	1	1	7	1	1	8	1	1	1	1	1
Sencor-PRE	1	5	8	8	8	9	9	2	7	9	1	8	1	8	7	3	10	7	10	6	3
Sinbar-PRE	6	8	5	8	6	9	9	3	7	10	1	8	5	8	7	6	10	8	10	6	3
Treflan TR-10-PRE	7	4	8	1	1	6	3	8	1	7	7	7	1	7	7	7	4	7	5	2	1
Velpar DF-PRE	7	6	5	6	6	9	8	3	5	8	1	7	3	7	8	6	10	5	10	5	3

[□]Crop hybrids vary in their response to herbicides. Crop safety ratings less than 3 indicate that crop yield should not be affected by any direct injury.

[◆]Glyphosate is the active ingredient in many products. The rates provided on this page are based on a 4 lb ai or 3 lb ae formulation. See the glyphosate product comparison table on page 146-147 for the use rate and more information on the product being used.

Alfalfa

Area or Use	Herbicide	Commercial Product per Acre	Application Time	Remarks and Approximate Cost Per Acre Broadcast
To control alfalfa, see <i>Troublesome Weeds and Woody Plants</i>, page 113.				
ALFALFA (Establishing new stands)	EPTAM 7E	2.5-3.5 pt	Preplant Use higher rate on soils with more than 2% OM	Apply to dry surface soil and immediately incorporate by cross tandem disking or equivalent soil mixing. Use lower rate on sandy soil. Early legume injury may occur. Controls primarily annual grasses. Cost: Eptam \$11.75-\$16.45; Trifluralin \$2.44-\$3.66.
	TRIFLURALIN	1.0-1.5 pt		
ALFALFA (Seedling or established)	BUCTRIL/MOXY 2E	1.0-1.5 pt	Weeds less than 2" tall. Alfalfa at least 2 trifoliolate leaves	Apply when the majority of alfalfa has 4 trifoliolate leaves. Temperatures above 80oF following Buctril application may result in crop injury. Do not cut spring treated alfalfa for feed within 30 days following treatment. Cost: Buctril \$8.38-\$12.56; Buctril + Pursuit \$21.99.
	BUCTRIL 2E + PURSUIT DG	1.0 pt 1.08 oz		
	BUCTRIL 2E + RAPTOR	1.0 pt 4.0 oz	Weeds less than 2" tall. Alfalfa with at least 2 trifoliolate leaves.	
	BUCTYRAC 200 2E + RAPTOR	2.0 qt 4.0 oz	Weeds less than 2" tall. Alfalfa with at least 2 trifoliolate leaves.	
ALFALFA (Seedling or established)	BUTYRAC 200 2E	1.0-3.0 qt	POST. Weeds less than 3" tall; alfalfa 2-4 trifoliolate leaves	DO NOT use treated forage for 60 days after treatment on new stands and 30 days on established stands. Use when temperature is above 50°F. Cost: \$9.00-\$27.00.
	POAST 1.5E	1.0-2.0 pt	Grasses 4" or less	Good coverage necessary. Use higher rate for sandbur, volunteer cereals, or winter annual grasses. Poast will not control over-wintered downy brome. Add COC to spray solution. Do not graze or cut for forage for 7 days or 14 days before cutting for dry hay following Poast. Cost: Poast \$9.00-\$18.13; Poast Plus \$10.24-\$20.48.
	POAST PLUS 1E	1.5-3.0 pt	Grasses 6" or less	
ALFALFA Seedling or established for one year	GLYPHOSATE♦ (Roundup-tolerant variety required.)	32-64 oz	Weeds 2-3"	Not all glyphosates may be immediately labeled. On new seedings apply glyphosate twice—once at the first trifoliolate and again two weeks later. Check with seed supplier for availability of Roundup-tolerant alfalfa seed. Use higher glyphosate rate on larger weeds and perennial grasses. Cost: \$11.44-\$21.84.
	PURSUIT DG	1.08-2.16 oz	Seedling alfalfa 2nd trifoliolate stage	Do not feed, graze, or harvest alfalfa for 30 days following Pursuit treatment. Do not feed, graze, or harvest alfalfa for 20 days following Raptor treatment. Both Pursuit and Raptor require adding an adjuvant. Cost: Pursuit \$13.60-\$27.21; Raptor \$18.20-\$27.18.
RAPTOR	4-6 oz	Seedling alfalfa 2nd trifoliolate stage. Weeds less than 3"		
	SELECT 2EC/ARROW	6-8 oz	Grasses 2-6"	Controls downy brome, annual, and perennial bluegrass. Do not feed, graze, or harvest alfalfa for 15 days following applications. Cost: \$6.94-\$9.25.

♦Glyphosate is the active ingredient in many products. The rates provided on this page are based on a 4 lb ai or 3 lb ae formulation. See the glyphosate product comparison table on pages 146-147 for the use rate and more information on the product being used.

Alfalfa (continued)

Area or Use	Herbicide	Commercial Product per Acre	Application Time	Remarks and Approximate Cost Per Acre Broadcast
ALFALFA (Established one year or more. For dodder control see <i>Troublesome Weeds Section</i> , page 117)	GLYPHOSATE [◆]	8 to 12 oz	Apply in spring to alfalfa that is dormant	Glyphosate should not be applied after alfalfa has broken dormancy and initiated trifoliolate leaf expansion. Do not use additional surfactant or ammonium sulfate. Allow 45 days after application before harvesting. Check label for local recommendations. Cost: \$2.81-\$4.21.
	GRAMOXONE MAX	1.3-2.1 pt	Dormant alfalfa	For control of downy brome and winter annual weeds. Do not apply after alfalfa has broken dormancy. Do not cut or harvest for 42 days after application. Cost: \$7.47-\$12.07.
	KARMEX 80DF	1.5-3.0 lb	Late fall to early spring to dormant alfalfa	For control of winter and summer annual weeds. Cost: \$6.60-\$13.20.
	MCP AMINE (4L)	1 pt	Apply in fall to dormant alfalfa	Apply in late fall following frosts when alfalfa is dormant. The temperature at the time of spraying should be above 40°F. Cost: \$2.50.
	SENCOR DF	0.5-1.0 lb	Late fall to early spring to dormant alfalfa	For control of downy brome, winter annual weeds and suppression of dandelions. Do not cut or harvest for 28 days after application. Cost: Sinbar \$16.50-\$33.00; Sencor \$11.00-\$22.00.
	SINBAR (80W)	0.5-1.0 lb		
	TREFLAN TR-10	5-7.5 lb	During dormancy, fall or prior to cutting, prior to weed emergence	Rainfall or irrigation of 0.5 inch within three days will activate. If not activated, use mechanical incorporation. Cost: \$4.35-\$6.52.
	VELPAR DF	0.66-2.0 lb	Late fall to early spring to dormant alfalfa	The 0.66 lb/A rate of Velpar is for low O.M. soils for downy brome control. Cost: Velpar DF \$15.84-\$48.00; Velpar L \$16.00-\$48.00.
	VELPAR L	2.0-6.0 pt		

◆Glyphosate is the active ingredient in many products. The rates provided on this page are based on a 4 lb ai or 3 lb ae formulation. See the glyphosate product comparison table on pages 146-147 for the use rate and more information on the product being used.

Weed Response to Selected Range and Pasture Herbicides

Response Ratings

Ratings are for light to moderate weed densities, favorable conditions and weed growth stage as specified on product label. High weed densities, adverse conditions, or large weeds will reduce control.

10 — (96-100%) 6 — (70-79%)
 9 — (90-95%) 5 — (60-69%)
 8 — (85-90%) 4-2 — less than 60
 7 — (80-84%) 1 — 0

Weeds	Amber	Cimarron	Curtail	Dicamba [•]	Glyphosate [♦]	Grazono P+D	Milestone	Overdrive	Plateau	Spilke 20P	Tordon 22K	Transline/Stinger	2,4-D ester
Arkansas rose	- ^a	7	6	6	-	7	-	5	4	6	7	5	6
Broom snakeweed	5	8	5	5	-	9	-	5	-	-	9	5	5
Buckbrush/snowberry	-	7	8	6	-	7	-	8	3	7	6	2	8
Canada thistle	6	7	7	7	6	9	9	7	6	6	9	9	6
Common mullein	-	7	3	6	7	7	-	8	-	7	9	4	-
Cottonwood	-	-	7	9	-	8	-	5	3	9	9 ^a	4	9
Curled/pale dock	6	7	7	9	7	9	9	9	7	9	9	9	6
Dogwood	-	9	6	9	-	6	-	5	-	9	7	-	7
Downybrome/cheatgrass	6	-	-	5	9	-	-	4	8	7	-	-	-
Field bindweed	-	-	5	8	8	9	-	8	6	-	9	-	7
Flodman thistle	6	6	8	8	8	9	9	8	5	-	9	9	8
Fringed sagebrush	-	-	5	5	-	8	-	3	-	4	9	-	6
Gumweed	-	-	6	9	-	9	-	5	-	-	8	4	9
Hemp	-	-	7	8	5	8	-	5	-	-	9	4	9
Hemp dogbane	-	-	6	8	7	7	-	8	-	-	8	4	7
Hoary cress	-	-	5	7	5	6	-	5	7	-	6	-	6
Honey/black locust	-	-	5	8	-	9	-	5	-	9	9	4	6
Honeyvine milkweed	-	-	6	6	7	7	-	6	-	-	7	4	7
Horseweed/marestail	8	7	7	8	7	6	9	9	-	7	7	7	6
Houndstongue	6	-	3	-	5	7	-	-	7	-	4	-	3
Kochia	8	8	5	8	9	5	-	9	8	6	5	-	6
Leafy spurge	-	3	5	6	7	9	-	6	9	-	9	-	6
Lespedeza sericea	-	7	4	6	7	4	-	6	-	-	-	-	3
Locoweed	-	-	7	7	5	8	-	5	-	-	8	8	7
Lupine species	-	-	4	9	5	9	-	5	-	-	9	-	7
Marshelder	8	8	7	-	5	7	9	-	-	-	8	8	7
Multiflora rose	-	7	3	6	-	7	-	5	3	9	9	4	4
Musk/plumeless thistle	6	8	8	9	7	9	9	9	7	7	9	9	7
Osage orange	-	-	5	4	-	5	-	3	-	6	7	4	6
Oaks	-	-	5	8	-	7	-	3	-	9	6	4	6
Perennial sowthistle	-	5	6	7	5	7	9	8	-	7	7	7	7
Plains larkspur	-	-	5	5	5	9	-	4	-	-	8	4	7
Prickly pear	-	6	4	6	-	8	-	4	-	-	9	4	6
Rabbit brush	-	-	4	7	-	5	-	4	-	-	9	-	6
Red cedar	-	-	3	4	-	4	-	3	7	7	9	-	4
Russian knapweed	-	-	6	7	7	7	9	6	7	-	7	7	4
Russian olive	-	-	3	8	-	7	-	4	-	9	9	-	6
Sand sagebrush	-	5	6	5	-	7	-	4	-	6	4	-	9
Siberian elm	-	-	5	9	-	8	-	5	-	9	9	4	7
Smooth sumac	-	8	5	7	4	8	-	5	-	7	9	4	9
Soapweed/yucca	-	8	4	5	-	6	-	4	-	4	6	-	4
Sweetclover	-	-	7	9	5	6	-	9	-	9	9	8	9
Tall larkspur	-	-	3	7	5	9	-	4	-	-	9	4	4
Western ragweed	6	3	6	7	5	8	9	9	8	7	9	4	7
Western ironweed	-	-	5	8	5	8	9	5	-	6	9	4	6
Wild licorice	-	-	4	7	3	6	-	5	-	-	6	-	3
Wild plum	-	-	6	8	-	5	-	5	-	9	9	-	8
Willows	-	-	6	9	-	5	-	5	-	9	5	-	9
Woollyleaf bursage	-	-	7	8	6	8	-	5	-	-	9	9	7
Yarrow	-	7	4	7	4	8	9	7	-	-	-	-	4
Yellow toadflax	-	-	3	-	4	5	-	-	7	-	8	-	3

[•]Dicamba is the active ingredient in Banvel, Clarity, Sterling and several other herbicides. The rates and information provided here are based on the same 4 lb/gal acid equivalent formulation found in Banvel, Clarity and Sterling.

[♦]Glyphosate is the active ingredient in many products. The rates provided on this page are based on a 4 lb ai or 3 lb ae formulation. See the glyphosate product comparison table on pages 146-147 for the use rate and more information on the product being used.

^aIf control data was not available for the weed and herbicide, a dash (-) was placed in the response chart.

Pastures and Ranges

(See pages 113-127 for specific weed)

Area or Use	Herbicide	Commercial Product per Acre	Application Time	Remarks and Approximate Cost Per Acre Broadcast
New and established grasses	PLATEAU	New—2-4 oz Established—4-8 oz	Apply pre-emergence or early postemergence to grass plantings. For established grasses apply early postemergence when weeds are less than 4".	Plateau is currently marketed and sold only to approved government agencies. Postemergence applications of Plateau require a spray adjuvant. Use on big bluestem, little bluestem, indiangrass, switchgrass (mixes only), sideoats and blue grama, buffalograss and eastern gamagrass. Postemergence to established smooth brome grass, common bluegrass, and wheatgrasses. Cost: \$4.92-\$19.68.
GRASS SEEDLINGS (Cool and warm season grasses)	2,4-D ester (4L)	1.0 pt	Grass 5-leaf stage or beyond	For broadleaf weeds. After grasses are well established, increase rate to 1 qt. Cost: \$1.88.
SOD SEEDING (Legumes into grass)	GRAMOXONE MAX	0.8-1.5 pt	Before or immediately after legume seeding	Add NIS (0.25% v/v) per 100 gal spray solution. Suppresses established sod. Seed legumes with a sod seeder. If grass is less than 3", use lower rate. During year of establishment, graze intensively for short periods only. Add X-77 surfactant. Cost: \$4.45-\$8.34.
SOD SEEDING (Native grass planted no-till)	GLYPHOSATE♦	16-32 oz	Spring, on cool season grasses	Suppresses established sod. Seed grasses with a sod seeder. Do not graze seeded area until dormancy after second growing season. Apply in no more than 10 gallons water per acre and add 2 qt X-77 and 17 lb ammonium sulfate per 100 gallons. Cost: \$5.48-\$10.95.
ANNUAL OR BIENNIAL BROADLEAF WEEDS IN PASTURES AND RANGES (For specific weeds see pages 113-127.)	RAVE	2-5 oz	Rosette stage in fall or when weeds are small in spring	Withhold milk cows from grazing treated areas for 7 days. With Banvel/Clarity mixture do not harvest hay for dairy animals within 37 days. Do not use Banvel/Clarity within 1/2 mile of sensitive crops. Combination controls greater variety of weed species. Fuego covers 8-11 acres per container. Cost: 2,4-D \$3.75; 2,4-D + Dicamba \$8.50; Amber \$2.49-\$4.98; Cimarron \$2.30-\$23.00; Cimarron Max \$290.00; Curtail \$10.00-\$20.00; Escort \$4.32-\$8.64; Grazon \$8.25-\$16.50; Overdrive \$12.50-\$25.00; Surmount \$11.25-\$15.00; Tordon 22K \$6.25-\$25.00; Rave \$3.00-\$6.00; Redeem R&P \$18.75-\$25.00.
	2,4-D ester 4L	1.0 qt		
	2,4-D ester (4L) + DICAMBA•	0.5 pt		
	AMBER	0.28-0.56 oz		
	CIMARRON	0.1-1 oz		
	CIMARRON MAX or CIMARRON	see label for rates 0.2-0.3 oz		
	+ DICAMBA•	1-4 pt		
	+ 2,4-D AMINE (4L)	0.5-1 pt		
	CURTAIL	2-4 pt		
	ESCORT	0.2-0.4 oz		
	GRAZON P+D	2-4 pt		
	OVERDRIVE	4-8 oz		
	REDEEM R+P	1.5-2pt		
	SURMOUNT	1.5-2 pt		
	TORDON 22K	0.5-2 pt		
MILESTONE	3.0-7.0 oz	For control of broadleaf weeds in noncropland areas, rights-of-way and wildlife openings, including grazed areas, and rangeland and grass pastures. Milestone: It is permissible to treat non-irrigation ditch banks, seasonally dry wetlands (such as flood plains, deltas, marshes, swamps or bogs) and transitional areas between upland and lowland sites. Cost: Milestone \$7.00-\$17.00; Transline \$11.56-\$60.13.		
TRANSLINE	0.25-1.3 pt			

•Dicamba is the active ingredient in Banvel, Clarity, Sterling and several other herbicides. The rates and information provided here are based on the same 4 lb/gal acid equivalent formulation found in Banvel, Clarity and Sterling.

♦Glyphosate is the active ingredient in many products. The rates provided on this page are based on a 4 lb ai or 3 lb ae formulation. See the glyphosate product comparison table on pages 146-147 for the use rate and more information on the product being used.

Pastures and Ranges (continued)

(See pages 113-127 for specific weed)

Area or Use	Herbicide	Commercial Product per Acre	Application Time	Remarks and Approximate Cost Per Acre Broadcast
PERENNIAL BROADLEAF WEEDS IN PASTURE AND RANGES Includes: vervains, broom snakeweed, western ironweed, woolly loco, flodman thistle and wavy leaf thistle. (For other weeds see pages 113-127.)	2,4-D LV ester (4L)	1.5 qt	At bud stage of predominant weed. Oct. or April for dandelion and musk thistle	Annual treatment for 2-3 years may be necessary. Withhold milk cows from grazing for 7 days. With Banvel/Clarity mixture do not harvest hay for dairy animals for 37 days. Do not use Banvel/Clarity within 1/2 mile of sensitive crops. Overdrive used alone or in tank mix combination with Tordon or Transline. Cost: 2,4-D \$5.63; 2,4-D + dicamba \$13.25; Curtail \$20.00-\$30.00; Grazon \$12.38-\$24.75; Overdrive \$12.50-\$25.00; Surmount \$15.00-\$30.00; Tordon 22K \$25.00-\$50.00; Redeem R&P \$25.00-\$50.00.
	2,4-D LV ester (4L)	1.0 qt		
	+ DICAMBA [•]	1.0 pt		
	CURTAIL	4-6 pt		
	GRAZON P+D	3-6 pt		
	OVERDRIVE	4-8 oz		
	REDEEM R+P	2-4 pt		
	SURMOUNT	2-4 pt		
	TORDON 22K	1-2 qt		
	MILESTONE	3.0-7.0 oz		
TRANSLINE	0.25-1.3 oz			
WINTER ANNUAL GRASS CONTROL Includes downybrome	GLYPHOSATE [♦]	1.0 pt	Late fall and late winter prior to forage grass greenup	Controls downy brome. Do not use on grasses for seed production. Do not harvest or graze for 8 weeks. Cost: \$4.13.
	PLATEAU	4-6 oz	Fall PRE or early POST before grass is 2" tall	Currently marketed and sold only to approved government agencies. Add 1 qt MSO. Wait 7 days before hay harvest. Cost: \$9.84-\$14.76.
WOODY PLANT CONTROL	GRAZON P+D + REMEDY	1 gal + 1 qt		For woody plant control, can be used for individual plant or small stands. Use lower rate of Spike in areas receiving 20" or less average rainfall. Cost: Spike \$0.25-\$0.50/100 sq ft; Grazon P+D + Remedy \$58.00.
	SPIKE (20P)	0.37-0.75 oz per 100 sq ft		
	SURMOUNT	3-6 pt		
	PASTUREGARD	3-8 pt		
			Apply when plants are actively growing and after leaves are fully expanded. Add a nonionic surfactant. No grazing restrictions for non-lactating dairy animals or other livestock. Cost: Surmount \$22.50-\$45.00; Pasturegard \$18.00-\$48.00.	

[•]Dicamba is the active ingredient in Banvel, Clarity, Sterling and several other herbicides. The rates and information provided here are based on the same 4 lb/gal acid equivalent formulation found in Banvel, Clarity and Sterling.

[♦]Glyphosate is the active ingredient in many products. The rates provided on this page are based on a 4 lb ai or 3 lb ae formulation. See the glyphosate product comparison table on pages 146-147 for the use rate and more information on the product being used.

^³If control data was not available for the weed and herbicide, a dash (-) was placed in the response chart.

Grazing Restrictions for Range and Pasture Herbicides

Herbicides	Product per Acre	Lactating Dairy Animals		Beef and Non-Lactating Animals (Includes equines and nonlactating dairy)		
		Before Grazing	Before Hay Harvest	Before Grazing	Before Hay Harvest	Removal Before Slaughter
ALLY	0.10 to 0.30 oz	0	0	0	0	0
AMBER	0.28-0.56 oz	0	0	0	0	0
BRASH/ CLARITY/BANVEL/ STERLING/DICAMBA [•]	Up to 1 pt Up to 2 pt Up to 4 pt Up to 16 pt	7 days 21 days 40 days 60 days	37 days 51 days 70 days 90 days	0 0 0 0	0 0 0 0	30 days 30 days 30 days 30 days
CIMARRON	0.1-1.0 oz	0	0	0	0	0
CIMARRON MAX	See label	7 days	37 days	0	0	30 days
CROSSBOW 3S	1 to 6 qt	1 year	1 year	5 weeks ^d	1 year	3 days
CURTAIL	2.0 to 4.0 pt	14 days	30 days	0	30 days	7 days ^f
ESCORT	0.2-0.4 oz	0	0	0	0	0
GARLON 3A	0.5-1.5 gal/100 gal	1 year	1 year	14 days	14 days	3 days
GLYPHOSATE [♦]	(Check label. Restrictions vary by product and type of application.)					
GRAMOXONE MAX ^a	0.8 to 1.5 pt	1 month	1 month	1 month	1 month	0
GRAZON P+D ^b	3.0-4.0 pt	7 days	30 days	0	30 days	3 days
MILESTONE	3-7 oz	0	0	0	0	0
OVERDRIVE	4-8 oz	0	0	0	0	3 days
PASTUREGARD	1.5-2 pt	1 year	1 year	0	14 days	3 days
PLATEAU	4-12 oz	0	7	0	7	0
RAVE	2-5 oz	7 days	-	0	-	30 days
REDEEM R&P	1.5-4.0 pt	14 days	1 year	0	7 days	3 days
REMEDY	1-2 qt	14 days	1 year	0	7 days	3 days
SPIKE 20P	1/2 oz per 45 sq ft	0 days ^f	1 year ^e	0	1 year ^e	0 days ^e
STINGER 3E	0.66 to 1.31 pt	0	0	0	0	0
SURMOUNT	1.5-4 pt	14 days	7 days	0	7 days	3 days
TORDON 22K ^b	0.5 to 2.0 pt	14 days	14 days	0	14 days (if greater than 1qt/A)	3 days
TRANSLINE	0.25-1.3 pt	0	0	0	0	0
2,4-D/MCPA ^c	0.5 pt-1 qt	7-14 days	30 days	0-7 days	0-30 days	0
WEEDMASTER	1-4 pts	7 days	37 days	0	37 days	30 days

^aRestrictions based on the degree of new seedling establishment before grazing. Suggested at least 6 inches of grass or legume seedling growth which is approximately one month. Late fall seeding may require 3 to 5 months before the suggested 6-inch height is reached.

^bMove livestock to untreated grass pasture for 7 days before transferring livestock to broadleaf crop or pasture areas. Removal before slaughter statement only applies to animals grazing treated forage for 2 weeks immediately after application. If greater than 1 qt/A, only spot treatments are allowed; total acres cannot exceed 25% of landowner's areas in any particular watershed.

^cBe sure to check individual product labels for restrictions and use rates due to the large number of formulations available.

^dOne year if more than 1.5 gal/A rate used.

^eIf no more than 20 lb per acre used.

^fWithdrawal not needed if 2 weeks or more time elapsed since application.

[•]Dicamba is the active ingredient in Banvel, Clarity, Sterling and several other herbicides. The rates and information provided here are based on the same 4 lb/gal acid equivalent formulation found in Banvel, Clarity and Sterling.

[♦]Glyphosate is the active ingredient in many products. The rates provided on this page are based on a 4 lb ai or 3 lb ae formulation. See the glyphosate product comparison table on pages 146-147 for the use rate and more information on the product being used.

CRP Acres

PREPLANT OR PREEMERGENCE

Herbicide	Commercial Product per Acre	Application Time	Remarks and Approximate Cost Per Acre
ATRAZINE (NEB. STATE LABEL) (Confirm your atrazine product is labeled.)	2.2 lb	PPI or PRE	Use only on loam or finer textured soils containing 1% or more organic matter. For use on big bluestem, eastern gamagrass and switchgrass. Cost: \$5.06.
GLYPHOSATE [♦]	24-32 oz	Before or at grass seeding	Will control most emerged seedling grass and broadleaf weeds. Apply glyphosate at 10 GPA carrier or less and include surfactant at 0.5% v/v. Ammonium sulfate added at 17 lb per 100 gal solution to improve glyphosate performance. Cost: glyphosate \$2.52-\$3.36.
2,4-D AMINE (4L) or ESTER (4L)	1-2 pt	At least 30 days before grass seeding	Controls most broadleaf annual weeds. Both treatments may injure grass seedlings if applied less than 30 days before planting. Cost: 2,4-D \$1.50-\$3.00; Landmaster BW \$6.49-\$8.64.
LANDMASTER BW	54-72 oz		
PLATEAU	2-4 oz	At grass/wildflower seeding	For use in big bluestem, little bluestem, indiangrass, buffalograss, sideoats grama, blue grama, selected wildflowers and legumes. Cost: \$4.92-\$9.85.
PROWL (3.3EC)/PROWL H ₂ O	1.2-2.4 pt	PPI or PRE	For use on legumes only. Incorporate immediately for best results. Cost: Prowl \$3.60-\$7.20; Treflan/Trifluralin \$2.44-\$5.63.
TREFLAN/TRIFLURALIN	1-1.5 pt	PPI	

POSTEMERGENCE

For established grass, see *Pastures and Ranges*, page 103.
For specific weeds, see *Troublesome Weeds and Woody Plants*, pages 113-127.

AMBER	0.28-0.56 oz	After 3-4 leaf stage of grass	Controls most broadleaf weeds. Use Escort on selected perennial grasses. Do not use on soils with pH greater than 8.0. Do not use on grass/legume mixtures. Add surfactant at 0.25% v/v. Cost: Amber \$2.49-\$4.98; Ally \$2.54; Escort \$2.16-\$21.60.
ALLY/CIMARRON ¹	0.1 oz		
ESCORT2	0.1-1.0 oz		
DICAMBA [•] + 2,4-D ester (4L)	0.25-0.5 pt 0.5-1 pt	After 5-leaf stage of grass	Controls most broadleaf weeds. Use lower rates on warm-season grasses. Do not use on grass/legume mixtures. Established grasses may be treated with 0.5-1 pt Banvel/Clarity/Sterling + 0.5-2 pt 2,4-D for perennial weed control. Cost: \$3.32-\$6.63.
BUCTRIL	1.5-2 pt	After 3-leaf stage of grass	Controls many broadleaf weeds. Apply in minimum 10 GPA by air. May be used on grass/legume mixtures after third trifoliate leaf stage of alfalfa. May be tank mixed with 2,4-D or MCPA for improved control. Tank mix may injure or kill legumes. Cost: \$12.57-\$16.76.
CURTAIL	2-4 pt	Established grasses	Use only on grasses established one season or longer. Controls most broadleaf weeds including thistles. Do not use on grass/legume mixtures. Cost: \$10.00-\$20.00
GLYPHOSATE [♦]	12-16 oz	Late fall or late winter	Apply when perennial grasses are dormant. Do not use ammonium sulfate. Cost: \$1.26-\$1.68.
PLATEAU	4 oz	Spring	Plateau is currently marketed and sold by approved government agencies. Apply when annual broadleaf and grass weeds are less than 6" tall. Cost: \$9.84.
PURSUIT DG	1.44 oz	Legumes 3-trifoliolate Grasses 4-leaf	Use on alfalfa, clover, crown vetch, birdsfoot trefoil, lespedeza, smooth brome, reed canarygrass, orchardgrass, big bluestem, little bluestem, switchgrass, Russian wildrye, wheatgrasses (intermediate, crested, tall). Cost: \$18.14.
2,4-D AMINE (4L) or 2,4-D ESTER (4L)	1 pt 0.5 pt	After 5-leaf stage of grass	Controls most broadleaf weeds. Reduce rate 25% if used on warm-season grasses. Will injure or kill legumes. Cost: 2,4-D amine \$1.50; 2,4-D ester \$0.94.

¹Ally can be applied POST only at 0.1 oz/A to the following grasses: blackwell switchgrass; blue grama; big and little bluestem; buffalo grass; green sprangletop; Indian grass; kleingrass; atherstone, sand, weeping, and wilmarn lovegrass; orchard grass, Russian wild-rye, sideoats grama; and crested, intermediate, western, tall, bluebunch, pubescent, slender Siberian, streambank, and thickspike wheatgrass.

²Escort can be applied to crested wheatgrass and smooth brome at 0.25 to 1.0 oz/A and to fescue and bluegrass at 0.25 to 0.5 oz/A.

[♦]Glyphosate is the active ingredient in many products. The rates provided on this page are based on a 4 lb ai or 3 lb ae formulation. See the glyphosate product comparison table on pages 146-147 for the use rate and more information on the product being used.

[•]Dicamba is the active ingredient in Banvel, Clarity, Sterling and several other herbicides. The rates and information provided here are based on the same 4 lb/gal acid equivalent formulation found in Banvel, Clarity and Sterling.

Noxious Weeds

Statement from the Nebraska Department of Agriculture:

Noxious weeds compete with crops, rangeland, and pastures, reducing yields substantially. Some noxious weeds are directly poisonous or injurious to man, livestock, and wildlife. The losses resulting from noxious weed infestations can be staggering, costing residents millions of dollars due to lost production. The business of noxious weed control is everyone's concern, and their control is to everyone's benefit. The support of all individuals within the state is needed and vital for the control of noxious weeds within Nebraska.

It is the duty of each person who owns or controls land in Nebraska to effectively control noxious weeds on such land. County boards or control authorities are responsible for administration of noxious weed control laws at the county level. This system provides the citizens of Nebraska with local control. Each county is required to implement a coordinated noxious weed program. When landowners fail to control noxious weeds on their property, the county has the ability to serve an individual notice upon the owner of such land. This notice shall give specific instructions and methods on when and how certain noxious weeds are to be controlled.

The University of Nebraska Cooperative Extension in cooperation with the Nebraska Department of Agriculture has developed a series of publications on the biology, identification, distribution and control of the state's noxious weeds. See *Canada Thistle* (EC02-171); *Plumeless Thistle* (EC02-172); *Spotted and Diffuse Knapweed* (EC02-173); *Leafy Spurge* (EC02-174); *Purple Loosetrife* (EC02-176); and *Musk Thistle* (EC02-177).

Weed	Herbicide	Product Per Acre	Application Time	Remarks and Approximate Cost Per Acre Broadcast
CANADA THISTLE	Tordon 22K	1 qt	Fall—actively growing or spring—early flower bud	For noncrop areas and spot treatment in pasture and range. Tordon may remain in the soil for three or more years. Cost: \$23.18. See NebGuide G80-509, <i>Canada Thistle Control</i> .
	Tordon 22K + 2,4-D ester (4L)	1 pt 1 qt	Fall; spring during flower bud	Cost: \$15.17.
	Roundup UltraMax	1.75-2.5 qt	Flower bud stage or in fall when growing actively	Idle ground or spot treatment in cropland before head or pod fill of crop. Avoid tillage for three days. Cost: \$22.31-\$31.88.
	Dicamba [•]	1-2 qt	Fall—actively growing or spring early flower bud	Idle ground or grassland. Avoid tillage for five days. Injury to forage grasses may occur. Broadleaf crops may be injured for two years, after treatment. Cost: \$21.72-\$43.52.
	Curtail	2-4 pt	Rosette to pre-bud or in fall when actively growing	Curtail—Use lower rate in wheat and barley, higher rate in fallow, pasture, or CRP. Stinger used in sugarbeet and corn. Transline is labeled for rangeland and permanent grass pastures. Cost: Curtail \$9.00-\$17.40; Stinger \$19.00-\$82.35; Transline \$27.99-\$66.30.
	Stinger	0.3-1.3 pt		
	or Transline	0.67-1.3 pt		
	Ally + Surfactant (broadcast)	0.3 oz	4-6" or rosette stage Prebloom to bloom or in the fall when actively growing	Ally used at 1.0 oz per acre is for spot treatment only. Escort or Telar for use in non ag crop land only. Use Ally in wheat, barley, or fallow to be planted to winter wheat or pasture and rangeland. One application suppresses Canada thistle. Cost: Ally \$2.35; Escort \$22.60; Telar \$22.00-\$66.30.
	Telar + Surfactant or Escort + Surfactant	1.0-3.0 oz 1.0 oz		
	Ally + Surfactant	1.0 oz		
	Grazon P+D ²	4.0-6.0 pt		Cost: \$13.33-\$20.00.
	Milestone	5.0-7.0 oz	Fall; spring during flower bud	It is permissible to treat non-irrigation ditchbanks, seasonably dry wetlands (such as flood plains, deltas, marshes, swamps or bogs) and transitional areas between upland and lowland sites. Cost: \$12.00-\$17.00.
	Overdrive + Tordon	4 oz 8 oz	Fall/spring	Cost: \$17.75.

Control Strategies

Spring and Summer — Keep Canada thistle from going to seed by mowing once in June and again in July or treating with an inexpensive herbicide (2,4-D ester at 2 quarts/A).

Fall after first frost — An investment in an efficacious herbicide (Milestone, Stinger, or Tordon) in the fall can provide excellent control.

[♦]Glyphosate is the active ingredient in many products. The rates provided on this page are based on a 4 lb ai or 3 lb ae formulation. See the glyphosate product comparison table on pages 146-147 for the use rate and more information on the product being used.

[•]Dicamba is the active ingredient in Banvel, Clarity, Sterling and several other herbicides. The rates and information provided here are based on the same 4 lb/gal acid equivalent formulation found in Banvel, Clarity and Sterling.

Noxious Weeds (Continued)

Weed	Herbicide	Product Per Acre	Application Time	Remarks and Approximate Cost Per Acre Broadcast	
DIFFUSE AND SPOTTED KNAPWEED	2,4-D ester (4L)	1 qt	Rosette stage	Cost: \$3.58.	
	Curtail	2-3 qt	Last bud to early rosette	Cost: \$9.00-\$13.50.	
	Grazon P+D [◇]	3-4 pt		Cost: \$6.66-\$9.99.	
	Transline	0.66-1 pt	Mid-bolt to last bud stage	Cost: \$27.57-\$41.78.	
	Redeem R&P Tordon 22K	1.5 qt 1-2 pt	Rosette to bud stage	Cost: Redeem \$25.48; Tordon 22K \$11.58.	
	Milestone	5.0-7.0 oz	Rosette to bolting stage	For broadcast and spot treatment on non-cropland, rangeland, pastures, and CRP. Cost: \$12.00-\$17.00.	
LEAFY SPURGE	2,4-D ester (4L)	2 qt	Bud stage in spring	Retreatment necessary. Annual applications gradually reduce infestation. Cost: 2,4-D \$7.15; Grazon P+D \$14.80. See NebGuide G87-834, Leafy Spurge.	
	Grazon P+D	2 qt			
	Plateau	8-12 oz	In fall 2 weeks before first frost		Do not apply herbicide in spring over area treated the previous fall with 8-12 oz/A. Use with MSO 1 qt/A. Cost: \$17.20-\$25.80.
	Tordon 22K	2-4 pt	Fall or spring Sept. to early Oct.		Tordon for noncrop areas and spot treatment in pasture and range. Glyphosate for use in trees or areas where grass stand is not a factor. Cost: Tordon \$46.35-\$92.70; glyphosate + 2,4-D \$11.80; Overdrive + Tordon \$15.56-\$20.72.
	Glyphosate [◆] + 2,4-D amine (4L)	24 oz 1 qt			
	Overdrive + Tordon	4 oz 8-16 oz	Flowering stage		
MUSK AND PLUMELESS THISTLE	Ally	0.2-0.3 oz	Late fall or spring before bolting	Use in pastures, grasses for seed, fallow and CRP. Curtail may be used in wheat. Cost: Ally \$4.70-\$7.05; Curtail \$9.70.	
	Curtail	2 pt			
	Escort	1 oz	Bolted plants in spring prior to flowering	Use in noncropland and roadsides. Add surfactant at 1 pint/100 gal. Cost: \$22.60.	
	Milestone	3.0-5.0 oz	Rosette through bolting or in the fall	For broadcast and spot treatment on non-cropland, rangeland, pasture, and CRP. Cost: \$12.00-\$17.00.	
	2,4-D ester (4L)	1.5-2 qt	Late fall treatment of rosettes or in spring before flowering stalks lengthen Oct. 1-Dec. 1	Annual treatments necessary for control of new seedlings. Fall applications after trees drop leaves and before leafing out in the spring reduces damage. Do not apply after soil freeze-up in the fall. For use on ranges and permanent pastures only. Cost: 2,4-D \$5.37-\$7.16; 2,4-D + dicamba \$9.02; Grazon P+D \$7.40-\$14.80; Tordon \$5.16-\$8.64; Transline \$13.79-\$41.78; Redeem R&P \$8.34-\$16.68; Overdrive \$5.20-\$10.40.	
	2,4-D ester (4L) + Dicamba [●]	1 qt 0.5 pt			
	Tordon 22K	8-12 oz			
	Grazon P+D	2-4 pt	Rosette to early bolt growth stage		
	Transline	0.33-1 pt			
	Redeem R&P	1.5-2.0 pt			
Overdrive	2-4 oz	Rosette in spring or fall			

[◇]Before use, confirm that generic glyphosates are approved for aquatic use and do not contain a surfactant. The rate listed is based on 3 lb ae aquatic glyphosate.

[◇]See manufacturer's label for application time.

[◆]Glyphosate is the active ingredient in many products. The rates provided on this page are based on a 4 lb ai or 3 lb ae formulation. See the glyphosate product comparison table on pages 146-147 for the use rate and more information on the product being used.

[●]Dicamba is the active ingredient in Banvel, Clarity, Sterling and several other herbicides. The rates and information provided here are based on the same 4 lb/gal acid equivalent formulation found in Banvel, Clarity and Sterling.

Noxious Weeds (Continued)

Weed	Herbicide	Product Per Acre	Application Time	Remarks and Approximate Cost Per Acre Broadcast	
PURPLE LOOSESTRIFE (Lythrum)					
Aquatic habitat (12 months under water)	2,4-D amine	5 pt/20 gal	Plants with active growth in bloom or later	Confirm that your brand of 2,4-D is labeled for aquatic uses. Do not use Roundup or other non-aquatic glyphosate products in aquatic habitat. Cost: 2,4-D-based products \$4.00-\$10.00; glyphosate-based products for aquatic use \$50.00-\$90.00.	
	2,4-D LV 4 ester	2-2.5 pt/5-15 gal			
	Weedar 64	2-4 qt/100 gal			
	Aquatic glyphosate [◆]	4-6 pt			
	Habitat	1-3 pt			Cost: \$33.00-\$99.00.
PURPLE LOOSESTRIFE (Lythrum) (continued)					
Intermittently wet or ponded areas or terrestrial noncropland	Garlon 3A	3-5 pt	Plants with active growth in bloom or later	Watch for desirable species. Garlon, 2,4-D, and Escort have some safety on many grassy species and cattails at the listed rates; however, they will injure or kill many broadleaf species. Cost: 2,4-D-based products \$4.00-\$10.00; glyphosate-based products for aquatic use \$60.00-\$100.00; Garlon 3A \$25.00-\$45.00; Escort \$20.00-\$40.00.	
	Garlon 3A + 2,4-D amine	3 pt 2.5 pt			
	Escort	2-4 oz			
	Escort + 2,4-D amine	1 oz 2.5 pt			
	Habitat (spot treat)	1-2 qt/100 gal			Add 1 qt NIS/100 gal. Spray foliage to wet, but not to runoff. Cost \$265.00/gal.
	Habitat (broadcast)	1-3 pts			Higher rates of Habitat are nonselective and will result in total vegetation control. Do not apply more than 6 pts/year. Cost: \$33.00-\$99.00.
	Krenite S	3-5 gals			Do not graze treated acres for 1 year. Do not apply more than 6 gal/year. Cost: \$165.00-\$275.00.
SALT CEDAR					
	Garlon 3A	5 pt	Late summer or early fall	Do not apply near irrigation ditches or water for domestic use. Do not disturb areas after they have been sprayed with Habitat. As of January 1, 2005 the director of the Nebraska Department of Agriculture has declared salt cedar to be a Noxious Weed in Nebraska. This is a temporary action until a public hearing can be held to determine whether a permanent Noxious Weed classification is appropriate. Cost: Garlon 3A \$48.56; Habitat \$113.25; Habitat + glyphosate \$81.75; Habitat \$265.00/gal; Plateau \$20.00-\$30.00/A.	
	Habitat	4 pt (broadcast)			
	Habitat	1% (spot spray)			
	Habitat ¹ + glyphosate [◆]	2 pt 1 qt			
	Garlon 4/Remedy	33% (spot spray)	Basal treatment. Apply directly to 18" length of lower trunk or fresh cut stump (page 112).		
	Plateau	8-12 oz	Broadcast on trees up to 3 feet tall		

¹This tank mix is not supported by BASF.

[◆]Glyphosate is the active ingredient in many products. The rates provided on this page are based on a 4 lb ai or 3 lb ae formulation. See the glyphosate product comparison table on pages 146-147 for the use rate and more information on the product being used.

Trees and Shrubs Including Shelterbelts, Christmas and Fruit Trees*

Herbicide	Rate Per Acre	Application Time	Remarks and Approximate Cost Per Acre Broadcast
CASORON 4G*	100 lb	PRE on trees at least 2 years old	Apply a 20" band on each side of tree row after trees are planted. Some injury to trees may result on low organic matter soil. Cost: \$220.00/A.
GLYPHOSATE♦	1-4 qt in 10 gal water/A	Directed post-emergence	Do not spray green bark or foliage. Spray may contact brown bark. Use lower rate on annuals. Cost: \$6.00-\$24.00.
GOAL	2-4 qt	Pre- or Post-emergence to weeds	Conifers only. Grasses should be treated before they are beyond 2-leaf stage. Use before bud break or after new growth hardens. Cost: \$50.00-\$100.00.
GRAMOXONE MAX*	1.3-2.5 pt	Directed post-emergence	Nonselective contact herbicide. Keep spray off tree foliage. Add surfactant. Cost: \$7.00-\$14.66.
KARMEX 80W*	2.5-5 lb	PRE on trees at least 2 years old	Karmex use limited to conifers, honey locust, green ash, apples, and pears. Cost: \$12.00-\$24.00.
POAST*	2 pt	POST before grasses tiller	Use on fruit trees limited to nonbearing trees. Add 1 qt crop oil concentrate per acre. Thorough coverage required. Cost: \$21.00.
PRINCEP CALIBER 90/ SIMIZINE 90*	2.2-4.4 lb	PRE on trees at least 2 years old	Fruit trees and many conifers. Cost: \$10.25-\$18.50.
SOLICAM 80WP*	2.5-5.0 lb	PRE, late fall or early spring	Fruit trees only. May be combined with Karmex and Princep for improved broadleaf control. Cost: \$36.10-\$72.80.
SURFLAN A.S.*	2-4 qt	PRE	Fruit trees only. May be combined with Karmex and Princep for improved broadleaf control. Cost: \$50.50-\$101.00.
2,4-D AMINE (4L)	1 qt	POST to weeds	Keep off new bark and foliage. Controls broadleaf weeds. Cost: \$3.00.

♦Glyphosate is the active ingredient in many products. The rates provided on this page are based on a 4 lb ai or 3 lb ae formulation. See the glyphosate product comparison table on pages 146-147 for the use rate and more information on the product being used.

*Denotes products registered for use on fruit trees.

Aquatic Weed Control Slow Moving and Still Water

Important: Before treating any body of water containing fish, contact the Nebraska Game and Parks Commission local representative. When possible, treat before aquatic weed growth becomes dense to avoid fish suffocation due to oxygen depletion from decaying vegetation. When dense weed growth is present in fish-containing waters, treat no more than half of the area. After vegetation in the treated area disappears, treat the remaining water.

Herbicide	Rate Per AF (Acre Foot) or SA (Surface Acre)	Weeds Controlled	Application Time	Remarks and Approximate Cost
AQUATIC GLYPHOSATE ¹	1 gal/SA	Most annual and perennial weeds	Apply to well emerged vegetation	NIS can be applied to most water situations. No restrictions on use of water for irrigation, recreation, and domestic purposes. Cost/SA: \$61.00.
COPPER SULFATE CRYSTALS	0.7-5.3 lb/AF	Algae (Moss) Chara	When growth first becomes visible	No restrictions on water usage at recommended rates except for use with sheep . Copper compounds can be corrosive to equipment. Use chelated copper in high pH water. Cost/SA: copper sulfate \$3.90.
COPPER CHELATES (Cutrine plus, Alge Pro)	0.67-1.25 gal/AF			
AQUATHOL G or AQUATHOL K	13-135 lb/AF 0.3-3.2 gal/AF	Burreed Coontail Milfoil Pondweed Naiad	Water has warmed and growth is visible	Handle with caution, extremely irritating. Overdose can be harmful to fish. Do not use water within 14 days for irrigation or domestic uses. Cost/AF: \$20.75-\$221.00.

¹Before use, confirm that generic glyphosates are approved for aquatic use and do not contain a surfactant. The rate listed is based on 3 lb ae aquatic glyphosate.

Aquatic Weed Control Slow Moving and Still Water (continued)

Herbicide	Rate Per AF (Acre Foot) or SA (Surface Acre)	Weeds Controlled	Application Time	Remarks and Approximate Cost
AVAST SRP	2.5-5.0 lb/AF	Coontail Milfoil Pondweed Duckweed Naiad	Before active growth	Do not use water for human consumption or irrigation. Cost: Consult dealer.
2,4-D AMINE or ESTER (4L) or 2,4-D 20G	1.50-4 qt/SA 7.50-20 lb/SA	Water Hyacinth Water Lily Water Primrose Duckweed Arrowhead Pondweed Milfoil	Use sprays on emerged weeds when in full leaf stage. Apply granules when first growth appears	Do not use water for 14 days for livestock or irrigation. Cost: \$4.50-\$12.00.
GARLON 3A	0.25-3.0 gal/SA	For control of woody plants, broadleaf weeds and vines in and around aquatic sites	When vegetation is fully emerged and actively growing	Cost: \$19.00-\$220.00.
HABITAT	1-6 pt	Emerged and shoreline aquatic weeds	Actively growing	Follow irrigation water restrictions. Not effective on submerged weeds. Cost: \$33.00-\$199.00.
RENOVATE 3	2-8 qt/SA	Emersed, submersed and floating aquatic broadleaf plants	When growth becomes visible	Cost/SA: \$60.00-\$240.00.
REWARD	1-2 gal/SA	Arrowhead Cattail Bulrush Elodea Pondweed	Post on foliage or on surface for submerged species	Do not use for 10 days for swimming, livestock or irrigation. Not effective in water with suspended silt. Cost: \$110.00-\$220.00.

Moss or Algae in Stock, Nurse, Spray and Other Water Tanks

Dissolve 1 oz copper sulfate in 1 pt of water in a glass jar. Add 7.5 tablespoons of the prepared solution to each 1,000 gallons of water. Mix thoroughly. Water can be used for crop spraying and livestock watering **except NOT for sheep**. Increase rate if water is extra hard. An alternative practice is to paint the tank black to prevent algae growth.

Noncrop Acres

Area or Use	Herbicide	Commercial Product	Application Time	Remarks and Approximate Cost Per Acre Broadcast	
ROADSIDES (Broadleaf weed control)	2,4-D (4L)	1 qt/A	Broadleaf weeds 2-6"	Repeat treatments may be necessary. Do not use near susceptible plants/trees. Cost: 2,4-D \$3.00; 2,4-D + Banvel/Clarity \$15.10; Fuego \$285.00/case.	
	2,4-D (4L) + DICAMBA [•]	1 qt/A			
	FUEGO	8-12 A/container	2-6"		
	GARLON 4	1.0-8.0 qt	Broadleaf weeds 2-6"		Cost: \$25.00-\$200.00.
	MILESTONE	3-7 fl oz	Broadleaf weeds 2-12"		For broadcast and spot treatment. Cost: \$7.00-\$17.00.
	OVERDRIVE	4-8 oz	Broadleaf weeds 2-6"		Cost: \$10.20-\$20.80.
	PLATEAU (tall fescue, smooth brome, Kentucky bluegrass)	4-12 oz	Dormant (fall) or growing season (spring-early summer)		Plateau is currently marketed and sold only to approved government agencies. Applications made in growing season may cause yellowing, especially at higher rates. Use with 1 qt/A MSO. Cost: \$11.20-\$30.00.
	REDEEM R&P	1.5-4.0 pt	Broadleaf weeds 2-6"		Cost: \$18.75-\$50.00.
	TELAR	0.25-0.5 oz/A	Weeds 0-2"		Use with surfactant 1 qt/100 gal. Cost: \$6.60-\$12.55.
	TORDON 101 MIXTURE	0.5-2.0 gal	Broadleaf weeds 2-6"		Cost: \$20.00-\$76.00.
	TRANSLINE	0.25-1.33 pt	Broadleaf weeds 2-6"		Cost: \$11.25-\$59.85.
	VISTA	0.67-1.3 pt	Broadleaf weeds 2-6"		Cost: \$7.30-\$14.70.
GRASS SUPPRESSION	OUST	1 oz/A	Grass 6-12"	Do not apply to bare soil. May move if soil moves. Suppresses height and heading of bromegrass and other cool season grasses. Do not use year after year in order to avoid development of resistant weeds. Trace amounts can harm crops and gardens. Imperative that label directions are read and followed. Cost: \$8.75-\$17.50.	
	PLATEAU (tall fescue, smooth brome, Kentucky bluegrass)	4-8 oz	Dormant (fall) or growing season (spring-early summer)	Plateau is currently marketed and sold only to approved government agencies. Applications made in growing season may cause yellowing, especially at higher rates. Use with 1 qt/A MSO. Cost: \$11.20-\$30.00.	
IRRIGATION DITCHBANKS	KARMEX 80W	5-10 lb/A	Soon after ditches are open. Treat before weeds appear or soon after	Use enough water to insure good coverage. Use 50 mesh or coarser screens. May injure nearby trees and shrubs. Cost: Karmex \$21.00-\$42.00; 2,4-D \$3.56.	
	2,4-D LV ester (4L)	1 qt/A	Broadleaf weeds 2-6"		
	RODEO + X-77	4 qt in 10 gal or less water/A	POST when good growth is present	Nonselective. No residual control. Use the lower rate on annual weeds and perennial grasses, the higher rates on perennial broadleaf weeds. Add X-77 at 1/2% v/v. Cost: \$51.30.	
PERENNIAL GRASSES (including smooth brome and quackgrass)	GLYPHOSATE [♦]	64 oz/A in 10 gal or less water/A	Full foliage or fall	Perennial grasses should have good top growth. Retreatment may be required. Cost: \$7.00.	

[♦]Glyphosate is the active ingredient in many products. The rates provided on this page are based on a 4 lb ai or 3 lb ae formulation. See the glyphosate product comparison table on pages 146-147 for the use rate and more information on the product being used.

[•]Dicamba is the active ingredient in Banvel, Clarity, Sterling and several other herbicides. The rates and information provided here are based on the same 4 lb/gal acid equivalent formulation found in Banvel, Clarity and Sterling.

Noncrop Acres (continued)

Area or Use	Herbicide	Commercial Product	Application Time	Remarks and Approximate Cost Per Acre Broadcast
PERENNIAL BROADLEAF WEEDS	MILESTONE	4-7 oz	Broadleaf weeds 2-12"	For broadcast and spot treatments. Cost: \$9.00-\$17.00.
	OVERDRIVE	4-8 oz	Full folilage	Cost: \$10.20-\$20.80.
	OVERDRIVE + TORDON	4 oz 8 oz	Full foliage	Cost: \$15.56.
	TRANSLINE	0.3-0.6 pt	Full foliage	For non-cropland use, can be used in wildlife openings including grazed areas on these sites. Provides control of knapweeds, Canada and musk thistle. Cost: \$13.50-\$27.00.
	TORDON 22K	0.5-4.0 pt	2 to full foliage	Cost: \$6.00-\$48.00.
	REDEEM R&P	1.5-4.0 pt	2 to full foliage	Cost: \$18.75-\$50.00.
	TORDON 101 MIXTURE	0.5-2.0 gal	2 to full foliage	Cost: \$19.00-\$76.00.

Total Vegetation Control (TVC)

If you have areas around a building or a parking lot where you always battle weeds, you know it can be frustrating, time consuming, and costly to constantly mow or trim areas where vegetation is not desired in the first place. Nonselective herbicides are available to prevent vegetation from growing on a particular site. This type of weed management is referred to as total vegetation control or sometimes "bareground" since it leaves the ground without vegetative cover. Total vegetation control herbicides allow for the control of undesirable vegetation in many commercial and agricultural settings (see examples below).

Agricultural	Commercial
Buildings	Driveways and parking areas
Fence lines	Cemeteries
Driveways	Fence lines
Equipment parking areas	Fuel storage
Waste lagoons	Outbuildings
Grain storage bins	Vacant lots

Herbicides used in total vegetation control can be broken down into two groups, long-term control and short-term control. Long-term control herbicides will have a strong residual allowing for control of vegetation for many months if not years depending on use rate. Do not use long-term control herbicides near root zones and other desirable plants as the herbicides may come in contact with those plants and trees and cause injury or loss of the entire plant or tree.

Herbicides with short-term vegetation control are useful for controlling all the vegetation in an area but not limiting future use of the site with residual. The residual for these herbicides may be as short as 7 days.

It is also important to be aware of herbicide-resistant weed such as ALS-resistant kochia . Consult labels for specific instructions on controlling problem weeds and conditions. You also may refer to the *Troublesome Weeds* section (pages 113-127) for other suggestions for control of these weeds.

Finally, do not use total vegetation control on land subject to erosion unless there is a plan to control erosion.

Long-Term Total Vegetation Control	Herbicide	Commercial Product	Application Time	Remarks and Approximate Cost Per Acre Broadcast
	Arsenal	1 oz /1000 ft2	Treat before weeds appear or soon after	Cost: \$2.35/1000 ft2.
	Hyvar X-L	0.75 pt/1000 ft	Treat before weeds appear	Cost: \$6.00/1000 ft2.
	Krovar I DF	10 oz/1000 ft2 6-16 lbs/A depending on weed	Treat before weeds appear	Do not use around homes, walks, driveways, recreational areas or allow cattle to graze. Cost: \$5.70/1000 ft2.
	Karmex DF/ Karmex IWC	5-15 lbs/A depending on weed	Treat before weeds appear	Cost: TBA
	Sahara	0.2 – 0.4 lb/1000 ft2 7-19 lbs/A	Actively growing weeds are preferred but it can be applied before weeds emerge	Use 1.0 % V/V methylated seed oil (MSO) for postemergence applications. Do not use near irrigation water. Can be used under pavement on only industrial sites. Do not use around homes, walks, driveways or recreational areas where desirable vegetation may come in contact with the herbicide. Cost: \$2.20-\$ 2.40/1000 ft2.
	Spike 20P	2.5-20lb/A	Treat before weeds appear or soon after	Not for residential use. Primarily for control of woody plants. Do not apply in areas with a water table less than 10 ft. Cost: \$27.50-\$220.00/A.
	Spike 80 DF	1.25-5.0 lb/A	Treat before weeds appear or soon after	Not for residential use. Primarily for control of woody plants. Do not apply in areas with a water table less than 10 ft. Cost: \$18.75-\$150.00/A.

Noncrop Acres (continued)

Area or Use	Herbicide	Commercial Product	Application Time	Remarks and Approximate Cost Per Acre Broadcast
SHORT-TERM TOTAL VEGETATION CONTROL	GLYPHOSATE♦	24-64 oz/A 1-3% spot treatment	Broadleaves less than 10"; grasses less than 24"	Add 2% v/v spray grade ammonium sulfate (AMS). Has no soil residual. Do not use around water. Cost: \$7.00-\$14.00/A.
	REGLONE/ REWARD L&A	1-2 pt/A 1-2 qt/100 gal spot treatment	Treat after weeds have emerged	Use 0.25% v/v NIS. Ensure good coverage. Cost: \$13.00-\$26.00/A.
	GRAMOXONE MAX	1.7-2.7 pts/A	Treat after weeds have emerged	Add 0.25% v/v NIS or 1% Crop Oil Concentrate (COC). Do not use around home gardens, schools, recreational parks, or playgrounds. Cost: \$8.00-\$15.00/A.

Description of Individual Plant Treatment Techniques

Individual plant treatment can be an efficient, cost-effective alternative to broadcast applications to control brush, shrubs, or vines. Individual plant treatments include spot-applied concentrate, high volume foliar, low volume basal, and cut-stump applications.

Spot-applied concentrate: Soil-applied spot applications of certain undiluted herbicides can be used to control brush species including eastern redcedar and other junipers. Apply undiluted herbicide with a spot gun, which automatically pre-measures the amount of herbicide. Apply to the soil inside the dripline in a ring around the plant.

High volume foliar: The high-volume foliar technique is ideal for small trees, vines, bushes with canes or stems, such as multiflora rose, or low-growing shrubs like buckbrush. Apply diluted herbicide directly and uniformly to the plant foliage. The treated plant should have healthy foliage. Insects, hail, freezing temperatures, drought or other conditions that damage foliage may reduce control. For best results, spray after full leaf expansion when the plants are actively growing.

Low volume basal: This method uses a high percentage of herbicide, so less spray volume is needed than other forms of basal application. Generally, the mix ratios are 20-30% herbicide plus 70-80% diesel fuel or vegetable-based oils. Use low-volume basal applications to control woody species with trunks less than 6 inches in diameter at the base of the tree. Apply enough of the spray to wet the lower 15 to 20 inches of the trunk, including the root collar area, but not to the point of runoff. Use this method any time of the year, except when snow or water prevents spraying to the groundline.

Cut-stump: Apply a solution of herbicide similar to that used for low volume basal treatments to a freshly cut stump. Spray the sides of the stump and the outer portion of the cut surface, including the cambium ring along the inner bark. Thoroughly wet the stem and root collar area, but not to the point of runoff. Treat stumps any time of the year, as long as snow or water doesn't prevent proper application.

Cut Stump Treatments—Trees and Woody Plants

Herbicide	Herbicide Concentration	Remarks and Cost
2,4-D ESTER (4L)	2 qt/10 gal diesel	Use to prevent resprouting of cut stumps. Apply to runoff to freshly cut surface. Delayed applications less effective. Injury to nearby trees may result from Tordon. Cost/10 gal of solution: 2,4-D ester \$3.60+ diesel.
GLYPHOSATE♦	Do not dilute more than 2 parts water to 1 part product + Garlon 4 — check local prices.	
GARLON 4/ REMEDY	20-30% with basal bark oil or diesel fuel	Basal bark application — use with bark-penetrating basal or diesel fuel. Apply enough spray to set the lower 15 to 20 inches of the trunk, including the root collar; do not spray to the point of runoff. Cut stump application — Spray sides of stump and the outer portion of the cut surface, including the cambium ring along the inner bark; thoroughly wet the stem and root collar but not the point of runoff; treat any time of year, as long as snow or water doesn't prevent proper application. Basal bark application — Apply enough spray to wet the lower 15 to 20 inches of the trunk, including the root collar; do not spray to the point of runoff. Cost: Remedy \$97.00/gal.
PATHFINDER II	Do not dilute	Cut stump application — Spray sides of the stump and the outer portion of the cut surface, including the cambium ring along the inner bark; thoroughly wet the stem and root collar but not to the point of runoff; treat any time of year, as long as snow or water doesn't prevent proper application. Cost: \$39.00/gal.
STALKER + GARLON 4	3.5% 15-20% with basal bark oil or diesel fuel	Use for basal bark applications with bark-penetrating basal oil or diesel fuel. Cost: Stalker \$330.00/gal.
TORDON RTU	Do not dilute	Cut stump application — Spray sides of stump and the outer portion of the cut surface, including the cambium ring along the inner bark; thoroughly wet the stem and root collar but not to the point of runoff; treat any time of year, as long as snow or water doesn't prevent proper application; treat immediately after tree is cut. Cost: \$8.90/qt.

♦Glyphosate is the active ingredient in many products. The rates provided on this page are based on a 4 lb ai or 3 lb ae formulation. See the glyphosate product comparison table on pages 146-147 for the use rate and more information on the product being used.

Troublesome Weeds and Woody Plants

(See pages 36-38 for additives)

Best control will be obtained if treatments are made when plants are actively growing. Treatment in following years may be required. An application just before flowering and a second application on fall regrowth will give best results on most perennials. Dust on leaves may interfere with herbicide activity. When the crop is not indicated, the treatment is for a weed growing in noncropland, pastures or rangeland. Always consult the label for latest information and directions.

This year control measures have been included for weeds that the Nebraska Department of Agriculture (NDA) has placed on its Watch List. These weeds are increasing in Nebraska and are being monitored by the Nebraska Department of Agriculture. The list is current as of Dec. 31, 2005; however, it is subject to change. These weeds are denoted by ✕

Weed	Herbicide	Product Per Acre	Application Time	Remarks and Approximate Cost per Acre Broadcast
ALFALFA (for control before planting wheat, soybean, dry edible bean, and potato)	2,4-D ester (4L)	1.5 qt	Alfalfa with 4-6" new growth; fall application best	Delay planting 30 days after application. Ester formulations are less persistent than amine formulations. Cost: \$5.55.
ALFALFA (for control before planting corn, wheat or sorghum)	2,4-D ester 4L + Dicamba [•]	1 qt + 0.5 pt	Alfalfa with 4-6" new growth in fall or spring; fall application best	Delay planting corn 10 days and delay sorghum 15 days. Best time to kill alfalfa is in the fall. Cost: \$10.04.
ALFALFA (For control of alfalfa in corn or sorghum)	2,4-D amine (4L) + Dicamba [•] (corn only)	0.25 pt + 0.5 pt	Alfalfa with 4-6" growth	Use drop tips on crop taller than 8". See no-till section of corn, sorghum or soybean to kill alfalfa prior to planting. Sorghum at 3-5 leaf stage. Cost: 2,4-D + Banvel/Clarity \$6.72; Dicamba \$6.34; Hornet \$10.67.
	Dicamba [•]	0.5 pt		
	Hornet WDG	3 oz		
ARTICHOKE JERUSALEM	2,4-D amine (4L) + Dicamba [•]	0.5 pt + 0.5 pt	12-18" tall	For use in corn. Use drop tips on corn taller than 8". Cost: \$7.10.
	Classic	0.75 oz	2-8" tall	For use in soybean. Cost: \$9.45.
	Exceed	1 oz	1-6" tall	For use in corn. Cost: \$12.10.
	Curtail 2,4-D ester (4L)	2 pt 1 qt	12-18" tall 18-24" tall	For use where no crop is present. Cost: 2,4-D \$4.48; Curtail \$20.00.
BEDSTRAW (annual) (in corn)	Dicamba [•]	0.50-1 pt	POST on corn less than 9"	Use lower rate on coarse-textured soils. Cost: \$6.34-\$12.68.
	Aim or with Atrazine	0.5 oz 0.75-1 lb	POST on corn less than 12"	Apply at 10 gpa or more. Cost: \$5.23-\$5.80.
BLUE MUSTARD	2,4-D ester (4L) 2,4-D amine (4L)	0.5 pt 1 pt	Nov. 15-Mar. 15 before blue mustard stem elongation	Use only on fully tillered wheat. Cost: \$0.89-\$1.52. See NebGuide G74-92, Blue Mustard Control.
	Amber or Cimarron or Finesse or Peak	0.1 oz 0.28 oz 0.2 oz 0.38-0.5 oz	Mar. 1-15 before blue mustard stem elongation; in spring, broadleaf weeds 2-4"	Add surfactant. Use only on wheat with four or more tillers. Use only on continuous wheat or wheat-fallow. Do not use on soils with pH of 7.9 or higher. Cost: Amber + 2,4-D \$3.36; Cimarron + 2,4-D \$2.60; Finesse + 2,4-D \$3.39; Peak + 2,4-D \$4.74-\$6.10.
	+ 2,4-D ester (4L)	4 oz		

✕Nebraska Department of Agriculture "Watch List" weed. List is current as of 12/31/05.

[•]Dicamba is the active ingredient in Banvel, Clarity, Sterling and several other herbicides. The rates and information provided here are based on the same 4 lb/gal acid equivalent formulation found in Banvel, Clarity and Sterling.

Troublesome Weeds and Woody Plants (continued)

Weed	Herbicide	Product Per Acre	Application Time	Remarks and Approximate Cost Per Acre Broadcast
BUCKBRUSH (snowberry)	Cimarron	0.5 oz	6-12" of new foliage	Cost: \$11.00.
	Cimarron + Rangestar	0.25 oz 1 pt	6-12" of new foliage	Cost: \$8.00-\$10.00.
	Cimarron + Weedmaster	0.25 oz 1 pt	6-12" of new foliage	Cost: \$8.00-\$10.00.
	Grazon P+D [◇]	4 pt		Cost: \$7.98-\$15.96.
	Telar	1.0 oz	6-12" of new foliage	Cost: \$20.00.
	2,4-D ester (4L)	2-3 qt	Full foliage (May 10-25)	Use sufficient water to insure good coverage. May have to retreat. Cost: \$7.40-\$11.10.
	✕BUCKTHORN (European)	Garlon 3A	3-5 pt	In fall 2-4 weeks before first frost
BUFFALOBUR	Atrazine 4L [■]	2 qt	Preplant or PRE on corn	Reduced rates less effective. Cost: \$5.30.
	Buctril	1.5 pt	In corn or sorghum weeds 3-5 leaf stage	Plants taller than 4" not controlled. Cost: \$12.11.
	Ultra Blazer	1.5 pt	Weeds 3-4 leaf stage in soybean	Weeds must be small. Follow-up treatments necessary. Cost: \$19.72.
	Callisto	3 oz	Weeds 3-4 leaf in corn	Add 0.25 ai atrazine plus COC. Cost: \$13.31.
	Cobra	12.5 oz	POST on soybean	Weeds need to have 4 true leaves. Cost: \$14.92.
	Exceed	1 oz	POST in corn weeds 1-5" tall	Cost: \$11.00.
	Grazon P+D [◇]	2-4 pt	Actively growing in spring pre-bloom	Cost: \$7.98-\$15.95.
	2,4-D ester (4L) + Dicamba [●]	0.5 pt 0.5 pt	POST on corn	Plants must be small. Cost: \$7.18.
	✕BULL THISTLE	Clarity	1-2 qt	Spring applications
Escort	0.2-0.4 oz	Spring applications	Cost: \$4.40-\$8.80.	
Garlon 3A	3 pt	Spring applications	Cost \$29.14.	
Grazon P+D	2-3 pt	Rosette stage	Cost: \$8.00-\$12.00.	
Milestone	3-5 oz	Rosette through bolting or in fall	Cost: \$7.00-\$12.00.	
Overdrive	4 oz	Rosette stage	Cost: \$16.20.	
Tordon 22K	8-12 oz	Fall	Cost: 5.16-\$8.64.	
Transline	0.5-1 pt	Spring applications	Cost \$22.52-\$45.04.	

✕Nebraska Department of Agriculture "Watch List" weed. List is current as of 12/31/05.

●Dicamba is the active ingredient in Banvel, Clarity, Sterling and several other herbicides. The rates and information provided here are based on the same 4 lb/gal acid equivalent formulation found in Banvel, Clarity and Sterling.

■If atrazine was applied at planting, the total amount of early and late applications cannot exceed 2.5 lb ai/A per calendar year. Use no more than 1.6 lb ai/A on highly erodible land with less than 30% crop residue. Using atrazine on soils with less than 1% organic matter increases carryover injury risk to susceptible crops, especially high pH soils. Do not use on sandy soils if water table is shallower than 30 ft.

Troublesome Weeds and Woody Plants (continued)

Weed	Herbicide	Product Per Acre	Application Time	Remarks and Approximate Cost Per Acre Broadcast
BURCUCUMBER and WILD CUCUMBER	Atrazine 4L [■]	2 qt	PRE in corn	Atrazine can also be used POST. Cost: atrazine \$5.30.
	Buctril 2 EC	1.5 pt	Weeds 3-5 leaf stage in corn or sorghum	Thorough coverage required. Cost: \$12.11.
	Exceed	1 oz	POST on corn and weeds 1-8" tall	Cost: \$12.10.
	Princep 4L	3 qt	PRE in trees	Cost: Princep \$13.80.
	Tough + Atrazine [■]	18 oz 1.25 qt	POST on corn	Cost: Tough + Atrazine \$14.49.
BURSAGE (skeletonleaf and woollyleaf)	Grazon P+D	3-4 pt	When growing actively to flower bud stage	Non-crop areas. Grazon P+D and Tordon may remain in soil for three or more years. Cost: Grazon P+D \$11.96-\$15.95; Tordon \$24.20.
	Tordon 22K	2 pt		
	2,4-D ester (4L) + Dicamba [●]	1 qt 1 qt	June or when growing actively	See remarks for field bindweed. If soil moisture conditions are poor, use oil-water emulsions as a carrier. Cost: \$28.70.
CACTUS — See <i>Pricklypear</i> for <i>Plains Pricklypear</i> , and <i>Brittle</i> or <i>Fragile Cactus</i>				
CANADA THISTLE — See <i>Noxious Weed Section</i> , page 105.				
CATTAILS	2,4-D ester (4L) or emulsifier	1.5 gal + 5% diesel oil + 0.5%	Boot to early flowering	Use the equivalent of 150 gal of water per acre. Retreat regrowth as necessary. Cost: 2,4-D \$23.00.
	Aquatic Glyphosate [◆]	3 qt	At flowering	Use aquatic glyphosate product in or near water. Cost: \$10.56.
	Habitat	1-3 pts	Boot to flowering	Cost: \$66.00-\$132.00.
CEDAR — See <i>Red Cedar</i>				
CHEAT GRASS — See <i>Downy Brome</i>				
COTTONWOOD, WILLOWS, SIBERIAN ELM, CHINESE ELM	2,4-D ester (4L)	2-3 qt	Full foliage (June-July); basal treatment anytime	2,4-D with aerial equipment at least 5 gal carrier, annual treatment for 2 to 3 years may be necessary. Basal or stump treatment: 2 qt of herbicide/10 gal of diesel; apply to point of runoff. Cost: 2,4-D \$7.15-\$10.13; Crossbow \$57.20; Grazon P+D \$31.90; Grazon P+D + Remedy \$29.90-\$60.60.
	Crossbow	1 gal		
	Grazon P+D	4 qt		
	Grazon P+D	3 qt + 1.5 pt	Trees greater than 10 feet tall	
	Remedy [◆]	2 qt + 1 pt	Trees less than 10 feet tall	
	Krenite S	2-3 gal in 100 gal water + surfactant	Late July, Aug., and Sept.	Has little effect on grasses. Results show the following spring. Cost: \$118.00-\$177.00.
	Spike 20P	0.25 oz/1" dia	Spring or fall	Apply under drip line. Cost: \$11.00/lb.
	Velpar L	4 ml/1" dia	Spring with spot gun to tree base	Cost: \$0.08/tree inch.
CUPGRASS, PRAIRIE (in corn)	Balance Pro ¹ + Harness Xtra [■]	1.5-2.2 oz 1.8-2.7 qt	0-8 DBP	POST treatments may be needed. Cost: Balance Pro + Harness Xtra \$24.95-\$37.13.

¹Balance is not recommended on coarse-textured soils of less than 1.5% O.M. or pH greater than 7.4. If applied PRE on medium-textured soils with a pH greater than 7.5, decrease Balance rate 0.25 oz/A. Corn seed must be covered with 1.5 to 2.0 inches of soil. Avoid planting when surface soil is wet. Rates could be increased by 0.25 oz/A in fields with organic matter greater than 2.5% or with crop residues exceeding 5,000 lb/A. Do not use if water table is shallower than 25 ft.

²See manufacturer's label for application time.

[■]If atrazine was applied at planting, the total amount of early and late applications cannot exceed 2.5 lb ai/A per calendar year. Use no more than 1.6 lb ai/A on highly erodible land with less than 30% crop residue. Using atrazine on soils with less than 1% organic matter increases carryover injury risk to susceptible crops, especially high pH soils. Do not use on sandy soils if water table is shallower than 30 ft.

[●]Dicamba is the active ingredient in Banvel, Clarity, Sterling and several other herbicides. The rates and information provided here are based on the same 4 lb/gal acid equivalent formulation found in Banvel, Clarity and Sterling.

[◆]Glyphosate is the active ingredient in many products. The rates provided on this page are based on a 4 lb ai or 3 lb ae formulation. See the glyphosate product comparison table on pages 146-147 for the use rate and more information on the product being used.

Troublesome Weeds and Woody Plants (continued)

Weed	Herbicide	Product Per Acre	Application Time	Remarks and Approximate Cost Per Acre Broadcast		
DANDELION — See <i>No-Till Burndown Tables for Corn and Soybean</i> , pages 41-42 and 56.						
✗DALMATION TOADFLAX	Cimarron	0.5-1 oz	Before flowering in spring or fall	Cost: Cimarron \$11.00-\$22.00; Plateau \$14.36-\$19.40; Tordon 22K \$24.23-\$48.45.		
	Plateau	8-12 oz				
	Tordon 22K	2-4 pts				
DEVILSCLAW Corn and sorghum treatments (also controls cocklebur and common sunflower)	Aim EW + Atrazine DF [■]	0.5 oz 0.25-0.5 lb	2-4"	Use COC with atrazine and Laddok. Cost: Aim + atrazine \$3.35-\$4.05; atrazine \$3.92; Basagran \$10.76-\$21.53; Buctril + atrazine \$9.04-\$14.40; Laddok S-12 \$14.58-\$21.87.		
	Atrazine DF [■]	1.4 lb	2-4"			
	Basagran + 28% N	1-2 pt 1 gal	Devilsclaw less than 4"			
	Laddok S-12 ¹	2.4 to 3.6 pt				
	Buctril 2EC + Atrazine DF [■]	1-1.5 pt 0.6-1.2 lb				
	Callisto	3 oz	POST in corn less than 5"		Use 1% COC + AMS. Cost: \$13.31.	
	Exceed/Spirit (Corn only)	0.8-1.0 oz	Devilsclaw 4-12"		Use 1 gal of 28% UAN + 1 qt of COC for effective control with Exceed. Cost: Exceed/Spirit \$8.80-\$12.00; 2,4-D \$0.93-\$1.85; Marksman \$6.24-\$14.57.	
	2,4-D ester (4L)	0.5-1 pt	Devilsclaw less than 6"			
	Marksman [■]	Corn Sorghum	2-3.5 pt 1.5-2 pt		Emergence to 5-leaf 2-5 leaf stage	
	Hornet (Corn only)	2.4 oz	Devilsclaw less than or equal to 6"		Apply to corn up to V6 stage. Include 1 gal COC + 2.5 gal. of UAN/100 gal of water. Cost: \$8.55.	
	Peak (Sorghum only)	0.75-1.0 oz	Devilsclaw 1-6"		Cost: \$8.48-\$11.30.	
	Permit	0.66-1.33 oz	Devilsclaw 1-6"		Cost: \$11.02-\$22.21.	
	Resource (Corn only)	4-8 oz	Devilsclaw 4-12"		Use 1 qt/A COC. Cost: \$5.59-\$11.18.	
	Soybean treatments	Command 3ME	1.5-2.0 pt		PPI/PRE to soybean planting	Command drift may damage green vegetation. Command residue may damage wheat planted the same fall. Cost: Command \$13.04-\$17.39.
		Classic + Harmony GT	0.25 oz 0.083 oz		POST	Add 28% UAN 1 gal/A + 0.125% v/v NIS. Cost: Classic + Harmony GT \$4.12.
Pursuit DG		1.44 oz	Devilsclaw less than 3"	Use with 1-2 qt of 28% UAN + NIS at 2 pt/100 gal. Cost: \$17.71.		
Resource		12 oz	Devilsclaw 30"	Use 1 qt/A COC. Cost: Resource \$16.76; glyphosate \$352.		
(Requires RR soybean)		Glyphosate [◆]	32 oz			

✗Nebraska Department of Agriculture "Watch List" weed. List is current as of 12/31/05.

[■]If atrazine was applied at planting, the total amount of early and late applications cannot exceed 2.5 lb ai/A per calendar year. Use no more than 1.6 lb ai/A on highly erodible land with less than 30% crop residue. Using atrazine on soils with less than 1% organic matter increases carryover injury risk to susceptible crops, especially high pH soils. Do not use on sandy soils if water table is shallower than 30 ft.

[◆]Glyphosate is the active ingredient in many products. The rates provided on this page are based on a 4 lb ai or 3 lb ae formulation. See the glyphosate product comparison table on page 130 for the use rate and more information on the product being used.

Troublesome Weeds and Woody Plants (continued)

Weed	Herbicide	Product Per Acre	Application Time	Remarks and Approximate Cost Per Acre Broadcast	
DOCK (curled and pale)	2,4-D ester (4L) + Dicamba [●]	1 qt 0.5 pt	Before flowering in spring or fall	For use on idle ground or grassland. For corn in VE stage use 1.3 pt of 2,4-D + 0.5 pt of dicamba. Cost: \$9.95.	
	Grazon P+D [◆]	2-3 pt			Cost: \$7.98-\$11.96.
	Glyphosate [◆]	16 oz	Preplant	Apply 1 week before planting soybean or corn. Plant Roundup Ready soybean or Roundup Ready corn and use labeled glyphosate POST. Cost: glyphosate \$11.76; glyphosate + 2,4-D \$2.36.	
	Glyphosate [◆] + 2,4-D ester (4L)	13 oz 0.5 pt			
	Overdrive	6 oz			
DODDER (Control in alfalfa)	Pursuit	1-2 oz	Apply after dodder has emerged but prior or soon after attachment	Cost: Pursuit \$12.30-\$24.60; Raptor \$17.20-\$26.72.	
	Raptor	4-6 oz			
	Glyphosate [◆] in Roundup Ready Alfalfa	32-64 oz	Cost: \$3.36-\$6.72.		
DOGWOOD (<i>Cornus</i> spp.)	Cimarron	1 oz	Spring or fall	Ground application only. Observe all drift precautions when using within 1/2 mile of sensitive crops. Cost: Cimarron \$20.00; dicamba \$25.00-\$58.00; Crossbow \$57.20-\$85.80; Grazon P+D \$25.00.	
	Dicamba [●]	1-2 qt	Full foliage during June		
	Crossbow	1-1.5 gal			
	Grazon P+D	3 pt	Spring or fall		Cost: \$19.75.
	Grazon P+D	1% v/v High volume foliar (See page 112)	Spring or fall		Cost: \$33.00/gal.
	Spike 20P	0.25 oz/1" dia	Spring or fall	Apply under drip line. Cost: \$8.60/lb.	
DOWNY BROME	Glyphosate [◆]	12-16 oz	Fall or early spring when desirable grasses are dormant Early spring	Use glyphosate before planting corn, sorghum, soybean and in fallow. Cost: \$1.32-\$1.76; or Oust \$8.00.	
	Oust (noncropland)	1-2 oz			
	Plateau (noncrop land, range, pasture CRP)	4-12 oz	Full PRE or early POST	Surfactant: MSO 1 qt/A. Cost: \$9.36-\$28.08.	
	Alternate system			Crop rotation—include a late spring seeded crop in the rotation. See NebGuide G78-422, Downy Brome Control.	

◆See manufacturer's label for application time.

●Dicamba is the active ingredient in Banvel, Clarity, Sterling and several other herbicides. The rates and information provided here are based on the same 4 lb/gal acid equivalent formulation found in Banvel, Clarity and Sterling.

◆Glyphosate is the active ingredient in many products. The rates provided on this page are based on a 4 lb ai or 3 lb ae formulation. See the glyphosate product comparison table on page 130 for the use rate and more information on the product being used.

Troublesome Weeds and Woody Plants (continued)

Weed	Herbicide	Product Per Acre	Application Time	Remarks and Approximate Cost Per Acre Broadcast
FIELD BINDWEED Retreatment is necessary. (When treating crops, adjust rates.) Glyphosate used only in Roundup Ready crops.	2,4-D ester (4L)	1 qt	Vigorous fall growth or flower bud stage in spring	Avoid tillage 5 weeks before and 1 week after application. Do not plant small grains for 15 days after 2,4-D and 45 days after dicamba. Plan to treat for several consecutive years. Cost: 2,4-D \$3.58; 2,4-D + \$9.95-\$16.20.
	2,4-D ester (4L) + Dicamba [•]	0.5-1 pt		
	Dicamba [•]	1-2 pt	Late summer or late fall actively growing	Apply glyphosate in 10 gal or less water/A. Avoid tillage for 5 days. Do not plant small grains for 15 days with 2,4-D and 45 days per pint of dicamba. Broadleaf crops may be injured 2 years after high rates of dicamba in western Nebraska. Cost: glyphosate + 2,4-D \$9.28; glyphosate + dicamba \$9.77; dicamba \$12.50-\$25.00; Landmaster BW \$7.93.
	Landmaster BW	54 oz		
	Glyphosate [♦] + 2,4-D amine (4L) or Dicamba [•]	32 oz 0.5 pt 0.5 pt		
	Paramount	5.3 oz	Fall	Preplant to wheat. Cost: \$16.34.
	Tordon 22K + 2,4-D ester (4L)	0.5-1 pt 1-2 pt	Fall after wheat harvest	Use in a wheat-fallow rotation. Retreat with 2,4-D or Landmaster BW in spring. Cost: \$7.90-\$15.80.
	Glyphosate [♦] + Classic	32 oz 0.3 oz	2-6" runners	Control of larger plants reduced by 30%. Cost: \$12.00.
	Glyphosate [♦] + Phoenix	32 oz 5 oz	2-6" runners	Control of larger plants reduced by 20%. Cost: \$12.00.
	Extreme	48 oz	2-6" runners	Control of larger plants reduced by 30%. Cost: \$13.00.
	Glyphosate [♦] + Raptor	32 oz 3 oz	2-6" runners	Control of larger plants reduced by 20%. Cost: \$25.00.
GARLIC MUSTARD	Glyphosate [♦]	24-32 oz or 2% spot spray	Full or early spray when desirable	Use glyphosate broadcast in spring and fall when other vegetation is dormant. Spot spray during growing season. Cost: \$2.62-\$3.52.
	2,4-D + Dicamba [•]	1 pt 8 oz	Vegetation is dormant; young small plants	Do not use 2,4-D ester or dicamba when air temperature exceeds 85oF. Cost: \$9.00-\$14.00.
GUMWEED (curlycup)	2,4-D ester (4L)	1.5 qt	Pre-bud	Cost: 2,4-D \$5.36; Grazon P+D \$7.40.
	Grazon P+D	1 qt		
HEMP (marijuana)	2,4-D ester (4L)	1 qt	2-12" tall	Cost: 2,4-D ester (4L) \$3.58; Grazon P+D \$7.40.
	Grazon P+D	2 pt		
HEMP DOGBANE	2,4-D ester (4L)	0.5-1 qt	Flower bud stage, spring	Use lower rates in crops. Cost: \$1.79-\$3.58.
	2,4-D ester (4L)	1 qt	Apply after corn is in the dough stage, but before the dogbane leaves start to turn yellow	Dogbane roots should have pink swollen buds. Cost: 2,4-D \$3.58. See NebGuide G83-665, Hemp Dogbane.
	Glyphosate [♦]	4 qt	Late summer or fall	Idle ground or spot treatment in cropland before head or pod fill of crop. Avoid tillage for at least 7 days after treatment. Cost: \$14.80.
	Surmount	2 pt	Summer	Rangeland, pasture and CRP. Cost: \$13.00.

[•]Dicamba is the active ingredient in Banvel, Clarity, Sterling and several other herbicides. The rates and information provided here are based on the same 4 lb/gal acid equivalent formulation found in Banvel, Clarity and Sterling.

[♦]Glyphosate is the active ingredient in many products. The rates provided on this page are based on a 4 lb ai or 3 lb ae formulation. See the glyphosate product comparison table on pages 146-147 for the use rate and more information on the product being used.

Troublesome Weeds and Woody Plants (continued)

Weed	Herbicide	Product Per Acre	Application Time	Remarks and Approximate Cost Per Acre Broadcast
HOARY CRESS	2,4-D ester (4L)	2 qt	Rosette stage in the fall or early bud in spring	Suppression only. Growth starts in early spring. Treat twice a year for 2 to 3 years. Cost: \$11.10.
	Plateau (pasture, range, noncropland, CRP)	6-12 oz	Late spring/summer at flowering	Cost: \$14.04-\$28.08.
HOARY VERVAIN	Grazon P+D	2-3 pt	Apply in early summer (up to 6" tall weed)	Cost: Grazon P+D \$7.40-\$11.10; Curtail \$11.13-\$16.68; Tordon 22K \$11.50; Salvo \$2.67-\$3.33; Weedmaster \$6.25.
	Curtail	2-3 pt		
	Tordon 22K	1 pt		
	Salvo	12-15 oz		
	Weedmaster	32 oz		
HORSETAIL (Scouring Rush)	Garlon 3A	5 pt	Spring treatment in pasture	Cost: \$48.50.
	Hornet (in corn)	4-5 oz 2-4 oz	PRE POST	POST application should be used if horsetail at least several inches tall. Cost: \$8.00-\$20.00.
✗HOUNDSTONGUE	Cimarron	1 oz	Apply in spring (rosette stage)	Cost: Cimarron \$21.50; Escort \$20.60; Plateau \$18.75-\$28.15; Telar DF \$23.30; Tordon \$36.30.
	Plateau	8-12 oz		
	Telar DF	1 oz		
	Tordon	1.5 pt		
IRONWEED	2,4-D ester (4L)	1.5 qt	Flower to bud stage	Cost: \$5.36.
	Grazon P+D [◆]	2-3 pt	Prior to bud stage	Rangeland. Cost: \$7.48-\$11.96.
✗JOHNSONGRASS (See shattercane for seedling control)	Accent Beacon	0.67 oz 0.76 oz	6-16"	See corn POST for application restrictions. Split-applications more effective. Cost: Accent \$15.36; Beacon \$28.29.
	Fusilade DX	1.5 pt	12-18" new growth	Can be used in soybean. Add 1 qt/A COC. Cost: Fusilade \$28.29.
	Poast Plus + AMS	2.25 pt	Johnsongrass 12-18"	Can be used in soybean. Cost: Poast Plus \$15.36.
	(Requires Roundup Ready seed)	Glyphosate [◆]	2-3 pt	Less than 8"
	Option	1.25-1.75 oz	Less than 16"	Cost \$13.75-\$19.25.
KNAPWEED—See <i>Noxious Weed Section</i> , page 106.				

[◆]See manufacturer's label for application time.

✗Nebraska Department of Agriculture "Watch List" weed. List is current as of 12/31/05.

[◆]Glyphosate is the active ingredient in many products. The rates provided on this page are based on a 4 lb ai or 3 lb ae formulation. See the glyphosate product comparison table on pages 146-147 for the use rate and more information on the product being used.

Troublesome Weeds and Woody Plants (continued)

Weed	Herbicide	Product Per Acre	Application Time	Remarks and Approximate Cost Per Acre Broadcast
KOCHIA— (dicamba-tolerant) May have to spray twice or cultivate for row crops.				
(in corn or sorghum)	Glyphosate [◆]	24-32 oz	Preplant to corn or sorghum. Kochia less than 2" tall	Include appropriate PRE herbicides. Dicamba-resistant kochia has been confirmed. Cost: Landmaster BW \$7.13; Gramoxone Max \$8.29; Balance \$7.20-\$27.36; include a grass herbicide.
	Gramoxone Max	1.5 pt		
	Balance Pro1	1.0-3.8 oz	PP or PRE to corn only	
	Buctril	1.0-1.5 pt	Kochia less than 2" tall	
	Buctril/atrazine	2-3 pt	POST to kochia less than 4" in corn or sorghum	
	Callisto + atrazine	3 oz 0.5 lb	POST to corn; weeds less than 5"	
	Lumax	2.5-3 qt	PRE in corn	
	Atrazine	1 lb	POST to corn only	
	Starane + 2,4-D	0.67-1.3 pt 0.5-1 pt		
	KUDZU			
	Cimarron	1-2 oz	Apply to spring foliage or in fall	Cost: \$22.00-\$49.00.
	Garlon 3A	3-5 pt		
LARKSBUR PRAIRIE				
	Grazon P+D	3-5 pt		Cost: Grazon P+D \$12.00-\$20.00; Cimarron \$11.00-\$22.00.
	Cimarron	0.5-1-1 oz		
LESPEDEZA SERICEA				
	PastureGard	1.5-2 pt		Cost: \$10.31-\$13.75.
	Remedy	1-1.5 pt	Before bloom	Cost: Remedy \$12.13-\$18.75; Cimarron \$8.80; Surmount \$15.00; PastureGard \$10.00-\$20.00.
	Cimarron	0.4 oz	Fall	
	Surmount	2-2.5 pt		
LOCUST (honey and black)				
	Dicamba [●]	2 qt	Full foliage during June; cut stump or basal treatment anytime	Ground application only. Observe all drift precautions. See cottonwood for basal and cut stump treatment. Cost: Dicamba \$50.00; Grazon P+D \$15.95-\$31.90; Remedy \$24.25-\$48.50.
	Grazon P+D	2-4 qt		
	Remedy ²	2-4 pt		
	Spike 20P	0.25 oz/1" dia	Spring or fall	Apply under drip line. Cost: \$11.00/lb.
	Surmount	2-3 pt	Full foliage during June	Cost: \$11.25-\$15.00.
In no-till corn:				
	Hornet	3-5 oz		Cost: \$10.67-\$17.78.

●Dicamba is the active ingredient in Banvel, Clarity, Sterling and several other herbicides. The rates and information provided here are based on the same 4 lb/gal acid equivalent formulation found in Banvel, Clarity and Sterling.

◆Glyphosate is the active ingredient in many products. The rates provided on this page are based on a 4 lb ai or 3 lb ae formulation. See the glyphosate product comparison table on pages 146-147 for the use rate and more information on the product being used.

Troublesome Weeds and Woody Plants (continued)

Weed	Herbicide	Product Per Acre	Application Time	Remarks and Approximate Cost Per Acre Broadcast
MARESTAIL (horseweed)	2,4-D ester (4L)	1 qt	Prior to bolt	Cost 2,4-D \$3.57; Redeem R&P \$12.50-\$25.00.
	Redeem R&P	1-2 pt		
	Callisto + atrazine	1.5 oz + 0.5 lb	Corn POST less than 10"	Add COC. Cost: \$9.90.
	Distinct	2-3 oz	PRE in Corn Marestalk less than 4" tall	Apply at least 14 days prior to planting. Cost: \$5.00-\$7.50.
	Distinct	6 oz	Corn POST 4-10"	Cost: \$15.00.
	Grazon P+D	2-3 pt	Prior to bolt	Cost: \$7.75-\$11.60.
	Glyphosate [♦]	32 oz	Before 6" tall	Cost \$2.64.
	Hornet WDG (corn)	3 oz	POST Marestalk less than 6" tall	Add 1% v/v COC or 0.25% v/v NIS. Cost: \$10.00.
	Overdrive	4-8 oz	2-6" tall in pasture	Cost: \$10.00-\$20.00/A.
MILKWEED, COMMON	2,4-D ester (4L) + Dicamba [•]	1 qt 0.5 pt	Flower bud to bloom stage	Do not plant small grains for 15 days after 2,4-D + dicamba treatment. 2,4-D + dicamba suppresses growth for 1 year. Cost: \$9.95.
	Glyphosate [♦]	3 qt	Flowering through maturity; ropewick application in soybean	Idle ground or spot treatment on cropland before head or pod fill of crop. Avoid tillage for 7 days. Cost: glyphosate \$10.56.
	Overdrive	4-8 oz	2-6" tall in pasture	Cost: \$10.00-\$20.00/A.
MILKWEED, HONEYVINE (climbing)	2,4-D amine (4L)	1-2 pt	Before vines reach 3 ft in length	For use in corn or sorghum. Use lower rates in sorghum. Gives suppression only. Cost: \$0.89-\$3.05. See NebGuide G77-384, Common Milkweed.
	2,4-D ester (4L)	0.5-1 pt		
✕MULTIFLORA ROSE	Ally/Cimarron	0.3 oz or 1 oz/100 gal water	Full foliage bud to bloom	Add 0.25% (v/v) nonionic surfactant (NIS). Cost: Ally/Cimarron \$6.60.
	Cimarron Max	0.5 oz Part A + 2 pt Part B	Full foliage bud to bloom	Cost: \$20.00.
	Dicamba [•]	1-2 qt or 1 qt/25 gal water	Full foliage	Cost: \$25.00-\$50.00.
	Spike 20P	0.25 oz/bush or 0.25 oz/22 ft ²	Anytime soil is not frozen	Cost: \$11.00/lb.
	Tordon 22K + 2,4-D (4L)	1 qt 2 qt	When plants are actively growing	Cost: \$25.70.
	Tordon RTU	Apply undiluted to cut stumps		Cost: Check local prices.
MULLEIN, COMMON	Cimarron	0.5 oz	Rosette stage in fall or spring	Add crop oil (COC) 2 qt/A. Cost: \$10.00.
	Grazon P+D	4 pt	Late fall on rosettes or spring before flowering stalks lengthen	Essential to apply in rosette stage. Add surfactant 2 pt/100 gal solution. Cost: \$15.96.
	Overdrive	6.0 oz	Fall or spring prior to bolting	Cost: \$15.00.

MUSK THISTLE — See Noxious Weed Section, page 106.

✕Nebraska Department of Agriculture "Watch List" weed. List is current as of 12/31/05.

•Dicamba is the active ingredient in Banvel, Clarity, Sterling and several other herbicides. The rates and information provided here are based on the same 4 lb/gal acid equivalent formulation found in Banvel, Clarity and Sterling.

♦Glyphosate is the active ingredient in many products. The rates provided on this page are based on a 4 lb ai or 3 lb ae formulation. See the glyphosate product comparison table on pages 146-147 for the use rate and more information on the product being used.

Troublesome Weeds and Woody Plants (continued)

Weed	Herbicide	Product Per Acre	Application Time	Remarks and Approximate Cost Per Acre Broadcast	
NUTSEDGE — See <i>Yellow Nutsedge</i>					
OAK	Dicamba [•]	2 qt	Full foliage June to July; cut stump or basal treatment anytime	Noncropland only for Spike and Crossbow. Cost: dicamba \$50.00; Crossbow \$85.80; Remedy + 2,4-D ester \$27.95-\$31.65; Spike \$11.00/lb; Velpar RP \$0.10/tree inch.	
	Crossbow	1.5 gal			
	Remedy + 2,4-D ester (4L)	1 qt 1-2 qt			
	Glyphosate [◆]	50% to 100% solution	June cut stump		Be careful of desirable tree roots grafting to treated tree roots.
	Spike 20P	0.25 oz/1" dia	Spring or fall		
	Velpar L	4 ml/1" dia	Spot gun in spring to tree base		
	Pasturegard	3-4 pt	In summer when leaves are fully emerged		Cost: \$18.00-\$24.00.
	Spike 20P	5-20 lbs	Anytime except when soil is frozen		Cost: \$37.50-\$150.00.
	Spike 80 DF	3.75-5 lb	Anytime except when soil is frozen		Cost: \$75.00-\$100.00.
	Surmount	3-4 pt	In summer when leaves are fully emerged		Cost: \$20.60-\$27.50.
OSAGE ORANGE	Crossbow	1-1.5 gal	Full foliage June to July; basal treatment anytime	Noncrop areas only. See remarks for cotton-wood. Cost: Crossbow \$57.20-\$85.80; Remedy + 2,4-D ester \$15.56-\$27.54; Spike \$11.00/lb; Velpar RP \$0.10 tree inch.	
	Remedy + 2,4-D ester (4L)	1-2 pt 1 qt			
	Spike 20P	0.5 oz/1" dia	Spring or fall		
	Velpar L	4 ml/1" dia	Spot gun in spring to tree base		
	✕PHRAGMITES (common reed)		Aquatic glyphosate		6-8 pt
		Habitat	3-4 pt		
PLUMELESS THISTLE — See <i>Noxious Weed Section</i> , page 106.					
POISON HEMLOCK	2,4-D ester (4L) + Dicamba [•]	1 qt 0.5 pt	Rosettes—fall or early spring	Do not allow livestock access to dry matter. Cost: \$10.00.	
	Grazon P+D [◇]	2-4 pt			
					Cost: \$7.98-\$15.95.
POISON IVY	Crossbow	1 - 1.5 gal	Full foliage in spring	Thoroughly wet all vegetation. Do not apply to cropland. Cost: Crossbow \$1.75/1000 sq ft; Remedy + 2,4-D ester \$15.56-\$27.54; glyphosate \$10.56-\$17.60.	
	Glyphosate [◆]	3-5 qt			
	Remedy + 2,4-D ester	1-2 pt 1 qt			
	Pasturegard	2-3 pt			Cost: \$12.00-\$18.00.

◇See manufacturer's label for application time.

✕Nebraska Department of Agriculture "Watch List" weed. List is current as of 12/31/05.

•Dicamba is the active ingredient in Banvel, Clarity, Sterling and several other herbicides. The rates and information provided here are based on the same 4 lb/gal acid equivalent formulation found in Banvel, Clarity and Sterling.

◆Glyphosate is the active ingredient in many products. The rates provided on this page are based on a 4 lb ai or 3 lb ae formulation. See the glyphosate product comparison table on pages 146-147 for the use rate and more information on the product being used.

Troublesome Weeds and Woody Plants (continued)

Weed	Herbicide	Product Per Acre	Application Time	Remarks and Approximate Cost Per Acre Broadcast
PRICKLY PEAR	Tordon 22K	1% v/v	As spot treatments to new growth	Cost: \$100.00/gal.
	Tordon 22K	1-2 pt	New growth to flowering	May take 1-2 years before death. Spot treat in pasture and grazingland. Include NIS in spray mixture. Cost: Tordon 22K \$12.10-\$24.20; Remedy + Tordon 22K \$8.16-\$24.23; Grazon P+D \$31.90.
	Remedy + Tordon 22K	0.5-1 pt 1 pt		
	Grazon P+D [◆]	4 qt		
PUNCTURE VINE	2,4-D ester (4L)	1 qt	Pre-bloom stage most effective	Mature burs not affected by 2,4-D. Retreatment necessary on new plants. Cost: \$3.58.
	2,4-D ester (4)	1 qt	POST on corn or sorghum	Cost: \$3.58.
	Callisto + atrazine (corn)	3 oz 1/4 lb	POST in corn	Cost: \$13.88.
	Cimarron + 2,4-D ester (4L)	0.3 oz 1 pt	PRE to seedlings	Ally provides residual control in noncrop areas. Cost: \$8.84.
	Dicamba [●]	1 pt	EPOST on corn or sorghum	Cost: \$12.50.
	Exceed	1 oz	POST on corn	Provides residual control. Add Banvel to control pigweed. Cost: \$12.10.
	Hornet WDG (corn)	3 oz	POST before V6 corn	Add 1% v/v COC or 0.25% v/v NIS. Cost: \$10.00.
	Journey	32 oz	POST in noncropland	Cost: \$26.50.
	Overdrive (range and pasture)	4-8 oz	4-8" in pasture	Cost: \$10.00-\$20.00.
	Peak	0.75-1 oz	POST on sorghum or proso millet	Cost: \$8.48-\$11.30.
	Plateau* (range, pasture CRP)	8-12 oz	Early POST	Add MSO 1 qt/A for use in warm-season grasses. Cost: \$18.72-\$28.08.
	PURPLE LOOSESTRIFE (lythrum) — See <i>Noxious Weed Section</i> , page 107.			
PURSLANE, Common (In fallow to be planted to winter wheat)	2,4-D ester (4L)	1 qt	When growing actively	Till 5-7 days after treatment. Do not plant small grains for 15 days. Cost: 2,4-D \$3.58.
	Cimarron or Amber or Finesse + 2,4-D ester (4L)	0.1 oz 0.2-0.3 oz 0.4 oz 4 oz	Early POST	Add surfactant when used POST. Surfactant 1-2 qt/100 gal solution. Do not use on soils with pH of 7.9 or higher. Allow 12 days before planting wheat. Cost: Cimarron + 2,4-D \$2.80; Amber + 2,4-D \$2.18-\$3.04; Finesse + 2,4-D \$6.46; Rave \$6.00.
	Rave	4 oz		
			Less than 6"	

[◆]See manufacturer's label for application time.

[●]Dicamba is the active ingredient in Banvel, Clarity, Sterling and several other herbicides. The rates and information provided here are based on the same 4 lb/gal acid equivalent formulation found in Banvel, Clarity and Sterling.

[◆]Glyphosate is the active ingredient in many products. The rates provided on this page are based on a 4 lb ai or 3 lb ae formulation. See the glyphosate product comparison table on page 146-147 for the use rate and more information on the product being used.

*Plateau is only available to approved government agencies.

Troublesome Weeds and Woody Plants (continued)

Weed	Herbicide	Product Per Acre	Application Time	Remarks and Approximate Cost Per Acre Broadcast
RAGWEED, WESTERN (perennial)	2,4-D ester (4L)	1 qt	Early summer	Follow-up treatments may be necessary. Cost: \$3.58.
	Grazon P+D	2-3 pt	Lower rate when weeds are small	Cost: \$7.97-\$11.96.
	Overdrive	4-6 oz		Cost: Overdrive \$12.35-\$18.50; Salvo \$2.67-\$3.35; Weedmaster \$6.25.
	Salvo	12-15 oz		
	Weedmaster	32 oz		
	Curtail	2-3 pts		Cost: \$10.00-\$15.00.
	Surmount	1.5-2 pt	Early summer	Cost: \$10.00-\$14.00.
	Transline	0.5-1 pt		Cost: \$22.52-\$45.04.
RED CEDAR, Eastern	Spike 20P	0.5 oz/1" dia	Spring or fall	Spike for use in noncrop areas only. Tordon and Velpar LP can be used on grazingland. Cost: Spike \$11.00/lb; Velpar RP \$0.10/tree inch; Tordon 22K \$0.63/tree inch
	Tordon 22K	4 ml/3 ft of tree height	Spring or fall	
	Velpar L	4 ml/1" dia	Spot gun in spring to tree base	
	Grazon P+D	6-8 pt	Apply broadcast up to 2 ft tall trees	Cost: Grazon P+D \$23.93-\$31.90; Tordon 22K \$18.15-\$24.20; Surmount \$18.00. See Extension Circular: <i>Integrated Management of Eastern Redcedar</i> (EC186)
	Tordon 22K	1.5-2 pt		
	Surmount	5 pt/A		
	Grazon P+D	2% v/v	Individual tree treatments (up to 10 ft tall trees)	
	Tordon 22K	1% v/v		
Surmount	1.5% v/v			
Alternative treatment — Prescribed Burn — See EC90-121.				
RUSSIAN KNAWEED	Curtail	3-4 qt	Apply at bud stage early flower	Idle ground or grassland. Avoid tillage for 7 days. Injury to forage grasses may occur. Broadleaf crops may be injured for 2 years after treatment. Cost: Curtail \$30.00-\$48.40; Dicamba \$25.00-\$50.00; Grazon P+D \$9.97-\$15.99; Redeem R&P \$31.25-\$50.00; Tordon \$24.20-\$48.40; Transline \$45.04-\$58.55.
	Dicamba [•]	1-2 qt		
	Grazon P+D [◆]	2.5-4.0 pt		
	Redeem R&P	2.5-4 pt		
	Tordon 22K	1-2 qt		
	Transline	1-1.3 pt	Apply from bud to mid-flower growth stage or treat in fall	
	Plateau	12 oz	Apply late in fall after killing frost	Pasture, range or noncropland. Add MSO 1qt/A. Cost: \$28.08.
RUSSIAN OLIVE	2,4-D ester (4L) + Dicamba [•]	2 qt 1 qt	Full foliage (early June)	See remarks for cottonwood. Cost: \$32.40.
	Remedy	1 qt/3 qt diesel or crop oil as basal treatment		Cost: \$24.00/qt
	Spike 20P	0.5 oz/1" dia	Spring or fall	Use on noncropland only. Cost: \$11.00/lb.
	Arsenal + 0.25% NIS	1-2 qt (broadcast) 1% (spot spraying)		Noncrop sites only. Cost: \$76.75-\$153.50.
	Pathfinder II	Apply undiluted as low volume basal treatment		

◆See manufacturer's label for application time.

•Dicamba is the active ingredient in Banvel, Clarity, Sterling and several other herbicides. The rates and information provided here are based on the same 4 lb/gal acid equivalent formulation found in Banvel, Clarity and Sterling.

Troublesome Weeds and Woody Plants (continued)

Weed	Herbicide	Product Per Acre	Application Time	Remarks and Approximate Cost Per Acre Broadcast
RUSSIAN THISTLE — See <i>Kochia</i> for controls, page 120.				
SAGEBRUSH (sand and fringed and green sagewort)	2,4-D ester (4L)	1.5-2 qt	4"-8" new growth (June)	1.5 qt/A 2,4-D adequate on sand sagebrush. Cost: 2,4-D \$5.36-\$7.15; Grazon + P+D \$11.10- \$14.80; See NebGuide G80-510, Sagebrush Control.
	Grazon P+D	3-4 pt		
	Garlon 3A	50% (spot spray)	Apply directly to fresh cut stump (pg. 103)	50% spot spray is 1 qt Garlon 3A plus 1 qt water. Cost: \$48.56.
SALT CEDAR — See <i>Noxious Weed Section</i> , page 107.				
SANDBUR (pasture, range and noncropland)	Plateau	4-10 oz	Spring PRE to early POST Sandbur less than 4"	Add 1 qt MSO/A. For use in warm season grasses. Cost: \$9.57-\$23.93.
✘SCOTCH THISTLE	2,4-D (4L)	1 qt	Spring or fall rosette	Cost: \$16.10.
	+ Dicamba [•]	1 pt		
	Ally/Cimarron	1.0 oz	Spot treatment to rosette	Cost: \$21.50/oz
	Milestone	4-6 oz	Spring and fall rosette	Cost: \$9.00-\$14.00.
	Overdrive	4-6 oz	Spring or fall	Cost: \$12.00-\$18.00.
	Tordon 22K	1-2 pt	Fall rosette	Cost: \$10.41-\$20.82.
SCOURING RUSH — See <i>Horsetail</i> , page 119.				
✘SERICEA, LESPEDEZA — See <i>Lespedeza Sericea</i> , page 120.				
SOAPWEED — See <i>Yucca</i> , page 127.				
SOW THISTLE (perennial)	2,4-D ester (4L)	1.5 qt	Fall rosette or spring bud stage	See remarks for field bindweed. Cost: \$5.36.
	Overdrive	4-6 oz	Spring bud stage	Cost: \$10.00-\$15.00.
SUMAC	2,4-D ester (4L)	1-2 qt	Full foliage	Use sufficient water for good coverage. Cost: \$3.58- \$7.16.
	Grazon P+D [◇]	2.0-4.0 pt		Cost: \$7.98-\$15.95.
	Cimarron + Weedmaster	0.5 oz 4 pt	Full foliage in June	Cost: Cimarron \$11.00; Weedmaster \$13.40.
SWAMP SMARTWEED (tanweed, shoestring)	2,4-D ester (4L)	1 qt	When growing vigorously	On crops use lower rates and amine formulations. Cost: \$16.10.
	+ Dicamba [•]	1 pt		
	Glyphosate [◆]	3-4 qt in 10 gal or less water/A	Full foliage mid to late summer	Idle ground or spot treatment in cropland before head or pod fill of crop. Avoid tillage for 7 days. Cost: \$10.56-\$14.08.
	Tordon 22K [◇]	1.0-2.0 pt		Cost: \$10.41-\$20.82.

[◇]See manufacturer's label for application time.

✘Nebraska Department of Agriculture "Watch List" weed. List is current as of 12/31/05.

[•]Dicamba is the active ingredient in Banvel, Clarity, Sterling and several other herbicides. The rates and information provided here are based on the same 4 lb/gal acid equivalent formulation found in Banvel, Clarity and Sterling.

[◆]Glyphosate is the active ingredient in many products. The rates provided on this page are based on a 4 lb ai or 3 lb ae formulation. See the glyphosate product comparison table on pages 146-147 for the use rate and more information on the product being used.

Troublesome Weeds and Woody Plants (continued)

Weed	Herbicide	Product Per Acre	Application Time	Remarks and Approximate Cost Per Acre Broadcast
SWEET CLOVER (in pasture)	2,4-D ester	1 qt	12-20" tall	Cost: \$3.50.
(in Roundup Ready soybean POST)	Glyphosate [♦] + Classic	32 oz 0.3 oz	4-6"	Control of taller plants reduced by 60%. Cost: \$10.90.
	Glyphosate [♦] + Flexstar	32 oz 8 oz	4-6"	Control of taller plants reduced by 50%. Cost: \$13.50.
TOOTHED SPURGE	Plateau	4-6 oz	Apply in spring (4-6" tall plants)	Cost: \$9.43-\$14.06.
VENICE MALLOW (in Roundup Ready soybean POST)	Glyphosate [♦] + Phoenix	32 oz 8 oz	4-6"	Cost: \$12.50.
	Glyphosate [♦] + Classic	32 oz 0.3 oz	4-6"	Cost: \$10.90.
	Extreme	48 oz	4-6"	Cost: \$12.75.
VERVAIN (HOARY) — See <i>Hoary Vervain</i> , page 119.				
WESTERN RAGWEED — See <i>Ragweed, Western</i> , page 124.				
WILD BUCKWHEAT (in Roundup Ready soybean POST)	Extreme	48 oz	When weeds are 1-4" tall	Cost: \$13.00.
	Glyphosate [♦] + Flexstar	32 oz 8 oz	When weeds are 1-4" tall	Cost: \$13.00.
	Glyphosate [♦] + Phoenix	32 oz 5 oz	When weeds are 1-4" tall	Cost: \$12.00-\$14.00.
	Glyphosate [♦] + Scepter	32 oz 1.44 oz	When weeds are 1-4" tall	Cost: \$12.00.
	Glyphosate [♦] + Ultra Blazer	32 oz 12 oz	When weeds are 1-4" tall	Cost: \$10.00.
	(in corn)	Distinct	4-6 oz	1-4"
	Hornet	3 oz		
(in wheat)	Curtail	2 pt	1-4"	Cost: \$10.00.
(in sugarbeet)	Stinger	4-6 oz	1-4"	Cost: \$16.00-\$20.00.
WILD CUCUMBER — See <i>Burcucumber</i> , page 115.				
WILD LICORICE	Tordon 22K	2 pt	Bloom stage	Cost: \$24.20.

WILD OAT — In Nebraska most likely weedy annual brome. See *Downy Brome*, page 117.

[♦]Glyphosate is the active ingredient in many products. The rates provided on this page are based on a 4 lb ai or 3 lb ae formulation. See the glyphosate product comparison table on pages 146-147 for the use rate and more information on the product being used.

Troublesome Weeds and Woody Plants (continued)

Weed	Herbicide	Product Per Acre	Application Time	Remarks and Approximate Cost Per Acre Broadcast
YARROW	Grazon P+D	2 pt	Fall or spring Pre-bloom	Cost: Grazon P+D \$7.40; 2,4-D + Dicamba \$9.95.
	2,4-D LV ester (4L) + Dicamba [●]	1 qt 0.5 pt		
	Overdrive	4-6 oz	Spring pre-bloom	Cost: \$10.00-\$15.00.
YELLOW NUTSEDGE (in corn)	Beacon	0.76 oz	1-4'	Cost: Beacon \$22.04; Permit \$22.21.
	Permit	1.33 oz		
✘YELLOW STAR THISTLE	Dicamba [●]	1-2 qt	Apply in rosette stage	Cost: Clarity \$25.38-\$50.75; Transline \$22.52-\$45.04; Curtail \$7.50-\$12.50; Tordon 22K \$6.05-\$18.15; Overdrive \$12.50.
	Transline	0.5-1 pt		
	Curtail	1.5-2.5 pt		
	Tordon 22K	0.5-1.5 pt		
	Overdrive	4 oz		
✘YELLOW TOADFLAX	Tordon 22K	2 pt	Early bloom	Cost: Tordon \$24.20; Clarity \$6.34.
	Clarity (in corn)	8 oz		
YUCCA (soapweed)	Ally +	1 oz		Cost: \$38.50.
	Rangestar	2 qt		
	Velpar L	4 ml/plant		
	Tordon 22K	1 ml/plant		
	Remedy	13 oz/5 gal of diesel or fuel oil		Thoroughly wet the center of the plant to the soil surface. Cost: \$9.73/5 gal.

✘Nebraska Department of Agriculture "Watch List" weed. List is current as of 12/31/05.

●Dicamba is the active ingredient in Banvel, Clarity, Sterling and several other herbicides. The rates and information provided here are based on the same 4 lb/gal acid equivalent formulation found in Banvel, Clarity and Sterling.

Time until Herbicides are Rainfast

Herbicide	Hours Until Rainfast	Herbicide	Hours Until Rainfast
ACCENT	4	GLYPHOSATE	1-4 ^a
ACCENT GOLD	4	HARMONY GT	1
AIM	1	HOELON	1
ALLY	4	HORNET WDG	2
AMBER	4	LADDOK S-12	4
ARROW	1	LANDMASTER BW	6
ASSURE II	1	LIBERTY	4
ASSERT	3	LIGHTNING	1
ATRAZINE	4	MARKSMAN	4
AVALANCHE	6	MCPA	1
AVENGE	6	MILESTONE	2
BANVEL	4	NORTHSTAR	4
BASAGRAN	4	OLYMPUS FLEX	4
BASIS	4	OPTION	2
BASIS GOLD	4	OVERDRIVE	4
BEACON	4	PARAMOUNT	6
BETAMIX	6	PEAK	4
BICEP II	4	PERMIT	4
BLAZER	6	PHOENIX	2
BRONATE	1	PINNACLE	1
BUCTRIL	1	POAST PLUS	1
BUTYRAC 200	6	PURSUIT	1
CALLISTO	1	RAVE	4
CELEBRITY PLUS	4	RAPTOR	1
CLARITY	4	REFLEX	1
CROSSBOW	6	RESOURCE	1
CURTAIL	8	ROUNDUP ORIGINAL MAX	0.5
CURTAIL M	6	ROUNDUP WEATHER MAX	0.5
CLASSIC	1	SCEPTER	2
COBRA	0.5	SELECT 2 EC	1
DISTINCT	4	SELECT MAX	1
EQUIP	2	SENCOR	6
EXCEED	4	SPIRIT	4
EXPERT	1	STARANE	1
EXPRESS	4	STEADFAST	4
EXTREME	4	STEADFAST ATZ	4
FIELD MASTER	1	STELLAR	1
FINESSE	4	STINGER	6
FIRST RATE	2	SYCHRONY	1
FLEXSTAR	1	TOUCHDOWN	1
FUSILADE DX	1	TOUCHDOWN TOTAL	1
FUSION	1	TOUGH	2
FALLOW MASTER	6	2,4-D	1
GALAXY	4	TORDON	2
GRAMOXONE MAX	0.5	ULTIMA 60	1
GRAZON P+D	4	UPBET	6
GLEAN	4	YUKON	4

^aCheck product label.

Preharvest Intervals/Crop Stage Limits For Herbicide Application

POST Herbicides in Corn

Herbicide	Preharvest Interval or Crop Height Limit	Herbicide	Preharvest Interval or Crop Height Limit
Accent	26" broadcast, 36" directed	Lightning	20" or V6
Accent Gold	12"	Lumax	45 days
Aim/Avalanche	8" collar	Marksman/Sterling Plus	5th leaf
Atrazine	12"	North Star	4-20" broadcast, 20-36" directed
Banvel/Sterling	1 pt 8", 0.5 pt 36", coarse-textured soils 0.5 pt	Option	70 days (grain)
Basagran	None	Permit	36" directed
Basis	2 collar	Pursuit (Clearfield Corn)	45 days
Basis Gold	12"	Resolve	12"
Beacon/Exceed	20" broadcast to 36" directed	Resource	10 leaf
Buctril/Moxy	Pre-tassel	Roundup Original MAX	7 days
Buctril-Atrazine	12"	Roundup Weather MAX	30" or V8, 48" new "event"
Callisto	30" or 8 leaf	Sencor + Basagran	60 days
Celebrity Plus	24"	Spirit	20" broadcast, 24" directed
Clarity	8", coarse-textured soils 0.5 pt	Starane	V5
Distinct	24"	Steadfast	12" or 6 collar
Equip	70 days	Steadfast ATZ	12" or V7
Glyphosate	Consult label	Stinger	24"
Hornet	20", 85 days	Touchdown	30" or V8
Liberty	24" or V7	Touchdown Total	7 days
Liberty ATZ	12"	2,4-D	8" broadcast, pre-tassel directed

POST Herbicides in Soybean

Herbicide	Preharvest Interval or Crop Height Limit
Arrow	60 days
Assure II	80 days
Basagran	30 days for forage or hay
Classic	60 days
Cobra	45 days
FirstRate	Bloom to 50% flowering
Fusilade	Bloom
Fusion	Bloom
Glyphosate	Consult label
Harmony GT	60 days
Liberty	Bloom
Phoenix	45 days
Poast Plus	90 days
Pursuit	85 days
Pursuit Plus	85 days
Raptor	85 days
Reflex/Flexstar	Bloom
Resource	60 days
Roundup Original MAX	7 days
Roundup Weather MAX	Bloom
Scepter	90 days
Select	60 days
Select MAX	60 days
Sequence	90 days
Touchdown	Full bloom
Touchdown Total	14 days
Ultra Blazer	50 days

POST Herbicides in Sorghum

Herbicide	Preharvest Interval or Crop Height Limit
Aim/Avalanche	6 leaf
Ally	Pre-boot
Atrazine	12"
Banvel/Clarity	8", 15" with drops
Basagran	Boot
Buctril	Pre-boot
Buctril-Atrazine	12"
Marksman	8"
Paramount	12"
Paramount + ATZ	12"
Peak	5-30"
Permit	Pre-boot
Starane	V7
2,4-D	8" broadcast, boot directed

Replant Options and Rotation Restrictions¹

Cereal and Broadleaf Crops

Herbicides	Common Name	Field Corn	Seed Corn	Popcorn	Sweet Corn	Winter Wheat	Spring Wheat	Oat	Winter Barley	Spring Barley
AAtrex	atrazine	AT	AT	AT	AT	NCS ^{bi}	2CS	2CS	NCS ^{bi}	2CS
Accent	nicosulfuron	AT	AT	10	10 ^a	4	8	8	4	8
Accent Gold	nicosulfuron + rimsulfuron + clopyralid + flumetsulam	AT	10.5	10.5	18	4	8	8	4	8
Accent Gold WDG	nicosulfuron + rimsulfuron + clopyralid + flumetsulam	AT	10.5	10.5	10.5/18 ^{bk}	4	8	8	4	8
Achieve	tralkoxydim	106 D	106 D	106 D	106 D	1	1	1	1	1
Aim	carfentrazone-ethyl	AT	AT	AT	AT	AT	AT	AT	AT	AT
Ally	metsulfuron	12 ^v	34 ^x	34 ^x	34 ^x	1	1	10	10	10
Amber	triasulfuron	4/14 ^z	4/FBA	4/FBA	4/FBA	AT	AT	6 ^y	6 ^y	6 ^y
Assert	imazamethabenz	NCS	15	15	15	NCS	NCS	15	NCS	NCS
Assure II	quizalofop-P	4	4	4	4	4	4	4	4	4
Authority	sulfentrazone	10	12	18	18	4	4	12	4	4
Avalanche Bulk Pak	see Aim									
Avenge	difenzoquat	NCS	NCS	NCS	NCS	AT	AT	NCS	AT	AT
Axiom	flufenacet + metribuzin	AT	AT	12	12	12	12	12	12	12
Backdraft	imazaquin + glyphosate	NCS/18 ^{bt, bu}	18	18	18	4/18 ^v	4/18 ^v	11/18 ^v	18	18
Balan	benfenin	10	10	10	10	10	10	10	10	10
Balance Pro	isoxaflutole	AT	AT ^s	6	6	4	4	18 ^f	6	6
Banvel	Dimethylamine salt of dicamba	NCS ^g	NCS ^g	NCS ^g	NCS ^g	NCS ^g	NCS ^g	NCS ^g	NCS ^g	NCS ^g
Banvel SGF	Sodium salt of dicamba	NCS ^g	NCS ^g	NCS ^g	NCS ^g	NCS ^g	NCS ^g	NCS ^g	NCS ^g	NCS ^g
Basagran	bentazon	AT	AT	AT	AT	AT	AT	AT	AT	AT
Basis	rimsulfuron + thifensulfuron	AT	18	10	10	4	8/9 ^{ab}	8/9 ^{ab}	4	8/9 ^{ab}
Basis Gold	rimsulfuron + nicosulfuron + atrazine	AT	10	10	10	10	18	18	10	18
Beacon	primisulfuron	14 D ^h	8	8	8	3	8	8	3	8
Betamix	phenmedipham + desmedipham	NI	NI	NI	NI	120 D	120 D	120 D	120 D	120 D
Beyond	imazamox	8.5	8.5	8.5	8.5	0/3 ^{bv}	0/3 ^{bv}	9	4/9/18 ^{bx}	4/9/18 ^{bx}
Bicep II Magnum (FC)	s-metolachlor + atrazine + benoxacor	AT	AT	AT	AT	2CS	2CS	2CS	2CS	2CS
Bicep Lite II Magnum	s-metolachlor + atrazine + benoxacor	AT	AT	AT	AT	2CS	2CS	2CS	2CS	2CS
Blanket	see Authority									
Boundary	s-metolachlor + metribuzin	8	8	8	8	4.5	8	12	4.5	8
Bronate	bromoxynil + MCPA	AT	AT	AT	AT	AT	AT	AT	AT	AT
Bronate Advanced	bromoxynil (octanoic & heptanoic acid) + MCPA	1	1	1	1	1	1	1	1	1
Buctril	bromoxynil	AT	AT	AT	AT	1	1	1	1	1
Buctril + Atrazine	bromoxynil + atrazine	AT	AT	AT	AT	2CS	2CS	2CS	2CS	2CS
Bullet	alachlor + atrazine	NCS	NCS	NCS	NCS	2CS	2CS	2CS	2CS	2CS
Callisto	mesotrione	AT	AT	AT	AT	NCS	120 D	120 D	120 D	120 D
Camix	s-metolachlor + mesotrione	AT	AT	AT	NCS	4.5	NCS	NCS	4.5	4.5
Canopy XL	sulfentrazone + chlorimuron	10 ^{br}	10 ^{br}	10 ^{br}	18 ^{br}	4 ^{br}	4 ^{br}	30 ^{br}	4 ^{br}	4 ^{br}
Canvas	thifensulfuron + tribenuron	12 ^{y, ai}	22/34 ^{ae}	22/34 ^{ae}	22/34 ^{ae}	1 ^y	1 ^y	10 ^y	10 ^y	10 ^y
Celebrity	dicamba + nicosulfuron	AT	AT	10	10	4	8	8	4	8
Celebrity Plus	dicamba + diflufenzopyr + nicosulfuron	7 D	7 D	10	10/15 ^a	4	8	8	4	8
Cinch	see Dual II Magnum									
Cinch ATZ	see Bicep II Magnum									
Cinch ATZ Lite	see Bicep Lite II Magnum									
Clarion	nicosulfuron + rimsulfuron	AT	10	10	10	4	8	8	4	8

¹Months unless otherwise noted. 0 = Days, AT = Any time, NCS = Next Cropping Season; 2CS = Second Cropping Season, 3CS = Third Cropping Season, NTE = No Tolerance Established. See page 138 for additional footnotes.

Rye	Grain Sorghum	Pearl & Proso Millet	Soybean	Canola	Buckwheat	Sunflower	Sugarbeet	Dry bean	Pea & Snap Bean	Potato	Alfalfa	Red Clover	Cotton	Tobacco
NCS ^{bi} 4	AT 10/18 ^b	2CS 10/18 ^b	NCS ^d 15 D	2CS 10/18 ^b	2CS 10/18 ^b	2CS 11/18 ^b	2CS 10/18 ^c	2CS 10	2CS 10	2CS 10/18 ^c	2CS 12	2CS 12	2CS 10	2CS 10/18 b
4	12	26/FBA	10.5	26/FBA	26/FBA	18	26/FBA	10.5	18	18	10.5	26/FBA	26/FBA	26/FBA
4 1	12 106 D	26 FBA 106 D	10.5/18 ^{bp} 106 D	26 FBA 106 D	26 FBA 106 D	18 106 D	26 FBA 106 D	10.5/18 ^{bp} 106 D	10.5/18 ^{bp} 106 D	18 106 D	10.5/12 ^{bq} 106 D	26 FBA 106 D	18 106 D	18 106 D
AT 34 ^x 6 ^y 15 4	AT 10 14 ^y 15 4	AT 10 4 15 4	AT 22/34 11/36 ^{aa} NCS AT	12 34 ^x 4/FBA 15 AT	AT 34 ^x 4/FBA 15 4	AT 22 24/FBA NCS 4	AT 34 ^x 24/FBA 20 AT	AT 34 ^x 4/FBA NCS AT	AT 34 ^x 4/FBA 15 AT	AT 34 ^x 4/FBA 15 4	12 34 ^x 4/FBA 15 4	12 34 ^x 4/FBA 15 4	AT 34 x 4/FBA 15 AT	AT 34 x 4/FBA 15 4
4	10/18	12	AT	30	12	AT	30	12	AT	12	12	18	18	AT
NCS 12 18	NCS 12 11	NCS 12 18	NCS AT AT	NCS 12 26	NCS 12 18	NCS 12 18	NCS 18 40	NCS 12 18	NCS 12 18	NCS 1 26	NCS 12 18	NCS 12 18	NCS 12 18	NCS 12 11
10 18 ^f NCS ^g NCS ^g AT	10 6 NCS ^g NCS ^g AT	10 18 ^f NCS ^g NCS ^g AT	AT 6 NCS ^g NCS ^g AT	AT 18 ^f NCS ^g NCS ^g AT	AT 18 ^f NCS ^g NCS ^g AT	AT 6 NCS ^g NCS ^g AT	10 18 ^f NCS ^g NCS ^g AT	AT 18 ^f NCS ^g NCS ^g AT	AT 18 ^f NCS ^g NCS ^g AT	10 6 NCS ^g NCS ^g AT	AT 10 ^f NCS ^g NCS ^g AT	AT 18 ^f NCS ^g NCS ^g AT	AT 18 f NCS ^g NCS ^g AT	AT 18 f NCS ^g NCS ^g AT
4 10 3 120 D 4	10 10 8 NI 9	18 18 8 NI 9	15 D/10 ^{ab} 10 8 NI AT	18 18 18* NI 0/26	18 18 18* NI 18	10 18 8 NI 9	10 18 18* NI 26/18 ^{bw}	8/10 ^{ab} 18 8 NI 18	8/10 ^{ab} 18 8 NI 18	AT 18 8 I NI 18/9 ^{bw}	10 18 8 NI 3	18 18 18* NI 18	18 10 8 NI 9	18 18 8 NI 9
2CS 2CS	AT ^j AT ^j	2CS 2CS	NCS ^{e,k} NCS ^{e,k}	2CS 2CS	2CS 2CS	2CS 2CS	2CS 2CS	2CS 2CS	2CS 2CS	2CS 2CS	2CS 2CS	2CS 2CS	NCS NCS	2CS 2CS
12 AT	12 AT	12 AT	AT ^s AT	12 AT	12 AT	12 AT	18 AT	12 AT	8 AT	8 AT	4.5 AT	12 AT	8 AT	12 AT
1 1 2CS 2CS	1 1 NCS NCS	1 1 2CS NI	1 1 NCS** NCS ^l	1 1 2CS 2CS	1 1 2CS 2CS	1 1 2CS 2CS	1 1 2CS 2CS	1 1 2CS 2CS	1 1 2CS 2CS	1 1 2CS 2CS	1 1 2CS 2CS	1 1 2CS 2CS	1 1 2CS 2CS	1 1 2CS 2CS
120 D 4.5 4 ^{br} 10 ^y 4	NCS NCS 10 ^{br} 4/10 ^{y,ak} 10/18 ^b	18 18 30 ^{br} 10 ^y 10/18 ^c	NCS ^d NCS ^d AT ^{br} 22/34 ^{aj} 1	NCS 18 30 ^{br} 34 ^x 10/18 ^c	18 18 30 ^{br} 22/34 ^{ae} 10/18 ^c	NCS 18 18 ^{br} 22 ^y 11/18 ^c	18 18 30 ^{br} 22/34 ^{ae} 10/18 ^c	18 18 12 ^{br} 10/22 ^{ak,al} 10	18 18 30 ^{br} 10/22 ^{ak,al} 10	NCS NCS 30 ^{br} 22/34 ^{ae} 10/18 ^c	18 18 12 ^{br} 10/22 ^{ak,al} 12	18 18 18 ^{br} 22/34 ^{ae} 12	NCS NCS 18 br 10 y ak 10	NCS 18 30 br 22/34 ^{ae} 10/18 ^c
4	10/18 ^b	10/18 ^c	4	10/18 ^c	10/18 ^c	11/18 ^c	10/18 ^c	10	10	10/18 ^c	12	12	10	10/18 ^c
8	10	18	15 D	18	18	11	10	10	10	18	12	18	10	18

Replant Options and Rotation Restrictions¹

Cereal and Broadleaf Crops (continued)

Herbicides	Common Name	Field Corn	Seed Corn	Popcorn	Sweet Corn	Winter Wheat	Spring Wheat	Oat	Winter Barley	Spring Barley
Clarity	dicamba-glycolamine	NCS	NCS	NCS	NCS	NCS ^m	NCS ^m	NCS ^m	NCS ^m	NCS ^m
Classic	chlorimuron	8/9 ^{ad}	8/9 ^{ad}	15/9 ^v	9	3	3	3	3	3
Cobra	lactofen	AT	AT	AT	AT	AT	AT	AT	AT	AT
Commit 3ME	clomazone	9	9/12 ^{ae}	9	9/12 ^{ae}	12	12	16	16	16
Confidence	see Harness									
Confidence Xtra	see Harness Xtra									
Confidence Xtra 5.6L	see Harness Xtra 5.6L									
Connect SP	Octanoic acid ester of bromoxynil	1	1	1	1	1	1	1	1	1
Curbit EC	ethalfluralin	NCS	NCS	NCS	NCS	NCS	NCS	NCS	NCS	NCS
Curtail	clopyralid + 2,4-D	1	10.5	10.5	10.5	1	1	1	1	1
Curtail M	clopyralid + MCPA	1	10.5	10.5	10.5	1	1	1	1	1
Define	flufenacet	AT	AT	12	12	12	12	12	12	12
Degree	acetochlor + safener	AT	AT	AT	AT	NCS	NCS	2CS	2CS	2CS
Degree Xtra	acetochlor + atrazine + safener	AT	AT	AT	AT	2CS	2CS	2CS	2CS	2CS
Distinct	diflufenzopyr + dicamba	7 D	4	4	4	4	4	4	4	4
Domain	flufenacet + metribuzin	1	2CS	2CS	2CS	12	12	2CS	12	12
DoublePlay	EPTC + acetochlor + safener	NCS	NCS	NCS	2CS	4	4	2CS	2CS	2CS
Dual II Magnum	s-metolachlor + benoxacor	AT	AT	AT	AT	4.5	4.5	4.5	4.5	4.5
Epic	flutenacet + isoxaflutole	AT	2CS	12	2CS	12	12	12	12	12
Eptam	EPTC	NCS	NCS	NCS	NCS	NCS	NCS	NCS	NCS	NCS
Eptek	see Eptam									
Equip	foramsulfuron + iodosulfuron-methyl-sodium	15 D	18/FBA	15 D	15 D	2	8	9	2	8
Eradicane	EPTC + safener	AT	AT	AT	AT	NCS	NCS	NCS	NCS	NCS
Everest	flucarbazone-sodium	NI	NI	NI	NI	4	4	NI	11	11
Exceed	prosulfuron + primisulfuron	1h	3 ^{an}	3 ^{an}	3 ^{an}	3 ^{an}	3 ^{an}	3 ^{an}	3 ^{an}	3 ^{an}
Expert	s-metolachlor + benoxacor + atrazine + glyphosate	AT	NCS	NCS	NCS	NCS	2CS	2CS	NCS	2CS
Extreme	imazethapyr + glyphosate	AT/8.5 ^{ad}	AT/8.5 ^{ad}	18	18	4	4	18	9.5	9.5
Field Master	acetochlor + atrazine + glyphosate	AT	AT	AT	AT	2CS	2CS	2CS	2CS	2CS
Finesse	chlorsulfuron + metsulfuron	11/36 ^v	FBA	FBA	FBA	0/4 ^{ae}	0/4 ^{ae}	10	10/16 ^{ae}	10/16 ^{ae}
FirstRate	cloransulam methyl	9	9 ^s	9	18	3	3	30/FBA30/FBA	30/FBA	30/FBA
Flexstar	fomesafen	10	10	10	10	4	4	4	4	4
Frontier	dimethenamid	AT	AT	AT	AT	4	NCS	NCS	4	NCS
FulTime	encapsulated acetochlor + atrazine + safener	AT	AT	AT	AT	15	15	2CS	2CS	2CS
Fusilade DX	fluazifop-P	2	2	2	2	2	2	2	2	2
Fusion	fluazifop-P + fenoxaprop	2	2	2	2	2	2	2	2	2
G-Max Lite	dimethenamid + atrazine	AT	AT	AT	AT	2CS	2CS	2CS	2CS	2CS
Galaxy	benzaton + acifluorfen	NCS	NCS	NCS	NCS	NCS	NCS	NCS	NCS	NCS
Gangster FR	see FirstRate									
Gangster V	see Valor									
Glean	chlorsulfuron	24/36 ^{bn}	FBA	FBA	FBA	0/4 ^{bm}	0/4 ^{bm}	10	10/16 ^{bm}	10/16 ^{bm}
glyphosate	glyphosate	AT	AT	AT	AT	AT	AT	AT	AT	AT
Goal	oxyfluorfen	10	10	10	10	10	10	10	10	10
Gramoxone Max	paraquat	AT	AT	AT	AT	AT	AT	AT	AT	AT
Guardsman	dimethenamid + atrazine	AT	AT	AT	AT	2CS	2CS	2CS	2CS	2CS
Guardsman Max	dimethenamid-P + atrazine	AT	AT	AT	AT	2CS	2CS	2CS	2CS	2CS
Harmony Extra & XP	thifensulfuron + tribenuron	45 D	45 D	45 D	45 D	AT	AT	AT	AT	AT
Harmony GT & XP	thifensulfuron	AT	45 D	45 D	45 D	AT	AT	AT	AT	AT
Harness	acetochlor + MON4660 safener	AT	AT	AT	NCS	NCS	NCS	2CS	2CS	2CS

¹Months unless otherwise noted. 0 = Days, AT = Any time, NCS = Next Cropping Season; 2CS = Second Cropping Season, 3CS = Third Cropping Season, NTE = No Tolerance Established. See page 138 for additional footnotes.

Rye	Grain Sorghum	Pearl & Proso Millet	Soybean	Canola	Buckwheat	Sunflower	Sugarbeet	Dry bean	Pea & Snap Bean	Potato	Alfalfa	Red Clover	Cotton	Tobacco
NCS ^m 3 AT 16	NCS 15/9 ^v AT 9	NI 30 AT 16	NCS AT AT AT	2CS 18 AT 16	2CS 30 AT 16	2CS 9/12 ^v AT 16	2CS 30 AT 9	2CS 9 AT 9	2CS 9 AT 9	2CS 30 AT 9	2CS 9/12 ^v AT 16	2CS 9/12 ^v AT 16	NCS 9 AT AT	2CS 15/9 ^v AT AT
1 NCS 1	1 NCS 10.5	1 NCS 18	1 AT 10.5/18 ^{ah}	1 NCS 10.5	1 NCS 18	1 AT 10.5/18 ^{ah}	1 8/13 ^{ac,u} NCS	1 AT 10.5/18 ^{ah}	1 NCS 18	1 NCS 18	1 NCS 10.5	1 NCS 18	1 NCS 18	1 NCS 18
1 12 2CS 2CS 4	10.5 12 NCS NCS** 4	18 12 2CS 2CS 4	10.5/18 ^{ah} AT NCS NCS** 4	10.5 12 2CS 2CS 4	18 12 2CS 2CS 4	10.5/18 ^{ah} 12 2CS 2CS 4	5 4 2CS 2CS 4	10.5/18 ^{ah} 12 2CS 2CS 4	18 12 2CS 2CS 4	18 1 2CS 2CS 4	10.5 12 2CS 2CS 4	18 12 2CS 2CS 4	18 4 2CS 2CS 4	18 12 NCS 2CS 4
12 2CS 4.5 12 NCS	12 NCS AT 12 NCS	2CS 2CS NI 12 NCS	AT NCS AT 6 NCS	2CS 2CS NCS 2CS NCS	12 2CS NCS 12 NCS	2CS 2CS NCS 12 AT	2CS 2CS NCS 12 AT	2CS 2CS AT 2CS NCS	2CS 2CS AT 2CS NCS	1 2CS AT 6 AT	12 2CS 4 12 AT	12 2CS 9 12 AT	2CS 2CS AT 6 NCS	2CS NCS NCS 2CS NCS
2 NCS NI 3 ^{an}	9 NCS NI 10 ^{an}	18/FBA NCS NI 10 ^{an}	9 NCS NI 18 ⁿ	18 NCS 11 18 ^{an}	18/FBA NCS NI 18 ^{an}	18 NCS NI 18 ^{an}	18 NCS NI 18 ^{an}	18 NCS NI 18 ⁿ	18 NCS NI 10 ^{an}	18 NCS 12 18 ^{an}	18 NCS NI 18 ^{an}	18 NCS NI 18 ^{an}	9/18 ^{xx} NCS NI 18 ^{an}	18/FBA NCS NI 18 ⁿ
2CS 4 2CS 0/4 ^{ac}	AT 18 NCS 14/24/36 ^v	2CS 40/FBA 2CS 11/36 ^v	NCS AT NCS1 14/24/36 ^v	2CS 40/FBA 2CS FBA	2CS 40/FBA 2CS FBA	NI 18 2CS FBA	2CS 40/FBA 2CS FBA	2CS 40/FBA 2CS FBA	2CS 4 2CS FBA	2CS 26 2CS FBA	2CS 4.5 2CS FBA	2CS 40/FBA 2CS FBA	NCS 18 2CS FBA	2CS 9.5 2CS FBA
30/FBA 4 4	9 18 AT	30/FBA 18 NCS	AT 18 AT	30/FBA 18 NCS	30/FBA 18 NCS	30/FBA 18 NCS	30/FBA 18 NCS	9 18 AT	9 18 NCS	30/FBA 18 NCS	9 18 NCS	30/FBA 18 NCS	9 18 NCS	30/FBA 18 NCS
2CS 2 2 2CS NCS	NCS 2 2 AT NCS	2CS 2 2 2CS NCS	NCS** AT AT NCS ^e AT	2CS AT AT 2CS NCS	2CS AT AT 2CS NCS	2CS AT AT 2CS NCS	2CS AT AT 2CS 18	2CS AT AT 2CS NCS	2CS AT AT 2CS NCS	2CS AT AT 2CS 18	2CS AT AT 2CS NCS	2CS AT AT 2CS NCS	2CS AT AT NCS NCS	NCS** AT AT 2CS NCS
0/4 ^{bm} AT 10 AT	14/24/36 ^{bn} AT 10 AT	24/36 ^{bn} AT 10 AT	14/26/36 ^{bn} AT 1 AT	FBA AT NI AT	FBA AT 10 AT	FBA AT NI AT	FBA AT 3 AT	FBA AT 2 AT	FBA AT 2 AT	FBA AT 2 AT	FBA AT 2 AT	FBA AT 2 AT	FBA AT 1 AT	FBA 1 NI AT
2CS 2CS 45 D 45 D 2CS	AT AT 45 D 45 D NCS	2CS 2CS 45 D 45 D 2CS	NCS ^e NCS ^e 45 D AT NCS	2CS 2CS 60 D 45 D 2CS	2CS 2CS 45 D 45 D 2CS	2CS 2CS 45 D 45 D 2CS	2CS 2CS 60 D 45 D 2CS	2CS 2CS 45 D 45 D 2CS	2CS 2CS 45 D 45 D 2CS	2CS 2CS 45 D 45 D 2CS	2CS 2CS 45 D 45 D 2CS	2CS 2CS 45 D 45 D 2CS	NCS NCS 45 D 45 D 2CS	2CS 2CS 45 D 45 D NCS

Replant Options and Rotation Restrictions¹

Cereal and Broadleaf Crops (continued)

Herbicides	Common Name	Field Corn	Seed Corn	Popcorn	Sweet Corn	Winter Wheat	Spring Wheat	Oat	Winter Barley	Spring Barley
Harness Xtra	acetochlor + Mon 4660 + atrazine	AT	AT	AT	NCS	NCS	NCS	2CS	2CS	2CS
Harness Xtra 5.6L	acetochlor + Mon 4660 + atrazine	AT	AT	AT	NCS	2CS	2CS	2CS	2CS	2CS
Hornet & WDG	flumetsulam + clopyralid	AT/14 D ^{eh}	NCS	10.5	10.5/18 ^q	4	4	4	4	4
Journey	imazapic + glyphosate	9	26	26	18	4	4	18	18	18
Karmex DF	diuron	12/24 ^{ae}	12/24 ^{ae}	12/24 ^{ae}	12/24 ^{ae}	12/24 ^{ae}	12/24 ^{ae}	12/24 ^{ae}	12/24 ^{ae}	12/24 ^{ae}
Keystone	acetochlor + dichlormid safener + atrazine	AT	AT	AT	2CS	15	15	2CS	2CS	2CS
Keystone LA	acetochlor + dichlormid safener + atrazine	AT	AT	AT	2CS	15	15	2CS	2CS	2CS
Laddok S-12	bentazon + atrazine	AT	AT	AT	AT	2CS	2CS	NCS ^e	2CS	2CS
Landmaster BW	glyphosate + 2,4-D amine	AT	AT	AT	AT	AT	AT	AT	AT	AT
Lariat	alachlor + atrazine	AT	AT	AT	AT	2CS	2CS	2CS	2CS	2CS
Lasso	alachlor	AT	AT	AT	AT	NCS	NCS	NCS	NCS	NCS
Lexar	s-metolachlor + atrazine + mesotrione	AT	AT	AT	NCS	NCS	NCS	NCS	NCS	NCS
Liberty	glufosinate	AT	AT	AT	AT	70 D	70 D	70 D	70 D	70 D
Liberty ATZ	glufosinate + atrazine	AT	NCS ^r	NCS ^r	NCS ^r	NCS ^r	NCS ^r	NCS ^r	NCS ^r	NCS ^r
Lightning	imazethapyr + imazapyr	8.5 ^h	8.5 ^h	18	18	4	4	18	9.5	9.5
Lumax	s-metolachlor + atrazine + mesotrione	AT	AT	NCS	NCS	4.5	NCS	2CS	4.5	4.5
Manifest	bentazon + acifluorfen + sethoxydim	NCS	NCS	NCS	NCS	NCS	NCS	NCS	NCS	NCS
Marksman	dicamba + atrazine	AT	AT ^s	AT ^s	2CS	10 ^e	10 ^e	10 ^e	10 ^e	10 ^e
Matrix	rimsulfuron	AT ^{bc}	AT ^{bc}	10 ^{bc}	10 ^{bc}	4 ^{bc}	9 ^{bc}	9 ^{bc}	18	9 ^{bc}
Maverick PRO	sulfosulfuron	12/FBA	12/FBA	12/FBA	12/FBA	AT	AT	12/FBA	12/FBA	12/FBA
MCPA	MCPA	0/3 ^{ae}	0/3 ^{ae}	0/3 ^{ae}	0/3 ^{ae}	0/3 ^{ae}	0/3 ^{ae}	0/3 ^{ae}	0/3 ^{ae}	0/3 ^{ae}
Me-Too-Lachlor II	metolachlor + safener	AT	12	AT	AT	4.5	4.5	4.5	4.5	4.5
metribuzin	metribuzin	4	4	4	4	8 ^{ax}	8 ^{ax}	18	8 ^{ax}	8 ^{ax}
Micro-Tech	alachlor (micro-encapsulated)	AT	AT	AT	AT	NCS	NCS	NCS	NCS	NCS
Moxy	bromoxynil	AT	AT	AT	AT	AT	AT	AT	AT	AT
NorthStar	primisulfuron + dicamba	14 D ^h	8 ^s	8	8	3 ^{**}	8	8	3 ^{**}	8
Nortron	ethofumesate	6/12 ^{bb}	6/12 ^{bb}	6/12 ^{bb}	6/12 ^{bb}	6/12 ^{bb}	6/12 ^{bb}	6/12 ^{bb}	6/12 ^{bb}	6/12 ^{bb}
lympus	propoxycarbazone-sodium	18	FBA	FBA	FBA	0	0	24	FBA	FBA
Olympus FLEX	propoxycarbazone + mesosulfuron	18	FBA	FBA	FBA	0	0	FBA	FBA	FBA
Option	foramsulfuron	7 D	2	2	2	2	2	2	2	2
Osprey	mesosulfuron-methyl	12	12	12	12	7 D	7 D	10	1	1
Outlook	dimethenamid-P	AT	AT	AT	AT	4	NCS	NCS	4	NCS
Paramount	quinclorac	10	10	10	10	AT	AT	10	10	10
Peak t	prosofuron	1 h	10	10	10	AT	AT	AT	AT	AT
Pendimax	pendimethalin	NCS	NCS	NCS	NCS	4	NCS	NCS	4	NCS
Permit	halosulfuron	1 h	2	3	3	2	2	2	2	2
Phoenix	lactofen	1	1	1	1	1	1	1	1	1
Plateau	ammonium salt of imazapic	9 ^{bo}	26 ^{bo}	26 ^{bo}	18 ^{bo}	4 ^{bo}	4 ^{bo}	18 ^{bo}	18 ^{bo}	18 ^{bo}
Poast	sethoxydim	4 ^{bf}	4	4	4	4	4	4	4	4
Poast Plus	sethoxydim	AT	AT	AT	AT	AT	AT	AT	AT	AT
Prefar	bensulide	4 ^{be}	4 ^{be}	4 ^{be}	4 ^{be}	4 ^{be}	4 ^{be}	4 ^{be}	4 ^{be}	4 ^{be}
Princep	simazine	NCS	2CS	2CS	2CS	2CS	2CS	2CS	2CS	2CS
Priority	carfentrazone-ethyl + halosulfuron-methyl	1	2	3	3	2	2	2	2	2
Prism	clethodim	1	1	1	1	1	1	1	1	1
Prowl (EC, H2O)	pendimethalin	NCS	NCS	NCS	NCS	4 ^{**}	NCS	NCS	4 ^{**}	NCS
Pursuit	imazethapyr	8.5 ^h	8.5	18	18	4	4	18	9.5	9.5
Pursuit Plus	imazethapyr + pendimethalin	0/8.5 ^{ad,ar}	8.5 ^s	18	18	4	4	18	9.5	9.5
Python	flumetsulam	AT	AT	9	10.5/18 ^s	4	4	4	4	4
Radius	flutenacet + isoxaflutole	AT	18	12	12	12	12	18	12	12
Raptor	imazamox	8.5	8.5	8.5	8.5	3	3	9	4	4

¹Months unless otherwise noted. 0 = Days, AT = Any time, NCS = Next Cropping Season; 2CS = Second Cropping Season, 3CS = Third Cropping Season, NTE = No Tolerance Established. See page 138 for additional footnotes.

Rye	Grain Sorghum	Pearl & Proso Millet	Soybean	Canola	Buckwheat	Sunflower	Sugarbeet	Dry bean	Pea & Snap Bean	Potato	Alfalfa	Red Clover	Cotton	Tobacco
2CS	NCS	2CS	NCS ^{1**}	2CS	2CS	2CS	2CS	2CS	2CS	2CS	2CS	2CS	2CS	NCS
2CS	NCS	2CS	NCS ^{1**}	2CS	2CS	2CS	2CS	2CS	2CS	2CS	2CS	2CS	2CS	2CS
4	12	NI	10.5/18 ^P	26/FBA	26/FBA	18	26/FBA	10.5/18 ^P	10.5/18 ^P	18	10.5/18 ^P	10.5/18 ^P	18	18
4	18	26	9	40	26	26	40	26	9	40	26	26	26	9
12/24 ^{ae}	12/24 ^{ae}	12/24 ^{ae}	12/24 ^{ae}	12/24 ^{ae}	12/24 ^{ae}	12/24 ^{ae}	12/24 ^{ae}	12/24 ^{ae}	12/24 ^{ae}	12/24 ^{ae}	12/24 ^{ae}	12/24 ^{ae}	12/24 ^{ae}	12/24 ^{ae}
2CS	NCS	2CS	2CS	2CS	2CS	2CS	2CS	2CS	2CS	2CS	2CS	2CS	2CS	2CS
2CS	NCS	2CS	2CS	2CS	2CS	2CS	2CS	2CS	2CS	2CS	2CS	2CS	2CS	2CS
2CS	AT	2CS	2CS	2CS	2CS	2CS	2CS	2CS	2CS	2CS	2CS	2CS	2CS	2CS
AT	AT	3	3	3	3	3	3	3	3	3	3	3	3	3
2CS	AT ^j	2CS	NCS ^{1**}	2CS	2CS	2CS	2CS	2CS	2CS	2CS	2CS	2CS	2CS	2CS
NCS	AT ^j	NCS	AT	NCS	NCS	NCS	NCS	NCS	NCS	NCS	NCS	NCS	NCS	NCS
NCS	NCS	18	NCS ^d	18	18	18	18	18	18	18	18	18	NCS	18
70 D	70 D	70 D	AT	4	70 D	4	AT	4	4	4	4	4	4	4
NCS ^r	NCS	NCS ^r	NCS ^{r,e,k}	NCS ^r	NCS ^r	NCS ^r	NCS ^r	NCS ^r	NCS ^r	NCS ^r	NCS ^r	NCS ^r	NCS ^r	NCS ^r
4	18	NI	9	40/FBA	40/FBA	18	40/FBA	40/FBA	9.5	26	9.5	NI	18	9.5
4.5	NCS	2CS	NCS ^d	2CS	2CS	2CS	2CS	2CS	2CS	2CS	2CS	2CS	2CS	2CS
NCS	NCS	NCS	AT	NCS	NCS	NCS	18	NCS	NCS	18	NCS	NCS	NCS	NCS
10 ^e	AT	2CS	NCS ^e	2CS	2CS	2CS	2CS	2CS	2CS	2CS	2CS	2CS	2CS	2CS
18	18	18	4 ^{bc}	18	18	10 ^{bc}	18	10 ^{bc}	10 ^{bc}	AT	18	18	18	18
12/FBA	12/FBA	12/FBA	12/FBA	12/FBA	12/FBA	12/FBA	12/FBA	12/FBA	12/FBA	12/FBA	12/FBA	12/FBA	12/FBA	12/FBA
0/3 ^{ae}	0/3 ^{ae}	0/3 ^{ae}	0/3 ^{ae}	0/3 ^{ae}	0/3 ^{ae}	0/3 ^{ae}	0/3 ^{ae}	0/3 ^{ae}	0/3 ^{ae}	0/3 ^{ae}	0/3 ^{ae}	0/3 ^{ae}	0/3 ^{ae}	0/3 ^{ae}
4.5	NCS	NCS	NCS	12	NCS	12	12	12	12	12	4	9	NCS	12
18	18	18	AT	18	18	18	18	18	18	18	4	18	18	18
NCS	AT ^j	NCS	AT	NCS	NCS	NCS	NCS	AT	NCS	NCS	NCS	NCS	NCS	NCS
AT	AT	AT	NCS	NCS	NCS	NCS	NCS	NCS	NCS	NCS	NCS	NCS	NCS	NCS
3 ^{**}	8 ^{**}	18 [*]	8	18 [*]	18 [*]	8 ^{**}	18 [*]	8	8	8	8 ^{**}	18 [*]	8	8
6/12 ^{bb}	6/12 ^{bb}	6/12 ^{bb}	6/12 ^{bb}	6/12 ^{bb}	6/12 ^{bb}	6/12 ^{bb}	AT	6/12 ^{bb}	6/12 ^{bb}	6/12 ^{bb}	6/12 ^{bb}	6/12 ^{bb}	6/12 ^{bb}	6/12 ^{bb}
FBA	12	4	4/12	FBA	24	12	24	FBA	FBA	FBA	FBA	FBA	12	FBA
FBA	12	4	12	FBA	FBA	FBA	FBA	FBA	FBA	FBA	FBA	FBA	FBA	FBA
2	2	2	14 D	2	2	2	2	2	2	2	2	2	2	2
10	10	10	3	10	10	1	10	3	3	10	10	10	3	10
4	AT	NCS	AT	NCS	NCS	NCS	NCS	AT	NCS	NCS	NCS	NCS	NCS	NCS
10	AT	10	10	10	10	10	24/FBA	10	24/FBA	24/FBA	24/FBA	24/FBA	10	24/FBA
AT	1	1	22	22	22	22	22	22	10	22	22	22	22	22
NCS	NCS	NCS	NCS	NCS	NCS	NCS	12 ^u	NCS	NCS	NCS	NCS	NCS	NCS	NCS
2	2	2	9	15		18	36	9	9	9	9	9	4	NI
1	1	1	AT	1	1	1	1	1	1	1	1	1	1	1
4 ^{bo}	18 ^{bo}	26 ^{bo}	9 ^{bo}	40 ^{bo}	26 ^{bo}	26 ^{bo}	40 ^{bo}	26 ^{bo}	26 ^{bo}	40 ^{bo}	26 ^{bo}	26 ^{bo}	18 ^{bo}	9 ^{bo}
4	4	4	AT	4	4	AT	AT	AT	AT	AT	AT	AT	4	AT
AT	AT	AT	AT	AT	AT	AT	AT	AT	AT	AT	AT	AT	AT	AT
4 ^{be}	4 ^{be}	4 ^{be}	4 ^{be}	4 ^{be}	4 ^{be}	4 ^{be}	4 ^{be}	4 ^{be}	4 ^{be}	4 ^{be}	4 ^{be}	4 ^{be}	AT	4 ^{be}
2CS	2CS	2CS	2CS	2CS	2CS	2CS	2CS	2CS	2CS	2CS	2CS	2CS	2CS	2CS
12	2	12	9	15	NI	18	24	12	12	12	12	12	4	NI
1	1	1	AT	1	1	1	AT	AT	1	1	AT	1	AT	1
NCS	NCS	NCS	NCS	NCS	NCS	NCS	12 ^u	NCS	NCS	NCS	NCS	NCS	NCS	NCS
4	18	40/FBA	AT	40/FBA	40/FBA	18	40/FBA	40/FBA	4	26	4	40/FBA	18	9.5
9.5	18	40/FBA	AT	40/FBA	40/FBA	18	40/FBA	40/FBA	4	26	9.5	40/FBA	18	9.5
4	12	26/FBA	AT	26/FBA	26/FBA	18	26/FBA	4	4	12	4	26/FBA	18	9
12	12	18	6	18	18	18	18	18	18	6	12	18	18	18
4	9	18	AT	18	18	9	18-26 ^{as}	18	9	9	9	18	9	9

Replant Options and Rotation Restrictions¹

Cereal and Broadleaf Crops (continued)

Herbicides	Common Name	Field Corn	Seed Corn	Popcorn	Sweet Corn	Winter Wheat	Spring Wheat	Oat	Winter Barley	Spring Barley
Rave	triasulfuron + Na salt of dicamba	4/36 ^{at}	4/36 ^{at}	4/36 ^{at}	4/36 ^{at}	12 D	12 D	6 ^y	6 ^y	6 ^y
Ready Master ATZ	glyphosate + atrazine	AT	AT	AT	AT	2CS	2CS	2CS	2CS	2CS
Reflex	fomesafen	10	10	10	10	4	4	4	4	4
Resolve	rimsulfuron	AT	18	10	10	4	9	9	18	9
Resource	flumiclorac	1	NCS	NCS	NCS	4	4	4	4	4
Ro-Neet	cycloate	NCS	NCS	NCS	NCS	NCS	NCS	NCS	NCS	NCS
Roundup OriginalMax	glyphosate (double check columns)	AT	AT	AT	AT	AT	AT	AT	AT	AT
Roundup WeatherMAX	glyphosate	AT	AT	AT	AT	AT	AT	AT	AT	AT
Scepter	imazaquin	9.5/18 ^{v,ad}	18	18	18	4/18 ^v	4/18 ^v	11/18 ^v	11/18 ^v	11/18 ^v
Select	clethodim	1	1	1	1	1	1	1	1	1
Select MAX	clethodim									
Sencor	metribuzin	4	4	4	4	8 ^{ax}	8 ^{ax}	12	8 ^{ax}	8 ^{ax}
Sequence	s-metolachlor + glyphosate	AT	AT	AT	AT	4.5	4.5	4.5	4.5	4.5
Silverado wild oat herbicide	mesosulfuron-methyl	12	12	12	12	7 D	7 D	10	1	1
Sinbar	terbacil	24	24	24	24	24	24	24	24	24
Sonalan HFP	ethalfuralin	NCS	NCS	NCS	NCS	NCS	NCS	NCS	NCS	NCS
Spartan	sulfentrazone	10	12	18	18	4	4	12	4	4
Spirit	proflsulfuron + primisulfuron	1 h	8	8	8	3	3	3	3	3
Squadron	imazaquin + pendimethalin	9.5/18 ^{ad,v}	18	18	18	4/18 ^v	4/18 ^v	18	18	18
Stalwart (C)	metolachlor	AT	12	AT	12	4.5	4.5	4.5	4.5	4.5
Stalwart Xtra	metolachlor + atrazine	AT	NCS	AT	NCS	18	2CS	2CS	2CS	2CS
Starane	fluroxypr	NCS	NCS	NCS	NCS	4	4	4	4	4
Steadfast	nicosulfuron + rimsulfuron	AT	10	10	10	4	8	8	4	8
Steadfast ATZ am	nicosulfuron + rimsulfuron + atrazine	AT	10	10	10 a	10	18	18	10	18
Steel	imazaquin + imazethapyr + pendimethalin	9.5/18 ^{ad,v}	18/26 ^{v,s}	18/26 ^v	18/26 ^v	4/18 ^v	4/18 ^v	18	11/18 ^v	11/18 ^v
Stellar	flumiclorac + lactofen	AT	1	1	1	4	4	4	4	4
Stinger	clopyralid	AT	AT	10.5	10.5	AT	AT	AT	AT	AT
Storm	bentazon + acifluorfen	NCS	NCS	NCS	NCS	NCS	NCS	NCS	NCS	NCS
Surpass	acetochlor + dichlormid safener	AT	AT	AT	2CS	4	4	2CS	2CS	2CS
Synchrony STS	chlorimuron + thifensulfuron	8/9 ^{v,ad}	NI	9	18	3	3	3	3	3
TopNotch	acetochlor + safener	AT	AT	AT	2CS	4	4	2CS	2CS	2CS
Tordon 22K	picloram	FBA	FBA	FBA	FBA	NCS	NCS	NCS	NCS	NCS
Touchdown Form:	glyphosate	AT	AT	AT	AT	AT	AT	AT	AT	AT
Treflan HFP	trifluralin	NCS	NCS	NCS	NCS	NCS	NCS	12/18 ^{ba}	NCS	NCS
Trifluralin	trifluralin	NCS	NCS	NCS	NCS	NCS	NCS	12/18 ^{ba}	NCS	NCS
Trizmet II	metolachlor + atrazine + safener	AT	NCS	NCS	NCS	18	2CS	2CS	2CS	2CS
Ultra Blazer	acifluorfen	AT	AT	AT	AT	AT	AT	AT	AT	AT
UpBeet	triflusulfuron methyl	21 D	21 D	21 D	21 D	14 D	14 D	14 D	14 D	14 D
Valor	flumioxazin	1/2 ^{bl}	12/FBA	12/FBA	4	1/2 ^{bl}	1/2 ^{bl}	12/FBA	4	4
Velpar	hexazinone	12 ^{bg}	24	24	24	24	24	24	24	24
Volley	acetochlor + dichlormid safener	AT	AT	AT	2CS	4	4	2CS	2CS	2CS
Volley ATZ	acetochlor + dichlormid safener + atrazine	AT	AT	AT	2CS	15	15	2CS	2CS	2CS
Volley ATZ Lite	acetochlor + dichlormid safener + atrazine	AT	AT	AT	2CS	15	15	2CS	2CS	2CS
Widematch	clopyralid + fluroxypr	AT	NI	4	AT	AT	AT	AT	AT	AT
Widematch M	clopyralid + fluroxypr + MCPA	AT	NI	4	AT	AT	AT	AT	AT	AT
Yukon	halosulfuron-methyl + dicamba	0/1 ^{bs}	2	3	3	2	2	2	2	2
Zorial Rapid 80	norflurazon	16	16	16	16	16	16	16	16	16
2,4-D ester	2,4-D	7/14 D	NCS	NCS	NCS	NCS	NCS	NCS	NCS	NCS
2,4-D amine	2,4-D	7/14 D	NCS	NCS	NCS	3	NCS	NCS	3	NCS
2,4-DB	2,4-DB									

¹Months unless otherwise noted. 0 = Days, AT = Any time, NCS = Next Cropping Season; 2CS = Second Cropping Season, 3CS = Third Cropping Season, NTE = No Tolerance Established.
See page 138 for additional footnotes.

Rye	Grain Sorghum	Pearl & Proso Millet	Soybean	Canola	Buckwheat	Sunflower	Sugarbeet	Dry bean	Pea & Snap Bean	Potato	Alfalfa	Red Clover	Cotton	Tobacco
6 ^y 2CS 4 18 10 4	14 ^y AT 18 10 NCS	4 2CS 18 10 NCS	11/26/36 ^{au} NCS AT 18 1	4/FBA 2CS 18 18 NCS	4/FBA 2CS 18 18 NCS	24/FBA 2CS 18 10 NCS	24/FBA 2CS 18 10 NCS	4/FBA 2CS 10 10 NCS	4/FBA 2CS 10 10 NCS	4/FBA 2CS 18 AT NCS	24/FBA 2CS 18 18 NCS	24/FBA 2CS 18 10 NCS	4/FBA 2CS 10 18 NCS	4/FBA 2CS 18 18 NCS
NCS AT AT 18	NCS AT AT 11	NCS AT AT 18	NCS AT AT AT	NCS AT AT 18-26 ^v	NCS AT AT 18	NCS AT AT 18	AT AT AT 40	NCS AT AT 18	NCS AT AT 18	NCS AT AT 18/26 ^v	NCS AT AT 18	NCS AT AT 18	NCS AT AT 18	NCS 1 1 9.5
1	1	1	AT	1	1	1	AT	AT	1	1	AT	1	AT	1
12 4.5	12 NCS	12 NI	4 AT	12 NI	12 NCS	12 NI	12 NI	12 AT	8 AT	4 NI	4 4	12 9	8 AT	12 NCS
10	10	10	3	10	10	1	10	3	3	10	10	10	10	10
24 NCS 4 3 18	24 NCS 10/18 ^{by} 10 11	24 NCS 12 10 18	24 AT AT 10/18 ^v AT	24 NCS 24 10/18 ^v 26	24 NCS 12 18 18	24 AT AT 18 18	24 8/13 ^{ae,u} 36 18 40	24 AT 12 10 11	24 NCS AT 10 18	24 NCS 12 10/18 ^v 26	24 NCS 12 18 18	24 NCS 12 18 18	24 NCS 18 18 18	24 NCS AT 10/18 ^v 9.5
4.5 2CS NCS 4 18	NCS NCS NCS 10/18 ^b	NCS 2CS NCS 10/18 ^{bh}	NCS NCS NCS 15 D 10	12 2CS NCS 10/18 ^{bh}	12 2CS NCS 10/18 ^{bh}	12 2CS NCS 10/18 ^b	12 2CS NCS 10/18 ^{bh}	12 2CS NCS 10	NCS 2CS NCS 10	12 2CS NCS 10/18 ^{bh}	4 2CS NCS 12 18	9 2CS NCS 12 18	NCS NCS NCS 10 10	12 2CS NCS 10/18 ^{bh} 18
40 4 AT NCS 2CS	18 1 10.5 NCS NCS	40 1 18/FBA NCS 2CS	AT AT 10.5 ^{ay} NCS NCS	40 1 AT NCS 2CS	40 1 18 NCS 2CS	40 1 10.5 ^{ay} NCS 2CS	40 1 18 NCS 2CS	11 1 10.5 ^{ay} NCS 2CS	18 1 18 NCS 2CS	26 1 18 18 2CS	18 1 10.5 NCS 2CS	40 1 18/FBA NCS 2CS	40 1 18/FBA NCS 2CS	9.5 1 18/FBA NCS NCS
3 2CS FBA AT	9 NCS 8 AT	30 2CS FBA AT	AT NCS 36/FBA AT	18 2CS 36/FBA AT	30 2CS 36/FBA AT	9/18 ^{v,ae} 2CS 36/FBA AT	30 2CS 36/FBA AT	9 2CS 36/FBA AT	9 2CS 36/FBA AT	30 2CS 36/FBA AT	9/12 ^{v,ae} 2CS 36/FBA AT	9/12 ^{v,ae} 2CS 36/FBA AT	9 2CS 36/FBA AT	9 NCS 36/FBA AT
NCS NCS 2CS AT 14 D	12/18 ^{ba} 12/18 ^{ba} AT AT 14 D	NCS NCS 2CS AT 14 D	AT AT NCS AT 14 D	NCS NCS 2CS AT 14 D	NCS NCS 2CS AT 14 D	AT AT 2CS AT 14 D	12/14 ^{az} NCS ^u 2CS 18 AT	AT AT 2CS AT 14 D	AT AT 2CS AT 14 D	AT AT 2CS 18 14 D	NCS NCS 2CS AT 14 D	NCS NCS 2CS AT 14 D	AT AT NCS AT 14 D	NCS NCS 2CS AT 14 D
4 24 2CS 2CS 2CS	1/2 ^{bl} 24 NCS NCS NCS	12/FBA 24 2CS 2CS 2CS	AT 24 NCS 2CS 2CS	12/FBA 24 2CS 2CS 2CS	12/FBA 24 2CS 2CS 2CS	1/2 ^{bl} 24 2CS 2CS 2CS	12/FBA 12 bg 2CS 2CS 2CS	4 24 2CS 2CS 2CS	12/FBA 24 2CS 2CS 2CS	12/FBA 12 bg 2CS 2CS 2CS	12/FBA 24 2CS 2CS 2CS	12/FBA 24 2CS 2CS 2CS	1/2 ^{bl} 24 2CS 2CS 2CS	1/2 ^{bl} 24 NCS 2CS 2CS
NI NI 2 16 NCS	10.5 10.5 2 16 7/14 D	NI NI 2 16 NCS	10.5/18 ^{bz} 10.5/18 ^{bz} 9 AT 7/30 D	4 4 15 16 NCS	NI NI 18 16 NCS	10.5/18 ^{bz} 10.5/18 ^{bz} 18 16 NCS	4 4 24 16 NCS	10.5/18 ^{bz} 10.5/18 ^{bz} 9 16 NCS	18 18 9 16 NCS	18 18 9 16 NCS	10.5 10.5 9 16 NCS	NI NI 9 16 NCS	NI NI 4 AT NCS	NI NI 16 NCS NCS
3	7/14 D	NCS	15/30 D	NCS	NCS	NCS	NCS	NCS	NCS	NCS	NCS	NCS	NCS	NCS

Replant Options and Rotation Restrictions

*All other crops.

**Injury may occur.

^a15 months for sweet corn varieties Merit, Carnival and Sweet Success.

^bpH \leq 7.5, interval is 10-11 months; pH $>$ 7.5, interval is 18 months.

^cpH \leq 6.5, interval is 10 months; if pH $>$ 6.5 and cumulative precipitation is $<$ 25 inches, interval is 18 months.

^dIn eastern Nebraska, do not rotate to soybean if the rate applied was more than 2.0 lb/ac ai or if the soil has a calcareous surface layer.

^eInjury may occur if surface soils are calcareous.

^f15 inches of cumulative precipitation from application to planting. (No more than 7 inches from overhead irrigation. Furrow or flood not to be included in total.)

^gRotation interval is 45 days per pint of Banvel applied and 23 days per pint of Banvel SGF, excluding days when the ground is frozen.

^hClearfield, IR or IMR field corn hybrids may be planted "anytime."

ⁱOnly following 0.38 oz/ac rate.

^jSafened seed only (Concep).

^k18 months if more than 2.0 lb/ac ai atrazine or equivalent band application was made to corn or sorghum.

^lDo not plant soybean in areas where furrow irrigation is practiced.

^mApplications of 24 oz/ac or less = 22 days for each 8 fluid oz; 24 oz/ac or more = 45 day interval for each 16 fluid oz/ac applied.

ⁿ10 months for STS soybean in Region B and canola, dry edible bean in Region C where soil pH is below 7.8.

^oIf applied after June 10, do not plant soybean the next season.

^p18 months when annual rainfall and/or irrigation is less than 15 inches on soils with less than 2% organic matter.

^qCertain sweet corn varieties may be planted 10.5 months following a soil or postemergence application of up to 3.2 oz/ac of Hornet or 4.0 oz/ac of Hornet WDG.

^rIf applied after June 10, do not rotate with crops other than corn or sorghum the next year or crop injury may occur. In high plains or intermountain region where rainfall is sparse and erratic or where irrigation is required, rotate only in the second cropping season.

^sVerify with the seed company (supplier) on the safety of the herbicide on inbred lines, hybrids or varieties.

^tRotation interval is different north/south of I-80, soil pH levels and application rates and dates.

^uMoldboard plow to a depth of 12 inches prior to planting.

^vRotation interval varies by location in Nebraska, soil pH, application rate and cumulative precipitation.

^wGenerally west of Hwy. 77 and east of the Panhandle and 15 inches of cumulative precipitation. Soybeans with soil pH $<$ 7.5 or 7.6-7.9 and 22/33 inches of cumulative precipitation.

^xAt least 28 inches of cumulative precipitation during the period.

^yWhere soil pH is 7.9 or less and one application at a standard rate was made.

^zFour months for IR corn, 14 months for "normal" corn and soil pH is 6.9 or lower.

^{aa}11 months for STS varieties, 36 months or earlier with a bioassay.

^{ab}Cropping intervals are according to rate of Basis used: 1/3 oz / 1/3-1 oz per acre rates.

^{ac}Should not be planted for 18 months after application if combined rainfall and irrigation during the previous growing season was less than 20 inches.

^{ad}IR, IMR/non-IR field corn.

^{ae}Rotation interval varies with application rates.

^{af}Areas receiving 20 inches or greater cumulative rainfall and irrigation or those receiving less than 20 inches.

^{ag}Areas receiving 20 inches or greater cumulative rainfall and irrigation moldboard 12 inches deep or those with less than 20 inches.

^{ah}10.5 months or 18 months if soils contain less than 2% organic matter and natural precipitation is less than 15 inches during the 10.5 months following treatment.

^{ai}Minimum of 15 inches of cumulative precipitation.

^{aj}pH 7.5 or lower and 22 inches of cumulative precipitation or soil pH of 7.6-7.9 and cumulative precipitation of 33 inches.

^{ak}Application rate of one Soluble Pack per 10 acres on wheat, barley or fallow on non-irrigated land.

^{al}Soil pH 6.8 or lower or those with a soil pH 6.9-7.9.

^{am}If applied after July 1, do not rotate with crops other than corn or sorghum the next year or injury may occur.

^{an}Soil pH is below 7.8.

^{ao}Soil pH of 7.9 or lower and 25 inches of cumulative precipitation.

^{ap}Soil should be reworked before planting.

^{aq}Soybean should not be planted in the same year as the application in areas receiving less than 25 inches of cumulative precipitation. Other areas can be planted after 1 inch of rain or irrigation.

^{ar}IR corn can be replanted, but do not rework the soil. Corn must be planted at least 2 inches deep or below the treated zone.

^{as}Soil pH is 6.2 or greater or those with a soil pH is less than 6.2

^{at}Four months for IR corn at any soil pH or 14 months for non-IR corn at a soil pH 6.9 or lower or 22 months with a soil pH 7.9 or lower, or 36 months if the soil pH is above 7.9.

^{au}STS soybeans — Non-STS soybeans with a soil pH below 7.9 and receives 46 inches of cumulative precipitation — all pH levels and field bioassay.

^{av}STS soybean varieties only.

^{aw}Processing sweet corn varieties only/other sweet corn varieties.

^{ax}Four months following peas, lentils or soybean.

- ^{ay}Use longer interval if soils contain less than 2% organic matter and natural precipitation is less than 15 inches during the 12 months following treatment.
- ^{az}Spring application/fall application
- ^{ba}All areas receiving more than 20 inches of rainfall and irrigation — those areas receiving less than 20 inches of rainfall and irrigation to produce a crop.
- ^{bb}Six months following split postemergence applications totaling 12 fl oz/ac or less — all types of applications totaling more than 12 fl oz/ac.
- ^{bc}Rotation intervals may need to be extended to 18 months if drought conditions prevail after application and before the rotational crop is planted, unless supplemental sprinkler irrigation has been applied and total is greater than 15 inches during the potato growing season.
- ^{bd}In areas where irrigation is necessary, do not rotate to winter wheat or winter barley if the crop was lost or destroyed and the land was fallowed that summer.
- ^{be}The soil must be tilled to a minimum depth of 4 inches prior to replanting.
- ^{bf}Poast Protected field corn hybrids may be planted anytime.
- ^{bg}Rate of Velpar did not exceed 1 lb/ac for corn and 2/3 lb/ac for sugarbeet and potato, except in areas of low rainfall (20 inches or less).
- ^{bh}10 months for a pH of 6.5/18 months when pH>6.5, except on irrigated soil where precipitation following application must exceed 25 inches prior to planting beets where the interval is 10 months on soils with pH<7.5.
- ^{bi}Consult label for rate, pH and organic matter restrictions.
- ^{bj}2.0 oz/ac or less/up to 3.0 oz/ac.
- ^{bk}Check the label for the planting interval for specific sweet corn hybrids.
- ^{bl}2.0 oz per acre or less/up to 3.0 oz per acre rate of Valor and a minimum of 1 inch of rainfall/irrigation has occurred between Valor application and replanting.
- ^{bm}Soil pH of 7.9 or lower and Glean rate of 1/6 to 1/3 oz per acre/1/2 oz/ac rate.
- ^{bn}Refer to Glean label for pH, rate and cumulative precipitation restrictions in specified Nebraska counties.
- ^{bo}Following the 4.0 oz per acre rate to Federal CRP (Conservation Reserve Program) land.
- ^{bp}For areas less than 15 inches of annual precipitation and less than 2% organic matter wait 18 months.
- ^{bq}Where soil pH is greater than 8.0, the interval is 12 months.
- ^{br}For fields South of Route 30 and East of Route 281 in Nebraska.
- ^{bs}IR, IMR field corn/ IT, Normal field corn.
- ^{bt}IR, IMR, IT field corn may be planted the next cropping season.
- ^{bu}If Backdraft was applied as a postemergence application at 1.5 qts/ac and at least 10 inches of rainfall or irrigation has been received from the date of application through October of the same year.
- ^{bv}Clearfield wheat/normal (non-Clearfield)
- ^{bw}West/east of Highway 83.
- ^{bx}Rotation interval is based on soil pH, rainfall and tillage and location west/east of Hwy. 83. See label.
- ^{by}18-month rotation for rates above 8.0 oz/ac.
- ^{bz}18 Months for soils less than 2% organic matter AND rainfall less than 15 inches during 12 months following application.

Forage, Feed, and Grazing Restrictions for Row Crop Herbicides*

The following information is provided as a reference to the restrictions and limitations for the grazing and feeding of row crops to livestock. This information serves as a guide only and does not replace or supersede the label. Always read and follow label directions.

Herbicide	Restrictions
2,4-D	Do not forage or feed corn fodder for 7 days following application. Do not permit dairy animals or meat animals being finished for slaughter to forage treated grain fields within 2 weeks after treatment. Do not feed treated straw to livestock if a preharvest or emergency treatment is used. See label for further information.
Accent	Do not graze or feed forage or grain from the treated areas to livestock within 30 days after application.
Accent Gold	Do not graze or feed forage, hay or straw from treated areas to livestock within 85 days of application.
Achieve	Mature straw and grain may be fed to livestock 45 days after treatment. Immature crops (forage) may be grazed or cut for hay 30 days after treatment.
Aim/Avalanche	Product is labeled for use on corn or silage. No information on other crops.
Arrosolo	No information on label. Consult product manufacturer.
Arrow	Do not graze treated fields or feed treated forage or hay to livestock.
Assure II	Do not graze treated fields or harvest for forage or hay.
Atrazine	Do not graze or feed forage from treated areas for 21 days following application, or illegal residues may result.
Authority	No information on label. Consult product manufacturer.
Axiom	No restrictions on corn. Do not graze or feed forage, hay or straw to livestock from treated soybeans.
Axiom AT	No information on label. Consult product manufacturer.
Backdraft	Do not graze or feed treated soybean forage, hay or straw to livestock.
Balance	No information on label. Consult product manufacturer.
Banvel	Do not graze or harvest for livestock feed prior to crop maturity.
Basagran	Do not graze treated fields for at least 21 days after application.
Basis Gold	Do not graze or feed forage or grain from the treated areas to livestock within 30 days after application.
Beacon	Do not graze or feed forage from treated corn to livestock within 30 days after application.
Beyond	There should be an interval of at least 30 days between an application and feeding or grazing of wheat forage and hay.
Bicep II/Bicep II Magnum, Bicep Lite II/Bicep Lite II Magnum	Do not graze or feed forage from treated areas for 30 days following application.
Blazer	Do not use treated plants for feed or forage.
Bolero	No information on label. Consult product manufacturer.
Boundary	Soybean plants or hay may be grazed or fed to livestock 40 days after application.
Bronate	Do not graze treated fields for 30 days following application.
Buctril + atrazine	Do not cut crop for feed or graze within 30 days after application.
Buctril	Do not cut for feed or graze within 30 days after application.
Buctril + atrazine	Do not cut crop for feed or graze within 30 days after application.
Buctril	Do not cut for feed or graze within 30 days after application.
Bullet	Do not graze treated area or feed treated forage to livestock for 21 days following application.
Butyrac/Butoxone (2,4-DB)	Do not graze or feed soybean hay within 60 days after application of a 2,4-DB tank-mix application.
Callisto	Do not harvest forage, grain, or stover within 45 days after application.
Camix	Do not graze or feed forage from treated areas for 45 days following application.
Canopy XL	Do not feed treated soybean forage or hay to livestock.
Caparol	Do not feed treated forage to livestock or graze treated areas or illegal residues may result.
Celebrity Plus	Do not apply within 32 days of forage harvest or 72 days of corn grain and stover harvest.
Clarion	Do not graze or feed forage, hay, or straw from treated areas to livestock within 30 days of application.
Clarity	For lactating dairy animals, do not harvest forage within 37, 51 or 70 days for 1, 2 and 4 pint use rates. No restrictions for other animals.
Classic	Do not graze treated fields or harvest for forage or hay.
Cobra	Do not graze animals on green forage or stubble. Do not use hay or straw for animal feed or bedding.
Command	Do not allow livestock to graze on treated fields or crop residue, or feed treated forage to livestock.
Command Xtra	Do not allow livestock to graze on treated soybean vines or feed treated soybean leaves or vine trash to livestock.

*This table is produced in cooperation with the University of Missouri.

Herbicide	Restrictions
Concert	Do not graze or feed forage hay or straw from treated areas to livestock.
Conclude/Conclude Ultra/ Conclude Xact/Conclude Xtra	Do not use treated plants for feed or forage.
Cotoran	Do not feed foliage from treated cotton plants or gin trash to livestock.
Degree	No information on label. Consult product manufacturer.
Degree Xtra	No information on label. Consult product manufacturer.
Domain	Do not graze or feed forage, hay or straw to livestock.
Distinct	Do not apply within 32 days of forage harvest. Do not apply within 72 days of corn grain and stover harvest.
DSMA	Do not feed treated foliage to livestock or graze treated areas.
Dual II/Dual II Magnum	Do not graze or feed forage from treated areas for 30 days following application.
Epic	No information on label. Consult product manufacturer.
Equip	Do not graze or feed within 45 days of application
Eradicane	No information on label. Consult product manufacturer.
ET	Do not allow livestock to graze treated areas.
Exceed	Do not graze or feed forage from treated crops until 30 days following application. Do not harvest for silage until 40 days following application.
Expert	Do not graze or feed forage from treated areas for 30 days.
Extreme	Do not graze or feed treated soybean forage, hay or straw to livestock.
Facet	No information on label. Consult product manufacturer.
FieldMaster	Do not feed forage from corn or graze treated areas within 8 weeks of application.
FirstRate	Do not harvest soybeans for forage or hay for 14 days after application.
Flexstar	Do not graze treated areas or harvest for forage or hay. Do not graze rotated small grain crops or harvest for livestock forage or straw.
Frontier	May be grazed or fed to livestock at 40 or more days after application.
Frontrow	Do not graze or feed treated soybean forage, hay or staw to livestock.
Fultime	No information on label. Consult product manufacturer.
Fusilade DX	Do not graze or harvest for forage or hay.
Fusilade 2000	Do not graze or harvest for forage or hay.
Fusion	Do not graze or harvest for forage or hay.
Galaxy	No forage restrictions on label.
Gauntlet	No information on label. Consult product manufacturer.
Gemini	Do not graze treated fields or harvest for forage or hay.
Glyphosate (generic)◆	Refer to product label for specific information
G-MAX Lite	<i>Corn:</i> Do not graze or feed treated forage within 40 days of application <i>Sorghum:</i> Do not graze or feed forage within 80 days of application
Goal	Do not use treated plants for feed or forage or allow animals to graze treated areas.
Gramoxone	<i>Soybean POST directed:</i> Do not graze treated areas or feed treated forage to livestock. <i>Corn harvest aid:</i> Do not use on corn grown for fodder or forage. Do not pasture livestock in treated fields. <i>Soybean harvest aid:</i> Do not pasture livestock within 15 days of treatment and remove 30 days before animal harvest.
Grandstand R	Do not graze lactating dairy animals or harvest hay from treated areas for one year following treatment. Withdraw livestock from forage treated with Grandstand at least 3 days before slaughter during the year of treatment.
Guardsman	May be grazed or fed to livestock at 40 or more days after application.
Guardsman Max	<i>Corn:</i> Do not graze or feed treated forage within 40 days of application. <i>Sorghum:</i> Do not graze or feed forage within 80 days of application.
Harmony Extra	Do not graze or feed forage or hay from treated areas to livestock (dry-harvested straw may be used for bedding and/or feed).
Harmony GT	Do not graze or feed forage, hay or straw from treated areas to livestock.
Harness	No information on label. Consult product manufacturer.
Harness Xtra	No information on label. Consult product manufacturer.
Hoelon	Do not allow livestock to graze treated fields. Do not harvest forage, hay or straw from treated fields.
Hornet WDG	Apply before corn is greater than 20 inches and allow 45 days before harvesting for forage or silage.
Intrro	<i>Corn:</i> Do not graze treated areas or feed treated forage to livestock for 21 days following application. <i>Grain sorghum:</i> Do not graze harvest forage for 70 days following application. <i>Soybeans:</i> Do not feed forage, hay or straw. Do not ensile treated soybeans.

◆Glyphosate is the active ingredient in many products. The rates provided on this page are based on a 4 lb ai or 3 lb ae formulation. See the glyphosate product comparison table on pages 146-147 for the use rate and more information on the product being used.

Herbicide	Restrictions
Karmex	Do not allow livestock to graze treated cotton.
Keystone	No information on label. Consult product manufacturer.
Laddok S-12	Do not graze treated areas or feed treated forage to livestock for 21 days following application.
Lariat	Do not graze treated area or feed treated forage to livestock for 21 days following application.
Liberty	Do not harvest corn forage within 60 days of application.
Liberty ATZ	Do not harvest corn forage within 60 days of application. Do not feed treated green immature growing soybean plants to livestock.
Lightning	Do not graze or feed treated corn forage, silage, fodder or grain for at least 45 days after application.
Linex	Do not graze treated fields or feed forage from treated areas to livestock. Do not feed gin trash to livestock.
Londax	Do not graze treated fields or feed treated forage within 80 days of last application.
Lumax	Do not graze or feed forage for 45 days. Do not harvest forage, grain, or stover within 45 days after application.
Marksman	Do not harvest or graze corn for dairy or beef feed prior to the ensilage (milk) stage of the crop. Do not graze or feed treated sorghum forage or silage prior to mature grain stage.
MCPA	Do not forage or graze meat or dairy animals on treated areas within 7 days of slaughter.
Me-Too-Lachlor II	Do not graze or feed forage from treatment areas for 30 days following application.
Microtech	<i>Corn</i> : Do not graze treated areas or feed treated forage to livestock for 21 days following application. <i>Grain sorghum</i> : Do not graze harvest forage for 70 days following application. <i>Soybeans</i> : Do not feed forage, hay or straw. Do not ensile treated soybeans.
Moxy	Do not cut crop for feed fodder or graze within 45 days of application.
MSMA	Do not feed treated foliage to livestock or graze treated areas.
NorthStar	Do not graze or feed forage from NorthStar-treated corn to livestock within 30 days following application. Do not harvest silage within 45 days after application.
Outlook	<i>Corn</i> : Do not graze or feed forage within 40 days of application. <i>Sorghum (forage)</i> : Do not graze or feed forage within 60 days of application. <i>Sorghum (grain)</i> : Do not graze or feed forage within 80 days of application.
Option	Do not graze within 45 days of application.
Ordram	Do not feed rice straw if application is made within 40 days of harvest.
Paramount	Do not graze treated areas. Do not harvest hay from treated areas for 309 days. Do not feed forage or fodder from treated areas.
Partner	<i>Corn</i> : Do not graze treated areas or feed treated forage to livestock for 21 days following application. <i>Grain sorghum</i> : Do not graze harvest forage for 70 days following application. <i>Soybeans</i> : Do not feed forage, hay or straw. Do not ensile treated soybeans.
Peak	Do not graze or feed forage from treated crops until 30 days following application. Do not harvest for silage until 40 days following application.
Permit	Allow 30 days before grazing and harvest of forage or silage.
Phoenix	Do not graze animals on green forage or stubble. Do not feed treated soybean silage (ensiled soybeans) to cattle. Do not utilize hay or straw for animal feed or bedding.
Poast/Poast Plus	Do not graze treated fields and do not feed treated soybean forage (green succulent) or ensilage to livestock. Treated soybean hay may be fed. Do not apply within 60 days of harvest for fodder or 45 days for corn forage/silage.
Princep	Do not graze treated areas, or illegal residues may occur.
Priority	Following application to foliage, allow 30 days before grazing livestock, harvesting forage or harvesting silage.
Prowl/Pendimax	<i>Sorghum</i> : Do not graze or feed forage within 21 days of application. <i>Wheat/barley</i> : Do not graze or feed forage within 25 days.
Pursuit Plus	Do not graze or feed treated soybean forage, hay or straw to livestock.
Pursuit	Do not graze or feed treated soybean forage, hay or straw to livestock.
Python	Do not graze or feed treated soybean forage, hay or straw to livestock. No corn information on label.
Ramrod	No information on label. Consult product manufacturer.
Raptor	Do not graze treated soybean forage, hay or straw to livestock.
Reflex	Do not graze treated areas or harvest for forage or hay. Do not graze rotated small grain crops or harvest for livestock forage or straw.
Reglone	Do not graze or feed treated forage to livestock. Do not use seed from treated plants for food, feed or oil purposes.

Herbicide	Restrictions
Resolve	Do not graze, feed forage, grain or fodder (stover) from treated areas to livestock within 30 days of Resolve DF application.
Resource	Do not graze treated fields or harvest for forage or hay.
Roundup	<i>Roundup Ready crops:</i> Do not harvest or feed treated crops for 8 weeks after application. <i>Spot treatment:</i> Allow 14 days following spot treatment or selective equipment before grazing domestic livestock. <i>Corn harvest aid:</i> Do not harvest or feed treated vegetation for 8 weeks following application. <i>Grain sorghum harvest aid:</i> Do not harvest or feed treated vegetation for 8 weeks following application. <i>Soybean harvest aid:</i> Do not graze or harvest treated crop for livestock feed within 25 days of last preharvest application. <i>Wheat harvest aid:</i> Wheat stubble may be grazed immediately after harvest.
Roundup Original MAX	Allow a minimum of 7 days for corn and 14 days for soybeans between application and feeding of treated vegetation.
Roundup Weather MAX	<i>Roundup Ready corn:</i> Do not harvest or feed treated crops within 7 days of application. <i>Roundup Ready soybeans:</i> Do not harvest or feed treated crops within 14 days of application. <i>Forage legumes:</i> If application greater than 44 oz wait 8 weeks before grazing or feeding to livestock. <i>Pastures:</i> Do not harvest or feed treated crops within 8 weeks of application. <i>Corn and sorghum harvest aid:</i> Allow 7 days between application and harvest of treated vegetation. <i>Soybean harvest aid:</i> Do not graze or harvest treated hay or fodder for livestock feed within 25 days of application.
Scepter	Do not graze or feed treated soybean forage, hay or straw to livestock.
Scepter O.T.	Do not graze or feed treated soybean forage, hay or straw to livestock.
Select	Except for alfalfa, do not graze treated fields or feed treated forage or hay to livestock.
Select MAX	Do not graze treated fields or feed treated forage or hay to livestock.
Sencor	Treated vines may be grazed or fed to livestock 40 days after application.
Sequence	Do not graze or feed treated forage or hay to livestock following a POST application to soybeans.
Shotgun	Do not graze for feed forage from treated areas for 21 days following application.
Sodium chlorate	<i>Grain sorghum:</i> Do not graze treated fields or feed treated fodder, forage or seeds within 14 days of application. <i>Rice:</i> No information on label. <i>Soybeans:</i> Do not graze treated fields or feed treated soybean foliage or fodder.
Sonalan	Do not graze or forage crop grown in treated soil or cut for hay or silage.
Spirit	Do not graze or feed forage from Spirit-treated crops to livestock until 30 days after application.
Squadron	Do not graze or feed treated soybean forage, hay or straw to livestock.
Stalwart C	Do not feed or graze forage from treated areas for 30 days following application.
Stalwart Xtra	Do not graze or feed forage from treated areas for 60 days following application to field corn or popcorn.
Stam	No information on label. Consult product manufacturer.
StamPro	Do not graze treated fields or feed forage within 80 days of last application.
Staple	Do not feed cotton gin byproducts (trash) to livestock.
Staple Plus	Do not feed cotton gin byproducts (trash) to livestock.
Starane	<i>Corn:</i> Do not allow livestock to graze or harvest forage from treated areas within 47 days of application. <i>Sorghum:</i> Do not allow livestock to graze or harvest forage from treated areas within 40 days of application.
Starfire	<i>Harvest aid:</i> Do not use on corn grown for fodder or forage. Do not pasture livestock in treated fields.
Steadfast	Do not graze or feed forage, hay, or straw from treated areas to livestock within 30 days of application.
Steadfast ATZ	Do not graze or feed forage, hay or straw from treated areas to livestock within 30 days of application.
Steel	Do not graze or feed treated forage, hay or straw to livestock.
Stellar	Do not graze animals on green forage or stubble. Do not use hay or straw for animal feed or bedding.
Storm	Do not use treated plants for feed or forage.
Surpass EC	No information on label. Consult product manufacturer.
Sutan +/- Genate Plus	No information on label. Consult product manufacturer.
Synchrony	Do not graze treated fields for forage or hay.
TopNotch	No information on label. Consult product manufacturer.
Touchdown	Do not graze or harvest treated cover crops for feed.
Touchdown Total	<i>Roundup Ready corn:</i> Allow a minimum of 50 days between POST application and harvest of forage. <i>Roundup Ready soybeans:</i> Do not graze or harvest for forage or hay.
Tough	Do not graze or otherwise feed treated corn grain, forage, or fodder to livestock within 68 days after application.
Treflan	<i>Alfalfa:</i> Wait 21 days after application before grazing alfalfa. No other information on label. Consult product manufacturer.
Trizmet II	Do not feed or graze forage from treated areas for 30 days following application.
Ultra Blazer	Do not use treated plants for feed or forage.
Yukon	<i>Corn:</i> Following application to foliage, corn may be grazed or harvested for feed after the crop reaches ensilage (milk) stage at least 30 days after application

Growth Regulator Herbicides

(Including 2,4-D, Aminopyralid, Banvel, Clarity, Stinger, Tordon and others)

Every year Extension specialists receive many questions about products that contain growth regulator herbicides. These include 2,4-D, Clarity, Stinger, MCPP, MCPA, Tordon and others. (See pages 18-19 for the different herbicides classified as growth regulators.) These herbicides are valuable in controlling many unwanted broadleaf weeds in crops, range, turf, and landscape situations. However these products also can easily damage nearby vegetables, ornamentals, trees, shrubs, or broadleaf crops.

First, it is important to understand the two kinds of drift: vapor drift and particle drift.

Vapor Drift. The vaporization of a herbicide followed by movement off target. The product vaporizes and can travel for long distances and eventually contact and damage nontarget plants. Vaporization and vapor drift increase as temperature increases.

Particle Drift. The movement of droplets (particles) from the sprayer nozzle. Spraying when the wind speed is too high is the leading cause of particle drift. Typically, if the windspeed is over 10 mph, it is too windy to spray.

Any product is subject to particle drift. See page 16 for pointers on reducing drift. No matter which growth regulator you use, be sure to spray the right one in the right conditions. Below is more information on some of the common growth regulators.

2,4-D

2,4-D is an active ingredient in many compounds. It has been used to successfully control broadleaf weeds for many years; however, each year its misuse affects many nontarget species as well.

2,4-D is available in 4 lb and 6 lb formulations. The 4 lb is most common. Make sure you understand what rate of what formulation you are going to spray since it only takes 2/3 pint of 6 lb 2,4-D to have the same activity as 1 pint of 4 lb 2,4-D.

In addition, 2,4-D is available in ester and amine formulations. Esters vaporize and result in vapor drift which can travel long distances. The low volatility (LV) esters reduce the amount of volatilization but some will still likely volatilize at temperatures above 85°F. The amine salt formulation is nonvolatile. During warm weather (temperatures above 85°F), only amine formulations of 2,4-D should be used. The ester formulation tends to penetrate the foliage easier so amine use rates are usually higher than ester rates. In the end, however, all 2,4-D formulations are subject to particle drift. Common products containing 2,4-D are listed below:

Amine 4	Landmaster BW
Amine 4 2,4-D	Low Vol 4 Ester Weed Killer
Aqua-Kleen	Maestro D
Banvel + 2,4-D	MEC Amine-D Turf Herbicide
Barrage	Millenium Ultra
Bentgrass Selective	Millenium Ultra Plus
Brash	Oasis
Brushmaster	Opti-Amine
Campaign	Outlaw
Chaser 2	PastureMaster
Chaser Turf Herbicide	Pasture MD
Chaser Ultra Weed & Feed	Pathway
Cimmaron Max	Phenoxy 088
Cornbelt Amine	Pro-Mate-Three Way SC
Cornbelt 4 lb. and 6 lb.	Range Star
Credit Master	Recoil
Crossbow	Saber
Curtail	Salvo
D-638	Savage
DMA4 IVM	Shotgun
Esteron 99	Speed Zone
Five Star	Starane + Esteron
Formula 40	Starane + Saber
Four Power Plus	Starane + Salvo
Grazon P+D	Strike 3
HardBall	Strike Three Ultra
Hi-DEP	SWP 2,4-D LV4
Kamba Master	Three-way Selective Herbicide

Triamine	2,4-D LV6
Trimec Broadleaf Herbicide	Unison
Trimec Classic	Veteran 10G
Trimec Plus	Weed Rhap A-4D
Trimec Turf	Weedar 64
Triplet	Weedone LV4
Turf Weed & Brush Control	Weedone LV6 EC
Turret	Weedone 638
2,4-D Amine 4	Weedmaster Herbicide
2,4-D LV4	

Aminopyralid

Aminopyralid is the newest growth regulator herbicide. This product may be used alone or in combination with other products, typically other growth regulators. Aminopyralid has about the same drift concerns as chlopyralid and triclopyr; however, it typically has less residual than picloram but more than 2,4-D, Banvel and clopyralid. A product that contains aminopyralid is:

Milestone

Clopyralid

Clopyralid is the active ingredient in Stinger. It is used in crop and brush control situations. While not as subject to vapor drift it can have particle drift and it does have more residual with the potential to carry over into the next year's growing season. Products that contain clopyralid include:

Accent Gold	Lontrel
Accent Gold WDG	Millenium Ultra
Battleship	Millenium Ultra Plus
Chaser Ultra	Reclaim
Chaser Ultra Weed & Feed	Redeem R&P
ClopyrAg Herbicide	Stinger
Confront	Strike Three Ultra
Curtail	Transline
Curtail M	WideMatch
Hornet WDG	WideMatch M

Dicamba

Dicamba is the active ingredient in Banvel, Clarity, Sterling, and other products. It is not as prone to vapor drift, as 2,4-D, however it still occurs. It is also subject to particle drift. Each year products containing dicamba damage trees, soybeans, alfalfa and other broadleaf plants in Nebraska. Know your herbicides and the conditions in which you spray. Following is a list of products containing dicamba as one of the active ingredients:

Banvel	NorthStar
Banvel + Atrazine	Op-Till
Banvel SGF	Outlaw
Banvel + 2,4-D	Overdrive
Bentgrass Selective	Pasture Master
Brash	Pasture MD
Brushmaster	Power Zone
Celebrity	Range Star
Celebrity Plus	Rave
Chaser Ultra Weed & Feed	Speed Zone
Cimmaron Max	Sterling
Clarity	Sterling Plus
Cool Power	Strike 3
Dicambazine	Three-way Ester II
Dicamba DMA Salt	Three-way Selective Herbicide
Distinct	Trimec Broadleaf
Eliminate	Trimec Classic
Fallow Master Broadspectrum	Trimec Plus
Fallow Star	Trimec Turf
Four Power Plus	Triplet
Fuego	TriPower Selective
Horsepower	Vanquish
Kamba Master	Veteran CST
Marksman	Veteran 710
Mec Amine-D Turf Herbicide	Veteran 10G
Millenium Ultra	Weedmaster Herbicide
Millenium Ultra Plus	Yukon

Fluroxypyr

Fluroxypyr is the newest growth regulator herbicide. This product may be used alone or in combination with other products, typically other growth regulators. Fluroxypyr has about the same drift concerns as clopyralid and triclopyr; however, it typically has less residual than clopyralid but more than 2,4-D or Banvel. Products that contain fluroxypyr include:

PastureGard	Starane + Salvo
Spotlight	Starane + Sword
Starane	Surmount
Starane + Estron	Vista
Starane + MCPA	WideMatch
Starane + Saber	WideMatch M

Picloram

Picloram is the active ingredient in Tordon. Typically this product is used in range and pasture weed control situations. This product also can have particle drift plus it has long soil residual activity resulting in carry-over. Products that contain picloram include:

Grazon P+D	Tordon 22K
Pathway	Tordon 101 Mixture
Surmount	Tordon RTU
Tordon K	

Triclopyr

Triclopyr is the active ingredient in Remedy and Garlon. This product may be used alone or in combination with other products, commonly clopyralid. Triclopyr is not typically subject to vapor drift; however, just like any of the herbicides, it is vulnerable to particle drift. Triclopyr typically has longer residual than 2,4-D and Banvel but slightly less than clopyralid. Products that contain triclopyr include:

Battleship	PastureGard
Chaser 2 Amine	Pathfinder II
Chaser Turf Herbicide	Redeem R&P
Confront	Remedy
Cool Power	Tahoe 3A
Crossbow	Three-Way Ester II
Eliminate	Triclopy 4 Ester R&P
Garlon 3A or 4A	Turflon Ester
Horsepower	

Glyphosate Comparison Table

The development of a large number of glyphosate products has led to confusion concerning active ingredient formulation, surfactants and use rates for herbicides labeled for Roundup Ready® corn and soybean in Nebraska. The products listed in this table are current at the time of printing.

Brand Name	Distributor	Active ingredient salt ¹	Concentration		Equivalent rates to Roundup Ultra ³		Additional surfactant	Registered for use in	
			Salt ²	Acid equivalent ³	1 pint	1 quart		RR soybeans	RR corn
			—— lbs/gal ——						
Bucaneer	Tenkoz	IPA	4	3	16 fl oz	32 fl oz	May be added	Yes	Yes
Bucaneer Plus	Tenkoz	IPA	4	3	16 fl oz	32 fl oz	May be added	Yes	Yes
Clearout 41	CPT-LLC	IPA	4	3	16 fl oz	32 fl oz	May be added	Yes	Yes
Clearout 41 Plus	CPT-LLC	IPA	4	3	16 fl oz	32 fl oz	Not required	Yes	Yes
Cornerstone	Agrilience	IPA	4	3	16 fl oz	32 fl oz	May be added	Yes	Yes
Cornerstone Plus	Agrilience	IPA	4	3	16 fl oz	32 fl oz	Not required	Yes	Yes
Credit	Nufarm	IPA	4	3	16 fl oz	32 fl oz	May be added	Yes	Yes
Credit Duo	Nufarm	IPA + MA	3.64 + 0.33	2.7 + 0.3	16 fl oz	32 fl oz	May be added	Yes	Yes
Credit Duo Extra	Nufarm	IPA + MA	3.64 + 0.33	2.7 + 0.3	16 fl oz	32 fl oz	Not required	Yes	Yes
Credit Extra	Nufarm	IPA	4	3	16 fl oz	32 fl oz	Not required	Yes	Yes
Debit TMF	Nufarm	IPA	4	3	16 fl oz	32 fl oz	Required	Yes	Yes
Durango	Dow	IPA	5.4	4	12 fl oz	24 fl oz	Not required	Yes	Yes
Extra Credit 5	Nufarm	IPA	5	4	12 fl oz	24 fl oz	May be added	Yes	Yes
Gly-4	UCPA	IPA	4	3	16 fl oz	32 fl oz	May be added	Yes	Yes
Gly-4 Plus	UCPA	IPA	4	3	16 fl oz	32 fl oz	Not required	Yes	Yes
Gly Star	Albaugh	IPA	4	3	16 fl oz	32 fl oz	May be added	Yes	Yes
Gly Star 5	Albaugh	IPA	5.4	4	12 fl oz	24 fl oz	Required	Yes	Yes
Gly Star Plus	Albaugh	IPA	4	3	16 fl oz	32 fl oz	Not required	Yes	Yes
GlyFlo	Microflo	IPA	4	3	16 fl oz	32 fl oz	May be added	Yes	Yes
Glyfos	Cheminova	IPA	4	3	16 fl oz	32 fl oz	May be added	Yes	Yes
Glyfos Gold	Cheminova	IPA	4	3	16 fl oz	13 fl oz	Not required	Yes	Yes
Glyfos Xtra	Cheminova	IPA	4	3	16 fl oz	32 fl oz	Not required	Yes	Yes
Glyphogan™	MANA	IPA	4	3	16 fl oz	32 fl oz	May be added	Yes	Yes
Glyphomax	Dow	IPA	4	3	16 fl oz	32 fl oz	May be added	Yes	Yes
Glyphomax Plus	Dow	IPA	4	3	16 fl oz	32 fl oz	Not required	Yes	Yes
Glyphomax XRT	Dow	IPA	5.4	4	12 fl oz	24 fl oz	Not required	Yes	Yes
Glyphosate 4	Farmsaver.com	IPA	4	3	16 fl oz	32 fl oz	May be added	Yes	Yes
Glyphosate 41%	Helm Agro US	IPA	4	3	16 fl oz	32 fl oz	May be added	Yes	Yes
Glyphosate Original	Griffin	IPA	4	3	16 fl oz	32 fl oz	May be added	Yes	No
Helosate Plus	Helm Agro US	IPA	4	3	16 fl oz	32 fl oz	May be added	Yes	Yes
Honcho	Monsanto	IPA	4	3	16 fl oz	32 fl oz	May be added	Yes	Yes
Honcho Plus	Monsanto	IPA	4	3	16 fl oz	32 fl oz	May be added	Yes	Yes
Mad Dog Glyphosate	Agsco	IPA	4	3	16 fl oz	32 fl oz	May be added	Yes	Yes
Mirage	UAP - Platte	IPA	4	3	16 fl oz	32 fl oz	May be added	Yes	Yes
Mirage Plus	UAP - Platte	IPA	4	3	16 fl oz	32 fl oz	May be added	Yes	Yes
Rascal	Agrilience	IPA	4	3	16 fl oz	32 fl oz	May be added	Yes	Yes
Rascal Plus	Agrilience	IPA	4	3	16 fl oz	32 fl oz	Not required	Yes	Yes
Rattler Plus	Helena	IPA	4	3	16 fl oz	32 fl oz	May be added	Yes	Yes
Recoil	NuFarm IPA								
Roundup Original II	Monsanto	IPA	4	3	16 fl oz	32 fl oz	May be added	Yes	Yes
Roundup Original Max	Monsanto	KSG	5.5	4.5	11 fl oz	22 fl oz	May be added	Yes	Yes
Roundup Ultra	Monsanto	IPA	4	3	16 fl oz	32 fl oz	Not required	Yes	Yes
Roundup UltraDry	Monsanto	MA	71.40%	65%	9 wt oz	18 wt oz	May be added	Yes	Yes
Roundup Ultra MAX II	Monsanto	KSG	5.5	4.5	11 fl oz	22 fl oz	Not required	Yes	Yes
Roundup Weather MAX	Monsanto	KSG	5.5	4.5	11 fl oz	22 fl oz	Not required	Yes	Yes
Sequence									
Silhouette	Agrilience	IPA	4	3	16 fl oz	32 fl oz	May be added	Yes	Yes
Supersate	UAP - Loveland	IPA	4	3	16 fl oz	32 fl oz	May be added	Yes	Yes
Touchdown	Syngenta	DA	3.75	3	16 fl oz	32 fl oz	Not required	Yes	Yes
Touchdown HiTech	Syngenta	KSG	5.5	5	9.6 fl oz	19.2 fl oz	Required	Yes	Yes
Touchdown Total	Syngenta	KSG	5	4.17	12 fl oz	24 fl oz	Not required	Yes	Yes

¹Glyphosate may be formulated into several different salts as a herbicide. IPA= Isopropylamine, MA = Monoammonium, DA = Diammonium, KSG = Potassium salt of glyphosate.

²The concentration of glyphosate can be expressed two ways: salt and acid equivalent. The actual salt formulation for Roundup Ultra is 4 lbs/gal but it only contains 3 lbs of glyphosate acid, thus giving the acid equivalent of 3 lbs per gallon. Similarly, Touchdown Pro contains 3.7 lbs of diammonium salt while it only contains 3 lbs of glyphosate acid per gallon.

³Rates are equivalent to the normal use rates of Roundup Ultra in Roundup Ready corn and soybeans. 1 pint = 16 oz; 1 quart = 32 oz.

Glyphosate Comparison Table (continued)

The following combination products are registered on Roundup Ready crops and contain the IPA* salt of glyphosate.

Brand Name	Distributor	Active Ingredients	Use
Backdraft	BASF	Imazaquin + IPA glyphosate	RR soybeans
Expert	Syngenta	Atrazine + s-Metolachlor + IPA Glyphosate	RR corn
Extreme	BASF	Imazethapyr + IPA glyphosate	RR soybeans
Field Master	Monsanto	Atrazine + Acetochlor + IPA glyphosate	RR corn
Recoil	Nufarm	IPA glyphosate + 2,4-D	RR corn
RoundupMaster ATZ	Monsanto	Atrazine + IPA glyphosate	RR corn
Ready Master ATZ	Monsanto	Atrazine + IPA glyphosate	RR corn
Sequence	Syngenta	IPA glyphosate + S-metachlor	RR soybeans

In 2004 Roundup Ready Corn 2 hybrids were introduced into the marketplace. This new hybrid allows up to 96 oz to be applied per season and also for application up to 48" tall corn. Check with your seed company about specific hybrid status. Not all corn hybrids are Roundup Ready Corn 2 hybrids. In addition not all glyphosate brands may be labeled for this higher application rate to taller corn. Check the specific glyphosate brand label or label supplement for compliance.

It is the University of Nebraska–Lincoln recommendation that AMS always be added to any glyphosate product being applied. This holds true regardless of whether hard water exists in the area. Research has shown that AMS increases herbicide activity even in soft water. AMS can be added at a 1% or 2% solution rate. This is equivalent to 8.5 to 17 lbs AMS per 100 gallons of spray. Only use a spray grade AMS.

Combination Herbicides

Trade name Manufacturer	Equivalent amount (active ingredient) contained in 1 gal. or 1 lb. of product	If you apply (per acre) ...	Then the equivalent product rates are: ^{1,2}
Accent Gold WDG 78.1% DuPont	0.054 lb nicosulfuron 0.054 lb rimsulfuron 0.514 lb clopyralid 0.159 lb flumetsulam	3.5 oz	0.25 oz Accent 75DF 0.19 oz ai rimsulfuron 3 oz Hornet WG
Axiom 68 DF Bayer	0.54 lb flufenacet 0.14 lb metribuzin	19 oz	17.1 oz Define 60 DF 3.5 oz Sencor 75DF
Axiom AT 75DF Bayer	0.196 flufenacet 0.049 lb metribuzin 0.505 atrazine	3 lb	17 oz Axion DF 1.70 lb atrazine 90DF
Backdraft BASF	0.25 lb imazaquin 0.94 lb ae glyphosate IPA	2 qt	2.9 oz Scepter 70DF 1.25 pt Roundup Ultra
Basis 75DF DuPont	0.50 lb rimsulfuron 0.25 lb thifensulfuron	0.33 oz	0.17 oz ai rimsulfuron 0.33 oz Pinnacle 25DF
Basis Gold 89.5DF DuPont	0.0134 lb rimsulfuron 0.0134 lb. nicosulfuron 0.868 lb atrazine	14 oz	0.19 oz ai rimsulfuron 0.25 oz Accent 75DF 13.5 oz atrazine 90DF
Betamix 1.3 EC Bayer	0.65 lb phenmedipham 0.65 lb desmedipham	2 pt	0.16 lb ai phenmedipham 1 pt Betanex 1.3E
Betamix Progress 1.8 EC Bayer	0.60 lb phenmedipham 0.60 lb desmedipham 0.60 lb ethofumesate	2 pt	0.15 lb ai phenmedipham 0.9 pt Betanex 1.3E 0.3 pt Nortron SC
Bicep II Magnum 5.5L Syngenta	2.4 lb s-metolachlor 3.1 lb atrazine	2.1 qt	1.3 pt Dual II Magnum 7.64EC 1.8 lb atrazine 90DF
Bicep Lite II Magnum 6L Syngenta	3.33 lb s-metolachlor 2.67 lb. atrazine	1.5 qt	1.3 pt Dual II Magnum 7.64EC 1.1 lb atrazine 90DF
Boundary 6.5EC Syngenta	5.25 lb s-metolachlor 1.25 lb metribuzin	1.8 pt	1.2 pt Dual II Magnum 7.64EC 0.38 lb Sencor 75DF
Brash Agrilience	1.0 dicamba 2.87 lb 2,4-D	2 pt	8 oz Clarity/Sterling 1.5 pt + 2.70 (4L)
Bronate 4E Bayer	2.0 lb bromoxynil 2.0 lb MCPA	1 pt	1 pt Bucril 2EC 1 pt MCPA 2EC
Bucril + Atrazine 3L Aventis	1.0 lb bromoxynil 2.0 lb atrazine	2 pt	1 pt Bucril 2EC 0.56 lb atrazine 90DF
Bullet 4ME Monsanto	2.5 lb alachlor 1.5 lb atrazine	4 qt	2.5 qt Micro-Tech 4ME 1.7 lb atrazine 90DF
Camix Syngenta	3.34 lb s-metolachlor 0.33 lb mesotrione	2 qt	1.75 pt Dual II Magnum 5.3 fl oz Callisto
Canopy 75DF DuPont	0.64 lb metribuzin 0.11 lb chlorimuron	6 oz	5.1 oz Sencor 75DF 2.6 oz Classic 25DF
Canopy XL 56.3DF DuPont	0.469 lb sulfentrazone 0.094 chlorimuron	6.8 oz	4.2 oz Authority 75DF 2.6 oz Classic 25DF
Celebrity Plus 70DF BASF	0.42 lb ae dicamba 0.17 lb diflufenzopyr 0.106 lb nicosulfuron	4.7 oz	4 oz Distinct 0.66 oz Accent 75DF
Commence 5.25E Dow/FMC	3.0 lb trifluralin 2.25 lb clomazone	2 pt	1.5 pt Treflan 1.1 pt Command 4E
Conclude B & G BASF	B=2.67 lb bentazon + 1.33 lb acifluorfen G=1.5 lb sethoxydim	1.5 pt + 1.5 pt	1.5 pt Storm 4S + 1.5 pt Poast 1.5SC
Confidence Xtra Agrilience	4.3 lb acetochlor 1.7 lb atrazine	2.3 qt	2.8 pt Confidence 1.1 lb atrazine 90DF

¹ai = active ingredient

ae = acid equivalent

²Active ingredients will match, but formulations may differ in the single ingredient products.

Combination Herbicides (continued)

Trade name Manufacturer	Equivalent amount (active ingredient) contained in 1 gal. or 1 lb. of product	If you apply (per acre) ...	Then the equivalent product rates are: ^{1,2}
Contour 3.38SC BASF	3.0 lb atrazine 0.38 lb imazethapyr	1.33 pt	0.55 lb atrazine 90DF 1.44 oz Pursuit 70DG
Crossbow 3E Dow AgroSciences	1.0 lb ae triclopyr 2.0 lb ae 2,4-D ester	1 gal	1 qt Garlon 4 2.9 qt 2,4-D 4E
Curtail 2.38E Dow AgroSciences	2.0 lb ae 2,4-D amine 0.38 ae clopyralid	2 pt	1 pt 2,4-D amine 4SC 0.25 pt Stinger 3C
Degree Xtra 4.04L Monsanto	2.7 lb acetochlor ME 1.34 lb atrazine	3.5 qt	2.5 qt Degree 1.3 lb atrazine 90DF
Detail 4.1E BASF	3.6 lbs dimethenamid 0.5 lb imazaquin	2 pt	1.2 pt Frontier 6E 2.9 oz Scepter 70DG
Distinct 70 WDG Bayer	0.2 lb diflufenzopyr 0.5 lb dicamba	6 oz	1.2 oz ai diflufenzopyr 6 fl oz Clarity 4S
Domain 60 WDG Bayer	0.36 lb metribuzin 0.24 lb flufenacet	10 oz	4.8 oz Sencor 75DF 4 oz Define 60 DF
Double Play Zeneca	1.4 lb acetochlor 5.6 lb EPTC	5 pt	1.1 pt Surpass 6.4EC 4.2 pt Eradicane 6.7EC
DPX-79406 75DF DuPont	0.375 micosulfuron 0.375 rimsulfuron	0.50 oz	0.25 oz Accent 75DF 0.19 oz ai rimsulfuron
Epic 58 WDG Bayer	0.48 lb flufenacet 0.10 lb isoxaflutole	12 oz	9.7 oz Define 60 DF 1.6 oz Balance 75WDG
Equip 32DF Bayer	0.30 lb foramsulfuron 0.02 lb iodosulfuron-methyl	1.5 oz	1.3 oz Option Not available as separate product
Exceed 57WG Syngenta	0.285 lb primisulfuron 0.285 lb prosulfuron	1 oz	0.38 oz Beacon 75WG 0.50 oz Peak 57WG
Expert 4.88L Syngenta	1 lb glyphosate IPA 1.74 lb s-metolachlor 2.14 lb atrazine	3 qt	24 oz glyphosate 4 1.33 pt Dual II Magnum 1.8 lb atrazine 90DF
Extreme 1.67L BASF	0.17 lb imazethapyr 1.5 lb ae glyphosate IPA	3 pt	1.44 oz Pursuit 70DG 1.25 pt Roundup Ultra
Fallow Master 1.6L Monsanto	1.1 lb ae glyphosate IPA 0.50 lb dicamba	2 qt	1.5 pt Roundup Ultra 0.50 pt Clarity 4S
Field Master 4.06L Monsanto	2.0 lb acetochlor 1.5 lb atrazine 0.56 lb ae glyphosate IPA	4 qt	2.3 pt Harness 7EC 1.7 lb atrazine 90DF 1.5 pt Roundup Ultra
Finesse 75 WG DuPont	0.625 lb chlorsulfuron 0.125 lb metsulfuron	0.3 oz	0.25 oz Glean 75DF 0.063 oz Ally 60DF
Frontrow (co-pack) Dow AgroSciences	0.84 lb chloransulam 0.80 lb flumetsulam	0.30 oz + 0.12 oz	0.30 oz First Rate + 0.12 oz Python
FulTime Dow AgroSciences	2.4 lb acetochlor 1.6 lb atrazine	3 qt	2.2 qt TopNotch 3.2CS 1.33 lb atrazine 90DF
Fusion 2.66E Syngenta	2.0 lb fluazifop-P 0.66 lb fenoxaprop	6 fl oz	6 oz Fusilade DX 2.0E 6 oz Option II
G-Max Lite 5.0L BASF	2.25 lb dimethamid-p 2.75 lb atrazine	3 pt/A	18 fl oz Outlook 1.15 lb atrazine 90 DF
Galaxy 3.67 E BASF	3.0 lb bentazon 0.67 lb acifluorfen	2 pt	1.5 pt Basagran 4SC 0.67 pt Blazer 2SC
Gangster (multi-pack) Valent	0.51 lb flumioxazen (v) 0.84 lb chloransulon-methyl (FR)	3.0 oz	2.5 oz Valor 0.5 oz First Rate

¹ai = active ingredient

ae = acid equivalent

²Active ingredients will match, but formulations may differ in the single ingredient products.

Combination Herbicides (continued)

Trade name Manufacturer	Equivalent amount (active ingredient) contained in 1 gal. or 1 lb. of product	If you apply (per acre) ...	Then the equivalent product rates are: ^{1,2}
Gauntlet (co-pack) FMC	0.75 lb sulfentrazone 0.84 lb chloransulam methyl	5.33 oz + 0.60 oz	5.33 oz Authority 0.60 oz FirstRate
Grazon P+D Dow AgroSciences	0.54 lb ae picloram 2.0 lb 2,4-D	2 pt	0.50 pt Tordon 22K 1.0 pt 2,4-D amine 4SC
Guardsman 5L BASF	2.33 lb dimethenamid 2.67 lb atrazine	4 pt	25 oz Frontier 6EC 1.4 lb atrazine 90DF
Guardsman Max 5.0L BASF	1.7 lb dimethenamid-p 3.3 lb atrazine	3.4 pt	15 oz Outlook 1.6 lb atrazine
Harmony Extra DuPont	0.50 lb thifensulfuron 0.25 lb tribenuron	0.4 oz	0.27 oz Pinnacle 75DF 0.13 oz Express 75DF
Harness Xtra 5.6L Monsanto	3.1 lb acetochlor 2.5 lb atrazine	2.3 qt	2 pt Harness 7E 1.6 lb atrazine 90DF
Harness Xtra 6L Monsanto	4.3 lb acetochlor 1.7 lb atrazine	2.3 qt	2.8 pt Harness 7EC 1.1 lb atrazine 90DF
Hornet WDG Dow AgroSciences	0.185 lb flumetsulam 0.50 lb clopyralid	4 oz	0.93 oz Python 80WG 5.3 fl oz Stinger 3C
Keystone Dow AgroSciences	3 lb acetochlor 2.25 lb atrazine	2.6 qt	2.44 pt Surpass EC 1.62 lb atrazine 90 DF
Keystone LA Dow AgroSciences	4 lb acetochlor 1.5 lb atrazine	2 qt	2.5 pt Surpass 0.83 lb atrazine 90DF
Laddok S-12 5L BASF	2.5 lb bentazon 2.5 lb atrazine	1.6 pt	1 pt Basagran 4SC 1.1 lb atrazine 90DF
Landmaster BW Monsanto	0.9 lb ae glyphosate 1.5 lb 2,4-D	40 fl oz	12 oz Roundup Ultra 15 oz 2,4-D 4E
Lariat 4F Monsanto	2.5 lb alachlor 1.5 lb atrazine	3.2 pt	2 pt Lasso 4E 1.3 lb atrazine 90DF
Lexar Syngenta	0.22 mesotrione 1.73 lb s-metolachlor 2.0 lb atrazine	3.0 qt	5.3 oz Callisto 1.4 pt Dual II Magnum 1.4 lb atrazine 90DF
Liberty ATZ 4.3L Bayer	1.0 lb glufosinate 3.3 lb atrazine	40 fl oz	24 fl oz Liberty 1.67 1.1 lb atrazine 90DF
Lightning 70DG BASF	0.525 imazethapyr 0.175 imazapyr	1.28 oz	0.96 oz Pursuit 70DG 0.90 fl oz Arsenal 2E
Lumax Syngenta	2.68 lb s-metolachlor 0.268 lb mesotrione 1.0 lb atrazine	2.5 qt	1.75 pt Dual II Magnum 5.4 fl oz Callisto 0.69 lb atrazine 90 DF
Manifest B&G (co-pack) BASF	B=(3.0 lb bentazon + 0.67 lb acifluorfen) G=1.5 lb sethoxydim	2 pt + 1.5 pt	2 pt Galaxy 3.67SC + 1.5 pt Poast 1.5SC
Marksman 3.2L BASF	1.1 lb dicamba 2.1 lb. atrazine	3.5 pt	1 pt Banvel 4SC 1 lb atrazine 90DF
Northstar 47.4WG Syngenta	0.075 lb primisulfuron 0.40 lb dicamba	5 oz	0.50 oz Beacon 75WG 4 fl oz Banvel 4SC
Olympus Flex Bayer	.0675 propoxycarbazone-sodium .0450 mesosulfuron-methyl	3 oz	0.3 oz Olympus 3.0 oz Osprey
OpTill 6EC BASF	5.0 lb dimethenamid 1.0 lb dicamba	38 fl oz	32 fl oz Frontier 6EC 9.5 fl oz Banvel 4SC
Priority 62.5 WDG Tenkoz	0.125 lb carfentrazone-ethyl 0.50 lb halosulfuron-methyl	1.0 oz	0.5 oz Aim EC 1.0 oz Permit

¹ai = active ingredient

ae = acid equivalent

²Active ingredients will match, but formulations may differ in the single ingredient products.

Combination Herbicides (continued)

Trade name Manufacturer	Equivalent amount (active ingredient) contained in 1 gal. or 1 lb. of product	If you apply (per acre) ...	Then the equivalent product rates are: ^{1,2}
Pursuit Plus 2.9EC BASF	2.7 lb pendimethalin 0.2 lb imazethapyr	2.5 pt	2 pt Prowl 3.3EC 4 fl oz Pursuit 2SC
Radius 4.0L Bayer	3.57 flufenacet 0.43 atrazine	16 oz 3 oz	14.3 oz Define SC 1.7 oz Balance Pro SC
Ready Master ATZ Monsanto	2.0 lb atrazine 1.5 lb glyphosate	2 qt	2.2 lb atrazine 90DF 2.0 pt Roundup Ultra
Redeem R&P 3L Dow Agroscience	2.25 triclopyr 0.75 clopyralid	2 pt	1.5 pt Garlon 3A 0.5 pt Stinger 3L
Rezult B&G (co-pack) BASF	B=5.0 lb bentazon G=1.0 lb sethoxydim	1.6 pt 1.6 pt	2 pt Basagran 4SC 1.6 pt Poast Plus 1SC
Sequence Syngenta	2.5 lb IPA/glyphosate 3 lb s-metalachlor	3 pt	40 oz IPA glyphosate 1.2 pt Dual II
Shotgun 3.25L UAP	2.25 lb atrazine 1.0 lb 2,4-D	2 pt	0.62 lb atrazine 90DF 0.53 pt 2,4-D ester
Spirit 57WDG Syngenta	0.428 lb primisulfuron 0.142 lb prosulfuron	1 oz	0.58 oz Beacon 75WG 0.25 oz Peak 57WG
Squadron 2.33 EC BASF	2.0 lb pendimethalin 0.33 lb imazaquin	3 pt	1.8 pt Prowl 3.3EC 2.8 oz Scepter 70DG
Stalwart Xtra SipCam	2.4 metolachlor 3.1 lb atrazine	2.1 qt	1.3 pt Stalwart C 1.8 lb atrazine 90DF
Starane + Salvo Dow AgroSciences	0.75 lb fluroxypyr 3.0 lb 2,4-D ester	1 pt	0.5 pt Starane 0.6 pt Salvo
Starane + Saber Dow AgroSciences	0.5 lb fluorxypyr 2.0 lb 2,4-D amine	1.5 pt	0.5 pt Starane 0.9 pt 2,4-D amine 4SC
Steadfast 75DF DuPont	0.50 nicosulfuron 0.25 rimsulfuron	0.75 oz	0.50 Accent 75DF 0.19 oz ai rimsulfuron
Steadfast ATZ 89.3 DF DuPont	0.027 nicosulfuron 0.013 rimsulfuron 0.853 atrazine	14 oz	0.75 oz Steadfast 13.3 oz atrazine 90 DF
Steel 2.59EC BASF	0.17 lb imazaquin 0.17 lb imazethapyr 2.25 lb pendimethalin	3 pt	1.44 oz Scepter 70 DG 1.44 oz Pursuit 70DG 2 pt Prowl 3.3EC
Stellar 3.1EC Valent	0.7 lb flumiclorac 2.4 lb lactofen	5 fl oz	4 fl oz Resource 0.86EC 6 fl oz Cobra 2EC
Storm 4SC BASF	2.67 lb bentazon 1.33 lb acifluorfen	1.5 pt	1 pt Basagran 4SC 1 pt Blazer 2SC
Synchrony STS 42DF DuPont	0.318 lb chlorimuron 0.102 lb thifensulfuron	0.5 oz	0.64 oz Classic 25DF 0.20 oz Pinnacle 25DF
Tri-Scept 3E BASF	2.57 lb trifluralin 0.43 lb imazaquin	2.3 pt	1.5 pt Treflan 2.9 oz Scepter 70DG
Trizmet II Drexel	2.4 lb metolachlor 3.1 lb atrazine	2.1 qt	1.3 pt Stalwart C 1.8 lb atrazine 90DF
Typhoon 1.41EC Syngenta	0.47 lb fluazifop-p 0.94 lb fomesafen	3.2 pt	0.75 pt Fusilade DX 2.0E 1.6 pt Flexstar 1.88E
Weedmaster 3.87SC BASF	1.0 lb dicamba 2.87 lb 2,4-D amine	2 pt	0.5 pt Banvel 4SC 1.4 pt 2,4-D amine 4SC
Yukon Monsanto	0.125 lb halosulfuron-methyl 0.55 lb dicamba (sodium salt)	6 oz	1 oz Permit 7.2 fl oz Banvel

¹ai = active ingredient

ae = acid equivalent

²Active ingredients will match, but formulations may differ in the single ingredient products.

2006 Approximate Retail Price (\$) per Unit of Selected Herbicides

Product	2006 Price (\$ per unit)	Product	2006 Price (\$ per unit)	Product	2006 Price (\$ per unit)
2,4-D amine	12.00/gal	Conclude Ultra	71.00/gal	Guardsman MAX	48.00/gal
2,4-D ester #4	15.00/gal	Crop Oil concentrate (COC)	4.80/gal	Harmony GT XP	13.00/oz
2,4-D ester #6	20.00/gal	Crossbow	60.00/gal	Harmony Xtra XP	14.00/oz
AAtrex 4L	13.00/gal	Curbit	50.00/gal	Harness	88.00/gal
AAtrex DF	2.80/lb	Curtail	40.00/gal	Harness 20G	2.50/lb
Accent	37.00/oz	Curtail M	46.00/gal	Harness Extra 5.6L	42.00/gal
Accent Gold	8.40/oz	Dacthal 75W	16.00/lb	Harness Extra 6L	55.00/gal
Accent WDG	7.00/oz	Define DF	21.00/lb	Hi-Dep	21.00/gal
Aim EW	187.00/qt	Degree Mini (120)	48.00/gal	Hoelon	75.00/gal
Alanap L	40.00/gal	Degree Extra	35.00/gal	Hornet WDG	59.00/lb
Ally	25.40/oz	Dicamba	76.00/gal	Hyvar XL	70.00/gal
Ally Extra	10.60/oz	Dimension	128.00/gal	INTRRO	22.00/gal
Amber Custom Pak	8.90/oz	Distinct	45.00/lb	Karmex 80W	4.40/lb
Ammonium Sulfate	0.17/lb	Diuron	4.20/lb	Kerb 50W	54.00/lb
Aquathol Super K	19.00/lb	Domain	13.80/lb	Keystone	40.00/gal
Aquathol 1.6E	73.00/gal	Double Play	37.00/gal	Keystone LA	48.00/gal
Arrow (clethodim)	148.00/gal	Dual Magnum	114.00/gal	Krenite	60.00/gal
Arsenal	308.00/gal	Dual II Magnum	121.00/gal	Krovar	12.80/lb
Assure II	146.00/gal	Durango (120)	30.00/gal	Laddock S-12	49.00/gal
Atrazine 4L	10.60/gal	Epic	39.00/lb	Landmaster BW	15.40/gal
Atrazine 90 DF	2.30/lb	Eptam 7E	37.60/gal	Lariat	22.00/gal
Authority 75DF	29.00/lb	Equip	11.60/oz	LeadOff Bulk	40.00/gal
Axiom	20.00/lb	Excort XP	21.60/oz	Lexar	41.00/gal
Backdraft SL	20.50/gal	Evik	7.10/lb	Liberty	71.00/gal
Balance Pro	7.50/oz	Exceed	12.40/oz	Libertz ATZ	56.00/gal
Banvel	76.00/gal	Expert	30.00/gal	Lightning	13.00/oz
Basagran	86.00/gal	Express	19.50/oz	Lumax	53.00/gal
Basis 75 DF	18.80/oz	Express XP	20.30/oz	Marksman	34.00/gal
Basis Gold	21.70/lb	Extreme	34.00/gal	Matrix	14.00/oz
Beacon	29.60/oz	Fallow Master Broad Spectrum	23.00/gal	Maverick	16.00/oz
Betamix	106.00/gal	Fallow Star	17.70/gal	MCPA Amine	17.50/gal
Beyond	580.00/gal	Field Master	29.60/gal	MCPA Ester 4 lb	20.00/gal
Bicep II Lite Magnum	59.00/gal	Finesse	15.50/oz	Micro-Tech	26.00/gal
Bicep II Magnum	45.00/gal	First Rate	29.40/oz	Milestone	358.00/gal
Ultra Blazer	67.00/gal	Five Star	26.00/gal	Moxy	60.00/gal
Boundary 6.5 EC	82.00/gal	Flexstar	113.00/gal	MSO Succeed	12.40/gal
Bronate Advanced	65.00/gal	Frontier (6.0)	95.00/gal	MSO/OS (Air Force)	22.00/gal
Buctril	67.00/gal	Fultime	32.00/gal	North Star	2.10/oz
Buctril + Atrazine	44.00/gal	Fusilade DX	157.00/gal	Nortron SC	124.00/gal
Bullet	22.00/gal	Fusion	166.00/gal	Olympus	11.00/oz
Butyrac 200	36.00/gal	Gangster	592.00/unit	Olympus FLEX	4.00/oz
Callisto	586.00/gal	Garlon 3 lb A	79.00/gal	Option	11.30/oz
Camix	61.00/gal	Garlon 4 lb E	103.00/gal	Outlaw	30.60/gal
Canopy XL	38.00/lb	Gauntlet	3.20/oz	Outlook	161.00/gal
Casoron 4G	2.35/lb	Glean	17.00/oz	Overdrive	50.00/lb
Celebrity Plus	92.00/lb	Glyphosate (generic) w surfactant	13.44/gal or 0.105/oz	Parallel (Metolachlor)	72.00/gal
Cimarron	23.00/oz	G-Max Lite	62.00/gal	Paramount	50.00/lb
Cimarron MAX	290.00/case	Goal 2XL	100.00/gal	Partner	2.60/lb
Cinch	104.00/gal	Gramoxone Max	46.00/gal	Peak	12.00/oz
Cinch ATZ	43.00/gal	Grazon P+D	33.00/gal	Pendimax	22.70/gal
Cinch ATZ Lite	56.00/gal	Guardsman	42.00/gal	Permit	17.20/oz
Clarity	103.00/gal			Phoenix	160.00/gal
Classic	14.00/oz			Plateau	315.00/gal
Cobra	158.00/gal			Poast	72.50/gal
Command	105.00/gal			Poast Plus	54.60/gal

Product	2006 Price (\$ per unit)	Product	2006 Price (\$ per unit)	Product	2006 Price (\$ per unit)
Pramitrol 25E	30.50/gal	Roundup UltraMax II	67.00/gal	Topnotch	39.00/gal
Pramitrol SP 5 PS	2.20/lb	RT Master	19.00/gal	Tordon 22K	100.00/gal
Prefar	50.00/gal	RT Master II (Bulk)	28.00/gal	Tordon RTU	9.80/qt
Princep 4L	19.00/gal	Sahara	10.70/lb	Touchdown CF	19.00/gal
Princep Cal 90	4.20/lb	Sandea	41.00/oz	Touchdown Hitech	32.60/gal
Progress	120.00/gal	Salvo	28.00/gal	Touchdown IQ	26.00/gal
Prowl	24.00/gal	Select 2 EC	210.00/gal	Touchdown Total	37.00/gal
Prowl H2O	32.00/gal	Sencor DF	22.00/lb	Transline	370.00/gal
Pursuit DG	12.60/oz	Sinbar	33.00/lb	Treflan	30.00/gal
Pursuit L	575.00/gal	Sonalan HFP	30.00/gal	Treflan HFP	30.00/gal
Pursuit Plus	54.00/gal	Sonalan 10G	1.07/lb	Treflan TR-10	0.87/lb
Python WDG	10.30/oz	Spartan 7F DF	48.00/lb	Trifluralin	19.50/gal
Range Star (Banvel + 2,4-D amine)	27.00/gal	Spartan 4L	430.00/gal	Trifluralin 10G	0.80/lb
Raptor	580.00/gal	Spike 20P	7.50/lb	Valor	70.00/lb
Rave	1.50/oz	Spike 80 DF	20.00/lb	Vista	92.00/gal
Ready Master ATZ	17.00/gal	Spirit	11.00/oz	Ultra Blazer	67.00/gal
Redeem R&P	100.00/gal	Starane	110.00/gal	Upbeet	52.00/oz
Reflex	104.00/gal	Steadfast	23.00/oz	Velpar DF	24.00/lb
Reglone	90.00/gal	Steadfast ATZ	22.00/lb	Velpar L	64.00/gal
Rely	66.00/gal	Strategy	84.00/gal	Weedmaster	28.00/gal
Resource	180.00/gal	Surmount	55.00/gal	Yukon	2.60/oz
Remedy	100.00/gal	Steel	30.00/gal	Zorial Rapid 80	16.00/lb
Remedy RTU	40.00/gal	Stellar	220.00/gal		
Result	54.00/gal	Stinger	136.00/qt		
Rodeo	50.00/gal	Storm	90.00/gal		
Roundup Original II	45.00/gal	Surfactant/Nonionic 90%	17.50/gal		
Roundup Original Max	37.50/gal	Surflan AS Ag Label	73.00/gal		
Roundup Weather Max	62.00/gal	Surpass	82.00/gal		
Roundup UltraDry	9.00/lb	Synchrony SP	10.80/oz		
Roundup UltraMax	57.00/gal	Telar	23.00/oz		

Herbicide Dictionary

This section gives the trade name, common name, formulation, use description, company, EPA Registration number, year label updated, whether the herbicide is a restricted use herbicide and classification for herbicide family, mode of action and herbicide resistance group of herbicides commonly used in Nebraska. Restricted use herbicides are listed as RUPs. For more information on family, mode of action, or herbicide resistance group see pages 18-19.

Read and follow label information before using these products. Below are examples of a herbicide entry and a breakdown of the information provided in each entry. Several brands of herbicides contain the same active ingredient. We have not listed all possible brand names. Some companies use a header for their line of ag chemical products; for example, Agrilience uses AgriSolutions.

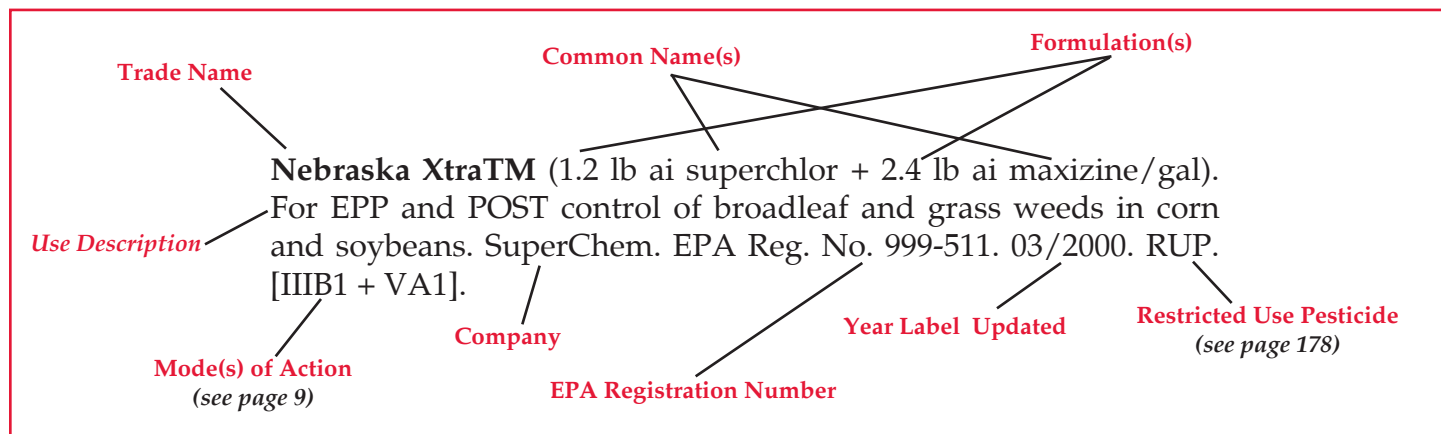

Many abbreviations are used in this dictionary and on herbicide labels. Below is a list of some of those abbreviations. Keep in mind that many abbreviations and acronyms cannot be defined since different manufacturers use the same acronyms with different meanings.

AC = Application Concentrate, ATZ = atrazine, CST = Cut Surface Treatment, DF = Dry Flowable, DG = Dispersible Granules, EC = Emulsifiable Concentrate, EPA = Environmental Protection Agency, F = Flowable, FC = Flowable Concentrate, G = Granules, HC = High Concentration, IVM = Industrial Vegetation Management, L = Liquid, ME = Micro-encapsulated, PPE = Personal Protection Equipment, RTU = Ready To Use, RUP = Restricted Use Pesticide, SC = Suspension Concentrate, SG = Soluble Granules, T/O = Turf/Ornamentals, W = Wettable Powder, WDG = Water Dispersible Granules, WDP = Water Dispersible Powder, WPS = Worker Protection Standard, WSP = Water Soluble Product.

AAtrex® (atrazine 4 lb ai/gal or 90% DF). Used for weed control in corn, sorghum, fallow and CRP. Syngenta. EPA Reg. No. 100-497 or 100-585. 02/2004 or 02/2004. RUP. [VA1].

Accent® (nicosulfuron 75% DF). POST grass control in corn. DuPont. EPA Reg. No. 352-560. 08/2003. [IIA2].

Accent® Gold™ (6.5% nicosulfuron + 6.5% rimsulfuron + 19.1% flumetsulam + 51.7% clopyralid). Used POST for broadleaf and grass weed control in field corn. DuPont. EPA Reg. No. 352-593. 05/1998. [IIA2 + IIA2 + IIA3 + IVA3].

Accent Gold® WDG (5.4% nicosulfuron + 3.4% rimsulfuron + 15.9% flumetsulam + 51.4% clopyralid). Used POST for broadleaf and grass weed control in field corn. DuPont. EPA Reg. No. 352-612. 07/2002. [IIA2 + IIA2 + IIA3 + IVA3].

Acclaim® Extra (fenoxaprop-ethyl 0.57 lb ai/gal). For selective POST grass in turfgrass and ornamentals. Bayer. EPA Reg. No. 432-950. 04/2000. [IA1].

Accord® Concentrate (isopropylamine salt of glyphosate 4 lb ae/gal or 5 lb ai/gal). For control of woody brush, trees and herbaceous weeds in utility right-of-way and aquatic weed control. Dow AgroSciences. EPA Reg. No. 62719-324. 10/2002. [IIB1].

Accord® SP (isopropylamine salt of glyphosate 3 lb ae or 4 lb ai/gal). For control of woody brush, trees and herbaceous weeds in utility right-of-way. Dow AgroSciences. EPA Reg. No. 62719-322. 06/2002. [IIB1].

Acetochlor. An active ingredient in Confidence, Confidence Xtra, Confidence Xtra 5.6L, Degree, Degree Xtra, Field Master, Full-Time, Harness, Harness 20G, Harness Xtra, Harness Xtra 5.6L, Keystone, Keystone LA, Surpass, TopNotch, Volley, Volley ATZ and Volley ATZ Lite for annual grass control in corn. [IIIB1].

Achieve® 40 DG or SC (tralkoxydim 40DG or 3.33 ai lb/gal). Used POST for control of grass weeds in wheat and barley. Syngenta. EPA Reg. No. 100-1105 or 100-1130. 07/2001 or 02/2004. [IA2].

Acifluorfen. An active ingredient in Blazer, Conclude Xact, Manifest, Storm and Ultra Blazer for broadleaf weed control in soybean. [VIA1].

Agri Star™, Gly Star™ 5 (see Gly Star 5)

Agri Star™, Gly Star™ Original (see Gly Star Original)

Agri Star™, Gly Star™ Pro (see Gly Star Pro)

Agri Star™ Landmaster (see Landmaster BW)

Herbicide Dictionary (continued)

Aim™ EC (carfentrazone-ethyl 2.0 lb ai/gal). For EPOST control of broadleaf weeds in field and seed corn, sweet corn, popcorn, silage, grain sorghum, soybean, barley, millet, oat and wheat. Not labeled for wheat in Nebraska. A 24c label is available for use as a harvest aid in corn, soybean and wheat for desiccation of broadleaf weeds. FMC. EPA Reg. No. 279-3241. 10/2003. [VIA3].

Aim™ EW (carfentrazone-ethyl 1.65 lb ai/gal). For EPOST control of broadleaf weeds in field, sweet and seed corn, popcorn, corn silage, grain sorghum, soybean, barley, oat and wheat. FMC. EPA Reg. No. 279-3242. 11/2002. [VIA3].

Aim™ Herbicide (carfentrazone-ethyl 40% w/w). For EPOST control of broadleaf weeds in field, seed and sweet corn, popcorn, silage, grain sorghum, soybean, barley, oat and wheat. FMC. EPA Reg. No. 279-3194. 11/2002. [VIA3].

Alachlor. An active ingredient in Alachlor 4 EC, Bullet, INTRRO, Lariat, Lasso, Lasso II G and Micro-Tech for annual grass control in corn, sorghum and soybean. RUP. [IIIB1].

Alachlor 4 EC (alachlor 4 lb ai/gal). For weed control, especially grasses, in corn, soybean and grain sorghum. Micro Flo. EPA Reg. No. 524-314-51036. 07/1998. RUP. [IIIB1].

Alanap® L (naptalam 2 lb ai/gal). A PRE or POST broadleaf and grass herbicide for cucurbit and nursery stock. Crompton/UniRoyal. EPA Reg. No. 400-49. 08/2002. [IIID1].

Ally® Herbicide or Ally® XP (metsulfuron 60% DF). Used PP, PRE or POST in wheat, barley, grain sorghum, pastures, rangeland, CRP and fallow for broadleaf and certain grass weed control. DuPont. EPA Reg. No. 352-435. 07/2002. [IIA2].

Ally® Extra (metsulfuron 15% + thifensulfuron methyl 37.5% + tribenuron methyl 18.75% by weight). Used POST in wheat, barley and fallow for broadleaf weed control. DuPont. EPA Reg. No. 352-610. 03/2003. [IIA2 + IIA2 + IIA2].

Amber® (triasulfuron 75% WDG). A PRE or POST herbicide for broadleaf weed control in wheat, barley, pastures, rangeland, CRP and fallow. Syngenta. EPA Reg. No. 100-768. 02/2004. [IIA2].

Ametryn. Active ingredient in Evik. Used for directed POST weed control in corn and nonselective weed control in noncrop areas. [VA1].

Amine 4 - 2,4-D (2,4-D amine 3.74 lb ae/gal). Used for selective broadleaf weed control in corn, sorghum, small grain and lawns. UAP Loveland. EPA Reg. No. 34704-120. 10/2001. [IVA1].

Amine 4 2,4-D Herbicide™ (2,4-D 3.8 lbs ae/gal). For control of broadleaf weeds in cereal crops, orchard floors, pastures, rangeland and noncrop areas. TENKōZ. EPA Reg. No. 42750-19-55467. 4/2002 [IVA1]

Amine 4CA 2,4-D Weed Killer™ (2,4-D 3.8 lbs ae/gal). For selective control of broadleaf weeds in cereal crops, lawns and noncrop areas. UAP Loveland. EPA Reg. No. 34704-5. 7/2004 [IVA1]

Aminopyralid. An active ingredient in Milestone. [IVA3].

Aquamaster™ (glyphosate 4 lb ae or 4.5 lb ai/gal). For use in aquatic sites. Monsanto. EPA Reg. No. 524-343. 11/2002. [IIB1].

Aqua-Kleen™ (19% ae 2,4-D ester). For aquatic weed control. Cerexagri. EPA Reg. No. 228-378-4581. 3/2003 [IVA1]

AquaNeat™ (glyphosate 4 lb ae or 5 lb ai/gal). For use on emerged aquatic weeds and brush in aquatic and other noncrop sites. Nufarm. EPA Reg. No. 228-365. 12/2002. [IIB1].

Aquathol® G or K (endothall 10% G or 4.23 lb ai/gal). An aquatic herbicide for use in still water. Cerexagri. EPA Reg. No. 4581-201 or 4581-204. 12/2003. [VIII A1].

Aquathol® Super K Granule (endothall 63% G). An aquatic herbicide for use in still water. Cerexagri. EPA Reg. No. 4581-388. 04/2003. [VIII A1].

Arrow 2EC Herbicide (clethodim 2lb ai/gal). Used POST for annual and perennial grasses in alfalfa, canola, potato, soybean, sunflower, sugarbeet and others. Makhteshim Agan N.A. EPA Reg. No. 66222-60. 12/2003. [IA2].

Arsenal® Herbicide (imazapyr 2 lb ai/gal). Provides total vegetation control for noncrop areas. BASF. EPA Reg. No. 241-346. 04/2000. [IIA1].

Arsenal® AC (imazapyr 4 lb ai/gal). Used for POST control of woody and herbaceous weed control for forest site preparation and release of conifers. BASF. EPA Reg. No. 241-299. 04/2000. [IIA1].

Assert® (imazamethabenz 2.5 lb ai/gal). POST control of wild oat and wild buckwheat in spring wheat and barley. Micro Flo. EPA Reg. No. 241-285-51036. 12/1999. [IIA1].

Assure® II (quizalofop 0.88 lb ai/gal). A POST grass herbicide for use in canola, dry bean, snapbean, soybean and sugarbeet. DuPont. EPA Reg. No. 352-541. 03/2003. [IA1].

Asulam. Active ingredient in Asulox, Asulam 3.3. [IIIA3].

Asulox® or Asulam 3.3 (asulam 3.34 lb ai/gal). For POST weed control in turf, ornamentals, Christmas trees and noncrop areas. Bayer. EPA Reg. No. 264-447. 05/2003. Agrilience. 9779-342. [IIIA3]. Not registered in Nebraska.

Atrazine. A PP, PRE and POST s-triazine for control of broadleaf and certain grass weeds in corn, sorghum, ecofallow and CRP. Also used for weed control in CRP and control of certain annual grasses in perennial grass roadways. Atrazine is an active ingredient in AAtrex, Atrazine 4F, Atrazine 4L, Atrazine 90 DF, Atrazine 90 WDG, Avalanche EW, Banvel + Arazine, Basis Gold, Bicep Lite II Magnum, Bicep II Magnum, Bromox Atrazine, Buctril + Atrazine, Bullet, Cinch ATZ, Cinch ATZ Lite, Confidence Xtra, Confidence Xtra 5.6L, Cornbelt Atrazine 4L or 90 DF, Degree Xtra, Dicambazine, Expert, Field Master, FulTime, G-Max Lite, Guardsman, Guardsman Max, Harness Xtra, Harness Xtra 5.6, Keystone, Keystone LA, Laddok S-12, Lariat, Lexar, Liberty ATZ, Lumax, Marksman, Moxy + Atrazine, Prompt, Ready Master ATZ, Shotgun, Simazat, Stalwart Xtra, Steadfast ATZ, Sterling Plus, Trizmet II, Volley ATZ & Volley ATZ Lite. RUP. [VA1].

Atrazine 4 F (atrazine 4 lb/gal). Albaugh/Agri Star. EPA Reg. No. 42750-45. 02/2000. RUP. [VA1].

Atrazine 4 L (atrazine 4 lb ai/gal). Agrilience. EPA Reg. No. 1381-158. 01/2000. RUP. [VA1].

Atrazine 4 L (atrazine 4 lb ai/gal). Helena. EPA Reg. No. 5905-470. 02/2004. [VA1].

Atrazine 90 DF (atrazine 90% DF). Drexel. EPA Reg. No. 10713-76. 02/222004. RUP. [VA1].

Herbicide Dictionary (continued)

Atrazine 90 WDG (atrazine 90% ai). Van Diest. EPA Reg. No. 11773-13. RUP. [VA1].

Authority™ Broadleaf Herbicide (46.9% sulfentrazone + 9.4% chlorimuron DG). For PPI or PRE broadleaf control in soybean. FMC. EPA Reg. No. 279-3179. 12/2002. [VIA3 + IIA2].

Authority® Herbicide (70% sulfentrazone). For broadleaf weed control in soybean; may be applied PPI, PP, or PRE. DuPont. EPA Reg. No. 352-00590. 05/2002. [VIA3].

Avalanche™ EW (carfentrazone + atrazine). Available from Agrilience in 2004.

Avalanche™ Bulk Pac (carfentrazone 1.9 lb ai/gal). For POST broadleaf control in field, sweet and seed corn, popcorn and silage, grain sorghum, soybean, wheat, barley and oat. Agrilience. EPA Reg. No. 279-3242-1381. 03/2002. [VIA3].

Avast!® SRP (fluridone 4 lb ai/gal). For control of aquatic weeds. Griffin. EPA Reg. No. 1812-447. 06/2003. [VIIA4].

Axial. (pinoxaden). Under development for use in cereal grains. Controls wild oat, barnyardgrass, green and yellow foxtail. Syngenta.

Axiom™ DF (54.4% flufenacet + 13.6% metribuzin). For PP, PPI, or PRE broadleaf and grass weed control in field corn and silage corn and soybean. Bayer. EPA Reg. No. 264-766. 10/2003. [IIIB2 + VA2].

Backdraft™ (0.25 lb ae imazaquin + 1.25 ai lb/gal glyphosate). Used PRE for weed control before planting soybean or POST in Roundup Ready soybean. BASF. EPA Reg. No. 241-407. 03/2001. [IIA1 + IIB1].

Backdraft™ SL (0.15 lb ae imazaquin + 1.20 ae lb/gal glyphosate). Used POST for weed control in Roundup Ready soybean. BASF. EPA Reg. No. 241-415. 07/2001. [IIA1 + IIB1].

Balan™ DF (benefin 60% DF). A PPI herbicide for annual grass control in alfalfa. UAP Loveland. EPA Reg. No. 34704-746. 09/2001. [IIIA1].

Balan™ 2.5 G (benefin 2.5% ai) PRE control of annual grasses in lawns and golf courses. Verdicon (formerly United Horticultural Supply). EPA Reg. No. 62719-96-65783. 09/2001. [IIIA1].

Balance® Pro (isoxaflutole 4 lb ai/gal). For selective PP and PRE control of grass and broadleaf weeds in field corn. Bayer. EPA Reg. No. 264-600. 05/2003. RUP. [VIIB1].

Banvel SGF® or Banvel® (dimethylamine salt of dicamba 2 or 4 lb ae/gal). A POST and PRE herbicide for selective broadleaf weed control in corn, sorghum, small grains and perennial grass. BASF or Micro Flo. EPA Reg. No. 7969-135 or 51036-289. 07/2001. [IVA2].

Banvel® + Atrazine (dicamba 1.0 lb ae + atrazine 2.2 lb ai/gal). For weed control in corn, grain sorghum and fallow. BASF or Micro Flo. EPA Reg. No. 7969-307. 07/2001. RUP. [IVA2].

Banvel + 2,4-D (DMA salt of dicamba 1.0 lb + 2.87 lb ae of 2,4-D DMA). For CRP, fallow systems, general farmstead, sorghum, grass (hay or silage), pastures, rangeland and wheat. Micro Flo. EPA Reg. No. 51036-308. 10/2003. [IVA2 + IVA1].

Barrage® HF (2-ethylhexyl ester of 2,4-D at 4.7 lb ae/gal). For broadleaf weed control in pastures, grassland, rangeland and fallow. PP, PRE, or POST in corn, grain and forage sorghum, wheat and oat. Helena. EPA Reg. No. 5905-529. 02/2004. [IVA1].

Barricade® (prodiamine 65WG or 4FL). A PRE herbicide for residual control of annual grass and broadleaf weeds in established turfgrasses, lawns, sod nurseries and landscape ornamentals. Syngenta. EPA Reg. No. 100-834 or 100-1139. 06/2001. [IIIA1].

Basagran® (bentazon 4 lb ai/gal). A POST dry edible bean, corn, sorghum and soybean herbicide for control of velvetleaf, cocklebur and other broadleaf weeds under 6 inches. Micro Flo; Agrilience. EPA Reg. No. 7969-45-51036-1381; 7969-45. 12/2000; 02/2000. [VC1].

Basagran® T/O (bentazon 4 lb ai/gal). POST broadleaf weed control in established turf. BASF; Micro Flo. EPA Reg. No. 7969-45; 7969-51036. 10/2003; 07/2002. [VC1].

Basis® Herbicide (50% rimsulfuron + 25% thifensulfuron -- 75% WDG). A POST herbicide for selective broadleaf and grass control in corn. DuPont. EPA Reg. No. 352-571. 05/2003. [IIA2 + IIA2].

Basis Gold® (1.34% rimsulfuron + 1.34% nicosulfuron + 82.44% atrazine WSG). Used POST for broadleaf and grass weed control in field corn. EPA Reg. No. 352-585. DuPont. 04/2001. RUP. [IIA2 + IIA2 + VA1].

Battleship (DMA salt of MCPA 3 lb ae + trichlopyr 0.27 lb ae + clopyralid 0.13 lb ae/gal). For control of annual and perennial broadleaf weeds in ornamental turf including sod. Helena. EPA Reg. No. 228-371-5905. 11/2000. [IVA2 + IVA3 + IVA3].

Bayonet® (trifluralin 10%). For weed control in various horticulture and field crops. Not registered in Nebraska. Helena. EPA Reg. No. 1812-328-5906. 09/2003. [IIIA1].

Beacon® (primisulfuron 75% WDG). POST grass and broadleaf weed control in field, silage and seed corn and popcorn. Syngenta. EPA Reg. No. 100-705. 03/2002. [IIA2].

Benefin (Also known as benfluralin.) Active ingredient in Balan DF, Balan 2.5G, Pro-Mate Turf Fertilizer and Team Pro for weed control in seedling alfalfa, turf and landscape ornamentals. [IIIA1].

Benoxacor. Safener to protect corn and sorghum from injury. Found in Dual Magnum products.

Bensulfuron. Active ingredient in Londax. [IIA2].

Bensulide. Active ingredient in Betasan 4-E or 12.5 G, Bensumec and Prefar 4-E for weed control in melons. [IIIC2].

Bensumec™ 4LF (bensulide 4 lb ai/gal). For PRE and PPI control of crabgrass and annual bluegrass in turf, ornamentals and groundcover. PBI Gordon. EPA Reg. No. 2217-696-ZB. [IIIC2].

Bentazon. An active ingredient in Basagran, Basagran T/O, Conclude Xact, Laddok S-12, Lescogran, Manifest, Prompt, Rezult and Storm for broadleaf weed control in corn, sorghum and soybean. [VC1].

Bentgrass Selective (dicamba 0.19 lb + 2,4-D amine 0.49 lb + mecoprop P 0.73 lb ae/gal). For use in controlling broadleaf weeds in ornamental lawns and turfgrass; not for turf being grown for sale. Lesco. EPA Reg. No. 10404-44. 12/2002. [IVA2 + IVA1 + IVA1].

Herbicide Dictionary (continued)

Betamix® Herbicide (0.65 lb phenmedipham + 0.65 lb desmedipham = 1.3 lb ai/gal). For POST broadleaf weed control in sugarbeet. Bayer. EPA Reg. No. 264-621. 05/2003. [VA3 + VA3].

Betanex® Herbicide (desmedipham 1.3 lb ai/gal). For POST broadleaf weed control, especially redroot pigweed in sugarbeet. Bayer. EPA Reg. No. 264-620. 04/2004. [VA3].

Betasan® 4-E or 12.5 G Turf Herbicide (bensulide 4 lb ai/gal). Used for PRE control of crabgrass and annual bluegrass in turf, ornamentals and ground cover. UAP Loveland. EPA Reg. No. 34704-211 or 34704-209. 05/2001. [IIC2].

Beyond™ (imazamox 1.0 lb ai/gal). Used POST to control downy brome and jointed goatgrass in Clearfield® winter wheat varieties. Beyond is also registered POST for weeds in Clearfield® sunflower. BASF. EPA Reg. No. 241-00379. 04/2001. [IIA2].

Bicep II Magnum® FC or Bicep II Magnum® (2.4 lb S-metolachlor + 3.1 lb ai/gal atrazine + benoxacor). For PRE broadleaf and grass weed control in corn and forage and grain sorghum treated with seed safener. Syngenta. EPA Reg. No. 100-817. 02/2004. RUP. [IIB1 + VA1].

Bicep Lite II Magnum® (S-metolachlor 3.33 lb + 2.67 lb ai atrazine). RUP. For weed control in corn and grain or forage sorghum. Syngenta. EPA Reg. No. 100-827. 02/2004. [IIB1 + VA1].

Bison™ (2 lb ai bromoxynil + 2 lb ae/gal MCPA). Used to control broadleaf weeds in small grains. Agrilience. EPA Reg. No. 9779-347. 01/2003. [VC2 + IVA1].

Blade™ Selective Herbicide (metsulfuron 60%). For POST control of broadleaf weeds and certain grasses including foxtail and ryegrass in turf. PBI Gordon. EPA Reg. No. 74477-1-2217. 03/2000. [IIA2].

Blazer (acifluorfen 2 lb ai/gal). A POST herbicide for broadleaf weed control in soybean. Blazer has more leaf burn than Ultra Blazer. *Discontinued*. See Ultra Blazer. United Phosphorus. EPA Reg. No. 7969-79. 04/1999. [VA1].

Boa™ Herbicide (paraquat 2.5 lb ai/gal). A contact herbicide and desiccant. Griffin. EPA Reg. No. 1812-420. RUP. 07/2000. [VIB1].

Bolero® 8 EC (thiobencarb 8 lb ai/gal). Rice herbicide. Valent. EPA Reg. No. 59639-79. 01/2000. [III3C].

Boundary® 6.5 EC (S-metolachlor 5.25 lb + 1.25 lb ai/gal metribuzin). For weed control in soybean. Syngenta. EPA Reg. No. 100-1162. 02/2004. [IIB1 + VA2].

Brash™ (dimethyl salt of dicamba 1 lb ai + 2.87 lb ae/gal of 2,4-D dimethylamine). For CRP, fallow systems, sorghum, rangeland, pastures and wheat. Agrilience. EPA Reg. No. 51036-308-9779. 10/2001. [IVA2 + IVA1].

BroadStar™ (flumioxazin-25% G). For PRE weed control in containers and field grown shrubs, trees and groundcovers. Valent. EPA Reg. No. 639-128. 11/2003. [VIA2].

Broclean® (bromoxynil 2 lb ai/gal EC). A contact herbicide for broadleaf weed control in alfalfa, corn, sorghum and small grains. UAP Loveland. EPA Reg. No. 51036-256-34704. 12/1999. [VC2].

Bromacil. Active ingredient in Hyvar X, Hyvar X-L and Krovar I DF. [VA4].

Bromox 2 E (2 lb ai/gal of bromoxynil). For control of certain broadleaf weeds in field corn and popcorn, grain and forage sorghum, sudangrass, seeding alfalfa, onions, grasses grown for seed and sod production, CRP and turfgrass. Micro Flo. EPA Reg. No. 51036-255. 09/1999. [VC2].

Bromox 2-2 (2 lb of bromoxynil + MCPA 2 lb ae/gal). For control of certain broadleaf weeds in field corn and popcorn, grain and forage sorghum, sudangrass, seeding alfalfa, onions, grasses grown for seed and sod production, CRP and turfgrass. Micro Flo. EPA Reg. No. 51036-254. 09/1999. [VC2].

Bromox + Atrazine (bromoxynil 1.0 lb + 2 lb ai/gal atrazine). For controlling certain weeds in corn and sorghum. Micro Flo. EPA Reg. No. 51036-255. 08/2001. RUP. [VC2 + VA1].

Bromoxynil 2 EC (bromoxynil 2 lb ai/gal). For control of broadleaf weeds in field corn and popcorn, grains and forage sorghum, small grain, seedling alfalfa and non-residential turf. Makhteshim Agan; Micro Flo. EPA Reg. No. 264-437-6622. 02/2002. [VC2].

Bromoxynil. An active ingredient in Bison, Broclean, Bromox + Atrazine, Bromox 2 E, Bromox- 2-2, Bromoxynil 2 EC, Bronate Herbicide, Bronate Advanced, Buctril 4 EC, Buctril 4 Cereals, Buctril + Atrazine, Connect 20 WSP, Maestro MA, Maestro D, Moxy 2E and Moxy + Atrazine Herbicide. RUP. [VC2].

Bronate® Herbicide (2 lb ai bromoxynil + 2 lb ae/gal MCPA). Used to control broadleaf weeds in small grains. Bayer. EPA Reg. No. 264-438. 05/2003. [VC2 + IVA1].

Bronate Advanced™ (2.5 lb ai bromoxynil + 2.5 lb ae/gal MCPA). For broadleaf weed control in small grains. Bayer. EPA Reg. No. 264-690. 11/2002. [VC2 + IVA1].

Brushmaster® (12.5% 2,4-D + 6.25% dichlorprop + 3.01% dicamba). For control of brush and broadleaf weeds in some trees. PBI/Gordon Corp. EPA Reg. No. 2217-774. 3/2003. [IVA1 + IVA1 + IVA2].

Buctril® or Buctril® 4EC (2 lb ae acid ester of bromoxynil 4 lb ai/gal EC). A contact herbicide for broadleaf weed control in seedling alfalfa, field corn and popcorn, grain and forage sorghum and small grains. Bayer. EPA Reg. No. 264-437 or 264-540 or 264-560. 06/1998 or 08/2000 or 02/2002 [VC2].

Buctril® + Atrazine (1 lb ai bromoxynil + 2 lb ai/gal atrazine). For POST broadleaf weed control in corn and grain sorghum. Bayer. EPA Reg. No. 264-477. 06/2003. RUP. [VC2 + VA1].

Buctril® 4 Cereals (4 lb ai/gal bromoxynil). For control of certain broadleaf weeds in wheat, barley, oat, rye and triticale. Bayer. EPA Reg. No. 264-540. 08/2000. [VC2].

Bullet® (2.5 lb ai alachlor + 1.5 lb ai atrazine 4 lb ai/gal). Used PRE or PPI to control broadleaf and grass weeds in all types of corn and grain sorghum. Monsanto. EPA Reg. No. 524-418. 01/2002. RUP. [IIB1 + VA1].

Butoxone® 200 Herbicide (2,4-DB-2 lb ae/gal). For control of seedling broadleaf weeds in alfalfa. Monterey. EPA Reg. No. 56077-26. 07/1999. [IVA1].

Butoxone® 7500 (2,4-DB-0.75 lb ae/gal). For controlling seedling broadleaf weeds in alfalfa. Monterey. EPA Reg. No. 56077-52. 07/2004. [IVA2].

Butylate. Active ingredient in Sutan+. [IIC3].

Herbicide Dictionary (continued)

Butyrac® 175 or 200 (2,4-DB 2.0 lb/gal). For selective control of cocklebur in soybean and small broadleaf weeds in alfalfa. Albaugh/Agri Star. EPA Reg. No. 42750-39 or -38. 11/2002 or 02/2000. [IVA1].

Callisto™ (mesotrione 4 lb ai/gal). Used PRE and POST for broadleaf weed control in field corn, production seed corn, yellow popcorn and silage corn. Syngenta. EPA Reg. No. 100-1131. 01/2002. [VIIB2].

Camix™ (S-metolachlor 3.3 lb ai + mesotrione 0.33 lb ai/gal). For PRE control of annual broadleaf and grass weeds in seed corn, field corn and corn grown for silage. Syngenta. EPA Reg. No. 100-1148. 04/2003. [IIIB1 + VIIB1].

Campaign® (1.2 lb ai or 0.9 lb ae glyphosate IPA + 1.9 ai or 1.5 ae lb/gal 2,4-D amine). For noncrop, rangeland and industrial weed control. Monsanto. EPA Reg. No. 524-351. 11/2002. [IIIB1 + IVA1].

Canopy XL® (46.9% sulfentrazone + 9.4% chlorimuron). Used PRE for broadleaf and grass weed control in soybean. DuPont. EPA Reg. No. 352-589. 08/2001. [VIA3 + IIA2].

Carfentrazone. Active ingredient in Aim, Aim EC, Aim EW, Avalanche Bulk Pac, Avalanche EW, Power Zone, Priority, Quick-Silver, Speed Zone and Teamwork. [VIA3].

Casoron® 4 G (dichlobenil 4% G). For PRE weed control in woody plants and certain herbaceous perennials. Crompton/Uniroyal. EPA Reg. No. 400-168. 08/2000. [IIIE2].

Celebrity® (69% dicamba + 7.5% nicosulfuron). Copack of Accent + Banvel. For POST weed control in field corn. BASF. EPA Reg. No. 7969-166. 04/1998. [IVA2 + IIA2].

Celebrity® Plus (42.4% dicamba + 17.0% diflufenzopyr + 10.6% nicosulfuron). For POST weed control in field corn. BASF. EPA Reg. No. 7969-175. 04/1999. [IVA2 + IIID2 + IIA2].

Certainty™ Turf Herbicide (sulfosulfuron 75%). For control of annual and perennial grass and broadleaf weeds in highly managed warm-season turf sites. Monsanto. EPA Reg. No. 524-534. 09/2004. [IIA2].

Chaser® Turf Herbicide (2,4-D butoxyethyl ester 2 lb ae + triclopyr 1 lb ae/gal). For POST control of annual and perennial broadleaf weeds in ornamental turf. Verdicon (formerly United Horticultural Supply). EPA Reg. No. 62719-67-65783. 10/2003. [IVA1 + IVA3].

Chaser® 2 Amine (2,4-D amine 2.78 lb ae + triclopyr 1.07 ae/gal). For POST control of annual grass and perennial broadleaf weeds in ornamental turf and sod farms. Verdicon (formerly United Horticultural Supply). EPA Reg. No. 228-316-65783. 01/2001. [IVA1 + IVA3].

Chaser® Ultra (MCPA 3.74 lb + clopyralid 0.18 + 0.18 lb ae/gal of dichloroprop). For broadleaf weed control in golf courses, parks and ornamental lawns. Verdicon (formerly United Horticultural Supply). EPA Reg. No. 228-372-65783. 08/2002. [IVA1 + IVA3 + IVA1].

Chaser® Ultra Weed & Feed (2,4-D acid 0.861% + 0.37% clopralid + 0.072% dicamba). For broadleaf weed and feed in lawns. Contains fertilizer. Verdicon (formerly United Horticultural Supply). EPA Reg. No. 228-376-65783. 08/2001. [IVA1 + IVA3 + IVA2].

Chateau™ SW (flumioxazin 51% WDG). For control of certain broadleaf weeds in soybean. Valent. EPA Reg. No. 59639-99. 12/2003. [VIA2].

Chlorimuron. An active ingredient in Authority Broadleaf, Canopy XL, Classic and Synchrony STS. [IIA2].

Chlorsulfuron. An active ingredient in Finesse, Glean FC, Landmark MP, Landmark II MP and Telar. [IIA2].

Chopper® (imazapyr-2 lb ai/gal). Mixed with water and/or diesel fuel to control regrowth from cut stumps of brush and trees. BASF. EPA Reg. No. 241-296. 02/2001 [IIA1].

Cimarron™ (60% metsulfuron). For weed control in pastures, rangeland, or CRP. DuPont. EPA Reg. No. 352-616. 03/2003. [IIA2].

Cimarron™ Max (0.60% metsulfuron plus dicamba + 2.87 lb ae/gal 2,4-D). Copack for controlling broadleaf weeds in pastures, rangeland, or CRP. DuPont. EPA Reg. No. 352-615. 03/2003. [IIA2 + IVA2 + IVA3].

Cinch® (S-metolachlor 7.64 lb ai/gal + benoxacor safener). Registered for weed control in corn, safflower, grain or forage sorghum, soybean and potato. DuPont. EPA Reg. No. 352-625. 06/2003. [IIIB1].

Cinch® ATZ (S-metolachlor 2.4 lb + benoxacor safener + atrazine 3.1 lb ai/gal). For weed control in corn and grain or forage sorghum. DuPont. EPA Reg. No. 352-624. 10/2003. RUP. [IIIB1 + VA2].

Cinch® ATZ Lite (S-metolachlor 3.33 lb + benoxacor safener + 2.67 lb ai atrazine). For weed control in corn and grain or forage sorghum. DuPont. EPA Reg. No. 100-827-352. 9/2002. RUP. [IIIB1 + VA2].

Clarion® (37.5% nicosulfuron + 37.5% rimsulfuron). For selective POST control of grass and broadleaf weeds in field corn. DuPont. EPA Reg. No. 352-572. 02/2004. [IIA2 + IIA2].

Clarity® (glycolamine salt of dicamba 4 lb ae/gal). A low volatile formulation of dicamba to be used POST for broadleaf weed control in corn, sorghum and small grains. BASF. EPA Reg. No. 7969-137. 01/2003. [IVA2].

Classic® Herbicide (chlorimuron 25% DF). A POST herbicide for broadleaf weed control in soybean. DuPont. EPA Reg. No. 352-436. 04/2003. [IIA2].

ClearOut 41 (IPA salt of glyphosate 3 lb ae or 4 lb ai/gal). For nonselective weed control and for Roundup Ready corn and soybean. Needs additional surfactant. CPT-LLC [IIB1].

ClearOut 41 Plus (IPA salt of glyphosate 3 lb ae or 4 lb ai/gal). For nonselective weed control and for Roundup Ready corn and soybean. CPT-LLC. [IIB1].

Clethodim. Active ingredient in Arrow 2 EC, Prizm and Select. [IA2].

Clodinafop-propargyl. Active ingredient in Discover Herbicide or Discover NG. [IA1].

Clomazone. An active ingredient in Command 3ME, Commence EC, Commit 3ME and Strategy. [VIIC].

Herbicide Dictionary (continued)

Clopyr® Ag Herbicide (clopyralid 3 lb ae/gal). Labeled for asparagus, tree plantations, fallow cropland, field corn, grasses grown for seed, sugarbeet and CRP. Ag Value. EPA Reg. No. 75147-4-73917. 05/2003. [IVA3].

Clopyralid. An active ingredient in Accent Gold, Accent Gold WDG, Battleship, Chaser Ultra, Chaser Ultra Weed & Feed, ClopyrAg Herbicide, Confront, Curtail, Curtail M, Hornet WDG, Lontrel, Millenium Ultra, Millenium Ultra Plus, Reclaim, Redeem R&P, Stinger, Strike Three Ultra, Transline, WideMatch and WideMatch M. [IVA3].

Cloransulam methyl. An active ingredient in FirstRate, Frontrow, Gangster, Gangster FR and Gauntlet. [IIA3].

Cobra® (lactofen 2lbs/gal ai). For selective weed control PRE & POST in soybeans and cotton. Valent. EPA Reg. No. 59639-34. 5/2003 [VIA1]

Command® 3 ME (clomazone 3 lb ai/gal). An encapsulated PRE herbicide for grass and broadleaf weed control in soybean. FMC. EPA Reg. No. 279-3158. 05/2003. [VIIC].

Commence® EC (3 lb ai trifluralin + 2.25 lb ai/gal clomazone). Used PPI to control weeds in soybean. FMC; UAP Loveland. EPA Reg. No. 279-3104; 279-3158-34704. 02/1995. [IIIA1 + VIIC].

Commit 3ME (clomazone 3 lb ai/gal). An encapsulated PRE herbicide for grass and broadleaf weed control in soybean. Agrilience. EPA Reg. No. 279-3158-1381. 8/16/2001 [VIIC].

Concep III® (fluxofenim 75% WP). A protectant for corn and sorghum seeds to reduce metolachlor injury. Syngenta. EPA Reg. No. 100-NC-2. 09/1998.

Conclude® Xact (2.67 ai bentazon + 1.33 lb ai acifluorfen 6 lb ai/gal + 2 lb ai sethoxydin). For POST grass and broadleaf weed control in soybean. Sold as a co-pack. BASF. EPA Reg. No. 7969-179. 04/2001. [VIC1 + VIA1 + IA2].

Confidence™ (acetochlor 7 lb ai/gal). PRE for grass weed control in field corn, seed corn, silage and popcorn. Same as Harness, but no safener. Agrilience. EPA Reg. No. 524-473. 01/2003. RUP. [IIIB1].

Confidence® Xtra (acetochlor 4.3 lb + atrazine 1.7 lb ai/gal). PRE for broadleaf and grass weed control in field, seed and silage corn and popcorn. Same as Harness Extra, but no safener. Agrilience. EPA Reg. No. 524-480. 01/2003. RUP. [IIIB1 + VA1].

Confidence® Xtra 5.6L (acetochlor 3.1 lb + atrazine 2.5 lb ai/gal). PRE for broadleaf and grass control in field and seed corn, silage, and popcorn. Agrilience. EPA Reg. No. 524-485. 01/2003. RUP. [IIIB1 + VA1].

Confront™ (2.25 lb triclopyr + 0.75 lb clopyralid lb ae/gal). For control of annual and perennial broadleaf weeds in established turf (golf course). Dow AgroSciences. EPA Reg. No. 62719-92. 08/1998. [IVA3 + IVA3].

Connect 20™ WSP (acid ester of bromoxynil equivalent to 20% bromoxynil). Controls certain broadleaf weeds in corn. Should be used with atrazine. Bayer. EPA Reg. No. 264-586. 06/2003. RUP. [VC2].

Cool Power™ (3 lb ae MCPA + 0.3 lb ae triclopyr + 0.3 lb ae/gal dicamba). For broadleaf weed control in golf courses, parks and ornamental turf lawns. Nufarm. EPA Reg. No. 228-317. 07/1998. [IVA1 + IVA3 + IVA2].

Copper-Komeen®. An aquatic herbicide (see Komeen).

Copper Sulfate. Available as crystals or in chelated form for algae control in moving and still water. Several brand names.

Cornbelt® 4 lb or 6 lb Lo Vol Ester (3.8 or 5.6 lb ae lb/gal 2-ethylhexyl ester of 2,4-D). For control of many broadleaf weeds susceptible to 2,4-D. May be applied in crop residue management systems in soybean when applied preplant. Van Diest. EPA Reg. No. 11773-3 or 11773-4. 04/2002. [IVA1].

Cornbelt® 4 lb amine (2,4-D dimethylamine salt 3.8 lb ae/gal). For broadleaf weed control in grass pastures, rangelands and certain crops. Van Diest. EPA Reg. No. 11773-5. 04/2002. [IVA1].

Cornbelt® Atrazine 4L or 90DF (atrazine 4 lb ai/gal or 90 DF). For season long weed control in corn, soybean and certain other crops. Van Diest. EPA Reg. No. 11773-1 or 11773-13. 07/1994 or 04/2002. RUP. [VA1].

Cornbelt® Trifluralin EX (trifluralin 4 lb ai/gal). PPI, PRE immediately after planting, POST, or layby application for weed control in many crops. Van Diest. EPA Reg. No. 1812-355-11773. 03/1999. [IIIA1].

Cornerstone® or **Cornerstone® Plus** (isopropylamine salt of glyphosate 3 lb ae or 4 lb ai/gal). For POST control of broadleaf and grass weeds in Roundup Ready corn and soybean, burndown and noncropland weed control. Additional surfactant optional. Agrilience. EPA Reg. No. 42750-60-1381. 02/2001. [IIB1]

Corral 2.68 G (pendimethalin 2.68% G). For use by commercial nursery, cutflower, foliage and landscape personnel. Scotts. EPA Reg. No. 538-188. 01/2004. [IIA2].

Cotoran® 80 DF or 4L (fluometron 80% or 4L). Used for weed control in cotton. Griffin. EPA Reg. No. 1812-323 or 1812-439. 01/2001 or 07/2003. [VB1].

Crabgrass Preventer with Barricade 295 or 50% Plus (prodiame 0.295 or 0.50%). For selective control of grass and broadleaf weeds in established turfs, lawns, landscape, ornamentals, established perennials and wild flower plantings. Do not use on golf course putting greens. Verdicon (formerly United Horticultural Supply). EPA Reg. No. 34704-820-65783. 04/2000 or 08/2002. [IIIA1].

Credit® System Herbicide (glyphosate 3 lb ae or 4 lb ai/gal). For POST control of broadleaf and grass weeds in Roundup Ready corn and soybean, burndown and noncropland weed control. Additional surfactant optional. Nufarm. EPA Reg. No. 71368-20. 10/2003. [IIB1].

Credit® Duo Herbicide or Credit® Duo Extra (2.7 lb ae isopropylamine salt + 0.3 lb ai/gal acid as monoammonium of glyphosate acid). Used for certain cropping systems including Roundup Ready corn, Roundup Ready soybean, reduced tillage and fallow systems and many noncrop areas. Additional surfactant of an 80% nonionic optional. Nufarm. EPA Reg. No. 71368-25. 09/2003. [IIB1].

Credit Master™ (glyphosate 0.9 lb ae + 2,4-D at 1.5 lb ae/gal). For POST control or suppression of field bindweed, broadleaf and grass weeds in fallow and reduced tillage systems. Additional surfactant optional. Nufarm. EPA Reg. No. 71368-31. 07/2001. [IIB1 + IVA1].

Herbicide Dictionary (continued)

Crossbow™ (2 lb ae 2,4-D + 1 lb ae triclopyr 3 lb ae/gal). For broadleaf weeds and woody plant control in rangeland, pastures, CRP and noncrop areas. Dow AgroSciences. EPA Reg. No. 62719-260. 01/2003. [IVA1 + IVA3].

Curbit® EC (ethalfluralin 3 lb ai/gal). Used PRE or PPI in melon, pumpkin, squash and cucumber for grass control. UAP Loveland. EPA Reg. No. 34704-610. 08/1999. [IIIA1].

Curtail™ (0.38 lb ae clopyralid + 2 lb ae 2,4-D = 2.38 lb ae/gal). For POST broadleaf control in wheat, barley, fallow, rangeland and pastures. Dow AgroSciences. EPA Reg. No. 62719-48. 06/2001. [IVA1 + IVA3].

Curtail™ M (0.42 lb clopyralid + 2.35 lb MCPA = 2.77 lb/gal). Used for POST broadleaf control in wheat and barley. Dow AgroSciences. EPA Reg. No. 62719-86. 07/2001. [IVA3 + IVA1].

Cyclone® Max (3.0 lb paraquat cation per gal). A weed, grass and harvest desiccant/defoliant herbicide. Syngenta. EPA Reg. No. 100-1074. RUP. 11/2002. [VIB1].

Cycolate. Active ingredient in Ro-Neet. [IIIC3].

Dacthal (also called DCPA). The active ingredient in Dacthal W-75 and Dacthal Flowable. [IIIA4].

Dacthal® W-75 or Dacthal® Flowable (DCPA-75% or 6 lb ai/gal). Used for control of annual grass weeds in potato and turf. AMVAC. EPA Reg. No. 5481-490 or 5481-487. 11/2002 or 08/2003. [IIIA4].

Dagger™ (isooctyl ester of MCPA 5.2 lb ae/gal). For selective control of broadleaf weeds in small grains, flax, grasses, rangelands, pastures and noncrop areas. Nufarm. EPA Reg. No. 228-267. 03/2003. [IVA1].

Dash HC. An anionic surfactant by BASF. EPA Reg. No. 34313-TX01.

DCPA. Another name for Dacthal. [IIIA3].

Define™ DF (flufenacet 60%). Used PPI or PRE for controlling certain grass and broadleaf weeds in field corn. Bayer. EPA Reg. No. 3125-487-264. 05/2002. [IIIB2].

Define™ SC Herbicide (flufenacet 41% or 4 lb ai/gal). Used for PPI control of certain grasses and broadleaf weeds in corn and soybean. Bayer Crop Science. EPA Reg. No. 264-819. [IVA4].

Degree™ Herbicide (3.8 lb ai/gal acetochlor). An encapsulated acetochlor with safener. EPP or PRE. Monsanto. EPA Reg. No. 524-496. 10/2002. RUP. [IIIB1].

Degree Xtra™ Herbicide (2.7 lb ai acetochlor + 1.34 lb ai atrazine/gal). For EPP and PRE control of broadleaf and grass weeds in field corn. Monsanto. EPA Reg. No. 524-511. 10/2002. RUP. [IIIB1 + VA1].

Derringer™ (glufosinate lb ae/gal). For nonselective weed control of emerged weeds in noncrop areas. Bayer. EPA Reg. No. 432-1228. 03/2001. [IIC1].

Des-I-Cate (endothall 0.52 lb ae/gal). Used POST as a desiccant in alfalfa, clover and potato. Cerexagri. EPA Reg. No. 4581-206. 12/2000. [VIII A2].

Desmedipham. An active ingredient in Betamix Herbicide, Betanex, Phen-Des 8+8 and Progress Herbicide. [VA3].

Dervinol 50-DF (napropamide 50% DF). For weed control in nut, pome fruit, small fruit, stone fruit and vegetable. United Phosphorus. EPA Reg. No. 100-1035-70506. 07/2003. [IIIB3].

Devrinol 2 G (napropamide 2% G). PRE for weed control in home flower gardens, landscape planting and turfgrass. United Phosphorus. EPA No. 100-1032-AA-70506. 02/2003. [IIIB3].

Dicamba. An active ingredient in Banvel, Banvel + Atrazine, Banvel SGF, Banvel + 2,4-D, Bentgrass Selective, Brash, Brushmaster, Celebrity, Celebrity Plus, Chaser Ultra Weed & Feed, Cimarron Max, Clarity, Cool Power, Dicambazine, Dicamba DMA Salt, Distinct, Eliminate, Fallow Master Broadpectrum, Fallow Star, Four Power Plus, Fuego, Horsepower, Kamba Master, Marksman, Mec Amine-D Turf Herbicide, Millenium Ultra, Millenium Ultra Plus, NorthStar CR, Op-Till, Outlaw, Overdrive, PastureMaster, Pasture MD, Power Zone, Range Star, Rave, Speed Zone, Sterling, Sterling Plus, Strike 3, Three-Way Ester II, Three-way Selective Herbicide, Trimec Broadleaf, Trimec Classic, Trimec Turf, Trimec Plus, Triplet, TriPower Selective, Vanquish, Veteran CST, Veteran 710, Veteran 10G, Weedmaster Herbicide and Yukon. [IVA2].

Dicamba DMA Salt™ (dicamba 4 lb ae/gal). For weed control in corn, sorghum, small grain, pasture, hay, rangeland and alfalfa. Albaugh/Agri Star/AgriStar. EPA Reg. No. 42750-40. 02/2000. [IVA2].

Dicambazine® (dicamba 1.1 lb ae + atrazine 2.1 lb ai/gal). For weed control in corn, grain sorghum and ecofallow systems. Albaugh/AgriStar. EPA Reg. No. 42750-41. 12/2000. RUP. [IVA2 + VA1].

Dichlobenil. Active ingredient in Casoron. [IIE2].

Dichlormid. Safener in Keystone, Keystone LA, Surpass, Top-Notch, Volley, Volley ATZ and Volley ATZ Lite.

Dichlorprop. Active ingredient in Brushmaster, Chaser Ultra, PRO-mate Three Way SC, Strike Three Ultra, Triamine, Triamine II and Turf Weed and Brush Control. Also called 2,4-DP. [IVA1].

Diclofop. Active ingredient in Hoelon. Controls certain annual grasses POST in wheat. [IA1].

Diflufenzopyr An active ingredient in Celebrity Plus, Distinct and Overdrive. Used POST in corn for broadleaf weed control. [IIID2].

Dimension™ 40 WP or EC (dithiopyr 1 lb ai/gal). Lawn, ornamental turf and landscape ornamental herbicide for control of annual grasses and broadleaf weeds in several turf grasses including buffalograss. Dow AgroSciences. EPA Reg. No. 707-245 or 62719-426. 02/2001. [IIIA2].

Dimension® Ultra WPS (dithiopyr 40% WPS). Lawn, ornamental turf and landscape ornamental herbicide for control of annual grasses and broadleaf weeds. Each 5 oz WS pouch contains 0.125 lb ai. Dow AgroSciences. EPA Reg. No. 62719-445. 02/2004. [IIIA2].

Dimethenamid. An active ingredient in Frontier, G-Max Lite, Guardsman, Guardsman Max, Op-till and Outlook for annual grass control in corn, grain sorghum and soybean. [IIIB1].

Diquat. Active ingredient in QuikPRO, Reglone Desiccant, Reward AccuGel and Weedtrine-D. [VIB1].

Direx® 4L or 80 DF (diuron 4 lb ai/gal or 80 DF). Similar to Karmex. Griffin. EPA Reg. No. 1812-257 or 1812-362. 06/2002. [VBI].

Herbicide Dictionary (continued)

Discover® Herbicide or Discover® NG (clodinafop-propargyl 2 lb ai/gal) For POST grass control in spring wheat. Syngenta. EPA Reg. No. 100-907 or 100-1173. 05/2000 or 10/2003. [IA1].

Distinct® (diflufenzopyr 0.2 lb ae + dicamba 0.5 lb ae gal – 70% WG). Used POST to control broadleaf weeds in corn. BASF. EPA Reg. No. 7969-150. 10/2003. [IID2 + IVA2]

Dithiopyr. Active ingredient in Dimension WP or EC, Dimension Ultra WSP and Pro-Mate Dimension 0.22% Plus Fertilizer. [IIIA2].

Diuron. An active ingredient in Diurex 4L, Diurex 80 DF, Diuron DF, Diuron 4L, Diuron IVM, Diuron WDG, Karmex DF, Krovar I DF, Sahara, Topsite and Velpar AlfaMax™ MP. [VB1].

Diuron DF or Diuron WDG (diuron 80% WP). A substituted urea for selective annual weed control at low rates in established alfalfa and as a soil sterilant at higher rates. Agrilience, UAP Loveland or Makhteshim Agan. EPA Reg. No. 9779-318 or 34704-648; 66222-51 or 66222-54. 03/2000. [VB1].

Diuron 4L IVM or 80 DF IVM (diuron-4 lb ai/gal or 80 DF). For nonselective weed control in noncropland. DowAgroScience. EPA Reg. No. 62719-311 or 310. 07/2000 or 02/2002. [VB1].

DMA™ 4 IVM (diamethylamine salt of 2,4-D-3.8 lb ae/gal). For selective broadleaf weed control in noncropland, noncrop turf and aquatic areas. Dow AgroScience. EPA Reg. No. 62719-3. 02/2001. [IVA1].

Domain™ 60 DF (24% flufenacet + 36% metribuzin). Used PP, PPI, PRE or POST weed control in soybean. Bayer. EPA Reg. No. 264-771. 05/2003. [IIB2 + VA2].

DPX-79406 75 DF (37.5% nicosulfuron + 37.5% rimsulfuron). For POST control of broadleaf and grass weeds in field corn. DuPont. EPA Reg. No. 352-572. 04/2001. [IIA2 + IIA2].

Drive® 75 DF (quinclorac 75% DF). Used PRE or early POST for weed control in turf including crabgrass and foxtail. BASF. EPA Reg. No. 7969-130. 04/2001. [IVA4].

DSMA. Active ingredient in DSMA Plus. [VIIIA2].

DSMA Plus (DSMA 3.6 lb ai/gal). Used to control weeds in turfgrass. UAP Loveland. EPA Reg. No. 50534-27-34704. 06/2000. [VIII].

Dual Magnum® (S-metolachlor 7.64 lb ai/gal + benoxacor). Active isomer of metolachlor used to control annual broadleaf and grass weeds in corn, grain or forage sorghum, potato, soybean, sugarbeet, sunflower and tomatoes. Needs safened seed for sorghum. Syngenta. EPA Reg. No. 100-816. 10/2003. [IIB1].

Dual II Magnum® or Dual II G Magnum™ (S-metolachlor + benoxacor safener-7.64 lb ai/gal or 16% G). For annual broadleaf and grass weed control in corn, potato, pod crops, grain or forage sorghum and soybean. The granules are used only on corn (all types), potato and soybean. Syngenta. EPA Reg. No. 100-818 or 910. 11/2002. [IIB1].

Dual II Magnum® SI (S-metolachlor 6.3 lb ai/gal+ benoxacor safener). Custom application to dry fertilizer for weed control in corn and soybean. Syngenta. EPA Reg. No. 100-829. 05/2003. [IIB1].

Durango™ (isopropylamine salt of glyphosate 3 lb ae or 4 lb ai/

gal). For POST control of broadleaf and grass weeds in Roundup Ready corn and soybean, burndown, fallow cropland and non-cropland weed control. Additional surfactant not required. Dow-AgroSci. EPA Reg. No.62719-517. 10/2004. [IIB1].

D-638™ (2,4-D acid + 2,4-D butoxyethyl ester 2.8 lb ae/gal). For controlling field bindweed, Russian knapweed, Canada thistle, cattail, annual broadleaf weeds and brush in pastures, rangeland, fallow ground, CRP, field corn, grain sorghum POST and pre-plant on soybean. Albaugh/Agri Star. EPA Reg. No. 42750-36. 03/2000. [IVA1].

Eagre™ (isopropylamine salt of glyphosate 4 lb ae or 5.4 lb ai/gal). For control of aquatic weeds and brush. Griffin. EPA Reg. No. 352-609-1812. 09/2002. [IIB1].

Eliminate Liquid Selective Herbicide (MCPA 3.8 lb + triclopyr 0.38 lb + dicamba 0.38 lb ae/gal). For selective control of broadleaf weeds in ornamental lawns and turfgrasses. Lesco. EPA Reg. No. 8-318-10404. 09/2003. [IVA1 + IVA2].

Endothall. Active ingredient in Aquathol G, Aquathol K, Aquathol Super K, Des-I-Cate. [VIII].

Endurance™ (prodiamine 65% WP). PRE control of weeds in noncrop areas, landscape ornamentals, established perennial and wildflower plantings and conifer and hardwood seedling nurseries. Syngenta. EPA Reg. No. 100-834. 06/2003. [IIA1].

E-99 Herbicide (6.1 lb ae/gal 2,4-D butoxyethyl ester). For controlling broadleaf weeds in corn, small grain, pastures and rangeland. Agrilience. EPA Reg. No. 62719-00365-01381. 1999. [IVA1].

Epic™ DF (48% flufenacet + 10% isoxaflutole). Used PP, PPI or PRE for weed control in field corn and corn grown for silage. Bayer. EPA Reg. No. 3125-522. 10/2003. RUP. [IIB2 + VIIA2].

Eptam® (EPTC-7 lb ai/gal). Used PPI for control of grass and broadleaf weeds in legumes, sugarbeet and many horticultural crops. Syngenta. EPA Reg. No. 100-1025. 03/2003. [IIC3].

EPTC. An active ingredient in DoublePlay, Eptam, Eptek and Eradicane. [IIC3].

Eptek™ 7E (EPTC 7 lb ai/gal). Used for controlling grass and broadleaf weeds in alfalfa and other legumes, sugarbeet and tomato. Drexel. EPA Reg. No. 19713-561. 10/04. [IIC3].

Equip™ Corn Herbicide (Formerly called AEF130660, foramsulfuron 30% + iodosulfuron-methyl-sodium 2%). For POST annual and perennial grass and broadleaf weed control in field corn. Bayer. EPA Reg. No. 264-686. 05/2003. [IIA2 + IIA2].

Eradicane® 6.7-E (EPTC + safener). PP soil incorporated treatment for grass control in field, pop, sweet and silage corn. Gowan. EPA Reg. No. 80225-00004-10163. 02/2004. [IIC3].

Escort® or Escort® XP (metsulfuron 60% DF). An industrial formulation of Ally. Used to control broadleaf weeds and brush in conifers and industrial turfgrass. DuPont. EPA Reg. No. 352-439. 06/2002. [IIA2].

Esteron® 99® (2-ethylhexyl ester of 2,4-D 3.8 lb ae/gal). Used for broadleaf weed control in pastures, certain crops and noncrop areas. Nufarm. EPA Reg. No. 62719-09-AA-71368. 10/2001. [IVA1].

Ethalfuralin. Active ingredient in Curbit, Sonalan HFP or 10G and Strategy. [IIIA1].

Etho SC (ethofumesate 42%). A PPI, PRE, or POST herbicide for sugarbeet. Ag Value. EPA Reg. No. 37429-GA-1. 07/2002. [IIC1]

Herbicide Dictionary (continued)

Ethofumesate. An active ingredient in Etho SC, Ethotron, Norton SC, Prograss EC and Progress Herbicide. [IIC1].

Ethotron (ethofumesate 42%). A PPI, PRE or POST herbicide for sugarbeet. United Phosphorous. EPA Reg. No. 264-613-70506. 02/2002. [IIC1].

ET (pyraflufen – ethyl 2.5%). PPO inhibitor herbicide for a defoliant and a desiccant. Registered for corn, soybean, cotton and potato. Nichino America, Inc. EPA Reg. No. 71711-7. 01/2005. [VIIIB3].

Everest® 70WDG (flucarbazone 70% granules). For control of wild oat and green foxtail in winter and spring wheat. Arvesta. EPA Reg. No. 66330-49. 03/2001. [IIA3].

Evik® DF (ametryn 80% WDG). Used as a POST directed spray for weeds in corn and noncropland. Syngenta. EPA Reg. No. 100-786. 06/2001. [VA1].

Exceed® CP (28.5% prosulfuron + 28.5% primisulfuron 57% WDG). For POST broadleaf weeds and shattercane control in field corn and popcorn. Syngenta. EPA Reg. No. 100-774. 03/2001. [IIA2 + IIA2].

Expert™ (*S*-metolachlor 1.74 lb ai + glyphosate 1.0 lb ai IPA + atrazine 2.14 lb ai/gal). PRE weed control in corn and grain or forage sorghum and after emergence of Roundup Ready corn. Syngenta. EPA Reg. No. 100-1161. 03/2003. RUP. [IIIB1 + IIB1 + VA1].

Express® XP or Express® Herbicide (tribenuron 75% DF). A short residual POST herbicide for broadleaf weed control in wheat, barley and fallow. DuPont. EPA Reg. No. 352-509. 09/2002. [IIA2].

Extra Credit™ (glyphosate 5 lb ai/gal). For POST control of weeds in Roundup Ready soybean, Roundup Ready corn, fallow and reduced tillage systems. Nufarm. EPA Reg. No. 71368-43. 09/2004. [IIB1].

Extreme® Herbicide (imazethapyr 0.17 lb + isopropylamine salt of glyphosate at 2 lb ai/gal). For weed control in Roundup Ready soybean. BASF. EPA Reg. No. 241-405. 10/2003. [IIA1 + IIB1].

Fallow Master® Broad Spectrum (isopropylamine salt of glyphosate 1.6 ae + 0.4 lb ae lb/gal dicamba). Used to control weeds POST in fallow and reduced tillage systems for selected counties in Nebraska. Monsanto. EPA Reg. No. 524-507. 05/2003 [IIB1 + IVA2].

Fallow Star™ (glyphosate 1.1 lb ae + dicamba 0.5 lb ae/gal). Controls or suppresses emerged weeds in fallow and reduced tillage small grain. Albaugh/Agri Star. EPA Reg. No. 42750-63. 06/2001. [IIB1 + IVA2].

Far-Go® (trallate 10% DF or 4 lb ai/gal). For PRE control of downy brome and other grass weeds in winter wheat and garbanzo bean. Monsanto. EPA Reg. No. 524-292 or 524-145. 01/2000. [IIC3].

Fenoxaprop. Active ingredient in Acclaim Extra, Fusion, Puma EC and Whip 360. [IA1].

Field Master® (2.1 lb ai acetochlor + 1.5 lb ai atrazine + 0.56 lb ae/gal glyphosate). For PP or PRE control of weeds in no-till and minimum tillage systems in field, seed and silage corn and popcorn. Also POST in Roundup Ready corn. Monsanto. EPA Reg. No. 524-497. 10/2002. RUP. [IIIB1 + VA1 + IIB1].

Finale® (glufosinate 1.0 lb ai/gal). For nonselective weed control of emerged weeds in turf and noncrop areas. Bayer. EPA Reg. No. 482-1229. 07/2001. [IIC1].

Finesse® (62.5% chloresulfuron + 12.5% metsulfuron 75% DF). For selective broadleaf weed control in barley, wheat and fallow. DuPont. EPA Reg. No. 352-445. 08/2001. [IIA2 + IIA2].

Fire Power™ (3 lb ae/gal glyphosate + 0.25 lb ai/gal oxyfluorfen). For control of weeds in dormant trees and fallow systems. Monsanto. EPA Reg. No. 524-520. 01/2002. [IIB1 + VIA1].

FirstRate™ (cloransulam methyl 84% ai WDG). For PRE and POST broadleaf weed control in soybean. Dow AgroSciences. EPA Reg. No. 62719-275. 11/2002. [IIA3].

Five Star™ (2,4-D isooctyl ester 5 lb ae/gal). For control of broadleaf weeds in field and sweet corn, popcorn, grain sorghum, sorghum-sudan grass, wheat, oat, barley and rye. Albaugh/Agri Star. EPA Reg. No. 42750-49. 10/1999. [IVA1].

Flexstar® HL (fomesafen 1.88 lb ai/gal). POST broadleaf weed control in soybean east of U.S. 281. Syngenta. EPA Reg. No. 10182-418. 10/2003. [VIA1].

Fluazifop. An active ingredient in Fusilade DX, Fusilade II and Fusion. [IA1].

Flucarbazone. Active ingredient in Everest 70 WDG. [IIA3].

Flufenacet. An active ingredient in Axiom DF, Define DF and SC, Domain and EPIC. [IVA4].

Flumetsulam. An active ingredient in Accent Gold, Accent Gold WDG, Frontrow, Hornet WDG and Python that controls broadleaf weeds in corn and soybean. [IIA3].

Flumiclorac. An active ingredient in Resource and Stellar that controls broadleaf weeds in corn and soybean. [VIA2].

Flumioxazin. Active ingredient in Broad Star, Chateau, Gangster, Gangster V, Payload, SureGuard, Valor, Valor SX and Valor WP. [VIA2].

Fluometron. Active ingredient in Cotoran. [VB1].

Fluridone. Active ingredient in Avast! and Sonar A.S. Used for aquatic weed control. [VIIA].

Fluroxypyr. Active ingredient in PastureGard, Spotlight, Starane, Starane + Estron, Starane + MCPA, Starane + Saber, Starane + Salvo, Starane + Sword, Surmount, Vista, WideMatch and Wide-Match M. [IVA3].

Fluxofenim. Safener for sorghum seed. Called Concep III.

Fomesafen. An active ingredient in Flexstar® HL and Reflex. [VIA1].

Foramsulfuron. An active ingredient in Option Corn Herbicide and Equip Corn Herbicide. [IIA2].

Formula 40® (2,4-D acid 3.67 lb ai/gal). For broadleaf weed control in corn, millet, small grains and sorghum. Nufarm T & S. EPA Reg. No. 228-357. 04/2004. [IVA1].

Fosamine. Active ingredient in Krenite S. [VIII2].

Four Power Plus® (dicamba 0.5 lb + 2,4-D amine 4 lb ae/gal). For selective broadleaf weed control in turfgrasses. Verdicon (formerly United Horticultural Supply). EPA Reg. No. 34704-84-65783. 01/2000. [IVA2 + IVA2].

Herbicide Dictionary (continued)

Frontier® 6.0 (dimethenamid 6.0 lb ae/gal). For PRE or PPI grass weed control in corn and soybean. BASF. EPA Reg. No. 5969-147. 04/2000. [IIB1].

Frontrow™ (0.84 lb ai cloransulam + 0.80 lb ai flumetsulam WDG). Co-pack product for POST broadleaf weed control in soybean. Dow AgroSciences. EPA Reg. No. 62719-299. 11/2002. [IIA3 + IIA3].

Fuego™ (triasulfuron 75% + diglycolamine salt of dicamba 4 lb ai/gal). Packaged as a co-pack for broadleaf weed control in pastures, rangeland, roadsides and nonfood crop sites. Syngenta. EPA Reg. No. 100-975. 12/2002. [IIA2 + IVA2].

FulTime™ Herbicide (2.4 lb of encapsulated acetochlor + 1.6 lb ai/gal of atrazine). For selective PRE annual grass and broadleaf weed control in field, seed and silage corn and popcorn. Dow AgroSciences. EPA Reg. No. 62719-371. 08/2003. RUP. [IIB1 + VA1].

Fusilade® DX (fluazifop 2 lb/gal). A selective POST herbicide for control of shattercane, volunteer corn and other grasses in soybean, fallow, nursery stock and ornamentals. Syngenta. EPA Reg. No. 100-1070. 04/2002. [IA1].

Fusilade® II Turf (fluazifop 2 lb/gal). Used for selective grass control in landscape areas, roadsides, nurseries, greenhouses, flower beds, groundcovers, sports fields, golf courses and residential areas. Syngenta. EPA Reg. No. 100-1084. 04/2002. [IA1].

Fusion® (2 lb fluazifop + 0.56 lb fenoxaprop = 2.56 lb ai/gal). For POST annual and perennial grass weed control in soybean and highway right-of-way. Syngenta. EPA Reg. No. 10182-343. 02/2001. [IA1 + IA1].

Galigan® 2 E (2 lb ai/gal oxyfluorfen). For PRE broadleaf weed control in broccoli, cabbage, cauliflower, nonbearing citrus, conifers and some deciduous trees. Makhteshim Agan. EPA Reg. No. 66222-28. 09/2002. [VIA1].

Gallery™ 75 DF or Gallery T&V (75% ai isoxaben). For PRE control of broadleaf weeds in established turf, landscape ornamentals, ornamental bulbs, Christmas trees and nonbearing orchards. Dow AgroSciences. EPA Reg. No. 62719-145. 10/2000. [IIIE1]. *Not labeled in Nebraska.*

Gangster™ (84% ai cloransulam [Gangster FR] + 51% flumioxazin [Gangster V]). A co-pack for PRE or burndown before crop emergence of grass and broadleaf weeds in soybean. Valent. EPA Reg. No. 59639-131. 03/2003. [IIA3 + IVA2].

Garlon™ 3 A or Forestry Garlon 4 A (triclopyr 3 or 4 lb ae/gal). For control of woody plants and broadleaf weeds on right-of-way, industrial sites and noncrop areas. Dow AgroSciences. EPA Reg. No. 62719-37 (04/2003) or 62719-40. (02/2002). [IVA3].

Gauntlet™ (sulfentrazone 75% DF + cloransulam 84%). Co-pack containing 26.5 oz of sulfentrazone and 5 water soluble packets each containing 0.6 oz of FirstRate. For weed control in soybean. FMC. EPA Reg. No. 279-3231 + 279-3148. 05/2003. [IVA3 + IIA3].

Genesis (glyphosate 3 lb ae or 4 lb ai/gal). Same product as Glyphelm 41% marketed by Farm Advantage.

Glean® FC (chlorsulfuron 75% DF). POST broadleaf herbicide for small grains. Restrictions on crop rotations. DuPont. EPA Reg. No. 352-522. 04/2004. [IIA2].

Glufosinate. Active ingredient in Derringer, Finale, Liberty, Liberty ATZ and Rely. [IIC1].

Gly-Flo (isopropylamine salt of glyphosate 3 lb ae or 4 lb ai/gal). For POST control of broadleaf and grass weeds in Roundup Ready corn, Roundup Ready soybean, burndown and noncropland weed control. Additional surfactant optional. Micro Flo. EPA Reg. No. 51036-312. 06/1999. [IIB1].

Glyfos® Aquatic (isopropylamine salt of glyphosate 4 lb ae or 2.4 lb ai/gal). For control of actively growing partially or fully emerged plants before seed head formation. Cheminova. EPA Reg. No. 4787-34. 07/2002. [IIB1].

Glyfos® Gold (isopropylamine salt of glyphosate 3 lb ae or 4 lb ai/gal). For POST control of broadleaf and grass weeds in Roundup Ready soybean, burndown and noncropland weed control. Additional surfactant not required. Cheminova.

Glyfos® Herbicide (isopropylamine salt of glyphosate 3 lb ae or 4 lb ai/gal). For POST control of broadleaf and grass weeds in Roundup Ready corn and soybean, canola, burndown and noncropland weed control. Additional surfactant optional. Cheminova. EPA Reg. No. 787-31. 07/2002. [IIB1].

Glyfos® Pro (glyphosate 3 lb ae/gal). For professional use on industrial turf and ornamental weed control. Labeled for controlling undesirable vegetation by habitat management and natural crops including rangeland and wildlife refuges. Additional surfactant not required. Cheminova. EPA Reg. No. 6776-57. 06/2003. [IIB1].

Glyfos® X-TRA (isopropylamine salt of glyphosate 3 lb ae or 4 lb ai/gal). For POST control of broadleaf and grass weeds in Roundup Ready soybean, burndown and noncropland weed control. Additional surfactant not required. Cheminova. EPA Reg. No. 4787-23. 06/2003. [IIB1].

Glyhelm 41% (isopropylamine salt of glyphosate 3 lb ae or 4 lb ai/gal). Same product as Glyphosate 41%. Helms Agro. [IIB1].

Glykamba™ (isopropylamine salt of glyphosate 1.6 lb ae/gal + dicamba 0.4 lb ai/gal). For control of grass and broadleaf weeds in fallow and reduced tillage systems. Nufarm. EPA Reg. No. 71368-30. 09/2003. [IIB1 + IVA2].

Glymix™ MT (isopropylamine salt of glyphosate 3 lb ae/gal + 2,4-D amine 0.4 lb ae/gal). For annual and perennial weed control in noncropland and PP and POST harvest aid in corn, grain sorghum, soybean and fallow systems in selected counties. Dow AgroSciences. EPA Reg. 62719-366. 06/2001. [IIB1 + IVA1].

Glyphogan (isopropylamine salt of glyphosate 3 lb ae or 4 lb ai/gal). For POST control of broadleaf and grass weeds in Roundup Ready crops, other cropping systems, burndown and noncropland weed control. MANA. EPA Reg. No. 6222-105. 2/2005. [IIB1].

GlyphoMate™ (glyphosate 2.8 lb ae or 3.8 lb ai/gal plus a surfactant). Labeled for most aquatic sites plus landscape plantings, turf renovations, nurseries, roadsides and fallow. BPI Gordon. EPA Reg. No. 2217-847. [IIB1].

Glyphomax® (isopropylamine salt of glyphosate 3 lb ae or 4 lb ai/gal). For POST control of broadleaf and grass weeds in Roundup Ready corn and soybean, burndown, fallow cropland and noncropland weed control. Additional surfactant optional. Dow AgroSciences. EPA Reg. No. 62719-323. 10/2002. [IIB1].

Herbicide Dictionary (continued)

Glyphomax® Plus (glyphosate 3 lb ae or 4 lb ai/gal). For POST control of broadleaf and grass weeds in Roundup Ready corn and soybean, burndown and noncropland weed control. Additional surfactant not required. Dow AgroSciences. EPA Reg. No. 62719-322. 11/2002. [IIB1].

Glyphomax® XRT (isopropylamine salt of glyphosate 3 lb ae or 4 lb ai/gal). For POST control of broadleaf and grass weeds in Roundup Ready corn and soybean, burndown, fallow cropland and noncropland weed control. Additional surfactant not required. Dow AgroSciences. EPA Reg. No. 62719-517. 10/2004. [IIB1].

Glyphosate. An active ingredient in Accord Concentrate, Accord SP, Aquamaster, AquaNeat, Backdraft, Backdraft SL, Buccaneer, Buccaneer Plus, Campaign, ClearOut 41, ClearOut 41 Plus, Cornerstone, Credit System Herbicide, Credit Duo, Credit Duo Extra, Credit Extra, Credit Master, Debit TMF, Durango, Eagre, Engame, Expert, Extra Credit 5, Extreme Herbicide, Fallow Master Broadpectrum, Fallow Star, Field Master, Fire Power, Gly-4, Gly-4 Plus, GlyFlo, Glyphos Herbicide, Glyphos Aquatic, Glyphos Pro, Glyphos X-TRA, Gly Pros Pro, Glymix MT, GlyphoMate, Glyphomax, Glyphomax Plus, Glyphomax XRT, Glyphosate herbicide, Glyphosate Original, Glyphosate VMF, Glyphosate 4, Glyphosate 41%, Glypro, Glypro Plus, Gly Star, Gly Star 5, Gly Star Plus, Gly Star Pro, Honcho, Honcho Plus, Jouney, Kleenup Pro, Landmaster BW, Mad Dog Glyphosate, Mirage Plus, One Step Herbicide, Prosecutor, Protocal, Quik PRO, Ranger Pro, Rattler, Rattler Plus, Razor Pro, Ready Master ATZ, Recoil, Rodeo, Roundup Original, Roundup Original II, Roundup Original Max, Roundup Pro, Roundup Pro Concentrate, Roundup ProDry, Roundup UltraMax, Roundup UltraMax II, Roundup UltraDry, Roundup Ultra Max RT, Roundup Weathermax, RT Master, RT Master II, Sequence, Silhouette, Staple Plus, Supersate, Touchdown HiTech and Touchdown Total. [IIB1].

Glyphosate 4 Herbicide (IPA of glyphosate 3 lb ae or 4 lb ai/gal). For use in Roundup Ready cropping systems, pre-harvest on wheat, PP or PRE at crop planting time. FarmSaver.com. EPA Reg. No. 72167-23-73220. 12/2003. [IIB1].

Glyphosate 41% (glyphosate IPA 3 lb ae or 4 lb ai/gal). Used as an aid to tillage, post harvest regrowth of sorghum, pasture renovation, before planting crops, preharvest aid and on Roundup Ready crops. Helms Agro. EPA Reg. No. 74530-4. 05/2003. [IIB1].

Glyphosate Herbicide (isopropylamine of glyphosate 3 lb ae or 4 lb ai/gal). Used for controlling weeds before desirable crop vegetation emerges or transplanted plants have been placed. Also may be used in dormant perennial grass, conifer release program, dormant rangeland for downy brome control and in ecofarming and other fallow reduced tillage systems. DuPont. EPA Reg. No. 352-607. 10/2000. [IIB2].

Glyphosate Original (glyphosate 3 lb ae or 4 lb ai/gal). For POST control of broadleaf and grass weeds in Roundup Ready soybean, ecofarming systems, burndown and noncropland weed control. Additional surfactant optional. Griffin. EPA Reg. No. 352-607-1812. 04/2001. [IIB1].

Glyphosate VMF (glyphosate 5.44 lb ai or 4 lb/gal). For control of many annual weeds, perennial weeds, woody brush and trees along electric power, pipeline and telephone rights-of-way. DuPont. EPA Reg. No. 352-609. 03/2001. [IIB1].

Glypro® (isopropylamine salt of glyphosate 4 lb ae or 5.4 lb ai/gal). For POST control of annual and perennial weeds and woody plants in forests, noncrop sites and around aquatic sites. Dow AgroSciences. EPA Reg. No. 62719-324. 02/2002. [IIB1].

Glypro™ Plus (glyphosate 3 lb ae or 4 lb ai/gal). For control of annual and perennial weeds and woody plants in noncropland and industry sites. Dow AgroSciences. EPA Reg. No. 62719-322. 03/2001. [IIB1].

Gly Pros® Pro (glyphosate-3 lb ae/gal). POST control of weeds in industry, turf and ornamental weed control. Cheminova. EPA Reg. No. 67760-57. 04/2004. [IB1].

Gly Star™ 5 (isopropylamine salt of glyphosate 4 lb ae or 4 lb ai/gal). For controlling weeds before planting crops. Must add NIS. Albaugh/Agri Star. EPA Reg. No. 42750-59. 02/2003. [IIB1].

Gly Star™ Original (isopropylamine salt of glyphosate 3 lb ae or 4 lb ai/gal). For POST control of emerged broadleaf and grass weeds preplant to corn, sorghum and soybean, burndown and noncropland weed control. Licensed for Roundup Ready corn and soybean. Additional surfactant optional. Albaugh/Agri Star. EPA Reg. No. 42750-60. 03/2001. [IIB1].

Gly Star™ Plus or Pro (isopropylamine salt of glyphosate 3 lb ae or 4 lb ai/gal with Transtar technology). For POST control of emerged broadleaf and grass weeds in PP, PRE, preharvest and postharvest corn, sorghum and soybean, burndown and noncropland weed control. Also POST on Roundup Ready crops. Additional surfactant not required. Albaugh/Agri Star. EPA Reg. No. 42750-61. 01/2002. [IIB1].

G-Max Lite™ (dimethenamid-P 2.25 lb + 2.75 lb ai/gal atrazine). Used for weed control in field, seed and sweet corn, popcorn and grain sorghum. BASF. EPA Reg. No. 7969-200. 06/2002. RUP. [IIB1 + VA1].

Goal 2XL™ (oxyfluorfen 2 lb/gal). A PRE herbicide for soybean, onion and nursery stock. Dow AgroSciences. EPA Reg. No. 707-243. 07/2002. [VIA1].

Gramoxone® Extra (paraquat 2.5 lb ai/gal). A nonselective grass, broadleaf and harvest aid herbicide. Syngenta. EPA Reg. No. 10182-280. 02/2002. RUP. [VIB1].

Gramoxone® Max Herbicide (paraquat dichloride 3 lb ai/gal). Similar use as Gramoxone Extra. Syngenta. EPA Reg. No. 100-01074. 01/2003. RUP. [VIB1].

Gramoxone® Super Tres (paraquat dichloride 3 lb ai/gal). For weed, grass and harvest aid desiccant/defoliant herbicide. Syngenta. EPA Reg. No. 10182-372. 07/2001. RUP. [VIB1].

Grazon™ P+D (0.54 lb ae picloram + 2.0 lb ae/gal 2,4-D). For woody and perennial weed control in range and permanent grass pastures. Dow AgroSciences. EPA Reg. No. 62719-182. 03/2001. RUP. [IVA3 + IVA1].

Guardsman® (2.33 lb dimethenamid + 2.67 lb atrazine 5 lb ai/gal). For selective PRE or EPOST broadleaf and grass weed control in field and sweet corn, popcorn and grain sorghum. BASF. EPA Reg. No. 7969-146. 04/2000 RUP. [IIB1 + VA1].

Guardsman Max™ (1.7 lb dimethenamid-P + 3.3 lb atrazine 5 lb ai/gal). For selective PRE or EPOST broadleaf and grass weed control in field, pop, sweet corn and grain sorghum. BASF. EPA Reg. No. 7969-192. 10/2003. RUP. [IIB1 + VA1].

Herbicide Dictionary (continued)

Habitat™ Herbicide (imazapyr 2 lb ai/gal). For aquatic, shoreline and floating weed species including salt cedar and purple loosestrife. BASF. EPA Reg. No. 00241-00426. 04/2003. [IIA1].

HardBall™ (2,4-D acid 1.74 lb ae/gal). For broadleaf weed control in crops and waste areas similar to other 2,4-Ds. Helena. EPA Reg. No. 05905-00549. 04/2004. [IVA1].

Halosulfuron. Active ingredient in Manage, Permit, Priority, Sandea, Sempra and Yukon. [IIA2].

Harmony® Extra or Harmony® Extra XP (50% thifensulfuron + 25% tribenuron 75% DF). For broadleaf weed control in barley, wheat, oat and fallow. DuPont. EPA Reg. No. 352-538 or 352-611. 03/2000 or 09/2002. [IIA2 + IIA2].

Harmony® GT or Harmony® GT XP (75% thifensulfuron DFG). For broadleaf weed control in wheat, barley, oat, soybean and fallow. DuPont. EPA Reg. No. 352-446. 08/2000 or 05/2002. [IIA2].

Harness® (acetochlor + MON 13900 safener 7 lb ai/gal). Used PP or PRE for selective grass weed control in field, seed and silage corn, and popcorn. Monsanto. EPA Reg. No. 524-473. 01/2001. RUP. [IIIB1].

Harness® 20 G (acetochlor + MON 13900 safener 20% G). Used PP or PRE for selective grass weed control in field, seed, and silage-corn and popcorn. Monsanto. EPA Reg. No. 524-487. 10/2002. RUP. [IIIB1].

Harness® Xtra 5.6L (3.1 lb acetochlor + MON 13900 safener + 2.5 lb atrazine 5.6 lb ai/gal). For PRE control of broadleaf and grass weeds in field, seed and silage corn and popcorn. Monsanto. EPA Reg. No. 524-485. 10/2002. RUP. [IIIB1 + VA1].

Harness® Xtra (4.3 lb acetochlor + MON 13900 safener + 1.7 lb atrazine 6.0 lb ai/gal). Used PRE for selective broadleaf and grass weed control in field, seed and silage corn and popcorn. Monsanto. EPA Reg. No. 524-480. 10/2002. RUP. [IIIB1 + VA1].

Helosate Plus (isopropylamine salt of glyphosate 3lb ae or 4 lb ai/gal). For POST control of broadleaf and grass weeds in Round-up Ready corn and soybean, burndown, fallow cropland and noncropland weed control. EPA Reg No. 74530-4. Helm Agro US. 12/2004. [IIB1].

Hexazinone. Active ingredient in Outstar, Velpar DF, Velpar L, Velpar AlfaMax MP and Westar. [VA2].

Hi-Dep® (2,4-D 3.8 lbs/gal ai). For low volume aerial or ground application to control broadleaf weeds PRE in corn, sorghum, soybeans, pasture and rangeland. PBI/Gordon Corp. EPA Reg. No. 2217-703. [IVA1]

Hoelon® 3 EC (diclofop 3 lb ai/gal). Used PPI or POST for certain annual grasses on wheat. Bayer. EPA Reg. No. 264-641. 10/2003. RUP. [IA1].

Honcho® Herbicide (isopropylamine salt of glyphosate 3lb ae or 4 lb ai/gal). Monsanto. EPA Reg. No. 524-445-ZE. 11/2002. [IIB1].

Honcho® Plus Herbicide (isopropylamine salt of glyphosate 3 lb ae or 4 lb ai/gal). Monsanto. EPA Reg. No. 524-454. 02/2002. [IIB1].

Hornet™ WDG (18.5% flumetsulam + 60.0% clopyralid 78.5%). For selective PP, PRE, or POST broadleaf weed control in field corn. Dow AgroSciences. EPA Reg. No. 62719-315. 12/2003. [IIA3 + IVA3].

Horsepower™ (MCPA 3.8 lb ae + triclopyr 0.38 lb ae + dicamba 0.38 lb ae/gal). For broadleaf weed control in ornamental lawns and turf grasses. Nufarm. EPA Reg. No. 228-313. 07/1999. [IVA1 + IVA3 + IVA2].

Hyvar® X WP or Hyvar® X-L (bromacil 80% or 2 lb ai/gal). Used as a soil sterilant and for woody plant control. DuPont. EPA Reg. No. 352-287 or 352-346. 12/2001 or 04/2003. [VA4].

Image® 70 DG (imazaquin 1.5 lb ai/gal or 70%). For weed control in zoysiagrass lawns and selected ornamentals. BASF. EPA Reg. No. 241-319. 09/2000. [IIA1].

Imazamox. Active ingredient in Beyond and Raptor. [IIA1].

Imazapic. Active ingredient in Journey, Oasis, Plateau and Plateau DG Eco-Pac. [IIA1].

Imazamethabenz. Active ingredient in Assert. [IIA1].

Imazapyr. An active ingredient in Arsenal, Arsenal AC, Chopper, Habitat, Lightning, Sahara DG, One Step Herbicide and Topside. [IIA1].

Imazaquin. An active ingredient in Backdraft, Backdraft SL, Image, Scepter, Squadron and Steel. [IIA1].

Imazethapyr. An active ingredient in Extreme Herbicide, Lightning, Pursuit Herbicide, Pursuit DG, Pursuit Plus and Steel. [IIA1].

Impact (topramezone) For use in corn. Label pending. AMVAC. [VIIB2].

INTRRO (alachlor 4.0 lb ai/gal). Use PRE and PPI for control of small seeded broadleaves and grasses in soybeans and grain sorghum. Monsanto. EPA Reg. No. 524-314. 12/2003. [IIIB1]

Iodosulfuron. An active ingredient in Equip. [IIA2].

Isoxaben. Active ingredient in Gallery 75DF, Gallery T&V and Snapshot 2.5 TG. [IIIE1].

Isoxaflutole. Active ingredient in Balance Pro and Epic for weed control in corn. RUP. [VIIB2].

Journey™ Herbicide. (imazapic 0.75 lb ai + glyphosate 1.5 lb ai/gal). For noncropland weed control, CRP and before planting native grasses or wild flowers and legumes. BASF Ag. EPA Reg. No. 00241-00417. [VIII2 + IIA1].

KambaMaster™ Herbicide (DMA salt of dicamba 1.0 lb ae + 2,4-D 2.87 lb ae/gal). For broadleaf control of CRP, fallow, sorghum, pastures, rangeland and wheat. Nufarm. EPA Reg. No. 71368-34. 11/2002. [IVA2 + IVA1].

Karmex® DF (diuron 80% WP). For annual weed control in alfalfa, asparagus, birdsfoot trefoil, grass seedling crops and red clover at low rates. Griffin. EPA Reg. No. 1812-362. 04/2002. [VB1].

Karmex® IWC 4 L (diuron 80% WP or 4 lb ai/gal). For industrial use as a soil sterilant. Griffin. EPA Reg. No. 1812-257. 04/2001. [VB1].

Kerb™ 50W or Kerb™ Specialty Herbicide (pronamide 50% WS). Use PRE or EPOST in alfalfa and other legumes, berry crops and fruit trees. Dow AgroSciences. EPA Reg. No. 62719-397. 01/2003. RUP. [IIIA3].

Keystone™ Herbicide (3.0 lb ai acetochlor + 2.25 lb ai/gal atrazine + dichlormid). A PP and PRE herbicide for weed control in corn. Dow AgroSciences. EPA Reg. No. 62719-368. 08/2002. RUP. [IIIB1 + VA1].

Herbicide Dictionary (continued)

Keystone™ LA (acetochlor 4 lb ai + atrazine 1.5 lb ai/gal + dichlormid). Used PRE for controlling grass and broadleaf weeds in field corn, production seed corn, silage corn and popcorn. Dow AgroSciences. EPA Reg. No. 62719-479. 02/2003. RUP. [IIB1 + VA1].

Kleenup® Pro (3 lb ae/gal glyphosate). For weed control of winter annual and tall fescue in dormant bermudagrass. UHS. EPA Reg. No. 524-445-65783. 08/2001. [IIB1].

Komeen® (8% elemental copper). For aquatic weed control in slow moving or quiescent water. Water may be used for fishing, swimming, drinking and watering livestock immediately. Griffin. EPA Reg. No. 1812-312. 12/2002. [VIII2].

Krenite® S (fosamine 4 lb ai/gal). A water soluble brush control agent that can be used on noncropland areas adjacent to water. DuPont. EPA Reg. No. 352-395. 09/2001. [VIII2].

Krovar® I DF (40% bromacil + 40% diuron DG). For control of annual weeds in noncropland. DuPont. EPA Reg. No. 352-505. 10/2002. [VA4 + VB1].

Lactofen. An active ingredient in Cobra, Phoenix and Stellar. [VIA1].

Laddok® S-12 (2.5 lb bentazon + 2.5 lb ai/gal atrazine). For POST broadleaf weed control in field, seed, silage and sweet corn, popcorn and grain and forage sorghum. Micro Flo Sipcam Agro. EPA Reg. No. 51036-415; 60063-18. 10/2003. RUP. [VC1 + VA1].

Landmark™ II MP (sulfometuron 56.25% + chlorosulfuron 18.75% DG). A PRE or EPOST herbicide for controlling weeds in noncrop areas. DuPont. EPA Reg. No. 352-620. 12/2002. [UA2 + IIA2].

Landmark™ MP (sulfometuron 50% + chlorosulfuron 25% DG). For PRE control of many weeds in noncrop sites. DuPont. EPA Reg. No. 352-621. 12/2002. [IIA2 + IIA2].

Landmaster® BW (0.9 lb ae glyphosate + 1.5 lb ae/gal 2,4-D). Used primarily for weed control in no-till systems before planting. Monsanto; Albaugh/Agri Star. EPA Reg. No. 524-351. 01/1997 or 42750-62. 06/2001. [IIB1 + IVA1].

Lariat® (2.5 lb alachlor + 1.5 lb ai/gal atrazine). Used PRE for selective weed control in field and sweet corn, silage and popcorn and grain sorghum. Monsanto. EPA Reg. No. 524-329. 10/2002. RUP. [IIB1 + VA1].

Lasso® Herbicide (alachlor 4 lb ai/gal). Used PP or PRE for annual grass and some broadleaf weeds in corn, sorghum, soybean and dry edible bean. Monsanto. EPA Reg. No. 524-314. 10/2002. RUP. [IIB1].

Lasso® II G (alachlor 15%). Granular formulation of Lasso. Monsanto. EPA Reg. No. 524-296. 01/1997. RUP. [IIB1].

Lescogran (bentazon 4 lb ai/gal). For homeowner use in controlling broadleaf weeds and sedge in established turf. Lesco. EPA Reg. No. 7969-45-10404. 10/2003. [VC1].

Lexar™ (s-metolachlor 1.74 lb + atrazine at 1.74 lb + mesotrione at 0.224 lb ai/gal + benoxacor safener). For PRE control of weeds in field, seed and silage corn and yellow popcorn. Syngenta. EPA Reg. No. 100-1201. 8/2004. [IIB1 + VIIB1 + VA1].

Liberty® (glufosinate ammonium 1.67 lb ai/gal). Registered for use in herbicide-tolerant LibertyLink® corn, canola and soybean. Bayer. EPA Reg. No. 264-660. 05/2003. [IIC1].

Liberty® ATZ (glufosinate ammonium 10.0% + atrazine 31.75%) For use in herbicide-tolerant LibertyLink® corn. Bayer. EPA Reg. No. 264-668. 05/2003. RUP. [IIC1 + VA1].

Lightning® (52.5% imazethapyr + 17.5% imazapyr WDG). Used for POST broadleaf and grass control in Clearfield® corn. BASF. EPA Reg. No. 241-377. 10/2003. [IIA1 + IIA1].

Linuron. Active ingredient in Linex 4L and Lorox DF. [VB1].

Linex® 4 L (linuron 4 lb ai/gal). For PRE grass and broadleaf weed control in field corn, grain sorghum, soybean and potato. Griffin. EPA Reg. No. 1812-245. 10/2000. [VB1].

Londax® (60% bensulfuron). For PRE use in rice. Dow AgroSciences. EPA Reg. No. 352-506. 12/2001. [IIA2].

Lontrel™ Turf and Ornamental (clopyralid 3 lb ae/gal). For selective POST control of broadleaf weeds in turf, sod farms and certain ornamental plantings. Dow AgroSciences. EPA Reg. No. 62719-305. 03/2001. [IVA3].

Lorox DF (50% linuron). For weed control in corn, potato, soybean and hybrid poplar. Griffin. EPA Reg. No. 1812-320. 04/2000. [VB1].

Low Vol 4 Ester Weed Killer (2,4-D ester 3.8 lbs/gal ai). Low volatile formulation for broadleaf control in cereal crops and noncropland. UAP Loveland. EPA Reg. No. 34704-124.7/2004 [IVA1]

Lumax™ (S-metolachlor 2.68 lb + mesotrione 0.268 lb + atrazine 1.0 lb ai/gal). PRE herbicide for field, seed and silage corn. Syngenta. EPA Reg. No. 100-1152. 07/2002. RUP. [IIB1 + VIIB1 + VA1].

Mad Dog Glyphosate (isopropylamine salt of glyphosate 3lb ae or 4 lb ai/gal). Agsco Inc. EPA Reg No. 71368-20-554. [IIB1].

Maestro™ D (octanoic acid ester of bromoxynil 2 lb ai/gal + isocetyl ester of 2,4-D + 1.9 lb ae/gal). For control of broadleaf weeds in wheat, barley, oat, triticale and rye. Nufarm. EPA Reg. No. 71368-39. 01/2004. [VC2 + VA1].

Maestro™ MA (acid ester of bromoxynil 2 lb ai + ester of MCPA 2 lb ai/gal). For control of certain broadleaf weeds in small grains, flax and CRP. Nufarm. EPA Reg. No. 71368-28. 10/2003. [VC2 + VAI].

Manage® (halosulfuron 75% WDG). For control of nutsedge and other weeds in turfgrass and landscape areas. Monsanto. EPA Reg. No. 524-465. 02/2000. [IIA2].

Manifest® (bentazon 3 lb + acifluorfen 0.67 lb + sethoxydim 2.5 lb ai/gal). Sold as a co-pack. For POST broadleaf and grass weed control in soybean. BASF. EPA Reg. No. 7969-77 and 7969-58. 04/1998. [VC3 + VIA1].

Marksman® (1.1 lb ai dicamba + 2.1 lb ai lb/gal atrazine). For POST broadleaf weed control in corn and sorghum. BASF. EPA Reg. No. 7969-136. 04/2000. RUP. [IVA2 + VA1].

Matador™ Herbicide (0.88 lb ai/gal quizalofop P-ethyl). A burn-down herbicide for annual grasses before or after planting soybean. FMC. EPA Reg. No. 279-3183. 02/1997. [IA1].

Matrix® (rimsulfuron 25% DF). Used PRE or POST for selective broadleaf and grass control in potato. DuPont. EPA Reg. No. 352-556. 10/2003. [IIA2].

Herbicide Dictionary (continued)

Maverick[®] (sulfosulfuron 75 WDG). For selective control of several annual and perennial weeds in winter and spring wheat. Monsanto. EPA Reg. No. 524-500. 01/2002. [IIA2].

Maverick[®] **PRO** (sulfosulfuron 75% WDG). For selective control of downy brome, Japanese brome, hairy chess, field pennycress and tansy mustard in winter wheat. For use in Colorado, Kansas, Nebraska, Oklahoma, Texas and Wyoming. Monsanto. EPA Reg. No. 524-525. 05/2003. [IIA2].

MCPA. A phenoxy similar to 2,4-D for control of broadleaf weeds, but safer on oats and legumes. Active ingredient in Battleship, Bison, Bronate, Bronate Advanced, Bromox-2-2, Chaser Ultra, Cool Power, Curtail M, Dagger, Eliminate, Horsepower, Maestro MA, MCPA Amine, MEC Amine-D Turf Herbicide, Power Zone, Rhomene MCPA Broadleaf, Rhonox MCPA Ester Herbicide, Starane + MCPA, Starane + Sword, Sword, Three-Way Ester II, TriPower Selective herbicide, Triamine II and Triplet. [IVA1].

MCPA-4 Amine Agrilance, Agri Star[®] **Solve**[™] **MCPA ester (Albaugh/Agri Star), Chiptox MCPA Ester**. For POST broadleaf weed control in spring and fall planted small grains, pastures, rangeland, CRP and turf. EPA Reg. No. 1381-104, 42750-22 and 11658-21-71368, respectively. 07/2003, 07/2002, or 05/2003. [IVA1].

MCPP or mecoprop-p. Active ingredient in herbicides. See mecoprop-p. [IVA1].

MEC Amine-D[®] **Turf Herbicide**. (2.44 lb ae 2,4-D amine + 1.30 lb ae MCPA + dicamba 0.22 lb ae/gal). For dandelion, clover, plantain control in lawns. Applied by lawn and landscape personnel. Verdicon (formerly United Horticultural Supply). EPA Reg. No. 34704-239-65783. 04/1999. [IVA1 + IVA1 + IVA2].

Mecoprop-p or MCPP. Active ingredient in Bentgrass Selective, Power Zone, Pro-Mat Three Way SC, Strike 3, Three-Way Selective, Triamine II, Triamine, Trimec Bentgrass Broadleaf Herbicide, Trimec Classic, Trimec Plus, Trimec Turf and TriPower Selective Herbicide. [IVA1].

Mesosulfuron-methyl. Active ingredient in Olympus FLEX, Osprey and Silverado Wild Oat Herbicide; used for weed control in wheat. [IIA2]

Mesotrione. Active ingredient in Callisto, Camix, Lexar and Lumar; used to control broadleaf weeds in field corn. [VIIIB1].

Metolachlor. An active ingredient that was replaced by S-metolachlor. Only Me-Too-Lachlor, Me-Too-Lachlor II, Parallel, Parallel PCS, Stalwart C, Stalwart Extra and Trizmet II have metolachlor. It is used for grass control in corn, sorghum, soybean, nurseries and turfgrass. See S-metolachlor for S-metolachlor trade names. [IIIB1].

Me-Too-Lachlor (metolachlor 8 lb ai/gal). For control of certain weeds in pod crops, potato, safflower and soybean. Drexel. EPA Reg. No. 19713-548. 02/2004. [IIIB1].

Me-Too-Lachlor II (metolachlor 7 lb ai/gal). For PRE control of weeds in field corn and popcorn. Drexel. EPA Reg. No. 19713-549. 02/2004. [IIIB1].

Metribuzin. Used PRE or POST for annual weeds in corn, soybean, alfalfa and potato; often used in combination with other herbicides. An active ingredient in Axiom DF, Boundary, Domain, Metribuzin 4L and DF and Sencor 4 or DF. [VA2].

Metribuzin 4 (metribuzin-4 lb ai/gal). For control of certain annual weeds in alfalfa, asparagus, carrots and tomato. Bayer Crop Science. EPA Reg. No. 264-735. 04/2004. [VA2].

Metribuzin DF (metribuzin 75% DF). For control of certain annual weeds in soybean, field corn, potato, alfalfa, asparagus and carrots. Bayer Crop Science. EPA Reg. No. 264-738. 02/2004. [VA2].

Metsulfuron. Active ingredient in Ally, Ally Extra, Ally XP, Blade, Cimarron, Cimarron Max, Escort, Escort XP, Finesse, Pasture MD, Metsulfuron Methyl 60 DF and Oust Extra. [IIA2].

Metsulfuron Methyl 60DF[™] (metsulfuron 60DF). For broadleaf weed control in wheat and fallow. FarmSaver. EPA Reg. No. 73220-3. 11/2002. [IIA2].

Micro-Tech[®] (encapsulated alachlor 4 lb ai/gal). For weed control in all types of corn, grain sorghum, soybean and types of dry bean except red kidney bean. Grain sorghum needs safened seed. Monsanto. EPA Reg. No. 524-344. 10/2002. RUP. [IIIB1].

Milestone[™] (aminopyralid 2 lb ae/gal). For selective control of broadleaf weeds on rangeland, pastures, non-cropland and CRP. Dow AgroSciences. EPA Reg. No. 62719-519. 08/2005. [IVA3].

Millenium Ultra[™] (3 lb ae 2,4-D DMA + 0.375 lb ae clopyralid + dicamba 0.375 lb ae/gal). For selective control of broadleaf weeds in ornamental lawns and turfgrass. Nufarm. EPA Reg. No. 228-322. [IVA1 + IVA3 + IVA2].

Millenium Ultra[™] **Plus** (0.5 lb 2,4-D DMA + 0.6 lb clopyralid + dicamba DAM 0.6 lb ae/gal + MSMA 18%). For control of broadleaf and grass in ornamental lawns and turfgrasses. Nufarm. EPA Reg. No. 228-382. [IVA1 + LVA3 + IVA2 + VIIIA1].

Mirage[®] **Plus** (IPA salt of glyphosate 3 lb ae or 4 lb ai/gal). A nonselective, broad-spectrum herbicide used for many cropping systems and CRP. Also may be used on Roundup Ready crops. UAP Loveland. EPA Reg. No. 524-454-34704. 01/2003. [IIB1].

Monument[™] (triflorsulfuron 75% WG). For control of certain broadleaf and grass weeds in turf. 100-1134. 09/2003. [IIA2].

MON 13900 Safener[®]. Used in Harness, Harness Xtra, Harness Xtra 5.6 and Harness 20 G.

Moxy[™] **2 E** (bromoxynil 2 lb/gal). Used for weed control in alfalfa, corn, small grains and grain and forage sorghum. Agrilience. EPA Reg. No. 9779-346. 03/2001. [VC2].

Moxy[™] + **Atrazine Herbicide** (1 lb/gal bromoxynil + 2 lb/gal atrazine). Used for POST control of grass and broadleaf weeds in corn. Agrilience. EPA Reg. No. 42750-50-1381. 01/2000 RUP. [VC2 + VA1].

MSMA (monosodium methanearsonate). Active ingredient in Millenium Ultra Plus, MSMA 6.6 Turf, MSMA Plus[®] H.C., 912 Herbicide, 120 Herbicide and Trimec Plus. Used for selective crabgrass control in turf. [VIIIA1].

MSMA 6.6 Turf Herbicide (MSMA 6.6 lb ai/gal). POST control of grass in turfgrass. Verdicon (formerly United Horticultural Supply); UAP Loveland. EPA Reg. No. 34704-111-65783; 34704-115. 03/2003. [VIIIA1].

MSMA Plus H.C. (MSMA 6.6 lb ai/gal includes a surfactant). POST control of grass in turfgrass. Helena. EPA Reg. No. 5905-164. 03/2000. [VIIIA1].

Herbicide Dictionary (continued)

Napropamide. Active ingredient in Devrinol 50 DF or 2G and Pre Pair [IIIB3].

Naptalam. Active ingredient in Alanap L. [IIID1].

Nicosulfuron. An active ingredient in Accent, Accent Gold, Accent Gold WDG, Basis Gold, Celebrity, Celebrity Plus, Clarion, DPX-79406 75DF, Steadfast and Steadfast ATZ. [IIA2].

912 Herbicide (MSMA B 6 lb ai/gal). For POST weed control in lawns and turf. Agrilience. EPA Reg. No. 9779-133. 09/1999. [VIIIA1].

Norflurazon. Active ingredient in Predict, Solicam and Zorial Rapid 80. [VIIA1].

NorthStar™ CR (7.5% primisulfuron + 39.9% dicamba WDG). For POST control of broadleaf weeds in field corn and popcorn. Syngenta. EPA Reg. No. 100-923. 06/2000. [IIA2 + IVA2].

Nortron® SC (ethofumesate 4 lb/gal). A PPI, PRE, or POST herbicide for sugarbeet. Bayer. EPA Reg. No. 264-613. 05/2003. [IIIC1].

Oasis® (2 lb ae imazapic + 4 lb ae/gal 2,4-D). For weed control, native grass release and turf growth suppression on roadsides and other noncrop areas. BASF. EPA Reg. No. 241-409. 10/2000. [IIA1 + IVA1].

OH2 (2% oxyfluorfen + 1% pendimethalin). For PRE control of weeds in containers and field grown ornamentals. Scotts. EPA Reg. No. 538-172. 01/2004. [VIA1 + IIIA1].

120 Herbicide (MSMA 6.6 lb ai/gal). For control of grass weeds in non-bearing grape, deciduous fruits, nuts and citrus orchards. Control of sandbur, mustards, barnyardgrass, chickweed and wood sorrel in zoysia, buffalograss and Bermuda lawns. Agrilience. EPA Reg. No. 9779-96. 01/2003. [VIII].

Olympus™ 70 WDG (propoxycarbazone-sodium 70% WDG). For POST control of certain grasses (primarily *Bromus* species) and broadleaf weeds in wheat. Bayer. EPA Reg. No. 00264-00809. 04/1004. [VIA3].

Olympus FLEX™ (propoxycarbazone-sodium 6.75% + mesosulfuron methyl 4.5%). For POST control of certain grasses and broadleaf weeds in fall sown or winter wheat. Bayer. EPA Reg. No. 264-833. 5/2005. [VIA3 + IIA2].

One Step® Herbicide (imazapyr 0.637 lb ai + 1.53 lb ae/gal of IPA glyphosate). POST control of most annual and perennial weeds, vines, brambles, hardwood brush and trees for forestry site preparation. BASF. EPA Reg. No. 241-414. 04/2003. [IIA1].

Op-Till (5 lb ai dimethenamid + 1 lb ae/gal dicamba). For PRE or PPI control of grass and broadleaf weeds in reduced till corn. BASF. EPA Reg. No. 7969-148. 04/1999. [IIIB1 + IVA2].

Option® Corn Herbicide (foramsulfuron 35% WDG). A POST grass and broadleaf herbicide for use in field corn. Bayer; Agrilience. EPA Reg. No. 264-685 or 264-685-1381. 05/2003. [IIA2].

Opti-Amine® (2,4-D amine 3.8 lb ae/gal). Helena. EPA Reg. No. 5905-501. 02/2004. [IVA1].

Ordrum 8® E (s-ethyl hexahydro-1H-azepine-1-carbothioate 8 lb ai/gal). A rice herbicide. Syngenta; Makhteshim Agan. EPA Reg. No. 100-1021. 05/2002. [IIIC3].

Oryzalin. Active ingredient in Oryzalin 4 A.S. and Surflan A.S. [IIIA1].

Oryzalin 4 A.S. (oryzalin 4 lb ai/gal). Used PRE for annual grass and broadleaf weeds in landscape ornamentals, Christmas tree plantations and established buffalograss turf. Farm Saver. Com. LLC; Vegetation Manger. EPA Reg. No. 72167-15-AA-77322; 72167-15-7447. 10/2002. [IIIA1].

Osprey (mesosulfuron methyl 4.5% WDG). For control of grass and broadleaf weeds in winter wheat. Bayer. EPA Reg. No. 264-802. 03/04. [IIA2].

Oustar® (hexazinone 63.2% + sulfometuron 11.8% DG). For weed control in the establishment of loblolly, slash and longleaf pines. DuPont. EPA Reg. No. 352-603. 09/2002. [VA2 + IIA2].

Oust® Herbicide (sulfometuron 75% DG). A noncropland herbicide that also provides suppression of perennial grasses at lower rates. DuPont. EPA Reg. No. 352-401. 03/1998. [IIA2].

Oust® Extra (sulfometuron 56.25% + metsulfuron 15%). For controlling many annual and perennial weeds in conifer plantations and noncrop areas. DuPont. EPA Reg. No. 352-622. 04/2003. [IIA2 + VA2].

Oust® XP (sulfometuron 75% DG). For control of weeds in industrial sites and forest sites. DuPont. EPA Reg. No. 352-601. 08/2002. [IIA2].

Outlaw™ (dicamba 1.09 lb ae/gal + 2,4-D acid 1.45 ai/gal). For control of annual, biennial and perennial broadleaf weed and brush control in pastures, rangeland, grass for silage or hay, wheat and fallow. Albaugh/Agri Star. 05/2003. [IVA2 + IVA1].

Outlook® Herbicide (dimethenamid-p 6 lb ai/gal). For PP and PRE use in field, seed and sweet corn, popcorn, dry edible bean, grain sorghum and soybean. BASF. EPA Reg. No. 7969-156. 10/2003. [IIIB1].

Outrider™ (sulfosulfuron 75% WDG). For PRE and POST control of many annual and perennial weeds on noncrop areas. Monsanto. EPA Reg. No. 524-500. 01/2002. [IIA2].

Overdrive® (diflufenzopyr 0.20 lb ae + 0.5 lb ae/gal of dicamba 70% WG). For broadleaf weed control in noncropland areas, pasture, hay and rangeland. BASF. EPA Reg. No. 7969-150. 04/2000. [IIID2].

Oxabetrinil. A seed protectant (Concep II) for reducing corn and sorghum injury from metolachlor.

Oxadiazon. An active ingredient in Pre Pair, Ronstar G, Ronstar 0.95% plus Fertilizer and Ronstar WSP. [VIII].

Oxyfluorfen. Active ingredient in Fire Power, Galigan, Goal 2XL, OH2 and Rout. [VIA1].

Paramount® (quinclorac 75% DF). Used for weed control in fallow systems, grass grown for seed, preplant wheat and preplant and in-crop for grain sorghum. Controls field bindweed. BASF. EPA Reg. No. 7969-113. 01/2004. [IVA4].

Paraquat. Active ingredient in Boa, Cyclone Max, Gramoxone Extra, Gramoxone Max, Gramoxone Super TRES and Starfire. RUP. [VIB1].

Parallel (metolachlor 7.8 lb ai/gal). For control of certain weeds in pod crops, potato, safflower and soybean. Makhteshim Agan. EPA Reg. No. 66222-87. 09/2004. [IIIB1].

Herbicide Dictionary (continued)

Parallel PCS (metolachlor 8 lb ai/gal). For control of certain weeds in pod crops, potato, safflower and soybean. Makhteshim Agan. EPA Reg. No. 66222-86. 09/2004. [IIIB1].

PastureGard™ (triclopyr 1.5 lb ae + fluroxypyr 0.5 lb ae/gal). For control of woody plants and annual and perennial broadleaf weeds in rangeland and perennial grass pastures, fence rows, nonirrigated ditchbanks and around farm buildings. Dow AgroSciences. EPA Reg. No. 62719-477. [IVA3 + IVA3].

Pasture MD™ (Co-pack of 1 lb/gal of dicamba + 2.87 lb/gal of 2,4-D amine plus 60% metsulfuron). For selective control of annual and perennial broadleaf weeds in pastures and rangeland or brush control. Nufarm. EPA Reg. No. 71368-41. 09/2004. [IV2 + IVA1 + IIA2].

PastureMaster™ (DMA salt of 2,4-D 1 lb ae + 1.0 lb ae/gal of dicamba). For brush and broadleaf weed control in pastures and rangelands. Nufarm. EPA Reg. No. 228-295-71368. 02/2001. [IVA1 + IVA2].

Pathfinder™ II (triclopyr 0.75 lb ae/gal). Ready to use for control of woody plants in right-of-way, etc. Dow AgroSciences. EPA Reg. No. 62719-176. 10/2002. [IVA3].

Pathway™ (picloram 3% + 2,4-D acid 11.2%). For controlling unwanted trees via cut surface in noncrop areas. Dow AgroSciences. EPA Reg. No. 62719-31. 06/1998. RUP. [IVA3 + IVA1].

Payload (flumioxazin 51% WDG). For maintaining ground weed control in noncrop areas. Valent. EPA Reg. No. 59639-120. 01/2004. [VIA2].

Peak® CP (prosofuron 57% WDG). PRE and POST for broadleaf weed control in grain sorghum, cereals and proso millet. Syngenta. EPA Reg. No. 100-763. 02/2002. [IIA2].

Pelargonic Acid. Active ingredient in Scythe. [VIC1].

Pendimax™ 3.3 (pendimethalin 3.3 lb ai/gal). Equivalent to Prowl. Dow AgroSciences. EPA Reg. No. 68156-6-62719. 10/1999. [IIIA1].

Pendimethalin. An active ingredient in Corral, OH2, Pendimax 3.3, Pendulum Aqua Cap, Pendulum 2G, Pendulum WDG, Pendulum® 3.3EC, Pentagon WDG, PRE-M 3.3 EC Turf Herbicide, Prowl, Prowl H20, Pursuit Plus, Squadron and Steel. [IIIA1].

Pendulum AquaCap™ (3.8 lb ae microencapsulated pendimethalin in an aqueous carrier). Used PRE in noncrop areas, ornamental plantings and nonresidential turf. BASF. EPA Reg. No. 241-4160. 10/2002. [IIIA1].

Pendulum® 2 G (2% pendimethalin). For use in turfgrass, ornamentals, landscape, or ground maintenance. BASF. EPA Reg. No. 241-375. 04/2001. [IIIA1].

Pendulum® 3.3 EC (pendimethalin 3.3 lb ai/gal). For use in turfgrass, ornamentals, landscape, or noncrop areas. BASF. EPA Reg. No. 241-341. 04/2001. [IIIA1].

Pendulum® WDG (60% pendimethalin). For use in turfgrass, ornamentals, landscape, or noncrop areas. BASF. EPA Reg. No. 241-340. 04/2001. [IIIA1].

Pennant Magnum (S-metolachlor 7.62 lb ai/gal). For weed control in nurseries, warm season turfgrasses and landscape planting. Syngenta. EPA Reg. No. 100-950. 09/2001. [IIIB1].

Pentagon® WDG (pendimethalin 60%). For weed control in selected crops including sunflower. BASF. EPA Reg. No. 241-268. 02/2002. [IIIA1].

Permit® (halosulfuron 75% WSG). Used POST for broadleaf weed control in field corn, field corn grown for seed and grain sorghum. Monsanto. EPA Reg. No. 524-465. 05/2003. [IIA2].

Phenmedipham. An active ingredient in Betamix Herbicide, Phen-Des 8+8, Progress Herbicide and Spin-Aid. [VA3].

Phen-Des 8+8 (phenmedipham 8% + desmedipham 8%) For post-emergence weed control in sugarbeet. United Phosphorus Incorporated (UPI). EPA Reg. No. 264-621-70506. 6/2002. [VA3].

Phoenix™ (lactofen 2.0 lb ai/gal). Used POST for broadleaf control in soybean. Valent. EPA Reg. No. 639-18. 07/2002. [VIA1].

Phenoxy 088™ (2,4-D acid + 2,4-D butoxyethyl ester 2.8 lb ae/gal). For broadleaf control. Labeled for PP, PRE and POST in corn, POST in sorghum and PP in soybean. Agrilience. EPA Reg. No. 42750-36-9779. 01/1998. [IVA1 + IVA1].

Picloram. An active ingredient in Grazon P+D, Pathway, Summit, Tordon K, Tordon 22K, Tordon 101 Mixture and Tordon RTU. [IVA3].

Plateau® (ammonium salt of imazapic 2 lb ai/gal or 70% EcoPac DG). For PRE or POST control of selected grass and broadleaf weeds in range, pasture, wildflower and native grass establishments, crown vetch and noncrop areas. DG is in water-soluble packets. BASF. EPA Reg. No. 241-365 or 241-393. 04/2001 or 04/2000. [IIA1].

Poast® (sethoxydim 1.5 lb ai/gal). A POST herbicide for control of volunteer corn and grass weeds in alfalfa, soybean and other broadleaf crops. Micro-Flo. EPA Reg. No. 7969-88. 04/1999. [IA2].

Poast Plus® (sethoxydim 1.0 lb ai/gal). A combination of sethoxydim + Dash surfactant. A POST herbicide for control of shattercane, volunteer corn and other grass weeds in alfalfa, soybean and other broadleaf crops. Micro-Flo. EPA Reg. No. 7969-88-51036. 10/2002. [IA2].

Power Zone™ (carfentrazone 0.04 lb ai + MCPA 2.2 lb ae + mecoprop 0.44 lb ae + dicamba 0.22 lb ae/gal). POST broadleaf control in turf. PBI Gordon. EPA Reg. No. 2217-834. 09/2001. [VIA3 + VIA1 + IVA1 + IVA2].

Pramitol® 25E (prometon 2 lb ai/gal). Used primarily for seasonal control of annual and perennial weeds in noncropped areas. UAP Loveland; Agrilience. EPA Reg. No. 66222-22-34704; 66222-22-9779. 01/2003. [VA1].

Pramitol 5PS (5% prometon + 0.76% simazine + 40% sodium chlorate + 40% sodium metaborate). Soil sterilant. UAP Loveland. EPA Reg. No. 66222-23-34704. 02/2002. [VA1 + VA1 + VIII + VIII].

Predict® (norflurazon 78%). For control of grass and broadleaf weeds in field-grown nursery stock and noncropland. Syngenta. EPA Reg. No. 100-849. 02/2001. [VIA1].

Preen (trifluralin 1.47% G). For weed control in garden flowers, bulbs, roses, shrubs, trees and vegetables. Lebanon Seaboard. EPA Reg. No. 967-280. [IIIA1].

Herbicide Dictionary (continued)

Prefar® 4-E (bensulide 4 lb/gal). Used PRE for grass and broadleaf weeds in cantaloupe, cucumber and watermelon. Gowan. EPA Reg. No. 10163-220. 10/2002. [IIC2].

Pre-M 3.3 EC Turf Herbicide™ (pendimethalin 3.3 lb ai/gal). For PRE control of weeds in lawns, established lawn ornamentals and non-bearing fruit and nut trees. Lesco. EPA Reg. No. 241-360-10404. 12/2002. [IIIA1].

Pre Pair® (napropamide 4%+ oxadiazon 2%). Selective control of annual grasses and broadleaf weeds in continuous field grown nursery stock, groundcovers, shade houses and landscape ornamentals. Verdicon (formerly United Horticultural Supply). EPA Reg. No. 34704-771-65783. 11/1999. [IIIB3].

Primisulfuron. An active ingredient in Beacon, Exceed, North-Star and Spirit. [IIA2].

Princep® 4 L or Princep® Caliber 90® (simazine 4 lb ai/gal or 90% WDG). A long lasting PRE for corn and shelterbelts. Syngenta. EPA Reg. No. 100-526 or 100-603. 06/2001. [VA1].

Priority™ (halofenuron 50% + carfentrazone 12.5%). For controlling broadleaf weeds in field corn, seed corn, popcorn, silage corn, sweet corn and grain sorghum. Tenkoz. EPA Reg. No. 33906-17-55467. 2/2004. [IIA2 + VIA3].

Prism® (clethodim 0.94 lb ai/gal). Used POST for selective control of grass weeds in dry bulb onion, soybean and sugarbeet. Valent. EPA Reg. No. 59639-78. 01/2002. [IA2].

Prodiamine. Active ingredient in Barricade 65 WG or 4L, Crabgrass Preventer, Endurance and Pro-Mate Barricade. [IIIA1].

Prograss® (ethofumesate 1.5 lb ai/gal). For grass and broadleaf weed control in ornamental turf. Bayer. EPA Reg. No. 432-941. 10/2003. [IIC1].

Progress® Herbicide (phenmedipham 7% + desmedipham 7% + ethofumesate 7% in 1.8 lb ai/gal). For POST control of weeds in sugarbeet. Bayer. EPA Reg. No. 264-632. 02/2002. [VA3 + VA3 + IIC1].

Pro-Mate® Three Way SC (16.5% 2,4-D + 8.1% dichlorprop + 8.2% mecoprop). For control of broadleaf weeds in turf. Helena. EPA Reg. No. 2217-740-5905. 08/2003. [IVA1 + IVA1 + IVA1].

Pro-Mate® Barricade® 0.22% Plus Fertilizer (prodiamine 0.22%) For PRE use in controlling broadleaf and grass weeds in established turfgrasses (excluding golf course putting greens). Helena. EPA Reg. No. 5905-543. 10/2003. [IIIA2].

Pro-Mate® Dimension 0.22% Plus Fertilizer (dithiopyr). EPA Reg. No. 5905-538. 03/2003. [IIIA2].

Pro-Mate® Turf Fertilizer. Contains Team® Pro 0.86% (0.43% benefin + 0.43 trifluralin). A granular fertilizer containing herbicides for PRE control of annual grasses and broadleaf weeds in established turf and established landscape ornamentals. Helena. EPA Reg. No. 62719-289-5905. 2002. [IIIA1 + IIIA1].

Prompt® 5 L (bentazon 2.5 lb + atrazine 2.5 lb ai/gal). POST control of weeds in athletic fields and lawns containing Bermuda grass or zoysia. Micro Flo. EPA Reg. No. 51036-363. 12/2000. RUP. [VC1 + VA1].

Prometon. An active ingredient in Pramitol 25E and Pramitol 5PS. [VA1].

Pronamide. Active ingredient in Kerb. [IIIA1].

Propanil. Active ingredient in Stam and Stampede. [VB2].

Propoxycarbazone. Active ingredient in Olympus.

Prosecutor® (glyphosate 3 lb ae/gal). POST weed control in industrial, turf and ornamental areas. Lesco. EPA Reg. No. 524-536-10404. 10/2003. [IIB1].

Prosulfuron. Active ingredient in Exceed CP, Peak CP and Spirit. [IIA2].

Protocal® (isopropylamine salt of glyphosate 3 lb ae or 4 lb ai/gal). Monsanto. EPA Reg. No. 524-326. 01/1997. [IIB1].

Prowl® (pendimethalin 3.3 lb ai/gal). Used PRE or EPOST on corn and PP or PRE on soybean and sunflower. BASF. EPA Reg. No. 241-337. 04/2001. [IIIA1].

Prowl® H20 (pendimethalin 3.8 lb ai/gal). A water-based formulation for use in controlling weeds in edible bean, corn, soybean and sunflower. BASF. EPA Reg. No. 241-410. 04/2003. [IIIA1].

Puma® 1 EC (fenoxaprop-ethyl 1.0 lb ai/gal). For selective control of emerged green and yellow foxtail, millet, barnyardgrass and wild oats in wheat and barley. Bayer. EPA Reg. No. 264-666. 03/2003. [IA1].

Pursuit® Herbicide (imazethapyr 2 lb ai/gal). For PP, PRE or POST control of broadleaf and grass weeds in alfalfa, pea, dry bean, Clearfield® corn and soybean. BASF. EPA Reg. No. 241-310. 10/2003. [IIA1].

Pursuit® Plus EC (0.2 lb imazethapyr + 2.7 lb pendimethalin 2.9 lb ai/gal). Used PPI to control broadleaf and grass weeds in Clearfield® field corn and soybean. BASF. EPA Reg. No. 241-331. 04/2001. [IIA1 + IIIA1].

Pursuit® SC or Pursuit® DG (imazethapyr 2 lb ai/gal or 70% DG, bag contains 1.125 lb ai/bag). Used POST for controlling broadleaf and grass weeds in alfalfa, Clearfield® corn, dry edible bean, pea and soybean. BASF. EPA Reg. No. 2412-310 or 241-350. 10/2003 or 01/2004. [IIAI].

Pyralufen. Active ingredient in ET-pyrafulen. [VIA1]

Pyramin SC or DF (pyrazon 4.5 lb/gal or 65% DF). Used PRE for control of broadleaf weeds in red table beet and sugarbeet. BASF or Micro Flo. EPA Reg. No. 7969-108 or 7969-81. 04/2000 or 06/2001. [VA5].

Pyrazon. Active ingredient in Pyramin SC and DF. [VA5].

Pyrithiobac sodium. Active ingredient in Staple and Staple Plus.

Python™ WDG (80% flumetsulam). For broadleaf weed control in field corn and soybean. Dow AgroSciences. EPA Reg. No. 62719-277. 08/2001. [IIA3].

QuickSilver™ or QuickSilver IVM (carfentrazone-ethyl 1.9 lb ai/gal). For commercial use only on right-of-way, utility and industrial sites and fence rows. Nufarm; FMC T&O. EPA Reg. No. 279-3772. 10/2003. [IVA3].

QuikPRO™ (glyphosate ammonium salt 73.3% + 2.9% diquat dibromide). For use in noncrop and non-timber areas to control unwanted vegetation. Monsanto. EPA Reg. No. 524-535. 10/2001. [IIB1 + VIB1].

Quinclorac. Active ingredient in Drive and Paramount. [IVA4].

Quizalofop. Active ingredient in Assure II and Matador. [IA1].

Herbicide Dictionary (continued)

Radius™ Herbicide. (flufenacet 3.57 lbs ai/gal + isoxaflutole 0.43 lbs ai/gal). For PRE use in field and silage corn for control of grass and broadleaf weeds. Bayer. EPA Reg. No. 264-852. 04/2005. [IIB2 + VIIA2].

Ranger Pro™ (glyphosate 3 lb ae/gal). For broad-spectrum POST herbicides for industrial, turf and ornamental weed control. Monsanto. EPA Reg. No. 524-517. 01/2004. [IIB1].

Range Star® (dicamba 1 lb ae + 2,4-D amine 2.87 lb ae/gal). For weed control in pastures, rangeland, wheat and sorghum. Albaugh/Agri Star. EPA Reg. No. 42750-55. 03/2000. [IVA2 + IVA1].

Raptor® (imazamox 1 lb ai/gal). Used for selective POST grass and broadleaf weed control in alfalfa and soybean. BASF. EPA Reg. No. 241-379. 10/2003. [IIA1].

Rascal® (isopropylamine salt of glyphosate 3 lb ae or 4 lb ai/gal). For nonselective weed control in noncrop areas, fallow and reduced tillage systems including ecofarming and ecofallow, as a harvest aid in grain sorghum, dormant pastures and Roundup Ready crops. Additional NIS may be added. Agilience. EPA Reg. No. 42750-60-1381. 11/2003. [IIB1].

Rascal® Plus (isopropylamine salt of glyphosate 3 lb ae or 4 lb ai/gal). For nonselective weed control in noncrop areas, fallow and reduced tillage systems including ecofarming and ecofallow, as a harvest aid in grain sorghum, dormant pastures and Roundup Ready crops. Additional NIS not required. Agilience. EPA Reg. No. 42750-61-1381. 1/2005. [IIB1].

Rattler® (isopropylamine salt of glyphosate 3 lb ae or 4 lb ai/gal). For nonselective weed control in noncrop areas, fallow and reduced tillage systems including ecofarming and ecofallow, as a harvest aid in grain sorghum and dormant pastures. Requires extra NIS. Helena. EPA Reg. No. 524-455-5905. 01/2001. [IIB1].

Rattler® Plus (isopropylamine salt of glyphosate 3 lb ae or 4 lb ai/gal). For nonselective weed control in noncrop areas, fallow and reduced tillage systems including ecofarming and ecofallow, as a harvest aid in grain sorghum, dormant pastures and Roundup Ready crops. May need extra NIS. Helena. EPA Reg. No. 524-455-5905. 02/2003. [IIB1].

Rave™ (8.8% triasulfuron + 50% dicamba WDG). Used POST for controlling broadleaf weeds in wheat, barley, fallow, CRP and pastures. Syngenta. EPA Reg. No. 100-927. 03/2001. [IIA2 + IVA2].

Razor® Pro Herbicide (IPA glyphosate 3 lb ae or 4 lb ai/gal). For broad spectrum postemergence professional herbicide for industry, forestry, turf, vegetative management and ornamental weed control. Nufarm. EPA Reg. No. 228-366. 10/2002. [IIB1].

Ready Master™ ATZ (IPA salt of glyphosate 1.5 lb ae/gal or 2.0 lb ai + 2 lb ai/gal atrazine). Used for POST weed control in Roundup Ready corn and fallow with residual weed control. Monsanto. EPA Reg. No. 524-509. 01/1999. RUP. [IIB1 + VA1].

Reclaim™ Herbicide (clopyralid 3 lb ae/gal). For control of mesquite and associated woody species on rangeland and permanent grass pastures in Arizona, New Mexico, Oklahoma and Texas. Dow AgroSciences. EPA Reg. No. 62719-83. 10/2002. [IVA3].

Recoil (glyphosate 2.13 lb ai or 1.58 lb ae/gal + 1.67 ai/gal 2,4-D). For control of nonselective weeds in cereal crops, preplant sorghum, soybean and corn + POST harvest for small grain and corn. Nufarm. EPA Reg. No. 71368-35. 12/2003. [IIB1 + IVA1].

Redeem™ R&P (2.25 lb ae triclopyr + 0.75 lb ae/gal clopyralid). For control of annual and perennial broadleaf weeds in rangeland and permanent grass pastures. Dow AgroSciences. EPA Reg. No. 62719-337. 05/2003. [IVA3 + IVA3].

Reflex® Herbicide (fomesafen 2 lb ai/gal). Used POST for selective POST broadleaf weed control in soybean east of U.S. 281. Syngenta. EPA Reg. No. 100-993. 01/2003. [VIA1].

Reglone® Desiccant (diquat 2 lb ai/gal). Used to desiccate seed crops of alfalfa, clover, grain sorghum and soybean; also used for potato. Syngenta. EPA Reg. No. 10182-353. 04/2000. [VIB1].

Rely® (glufosinate 1 lb ai/gal). For control of emerged weeds in apples, grapes and tree nuts and for potato vine desiccation. Bayer. EPA Reg. No. 264-652. 04/2001. [IIC1].

Remedy™ (triclopyr 4 lb ae/gal). For control of woody plants and broadleaf weeds on rangeland and grass pasture. Dow AgroSciences. EPA Reg. No. 62719-70. 04/1999. [IIA1].

Resolve™ DF (rimsulfuron 25%). For post grass and broadleaf weed control in corn. DuPont. EPA Reg. No. 352-556. 1/2005 [IIA2]

Resource® Herbicide (flumiclorac 0.86 lb/gal). Used for selective POST broadleaf weed control (especially velvetleaf) in soybean and corn. Valent. EPA Reg. No. 59639-82. 07/2002. [VIA2].

Reward® AccuGel™ Aquatic Herbicide (diquat dibrome 16.6%). For control of aquatic weeds in still water. Syngenta. EPA Reg. No. 100-1194 A-L1. 06/2004. [VIB1].

Rezult® Herbicide (bentazon 5 lb ai + sethoxydim 1 lb/gal). Sold as a co-pack for POST broadleaf and grass weed control in dry bean and soybean and POST weed control in POST protected corn. BASF. EPA Reg. No. 7969-112. 04/1999. [VC1].

Rhomene® MCPA Broadleaf (DMA salt of MCPA 3.7 lb ae/gal). Used for selective POST control of many broadleaf weeds in wheat, oat, barley, rye, flax, established grassland and noncrop areas. Nufarm. EPA Reg. No. 226-143AA-7138. 09/2003. [IVA1].

Rhonox® MCPA Ester (MCPA ester 3.7 lb ae/gal). Used for control of broadleaf weeds in flax, pasture, rangeland, turf and noncrop areas. Nufarm. EPA Reg. No. 11685-21-71368. 05/2003. [IVA1]

Rimsulfuron. An active ingredient in Accent Gold, Accent Gold WDG, Basis, Basis Gold, Clarion, DPA-79406, Matrix, Resolve DF, Shadeout, Steadfast and Steadfast ATZ. [IIA2].

Rodeo® (glyphosate 4 lb ae/gal). Special formulation of glyphosate for aquatic weed control. Dow AgroSciences. EPA Reg. No. 62719-324. 05/2002. [IIB1].

Ro-Neet® 6 E (cycloate 6 lb ai/gal). Used PPI in sugarbeet, table beet and spinach for controlling annual grasses and some broadleaf weeds. Monterey; Helm Agro. EPA Reg. No. 73767-5-56077; 7376-5-4530. 09/2001. [IIIC3].

Ronstar® or G (oxadiazon 2%). For PRE weed control in turf and ornamental shrubs, vines and trees. Applied by commercial nursery, turf or landscape personnel only. Bayer. EPA Reg. No. 432-886. 08/2003. [VIII].

Ronstar® 50 WSP (oxadiazon 50% ai). For selective PRE control of annual weeds in turf including buffalograss and ornamentals. Bayer. EPA Reg. No. 432-893. 07/2001 [VIII].

Herbicide Dictionary (continued)

Ronstar 0.95% Plus Fertilizer (0.95% oxadiazon + 20-2-20 fertilizer). For use in ornamental gardens, parks, golf courses and lawns. Lesco. EPA Reg. No. 10404-63. [VIII].

Roundup® Original™ or Roundup Original II® (isopropylamine salt of glyphosate 3 lb ae or 4 lb ai/gal). NIS at 0.5% v/v may be added to improve weed control. Used for PP burndown in corn and soybean and POST for Roundup Ready corn and soybean. Monsanto. EPA Reg. No. 524-445 or 524-454. 02/2004 or 10/2003 [IIB1].

Roundup® Original® Max Herbicide (potassium salt of glyphosate 4.5 lb ae or 5.0 ai lb/gal). A POST nonselective herbicide for broad spectrum control of annual and perennial grass and broadleaf weeds in Roundup Ready crops and many cropping systems. EPA Reg. No. 524-539. 05/2003. [IIB1].

Roundup Pro® (isopropylamine salt of glyphosate 3 lb ae or 4 lb ai/gal + surfactant). A POST nonselective translocated herbicide for annual and perennial grass and broadleaf weed control. Monsanto. EPA Reg. No. 524-475-2A. 10/2003. [IIB1].

Roundup Pro Concentrate™ (isopropylamine salt of glyphosate 5 lb ai/gal). For use in industry, turf and ornamental weed control. Monsanto. EPA Reg. No. 524-529AA. 10/2003. [IIB1].

Roundup ProDry™ (ammonium salt of glyphosate 71% or 64.9% ae w/w). For weed control in noncrop areas. Monsanto. EPA Reg. No. 524-505-AA. 10/2003. [IIB1].

Roundup UltraMax® (isopropylamine salt of glyphosate 3.7 lb ae or 5 lb ai/gal). For POST control of broadleaf and grass weeds in Roundup Ready corn and soybean and burndown and noncropland weed control. Additional surfactant not required. Monsanto. EPA Reg. No. 524-512-AA. 01/2003. [IIB1].

Roundup UltraMax® II (potassium salt of glyphosate 4.5 lb ae or 5.5 lb ai/gal). A POST nonselective translocated herbicide for annual and perennial grass and broadleaf weed control. Roundup Ultra is labeled for weed control in Roundup Ready corn hybrids and soybean varieties. Use in Nebraska is restricted to western Nebraska. Monsanto. EPA Reg. No. 524-537. 06/2003. [IIB1].

Roundup UltraMax® RT (IPA salt of glyphosate 3 lb ae/gal). Labeled in states west of Nebraska. Monsanto. EPA Reg. No. 524-512. 01/2001. [IIB1].

Roundup WeatherMax™ (potassium salt of glyphosate 4.5 lb ae or 5.5 lb ai/gal). Selective control of weeds in Roundup Ready crops. Nonselective control of weeds in other cropping systems. Monsanto. EPA Reg. No. 524-537. 06/2003. [IIB1].

Rout (oxyfluorfen 2% + oxyzalin 1%). For PRE control of weeds in containers, field grown and landscape ornamentals, cut flowers and foliage crops. Scotts. EPA Reg. No. 58185-27. 12/2003. [VIA1 + IIIA1].

RT Master™ (isopropylamine salt of glyphosate 3 lb ae or 4 lb ai/gal + 2,4-D amine at 0.4 lb ai/gal). For use in cropland and noncropland. Restricted to counties in western Nebraska. Monsanto. EPA Reg. No. 524-531. 01/2004. [IIB1].

RT Master® II (potassium salt of glyphosate 4.5 lb ae or 5.5 lb ai/gal). Labeled for controlling emerged weeds before Roundup Ready crops as there is no 2,4-D in RT Master II. Not labeled for crop use. The red dye in RT Master was replaced with a blue dye. Designed for use in fallow. Restricted to counties in western Nebraska. Monsanto. EPA Reg. No. 524-539. 01/2004 [IIB1].

Saber® (2,4-D dimethyl amine salt 3.8 lb ai/gal). For control of broadleaf weeds in small grain, corn and grain sorghum. UAP Loveland. EPA Reg. No. 34704-803. 04/1999. [IVA1].

Sahara® DG (7.78% imazapyr + 62.22% diuron). For control of all plants where bare ground is desired. BASF. EPA Reg. No. 241-372. 04/2001. [IIA1 + VB1].

Salvo® (isooctyl ester of 2,4-D-5 lb/gal). A low volatile ester. UAP Loveland. EPA Reg. No. 34704-609. 07/2001. [IVA1].

Sandea® (halosulfuron 75% WP). A selective POST herbicide for control of some broadleaf weeds and nutsedge in sweet corn. Gowan. EPA Reg. No. 10163-254. 02/2003. [IIIA2].

Savage® (2,4-D 95% WP or 78.9% ae). Water soluble crystals of dimethylamine salt of 2,4-D. UAP Loveland. EPA Reg. No. 34704-606. 05/2002. [IVA1].

Scepter® 70DG (imazaquin 70% DG). A PPI, PRE or POST grass and broadleaf weed control herbicide for soybean. BASF. EPA Reg. No. 241-306. 04/2001. [IIA1].

Scythe® (pelargonic acid 4.2 lb ai/gal). For burndown and aquatic weed control. Also labeled to mix with glyphosate. Dow Agro-Sciences. Mycogen. EPA Reg. No. 62719-342 or 53219-7. 05/2002 or 04/1998. [VIC1].

Select® (clethodim 2 lb/gal). Used POST for annual and perennial grasses in alfalfa, canola, potato, soybean, sunflower, sugarbeet and others. Valent. EPA Reg. No. 59639-3. 07/2002. [IA2].

Select Max™ (clethodim 0.97 lb ai/gal). Used POST for volunteer corn plus annual and perennial grasses in soybeans only. More flexible adjuvant requirements than Select. Valent. EPA Reg. No. 59639-132. 03/2005. [IA2].

Sempra® (halosulfuron-methyl 75%). Use for POST broadleaf weeds and nutsedge control in field and sweet corn, popcorn, grain sorghum and turf sod. Monsanto. EPA Reg. No. 524-465. 01/2001. [IIA2].

Sencor® 4 L or DF (metribuzin 4 lb ai/gal or 75% DF). Trade name for metribuzin used for weed control in alfalfa, corn, potato, soybean and fallow. Bayer. EPA Reg. No. 3125-314 (09/2000) or 3125-325. 11/2000. [IIA2].

Sequence™ Herbicide (glyphosate 2.5 lb ae + S-metolachlor 3 lb ai/gal). Foliage and PRE control of weeds in soybean and sorghum before planting. Labeled for use with Roundup Ready soybeans. Syngenta. EPA Reg. No. 100-1185. 03/2004. [IIB1 + IIIB1].

Sethoxydim. Active ingredient in Conclude Xact, Manifest, Poast, Poast Plus, Rezult and Vantage for grass control in alfalfa, soybean and other broadleaf crops. [IA2].

Shadeout® (rimsulfuron 25% DF). PRE or POST for broadleaf and grass weed control in tomato. DuPont. EPA Reg. No. 352-556. 10/2000. [IIA2]. *Not labeled in Nebraska.*

Shotgun® (1.0 lb 2,4-D + 2.25 lb atrazine 3.75 lb/gal). For POST broadleaf weed control in sorghum and corn. UAP Loveland. EPA Reg. No. 34704-728. 05/1999. RUP. [IVA1 + VA1].

Siduron. Active ingredient in Tupersan [VB1].

Silhouette® (glyphosate 3 lb ae or 4 lb ai/gal). For POST control of broadleaf and grass weeds for burndown and noncropland weed control. Additional surfactant optional. Agrilience. EPA Reg. No. 524-445-1381. 2001. [IIB1]

Herbicide Dictionary (continued)

Silverado™ Wild Oat herbicide (mesosulfuron 2%). For control of wild oat in wheat including durum. Bayer Crop Sciences. EPA Reg No. 264-801. 3/2004.

Simazine. An active ingredient in Pramitol 5PS, Princep 4L, Princep Caliber 90, Simazine 4L and 90 DF, Simazat and Sim-trol. Used for aquatic weed control, corn, shelterbelts and soil sterilants. [VA1].

Simazat™ 4L Herbicide (atrazine 2 lb ai + simazine 2 lb ai/gal). For control of weeds in corn and Christmas tree plantations. Drexel. EPA Reg. No. 19713-171. 08/2002. [VA1]. RUP.

Simazine 4L or 90 DF (simazine 4 lb ai/gal or 90% DF). Used for weed control in fruit and nut crops, corn and shelterbelts. Agriliance; UAP Loveland. EPA Reg. No. 9779-296 or 9779-295; 34704-687 or 34704-686. Drexel 19713-252. 08/2002 or 10/2002; 02/2003 or 10-1999; 02/2004. [VA1].

Sim-trol 90DF (simazine 90% DF). For weed control in certain crops and ornamental plantings. Sipcam. Agro. EPA Reg. No. 35915-12-60063. 12/2003. [IVA1].

Sinbar® (terbacil 80% WP). Used in dormant season for control of annual grass and broadleaf weeds in established alfalfa. DuPont. EPA Reg. No. 352-317. 11/1999. [VA4].

S-metolachlor. Active ingredient in Bicep II Magnum FC, Bicep II Magnum, Bicep Lite II Magnum, Boundary, Camix, Cinch, Cinch ATZ, Cinch ATZ Lite, Dual Magnum, Dual II Magnum, Dual II G Magnum, Dual II Magnum SI, Expert, Lexar, Lumax, Pennant Magnum and Sequence. More active isomer than metolachlor found in Dual. [IIIB1].

Snapshot™ 2.5 TG (2.0% trifluralin + 0.5% isoxaben). For PRE control of annual broadleaf and grass weeds in landscape ornamental and ground covers. Dow AgroSciences. EPA Reg. No. 62719-175. 05/2000. [IIIA1 + IIIE1].

Sodium chlorate. An active ingredient in Pramitol 5PS and Sodium Chlorate Weed Killer. [VIII2].

Sodium Chlorate Weed Killer (sodium chlorate 6 lb/gal). Used as a corn, dry edible bean, sorghum, soybean, or sunflower desiccant. Simplot. EPA Reg. No. 7001-342. 08/1999. [VIII2].

Sodium metaborate. An active ingredient in Pramitol 5PS. [VIIA2].

Solicam® DF (norflurazon 78.6% DF). Used PRE for controlling weeds in asparagus, grapes and fruit trees. Syngenta. EPA Reg. No. 100-849. 10/2002. [VIIA3].

Sonalan™ HFP or 10G (ethalfluralin 3 lb ai/gal or 10G). Use PPI for annual grasses and certain broadleaf weeds in corn, dry edible bean, soybean and sunflower. Dow AgroSciences. EPA Reg. No. 62719-188 (12/1998) or 62719-184. 06/1999. [IIIA1].

Sonar™ A.S. (fluridone 4lbs/gal ai). For aquatic weed control. SePRO. EPA Reg. No. 67690-4. 12/2002 [VIIA]

Spartan® (sulfentrazone 75% DF or 4F which is 4 lb ai/gal). For broadleaf weed control in sunflower. FMC. EPA Reg. No. 279-3189 or 279-3220. 10/2003 or 10/2003. [VIA3].

Speed Zone™ (carfentrazone-ethyl 0.05 lb + 2,4-D ethylhexylester 1.53 lb + dicamba 0.14 ae lb/gal). For broadleaf control in turf. PBI Gordon. EPA Reg. No. 0217-838. 09/2001. [VIA3 + IVA2].

Spike™ 80 DF or 20 P (tebuthiuron). Used for total vegetation and selective brush control in grassland and noncrop areas. Dow AgroSciences. EPA Reg. No. 62719-107 or 62719-121. 09/1999 or 08/2000. [VB1].

Spin-Aid® (phenmedipham 1.1 lb ai/gal). For POST weed control in spinach and red beet. Bayer. EPA Reg. No. 264-616. 08/1995. [AV3].

Spirit™ Herbicide (14.2% prosulfuron + 42.8% primsulfuron WDG). Used for POST broadleaf weed control in field corn and popcorn. Syngenta. EPA Reg. No. 100-911. 05/1999. [IIA2 + IIA2].

Spotlight™ (fluroxypyr 1 lb/gal). For POST control of annual and perennial broadleaf and woody brush in established turf, including residential lawns. DowAgroSci. EPA Reg. No. 62719-308. 12/2003. [IVA3].

Spyder™ (sulfometuron 75% DG). For PRE and POST control of grasses and broadleaf weeds in conifers and hardwood site preparation and release areas. Nufarm. EPA Reg. No. 228-408. 02/2004. [IIA2].

Squadron® (0.33 ai lb imazaquin + 2 ai lb/gal of pendimethalin). For PP, PPI or PRE weed control in soybean. BASF. EPA Reg. No. 241-327. 04/2001. [IIA1 + IIIA1].

Stalwart™ C (metolachlor 7.8 lb ai/gal). For weed control in field corn and popcorn. Sipcam Agro. EPA Reg. No. 60063-22. [IIIB1].

Stalwart™ Xtra (atrazine 3.1 lb ai + metolachlor 2.4 lb ai/gal). For weed control in field corn and popcorn. Sipcam Agro. EPA Reg. No. 60063-23. 01/2004. [VA1 + IIIB1].

Stam™ (propanil 4 lb ai/gal). A rice herbicide. Dow AgroSciences. EPA Reg. No. 62719-19-392. 08/2002. [VIA4].

Stampede™ 80 DF (propanil 80%). Contact herbicide for POST control of green and yellow foxtail, wild millet, in spring wheat, spring barley and oat. *Not labeled for Nebraska*. Dow AgroSciences. EPA Reg. No. 707-226. 09/1993. [VIA4].

Staple® Herbicide (pyrithiobac sodium 85%). For PRE weed control in cotton. DuPont. EPA Reg. No. 352-576. 03/2003. [IIIA]. *Not labeled for Nebraska*.

Staple® Plus (pyrithiobac sodium 1.7% + glyphosate 40.2%). For POST weed control in glyphosate-tolerant cotton. DuPont. EPA Reg. No. 352-606. 05/2001. [IIA + IIB1].

Starane™ (fluroxypyr 1.5 lb ae/gal). POST for controlling kochia and other broadleaf weeds in small grain, corn and grain sorghum. Dow AgroSciences, UAP Loveland. EPA Reg. No. 62719-286. 01/2004. [IVA3].

Starane™ + Esteron (0.75 lb ae fluroxypyr + 2,4-D ester 3 lb ae/gal). For control of broadleaf weeds and volunteer potato in small grain, especially kochia. Dow AgroSciences. EPA Reg. No. 62719-306. 02/2002. [IVA3 + IVA1].

Starane™ + MCPA (0.71 lb ae fluroxypyr + 2.84 lb ae/gal MCPA). For control of annual and perennial broadleaf weeds, especially kochia and volunteer potato in small grain. UAP Loveland. EPA Reg. No. 62719-307. 12/2003. [IVA3 + IVA1].

Starane™ + Saber® (0.5 lb ae fluroxypyr + 2.0 lb ae 2,4-D amine = 2.5 lb ae/gal). Used POST for broadleaf control in small grains, especially for kochia. UAP Loveland. EPA Reg. No. 62719-333. 02/2003 [IVA3 + IVA1].

Herbicide Dictionary (continued)

Starane™ + Salvo® (0.75 lb ae fluroxypyr + 3 lb ae 2,4-D ester = 0.75 lb ae/gal). For POST broadleaf weed control in small grains, especially for kochia. UAP Loveland. EPA Reg. No. 62719-306. 02/2003. [IVA3 + IVA1].

Starane™ + Sword (0.71 lb ae fluroxypyr + 2.84 lb ae MCPA = 3.55 lb ae/gal). Used POST for controlling broadleaf weeds in small grain, especially for kochia. Dow AgroSciences, UAP Loveland. EPA Reg. No. 62719-307. 05/2001. [IVA3 + IVA1].

Starfire® Herbicide (1.5 lb ai/gal paraquat). A weed, grass and harvest aid herbicide. Syngenta. EPA Reg. No. 10182-103. 08/2001. RUP. [VIB1].

Steadfast® (50% nicosulfuron + 25% rimsulfuron DG). For POST broadleaf and grass control in field corn. DuPont. EPA Reg. No. 352-608. 05/2003. [IIA2 + IIA2].

Steadfast® ATZ (nicosulfuron 2.7% + rimsulfuron 1.3% + atrazine 85.3%). For weed control in corn. DuPont. EPA Reg. No. 359-619. 07/2004. RUP. [IIA1 + IIA1 + VAI].

Steel® (0.17 lb imazaquin + 0.17 lb imazethapyr + 2.59 lb pendimethalin 3.4 lb ai/gal). For PP, PPI or PRE control of grass and broadleaf weeds in soybean. BASF. EPA Reg. No. 241-376. 04/2001. [IIA1 + IIA1 + IIIA1].

Stellar® (0.7 lb flumiclorac + lactofen 2.4 lb/gal). Used for POST broadleaf weed control in soybean. Valent. EPA Reg. No. 59639-92. 07/2002. [VIA2 + VIA1].

Sterling™ (dimethylamine salt of dicamba 4 lb ae/gal). For PP, PRE, or POST broadleaf weed control in field corn, seed corn, popcorn and silage corn; grain sorghum and small grains. Some varieties are more sensitive. Also for pasture, hay, rangeland and noncropland. Agrilience. EPA Reg. No. 51036-289-9779. 03/2000. [IVA2].

Sterling™ Plus (potassium salt of dicamba 1.1 lb ai ae + 2.1 lb ai/gal of atrazine). Used for weed control in corn, grain sorghum and fallow systems. Agrilience. EPA Reg. No. 51036-307-9779. 04/2001. RUP. [IVA2 + VA1].

Stinger™ (clopyralid 3 lb ae/gal). For POST broadleaf weed control in canola, sugarbeet, sweet corn and popcorn. Dow AgroSciences. EPA Reg. No. 62719-73. 03/2001. [IVA3].

Storm® (bentazon 2.67 lb + acifluorfen 1.33 lb ai/gal). For weed control in soybean. United Phosphorus. EPA Reg. No. 7969-76. 04/1999. [VC1 + VIA1].

Strategy (ethalfluralin 1.6 lb + clomazone 0.51 lb ai/gal). For selective control of annual grass and broadleaf weeds in cucumber, melon, pumpkin, squash and watermelon. UAP Loveland. EPA Reg. No. 34704-836. 07/2003. [IIA1 + VIIC].

Strike 3™ (2.44 lb ae DMA salt of 2,4-D 0.63 lb ae + mecoprop + 0.22 lb ae/gal of DMA dicamba). For selective control for turf-grasses including use on sod farms. Agrilience. EPA Reg. No. 14774-02. 01/1999. [IVA2 + IVA3 + VA2].

Strike Three Ultra (DMA of 2,4-D 2.9 lb + clopyralid 0.15 lb ae + dichlorprop 0.75 lb ae/gal). POST control of broadleaf weeds on golf courses, parks, ornamental turf grass. Agrilience. EPA Reg. No. 228-374-1381. 07/2001. [IVA2 + IVA3 + IVA1].

Sulfentrazone. An active ingredient in Authority Herbicide, Authority Broadleaf, Canopy XL, Gauntlet and Spartan. [IVA3].

Sulfometuron. Active ingredient in Landmark MP, Landmark II MP, Oust, Oust Extra, Oust XP, Oustar and Westar. [IIA2].

Sulfosulfuron. Active ingredient in Maverick and Maverick Pro for control of downy brome in winter wheat, Outrider for non-cropland, Spyder and Certainty for selective grass and broadleaf control in some warm season turfs. [IIA2].

Supersate® (isopropylamine salt of glyphosate 41%). For POST control of broadleaf and grass weeds in Roundup Ready corn and soybean, burndown, fallow cropland and noncropland weed control. UAP Loveland. EPA Reg. No. 524-445-34704. 11/2004. [IIB1].

Sureguard™ (flumioxazin-51% WDG). For PRE control of weeds in containers and field grown ornamentals, conifers and deciduous trees. Valent. EPA Reg. No. 59639-120. 01/2004. [VIA2].

Surflan™ A.S. or Surflan A.S. Speciality (oryzalin 4 lb ai/gal). Used PRE for annual grass and broadleaf weeds in fruit, nut and Christmas trees, turf and ornamentals. Dow; United Phosphorus. EPA Reg. No. 62719-112 or -113; 70506-43 or -44. 05/2002. [IIIA1].

Surmount™ (fluroxypyr 0.67 lb ae + picloram 0.67 lb ae/gal). For control of woody plants and annual and perennial broadleaf weeds in rangeland and perennial grass pastures, fence rows, nonirrigated ditchbanks and around farm buildings. Dow AgroSciences. EPA Reg. No. 62719-480. 10/04. [IVA3 + IVA3].

Surpass™ EC or 20 G (acetochlor 6.4 lb ai/gal or 20G + dichlor-mid safener). Used PRE for control of annual grass weeds in corn. Dow AgroSciences. EPA Reg. No. 62719-367 or 370. 08/2003. RUP. [IIIB1].

Sutan +® 6.7-E (butylate 6.7 lb ai/gal). PPI herbicide for annual grass control in field corn, sweet corn, popcorn and silage corn. Helm Agro. EPA Reg. No. 73637-3-74530. 07/2003. [IIIC3].

Sword™ (MCPA 5.2 lb/gal). Used for broadleaf weed control in small grain and pastures. UAP Loveland. EPA Reg. No. 228-267-34704. 10/2001. [IVA1].

SWB™ 2,4-D LV4 (2-ethyhexl ester of 2,4-D 3.76 lb ae/gal). Used to control broadleaf weeds in cereal crops, corn, sorghum, soybean, weeds and brush in rangeland, pastures and rights-of-way. Agrilience. EPA Reg. No. 42750-22-ZA-9779. 06/2001. [IVA1].

Synchrony® STS® (31.8% chlorimuron + 10.2% thifensulfuron DG). For POST broadleaf control in STS soybean. DuPont; Agrilience. EPA Reg. No. 352-599. 08/2001. [IVA2].

Tahoe™ 3 A or 4 E (triclopyr 3 or 4 lb ae/gal). Used for woody plants and broadleaf weeds on rights-of-way, forests and wildlife openings, including grazed areas. Nufarm. EPA Reg. No. 228-384 or 228-385. 02/2003. [IVA3].

Team® Pro Fertilizer with 0.86% Team® (0.43% benefin + 0.43% trifluralin). A granular fertilizer containing herbicides for PRE control of annual grasses and broadleaf weeds in established turf and established landscape ornamentals. Verdicon (formerly United Horticultural Supply). EPA No. 62719-289. 06/2001. [IIIA1 + IIIA1].

Teamwork™ (carfentrazone 40% w/w). For early POST control of broadleaf weeds in field and seed corn, popcorn, silage corn, grain sorghum, soybean, barley, oat and wheat. Agrilience. EPA Reg. No. 279-3194-1381. 08/2000. [VIA3].

Herbicide Dictionary (continued)

Tebuthiuron. Active ingredient in Spike 80W or 20 P. [VB1].

Telar® DF (75% chlorsulfuron). Labeled for weed control in non-crop and industrial sites. DuPont. EPA Reg. No. 352-522. 12/2002. [IIA2].

Terbacil. Active ingredient in Sinbar. [VA4].

Thifensulfuron. An active ingredient in Ally Extra, Basis, Harmony Extra, Harmony GT, Harmony GT XP and Synchrony STS. [IIA2].

Thiobencarb. Active ingredient in Bolero. [III3C]

Three-Way Selective Herbicide (2,4-D 2.38 lb + mecoprop 0.63 lb + dicamba 0.22 lb ae/gal). Lesco. EPA Reg. No. 10404-43. 10/2003. [IVAI + IVA1 + IVA2].

Three-Way™ Ester II (3 lb of MCPA, 0.3 lb of triclopyr + 0.3 lb ae/gal of dicamba). Used for POST control of broadleaf weeds in turf grasses. Lesco. EPA Reg. No. 228-317-10404. 10/2003. [IVA1 + IVA3 + IVA1].

TopNotch™ (acetochlor 3.2 lb ai/gal + dichlormid safener). An encapsulated form of Surpass for selective PRE weed control in field, seed and silage corn and popcorn. Dow AgroSciences. EPA Reg. No. 62719-369. 03/2003. RUP. [IIIB1].

Topramezone. Active ingredient in Impact. [VIIIB2].

Topsite™ (0.5% imazapyr + 2.0% diuron 2.5% G). Controls many annual and perennial weeds in noncrop areas. UAP Loveland. EPA Reg. No. 228-308-34704. 02/1996. [IIA2 + VB1].

Tordon 101™ Mixture (0.54 lb picloram + 2,4-D 2.0 lb ae/gal). For control of annual and perennial broadleaf weeds, woody plants and vines on noncrop areas. Dow AgroSciences. EPA Reg. No. 62719-5. 05/2003. RUP. [IVA3 + IVA1].

Tordon™ 22K or Tordon™ K (picloram 2 lb ae/gal). A POST herbicide for annual and perennial broadleaf weeds. Residues may last for several years in the soil. Dow AgroSciences. EPA Reg. No. 62719-6. 01/2005. RUP. [IVA3].

Tordon™ RTU (picloram 3.0% + 2,4-D TPA 11.2%). For control of unwanted trees via cut surface treatments in forest and noncrop areas. Dow AgroSciences. EPA Reg. No. 62719-31. RUP. [IVA3 + IVA1].

Touchdown® (glyphosate diammonium salt 3 lb ae/gal or 3.75 lb ai/gal). For nonselective weed control and POST in glyphosate-tolerant corn or soybean. A NIS surfactant may be added. Syngenta. EPA Reg. No. 100-1117. 08/2001; 10/2003. [IIB1].

Touchdown 009 (glyphosate 2.5 lb ae + S-metolachlor 3 lb ai/gal). Foliage and PRE control of weeds in corn, cotton, soybean, pod crops and sorghum before planting. Not labeled for use on Roundup Ready crops. Syngenta. EPA Reg. No. 100-1185. 11/2004. [IIB1 + IIIB1].

Touchdown™ CF (glyphosate diammonium salt 3 lb ae/gal). For nonselective weed control in crop, fallow land, cropland and pastures. Not registered on Roundup Ready crops. Syngenta. EPA Reg. No. 100-1157. 1/2003. [IIB1].

Touchdown™ CT (glyphosate potassium salt 4.17 lb ae or 5lb ai/gal). For nonselective weed control in crop, fallow land, cropland and pastures. Not registered on Roundup Ready crops. Syngenta. EPA Reg. No. 100-1212 11/2004. [IIB1].

Touchdown™ HiTech (glyphosate 5 lb ae/gal potassium salt). For nonselective foliar systemic control of weeds in Roundup Ready crops, fallow, cropland and pastures. Syngenta. EPA Reg. No. 100-1182. 02/2004. [IIB1].

Touchdown® Pro (diammonium salt of glyphosate 3 lb ae or 3.75 lb ai/gal). For nonselective weed control in turf, industrial and noncropland uses. Contains IQ Technology. Additional surfactant optional. Syngenta. EPA Reg. No. 100-1121. 01/2002. [IIB1].

Touchdown™ Total (glyphosate potassium salt 4.17 lb ae or 5lb ai/gal IQ™ Technology). For nonselective weed control and POST in glyphosate-tolerant corn or soybean. Syngenta. EPA Reg. No. 100-1169. 12/03. [IIB1].

Tralkoxydim. Active ingredient in Achieve; used for summer annual grass control in wheat and barley. [IA2].

Trans-Star™ A special translocating surfactant used with glyphosate and Touchdown. Monsanto. Reg. EPA. No. 10182-449.

Transline™ (cloprialid 3 lb ae/gal). For selective control of broadleaf weeds in noncrop areas. Dow AgroSciences. EPA Reg. No. 62719-259. 07/1999. [IVA3].

Treflan™ HFP or TR-10 (trifluralin 4 lb/gal or 10% WP). Used PPI or PRE (spinkler irrigation) in corn, dry edible bean, soybean, several vegetables and nursery stock for annual grass and broadleaf weed control. Dow AgroSciences. EPA Reg. No. 62719-250 or 131. 02/2003 or 02/2003. [IIIA1].

Triallate. An active ingredient in Far-Go. [IIIC3].

Triamine® (2,4-D 1.24 lb ae + mecoprop 0.63 lb ae + dichloprop 0.6 lb ae/gal). For broadleaf weed control in commercial lawns. Nufarm. EPA Reg. No. 228-178. 09/2003. [IVA1 + IVA1 + IVA1].

Triamine® II (Amine MCPA 1.27 lb ae/gal, mecoprop 0.63 lb ae/gal and dichlorprop 8.34 lb ae/gal). For use in golf courses, parks, highways and turf lawns for control of broadleaf weeds. Nufarm. EPA Reg. No. 228-206. 09/2003. [IVA1 + IVA1 + IVA1].

Triasulfuron. An active ingredient of Amber, Fuego and Rave [IIA2].

Tribenuron. An active ingredient of Ally Extra, Express Herbicide, Express XP and Harmony Extra. [IIA2].

Triclopyr. An active ingredient in Battleship, Chaser 2 Amine, Chaser Turf Herbicide, Confront, Cool Power, Crossbow, Eliminate, Garlon 3A or 4A, Horsepower, PastureGard, Pathfinder II, Redeem R&P, Remedy, Tahoe 3A, Three-Way Ester II, Triclopyr 4 Ester R&P and Turflon Ester. [IVA3].

Triclopyr 4 Ester R&P (triclopyr 4 lb ae/gal). For control of woody plants and broadleaf weeds in rangeland, permanent grass pastures and CRP. Micro Flo. EPA Reg. No. 51036-377. 10/2003. [IVA3].

Trifluralin. An active ingredient in AgriStar Trifluralin 4EC, Bayonet, Commence, Cornbelt Trifluralin, Preen, Pro-Mate Turf Fertilizer, Snapshot 2.5 TG, Team Pro, Treflan HFP or 10 G, Trifluralin HF Clean Crop, Triflurex HFP, Trillin 5A and Trust. [IIIA1].

Trifluralin 4 EC Agri Star™, Cornbelt® Trifluralin EC or Helena Trifluralin 4 EC (trifluralin 4 lb ai/gal). For PPI control of weeds in established alfalfa, pea, canola, potato and soybean. Albaugh/Agri Star, Van Diest, or Helena. EPA Reg. No. 42750-32, 1812-355-11773, or 5905-519. 10/1999, 03/1999, or 05/2003. [IIIA1].

Herbicide Dictionary (continued)

Trifluralin HF Clean Crop (trifluralin 4 lb ai/gal). May be used under paved surfaces at higher rates. UAP Loveland. EPA Reg. No. 34706-792. 07/2003. [IIIA1].

Triflurex[®] HFP (trifluralin 4 lb ai/gal). For PPI weed control in established alfalfa, asparagus, most dry and fresh bean or pea, chicory, many vegetables, trees and soybean. Makhteshim Agan. EPA Reg. No. 66222-46. 09/2004. [IIIA1].

Triflurosulfuron. Active ingredient in Monument and Upbeet. [IIA2].

Trillin[®] 5. A 4L formulation of trifluralin. Tri Corp. EPA Reg. No. 1812-353. 09/1999. [IIIA1].

Trimec[®] Broadleaf Herbicide. Bentgrass formula (DMA salt of mecoprop 0.71 lb ae + DMA salt of 2,4-D 0.44 lb ae + dicamba 0.18 lb ae/gal). For POST control of broadleaf weeds in lawns. PBI Gordon. EPA Reg. No. 2217-529. 09/2001. [IVA1 + IVA1 + IVA2].

Trimec Classic (2,4-D 1.98 lb ae/gal + mecoprop 0.53 lb ae/gal + dicamba 0.21 lb ae/gal). For broadleaf weed control in warm and cool season grasses by lawn care professionals. PBI/Gordon Corp. EPA Reg. No. 2217-543. 11/2003 [IVA1 + IVA2]

Trimec[®] Plus (MSMA 1.8 lb + 2,4-D 0.48 lb ae + mecoprop 0.24 lb ae + dicamba 0.12 lb ae/gal). For POST control of grass and broadleaf weeds in lawns. PBI Gordon. EPA Reg. No. 2217-709. 11/2000. [IVA1 + IVA1 + IVA2].

Trimec[®] Turf Herbicide (2.44 lb ae 2,4-D + 1.3 lb ae mecoprop + 0.22 lb ae/gal dicamba). For broadleaf weed control in lawns. PBI Gordon. EPA Reg. No. 2217-517. 10/2000. [IVA1 + IVA1 + IVA2].

Triplet[®] SP (2,4-D 2.38 lb ae + MCPA 0.63 lb ae + dicamba 0.22 lb ae/gal). For broadleaf control in turfgrasses. Nufarm. EPA Reg. No. 228-312. 12/2000. [IVA1 + IVA1 + IVA2].

Tri-Power[®] Selective Herbicide (MCPA 3.1 lb ae/gal + mecoprop-p 0.6 lb ae/gal + dicamba 0.3 lb ae/gal). For selective broadleaf weed control in lawns. Nufarm Turf and Specialty. EPA Reg. No. 228-262. 9/1999 [IVA1 + IVA1 + IVA2]

Trizmet II Herbicide (atrazine 2.1 lb ai + metolachlor 2.4 lb ai/gal). For weed control in field corn and popcorn. Drexler. EPA Reg. No. 19173-517. 09/2003. RUP. [VA1 + VA1]

Trust[®] 4 EC or 10 G (trifluralin 4 lb ai/gal or 4 lb ae/gal 10G). For PPI control of weeds in established alfalfa, canola, pea, potato and soybean. Agrilience. EPA Reg. No. 9779-303 or 1381-16. 03/2003 or 09/2001. [IIIA1].

Tupersan[®] (siduron 50% w/w). For control of annual grasses in turfgrasses. Gowan. EPA Reg. No. 10163-213. 12/1999. [VB1].

Turf Weed and Brush Control (iso-octyl ester of 2,4-D and dichlorprop at 1.83 and 1.87 lb ae/gal). For controlling mixed brush and perennial broadleaf weeds on both crop and noncrop plants plus lawns, golf courses and parks. Nufarm. EPA Reg. No. 228-167. [IVA1 + IVA1].

Turflon[™] Ester (triclopyr 4 lb ae/gal). For control of annual and perennial broadleaf weeds in ornamental turf. Dow AgroSciences. EPA Reg. No. 62719-258. 08/2002. [IVA3].

Turret[®] (5.5 lb ai/gal solventless ester of 2,4-D). For control of

broadleaf weeds in crop and noncrop areas. Nufarm. EPA Reg. No. 228-95-71368. [VA1]

2,4-D. A growth-regulating phenoxy herbicide for broadleaf weed control in grass crops. Amine 4, Amine 4 2,4-D, Aqua-Kleen, Banvel + 2,4-D, Barrage, Bentgrass Selective, Brash, Brushmaster, Campaign, Chaser 2, Chaser Turf Herbicide, Chaser Ultra Weed & Feed, Cimarron Max, Cornbelt Amine, Cornbelt 4 Lb. and 6 Lb., Credit Master, Crossbow, Curtail, D-638, DMA4 IVM, Esteron 99, Five Star, Formula 40, Four Power Plus, Grazon P+D, HardBall, Hi-DEP, Kamba Master, Landmaster BW, Low Vol 4 Ester Weed Killer, Maestro D, MEC Amine-D Turf Herbicide, Millenium Ultra, Millenium Ultra Plus, Oasis, Opti-Amine, Outlaw, Pasture-Master, Pasture MD, Pathway, Phenoxy 088, Pro-Mate-Three Way SC, Range Star, Recoil, Saber, Salvo, Savage, Shotgun, Speed Zone, Starane + Esteron, Starane + Saber, Starane + Salvo, Strike 3, Strike Three Ultra, SWP 2,4-D LV4, Three-Way Selective Herbicide, Tordon Mixture, Tordon RTU, Triamine, Trimec Broadleaf Herbicide, Trimec Classic, Trimec Plus, Trimec Turf, Triplet, Turf Weed & Brush Control, Turret, 2,4-D Amine 4, 2,4-D LV4, 2,4-D LV6, Unison, Veteran 10G, Weed Rhap A-4D, Weedar 64, Weedone LV4, Weedone LV6 EC, Weedone 638, Weedmaster Herbicide. [IVA1].

2,4-D Amine 4 (3.8 lb ae/gal 2,4-D amine). PP, PRE and POST control of annual and biennial broadleaf weeds in field and sweet corn, PP to soybean, POST to small grain, grain sorghum, fallow, pastures, rangeland, turfgrass, lawns and aquatic areas. Agrilience. EPA Reg. No. 1381-103. 01/2003. [IVA1].

2,4-DB. A growth regulating phenoxy herbicide for broadleaf weed control in alfalfa and soybean. An active ingredient in Butoxone 200, Butoxone 7500, Butyrac 175, 2,4-DB 200, Butyrac 200, Chaser Turf Herbicide, D-638 and Phenoxy 088. [IVA1].

2,4-DB 200 (22% ae 2,4-DB). For broadleaf weed control in soybeans and alfalfa. Agrisolutions. EPA. Reg. No. 42750-38-9779. 1/1998 [IV A1]

2,4-D LV 4 (3.8 lb ae/gal of 2-ethylhexyl ester of 2,4-D). Controls same weeds as 2,4-D Amine 4 except in aquatic areas. Agrilience. EPA Reg. No. 1381-102. 12/2002. [IVA1].

2,4-D LV 6 (5.6 lb ae/gal of 2-ethylhexyl ester 2,4-D). For control of same weeds listed under 2,4-D Amine 4, except aquatic areas. Agrilience. EPA Reg. No. 1381-101. 11/2001. [IVA1].

2,4-DP. See dichlorprop. [IVA1].

Ultra Blazer[™] (acifluorfen-2 lb ai/gal). A POST herbicide for broadleaf weed control in soybean. Ultra Blazer has less leaf burn than Blazer. United Phosphorus. EPA Reg. No. 7969-79. 04/1999. [VIA1].

UpBeet[®] (triflurosulfuron 50% WDG). POST control of broadleaf and grass weeds in sugarbeet. DuPont. EPA Reg. No. 352-569. 08/2001. [IIA2]

Unison[™] (2,4-D acid 1.74 lb/gal). For POST broadleaf weed control in cereal and corn crops, pastures and rangeland. Helena. EPA Reg. No. 5905-542. 02/2004. [IVA2].

Valor[®] SX or Valor[®] WP (flumioxazin 51% WDG or WP). Use PRE for broadleaf weeds and grass suppression in soybean. Valent. EPA Reg. No. 59639-99 or 59369-98. 09/2002. [VIA2].

Herbicide Dictionary (continued)

Vantage® herbicide (sethoxidim 1.0 lb ai/gal). For selective EP-OST control for annual and perennial weeds in turf, ornamental and noncrop areas. BASF or Micro Flo. EPA Reg. No. 7969-88-51036. 12/1999. [IA2].

Vanquish® (diglycolamine salt of dicamba 4 lb ai/gal). For selective broadleaf and brush control on noncropland and lawns. Syngenta. EPA Reg. No. 100-884. 06/2001. [IVA2].

Velpar® DF or Velpar® L (hexazinone 75% DF or 2 lb ai/gal). Used for nonselective POST weed control on noncropland, Christmas tree plantings and alfalfa. DuPont. EPA Reg. No. 352-581. 08/2001 or 352-392. 08/2001. [VA2].

Velpar Alfa Max™ MP (hexazinone 35% + diuron 42.4%). For PRE broadleaf weed control in dormant alfalfa. DuPont. EPA Reg. No. 352-634. 02/2004. [VA2 + VB1].

Veteran® 720 or Veteran 10 G (DMA salts of 2,4-D 1.9 lb ae + 1.0 lb ae/gal dicamba or 10% dicamba G). Water soluble industrial herbicide for controlling broadleaf weeds. Nufarm. EPA Reg. No. 228-295 or 228-309. 05/2003. [IVA1 + IVA2 or IVA2].

Veteran® CST (DMA salt of dicamba 1 lb ae/gal). For cut surface treatment to control undesirable trees. Nufarm. EPA Reg. No. 228-297. 06/2003. [IVA2].

Vistar (fluroxypyr 1.5 lb ae/gal). Selective POST control of annual and perennial broadleaf weeds in noncrop areas. Dow AgroSciences. EPA Reg. No. 62719-308. 02/2002. [IVA3].

Volley (acetochlor + safener 6.4 lb ai/gal). Used PRE for control of annual grass weeds in corn. Tenkoz. EPA Reg. No. 55467-8. 12/2003. [IIIB1].

Volley ATZ (3.0 lb ai acetochlor + 2.25 lb ai/gal atrazine + safener). A PP and PRE herbicide for weed control in corn. Tenkoz. EPA Reg. No. 55467-7. 1/2004. [IIIB1 + VA1]

Volley ATZ Lite (acetochlor 4 lb ai + atrazine 1.5 lb ai/gal + safener). Used PRE for controlling grass and broadleaf weeds in field corn, production seed corn, silage corn and popcorn. Tenkoz. EPA Reg. No. 55467-6. 12/2003. [IIIB1 + VA1].

Weedar® 64 (2,4-D dimethylamine salt 3.8 lb ae/gal). For broadleaf weed control in small grains, field and sweet corn, grain sorghum and preplant to soybean. Nufarm. EPA Reg. No. 71368-1. 10/2003. [IVA1].

Weedone® LV4 EC (isooctyl (2-ethylhexyl) ester of 2,4-D 4 lb ae/gal). For broadleaf weed control in small grains, field and sweet corn, grain sorghum and preplant to soybean. Nufarm. EPA Reg. No. 228-139-71360. 01/2004. [IVA1].

Weedmaster® Herbicide (dicamba 1 lb ae + 2.87 lb ae 2,4-D dimethylamine salt lb/gal). For use in barley, forage sorghum, oat, rye, sudangrass, wheat, pastures, rangeland and noncrop land. BASF. EPA Reg. No. 7969-133. 04/1998. [IVA2 + IVA1].

Weedone® 638 (1 lb 2,4-D acid and 1.8 lb of 2,4-D ester 2.8 lb ae/gal). Nufarm. EPA Reg. No. 71368-3. 05/2003. [IVA1 + IVA1].

Weedone® LV4 Solventless (isooctyl ester of 2,4-D 3.8 lb ae/gal). For broadleaf control of weeds in small grains, field corn, grain sorghum and preplant to soybean. Nufarm. EPA Reg. No. 71368. 02/2004. [IVA1].

Weedone® LV6 EC (isocotyl ester of 2,4-D 5.4 lb ae/gal). For broadleaf control of weeds in small grain, field corn, grain sorghum and preplant to soybean. Nufarm. EPA Reg. No. 71368-11. 02/2004. [IVA1].

Weed Rhap A-4D (DMA salt of 2,4-D 3.8 lb ae/gal). For broadleaf weed control in small grain, field and sweet corn, grain sorghum, turf, established pastures and rangeland and fallow. Helena. EPA Reg. No. 5905-501. 02/2004. [IVA1].

Weedtrine® -D (diquat 0.4 lb diquat cation/gal or 0.7 lb salt/gal). Aquatic herbicide for use in and around still lakes, ponds and ditches. EPA Reg. No. 8959-9. 09/1998. RUP. [VIB1].

Westar™ (hexazinone 68.6% + sulfomethuron 6.5%). For weed control in noncrop land plus conifers, especially Douglas fir. DuPont. EPA Reg. No. 00352-00626. 10-2003. [VA2 + IIA2].

Whip® 360 (fenoxapro-p-ethyl 0.57 lb ai/gal). For weed control in rice. Bayer. EPA Reg. No. 264-647. 06/2002. [IA1].

WideMatch™ herbicide or WideMatch™ M herbicide (fluroxypyr 0.75 lb ai + clopyralid at 0.5 lb ai gal or co-pack of fluroxypyr + clopyralid + MCPA at 1.5 + 0.42 + 2.35 lb ai /gal). For POST control of kochia, Canada thistle, wild buckwheat and more than 20 broadleaf weeds in small grains like wheat, durum, barley and oat. Dow AgroSciences. EPA Reg. No. 62719-00512 or EPA Reg. No. 62719-00513. 03/2004. [IVA3 + IVA3 + VA1].

Yukon™ (halosulfuron 12.5% + 55% sodium salt of dicamba WDG). For selective control of broadleaf and nutsedge in corn, field corn grown for seed and grain sorghum. Monsanto. EPA Reg. No. 33906-11-524. 02/2002. [IIA2 + IVA2].

Zorial Rapid 800® (78.6% ai norflurazon). For PRE control of grasses, broadleaf and sedge weeds in soybeans and alfalfa. Syngenta. EPA Reg. No. 100-848 1/2001 [VIIA1]

Restricted Use Herbicides

Atrazine	Hoelon
AAtrex	Intrro
Alachlor	Kerb
Balance Pro	Keystone/Keystone LA
Basis Gold	Laddok
Bicep II Magnum	Lariat
Bicep Lite II Magnum	Lasso/Lasso II
Boa	Lexar
Bromoxynil	Liberty ATZ
Buctril	Lumax
Bullet	Marksman
Cinch ATZ	Micro-Tech
Cinch ATZ Lite	Paraquat
Confidence	Pathway
Confidence Xtra	Prompt
Connect	Radius
Cyclone Max	Ramrod/Atrazine
Degree	Ready Master ATZ
Degree Xtra	Simazat
Dicambazine	Starfire
Epic	Steadfast ATZ
Expert	Sterling Plus
Field Master	Surpass
Freedom	Topnotch
Fultime	Tordon
G-Max Lite	Trizmet II
Gramoxone Max/Extra/Super Tres	Weedtrine-D
Grazon P+D	Volley
Guardsman	Volley ATZ
Guardsman Max	Volley ATZ Lite
Harness	
Harness Xtra/Xtra 5.6	

The label will indicate if a product is Restricted Use. Only certified applicators should apply or supervise the application of restricted use herbicides. See your Extension Educator if you need to be certified.

Weed Science Resources

Most of the following resources are published by the University of Nebraska–Lincoln Extension and are available from your Extension Educators. Many also are available on the Web at ianrpubs.unl.edu.

Annual Grass and Perennial Weed Identification — RP92

Aquatic Weed Control — RP241

Common Weed Seedlings of the United States and Canada. Cooperative Extension Service, University of Georgia

Conducting a Prescribed Burn and Prescribed Burning Checklist — EC121

Controlling Jointed Goatgrass — G1252 (ianrpubs.unl.edu/weeds/g1252.htm)

Downy Brome Control — G422 (ianrpubs.unl.edu/weeds/g422.htm)

Effective Herbicide Use in Christmas Tree Plantations — RP251

Factors Affecting Foliar-Applied Herbicides — RP250

Field Records for Restricted Use Pesticide Applications and Integrated Crop Management by Private Applicators — EC2540

Herbicide Mode of Action and Injury Symptoms — RP377

Herbicide Resistant Weeds — RP468

Herbicide Resistant Weeds — G1399 (ianrpubs.unl.edu/weeds/g1399.htm)

Integrated Turfgrass Management for the Northern Great Plains — EC1557

Nozzles-Selection and Sizing — G955 (ianrpubs.unl.edu/farmpower/g955.htm)

Pesticide Laws and Regulations — G479 (ianrpubs.unl.edu/pesticides/g479.htm)

Pigweed Identification — A Pictorial Guide to the Common Pigweeds of the Great Plains — EC138

The Thistles of North Dakota — NDSU Ext. Serv. W-1120.

Toxic Varieties — Plants and Mushrooms in the Midwest. Poison Control Center, Children's Memorial Hospital, Omaha.

Use of Herbicide Tolerant Crops as a Component of an Integrated Weed Management Program — G1484 (ianrpubs.unl.edu/weeds/g1484/htm)

Vine Weeds — RP33

Other Resources

Weeds of Nebraska and the Great Plains. Bureau of Plant Industry, Nebraska Department of Agriculture.

Internet Web Sites

University of Nebraska–Lincoln Weed Science
weedscience.unl.edu

Agronomy Department, University of Nebraska–Lincoln
agronomy.unl.edu

University of Nebraska–Lincoln Extension Web Publications
ianrpubs.unl.edu/

CropWatch, University of Nebraska
cropwatch.unl.edu

Pesticide Education Resources, University of Nebraska
pested.unl.edu/

Crop Protection Clinics
cpc.unl.edu

Software

WeedSOFT — Weed Management Decision Support System, available from the University of Nebraska–Lincoln, Department of Agronomy and Horticulture, P.O. Box 830910, Lincoln, NE 68583-0910. Visit the WeedSOFT Web site at weedsoft.unl.edu.

Weight and Measure Conversion

Common Abbreviations

cc = cubic centimeter
 cu ft = cubic feet
 fl oz = fluid ounce
 ft = foot
 gal = gallon
 L = liter
 lb = pound
 ml = milliliter
 oz = ounce in weight
 pt = pint
 qt = quart
 T = tablespoon
 t = teaspoon

Volume

1 bushel = 35.24 liters
 27 cubic feet = 1 cubic yard
 1 cubic foot = 0.028 cubic meters
 1 cubic foot = 1728 cubic inches = 7.48 gallons
 1 gallon = 231 cubic inches
 Volume of spire = $D^3 \times 0.5236$

Weight

16 ounces = 1 pound = 453.6 grams
 1 gallon water = 8.34 pounds = 3.78 liters
 1 pint water = 1.04 lbs
 1 short ton = 2,000 lbs
 1 long ton = 2,240 lbs
 1 cubic foot water = 62.43 lbs

Liquid Measure

1 milliliter = 1 cubic centimeter = .034 fluid ounces
 1 fluid ounce = 2 tablespoons = 29.58 milliliters
 16 fluid ounces = 1 pint = 2 cups
 1 quart = 2 pints = 32 fluid ounces
 8 pints = 4 quarts = 1 gallon
 1 gallon = 128 ounces = 3785 milliliters = 3.785 liters
 1 cup = 16 tablespoons = 48 teaspoons = 236.5 ml
 2 tablespoons = 1 oz = 29.58 ml
 3 t = 1 T = 14.79 ml
 1 qt = .946 liters = 946 milliliters
 1 pt = .473 liters = 473 milliliters

Dry Measure

1 ounce = 28.3495 grams

Length

1 inch = 2.54 centimeters
 3 feet = 1 yard = 91.44 centimeters
 16.5 feet = 1 rod
 5280 feet = 1 mile = 1.61 kilometers
 320 rods = 1 mile

Area

43560 square feet = 1 acre = 160 square rods
 1 acre = 0.405 hectare
 640 acres = 1 square mile
 1 square mile = 2.59 square kilometers
 1 square foot = .093 square meters
 1 hectare = 2.47 acres
 9 square feet = 1 square yard

Speed

88 feet per minute = 1 mph
 1 mph = 0.477 meter/sec
 1 mph = 1.61 km/h

Other Abbreviations and Terms

GPM = gallons per minute
 GPA = gallons per acre
 psi = pounds per square inch
 mph = miles per hour
 RPM = revolutions per minute
 GPH = gallons per hour
 FPM = feet per minute

Circles

Circumference = diameter \times 3.1416
 Circle area = radius² \times 3.1416

Spraying Systems Microns

Very fine = 153 and less
 Fine = 154 - 241
 Med = 242 - 358
 Coarse = 359 - 451
 Very coarse = 452 - 740
 Ext. coarse = greater than 740

Fertilizer Facts—Weight at 60°F

10-34-0	11.40 lb	28-0-0	10.65 lb
11-37-0	11.60 lb	32-0-0	11.06 lb
7-21-7	11.00 lb	82-0-0	5.15 lb
28-0-0	10.65 lb	12-0-0-26	11.50 lb

Concentration

1 ppm = 1 sec in 12 days
 0.013 ounces in 100 gallons
 or about 8/10 of 1 teaspoon in 1000 gallons
 1 ppb = 1 sec in 32 years
 0.013 ounces in 100,000 gallons
 or about 8/10 of teaspoon in 1,000,000 gal
 1 ppt = 1 sec in 320 centuries

452 gpm = 1"/1 acre/1 hr

Grain Information

	<u>Lbs/bu</u>	<u>Moisture %</u>
Corn	56	15.5
Soybeans	60	13.0
Grain sorghum	56	14.0
Wheat	60	13.5
Sunflower	25	10.0
Oats	32	14

Cu ft \times 0.8 = bushel of grain
 Cu ft \times 0.4 = bushel of ear corn

1 horsepower = 550 ft lbs/sec
 = 33,000 ft lbs/min
 = 746 watts

Rate Conversion

1 bu/acre = 62.7 kg/ha @ 56 lb/bu crops
 1 qt/acre = 2.33 l/ha
 1 lb/acre = 1.12 kg/ha
 1 gal/acre = 9.34 l/ha
 1 kg/ha = 0.89 lb/acre
 1 kg/ha = 0.015 bu/acre
 1 l/ha = 0.107 gal/acre

Weight and Measure Conversion (continued)

Spray Volumes

$$\text{GPM (per nozzle GPA)} = \frac{\text{GPA} \times \text{MPH} \times W^*}{5,940}$$

$$\text{GPA} = \frac{5,940 \times \text{GPM (per nozzle)}}{\text{MPH} \times W^*}$$

W*-Nozzle spacing (in boom spraying) or swath (in boomless spraying)...inches

Length of Row Required For One Acre

Row Spacing inches	Distance yards	feet
24	7,260	21,780
30	5,808	17,424
36	4,840	14,520
42	4,149	12,445
48	3,630	10,890

Tractor Speeds

Speed in MPH	Time Required in Seconds to Travel a Distance of:		
	100 feet	200 feet	300 feet
3.0	23.0	45.0	68.0
3.5	20.0	39.0	58.0
4.0	17.0	34.0	51.0
4.5	15.0	30.0	45.0
5.0	14.0	27.0	41.0
6.0	11.0	23.0	34.0
7.0	9.7	19.0	29.0
7.5	9.0	18.0	27.0
8.0	8.5	17.0	26.0
9.0	7.6	15.0	23.0
10.0	6.8	14.0	20.0
12.0	5.7	11.0	17.0
15.0	4.5	9.0	13.6
20.0	3.4	6.8	10.2

Rates of Flow For Calibrating Spray Tips

GPM	Seconds to Collect 1 qt	GPM	Seconds to Collect 1 qt
0.05	300	0.20	75
0.06	250	0.23	67
0.07	214	0.25	60
0.08	188	0.30	50
0.09	167	0.35	43
0.10	150	0.40	38
0.11	136	0.50	30
0.12	125	0.60	25
0.13	115	0.70	21
0.14	107	0.80	19
0.15	100	0.90	17
0.17	88	1.00	15

Converting Rate Per Acre To 1,000 Square Feet

- Known facts and assumptions:
 - 1 acre = 43,560 sq ft
 - 2 lb = 32 fl oz; 1 pt = 16 fl oz; 1 qt = 32 fl oz
 - 1 fl oz = 2 tablespoons = 6 teaspoons
 - Herbicide rate per acre from bulletin or label
 - Hand sprayers apply about 1 gal per 1,000 sq ft
- Convert herbicide rate per acre to ounces:
 - For example, 2 quarts per acre = 64 fl oz
- Convert 64 fl oz per acre to fl oz per 1,000 sq ft
 - 64 fl oz / 43.56 sq ft = 1.50 fl oz
 - or 3 tablespoons per 1,000 sq ft
- Add 3 tablespoons of the product to 1 gal of water and apply uniformly to 1,000 sq ft

Spot Treatment

For hand sprayers used for spot treatments, add 1 1/2 tablespoons of herbicide per gallon of water for each 1 quart per acre required broadcast. Apply to 1,000 sq ft. Application amounts are dependent upon spray pressure, walking speed during treatment, and tip size. For powered handgun applications, mix broadcast rate in 100 gallons of water.

NOTE: Wettable powder herbicide rates would be determined by the same procedure; however, since volume or density of wettable powder herbicides varies, the calculated rate per 1,000 sq ft should be carefully measured by weighing on a precision scale.

Active Ingredient Per Gallon Conversions

Pounds of active material per gal of commercial product	Pints of commercial product needed per acre to give the following pounds of herbicide per acre		
	1/4 lb	1/2 lb	1 lb
2.00	1	2	4
2.64	3/4	1 1/2	3
3.00	2/3	1 1/3	2 2/3
3.34	3/5	1 1/5	2 2/5
4.00	1/2	1	2
5.00	2/5	4/5	1 2/3
6.00	1/3	2/3	1 1/3

Quick Metric Conversions

Symbol	When you know	Multiply by	To find	Symbol
lb	pounds	0.454	kilograms	kg
pt	pints	0.473	liters	L
qt	quarts	0.946	liters	L
fl oz	fluid ounces	28.4	milliliters	ml
A	acres	0.405	hectares	ha
ha	hectares	2.47	acres	A
Gal	gallons	3.785	liters	L
L	liters	0.264	gallons	Gal
kg	kilograms	2.205	pounds	lb

Abbreviations

ae — acid equivalent	gal/A — gallons per acre, gpa, GPA	PSI — lb/sq inch
AF — acre foot	IMI — imidazolinone	PT — Poast-tolerant
ai — active ingredient	IMR — imidazolinone resistant	pt/A — pints per acre
AMS — ammonium sulfate	IR — imidazolinone resistant	qt/A — quarts per acre, qpa
COC — crop oil concentrate	IT — imidazolinone tolerant	qt/100 — quarts/100 gal of spray solution
DAA — Days after application	lb/A — pounds per acre	RR — Roundup Ready®
DAP — days after planting	LPOST — late postemergence	RR2 — Roundup Ready 2®
DBP — days before planting	LL — Liberty-Link®	SA — surface acres
DF — dry flowable	ME — micro-encapsulated	SG — soluble granules
DG — dispersible granules	MSO — methylated seed oil	SM — surface mix
EC — emulsifiable concentrate	NIS — nonionic surfactant	SP — soluble packet
EPOST — early postemergence	OM — organic matter	STS — soybean tolerance to sulfonylurea
EPP — early preplant	OP — organophosate insecticide	tsp — teaspoon
ESO — esterified seed oil	OS — organosilicone surfactant	UAN — urea-ammonium nitrate
F — flowable	POST — postemergence	V/V — volume per volume
fb — followed by	PP — preplant	WDG — wettable dispensable
G — granules	PPSA — preplant surface applied	WG — wettable granule
gm/A — grams per acre	PRE — pre-emergence	WP — wettable powder

More abbreviations can be found in the *Dictionary Section* starting on page 154.

Evaluation Form for the 2006 Guide for Weed Management

Please fill out and return this evaluation after you've had time to adequately use and evaluate the *2006 Weed Management Guide*. Your response helps us provide the information you need and produce a better quality guide. This form is pre-addressed and postage-paid. Just tear out this sheet, fold, tape, and mail it back to us. Please return by August 31, 2006. Thank you for your time and information.

Did you use the *2005 Guide for Weed Management in Nebraska*? Yes No

How many years have you been using the guide? 1-5 6-10 Greater than 10

What is your profession:

Farmer Pesticide/Fertilizer Dealer UNL Staff
 Applicator State/Fed. Govt. Agency Field Scout
 Agribusiness Turf Business Other _____

Approximately how many acres will you grow, manage, or scout this year?

Corn Soybeans Wheat Sorghum Alfalfa
 Turf Other _____

Please rate the guide on the following criteria. (Circle one for each section):

	Not Very	Somewhat	Moderately	Very Much
Guide is useful	1	2	3	4
Information is relevant	1	2	3	4
Information is reliable	1	2	3	4
Increased your weed management knowledge	1	2	3	4

On what portion of the acres you grow, manage, or scout did you change your practices as a result of what you have learned through the *Guide for Weed Management in 2006*? _____% of acres

What would you estimate is the value of this information to you based on what you learned or used from the *2006 Guide for Weed Management*? _____ (\$/A).

What suggestions do you have for future *Weed Management Guides*?

Please Return by August 31, 2006

Fold



BUSINESS REPLY MAIL
FIRST CLASS PERMIT NO. 355 LINCOLN, NE

POSTAGE WILL BE PAID BY ADDRESSEE

NO POSTAGE
NECESSARY
IF MAILED
IN THE
UNITED STATES

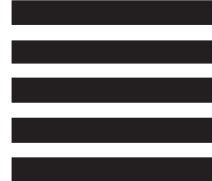

University of Nebraska–Lincoln
Agronomy and Horticulture
Brady Kappler
362A Plant Science Bldg.
P.O. Box 830910
Lincoln, Nebraska 68501-9988

EC130 Review



Fold



Extension is a Division of the Institute of Agriculture and Natural Resources at the University of Nebraska–Lincoln cooperating with the Counties and the United States Department of Agriculture.

University of Nebraska–Lincoln Extension educational programs abide with the nondiscrimination policies of the University of Nebraska–Lincoln and the United States Department of Agriculture.