

University of Nebraska - Lincoln

DigitalCommons@University of Nebraska - Lincoln

USDA Systematic Entomology Laboratory

Entomology Collections, Miscellaneous

2006

**KEY TO SELECTED PYRALOIDEA (LEPIDOPTERA) LARVAE
INTERCEPTED AT U. S. PORTS OF ENTRY: REVISION OF
PYRALOIDEA IN "KEYS TO SOME FREQUENTLY INTERCEPTED
LEPIDOPTEROUS LARVAE" BY WEISMAN 1986**

M. Alma Solis

Systematic Entomology Laboratory, PSI, Agriculture Research Service, USDA, alma.solis@ars.usda.gov

Follow this and additional works at: <https://digitalcommons.unl.edu/systementomologyusda>

 Part of the [Entomology Commons](#)

Solis, M. Alma, "KEY TO SELECTED PYRALOIDEA (LEPIDOPTERA) LARVAE INTERCEPTED AT U. S. PORTS OF ENTRY: REVISION OF PYRALOIDEA IN "KEYS TO SOME FREQUENTLY INTERCEPTED LEPIDOPTEROUS LARVAE" BY WEISMAN 1986" (2006). *USDA Systematic Entomology Laboratory*. 1.
<https://digitalcommons.unl.edu/systementomologyusda/1>

This Article is brought to you for free and open access by the Entomology Collections, Miscellaneous at DigitalCommons@University of Nebraska - Lincoln. It has been accepted for inclusion in USDA Systematic Entomology Laboratory by an authorized administrator of DigitalCommons@University of Nebraska - Lincoln.

KEY TO SELECTED PYRALOIDEA (LEPIDOPTERA) LARVAE INTERCEPTED AT U. S.
PORTS OF ENTRY: REVISION OF PYRALOIDEA IN “KEYS TO SOME FREQUENTLY
INTERCEPTED LEPIDOPTEROUS LARVAE” BY WEISMAN 1986
(updated 2006)

M. ALMA SOLIS

Systematic Entomology Laboratory, PSI, Agriculture Research Service, U.S. Department of
Agriculture, National Museum of Natural History, Smithsonian Institution, Washington, D.C. 20560-
0168
asolis@sel.barc.usda.gov

Abstract. - A key to frequently intercepted lepidopterous larvae, designed for U. S. Department of Agriculture, Animal and Plant Health Inspection Service (USDA, APHIS) identifiers at U.S. ports, was last revised in 1986. Since then many changes have occurred in the classification, nomenclature, and the nature of commodities being imported into the U.S. In this revision of the section on Pyraloidea, species recently intercepted are included, the most recent generic combinations are used, and families and subfamilies are now included in the key. Distributions are updated, stating if the species occurs in Hawaii or restricted areas of the continental United States. A “Note” section explains changes and additions, and gives references to further information. Two tables are provided, one to the classification of Pyraloidea with reference to placement in the key and another to the hosts and/or commodities.

Key Words. - continental United States, Florida, Hawaii, hosts, Pyralidae, Crambidae

The Pyraloidea is estimated to be the second largest superfamily in the Lepidoptera, with more than 16,000 described species worldwide. Pyraloid caterpillars are very diverse in what they eat: “they consume dried or decaying plant or animal matter, wax in bee and wasp nests, and living plants. Some are known to be inquilines in ant nests (some Galleriinae), predators of scale insects (some Phycitinae), and aquatic scavengers in flowing water (some Nymphulinae) (Solis 1997). The plant feeders can be leaf rollers, leaf tiers, leafminers, and stem borers, and sometimes a combination. Pyraloid caterpillars are pests that cause damage and economically affect crops such as rice, sugarcane, corn, tomato, and many more; some are worldwide pests of stored products such as grains and fruits (Solis 1996).

Because so many pyraloid caterpillars are intercepted at ports in commodities being imported into the United States, the Pyraloidea part of “Keys for the identification of some lepidopterous larvae frequently intercepted at quarantine” by Hahn W. Capps, Division of Insect Identification, Bureau of Entomology and Plant Quarantine, U. S. Department of Agriculture was first published in 1939. It was published again in Spanish (Capps 1955) by the Agriculture Department of Mexico and again in English (Capps 1956, 1963) with only nomenclatural revision. It was not significantly revised again until 1986, when D. M. Weisman published “Keys for the identification of some frequently intercepted lepidopterous larvae.” He added 40 species and replaced the Heinrich (1916) system of setal nomenclature with the Hinton (1946) system. The revision presented here adds new taxa, incorporates recent new combinations, and provides keys to the family and subfamily levels of Pyraloidea. This revision also updates distributions, stating if taxa occur in restricted areas of the continental U.S. and Hawaii. A “Note” section explains changes and additions, adds relevant information, and gives references to further information. Two tables provide host and classification information.

The Pyraloidea has undergone both phylogenetic and nomenclatural changes because it is a group where taxonomists are actively pursuing questions that have both theoretical and applied ramifications. In the 1980’s, Minet published a series of morphological papers on the tympanal organs in the Lepidoptera, including the Pyraloidea (1982). Based on the morphologically distinct tympanal organs and the work on larvae by Hasenfuss (1960), Minet proposed elevating two groups, known in the informal sense as Pyraliformes and Crambiformes (Munroe 1972), to Pyralidae and Crambidae. Most workers in the Pyraloidea agree with Minet (e.g., Munroe 1989; Solis & Mitter 1992, Solis & Maes 2002). Taxonomy is not a static field but a field where new morphological and biological information continually becomes available, and it is necessary to change the classification to reflect this new information. In addition, several major checklists (Munroe et al. 1995; Shaffer et al. 1996) from several major geographic areas have been published in the last ten years with many new combinations and synonymies. Table 1 gives the current classification of Pyraloidea as an alphabetical list of the taxa treated in this work in the two families by subfamily, with the number of the couplet where they are found in the key for quick retrieval.

DESCRIPTION OF THE KEY AND ITS COMPONENTS

Capps' (1939) description of the function and basis of his key is still applicable today: "The following keys are intended to assist quarantine inspectors in recognizing the lepidopterous larvae most frequently intercepted at ports of entry and are based on the differential characters noted in the literature, and on the larval collection and host catalogue in the United States National Museum." The title of this revision reflects a change from "most frequently" taxa intercepted to "selected" taxa intercepted. I retained all taxa included in Weisman's key even though the species may no longer be intercepted frequently; this in part because the species intercepted depend on the commodities being imported into the U.S. and these species may again be intercepted in the future. The addition of species to this current key is based on the actual interceptions submitted by APHIS port identifiers. Specimens are submitted for identification until the port identifier receives "port authority" for the identification of particular species; and then they no longer send specimens for verification of that species. The top twelve species sent into the SEL (Systematic Entomology Laboratory) for identification in order from more frequent to less frequent during 1998 were: *Ectomyelois ceratoniae*, *Cadra cautella*, *Leucinodes orbonalis*, *Diatraea considerata*, *Spoladea recurvalis*, *Neoleucinodes elegantalis*, *Etiella zinckenella*, *Conogethes* sp., *Pyrausta* sp., *Phidotricha erigens*, *Plodia interpunctella*.

Capps (1939) also wrote: "In using the keys, it should be borne in mind that their validity is dependent on three factors, viz., (1) structure, (2) origin, and (3) host." The origin referred to by Capps indicates the country where the commodity supposedly originated and does not imply evolutionary origin; for this reason Weisman (1986) probably chose to use the term "distribution" rather than "origin." The origin documented by port identifiers is the origin of the vehicle transporting the commodity prior to entering the U.S. The point of origin of the insect could be several ports removed if the vehicle made multiple stops, or entirely outside the vehicle's itinerary if infested cargo was transferred en route.

Further, Capps (1939) wrote: "Moreover, the characters used for separating the families are not completely diagnostic for the entire family but will serve to separate the species treated here." This is emphasized for two reasons: one, the percentage of lepidopterous larvae known is very small, usually only the larval morphology of the pest species in a genus is well known, and hence, the distribution of the characters across taxa are unknown; and two, the loss or reduction of characters in larvae in general is inferred to occur extensively (see also Passoa 1985).

All current taxonomic and phylogenetic information has been incorporated into the revision of this key. Distributions vary according to the information provided with the submitted material and are based specifically on the usage by port identifiers, for example, a country versus an area of a continent. It is stated if the species occurs in Hawaii or a few states in the continental U. S. Changes in distribution in this revision are based on the current literature and unpublished localities in the Pyraloidea collection of the National Museum of Natural History, Smithsonian Institution, Washington, D.C. (USNM). New records in the U.S. are taken into account if there is evidence to support that a population has been established. It is common in certain parts of the U.S. adjoining the Gulf of Mexico to catch one or more adult(s) of a species at light, but this is not evidence that the species is established in the U.S. Specifically, distribution records from Hawaii are from Nishida (1992); it uses three words to reflect residency status: endemic, indigenous, and adventive. I used only adventive when applicable: "immigrant"; used in place of "introduced" to differentiate from

those that were purposely introduced. Species that are known only from quarantine records (reported as intercepted) or those considered not established are present in the database, but do not appear in the checklist” (Nishida 1992). The “Old World” includes all land masses except the Western Hemisphere.

The plant names are based primarily on the names given to commodities being imported or brought into the U.S. for any variety of purposes; in this work the biological term “host” and the economic term “commodity” are often one and the same. The names of hosts are either a scientific name or a common name as supplied by port identifiers and checked against Brako, Rossman, and Farr (1995) for U.S. names, and Mabberley (1997) and the Missouri Botanical Garden’s VAST nomenclatural database (<http://mobot.mobot.org/w3t/search/>) for all other localities and are listed under the “Hosts” section of each species. In the key, the 2006 host records are directly from the SELIS database (Systematic Entomology Laboratory Identification Service) as submitted by port identifiers and listed alphabetically. Pre-1998 records can be from a variety of sources and are primarily those listed in Weisman (1986), with additions from the SELIS database, the USNM larval collection, and are mainly historical records. If the scientific name of a host appeared in both the 2006 list and pre-1998 list, it was removed from the pre-1998 list. The lists of hosts at times lack detail (e.g. “stored vegetable products”) because many pyraloid pest species are highly polyphagous. Table 2 gives the hosts of the pyraloid larvae. If a scientific name for the commodity is given, the table refers to the common name as given by the port identifiers also; scientific names were not generally used prior to the mid-1980’s. The common name is followed by the scientific name in brackets for purposes of cross-indexing.

The “Note” sections comment on a variety of topics that may be useful to the port identifier, it is not meant to be comprehensive: on character variability, explanations of recent nomenclatural changes, nomenclatural method of reporting based on morphological and distributional information available, and relevant literature. The amount of literature available is scattered and very large for pest species, and is less large for geographical works (e.g. Carter 1984; Mutuura et al. 1965). This work does not attempt to review the entirety of the literature, but rather to point to seminal literature that provides relevant information.

HOW TO DISTINGUISH PYRALOIDEA LARVAE

Pyraloidea larvae can be distinguished from other Lepidoptera larvae by a combination of characters. Many “micro” lepidopteran groups have 3 setae in the prespiracular group of the prothorax (Fig. 1), but some may have 2 or 1 (Stehr 1987) and they do not have typical pyraloid crochets (see below). Pyraloids, noctuids, and other “macro” lepidopteran groups have two setae in the prespiracular group of the prothorax (Fig. 2) (Stehr 1987). The Noctuoidea and Carposinidae, two groups that are intercepted frequently and are of importance to port indentifiers, can be confused with pyraloids based on the presence of two setae in the prothoracic prespiracular group. But pyraloids can be distinguished from noctuoids because noctuoids have the crochets in a mesoseries (Fig. 3), and pyraloids have the crochets in a complete circle or penellipse (Figs. 4-5).

Larvae of the Carposinidae are also confused with pyraloids because they also have two setae in the prespiracular group of the prothorax and crochets in a complete circle. Generally, pyraloids can be separated from carposinids because pyraloids have 3 subventral setae on abdominal segments 3 to 6 (Fig. 6), and carposinids usually have 4 subventral setae (Fig. 7), but the number of subventral

setae may vary from segment to segment (see Common 1990). It should be noted here that Weisman (1986) used “the spiracle on abdominal segment 8 well above level of those on preceding segments” to separate them from pyraloids, but many pyraloids have the spiracle on segment 8 above the level of those on the preceding segments.

For recent, more general information on other nearctic pyraloid larvae and lepidopteran larvae and comparisons to other families and other geographic regions see Stehr (1987) and Common (1990).

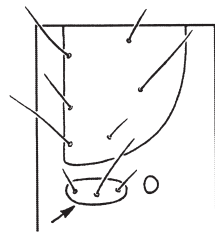

1

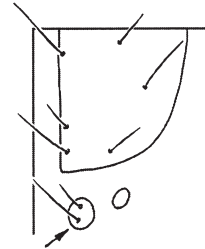

2

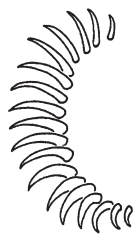

3

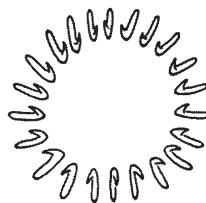

4

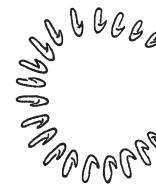

5

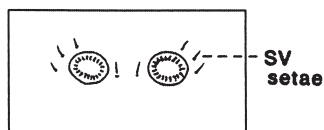

6

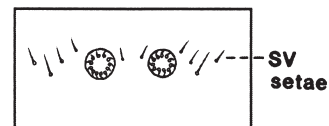

7

Table 1. Classification of Pyraloidea (number refers to couplet in the key).

CRAMBIDAE	PYRALIDAE -1
CRAMBINAE	CHRYSAUGINAE - 22
Chilo suppressalis (Walker) - 31	EIPASCHIINAE
Diatraea sp. - 31	Phidotricha erigens (Ragonot) - 19
Eoreuma loftini (Dyar) -30	GALLERIINAE
EVERGESTINAE	Alpheias conspirata Heinrich - 24
Evergestis rimosalis (Guenée) -37	Corcyra cephalonica (Stainton) - 26
GLAPHYRIINAE	Paralipsa gularis (Zeller) - 26
Hellula rogatalis (Hulst) - 39	Genopaschia protomis Dyar - 24
Hellula phidilealis (Walker) - 39	Trachylepidia fructicassiella Ragonot - 25
ACENTROPINAE	PHYCITINAE
Parapoynx diminutalis Snellen - 27	Amyelois transitella (Walker) - 13
PYRAUSTINAE	Ancylostomia stercorea (Zeller) - 8
Achyra rantalis (Guenée) - 41	Cadra cautella (Walker) - 17
Ostrinia nubilalis (Hübner) - 36	Cadra figulilella (Gregson) - 18
Pyrausta sp. - 33	Cadra calidella (Guenée) - 18
SPILOMELINAE	Cryptoblabes sp. - 6
Conogethes spp. - 34	Ectomyelois ceratoniae (Zeller) - 13
Diaphania nitidalis (Cramer) - 50	Elasmopalpus lignosellus (Zeller) - 6
Diaphania indica complex - 50	Ephestia elutella (Hübner) - 16
Duponchelia fovealis Zeller - 48	Ephestia kuehniella (Zeller) - 16
Hendecasis duplifascialis Hampson - 48	Etiella zinckenella (Treitschke) - 20
Herpetogramma bipunctalis (Fabricius) - 43	Fundella pellucens Zeller - 10
Leucinodes orbonalis (Guenée) -51	Homoeosoma electellum Hulst - 11
Lineodes integra (Zeller) - 46	Hypsipyra sp. - 9
Loxomorpha flavidissimalis Grote - 41	Moodna bisinuella Hampson - 9
Maruca vitrata (Fabricius) - 35	Mussidia nigrivenella Ragonot - 4
Megastes sp. - 35	Plodia interpunctella (Hübner) - 14
Neoleucinodes elegantalis (Guenée) - 51	PYRALINAE
Rhectocraspeda periusalis (Walker) - 43	Pyralis farinalis Linnaeus - 21
Spoladea recurvalis Fabricius - 45	Aglossa caprealis (Hübner) - 21
Udea rubigalis (Guenée) - 46	
SCHOENOBIIINAE - 28	

Key to Selected Intercepted Pyraloidea Larvae

1. Sclerotized ring around seta SD1 on A 8 (missing in some phycitines) (Fig. 8); three (sometimes two) setae in the L group on A 9 (Fig. 9)**Pyralidae**.....2
 Subfamilies: Chrysauginae, Epipaschiinae, Galleriinae, Phycitinae, Pyralinae
 Note: Sclerotized rings sometimes hard to see and appear as shiny, unsclerotized rings; 2 L setae in *Etiella zinckenella* (Tr.) and others
- No sclerotized ring around seta SD1 on A 8 (Fig. 10); one seta in the L group on A 9 (Fig. 11).
**Crambidae**.....27
 Subfamilies: Cathariinae, Crambinae, Cybalomiinae, Evergestinae, Glaphyriinae (includes Dichogaminae), Linostinae, Midilinae, Musotiminae, Noordinae, Nymphulinae, Odontiinae, Pyraustinae (includes Spilomelinae), Schoenobiinae, Scopariinae, Wurthiinae

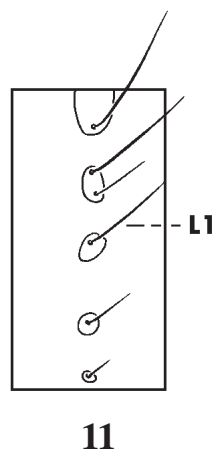
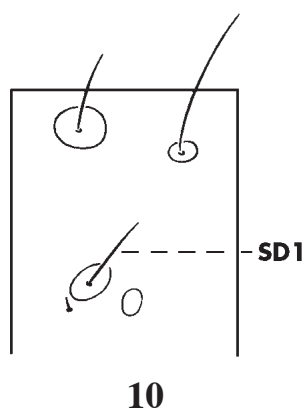
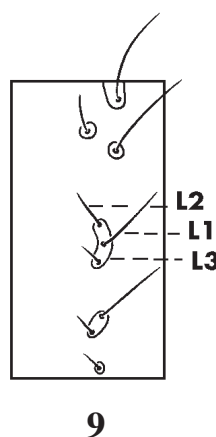
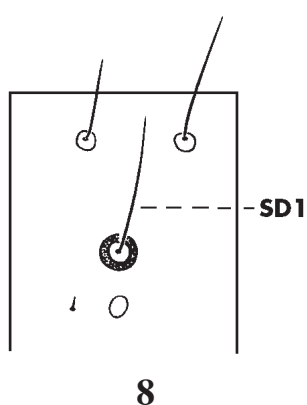

2. Sclerotized ring around seta SD1 on mesothorax, metathorax, or A1 (Fig. 12).....**Galleriinae, Chrysauginae, Phycitinae**.....3
 Note: Sclerotized ring sometimes absent on these segments, but in taxa not covered in this key (Solis & Mitter 1992)
- No sclerotized ring around seta SD1 on mesothorax, metathorax, or A1.....**Pyralinae, Epipaschiinae, few Phycitinae**.....19

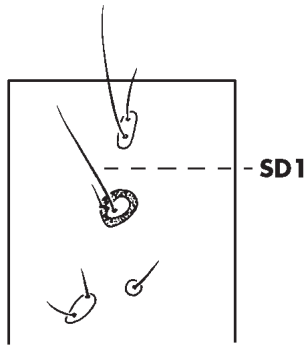

12

- 3. Sclerotized ring around seta SD1 of metathorax or A1.....**Chrysauginae, Galleriinae**.....22
- Sclerotized ring around seta SD1 on mesothorax.....**most Phycitinae**.....4
- 4. Sclerotized ring around seta SD1 on A2 to A7.....*Mussidia nigrivenella* Ragonot
 Distribution: west tropical Africa; does not occur in the U.S.
 Hosts: 2006: *Capsicum* sp., *Ceratonia siliqua*, *Entada* sp., *Punica granatum*, stored seeds, *Tamarindus indica*, *Tetrapleura* sp.
 pre-1998: butter beans, cacao, calabar beans, carob or locust bean, stored grains (cereals)
 Note: see Aitken 1963; Corbet & Tams 1943
- Sclerotized ring around seta SD1 of mesothorax.....**other Phycitinae**.....5
 Note: see Hinton 1943; some Phycitinae lack this character, e.g. *Etiella* sp.
- 5. Prespiracular shield of prothorax extending below and behind the spiracle (Fig. 13) or completely enclosing spiracle (Fig. 16).....6
- Prespiracular shield of prothorax never extending below and behind spiracle (Fig.14).....7



13

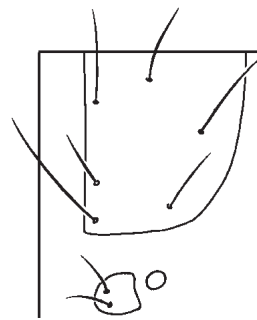

14

- 6. Posterior portion of prespiracular shield weakly pigmented (Fig. 13); body pink with whitish discontinuous longitudinal bands on most segments (Fig. 15); ring around mesothoracic seta SD1 not prominently sclerotized (Fig. 12)..... *Elasmopalpus lignosellus* (Zeller)
 Distribution: Western Hemisphere; adventive in Hawaii
 Hosts: 2006: *Ananas comosus*, *Asparagus officinalis*, *Ceratonia siliqua*, *Coffea arabica*, *Corylus avellana*, *Maranta* sp., *Mentha* sp., *Mimosa asperata*, *Sida* sp., *Sorghum* sp., *Zea mays* (unpopped corn)
 pre-1998: alfalfa, beans, cowpea, Johnsongrass, peas, soybean, strawberry, string bean, sugarcane
 Note: see Heinrich 1956; Luginbill & Ainslie 1917; Neunzig 1979

- Prespiracular shield completely enclosing spiracle weakly pigmented (Fig. 16); prominent longitudinal dark bands on all segments; ring around mesothoracic seta SD1 prominently sclerotized (Fig. 17).....*Cryptoblables* sp.
 Distribution: Europe, Africa, Asia
 Hosts: 2006: *Annona squamosa*, *Brassica* sp., *Citrus sinensis*, *Dimocarpus longan*, *Diospyros* sp., *Musa* sp., *Nephelium* sp., *Nephelium lappaceum*, *Passiflora* sp., *Phoenix* sp., *Pinus* sp., *Psidium guajava*, *Punica granatum*, *Quercus* sp., *Schinus* sp., *Xylopicia* sp.
 pre-1998: *Amaranthus* sp., *Chaenomeles japonica*, grape, *Lythrum* sp., pineapple, raisin, *Tamarix* sp.
 Note: should be reported as “*Cryptoblables gnidiella* (Millière)” if the origin is from the Western Hemisphere where it was introduced (Heinrich 1956); does not occur in the continental U.S. or Hawaii; see Neunzig 1986

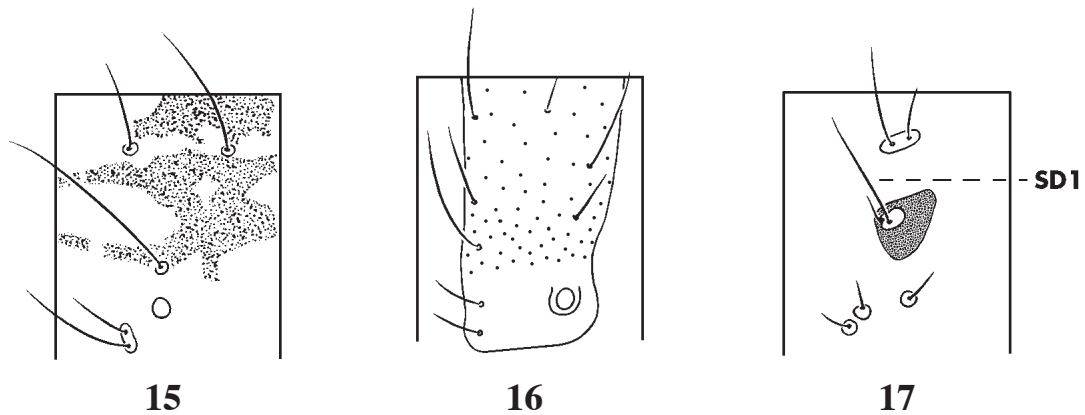

- 7. Integument granulose under low magnification (30X) (Fig.18).....8
- Integument not granulose under low magnification.....10

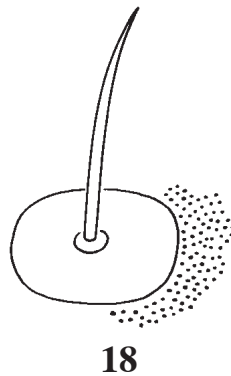

- 8. Prothoracic shield with black areas on lateral margins and longitudinal black areas on either side midway between center line and lateral margins (black areas on either side of center line may be very faint) (Fig. 19)..... *Ancylostomia stercorea* (Zeller)
 Distribution: tropical Western Hemisphere including southeastern U.S., Florida to Texas
 Hosts: 2006: *Cajanus cajan*, *Lablab* sp., *Mangifera indica*, *Momordica charantia*, *Phaseolus* sp., *Phaseolus vulgaris*, *Pisum* sp., *Pisum sativum*, *Psidium guajava*, *Rumex* sp.

pre-1998: chick pea, cow pea

Note: see Heinrich 1956

- Prothoracic shield not with the above color pattern.....9

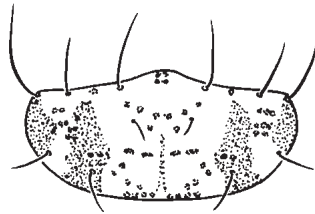

19

- 9. Pinacula of body setae large and dark (Fig. 20); seta D2 of A1 to A7 below level of seta D1 (Fig. 20)..... *Hypsipyla* sp.

Distribution: tropical Western Hemisphere including southern Florida

Hosts: 2006: *Zea mays* (unpopped corn)

pre-1998: crabwood, mahogany, Spanish cedar logs

Note: see Heinrich 1956; Neunzig 1990

- Pinacula of body setae very small and pale (fig. 21); seta D2 of A1 to A7 at level of seta D1 (fig. 21)..... *Moodna bisinuella* Hampson

Distribution: southern Texas to Mexico, El Salvador

Hosts: 2006: *Phaseolus* sp., *Zea mays*

Note: see Heinrich 1956; Neunzig 1990

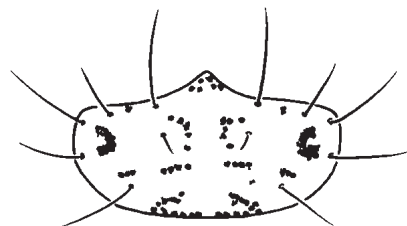
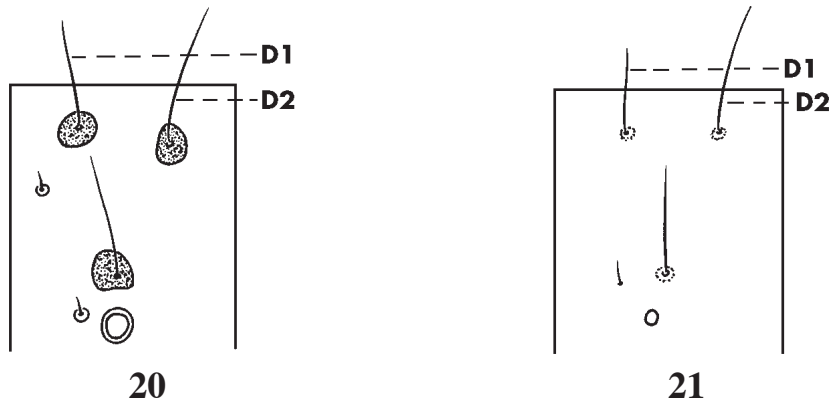

22

10. Prothoracic shield yellow with pattern of dark marks as illustrated (Fig.22).....
*Fundella pellucens* Zeller
 Distribution: tropical Western Hemisphere including Florida
 Hosts: 2006: *Cajanus cajan*, *Cyamopsis tetragonoloba*, *Garcinia mangotana*, *Phaseolus*
sp., *Phaseolus vulgaris*, *Pisum sativum*, *Vigna sp.*, *Vigna sesquipedalis*, *Vigna*
unquiculata
 pre-1998: beans, cowpea, lima bean, peas
 Note: see Heinrich 1956
 - Prothoracic shield yellowish without the pattern as above.....10
11. Prothoracic shield with black areas on lateral and posterior margins (sometimes without
 black area on posterior margin) (Fig. 23); prominent longitudinal dark bands on all segments
 (Fig. 24); head with dark band from ocelli to posterior margin.....
*Homoeosoma electellum* Hulst
 Distribution: North and South America
 Hosts: 2006: *Bidens sp.*, *Helianthus annuus*, *Limonium sp.*, *Matricaria chamomilla*, *Tagetes*
sp.
 pre-1998: Asteraceae, cotton, orange
 Note: see Heinrich 1956; Neunzig 1997
 - Prothoracic shield yellowish without the pattern as in Fig. 23.....12

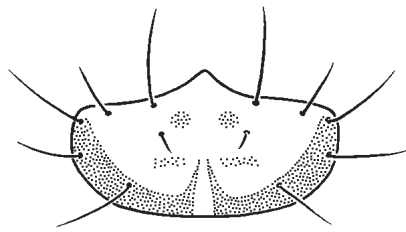

23

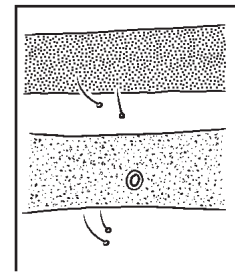

24

12. Coronal suture absent (Fig. 25); A1 to A7 with a crescent-shaped patch above seta SD1
 (usually reduced to a small smudge or missing in *Amyelois transitella*) (Fig.26).....13
 - Coronal suture present (Fig.27); A1 to A7 without crescent-shaped patch above seta SD1
 (Fig. 28).....14

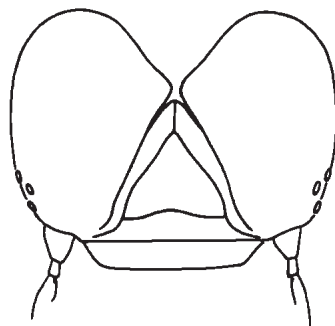

25

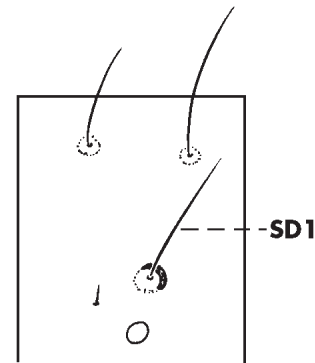

26

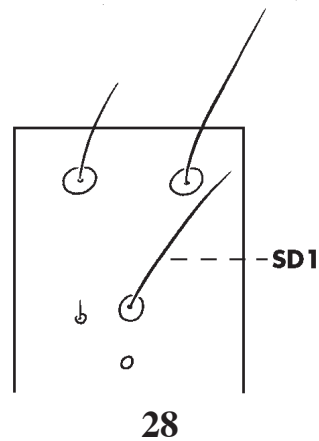
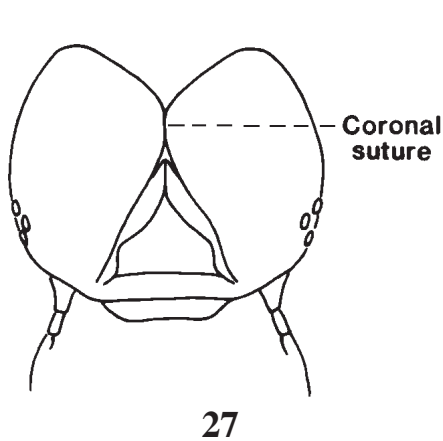

13. Anal plate with seta SD1 closer to seta D1 than to seta L1 (Fig. 29); seta SD2 of A8 usually separated from the spiracle by 2 or more times the diameter of the spiracle (Fig. 30); sclerotized ring around seta SD1 on A8 usually complete (Fig. 30).....

.....*Ectomyelois ceratoniae* (Zeller)

Distribution: nearly cosmopolitan including Florida

Hosts: 2006: *Annona* sp., *Annona cherimola*, *Capsicum* sp., *Capsicum annum*, *Cassia* sp., *Castanea sativa*, *Ceratonia siliqua*, *Cereus* sp., *Chimonanthus* sp., *Citrus sinensis*, *Cucurbita* sp., *Cydonia* sp., *Cydonia oblonga*, *Dialium guineense*, *Dioscorea* sp., *Diospyros* sp., *Ficus carica*, *Juglans* sp., *Juglans nigra*, *Juglans regia*, *Lansium domesticum*, *Malus* sp., *Malus pumila*, *Malus sylvestris*, *Mangifera indica*, *Melicoccus bijugatus*, *Phaseolus* sp., *Phoenix* sp., *Phoenix dactylifera*, *Pithecellobium dulce*, *Prunus americana*, *Prunus avium*, *Psidium guajava*, *Punica* sp., *Pyrus communis*, *Pyrus pyriflora*, *Punica granatum*, *Sesbania* sp., *Tamarindus* sp., *Tamarindus indica*, *Vigna* sp., *Vigna unguiculata*, *Zea mays*

pre-1998: carob or locust bean, dates, legumes, nuts, and others

Note: If the origin is from the tropical areas of the Western Hemisphere it should be reported as “probably *E. decolor* (Zeller)”; see Neunzig 1979, 1990

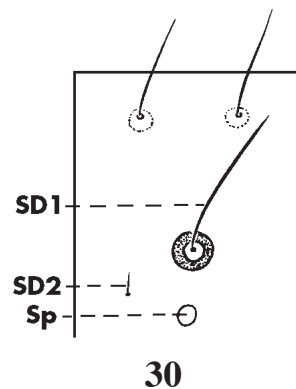
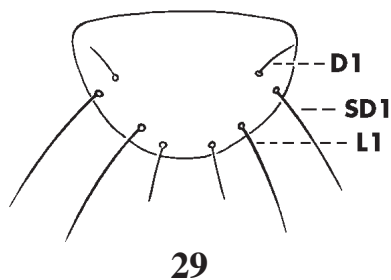

- Anal plate with seta SD1 equidistant from setae D1 and L1 (Fig. 31); seta SD2 of A8 usually separated from the spiracle by one to 1.5 times the diameter of the spiracle (Fig. 32); sclerotized ring around seta SD1 on A8 incomplete (Fig. 32).....*Amyelois transitella* (Walker)
- Distribution: tropical Western Hemisphere including southern U.S.
- Hosts: 2006: *Citrus reticulata*, *Diospyros* sp., *Phaseolus* sp., *Phoenix* sp., *Pistacia vera*, *Randia echinocarpa*, *Vigna sesquipedalis*
- pre-1998: *Annona* sp., *Caesalpinia pulcherrima*, *Cajanus cajan*, *Citrus sinensis*, *Cydonia oblonga*, *Juglans* sp., *Malus* sp., *Malus sylvestris*, *Mangifera indica*, peach, peony, *Punica granatum*, *Pyrus communis*, *Randia* sp., *Tamarindus indica*, *Zea mays*, and other fruits and pods
- Note: see Neunzig 1990

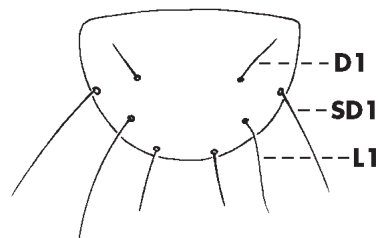

31

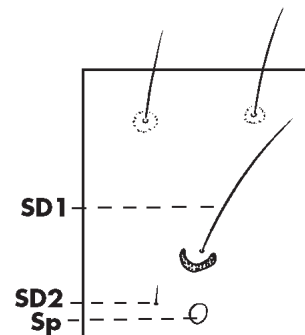

32

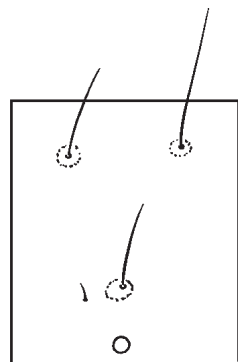

33

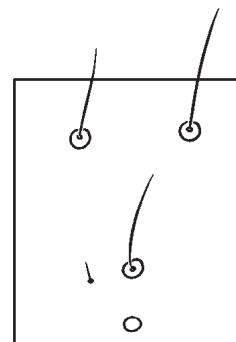

34

14. A1 to A8 apparently without pinacula (pinacula concolorous with body and not evident) (Fig. 33).....*Plodia interpunctella* (Hübner)
- Distribution: cosmopolitan, adventive in Hawaii
- Hosts: 2006: *Abies nordmanniana*, *Anacardium occidentale*, *Ananas comosus*, *Arachis* sp., *Berberis* sp., *Camellia sinensis*, *Capsicum* sp., *Capsicum annuum*, *Castanea sativa*, *Cicer arietinum*, *Citrus* sp., *Coffea* sp., *Coffea arabica*, *Cola acuminata*, *Corylus* sp., *Cucurbita* sp., *Eucalyptus* sp., *Fernaldia pandurata*, *Ficus* sp., *Ficus carica*, *Gleditsia* sp., *Glycine max*, *Inga edulis*, *Juglans regia*, *Mentha* sp., *Morus* sp., *Musa paradisiaca*, *Olea* sp., *Oryza* sp., *Paeonia suffruticosa*, *Panax* sp., *Phaseolus* sp., *Pinus* sp., *Pistacia* sp., *Pistacia vera*, *Pithecellobium dulce*, *Pouteria sapota*, *Poaceae*, *Prosopis* sp., *Prunus* sp.,

Prunus americana, *Prunus armeniaca*, *Prunus avium*, *Prunus domestica*,
Prunus persica, *Punica granatum*, *Pyrus communis*, *Raphanus* sp., *Sesamum*
orientale, *Simmondsia chinensis*, *Solanum* sp., *Spondias dulcis*, *Tamarindus*
indica, *Trifolium repens*, *Triticum aestivum*, *Vicia faba*, *Vitis* sp., *Zea mays*,
Ziziphus zizyphus

pre-1998: stored fruit, grain, and vegetable products

Note: see Neunzig 1990

- A1 to A8 with small pigmented pinacula (Fig. 34).....15
- 15. A8 with seta SD2 separated from spiracle by 2 to 3 times the horizontal diameter of the spiracle (Fig. 35).....16
- A8 with seta SD2 separated from spiracle by a distance equal to the horizontal diameter of the spiracle (Fig. 36).....17

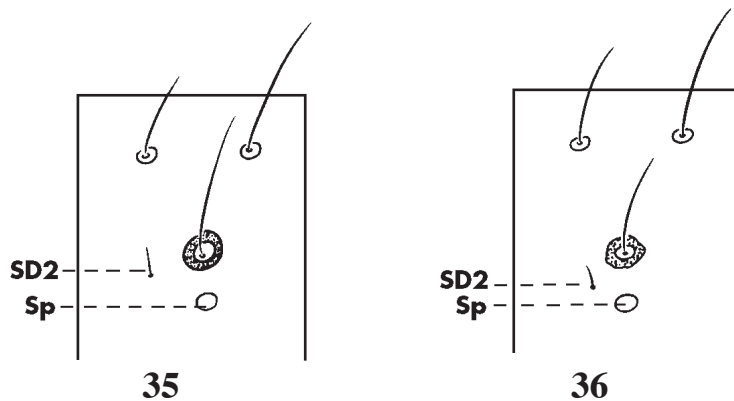

- 16. Spiracle of A8 as large as the area enclosed by the sclerotized ring around seta SD1 (Fig.37)..
.....*Ephestia kuehniella* (Zeller)

Distribution: nearly cosmopolitan; does not occur in Hawaii

Hosts: 2006: *Annona* sp., *Annona cherimola*, *Cajanus cajan*, *Chrysophyllum* sp.,
Chrysophyllum cainito, *Dennettia* sp., *Ixora* sp., *Mangifera indica*, *Moringa*
oleifera, *Vigna unquiculata*, *Zea mays*

pre-1998: stored grain, stored and dried vegetable products

Note: see Neunzig 1990

- Spiracle of A8 two-thirds or less as broad as the area enclosed by the sclerotized ring around seta SD1 (Fig. 38).....*Ephestia elutella* (Hübner)

Distribution: Nearly cosmopolitan; does not occur in Hawaii

Hosts: 2006: *Acanthocereus* sp., *Allium* sp., *Allium sativum*, *Arctium lappa*, *Brassica*
sp., *Capsicum* sp., *Castanea* sp., cereal products, *Citrus* sp., *Craspedia* sp.,
Diospyros sp., *Durio zibethinus*, *Eucalyptus* sp., *Ficus carica*, *Humulus*
lupulus, *Hydrangea* sp., *Juglans* sp., *Juglans nigra*, *Lavandula* sp., *Malus*
sp., *Medicago sativa*, *Ocimum basilicum*, *Oryza sativa*, *Persea americana*,
Phaseolus vulgaris, *Protea* sp., *Prunus* sp., *Prunus armeniaca*, *Prunus avium*,
Punica granatum, *Quercus* sp., *Ribes* sp., *Ribes rubrum*, *Tagetes* sp., *Triticum*
sp., *Vitis* sp., *Zea mays*

pre-1998: stored and dried vegetable products

Note: see Neunzig 1990; early instars with partial sclerotization of SD1 ring A1 to

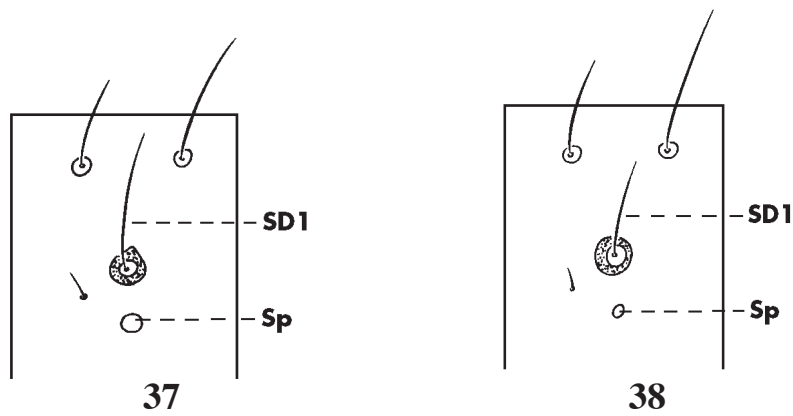

A7

17. Seta D2 of A1 to A 8, two to two and one-half times the length of seta D1 (Fig. 39)
*Cadra cautella* (Walker)

Distribution: cosmopolitan, adventive in Hawaii

Hosts: 2006: *Abelmoschus esculentus*, *Allium* sp., *Allium sativum*, *Anacardium* sp.,
Anacardium occidentale, *Ananas comosus*, *Arachis hypogaea*, *Arctium lappa*, *Areca* sp.,
Areca catechu, *Bambusa* sp., *Berberis* sp., *Bertholletia excelsa*, *Blighia sapida*,
Capsicum sp., *Carica papaya*, *Chamaemelum nobile*, *Cicer arietinum*, *Citrus* sp.,
Cocos nucifera, *Coffea* sp., *Coffea arabica*, *Cola acuminata*, *Colocasia* sp.,
Corylus sp., *Crotalaria* sp., *Cucumeropsis manii*, *Cucurbita* sp., *Cuminum* sp.,
Desmoncus sp., *Elettaria cardamomum*, *Erythrina* sp., *Ficus carica*, *Glycine max*,
Guizotia abyssinica, *Hordeum vulgare*, *Lavandula* sp., *Linum usitatissimum*,
Macadamia integrifolia, *Malus* sp., *Malus sylvestris*, *Mangifera indica*, *Morus* sp.,
Musa paradisiaca, *Myristica fragrans*, *Oryza* sp., *Oryza sativa*, *Phaseolus* sp.,
Phaseolus vulgaris, *Phoenix dactylifera*, *Piper nigrum*, *Pisum sativum*,
Pithecellobium dulce, *Prunus* sp., *Prunus americana*, *Prunus avium*, *Prunus persica*,
Psidium guajava, *Pyrus communis*, *Rosa* sp., *Rubus* sp., *Sesamum orientale*,
Strelitzia reginae, *Tamarindus* sp., *Tamarindus indica*, *Theobroma cacao*,
Triticum sp., *Vaccinium* sp., *Vigna* sp., *Vitis* sp., *Zea mays*, cooked bamboo roots

pre-1998: stored and dried vegetable products

Note: see Neunzig 1990

- Seta D2 of A1 to A8, three to five times the length of seta D1 (Fig. 40).....18

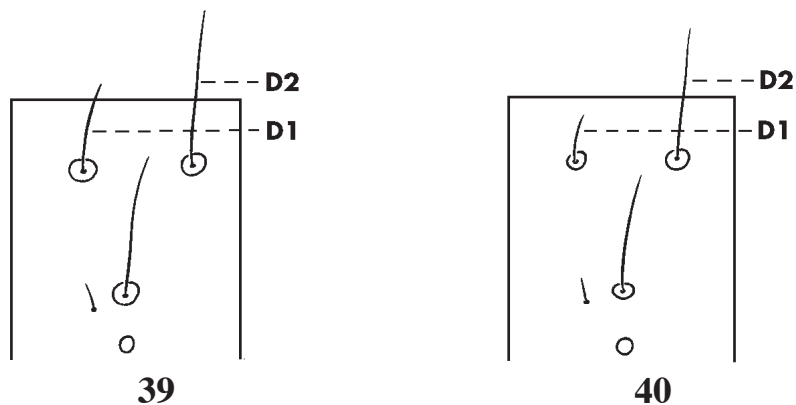

18. Metathorax with the distance between setae V1 2 times or less than the distance between seta V1 and the coxa (Fig. 41).....*Cadra figulilella* (Gregson)
 Distribution: nearly cosmopolitan; occurring in the continental U.S. and adventive in Hawaii
 Hosts: 2006: *Allium sativum*, *Allium cepa*, *Alstroemeria* sp., *Berberis* sp., *Capsicum* sp., *Castanea sativa*, *Ficus* sp., *Ficus carica*, *Juglans* sp., *Litchi chinensis*, *Macadamia integrifolia*, *Manihot esculenta*, *Morus* sp., *Phaseolus* sp., *Phoenix* sp., *Phoenix dactylifera*, *Prunus* sp., *Prunus avium*, *Psidium* sp., *Prunus americana*, *Prunus domestica*, *Psidium guajava*, *Saccharum officinarum*, *Tamarindus indica*, *Zea mays*
 pre-1998: dried beans, fruits, nuts, and seeds
 Note: see Neunzig 1990
- Metathorax with the distance between setae V1 3 to 5 times the distance between seta V1 and the coxa (Fig. 42).....*Cadra calidella* (Guenée)
 Distribution: Mediterranean; does not occur in the U.S
 Hosts: 2006: *Capsicum annuum*, *Castanea* sp., *Ceratonia siliqua*, dried foodstuffs, *Ficus* sp., *Ficus carica*, *Morus* sp., *Phoenix* sp., *Prunus* sp., *Prunus dulcis*, *Theobroma cacao*
 pre-1998: dried fruit and nuts, *Plectranthus* sp. (seed), *Vitis vinifera*
 Note: see Aitken 1963

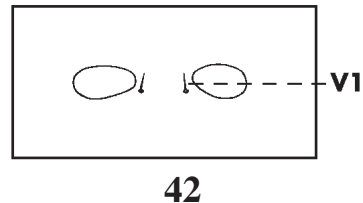
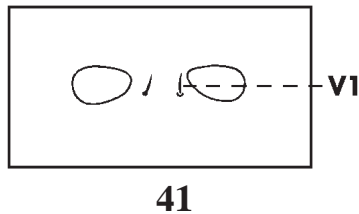

19. V1 on abdominal segment 7 as far apart as on segment 9 (Fig. 43); body without longitudinal dark bands.....**Phycitinae, Pyralinae**.....20
- V1 on abdominal segment 7 twice as far apart as on segment 9 (Fig. 44); body with longitudinal dark bands (Fig. 45).....**Epipaschiinae, Phidotricha erigens** (Ragonot)
 Distribution: tropical Western Hemisphere including southern Florida
 Hosts: 2006: *Averrhoa bilimbi*, *Benincasa hispida*, *Citrus sinensis*, *Cucumis* sp., *Mammea* sp., *Mimosa asperata*, Passion fruit, *Petiveria alliacea*, *Pithecellobium dulce*, *Vigna* sp., *Zea mays*, *Zingiber* sp.
 pre-1998: cotton, lima bean, loquat, mango, sorghum, tamarind
 Note: misidentified in the literature as *Pococera atramentalis* Lederer (Solis 1993); see Allyson 1977
20. Prothoracic shield with pattern of dark markings as illustrated (Fig. 46).....**Phycitinae, Etiella zinckenella** (Treitschke)
 Distribution: nearly cosmopolitan; does not occur in Hawaii
 Hosts: 2006: *Abelmoschus esculentus*, *Artemisia* sp., *Caesalpinia pulcherrima*, *Cajanus cajan*, *Capsicum annuum*, *Castanea* sp., *Castanea sativa*, *Cicer arietinum*, *Cucumis* sp., *Cucurbita* sp., *Cydonia oblonga*, *Lablab purpureus*, *Malus* sp., *Malus pumila*, *Opuntia* sp., *Parkia* sp., *Parkia speciosa*, *Persea americana*,

Phaseolus sp., *Phaseolus lunatus*, *Phaseolus vulgaris*, *Pisum* sp., *Pisum sativum*, *Solanum* sp., *Solanum tuberosum*, *Vicia faba*, *Zea mays*

pre-1998: legumes and other stored vegetable products

Note: because several immatures of species are indistinguishable, it should be reported as “*Etiella* sp.” if the origin is southeast Asia; markings on prothorax can be more or less distinct

- Prothoracic shield not patterned as above.....21

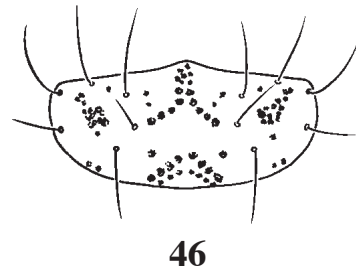
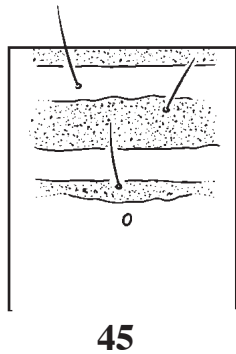
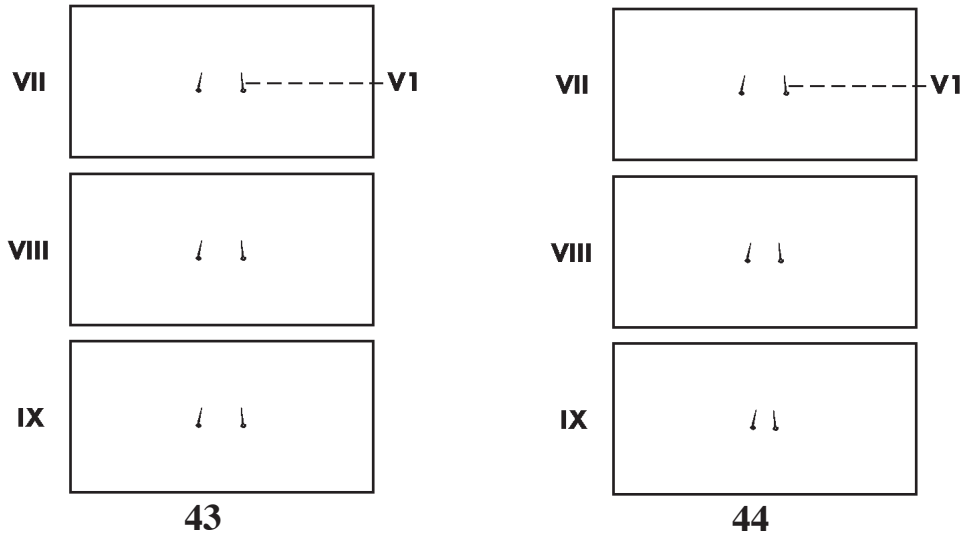

21. Head with only 4 distinct ocelli (ocelli I and II fused and ocellus VI usually missing) (Fig. 47); A9 with one subventral seta (Fig. 48).....*Pyralis farinalis* Linnaeus

Distribution: nearly cosmopolitan, does not occur in Hawaii

Hosts: 2006: *Allium* sp., *Alpinia purpurata*, foodstuffs, *Musa* sp., *Narcissus tazetta*, packing, *Triticum* sp.

pre-1998: dried vegetable products

Note: the packing is usually associated with polished monuments, marble blocks, and tiles in wood crates

- Head with 6 ocelli (Fig. 49); A9 with two subventral setae (Fig.50).....*Aglossa caprealis* (Hübner)

Distribution: Nearly cosmopolitan, does not occur in Hawaii

Hosts: 2006: *Allium sativum*, *Momordica* sp.

pre-1998: damp grain and rotting vegetable matter, *Nephelium lappaceum*, packing in crates, *Persea americana*

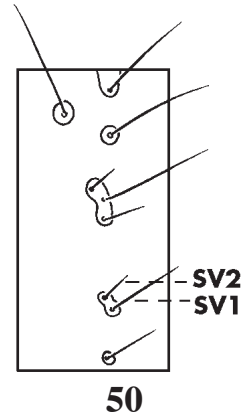
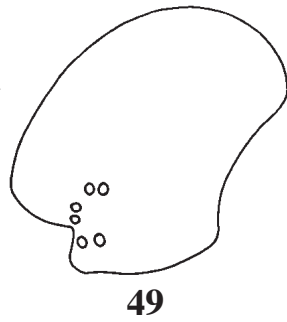
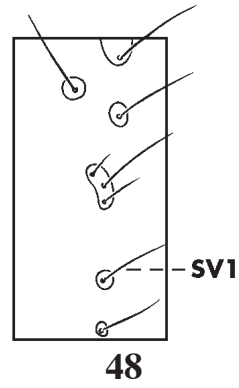
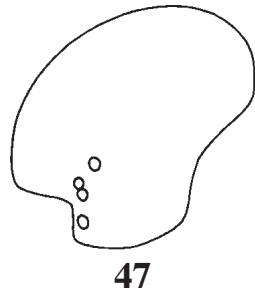

22. Sclerotized ring around seta SD1 of metathorax (Fig. 51).....**Chrysauginae**
 - Sclerotized ring around seta SD1 of A1 (Fig. 52).....**Galleriinae**.....23

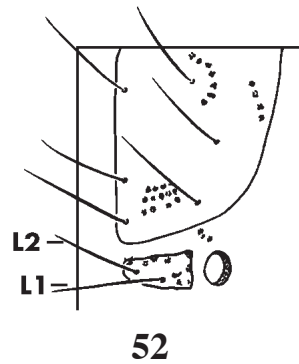
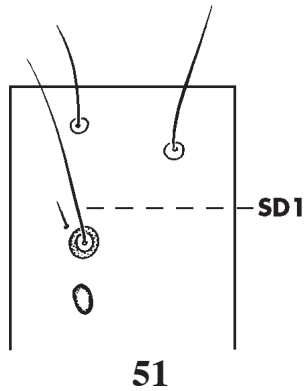

23. Prespiracular and prothoracic shields entirely fused (Fig. 53).....24
 - Prespiracular and prothoracic shields not fused (Fig. 54).....25

24. Sclerotized rings around seta SD1 on A2 to A7 in addition to A1 and A8.....
 ***Alpheias conspirata*** Heinrich

Distribution: Mexico
 Hosts: *Ananas comosus*
 Note: See Solis 2003b

- No sclerotized rings around seta SD1 on A2 to A7; sclerotized rings around A1 and A8 only
.....*Genopaschia protomis* Dyar

Distribution: Panama
 Hosts: *Ananas comosus*
 Note: See Solis 2003b

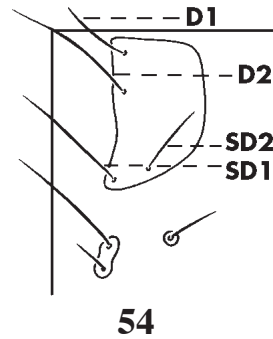
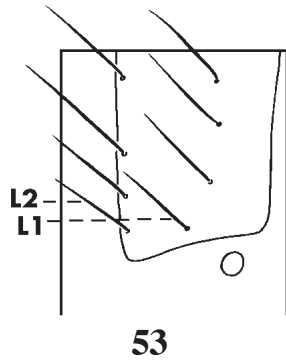

- 25. Prespiracular shield of prothorax not extending below and behind spiracle (Fig. 52).....26
- Prespiracular shield of prothorax extending below and behind the spiracle (Fig. 55).....
.....*Trachylepidia fructicassiella* Ragonot

Distribution: pantropical
 Hosts: 2006: *Cassia* sp., *Cassia fistula*, *Cassia grandis*, dried vegetable products, *Vigna* sp.
 pre-1998: *Inga*

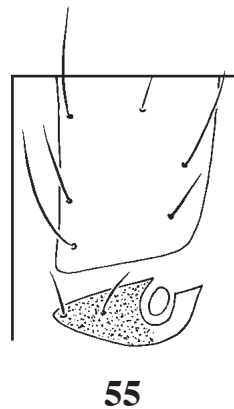

- 26. Sclerotized ring around seta SD1 on A1 and A8 not complete (Fig. 56); spiracular peritreme thicker on caudal margin (Fig. 56); pinacula of setae D1 and D2 on abdominal segments not pigmented (Fig. 56).....*Corcyra cephalonica* (Stainton)

Distribution: cosmopolitan
 Hosts: 2006: *Anacardium occidentale*, *Arachis* sp., *Bertholletia* sp., *Brassica* sp., *Cucurbita* sp., *Guazuma ulmifolia*, *Lens* sp., *Oryza* sp., *Oryza sativa*, *Phaseolus* sp., *Phaseolus vulgaris*, *Prunus americana*, *Sorghum bicolor*, *Theobroma cacao*, *Triticum* sp., *Vicia* sp.
 pre-1998: *Abelmoschus esculentus*, *Acacia* sp., cacao, *Cassia* sp., coffee, *Cola* sp., *Cuminum* sp., *Inga* sp., *Sesamum orientale*, *Sorghum* sp., stored vegetable products

- Sclerotized rings around seta SD1 on A1 and A8 complete (Fig. 57); spiracular peritremes of uniform thickness (Fig. 57); pinacula of setae D1 and D2 on abdominal segments pigmented (Fig. 57)*Paralipsa gularis* (Zeller)
 Distribution: nearly cosmopolitan, adventive in Hawaii
 Hosts: 2006: *Ananas* sp., *Arctium lappa*, *Capsicum annuum*, *Cucurbita* sp., *Dimocarpus longan*, *Garcinia mangotana*, *Lansium domesticum*, *Nephelium lappaceum*, *Phoenix* sp., *Phoenix dactylifera*, *Punica granatum*, *Rhododendron* sp., *Solanum* sp., *Solanum melongena*, *Solanum tuberosum*, *Triticum aestivum*, *Zea mays*
 pre-1998: *Ananas comosus*, *Areca catechu*, *Bambusa* sp., *Calophyllum antillanum* (*brasiliense*), *Cassia* sp., *Castanea* sp., *Ceratonia siliqua*, dunnage, *Elasis* sp., *Oncidium* sp., papyrus, *Stirlingia* sp., stored vegetable products

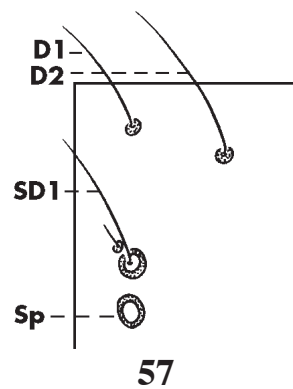
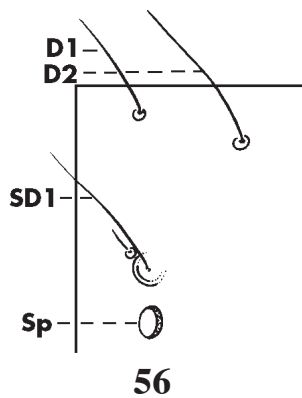

- 27. Lateral gills on body segments (Figs. 58, 59).....*Acentropinae*.....*Parapoinx diminutalis* Snellen
 Distribution: southeastern Asia, Africa, Australia, Europe, U.S.
 Hosts: 2006: *Cabomba caroliniana*, *Dracaena fragrans*, *Egeria densa*, *Hygrophila* sp., *Ludwigia* sp., *Mayaca fluviatilis*, *Rotala* sp., *Vallisneria* sp., *Vallisneria americana*
 pre-1998: *Cabomba* sp., *Hydrilla* sp., *Limnophila* sp., *Myriophyllum* sp.
 Note: Fig. 59 is an enlargement of one lateral gill, note base; *P. fluctuosalis* is adventive in Hawaii; Acentropinae = Nymphulinae; see Goater 1986
- Without lateral gills.....28

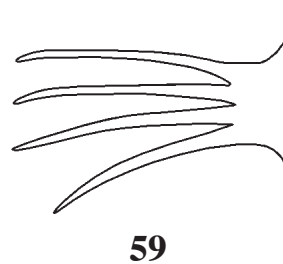
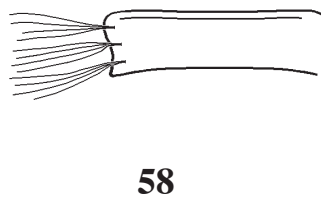

28. With membranous sac or gibbosity anterior to prothoracic coxae.....**Schoenobiinae**
 Hosts: 2006: *Typha latifolia*
 pre-1998: *Pistia stratiotes*
 Note: for further information on this group see Passoa (1987) and Stehr (1987)
- Without membranous sac or gibbosity anterior to prothoracic coxa.....29
29. A single transverse plate posterior to dorsal pinacula on mesothorax (Fig. 60); crochets in complete circle (Fig. 61)**Crambinae**.....30
- A pair of transverse plates posterior to dorsal pinacula on mesothorax (Fig. 62) or plates absent; crochets in a mesal penellipse (Fig. 63) (or may be a circle weaker on lateral edge in *Lineodes integra* and *Udea rubigalis*) (Figs. 91, 93).....

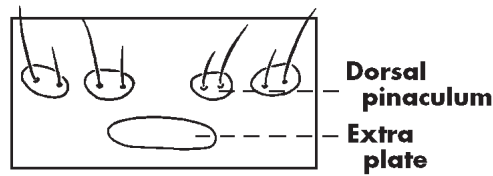

60

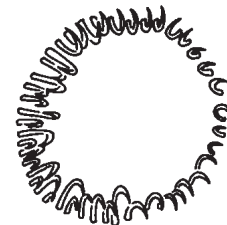

61

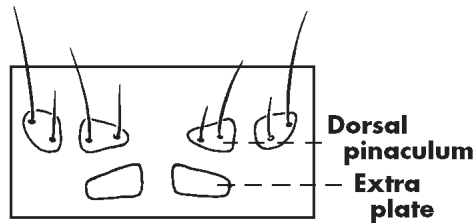

62



63

.....**Pyraustinae, Glaphyriinae, Evergestinae**.....32
 Note: Unless otherwise stated, the taxa following couplet 31 are **Pyraustinae**

30. One subventral seta on meso- and metathorax (Fig. 64); body with 2 pink longitudinal stripes on each side (Fig. 65); pink-pigmented area around lateral setae on proleg-bearing segments.....**Eoreuma loftini** (Dyar)

Distribution: Mexico and United States

Hosts: 2006: *Cymbopogon citratus*, *Saccharum* sp., *Saccharum officinarum*

pre-1998: corn, millet, rice, sorghum

Note: one SV seta also occurs in *Crambus*; see Rodriguez-del-Bosque et al. 1990

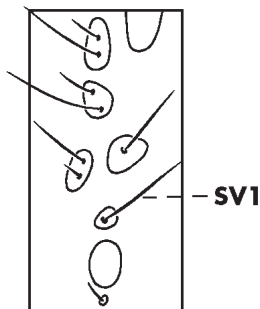

64

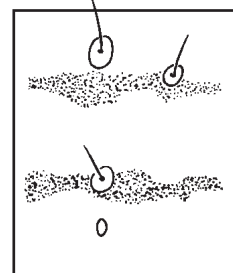

65

- Two subventral setae on meso- and metathorax (Fig.66); body with or without pigmented stripes; no pigmented area around lateral setae on proleg-bearing segments.....31

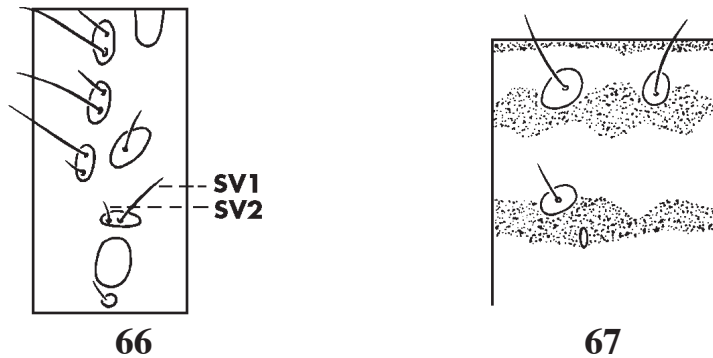

- 31. Body with pinkish middorsal stripe and two lateral stripes on each side (Fig. 67); setal pinacula concolorous with body.....*Chilo suppressalis* (Walker)
 Distribution: Europe, Middle East, Southeast Asia to India, Oceania; adventive in Hawaii
 Hosts: 2006: *Cymbopogon citratus*, *Cymbopogon flexuosus*, reed, *Phragmites* sp., *Phragmites australis*, *Saccharum* sp., *Saccharum officinarum*
 pre-1998: cabbage, corn, eggplant, millet, rice straw, sugarcane, sorghum, tomato, and wheat, many others
 Note: early instars with crochets in an incomplete circle on specimens on reed from China see Bleszynski 1970; Meijermann & Ulenberg 1996; Whittle & Ferguson 1988
- Body with or without lateral stripes, but without pinkish middorsal stripe; setal pinacula concolorous with body (winter form) or darkly pigmented (summer form).....*Diatraea* spp.
 Distribution: tropical Western Hemisphere including southern U.S.
 Hosts: 2006: *Cymbopogon citratus*, *Cyperus papyrus*, *Musa* sp., *Saccharum officinarum*, *Spartina alterniflora*, *Tripsacum dactyloides*, *Zea mays*
 pre-1998: rice, sorghum
 Note: Some species of *Chilo* will key to *Diatraea* based on color pattern (Passoa, pers. comm.), but *Diatraea* does not occur in the Old World; see Box 1931; Dyar & Heinrich 1927; Riey & Solis 2005; Solis 2004.
- 32. Meso- and metathorax without nonsetal bearing plates posterior to dorsal pinacula.....33
- Meso- and metathorax with a pair of nonsetal bearing plates posterior to dorsal pinacula (Fig. 68).....34
- 33. Small pinacula anterior to dorsal and subdorsal pinacula bearing microscopic setae on meso- and metathorax (also occurring in *L. orbonalis*, see couplet 36) (Fig. 68).....*Pyrausta* sp.
 Distribution: cosmopolitan
 Hosts: 2006: *Acalypha hispida*, *Allium* sp., *Allium cepa*, *Anthemis* sp., *Citrullus lanatus*, *Crotalaria* sp., *Erythrina* sp., *Gomphrena* sp., *Limonium* sp., *Lippia graveolens*, *Mentha* sp., *Mentha arvensis*, *Mentha piperita*, *Momordica charantia*, *Ocimum* sp., *Ocimum basilicum*, *Origanum* sp., *Origanum vulgare*, *Origanum magorana*, *Rosmarinus* sp., *Rosmarinus officinalis*, *Salvia* sp., *Salvia officinalis*, *Satureja hortensis*, *Spinacia oleracea*, *Thymus* sp., *Thymus*

vulgaris, *Xanthosoma* sp.

pre-1998: *Amaranthus* sp.

Note: According to Allyson (1981b) last instar larvae are characterized by 2 or 3 SV setae on A1, prothoracic shield lightly pigmented, pinacula below spiracles with paler pigmentation than those above spiracles, body at most 20 mm long; although the genus is cosmopolitan, most of the interceptions on the host plants are from the tropical Western Hemisphere

- No small pinacula anterior to dorsal and subdorsal pinacula (Fig. 69).....36

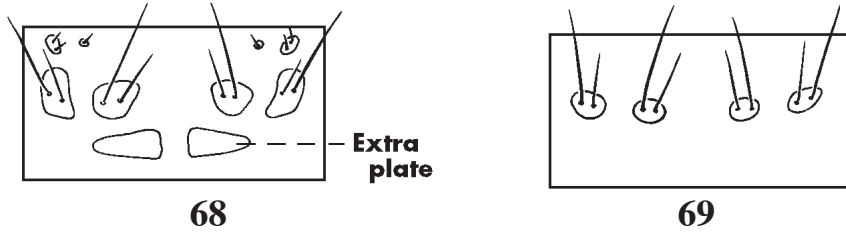

- 34. No extra nonsetal bearing plate below seta L3 on meso- and metathorax (Fig. 70) and behind L1 and L2 on abdominal segments 1 to 7 (Fig. 71).....35
- An extra nonsetal bearing plate below seta L3 on meso- and metathorax (Fig. 72) and behind L1 and L2 on A1 to A7 (Fig. 73).....*Conogethes* spp.

Distribution: southeast Asia, including India and Pakistan, Australia; does not occur in Hawaii

Hosts: 2006: *Castanea* sp., *Castanea sativa*, *Dimocarpus longan*, *Eugenia* sp., *Euphorbia* sp., *Gardenia* sp., *Litchi chinensis*, *Nephelium lappaceum*, *Psidium* sp., *Psidium guajava*, *Pyrus communis*, *Syzygium* sp., *Syzygium jambos*, *Syzygium malacense*, *Syzygium samarangense*

pre-1998: *Catalpa*, peach, pine

Note: prespiracular shield of prothorax extending below and beyond spiracle (Fig. 74); this species was known as *Dichocrocis punctiferalis* (Guenée); *C. punctiferalis* is a complex of species (unpublished).

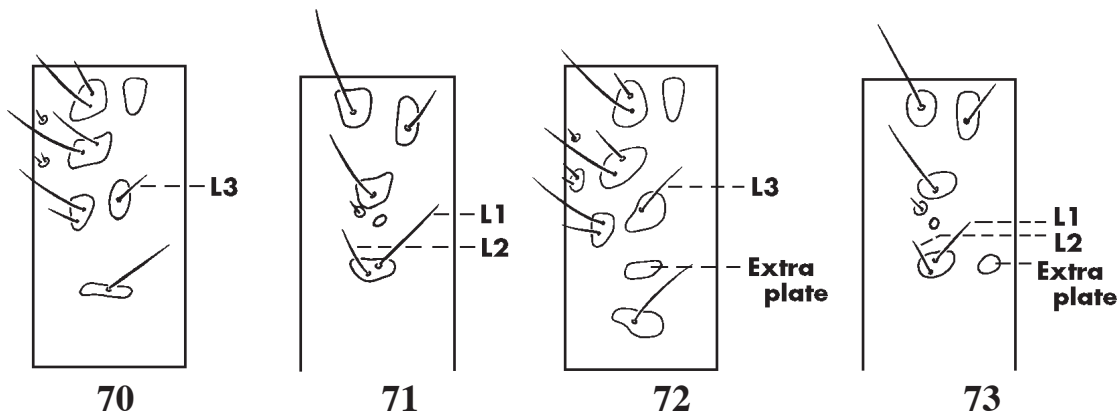

- 35. Prespiracular shield of prothorax crescent shaped extending below spiracle (Fig. 75).....*Maruca vitrata* (Fabricius)

Distribution: Africa, Asia, Australia, Mexico to South America, adventive in Hawaii

Hosts: 2006: *Lablab* sp., *Lablab purpureus*, *Lathyrus* sp., *Limonium sinuatum*, *Phaseolus*

sp., *Phaseolus lunatus*, *Phaseolus vulgaris*, *Pisum sativum*, *Psophocarpus tetragonolobus*, *Sesbania grandiflora*, *Vigna* sp., *Vigna sesquipedalis*, *Vigna unguiculata*

pre-1998: beans, legumes, peas, pigeon pea

Note: this species was known as *Maruca testulalis* (Geyer), synonymized by Munroe et al. 1995; there are a few records of adults captured in the southern U.S; see also Ferguson, not dated; Solis 2003

- Prespiracular shield of prothorax extending below and behind spiracle (Fig. 76).....*Megastes* sp.

Distribution: West Indies

Host: sweet potato

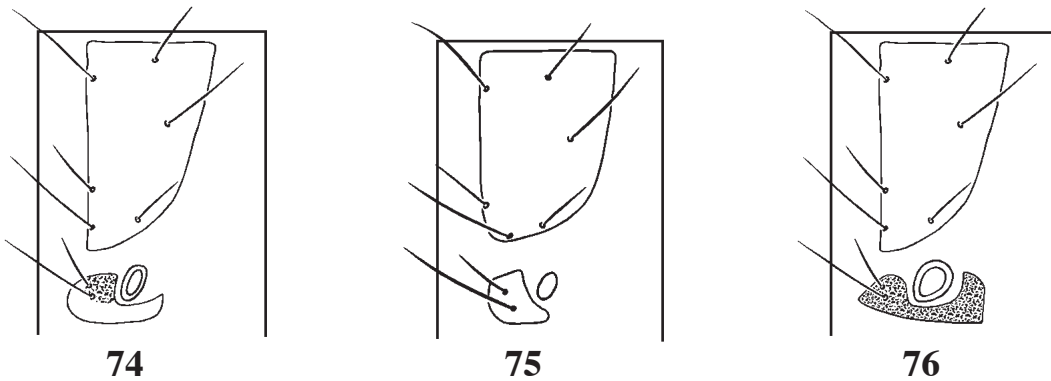

- 36. Head capsule with a lobelike extension over base of antenna (Fig.77).....*Ostrinia nubilalis* (Hübner)

Distribution: Europe and United States

Hosts: 2006: *Capsicum* sp., *Capsicum annuum*, *Malus* sp., *Phaseolus* sp., *Phaseolus lunatus*, *Phaseolus vulgaris*, strawberry, *Zea mays*

pre-1998: beans, beets, celery, clover, cucumber, eggplant, lettuce, peas, potatoes, rhubarb, string bean, tomato, wheat

Note: see Heinrich 1919; Allyson 1981b

- Head capsule without a lobelike extension over base of antenna (Fig. 78).....37

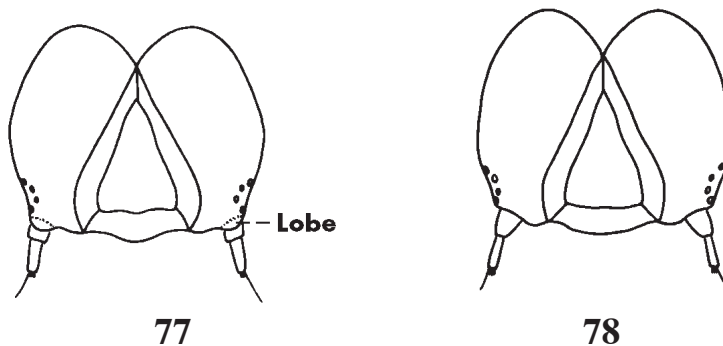

37. Dorsal and subdorsal setae of the abdominal segments on strongly conical black chalazae.....
**Evergestinae, *Evergestis rimosalis*** (Guenée)
 Distribution: Western Hemisphere
 Hosts: 2006: *Brassica* sp.
 pre-1998: Brassicaceae: cabbage, brussel sprouts, cauliflower, watercress
 Note: it should be reported as “probably *E. forficalis* (L.)” if the origin is Europe;
 see Munroe 1973
 - Abdominal segments without conical black chalazae.....38

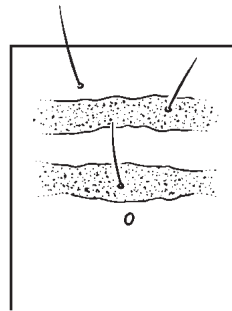

79

38. Body with pinkish longitudinal stripes (Fig. 79).....39
 - Body without pinkish longitudinal stripes.....40

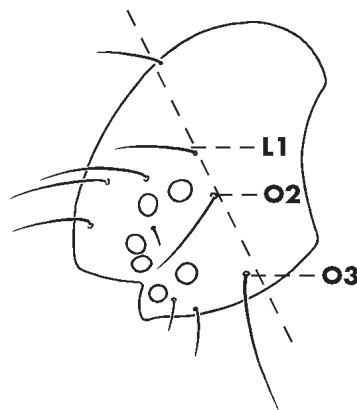

80

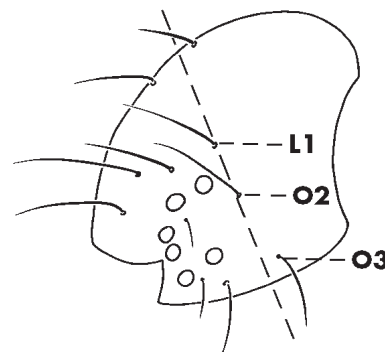

81

39. Head blackish or brownish with whitish areas along adfrontal sutures extending to vertex,
 seta O3 anterior to a line joining setae L1 and O2 (Fig. 80).....
**Glaphyriinae, *Hellula rogatalis*** (Hulst)
 Distribution: Western Hemisphere; does not occur in Hawaii
 Hosts: 2006: *Brassica* sp., *Brassica chinensis*, *Brassica oleracea*, *Brassica rapa*
 pre-1998: mustard, radish, other Brassicaceae
 Note: should be reported as “probably *H. undalis* (F.)” if the origin is the Old
 World; see Munroe 1972; Allyson 1981a

- Head pale, mottled, area along adfrontal sutures pale but not white, seta O3 posterior to a line joining setae L1 and O2 (Fig. 81).....**Glaphyriinae, *Hellula phidilealis*** (Walker)
 Distribution: Western Hemisphere; adventive in Hawaii
 Hosts: 2006: *Brassica* sp., *Brassica oleracea*, *Brassica pekinensis*, *Brassica rapa*,
Raphanus sativus, *Spinacia oleracea*
 pre-1998: white chard, and other Brassicaceae
 Note: see Munroe 1972

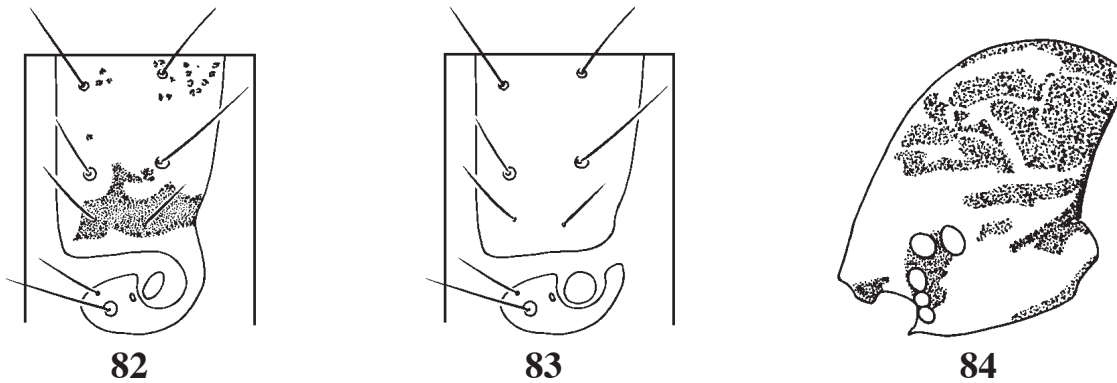

- 40. Prespiracular shield of prothorax extending below and behind spiracle (Figs. 82, 83).....41
- Prespiracular shield of prothorax not extending below and behind spiracle, but may completely enclose the spiracle (Figs.85, 87).....42
- 41. Prothorax with sclerotization extending from posterolateral margin of prothoracic shield behind and below spiracle to prespiracular shield (Fig. 82).....***Achyra rantalis*** (Guenée)
 Distribution: Mexico, West Indies, and United States
 Hosts: 2006: *Medicago sativa*, *Rosa* sp., *Sesuvium* sp., *Zea mays*
 pre-1998: beets, cotton, soybean, and many others
 Note: see Allyson 1976, 1981b
- Prespiracular shield of prothorax extending below and behind spiracle, not fused with posterolateral margin of prothoracic shield (Fig. 83).....***Loxomorpha flavidissimalis*** Grote
 Distribution: Mexico
 Hosts: cactus
- 42. Head yellow with dark pattern (Fig. 84); prothoracic shield broadly shaded laterally (Figs. 85, 87).....43
- Head not patterned; prothoracic shield without dark shading laterally.....44

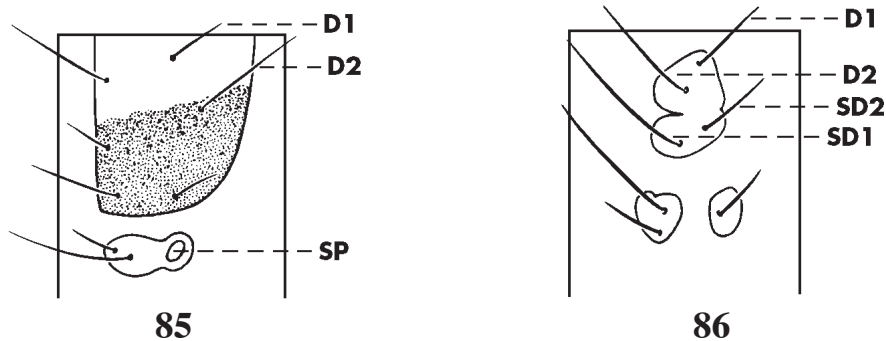

43. Prespiracular shield enclosing the spiracle (Fig. 85); A1 with SV trisetose; prothoracic shield with dark lateral shading extending to seta D2 (Fig. 85); dorsal and subdorsal pinacula of mesothorax fused (sometimes not fused in early instars) (Fig. 86).....
*Herpetogramma bipunctalis* (Fabricius)

Distribution: Western Hemisphere

Hosts: 2006: *Amaranthus* sp., *Amaranthus caudatus*, *Anthemis* sp., *Asparagus officinalis*, *Brassica oleracea*, *Capsicum* sp., *Colysis pteropus*, *Corchorus olitorius*, *Coriandrum sativum*, *Gomphrena* sp., *Jatropha* sp., *Piper aduncum*, *Solanum nigrum*, *Spinacia* sp., *Strobilanthes* sp., *Xanthosoma* sp., *Xanthosoma brasiliense*

pre-1998: alfalfa, beets, cotton, soybean

Note: see Allyson 1984

- Prespiracular shield not enclosing the spiracle (Fig. 87); A1 with SV setae bisetose; dorsal and subdorsal pinacula of mesothorax usually not fused (Fig. 88).....
*Rhectocraspeda periusalis* (Walker)

Distribution: West Indies and United States

Hosts: 2006: *Amaranthus* sp., *Chenopodia charantia*, *Fernaldia* sp., *Momordica charantia*, *Strobilanthes* sp.

pre-1998: Solanaceae, including eggplant, potatoes, and tomato

Note: *Pilemia* Möschler is a junior synonym of *Rhectocraspeda* Warren, new combination in Munroe et al. 1995

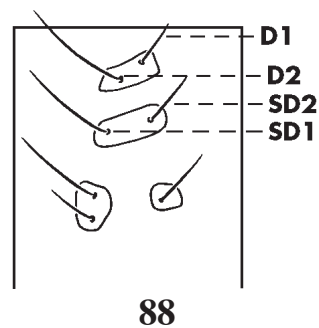
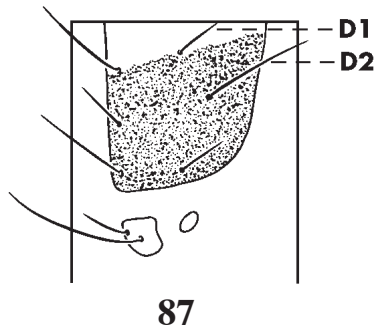

44. Prothoracic shield with at least one dark reniform spot posterior to seta XD2 (Figs. 90, 92).....45
 - Prothoracic shield without dark reniform spot posterior to seta XD2.....47

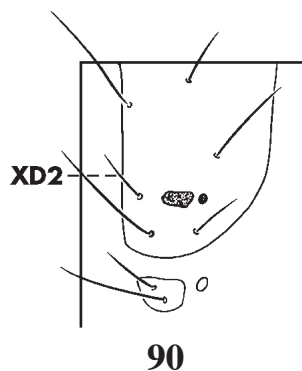
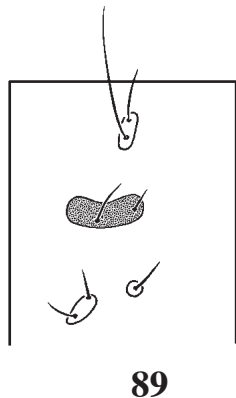

45. D1 and D2 on mesothorax on the same sclerotized pinaculum (Fig. 89).....
*Spoladea recurvalis* Fabricius
 Distribution: cosmopolitan, adventive in Hawaii
 Hosts: 2006: *Amaranthus* sp., *Apium graveolens*, *Atriplex* sp., *Beta vulgaris*, *Spermacoce* sp., *Bougainvillea* sp., *Brassica* sp., *Carya illinoensis*, *Celosia* sp., *Chenopodium* sp., *Chrysanthemum* sp., *Colocasia* sp., *Corchorus* sp., *Corchorus olitorius*, *Eryngium foetidum*, *Eupatorium* sp., *Hemigraphis alternata*, *Impatiens* sp., *Jatropha curcas*, *Lactuca* sp., *Mentha* sp., *Nomaphila* sp., *Ocimum basilicum*, *Petroselinum crispum*, *Phytolacca* sp., *Phytolacca americana*, *Polygonum perfoliatum*, *Porophyllum* sp., *Ruta* sp., *Salvia officinalis*, *Spinacia* sp., *Spinacia oleracea*, *Viburnum* sp., *Xanthosoma* sp., *Xanthosoma brasiliense*, *Xanthosoma hastifolium*, *Zea mays*
 pre-1998: *Amaranthaceae*, *Areca* palm, *Asteraceae*, beets, *Chenopodiaceae*, soybean, Swiss chard
 Note: see Allyson 1984
 - D1 and D2 on mesothorax on separate, unsclerotized pinacula.....46

46. Prespiracular shield ovate (Fig. 90); crochets triordinal on mesal aspect (Fig. 91).....
*Udea rubigalis* (Guenée)
 Distribution: Canada south to Costa Rica
 Hosts: 2006: *Amaranthus* sp., *Apium graveolens*, *Aster* sp., *Beta vulgaris*, *Chrysanthemum* sp., *Coriandrum sativum*, *Daucus* sp., *Daucus carota*, *Eryngium foetidum*, *Ipomoea* sp., *Limonium* sp., *Mentha* sp., *Momordica charantia*, *Ocimum* sp., *Ocimum basilicum*, *Petroselinum crispum*, *Pimenta dioica*, *Raphanus sativus*, *Solidago* sp., *Spinacia oleracea*
 pre-1998: alfalfa, cabbage, celery, *Chrysanthemum*, clover, cucumber, lettuce, peas, rose, sugar beet, sweet potato
 Note: should be reported as “probably *Udea ferrugalis* (Hübner)” if the origin is rope; see Allyson 1984

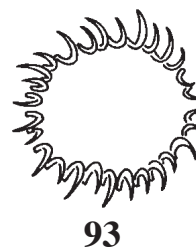
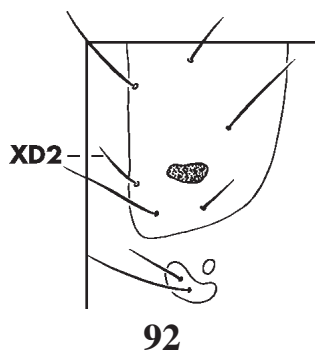

- Prespiracular shield crescent shaped extending below spiracle (Fig. 92); crochets biordinal on mesal aspect (Fig. 93).....*Lineodes integra* (Zeller)
 Distribution: Western Hemisphere
 Hosts: 2006: *Capsicum* sp., *Lavandula* sp., *Physalis peruviana*, *Physalis philadelphica*, *Solanum lycopersicum*, *Solanum torvum*, *Thymus* sp.
 pre-1998: *Solanaceae*, including eggplant

47. A1 with three subventral setae (Fig. 94).....48
 - A1 with less than three subventral setae (Figs. 99, 101).....49
48. Prothorax with seta XD2 equidistant from setae SD1 and XD1 (Fig. 95); crochets biordinal (Fig. 96).....*Hendecasis duplifascialis* Hampson
 Distribution: southeastern Asia, does not occur in Hawaii
 Hosts: 2006: *Cestrum* sp., *Dianthus* sp., *Gardenia* sp., *Gardenia jasminoides*, *Jasminum sambac*, *Murraya paniculata*, *Musa* sp., Orchidaceae, *Plumeria rubra*, *Polianthes tuberosa*, *Rosa* sp.
 pre-1998: jasmine
 - Prothorax with seta XD2 closer to seta SD1 than to seta XD1 (Fig. 97); crochets triordinal (Fig. 98).....*Duponchelia fovealis* Zeller
 Distribution: Europe, Middle East, Africa
 Hosts: 2006: *Annona* sp., *Amaranthus* sp., *Anemone* sp., *Anthurium* sp., *Begonia* sp., *Beta vulgaris*, *Capsicum* sp., *Capsicum annuum*, *Limonium* sp., *Mentha* sp., *Ocimum basilicum*, *Origanum majorana*, *Paeonia* sp., *Sarracenia* sp., *Solanum lycopersicum*, *Tanacetum* sp.
 Note: SV1 pinaculum elongate on all thoracic segments, darkly sclerotized pinaculum 3X as long as wide posterior to the seta. Commonly intercepted on peppers from the Netherlands, but has been found in a wide variety of hosts including cut flowers.

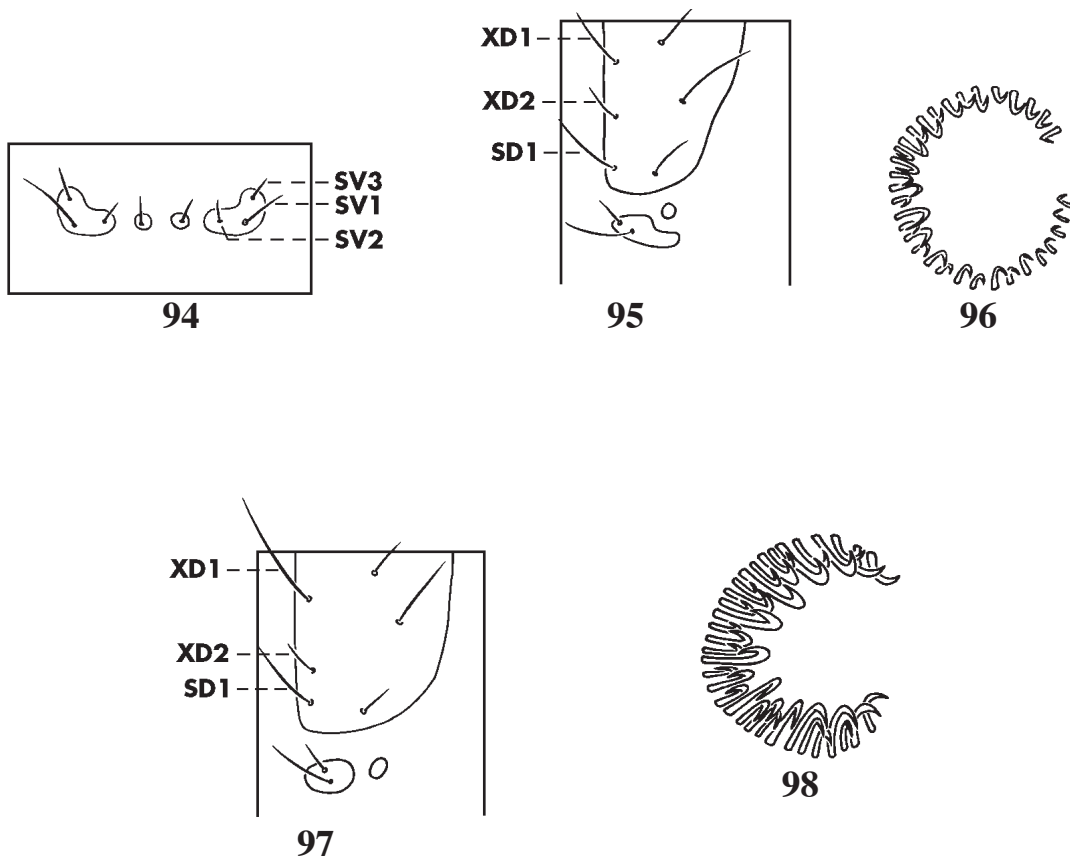

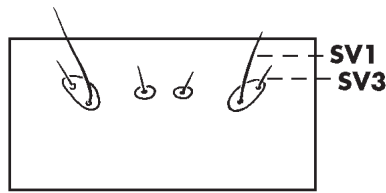

99

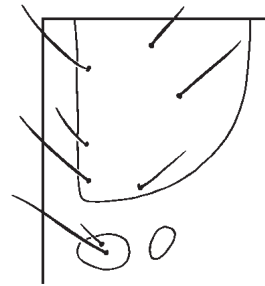

100

49. A1 with two (rarely three) subventral setae (Fig. 99); prespiracular shield oblong (Fig. 100); pinaculum of seta D1 on A2 to A8 without dark spot on anterior margin (Fig. 103).....50
 - A1 with one subventral seta (Fig. 101); prespiracular shield crescent shaped, may extend under spiracle (Fig. 102); pinaculum of seta D1 on A 2 to A 8 with dark spot on anterior margin (Fig. 103) (dark spot can appear very shiny white after preservation)51

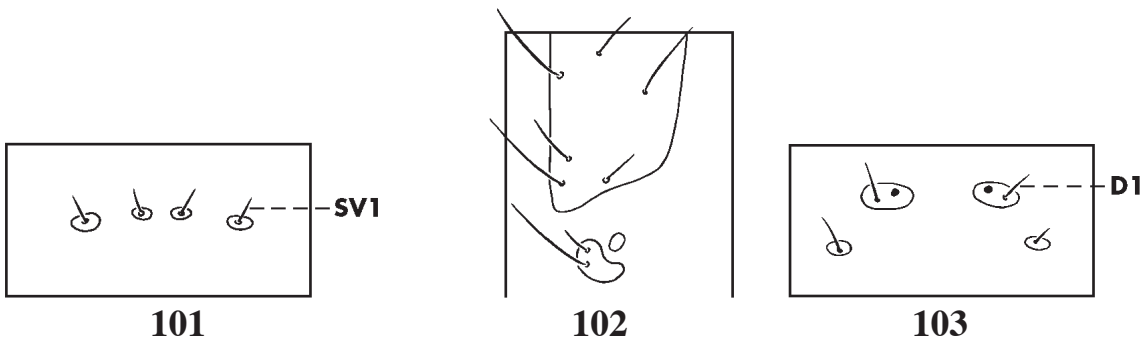

101

102

103

50. Head with a pigmented spot at genal angle (Fig. 104); mandible without a projection on lateral margin (Fig. 105); pinacula dark on early instars, pale in later instars.....
*Diaphania nitidalis* (Cramer)
 Distribution: Tropical worldwide
 Hosts: 2006: *Coccinia* sp., *Coccinia grandis*, *Cucumis* sp., *Cucumis melo*, *Cucumis sativus*, *Cucurbita* sp., *Cucurbita pepo*, *Sechium edule*, *Coccinia* sp., *Luffa* sp., *Momordica* sp., *Momordica charantia*, *Physalis philadelphica*
 pre-1998: Cucurbitaceae, including gourd, melon, squash
 - Head without pigmented spot at genal angle; mandible with a projection on lateral margin (Fig. 106); pinacula concolorous with body in all instars.....
*Diaphania indica* Saunders complex
 Distribution: tropical worldwide, including Western Hemisphere
 Hosts: 2006: *Coccinia* sp., *Cucurbita* sp., *Cucurbita pepo*, *Fernaldia* sp., *Luffa* sp., *Luffa acutangula*, *Momordica* sp., *Momordica charantia*, *Momordica balsimina*, *Murraya* sp., *Ocimum basilicum*, *Sechium edule*, *Thymus vulgaris*
 pre-1998: Cucurbitaceae, including cucumber, cantaloupe, gourd, melon, pumpkin, squash
 Note: to separate pupae of *D. hyalinata* (L.) from *D. indica* (Saunders): proboscis extends to A7 in *indica* and to A8 or A9 in *hyalinata*; *hyalinata* occurs from Canada south to Argentina, *indica* is cosmopolitan, in the Western Hemisphere occurring from Florida to South America; see Whittle & Ferguson 1987a; Clavijo 1990.

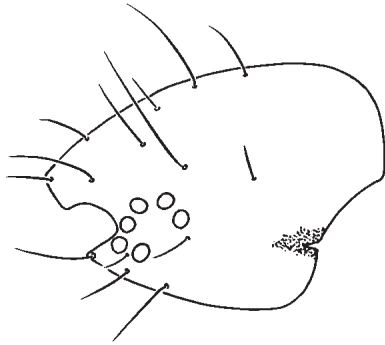

104

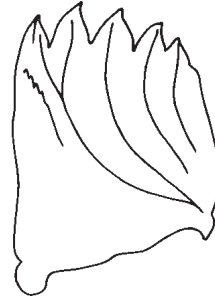

105

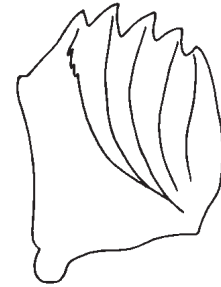

106

51. Head, prothoracic shield, and body pinacula brownish yellow, not concolorous.....
*Leucinodes orbonalis* (Guenée)
 Distribution: Africa and Southeast Asia, does not occur in Hawaii
 Hosts: 2006: *Capsicum* sp., *Cyphomandra betacea*, *Punica granatum*, *Solanum* sp.,
Solanum melongena, *Solanum torvum*
 pre-1998: chayote, potatoes, Solanaceae, tomato
 Note: The character that separates *L. orbonalis* from *N. elegantalis*, the presence of a
 dark spot on the anterior margin of the pinaculum of seta D1 of A2 to A8, was
 found to occur in both species; no adults of this species have been observed
 from the Western Hemisphere; see Capps 1948 and Whittle & Ferguson 1987b
- Head and prothoracic shield pale yellow, pinacula concolorous with body.....
*Neoleucinodes elegantalis* (Guenée)
 Distribution: Mexico to South America, and West Indies
 Hosts: 2006: *Capsicum* sp., *Capsicum annuum*, *Sechium edule*, *Solanum* sp., *Solanum*
lycopersicum, *Solanum melongena*, *Solanum quitoense*, *Solanum torvum*
 pre-1998: Solanaceae
 Note: See Capps 1948

Acknowledgments

I thank Douglas Ferguson who answered many questions about pyraloid larvae when I first began working at the Systematic Entomology Laboratory (SEL), USDA. I am grateful to all the port identifiers (especially D. Riley, S. Broda-Hydorn, and L. Pagan Gallardo) who sent material, asked questions, and asked for more clarification. Terry Nuhn, SEL, USDA, scanned the images into Adobe Pagemaker, Pete Touhey, SEL, USDA, retrieved data from the SELIS database, and Jon Lewis, SEL, USDA, retrieved data from specimens in the USNM collection. I thank Joe Cavey and Steve Passoa, APHIS-PPQ, USDA, Dave Smith and Natalia Vandenberg, SEL, ARS, USDA, and Dale Habeck, University of Florida at Gainesville, for reviewing the manuscript and providing invaluable suggestions. I especially thank Jon Lewis, SEL, USDA, and Steve Passoa for comments that improved the manuscript.

Literature Cited

- Aitken, A. D. 1963. A key to the larvae of some species of Phycitinae (Lepidoptera, Pyralidae) associated with stored products, and of some related species. *Bulletin of Entomological Research* 54(2): 175-188.
- Allyson, S. 1976. North American larvae of the genus *Loxostege* Hübner (Lepidoptera: Pyralidae: Pyraustinae). *Canadian Entomologist* 108(1): 89-104.
- Allyson, S. 1977. A study of some North American larvae of the genus *Tetralopha* Zeller (Lepidoptera: Pyralidae: Epipaschiinae). *Canadian Entomologist* 109: 329-336.
- Allyson, S. 1981a. Description of the last instar larva of the cabbage webworm, *Hellula rogatalis* (Lepidoptera: Pyralidae), with a key to larvae of North American species of *Hellula* Guenée. *Canadian Entomologist* 113: 361-364.
- Allyson, S. 1981b. Last instar larvae of Pyraustini of America north of Mexico (Lepidoptera: Pyralidae). *Canadian Entomologist* 113: 463-518.
- Allyson, S. 1984. Description of last-instar larvae of 22 species of North American Spilomelini (Lepidoptera: Pyralidae: Pyraustinae) with a key to species. *Canadian Entomologist* 116: 1301-1334.
- Bleszynski, S. 1970. A revision of the world species of *Chilo* Zincken (Lepidoptera: Pyralidae). *Bulletin of the British Museum (Natural History) Entomology* 25 (4): 101-195.
- Box, H. E. 1931. The crambine genera of *Diatraea* and *Xanthoherne* (Lep., Pyral.). *Bulletin of Entomological Research* 22 (1): 1-50.
- Brako, L., A. Y. Rossman, and D. E. Farr. 1995. *Scientific and Common Names of 7,000 Vascular Plants in the United States*. APS Press, St. Paul, Minnesota. 295 pp.
- Capps, H. 1939. Keys for the identification of some lepidopterous larvae frequently intercepted at

- quarantine. E-475. Bureau of Entomology and Plant Quarantine, United States Department of Agriculture. Washington, D. C. 37 pp.
- Capps, H. 1948. Status of pyraustid moths of the genus *Leucinodes* in the New World, with descriptions of new genera and species. *Proceedings of the U.S. National Museum* 98(3223): 69-83.
- Capps, H. 1955. Claves para la identificacion de algunas larvas de Lepidopteros que con frecuencia se interceptan en las inspecciones aduanales. *Fitófilo* 7 (9): 15-51.
- Capps, H. 1956. Keys for the identification of some lepidopterous larvae frequently intercepted at quarantine. ARS-33-20. Agriculture Research Service, United States Department of Agriculture. Washington, D. C. 37 pp.
- Capps, H. 1963. An illustrated key for identification of some lepidopterous larvae frequently intercepted at quarantine. ARS 30-20-1. Agricultural Research Service, United States Department of Agriculture. Washington, D. C. 37 pp.
- Carter, D. J. 1984. Pest Lepidoptera of Europe with species reference to the British Isles. Dr W. Junk Publishers, Dordrecht, Netherlands. 431 pp.
- Clavijo, J. A. 1990. Systematics of black and white species of the genus *Diaphania* Hübner (1818) (Lepidoptera: Pyralidae: Pyraustinae). Dissertation: McGill University. Montreal, Canada. 215 pp.
- Common, I. F. B. 1990. Moths of Australia. Melbourne University Press, Carlton, Australia. 535 pp.
- Corbet, A. S. & W. H. T. Tams. 1943. Keys for the identification of the Lepidoptera infesting stored food products. *Proceedings of the Zoological Society of London* 113 (3): 55-148.
- Dyar, H. G. & C. Heinrich. 1927. The American moths of the genus *Diatraea* and allies. *Proceedings of the United States National Museum* 71 (19): 1-48.
- Ferguson, D. C. and Biological Assessment Support Staff. no date. Bean Pod Borer, *Maruca testulalis* (Geyer). Pests not known to occur in the United States or of limited distribution, U. S. Department of Agriculture, APHIS 40: 1-6.
- Goater, B. 1986. British Pyralid Moths. Harley Books, England. 175 pp.
- Hasenfuss, I. 1960. Die Larvalsystematik der Zünsler (Pyralidae). Berlin: Akademie Verlag. 263 pp.
- Heinrich, C. 1916. On the taxonomic value of some larval characters in the Lepidoptera. *Proceedings of the Entomological Society of Washington* 18 (2): 154-164.
- Heinrich, C. 1919. Note on the European corn borer (*Pyrausta nubilalis* Hübner) and its nearest American allies, with description of larvae, pupae, and one new species. *Journal of Agricultural Research* 18(3): 171-178.
- Heinrich, C. 1956. American moths of the subfamily Phycitinae. *Bulletin of the United States Na-*

tional Museum 207: 1-581.

Hinton, H. E. 1943. The larvae of the Lepidoptera associated with stored products. *Bulletin of Entomological Research* 34: 163-212.

Hinton, H. E. 1946. On the homology and nomenclature of the setae of lepidopterous larvae with some notes on the phylogeny of the Lepidoptera. *Transactions of the Royal Entomological Society, London* 97: 1-37.

Luginbill, P. & G. G. Ainslie. 1917. The lesser corn stalk-borer. *United States Department of Agriculture Bulletin* 539: 1-27.

Mabberly, D. J. 1997. *The Plant Book*. Cambridge University Press, United Kingdom. 858 pp.

Meijerman, L. & S. A. Ulenberg. 1996. Identification of African stemborer larvae (Lepidoptera: Noctuidae, Pyralidae) based on morphology. *Bulletin of Entomological Research* 86: 567-578.

Minet, J. 1982. Les Pyraloidea et leurs principales divisions systematiques. *Bulletin de la Société Entomologique de France* 86: 262-280.

Munroe, E. 1972. Pyraloidea. Pyralidae (in part), Fasc. 13.1B. In Dominick, R.B. et al. eds. *The Moths of America North of Mexico*. E. W. Classey, Ltd and The Wedge Entomological Research Foundation, London: 137-250.

Munroe, E. 1973. Pyraloidea. Pyralidae (in part), Fasc. 13.1C. In Dominick, R.B et al. eds. *The Moths of America North of Mexico*. E. W. Classey, Ltd and The Wedge Entomological Research Foundation, London: 253-304.

Munroe, E. 1989. Changes in classification and names of Hawaiian Pyraloidea since the publication of *Insects of Hawaii, Volume 8*, by E. C. Zimmerman (1958). *Bishop Museum Occasional Papers* 29: 199-212.

Munroe, E, V. O. Becker, J. C. Shaffer, M. Shaffer, and M. A. Solis. 1995. Pyraloidea In Heppner, J. B. , ed. *Checklist: Part 2, Atlas of Neotropical Lepidoptera*. Association for Tropical Lepidoptera, Gainesville, Florida: 34 105.

Mutuura, A., Y. Yamamoto, and I. Hattori [revised by S. Issiki]. 1973. *Early stages of Japanese moths in color*. Hoikusha Publishing Co., Osaka, Japan. 238 pp.

Neunzig, H. H. 1979. Systematics of immature phycitines (Lepidoptera: Pyralidae) associated with leguminous plants in the southern United States. *United States Department of Agriculture Technical Bulletin*: 1-119.

Neunzig, H. H. 1986. Pyraloidea. Pyralidae (in part), Fasc 15.2. In Dominick, R. B. et al., eds. *The Moths of America North of Mexico*. The Wedge Entomological Research Foundation, Washington, D.C.: 1-112.

- Neunzig, H. H. 1990. Pyraloidea. Pyralidae (in part), Fasc 15.3. In Dominick, R. B. et al., eds. The Moths of America North of Mexico. The Wedge Entomological Research Foundation, Washington, D.C.: 1-165.
- Neunzig, H. H. 1997. Pyraloidea. Pyralidae (in part), Fasc 15.4. In Dominick, R. B. et al., eds. The Moths of America North of Mexico. The Wedge Entomological Research Foundation, Washington, D.C.: 1-157.
- Nishida, G. M. (ed.) 1992. Hawaiian Terrestrial Arthropod Checklist. Bishop Museum Technical Report No. MS-092192: 1-262.
- Passoa, S. 1985. Taxonomy of the larvae and pupae of economically important Pyralidae in Honduras. M.S. Thesis. University of Florida. Gainesville, Florida. 486 pp.
- Passoa, S. 1987. A description of the larva and pupa of *Rupela albinella*, a pest of rice in Latin America (Lepidoptera: Pyralidae: Schoenobiinae). The Florida Entomologist 70(3): 368-375.
- Riley, D. R. and M. A. Solis. 2005. Keys to immatures of the sugarcane borer and Neotropical cornstalk borer from Mexico intercepted on corn in southeastern Texas. Southwestern Entomologist 30(1): 35-39.
- Rodriguez-del-Bosque, L. A., J. W. Smith, & H. W. Browning. 1990. Feeding and pupation sites of *Diatraea lineolata*, *D. saccharalis*, and *Eoreuma loftini* (Lepidoptera: Pyralidae) in relation to corn phenology. Journal of Economic Entomology 83(3): 850-855.
- Shaffer, M., E. S. Nielsen, & M. Horak. 1996. Pyralidae In Nielsen, E. S., E. D. Edwards, & T. V. Ransi, eds. Checklist of the Lepidoptera of Australia. Monographs on Australian Lepidoptera, CSIRO Publications, East Melbourne. 529 pp.
- Solis, M. A. 1993. A phylogenetic analysis and reclassification of the genera of the *Pococera* complex. Journal of the New York Entomological Society 101(1): 1-83.
- Solis, M. A. 1996. Pyraloidea (Lepidoptera) In Llorente, J., A. N. Garcia, & E. Gonzalez, eds. Biodiversidad, taxonomia y biogeografia de artropodos de Mexico: Hacia una sintesis de su conocimiento. Universidad Nacional Autonoma de Mexico, Mexico. 660 pp.
- Solis, M. A. 1997. Snout moths: unraveling the taxonomic diversity of a speciose group in the neotropics In Reaka-Kudla, M., D. E. Wilson, & E. O. Wilson, eds. Joseph Henry Press, Washington, D. C. 551 pp.
- Solis, M. A. 2003a. *Maruca vitrata* (Fabricius, 1787), senior valid name for *Maruca testulalis* (Geyer, 1832), a worldwide pest of leguminaceous crops. Newsletter for the Brazilian Entomological Society 28: 3.
- Solis, M. A. 2003b. A new species of *Epimorius* Zeller feeding on Bromeliaceae in Costa Rica (Lepidoptera: Pyralidae: Galleriinae). Tropical Lepidoptera 11(1-2): 28-32.
- Solis, M. A. 2004. Systematics of Mexican stalkboring crambine Pyraloidea, pp. 6-22 In: L.A.

Rodríguez del Bosque, G. Vejar Cota, and E. Cortez Mondaca (Eds.) Taller Internacional sobre Barrenadores del Tallo de Caña de Azúcar, Los Mochis, Sinaloa, México. Sociedad Mexicana de Control Biológico 1004pp.

Solis, M. A. and K. V. N. Maes. 2002. Preliminary phylogenetic analysis of the subfamilies of Crambidae (Pyraloidea: Lepidoptera). Belgian Journal of Entomology 4: 53-95.

Solis, M. A. and C. Mitter. 1992. Review and preliminary phylogenetic analysis of the subfamilies of the Pyralidae (sensu stricto) (Lepidoptera: Pyralidae). Systematic Entomology 17: 79-90.

Stehr, F. W. 1987. Lepidoptera, pp. 288-596 In Stehr, F. W., ed., Immature Insects. Kendall Hunt Publishing Co, Dubuque, Iowa. 754 pp.

Weisman, D. M. 1986. Keys for the identification of some frequently intercepted lepidopterous larvae. U. S. Department of Agriculture, APHIS 81-47. 64 pp.

Whittle, K. and D. C. Ferguson. 1987a. Pumpkin Caterpillar, *Diaphania indica* Saunders. Pests not known to occur in the United States or of limited distribution, U. S. Department of Agriculture, APHIS 84: 1-8.

Whittle, K. and D. C. Ferguson. 1987b. Eggplant fruit borer, *Leucinodes orbonalis* Guenée. Pests not known to occur in the United States or of limited distribution, U. S. Department of Agriculture, APHIS 85: 1-9.

Whittle, K. and D. C. Ferguson. 1988. Asiatic Rice Borer, *Chilo suppressalis* (Walker). Pests not known to occur in the United States or of limited distribution, U. S. Department of Agriculture, APHIS 97: 1-10.

Table 2: Hosts and pyraloid larvae.

Host	Pyraloid Species	Page	Key Couplet
abata cola	<i>Cadra cautella</i> (Walker)	16	17
	<i>Plodia interpunctella</i> (Hübner)	14	14
<i>Abelmoschus esculentus</i>	see okra		
<i>Abies nordmanniana</i>	see Nordman fir		
acacia	<i>Corcyra cephalonica</i> (Stainton)	20	26
<i>Acacia</i>	see acacia		
<i>Acalypha hispida</i>	see chenille plant		
<i>Acanthocereus</i>	see cactus		
<i>Afzelia</i>	see mahogany		
akee	<i>Achyra rantalis</i> (Guenée)	27	41
alfalfa	<i>Cadra cautella</i> (Walker)	16	17
	<i>Elasmopalpus lignosellus</i> (Zeller)	9	6
	<i>Ephestia elutella</i> (Hübner)	15	16
	<i>Herpetogramma bipunctalis</i> (Fabricius)	27	43
	<i>Udea rubigalis</i> (Guenée)	29	46
<i>Allium</i>	<i>Cadra cautella</i> (Walker)	16	17
	<i>Ephestia elutella</i> (Hübner)	15	16
	<i>Pyralis farinalis</i> Linnaeus	18	21
	<i>Pyrausta</i> sp.	23	33
<i>Allium cepa</i>	see onion		
<i>Allium sativum</i>	see garlic		
allspice	<i>Udea rubigalis</i> (Guenée)	29	46
almond, sweet	<i>Cadra calidella</i> (Guenée)	17	18
<i>Alpinia purpurata</i>	see red ginger		
<i>Alstroemeria</i>	see amaryllis		
amaranth	<i>Herpetogramma bipunctalis</i> (Fabricius)	27	43
	<i>Pyrausta</i> sp.	23	33
Amaranthaceae	<i>Spoladea recurvalis</i> Fabricius	28	45
<i>Amaranthus</i>	<i>Cryptoblabes</i> sp.	10	6
	<i>Duponchelia fovealis</i> Zeller	30	48
	<i>Herpetogramma bipunctalis</i> (Fabricius)	27	43
	<i>Pyrausta</i> sp.	23	33
	<i>Rhectocraspeda periusalis</i> (Walker)	28	43
	<i>Spoladea recurvalis</i> Fabricius	28	45
	<i>Udea rubigalis</i> (Guenée)	29	46
<i>Amaranthus caudatus</i>	see tassel flower		
amaryllis	<i>Cadra figulilella</i> (Gregson)	17	18
<i>Anacardium</i>	<i>Cadra cautella</i> (Walker)	16	17
<i>Anacardium occidentale</i>	see cashew		
<i>Ananas</i>	<i>Paralipsa gularis</i> (Zeller)	20	26
<i>Ananas comosus</i>	see pineapple		
Anemone	<i>Duponchelia fovealis</i> Zeller	30	48
<i>Annona</i>	<i>Amyelois transitella</i> (Walker)	14	13
	<i>Duponchelia fovealis</i> Zeller	30	48
	<i>Ectomyelois ceratoniae</i> (Zeller)	13	13
	<i>Ephestia kuehniella</i> (Zeller)	15	16
<i>Annona cherimola</i>	see chirimoya		
<i>Annona squamosa</i>	see sugar apple		
<i>Anthemis</i>	<i>Herpetogramma bipunctalis</i> (Fabricius)	27	43
	<i>Pyrausta</i> sp.	23	33
<i>Anthurium</i>	<i>Duponchelia fovealis</i> Zeller	30	48
<i>Antilles calophyllum</i>	<i>Paralipsa gularis</i> (Zeller)	20	26
<i>Apium</i>	see celery		

Host	Pyraloid Species	Page	Key Couplet
<i>Apium graveolens</i>	see wild celery		
apple	<i>Amyelois transitella</i> (Walker)	14	13
	<i>Cadra cautella</i> (Walker)	16	17
	<i>Ectomyelois ceratoniae</i> (Zeller)	13	13
	<i>Ephestia elutella</i> (Hübner)	15	16
	<i>Etiella zinckenella</i> (Treitschke)	17	20
	<i>Ostrinia nubilalis</i> (Hübner)	25	36
apple, Malaysian	<i>Conogethes</i> spp.	24	34
apple, paradise	<i>Ectomyelois ceratoniae</i> (Zeller)	13	13
	<i>Etiella zinckenella</i> (Treitschke)	17	20
apricot	<i>Plodia interpunctella</i> (Hübner)	14	14
	<i>Ephestia elutella</i> (Hübner)	15	16
<i>Arachis hypogaea</i>	see peanut		
<i>Arachis</i>	see peanut		
<i>Arctium lappa</i>	see greater burdock		
<i>Areca catechu</i>	see betel palm		
areca palm	<i>Cadra cautella</i> (Walker)	16	17
	<i>Spoladea recurvalis</i> Fabricius	28	45
<i>Areca</i>	see areca palm		
<i>Artemisia</i>	<i>Etiella zinckenella</i> (Treitschke)	17	20
asparagus, garden	<i>Elasmopalpus lignosellus</i> (Zeller)	9	6
	<i>Herpetogramma bipunctalis</i> (Fabricius)	27	43
<i>Asparagus officinalis</i>	see asparagus, garden		
Asteraceae	<i>Homoeosoma electellum</i> Hulst	12	11
	<i>Spoladea recurvalis</i> Fabricius	28	45
aster	<i>Udea rubigalis</i> (Guenée)	29	46
<i>Aster</i>	see aster		
<i>Atriplex</i>	see saltbush		
<i>Averrhoa bilimbi</i>	see bilimbi		
avocado	<i>Aglossa caprealis</i> (Hübner)	18	21
	<i>Ephestia elutella</i> (Hübner)	15	16
	<i>Etiella zinckenella</i> (Treitschke)	17	20
balsampear	<i>Ancylostomia stercorea</i> (Zeller)	10	8
	<i>Diaphania indica</i> Saunders complex	31	50
	<i>Diaphania nitidalis</i> (Cramer)	31	50
	<i>Pyrausta</i> sp.	23	33
	<i>Rhectocraspeda periusalis</i> (Walker)	28	43
	<i>Udea rubigalis</i> (Guenée)	29	46
balsampear, southern	<i>Diaphania indica</i> Saunders complex	31	50
bamboo	<i>Cadra cautella</i> (Walker)	16	17
	<i>Paralipsa gularis</i> (Zeller)	20	26
<i>Bambusa</i>	see bamboo		
<i>Bambusa</i>	see cooked bamboo roots		
banana	<i>Cryptoblabes</i> sp.	10	6
	<i>Diatraea</i> spp.	23	31
	<i>Hendecasis duplifascialis</i> Hampson	29	48
	<i>Pyralis farinalis</i> Linnaeus	18	21
Barbados nut	<i>Spoladea recurvalis</i> Fabricius	28	45
barberry	<i>Cadra cautella</i> (Walker)	16	17
	<i>Cadra figulilella</i> (Gregson)	17	18
	<i>Plodia interpunctella</i> (Hübner)	14	14
barley, common	<i>Cadra cautella</i> (Walker)	16	17
basil	<i>Pyrausta</i> sp.	23	33
	<i>Udea rubigalis</i> (Guenée)	29	46
basil, sweet	<i>Diaphania indica</i> Saunders complex	31	50

Host	Pyraloid Species	Page	Key Couplet
	<i>Duponchelia fovealis</i> Zeller	30	48
	<i>Ephestia elutella</i> (Hübner)	15	16
	<i>Pyrausta</i> sp.	23	33
	<i>Spoladea recurvalis</i> Fabricius	28	45
	<i>Udea rubigalis</i> (Guenée)	29	46
bastardcedar	<i>Corcyra cephalonica</i> (Stainton)	20	26
bean	<i>Amyelois transitella</i> (Walker)	14	13
	<i>Ancylostomia stercorea</i> (Zeller)	10	8
	<i>Cadra cautella</i> (Walker)	16	17
	<i>Cadra figulilella</i> (Gregson)	17	18
	<i>Corcyra cephalonica</i> (Stainton)	20	26
	<i>Ectomyelois ceratoniae</i> (Zeller)	13	13
	<i>Elasmopalpus lignosellus</i> (Zeller)	9	6
	<i>Etiella zinckenella</i> (Treitschke)	17	20
	<i>Fundella pellucens</i> Zeller	11	10
	<i>Maruca vitrata</i> (Fabricius)	24	35
	<i>Moodna bisinuella</i> Hampson	11	9
	<i>Ostrinia nubilalis</i> (Hübner)	25	36
	<i>Plodia interpunctella</i> (Hübner)	14	14
bean, butter	<i>Mussidia nigrivenella</i> Ragonot	9	4
bean, calabar	<i>Mussidia nigrivenella</i> Ragonot	9	4
bean, kidney	<i>Ancylostomia stercorea</i> (Zeller)	10	8
	<i>Cadra cautella</i> (Walker)	16	17
	<i>Corcyra cephalonica</i> (Stainton)	20	26
	<i>Ephestia elutella</i> (Hübner)	15	16
	<i>Etiella zinckenella</i> (Treitschke)	17	20
	<i>Fundella pellucens</i> Zeller	11	10
	<i>Maruca vitrata</i> (Fabricius)	24	35
	<i>Ostrinia nubilalis</i> (Hübner)	25	36
bean, lima or sieva	<i>Etiella zinckenella</i> (Treitschke)	17	20
	<i>Fundella pellucens</i> Zeller	11	10
	<i>Maruca vitrata</i> (Fabricius)	24	35
	<i>Ostrinia nubilalis</i> (Hübner)	25	36
	<i>Phidotricha erigens</i> (Ragonot)	17	19
bean, winged	<i>Maruca vitrata</i> (Fabricius)	24	35
bean, yardlong	<i>Amyelois transitella</i> (Walker)	14	13
	<i>Fundella pellucens</i> Zeller	11	10
	<i>Maruca vitrata</i> (Fabricius)	24	35
beet	<i>Achyra rantalis</i> (Guenée)	27	41
	<i>Duponchelia fovealis</i> Zeller	30	48
	<i>Herpetogramma bipunctalis</i> (Fabricius)	27	43
	<i>Ostrinia nubilalis</i> (Hübner)	25	36
	<i>Spoladea recurvalis</i> Fabricius	28	45
	<i>Udea rubigalis</i> (Guenée)	29	46
beggarticks	<i>Homoeosoma electellum</i> Hulst	12	11
begonia	<i>Duponchelia fovealis</i> Zeller	30	48
<i>Begonia</i>	see begonia		
<i>Benincasa hispida</i>	see waxgourd		
<i>Berberis</i>	see barberry		
<i>Bertholletia excelsa</i>	see brazil nut		
<i>Bertholletia</i>	<i>Corcyra cephalonica</i> (Stainton)	20	26
<i>Beta vulgaris</i>	see beet		
<i>Beta vulgaris</i>	see sugar beet		
<i>Beta vulgaris</i> ssp. <i>Cicla</i>	see Swiss chard		
betel palm	<i>Cadra cautella</i> (Walker)	16	17

Host	Pyraloid Species	Page	Key Couplet
	<i>Paralipsa gularis</i> (Zeller)	20	26
<i>Bidens</i>	see beggarticks		
bilimbi	<i>Phidotricha erigens</i> (Ragonot)	17	19
bird-of-paradise	<i>Cadra cautella</i> (Walker)	16	17
blackberry	<i>Cadra cautella</i> (Walker)	16	17
<i>Blighia sapida</i>	see akee		
blueberry	<i>Cadra cautella</i> (Walker)	16	17
bougainvillea	<i>Spoladea recurvalis</i> Fabricius	28	45
<i>Bougainvillea</i>	see bougainvillea		
box, Chinese	<i>Hendecasis duplifascialis</i> Hampson	29	48
<i>Brassica chinensis</i>	see pak choi		
<i>Brassica oleracea</i>	see cabbage		
<i>Brassica oleracea</i> var <i>botrytis</i>	see broccoli		
<i>Brassica oleracea</i> var <i>botrytis</i>	see cauliflower		
<i>Brassica oleracea</i> var <i>gemmifera</i>	see brussel sprouts		
<i>Brassica rapa</i>	see mustard		
Brassicaceae	<i>Cadra cautella</i> (Walker)	16	17
	<i>Evergestis rimosalis</i> (Guenée)	25	37
	<i>Hellula phidilealis</i> (Walker)	26	39
brazil nut	<i>Hellula rogatalis</i> (Hulst)	26	39
Brazilian waterweed	<i>Parapoynx diminutalis</i> Snellen	21	27
broccoli	<i>Hellula phidilealis</i> (Walker)	26	39
	<i>Hellula rogatalis</i> (Hulst)	26	39
	<i>Herpetogramma bipunctalis</i> (Fabricius)	27	43
brussel sprouts	<i>Evergestis rimosalis</i> (Guenée)	25	37
buttonweed	<i>Spoladea recurvalis</i> Fabricius	28	45
cabbage	<i>Chilo suppressalis</i> (Walker)	23	31
	<i>Evergestis rimosalis</i> (Guenée)	25	37
	<i>Udea rubigalis</i> (Guenée)	29	46
<i>Cabomba caroliniana</i>	see Carolina fanwort		
<i>Cabomba</i>	<i>Parapoynx diminutalis</i> Snellen	21	27
cacao	<i>Cadra calidella</i> (Guenée)	17	18
	<i>Cadra cautella</i> (Walker)	16	17
	<i>Corcyra cephalonica</i> (Stainton)	20	26
	<i>Mussidia nigrivenella</i> Ragonot	9	4
cactus	<i>Ephestia elutella</i> (Hübner)	15	16
<i>Caesalpinia pulcherrima</i>	see pride of Barbados		
<i>Cajanus cajan</i>	see pigeon pea		
callingcard vine	<i>Mussidia nigrivenella</i> Ragonot	9	4
<i>Calophyllum antillanum</i> (brasiliense)	see Antilles calophyllum		
<i>Camellia sinensis</i>	see tea		
cantaloupe	<i>Diaphania indica</i> Saunders complex	31	50
	<i>Diaphania nitidalis</i> (Cramer)	31	50
cape jasmine	<i>Hendecasis duplifascialis</i> Hampson	29	48
<i>Capsicum</i>	see pepper		
<i>Capsicum annuum</i>	see cayenne pepper		
<i>Carapa guianensis</i>	see crabwood		
cardamom	<i>Cadra cautella</i> (Walker)	16	17
<i>Carica papaya</i>	see papaya		
carob or locust bean	<i>Cadra calidella</i> (Guenée)	17	18
	<i>Ectomyelois ceratoniae</i> (Zeller)	13	13
	<i>Elasmopalpus lignosellus</i> (Zeller)	9	6
	<i>Mussidia nigrivenella</i> Ragonot	9	4
	<i>Paralipsa gularis</i> (Zeller)	20	26
Carolina fanwort	<i>Parapoynx diminutalis</i> Snellen	21	27

Host	Pyraloid Species	Page	Key Couplet
carrot	<i>Udea rubigalis</i> (Guenée)	29	46
<i>Carya illinoensis</i>	see pecan		
cashew	<i>Cadra cautella</i> (Walker)	16	17
	<i>Corcyra cephalonica</i> (Stainton)	20	26
	<i>Plodia interpunctella</i> (Hübner)	14	14
cassava	<i>Cadra figulilella</i> (Gregson)	17	18
cassia	<i>Corcyra cephalonica</i> (Stainton)	20	26
	<i>Ectomyelois ceratoniae</i> (Zeller)	13	13
	<i>Paralipsa gularis</i> (Zeller)	20	26
	<i>Trachylepidia fructicassella</i> Ragonot	20	25
<i>Cassia</i>	see cassia		
<i>Cassia fistula</i>	see golden shower		
<i>Cassia grandis</i>	see pink shower		
<i>Castanea</i>	see chestnut		
<i>Castanea sativa</i>	see European chestnut		
catalpa	<i>Conogethes</i> spp.	24	34
<i>Catalpa</i>	see catalpa		
cattail, broadleaf	Schoenobiinae	21	28
cauliflower	<i>Evergestis rimosalis</i> (Guenée)	25	37
cayenne pepper	<i>Cadra calidella</i> (Guenée)	17	18
	<i>Duponchelia fovealis</i> Zeller	30	48
	<i>Ectomyelois ceratoniae</i> (Zeller)	13	13
	<i>Etiella zinckenella</i> (Treitschke)	17	20
	<i>Neoleucinodes elegantalis</i> (Guenée)	32	51
	<i>Ostrinia nubilalis</i> (Hübner)	25	36
	<i>Paralipsa gularis</i> (Zeller)	20	26
	<i>Plodia interpunctella</i> (Hübner)	14	14
	<i>Ostrinia nubilalis</i> (Hübner)	25	36
	<i>Udea rubigalis</i> (Guenée)	29	46
<i>Celosia</i>	see cock's comb		
<i>Ceratonia siliqua</i>	see carob or locust bean		
cereal products	<i>Ephestia elutella</i> (Hübner)	15	16
<i>Cereus</i>	see sweet potato cactus		
<i>Cestrum</i>	see jessamine		
<i>Chaenomeles japonica</i>	see Maule's quince		
<i>Chamaemelum nobile</i>	see Roman chamomile		
chamomile, German	<i>Homoeosoma electellum</i> Hulst	12	11
chayote	<i>Diaphania indica</i> Saunders complex	31	50
	<i>Diaphania nitidalis</i> (Cramer)	31	50
	<i>Leucinodes orbonalis</i> (Guenée)	32	51
	<i>Neoleucinodes elegantalis</i> (Guenée)	32	51
chenille plant	<i>Pyrausta</i> sp.	23	33
Chenopodia charantia	<i>Rhectocraspeda periusalis</i> (Walker)	28	43
<i>Chenopodium</i>	see goosefoot		
cherry, sweet	<i>Cadra cautella</i> (Walker)	16	17
	<i>Cadra figulilella</i> (Gregson)	17	18
	<i>Ectomyelois ceratoniae</i> (Zeller)	13	13
	<i>Ephestia elutella</i> (Hübner)	15	16
	<i>Plodia interpunctella</i> (Hübner)	14	14
chestnut	<i>Cadra calidella</i> (Guenée)	17	18
	<i>Conogethes</i> spp.	24	34
	<i>Ephestia elutella</i> (Hübner)	15	16
	<i>Etiella zinckenella</i> (Treitschke)	17	20
	<i>Paralipsa gularis</i> (Zeller)	20	26
chick pea	<i>Ancylostomia stercorea</i> (Zeller)	10	8

Host	Pyraloid Species	Page	Key Couplet
	<i>Cadra cautella</i> (Walker)	16	17
	<i>Etiella zinckenella</i> (Treitschke)	17	20
	<i>Plodia interpunctella</i> (Hübner)	14	14
<i>Chimonanthus</i>	<i>Ectomyelois ceratoniae</i> (Zeller)	13	13
chirimoya	<i>Ectomyelois ceratoniae</i> (Zeller)	13	13
	<i>Ephestia kuehniella</i> (Zeller)	15	16
chrysanthemum	<i>Udea rubigalis</i> (Guenée)	29	46
<i>Chrysanthemum</i>	see daisy		
chrysophyllum	<i>Ephestia kuehniella</i> (Zeller)	15	16
<i>Chrysophyllum</i>	see chrysophyllum		
<i>Chrysophyllum cainito</i>	see star apple		
<i>Cicer arietinum</i>	see chick pea		
<i>Citrullus lanatus</i>	see watermelon		
citrus	<i>Cadra cautella</i> (Walker)	16	17
	<i>Ephestia elutella</i> (Hübner)	15	16
	<i>Plodia interpunctella</i> (Hübner)	14	14
<i>Citrus reticulata</i>	see tangerine		
<i>Citrus sinensis</i>	see orange		
clover	<i>Ostrinia nubilalis</i> (Hübner)	25	36
	<i>Udea rubigalis</i> (Guenée)	29	46
clover, white	<i>Plodia interpunctella</i> (Hübner)	14	14
coccinia	<i>Diaphania indica</i> Saunders complex	31	50
	<i>Diaphania nitidalis</i> (Cramer)	31	50
<i>Coccinia</i>	see coccinia		
<i>Coccinia grandis</i>	see ivy gourd		
cock's comb	<i>Spoladea recurvalis</i> Fabricius	28	45
coconut palm	<i>Cadra cautella</i> (Walker)	16	17
<i>Cocos nucifera</i>	see coconut palm		
<i>Coffea</i>	see coffee		
<i>Coffea arabica</i>	see coffee, Arabian		
coffee	<i>Cadra cautella</i> (Walker)	16	17
	<i>Corcyra cephalonica</i> (Stainton)	20	26
	<i>Plodia interpunctella</i> (Hübner)	14	14
coffee, Arabian	<i>Cadra cautella</i> (Walker)	16	17
	<i>Elasmopalpus lignosellus</i> (Zeller)	9	6
	<i>Plodia interpunctella</i> (Hübner)	14	14
cola	<i>Corcyra cephalonica</i> (Stainton)	20	26
<i>Cola</i>	see cola		
<i>Cola acuminata</i>	see abata cola		
colocasia	<i>Cadra cautella</i> (Walker)	16	17
	<i>Spoladea recurvalis</i> Fabricius	28	45
<i>Colocasia</i>	see colocasia		
<i>Colysis pteropus</i>	<i>Herpetogramma bipunctalis</i> (Fabricius)	27	43
cooked bamboo roots	<i>Cadra cautella</i> (Walker)	16	17
corchorus	<i>Spoladea recurvalis</i> Fabricius	28	45
<i>Corchorus</i>	see corchorus		
<i>Corchorus olitorius</i>	see nalta jute		
cordgrass, smooth	<i>Diatraea</i> spp.	23	31
coriander	<i>Herpetogramma bipunctalis</i> (Fabricius)	27	43
	<i>Udea rubigalis</i> (Guenée)	29	46
<i>Coriandrum sativum</i>	see coriander		
corn	<i>Achyra rantalis</i> (Guenée)	27	41
	<i>Amyelois transitella</i> (Walker)	14	13
	<i>Cadra cautella</i> (Walker)	16	17
	<i>Cadra figulilella</i> (Gregson)	17	18

Host	Pyraloid Species	Page	Key Couplet
	<i>Chilo suppressalis</i> (Walker)	23	31
	<i>Diatraea</i> spp.	23	31
	<i>Ectomyelois ceratoniae</i> (Zeller)	13	13
	<i>Elasmopalpus lignosellus</i> (Zeller)	9	6
	<i>Eoreuma loftini</i> (Dyar)	22	30
	<i>Ephestia elutella</i> (Hübner)	15	16
	<i>Ephestia kuehniella</i> (Zeller)	15	16
	<i>Etiella zinckenella</i> (Treitschke)	17	20
	<i>Hypsipyla</i> sp.	11	9
	<i>Moodna bisinuella</i> Hampson	11	9
	<i>Ostrinia nubilalis</i> (Hübner)	25	36
	<i>Paralipsa gularis</i> (Zeller)	20	26
	<i>Phidotricha erigens</i> (Ragonot)	17	19
	<i>Plodia interpunctella</i> (Hübner)	14	14
	<i>Spoladea recurvalis</i> Fabricius	28	45
<i>Corylus avellana</i>	see filbert, common		
<i>Corylus</i>	see hazelnut		
cotton	<i>Achyra rantalis</i> (Guenée)	27	41
	<i>Herpetogramma bipunctalis</i> (Fabricius)	27	43
	<i>Homoeosoma electellum</i> Hulst	12	11
	<i>Phidotricha erigens</i> (Ragonot)	17	19
cowpea	<i>Ancylostomia stercorea</i> (Zeller)	10	8
	<i>Cadra cautella</i> (Walker)	16	17
	<i>Ectomyelois ceratoniae</i> (Zeller)	13	13
	<i>Elasmopalpus lignosellus</i> (Zeller)	9	6
	<i>Fundella pellucens</i> Zeller	11	10
	<i>Maruca vitrata</i> (Fabricius)	24	35
	<i>Phidotricha erigens</i> (Ragonot)	17	19
	<i>Trachylepidia fructicassiella</i> Ragonot	20	25
crabapple, European	<i>Amyelois transitella</i> (Walker)	14	13
	<i>Cadra cautella</i> (Walker)	16	17
	<i>Ectomyelois ceratoniae</i> (Zeller)	13	13
crabwood	<i>Hypsipyla</i> sp.	11	9
<i>Craspedia</i>	<i>Ephestia elutella</i> (Hübner)	15	16
<i>Crotalaria</i>	see rattlebox		
cucumber	<i>Diaphania indica</i> Saunders complex	31	50
	<i>Diaphania nitidalis</i> (Cramer)	31	50
	<i>Ostrinia nubilalis</i> (Hübner)	25	36
	<i>Udea rubigalis</i> (Guenée)	29	46
<i>Cucumeropsis manii</i>	<i>Cadra cautella</i> (Walker)	16	17
<i>Cucumis</i>	see melon		
<i>Cucumis melo</i>	see cantaloupe		
<i>Cucumis sativus</i>	see cucumber		
<i>Cucurbita</i>	see gourd		
<i>Cucurbita</i>	see squash		
<i>Cucurbita pepo</i>	see pumpkin		
Cucurbitaceae	<i>Diaphania indica</i> Saunders complex	31	50
	<i>Diaphania nitidalis</i> (Cramer)	31	50
cumin	<i>Cadra cautella</i> (Walker)	16	17
	<i>Corcyra cephalonica</i> (Stainton)	20	26
<i>Cuminum</i>	see cumin		
currant	<i>Ephestia elutella</i> (Hübner)	15	16
currant, cultivated	<i>Ephestia elutella</i> (Hübner)	15	16
<i>Cyamopsis tetragonoloba</i>	see guar		
cydonia	<i>Ectomyelois ceratoniae</i> (Zeller)	13	13

Host	Pyraloid Species	Page	Key Couplet
<i>Cydonia</i>	see cydonia		
<i>Cydonia oblonga</i>	see quince		
<i>Cymbopogon citratus</i>	see lemon grass		
<i>Cymbopogon flexuosus</i>	see lemon grass, east Indian		
<i>Cyperus papyrus</i>	see papyrus		
<i>Cyphomandra betacea</i>	see tree tomato		
daisy	<i>Spoladea recurvalis</i> Fabricius	28	45
	<i>Udea rubigalis</i> (Guenée)	29	46
damp grain	<i>Aglossa caprealis</i> (Hübner)	18	21
dancing-lady orchid	<i>Paralipsa gularis</i> (Zeller)	20	26
<i>Daucus</i>	see carrot		
<i>Daucus carota</i>	see carrot		
<i>Dennettia</i>	<i>Ephestia kuehniella</i> (Zeller)	15	16
<i>Desmoncus</i>	<i>Cadra cautella</i> (Walker)	16	17
<i>Dialium guineense</i>	see velvet tamarind		
<i>Dianthus</i>	see pink		
<i>Dimocarpus longan</i>	see longan		
<i>Dioscorea</i>	see yam		
diospyros	<i>Amyelois transitella</i> (Walker)	14	13
	<i>Cryptoblabes</i> sp.	10	6
	<i>Ectomyelois ceratoniae</i> (Zeller)	13	13
	<i>Ephestia elutella</i> (Hübner)	15	16
<i>Diospyros</i>	see diospyros		
dock	<i>Ancylostomia stercorea</i> (Zeller)	10	8
<i>Dracaena fragrans</i>	see fragrant dracaena		
dried beans	<i>Cadra figulilella</i> (Gregson)	17	18
dried foodstuffs	<i>Cadra calidella</i> (Guenée)	17	18
dried fruit	<i>Cadra calidella</i> (Guenée)	17	18
	<i>Cadra figulilella</i> (Gregson)	17	18
dried vegetable products	<i>Cadra cautella</i> (Walker)	16	17
	<i>Ephestia elutella</i> (Hübner)	15	16
	<i>Ephestia kuehniella</i> (Zeller)	15	16
	<i>Pyralis farinalis</i> Linnaeus	18	21
	<i>Trachylepidia fructicassiella</i> Ragonot	20	25
dunnage	<i>Paralipsa gularis</i> (Zeller)	20	26
durian	<i>Ephestia elutella</i> (Hübner)	15	16
<i>Durio zibethinus</i>	see durian		
eelgrass	<i>Parapoynx diminutalis</i> Snellen	21	27
eelgrass, American	<i>Parapoynx diminutalis</i> Snellen	21	27
<i>Egeria densa</i>	see Brazilian waterweed		
eggplant	<i>Chilo suppressalis</i> (Walker)	23	31
	<i>Leucinodes orbonalis</i> (Guenée)	32	51
	<i>Lineodes integra</i> (Zeller)	29	46
	<i>Neoleucinodes elegantalis</i> (Guenée)	32	51
	<i>Ostrinia nubilalis</i> (Hübner)	25	36
	<i>Paralipsa gularis</i> (Zeller)	20	26
	<i>Rhectocraspeda periusalis</i> (Walker)	28	43
Elasis	<i>Paralipsa gularis</i> (Zeller)	20	26
elephant's ear	<i>Herpetogramma bipunctalis</i> (Fabricius)	27	43
	<i>Pyrausta</i> sp.	23	33
	<i>Spoladea recurvalis</i> Fabricius	28	45
<i>Elettaria cardamomum</i>	see cardamom		
<i>Entada</i>	see callingcard vine		
<i>Eriobotrya</i>	see loquat		
<i>Eryngium foetidum</i>	see spiritweed		

Host	Pyraloid Species	Page	Key Couplet
erythrina	<i>Cadra cautella</i> (Walker)	16	17
	<i>Pyrausta</i> sp.	23	33
<i>Erythrina</i>	see erythrina		
<i>Eucalyptus</i>	<i>Ephestia elutella</i> (Hübner)	15	16
	<i>Plodia interpunctella</i> (Hübner)	14	14
<i>Eugenia</i>	<i>Conogethes</i> spp.	24	34
<i>Eupatorium</i>	see thoroughwort		
<i>Euphorbia</i>	<i>Conogethes</i> spp.	24	34
European chestnut	<i>Cadra figulilella</i> (Gregson)	17	18
	<i>Conogethes</i> spp.	24	34
	<i>Ectomyelois ceratoniae</i> (Zeller)	13	13
	<i>Etiella zinckenella</i> (Treitschke)	17	20
	<i>Plodia interpunctella</i> (Hübner)	14	14
fanpetals	<i>Elasmopalpus lignosellus</i> (Zeller)	9	6
<i>Fernaldia</i>	<i>Diaphania indica</i> Saunders complex	31	50
	<i>Rhectocraspeda periusalis</i> (Walker)	28	43
<i>Fernaldia pandurata</i>	see loroco		
<i>Ficus</i>	<i>Cadra calidella</i> (Guenée)	17	18
	<i>Cadra figulilella</i> (Gregson)	17	18
	<i>Plodia interpunctella</i> (Hübner)	14	14
<i>Ficus carica</i>	see fig		
fig	<i>Cadra calidella</i> (Guenée)	17	18
	<i>Cadra cautella</i> (Walker)	16	17
	<i>Cadra figulilella</i> (Gregson)	17	18
	<i>Ectomyelois ceratoniae</i> (Zeller)	13	13
	<i>Ephestia elutella</i> (Hübner)	15	16
	<i>Plodia interpunctella</i> (Hübner)	14	14
filbert, common	<i>Elasmopalpus lignosellus</i> (Zeller)	9	6
flax, common	<i>Cadra cautella</i> (Walker)	16	17
foodstuffs	<i>Pyralis farinalis</i> Linnaeus	18	21
<i>Fragaria</i>	see strawberry		
fragrant dracaena	<i>Parapoinx diminutalis</i> Snellen	21	27
gamagrass, eastern	<i>Diatraea</i> spp.	23	31
<i>Garcinia mangostana</i>	see mangosteen		
gardenia	<i>Conogethes</i> spp.	24	34
	<i>Hendecasis duplifascialis</i> Hampson	29	48
<i>Gardenia</i>	see gardenia		
<i>Gardenia jasminoides</i>	see cape jasmine		
garlic	<i>Aglossa caprealis</i> (Hübner)	18	21
	<i>Cadra cautella</i> (Walker)	16	17
	<i>Cadra figulilella</i> (Gregson)	17	18
	<i>Ephestia elutella</i> (Hübner)	15	16
ginger	<i>Phidotricha erigens</i> (Ragonot)	17	19
ginseng	<i>Plodia interpunctella</i> (Hübner)	14	14
<i>Gleditsia</i>	see locust		
<i>Glycine max</i>	see soybean		
golden shower	<i>Trachylepidia fructicassella</i> Ragonot	20	25
goldenrod	<i>Udea rubigalis</i> (Guenée)	29	46
<i>Gomphrena</i>	see amaranth		
goosefoot	<i>Spoladea recurvalis</i> Fabricius	28	45
<i>Gossypium</i>	see cotton		
gourd	<i>Cadra cautella</i> (Walker)	16	17
	<i>Corcyra cephalonica</i> (Stainton)	20	26
	<i>Diaphania indica</i> Saunders complex	31	50
	<i>Diaphania nitidalis</i> (Cramer)	31	50

Host	Pyraloid Species	Page	Key Couplet
	<i>Ectomyelois ceratoniae</i> (Zeller)	13	13
	<i>Etiella zinckenella</i> (Treitschke)	17	20
	<i>Paralipsa gularis</i> (Zeller)	20	26
grape	<i>Plodia interpunctella</i> (Hübner)	14	14
	<i>Cadra cautella</i> (Walker)	16	17
	<i>Cryptoblabes</i> sp.	10	6
	<i>Ephestia elutella</i> (Hübner)	15	16
	<i>Plodia interpunctella</i> (Hübner)	14	14
grape, wine	<i>Cadra calidella</i> (Guenée)	17	18
greater burdock	<i>Cadra cautella</i> (Walker)	16	17
	<i>Ephestia elutella</i> (Hübner)	15	16
	<i>Paralipsa gularis</i> (Zeller)	20	26
groundcherry, Mexican (tomatillo)	<i>Diaphania nitidalis</i> (Cramer)	31	50
	<i>Lineodes integra</i> (Zeller)	29	46
groundcherry, Peruvian	<i>Lineodes integra</i> (Zeller)	29	46
guar	<i>Fundella pellucens</i> Zeller	11	10
guava	<i>Ancylostomia stercorea</i> (Zeller)	10	8
	<i>Cadra cautella</i> (Walker)	16	17
	<i>Cadra figulilella</i> (Gregson)	17	18
	<i>Conogethes</i> spp.	24	34
	<i>Cryptoblabes</i> sp.	10	6
	<i>Ectomyelois ceratoniae</i> (Zeller)	13	13
<i>Guazuma ulmifolia</i>	see bastardcedar		
guinea henweed	<i>Phidotricha erigens</i> (Ragonot)	17	19
<i>Guizotia abyssinica</i>	see ramtilla		
hazelnut	<i>Cadra cautella</i> (Walker)	16	17
	<i>Plodia interpunctella</i> (Hübner)	14	14
<i>Helianthus annuus</i>	see sunflower, common		
<i>Hemigraphis alternata</i>	see redivy		
higuillo de hoja menuda	<i>Herpetogramma bipunctalis</i> (Fabricius)	27	43
hop, common	<i>Ephestia elutella</i> (Hübner)	15	16
<i>Hordeum vulgare</i>	see barley, common		
horsebean	<i>Etiella zinckenella</i> (Treitschke)	17	20
	<i>Plodia interpunctella</i> (Hübner)	14	14
horseradishtree	<i>Ephestia kuehniella</i> (Zeller)	15	16
<i>Humulus lupulus</i>	see hop, common		
hyacinthbean	<i>Etiella zinckenella</i> (Treitschke)	17	20
	<i>Maruca vitrata</i> (Fabricius)	24	35
hydrangea	<i>Ephestia elutella</i> (Hübner)	15	16
<i>Hydrangea</i>	see hydrangea		
hydrilla	<i>Parapoynx diminutalis</i> Snellen	21	27
<i>Hydrilla</i>	see hydrilla		
<i>Hygrophila</i>	see swampweed		
icecreambean	<i>Plodia interpunctella</i> (Hübner)	14	14
<i>Impatiens</i>	see touch-me-not		
indigoberry	<i>Amyelois transitella</i> (Walker)	14	13
inga	<i>Corcyra cephalonica</i> (Stainton)	20	26
	<i>Trachylepidia fructicassella</i> Ragonot	20	25
<i>Inga</i>	see inga		
<i>Inga edulis</i>	see icecreambean		
<i>Ipomoea</i>	see morning-glory		
<i>Ipomoea batatas</i>	see sweet potato		
ivy gourd	<i>Diaphania nitidalis</i> (Cramer)	31	50
ixora	<i>Ephestia kuehniella</i> (Zeller)	15	16
<i>Ixora</i>	see ixora		

Host	Pyraloid Species	Page	Key Couplet
jasmine	<i>Hendecasis duplifascialis</i> Hampson	29	48
jasmine, Arabian	<i>Hendecasis duplifascialis</i> Hampson	29	48
<i>Jasminum sambac</i>	see jasmine, Arabian		
<i>Jatropha curcas</i>	see Barbados nut		
<i>Jatropha</i>	see nettlespurge		
jessamine	<i>Hendecasis duplifascialis</i> Hampson	29	48
Johnsongrass	<i>Elasmopalpus lignosellus</i> (Zeller)	9	6
jojoba	<i>Plodia interpunctella</i> (Hübner)	14	14
<i>Juglans</i>	see walnut		
<i>Juglans nigra</i>	see walnut, black		
<i>Juglans regia</i>	see walnut, English		
jujube, common	<i>Plodia interpunctella</i> (Hübner)	14	14
lablab	<i>Ancylostomia stercorea</i> (Zeller)	10	8
	<i>Maruca vitrata</i> (Fabricius)	24	35
<i>Lablab</i>	see lablab		
<i>Lablab purpureus</i>	see hyacinthbean		
<i>Lactuca</i>	see lettuce		
langsats	<i>Ectomyelois ceratoniae</i> (Zeller)	13	13
	<i>Paralipsa gularis</i> (Zeller)	20	26
<i>Lansium domesticum</i>	see langsats		
<i>Lathyrus</i>	see pea		
<i>Lavandula</i>	see lavender		
lavender	<i>Cadra cautella</i> (Walker)	16	17
	<i>Ephestia elutella</i> (Hübner)	15	16
	<i>Lineodes integra</i> (Zeller)	29	46
legume	<i>Ectomyelois ceratoniae</i> (Zeller)	13	13
	<i>Etiella zinckenella</i> (Treitschke)	17	20
	<i>Maruca vitrata</i> (Fabricius)	24	35
lemon grass	<i>Chilo suppressalis</i> (Walker)	23	31
	<i>Diatraea</i> spp.	23	31
	<i>Eoreuma loftini</i> (Dyar)	22	30
lemon grass, east Indian	<i>Chilo suppressalis</i> (Walker)	23	31
<i>Lens</i>	see lentil		
lentil	<i>Corcyra cephalonica</i> (Stainton)	20	26
lettuce	<i>Ostrinia nubilalis</i> (Hübner)	25	36
	<i>Spoladea recurvalis</i> Fabricius	28	45
	<i>Udea rubigalis</i> (Guenée)	29	46
<i>Limnophila</i>	see marshweed		
<i>Limonium</i>	see sealavender		
<i>Limonium sinuatum</i>	see sealavender, wavyleaf		
<i>Linum usitatissimum</i>	see flax, common		
<i>Lippia graveolens</i>	see oregano, Mexican		
<i>Litchi chinensis</i>	see lychee		
locust	<i>Plodia interpunctella</i> (Hübner)	14	14
longan	<i>Conogethes</i> spp.	24	34
	<i>Cryptoblabes</i> sp.	10	6
	<i>Paralipsa gularis</i> (Zeller)	20	26
loosestrife	<i>Cryptoblabes</i> sp.	10	6
loquat	<i>Phidotricha erigens</i> (Ragonot)	17	19
loroco	<i>Plodia interpunctella</i> (Hübner)	14	14
<i>Ludwigia</i>	see primrose-willow		
luffa	<i>Diaphania indica</i> Saunders complex	31	50
	<i>Diaphania nitidalis</i> (Cramer)	31	50
<i>Luffa</i>	see luffa		
<i>Luffa acutangula</i>	see sinkwa towelsponge		

Host	Pyraloid Species	Page	Key Couplet
lychee	<i>Cadra figulilella</i> (Gregson)	17	18
	<i>Conogethes</i> spp.	24	34
<i>Lythrum</i>	see loosestrife		
<i>Macadamia integrifolia</i>	see macadamia nut		
macadamia nut	<i>Cadra cautella</i> (Walker)	16	17
	<i>Cadra figulilella</i> (Gregson)	17	18
mahogany	<i>Hypsipyla</i> sp.	11	9
<i>Malus</i>	see apple		
<i>Malus pumila</i>	see apple, paradise		
<i>Malus sylvestris</i>	see crabapple, European		
mammea	<i>Phidotricha erigens</i> (Ragonot)	17	19
<i>Mammea</i>	see mammea		
mammee sapote	<i>Plodia interpunctella</i> (Hübner)	14	14
<i>Mangifera indica</i>	see mango		
mango	<i>Amyelois transitella</i> (Walker)	14	13
	<i>Ancylostomia stercorea</i> (Zeller)	10	8
	<i>Cadra cautella</i> (Walker)	16	17
	<i>Ectomyelois ceratoniae</i> (Zeller)	13	13
	<i>Ephestia kuehniella</i> (Zeller)	15	16
	<i>Phidotricha erigens</i> (Ragonot)	17	19
mangosteen	<i>Fundella pellucens</i> Zeller	11	10
	<i>Paralipsa gularis</i> (Zeller)	20	26
<i>Manihot esculenta</i>	see cassava		
maranta	<i>Elasmopalpus lignosellus</i> (Zeller)	9	6
<i>Maranta</i>	see maranta		
marigold	<i>Ephestia elutella</i> (Hübner)	15	16
	<i>Homoeosoma electellum</i> Hulst	12	11
marjoram, sweet	<i>Duponchelia fovealis</i> Zeller	30	48
	<i>Pyrausta</i> sp.	23	33
marshweed	<i>Parapoynx diminutalis</i> Snellen	21	27
<i>Matricaria chamomilla</i>	see chamomile, German		
Maule's quince	<i>Cryptoblabes</i> sp.	10	6
<i>Mayaca fluviatilis</i>	see stream bogmoss		
<i>Medicago sativa</i>	see alfalfa		
<i>Melicoccus bijugatus</i>	see spanish lime		
melon	<i>Diaphania indica</i> Saunders complex	31	50
	<i>Diaphania nitidalis</i> (Cramer)	31	50
	<i>Etiella zinckenella</i> (Treitschke)	17	20
	<i>Phidotricha erigens</i> (Ragonot)	17	19
<i>Mentha</i>	see mint		
<i>Mentha arvensis</i>	see mint, wild		
<i>Mentha piperita</i>	see peppermint		
mesquite	<i>Plodia interpunctella</i> (Hübner)	14	14
millet	<i>Chilo suppressalis</i> (Walker)	23	31
	<i>Eoreuma loftini</i> (Dyar)	22	30
<i>Mimosa pigra</i>	see Puerto Rico sensitive-briar		
mint	<i>Duponchelia fovealis</i> Zeller	30	48
	<i>Elasmopalpus lignosellus</i> (Zeller)	9	6
	<i>Plodia interpunctella</i> (Hübner)	14	14
	<i>Pyrausta</i> sp.	23	33
	<i>Spoladea recurvalis</i> Fabricius	28	45
	<i>Udea rubigalis</i> (Guenée)	29	46
mint, wild	<i>Pyrausta</i> sp.	23	33
mombin, yellow	<i>Plodia interpunctella</i> (Hübner)	14	14
momordica	<i>Aglossa caprealis</i> (Hübner)	18	21

Host	Pyraloid Species	Page	Key Couplet
	<i>Diaphania indica</i> Saunders complex	31	50
	<i>Diaphania nitidalis</i> (Cramer)	31	50
<i>Momordica</i>	see momordica		
<i>Momordica balsamina</i>	see balsampear, southern		
<i>Momordica charantia</i>	see balsambear		
monkeypod	<i>Cadra cautella</i> (Walker)	16	17
	<i>Ectomyelois ceratoniae</i> (Zeller)	13	13
	<i>Phidotricha erigens</i> (Ragonot)	17	19
	<i>Plodia interpunctella</i> (Hübner)	14	14
<i>Moringa oleifera</i>	see horseradish tree		
morning-glory	<i>Udea rubigalis</i> (Guenée)	29	46
<i>Morus</i>	see mulberry		
mulberry	<i>Cadra calidella</i> (Guenée)	17	18
	<i>Cadra cautella</i> (Walker)	16	17
	<i>Cadra figulilella</i> (Gregson)	17	18
	<i>Plodia interpunctella</i> (Hübner)	14	14
murraya	<i>Diaphania indica</i> Saunders complex	31	50
<i>Murraya</i>	see murraya		
<i>Murraya paniculata</i>	see box, Chinese		
<i>Musa</i>	see banana		
<i>Musa paradisiaca</i>	see plantain, French		
mustard	<i>Corcyra cephalonica</i> (Stainton)	20	26
	<i>Cryptoblabes</i> sp.	10	6
	<i>Ephestia elutella</i> (Hübner)	15	16
	<i>Evergestis rimosalis</i> (Guenée)	25	37
	<i>Hellula phidilealis</i> (Walker)	26	39
	<i>Hellula rogatalis</i> (Hulst)	26	39
	<i>Spoladea recurvalis</i> Fabricius	28	45
<i>Myriophyllum</i>	see watermilfoil		
<i>Myristica fragrans</i>	see nutmeg		
nalta jute	<i>Herpetogramma bipunctalis</i> (Fabricius)	27	43
	<i>Spoladea recurvalis</i> Fabricius	28	45
naranjilla	<i>Neoleucinodes elegantalis</i> (Guenée)	32	51
<i>Narcissus tazetta</i>	see narcissus, cream		
narcissus, cream	<i>Pyralis farinalis</i> Linnaeus	18	21
<i>Nasturtium officinale</i>	see watercress		
nephelium	<i>Cryptoblabes</i> sp.	10	6
<i>Nephelium</i>	see nephelium		
<i>Nephelium lappaceum</i>	see rambutan		
nettlespurge	<i>Herpetogramma bipunctalis</i> (Fabricius)	27	43
nightshade	<i>Etiella zinckenella</i> (Treitschke)	17	20
	<i>Leucinodes orbonalis</i> (Guenée)	32	51
	<i>Neoleucinodes elegantalis</i> (Guenée)	32	51
	<i>Paralipsa gularis</i> (Zeller)	20	26
	<i>Plodia interpunctella</i> (Hübner)	14	14
nightshade, black	<i>Herpetogramma bipunctalis</i> (Fabricius)	27	43
nomaphila	<i>Spoladea recurvalis</i> Fabricius	28	45
<i>Nomaphila</i>	see nomaphila		
Nordman fir	<i>Plodia interpunctella</i> (Hübner)	14	14
nutmeg	<i>Cadra cautella</i> (Walker)	16	17
nuts	<i>Cadra calidella</i> (Guenée)	17	18
	<i>Cadra figulilella</i> (Gregson)	17	18
	<i>Ectomyelois ceratoniae</i> (Zeller)	13	13
oak	<i>Cryptoblabes</i> sp.	10	6
	<i>Ephestia elutella</i> (Hübner)	15	16

Host	Pyraloid Species	Page	Key Couplet
<i>Ocimum</i>	see basil		
<i>Ocimum basilicum</i>	see basil, sweet		
okra	<i>Cadra cautella</i> (Walker)	16	17
	<i>Corcyra cephalonica</i> (Stainton)	20	26
	<i>Etiella zinckenella</i> (Treitschke)	17	20
<i>Olea</i>	see olive		
olive	<i>Plodia interpunctella</i> (Hübner)	14	14
<i>Oncidium</i>	see dancing-lady orchid		
onion	<i>Cadra figulilella</i> (Gregson)	17	18
	<i>Pyrausta</i> sp.	23	33
<i>Opuntia</i>	see pricklypear		
orange	<i>Amyelois transitella</i> (Walker)	14	13
	<i>Cryptoblabes</i> sp.	10	6
	<i>Ectomyelois ceratoniae</i> (Zeller)	13	13
	<i>Homoeosoma electellum</i> Hulst	12	11
	<i>Phidotricha erigens</i> (Ragonot)	17	19
Orchidaceae	<i>Hendecasis duplifascialis</i> Hampson	29	48
oregano	<i>Pyrausta</i> sp.	23	33
oregano, Mexican	<i>Pyrausta</i> sp.	23	33
origanum	<i>Pyrausta</i> sp.	23	33
<i>Origanum</i>	see origanum		
<i>Origanum majorana</i>	see marjoram, sweet		
<i>Origanum vulgare</i>	see oregano		
<i>Oryza</i>	see rice		
<i>Oryza sativa</i>	see rice		
packing in crates	<i>Aglossa caprealis</i> (Hübner)	18	21
	<i>Pyralis farinalis</i> Linnaeus	18	21
<i>Paeonia</i>	see peony		
<i>Paeonia suffruticosa</i>	see peony, moutan		
pak choi	<i>Hellula rogatalis</i> (Hulst)	26	39
palm, date	<i>Amyelois transitella</i> (Walker)	14	13
	<i>Cadra calidella</i> (Guenée)	17	18
	<i>Cadra cautella</i> (Walker)	16	17
	<i>Cadra figulilella</i> (Gregson)	17	18
	<i>Cryptoblabes</i> sp.	10	6
	<i>Ectomyelois ceratoniae</i> (Zeller)	13	13
	<i>Paralipsa gularis</i> (Zeller)	20	26
<i>Panax</i>	see ginseng		
papaya	<i>Cadra cautella</i> (Walker)	16	17
papyrus	<i>Diatraea</i> spp.	23	31
	<i>Paralipsa gularis</i> (Zeller)	20	26
parkia	<i>Etiella zinckenella</i> (Treitschke)	17	20
<i>Parkia</i>	see parkia		
<i>Parkia speciosa</i>	see parkia		
parsley	<i>Spoladea recurvalis</i> Fabricius	28	45
	<i>Udea rubigalis</i> (Guenée)	29	46
<i>Passiflora</i>	see passionflower		
<i>Passiflora edulis</i>	see Passion fruit		
Passion fruit	<i>Phidotricha erigens</i> (Ragonot)	17	19
passionflower	<i>Cryptoblabes</i> sp.	10	6
pea	<i>Ancylostomia stercorea</i> (Zeller)	10	8
	<i>Etiella zinckenella</i> (Treitschke)	17	20
	<i>Maruca vitrata</i> (Fabricius)	24	35
pea, blackeyed	<i>Ectomyelois ceratoniae</i> (Zeller)	13	13
	<i>Ephestia kuehniella</i> (Zeller)	15	16

Host	Pyraloid Species	Page	Key Couplet
	<i>Fundella pellucens</i> Zeller	11	10
	<i>Maruca vitrata</i> (Fabricius)	24	35
pea, garden	<i>Ancylostomia stercorea</i> (Zeller)	10	8
	<i>Cadra cautella</i> (Walker)	16	17
	<i>Elasmopalpus lignosellus</i> (Zeller)	9	6
	<i>Etiella zinckenella</i> (Treitschke)	17	20
	<i>Fundella pellucens</i> Zeller	11	10
	<i>Maruca vitrata</i> (Fabricius)	24	35
	<i>Ostrinia nubilalis</i> (Hübner)	25	36
	<i>Udea rubigalis</i> (Guenée)	29	46
peach	<i>Amyelois transitella</i> (Walker)	14	13
	<i>Cadra cautella</i> (Walker)	16	17
	<i>Conogethes</i> spp.	24	34
	<i>Plodia interpunctella</i> (Hübner)	14	14
peanut	<i>Cadra cautella</i> (Walker)	16	17
	<i>Corcyra cephalonica</i> (Stainton)	20	26
	<i>Plodia interpunctella</i> (Hübner)	14	14
pear, chinese	<i>Ectomyelois ceratoniae</i> (Zeller)	13	13
pear, common	<i>Amyelois transitella</i> (Walker)	14	13
	<i>Cadra cautella</i> (Walker)	16	17
	<i>Conogethes</i> spp.	24	34
	<i>Ectomyelois ceratoniae</i> (Zeller)	13	13
	<i>Plodia interpunctella</i> (Hübner)	14	14
pecan	<i>Spoladea recurvalis</i> Fabricius	28	45
peony	<i>Amyelois transitella</i> (Walker)	14	13
	<i>Duponchelia fovealis</i> Zeller	30	48
peony, moutan	<i>Plodia interpunctella</i> (Hübner)	14	14
pepper	<i>Cadra cautella</i> (Walker)	16	17
	<i>Cadra figulilella</i> (Gregson)	17	18
	<i>Duponchelia fovealis</i> Zeller	30	48
	<i>Ectomyelois ceratoniae</i> (Zeller)	13	13
	<i>Ephestia elutella</i> (Hübner)	15	16
	<i>Herpetogramma bipunctalis</i> (Fabricius)	27	43
	<i>Leucinodes orbonalis</i> (Guenée)	32	51
	<i>Lineodes integra</i> (Zeller)	29	46
	<i>Mussidia nigrivenella</i> Ragonot	9	4
	<i>Neoleucinodes elegantalis</i> (Guenée)	32	51
	<i>Ostrinia nubilalis</i> (Hübner)	25	36
	<i>Plodia interpunctella</i> (Hübner)	14	14
pepper, black	<i>Cadra cautella</i> (Walker)	16	17
peppermint	<i>Pyrausta</i> sp.	23	33
peppertree	<i>Cryptoblabes</i> sp.	10	6
<i>Persea americana</i>	see avocado		
<i>Petiveria alliacea</i>	see guinea henweed		
<i>Petroselinum crispum</i>	see parsley		
<i>Phaseolus</i>	see bean		
<i>Phaseolus lunatus</i>	see bean, butter		
<i>Phaseolus lunatus</i>	see bean, lima or sieva		
<i>Phaseolus vulgaris</i>	see bean, kidney		
<i>Phoenix</i>	see palm, date		
<i>Phoenix dactylifera</i>	see palm, date		
<i>Phragmites</i>	see reed		
<i>Phragmites australis</i>	see reed, common		
<i>Physalis peruviana</i>	see groundcherry, Peruvian		
<i>Physalis philadelphica</i>	see groundcherry, Mexican (tomatillo)		

Host	Pyraloid Species	Page	Key Couplet
<i>Physostigma venenosum</i>	see bean, calabar		
<i>Phytolacca</i>	see pokeweed		
<i>Phytolacca americana</i>	see pokeweed, american		
pigeon pea	<i>Amyelois transitella</i> (Walker)	14	13
	<i>Ancylostomia stercorea</i> (Zeller)	10	8
	<i>Ephestia kuehniella</i> (Zeller)	15	16
	<i>Etiella zinckenella</i> (Treitschke)	17	20
	<i>Fundella pellucens</i> Zeller	11	10
	<i>Maruca vitrata</i> (Fabricius)	24	35
<i>Pimenta dioica</i>	see allspice		
pine	<i>Conogethes</i> spp.	24	34
	<i>Cryptoblabes</i> sp.	10	6
	<i>Plodia interpunctella</i> (Hübner)	14	14
pineapple	<i>Alpheias conspirata</i> Heinrich	19	24
	<i>Cadra cautella</i> (Walker)	16	17
	<i>Cryptoblabes</i> sp.	10	6
	<i>Elasmopalpus lignosellus</i> (Zeller)	9	6
	<i>Genopaschia protomis</i> Dyar	19	24
	<i>Paralipsa gularis</i> (Zeller)	20	26
	<i>Plodia interpunctella</i> (Hübner)	14	14
pink	<i>Hendecasis duplifascialis</i> Hampson	29	48
pink shower	<i>Trachylepidia fructicassella</i> Ragonot	20	25
<i>Pinus</i>	see pine		
<i>Piper aduncum</i>	see higuillo de hoja menuda		
<i>Piper nigrum</i>	see pepper, black		
pistache	<i>Plodia interpunctella</i> (Hübner)	14	14
pistachio nut	<i>Amyelois transitella</i> (Walker)	14	13
	<i>Plodia interpunctella</i> (Hübner)	14	14
<i>Pistacia</i>	see pistache		
<i>Pistacia vera</i>	see pistachio nut		
<i>Pistia stratiotes</i>	see water lettuce		
<i>Pisum</i>	see pea		
<i>Pisum sativum</i>	see pea, garden		
pitcherplant	<i>Duponchelia fovealis</i> Zeller	30	48
<i>Pithecellobium dulce</i>	see monkeypod		
plantain, French	<i>Cadra cautella</i> (Walker)	16	17
	<i>Plodia interpunctella</i> (Hübner)	14	14
plectranthus	<i>Cadra calidella</i> (Guenée)	17	18
<i>Plectranthus</i> (seed)	see plectranthus		
plum	<i>Cadra calidella</i> (Guenée)	17	18
	<i>Cadra cautella</i> (Walker)	16	17
	<i>Cadra figulilella</i> (Gregson)	17	18
	<i>Ephestia elutella</i> (Hübner)	15	16
	<i>Plodia interpunctella</i> (Hübner)	14	14
plum, American	<i>Cadra cautella</i> (Walker)	16	17
	<i>Cadra figulilella</i> (Gregson)	17	18
	<i>Corcyra cephalonica</i> (Stainton)	20	26
	<i>Ectomyelois ceratoniae</i> (Zeller)	13	13
	<i>Plodia interpunctella</i> (Hübner)	14	14
plum, European	<i>Cadra figulilella</i> (Gregson)	17	18
	<i>Plodia interpunctella</i> (Hübner)	14	14
plum, Malabar	<i>Conogethes</i> spp.	24	34
<i>Plumeria rubra</i>	see templetree		
Poaceae	<i>Plodia interpunctella</i> (Hübner)	14	14
pokeweed	<i>Spoladea recurvalis</i> Fabricius	28	45

Host	Pyraloid Species	Page	Key Couplet
pokeweed, american	<i>Spoladea recurvalis</i> Fabricius	28	45
<i>Polianthes tuberosa</i>	see tuberose		
Polygonum perfoliatum	see tearthumb, Asiatic		
pomegranate	<i>Amyelois transitella</i> (Walker)	14	13
	<i>Cryptoblabes</i> sp.	10	6
	<i>Ectomyelois ceratoniae</i> (Zeller)	13	13
	<i>Ephestia elutella</i> (Hübner)	15	16
	<i>Leucinodes orbonalis</i> (Guenée)	32	51
	<i>Mussidia nigrivenella</i> Ragonot	9	4
	<i>Paralipsa gularis</i> (Zeller)	20	26
	<i>Plodia interpunctella</i> (Hübner)	14	14
poreleaf	<i>Spoladea recurvalis</i> Fabricius	28	45
<i>Porophyllum</i>	see poreleaf		
potato	<i>Leucinodes orbonalis</i> (Guenée)	32	51
	<i>Ostrinia nubilalis</i> (Hübner)	25	36
	<i>Rhectocraspeda periusalis</i> (Walker)	28	43
potato, irish	<i>Etiella zinckenella</i> (Treitschke)	17	20
	<i>Paralipsa gularis</i> (Zeller)	20	26
<i>Pouteria sapota</i>	see mammee sapote		
pricklypear	<i>Etiella zinckenella</i> (Treitschke)	17	20
	<i>Loxomorpha flavidissimalis</i> Grote	27	41
pride of Barbados	<i>Amyelois transitella</i> (Walker)	14	13
	<i>Etiella zinckenella</i> (Treitschke)	17	20
primrose-willow	<i>Parapopynx diminutalis</i> Snellen	21	27
<i>Prosopis</i>	see mesquite		
protea	<i>Ephestia elutella</i> (Hübner)	15	16
<i>Protea</i>	see protea		
<i>Prunus</i>	see plum		
<i>Prunus americana</i>	see plum, American		
<i>Prunus armeniaca</i>	see apricot		
<i>Prunus avium</i>	see cherry, sweet		
<i>Prunus domestica</i>	see plum, European		
<i>Prunus dulcis</i>	see almond, sweet		
<i>Prunus persica</i>	see peach		
<i>Psidium</i>	see guava		
<i>Psidium guajava</i>	see guava		
<i>Psophocarpus tetragonolobus</i>	see bean, winged		
Puerto Rico sensitive-briar	<i>Elasmopalpus lignosellus</i> (Zeller)	9	6
	<i>Phidotricha erigens</i> (Ragonot)	17	19
pumpkin	<i>Diaphania indica</i> Saunders complex	31	50
	<i>Diaphania nitidalis</i> (Cramer)	31	50
<i>Punica</i>	see pomegranate		
<i>Punica granatum</i>	see pomegranate		
<i>Pyrus communis</i>	see pear, common		
<i>Pyrus pyriflora</i>	see pear, chinese		
<i>Quercus</i>	see oak		
quince	<i>Amyelois transitella</i> (Walker)	14	13
	<i>Ectomyelois ceratoniae</i> (Zeller)	13	13
	<i>Etiella zinckenella</i> (Treitschke)	17	20
radish	<i>Hellula rogatalis</i> (Hulst)	26	39
	<i>Plodia interpunctella</i> (Hübner)	14	14
radish, cultivated	<i>Hellula phidilealis</i> (Walker)	26	39
	<i>Udea rubigalis</i> (Guenée)	29	46
raisin	<i>Cryptoblabes</i> sp.	10	6
rambutan	<i>Aglossa caprealis</i> (Hübner)	18	21

Host	Pyraloid Species	Page	Key Couplet
	<i>Conogethes</i> spp.	24	34
	<i>Cryptoblabes</i> sp.	10	6
	<i>Paralipsa gularis</i> (Zeller)	20	26
ramtilla	<i>Cadra cautella</i> (Walker)	16	17
<i>Randia</i>	see indigoberry		
<i>Randia echinocarpa</i>	<i>Amyelois transitella</i> (Walker)	14	13
<i>Raphanus</i>	see radish		
<i>Raphanus sativus</i>	see radish, cultivated		
rattlebox	<i>Cadra cautella</i> (Walker)	16	17
	<i>Pyrausta</i> sp.	23	33
red ginger	<i>Pyralis farinalis</i> Linnaeus	18	21
redivy	<i>Spoladea recurvalis</i> Fabricius	28	45
reed	<i>Chilo suppressalis</i> (Walker)	23	31
reed, common	<i>Chilo suppressalis</i> (Walker)	23	31
<i>Rheum</i>	see rhubarb		
rhododendron	<i>Paralipsa gularis</i> (Zeller)	20	26
<i>Rhododendron</i>	see rhododendron		
rhubarb	<i>Ostrinia nubilalis</i> (Hübner)	25	36
<i>Ribes</i>	see currant		
<i>Ribes rubrum</i>	see currant, cultivated		
rice	<i>Cadra cautella</i> (Walker)	16	17
	<i>Corcyra cephalonica</i> (Stainton)	20	26
	<i>Diatraea</i> spp.	23	31
	<i>Eoreuma loftini</i> (Dyar)	22	30
	<i>Ephestia elutella</i> (Hübner)	15	16
	<i>Plodia interpunctella</i> (Hübner)	14	14
rice straw	<i>Chilo suppressalis</i> (Walker)	23	31
riverhemp	<i>Ectomyelois ceratoniae</i> (Zeller)	13	13
Roman chamomile	<i>Cadra cautella</i> (Walker)	16	17
<i>Rosa</i>	see rose		
rose	<i>Achyra rantalis</i> (Guenée)	27	41
	<i>Cadra cautella</i> (Walker)	16	17
	<i>Hendecasis duplifascialis</i> Hampson	29	48
	<i>Udea rubigalis</i> (Guenée)	29	46
rosemary	<i>Pyrausta</i> sp.	23	33
<i>Rosmarinus</i>	see rosemary		
<i>Rosmarinus officinalis</i>	see rosemary		
rotala	<i>Parapoynx diminutalis</i> Snellen	21	27
<i>Rotala</i>	see rotala		
rotting vegetable matter	<i>Aglossa caprealis</i> (Hübner)	18	21
<i>Rubus</i>	see blackberry		
rue	<i>Spoladea recurvalis</i> Fabricius	28	45
<i>Rumex</i>	see dock		
<i>Ruta</i>	see rue		
<i>Saccharum</i>	see sugarcane		
<i>Saccharum officinarum</i>	see sugarcane		
sage	<i>Pyrausta</i> sp.	23	33
sage, blue	<i>Pyrausta</i> sp.	23	33
	<i>Spoladea recurvalis</i> Fabricius	28	45
saltbush	<i>Spoladea recurvalis</i> Fabricius	28	45
<i>Salvia</i>	see sage		
<i>Salvia officinalis</i>	see sage, blue		
<i>Sarracenia</i>	see pitcherplant		
<i>Satureja hortensis</i>	see summer savory		
<i>Schinus</i>	see peppertree		

Host	Pyraloid Species	Page	Key Couplet
sealavender	<i>Duponchelia fovealis</i> Zeller	30	48
	<i>Homoeosoma electellum</i> Hulst	12	11
	<i>Pyrausta</i> sp.	23	33
	<i>Udea rubigalis</i> (Guenée)	29	46
sealavender, wavyleaf	<i>Maruca vitrata</i> (Fabricius)	24	35
seapurslane	<i>Achyra rantalis</i> (Guenée)	27	41
<i>Sechium edule</i>	see chayote		
seeds	<i>Cadra figulilella</i> (Gregson)	17	18
sesame	<i>Cadra cautella</i> (Walker)	16	17
	<i>Corcyra cephalonica</i> (Stainton)	20	26
	<i>Plodia interpunctella</i> (Hübner)	14	14
<i>Sesamum orientale</i>	see sesame		
<i>Sesbania</i>	see riverhemp		
<i>Sesbania grandiflora</i>	see vegetable hummingbird		
<i>Sesuvium</i>	see seapurslane		
<i>Sida</i>	see fanpetals		
<i>Simmondsia chinensis</i>	see jojoba		
sinkwa towelsponge	<i>Diaphania indica</i> Saunders complex	31	50
Solanaceae	<i>Leucinodes orbonalis</i> (Guenée)	32	51
	<i>Lineodes integra</i> (Zeller)	29	46
	<i>Neoleucinodes elegantalis</i> (Guenée)	32	51
	<i>Rhectocraspeda periusalis</i> (Walker)	28	43
		see nightshade	
<i>Solanum</i>	see potato		
<i>Solanum lycopersicum</i>	see tomato		
<i>Solanum melongena</i>	see eggplant		
<i>Solanum nigrum</i>	see nightshade, black		
<i>Solanum quitoense</i>	see naranjilla		
<i>Solanum torvum</i>	see turkey berry		
<i>Solanum tuberosum</i>	see potato, irish		
<i>Solidago</i>	see goldenrod		
sorghum	<i>Chilo suppressalis</i> (Walker)	23	31
	<i>Corcyra cephalonica</i> (Stainton)	20	26
	<i>Diatraea</i> spp.	23	31
	<i>Elasmopalpus lignosellus</i> (Zeller)	9	6
	<i>Eoreuma loftini</i> (Dyar)	22	30
	<i>Phidotricha erigens</i> (Ragonot)	17	19
		see sorghum	
<i>Sorghum bicolor</i>	see sorghum		
<i>Sorghum halepense</i>	see Johnsongrass		
soybean	<i>Achyra rantalis</i> (Guenée)	27	41
	<i>Cadra cautella</i> (Walker)	16	17
	<i>Elasmopalpus lignosellus</i> (Zeller)	9	6
	<i>Herpetogramma bipunctalis</i> (Fabricius)	27	43
	<i>Plodia interpunctella</i> (Hübner)	14	14
	<i>Spoladea recurvalis</i> Fabricius	28	45
Spanish cedar logs	<i>Hypsipyla</i> sp.	11	9
spanish lime	<i>Ectomyelois ceratoniae</i> (Zeller)	13	13
<i>Spartina alterniflora</i>	see cordgrass, smooth		
Spermacoce (Borreria)	see buttonweed		
spinach	<i>Hellula phidilealis</i> (Walker)	26	39
	<i>Herpetogramma bipunctalis</i> (Fabricius)	27	43
	<i>Pyrausta</i> sp.	23	33
	<i>Spoladea recurvalis</i> Fabricius	28	45
	<i>Udea rubigalis</i> (Guenée)	29	46

Host	Pyraloid Species	Page	Key Couplet
spinach, Tahitian	<i>Herpetogramma bipunctalis</i> (Fabricius)	27	43
spinach, Tahitian	<i>Spoladea recurvalis</i> Fabricius	28	45
<i>Spinacia</i>	see spinach		
<i>Spinacia oleracea</i>	see spinach		
spiritweed	<i>Spoladea recurvalis</i> Fabricius	28	45
	<i>Udea rubigalis</i> (Guenée)	29	46
<i>Spondias dulcis</i>	see mombin, yellow		
squash	<i>Diaphania indica</i> Saunders complex	31	50
	<i>Diaphania nitidalis</i> (Cramer)	31	50
star apple	<i>Ephestia kuehniella</i> (Zeller)	15	16
<i>Stirlingia</i>	<i>Paralipsa gularis</i> (Zeller)	20	26
stored fruit	<i>Plodia interpunctella</i> (Hübner)	14	14
stored grain	<i>Ephestia kuehniella</i> (Zeller)	15	16
	<i>Mussidia nigrivenella</i> Ragonot	9	4
	<i>Plodia interpunctella</i> (Hübner)	14	14
stored seeds	<i>Mussidia nigrivenella</i> Ragonot	9	4
stored vegetable products	<i>Cadra cautella</i> (Walker)	16	17
	<i>Corcyra cephalonica</i> (Stainton)	20	26
	<i>Ephestia elutella</i> (Hübner)	15	16
	<i>Ephestia kuehniella</i> (Zeller)	15	16
	<i>Etiella zinckenella</i> (Treitschke)	17	20
	<i>Paralipsa gularis</i> (Zeller)	20	26
	<i>Plodia interpunctella</i> (Hübner)	14	14
strawberry	<i>Elasmopalpus lignosellus</i> (Zeller)	9	6
	<i>Ostrinia nubilalis</i> (Hübner)	25	36
stream bogmoss	<i>Parapoynx diminutalis</i> Snellen	21	27
<i>Strelitzia reginae</i>	see bird-of-paradise		
string bean	<i>Elasmopalpus lignosellus</i> (Zeller)	9	6
	<i>Ostrinia nubilalis</i> (Hübner)	25	36
<i>Strobilanthes</i>	<i>Herpetogramma bipunctalis</i> (Fabricius)	27	43
	<i>Rhectocraspeda periusalis</i> (Walker)	28	43
sugar apple	<i>Cryptoblabes</i> sp.	10	6
sugar beet	<i>Udea rubigalis</i> (Guenée)	29	46
sugarcane	<i>Cadra figulilella</i> (Gregson)	17	18
	<i>Chilo suppressalis</i> (Walker)	23	31
	<i>Diatraea</i> spp.	23	31
	<i>Elasmopalpus lignosellus</i> (Zeller)	9	6
	<i>Eoreuma loftini</i> (Dyar)	22	30
summer savory	<i>Pyrausta</i> sp.	23	33
sunflower, common	<i>Homoeosoma electellum</i> Hulst	12	11
swampweed	<i>Parapoynx diminutalis</i> Snellen	21	27
sweet potato	<i>Ectomyelois ceratoniae</i> (Zeller)	13	13
	<i>Megastes</i> sp.	25	35
	<i>Udea rubigalis</i> (Guenée)	29	46
Swiss chard	<i>Spoladea recurvalis</i> Fabricius	28	45
syzygium	<i>Conogethes</i> spp.	24	34
<i>Syzygium</i>	see syzygium		
<i>Syzygium jambos</i>	see plum, Malabar		
<i>Syzygium malaccense</i>	see apple, Malaysian		
<i>Syzygium samarangense</i>	see syzygium		
<i>Tagetes</i>	see marigold		
tamarind	<i>Amyelois transitella</i> (Walker)	14	13
	<i>Cadra cautella</i> (Walker)	16	17
	<i>Cadra figulilella</i> (Gregson)	17	18
	<i>Ectomyelois ceratoniae</i> (Zeller)	13	13

Host	Pyraloid Species	Page	Key Couplet
	<i>Mussidia nigrivenella</i> Ragonot	9	4
	<i>Plodia interpunctella</i> (Hübner)	14	14
	<i>Phidotricha erigens</i> (Ragonot)	17	19
<i>Tamarindus</i>	see tamarind		
<i>Tamarindus indica</i>	see tamarind		
tamarisk	<i>Cryptoblabes</i> sp.	10	6
<i>Tamarix</i>	see tamarisk		
<i>Tanacetum</i>	see tansy		
tangerine	<i>Amyelois transitella</i> (Walker)	14	13
tansy	<i>Duponchelia fovealis</i> Zeller	30	48
tassel flower	<i>Herpetogramma bipunctalis</i> (Fabricius)	27	43
tea	<i>Plodia interpunctella</i> (Hübner)	14	14
tearthumb, Asiatic	<i>Spoladea recurvalis</i> Fabricius	28	45
templetree	<i>Hendecasis duplifascialis</i> Hampson	29	48
<i>Tetrapleura</i>	<i>Mussidia nigrivenella</i> Ragonot	9	4
<i>Theobroma cacao</i>	see cacao		
thoroughwort	<i>Spoladea recurvalis</i> Fabricius	28	45
thyme	<i>Lineodes integra</i> (Zeller)	29	46
	<i>Pyrausta</i> sp.	23	33
thyme, garden	<i>Diaphania indica</i> Saunders complex	31	50
	<i>Pyrausta</i> sp.	23	33
<i>Thymus</i>	see thyme		
<i>Thymus vulgaris</i>	see thyme, garden		
tomato	<i>Chilo suppressalis</i> (Walker)	23	31
	<i>Duponchelia fovealis</i> Zeller	30	48
	<i>Leucinodes orbonalis</i> (Guenée)	32	51
	<i>Lineodes integra</i> (Zeller)	29	46
	<i>Neoleucinodes elegantalis</i> (Guenée)	32	51
	<i>Ostrinia nubilalis</i> (Hübner)	25	36
	<i>Rhectocraspeda periusalis</i> (Walker)	28	43
touch-me-not	<i>Spoladea recurvalis</i> Fabricius	28	45
tree tomato	<i>Leucinodes orbonalis</i> (Guenée)	32	51
<i>Trifolium</i>	see clover		
<i>Trifolium repens</i>	see clover, white		
<i>Tripsacum dactyloides</i>	see gamagrass, eastern		
<i>Triticum</i>	see wheat		
<i>Triticum aestivum</i>	see wheat, common		
tuberose	<i>Hendecasis duplifascialis</i> Hampson	29	48
turkey berry	<i>Leucinodes orbonalis</i> (Guenée)	32	51
	<i>Lineodes integra</i> (Zeller)	29	46
	<i>Neoleucinodes elegantalis</i> (Guenée)	32	51
<i>Typha latifolia</i>	see cattail, broadleaf		
<i>Vaccinium</i>	see blueberry		
<i>Vallisneria</i>	see eelgrass		
<i>Vallisneria asiatica</i>	see eelgrass, American		
vegetable hummingbird	<i>Maruca vitrata</i> (Fabricius)	24	35
velvet tamarind	<i>Ectomyelois ceratoniae</i> (Zeller)	13	13
vetch	<i>Corcyra cephalonica</i> (Stainton)	20	26
viburnum	<i>Spoladea recurvalis</i> Fabricius	28	45
<i>Viburnum</i>	see viburnum		
<i>Vicia</i>	see vetch		
<i>Vicia faba</i>	see horsebean		
<i>Vigna</i>	see cowpea		
<i>Vigna unguiculata</i>	see pea, blackeyed		
<i>Vigna unquiculata</i> ssp. <i>sesquipedalis</i>	see bean, yardlong		

Host	Pyraloid Species	Page	Key Couplet
<i>Vitis</i>	see grape		
<i>Vitis</i>	see raisin		
<i>Vitis vinifera</i>	see grape, wine		
walnut	<i>Amyelois transitella</i> (Walker)	14	13
	<i>Cadra figulilella</i> (Gregson)	17	18
	<i>Ectomyelois ceratoniae</i> (Zeller)	13	13
	<i>Ephestia elutella</i> (Hübner)	15	16
walnut, black	<i>Ectomyelois ceratoniae</i> (Zeller)	13	13
	<i>Ephestia elutella</i> (Hübner)	15	16
walnut, English	<i>Ectomyelois ceratoniae</i> (Zeller)	13	13
	<i>Plodia interpunctella</i> (Hübner)	14	14
water lettuce	Schoenobiinae	21	28
watercress	<i>Evergestis rimosalis</i> (Guenée)	25	37
watermelon	<i>Pyrausta</i> sp.	23	33
watermilfoil	<i>Parapoynx diminutalis</i> Snellen	21	27
waxgourd	<i>Phidotricha erigens</i> (Ragonot)	17	19
wheat	<i>Cadra cautella</i> (Walker)	16	17
	<i>Chilo suppressalis</i> (Walker)	23	31
	<i>Corcyra cephalonica</i> (Stainton)	20	26
	<i>Ephestia elutella</i> (Hübner)	15	16
	<i>Ostrinia nubilalis</i> (Hübner)	25	36
	<i>Pyralis farinalis</i> Linnaeus	18	21
wheat, common	<i>Paralipsa gularis</i> (Zeller)	20	26
	<i>Plodia interpunctella</i> (Hübner)	14	14
white chard	<i>Hellula phidilealis</i> (Walker)	26	39
wild celery	<i>Spoladea recurvalis</i> Fabricius	28	45
	<i>Udea rubigalis</i> (Guenée)	29	46
<i>Xanthosoma</i>	see elephant's ear		
<i>Xanthosoma brasiliense</i>	see spinach, Tahitian		
<i>Xanthosoma hastifolium</i>	<i>Spoladea recurvalis</i> Fabricius	28	45
xylopia	<i>Cryptoblabes</i> sp.	10	6
<i>Xylopia</i>	see xylopia		
yam	<i>Ectomyelois ceratoniae</i> (Zeller)	13	13
<i>Zea mays</i>	see corn		
<i>Zingiber</i>	see ginger		
<i>Ziziphus zizyphus</i>	see jujube, common		