

**Smart plugs: Perceived usefulness and satisfaction:  
Evidence from United Arab Emirates**

GHAZAL, M, AKMAL, M <<http://orcid.org/0000-0002-3498-4146>>, IYANNA, S  
and GHOUDI, K

Available from Sheffield Hallam University Research Archive (SHURA) at:

<http://shura.shu.ac.uk/23063/>

---

This document is the author deposited version. You are advised to consult the  
publisher's version if you wish to cite from it.

**Published version**

GHAZAL, M, AKMAL, M, IYANNA, S and GHOUDI, K (2016). Smart plugs: Perceived  
usefulness and satisfaction: Evidence from United Arab Emirates. *Renewable and  
Sustainable Energy Reviews*, 55 (C), 1248-1259.

---

**Copyright and re-use policy**

See <http://shura.shu.ac.uk/information.html>



ELSEVIER

Contents lists available at ScienceDirect

## Renewable and Sustainable Energy Reviews

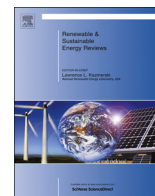
journal homepage: [www.elsevier.com/locate/rser](http://www.elsevier.com/locate/rser)

## Smart plugs: Perceived usefulness and satisfaction: Evidence from United Arab Emirates

Mohammed Ghazal<sup>a,\*</sup>, Muhammad Akmal<sup>a</sup>, Shilpa Iyanna<sup>b</sup>, Kilani Ghoudi<sup>c</sup><sup>a</sup> Abu Dhabi University, College of Engineering, Electrical and Computer Engineering Department, Abu Dhabi, United Arab Emirates<sup>b</sup> Abu Dhabi University, College of Business Administration, Abu Dhabi, United Arab Emirates<sup>c</sup> United Arab Emirates University, College of Business and Economics, Department of Statistics, AlAin, United Arab Emirates

## ARTICLE INFO

Available online 28 August 2015

## Keywords:

Sustainable consumption  
Mobile computing  
Wireless sensor networks  
Structural equation modeling  
Embedded systems

## ABSTRACT

The UAE per capita energy consumption is one of the highest in the world. Since the energy sector is the center of most ecological problems facing the world today, eco-efficiency and eco-innovations are at the top of the sustainability agenda in most countries. The UAE “Green Economy for Sustainable Development” (2012–2021) aims to position the country as a center for the export and re-export of green products and technologies. In light of the above, the focus of this paper is to present a smart plug system for monitoring and controlling household energy consumption using a mobile application. The smart plug system is an essential component in smart grids as it provides real-time high-resolution information for distribution companies to aid them in decision-making. In addition, the study measures the perceived usefulness and satisfaction of the smart plug system and its mobile application in the UAE. The paper makes an important theoretical contribution by including environmental concern as an additional variable to a well-established information systems success model. Our findings suggest that the smart plug system provides users with convenient access to information regarding their personal energy consumption and allows them to control their per capital energy consumptions via the mobile application at very low costs. Further, we validated our theoretical model using structural equation modeling and conclude that environmental concern has an indirect impact on the perceived satisfaction and both an indirect and a direct impact on the perceived usefulness of the smart plug system. The practical implications of our study suggest that per capita energy consumption is likely to significantly decrease with wide adoption of the smart plug system in the UAE.

© 2015 The Authors. Published by Elsevier Ltd. This is an open access article under the CC BY-NC-ND license (<http://creativecommons.org/licenses/by-nc-nd/4.0/>).

## Contents

1. Introduction	1248
2. Literature review	1249
3. Proposed smart plug	1251
4. Theoretical model and methodology	1253
5. Results and analysis	1254
5.1. Implemented smart plug	1256
5.2. Measurement model and its validity	1257
5.3. Structure equation model	1257
6. Conclusion	1258
Acknowledgments	1258
References	1258

## 1. Introduction

“We recognize that preserving our energy resources will be one of the greatest challenges in our drive towards sustainable

\* Corresponding author.

E-mail address: [mohammed.ghazal@adu.ac.ae](mailto:mohammed.ghazal@adu.ac.ae) (M. Ghazal).

development. This, however, will not materialize unless the different facets of our society adopt energy conservation principles in their core values. The future generations will be the chief beneficiary of our achievements and the biggest judge of what we accomplish in this field” – H.H. Sheikh Mohammed bin Rashid Al Maktoum The UAE Vice President, Prime Minister and Ruler of Dubai

Sustainable Development has been defined as “development that meets the needs of the present without compromising the ability of the future generations to meet their own needs” [1]. Energy is central to sustainable development and poverty reduction efforts as it affects all aspects of development – social, economic, and environmental – including livelihoods, access to water, agricultural productivity, health, population levels, education, and gender-related issues (United Nations Development Program). The energy cycle, from energy extraction to energy use, is said to be responsible for many of the environmental problems at the local, national as well as global levels. Documented evidence by the UNDP suggests that many of the environmental problems confronting us today such as deforestation, water pollution, and air quality health problems can be linked back to the energy sector. The most serious problem facing the world today is climate change. Research has shown that energy efficiency is closely linked to climate change (UNDP). The recent years has seen an increased support for improving energy efficiency and the role energy efficiency can play in addressing many of the pressing environmental and energy concerns.

Research suggests that the residential sector accounts for one-fifth of the global energy consumption [2], thus energy efficiency of the housing market has become an important target for policy makers and a promising tool for those seeking to comply with the Kyoto protocol [3]. The Kyoto Protocol is an international agreement linked to the United Nations Framework Convention on Climate Change, which commits its Parties by setting internationally binding emission reduction targets (UNFCCC). In 2005 the United Arab Emirates ratified the Kyoto Protocol to the UN Convention on Climate Change, becoming one of the first major oil-producing countries to do so.

The United Arab Emirates (UAE) has the world's sixth largest proven oil reserves and the fifth largest natural gas reserves, making the country a critical partner and responsible supplier in global energy markets. Although, UAE is the world's third largest exporter of crude oil, oil exports account for only about one-third of economic activity, as a result of aggressive government policies designed to diversify the UAE economy. Economic growth across the UAE has led to massive increases in the demand for electricity [4]. The demand for energy in the United Arab Emirates is growing at a rate of 9%, three times greater than the global average. Energy demand is expected to exceed 40,000 MW by 2020 [5].

Research shows that buildings, especially residential buildings, account for a large share of energy consumption and offer a natural target for policies that seek to reduce energy consumption and increase energy efficiency [6]. On November 13, 2014, the UAE government revised the water and electricity tariffs for both Emiratis and expatriates which would come into effect from January 1, 2015. Utility tariffs in the UAE have been heavily subsidized by the government. The electricity subsidy in Abu Dhabi, the capital of UAE, for residential buildings ranges from 55% to 90% and the water subsidy ranges from 79% to 100%. Under the new tariff, Emiratis who use up to 30 kW h (kilowatt hours) a day in flats and 400 kW h a day in villas, will continue to pay the existing rate of 5 fils per kW h. But Emiratis who use above this limit have to pay a new tariff of 5.5 fils per kW h. Electricity tariff for expatriates who have a low consumption will pay anything between 15 and 21 fils per kW h. Those who use beyond 20 kW h in flats and 200 kW h in villas will, however, have to pay a higher tariff. Changes to the tariff structure are part of a wider initiative aimed at driving behavioral change in how water and

electricity are currently consumed in the Emirate of Abu Dhabi. The change aims to encourage the efficient use of water and electricity, and raise awareness of the importance of reducing consumption to support the sustainable growth of the emirate (i.e. Abu Dhabi) [7]. These efforts are not only limited to the UAE. Reliable and sustainable energy for the future has become a major concern with many developed and developing countries spending a significant capital to invest on smart grids for better energy management and convenience of consumers and utilities [8]. Smart grids are believed to play an important role in delivering enough, and efficient power required for the energy demands of the future. Information and communications technology (ICT) is playing the key role in real-time implementation of smart strategies to incorporate various tasks and responses required for the operation of smart grids. The challenge is to come up with innovative ideas and solutions which will help in monitoring and managing electric power usage, and consequently lead to improving power grids and reducing power consumption.

Gans et al. argue that providing better information and feedback on consumption helps improve energy efficiency in the residential sector, especially when information and feedback is combined with other traditional policy tools such as economic incentives, pricing and regulation [6]. Increased transparency in energy consumption may encourage energy conservation among private consumers [3]. In an attempt to provide information on energy consumption, we have developed a low-cost smart plug that will help individuals monitor their household's energy consumption. Our proposed smart plug design emphasizes ease of deployability and use. As the smart plug is currently in the market test stage, the focus of this study is to measure consumer's perceived usefulness and satisfaction of the smart plug in effectively and efficiently monitoring their energy consumption. To achieve this, we also propose a model to measure the usefulness and satisfaction of smart plugs by extending the IS success model proposed by Seddon and Kiew [9]. We validate the model by running two experiments with and without live interaction with the proposed smart plug. To our knowledge, this is the first study targeting UAE consumers and integrating both the technical description of smart plugs and an analysis of the practical users experience.

The rest of this paper is organized as follows: [Section 2](#) gives a literature review of smart grids and smart metering in general. [Section 3](#) provides a technical overview of the proposed smart plug. [Section 4](#) describes the theoretical model that will be used to measure consumers' perceived usefulness and satisfaction with the proposed system and describes our methodology. [Section 5](#) emphasizes the analysis and key findings. Concluding comments are provided in [Section 6](#).

## 2. Literature review

Electric power systems constitute one of the most important infrastructure of a modern society. The electric power grid is defined as the combination of entire apparatus of wires and machines that connects the power generation with the customers [10]. It is one of the largest and most complex infrastructures and it is critical to the operation of society and other infrastructures. Power systems have been operating for the last about 100 years using the same fundamental principles. Technology has allowed an improvement of their performance, but it has not revolutionized the basic operating principles. The power system has been driven by a fundamental principle, i.e., to keep a balance in the supply and demand under all operating conditions and to have the amount of generated power equal to the power absorbed by the loads [11]. Although the generation is controllable and the loads are predictable to an extent, the conventional grid system has very limited automation because of an absence of data from the consumer side, which can help with managing and reducing

power consumption. In this type of grid, the major source for generation is based on fossil fuels which accounts for 40% of human caused greenhouse gasses [12]. In order to decrease the emissions of greenhouse gasses and move forward towards more sustainable power generation, the world is focusing on alternative sources of energy. The renewable sources of energy utilize the freely available energy in nature in different forms which mainly includes solar, wind, biomass, geothermal, etc. The problems with renewable sources are that they are not compatible with the grid and a number of strategies and control systems are required to make them grid connected. The need for sustainable consumption and technologies to assist with it becomes apparent when considering the rising demand for power which is expected to double by year 2030 [13]. Hence, the current status of the grid needs major improvements.

The smart grid concept is relatively new having been termed in 2007 at an IDC energy conference in Chicago by Andres E. Carvallo. He declared that the smart grid is an amalgamation of energy, hardware, software, and communications systems. It will help in delivering sufficient power efficiently as required for the energy demands of the 21st century. Furthermore, this modern grid system would be distributed, interactive, and self-healing [14]. Since then there is a lot of research and development in the smart grids area including its various functional components and communication between these components. A review of wireless communication technologies for smart grid has been presented in [15], which outlines and compares most of the wireless communication techniques that are useful for smart grids. These techniques include ones suitable for Home Area Networks like ZigBee, Bluetooth, Wi-Fi, 6LoWPAN and Z-Wave. The authors in [15] also describes techniques for Neighborhood Area Networks which include WiMAX and GSM based cellular standards. Another survey of communication and networking technologies in smart grids is presented in [16], which also includes synthesized requirements of smart grids. These requirements include advanced metering infrastructure, wide area situational awareness, IT network integration, interoperability, demand response and consumer efficiency.

Demand response, demand side management, and data collection are also the key requirements for the operation of smart grids. Demand response and demand side management reshapes the consumer electricity demand by shifting the peak load to off peak periods based on customer incentives and dynamic pricing. This helps in smoother power system operation and hence a key requirement in smart grids [17]. User responsive actions are required to shift the peak demand to off-peak hours by offering incentives to customer. This is possible if the customers know how much power they are using at a certain time and they can plan some load schedules using an interface in computer or more conveniently in a mobile application. Some of the current schemes and technologies are described here as a reference [18,19]. There are two categories for electricity pricing which are fixed and variable with respect to time. The fixed pricing is constant regardless of time and system load. This scheme does not offer any motivation to change consumption pattern as desired by the utilities. On the other hand, variable pricing is dynamically changing with time which is further divided into three sub-categories: time-of-use (TOU) pricing, critical peak pricing, and real time pricing. These are discussed here in brief [19].

An assessment of primary energy consumption and its environmental consequences in the United Arab Emirates has been presented in [20] where the author describes the historical trends in economic growth, population growth and urbanization of the UAE which leads to increase per capita energy consumption and ultimately increased carbon emissions and environmental pollution. This paper also compares the patterns of per capita primary energy consumption in the UAE with Middle East, Europe, US and the World. The research in paper [21] describes a strategy for sustainable

development in the UAE using hydrogen energy and reports different types of generation technologies, their scope for energy generation in the UAE and how renewable energy technologies (including solar, wind, fuel cell, geothermal, biomass, and wave energy) can help in power generation and overcome the carbon emissions and ultimately contribute in sustainable energy development in the UAE. The work in [21] also describes the applications of hydrogen energy in residential and commercial buildings and transportation sector. An integrated model for sustainable energy transition has been used to evaluate the integration of various renewable energy technologies, the conservation of energy and emissions reduction, and conventional capacity cost saving in the UAE [22].

Energy consumption, economic growth and CO<sub>2</sub> emissions in the MENA (Middle East and North Africa) region countries have been described in [23] by implementing bootstrap panel unit root tests and co-integration techniques to investigate the relationship between carbon dioxide emissions, energy consumption, and real GDP for 12 Middle East and North African Countries (MENA) over the period 1981–2005. The results show that in the long-run energy consumption has a positive significant impact on CO<sub>2</sub> emission and real GDP exhibits a quadratic relationship with CO<sub>2</sub> emissions for the region as a whole.

Active demand response can support demand-side management and operate the power system more economically. An example of demand response based on real-time pricing using bidirectional electrical vehicles (EV) and energy storage system (ESS) in a household setting is given in [24]. Mixed Integer Linear Programming based modelling has been used there to assess home energy management and the economic impact of using bidirectional use of electric vehicle and energy storage system. Different charging and discharging regimes for EV and ESS are used in correspondence with the time-varying price signal and show that there is a significant cost saving for the customer up to 65% as compared to the original cost when there is a bidirectional use of EV and ESS is in operation. A review of applications and implementation strategies for demand response for sustainable energy has been presented in [25], which mainly describes Advanced Metering Infrastructure (AMI) energy controllers, communication systems and the benefits to include these in the smart grids. The information flow has been given in a sequence of operations starting from the utility to each individual load. The loads have been divided among dispatchable and non-dispatchable categories for unit commitment and power system operation. Then the smart meters enable the demand response controllers on the basis of real-time price. The penetration of AMI was approximately 22.9% in 2011 in the US which enables consumers to participate in DR programs [25].

A survey of demand response and smart grids has been presented in [26]. In addition, the applications of smart technologies for buildings home energy management, backup generators and energy storages for industrial and commercial customers are also reviewed comprehensively. It has been highlighted how important is the interaction between the utilities and customers for an improved and economical smart grid operation. The work in [27] has given load profiles of selected major household appliances and the opportunities of utilizing their demand response. The selected appliances are washing machine, cloth dryer, air conditioner, electric water heater, electric oven, dishwasher and refrigerator. The potential of each appliance has been assessed and it has been concluded that the cloth dryer offers the highest potential for DR followed by electric water heater (if present in a house). Somewhat potential is there for AC, dishwasher, low DR for washing machine and refrigerator and no DR for electric oven [27]. Dynamic demand response controller based on real-time retail price for residential buildings has been explained in [28] which focuses on an HVAC system of a family house as the load and describes the design of the controller for DR. Power electronics

based smart socket applications with DC distribution in smart building power management has been given in [29]. Loads are assigned with priority and used in automatic load shedding if required for energy management.

A comprehensive study has been presented in [30] which compares various feedback devices for residential real-time energy monitoring. According to this study, real-time in-home feedback is a relatively new technology. These days a number of instruments are available to monitor energy consumption in the residential sector. These instruments allow users to input utility rate structures and receive feedback in the form of numerical and graphical data. Users are informed of their electricity consumption with costs. The instruments discussed in this study are Ambient Energy Orb, Aztech In-Home Display, Cent-A-Meter, EML 2020H, The Energy Detective, The Power Cost Monitor, Wattson and Eco-Eye Elite energy monitoring devices. Surveys were conducted on the real users and the maximum energy saving in these cases was 12% and it has been suggested to use more incentives and strategies to increase energy saving. The work in [31] argues to install coordinated home energy management systems for energy consuming devices for increasing penetration of renewable energy into the grid. This paper discusses the integration of smart and legacy devices into a generic system architecture and, subsequently, elaborates the requirements and components which are necessary to realize such an architecture including an application of load detection for the identification of running loads and their integration into existing home energy management systems.

A survey on demand response programs in smart grids has been presented in [32] which mainly includes pricing methods and optimization algorithms used to support demand response and smart grids. This paper classifies various categories of demand response which is mainly based on control mechanism, offered motivations, and decision variables. The motivation based DR is further classified into price-based and incentive based. Then this paper discusses and compares various pricing techniques e.g. critical peak pricing, time of use pricing, variable peak pricing, peak load pricing, peak day rebates and real time pricing in terms of the provision of demand response.

Smart plugs for smart environments are described in [33] with a primary objective of detecting the location of a certain device and controlling it remotely. Power outlets are fitted with RFID readers connected to the main computer. Electrical appliances have RFID tags containing information about the device. When the appliance is plugged, the reader reads the tag, gets its contents and transfers it to the main computer. Using this information, the main computer can identify this device. Paper [34] describes the electric energy

management in the smart home under the influence of enabling technologies and consumer behavior. Enabling technologies discussed in the paper from the utility side are rates, demand response, and smart meters, and from the consumer side smart loads and control portals. For the consumer behavior, the paper stresses to include human behaviors to increase energy efficiency and argues that if the behaviors are not taken into consideration then, for the time being, the energy efficiency will be improved but it may start decreasing again if it is deteriorating the customer's freedom. Therefore, automation must allow consumers to reduce energy use without being perceived as interfering with these important functions. Otherwise, the end-user may circumvent the technology and reduce the efficiency of the smart home.

Decreasing energy consumption can decrease the required generation from the plants, which are dominantly operated by fossil fuels in the UAE, and ultimately decrease carbon emissions. The smart plug system proposed in this paper addresses the major challenges related to data collection and communication and can be easily incorporated in the grids to make them smarter and clearer in terms of customer requirements and control. Deployment cost is reduced by designing the system to allow the user to connect the smart plug to existing outlets, without the need for rewiring and with reduced need for technical assistance. Current smart plugs in the market focus on allowing the user control over a radio-based remote control [35] or reading and displaying the current power measurement [36]. Providing control over multiple sockets from a mobile application is more convenient and easy to use. The master-slave architecture reduces the cost and bandwidth required by the system, since the system scales using slaves units which are less expensive than master units. Localization of smart plug locations and providing visual temporal information about power consumption increase the usefulness of the system to the user. The consumption information is also made available to the power distribution company, which is crucial for data mining, production and distribution management, launching targeted awareness campaigns, and to offer dynamic pricing and eventually have a better control over the electrical demand.

### 3. Proposed smart plug

The proposed system consists of multiple smart plugs connected in a wireless sensor network. The network consists of two unit types: (1) a slave unit type with power measuring and control electronics (the smart plug itself); and (2) a master unit type that

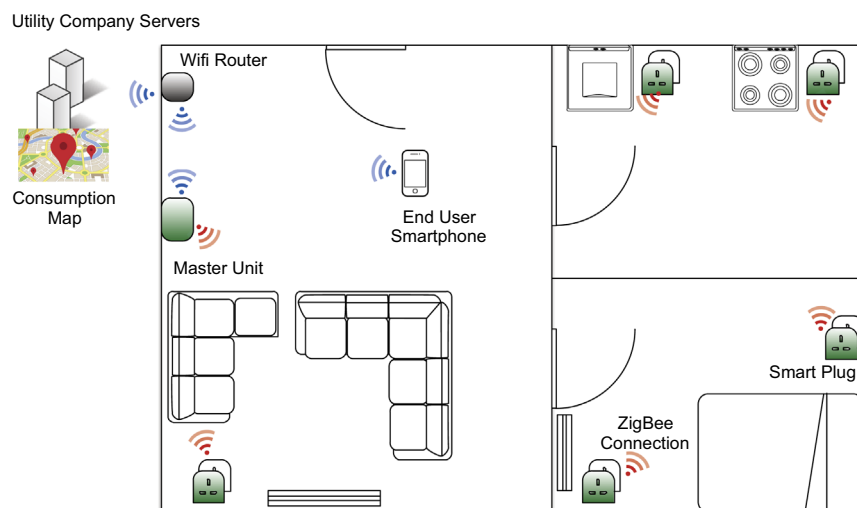

**Fig. 1.** Overall system architecture. Red waves indicate ZigBee connection and blue waves indicate Wifi or WAN connections. (For interpretation of the references to color in this figure caption, the reader is referred to the web version of this paper.)

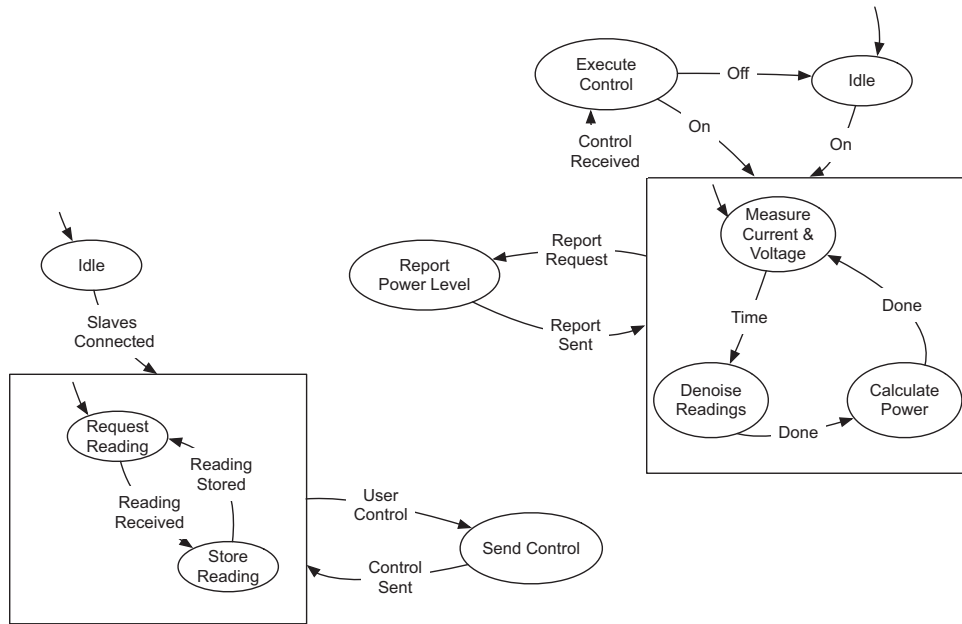

Fig. 2. Finite state machine describing the behavior and interaction between master and slave units.

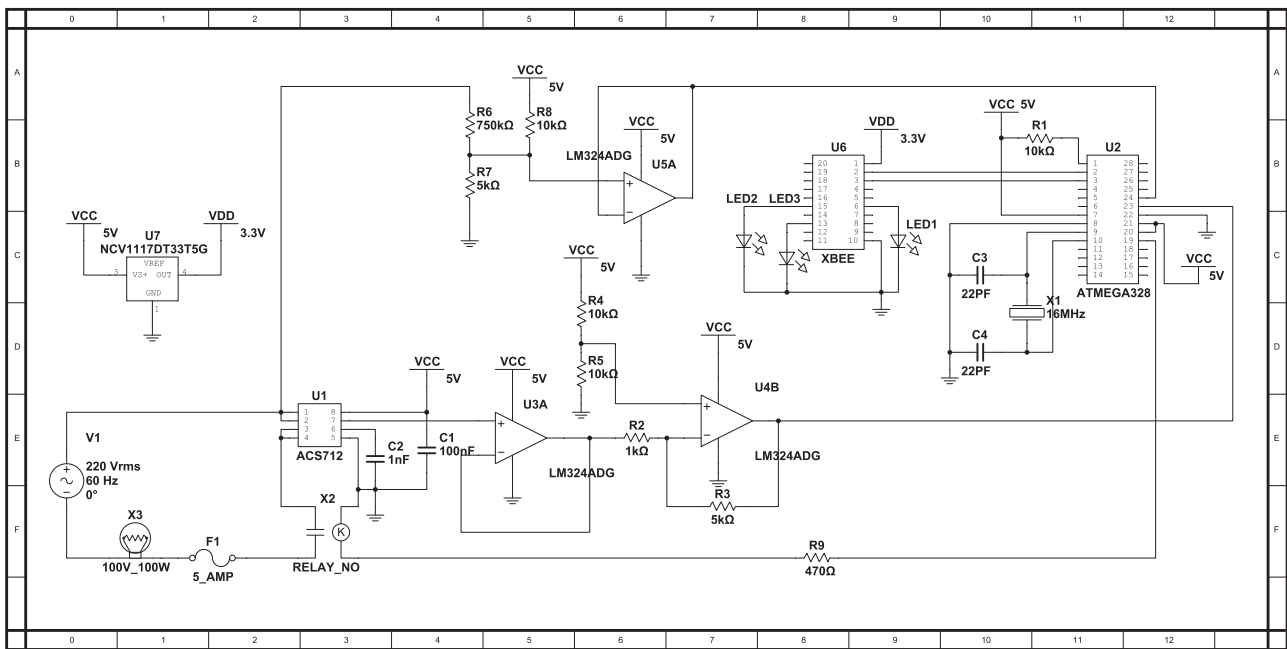

Fig. 3. Slave circuit hardware.

coordinates the network activities and provides access to its collected data. In a typical household installation, we have slave units extending the functionality of typical wall plugs. These smart slave units plug directly into the wall plugs and look almost identical to them, which is important for aesthetics and to significantly reduce installation cost making it a task that can be performed by the end user. Both these properties encourage deployment of the system. Fig. 1 depicts the overall system architecture. The smart plugs use the ZigBee protocol in a mesh network to extend their range and communicate with a master unit. The master unit uses the home's existing Wifi network to serve the user information and control capabilities. While the slaves are 8-bit microcontroller-based embedded systems, the master is a 32-bit embedded Linux system with more computing resources. The slaves are thus sharing the communication and

computing resources of the master unit. The master unit pulls power consumption information from the slaves and pushes it to a server for storage. A hierarchical concurrent finite state machine describing the behavior of the master and slave units and their interaction is shown in Fig. 2. The master and the slave have main measurement loops (in square) that are interrupted by control requests coming from the user. The slaves are also interrupted by the master regularly to collect their power consumption data.

The hardware design of the slave circuit is shown in Fig. 3. Calculating power consumption begins with reading current a voltage measurements. The voltage level is first brought down from 220 V AC to 5 V AC using the signal conditioning circuit in (A4–B5) to make the maximum use of the analog-to-digital converter resolution. The high and low voltage parts of the circuit are connected through buffers (B6) for protection. A 5 A fuse is also

**Table 1**  
Scale description.

Scale	Description
Information Quality	Desirable qualities of the system. For example, relevance, understandability, accuracy, completeness, etc. [44]
App Usefulness	The degree to which consumers believe that using the app would enhance efficiency
App Usage Characteristics	The desirable characteristics of an information system. For example, ease of use, system flexibility, system reliability, ease of learning, etc. [44]
Perceived overall Satisfaction	Users level of satisfaction with the apps performance
Importance	The importance of the task that the app performance
Environmental Concern	The extent to which consumers are concerned about the environment

added for protection. The relay in F3 is controlled by the micro-controller in B11–C11 and is responsible for connecting or disconnected the supply. We use the ACS712 20 A current sensor (E3) and connect its output to another buffer and signal conditioning circuit before feeding the output to the Atmega328 microcontroller. The XBee module in B8 is connected serially to the micro-controller and is used to communicate with it. The master circuit is an embedded Linux board connected with the microcontroller network through a XBee module and to the home area network through a Wifi module. The output of the  $n$ -bit analog-to-digital converters is then used to calculate instantaneous voltage  $V_t$  using

$$V_t = \sqrt{2}V_{rms} \left( \frac{2A_t^k}{2^{n-1}} - 1 \right) V, \quad (1)$$

where  $A_t^k$  is the reading from channel  $k$  of the analog to digital converter at time  $t$  and  $V_{rms}$  is the root mean square voltage (equivalent DC voltage). We use  $n=10$  and  $V_{rms}$  in the UAE is 220 V. The instantaneous current  $I_t$  is calculated using

$$I_t = \frac{\sqrt{2}V_{cc}}{2R} \left( \frac{2A_t^l}{2^{n-1}} - 1 \right) A, \quad (2)$$

where  $R$  is the sensor resolution (we use 0.1 V/A),  $A_t^l$  is the reading from analog to digital converter channel  $l$  where the current sensor is connected, and  $V_{cc}$  is the circuit supply voltage, which is 5 V in our case. Instantaneous power, i.e.,  $P_t$  is calculated from the instantaneous voltage and current using

$$P_t = I_t V_t. \quad (3)$$

If the amount of time the load is connected  $T$  is known, the amount of energy consumed in kW h is then calculated using  $E = P_t \times T$ . Since  $T$  is not known, we use an discrete-time accumulator to find  $E_t$  using

$$E_t = \sum_{i=-\infty}^t P_i t_s, \quad (4)$$

where  $t_s$  is the time step.  $E_t$  is multiplied by the tariff to calculate the money spent on each socket.

#### 4. Theoretical model and methodology

Research focused on measuring the success of information systems (IS) has been going on for nearly three decades [37–39]. The technology acceptance model (TAM) proposed by Davis [40] has been widely used to assess and predict user acceptance of information technologies [41]. Using the theoretical foundation of the Theory of Reasoned Action and Theory of Planned Behavior [42,43], TAM attempts to explain the acceptance of information systems by users. The criticism however was that user acceptance of an IS does not equate to IS success, although acceptance of a system is the necessary prerequisite to IS success [44]. To address this issue [45] proposed an IS success model that identified six variables that could be used to

measure IS success, namely, system quality, information quality, use, user satisfaction, individual impact and organizational impact.

Answering the call by DeLone and McLean for further development and validation of their model, Seddon and Kiew [9] proposed a modified IS success model where use variable was substituted with usefulness. They argue that the underlying success construct that researchers have been trying to tap is usefulness not use [9]. Further, Seddon and Kiew state that in conditions where the use of IS is compulsory, usefulness is a more appropriate measure than use. Another change proposed by Seddon and Kiew was the incorporation an additional variable labelled Importance of the System. The justification for this was that systems that perform more important tasks are perceived as more useful, irrespective of the quality of the actual system [9]. Thus, the revised model proposed by Seddon and Kiew had five variables namely, Information Quality, System Quality/System use Characteristics, Importance of the System, Perceived Usefulness and User Satisfaction. This revised model, however, is not free of criticisms. For instance, Armstrong et al. [46] criticized the Seddon and Kiew's model stating that although Seddon and Kiew tested their model using SEM, psychometric information about their instrument was largely absent. Further, factor loading of their measurement model suggests a high degree of overlap. Armstrong et al. further reviewed Seddon and Kiew model and provide a valid and reliable instrument that can be used by researchers to measure IS success [46].

A primary aim of this paper is to measure consumer's perceived usefulness and satisfaction with the smart plug in monitoring their energy consumption. To achieve this we use the IS success model proposed by Seddon and Kiew as perceived usefulness and user satisfaction are key variables in the model. To avoid overlap of items we use the instrument developed by Armstrong et al. that covers all the key variables identified by Seddon and Kiew. We hypothesis that while Information Quality, Apps Usage Characteristics, Importance are key factors in assessing Apps Usefulness and Perceived Satisfaction in typical information systems, Environmental Concern also may impact usefulness and satisfaction, especially when the information system (i.e. smart plug) may positively affect the environment. Thus, in this study we proposed to extend the IS success model proposed by Seddon and Kiew by incorporating environmental concern as another variable that could impact usefulness and satisfaction. Environmental concern was considered as an important variable because research provides evidence that consumers with high scores on the environmental concern scale are likely to engage in pro-environmental behavior [47]. The New Environmental Paradigm (NEP) scale was first developed by Dunlap and Van Liere in [48]. The scale proposed by them consists of a 12 item scale aimed at measuring three aspects on environmental concern, that is, (1) humanity's ability to upset the balance of nature; (2) the existence of limits to growth for human societies; and (3) humanity's right to rule over the rest of nature [49]. The original 12 item scale has been successfully reduced to 6 items by Steger et al. in [50]. It is this revised scale that will be used in this research to measure environmental concern. A brief description of

the scales used in this research is provided in Table 1. The theoretical model proposed in this study is shown in Fig. 4.

Considering the diversity of UAE's population, data was collected using a questionnaire both in English and Arabic. 56% of respondents took the Arabic survey, while the remaining 44% used the English survey. In order for the respondent to understand the proposed system, a video demonstration and a flyer showing the applications use case scenario was included into the questionnaire. The study targeted smartphone users who have been living in UAE for at least a year. Mall-Intercept is not permitted in the UAE and phone-interviews were not suitable as respondents were expected to watch the video demonstration of the application before answering the questionnaire. Therefore, questionnaires were distributed electronically based on a database of 970,000 e-mails collected over the years by professional market researchers by calling companies listed in the yellow pages, mining the Internet, and visiting exhibitions and events organized by the government and private sectors. In addition, questionnaires were electronically distributed to graduate students and graduate student alumni. Approximately 16% of the respondents came from the graduate student and alumni list, while the remaining 84% came from the main e-mail list. Over 400 respondents completed the survey. The

data was cleaned to exclude people from outside the UAE, respondents who are not smartphone users, or ones that did not live in the UAE for one year. The final sample size was 357 for a margin of error of 5.14% and a confidence level of 95%. The detailed questionnaire used in this study is provided in Table 2.

Expats constitute 80% of the UAE population. In our survey people were asked how long have they lived in the UAE, and the answer are very reflective of the UAE population. In particular, about 75% have been in the UAE for less than 20 year which is almost the percentage of expats in the country. We also find that the number of individuals per household is very reflective of the situation in the UAE. In fact, the average in our sample is 5.1 individuals per household while the reported average for the UAE is 4.2 for Dubai and 4.3 for Abu Dhabi and 5.09 for the UAE. Therefore, we believe that the sample is quite representative of the UAE residents population.

To further validate our findings, we have also repeated the survey in a second experiments with individuals who have tested a trial version of the equipment. To achieve this, we have developed a mobile laboratory setup consisting of a trolley carrying a 12 V DC car battery connected to a DC to AC inverter and powering an extension cord. After a discussion describing the system and responding to questions, users connected the smart plug and different loads to the extension cord and used the mobile application themselves before taking the survey. This experiment was repeated for a 100 participants.

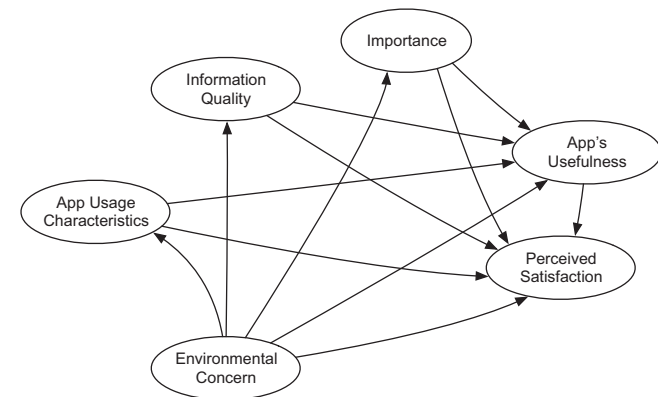

Fig. 4. Theoretical model with Environmental Concern affecting App's Usefulness and Perceived Satisfaction.

### 5. Results and analysis

In this section, we present and discuss the results of our experiments. First, we discuss the implemented smart plug system and the results obtained from testing and using it in Section 5.1. We then move on to share the results of the survey and validate the theoretical model used to measure the perceived system usefulness and user satisfaction. We begin by reporting on the measurement model validity and show that there are no validity concerns in Section 5.2 before presenting and discussing the findings from structural equation modeling in Section 5.3.

Table 2 Proposed research instrument for perceived usefulness and satisfaction with smart plugs.

How many people live in your household?						
How many years have you lived in the UAE?						
For how many years have you used a smartphone?						
<b>Information Quality</b>						
I think power consumption information I get from this app will be clear	1	2	3	4	5	6 7
I think this app will provide me with sufficient information about my family's power consumption	1	2	3	4	5	6 7
I think this app will provide me with up-to-date information about my family's power consumption	1	2	3	4	5	6 7
<b>App Usefulness</b>						
Using this app increases energy conservation	1	2	3	4	5	6 7
Using the app saves money	1	2	3	4	5	6 7
Using the app improves control over power consumption	1	2	3	4	5	6 7
<b>App Usage Characteristics</b>						
The app seems easy to use	1	2	3	4	5	6 7
The app seems easy to learn	1	2	3	4	5	6 7
It seems easy to get the app to do what I want it to do	1	2	3	4	5	6 7
<b>Perceived Overall Satisfaction</b>						
I feel that the app meets the needs of my household or business	1	2	3	4	5	6 7
Overall, I would be satisfied with this app	1	2	3	4	5	6 7
<b>Importance</b>						
In relation to my household, the app is	Non essential	.	.	.	.	Essential
	1	2	3	4	5	6 7
<b>Environmental Concern</b>						
The so-called ecological crisis facing humankind has been greatly exaggerated	1	2	3	4	5	6 7
The earth is like a spaceship with limited room and resources	1	2	3	4	5	6 7
If things continue on their present course, we will soon experience a major ecological catastrophe	1	2	3	4	5	6 7
The balance of nature is strong enough to cope with the impacts of modern industrial nations	1	2	3	4	5	6 7
Humans are severely abusing the environment	1	2	3	4	5	6 7



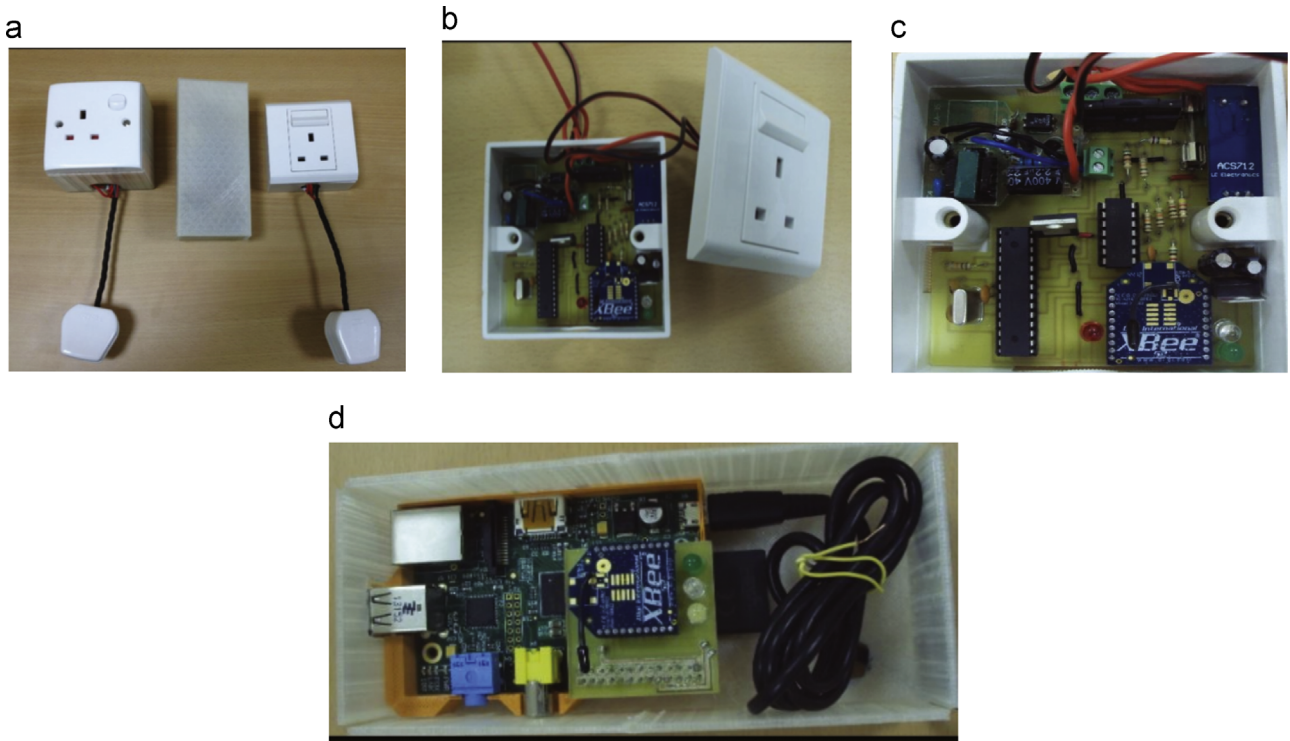

Fig. 5. Hardware of implemented smart plug. (a) Finished smart plug. (b) Insides of slave unit. (c) Close-up of slave unit. (d) Insides of master unit.

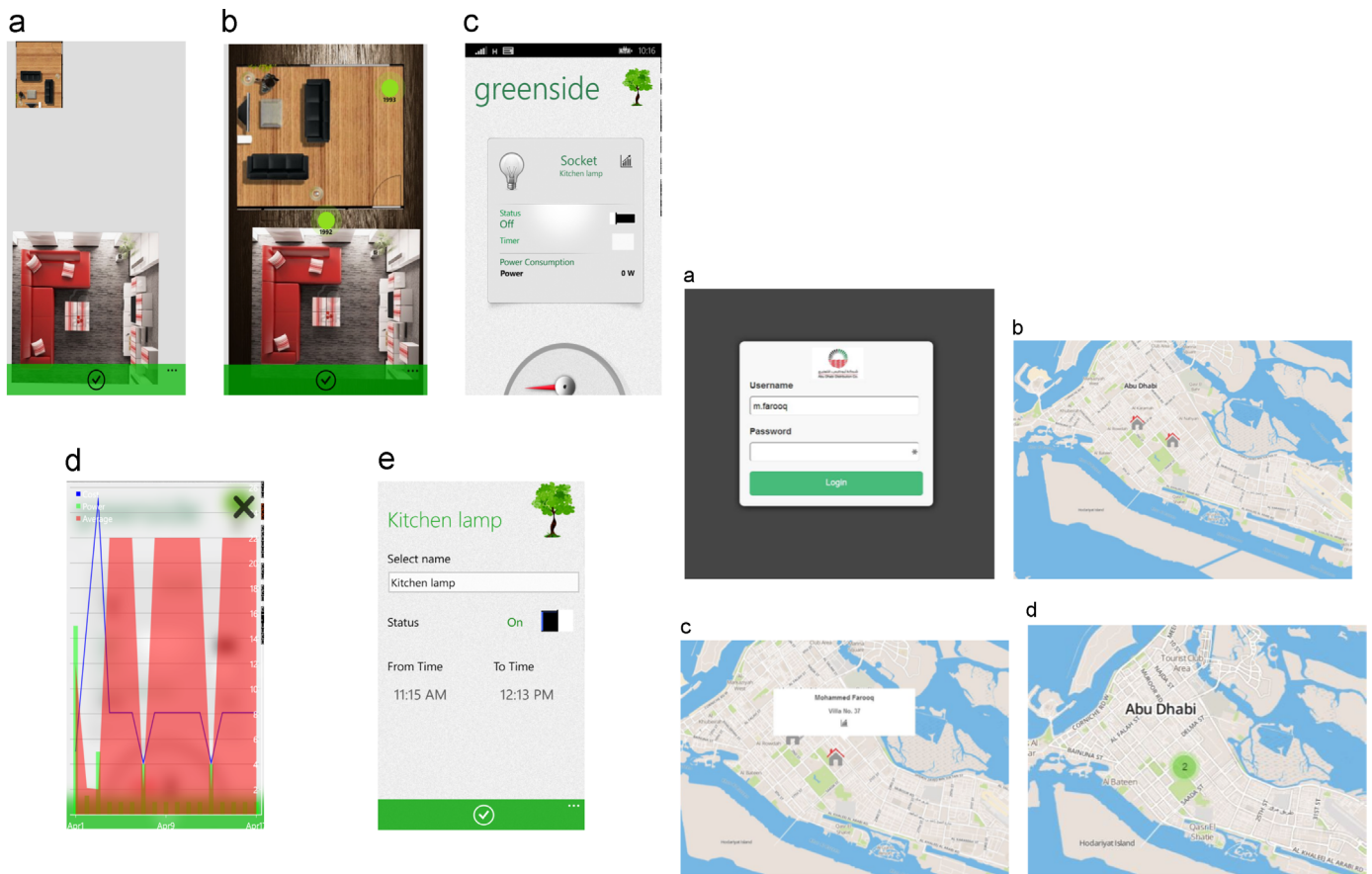
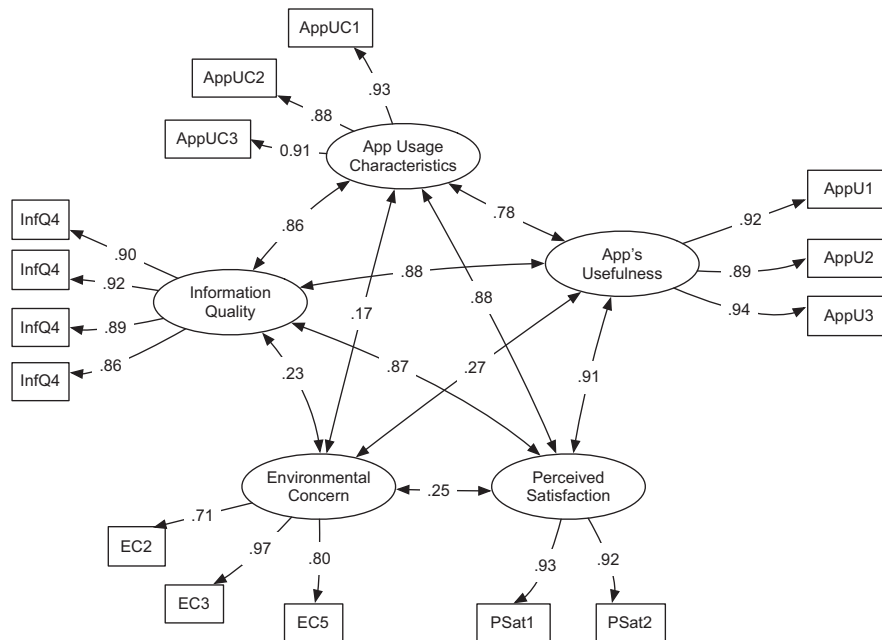

Fig. 6. Mobile application providing power consumption information and control over smart plugs. Left: (a) User designs a digital model of home. (b) User marks locations of smart plug installations. (c) Power consumption and control are available to user. (d) Power consumption data over time is available to user. (e) User can program certain smart plug for automated conservation. Right: (a) Login view. (b) Map view. (c) Marker clicked. (d) Marker clustering.

**Table 3**  
Descriptive statistics from survey.

Question	Minimum	Maximum	Mean	Std. deviation
I think power consumption information I get from this app will be clear	1	7	5.03	1.646
I think this app will provide me with sufficient information about my family's power consumption	1	7	5.11	1.562
I think this app will provide me with up-to-date information about my family's power consumption	1	7	5.21	1.560
I think this app will provide me with the information and control that seem to be just about what I need	1	7	5.22	1.547
Using this app increases energy conservation	1	7	5.22	1.585
Using the app saves money	1	7	5.12	1.612
Using the app improves control over power consumption	1	7	5.32	1.539
The app seems easy to use	1	7	5.07	1.577
The app seems easy to learn	1	7	5.08	1.510
It seems easy to get the app to do what I want it to do	1	7	5.07	1.530
I feel that the app meets the needs of my household or business	1	7	5.12	1.556
Overall, I would be satisfied with this app	1	7	5.13	1.464
In relation to my household, the app is	1	7	5.14	1.539
The so-called ecological crisis facing humankind has been greatly exaggerated	1	7	3.55	1.734
The earth is like a spaceship with limited room and resources	1	7	3.75	1.949
If things continue on their present course, we will soon experience a major ecological catastrophe	1	7	4.33	1.785
The balance of nature is strong enough to cope with the impacts of modern industrial nations	1	7	3.71	1.765
Humans are severely abusing the environment	1	7	4.68	1.902



**Fig. 7.** Measurement model validation. Error terms are not included in the figure.

**Table 4**  
Measurement model validity assessment using composite reliability (CR), average variance extracted (AVE), maximum shared variance (MSV), and average shared variance (ASV).

Scale	CR	AVE	MSV	ASV	Environmental concern	Information quality	Usefulness	Usage charact.	Perceived satisfaction
Environmental Concern	0.869	0.692	0.072	0.053	0.832				
Information Quality	0.942	0.802	0.766	0.579	0.228	0.896			
Usefulness	0.937	0.833	0.826	0.568	0.269	0.875	0.913		
Usage Charactmacmac	0.933	0.823	0.766	0.535	0.172	0.858	0.78	0.907	
Perceived Satisfaction	0.922	0.856	0.826	0.604	0.245	0.874	0.909	0.875	0.925

**5.1. Implemented smart plug**

The proposed system was implemented and tested in our laboratory. Fig. 5 shows the hardware of the implemented smart plug. The smart plug has the same dimensions as a typical plug. The printed circuit board sizes were optimized to fit inside the plug. To test the accuracy of the system, we used an energy analyzer to determine readings for current, voltage, reactive

power, apparent power, and power factor and compare them to those reported by the slave units. We connected several loads in combinations such as a 12.5 W eco lamp, a 22 W fan, and a 100 W light lamp. The maximum error reported in these tests is 5%. Since an 8 A solid state relay is used in the slave plug with a 6.3 A fuse, the maximum load the slave plug can measure before burning the fuse is 240 × 63 = 1512 W. Slave plugs for higher ratings can be designed by changing the choice of electronics. The overall cost of

making the master and slave unit is 180 dirhams and 400 dirhams for the master unit. The costs are based on prototype costs and while low can be significantly reduced at production time.

The mobile application (left-side of Fig. 6) exposes the power consumption information and provides the user with the ability to control all smart plugs. It starts by asking the user to design a digital model of their home by dragging and dropping different rooms as in Fig. 6(a). The purpose of this feature is for the user to easily localize the smart plugs. Next, the user places markers where the smart plugs were installed in the home as in Fig. 6(b). Clicking on an active marker brings the screen in Fig. 6(c) which shows a meter indicating the current level of power consumption and how much money and power has this smart plug consumed this month. Power consumption over time is also displayed to allow the user to identify patterns of usage and alter behavior accordingly as seen in Fig. 6(d). Real-time and detailed consumption information from participating households becomes available to distribution companies as shown in the right side of Fig. 6. This information can then be data mined for patterns of consumptions or used as basis for awareness campaigns.

5.2. Measurement model and its validity

Table 3 shows the descriptive statistics resulting from running the survey. In validating the measurement, we are not interested in the relationship between the factors, but checking if each of our factors is a consistent entity by itself. Our measurement model is shown in Fig. 7. We removed items 1 and 4 of environmental concern questions since they have low loading. The two removed questions seem to have low correlation with the rest of the items used in this construct. All questions used for measuring a factor are

significant and strongly related to that factor with a *p* value less than 0.001. We assess the goodness of fit for our model using the reduced Chi-squared statistic defined as Chi-squared divided by the degrees of freedom. Our model has a reduced Chi-squared of 2.33. While the value should be ideally below 2, a value between 2 and 5 is acceptable and considered a good fit [51]. The Comparative Fit Index (CFI) for our model is 0.98 and the Normed Fit Index (NFI) is 0.967. Values above 0.93 and 0.90, respectively, indicate that our model is regarded as acceptable [51]. Moreover, our model has a root mean square error of 0.061 with a low and high 90% confidence band of 0.05 and 0.073 respectively, all below 0.08 as preferred.

Our measurement model has no validity concerns as can be seen from Table 4. All factors have a Composite Reliability (CR) greater than 0.7 (internally consistent) and an Average Extracted Variance (AVE) greater than 0.5, thus has convergent validity. All values of the Maximum Shared Variance (MSV) and Average Shared Variance (ASV) are smaller than the AVE with MSV greater than ASV. Our model has discriminant validity [51].

5.3. Structure equation model

The structural equation model is given in Fig. 8. The CFI of the structural equation model is 0.98, greater than 0.9. The root mean square error is 0.05 with a low 90% confidence band of 0.048 and a high 90% confidence band of 0.070. Data collected in the second experiments by asking participants to take the survey after live interaction with the system fit the proposed model as well. Importance has a positive and significant effect on App's Usefulness. App's Usage Characteristics effect on App's Usefulness is not significant. Information Quality has a positive and highly significant effect on App's Usefulness. Its direct effect on Perceived Satisfaction is not significant but it has an indirect effect on Perceived Satisfaction of 0.205. Environmental Concern did not directly affect App's Usefulness in the first experiment with the respondents only viewing a recorded demonstration of the system. In the second experiments with a live demonstration and interaction with the system, Environmental Concern is found to have a direct effect of 0.229 on the App's Usefulness. This can be attributed to the effect of interacting with a live interactive system. Importance and App's Usage Characteristics have a positive significant effect on Perceived Usefulness. Environmental Concern does not have a direct impact on Perceived Satisfaction. App's Usefulness has a positive direct effect on Perceived Satisfaction. Environmental Concern, however, affects positively Importance, Information Quality, and App Usage Characteristics. Our results show that Environmental Concern has a positive indirect effect over Perceived Satisfaction (with an indirect effect of 0.262) and both a direct and an indirect effect on App

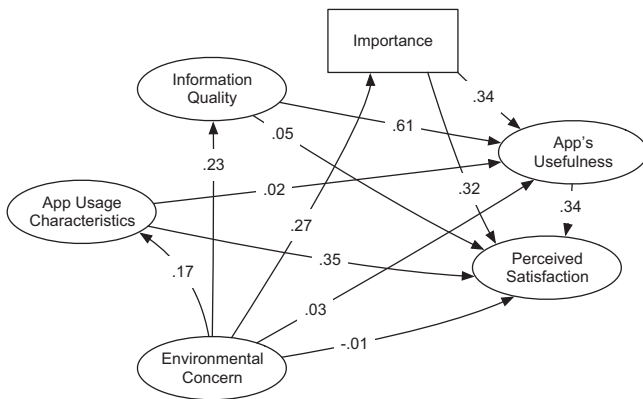

Fig. 8. Structural equation model results with standardized regression weights.

Table 5

Structural equation model regression weights. *P* value of \*\*\* is less than 0.001. SE is short for standard error. All columns represent data from first (main) experiment. The last column shows the regression weights from the repeated validation experiment after respondents' live interaction with the system.

Scale	Relationship	Estimate	S. E.	C.R.	<i>P</i>	Estimate (Exp2)
App Usage Charact.	< – Environmental Concern	0.182	0.06	3.039	0.002	0.549
Information Quality	< – Environmental Concern	0.234	0.058	4.033	***	0.545
Importance	< – Environmental Concern	0.302	0.06	4.989	***	0.662
App Usefulness	< – Importance	0.318	0.038	8.347	***	0.120
App Usefulness	< – App Usage Charact.	0.023	0.063	0.371	0.711	0.566
App Usefulness	< – Information Quality	0.622	0.071	8.715	***	0.198
App Usefulness	< – Environmental Concern	0.035	0.03	1.154	0.248	0.230
Percieved Satisfaction	< – Importance	0.305	0.036	8.5	***	0.592
Percieved Satisfaction	< – App Usage Charact.	0.347	0.051	6.804	***	0.390
Percieved Satisfaction	< – Information Quality	0.053	0.071	0.752	0.452	–0.055
Percieved Satisfaction	< – Environmental Concern	–0.011	0.024	–0.439	0.66	–0.039
Percieved Satisfaction	< – App Usefulness	0.336	0.065	5.189	***	0.176

Usefulness (with a direct effect index of 0.229 and an indirect effect index of 0.245). The results are summarized in Table 5.

## 6. Conclusion

This paper proposed a smart plug system consisting of a wireless sensor network interfaced with a mobile application. The proposed system allows personal consumers real-time access to energy consumption information. It also facilitate controlling this consumption by allowing the end users to turn on or off loads connected to the smart plug system. The paper also studies the perceived usefulness and satisfaction with the system using an extended information system success model which integrates environmental concerns as a participating key factor. We conclude that environmental concerns impact positively the perceived usefulness and satisfaction with the system. This suggests that wide-spread deployment of our proposed smart plug system is likely to reduce the per capita energy consumption in the UAE, which is one of the highest in the world.

## Acknowledgments

The authors would like to thank Mahdi Debouza, Ahmed Musleh, Mohammed Faroq, Ahmed Sweleh, and Riad Kanan for their work on the system and the Office of Research and Sponsored Program of Abu Dhabi University for supporting the work.

## References

- Commission B. Report of the World Commission on Environment and Development: Our common future—A/42/427 Annex—UN documents: gathering a body of global agreements; 1987. URL (<http://www.un-documents.net/wced-ocf.htm>).
- Brounen D, Kok N, Quigley JM. Energy literacy, awareness, and conservation behavior of residential households. *Energy Econ* 2013;38:42–50. <http://dx.doi.org/10.1016/j.eneco.2013.02.008>.
- Brounen D, Kok N, Quigley JM. Residential energy use and conservation: economics and demographics. *Eur Econ Rev* 2012;56(5):931–45. <http://dx.doi.org/10.1016/j.euroecorev.2012.02.007>.
- uae-embassy.org. Energy in the UAE—UAE embassy in Washington, DC; 2014. URL (<http://www.uae-embassy.org/uae/energy>).
- Sofia M. UAE's electricity demand to exceed 40,000MW by 2020—Gulf Business; 2013. URL (<http://gulfbusiness.com/2013/11/uaes-energy-demand-to-exceed-40000mw-by-2020/#.Vlv4DIqUf4>).
- Gans W, Alberini A, Longo A. Smart meter devices and the effect of feedback on residential electricity consumption: evidence from a natural experiment in northern Ireland. *Energy Econ* 2013;36:729–43.
- Abdul Kader B. Abu Dhabi revises water and electricity tariff; 2014. URL (<http://gulfnews.com/news/gulf/uae/government/abu-dhabi-revises-water-and-electricity-tariff-1.1411802>).
- Fadaeenejad M, Saberian A, Fadaee M, Radzi M, Hizam H, AbKadir H. The present and future of smart power grid in developing countries. *Renew Sustain Energy Rev* 2014;29:828–34. <http://dx.doi.org/10.1016/j.rser.2013.08.072>.
- Seddon P, Kiew MY. A partial test and development of Delone and Mclean's model of IS success. *Australasian J Inf Syst* 4 (1), <http://dx.doi.org/10.3127/ajis.v4i1.379>.
- Amin M, Stringer J. The Electric power grid: today and tomorrow. *MRS Bull* 2008;33(04):399–407. <http://dx.doi.org/10.1557/mrs2008.80>.
- Kyriakides E, Polycarpou M. Intelligent monitoring, control, and security of critical infrastructure systems. Springer, <http://dx.doi.org/10.1007/978-3-662-44160-2>, ISBN is 978-3-662-44160-2. online eBook.
- Arnold G. NIST smart grid program, 1st ed. U.S. Department of Commerce; 2012. URL ([https://www.smartgrid.gov/sites/default/files/doc/files/NIST\\_Smart\\_Grid\\_Program\\_Overview.pdf](https://www.smartgrid.gov/sites/default/files/doc/files/NIST_Smart_Grid_Program_Overview.pdf)).
- Folly KA. Challenges in implementing smart grid technologies in Africa: the south African case; 2012. URL ([http://www.esi-africa.com/wp-content/uploads/i/p/Komla-Folly\\_SmartGrid.pdf](http://www.esi-africa.com/wp-content/uploads/i/p/Komla-Folly_SmartGrid.pdf)).
- Schneidewind N. Representativeness models of systems: smart grid example. *Innov Syst Softw Eng* 2011;7(1):23–41. <http://dx.doi.org/10.1007/s11334-011-0140-9>.
- Mahmood A, Javaid N, Razaq S. A review of wireless communications for smart grid. *Renew Sustain Energy Rev* 2014;41:248–60. <http://dx.doi.org/10.1016/j.rser.2014.08.036>.
- Gao J, Xiao Y, Liu J, Liang W, Chen CP. A survey of communication/networking in smart grids. *Fut Gener Comput Syst* 2012;28(2):391–404. <http://dx.doi.org/10.1016/j.future.2011.04.014>.
- Jiang T, Cao Y, Yu L, Wang Z. Load shaping strategy based on energy storage and dynamic pricing in smart grid. *IEEE Trans Smart Grid* 2014;5(6):2868–76. <http://dx.doi.org/10.1109/tsg.2014.2320261>.
- Erdinc O. Economic impacts of small-scale own generating and storage units, and electric vehicles under different demand response strategies for smart households. *Appl Energy* 2014;126:142–50. <http://dx.doi.org/10.1016/j.apenergy.2014.04.010>.
- Celebi E, Fuller JD. A model for efficient consumer pricing schemes in electricity markets. *IEEE Trans Power Syst* 2007;22(1):60–7. <http://dx.doi.org/10.1109/tpwrs.2006.888956>.
- Kazim AM. Assessments of primary energy consumption and its environmental consequences in the United Arab Emirates. *Renew Sustain Energy Rev* 2007;11(3):426–46. <http://dx.doi.org/10.1016/j.rser.2005.01.008>.
- Kazim A. Strategy for a sustainable development in the UAE through hydrogen energy. *Renew Energy* 2010;35(10):2257–69. <http://dx.doi.org/10.1016/j.renene.2010.03.013>.
- Sgouridis S, Griffiths S, Kennedy S, Khalid S, Zurita S. A sustainable energy transition strategy for the United Arab Emirates: Evaluation of options using an integrated energy model. *Energy Strategy Rev* 2013;2(1):8–18. <http://dx.doi.org/10.1016/j.esr.2013.03.002>.
- Aroui MEH, Ben Youssef A, M'henni H, Rault C. Energy consumption, economic growth and CO2 emissions in middle east and north African countries. *Energy Policy* 2012;45:342–9. <http://dx.doi.org/10.1016/j.enpol.2012.02.042>.
- Erdinc O, Paterakis NG, Mendes TDP, Bakirtzis AG, Catalao JPS. Smart household operation considering bi-directional EV and ESS utilization by real-time pricing-based DR. *IEEE Trans Smart Grid* 2015;6(3):1281–91. <http://dx.doi.org/10.1109/tsg.2014.2352650>.
- Shariatzadeh F, Mandal NG, Srivastava AK. Demand response for sustainable energy systems: a review, application and implementation strategy. *Renew Sustain Energy Rev* 2015;45:343–50. <http://dx.doi.org/10.1016/j.rser.2015.01.062>.
- Siano P. Demand response and smart grids: a survey. *Renew Sustain Energy Rev* 2014;30:461–78. <http://dx.doi.org/10.1016/j.rser.2013.10.022>.
- Pipattanasomporn M, Kuzlu M, Rahman S, Teklu Y. Load profiles of selected major household appliances and their demand response opportunities. *IEEE Trans Smart Grid* 2014;5(2):742–50. <http://dx.doi.org/10.1109/tsg.2013.2268664>.
- Yoon JH, Baldick R, Novoselac A. Dynamic demand response controller based on real-time retail price for residential buildings. *IEEE Trans Smart Grid* 2014;5(1):121–9. <http://dx.doi.org/10.1109/tsg.2013.2264970>.
- Keles C, Karabiber A, Akcin M, Kaygusuz A, Alagoz BB, Gul O. A smart building power management concept: smart socket applications with DC distribution. *Int J Electr Power Energy Syst* 2015;64:679–88. <http://dx.doi.org/10.1016/j.ijepes.2014.07.075>.
- Alahmad MA, Wheeler PG, Schwer A, Eiden J, Brumbaugh A. A comparative study of three feedback devices for residential real-time energy monitoring. *IEEE Trans Ind Electron* 2012;59(4):2002–13. <http://dx.doi.org/10.1109/tie.2011.2165456>.
- Egarter D, Monacchi A, Khatib T, Elmenreich W. Integration of legacy appliances into home energy management systems; 2014. URL (<http://arxiv.org/abs/1406.3252>).
- Vardakas JS, Zorba N, Verikoukis CV. A survey on demand response programs in smart grids: pricing methods and optimization algorithms. *IEEE Commun Surv Tutor* 2015;17(1):152–78. <http://dx.doi.org/10.1109/comst.2014.2341586>.
- Elzabadian H, Helal A, Abdulrazak B, Jansen E. Self-sensing spaces: smart plugs for smart environments, 3rd ed. In: International Conference on Smart homes and health Telematic (ICOST), 2015. URL (<http://www.harris.cise.ufl.edu/projects/publications/2005-ICOST-Selfsensingspaces.pdf>).
- Zipperer A, Aloise-Young PA, Suryanarayanan S, Roche R, Earle L, Christensen D, et al. Electric energy management in the smart home: perspectives on enabling technologies and consumer behavior. *Proc IEEE* 2013;101(11):2397–408. <http://dx.doi.org/10.1109/jproc.2013.2270172>.
- Jetyoung.en.alibaba.com. Jetyoung smart power socket, remote control socket; zigbee socket, view wireless power socket, mit \*zigbee product details from leader technology (shenzhen) ltd. on alibaba.com; 2014. URL ([http://jetyoung.en.alibaba.com/product/515950000-210157504/JETYOUNG\\_smart\\_power\\_socket\\_remote\\_control\\_socket\\_zigbee\\_socket.html](http://jetyoung.en.alibaba.com/product/515950000-210157504/JETYOUNG_smart_power_socket_remote_control_socket_zigbee_socket.html)).
- Amazon.co.uk. Plug-in power and energy monitor: Amazon.co.uk: Diy and tools; 2014. URL (<http://www.amazon.co.uk/Plug-In-Power-and-Energy-Monitor/dp/B000Q7PJGW>).
- King WR, Rodriguez JI. Evaluating management information systems. *MIS Q* 1978;43–51.
- Myers BL, Kappelman LA, Prybutok VR. A comprehensive model for assessing the quality and productivity of the information systems function: toward a theory for information systems assessment. *Inf Resour Manag J* 1997;10(1):6–26.
- Gable G, Sadera D, Chan T. Enterprise systems success: a measurement model. In: ICIS 2003 proceedings; 2003. p. 48.
- Davis Jr FD. A technology acceptance model for empirically testing new end-user information systems: theory and results [Ph.D. thesis]. Massachusetts Institute of Technology; 1986.

- [41] Davies F, Venkatesh V. Measuring user acceptance of emerging information technologies: an assessment of possible method biases. in: 1995 Proceedings of the twenty-eighth Hawaii international conference on system sciences, vol. 4. IEEE; 1995. p. 729–36.
- [42] Fishbein M, Ajzen I. Belief, attitude, intention and behavior: an introduction to theory and research; 1975.
- [43] Ajzen I, Fishbein M. Understanding attitudes and predicting social behaviour, 1980, Prentice-Hall, <https://books.google.com.eg/books?id=AnNqAAAAMAAJ>, ISBN:9780139364433, ICCN: lc79026063.
- [44] Petter S, DeLone W, McLean E. Measuring information systems success: models, dimensions, measures, and interrelationships. *Eur J Inf Syst* 2008;17(3):236–63.
- [45] DeLone WH, McLean ER. Information systems success: the quest for the dependent variable. *Inf Syst Res* 1992;3(1):60–95.
- [46] Armstrong B, Fogarty GJ, Dingsdag D, Dimpleby J. Validation of a computer user satisfaction questionnaire to measure is success in small business. *J Res Pract Inf Technol* 2005;37(1):27–42.
- [47] Wang P, Liu Q, Qi Y. Factors influencing sustainable consumption behaviors: a survey of the rural residents in China. *J Clean Prod* 2014;63:152–65. <http://dx.doi.org/10.1016/j.jclepro.2013.05.007>.
- [48] Dunlap RE, VanLiere KD. The new environmental paradigm. *J Environ Educ* 1978;9(4):10–9.
- [49] Dunlap RE, VanLiere KD, Mertig AG, Jones RE. New trends in measuring environmental attitudes: measuring endorsement of the new ecological paradigm: a revised nep scale. *J Soc Iss* 2000;56(3):425–42.
- [50] Steger MAE, Pierce JC, Steel BS, Lovrich NP. Political culture, postmaterial values, and the new environmental paradigm: a comparative analysis of Canada and the united states. *Polit Behav* 1989;11(3):233–54.
- [51] Hair JF, Black B, Babin B, Anderson R, Tatham RL. *Multivariate data analysis*. 6th ed. Pearson: Prentice-Hall; 2006. p. 745–54.