

UDC 622.834.2:622.862.3

<https://doi.org/10.15407/mining12.04.009>

## EXPERIMENTAL STUDIES OF THE SEAM OPENINGS COMPETENCE IN DIFFERENT METHODS OF PROTECTION UNDER PITCH AND STEEP COAL SEAMS DEVELOPMENT

Ya. Liashok<sup>1</sup>, I. Iordanov<sup>1</sup>, D. Chepiga<sup>1\*</sup>, S. Podkopaiev<sup>1</sup><sup>1</sup>Donetsk National Technical University, Pokrovsk, Ukraine\*Corresponding author: e-mail [daria.chepiha@donmtu.edu.ua](mailto:daria.chepiha@donmtu.edu.ua), tel. +380999815583

### ABSTRACT

**Purpose.** Investigation of the seam openings competence in different methods of protection in complex mining and geological conditions of pitch and steep coal seams development of Donbas.

**Methods.** To achieve this purpose, the research uses a complex approach, including analysis and generalization of the openings protection experience, studying the static field of stress distribution in a coal-rock mass on cloudy crystal ball model, a mine experiment to study the haulage gate hardness and the experimental data.

**Findings.** When studying the wall-rock displacements on the haulage gate contour, it was recorded that in the case of yieldable protective facilities usage for seam openings, the roof and foot convergence of the coal bed mining as the productive workings advance is observed until the complete protective facilities compression, and in the zone of steady rock pressure is damped. In the case of coal pillars usage for roadway protection, after the destruction their hardness varies in a linear fashion, which contributes to a significant deterioration in the haulage gate stability behind the face. The use of a goaf stowing for the seam opening protection, from the point of view of stresses distribution in the coal-rock mass, ensures a gentle deflection of the wall-rocks behind the face by increasing the area of the subsidence strata actual contact with the filling mass, when compared with the roadway protection with the coal pillars.

**Originality.** The effectiveness of the applied method for the seam openings protection is proposed to be evaluated according to the change in the stability of the haulage gate, but taking into account the hardness of the protective facilities. The hardness of protective facilities reflects their ability to resist deformation when the delaminated rock strata is displaced and depends on the value of the external force, the time factor, and the geological conditions of the developed coal seam.

**Practical implications.** The use of a goaf stowing, as a method for controlling the roof or for wide yielding seats located above the roadway, will allow the haulage gates operational condition to be operational and increase the safety of work while maintaining the workings.

**Keywords:** haulage gate, displacement, pillar, protective facilities, goaf stowing, delaminated rock strata

### 1. INTRODUCTION

The efficiency of coal seams mining with increasing depth of development and reliability of mining work to a large extent depends on the state of mine opening. Their unsatisfactory condition, especially when maintaining seam roadways in difficult mining and geological conditions, increases the level of miners injuries. In the development of pitch and steep coal seams, due to the specific features of the development associated with the angles of incidence, there is a danger of sudden caving of the roof rocks and the displacement of the bedrock. In some cases, cavings of wall-rocks extend to the long face space, often along its entire length and are accompanied by a partial or

complete cave-in of the productive workings and openings. In other cases, these phenomena occur behind long face and lead only to the caving of openings. In this case, there is a loss of the roadway section regulated by the PR (Preventive Regulations), which in turn contributes to an increase in the level of injuries during the mine workings.

As it seems, as a result of the delaminated rock strata shifting, in the vicinity of the shored up mine workings, not only changes in the stress-deformed state of the wall-rocks occur, as a result of which their competence may deteriorate, but also the loss of the cross-sectional area of the openings, specific measures aimed at maintaining the haulage gates in the operational state, will meet the requirements of safe mining.

The study of the rock pressure manifestation features in the excavations at great depth made it possible to establish that the nature of its dangerous manifestations is determined not only by the stress condition of the sedimentary rock massif and their physico-mechanical properties, but also by the specific formation of the latter, which causes inelastic deformation under volume compression, as well as the ability to deform and collapse during unloading (Nikolin, Podkopaev, Agafonov, & Maleev, 2005).

In the coal-rock mass, containing workings, delamination is always preceded collapses and landslides associated with the detachment of a certain volume of rocks from the rest of the massif. In relation to this, the cleavage foliation of a coal-rock mass should be considered as a factor that weakens the rock, on which the roof competence of the coal bed mining and seam openings state depends.

In this connection, in real conditions of coal seams development, in various ways of protecting mine workings, in practice one has to meet with a special kind of wall-rocks loading depending on mining and geological conditions.

In most cases, as a parametric support for geomechanical calculations of wall-rocks and mine workings competence, the situations determined by the static method of applying the load are used. However, a number of events, to which sudden roof caving or delaminated rock strata collapse should be attributed, are characterized by the application of dynamic loads. The latter should be considered as impact phenomena, which adversely affect wall-rocks.

It is known (Shakirzyanov & Shakirzyanov, 2005; Lawson, Tesarik, Larson, & Abraham, 2017; Jordanov et al., 2018; Wang, Zhang, Zhao, Liao, & Zhang, 2018) that in the dynamic structures behavior a huge role is played the presence of a yielding base, the damping ability of which leads to smoothing of stresses upon impact. The use of a yielding base is one of the ways to protect structures based on the prevention or localization of a dynamic effect, or lowering the intensity of a static load (Zhang et al., 2006; Kumpyak & Mescheulov, 2017).

In the case of the horizon coal seams mining, as a result of productive workings advance, layers are gradually separated from the overlying strata and they are bent along the normal to bedding, like a plate with a bi-directional backfill (Shashenko, Pustovoytenko, & Sdvizhkova, 2016). With the increase in the angle of incidence of the layer, the delaminated and destroyed layers of the under-filled layer, under the influence of their own weight, tend to descend downward, promoting the manifestation of various kinds of loads on the wall-rocks (Zhukov, 2001).

In the conditions of pitch occurrence of coal seams and on dip at high angles, it is possible to take pressure on the barring of the haulage gate as an action of the socle beam, which underwent a fracture in the coal massif (Shashenko, Pustovoytenko, & Sdvizhkova, 2016). In addition, the condition of the openings is determined by wall-rock shifts in the long face, resulting in the formation of barring load (Zhukov, 2001; Hoek, 2002; Tajduś, Cała, & Tajduś, 2012).

As the study of wall-rocks shifting and deformation process (Viktorov, Iofis, & Goncharov, 2005) shows, when coal is extracted in the faulty strata, formation of

characteristic shift zones takes place, the parameters of which are significantly influenced by the way of roof control in long face and roadways protection. It is known (Zhukov, 2001; Viktorov, Iofis, & Goncharov, 2005) that the most favorable for the wall-rocks condition, and, consequently, for the mine workings, is provided by the method of controlling the roof by goaf stowing.

The study of the process of wall-rock displacements on the opening contour, the determination of the displacements magnitude, as well as the correct understanding of the geomechanical processes, will allow us to justify the choice of a rational method for protecting mine workings in specific mining and geological conditions. However, it is practically impossible to take into account the variety of factors affecting the state of roadways, therefore it is proposed to maintain the maintenance conditions according to the size of contours rocks convergence, changing the cross-sectional area, but taking into account the hardness of the protective facilities and the stress-deformed state of the wall-rocks.

The purpose of the research is to study the features of the rock pressure manifestation in seam openings and changes of the stress-deformed state of the wall-rocks under various methods of haulage gates protection in complex mining and geological conditions.

In this regard, the study of rock pressure manifestations in seam opening was accepted as the main object of research, and for quantitative evaluation – the use of the amount of rock displacement on the roadway contour and the change in the hardness of protection structures, depending on the method of protection and the distance from the face.

## 2. METHODOLOGY

At the first stage of the research, in order to study the periodic character of the rock pressure manifestations in seam openings and determining the magnitude of the wall-rocks displacement on their contour, with various methods of protection, experimental investigations of the haulage gates competence were carried out in the conditions of the state enterprise “Torez-Vuhol” at the “Toretska” and “Centralna” mines<sup>1</sup>).

When carrying out experimental observations in the haulage gate, at specially equipped gauge stations, the value of the control points shift was established, for the time interval between the measurements. The scheme of the experimental section is shown in Figure 1. At a specially equipped gauge station, using the VNIMI tape measure, the amount of the wall rocks displacement on the haulage gate contour was determined when the bench marks convergence to each other was determined, according to the most characteristic directions for pitch and steep-coal seams. The measurement error did not exceed  $\pm 2$  mm. The scheme of the gauge stations is shown in Figure 2.

The investigations were carried out in the haulage gate driven on layer  $l_3$  “Mazurka” horizon of 810 m level of “Toretska” mine, on a section length  $l = 70$  m, when the roadway was protected with hardwood chock, and on a section length  $l = 100$  m, while protecting this roadway with the pillars of coal.

<sup>1</sup> PhD Student A.V. Polozhyi (DonNTU) and engineer A.V. Korol (DTEK) were involved in the research

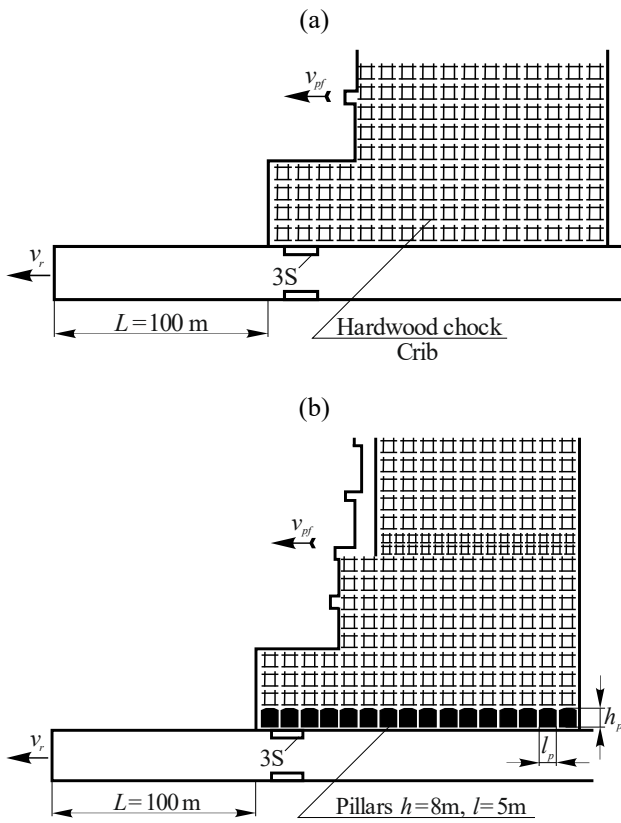

Figure 1. Scheme of experimental stretches for determination of wall-rocks displacements on the haulage gate contour, driven on the seam  $l_3$  “Mazurka”, with protection (a) by hardwood chocks or cribs, (b) coal pillars: 3S – location of the gauge station;  $h_p$ ,  $l_p$  – respectively, the height and width of the pillar, (m)

The cross-sectional area of the roadway, at the moment of the pursuance of the research, was  $S = 8.2 \text{ m}^2$ , the distance between arch timbering frames AP-3 with a wooden lagging of 0.8 m. The roadway was carried out with the help of drilling and blasting operations (DBO). The roadway advance is  $v_r = 10 \text{ m/month}$ , productive workings advance is  $v_{pw} = 7 \text{ m/month}$ . Longwall face was with a flat back stoppe. The way to control the roof in longwall face was to hold on the chocks. The protection of the roadway was carried out with hardwood chocks, and after a while, due to the deterioration of the mining and geological conditions, with the coal pillars, whose size was  $h = 8 \text{ m}$ ,  $l_p = 5 \text{ m}$ , where  $h$  was the height of the pillar, m;  $l_p$  was the width of the pillar, m.

The thickness of a coal seam  $l_3$  in the “Toretska” mine conditions was  $m = 1.32 \text{ m}$ , the angle of incidence of the seam was  $\alpha = 29^\circ$ . In the adjacent strata there was irregular metal, of medium competence, up to  $m = 4 \text{ m}$  thickness, the main roof was represented with metal stone, up to  $m = 10 \text{ m}$  thickness. In the adjacent strata of the coal seam there was irregular metal, of medium competence, up to  $m = 1.5 \text{ m}$ , in the main one – irregular metal, up to  $m = 4.1 \text{ m}$  thickness. The advance of the roadway, at the moment of carrying out full-scale investigations, was  $L = 100 \text{ m}$ .

Experiments in the “Centralna” mine were carried out in the haulage gate of seam  $l_3$  of 1146 m level in a section length  $l = 55 \text{ m}$  while protecting the roadway with cribs and in a section that length was  $l = 78 \text{ m}$  when the roadway was protected with coal pillars.

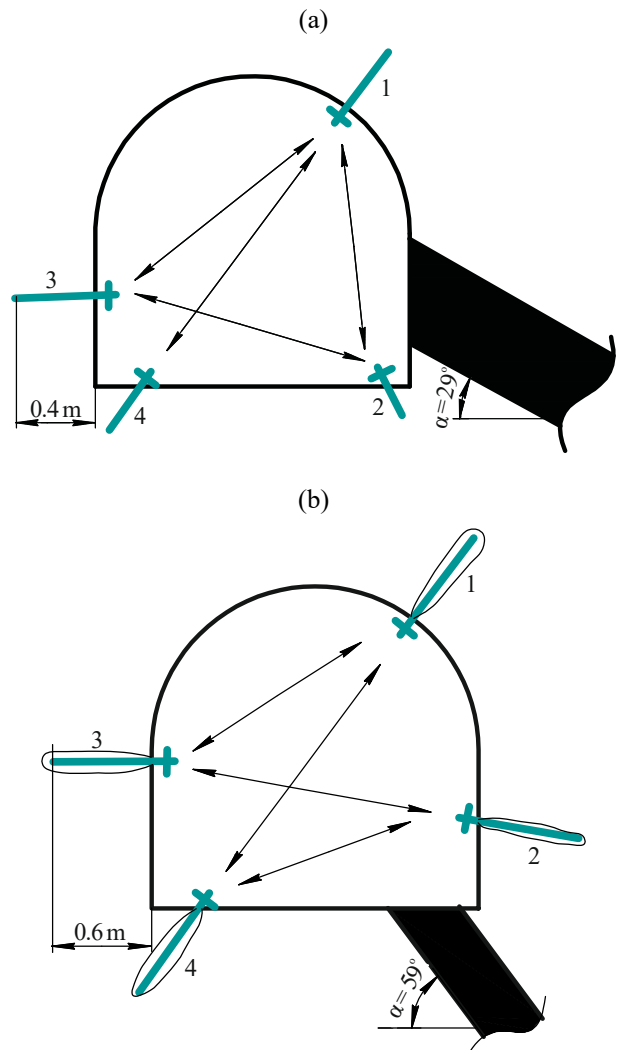

Figure 2. Schemes of gauge stations for wall-rock displacements determination on the contour of the haulage gate, driven on seam  $l_3$ : (a) at 810 m level of the “Toretska” mine; (b) at the 1146 m level of the “Centralna” mine; 1,2,3,4 – bench marks; 1 – 3, 1 – 4, 1 – 2, 2 – 3, 2 – 4 – convergence of 1, 2 bench marks in the direction to 3, 4 bench marks

The cross-sectional area of the roadway was  $S = 8.5 \text{ m}^2$ , the distance between the AP-3 timbering frames with the wooden lagging is 0.8 m. The roadway was carried out with the help of the DBO. The roadway advance was  $v_r = 18 \text{ m/month}$ , productive workings advance  $v_{pw} = 12 \text{ m/month}$ . The roadway was protected with cribs for some time, and then by coal pillars, the size of which corresponded to  $h = 8 \text{ m}$ ,  $l_p = 5 \text{ m}$ .

The thickness of coal seam  $l_3$  in the “Centralna” mine conditions was  $m = 1.17 \text{ m}$ , angle of incidence was  $\alpha = 59^\circ$ . In the adjacent strata of the coal seam there was irregular metal, up to  $m = 4 \text{ m}$  thickness, in the main room was metal stone, up to  $m = 7 \text{ m}$  thickness. In the ground there was irregular metal, up to  $m = 15 \text{ m}$  thickness. The advance of the roadway, at the moment of carrying out investigations, was  $L = 100 \text{ m}$ .

When conducting full-scale investigations on experimental stretches, the main attention was paid to the rocks displacement on the contour of openings under various protective methods, depending on the distance to the productive workings, the depth of mining operations and taking into account the geological conditions.

### 3. RESULTS AND DISCUSSION

Based on the results of the experimental data processing, the graphs of the rocks displacement on haulage gate contour of the  $l_3$  Mazurka of 810 m level of the “Toretska” mine were plotted, while it was protected for  $l = 70$  m with hardwood chocks (Fig. 3a) and  $l = 100$  m with the coal pillars (Fig. 3b).

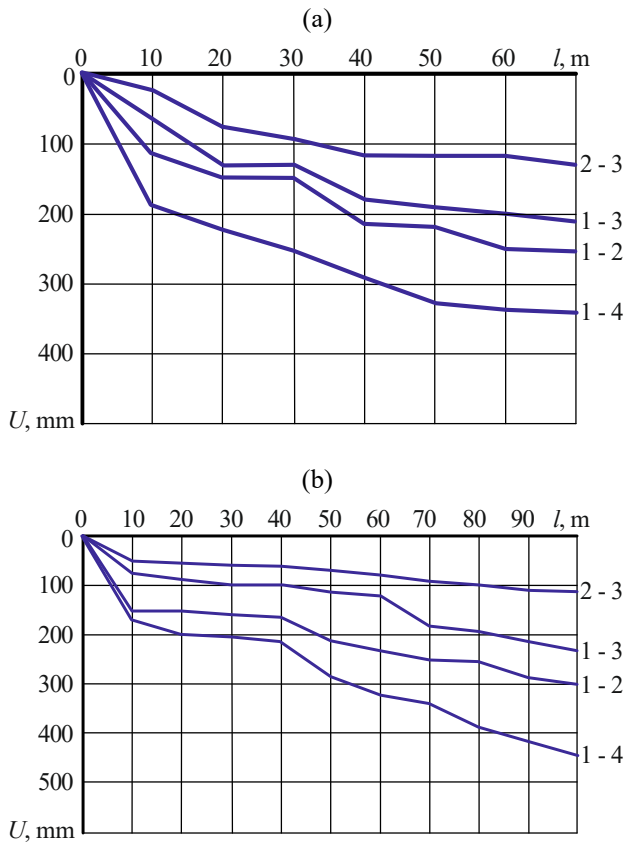

**Figure 3. Rocks displacement  $U$ , (mm) on the haulage gate contour of  $l_3$  seam along the length  $l$ , (m) at the 810 m level of the “Toretska” mine: (a) when protecting with hardwood chock; (b) when protecting with the coal pillars**

As a result of the full-scale investigations and measurements in the haulage gate of the  $l_3$  mine of the “Toretska” mine, it was established that the maximum displacement values on the opening contour, when protecting with hardwood chocks, were marked at a distance  $l = 70$  m behind the face, in directions 1 – 4 and 1 – 2. At this point, the bench marks convergence value in these directions was, respectively,  $U_{1-4} = 340$  mm,  $U_{1-2} = 250$  mm (Fig. 3a).

When protecting the roadway with coal pillars, the maximum displacements were recorded at a distance  $l = 100$  m behind the longwall face, in directions 1 – 4 and 1 – 2. In quantitative terms, the displacement in the direction of the bench marks 1 – 4 was  $U_{1-4} = 440$  mm, in the direction of the bench marks 1 – 2 was  $U_{1-2} = 300$  mm (Fig. 3b).

Simultaneously, with the recording of bench marks convergence on the contour of the opening, as the longwall face advanced, a change in the cross-sectional area of the roadway  $S$  ( $m^2$ ) was recorded. For this purpose,

measurements of the seam opening width  $b$ , (m) and height  $h$ , (m) behind longwall face were made. Hence, in Figure 4, graphs of the roadway cross-sectional area change  $S$ , ( $m^2$ ) along its length, are given for various ways of protection, taking into account the face advance.

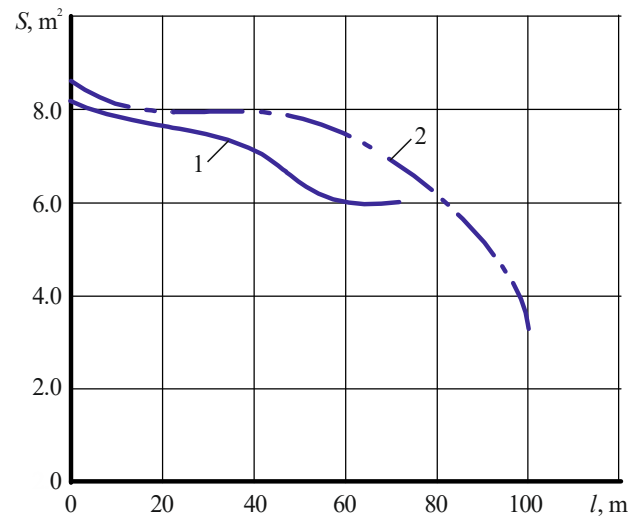

**Figure 4. Change in the cross-sectional area  $S$ , ( $m^2$ ) of the haulage gate of  $l_3$  seam along the length  $l$ , (m) on 810 m level of the “Toretska” mine during protection with: 1 – hardwood chocks; 2 – coal pillars**

It can be seen from the presented dependences that when the roadway was protected with hardwood chocks, its section  $S$ , ( $m^2$ ) changed from  $S = 8.2$   $m^2$  to  $S = 6.0$   $m^2$  at a distance  $l = 65$  m behind the longwall face, i.e. the reduction was up to 25%. Subsequently, beyond this mark, the wall-rocks convergence was not observed (Fig. 4, 1 dependence).

With the use of coal pillars for protecting the roadway, the cross-section of the roadway  $S$  ( $m^2$ ) over the distance  $l = 100$  m has changed from  $S = 8.5$   $m^2$  to  $S = 3.6$   $m^2$  (Fig. 4, 2 dependence). In this case, the reduction was up to 60%.

Data from experimental data processing obtained under the “Centralna” mine conditions, when the haulage gate, driven on seam  $l_3$  of 1146 m level, was protected with cribs in a section with length  $l = 55$  m and coal pillars at  $l = 75$  m, are presented in the form of the dependencies depicted in Figure 5.

According to the experimental studies results of bench marks convergence measurements in the opening, it was established that the maximum displacements during the protection of the roadway with cribs were marked at a distance  $l = 55$  m behind the longwall face, in directions 1 – 4 and 1 – 3, when  $U_{1-4} = 350$  mm,  $U_{1-3} = 290$  mm (Fig. 5a).

When changing the protection method to coal pillars, bench marks convergence in these directions was, respectively,  $U_{1-4} = 440$  mm,  $U_{1-3} = 320$  mm, at a distance  $l = 75$  m behind the face (Fig. 5b).

Analyzing the roadway cross-sectional area change  $S$ , ( $m^2$ ) along the entire length, as the productive workings advance, it was found that when the seam opening was protected with cribs, its cross-section decreased from  $S = 8.5$   $m^2$  to  $S = 6.8$   $m^2$  at the distance  $l = 55$  m behind the face (Fig. 6, 1 dependence).

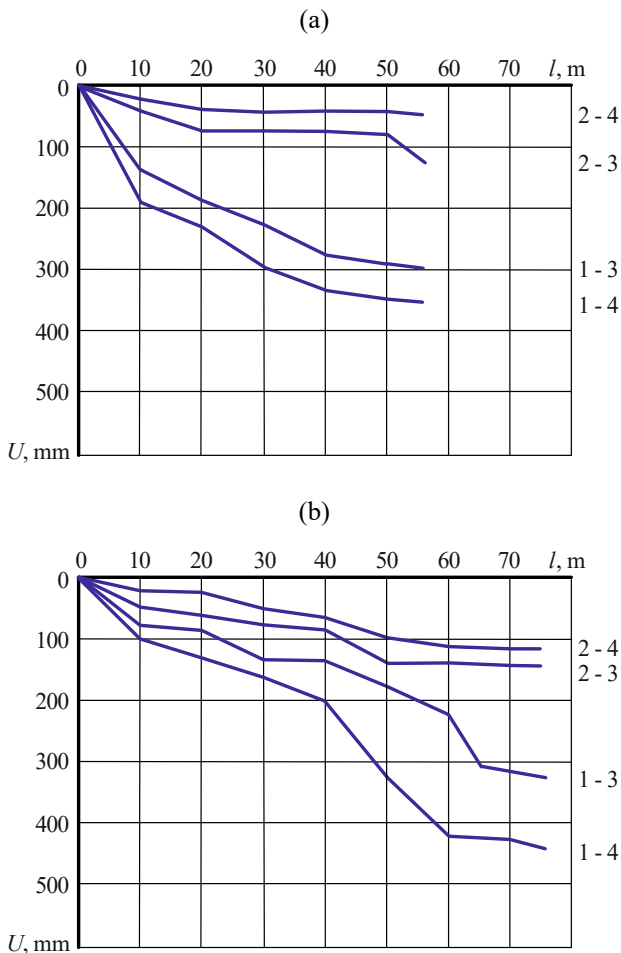

Figure 5. Rocks displacement  $U$ , (mm) on the haulage gate contour of  $l_3$  seam along the length  $l$ , (m) at 1146 m level of the “Centralna” mine: (a) when protecting with cribs; (b) when protecting with coal pillars

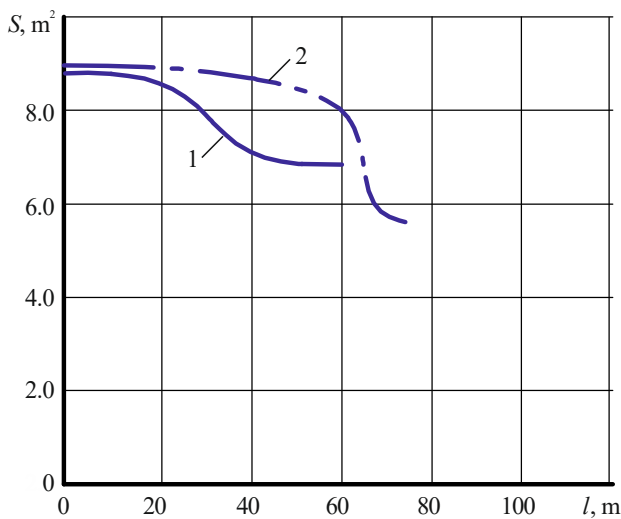

Figure 6. Change in the cross-sectional area  $S$ , ( $m^2$ ) of the haulage gate of  $l_3$  seam along the length  $l$ , (m) at 1146 m level of the “Centralna” mine during protection with: 1 – cribs; 2 – coal pillars

When using coal pillars, the section of the roadway  $S$ , ( $m^2$ ) has changed from  $S = 8.6 m^2$  to  $S = 5.5 m^2$  over  $l = 75 m$  (Fig. 6, 2 dependence). It should be noted that

the reduction in the cross-sectional area  $S$ , ( $m^2$ ) in the first case was 20%, in the second case was about 35%.

As a result of the carried out studies, it was established that the largest displacements, taking into account the protection methods of the haulage gates used in the mines, were fixed by the bench marks, from the side of the roof rocks. It is characteristic that the displacements on the hanging side, in all cases, were represented by ground lit-by-lit flexure. Irregular metal, lying in the rocks of adjacent strata, under the influence of the bearing pressure, was broken by a series of fractures, as a result of which, in some cases, there was rocks rush in the roadway. It was noted that the roof-lowering can stop at a different distance from the face in the direction of the mined-out space. This is due to the type of protective facilities, when protecting the openings with timber constructions, behind the mark  $l = 50 m$  behind the face, the wall-rock displacements practically fade and stabilize. In the case of protection openings with coal pillars, such a pattern can not be in evidence. Nevertheless, the nature of wall-rocks displacement on the opening contour, with the removal from the face in the mined-out space direction, has the same qualitative picture, but differs in intensity.

Depending on the face position, the cross section of the roadway was reduced due to the delaminated rock strata pressure on the barring. The most intensive rocks pressure on the roadway barring occurs from the adjacent strata in a direction close to the normal toward the formation. The opening barring was deformed specifically from the hanging side, it is inherent in the roadway haulage level. From the foot wall side, i.e. ground of the developed coal seam, deformations are insignificant. However, in case of protection with coal pillars, the ground displacement increased by 25 – 30%, in comparison with the use of timber constructions as a protective facility.

Apparently, without rejecting the principal possibility of improving the roadway condition by increasing the load-bearing strength of the barring, still the main direction ensuring the safety of the workings in an operational condition that meets the preventive regulations in difficult mining and geological conditions should be considered the search for more reliable and constructively simple ways to protect the haulage gates.

Because of the complexity of mining and geological conditions for the coal seams development, in a coal-rock mass containing openings, mining operations, geomechanical situations having negative impact on the rocks state occur. To ensure their continuity, as well as the safety of mine workings, in practice, various methods of protection are used, the effectiveness of which depends on the competence of the physical and mechanical system “coal seam – side rocks – protective facilities”. To minimize the negative rock pressure manifestations in the vicinity of the supported haulage gate, it is recommended the use of yieldable protective facilities (Jordanov et al., 2018). In this case, in the presence of yieldable links in the physical-mechanical system, protective facilities designed to support wall-rocks behind the face must have a hardness rate – the modulus of elasticity, as well as the springs (Yakobi, 1987; Das et al., 2017).

Therefore, in the second stage of the research, we use the displacement method and the method of forces (Ikrin,



2004) to determine the hardness influence of the applied protective facilities on the openings state and the analysis of the geomechanical situation in the vicinity of the supported roadways. Applied to the problem being solved, we consider the roof rocks displacement of the developed coal seam to be the largest displacement, when the movement of the 1 bench mark in the direction to the 4 bench mark was fixed on the haulage gate contour, when it was protected with timber constructions (hardwood chock, cribs) or coal pillars. Then the coupling equation in the system under consideration, taking into account the fact that the applied unit force in the direction of the largest displacements has the form:

$$C = \frac{1}{U_{1-4}}, \quad (1)$$

where:

$U_{1-4}$  – convergence of the 1 bench mark in the direction to the 4 one, m.

According to (1), we can conclude that the hardness  $C$ , (N/m) reflects the ability of protective facilities to resist deformation under external influence and depends on the static displacement, in the case under consideration, the displacement of the adjacent strata rocks along a line perpendicular to the strata. Meanwhile, in calculating the wall-rocks and mine workings competence, we can introduce the assumption that the movement of the body point at any time of the static loading is the same as under the action of a dynamic loading (Rusakov, 2003).

Deformation of protective facilities consists of elastic and residual parts. Depending on the possible magnitude of the latter, we can talk about the plasticity or brittleness of the protective facility (Sokolovskiy, 1969).

Figure 7a, b shows the dependences reflecting the change in the hardness  $C$ , (N/m) of hardwood chocks (a) and coal pillars (b), as the productive workings advance under the conditions of the “Toretska” mine.

Analogous dependencies were obtained for the conditions of the “Centralna” mine, when cribs and coal pillars were used for the haulage gate protection. The results of the studies are shown in Figure 8a, b.

For yielding protective facilities, plastic deformation is typical, with a smooth increase in their reaction to the maximum value. In these cases, the angled graph arm, depicted in Figures 7a and 8a, characterizes the convergence of the wall-rocks, when compression of protective facilities occurs for a certain period of time. Having depleted its yielding and reached a certain amount of hardness, equal to  $C = 2.75$  N/m (Fig. 7a) and  $C = 2.9$  N/m (Fig. 7b) at a distance  $l = 50$  m behind the longwall face, conditions are created when in the zone of steady-state rock pressure, the convergence of the wall-rocks is not observed, and the roof-lowering has reached a maximum value (Fig. 7a, 8a).

It is known (Das et al., 2017) that the strength and deformation properties of the coal pillar are determined by the presence of defects in it and their characteristics.

As a result of the experimental studies, it was established that the magnitude of the coal pillar hardness under the conditions of the pitch coal seams occurrence (“Toretska” mine) varies from  $C = 5.8$  N/m at a distance  $l = 10$  m behind the face, to  $C = 3.0$  N/m at a distance  $l = 70$  m (Fig. 7b).

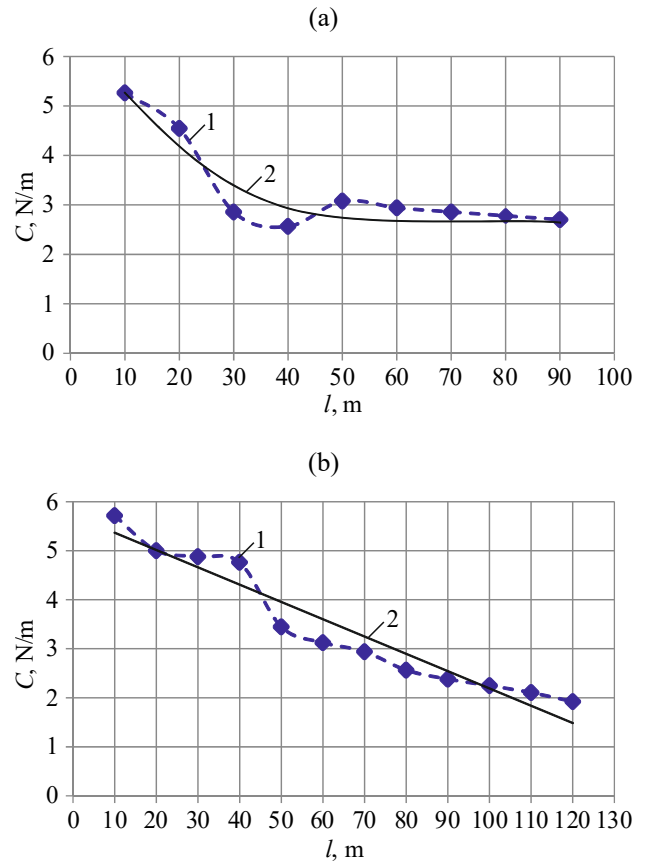

Figure 7. Changes in hardness  $C$ , (N/m) of protective facilities along the haulage gate length  $l$ , (m) behind the longwall face in the “Toretska” mine under protection: (a) hardwood chocks; (b) coal pillars; 1 – experimental data; 2 – dependencies after treatment 1 ( $R^2 = 0.92$ )

In the conditions of dip at high angles of the strata (“Centralna” mine), the change in the pillar hardness is  $C = 10$  N/m at  $l = 10$  m, and  $C = 2.1$  N/m at a distance  $l = 70$  m (Fig. 8b). In the first case, the reduction in hardness is about 50%, in the second one is about 75%. With the further advance of the face, under the conditions of the “Toretska” mine, the pillar hardness was reduced to  $C = 2.15$  N/m, at a distance  $l = 100$  m (Fig. 7b), which led to a decrease in the investigated value by 65%.

Taking this into account, Figure 9 shows the linear dependencies presenting the change in  $P$ , (%) of the coal pillar hardness along the length  $l$ , (m) of the haulage gate.

Correlation of the experimental data presented in the form of the dependencies depicted in Figure 9 allows determining the change in the hardness of the brittle protective facilities along the length of the haulage gate, taking into account the external force. In the cases under consideration, between the convergence of the wall-rocks and the change in the pillars hardness, there is a linear dependency; the nature of the change depends on the mining and geological conditions of the coal seam development (Fig. 9).

In a rock-fracture zone, the pillar is in the limit stress-deformed state and its load-bearing strength is insufficient to support the underworked seams (Protosenya & Verbilo, 2017). In such conditions, the protective coal pillars are prone to destruction and eruption.

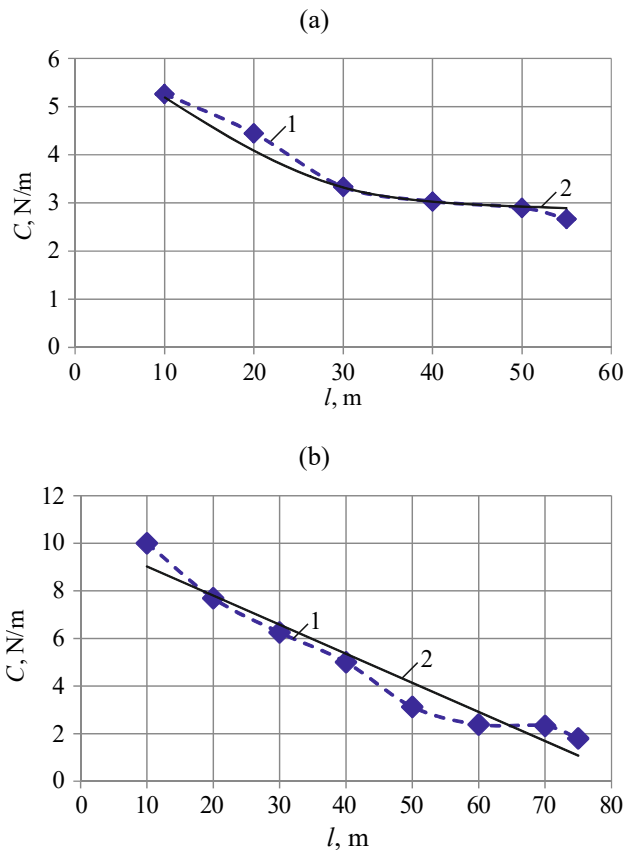

Figure 8. Changes in hardness  $C$ , (N/m) of protective facilities along the haulage gate length  $l$ , (m) behind the longwall face in the conditions of the “Centralna” mine during protection: (a) cribs; (b) coal pillars; 1 – experimental data; 2 – dependencies after treatment 1 ( $R^2 = 0.92$ )

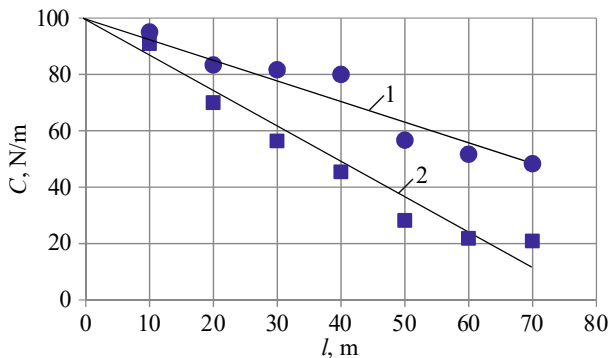

Figure 9. Changes in the coal pillar hardness  $P$  (%) along the length of haulage gate  $l$  (m): 1 – “Toretska” mine; 2 – “Centralna” mine; ■, • – experimental values ( $R^2 = 0.91$ )

This leads to the formation of openings above the roadway, a significant decrease in the pillar hardness and, consequently, the loss of the cross-sectional area of the formation haulage gate when it is maintained in the mined-out space, i.e. behind the face.

This fact is confirmed by studies of the formation haulage gate condition, protected by the coal pillars under the conditions of the “Centralna” mine, when a sharp destruction of the pillar and the adjacent strata of the developed coal seam was recorded behind the mark

$l = 50 - 60$  m behind the longwall face, as well as a decrease in the cross-sectional area of the opening.

The experience of mines on layers with complex mining and geological conditions showed that in some cases, where timber constructions (hardwood chock, cribs) were laid to protect the haulage gate, still there were roof collapses. Analysis of such situations made it possible to establish that this was due not only to mining and geological, but also to technical factors. The latter should be attributed to the inconsistency of the methods used to protect mine workings and roof management, the particular exploitation conditions.

DonUGI and DonNTU studies previously found that the filling mass prevents the development of intensive fracturing in the vicinity of the mine workings and creates zones of hard ground, in the worked out space, behind the face. At the same time, for various reasons, the method of complete goaf stowing is not currently applied, although its implementation eliminated the collapse of the adjacent and caving of the main roof, as well as the displacement of the bedrock.

In view of the foregoing, in order to study the negative manifestations of rock pressure in a coal-rock mass containing workings, studies were conducted on cloudy crystal ball models. The purpose of such studies was to determine the initial qualitative picture of tangential stresses distribution, at which comparatively smaller negative manifestations of the rock pressure in the haulage gate should be expected when it is protected with rock walls of different hardness or with the coal pillars.

Investigation of the stress-deformed state of the rock massif in the vicinity of the haulage gate was carried out using cloudy crystal ball model of igdantine using the photoelastic method (Stepanova & Dolgih, 2017) in the DonNTU rock pressure laboratory. The simulated depth corresponded to  $H = 1200$  m, the seam inclination was  $\alpha = 60^\circ$ , the thickness of the coal seam was  $m = 1$  m. The thickness of the adjacent and main roof rocks corresponded to 5 m, where  $m$  is the thickness of the coal seam, (m). The rocks of the adjacent roof and ground in their properties corresponded to rocks such as irregular metal of medium competence, rocks of the main roof and ground corresponded to metal stone of medium competence. Three models were tested. The thickness of the models was 40 mm. The scale of the simulation corresponded to M1:100. Simulation is performed in accordance with recommendations (Surendra & Simha, 2015; Alsiya, Lekshmi, Priya, & Mehta, 2016). The physical and mechanical properties of the coal pillar and the rock wall in the model corresponded to the actual samples.

In models, the filling material of the rock wall was modeled with foam rubber. To impart hardness to such a material, the foam for a while was placed in a paraffin solution and held in it for  $t = 1$  s and  $t = 3$  s. The magnitude of the rock wall yielding property was determined according to recommendations (Shakirzyanov & Shakirzyanov, 2005), using the method of photographic fixation (Obiralov, Limonov, & Gavrilova, 2004). The results of the studies are presented in Table 1. The photoelastic method makes it possible to establish an initial picture of stress distribution in a place that is formed in the wall-rocks in the first period of time after the coal is extracted.

**Table 1. Data of laboratory studies of the rock wall hardness determination**

Time, $t$ , (s)	Simulation variant	Yielding capacity, (m)	Hardness, $C$ , (N/m)	Average value of hardness $C$ , (N/m)
1s	1	0,028	35	34
	2	0,03	33	
	3	0,029	34	
	4	0,03	33	
	5	0,029	34	
3s	1	0,011	84	85
	2	0,011	85	
	3	0,011	85	
	4	0,012	83	
	5	0,011	84	

The method is based on the transmission by a parallel light beam of the model, when the lines of the greatest tangential stress action are identified on the screen (Surendra & Simha, 2015; Alsiya, Lekshmi, Priya, & Mehta, 2016).

When using the photoelastic method in the problem being solved, it is considered (Baklashov, 2004) that the stress concentration leads to creepages, and in the course of time, in the places of compressive and tensile stresses concentration the destruction of the subsidence massif takes place. This is confirmed by an earlier analysis of the mechanical processes taking place in a coal-rock mass with mining workings, when the stress state of the rocks, as far as the distance from the development contour, changes from a state close to the general extension and displacement to a compression state in the depth of the massif (Norel, 1983).

The simulation results are shown in Figure 10 and 11a, b. Analysis of the static field of tangential stresses indicates that when protecting the roadway with the coal pillars, we have the maximum concentration of stresses in the roof rocks and ground, and also in the vicinity of the haulage gate (Fig. 10).

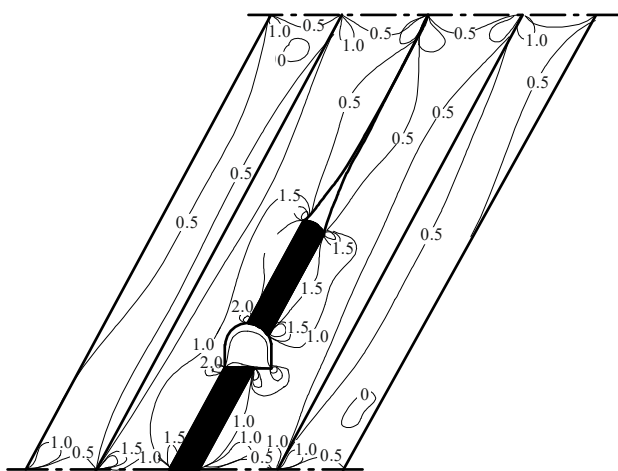

**Figure 10. Static field of tangential stresses in the vicinity of the haulage gate during protection of the coal pillars**

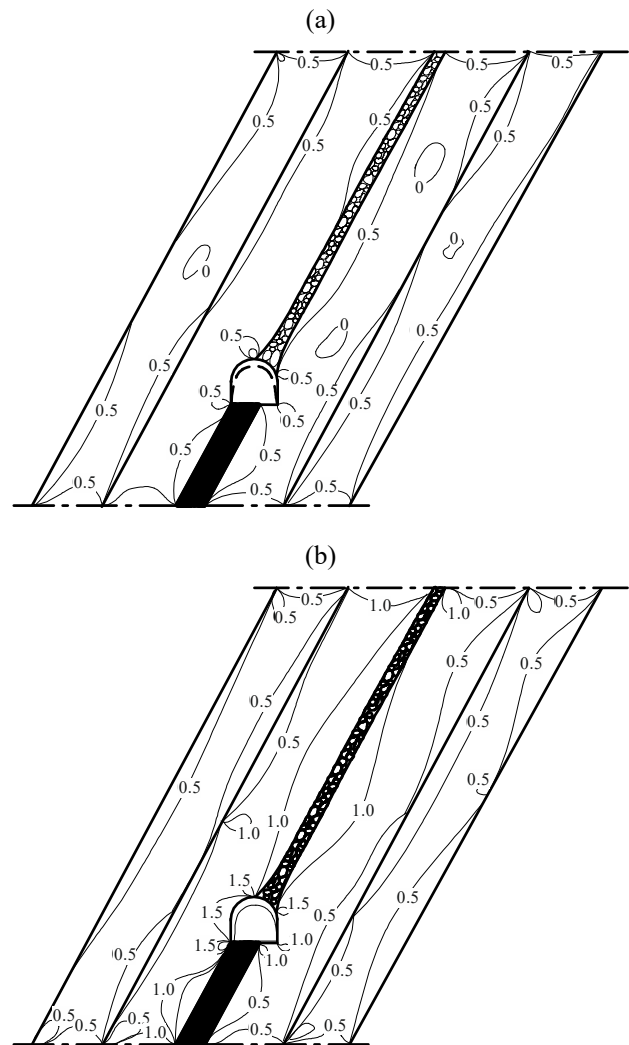

**Figure 11. Static field of tangential stresses in the vicinity of the haulage gate in the method of the mining pressure controlling in face with goaf stowing: (a) with the filling mass hardness  $C = 35 \text{ N/m}$ ; (b) the same,  $C = 84 \text{ N/m}$**

Coal pillar is a brittle body and is a classic object of linear fracture mechanics. In the linear fracture mechanics, brittle failure is viewed from the standpoint of the accumulation mechanism of damages and fractures growth (Karkashadze, 2004).

While pillar loading is applied to the moment of displacement, the accumulation of loads in it occurs according to linear fashion, with relatively small deformations (Khani, Baghbanan, Norouzi, & Hashemolhosseini, 2013; Fekmistov & Golovin, 2015). Apparently, the greater the load-bearing strength and hardness of the protective facilities, all other things being equal, the more destructive efforts are exerted on the rocks of the adjacent strata at the places of overstress that are formed due to the contact of the nonyielding facility with the wall-rocks (Fig. 10).

The foregoing negative geomechanical features of rocks performance are reduced to the minimum in the method of roof control with goaf stowing. The modeling data show that the use of a filling mass for roof rocks maintenance, reduces the concentration of stresses in the coal-rock mass. However, the hardness of the filling mass has a significant influence on the stress level (Fig. 11a, b).



The hardness of the filling mass determines the level of stress concentration in the wall-rocks. Reduction of this value by 2.5 times leads to minimum values of stresses in the coal-rock mass, when we have a gentle deflection of the wall-rocks along the entire length of the longwall face. At the same time, the area of actual contact of subsidence rocks with a rock walls does not change, and only stresses redistribution at the boundary of contact between wall-rocks and the filling mass occurs. In all cases, in the protection of seam opening with rock walls, the barring in the haulage gate is uniformly deformed (Fig. 11a, b). It follows that the most favorable for the mining workings state located in a sedimentary rocks massif, in terms of stress distribution, is influenced by the method of roof control with goaf stowing.

In a coal-rock mass with mining workings, the underworked and delaminated seam roof rocks, which are a block mass consisting of beams of different length, uncontrollably subside behind the productive workings, creating an unfavorable geomechanical situation in the vicinity of the shored up openings. Unexpected appearance of such situations contributes to the negative dynamic loads manifestation and it is one of the seams development features with yielding wall-rocks. In order to minimize rock pressure negative manifestations, it is necessary to ensure the effective of the coal roof rocks maintenance.

Experimental studies of the flexural modes of the simulated beam were conducted to study the competence of the coal roof, which was represented in the form of a socle beam, which was supported behind a filling mass of various hardness, under the influence of instantaneous loads in such conditions, in the form of sudden wall-rocks collapses, in the DonNTU rock pressure laboratory on models of equivalent materials (Jordanov et al., 2018).

As a result of the studies carried out, it was found that the filling mass, whose cavitation is  $M \leq 6\%$  at the maximum loose density, is a hard base for the delaminated roof rocks, and the latter, with the action of external force, are more yieldable to destruction. It is evident, that to ensure the operational status of seam openings, using a filling mass of the mined-out space, certain requirements must be imposed on the filling mass. In particular, for the normal functioning of the system under consideration, it is necessary that the filling mass consisted of a nonhomogeneous particles of the loosened rock or had a cavitation  $M = 7 - 20\%$  with a decrease in the loose density. When these conditions were fulfilled, the integrity of the modeled strata beam was ensured when an external force was applied to it.

Thus, in accordance with the results of the studies performed, it can be stated that in order to ensure the operational state of seam openings in difficult mining and geological conditions, when the requirement to effective wall-rocks maintaining of the developed coal seam behind the longwall face along the haulage gate was be regarded, application of wide yielding seat or goaf stowings as protective facilities would be reasonable. Protective facilities of this type provide sufficient overpressure to the subsidence rocks of the hanging wall and their gentle deflection behind the longwall face, in the mined-out space.

When comparing the original qualitative picture of the tangential stresses distribution in a coal-rock mass containing workings, while protecting the haulage gate with goaf stowing, we have less negative manifestations of rock pressure than when it is protected with coal pillars.

Coal pillars are brittle protective facilities, the change in hardness of which occurs according to a linear law, taking into account the mining and geological conditions of the developed coal seam. As a result of the effect on these seats of external force, after the destruction their hardness decreases, which contributes to a sharp deterioration in the competence of the haulage gate behind the longwall face.

#### 4. CONCLUSIONS

As a result of carried out experimental studies on the wall-rocks displacement nature on the contour of seam openings under various methods of protection, the effectiveness of the latter was assessed by changing the condition of the roadway, taking into account the hardness of the protective facilities. In order to ensure the operational status of haulage gates, in difficult mining and geological conditions, it is necessary to focus on the use of a goaf stowing as a method of rock pressure or wide yielding protective facilities control, which will make it possible to maintain effectively and gentle deflection of the wall-rocks behind the face, along the length of the openings.

#### ACKNOWLEDGEMENTS

The authors are grateful to the staff of the 10<sup>th</sup> VGSO Minvuhleprom of Ukraine and the technical directorate of SE "Torez-Vuhillia" for their assistance in conducting experimental studies.

#### REFERENCES

- Alsiya, S., Lekshmi, C.J., Priya, B.P.J., & Mehta, R.C. (2016). Image processing algorithm for fringe analysis in photoelasticity. *Scholars Journal of Engineering and Technology*, 4(7), 325-328.  
<https://doi.org/10.21276/sjet.2016.4.7.5>
- Baklashov, I.V. (2004). *Geomechanika*. Moskva: Izdatel'stvo Moskovskogo Gornogo Instituta.
- Das, A.J., Mandal, P.K., Bhattacharjee, R., Tiwari, S., Kushwaha, A., & Roy, L.B. (2017). Evaluation of stability of underground workings for exploitation of an inclined coal seam by the ubiquitous joint model. *International Journal of Rock Mechanics and Mining Sciences*, (93), 101-114.  
<https://doi.org/10.1016/j.ijrmms.2017.01.012>
- Fekmistov, Yu.G., & Golovin, A.D. (2015). Obosnovanie raspredeleniya davleniya na tseliki v osadochnykh gornyykh porodakh. *Litosfera*, (6), 130-135.
- Hoek, E. (2002). *Practical rock engineering*. London, United Kingdom: Institution of Mining and Metallurgy.
- Ikrin, V.A. (2004). *Soprotivlenie materialov s elementami teorii uprugosti i plastichnosti*. Moskva: Izdatelstvo ASV.
- Jordanov, I.V., Chepiga, D.A., Kolomiets, V.A., Podkopaev, E.S., Korol, A.V., & Dovgal, V.Yu. (2018). O vliyanii izgibnykh deformatsiy na sostoyanie krovli ugolnogo plasta pri vnezapnykh obrusheniyah porodnoy tolschi. *Visnyk Natsionalnoho tekhnichnoho universytetu "Kharkivskiy politekhnichnyi instytut"*, 16(1992), 27-40.  
<https://doi.org/10.209998/2413-4295.2018.16.05>

- Karkashadze, G.G. (2004). *Mekhanicheskoe razrushenie gornyh porod*. Moskva: Izdatel'stvo MGGU.
- Khani, A., Baghbanan, A., Norouzi, S., & Hashemolhosseini, H. (2013). Effects of fracture geometry and stress on the strength of a fractured rock mass. *International Journal of Rock Mechanics and Mining Sciences*, (60), 345-352. <https://doi.org/10.1016/j.ijrmms.2013.01.011>
- Kumpyak, O.G., & Mescheulov, N.V. (2017). Chislennoe modelirovanie podatlivykh opor v vide trub koltsevogo secheniya pri staticheskom i kratkovremennom dinamicheskom nagruzhении. *Vestnik Tomskogo Gosudarstvennogo Arhitekturno-Stroitel'nogo Universiteta*, (5), 121-134.
- Lawson, H.E., Tesarik, D., Larson, M.K., & Abraham, H. (2017). Effects of overburden characteristics on dynamic failure in underground coal mining. *International Journal of Mining Science and Technology*, 27(1), 121-129. <https://doi.org/10.1016/j.ijmst.2016.10.001>
- Nikolin, V.I., Podkopaev, S.V., Agafonov, A.V., & Maleev, N.V. (2005). *Snizhenie travmatizma ot proyavleniy gornogo davleniya*. Donetsk: Nord-Press.
- Norel, B.K. (1983). *Izmenenie mekhanicheskoy prochnosti ugol'nogo plasta v massive*. Moskva: Nauka.
- Obiralov, A.I., Limonov, A.N., & Gavrilova, N.A. (2004). *Fotogrammetriya*. Moskva: Kolos S.
- Protosenya, A.G., & Verbilo, P.E. (2017). Raschet nesushey sposobnosti i izuchenie anizotropii prochnostnykh harakteristik mezhdukamernykh tselikov v blochnom gornom massive. *Innovatsionnye napravleniya v proektirovanii gornodobyvayushchih predpriyatiy: Geomekhanicheskoe obespechenie proektirovaniya i sprovovzheniya gornyh rabot*, 219-225.
- Rusakov, A.I. (2003). Korrektnyi raschet privedennykh mass pri udare. *Vestnik RGUPS*, (2), 134-137.
- Shakirzyanov, R.A., & Shakirzyanov, F.R. (2005). *Dinamika i ustoychivost sooruzheniy*. Kazan': Izdatel'stvo Kazanskogo gosudarstvennogo arhitekturno-stroitel'nogo universiteta.
- Shashenko, A.N., Pustovoytenko, V.P., & Sdvizhkova, E.A. (2016). *Geomehanika*. Kyiv: Naukovyi druk.
- Sokolovskiy, V.V. (1969). *Teoriya plastichnosti*. Moskva: Vysshaya shkola.
- Stepanova, L.V., & Dolgih, V.S. (2017). Tsifrovaya obrabotka rezultatov optoelektronnykh izmereniy. Metod fotouprugosti i ego primenenie dlya opredeleniya koeffitsientov mnogoparametricheskogo asimptoticheskogo razlozheniya M. Uilyamsa polya napryazheniy. *Vestnik Samarskogo Gosudarstvennogo Tehnicheskogo Universiteta. Seriya "Fiziko-Matematicheskie nauki"*, 21(4), 717-735.
- Surendra, K.V.N., & Simha, K.R.Y. (2015). Digital image analysis around isotropic points for photoelastic pattern recognition. *Optical Engineering*, 54(8), 081209. <https://doi.org/10.1117/1.oe.54.8.081209>
- Tajduś, A., Cała, M., & Tajduś, K. (2012). *Geomechanika w budownictwie podziemnym*. Kraków, Polska: Wydawnictwa AGH.
- Viktorov, S.D., Iofis, M.A., & Goncharov, S.A. (2005). *Sdvizhenie i razrushenie gornyh porod*. Moskva: Nauka.
- Wang, C., Zhang, C., Zhao, X., Liao, L., & Zhang, S. (2018). Dynamic structural evolution of overlying strata during shallow coal seam longwall mining. *International Journal of Rock Mechanics and Mining Sciences*, (103), 20-32. <https://doi.org/10.1016/j.ijrmms.2018.01.014>
- Yakobi, O. (1987). *Praktika upravleniya gornym davleniem*. Moskva: Nedra.
- Zhang, W., Su, M.L., Yu, H.L., Jiao, Z., Zhang, J.H. & Yang, H.J. (2006). The elastic mechanics solution of statically indeterminate beams fixed at two sides under the action of concentrated load. *Journal of North China Institute of Water Conservancy and Hydroelectric Power*, 27(4), 40-42.
- Zhukov, V.E. (2001). Ob odnoy strategicheskoy oshibke v razreshenii problemy razrabotki krutykh plastov. *Ugol Ukrainy*, (7), 6-10.

## ЕКСПЕРИМЕНТАЛЬНІ ДОСЛІДЖЕННЯ СТІЙКОСТІ ПІДГОТОВЧИХ ВИРОБОК ПРИ РІЗНИХ СПОСОБАХ ОХОРОНИ В УМОВАХ ПОХИЛИХ І КРУТИХ ВУГІЛЬНИХ ПЛАСТІВ

Я. Ляшок, І. Іорданов, Д. Чепіга, С. Подкопаєв

**Мета.** Дослідження стійкості пластових підготовчих виробок при різних способах охорони у складних гірничо-геологічних умовах розробки похилих і крутих вугільних пластів Донбасу.

**Методика.** Для досягнення поставленої мети в дослідженнях використовується комплексний підхід, що включає аналіз і узагальнення досвіду охорони підготовчих виробок, вивчення статичного поля розподілу напружень у вуглепородному масиві на оптичних моделях, шахтний експеримент із вивчення стійкості відкаточних штреків та обробку експериментальних даних.

**Результати.** При вивченні зсувів бічних порід на контурі відкаточного штреку зафіксовано, що в разі використання для охорони пластових підготовчих виробок піддатливих охоронних споруд, конвергенція покрівлі й підосви вугільного пласта, який розробляється, в міру посування очисного забою спостерігається до повного стиснення охоронної споруди, а в зоні сталого гірського тиску практично згасає. У разі використання для охорони штреків ціликів вугілля після руйнування їх жорсткість змінюється за лінійним законом, що сприяє значному погіршенню стійкості відкаточного штреку позаду очисного вибою. Застосування закладання виробленого простору для охорони пластових підготовчих виробок, з точки зору розподілу напружень у вуглепородному масиві, забезпечує плавний прогин бічних порід позаду очисного вибою за рахунок збільшення площі фактичного притискання товщі, що опускається, до закладного масиву, при порівнянні з охороною штреків ціликами вугілля.

**Наукова новизна.** Ефективність застосовуваного способу охорони пластових підготовчих виробок пропонується оцінювати за зміною стійкості відкаточного штреку, але з урахуванням жорсткості охоронних споруд. Жорсткість охоронних споруд відображає їх здатність чинити опір деформації при зрушенні розширеної породної товщі й залежить від значення зовнішньої сили, фактору часу та гірничо-геологічних умов розроблюваного вугільного пласта.

**Практична значимість.** Застосування закладання виробленого простору, як способу управління покрівлею або широких піддатливих опор, розташованих над штреком, дозволить забезпечити експлуатаційний стан відкаточних штреків і підвищити безпеку робіт при підтриманні підготовчих виробок.

**Ключові слова:** відкаточний штрек, зміщення, цілик, охоронні споруди, закладання виробленого простору, розширення бічних порід

## **ЭКСПЕРИМЕНТАЛЬНЫЕ ИССЛЕДОВАНИЯ УСТОЙЧИВОСТИ ПОДГОТОВИТЕЛЬНЫХ ВЫРАБОТОК ПРИ РАЗЛИЧНЫХ СПОСОБАХ ОХРАНЫ В УСЛОВИЯХ НАКЛОННЫХ И КРУТЫХ УГОЛЬНЫХ ПЛАСТОВ**

Я. Ляшок, И. Иорданов, Д. Чепига, С. Подкопаев

**Цель.** Исследование устойчивости пластовых подготовительных выработок при различных способах охраны в сложных горно-геологических условиях разработки наклонных и крутых угольных пластов Донбасса.

**Методика.** Для достижения поставленной цели в исследованиях используется комплексный подход, включающий анализ и обобщение опыта охраны подготовительных выработок, изучение статического поля распределения напряжений в угленосном массиве на оптических моделях, шахтный эксперимент по изучению устойчивости откаточных штреков и обработку экспериментальных данных.

**Результаты.** При изучении смещений боковых пород на контуре откаточного штрека зафиксировано, что в случае использования для охраны пластовых подготовительных выработок податливых охранных сооружений, конвергенция кровли и почвы разрабатываемого угольного пласта по мере подвигания очистного забоя наблюдается до полного сжатия охранных сооружений, а в зоне установившегося горного давления практически застывает. В случае использования для охраны штреков целиков угля после разрушения их жесткость изменяется по линейному закону, что способствует значительному ухудшению устойчивости откаточного штрека позади очистного забоя. Применение закладки выработанного пространства для охраны пластовых подготовительных выработок, с точки зрения распределения напряжений в угленосном массиве, обеспечивает плавный прогиб боковых пород позади очистного забоя за счет увеличения площади фактического касания опускающейся толщи с закладочным массивом, при сравнении с охраной штреков целиками угля.

**Научная новизна.** Эффективность применяемого способа охраны пластовых подготовительных выработок предлагается оценивать по изменению устойчивости откаточного штрека, но с учетом жесткости охранных сооружений. Жесткость охранных сооружений отражает их способность сопротивляться деформации при сдвигении расслоившейся породной толщи и зависит от значения внешней силы, фактора времени и горно-геологических условий разрабатываемого угольного пласта.

**Практическая значимость.** Применение закладки выработанного пространства, как способа управления кровлей или широких податливых опор, расположенных над штреком, позволит обеспечить эксплуатационное состояние откаточных штреков и повысить безопасность работ при поддержании подготовительных выработок.

**Ключевые слова:** *откаточный штрек, смещения, целик, охранные сооружения, закладка выработанного пространства, расслоение боковых пород*

### **ARTICLE INFO**

Received: 3 May 2018

Accepted: 2 October 2018

Available online: 12 October 2018

### **ABOUT AUTHORS**

Yaroslav Liashok, Doctor of Economic Sciences, Rector of the Donetsk National Technical University, 2 Shybankova Ave., 85300, Pokrovsk, Ukraine. E-mail: [iaroslav.liashok@donntu.edu.ua](mailto:iaroslav.liashok@donntu.edu.ua)

Ihor Iordanov, Candidate of Technical Sciences, Associate Professor of the Department of Mineral Deposits, Donetsk National Technical University, 2 Shybankova Ave., 85300, Pokrovsk, Ukraine. E-mail: [gendir@eme.kiev.ua](mailto:gendir@eme.kiev.ua)

Daria Chepiga, PhD Student of the Department of Mineral Deposits, Donetsk National Technical University, 2 Shybankova Ave., 85300, Pokrovsk, Ukraine. E-mail: [daria.chepiha@donntu.edu.ua](mailto:daria.chepiha@donntu.edu.ua)

Serhii Podkopaiev, Doctor of Technical Sciences, Professor of the Department of Mineral Deposits, Donetsk National Technical University, 2 Shybankova Ave., 85300, Pokrovsk, Ukraine. E-mail: [serhii.podkopaiev@donntu.edu.ua](mailto:serhii.podkopaiev@donntu.edu.ua)