



Article (refereed) – Published version

Balfour, C.A.; Howarth, M.J.; Jones, D.S.; Doyle, T.. 2013 The Design and Development of an Irish Sea Passenger-Ferry-Based Oceanographic Measurement System. *Journal of Atmospheric and Oceanic Technology*, 30 (6). 1226-1239.
[10.1175/JTECH-D-12-00223.1](https://doi.org/10.1175/JTECH-D-12-00223.1)

This version available at <http://nora.nerc.ac.uk/502703/>

NERC has developed NORA to enable users to access research outputs wholly or partially funded by NERC. Copyright and other rights for material on this site are retained by the rights owners. Users should read the terms and conditions of use of this material at <http://nora.nerc.ac.uk/policies.html#access>

© Copyright 2013 American Meteorological Society (AMS).
Permission to use figures, tables, and brief excerpts from this work in scientific and educational works is hereby granted provided that the source is acknowledged. Any use of material in this work that is determined to be “fair use” under Section 107 of the U.S. Copyright Act September 2010 Page 2 or that satisfies the conditions specified in Section 108 of the U.S. Copyright Act (17 USC §108, as revised by P.L. 94-553) does not require the AMS’s permission. Republication, systematic reproduction, posting in electronic form, such as on a web site or in a searchable database, or other uses of this material, except as exempted by the above statement, requires written permission or a license from the AMS. Additional details are provided in the AMS Copyright Policy, available on the AMS Web site located at (<http://www.ametsoc.org/>) or from the AMS at 617-227-2425 or copyrights@ametsoc.org.

Contact NOC NORA team at
publications@noc.soton.ac.uk

The Design and Development of an Irish Sea Passenger-Ferry-Based Oceanographic Measurement System

C. A. BALFOUR, M. J. HOWARTH, D. S. JONES, AND T. DOYLE

National Oceanography Centre, Liverpool, United Kingdom

(Manuscript received 12 October 2012, in final form 6 December 2012)

ABSTRACT

An evolving coastal observatory has been hosted by the National Oceanography Centre at Liverpool, United Kingdom, for more than nine years. Within this observatory an instrumented ferry system has been developed and operated to provide near-surface scientific measurements of the Irish Sea. Passenger vessels such as ferries have the potential to be used as cost-effective platforms for gathering high-resolution regular measurements of the properties of near-surface water along their routes. They are able to operate on an almost year-round basis, and they usually have a high tolerance to adverse weather conditions. Examples of the application of instrumented ferry systems include environmental monitoring, the generation of long-term measurement time series, the provision of information for predictive model validation, and data for model assimilation purposes.

This paper discusses the development of an engineering system installed on board an Irish Sea passenger ferry. Particular attention is paid to explaining the engineering development required to achieve a robust, automated measuring system that is suitable for long-term continuous operation. The ferry, operating daily between Birkenhead and Belfast or Dublin, United Kingdom, was instrumented between December 2003 and January 2011 when the route was closed. Measurements were recorded at a nominal interval of 100 m and real-time data were transmitted every 15 min. The quality of the data was assessed. The spatial and temporal variability of the temperature and salinity fields are investigated as the ferry crosses a variety of shelf sea and coastal water column types.

1. Introduction

The exploitation of regularly scheduled commercial vessels to gather scientific measurements is a technique that has been increasing in popularity for some time (Hydes et al. 2009; Petersen et al. 2011; Grayek et al. 2010; Buzzelli et al. 2003). The basic premise is to install scientific instrumentation on board a commercial sea-going vessel to automatically gather information such as seawater quality measurements for the waters through which the vessel sails. This approach can represent a cost-effective mechanism for scientific studies by the exploitation of regularly scheduled vessels of opportunity.

Under the European Union's (EU) fifth framework (contract EVK2-2002-00144) funding was received from 2002 to 2005 by the National Oceanography Centre (NOC) in Liverpool to install instrumentation on

board an Irish Sea passenger vessel to form what is commonly referred to as a FerryBox. The general objective was to gather long-term oceanographic measurements to complement a suite of Irish Sea measurement and modeling systems. This was used to form a coastal observatory (Howarth and Palmer 2011) that represented a national capability for U.K. science (<http://noc.ac.uk/ocean-watch/about>). A key feature of the Irish Sea FerryBox was the ability to use regular sailings to gather measurements on an almost daily year-round basis. Passenger vessels tend to have a higher tolerance to adverse weather conditions than smaller survey vessels. This subsequently offers an opportunity to gather measurements across complete transects of the Irish Sea that would be difficult or expensive to accomplish by other means. Potential limitations of this approach are that ferries tend to follow fixed routes and usually only near-surface measurements can be generated. This results in datasets that usually have excellent temporal resolution with only a limited spatial resolution.

In the early stages of the project commissioning, a bespoke in-house-designed system was selected because

Corresponding author address: Dr. Christopher Balfour, National Oceanography Centre, 3 Brownlow St., Liverpool L3 5DA, United Kingdom.
E-mail: cabal@noc.ac.uk

of the prohibitive cost of the commercial systems that existed at that time (Englander 2009; Petersen et al. 2003). There are many engineering challenges to overcome to develop a reliable and robust FerryBox system. The key scientific requirements were for measurements every 100 m, a near-real-time data transfer capability, and regular ferry-based sensor calibration verification. The basis of this is that the ferry is required to resolve frontal gradients, for which a horizontal resolution of 100 m is sufficient. This requirement resulted in the selection of an instrumentation sampling rate of 10 s for a typical ferry speed of 20 kt. This represents an appropriate choice for the sampling rate that is well within the capabilities of the instrumentation used.

Problems to be addressed when implementing the FerryBox include a potentially unreliable external power source in the ferry, electrical interference from the ship's systems, and reliable long-distance data communications between instrumentation in the engine room and a data management system in the bridge of the ferry. Sedimentary and biological fouling of the scientific sensors used also represented a potential source of data quality limitations. This paper discusses the techniques applied to design such a system and the key scientific measurements the FerryBox has been used to generate.

After an introductory section, this paper provides a review of the instrumentation and supporting engineering infrastructure system design. Details of the telemetry system are provided before the sensor evaluation, development, and scientific results are presented. The paper concludes with a review of the sensor system results and achievements along with a series of suggested additional applications.

2. Instrumentation system development

The close proximity of the 12 Quays ferry terminal at Birkenhead, United Kingdom, to the NOC Liverpool laboratory made this facility a suitable choice for implementing an Irish Sea FerryBox. Initially, Norse Merchant Ferries, then Norfolkline, and then DFDS Seaways operated a fleet of four cargo and passenger vessels. Two vessels sailed between Birkenhead and Belfast, in the United Kingdom. The other vessels sailed between Birkenhead and Dublin in the Republic of Ireland (Fig. 8a) until the closure of these routes in January 2011. One of these vessels, the *M/V Liverpool Seaways*, had the FerryBox installed. This ship provided oceanographic measurements during sailings between Birkenhead and Dublin twice daily from Tuesday to Saturday, with single sailings on Sunday and Monday. A crossing of the Irish Sea normally required approximately

7 h for completion. Ferry measurements were an important component of a coastal observatory that complimented other measurements taken via ship-based survey grids, instrumented moorings, surface buoys, coastal tide gauges, satellite sensing, and autonomous underwater gliders.

The oceanographic instrumentation fitted on board the ferry was composed of two main components. First, there was a sensor system fitted in the engine room that was located approximately 3 m away from the main seawater inlet and water storage chest to the ferry that was used for engine cooling purposes. This cooling water was pumped from an inlet in the ferry hull. The inlet was at a nominal water depth of approximately 3 m below the sea surface during sailings. A proportion of this cooling water was subsequently pumped through a pressure vessel in the ferry engine room that contained a series of oceanographic sensors. The flow rate through the pressure vessel was relatively high with a refresh of the chamber water occurring typically every 20–30 s. The measured parameters were composed of seawater conductivity, temperature, pressure, derived salinity, dissolved oxygen concentration, optical backscatter (OBS) turbidity, and chlorophyll *a* concentration. A satellite-based telemetry system was included that allowed a subset of the ferry-based measurements to be available in near-real time during sailings. A 2-week service interval was used that involved exchanging the instrumentation in the engine room for a replacement set of instruments that have recently been cleaned, serviced, and calibration checked. During servicing, a visit was also made to the bridge of the ferry that hosted the second key set of instrumentation for the FerryBox. This was basically composed of a data recorder, a GPS receiver, and a satellite data telemetry modem. The service visit to the bridge of the ferry was primarily to copy the stored oceanographic data that had been recorded by a custom real-time datalogger and to check the instrumentation system status. Following the service visit, the recovered instrumentation was returned to the NOC laboratories for data downloading, servicing, and calibration testing. In addition to this, a buoy in the Liverpool Bay with a similar instrumentation package that was regularly serviced by a different institute was used for scientific measurement comparison. This assisted with the process of FerryBox sensor calibration between instrumentation service visits to the ferry.

There are many potential problems with installing sensitive instrumentation electronics in a large passenger vessel. The design of the FerryBox instrumentation has paid careful attention to addressing any difficulties that may arise with interference and electromagnetic compatibility (EMC; Horowitz and Hill 1993; Chatterton

TABLE 1. FerryBox instrumentation.

Sensor type	Supplier	Range	Accuracy
Conductivity (shielded inductive) (NXIC)	Teledyne	0–9 S m ⁻¹	±0.0009
Temperature (aged thermistor)	Teledyne	–5° to +35°C	±0.005
Pressure (micromachined silicon)	Teledyne	0–200 m	0.05%*
Chlorophyll <i>a</i>	Chelsea	0–100 µg L ⁻¹	±2%
Turbidity (OBS with mechanical wiper)	Seapoint	0–25 FTU	±2%
Dissolved oxygen	Aanderaa	0–500 µM L ⁻¹ or 0%–140%	<5%

* Percentage of full scale.

and Houlden 1991). This has helped to ensure reliable operation when delicate, precision oceanographic sensors are placed in close proximity to possible sources of interference, such as the various ship-based power and instrumentation systems. A detailed list of the instrumentation installed in the engine room is provided in Table 1. At the heart of the engine room instrumentation was an autonomously logging Teledyne Citadel NXIC CTD (Teledyne RD Instruments 2010). A series of auxiliary sensors were also connected to the CTD to supplement the recorded parameters. The CTD was configured to internally record a backup of the sensor readings at 10-s intervals and to broadcast these data in real time via a serial interface. Labeled photographs of the instrumentation frame and the pressure vessel enclosure are shown (Fig. 1). To the left-hand side of the pressure vessel, an electrically actuated valve was used

to control the water flow through the inlet to the FerryBox pressure vessel. Water exiting the pressure vessel traveled through a nonreturn flow valve and an overboard drain.

In addition to the instrumentation listed in Table 1, a mechanical wiper (Zebra Technologies Ltd. 2010) has been installed. The function of this Hydro-Wiper was to provide automated mechanical cleaning for the Seapoint OBS sensor (Seapoint Sensors Inc. 2001) at 2-h intervals. This served to discourage the onset of sedimentary and biological fouling of the sensor optical face, allowing the measurement quality of this sensor to be sustained. Instrumentation electronics provided a battery-backed power source and reliable data communications over a distance of approximately 100 m. This was required to communicate with the instrumentation system that was installed in the bridge of the ferry, in close

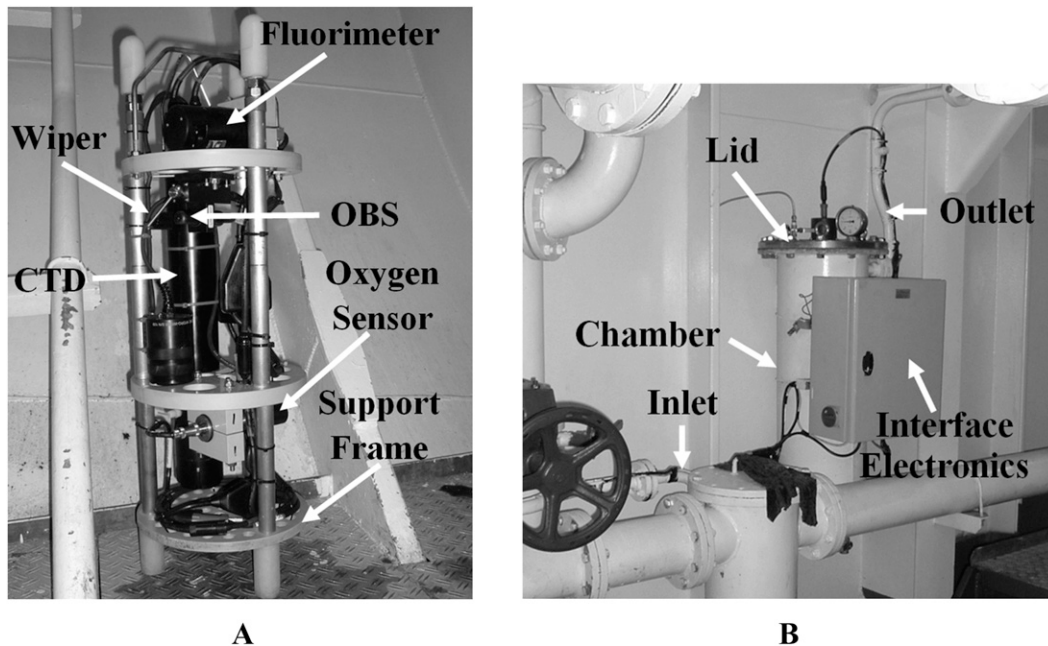

FIG. 1. Engine room instrumentation photographs of (a) the sensor frame and (b) the pressure vessel, which incorporates the instrumentation frame.

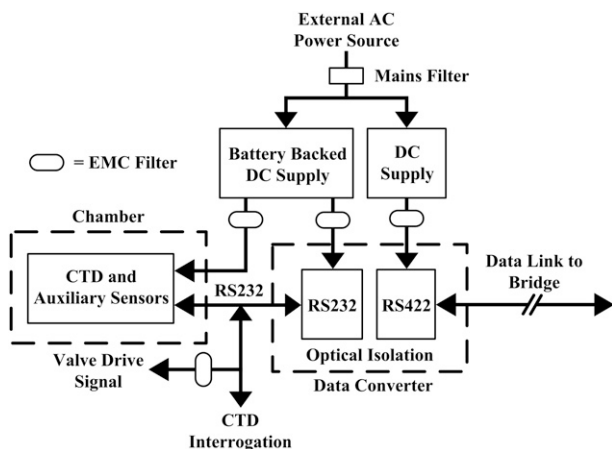

FIG. 2. Robust engine room to bridge data communications.

proximity to some externally mounted antennas. The functional diagram (Fig. 2) indicates how a robust mechanism for data communications has been implemented. In general the external power supply generated by the ship can be subject to interference and interruption. A commercial electrical mains filter with an in-line earth inductor was used to suppress electrical noise in the ship-generated alternating current (ac) supply that drives the FerryBox electronics. A battery-backed, electrically isolated direct current (dc) supply was then used to power the marine sensors inside a pressure vessel using a waterproof cable feed. The battery backup used provided sufficient power to maintain the instrumentation operation in the event of an external power failure for durations of up to approximately two days. This was used to sustain the operation of the system during periods of routine maintenance of the ferry that may involve prolonged interruptions to the external power supply in the engine room. All of the dc power lines used within the instrumentation system implemented independent fuses for electrical safety purposes. An external RS232 serial connector was located via a short connection approximately 2 m in length close to the pressure vessel. This allowed local monitoring and configuration of the in situ CTD in addition to communications with the bridge instrumentation. A commercial data converter (B&B Electronics 2012) was used to provide optical isolation for the category 5 (American National Standards Institute 2001) shielded twisted pair data cable that was used for the 100-m-long data link. This ensured that the bridge instrumentation was electrically separate from the engine room instrumentation. The RS422 side of the data converter was powered by an electrically isolated dc power supply. The differential RS422 standard (American National Standards Institute 2005) was selected for its ability to implement long-distance

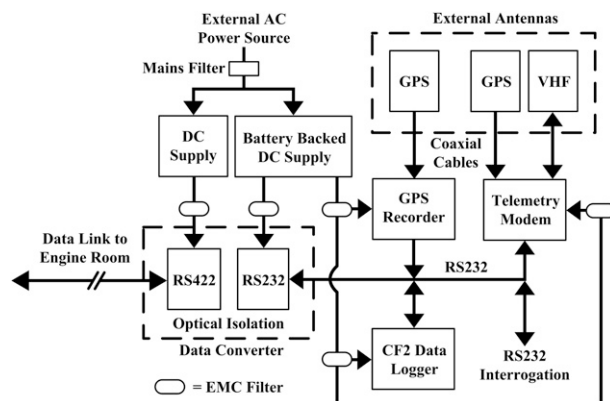

FIG. 3. Bridge data communications and electronics.

(>1000 m) point-to-point data connections with a high degree of tolerance of electrical interference. The ship's earth was also electrically separate from the instrumentation common connection to eliminate this as a potential source of interference and EMC problems. A series of EMC filters (Montrose 1999) were added to the main power and data lines. These were primarily composed of torus-shaped ferrites installed around power and data cables to improve electrical interference rejection. These design features and characteristics have served to implement a robust power supply and data communications link.

In a similar manner to the engine room electronics, a filtered external mains supply was used to power the bridge systems (Fig. 3). An optically isolated data converter communicated with the engine room electronics. An electrically isolated dc power supply drives the instrumentation electronics with a standby rechargeable battery. This provided the capability to power the various systems for up to approximately half a day if an interruption in the externally generated ac power occurs. This reduced-capacity backup was primarily due to space constraints and proved to be sufficient for this application. A GPS recorder (Laipac Technology Inc. 2007) provided a series of internal records of positional and accurate time recordings in addition to generating a stream of RS232-based GPS readings at 1-s intervals. A low-Earth-orbit satellite communications data modem (Digi International 2009) sampled instrumentation data arriving from the engine room and added a GPS positional fix in addition to an accurate time reference. This information was then transferred at a nominal time interval of 15 min to a land-based downlink. The telemetry modem incorporated an independent GPS receiver that also provided redundancy for the transfer of positional information at 15-min intervals in the event of a failure of the main GPS receiver. A series of coaxial

leads were installed to connect the GPS receiver and telemetry modem to the required external antennas on the upper deck of the ferry using weatherproof bulkhead couplings.

A key component of the FerryBox system and the bridge-based electronics was a small computer system that undertook such functions as data logging, FerryBox water flow valve control, and GPS data processing. A Persistor Instruments CF2 embedded processor system (Persistor Instruments Inc. 2005) was used to decode the engine room instrumentation data and RS232-based serial GPS fix information. The primary function of the Persistor unit was the generation of an American Standard Code for Information Interchange (ASCII) text record of the complete set of oceanographic measurements in engineering units in real time. These recorded data included a GPS-derived position, an accurate time reference, and the derived 1978 Practical Salinity Scale (PSS-78) salinity. The data record was stored in a removable flash memory card. Temporary removal of this card allowed the downloading of a copy of the recorded scientific measurement data during service visits to the ferry. In a similar manner to the engine room electronics features such as EMC filters, power line fuses and electrical isolation were added to construct a system with a high degree of tolerance to possible electrical interference from the various ship systems. A series of RS232 connectors were included to allow monitoring and interrogation of the received engine room data, GPS positional information, telemetry modem status, and the Persistor embedded control computer unit operation.

Custom software was developed for the Persistor data recorder for the FerryBox application. A simplified overview of the software operation (Fig. 4) was that every 10 s the sensor data broadcast from the engine room prompted processing by the data recorder software. This information was decoded in real time into engineering units and the latest GPS fix data were added. The GPS data were extracted by parsing a serial NMEA 0183 (National Marine Electronics Association 2002) sequence of strings from the GPS recorder. GPS data decoding was achieved using the Persistor computer during the time available between measurements arriving from the engine room. The complete decoded GPS-derived accurate time, latitude, longitude, and the decoded CTD data were then stored in a removable flash memory card inside the Persistor computer as ASCII text in real time. At the end of this process, a test was then made to determine if a number of predefined GPS control boundaries had been reached. If this occurred, then an appropriate valve control signal was generated. This ensured that when the ferry was close to port, the FerryBox water pressure chamber flow control valve

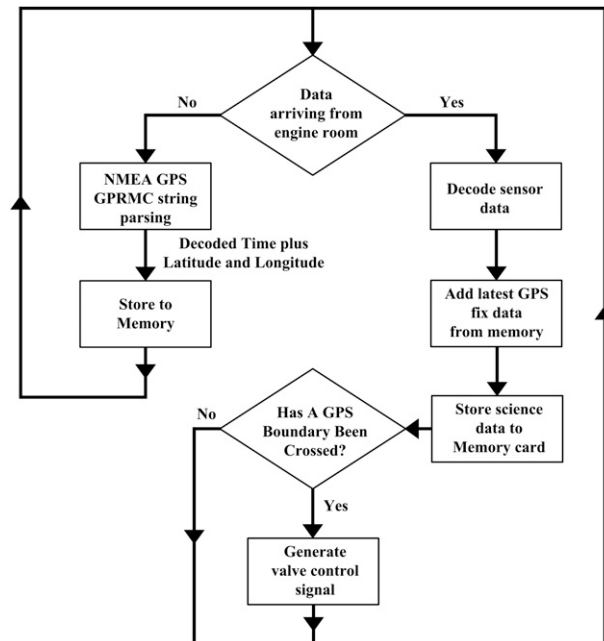

FIG. 4. Simplified schematic of the Persistor CF2-based data decoding and recording software operation.

operated correctly and measurements were temporarily suspended. When the data decoding and valve boundary testing were complete, the Persistor computer then resumed decoding the latest GPS fix data at 1-s intervals. The storing of this information to internal memory ensured that an up-to-date ship position and accurate time reference were available in the Persistor computer.

Each of the Birkenhead, Dublin, and Belfast ports the ferry can visit has two GPS-derived boundaries predefined within the Persistor computer. An inner boundary was defined at a specified distance from the ship's mooring location in port of typically 1 km. An outer boundary was then defined at a farther distance away from the port-based mooring location that was usually in the order of several hundred meters. A GPS boundary with hysteresis was implemented such that when the ship crossed the inner port boundary, the instrumentation chamber water flow control valve in the engine room was closed. This was required to stop heavily turbid waters in the river Mersey, particularly when the ship was close to the Birkenhead port berth, from fouling the instrumentation. When the ship left port, the outer GPS boundary needed to be crossed to allow the instrumentation chamber water flow control valve to open again. This dual boundary technique introduces backlash that prevents the possibility of the control valve from being rapidly switched as a boundary was crossed due to the possible variation of practically derived GPS information. The GPS boundaries for the

Birkenhead port were extended to approximately 2 km to limit the effect fouling. A watchdog time-out feature was added to the Persistor CF2 software such that if external interference causes the Persistor CF2 computer to stop operating correctly, then after a predefined time of approximately 20 s the computer will be automatically reset. Once this has occurred, normal data recording and valve control operations will be resumed. The result of this was to implement robust, reliable scientific data recording with integrated instrumentation chamber water flow valve control.

3. Marine data telemetry

An important requirement was for the FerryBox to be able to transfer measurement data in near-real time. This information allowed the performance of the FerryBox sensors to be closely monitored in addition to providing the latest scientific measurements for publication. If a problem was identified with the FerryBox measurements using the near-real-time data, then this could be dealt with outside of the normal 2-week service schedule. This helped to sustain the quality controlled scientific output from the FerryBox. Norse Merchant Ferries, Norfolkline, and then latterly DFDS Seaways Irish Sea ferries did not have Internet connectivity during sailings. The limited range of shore-based services, such as radio frequency communications and mobile or cellular telephones, prompted the choice of low-Earth-orbit satellites. This approach implemented a near-real-time marine data telemetry system that could operate during the full Irish Sea transects of the ferry.

The satellite service selected allowed small volumes of data in the order of several tens of bytes to be transferred using the very high frequency (VHF) band. A specialist data modem was required for wireless data transfer from the ferry via satellite to a ground-based satellite communications station with Internet access. As one of the Orbcomm (Orbcomm 2001) low-Earth-orbit satellites passed within range of the ferry-based data modem, two-way communications with the satellite could be established from the ferry using a radio frequency data link.

The m100 (Digi International 2009) satellite modem was selected for the FerryBox. This modem required significant adaptation to be used for marine data telemetry applications. Custom electronics and bespoke modem software were developed to allow the m100 to be connected to and process the serial data broadcast in real time from the engine room of the ferry. These data were decoded, compressed to binary, a GPS time and positional measurement were added from the m100 GPS receiver, and then the message was queued for transfer. A series of empirical trials was then conducted to

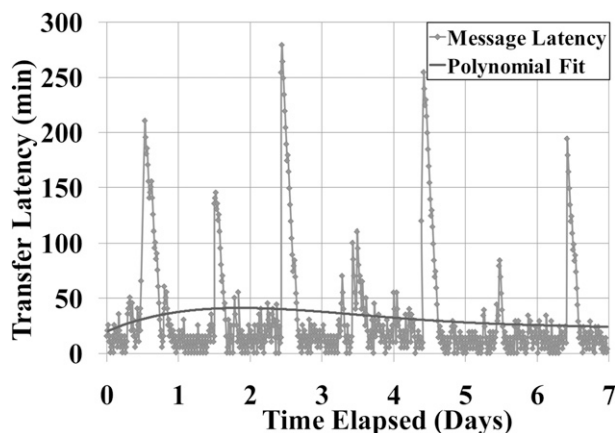

FIG. 5. Near-real-time ferry data transfer latency from 5 to 11 Jan 2010. Fitted curve indicates the general message latency times in the range of 20–30 min.

determine the preferred antenna arrangement and data transfer rates to be used (Balfour 2012).

The actual near-real-time data transfer follows a complex path from measurement to decoding. The sequence basically comprises instrumentation measurement data from the engine room being received in the bridge and subsequently checked for integrity. These data were decoded into engineering units and then range tested. If these tests are passed and the data fall within the ranges expected of the originating sensors, then the measurements were queued for transmission to a satellite using the m100 modem in the bridge electronics enclosure. As soon as a satellite passes within range of the ferry-based satellite modem, the measurement data were transferred to a ground-based communications station when the satellite network had the capacity to do so. The data received by a ground-based satellite downlink were then transferred using e-mail via the Internet to an account hosted by the NOC laboratory. This e-mail account was interrogated every 20 min using an automated-computer-based script. After a series of data validation tests, if the format of the data was correct, then the latest near-real-time ferry measurements were entered into a database. These data were available for download and published using the NOC Coastal Observatory Internet site (<http://cobs.pol.ac.uk/cobs/ferries/>).

Variable message latencies were introduced during this process (Fig. 5). The limited number of satellites in the Orbcomm constellation and the use of communication frequencies similar to ship- and land-based systems can introduce near-real-time data transfer delays. Any problems that occur with the NOC information technology (IT) infrastructure can also introduce measurement data reception delays. Occasional latencies of several hours for near-real-time data transfer can occur (Fig. 5).

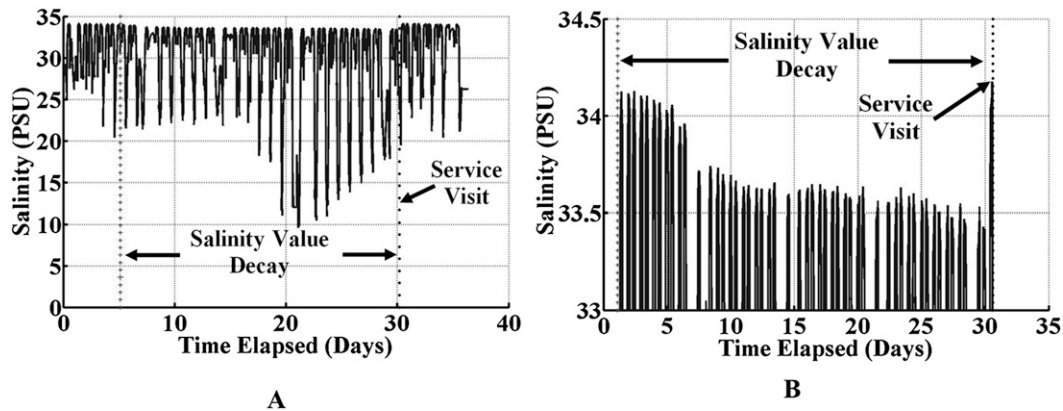

FIG. 6. NXIC CTD sedimentary fouling salinity measurement decay: (a) FSI salinity measurement decay between service visits and (b) expanded view of the FSI salinity decay profile.

However, the general near-real-time data transfer latency tends to be on the order of approximately 20–30 min, as indicated by the fitted curve (Fig. 5). Despite the limitations of Orbcomm, the comparatively low cost of the service against other satellite-based telemetry options resulted in the choice of this system. The latencies introduced, while undesirable, were considered to be satisfactory for the purpose of FerryBox near-real-time performance monitoring and measurement data transfer.

4. Sensor operation, scientific measurements, and data analysis

This section reviews the performance of the sensors that were incorporated in or trialed in the FerryBox before presenting some of the key scientific measurements undertaken by the system. A long-term problem with measurements undertaken in the Irish Sea and Liverpool Bay is that of progressive sensor fouling and subsequent loss of measurement quality. While biological fouling of sensors almost inevitably occurs over time, a particularly acute problem has been the effect of sedimentation. Suspended matter, particularly in the highly turbid waters of the river Mersey and Liverpool Bay, caused progressive fouling of the oceanographic instrumentation as seawater was pumped through the FerryBox instrumentation chamber. This frequently resulted in reductions in scientific measurement quality. This problem has primarily affected the measurement of seawater salinity and chlorophyll fluorescence, as reported previously (Balfour et al. 2007).

a. Oceanographic sensor performance evaluation

Throughout the lifetime of the FerryBox, there has been an ongoing process in operation to evaluate the performance of oceanographic sensors that are used in the demanding coastal areas required by the NOC

Coastal Observatory. Previous studies had found a potential robustness of conductivity measurement advantage of the Teledyne Citadel nonexternal inductive cell (NXIC) CTD (Teledyne RD Instruments 2010), formerly referred to as a Falmouth Scientific, Inc., (FSI) CTD, when compared to a Sea-Bird CTD (Sea-Bird Electronics Inc. 2007) for this application. Sea-Bird CTDs use an electrode-based conductivity measurement cell with a comparatively smaller geometry. This had a tendency to rapidly foul with sediment deposits when used in the Irish Sea FerryBox. In contrast to this, the Citadel CTD uses a larger geometry-shielded inductive conductivity cell that exhibited a more robust measurement in the Irish Sea FerryBox. Following the installation of this type of sensor in the FerryBox, it has transpired that salinity measurement drift still occurs in response to sedimentary fouling, albeit to a lesser degree than previously observed with the Sea-Bird instrumentation. The NXIC CTD salinity plots (Fig. 6) for data collected during 2007 show a step change in the measurement after a service visit. This serves to illustrate the problem of instrumentation fouling. The plots (Figs. 6a and 6b) show a roll off of measured salinity between service visits to the FerryBox to exchange the sensors in the engine room. The measured value recovers after the service visit before a progressive value underestimate occurs again during the sensor set deployment. Clearly, any measurement error is undesirable, and the first step taken to address this problem was to install a valve to stop the FerryBox chamber water flow when the ferry was close to port. This was to suspend the measurements while the ship was in highly turbid and disturbed near-shore waters. The penalty for this was to interrupt the measurements when the valve was closed. The plot (Fig. 7a) shows changes in the peak salinity measurement per crossing. The peak salinity value occurs as the ferry crosses the Irish Sea between

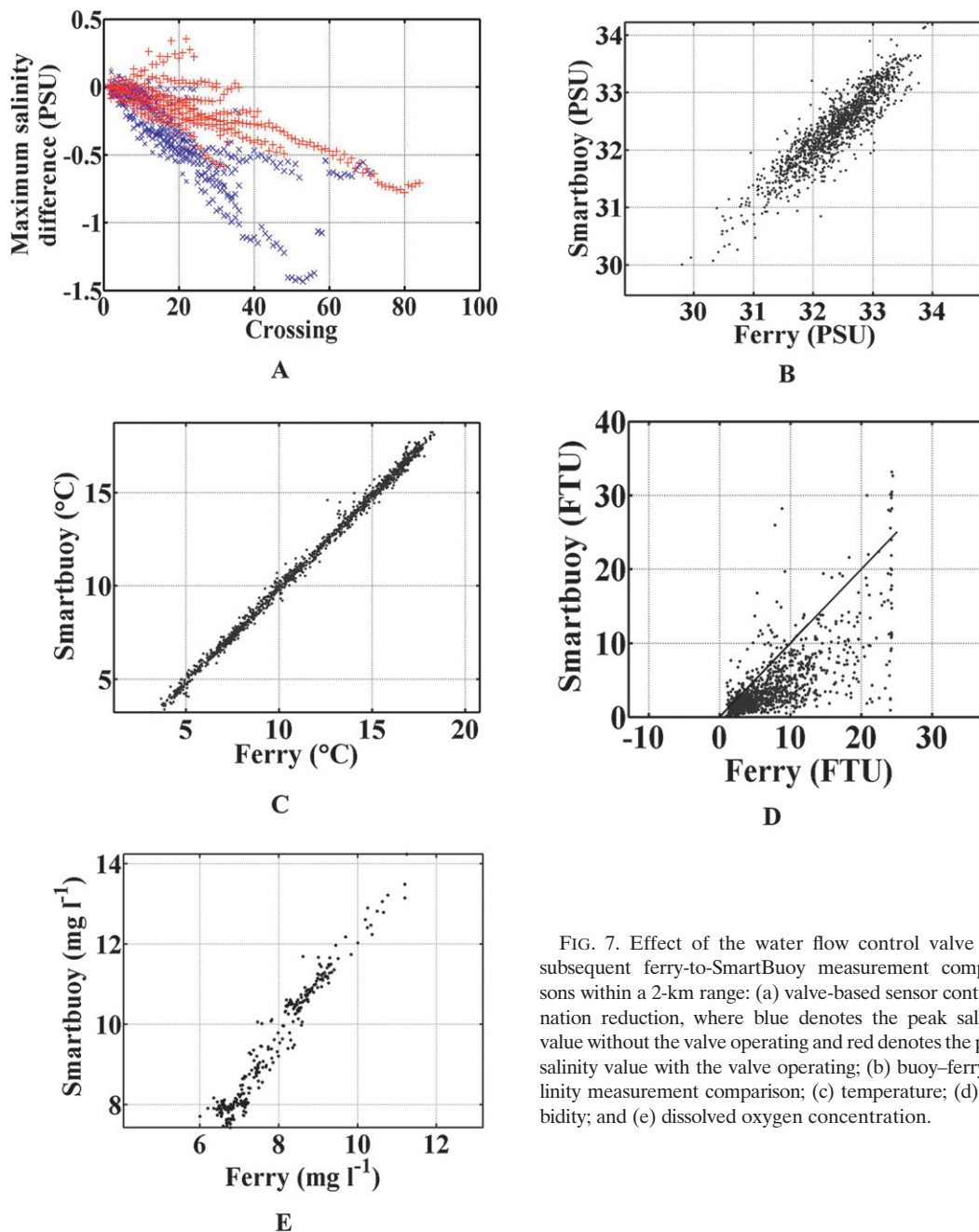

FIG. 7. Effect of the water flow control valve and subsequent ferry-to-SmartBuoy measurement comparisons within a 2-km range: (a) valve-based sensor contamination reduction, where blue denotes the peak salinity value without the valve operating and red denotes the peak salinity value with the valve operating; (b) buoy–ferry salinity measurement comparison; (c) temperature; (d) turbidity; and (e) dissolved oxygen concentration.

Anglesey and Dublin. The peak salinity value does not vary significantly in the short term and thus can be used to assess the effect of the valve. The remainder of the plots (Figs. 7b–e) compare ferry measurements with the regularly serviced Centre for Environment, Fisheries and Aquaculture Science (CEFAS) SmartBuoy (Mills et al. 2005) in Liverpool Bay, which is located at 53°32'N, 3°21.8'W, when the ferry was at a distance of approximately 2 km from the buoy. This represented the closest distance that the ferry regularly passed the buoy. The

maximum time difference of the ferry from the buoy at 2 km was 15 min, with the ferry passing north or south of the buoy. While the tidal currents are rectilinear approximately east–west and the salinity gradient is east–west, differences resulting from a maximum separation of up to 15 min were small, as shown by the temperature and salinity standard deviations (Table 2).

The peak salinity reduction per crossing (Fig. 7a) for a particular set of instrumentation illustrates the fouling problem. The red points were generated when the

control valve closed off the instrumentation system water flow close to port. The blue points show the peak salinity decay when the valve is left open, with water flowing through the instrumentation chamber at all times. The reduction in the rate of peak salinity decay per crossing due to the valve operation can be clearly seen by the points in red. This effect was more pronounced if routine service visits were missed and a longer service interval than the standard 24 crossings occurred. Based upon these results, the average rate of decay of the peak salinity value per ferry crossing was reduced from 0.019 to 0.009 PSU with the inclusion of the water flow control valve. If an allowance for the seawater intake lags in the system was made and the FSI average peak salinity decay correction was applied, then the salinity measurement was improved. When the corrected ferry salinity was compared to the SmartBuoy salinity, the correlation coefficient r subsequently improved from the 0.19 previously reported before the use of the FSI NXIC CTDs to 0.91 (Fig. 7b). Temperature measurement (Fig. 7c) in contrast to salinity has always proved to be robust. For the temperature measurements, a sensor was not installed at the hull-based water inlet to the ferry. Comparisons with the SmartBuoy show that only a small parasitic temperature elevation of 0.16°C occurred as the water was pumped through the FerryBox instrumentation chamber. The comparison scatterplot (Fig. 7c) shows a good agreement between the ferry and SmartBuoy measurements, with a correlation coefficient of 0.99 achieved. For measurements of turbidity (Fig. 7d), a higher dispersion was observed in this optically derived measurement. The same sensor type was used for both the ferry and the buoy for comparison. The exact reason for this difference is unclear, although the measurement could be disturbed by the route seawater takes before being measured in the FerryBox. Dissolved oxygen concentration measurements (Fig. 7e) (Panton 2012) show a good correlation between the measurements for the comparison of 277 data points. There is a lower value that is consistently measured in the FerryBox, although the same sensor is used by the SmartBuoy.

While the accuracy of the sensors is listed in Table 1, uncertainties associated with the practical measuring systems used in the SmartBuoy and the ferry will result in small differences in the measured parameters between each system. In coastal environments the achievable and meaningful target precisions for temperature and salinity measurements have been shown to be much larger than manufacturer specifications. Realistic accuracies have been demonstrated as in the order 0.1°C and 0.1 PSU for temperature and salinity, respectively. The ferry measurements presented in this paper demonstrate this (Table 2).

TABLE 2. FerryBox to SmartBuoy measurement comparison statistics.

Figure and measurement	Corr coef r	Mean difference (ferry – buoy)	Std dev of the difference	No. of data points
7b salinity (PSU)	0.91	–0.01	0.27	1373
7c temperature (°C)	0.998	0.16	0.24	1409
7d turbidity (FTU)	0.69	3.09	4.17	1147
7e dissolved oxygen (mg L ⁻¹)	0.95	–1.59	0.51	277

Between the near-surface-water inlet to the ferry and the FerryBox instrumentation pressure chamber, the pipe work and a seawater storage chest introduced a measurement time lag. A delay existed between when water was pumped into the ferry and when the scientific measurements from this water occurred. An estimation of this lag has been determined. This is subsequently taken into account to determine the position that a set of measurements were recorded. During ferry transects (Fig. 8a) the engine cooling water inlet pump, with a peak flow of 1000 m³, the corresponding pipe work, and an inline seawater storage chest with a capacity of 300 m³ introduced a measurement time lag. The eastbound and westbound ferry spatial measurement differences illustrated this time lag for consecutive crossings along the same route. Measurement of the salinity gradients between the Liverpool Bay and the mouth of the river Mersey (Fig. 8b) allowed this lag to be estimated. The salinity gradient differences between consecutive inward and outward ferry crossing were used, taking into account the ship's speed. For an average of consecutive crossings, an estimation of a 5-min lag in the measurements was determined. In addition to this, the pressure reading from the CTD was used as a proxy for variations in the flow rate through the FerryBox from the nominal values. Changes in this pressure indicated seawater inlet flow rate alterations due to such factors as ferry maintenance. Unless the anticipated nominal values of pressure were measured in the instrumentation chamber, the data from the FerryBox were disregarded.

The salinity measurement comparison (Fig. 9) illustrates the advantages of the Alec Electronics temperature and conductivity with mechanical wiper (CTW) sensor (Horiuchi et al. 2010) when compared to the NXIC-type design. These data were generated when the sensors were operated in the FerryBox at the same time in coastal waters with high levels of sedimentation. The sensor performance evaluation graph (Fig. 9a) shows a roll off of the measured salinity with the NXIC CTD over a 27-day deployment in the FerryBox. In contrast to this, the Alec CTW sustained the measurement over

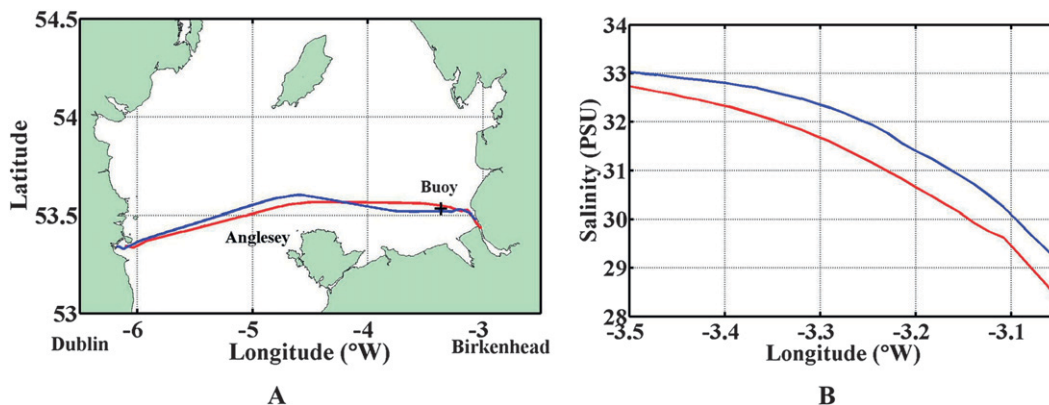

FIG. 8. Ferry eastbound and westbound consecutive transect measurements. Blue is eastbound and red is westbound. (a) Ferry transect with the SmartBuoy position in the Liverpool Bay marked. (b) Expanded view of the ferry measurement gradient change in the Liverpool Bay area, illustrating a lag.

the full deployment duration. Although the accuracy quoted by Alec conductivity cell measurement is $\pm 0.05 \text{ mS cm}^{-1}$ compared to the more accurate NXIC of $\pm 0.009 \text{ mS cm}^{-1}$ quoted by the manufacturer, the graphs (Fig. 9) clearly illustrate the advantage of mechanical conductivity measurement cell cleaning for this application.

b. Scientific measurements

From a scientific measurement perspective, the ferry route between Birkenhead and Dublin (Fig. 8a) crossed six different water types. These range from the fresher water of the Mersey estuary, through Liverpool Bay, past Anglesey, and then across the principal axis of the Irish Sea to Dublin, and are briefly described below.

1) MERSEY ESTUARY

The average discharge of the Mersey is 72 m s^{-3} , with floods regularly exceeding 500 m s^{-3} . Because tidal

mixing is strong in the region, the surface salinity at the mouth averages 28.5 PSU .

2) LIVERPOOL BAY

The bay is relatively shallow, less than 50 m, so this is a mixing zone, which despite the strong tidal currents can become stratified, primarily because of the freshwater input, on tidal and occasionally longer (few days) time scales. In addition to the Mersey, the rivers Conwy, Clwyd, Dee, and Ribble discharge into the bay with a combined mean freshwater flux of 230 m s^{-3} .

3) NEAR ANGLESEY

The tidal currents around Anglesey are strong (the maximum tidal current for an average spring tide is 1.7 m s^{-1}), so that the water column remains well mixed throughout the year.

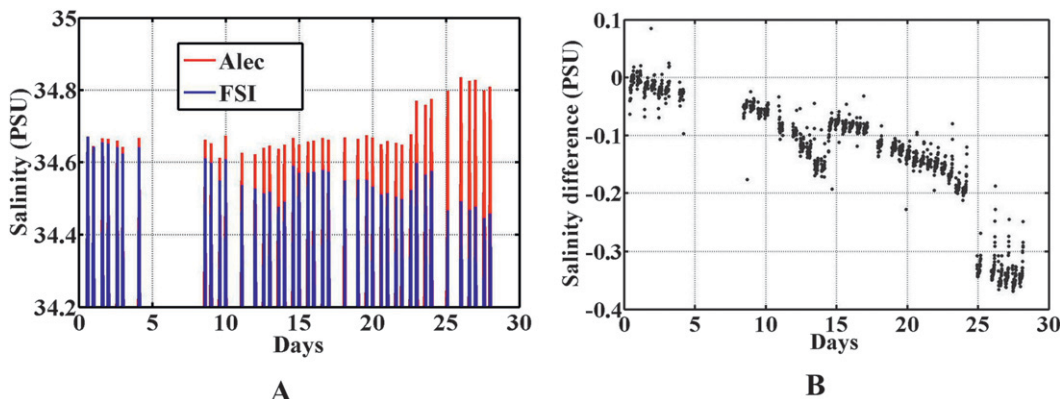

FIG. 9. Ferry-based FSI CTD and Alec CTW measurement comparison: (a) Alec CTW and FSI salinity measurements showing a progressive FSI roll off in the peak salinity measured during each ferry crossing, and (b) magnitude and form of the FSI to Alec salinity difference.

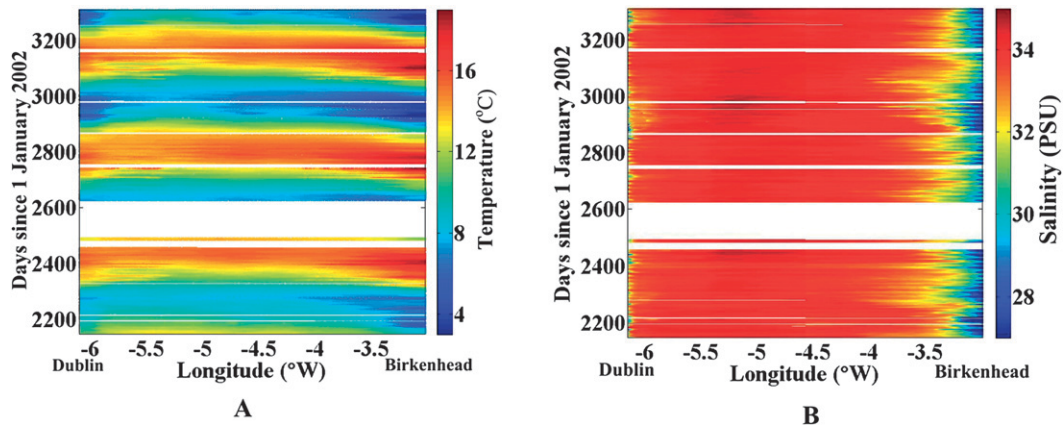

FIG. 10. Temperature and salinity measurements. The missing sections represent the times when maintenance was being undertaken to the ferry or the FerryBox measurement system. (a) FSI temperature measurements, and (b) FSI salinity measurements.

4) IRISH SEA

This is the deepest section (the maximum depth exceeds 100 m) and has the maximum salinity (in the range 33.8–34.8 PSU) from water of Atlantic origin, since the mean flow through the Irish Sea is from south to north. The ferry track crosses the southern end of the summer thermal stratified region to the west of the Isle of Man.

5) APPROACHES TO DUBLIN

These differ markedly from the approaches to Birkenhead. The mean flow from the Liffey is less ($14 \text{ m}^3 \text{ s}^{-1}$), the water depth is deeper, rapidly reaching 50 m, and the tidal currents are weaker, subsequently resulting in a freshwater mixing zone that is much narrower.

The temperature and salinity measurements that were recorded by the FerryBox since the NXIC CTD was installed in late December 2007 have been generated with corrections for salinity decay between servicing (Fig. 10). The missing sections in the dataset represent the times when maintenance was being undertaken to the ferry or the FerryBox measurement system. The figure demonstrates that a system capable of sustained spatially and temporally continuous scientific measurements has been developed. The seasonal change in temperature can be clearly seen (Fig. 10a) and will not be discussed further as the underlying physics are well known. Of greater interest is the 3-yr salinity record (Fig. 10b), where the seasonal cycle is much less pronounced (r^2 values for fitting an annual cycle are less than 0.25 compared with >0.9 for temperature). The dominant feature is the mean salinity (Fig. 11), illustrating the different water masses described previously. The ferry salinity measurements also give detailed information on its spatial and temporal variability where

two topics are particularly noteworthy, Liverpool Bay and the maximum salinity on each crossing.

The mixing zone in Liverpool Bay lies between $3.5^\circ\text{--}4^\circ$ and 3°W (the mouth of the Mersey). Salinity here is highly variable and can reach as high as 32.4 PSU at the mouth of the Mersey and as low as 29.3 PSU at the Mersey Bar site (3.36°W). This variability is demonstrated in Fig. 12, showing the longitude where 32 PSU is crossed. The variability within the bay seems to depend more on the bay's circulation (on average, northward at the surface with a strong wind influence) than on variations in the freshwater discharge. Of exceptional value are the inshore time series measurements between the SmartBuoy site and the mouth of the Mersey, which are measurements of the river plume that only a ferry can provide. The time series of the measurements at the mouth of the river Mersey, approximately 1500 m from

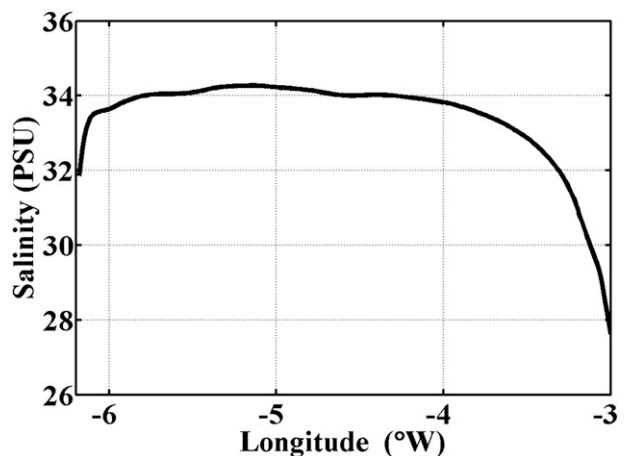

FIG. 11. The average salinity plotted against longitude.

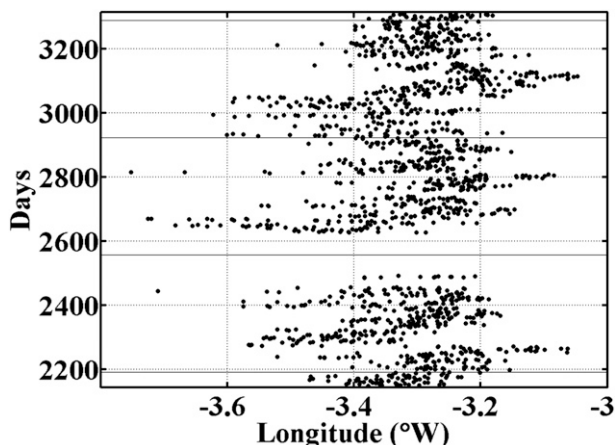

FIG. 12. The longitude where the ferry crossed 32 PSU. The water to the east is fresher and to the west saltier.

Birkenhead port, are compared to the measurements approximately 20 km westward of this, when the ferry passed close to the SmartBuoy (Fig. 14). While as expected the temperatures are well correlated and the differences predictable, the salinities are much less well correlated (correlation coefficient $r = 0.42$), demonstrating the large variable gradients close to the coast, a region where numerical models are less accurate.

There was considerable variability of the maximum salinity on each crossing against time and longitude (Fig. 13). This is an indication of the variability in the weak average flow of water of Atlantic origin from south to north through the Irish Sea. There is no correlation between the position, which varies from north of Anglesey to close to Dublin, and the salinity value.

The higher-frequency variations (Fig. 14) show the effect on temperature and salinity in response to tidal

cycles. Salinity and temperature were the key values used for scientific research. The other optical sensor measurements of chlorophyll *a* concentration, turbidity, and dissolved oxygen concentration had laboratory-based reference value checks applied for each of these sensors prior to deployment to look for any evidence of measurement drift. The subsequent data from these sensors was then archived for future scientific analysis.

5. Discussion and future work

Coastal environments place particularly rigorous requirements on oceanographic sensors in terms of their resistance to sedimentary and biological fouling. The choice of sensing technology used can have a direct impact on both the quality of the measurements made and the underlying science that relies on the integrity of this information. Organizations such as the U.S. government-funded Alliance for Coastal Technologies (ACT) (www.act-us.info) have been commissioned to subject new and existing sensing technology to a series of common performance evaluations that are independent of a particular manufacturer (Alliance for Coastal Technologies 2006). The result of this is the provision of information to assist with the choice of the most suitable sensors for a particular coastal application. Bearing in mind the potential diversity of practical coastal monitoring applications, it is believed that there is still scope for individual performance trials. This paper has discussed the specific experiences of water quality sensors and their performance for an Irish Sea-based instrumented ferry system.

The instrumented ferry has served as an important source of scientific measurements within the NOC Coastal Observatory. The measurements from the

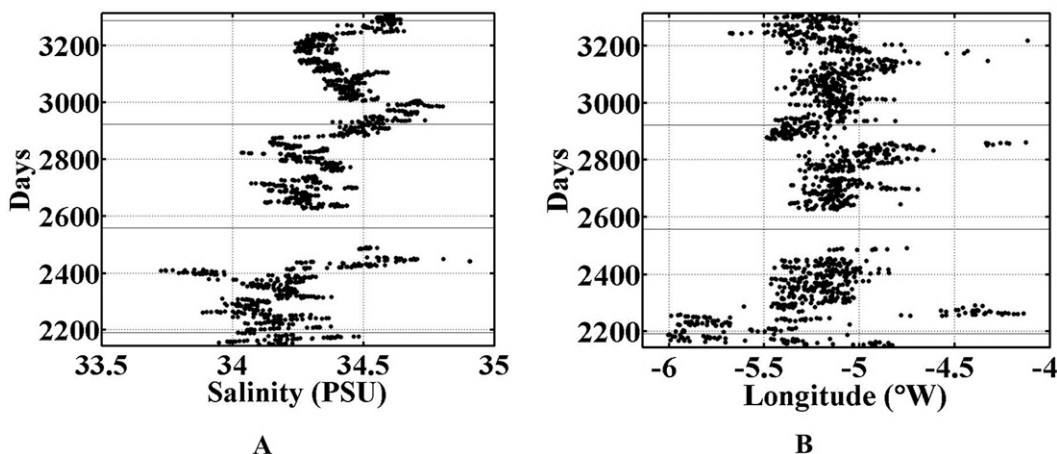

FIG. 13. The maximum salinity on each crossing plotted against (a) time and (b) longitude.

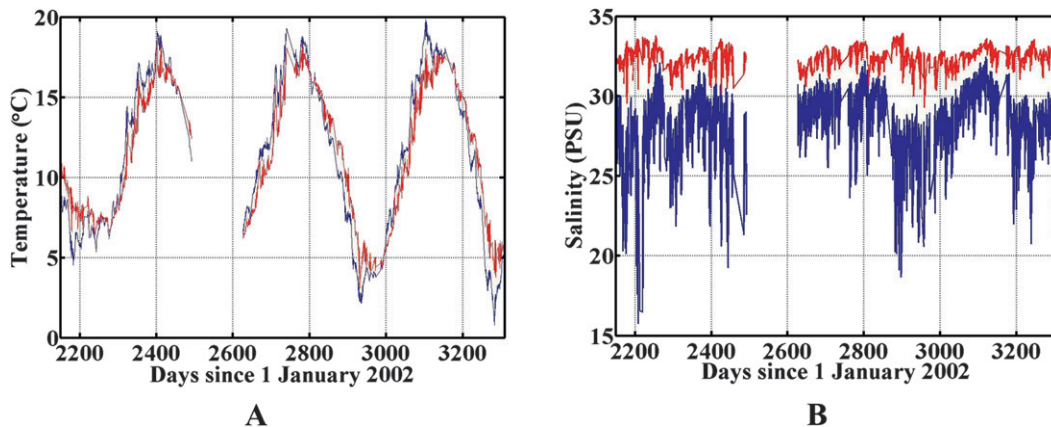

FIG. 14. Temperature and salinity seasonal cycle measurement comparisons and inshore gradients. Liverpool Bay is in red and mouth of the river Mersey in blue. (a) FSI temperature measurements, and (b) FSI salinity measurements illustrating the gradients.

FerryBox also provided a mechanism for the validation of predictive models such as the NOC Proudman Oceanographic Laboratory Coastal Ocean Modelling System (POLCOMS) Irish Sea model. In addition to this, the introduction of dissolved oxygen measurement to the FerryBox increased the scientific data range of the instrumentation installed. Dissolved oxygen measurements assist with the task of water quality assessment by organizations such as the U.K. Environment Agency in response to the EU Water Framework Directive (European Parliament 2000). This directive deals with environmental protection and the promotion of sustainable water use. The core water quality assessment parameters are listed as oxygen content, pH value, conductivity, nitrate, and ammonium.

From the perspective of the FerryBox sensor development, the migration to a shielded-inductive-type conductivity cell has improved the robustness of the ferry-based salinity measurements. This measuring system was further improved when an automated shut of the valve was used to prevent highly turbid waters from being pumped through the instrumentation chamber when the ferry is close to port or maneuvering in or out of its port-based berth. It is also clear from the measurement value decays between service visits that the performance of the Teledyne Citadel NXIC conductivity cell would improve further if an automated conductivity cell mechanical cleaning system was installed. This is clearly illustrated by the results of the trials of the Alec Electronics CTW. This self-cleaning electrode-type conductivity cell, while offering approximately one decimal place less in quoted temperature- and conductivity-measured accuracy, has clearly demonstrated a robustness of measurement advantage if mechanical cleaning is used. This is particularly evident in the enhanced

stability of the derived salinity from the CTW when compared with the NXIC conductivity cell during a simultaneous dual deployment in the FerryBox. A drawback with the CTW is that it does not have a standard provision for a real-time data output in conjunction with internal logging or the ability to record data from auxiliary sensors. The optical measurements of turbidity and dissolved oxygen show some differences between buoy-based observations. The exact reason for this will require further investigation.

In terms of the scientific analysis of the data from the FerryBox, aliasing of ferry measurements occurs due to a ferry sailing pattern that is out of synchronization with the nominal 12.4-h tidal cycle. To assist with the data analysis, it would be advantageous to install a robust measurement of at least temperature and salinity close to the mouth of the river Mersey. This could be used to provide round-the-clock data for this area that would provide measurement gradient information when an Irish Sea ferry is away from inshore waters. The FerryBox is one of the few measurement systems capable of providing inshore water quality measurements. This information is important for scientific studies and to assist with the improvement of predictive models. A desirable addition to this type of FerryBox system would be automated water sample collection and refrigeration along a series of waypoints during the ferry route. The regular collection and laboratory analysis of these samples could provide an additional source of sensor calibration data for the FerryBox.

The system that has been designed can be incorporated into other ships of opportunity using the modular pressure chamber and electronics enclosures that have been devised. The Persistor CF2-based centralized datalogger is a key component that provides a science

and positional data record. Additionally, this unit controls the operation of the FerryBox and water flow control valve. Custom software for the CF2 FerryBox application has been developed using structured design methodologies, allowing adaptation for future applications. Data recording redundancy is provided with the CTD internal data record in the engine room, the GPS receiver internal record, and the telemetry modem GPS receiver. Support from a ship operator is required for vessel access, particularly during the commissioning of such an oceanographic sensor system. A progressive approach to the installation is recommended to construct and test the system in stages while the vessel is in port between sailings or for maintenance. For the efficient operation of such a FerryBox, convenient port access is desirable. The risks of this approach include vessel rescheduling and route closures. The possible need to remove and relocate the sensor system should be considered.

While it is disappointing that the Birkenhead–Dublin ferry route discussed in this paper has been closed, it is envisaged that a series of further applications exist for the instrumentation system that has been developed. Examples of this include sensors installed on alternative ferry routes or long-range cargo vessels to provide a range of cost-effective, sustained coastal and offshore scientific measurements.

Acknowledgments. The authors express their thanks to the EU and the U.K. Natural Environment Research Council (NERC) for the provision of funding to research this activity. Norse Merchant Ferries, Norfolkline, and DFDS Seaways are also acknowledged for their co-operation and support of this project.

REFERENCES

- Alliance for Coastal Technologies, 2006: Protocols for verifying the performance of in situ turbidity sensor. Alliance for Coastal Technologies Rep. PV06-01, 20 pp.
- American National Standards Institute, 2001: TIA/EIA standard: Commercial building telecommunications cabling standard. Part 1: General requirements, American National Standards Institute TIA/EIA-568-B.1, 79 pp.
- , 2005: TIA/EIA standard: Electrical characteristics of balanced voltage digital interface circuits. American National Standards Institute TIA-422-B, 36 pp.
- Balfour, C. A., 2012: Cost-effective remote data acquisition and instrumentation management for oceanographic and environmental monitoring applications. *Oper. Oceanogr.*, **5**, 41–52.
- , M. J. Howarth, M. J. Smithson, D. S. Jones, and J. Pugh, 2007: The use of ships of opportunity for Irish Sea based oceanographic measurements. *Proc. OCEANS '07 Conf.*, Aberdeen, Scotland, IEEE/OES, Paper 061211-007.
- B&B Electronics, 2012: 485LDR9 industrial RS-232 to RS-422/485 converter. B&B Electronics Data Sheet, 2 pp.
- Buzzelli, C. P., J. Ramus, and H. W. Paerl, 2003: Ferry-based monitoring of surface water quality in North Carolina estuaries. *Estuaries*, **26**, 975–984.
- Chatterton, P. A., and M. A. Houlden, 1991: *EMC: Electromagnetic Theory to Practical Design*. Wiley, 295 pp.
- Digi International, 2009: The Digi m100 smart satellite modem. Digi International Data Sheet, 2 pp.
- Englander, J., 2009: The International Seakeepers Society: A decade of innovation and progress. *Sea Technol.*, **50**, 34–35.
- European Parliament, 2000: Directive 2000/60/EC of the European parliament and of the council. European Parliament and Council of the European Union, 72 pp.
- Grayek, S., J. Staneva, J. Schulz-Stellenfleth, W. Petersen, and E. V. Stanev, 2010: Use of FerryBox surface temperature and salinity measurements to improve model based state estimates for the German Bight. *J. Mar. Syst.*, **88**, 45–59.
- Horiuchi, T., F. Wolk, and P. Macoun, 2010: Long-term stability of a new conductivity-temperature sensor tested on the VENUS cabled observatory. *Proc. OCEANS '10 Conf.*, Sydney, NSW, Australia, IEEE, 1–4.
- Horowitz, P., and W. Hill, 1993: Interference: Shielding and grounding. *The Art of Electronics*, 2nd ed. P. Horowitz and W. Hill, Eds., Cambridge University Press, 455–465.
- Howarth, M. J., and M. R. Palmer, 2011: The Liverpool Bay Coastal Observatory. *Ocean Dyn.*, **61**, 1917–1926.
- Hydes, D. J., M. C. Hartman, J. Kaiser, and J. M. Campbell, 2009: Measurement of dissolved oxygen using optodes in a FerryBox system. *Estuarine Coastal Shelf Sci.*, **83**, 485–490.
- Laipac Technology Inc., 2007: The G35L GPS data logger user manual V1.0. Laipac Technology Inc., 13 pp.
- Mills, D. K., N. Greenwood, S. Kröger, M. Devlin, D. B. Sivyer, D. Pearce, S. Cutchey, and S. J. Malcolm, 2005: New approaches to improve the detection of eutrophication in UK coastal waters. *Environ. Res. Eng. Manage.*, **2**, 36–42.
- Montrose, M. I., 1999: EMC inside the PCB. *EMC and the Printed Circuit Board: Design, Theory, and Layout Made Simple*. IEEE Press, 23–52.
- National Marine Electronics Association, 2002: The NMEA-0183 standard, version 3.01. National Marine Electronics Association, 88 pp.
- Orbcomm, 2001: Orbcomm system overview: A80TD0008—Revision G. Orbcomm LLC, 54 pp.
- Panton, A., 2012: The impact of physical processes on primary and secondary production in a temperate shelf sea. Ph.D. thesis, University of Liverpool, 149 pp.
- Persistor Instruments Inc., 2005: The Persistor CF2 getting started guide, revision 2.0. Persistor Instruments Inc., 30 pp.
- Petersen, W., M. Petschatnikov, F. Schroeder, and F. Colijn, 2003: FerryBox—A new system for automatic measurement of biological-chemical parameters from ferry boats. *Proc. OCEANS 2003 Conf.*, San Diego, CA, IEEE, 2234–2237.
- , F. Schroeder, and F. D. Bockelmann, 2011: FerryBox—Application of continuous water quality observations along transects in the North Sea. *Ocean Dyn.*, **61**, 1541–1554.
- Sea-Bird Electronics Inc., 2007: SBE 16plus SEACAT user's manual. Sea-Bird Electronics Inc. Manual Version 18, 89 pp.
- Seapoint Sensors Inc., 2001: Seapoint turbidity meter user manual standard version. Seapoint Sensors Inc., 13 pp.
- Teledyne RD Instruments, 2010: Citadel CTD technical manual P/N A176-004. Teledyne RD Instruments, 150 pp.
- Zebra Technologies Ltd., 2010: Hydro-Wiper operation manual. Zebra-Tech Ltd., 8 pp.