

Methodology of the direct measurement of the switching latency

Abstract. The article provides a measurement methodology based on the related RFCs. It brings a solution of determining the switching latency on the physical layer using common measuring devices. As a proof of concept were done a number of the experimental measurements, including analysis of the results. Switching latency is an important performance parameter which participates in the decision-making whether to deploy the switch to low-latency environments. This is especially important in industrial networks for real-time systems involving smart grids. Determine the value of the switching latency is also an important step in the eventual deployment of the OpenFlow technology on this field.

Streszczenie. Zaprezentowano metodę badania opóźnień w przełączaniu (switching latency) bazująca na RFC. Parametr ten jest bardzo ważny w sieciach przemysłowych łącznie z sieciami typu smart grid. (Metoda bezpośredniego pomiaru opóźnień przełączania w sieciach komputerowych)

Keywords: switching latency, measurement methodology, OpenFlow, industrial networks, low-latency, Smart Grids.

Słowa kluczowe: opóźnienie przełączania, sieci komputerowe.

Introduction

Massive global usage of Ethernet as a transmission technology in local area networks has led to its use in other specialized sectors and exacting environments. These low-latency environments lay great demands on the transmission time of critical messages interchanged between real-time systems. Critical fields of application are Ethernet networks in substation automation (SA). The standard IEC 61850 deals with these types of industrial networks. It defines that a network as a whole has to ensure the transmission delay less than 3 ms for GOOSE (Generic Object Oriented Substation Event) type messages. GOOSE messages contain information about incidents, as described in the IEC 61850-8-1 [1] or can carry sampled values from the IEC 61850-9-2 [2]. General requirements for the transmission delay of different traffic types are defined in the IEEE Std 1646-2004 [3].

Great demands placed on the transmission delay in SA networks have requested a transmission of the GOOSE messages content directly on the second layer of ISO/OSI model without deceleration arising from usage of the higher layers. This is the reason why it is possible to send and receive messages only within the bounds of local area network. For solving the problem of transmission delay of critical messages in the industrial networks there is interesting the OpenFlow technology. It is increasingly getting into the production environment and allows centrally managing data flows in the network from a controller. It enables systematic computing, implementation of optimal data flow paths and reserving transmission resources for both unicast and multicast traffic. Switching latency is an important parameter in the deployment of the OpenFlow technology [4]. The transmission time is not the only crucial requirement for critical messages. We have to consider also its reliability. Therefore, by its very nature there is used store-and-forward solution to the cut-through. Values of delay are often mentioned by manufacturers in various forms and under differently defined conditions which are not sufficient in highly challenging environment. The switching latency can be measured by various methods but often only through very specialized and expensive measuring equipment. Therefore it has been decided to create a measuring methodology directly on a transmission medium, in this case on the physical layer [5], [6]. The aim was to develop a measurement methodology that would allow a delay determination of the switching fabric for all common data rates used in local networks. Namely it is the technology 10Base-T, 100Base-TX and 1000Base-T. The measurement was designed under zero switch loads to

avoid the influence of frame sorting in queues and congestion.

The results obtained from experimental measurements have demonstrated an applicability of this measuring methodology and their analysis brought some interesting results. An accuracy of the measured latencies is in tenths of microseconds which is sufficient for comparison of the individual devices.

Standards and related works

Requirements for the transmission delays are defined for example in the aforementioned standards [1-3]. For purposes of the methodology there have been used related RFCs published by the IETF RFCs which are coupled to this topic. The fundamental description of the switching latency is based on RFC 1242 [7]. In this RFC there is defined the latency of the store-and-forward devices. Thus, processing frame time is determined as the starting time interval when the last bit of the input frame reaches the input port and as the ending time interval when the first bit of the output frame is seen on the output port. This approach is typically called LIFO. The second type is cut-through approach which uses the FIFO method. Cut-through devices are typically used in data centers and in other computing clusters (HPC). Further document that covers the measurement methodology is universally known as RFC 2544 [8]. Wide range of specialized measuring equipment implements this recommendation. There are described, inter alia, time intervals between taking individual measurements and also frame lengths needed for measurement. The number of reading repetition is determined to at least 20. The RFC 2899 of 2000, which describes the area under examination, only specifies the latency at switching broadcast frames and it is not applicable to this methodology [9]. Other published works such as [10], which deals with QoS and traffic shaping, use for latency measurement synchronization via NTP protocol. This solution is not sufficiently accurate for measurements at higher data rates. For achieving better device synchronization there can be used IEEE 1588 but at a cost of further expenses on additional hardware. Deployment options of such synchronization under laboratory conditions are described in the paper [11].

Switch architecture and measurement limits

The architecture of various types of switches can differ widely and it is a part of the know-how of each manufacturer. Generally, the switch can be viewed in two perspectives. The first is given by an arrangement of physical components in a real device. The second is the

switching logic itself. Thus, how a switch puts frames into queues, how it schedules their forwarding and how it implements all this functions into a memory. From the hardware point of view a general switch is composed of line cards, CPU and different structure memories (SRAM, CAM, TCAM). The arrangement is shown in Fig. 1. All components are connected by internal bus on the switch backplane. The backplane can become a bottleneck if the architecture is designed insufficiently. The line card contains at least interface for signal processing at the physical layer (PHY) and medium control access to the transmission medium (MAC). The architecture of modular switches and large enterprise switches differs in both backplane design and line card construction either. They are usually extended by additional CPUs and memories.

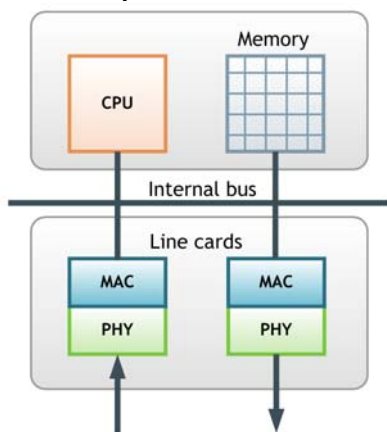

Fig. 1. The physical arrangement of the components of a general switch.

The second view is from the point of frame processing and memory usage. All switches which were experimentally measured, and are widespread nowadays, use the shared memory. Due to the utilization of resources and the best ratio of delay to throughput today it is very favoured the architecture shown in Fig. 2. It is called CIOQ (Combined Input and Output Queuing with Virtual Output Queuing) [12]. In this architecture the incoming frames are arranged into a shared memory dedicated to appropriate output port queues (Virtual Output Queues). This solution prevents head of the line blocking (HOL). After processing the frame it is passed to the output queue of destination port.

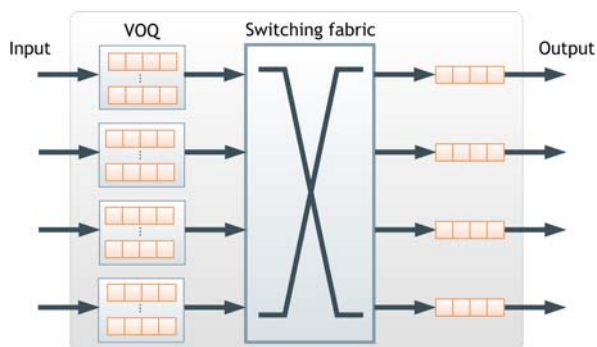

Fig. 2. The CIOQ architecture sorts incoming frames into virtual output queues according to destination port and then into output queues.

From all the mentioned facts it is clear that the overall processing time of frame transmission between the input and output port is composed of a wide range of delays. Thereby the integrated design of the switches in one box is not possible to measure the latency of the switching element directly by means of CFrames, as suggested in

[13]. The minimum measurable switching latency of for the architecture can be estimated as in expression (1):

$$(1) \quad t_{sw} = 2t_{lc} + t_{sf} + t_{iq} + t_{oq}$$

where: t_{sw} – total switching latency, t_{lc} – line card delay (PHY, MAC), t_{sf} – switching fabric delay, t_{iq} – VOQ delay, t_{oq} – output queue delay.

Making usage of memories and their arrangement can vary considerably. Today's switches are not only designed to forward frames by MAC addresses. Switches provide more sophisticated features in recent years such as Access lists, QoS, L3 forwarding and even more. The general switch finds the output port by destination MAC address is done via CAM (Content-Addressable Memory) which cells take only binary states. To allow advanced functions Ternary CAM have been introduced. TCAM provides the third state representing the "do not care" value. This state allows using a mask for routing or forwarding and allows the creation of access rules without the need for storing them in the memory for each individual address. The TCAM has been optimized for a long time and for specific applications. That is the reason why it is not possible to match all OpenFlow tuples by the hardware path. The evaluation of these flow rules must be realized by the software path. Whether the flow rule will be evaluated in software or hardware depends on the used set of OpenFlow tuples and implementation of a particular switch. It is expected that the delay achieved by software processing outside a TCAM will be higher.

Measurement methodology

The fundamental principle of the measurement methodology is to compare the time difference between the input and output switch port using the FIFO method directly at the physical layer. All measurements must be done using the 10Base-T Ethernet on the measured interfaces. This variant uses Manchester encoding and transmission channel which is not burdened by any other broadcasting in the rest. Due to these characteristics there can be achieved unambiguous identification of the passing frame. There is always signal broadcasted on channel of variants 100Base-TX and 1000Base-T to keep sender and receiver synchronized. Thus, it is not possible to determine the tail and the head of the passing frame only by the oscilloscope.

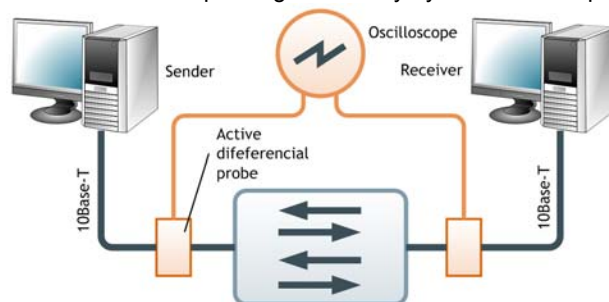

Fig. 3. The wiring of the measuring workplace with active differential probes for the first measuring methodology of 10Base-T.

Test traffic consists of ICMP packets and is generated by the sender station using common ping application. It is sufficient for measuring purposes and it allows latency measurement without any additional specialized software. On measured switches all their unnecessary features generating unwanted traffic must be disabled. It would not be possible to identify the test frame unambiguously. The unwanted traffic could fill up queues and cause distortion of the measured data. It is primarily generated by services like STP, RSTP, multicast and the time synchronization (IEEE 1588 or NTP). It is also appropriate to set static MAC address entries to reduce the ARP. Wiring necessary for

measurement was designed in two different variants. The first diagram is shown in Fig. 3. It is intended for measuring the switching latency of Ethernet 10Base-T. Measurement of the time difference between channels is performed on the oscilloscope which is connected by active differential probes directly to the transmission medium. The probes have an input impedance of 100 Ω. These probes are commercially available, but for experimental measurement were used prototypes created in another project [14]. If it is possible, it is necessary to deactivate ports Automatic MDI/MDI-X feature (pair swapping). This can cause considerable difficulties by determination of transmitting and receiving pairs of symmetric lines at the switch input and output port. The measurement is usually carried out on the TD+ and TD- pair before and after the switch in the direction from sender to receiver of the test frame.

Readings of the latencies are made according to RFC 2544 in series of different frame lengths (64 B, 128 B, 256 B, 512 B, 1024 B, 1280 B, 1518 B). The number of repetitions must be at least 20 times for each series of measurement; they should be carried out in regular intervals of 60 sec. and in flow duration at least 120 sec. Higher number of repetitions reduces the statistical error of measurement. An Oscilloscope often provides the automatic delay readings. Alternatively, it can be connected to a PC and readings may be implemented programmatically. The digital oscilloscope must have sufficient sampling frequency to meet the Nyquist-Shannon sampling theorem (minimum sampling rate at 100 MS/s). The threshold voltage level is 500 mV and it is based on the resistance of the used probe. The selection of the appropriate measuring ports is widely described by RFC 2889. Experimental measurements were always carried out only between neighbouring and outermost switch ports.

For measuring the switching latency of other Ethernet types it was necessary to extend wiring diagram. By involving two auxiliary devices, which use 10Base-T on input and output interface there was achieved the possibility to measure 100Base-TX and 1000Base-T Ethernet. The diagram is in Fig. 4. This arrangement is no longer direct within the meaning of measuring latency on the input and output port of the examined device but still it is a direct measurement of the delay on the physical layer. At first it is necessary to measure the characteristic delay between the auxiliary switches without inserting the measured switch. The measurement of the characteristics is the same procedure as described above for all frame lengths and examined data rates. It is then possible to connect measured switch between those auxiliary ones and take all measurement series again.

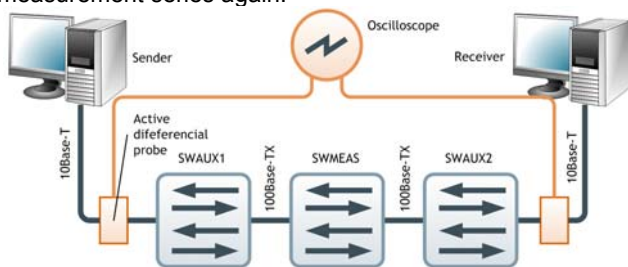

Fig. 4. The wiring of the measuring workplace for variants of 100Base-TX and 1000Base-T. SWAUX are auxiliary switches and SWMEAS is the examined switch.

From the set of values obtained by measuring individual series it is calculated the mean value of the switching latency. For the first type of measurement assuming a normal distribution it is possible to use the expression (2). It is necessary to cleanse results obtained from the second measurement methodology of pre-measured characteristics

of the auxiliary devices and time required to transfer frame through the newly formed segment. It cannot be included in the pre-measured characteristics and must be computed. Since the measurement itself is carried out on the physical layer, it is used to compute the symbol rate that is in both cases 125 MBaud. Furthermore, it is necessary to compute the actual size of the frame given by applied coding ratio. The computation of the mean value for given frame length can be performed using (3):

$$(2) \quad \bar{t}_{sw1} = \frac{1}{N} \sum_{i=1}^N t_{mes_i}$$

$$(3) \quad \bar{t}_{sw2} = \frac{1}{N} \sum_{i=1}^N t_{mes_i} - \bar{t}_{aux} - \frac{l_{pr} + l_{test} \cdot e_r}{r_s}$$

where: N – number of measurements in the series [-], t_{mes} – value of latency from one measurement [s], t_{aux} – mean delay with aux. switches [s], l_{pr} – preamble length (64 bits) [b], l_{test} – length of test frame [b], e_r – coding ratio (4B/5B, 8b/10b) [-], r_s – symbol rate [Baud], t_{sw} – mean value of the switching latency [s].

Type A - standard uncertainty of measured results for the first measurement methodology can be evaluated as sample experimental standard deviation of the mean written down in (4).

$$(4) \quad u_A(t_{sw1}) = \sqrt{\frac{1}{N(N-1)} \sum_{i=1}^N (t_{mes_i} - \bar{t}_{sw1})^2}$$

For the second measurement methodology may be used the same expression to determine the standard deviation of the mean. However, the type A standard uncertainty of measured results must be evaluated as the sum of the squares of the standard deviation s of measurement without inserted measured switch and with it as in expression (5) [15].

$$(5) \quad u_A(t_{sw2}) = \sqrt{s_{t_{sw2}}^2 + s_{t_{aux}}^2}$$

The expanded standard measurement uncertainty then can be determined by a known expression (6). There $u_B(t_{sw})$ corresponds to a standard uncertainty of type B primarily caused by the specific characteristics of the used oscilloscope as the sampling rate, resolution and more. The signal propagation delay on the wire can be neglected. For example if the length of the wire is 2 m than the propagation delay is up to 50 ns. To achieve a 95% probability that the searched value is in the given interval, it is necessary to multiply the value of the expanded uncertainty $u_C(t_{sw})$ by coverage factor $k_f=2$.

$$(6) \quad u_C(t_{sw}) = \sqrt{u_A^2(t_{sw}) + u_B^2(t_{sw})}$$

Analysis of experimental measurements

Experimental measurements were carried out by the Tektronix DPO4032 oscilloscope with a sampling frequency 2.5 GS/s. Achieved expanded uncertainty of measurement of 100Base-TX having a coverage factor 2 was for most of the measured devices up to 0.5 μs. The expanded uncertainty for 10Base-T variant was in 0.2 μs due to more straightforward methodology of measurement. For 1000Base-T variant is the obtained value in 0.5 μs of uncertainty too large because its relative value reaches 50%.

The characteristic delays between auxiliary switches (2xRB2011LS-IN) had linear progression. Using the linear

regression were estimated parameters shown in Tab. 1. From the table is obvious that the coefficient of determination R^2 is very close to 1.00 so there is a high correlation between the outcomes are and their predicted values.

Table 1. Linear regressed functions

| Ethernet | Aux. linear function | R^2 |
|------------|----------------------|-------|
| 10Base-T | $y=0.7993x+35,644$ | 1.00 |
| 100Base-TX | $y=0.0802x+15,598$ | 1.00 |
| 1000Base-T | $y=0.008x+15,685$ | 0.99 |

The results of experimental measurements can be summarized in a performance division shown in Tab. 2. In the calculation there are included worse results if there were carried out more measurements to several ports on a switch. Groups A and B are the performance group (in terms of switching latency) that are incompatible due to the large difference in the measured values of latency. The results were obtained in more than six thousand measurements on fourteen different switches. Due to the lack of representatives the results do not include measured switches which greatly exceeded the value of corresponding performance group.

Table 2. Latency performance groups

| Ethernet | Group | Mean [μs] | | | Standard dev. [μs] | | |
|------------|-------|-----------|-------|--------|--------------------|-------|--------|
| | | 64 B | 512 B | 1518 B | 64 B | 512 B | 1518 B |
| 1000Base-T | - | 1.97 | 1.93 | 2.24 | 1.13 | 1.07 | 1.25 |
| 100Base-TX | A | 2.82 | 2.75 | 2.86 | 0.74 | 1.00 | 1.17 |
| | B | 6.70 | 5.33 | 4.63 | 0.89 | 1.99 | 1.74 |
| 10Base-T | A | 10.08 | 9.78 | 10.02 | 1.36 | 0.64 | 0.96 |
| | B | 14.01 | 14.17 | 13.85 | 0.82 | 0.83 | 0.50 |

Measurements of aging 10Base-T brought the most straightforward results using the first methodology. Obtained results of all measured switches are in Fig. 5. The values of switch latency are mainly in area of 10 μs. The only exceptions are surprisingly Hirschmann industrial switches that show sharply higher values. In the first case the Hirschmann MS20/MM23 has constantly higher latencies which could be caused by its modular architecture and probably slow backplane. In the second case the Hirschmann RS2 FX/FX switching latencies more correspond to a software bridge mode then to a L2 switch. Its progression is very similar to the RB2011LS in a bridge mode which was measured to comparison. Such a solution is for deployment in industrial networks completely inappropriate because the switching latency grows linearly with the length of the frame.

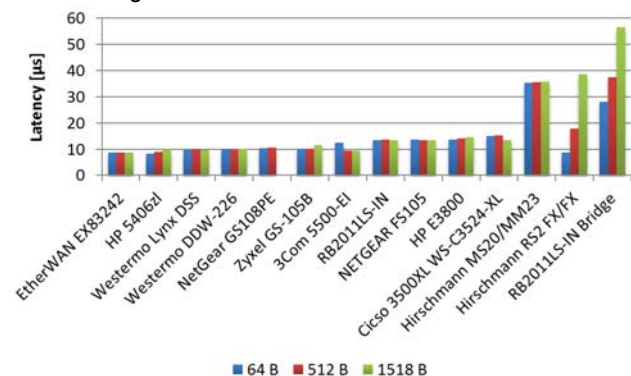

Fig. 5. Measured switching latencies for Ethernet 10Base-T.

From the perspective of the use frequency in industrial networks the 100Base-TX Ethernet is particularly important. The graph in Fig. 6 shows the dependence of switching

latency on frame length for all measured switches. As representative results there were selected series of frame lengths 64 B, 512 B and 1518 B, thus the maximum Ethernet frame size.

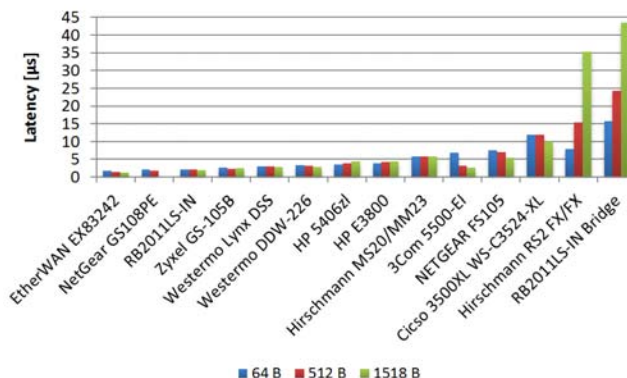

Fig. 6. Measured switching latencies for Ethernet 100Base-TX.

As mentioned above, switches can be divided into several groups according to the switching latency. In the first group the switching latency is up to 3 μs (group A). In the second group it is over 5 μs (group B) and in the last one over 10 μs (potential group C). In this group is the Hirschmann RS2 FX/FX industrial switch again. Its switching latency still increases linearly like in a bridge mode whereas the second Hirschmann switch has moved to the second third of the chart.

Other industrial switches proved themselves especially in the stability of switching latency which was often nearly constant. Inexpensive home devices also showed low values when switching but they did not provide any other services required in industrial networks. Some of the office and enterprise switches unexpectedly showed the opposite trend of decreasing latency with increasing frame length. It is probably caused by inner switching optimization.

The last results of 1000Base-T were obtained only for 6 switches. Almost all switches indicate latency values less than 5 μs. Only the RB2011LS-IN in a bridge and the HP 5406zl show higher latencies. The last one was measured with the early revision firmware K.15.06.0017 which could cause these higher values. Results are shown in Fig. 7.

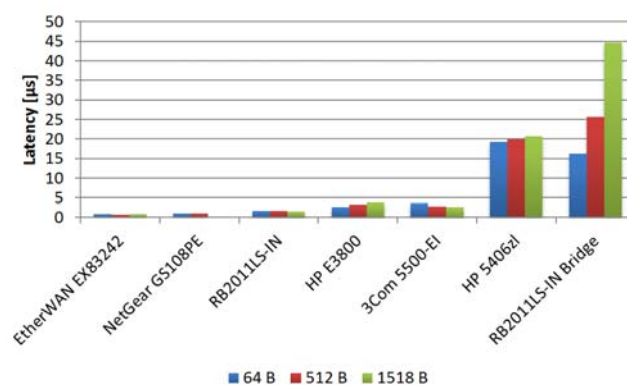

Fig. 7. Measured switching latencies for Ethernet 1000Base-T.

In the view of potential application of the OpenFlow technology is the stable value of switching latency a big advantage in the sense of downloaded flow rules execution. If a controller implements the flow rules to the switch and they are processed in hardware path, no more delays will arise. For comparison where was carried out another set of measurements which should show a difference in the operation of the general L2 switch and identical OpenFlow solution. The rules in the flow table were injected

proactively by the controller before the measurement in order to avoid its influence.

Since switches from HP are not able to implement hardware matching based on MAC addresses due to the implementation of TCAM, this evaluation is done through the software path [16]. From Tab. 3. it is obvious that the switching latency of software processing of OpenFlow rules based on MAC addresses is up to 200 μ s. In comparing latency values with and without OpenFlow there is an increase up to 7000%. Such latency in larger topologies may result in failure of time requirements of critical traffic even in case of zero load.

Table 3. The comparison of the OF and non-OF modes

| Switch | Mode | Mean [μ s] | | | Exp. Std. Dev. of the mean [μ s] | | |
|--------------|---------------|-----------------|--------|--------|---------------------------------------|-------|--------|
| | | 64 B | 512 B | 1518 B | 64 B | 512 B | 1518 B |
| HP 5406zl | 1000Base-T | 19.34 | 19.87 | 20.64 | 0.40 | 0.33 | 0.41 |
| | OF 1000Base-T | 171.70 | 192.98 | 221.14 | 25.56 | 12.76 | 25.49 |
| | 100Base-TX | 3.56 | 3.84 | 4.34 | 0.27 | 0.29 | 0.24 |
| | OF 100Base-TX | 160.45 | 181.56 | 197.73 | 12.17 | 4.27 | 6.17 |
| | 10Base-T | 8.30 | 9.15 | 9.91 | 0.11 | 0.22 | 0.20 |
| | OF 10Base-T | 174.37 | 180.83 | 216.01 | 11.08 | 12.04 | 7.21 |
| HP E3800 | 1000Base-T | 2.68 | 3.23 | 3.74 | 0.39 | 0.34 | 0.36 |
| | OF 1000Base-T | 190.07 | 168.20 | 207.33 | 7.67 | 12.41 | 19.28 |
| | 100Base-TX | 3.84 | 4.33 | 4.37 | 0.32 | 0.34 | 0.25 |
| | OF 100Base-TX | 162.71 | 199.09 | 214.69 | 3.79 | 5.41 | 7.90 |
| | 10Base-T | 13.68 | 14.23 | 14.59 | 0.14 | 0.19 | 0.18 |
| | OF 10Base-T | 175.23 | 192.77 | 224.96 | 11.97 | 6.84 | 8.63 |

Conclusions

The described methodology provides measuring solution in the field of the determination the minimum achievable switching latency using a digital oscilloscope and other widely available devices. It is possible to verify the suitability of the switch deployment in industrial environments without the required information from the manufacturer.

Results obtained from experimental measurements have demonstrated that the methodology of measurement is able to give very accurate results with the expanded measurement uncertainty of 0.5 μ s for the most common industrial 100Base-TX Ethernet networks. Furthermore, the measurements revealed possible problems caused by using switches with a strong linear relationship between the frame length and the switching latency similar to a bridge mode. With the proposed methodology it was possible to verify the suitability of the OpenFlow deployment in low-latency environments. Although the data flows can be controlled by using rules based on IP tuples, it has not to be sufficient i.e. for L2 multicast. It is used very much in SA networks for its straightness and low overhead which leads to lower delays. Results also clearly show that the application of the technology OpenFlow technology is not recommended for such a purpose of evaluating flow rules by the software path. The possible enhancement to this measurement methodology is in obtaining the switching latency when forwarding different load levels corresponding to the real operation in industrial networks.

REFERENCES

ACKNOWLEDGEMENTS

This work was supported by Grant Project SGS12/186/OHK3/3T/13 and by the European Community's Seventh Framework Programme (FP7/2007-2013) under grant agreement no. 218086.

- [1] IEC. Communication networks and systems in substations: Specific Communication Service Mapping (SCSM) – Mappings to MMS (ISO 9506-1 and ISO 9506-2) and to ISO/IEC 8802-3. 1st ed. Geneva (2003).
- [2] IEC. Communication networks and systems in substations: Specific Communication Service Mapping (SCSM) – Sampled values over ISO/IEC 8802-3. 1st ed. Geneva (2003).
- [3] IEEE standard communication delivery time performance requirements for electric power substation automation. New York (2005).
- [4] Skorpil V., Precechtel R., Training a Neural Network for a New Node Element Design. *Przeglad Elektrotechniczny*, Volume 89 (2013), Issue 2B, 187-192.
- [5] Fazio P., De Rango F., Veltri F., Marano S., Performance evaluation of the packet error rate of DS-SS physical layer in UWB networks. *Canadian Conference on Electrical and Computer Engineering*, Ottawa (2006), 1147-1150.
- [6] Komosny D., Balej J., Sathu H., Shukla R., Dolezel P., Cable length based geolocation. *Przeglad Elektrotechniczny*, Volume 88 (2012), Issue 7A, 26-32.
- [7] RFC 1242, Benchmarking Terminology for Network Interconnection Devices. IETF (1991).
- [8] RFC 2544. Benchmarking Methodology for Network Interconnect Devices. IETF, (1999).
- [9] RFC 2889. Benchmarking Methodology for LAN Switching Devices. IETF, (2000).
- [10] Loeser J., Haertig H., Low-latency hard real-time communication over switched Ethernet. In *Proceedings Euromicro Workshop on Real-Time Systems*, Catania (2004). 13-22.
- [11] Pravda M., Lafata P., Vodrazka J., Precision Clock Synchronization Protocol and Its Implementation into Laboratory Ethernet Network. In *Proc.33rd International Conference on Telecommunication and Signal Processing*, Baden near Vienna (2010). 286-291.
- [12] Chao H., Liu B., *High performance switches and routers*. Wiley-IEEE Press (2007).
- [13] Poursepanj A., Benchmarks Rate Switch-Fabric. In: *Communication System Design* (2003).
- [14] Havlan M., Active differential probes. In *Access Server*, Prague (2007). Available: <http://access.feld.cvut.cz>.
- [15] JCGM 100:2008. Evaluation of measurement data — Guide to the expression of uncertainty in measurement. BIPM: Joint Committee for Guides in Metrology (2008). Available: http://www.bipm.org/utis/common/documents/jcgm/JCGM_100_2008_E.pdf
- [16] OpenFlow support with HP Procurve 5400zl series. In: *OpenFlow*, 2011. Available: http://www.openflow.org/wp-content/uploads/2011/04/HP_Procurve_OpenFlow_support.pdf

Authors: MSc. Tomas Hegr, Czech Technical University in Prague, Faculty of Electrical Engineering, st. Technicka 2, 16000 Prague, Czech Republic, E-mail: tomas.hegr@fel.cvut.cz; MSc. Leos Bohac, Ph.D., Czech Technical University in Prague, Faculty of Electrical Engineering, st. Technicka 2, 16000 Prague, Czech Republic, E-mail: leos.bohac@fel.cvut.cz; MSc. Zbynek Kocur, Czech Technical University in Prague, Faculty of Electrical Engineering, st. Technicka 2, 16000 Prague, Czech Republic, E-mail: zbynek.kocur@fel.cvut.cz; Assoc. Prof. Miroslav Voznak, Ph.D., VSB-Technical University of Ostrava, Faculty of Electrical Engineering and Computer Science, st. 17. Listopadu 15, 70833 Ostrava, Czech Republic, E-mail: voznak@ieeee.org; MSc. Petr Chlumsky, Czech Technical University in Prague, Faculty of Electrical Engineering, st. Technicka 2, 16000 Prague, Czech Republic, E-mail: petr.chlumsky@fel.cvut.cz