

Effect of Phosphorus and Strontium Additions on Formation Temperature and Nucleation Density of Primary Silicon in Al-19 Wt Pct Si Alloy and Their Effect on Eutectic Temperature

FARAJI, Masoumeh, TODD, I. and JONES, H

Available from Sheffield Hallam University Research Archive (SHURA) at:

<http://shura.shu.ac.uk/7250/>

This document is the author deposited version. You are advised to consult the publisher's version if you wish to cite from it.

Published version

FARAJI, Masoumeh, TODD, I. and JONES, H (2009) Effect of Phosphorus and Strontium Additions on Formation Temperature and Nucleation Density of Primary Silicon in Al-19 Wt Pct Si Alloy and Their Effect on Eutectic Temperature. *Metallurgical and Materials Transactions. A., Physical Metallurgy and Materials Science*, 40 (7). 1710-1715. ISSN 1073-5623

Repository use policy

Copyright © and Moral Rights for the papers on this site are retained by the individual authors and/or other copyright owners. Users may download and/or print one copy of any article(s) in SHURA to facilitate their private study or for non-commercial research. You may not engage in further distribution of the material or use it for any profit-making activities or any commercial gain.

Effect of Phosphorus and Strontium Additions on Formation Temperature and Nucleation Density of Primary Silicon in Al-19 Wt Pct Si Alloy and Their Effect on Eutectic Temperature

M. FARAJI, I. TODD, and H. JONES

The influence of P and Sr additions on the formation temperature and nucleation density of primary silicon in Al-19 wt pct Si alloy has been determined, for small volumes of melt solidified at cooling rates \dot{T} of ~0.3 and 1 K/s. The proportion of ingot featuring primary silicon decreased progressively with increased Sr addition, which also markedly reduced the temperature for first formation of primary silicon and the number of primary silicon particles per unit volume \bar{N}_v . When combined with previously published results, the effects of amount of P addition and cooling rate on \bar{N}_v are in reasonable accord with $\bar{N}_v/\dot{T} = (\pi/6f)^{1/2} 10^9 [250 - 215 (\text{wt pct P})^{0.17}]^{-3}$, where \bar{N}_v is in mm^{-3} , \dot{T} is in K/s, and f is volume fraction of primary silicon. Increased P addition reduces the eutectic temperature, while increased Sr appears to generate a minimum in eutectic temperature at about 100 ppmw Sr.

DOI: 10.1007/s11661-009-9842-0

© The Minerals, Metals & Materials Society and ASM International 2009

I. INTRODUCTION

HYPEREUTECTIC Al-Si-based alloys continue to attract interest because of their good wear and corrosion resistance, low thermal expansivity, and low density.^[1-3] Optimum mechanical properties require refinement of primary silicon as well as effective modification of the eutectic matrix. Attempts to achieve this by simultaneous additions have been frustrated, however, by destructive interactions between P-based refiner and Na- or Sr-based modifier.^[4] The present work was carried out to investigate the effects of phosphorus and strontium additions on primary silicon formation from small melts of Al-19 wt pct Si alloy at different cooling rates. Our earlier article^[5] reviewed the effect of cooling rate \dot{T} and phosphorus inoculation on the number per unit volume \bar{N}_v of primary silicon particles in hypereutectic Al-Si alloys. Most of the published results showed a good fit (within a factor of 3 in \bar{N}_v) with

$$\bar{N}_v = A\dot{T}^n \quad [1]$$

Here $n = 1$ and $A = 130 \text{ mm}^{-3} (\text{K/s})^{-1}$ in the absence of phosphorus addition, and $n = 1$ and $A = 720 \text{ mm}^{-3} (\text{K/s})^{-1}$ in the presence of 0.1 to 0.2 wt pct P addition. Any attempt to model such size refinement of the primary silicon requires knowledge of the effect of

variables on the temperature range over which the primary silicon forms.

Teraï^[6] reported increased undercooling (*i.e.*, decreased formation temperature, T_1) to form primary silicon with increased cooling rate regardless of whether P or Na was added, with added P increasing T_1 and added Na decreasing T_1 at each cooling rate. Crosley and Mondolfo^[7] also reported lower T_1 when Na was added rather than P. Colligan and Gunes^[8] reported formation of primary silicon at lower T_1 from P-refined melts. Tenekedjiev *et al.*^[9] reported decreased T_1 on Sr addition with or without P addition to Al-17 wt pct Si alloy,* and Chang *et al.*^[10] reported

*The data in their Table III for Sr added alone, however, contradict this.

decreased T_1 with increased rare earth addition to Al-21 wt pct Si alloy. Kyffin *et al.*^[11] found a primary silicon arrest at some 50 K undercooling for Al-20 wt pct Si, which disappeared when 100 ppm P was present. Zhang *et al.*^[12] reported formation of primary silicon at higher temperature when P was added to Al-25 wt pct Si. Song *et al.*^[13] reported that 0.02 wt pct P raised the primary silicon start temperature T_1 by 5.5 K in their BH135 alloy. Nogita *et al.*^[14] reported that addition of 50 to 360 ppm Sr reduced the primary silicon reaction temperature of Al-17 wt pct Si by some 40 K, while Robles Hernandez and Sokolowski^[15] reported that 60 ppm P raised T_1 by 2.3 K while 60 ppm Sr raised T_1 by 1.8 K in the presence of 60 ppm P. In contrast, Nafisi *et al.*^[16] reported a 65 K reduction in T_1 on addition of 1500 ppm Sr in the presence of 500 ppm P.

M. FARAJI, formerly Ph.D. Student with the Department of Engineering Materials, University of Sheffield, is Lecturer in Metallurgy, Department of Materials, University of Semnan, Semnan 35131-1911, Iran. Contact e-mail: mas.faraji@yahoo.com I. TODD, Reader in Metallurgy, and H. JONES, Emeritus Professor of Metallurgy and Materials, are with the Department of Engineering Materials, University of Sheffield, Sheffield S1 3JD, United Kingdom.

Manuscript submitted October 9, 2008.

Article published online May 14, 2009

II. EXPERIMENTAL

The Al-20 wt pct Si alloy ingot, with supplied composition Al-19.7Si-0.3Fe-0.02Cu-0.02Ti-0.1Mn (wt pct) and 14 ppmw P, for remelting, was obtained from Norton Aluminium Products Ltd., Cannock, Staffs, UK. Analysis for silicon macrosegregation gave a mean of 18.6 wt pct Si with maximum variation ± 0.3 wt pct between ingot top, middle, and bottom. Phosphorus and strontium additions to melts were made using aluminum foil wrapped Al-6.8Fe-4.4P (wt pct) inoculant and pieces of Al-5.9 wt pct Sr modifier supplied by KB alloys and London & Scandinavian Metallurgical Co. Limited (Rotherham, South Yorkshire, UK), respectively. Additions were made at 800 °C, holding for 15 minutes before casting, in the case of single additions. When both inoculant and modifier were added, the modifier was added 15 minutes after the inoculant was added and the melt held for a further 15 minutes. Degassing with NITRAL was carried out prior to casting.

Remelting of 90 g charges and melt treatment and bottom casting into bonded sand molds were carried out in the apparatus shown in Figure 1. The alumina melting crucible had 220-mm height and 80-mm bore, charged with 150 g of alloy for melting. This was stopped by a tubular alumina rod until teeming was required through the 6.5-mm bore of a replaceable graphite nozzle in its base. Teeming was carried out into a bonded sand mold of dimensions shown in Figure 2. To collect cooling curve data, this mold had an axially located K-type thermocouple with output fed to a data logger.

In a separate procedure, solidification in alumina or steel crucible molds was carried out by first crucible melting a cold charge of 35 g in a muffle furnace set to 800 °C. Addition of inoculant to the melt was enacted outside the furnace. Then the melt was returned to the furnace. After 15 minutes, it was removed onto a copper block. The temperature of the solidifying melt was monitored by means of a sheathed thermocouple inserted through the ceramic fiber lid of the crucible. The alumina crucible had height 45 mm, bore 40 mm, and wall thickness 2 mm. The stainless steel crucible had height 30 mm, bore 30 mm, and wall thickness 1 mm, and was internally coated with Holcote 110 supplied by Foseco (Tamworth, Staffs, UK).

Microstructural studies were carried out on longitudinal sections of the resulting small ingots. The numbers of primary silicon particles per unit area (N_A) were counted typically in 15 areas of each ingot.

III. RESULTS

Sand mold ingots showed regions of primary silicon plus eutectic (Si + Eu) with regions of eutectic alone. Typically, eutectic alone occurred in a layer immediately above a thin layer of Si + Eu at the bottom face of the ingot. Si + Eu dominated the upper part of the ingots, its primary silicon being refined when inoculant had been added, with or without modifier. The addition of 0.04 wt pct Sr alone, however, introduced a region of

modified eutectic, free of primary silicon, which confined the Si + Eu region to the very top of the ingot. Figure 3 shows the percentage of the ingot occupied by this modified eutectic, free of primary silicon, as a function of the amount of Sr added.

Figure 4 shows the lengths (vertical direction) of Si + Eu and refined eutectic regions in the absence and presence of inoculant addition. Table I summarizes measurements of the number of primary silicon particles per unit area N_A in primary silicon zones of ingots and derived number per unit volume N_V , together with temperature T_1 of first formation of primary silicon and eutectic minimum formation and arrest temperatures T_2 and T_3 derived from cooling curves. Each measurement shown is the average typically of three or four repeated tests (*i.e.*, three or four ingots cast under identical conditions). The value of T_1 was determined as the temperature at which a sudden reduction of slope occurred on the cooling curve, while T_2 was the minimum prior to the eutectic arrest at T_3 .

IV. DISCUSSION

The effect of added Sr in suppressing formation of primary silicon in hypereutectic Al-Si alloys, exemplified in Figure 3, accords with reports by Jenkinson and Hogan^[17] and Nogita *et al.*^[14] Table I indicates a marked reduction in temperature T_1 of first formation of primary silicon in the sand mold from 654 ± 1 °C in the absence of addition to 614 ± 7 °C when 0.2 wt pct Sr was added. This was associated with a reduction in N_V from 270 ± 60 mm⁻³ to 12 ± 1 mm⁻³, similar reductions being evident when 0.02 wt pct P was added prior to adding the Sr. These results on the effect of Sr addition on T_1 are presented in Figure 5 together with previous results.^[9,14-16] While the results show a lot of scatter, the overall downward trend with increasing Sr additions is evident. Any effect of additional P is within experimental scatter. The large recorded reductions in T_1 from Reference 14 by small additions below 0.02 wt pct Sr could possibly be associated with the relatively higher cooling rate (2 K/s) used by these authors.

Nogita *et al.*^[14] attribute this effect of Sr addition either to constitutional instabilities caused by segregation of Sr at the primary silicon/melt interface or to “poisoning” of the layer growth mechanism. Clapham and Smith^[18] used atomic adsorption spectroscopy to demonstrate preferential segregation of Sr to the silicon phase in the Al-Si eutectic. This was confirmed by Nogita *et al.*^[19] via X ray fluorescence, by Simensen *et al.*^[20] using Nano SIMS, and by Kim *et al.*^[21] using electron-probe microanalysis. This Sr segregation could also account for the factor of 20 to 40 reduction of N_V in Table I when 0.2 wt pct Sr was added.

Concerning any effect of cooling rate, the results in Table I for N_V without additions show no effect from the factor of 3 increase in \dot{T} for steel compared with sand molds. Table I shows no systematic significant effect on T_1 of the amount of P addition with a steel mold (Figure 6 plots N_V vs amount of added P), though an

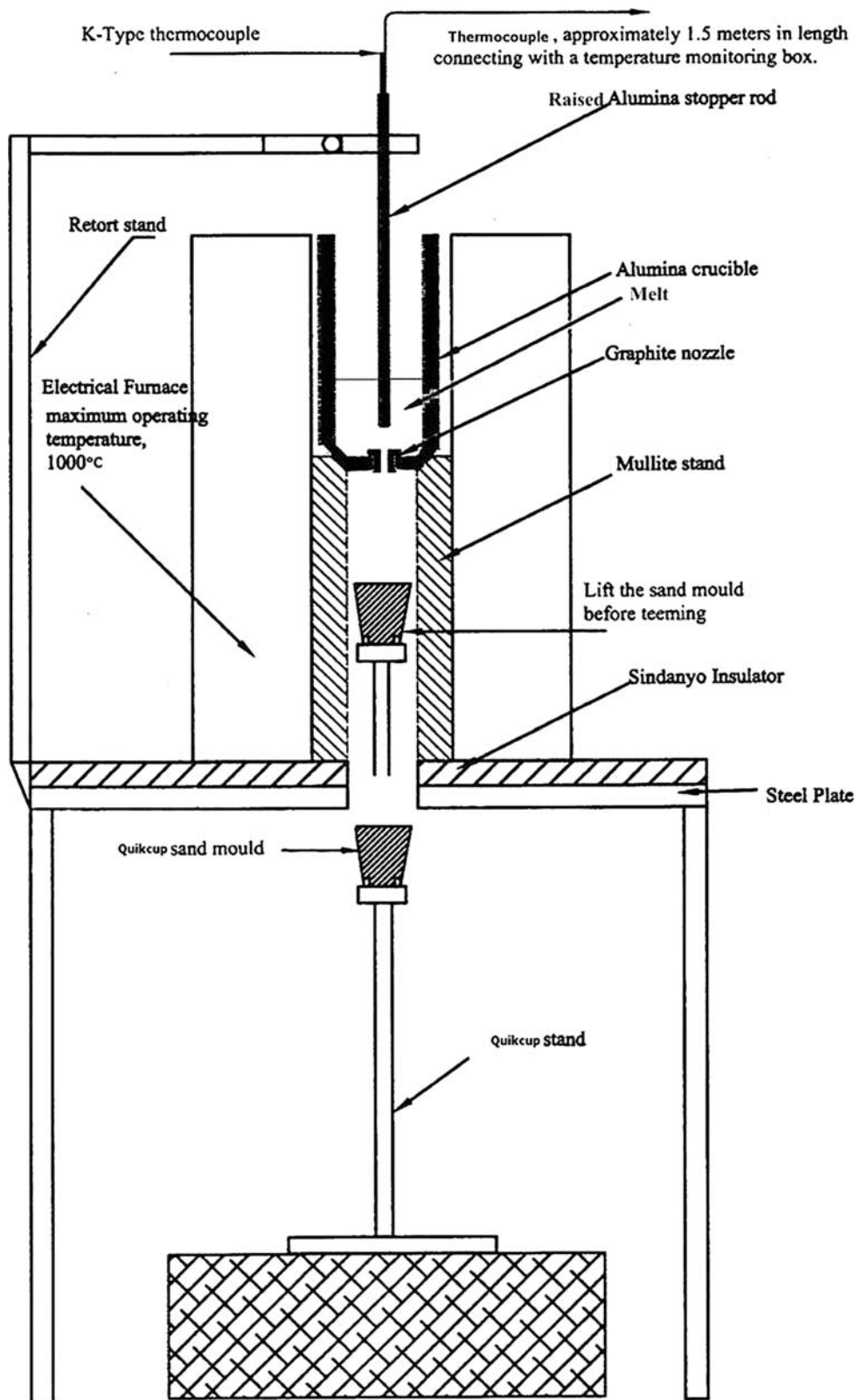

Fig. 1—Apparatus for bottom casting into a bonded sand mold.

effect on eutectic minimum formation and arrest temperature, T_2 and T_3 , is indicated (reduction by 1.9 and 2.4 K, respectively, for a 0.08 wt pct P addition).

The effect of P in decreasing eutectic temperatures T_2 and T_3 has also been reported by Cho *et al.*^[22] for a hypoeutectic alloy (Figure 7); this depression begins to

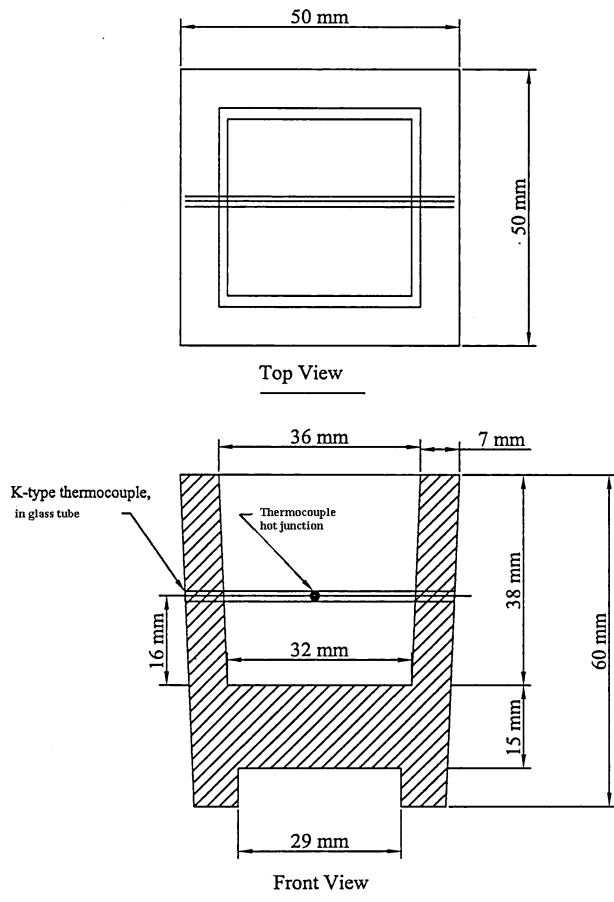

Fig. 2—Dimensions of the bonded “Quikcup” sand mold showing thermocouple location.

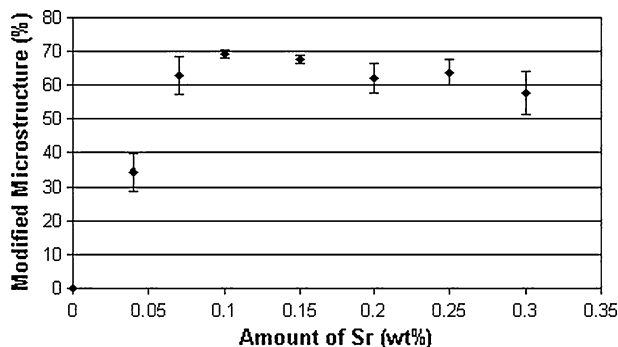

Fig. 3—Percentage of ingot cast in bonded sand mold featuring modified eutectic without primary silicon vs amount of strontium addition.

disappear, however, on adding 60 ppmw. These results in Table I for N_v can be compared with the empirical relation for mean primary silicon spacing λ on random sections derived by Kyffin *et al.*^[23] from their results and those of References 24 through 26, valid for 0.01 to 0.2 wt pct P addition to Al-18 to 31 wt pct Si:

$$\lambda \dot{T}^{1/3} = 250 - 215(\text{wt pct P})^{0.17} \quad [2]$$

Here, λ is mean primary silicon spacing on a random section and is in microns and \dot{T} is in K/s. Now,

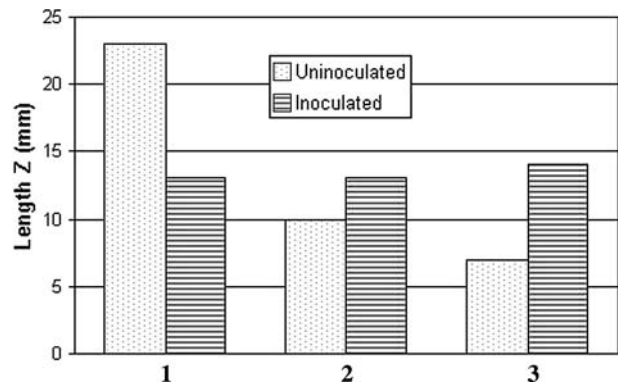

Fig. 4—Average length of microstructure zones for uninoculated and inoculated ingots cast in bonded sand mold: 1 = unrefined primary silicon plus unmodified eutectic, 2 = unmodified eutectic, and 3 = refined primary silicon plus unmodified eutectic.

$\lambda = \overline{N}_A^{-2}$, where \overline{N}_A is the mean number of primary silicon particles on the random section, and $\overline{N}_v = (\pi/6f)^{1/2} \overline{N}_A^{3/2}$,^[5] where f is the volume fraction of primary silicon, so Eq. [2] can be rewritten as

$$\overline{N}_v = \left(\frac{\pi}{6f}\right)^{1/2} \frac{10^9 \dot{T}}{[250 - 215(\text{wt pct P})^{0.17}]^3} \quad [3]$$

where \overline{N}_v is in mm^{-3} and \dot{T} is in K/s. For 0.02, 0.04, and 0.08 wt pct P additions, Eq. [3] gives $N_v/\dot{T} = 600, 820,$ and $1210 \text{ mm}^{-3} (\text{K/s})^{-1}$ within a factor of 2 of the results 480, 640, and $700 \text{ mm}^{-3} (\text{K/s})^{-1}$ for the steel mold in Table I.

Adding Sr to Al-Si alloy causes a downward shift in eutectic temperature.^[27] As shown by Table I, adding 0.2 wt pct Sr reduced the eutectic arrest temperature T_3 by 1.7 K. However, it seems that there is a limit beyond which this reduction in eutectic arrest temperature is replaced by an increase.^[28] Figure 8 summarizes the effect of Sr on T_3 for the result of the present work and those of Nogita *et al.*,^[19] Kim *et al.*,^[21] Bäckerud *et al.*,^[28] Faraji and Katgerman,^[29] Shabestari and Ghodrat,^[30] Djurdjevic *et al.*,^[31] and Heusler and Schneider^[32] for Al-8.5 to 19 wt pct Si, A356, and 319 alloys. Bäckerud *et al.*^[28] showed that, when the optimum modification was reached, eutectic nucleation and growth temperatures were reduced and recalescence disappeared. However, by increasing the holding time to 6 hours and fading the modification, the nucleation and growth temperatures increased and the recalescence effect reappeared. They also observed that adding in excess of 0.02 wt pct Sr to A356 alloy resulted in formation of intermetallic particles of $\text{Al}_2\text{Si}_2\text{Sr}$. This decreased the amount of modifying agent in solution and, as a result, T_3 increased, and Shabestari and Ghodrat^[30] found 120 to 160 ppmw Sr addition to be optimum for 319 aluminum alloy. According to Figure 8, regardless of the silicon or other alloying content, there is a minimum in T_3 at 100 to 200 ppm Sr. This effect may be attributed to the formation of the increasing amount of $\text{Al}_2\text{Si}_2\text{Sr}$ particles at such Sr levels,

Table I. Results of Measurements of Primary Silicon First Formation Temperature T_1 , Eutectic First Formation, and Arrest Temperatures T_2 and T_3 from Cooling Curves, and of the Number of Primary Silicon Particles per Unit Area and Volume N_A and Derived N_V vs Melt Treatment and Cooling Conditions. Here $N_V = (\pi/6f)^{1/2} N_A^{3/2}$, and f is Volume Fraction of Primary Silicon ($=0.20 \pm 0.04$ by Image Analysis)*

Melt Addition (Wt Pct)	Mold Material	Cooling Rate, K/s	T_1 °C	T_2 °C	T_3 °C	N_A mm ⁻²	N_V mm ⁻³
	sand	0.35 ± 0.06	653.6 ± 1.1	574.1 ± 0.9	576.3 ± 0.1	30 ± 4	270 ± 60
0.02P	sand	0.35 ± 0.04	651.6 ± 2.3	573.9 ± 0.8	576.0 ± 0.5	40 ± 7	410 ± 110
0.2Sr	sand	0.30 ± 0.07	614.1 ± 6.6	574.6 ± 0.5	574.6 ± 0.2	3.8 ± 0.2	11.9 ± 1.0
0.02P + 0.2Sr	sand	0.27 ± 0.01	621.5 ± 2.4	574.6 ± 0.6	574.8 ± 0.6	3.4 ± 0.6	10.4 ± 2.8
	alumina	0.94 ± 0.23	650.5 ± 4.8	574.0 ± 3.0	576.5 ± 0.6	35 ± 6	340 ± 90
0.02P	alumina	0.82	—	—	—	60 ± 8	750 ± 150
	steel	0.91 ± 0.15	651.7 ± 5.0	574.7 ± 0.9	575.5 ± 0.6	30 ± 5	270 ± 70
0.02P	steel	0.89 ± 0.11	642.0 ± 10.4	574.0 ± 1.3	574.5 ± 1.3	40 ± 6	430 ± 90
0.04P	steel	1.10 ± 0.01	652.2 ± 1.2	573.4 ± 0.8	574.7 ± 1.0	57 ± 3	700 ± 60
0.08P	steel	1.05 ± 0.20	651.6 ± 0.9	572.3 ± 1.0	573.6 ± 0.3	59 ± 7	740 ± 130

*The cooling rates were estimated from the cooling curves, as the average slope between the primary silicon nucleation and eutectic arrest temperatures.

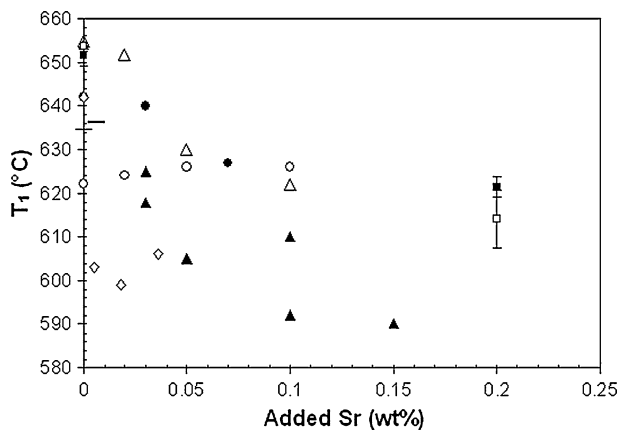

Fig. 5—Primary silicon first formation temperature T_1 vs amount of Sr addition. ○● Ref. 9 (Al-17Si), △ Ref. 9 (A390), ◇ Ref. 14 (Al-17Si), ■ Ref. 15 (390 alloy), ▲ Ref. 16 (Al-17Si), and □■ present work (Al-19Si). Filled points are for added 0.003 P [●], 0.006 P [▼], 0.05 P [▲], and 0.02 [■] wt pct additional to Sr. Cooling rates were ◇ 2 K/s, ○● unspecified, ▲ 0.5 to 0.8 K/s, □■ 0.3 K/s, and ■ 0.1 K/s.

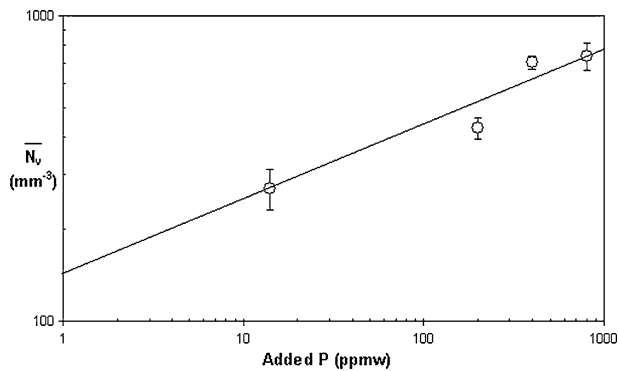

Fig. 6—Effect of amount of P addition on number of primary silicon particles per unit volume N_V for solidification in the steel mold (cooling rate ~ 1 K/s).

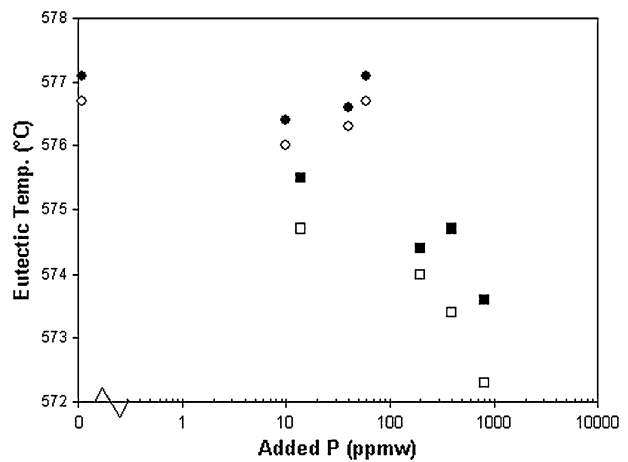

Fig. 7—Effect of P addition on eutectic minimum formation temperature (T_2) and eutectic arrest temperature (T_3): □ T_2 ■ T_3 present work, and ○ T_2 ● T_3 Ref. 22 (Al-10Si-1.1Fe).

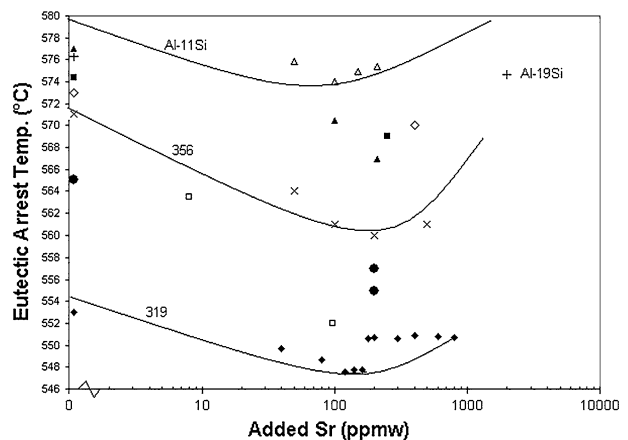

Fig. 8—Effect of Sr addition on eutectic arrest temperature (T_3): ■ Ref. 19 (Al-10Si-1.2Cu), ◇ Ref. 21 (Al-8.5Si) × Ref. 28 (356), ● Ref. 29 (A356), ◆ Ref. 30 (319), □ Ref. 31 (319), ▲ Ref. 32 (Al-11Si, steel mold), and △ Ref. 32 (Al-11Si, ceramic crucible) + present work.

which reduces the amount of Sr in solution in the melt.^[28,30]

V. CONCLUSIONS

1. Addition of Sr to Al-19 wt pct Si suppresses formation of primary silicon even in the presence of added P.
2. At a cooling rate of 0.3 K/s, addition of 0.2 wt pct Sr to this alloy gave a reduction in temperature of first formation of primary silicon of 40 K together with a reduction in number of primary silicon particles per unit volume \bar{N}_v by a factor between 20 and 30 while also reducing the proportion of ingot volume in which primary silicon formed.
3. Adding P up to 0.08 wt pct depresses the eutectic minimum formation temperature and eutectic arrest temperature by ~2 and 2.5 K, respectively.
4. When combined with previously published data, the effect of cooling rate \dot{T} and P addition on \bar{N}_v is in reasonable accord with

$$\bar{N}_v/\dot{T} = (\pi/6f)^{1/2}10^9 [250 - 215(\text{wt pct P})^{0.17}]^{-3}$$

where f is volume fraction of primary silicon, N_v is in mm^{-3} , and \dot{T} is in K/s.

5. Increased P addition to Al-Si alloys reduces the eutectic temperature, while increased Sr addition appears to give rise to a minimum in eutectic arrest temperature at about 100 ppmw Sr.

ACKNOWLEDGMENT

This work formed part of an MPhil/PhD program at the University of Sheffield by MF, financed by the Iranian Government.

REFERENCES

1. N. Tenekedjiev and J.E. Gruzleski: *Cast Met.*, 1990, vol. 3 (2), pp. 96–105.
2. J.L. Jorstad: *AFS Trans.*, 1996, vol. 104, pp. 669–71.
3. R.J. Donahue: *Adv. Mater. Proc.*, 2002, vol. 160 (2), p. 11.
4. J. Cissé, G.F. Bolling, and H.W. Kerr: *Metall. Trans. B*, 1975, vol. 6B, pp. 195–97.
5. M. Faraji, I. Todd, and H. Jones: *J. Mater. Sci.*, 2005, vol. 40, pp. 6363–65.
6. S. Terai: *Sumitomo Met.*, 1958, vol. 10 (3), pp. 40–51.
7. P.B. Crosley and L.F. Mondolfo: *AFS Trans.*, 1966, vol. 74, pp. 53–64.
8. G.A. Colligan and M.A. Gunes: *AFS Trans.*, 1973, vol. 81, pp. 359–65.
9. N. Tenekedjiev, D. Argo, and J.E. Gruzleski: *AFS Trans.*, 1989, vol. 97, pp. 127–36.
10. J. Chang, I. Moon, and C. Choi: *J. Mater. Sci.*, 1998, vol. 33, pp. 5015–23.
11. W.J. Kyffin, W.M. Rainforth, and H. Jones: *Mater. Trans.*, 2001, vol. 42, pp. 2098–2101.
12. Z.-H. Zhang, X.-F. Bian, Y. Wang, and X.-F. Liu: *Trans. Non-ferrous Met. Soc. China*, 2001, vol. 11 (3), pp. 374–77.
13. X. Song, X. Bian, X. Qi, X. Liu, J. Zhang, B. Wang, and L. Zhu: *J. Univ. Sci. Technol. Beijing*, 2004, vol. 11 (1), pp. 81–84.
14. K. Nogita, S.D. McDonald, and A.K. Dahle: *Phil. Mag.*, 2004, vol. 84, pp. 1683–96.
15. F.C. Robles Hernandez and J.H. Sokolowski: *J. Alloys Compd.*, 2006, vol. 426, pp. 205–12.
16. N. Nafisi, J. Hedjazi, S.M.A. Boutorabi, and R. Ghomashci: *Light Metals 2004*, Proc. Symp., A.T. Tobereaux, ed., Charlotte, NC, Mar. 14–18, 2004, TMS, Warrendale, PA, 2004, pp. 851–56.
17. D.C. Jenkinson and L.M. Hogan: *J. Cryst. Growth*, 1975, vol. 28, pp. 171–87.
18. L. Clapham and R.W. Smith: *J. Cryst. Growth*, 1988, vol. 92, pp. 263–70.
19. K. Nogita, H. Yasuda, K. Yoshida, K. Oesugi, A. Takeuchi, Y. Suzuki, and A.K. Dahle: *Scripta Mater.*, 2006, vol. 55, pp. 787–90.
20. C.I. Simensen, Ø. Nielsen, F. Hillion, and J. Voje: *Metall. Mater. Trans. A*, 2007, vol. 38A, pp. 1448–51.
21. M.H. Kim, Y.M. Hong, and H.Y. Cho: *Metall. Mater. Int.*, 2004, vol. 10, pp. 513–20.
22. Y.H. Cho, H.-C. Lee, K.H. Oh, and A.K. Dahle: *Metall. Mater. Trans. A*, 2008, vol. 39A, pp. 2435–48.
23. W.J. Kyffin, W.M. Rainforth, and H. Jones: *J. Mater. Sci.*, 2001, vol. 36, pp. 2667–72.
24. P. Mandal, A. Saha, and M. Chakraborty: *AFS Trans.*, 1991, vol. 99, pp. 643–51.
25. J. Sulzer: *Mod. Cast.*, 1961, vol. 39 (1), pp. 38–43.
26. J. Kaneko, M. Sugamata, and K.-I. Aoki: *J. Jpn. Inst. Met.*, 1978, vol. 42, pp. 966–72; *Trans. Jpn. Inst. Met.*, 1979, vol. 20, pp. 733–41.
27. B. Closset and J.E. Gruzleski: *AFS Trans.*, 1981, vol. 89, pp. 801–08.
28. L. Bäckerud, G. Chai, and J. Tamminen: *Solidification Characteristics of Aluminum Alloys*, Foundry Alloys, AFS/Skanaluminum, Stockholm, 1990, vol. 2, pp. 33–38.
29. M. Faraji and L. Katgerman: *Int. Foundry Res.*, 2009, vol. 61 (2), in press.
30. S.G. Shabestari and S. Ghodrat: *Mater. Sci. Eng. A*, 2007, vol. 467, pp. 150–58.
31. M. Djurdjevic, H. Jiang, and J. Sokolowski: *Mater. Charact.*, 2001, vol. 46, pp. 31–38.
32. L. Heusler and W. Schneider: *J. Light Met.*, 2002, vol. 2, pp. 17–26.