

Durham E-Theses

*"Studies on the malpighian tubules of *Locusta migratoria migratorioides* (R + F), with particular reference to the role of Na⁽⁺⁾-K⁽⁺⁾ activated ATPase in fluid secretion*

Bell, Diana M.

How to cite:

Bell, Diana M. (1977) *"Studies on the malpighian tubules of *Locusta migratoria migratorioides* (R + F), with particular reference to the role of Na⁽⁺⁾-K⁽⁺⁾ activated ATPase in fluid secretion*, Durham theses, Durham University. Available at Durham E-Theses Online: <http://etheses.dur.ac.uk/8371/>

Use policy

The full-text may be used and/or reproduced, and given to third parties in any format or medium, without prior permission or charge, for personal research or study, educational, or not-for-profit purposes provided that:

- a full bibliographic reference is made to the original source
- a [link](#) is made to the metadata record in Durham E-Theses
- the full-text is not changed in any way

The full-text must not be sold in any format or medium without the formal permission of the copyright holders.

Please consult the [full Durham E-Theses policy](#) for further details.

Academic Support Office, Durham University, University Office, Old Elvet, Durham DH1 3HP
e-mail: e-theses.admin@dur.ac.uk Tel: +44 0191 334 6107
<http://etheses.dur.ac.uk>

A thesis submitted for the degree of Doctor of Philosophy of the
University of Durham

"Studies on the Malpighian tubules of *Locusta Migratoria*
migratorioides (R + F), with particular reference to
the role of $\text{Na}^+ - \text{K}^+$ activated ATPase in fluid secretion"

by

Diana M. Bell B.Sc. (Dunelm)

The copyright of this thesis rests with the author.
No quotation from it should be published without
his prior written consent and information derived
from it should be acknowledged.

St Mary's College
University of Durham

January 1977



CONTENTS

	<u>Page</u>
Acknowledgements.....	3
Abstract.....	4
Glossary.....	5
Chapter 1. Introduction.....	7
Chapter 2. General materials and Methods.....	11
Chapter 3. Scanning and Transmission Electron Microscope studies on the ultrastructure of the Malpighian tubules of <u>Locusta</u> <u>migratoria</u>	14
Chapter 4. Biochemical studies on the Mg^{2+} dependent $Na^+ K^+$ stimulated ATPase from the Malpighian tubules and hindgut of <u>Locusta</u> <u>migratoria</u>	42
Chapter 5. Relationship between $Na^+ K^+$ ATPase activity and Respiratory rate in the Malpighian tubules of <u>Locusta migratoria</u>	87
Chapter 6. Studies of fluid secretion by the Malpighian tubules of <u>Locusta migratoria, in vitro</u>	104
Chapter 7. Relationship between $Na^+ K^+$ ATPase activity and the trans-wall potential across isolated Malpighian tubules of <u>Locusta migratoria</u> ...	146



	<u>Page</u>
Chapter 8. Discussion.....	165
Appendices to Chapter 4.....	178
Appendices to Chapter 5.....	190
Appendices to Chapter 6.....	192
Bibliography.....	200

ACKNOWLEDGEMENTS

I would like to thank Dr. J.H. Anstee for his supervision during this work, and his guidance in the preparation of the thesis; Professor D.Barker for making the facilities of the zoology department available to me; and to Dr. K.Bowler and Mr. D. Hyde for many stimulating discussions.

I am indebted to the technical staff of the zoology department, Durham University, for their cheerful assistance in many ways throughout my three years, and to Mr. Boulton of the Electron Microscopy Unit, School of Chemistry Newcastle University, who made the use of a scanning electron microscope available to me.

I am very grateful to Miss. J.Pugh and Miss.G. Naseem for typing the manuscript, and to Miss.G.Naseem and Mr.S.Naseem for invaluable assistance with the diagrams. Finally my thanks are due to my parents and my fiancé for their unfailing support and encouragement throughout.

I acknowledge the support of a Science Research Council grant for two years of this study.

ABSTRACT

The presence of a Na^+ - K^+ activated, Mg^{2+} dependent ATPase (E.C. 3.6.1.3.) has been demonstrated in microsomal preparations from Malpighian tubules and hindgut of Locusta migratoria migratorioides (R+F) and the conditions for optimal activity determined. The pH optimum was 7.5 and the temperature optima 45°C for Na^+ - K^+ ATPase whilst Mg^{2+} ATPase activity was still rising at 50°C . Activation energies for the Na^+ - K^+ ATPase were 121.6 ± 4.5 and 59.8 ± 2.7 Kjoules Mole $^{-1}$ between 6.3 - 21°C and 21 - 42°C respectively. The Mg^{2+} ATPase had activation energies of 95.8 ± 1.9 and 51.7 ± 3.9 Kjoules Mole $^{-1}$ over the same ranges. Maximal activation of the Na^+ - K^+ ATPase occurred at an ATP : Mg^{2+} ratio of 1:1.3, and at 100mM Na^+ ; 20mM K^+ . The Na^+ - K^+ ATPase was inhibited by ouabain with a pI_{50} value of 6.1. The K_m of Na^+ - K^+ ATPase was 0.15 ± 0.01 mMole l^{-1} with no significant difference between values obtained at 20°C , 30°C and 40°C . The values for V_{max} were 113.6 ± 42 , 213 ± 53 and 373 ± 109 for these temperatures respectively.

Physiological studies on fluid secretion by Malpighian tubules in vitro have shown secretion was inhibited by ouabain at concentrations greater than 10^{-6}M , and also in the absence of Na^+ or K^+ ions. This strongly suggested the involvement of Na^+ - K^+ ATPase in secretion which was further implicated by polarographic studies showing a corresponding 35% reduction in oxygen uptake in the presence of ouabain, or

absence of K^+ . Similarly the trans-wall potential has been shown to fall in these circumstances. The optimum temperature for secretion was $40^{\circ}C$, the process having an activation energy of $58.307 \text{ Kjoules Mole}^{-1}$ between $5-40^{\circ}C$. Rate of secretion was inversely proportional to osmotic concentration, and the urine was hyperosmotic to the bathing medium by $22.9 \pm 2.6m$. Osmoles. Fluid secretion was stimulated by cyclic AMP ($3 \times 10^{-4}M$), but 5HT had no effect. Potassium has been shown to be concentrated in the urine, but as electrophysiological studies revealed that the trans-wall potential did not correspond with the values for K^+ predicted by NERNST, the K^+ movement must have resulted from active transport.

Ultrastructural studies using both scanning and transmission electron microscopy in normal and ouabain Ringer solutions revealed that ouabain had no effect on structure.

The results were discussed in terms of the relationship between cell structure, fluid secretion and Na^+-K^+ ATPase activity.

GLOSSARY

A.D.P.	adenosine diphosphate
A.T.P.	adenosine triphosphate
B.S.A.	bovine serum albumen (Fraction V, Sigma)
Cyclic A.M.P.	cyclic adenosine 3'5'-monophosphate
E.D.T.A.	ethylene diamine tetra-acetic acid
Mg ²⁺ ATPase	magnesium activated adenosine triphosphatase
mV	millivolts
Na ⁺ -K ⁺ ATPase	magnesium dependent, sodium, potassium stimulated adenosine triphosphate
Pi	inorganic phosphate
r.p.m.	revolutions per minute
Tris.	tris (hydroxymethyl) amino methane
5-HT	5- hydroxytryptamine

CHAPTER 1

INTRODUCTION

The secretion of urine by the Malpighian tubules of insects has been the subject of numerous studies in the past (RAMSAY, 1953, 1954, 1955, 1956; BERRIDGE, 1965, 1968; MADDRELL, 1969; PILCHER, 1970; GEE, 1975). As a result of these, and other studies (see review by MADDRELL, 1971) a model has been proposed to explain fluid transport across the walls of the tubules. The main features of this model are that active transport of ions takes place at the basal and apical surfaces of the cells and that water movements are osmotically linked with ion movements. In most insect species potassium has been shown to be the ion which is actively pumped against a concentration gradient to provide the osmotic force necessary for fluid transport (BERRIDGE, 1968), although there are some exceptions, for example Glossina, in which sodium is pumped (GEE, 1975a). BERRIDGE and OSCHMAN (1969) have suggested that two active membrane bound pumps are involved in cation transport, an electrogenic K^+ pump on the apical surface and on the basal side a coupled sodium-potassium pump.

A great deal of controversy has developed regarding the proposed sodium-potassium exchange pump on the basal surface. The enzyme which has been shown to be responsible for the active transport of monovalent cations, and the associated



water movement across many epithelia is a magnesium dependent sodium and potassium stimulated adenosine-triphosphatase ($\text{Na}^+-\text{K}^+\text{ATPase}$) (E.C.3.6.1.3; SKOU, 1965). This enzyme has been demonstrated in a wide variety of epithelia from numerous animal species e.g. crab nerve (SKOU, 1957), cockroach nerve (GRASSO, 1967), elasmobranch rectum (BONTING, 1966), mammalian kidney (WHITTAM and WHEELER, 1961; SKOU, 1962 and KINSOLVING et al., 1963), dog pancreas (RIDDERSTAP and BONTING, 1969), frog and rat brain (BOWLER and DUNCAN 1968 a and b respectively) and toad bladder (CRABBE et al., 1974) to name but a few. It was suggested, therefore, that this enzyme might also be involved in ion and water movement across the Malpighian tubules of insects. Early attempts to demonstrate the presence of a $\text{Na}^+-\text{K}^+\text{ATPase}$ in insect Malpighian tubules were, however, unsuccessful. BERRIDGE and GUPTA (1968) failed to demonstrate the presence of a $\text{Na}^+-\text{K}^+\text{ATPase}$ either biochemically or histochemically and the only demonstration of a membrane ATPase was the electron histochemical localization of a $\text{Mg}^{2+}\text{ATPase}$ in both the apical and the basal membranes (SMITH, 1968). More recently PEACOCK et al. (1972) were able to demonstrate, by biochemical means, the presence of a $\text{Na}^+-\text{K}^+\text{ATPase}$ enzyme in microsomal preparations from the hindgut and Malpighian tubules of two insects, Schistocerca gregaria and Jamaicana flava. Subsequent studies have

revealed the presence of this enzyme in the hindgut and tubules of Homorocoryphus nitidulus (PEACOCK et al ., 1976) and in Locusta migratoria (PEACOCK, 1975).

One of the main objections raised concerning the involvement of the $\text{Na}^+ \text{K}^+ \text{ATPase}$ in fluid secretion was the failure, by several workers, to demonstrate that fluid secretion by isolated Malpighian tubules was sensitive to the cardiac glycoside, ouabain; a specific $\text{Na}^+ \text{K}^+ \text{ATPase}$ inhibitor (BERRIDGE, 1968; MADDRELL, 1969; PILCHER 1970b and GEE, 1975). In contrast, however, ouabain has been shown to effect secretion by the Malpighian tubules of Drosophila hydei in vivo (ATZABACHER et al ., 1974) and also secretion in vitro by the Malpighian tubules of the pill millipede, Glomeris marginata (FARQUHARSON, 1974b). There are two possible reasons for this discrepancy. In the cases where ouabain failed to have an effect it may be that it did not reach the site of active transport in sufficient quantity, or alternatively it may be that the mechanism of tubule function varies from one insect species to another.

A further objection to $\text{Na}^+ \text{K}^+ \text{ATPase}$ involvement in fluid secretion across insect Malpighian tubules put forward by MADDRELL (1971) was that an exchange pump provided no net transfer of solute and consequently no osmotic imbalance would be created. This objection assumes, however, that the $\text{Na}^+:\text{K}^+$ exchange is on a 1:1 basis, which is not necessarily the case. Indeed in red blood cells 3Na^+ ions are moved in one direction and 2K^+ in the other for each ATP bond split (POST and SEN, 1967).

The present study was carried out in order to confirm the presence of a $\text{Na}^+ \text{K}^+$ ATPase in the Malpighian tubules and hindgut of Locusta migratoria migratorioides (R+F), to partially characterise the enzyme, and to determine the extent to which it is involved in the mechanism of fluid secretion. Other factors influencing fluid secretion by the tubules in vitro such as temperature, osmotic concentration and the influence of cyclic AMP and 5HT were also studied, with the aim of providing greater understanding of the mechanisms involved in urine production by the Malpighian tubules of Locusta. Three main lines of approach have been followed throughout this study : biochemical, physiological and ultrastructural.

CHAPTER 2

General Materials and Methods

Maintenance of insects

Populations of Locusta migratoria migratorioides

R and F, phase gregaria (specimens of which were originally supplied by Philip Harris, Biological Supplies), were housed in an insectary at a temperature of $28 \pm 0.5^{\circ}\text{C}$, and $50 \pm 5\%$ relative humidity. A slight but continuous air exchange was obtained in the insectary due to two small ventilators and air circulation was effected by two large electric fans. A constant photoperiod of 12 hours light and 12 hours dark was maintained. The animals were reared in cages (43cm x 58cm x 58cm); these had a dexion angles metal framework with aluminium top and sides, and a perspex front. There was a "false" floor to each cage made in perforated aluminium. This contained four holes into which plastic cups filled with sand were put and into which female locusts placed their egg pods. The false floor was separated from the true floor by a space 10cm high and the faeces from the locusts passed through the holes in the false floor into the space beneath .

Each cage was illuminated by a single 40 Watt bulb which resulted in temperatures within the cages varying according to proximity to the bulb, often rising to 40°C in the region immediately adjacent to it. Humidity also varied a little

when fresh food and water were supplied. The locusts were fed daily on grass, Bemax and water.

Throughout their development animals were reared at sufficiently high density to ensure their remaining "gregarious" (JOLY and JOLY, 1953).

Glassware washing procedure

All glassware was soaked overnight in 2% (W/V) "Quadralene" laboratory detergent, then rinsed 6 times in tap water followed by 6 rinses in distilled water. Glassware was then dried in drying ovens, but glass/teflon homogenisers and centrifuge tubes were allowed to drain at room temperature.

Chemicals : All reagents used were the purest available and were generally supplied by Sigma Co., Kingston-upon-Thames, Surrey, U.K. or B.D.H., Poole, Dorset, U.K.

Insect Ringer Solution : Unless stated otherwise in the text, the composition of the insect Ringer used in most experiments was as follows : NaCl 129mM, KCl 8.6mM, $MgCl_2 \cdot 6H_2O$ 8.5mM, $CaCl_2$ 2mM., $NaHCO_3$ 10.2mM, NaH_2PO_4 4.3mM, Glucose 34mM pH 7.2 (MADDRELL, 1969).

Statistical techniques :

Statistical comparisons of data were performed using conventional techniques described by SNEDECOR and COCHRAN

(1967). Where necessary the statistical tables of FISHER^C and YATES (1963) were used. Values and probabilities less than 0.05 were taken as significant. An Olivetti Programma 101 programmable calculator was generally used.

CHAPTER 3

Scanning and Transmission Electron Microscope Studies of the Ultrastructure of the Malpighian tubules of *Locusta migratoria*

Introduction

In the past numerous transmission electron microscope studies have been carried out to determine the ultrastructure of the Malpighian tubules from a variety of insects, e.g. BEAMS et al. (1955) *Melanoplus differentialis*; TSUBO and BRANDT (1962) *Dissosteira carolina*; BERRIDGE and OSCHMAN (1969) *Calliphora erythrocephala*; TAYLOR (1971a and b) *Carausius morosus*; WALL et al. (1975) *Periplaneta americana*; WESSING and EICHELBERG (1975) *Drosophila melanogaster* and *Drosophila hydei*; and PEACOCK (1975) *Jamaicana flava*. A considerable degree of uniformity has been shown to exist in the ultrastructure of the urine secretory cells in this wide variety of insects. All are one cell thick with extensive invaginations of the basal and apical surfaces creating a complex system of extracellular spaces and channels. These invaginations produce a large surface area for fluid transport, and the numerous mitochondria associated with them suggest that transport is an energy requiring process. Similar structures are observed in many other secretory epithelia, such as *Calliphora* salivary gland (OSCHMAN and BERRIDGE, 1970); gall bladder (KAYE et al., 1966; TORMAY and DIAMOND, 1967) and kidney (RHODIN, 1958); (review article BERRIDGE and OSCHMAN, 1972).

Many models have been produced to explain the movement of water through epithelia. DIAMOND and BOSSERT (1967, 1968), and CURRAN and MACINTOSH (1962) suggest water moves passively as a result of active ion "pumping" into the extracellular spaces created between the infoldings of the apical and basal cell membranes. This results in the formation of local gradients which induce water movement. These theories originally proposed for rabbit gall bladder, have been applied to the Malpighian tubules of Calliphora by BERRIDGE and OSCHMAN (1969).

In a number of insects which have been studied approximately 1% of the cells making up the tubule are structurally different from the "normal" secretory cells. These cells have been called Type II cells by TAYLOR (1971b) in Carausius morosus, stellate cells by BERRIDGE and OSCHMAN (1969) in Calliphora erythrocephala and by WALL et al (1975) in Periplaneta americana, and secondary cells by PEACOCK (1975) in Jamaicana flava. They are much smaller than the "primary". (BERRIDGE and OSCHMAN, 1969) or Type I cells (TAYLOR 1971a) which make up the majority of the tubule, and they have reduced microvilli. The cytoplasm of secondary cells lacks vacuoles and concretions but is very rich in endoplasmic reticulum, multivesicular bodies, lysosomes, and Golgi bodies. Their precise function is uncertain, although it has been suggested that they may secrete a mucopolysaccharide, (MARTOJA, 1956, 1959, 1961; BERKALOFF, 1960 and GABE, 1962), or reabsorb Na^+ from the lumen (BERRIDGE and OSCHMAN, 1969).

TAYLOR (1971b) suggests they might well perform both of these functions. Secondary cells have been described in the Malpighian tubules of Locusta migratoria by MARTOJA (1959; 1960); PEACOCK (1975) and CHARNLEY (1975), and were also observed in the present study. However, since they are apparently not directly concerned with the production of primary urine by the tubules, they were omitted from the present study.

Recently, extensive studies on normal and diseased kidney tissue (ANDREWS, 1973; 1974; 1975a and b; FUJITA et al., 1976) have revealed the enormous advantages of using transmission electron microscopy (T.E.M.) in conjunction with scanning electron microscopy (S.E.M.) to obtain a clearer knowledge of ultrastructure. The above workers were able to observe for the first time certain structures such as isolated cilia on the luminal surface of the proximal and distal tubules and on the Bowman's capsule. Very little S.E.M. has been carried out on insect gut, the exceptions being KLEIN and APPLEBAUM (1975) who studied the hindgut cuticle of Locusta migratoria, and CROWDER and SHANKLAND (1972) who studied the muscle on the Malpighian tubules of Periplaneta americana. To date no published work has been presented on the ultrastructure of insect Malpighian tubules as observed with the scanning electron microscope.

The purpose of this study is to examine the ultrastructure of the "primary" cells of the Malpighian tubules of Locusta migratoria using a combination of transmission and

scanning electron microscopy. The observations provide a basis for the subsequent physiological studies.

Materials and Methods

Sexually mature locusts of both sexes were used for the ultrastructural studies. The technique of tissue fixation was identical for scanning and transmission electron microscopy.

The animals were killed by decapitation and the Malpighian tubules, together with the adjoining "collar" of gut, were quickly dissected free in ice cold Ringer solution and fixed in cold (ca. 4°C) 5% glutaraldehyde buffered with 0.1M sodium cacodylate (pH 7.3) overnight. The tissue was then washed for 2 hours in 0.1M sodium cacodylate buffer containing 0.2M sucrose (pH 7.3). Subsequent treatment varied for the two techniques, and will therefore, be described separately.

1. Scanning electron microscopy (S.E.M.)

The tissue was dehydrated by passing through a series of acetones; 10 minutes in 70% and 90% and two periods of 10 minutes in absolute acetone. It was then dried using the Critical-point drying technique (Polaron Ltd. E3000 apparatus). The dried tissue was stuck on metal stubs using two sided sellotape. In some cases the tubules were fractured on the stub to expose broken tubule ends and some tubules were split longitudinally using a scalpel. The tissue was then coated

on uncoated copper grids. Sections were stained in uranyl acetate and lead citrate (REYNOLDS, 1963) and were examined in an AEI801 electron microscope.

Observations

Locusta migratoria have approximately 200 Malpighian tubules. These are blind ending pink/brown tubes 15-20mm long and 50-80 μm in diameter. They have a similar morphological appearance along their length, and lie free in the haemolymph reaching as far forward as the anterior caecae and back as far as the posterior end of the rectum. The tubules open into the alimentary canal via 12 irregularly shaped ampullae which lie at the midgut/hindgut junction (Plate 1).

The Malpighian tubules are in continuous writhing motion due to the action of spirally coiled muscles along their length. PALM (1946) describes the typical "Orthopteran" arrangement of muscle on Malpighian tubules as consisting of two parallel muscle fibres winding helically along the length of the tubule. The tubule muscles of Locusta would appear to be consistent with his description as they consist of two parallel fibres 5-8 μm wide running very close together (less than 3 μm apart) (see Plate 2). The muscle fibres are wrapped helically around the tubules with approximately 200 μm between turns (Plate 8). The muscles appear to be held in close contact with the tubule surface as they are covered by a thin outer layer of the basement membrane (Plate 3). Numerous

PLATE 1

Low power scanning electron micrograph of the Malpighian tubules together with the "collar" of gut (C) to which they are attached.

Scale = 600 μ m

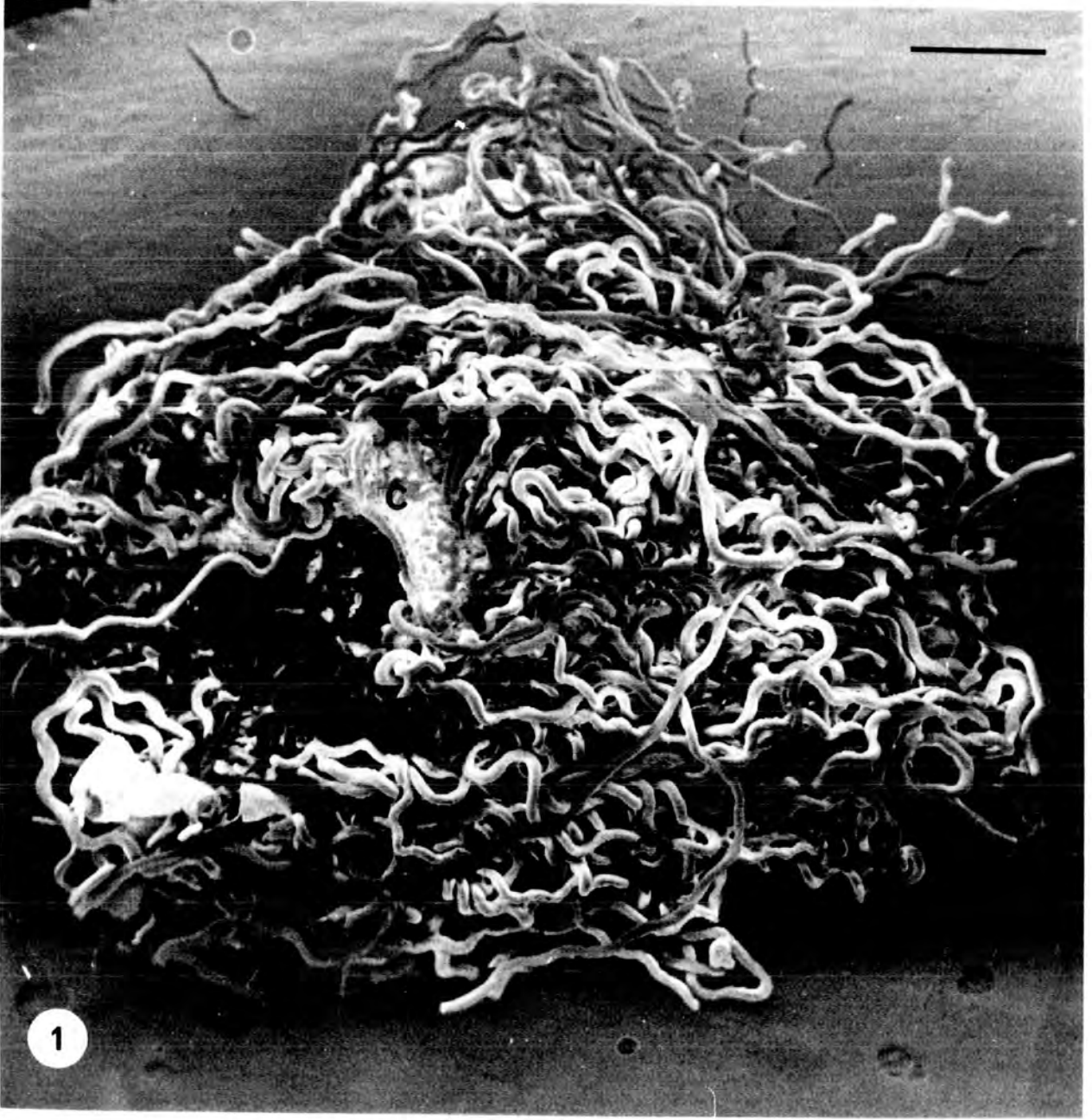

PLATE 2

Scanning electron micrograph showing the two parallel muscle fibres on the surface of Malpighian tubule.

Scale = $10\mu\text{m}$

PLATE 3

Low power transmission electron micrograph showing a T.S. through one of the muscles (Ms) on the surface of a Malpighian tubule. The basement membrane (BM) can be seen on either side of the muscle. The basal region of the Malpighian tubule (B) is also shown.

Scale = $2\mu\text{m}$

PLATE 4

Transmission electron micrograph showing a T.S. through a part of the Malpighian tubule muscle. The absence of thick filaments in certain regions indicate that the section has passed through the I band (I). Note also the A band (A); Z membrane (Z); Basement membrane (BM); Dyad (D); Mitochondrion (M); Sarcoplasmic reticulum (SR) and the T. system (T).

Scale = $0.5\mu\text{m}$

PLATE 5

A high power transmission electron micrograph through the A band to show the arrangement of the thick (myosin) and thin (actin) filaments. Each myosin filament is surrounded by approximately 12 actin filaments.

Scale = $0.25\mu\text{m}$

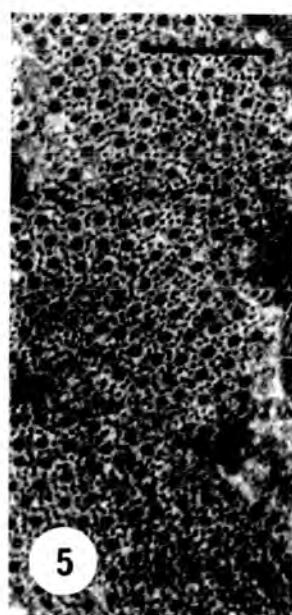
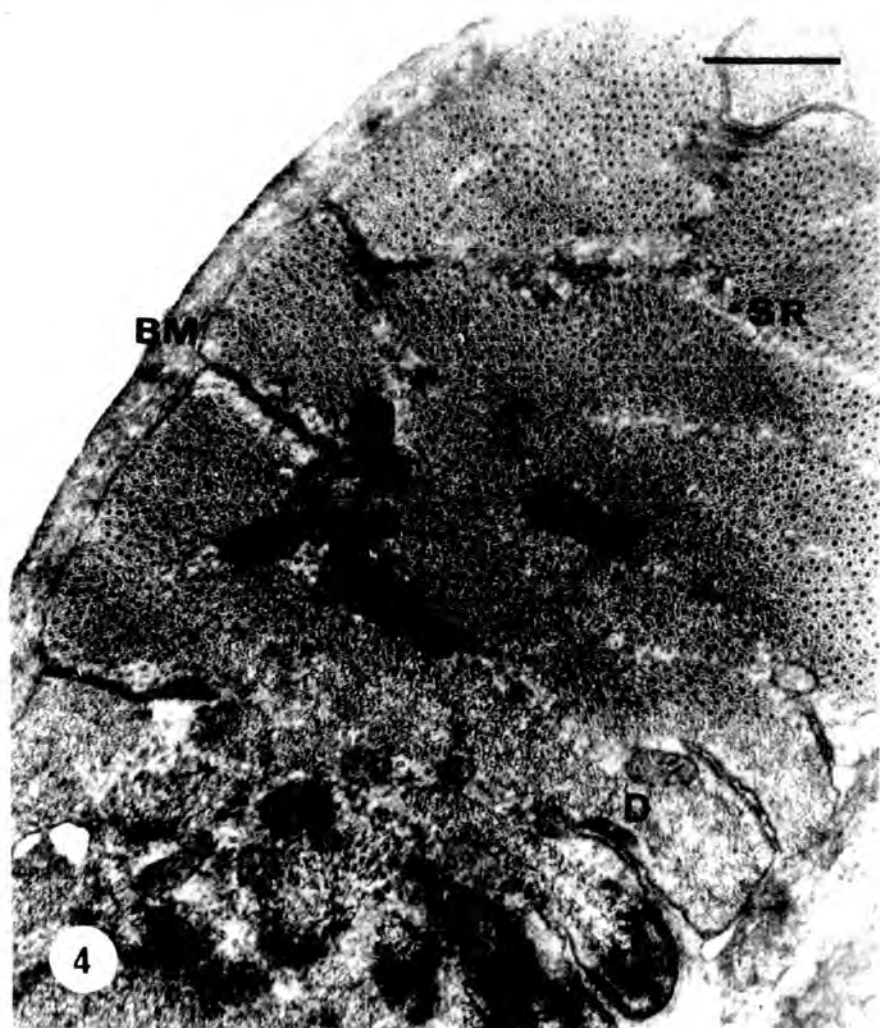
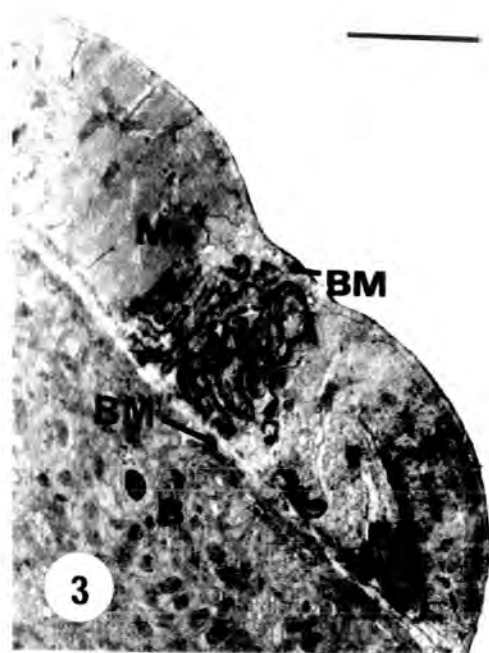
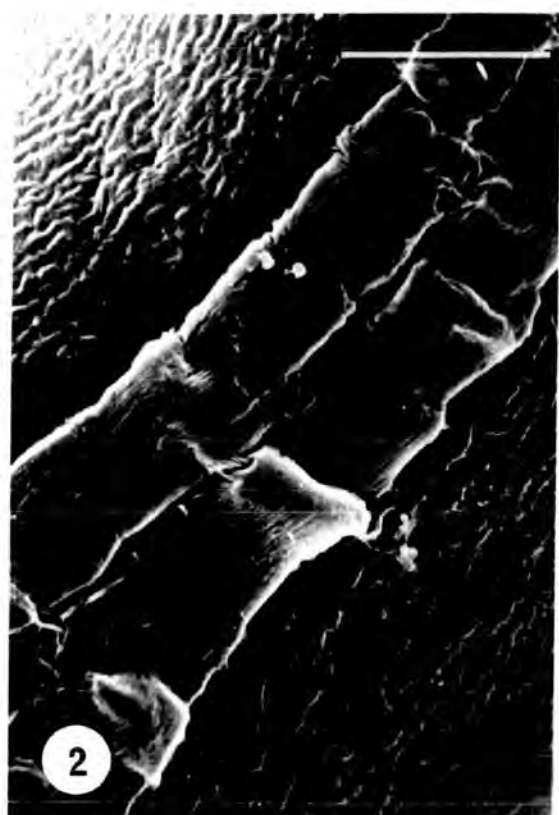

mitochondria can be seen in the muscle tissue, and there is a well developed T. system and much sarcoplasmic reticulum (Plates 3 and 4). Although the ratio of the actin filaments to the myosin filaments is about 7:1, many of the actin filaments are shared by several myosin filaments. The resulting arrangement is that each myosin filament is surrounded by about 12 actin filaments (Plate 5). This is the typical arrangement observed in insect visceral muscle (USHERWOOD, 1975) and was also seen in the muscle of Malpighian tubules of the cockroach Periplaneta americana (CROWDER and SHANKLAND, 1972).

The Malpighian tubules are richly supplied with trachea. Large trachea 200 μ m in diameter are found entwined in the tubule mass (Plate 6), these give off numerous branches which wind helically around individual tubules (Plate 8) often in close association with the muscle. Each tracheal branch gives off numerous tracheoles which run all over the surface of the tubule penetrating the tissue (Plates 7,9). The tracheoles are enveloped between layers of the basement membrane to ensure intimate contact with the cellular interior of the tubule is maintained (Plate 14).

The basement membrane is a complex layered structure 0.3 μ m thick which ensheaths the outer surface of the tubule (Plates 10,13). The inner layer consists of a feltwork of fine fibres in a sponge like arrangement. The middle layer is composed entirely of fibres running in a circular direction.

PLATE 6

Scanning electron micrograph showing a large trachea (T) entwined in the Malpighian tubules. The taenidia lining the trachea are clearly visible.

Scale = 75 μ m

PLATE 7

Scanning electron micrograph showing a tracheal branch giving rise to numerous tracheoles (t) which ramify over the surface of the tubule.

Scale = 7.5 μ m

PLATE 8

Scanning electron micrograph of a Malpighian tubule. Note the "paired" arrangement of the trachea (T) and muscle (M) as they spiral around the tubule. Numerous tracheolar branches can be seen running over the surface of the tubule.

Scale = 30 μ m

PLATE 9

High power micrograph of a portion of the tubule surface showing the tracheoles (t) referred to in the description of Plate 8 above.

Scale = 7.5 μ m

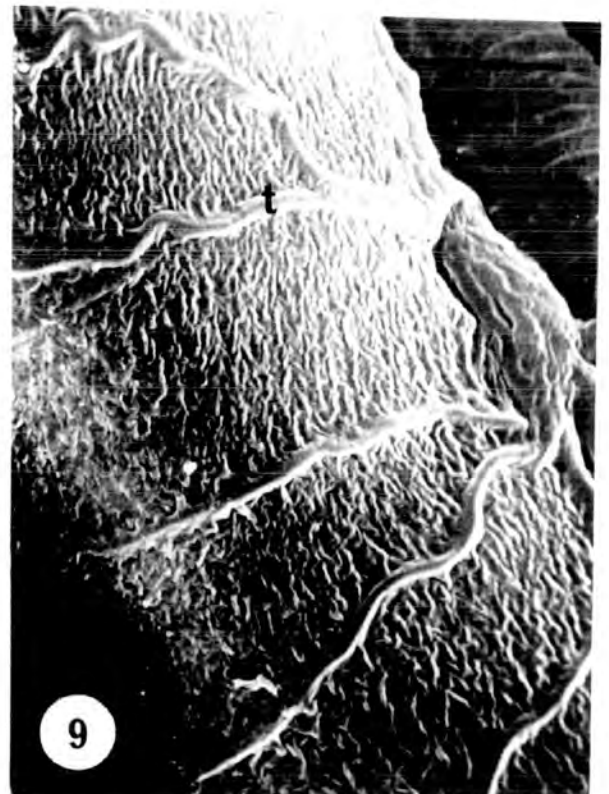
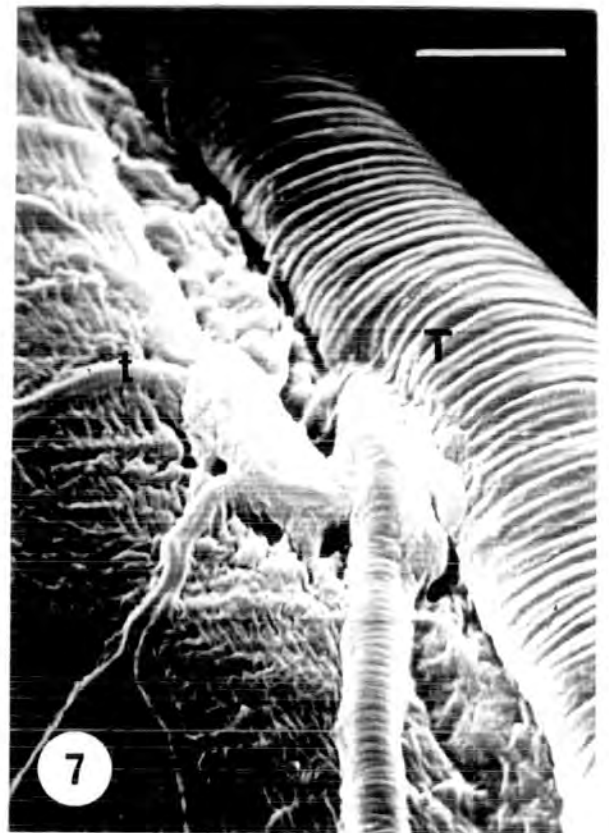

PLATE 10

Low power transmission electron micrograph showing a T.S. of a Malpighian tubule. Three main regions can be distinguished; Basal(B) characterised by invaginations of the basal cell membrane; intermediate(I) which contains the nucleus (N) and numerous inclusions; Apical(A) which possesses numerous microvilli (MV) which project into the lumen (L). The tubule is surrounded by a basement membrane (BM), in which a tracheole (t) is embedded.

Scale= 5 μ m

PLATE 11

Scanning electron micrograph showing the broken end of a Malpighian tubule. Basal (B), intermediate (I) and microvilli apical regions (MV) can be distinguished.

Scale=10 μ m

PLATE 12

Scanning electron micrograph showing a tubule which has been fractured obliquely. The microvilli lining the lumen present varying profiles.

Scale=20 μ m

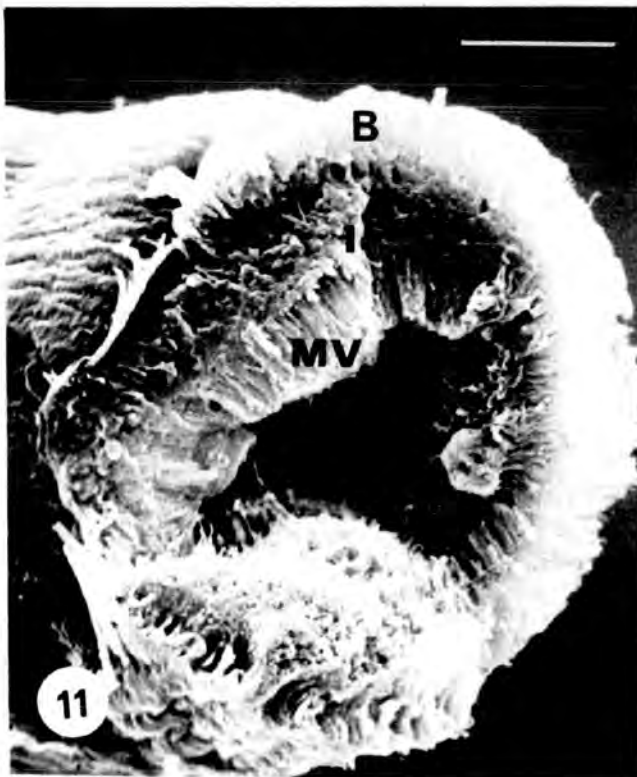
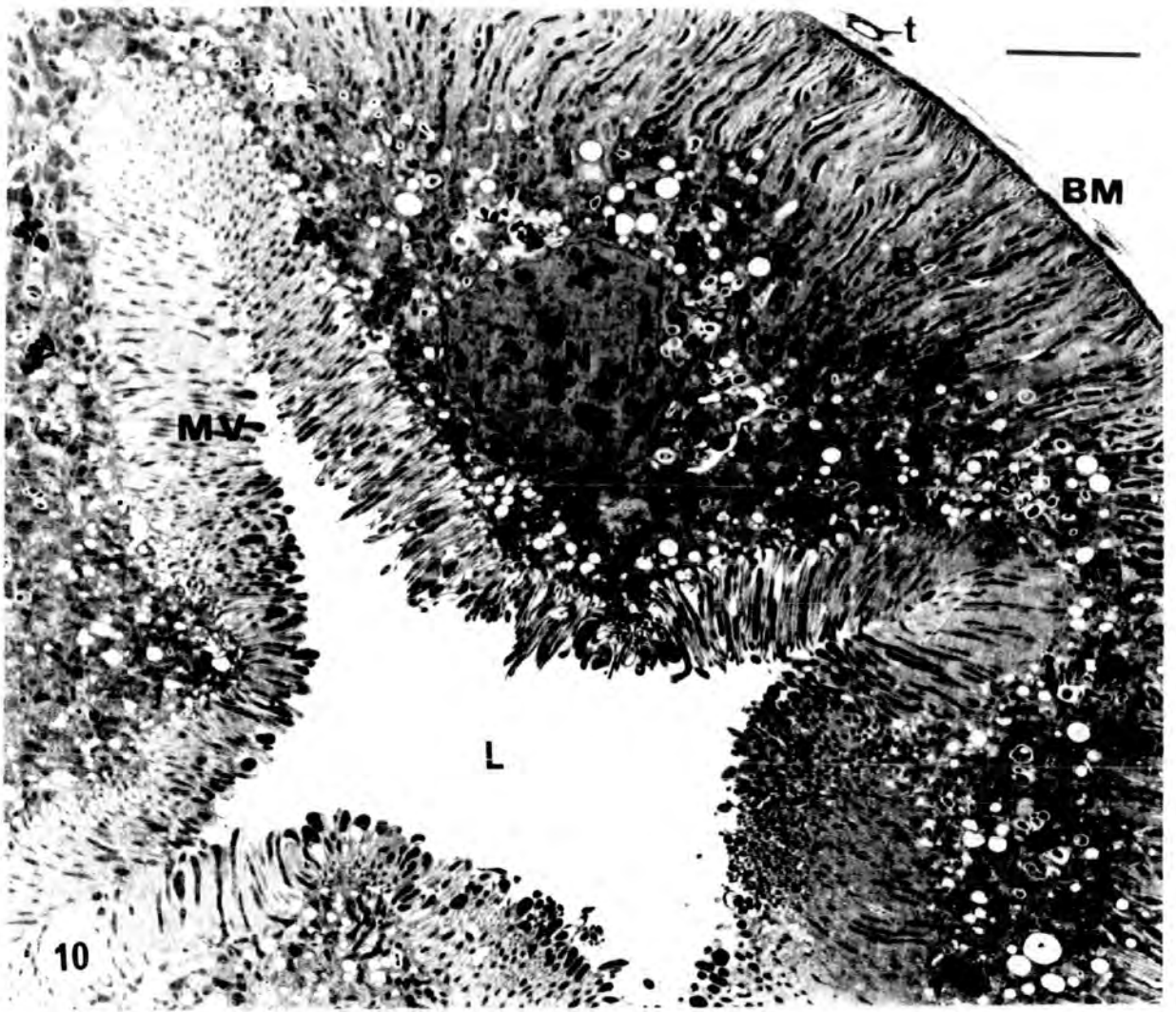

The outer layer resembles the inner one consisting of layers of fine material. It is part of this outer layer which envelopes the tracheoles and muscles (Plates 3, 10, 14). It has been suggested elsewhere that collagen fibres associated with the outer layer provide the elasticity to accommodate tubule motion (ASHURST, 1968; TAYLOR, 1971a; WALL et al., 1975).

The structure of the primary cells as seen with T.E.M. is similar to that described for other insects. The cytoplasm can be divided into 3 distinct regions; basal, intermediate and apical (Plates 10, 11, 12).

1. Basal region

The basal cell membrane is extensively folded forming a complex system of long, narrow extracellular channels running perpendicular to the basement membrane (Plates 13, 14). The channels extend a third to a quarter of the distance from the basement membrane to the base of the microvilli. The cytoplasmic plates between these extracellular channels are 0.03-0.1 μ m wide and about 6 μ m long. Where the basal cell membrane meets the basement membrane, there is an increase in electron density on the cytoplasmic side forming a hemidesmosome junction similar to that described by TAYLOR, (1971a) in the Malpighian tubules of Carausius morosus, and by BERRIDGE and OSCHMAN (1969) in Calliphora. Numerous rod shaped and oval mitochondria are present, the majority with their long axes parallel to the infoldings. Numerous "coated depressions" and vesicles similar to those observed

PLATE 13

Transmission electron micrograph showing a T.S. through the basal region of a Malpighian tubule. The numerous infoldings of the basal cytoplasm give rise to many extracellular spaces (ES). Where the basal cell membrane meets the basement membrane, there is an increase in electron density on the cytoplasmic side forming hemidesmosome junctions (two of which are indicated by the white arrows). Note also the presence of several vesicles (V), a concretion (C), numerous mitochondria (M), and the basement membrane (BM).

Scale = 1.0 μ m

PLATE 14

Transmission electron micrograph of a T.S. through the basal region of a Malpighian tubule cell showing the tracheoles embedded in the basement membrane. Taenidia-like spiral thickenings are visible in the luminal wall of the trachea.

Scale = 1.0 μ m

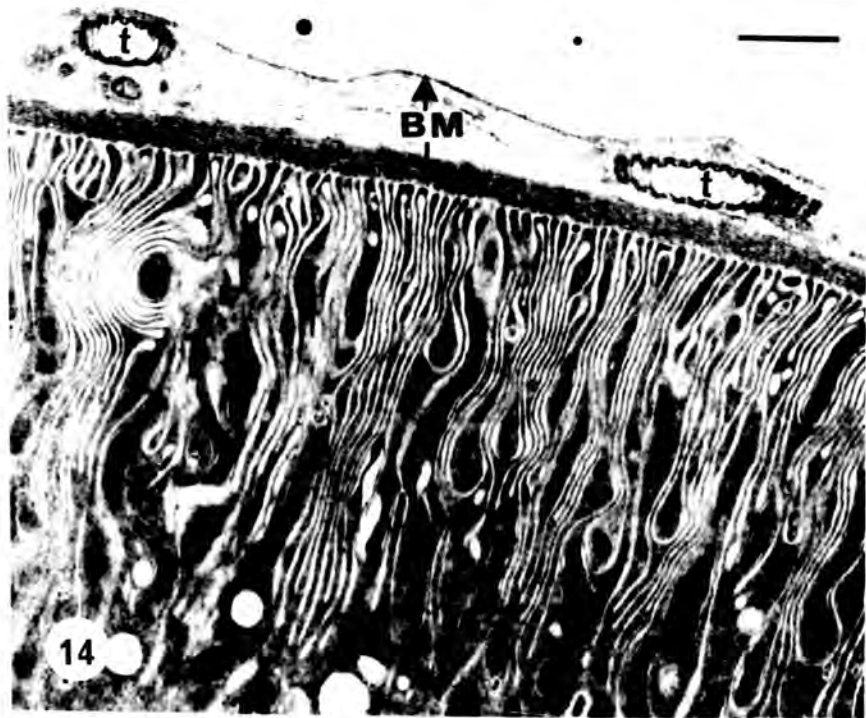
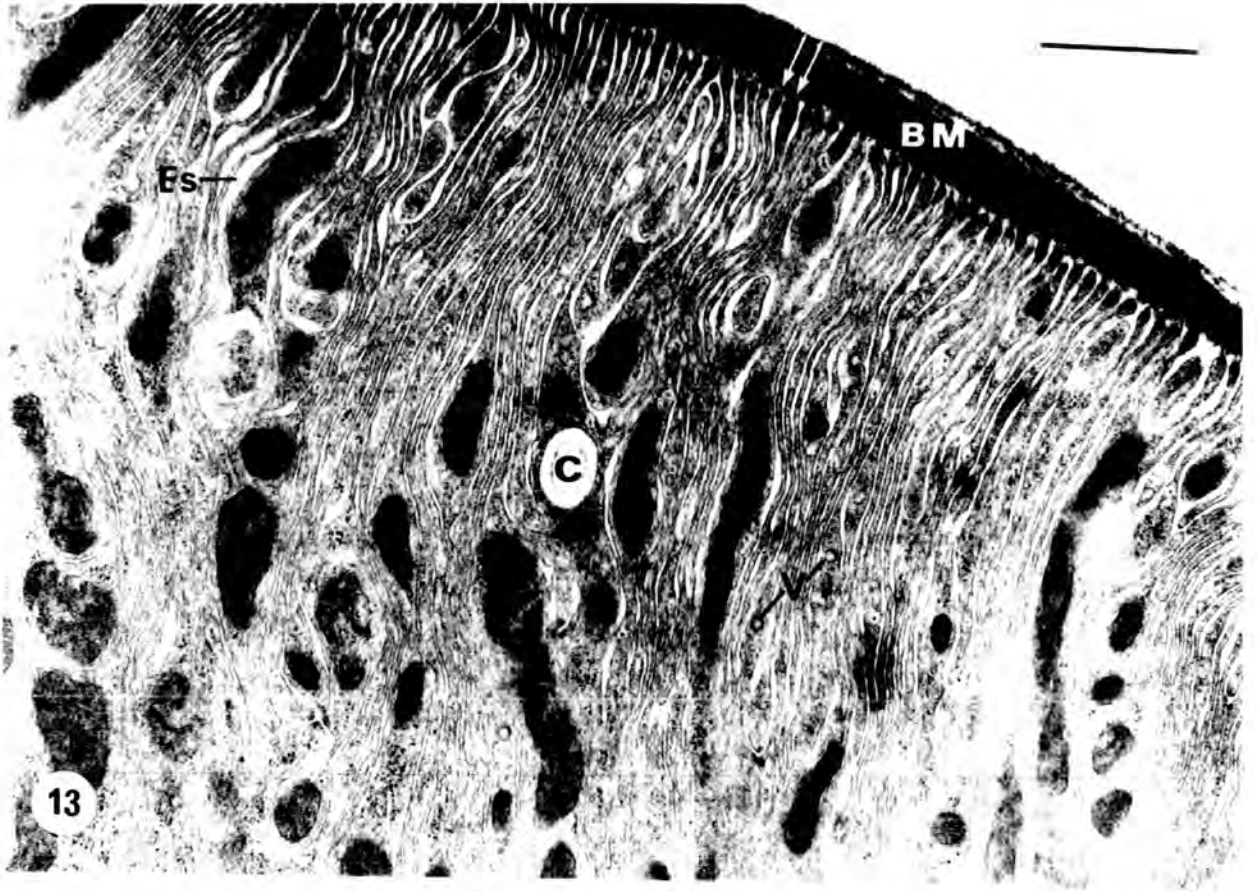

by TAYLOR (1971a) and PEACOCK (1975) are also present (Plate 13).

2. Intermediate region

This zone contains the nucleus and most of the cellular inclusions. The nucleus is a large, roughly spherical body surrounded by a well defined nuclear membrane (Plate 10). The cytoplasm contains numerous vacuoles of various sizes. Some of these appear empty but others contain a variety of filaments, granules or concentric concretions (Plate 15). These closely resemble those observed by other workers (eg. BERKALOFF, 1958, 1959; WIGGLESWORTH and SALPETER, 1962; GOURANTON, 1968; WALL et al 1975; WESSING and EICHELBERG, 1975). Multivesicular bodies (TAYLOR, 1970) are also observed (Plate 17). The cytoplasm also contains many mitochondria, together with Golgi bodies, lysosomes, rough and smooth endoplasmic reticulum and free ribosomes (Plate 15). The many small, round areas of electron dense material observed may be stages in the degeneration of mitochondria (WIGGLESWORTH and SALPETER, 1968) or "formed bodies" (RIEGEL, 1966) (Plate 17).

3. Apical region

The apical surface is composed of tightly packed microvilli which project into the lumen (Plates 19, 20).

PLATE 15-18

Transmission electron micrographs of a T.S. through the intermediate region showing the various structures observed.

PLATE 15

Note the presence of numerous concretions (C) of various electron density and the presence of numerous mitochondria and free ribosomes. (R)

Scale = 1.0 μ m

PLATE 16

Electron micrograph showing the junction between two adjacent cells in the apical region. The cell membranes are joined laterally by a septate desmosome junction (S.D.). In the apical region the desmosome widens out to form a zonula adhaerens junction (Z.A.) in which a layer of electron dense material is attached to the cytoplasmic side of the membrane. There is a short distance between the zonula adhaerens and the septate desmosome where the membrane has no junctional structure.

Scale = 0.75 μ m

PLATE 17

Electron micrograph showing the detailed structure of the multivesicular bodies (MB). Note also the presence of smooth endoplasmic reticulum (SER) and rough endoplasmic reticulum (RER).

Scale = 1.0 μ m

PLATE 18

High power micrograph of a septate desmosome in the apical region. Note the convoluted nature of the desmosome.

Scale = 0.5 μ m

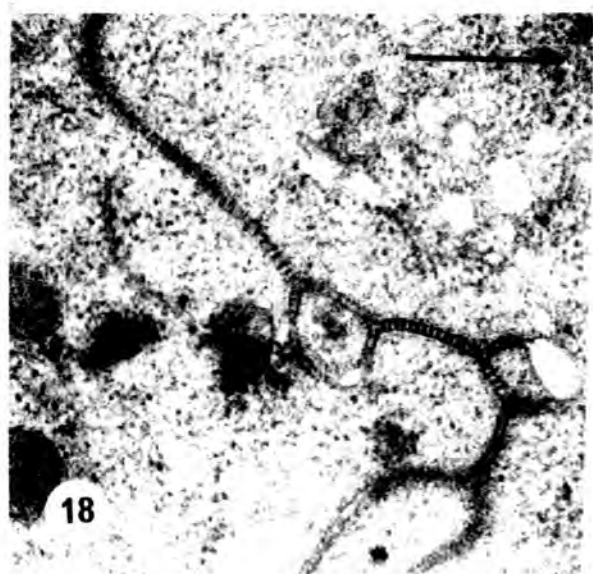
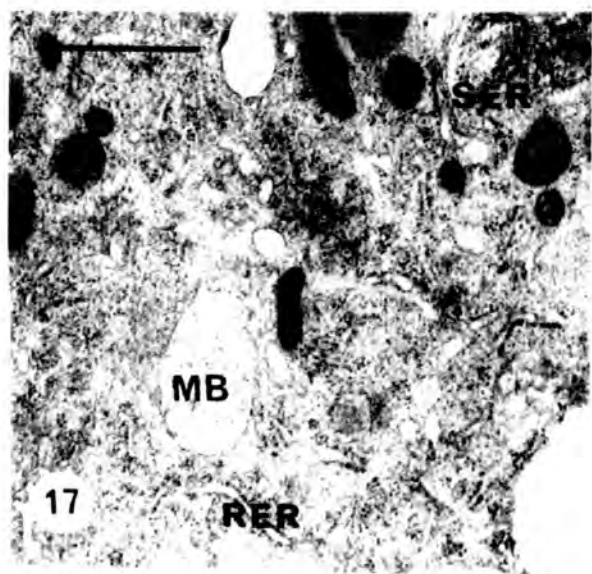
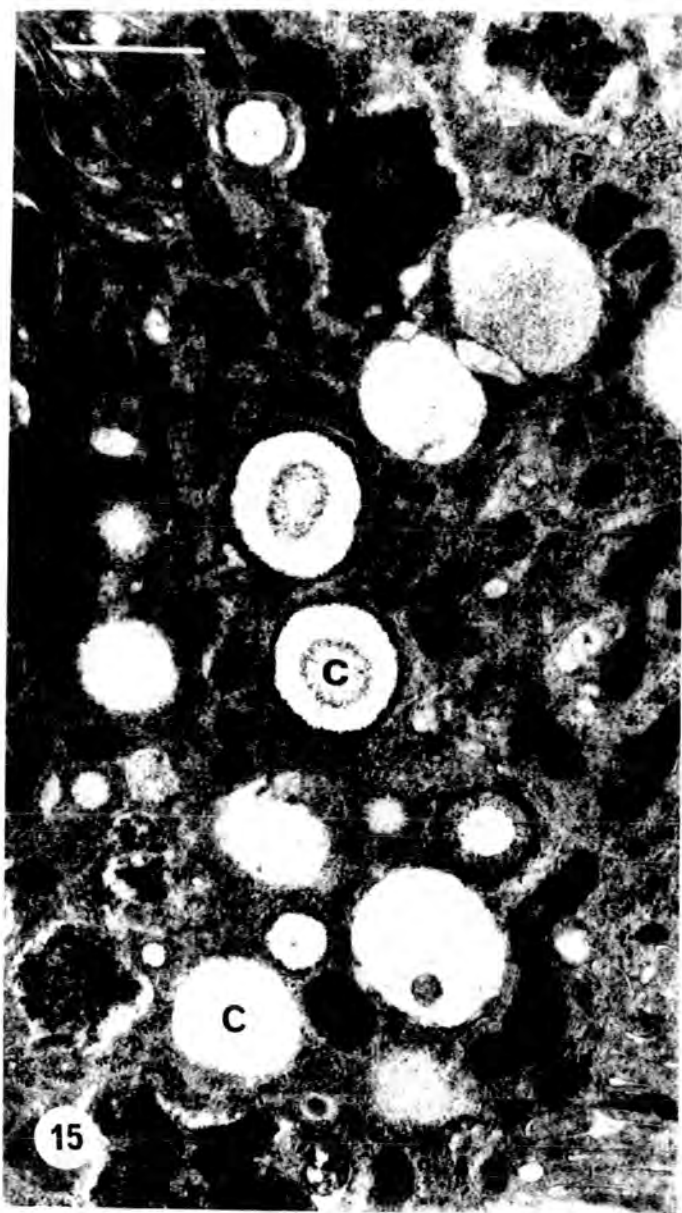

They are 3.5-5 μ m in length and 0.1-0.2 μ m in diameter. Many have swollen tips which often contain mitochondria, and elongated mitochondria are also found in the cylindrical portion of the microvilli. Most microvilli arise from the apical surface singularly although several microvilli may share a common stem. Occasionally branching of the microvilli is observed (Plates 19, 20). Small vesicles similar to those described by TAYLOR (1971a) can be seen at the base of the microvilli and also in some cases at the swollen tips. Most of the microvilli also contain endoplasmic reticulum which extends some way up, but not as far as the tip. (Plate 19). This was also observed in Jamaicana (PEACOCK, 1975), Carausius (TAYLOR, 1971a), Periplaneta (WALL et al, 1975) and Drosophila (EICHEBERG and WESSING, 1975).

The cell membranes of adjacent primary cells are joined to one another laterally by septate desmosome junctions (DANILOVA et al, 1969) (Plate 18). In the apical region the desmosomes normally widen out to form zonula adhaerens junctions in which a layer of electron dense material is attached to the cytoplasm side of the membrane (Plate 16). There is a short zone between the zonula adhaerens and the septate desmosome where the membrane has no junctional structure (SMITH, 1968). Junctions of the macula occludens type can be seen in the basal region joining two sides of the membrane across the extracellular space.

PLATE 19

Transmission electron micrograph of the apical region showing numerous club-shaped microvilli. Numerous mitochondria (M) are present in the apical cytoplasm. Branching of the microvilli can be observed (indicated by an arrow ↑) and some microvilli share a common stem (indicated by *). Note also coated vesicles (v) in the microvilli and the presence of rough endoplasmic reticulum (RER).

Scale = 1.5 μ m

PLATE 20

High power scanning electron micrograph of the broken end of a Malpighian tubule showing detail of the microvilli.

Scale = 4 μ m

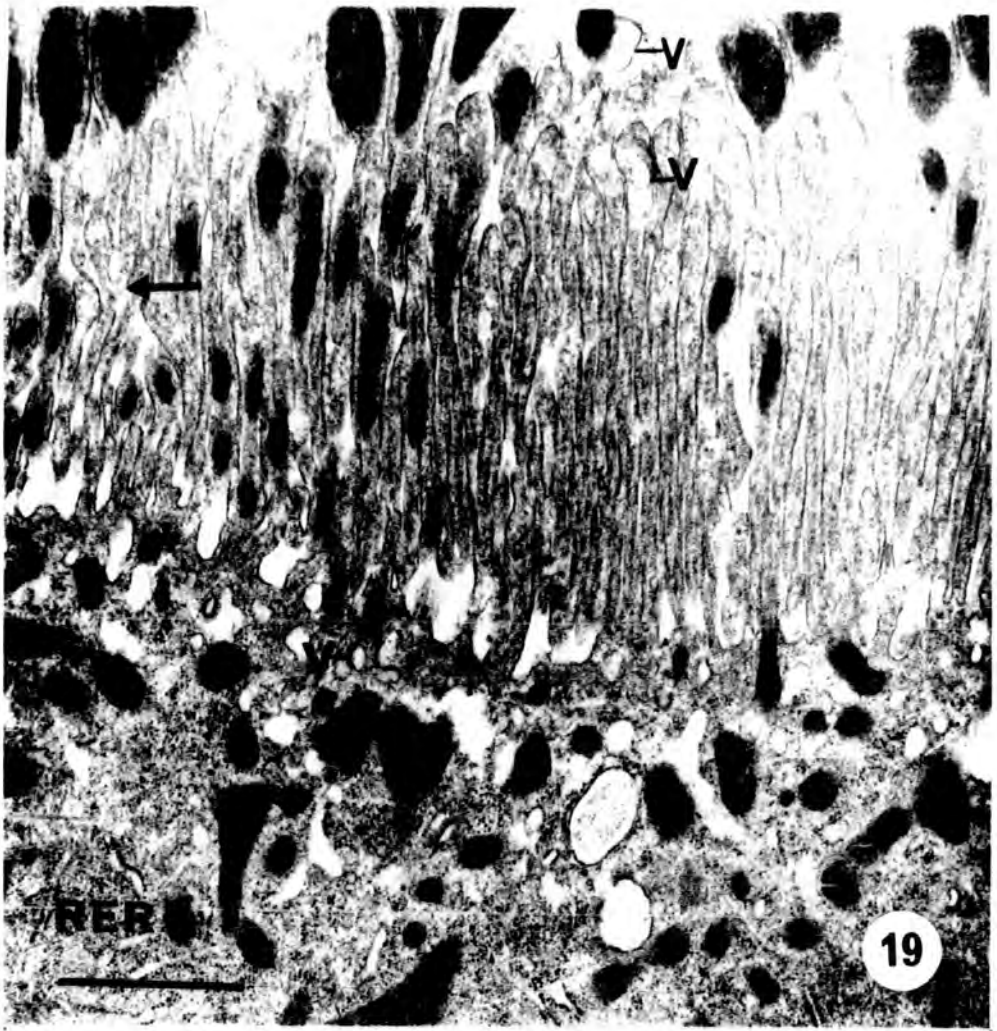

PLATE 21

Scanning electron micrograph of the luminal surface of the alimentary canal at the junction between the midgut (MG) and hindgut(HG). The opening of the ampullae (A) of the Malpighian tubules can be observed. Note also the 3 prominent cuticular pads in the hindgut region.

Scale=200 μ m

PLATE 22

Scanning electron micrograph showing the detail of a single ampullar opening.

Scale=40 μ m

PLATE 23

Scanning electron micrograph of the luminal surface of midgut showing numerous long microvilli.

Scale=10 μ m

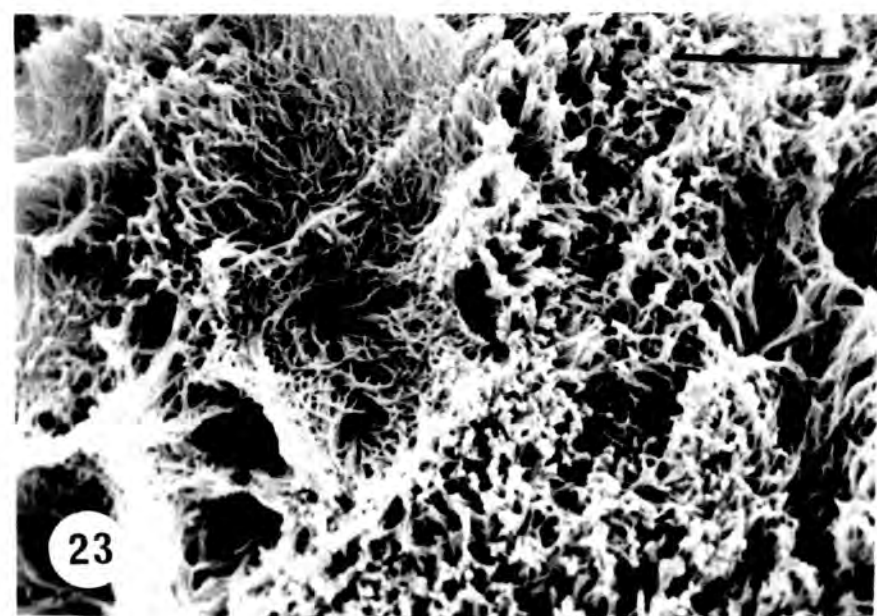
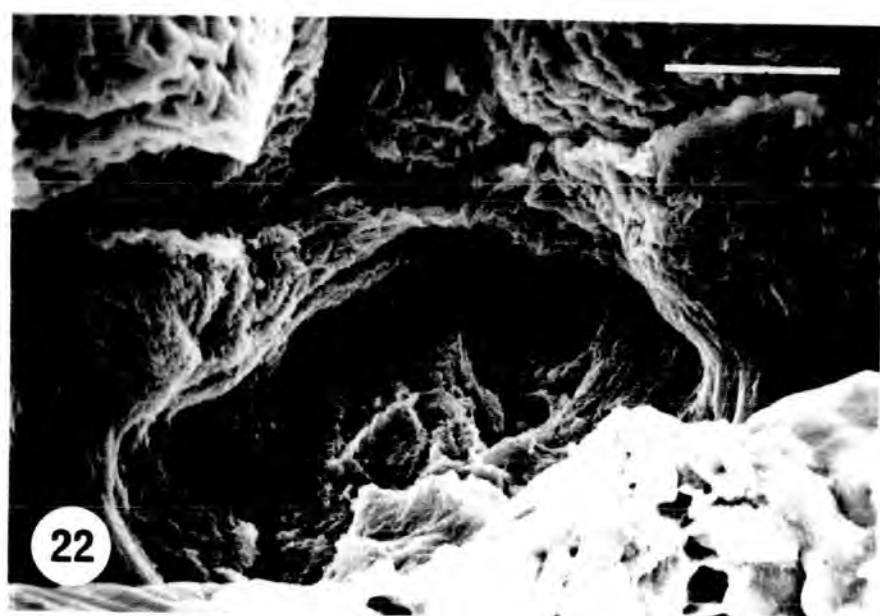
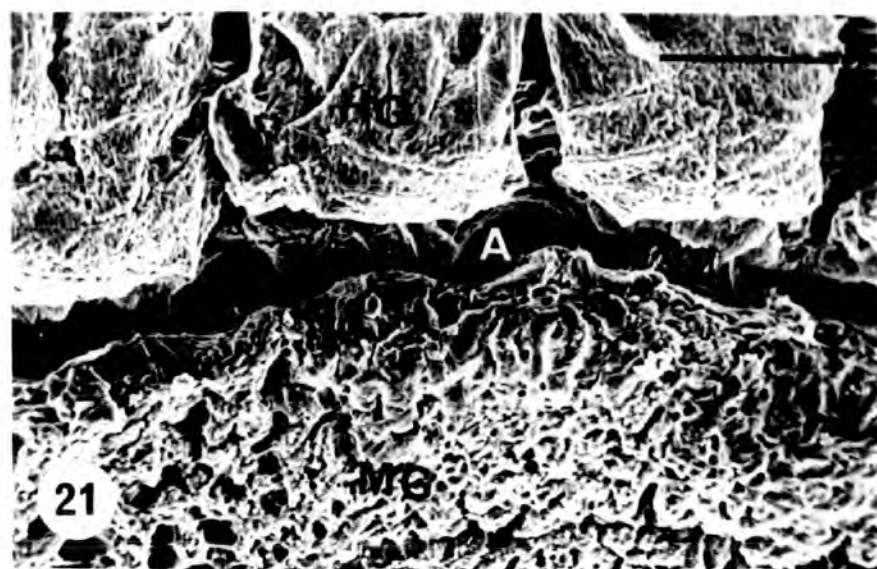

As was mentioned earlier the tubules enter the gut via a series of ampullae 95-100 μ m in diameter which lie in a ring around the midgut/hindgut junction (Plate 21,22). It is not possible to detect muscle sphincters at the opening of the ampullae into the gut as suggested by PALM (1946). The internal structure of the canals resembles that of the tubules, but the microvilli appear to be slightly shorter.

There is a sharp contrast between the tissue of the midgut and that of the hindgut, and this is well illustrated in Plates 21,22,23,24 , the midgut being lined by microvilli whereas hindgut lining consists of a series of cuticular folds approximately 3 μ m wide (Plates 25,26). On the surface of the cuticle there are numerous spines which are directed towards the hindgut, these were also observed by KLEIN and APPLEBAUM (1975) in Locusta.

Discussion

It would seem from the ultrastructural studies that the structure of the primary cells of the Malpighian tubules of Locusta migratoria very closely resembles that observed for other species (BEAMS et al, 1955; TSUBO and BRANDT, 1962; BERKALOFF, 1960; WIGGLESWORTH and SALPETER, 1962; BERRIDGE and OSCHMAN, 1969; TAYLOR, 1971a; WALL et al, 1975) being characterised by the presence of highly folded apical and basal surfaces. As was mentioned earlier the numerous

PLATE 24

Scanning electron micrograph of the cuticular lining of the hindgut lumen. Note the numerous cuticular spines projecting from its surface. These are directed towards the rectum.

Scale = 20 μ m

PLATE 25

Scanning electron micrograph showing detail of the surface structure of a cuticular pad in the hindgut. Note the extensive folding and the presence of spines directed towards the rectum.

Scale = 10 μ m

PLATE 26

Scanning electron micrograph of the region between two adjacent cuticular pads. The top of the micrograph is nearest the rectum.

Scale = 40 μ m

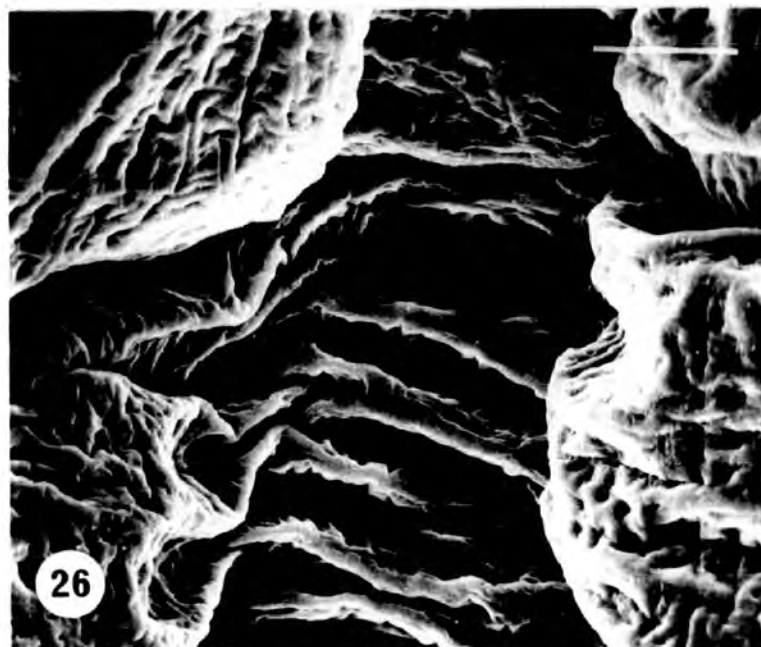
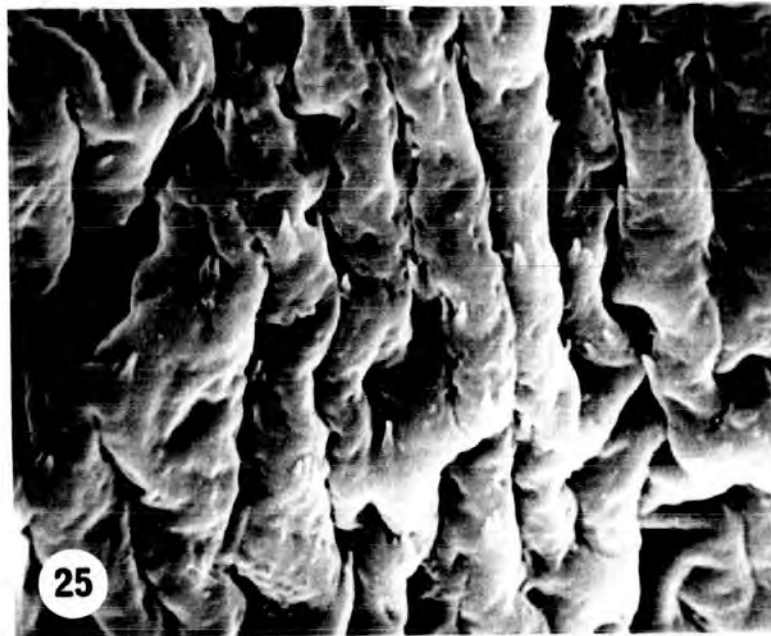
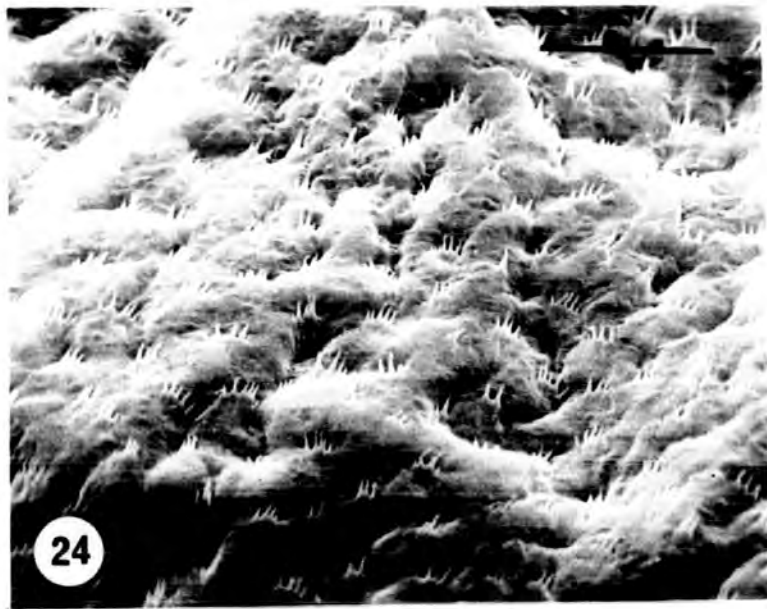

invaginations of the apical and basal cell membranes provide a large surface area for ion and water transport, but it is thought that the "architecture" of such invaginations has a direct bearing on ion and water movement across the epithelia. DIAMOND and BOSSERT (1967) proposed a model to demonstrate the interrelationship of structure and function in fluid transport across rabbit gall bladder. This was later applied to insects by BERRIDGE and OSCHMAN (1969) to explain the transport across the Malpighian tubules of Calliphora. The basis of the model ("standing gradient hypothesis") is that localised osmotic gradients are developed within the extracellular spaces formed by the basal and apical membrane invaginations. Fig.3:1 shows the DIAMOND and BOSSERT (1968) model for fluid flow in and out of "forward facing" and "backward facing" channels. "Forward facing" channels face in the direction of fluid flow and are, therefore, found between the microvilli. "Backward facing" channels face in the opposite direction to fluid flow, and are represented by the basal infoldings. Active solute uptake from the basal channels into the cytoplasm makes the channel fluid hypotonic with respect to the cytoplasm. Water, therefore, follows passively as a result of the osmotic gradient. The solute in the channel will gradually be replaced by diffusion of solute from the haemolymph. In the steady state, therefore, a "standing osmotic gradient" is maintained in the channel by active solute transport with osmolarity decreasing progressively

FIG . 3:1

Application of the standing gradient hypothesis of solute-linked water transport to provide a model for urine formation by the Malpighian tubules. (redrawn from BERRIDGE and OSCHMAN, 1969)

Basal Surface : Active solute uptake (\rightarrow) from the basal infolds (A-B) into the cytoplasm (C-D) makes the channel fluid hypotonic with respect to the cytoplasm. Water follows passively as a result of the osmotic gradient (\leftarrow). A standing gradient exists in the basal infold (A-B) with the osmolarity decreasing from the open end to the closed end similarly a gradient occurs in the cytoplasm projection (C-D). (Gradients are indicated by the density of dots). Gradients cause solute to move down towards the less concentrated region.

Apical Surface : Active solute uptake from the microvilli (E-F) leads to increased osmolarity of the fluid in the channels between the microvilli (G-H). Water follows passively. A standing gradient exists in the channel G-H with osmolarity decreasing from the closed end to the open end, and similarly a gradient occurs down the microvilli.

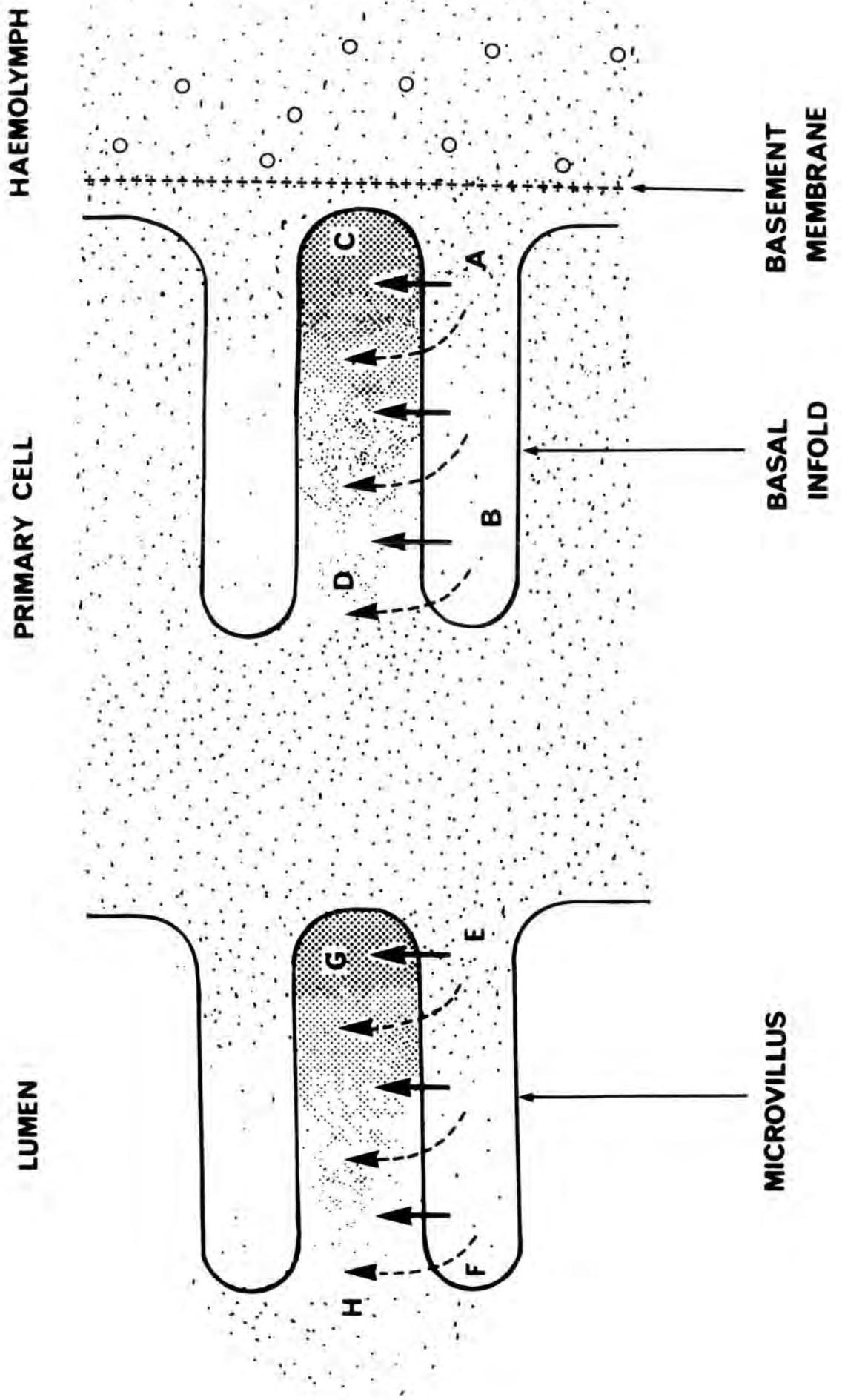

from the open end to the closed end. A fluid of fixed osmolarity (isotonic or hypertonic depending on such parameters as radius, length, and water permeability) constantly enters the channel at the mouth and is secreted across its walls. The reverse situation occurs in the microvilli. Solute is actively transported into the channel across the walls of the microvilli making the channel fluid hypertonic with respect to the cytoplasm. Water follows passively, therefore, as a result of osmosis. The excess solute in the channel gradually diffuses down its concentration gradient towards the open mouth. In the steady state, therefore, a "standing gradient" is maintained with osmolarity decreasing progressively from the open end to the closed end. A fluid of fixed osmolarity (isotonic or hypertonic depending on the parameters of the system) will constantly emerge from the mouth. The dimensions and structure of the tubule cells in Locusta certainly suggest that standing gradients could be formed and may be important in fluid transport. The presence of numerous mitochondria associated with the membrane invaginations together with the extensive tracheal supply suggest high metabolic demands by the tissue in this area. This would be expected if localised active transport was taking place.

A certain amount of cytoplasmic activity has been shown in some insects such as Gryllus domesticus (BERKALOFF, 1960) Drosophila (WESSING, 1965;

EICHELBERG and WESSING, 1975) and Carausius (TAYLOR, 1971a) In these species numerous small, coated vesicles were observed throughout the cytoplasm. Experiments using tracers such as 3-hydroxykynurenin were able to demonstrate in Drosophila that the vesicles arise from the basal cellular membrane infoldings and pass through the cell cytoplasm to the lumen where they empty their contents. While the vesicles pass through the cytoplasm they are often connected to the channels in the endoplasmic reticulum (EICHELBERG and WESSING, 1975). The presence of similar vesicles in the basal, intermediate and apical regions of Locusta Malpighian tubules suggest that some substances may be transported across the tubule in this manner. TAYLOR(1971a) points out, however, that although substances are clearly transported from the haemolymph to the lumen in vesicles it is unlikely that this process contributes in any way to normal urine production. He bases his rejection of this mechanism on the fact that vesicle formation and movement would have to be impossibly rapid to produce sufficient volumes of urine.

RIEGEL (1966) observed membrane bound "formed bodies" in the urine of the stick insect Carausius morosus and in fluid secreted from frog nephron, and crayfish antennal gland. These are lysosome like spherical vesicles approximately 20 μ m in diameter which contain protein and proteases. These are thought to be formed in the cytoplasm, and secreted into the lumen of the Malpighian tubules.

RIEGEL'S theory (1970) is that, once in the lumen the proteases become activated resulting in the hydrolysis of the proteins. This increases the osmotic pressure within the "formed bodies"; water enters by osmosis and the "formed bodies" swell. Solutes within the lumen that are unable to penetrate the "formed bodies" become concentrated as water is drawn into the "formed bodies". The increased osmotic pressure of the luminal fluid then draws water across the epithelial cell layer by osmosis. TAYLOR (1971a) also working with Carausius was, however, unable to detect any evidence for "formed bodies". He also suggests that the membrane bound vesicles observed in the lumen of Rhodnius Malpighian tubules by WIGGLESWORTH and SALPETER (1962) which were suggested by RIEGEL (1966) to be formed bodies were, in fact, merely fixation artefacts. In Locusta the cytoplasm contains numerous inclusions some of which superficially resemble "formed bodies". However, in the present study there was a complete absence of such bodies in the lumen.

There are a variety of cytoplasmic inclusions in Locusta (Plates 16, 17) ranging from vacuoles and multivesicular bodies to various stages in the formation of the laminated inclusions which have been observed in many insects. There has been much controversy in the past as to the nature of the laminated inclusions. BERKALOFF (1958, 1959) and SRIVASTAVA (1962) working on

Gryllus domesticus and the Lepidopteran Corcyra cephalonica respectively suggest that they are urate spheres. WIGGLESWORTH and SALPETER (1962) using Rhodnius, and GOURANTON (1968) using Homopterans were, however, unable to show the presence of urate, but identified substances such as Ca^{2+} , Mg^{2+} , Fe^{3+} carbonates and phosphates together with acid mucopolysaccharide. It is, therefore, most likely that these structures in the locust are sites of calcium phosphate storage. However further studies will be necessary to confirm or refute this fact.

The embryological origin of the Malpighian tubules has been another very controversial topic. Opinion has differed on whether the tubules are derived from midgut or hindgut tissue (review SRIVASTAVA and KHARE, 1966). SAVAGE (1956, 1962) has shown histological similarities between the Malpighian tubules and the midgut in Schistocerca and Carausius respectively suggesting the tubules, like the midgut, have an endodermal origin. SRIVASTAVA and KHARE (1962) disagree with this view as the Malpighian tubules of the Lepidopteran Philosamia bud off from the blind end of the proctodeal invagination before the mesenteron has formed. These authors also point out that histological similarity does not prove common embryological origin. WALL et al (1975) have examined the ultrastructure of the Malpighian tubules, ampullae and midgut of Periplaneta americana using transmission electron microscopy. They find very striking similarities

at the ultrastructural level showing that the tubules have similar microvilli and basal infoldings and are anatomically continuous with the ampullae and midgut. They suggest that the origin of the Malpighian tubules was endodermal. The present studies using scanning electron microscopy are in agreement with the observations of WALL et al (1975) the midgut, ampullae, and Malpighian tubules all possessing microvilli whereas the hindgut is lined with cuticle. The great similarity between the midgut, ampullae and tubules suggest that they have a common origin in Locusta migratoria.

The use of scanning electron microscopy in addition to transmission electron microscopy has greatly aided the study of the Malpighian tubules of the locust and has helped to produce a clearer picture of their structure. As WESSING and EICHELBERG (1975) have stated " In the Malpighian tubule the function and architecture doubtless correspond". The subsequent chapters will attempt to demonstrate the relationship between the two.

CHAPTER 4

Biochemical studies on the Mg^{2+} dependent $Na^+ K^+$ Stimulated ATPase from the Malpighian tubules and hindgut of *Locusta migratoria*

Introduction

The enzyme responsible for the movement of monovalent cations and fluid in most secretory and absorptive epithelia is a magnesium dependent, sodium and potassium stimulated adenosinetriphosphate ($Na^+ K^+$ ATPase) (E.C.3.6.1.3. SKOU, 1965). It is likely that insects are no exception and BERRIDGE (1967, 1968a) has strongly implicated $Na^+ K^+$ ATPase involvement in the function of the Malpighian tubules and rectal sac of *Calliphora*. He was not, however, able to demonstrate this experimentally.

The $Na^+ K^+$ ATPase enzyme was first recognised by SKOU in 1957 using crab nerve. Subsequently it has been demonstrated in numerous other tissues from a range of animal species (extensive reviews : WHITTAM and WHEELER, 1970; BAKER, 1972; SCHWARTZ *et al.*, 1972; DAHL and HOKIN, 1974). A $Na^+ K^+$ ATPase enzyme from any source has the following basic characteristics (SKOU, 1965).

- 1) Located on cell membranes.
- 2) Capable of hydrolysing ATP and thus converting the energy from ATP into the cation movement.
- 3) Requires Mg^{2+}

- 4) Stimulated by the simultaneous presence of Na^+ and K^+ (i.e. synergistic stimulation).
- 5) Inhibited by the cardiac glycoside, ouabain.
- 6) The rate of ATP hydrolysis is dependent on the concentration of the Na^+ inside the cell and the K^+ outside the cell as there is a sodium site on the internal face, and a potassium site on the outer face. The cations are translocated across the membrane by the enzyme. In red blood cells 3Na^+ ions are moved in one direction and 2K^+ in the other for each ATP bond split (POST and SEN, 1967).
- 7) Characteristically a second ATPase enzyme exists in association with the Na^+-K^+ ATPase. It is a Mg^{2+} ATPase which is not inhibited by ouabain. The function of the Mg^{2+} ATPase is still not clearly understood. It is not directly involved in monovalent cation transport and is thought to be a separate enzyme (NAKAO et al., 1963). It has been suggested that it may be important in controlling passive permeability (BOWLER and DUNCAN, 1967) or in calcium transport (WINS and SCHOFFENIELS, 1966, and SCHATZMAN and VINCENZI, 1969) but no definite conclusions have been reached.

Numerous models have been proposed to explain how the Na^+K^+ ATPase enzyme works (recent reviews WHITTAM and CHIPPERFIELD, 1975, and SKOU, 1975).

Most agree that transport occurs in a series of steps

involving conformational changes of the enzyme related to cyclic phosphorylation and dephosphorylation. In the dephosphorylated form the Na^+ site faces inwards. Once Na^+ is bound phosphorylation occurs enabling a conformational change to take place. This transfers Na^+ to the outside of the membrane where it is deposited and exposes the K^+ site on that surface. Once K^+ is attached dephosphorylation occurs converting the enzyme back to its original form, and depositing K^+ on the internal surface of the membrane. A generally accepted model proposed by WHITTAM and CHIPPERFIELD (1975) is shown below :-

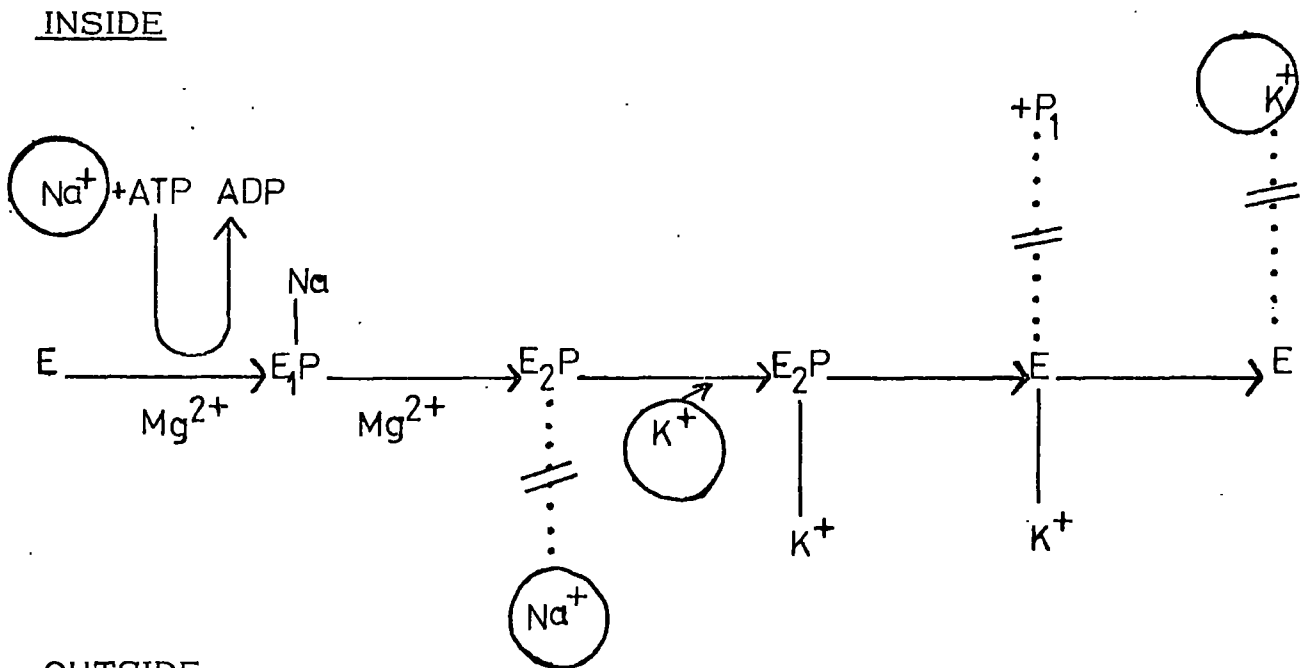

In this model E represents the Na^+-K^+ ATPase enzyme and E_1P and E_2P are phosphorylated intermediates formed during the translocation of Na^+ from the inside to the outside of the membrane. Once K^+ becomes attached on the

outer side the enzyme becomes dephosphorylated (represented by $E \cdots \text{Pi}$) and the resulting conformational change deposits K^+ on the inside.

Ouabain acts as a competitive inhibitor at the K^+ site. Once it is attached it remains in position thus preventing further K^+ attachment, dephosphorylation, or translocation. (CHARNOCK and POST, 1963a).

The phosphorylated intermediates proposed by the models have now been isolated and identified as acyl phosphates (NAGANO et al., 1965; HOKIN et al., 1965; BADER et al., 1966). There is still, however, some confusion as to the precise nature of the acyl phosphate, with KAHLENBERG et al., (1968) proposing an L-glutamyl phosphate, whilst DEGANI and BOYER (1973) and POST and KLUME (1973) suggest it is a β -aspartyl phosphate. These differences may, perhaps, be best resolved along the lines suggested earlier by POST et al., (1965) and FAHN et al. (1966) that more than one phosphorylated intermediate may be involved.

There have been many problems in obtaining pure samples of $Na^+ - K^+$ ATPase to establish its structure due to its firm association with plasma membranes.

Recently the enzyme has been isolated in nearly pure form by several workers using a variety of separation techniques. (UESEGI et al., 1971; KYTE, 1971; HOKIN et al., 1973; HOKIN, 1974; JØRGENSEN, 1974a and b). From such studies it is suggested that the ATPase consists almost entirely of two protein chains, a large polypeptide of MW

85,000-95,000 and a sialoglycoprotein of M.W. 5000-6000. Experiments have shown that it is the large protein chain which possesses the binding sites for Na^+ , K^+ , ATP and ouabain (HART and TITUS, 1973) and which becomes phosphorylated when ATP is split (UESUGI et al., 1971; KYTE, 1971b). The precise function of the glycoprotein is uncertain but it is likely that it is necessary for ATPase function as it has been shown to be extremely closely associated to the large unit both by cross linkage studies (KYTE, 1972) and treatment with antibodies (JEAN et al., 1975; RHEE and HOKIN, 1975). The latter work suggests that the functional ATPase unit is an oligomer formed from 2 large chains and 2 small chains.

In SKOU'S early work active ATPase preparations were isolated by homogenization in a sucrose medium containing a chelating agent such as ethylenediaminetetra-acetic acid (EDTA). This was followed by differential centrifugation to yield a microsomal preparation. This technique was subsequently modified to increase the $\text{Na}^+ - \text{K}^+$ ATPase activity by chemically breaking up the membranes and vesicles which bind the enzyme. SKOU (1962) and JØRGENSEN and SKOU (1969) showed that the presence of sodium deoxycholate in the homogenization medium greatly increased the level of $\text{Na}^+ - \text{K}^+$ ATPase activity compared to the Mg^{2+} ATPase level. The

work of NAKAO et al. (1963) illustrated the effectiveness of high concentrations of sodium iodide (NaI) in producing preparations with high $\text{Na}^+ - \text{K}^+$ ATPase activity. ROBINSON (1967) has shown that a combination of the two increases the $\text{Na}^+ - \text{K}^+$ ATPase : Mg^{2+} -ATPase ratio still further. AHMED and JUDAH (1964) also showed an additional improvement by the use of Mannitol in place of sucrose in the homogenization medium.

To date very little work has been carried out using insect tissue. Early biochemical studies using sucrose extraction on cockroach leg muscle failed to show any $\text{Na}^+ - \text{K}^+$ ATPase activity (WAREHAM et al., 1968). BERRIDGE and GUPTA (1968) were also unable to demonstrate biochemically the presence of a $\text{Na}^+ - \text{K}^+$ ATPase in Calliphora rectum, despite showing the presence of a Mg^{2+} ATPase by histochemical methods. The first successes were with nervous tissue when GRASSO (1967) managed to extract and characterize a $\text{Na}^+ - \text{K}^+$ ATPase from cockroach nerve cord and CHENG and CUTKOMP (1972) identified it in bee brain. The first demonstration of an active $\text{Na}^+ - \text{K}^+$ ATPase enzyme in the hindgut and Malpighian tubules was carried out by PEACOCK et al. (1972) using two insects Schistocerca gregaria and Jamaicana flava. The extraction technique employed in this study involved the use of sodium iodide, deoxycholate and mannitol to increase the $\text{Na}^+ - \text{K}^+$ ATPase Mg^{2+} ATPase ratio. Subsequently PEACOCK (1975; 1976)

demonstrated a similar enzyme in the hindgut and Malpighian tubules of Locusta migratoria, and also in the tettigoniid Homorocoryphus nitidulus vicinus (PEACOCK et al., 1976). The rectal epithelium of Periplaneta americana has also recently been shown to possess a $\text{Na}^+ - \text{K}^+$ ATPase (TOLMAN and STEELE, 1976).

The purpose of the present work is to confirm the presence of a $\text{Na}^+ - \text{K}^+$ ATPase in the Malpighian tubules and hindgut of Locusta migratoria migratorioides R and F, and to characterise it with a view to comparing it with ATPase from other sources.

Materials and Methods

The method employed was essentially that described by PEACOCK et al. (1972).

1) Preparation of membrane microsomal fraction

Approximately equal numbers of male and female locusts were used. The number varied depending on the size of the experiment but was generally about 12. Individuals were killed by decapitation and the guts quickly dissected free and placed in homogenization medium in a glass petri-dish surrounded by ice. Homogenization medium consisted of : 250mM Mannitol , 5mM E.D.T.A. ,0.1% sodium deoxycholate, in 30mM Histidine/ HCl pH 7.2. The guts were severed anterior to the junction with the Malpighian tubules and any gut contents removed. After quickly rinsing the tissues in fresh medium they were transferred to a homogenization tube containing 10mls of homogenization

medium and stored on ice until ready to use. The medium in the petri dish was changed after every third dissection to prevent contamination by gut contents. For some experiments the Malpighian tubules alone were required and so the gut was severed on either side of the point where the tubules join the gut. This small ring of tissue plus the attached tubules was used. For other experiments only the rectal sacs were used.

Homogenization was carried out in a Potter-Elvehjem homogenizer with a Teflon pestle (clearance 0.1 to 0.15mm) with 20 passes of the plunger at 1000 rev/min. The homogenization tube was surrounded by ice throughout this procedure. The resulting homogenate was extracted using sodium iodide solution consisting of 4mM NaI, 5mM $MgCl_2 \cdot 6H_2O$, 10mM E.D.T.A. pH 7.2 after the method of NAKAO et al., (1965.) The homogenate was then transferred to a 100ml Pyrex conical flask and 10mls of NaI solution was mixed with it. The mixture was then allowed to stand for 30 minutes on ice. After this extraction time it was diluted in the ratio of 2 NaI extract : 3H₂O by the addition of 30mls of deionized water. This produced a final NaI concentration of 0.8mM.

Centrifugation was carried out at 0°C in an M.S.E. Automatic Superspeed 40, head number 2409. The dilute homogenate was transferred to thin walled polypropylene tubes and was centrifuged for 30 minutes at 50,000g (27,000 rpm). The pellet was discarded and the supernatant centrifuged at 100,000g (38,000 rpm) for 60 minutes. The supernatant was discarded and the pellet resuspended in approximately 10mls of

washing medium consisting of 5mM NaCl, 5mM EDTA pH 7.2. Resuspension was achieved by uptake and extrusion of washing medium surrounding the pellet using a Pasteur pipette. The preparation was centrifuged for 45 minutes at 100,000g, and then the complete washing procedure was repeated. The resulting microsomal pellet was resuspended in ice cold deionized water and was homogenized gently (approximately 6 passes of the plunger) to ensure an even suspension. The volume of the final suspension varied depending on the size of the experiment, but sufficient animals were used to ensure the final protein content did not fall below 80 μ g/ml.

ii) Experimental Procedure

Unless otherwise stated experiments were run at 30 $^{\circ}$ C for 30 minutes. The temperature of the water bath was controlled to $\pm 0.1^{\circ}$ C by a 500 watt immersion heater connected by a hot wire switch relay (Sunvic controls Ltd.) to a "Jumos" electric current thermometer (A.Gallenkamp and Co. Ltd.)

Appropriate reaction media were equilibrated for 10 minutes in the water bath in MSE borosilicate centrifuge tubes. These consisted of 1ml of ionic medium, 0.5ml of 12mM Tris ATP (Method of preparation see Appendix 4(i)). Generally, the Mg²⁺ ATPase activity was determined in a reaction medium

with the final concentrations as follows: 4mM MgCl₂ in 50 mM Histidine/HCl pH 7.2 , and the Na⁺ K⁺ATPase in a reaction medium with final concentrations of 4mM MgCl₂, 20mM KCl, 100mM NaCl in 50mM Histidine/HCl pH 7.2. In those cases where the compositions of the reaction media differed from these, the new media will be referred to in the text. Reactions were started by the addition of 0.5mls. homogenate, and they were stopped by adding 4mls of a 1:1 mixture of 1% lubrol W (or Cirrasol ALN-WF) in deionized water and 1% ammonium molybdate in 1.8N H₂SO₄ (ATKINSON et al, 1973). The tubes were left for 10 minutes at room temperature to allow the yellow colour to develop, and they were then transferred to crushed ice. Control tubes assaying non-enzymatic hydrolysis of ATP were set up in each experiment. These tubes contained the normal reaction media and were incubated for the same time as the experimental tubes, but the microsomal suspension was not added until immediately after the lubrol. Any protein that precipitated was removed by centrifugation at 1000g in a MSE Mistral 2L refrigerated centrifuge for 10 minutes at 0°C, and the supernatant was poured into fresh, pre-cooled Pyrex test tubes and stored on ice. Subsequently they were transferred into glass cuvettes and the optical density determined against a distilled water blank at 390nm. on a Pye Unicam Dual Beam Spectrophotometer with a tungsten filament light source and a 10mm light path.

iii) Estimation of the Na⁺-K⁺ATPase Activity

The Na⁺-K⁺ATPase activity was calculated as the difference between the activity in the presence of Mg²⁺ ions alone, when only the Mg²⁺ component was able to work, and the value when Mg²⁺, Na⁺ and K⁺ ions are present in the medium when both the Mg²⁺ and the Na⁺-K⁺ATPases would be active. The Mg²⁺ATPase activity was calculated by subtracting the values for the control tubes from those containing Mg²⁺ ions alone. All results were expressed as n.moles Pi liberated/mg protein/min. The phosphate values were estimated by comparing the unknowns with standard calibration curves produced by the method of ATKINSON et al. (1973) (see Appendix 4(ii)). Protein values were determined using the method of LOWRY et al. (1951) with Bovine serum albumin (B.S.A.) fraction V to construct the standard curve (see Appendix 4(iii)).

Estimation of temperature coefficients

Q₁₀ values were calculated using the following formula

$$Q_{10} = \frac{K_1}{K_0}^{(10/T_1 - T_0)}$$

Where K₁ is the rate at the higher temperature (T₁) and K₀ is the rate at the lower temperature (T₀).

Estimation of Arrhenius activation energy

Arrhenius plots of \log_{10} of rate against $\frac{1}{T^{\circ}}$

Absolute were plotted. The slopes were determined by regression analysis using the method of least squares. (SNEDECOR and COCHRAN, 1967) which produced the best straight line for the data. Arrhenius activation energy was computed from the equation $E_a = R \times 2.303 \times \text{slope K joules mole}^{-1}$.

Where R = gas constant, 8.314 K joules/mole/ $^{\circ}$ A.

Treatment of saturation kinetics data

The results were represented graphically using the LINEWEAVER and BURKE (1934) plot which modifies the Michaelis Menton equation. $\left[\frac{1}{S} \right]$ was plotted against $\left[\frac{1}{V} \right]$ (S = substrate concentration, V = reaction velocity). V_{\max} was calculated from $\frac{1}{\text{intercept}}$ on the Y axis and $K_m = V_{\max} \times \text{slope}$. The slopes were calculated using regression analysis.

RESULTS

1. ATPase Activity

The results shown in Table 4:1 were obtained using microsomal preparations from the Malpighian tubules alone, and allowing ATPase activity to be estimated in five different reaction media.

TABLE 4:1

ATPase Activity of Microsomal Preparations of Malpighian Tubules

Composition of reaction media	Enzyme activity in nmoles Pi liberated/mg. protein/min
4mM Mg ²⁺	29.3 (± 4.9)
4mM Mg ²⁺ , 100mM Na ⁺	a) 31.7 b) 25.9
4mM Mg ²⁺ , 20mM K ⁺	a) 46.1 b) 31.8
4mM Mg ²⁺ , 100mM Na ⁺ , 20mM K ⁺	229.8 (± 27.3)
4mM Mg ²⁺ , 100mM Na ⁺ , 20mM K ⁺ , 1mM ouabain	24.5 (± 5.9)
Activity in the presence of Mg ²⁺ , Na ⁺ , K ⁺ minus activity in the presence of Mg ²⁺ , Na ⁺ , K ⁺ and 1mM ouabain	205.3 (± 27.2)
Activity in the presence of Mg ²⁺ , Na ⁺ , K ⁺ minus activity in the presence of Mg ²⁺ alone	200.5 (± 26.6)

ATPase activity is expressed as the mean of five separate determinations (± S.E. of the mean). The exceptions (a) and (b) above) refer to the individual data obtained for each of two separate determinations.

The results clearly show that the Malpighian tubules of Locusta migratoria are able to hydrolyse ATP. Two distinct components of ATPase activity were seen: a Mg²⁺ ATPase requiring

Mg^{2+} only and an enzyme which also required Mg^{2+} but was synergistically stimulated by the presence of Na^+ and K^+ ions (Na^+-K^+ ATPase). There was no stimulation of the Na^+-K^+ ATPase enzyme in the presence of Na^+ alone, and only minimal stimulation in the presence of K^+ alone. Clearly the activity in the presence of both ions far exceeded the sum of the activity with both ions separately suggesting true synergistic stimulation. The activity of the Na^+-K^+ ATPase was much greater than that of the Mg^{2+} ATPase probably as a result of the extraction methods. The $\frac{Na^+-K^+ATPase}{Mg^{2+}ATPase}$ value for these experiments is 7.01.

The Na^+-K^+ ATPase activity was shown to be completely inhibited by the cardiac glycoside ouabain with the activity level in its presence resembling that in the presence of Mg^{2+} alone. From this it would appear that the Mg^{2+} ATPase is unaffected by ouabain.

2. The effect of differing ouabain concentrations on Na^+-K^+ ATPase activity

Na^+-K^+ ATPase activity from Malpighian tubules was assayed in reaction media containing concentrations of ouabain from $0-10^{-3}M$.

TABLE 4:2

Mean Values from 3 Experiments showing the Effect of Ouabain Concentrations on Na⁺-K⁺ATPase Activity

Ouabain Concentration	Na ⁺ -K ⁺ ATPase activity n. moles Pi/Mg protein/ min	S.E.
10 ⁻³ M	17.59	± 6.18
10 ⁻⁴ M	23.19	± 7.14
10 ⁻⁵ M	54.72	± 11.02
5 x 10 ⁻⁶ M	72.98	± 10.47
3 x 10 ⁻⁶ M	77.47	± 7.49
10 ⁻⁷ M	145.47	± 10.13
10 ⁻⁸ M	211.42	± 5.21
0	232.7	± 13.7

The results (Table 4:2) show that the inhibition of the Na⁺-K⁺ATPase increased as the concentration of ouabain increased from 10⁻⁸ to 10⁻⁴ M. At ouabain concentrations of 10⁻⁴ M and higher, inhibition was found to be more or less complete. Fig. 4:1 shows the % of total activity against the negative logarithm of the ouabain concentration. The inhibition curve has the typical sigmoid shape, and the negative logarithm of the ouabain concentration causing 50% inhibition of the Na⁺-K⁺ATPase (pI₅₀) was 6.1.

FIG. 4:1

Dose-response curve of the inhibition of the $\text{Na}^+ \text{K}^+ \text{ATPase}$ by ouabain. The vertical lines represent $\pm 2\text{S.E.}$ of the mean.

Ordinate: % of the activity obtained in the absence of ouabain.

Abscissa: Negative \log_{10} of ouabain concentration.

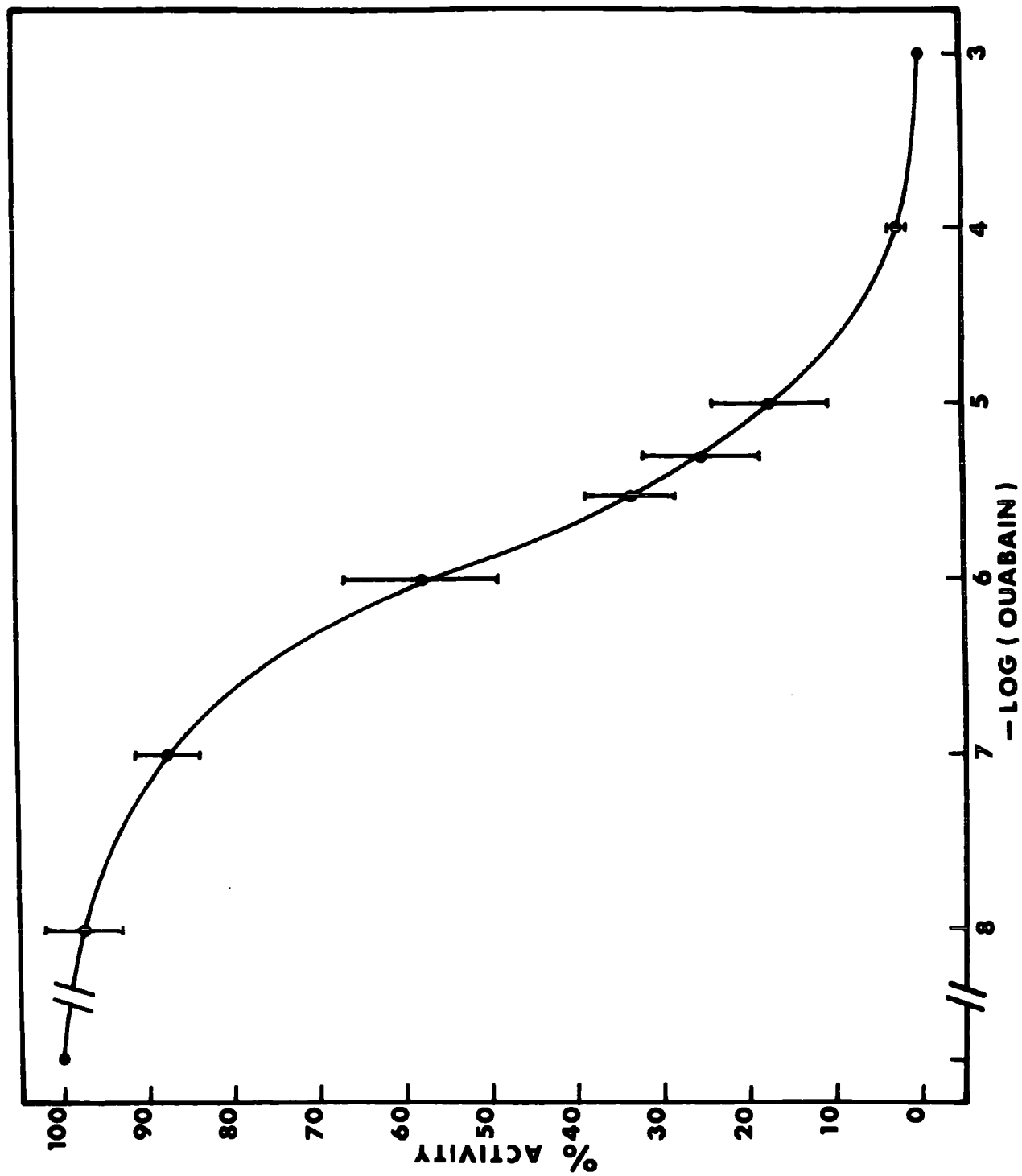

FIG. 4:2

Phosphate release resulting from $\text{Na}^+ \text{K}^+$ ATPase activity at 10°C , 30°C and 40°C .

Ordinate: $\text{Na}^+ \text{K}^+$ ATPase activity (n. moles Pi/
mg. protein).

Abscissa: Time in minutes.

(Lines fitted by regression analysis).

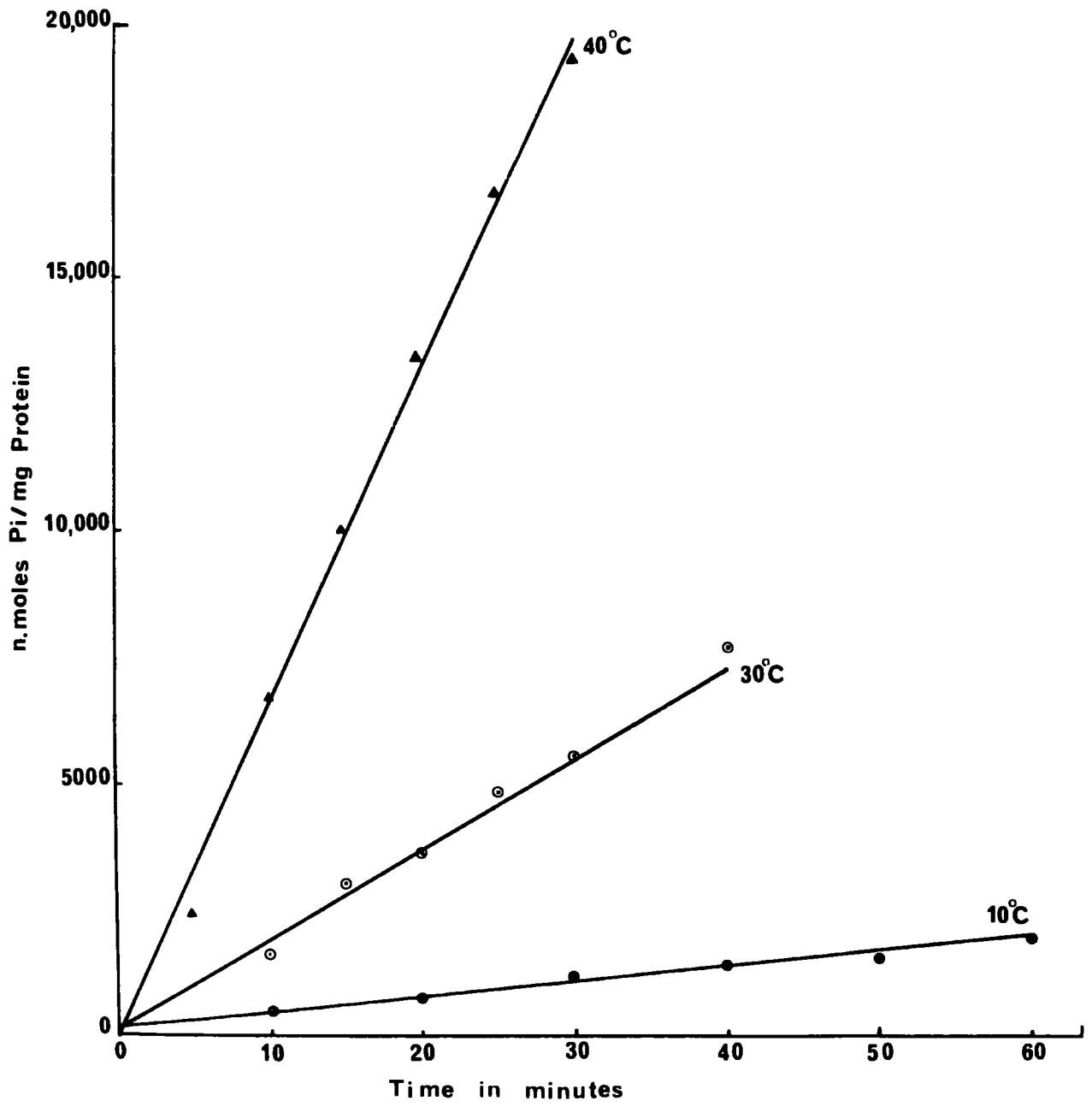

3. Effect of temperature on the $\text{Na}^+ - \text{K}^+$ ATPase activity

Temperature gradients were set up using a thick aluminium bar (1.2 x 0.1 x 0.06M) with a series of water filled holes at short intervals along its length which accommodated the assay tubes. A crushed ice bath at one end, and a hot water bath at the other provided a gradient of temperature from 5°C-50°C. Pairs of tubes, one containing 4mM Mg^{2+} , 3mMATP, and the other 4mM Mg^{2+} , 100mM Na^+ , 20 mM K^+ and 3mM ATP were equilibrated for 10 minutes at each temperature prior to the introduction of the microsomal preparation. ATPase activity was determined in the normal fashion but the reaction was allowed to proceed for different times depending on the temperature : 60 minutes at temperatures below 17°C, 45 minutes from 17°C-30°C and 30 minutes above 30°C. Earlier studies had shown that the reactions were linear over these periods at the temperatures indicated (see Fig.4:2). Temperature experiments were carried out using Malpighian tubules alone, rectal sacs alone and hindguts plus Malpighian tubules. Fig. 4:3 shows the results obtained with Malpighian tubules, but they are typical of those obtained with rectal sacs, and hindgut plus tubules as well. $\text{Na}^+ - \text{K}^+$ ATPase activity was maximal at ca. 45°C, whilst Mg^{2+} ATPase activity was still rising at 50°C. Arrhenius μ plots were drawn for $\text{Na}^+ - \text{K}^+$ ATPase and Mg^{2+} ATPase values from all the experiments and activation energies calculated. (Appendix 4 (iv) a and b). Typical examples of Arrhenius μ plots are shown in Figs. 4:4 and 4:5. Both Mg^{2+} ATPase and $\text{Na}^+ - \text{K}^+$ ATPase produced essentially curvilinear

FIG 4:3

Effect of temperature on $\text{Na}^+ \text{K}^+$ ATPase (●)
and Mg^{2+} ATPase (▲) activity.

Ordinate: ATPase activity (n.moles Pi/mg.
protein/min)

Abscissa: Temperature °C.

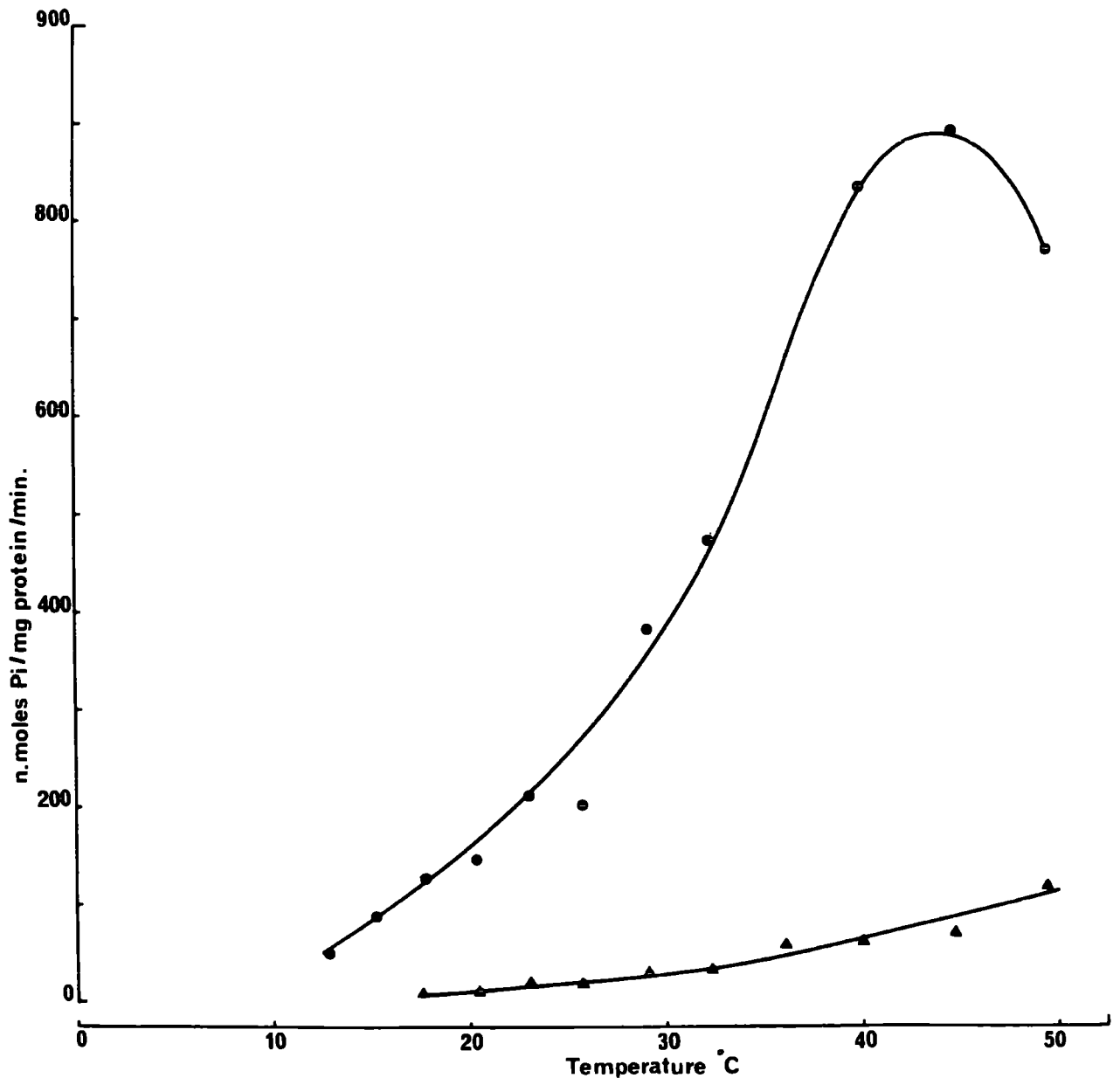

FIG. 4:4

Arrhenius μ plot from Malpighian tubules
showing $\text{Na}^+ \text{K}^+$ ATPase (●) and Mg^{2+} ATPase (○)
activity.

Ordinate: \log_{10} ATPase activity (n. moles Pi/
mg. protein/min).

Abscissa: Reciprocal of temperature in
degrees Absolute $\times 10^3$.

(Lines fitted by regression analysis).

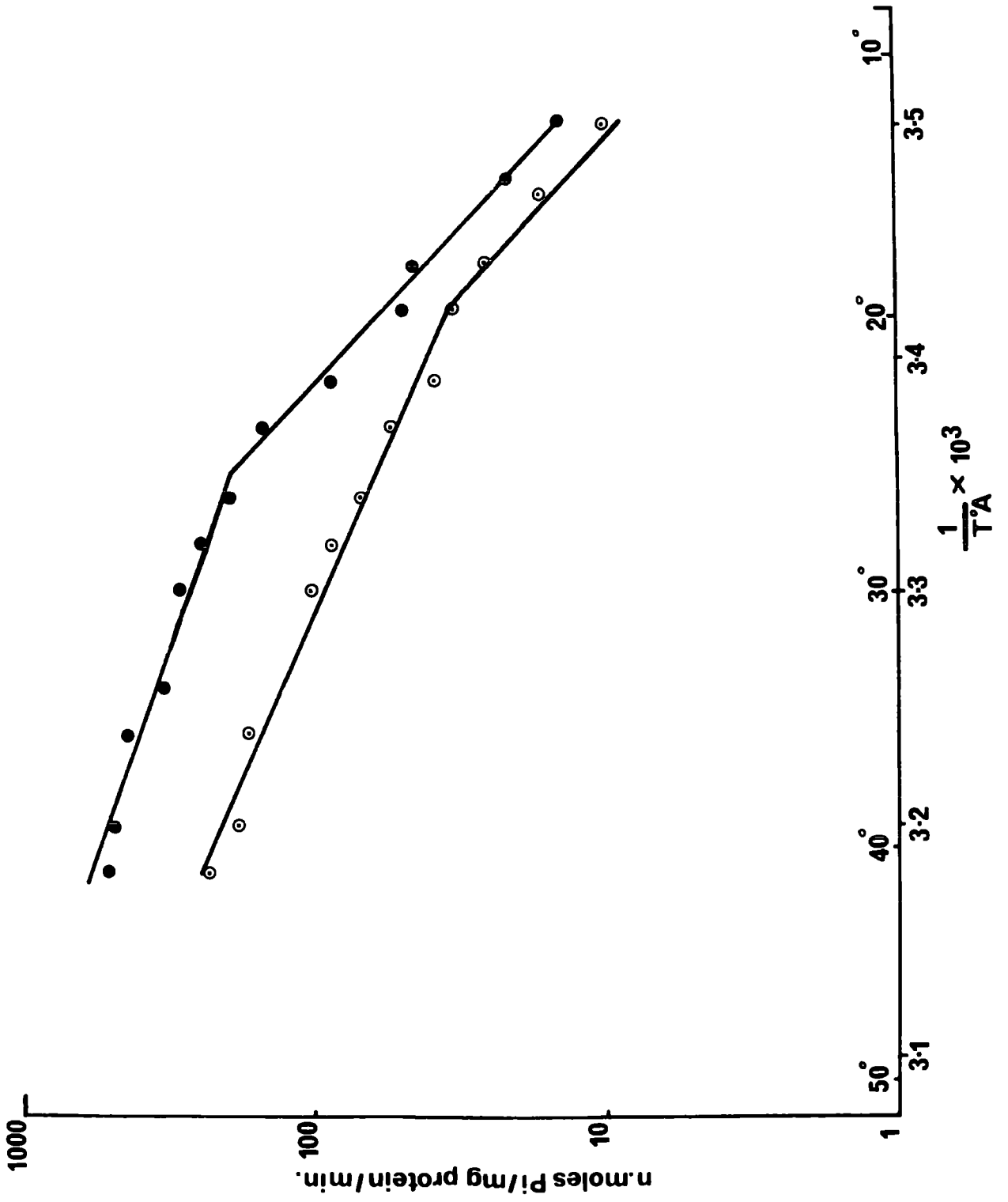

FIG. 4:5

Arrhenius μ plot for $\text{Na}^+ \text{K}^+$ ATPase enzymes extracted from Malpighian tubules (\circ), rectal sacs (\bullet) and hindgut plus Malpighian tubules (Δ).

Ordinate: \log_{10} $\text{Na}^+ \text{K}^+$ ATPase activity
(n. moles Pi/mg. protein/min).

Abscissa: Reciprocal of temperature in
degrees Absolute $\times 10^3$.

(Lines fitted by regression analysis).

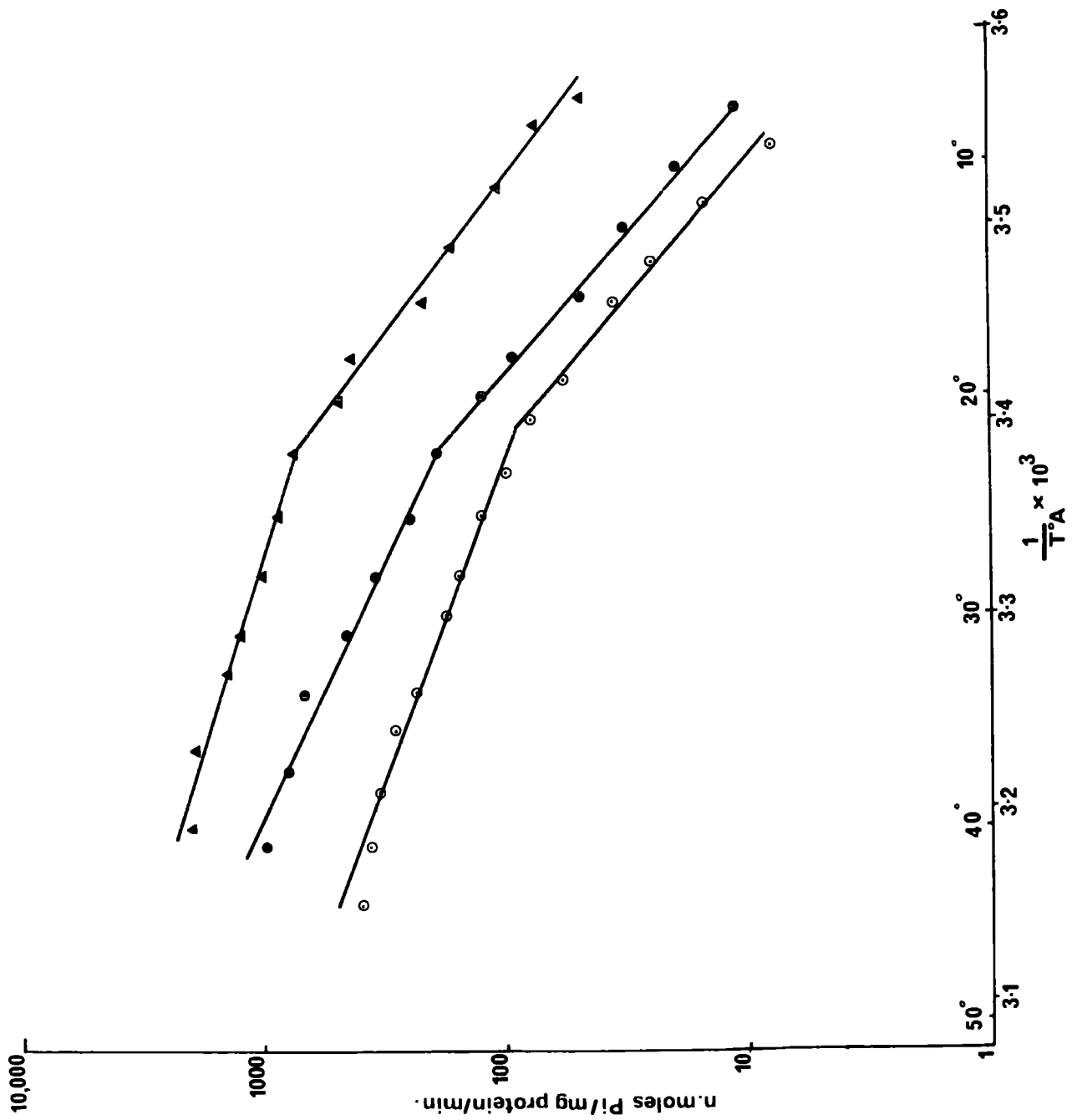

TABLE 4:3

Activation energies expressed as K_i oules moles⁻¹

Temperature Range	MALPIGHIAN TUBULES		RECTAL SAC		HINDGUT + MALPIGHIAN TUBULES	
	Na ⁺ -K ⁺ ATPase	Mg ²⁺ ATPase	Na ⁺ -K ⁺ ATPase	Mg ²⁺ ATPase	Na ⁺ -K ⁺ ATPase	Mg ²⁺ ATPase
6.3-21°C	122.78 ± 13.6 (n = 3)	98.4 ± 0.5 (n = 3)	119.2 ± 11.26 (n = 3)	(i) 86.9 (ii) 98.2	122.2 ± 5.2 (n = 6)	96.9 ± 3.8 (n = 4)
	62.9 ± 6.9 (n = 3)	57.5 ± 5.5 (n = 3)	61.65 ± 6.8 (n = 3)	(i) 51.4 (ii) 49.8	58.09 ± 3.4 (n = 6)	46.8 ± 4.6 (n = 4)

Arrhenius plots but 2 straight lines could be constructed through the points by regression analysis. For both enzymes a "break point" in the lines occurred at about 21°C (mean break point for Na⁺-K⁺ATPase = 21.9°C ± 0.6, and for Mg²⁺ATPase at 21.13°C ± 1.2). Students' "t" tests on the results showed that there was no significant difference in activation energies between the ATPase from the 3 tissues examined, (see Table 4:3). This being so, mean activation energy values were calculated for the Na⁺-K⁺ATPase and Mg²⁺ATPase using the combined results (Table 4:4).

TABLE 4:4

Mean activation energies of whole hindguts plus Malpighian tubules (Activation energy in K joules Moles⁻¹)

	6.3-21°C	21°-42°C	Number
Na ⁺ -K ⁺ ATPase	121.6 ± 4.5	59.8 ± 2.7	12
Mg ²⁺ ATPase	95.8 ± 1.9	51.7 ± 3.9	9

Students' "t" tests showed that the activation energy of the Mg²⁺ATPase was significantly lower than that of the Na⁺-K⁺ATPase enzyme in the lower temperature range, but it was not significantly different at the higher temperatures. The activation energies for each enzyme observed between 6.3-21°C and 21°-42° were significantly different for both enzymes.

Q_{10} values were also calculated from 10°C-20°C and from 21°C-31°C. The values for both the $\text{Na}^+ \text{K}^+$ ATPase and the Mg^{2+} ATPase from the Malpighian tubules, rectal sac and whole hindgut plus Malpighian tubules did not differ significantly from one tissue to another.

Consequently it was felt that the values could legitimately be pooled, and mean Q_{10} values determined for each enzyme. (Table 4:5)

TABLE 4:5

Mean Q_{10} values for whole hindguts plus Malpighian tubules

	10-20°C	21-31°C	n
$\text{Na}^+ \text{K}^+$ ATPase	4.22 ± 0.21	2.20 ± 0.1	11
Mg^{2+} ATPase	3.35 ± 0.31	2.03 ± 0.16	10

Application of students "t" tests showed that for both enzymes, the Q_{10} values were significantly different over the two temperature ranges. The Q_{10} of the Mg^{2+} ATPase was significantly lower than that of the $\text{Na}^+ \text{K}^+$ ATPase over the lower temperature range ($P < 0.05$) but no significant difference was observed at the higher range.

All subsequent ATPase experiments were carried out using combined Malpighian tubule and hindgut preparations. Thus ensuring more enzyme activity without needing to use very large numbers of insects.

4. The effect of pH on Na⁺ - K⁺ATPase activity

A 25mM Bis Tris Propane buffer system was used to produce an uninterrupted stable pH range between 5 and 10. Reaction media containing the appropriate ions dissolved in Bis Tris Propane and mixed with Tris ATP (Final strength 3mM) were adjusted to the required pH using concentrated HCl. The buffered media were then stored at -20°C until required. The need for ATP to be mixed with buffer prior to pH adjustment was realised when later additions were shown to alter the pH by as much as 1 unit, at the extremes of the range. 2mls of reaction media were used for each assay and the reaction started by the addition of 200µls of homogenate. Pairs of tubes were set up at each pH and Na⁺ - K⁺ATPase activity was determined from the difference between tubes containing Na⁺, K⁺ and Mg²⁺, and those containing Na⁺, K⁺, Mg²⁺ and 1mM ouabain. It was found to be essential to use this means of assessing the Na⁺ - K⁺ATPase activity due to the fact that in the presence of Mg²⁺ ions alone, and particularly at pH values above 8, there was a considerable non-enzymatic hydrolysis of ATP. Since this was not seen in the presence of Na⁺, K⁺ and Mg²⁺ one must presume that in the presence of Na⁺ and K⁺, the strong positive charges on these cations attract OH⁻ ions in solution, and so reduce the hydrolysis of the terminal phosphate bonds. Fig. 4:6 shows the release of Pi due to the non-enzymatic hydrolysis of ATP in control

FIG 4:6

Effect of pH on non-enzymatic hydrolysis of ATP in control experiments using ionic media containing Mg^{2+} only (●), and Mg^{2+} , K^+ , Na^+ (■).

Ordinate; Non-enzymatic ATP hydrolysis
(n. moles Pi/mg. protein/min).

Abscissa: pH

FIG 4:7

Effect of pH on $Na^+ K^+$ ATPase activity.

Ordinate: $Na^+ K^+$ ATPase activity
(n. moles Pi/mg. protein/min).

Abscissa: pH

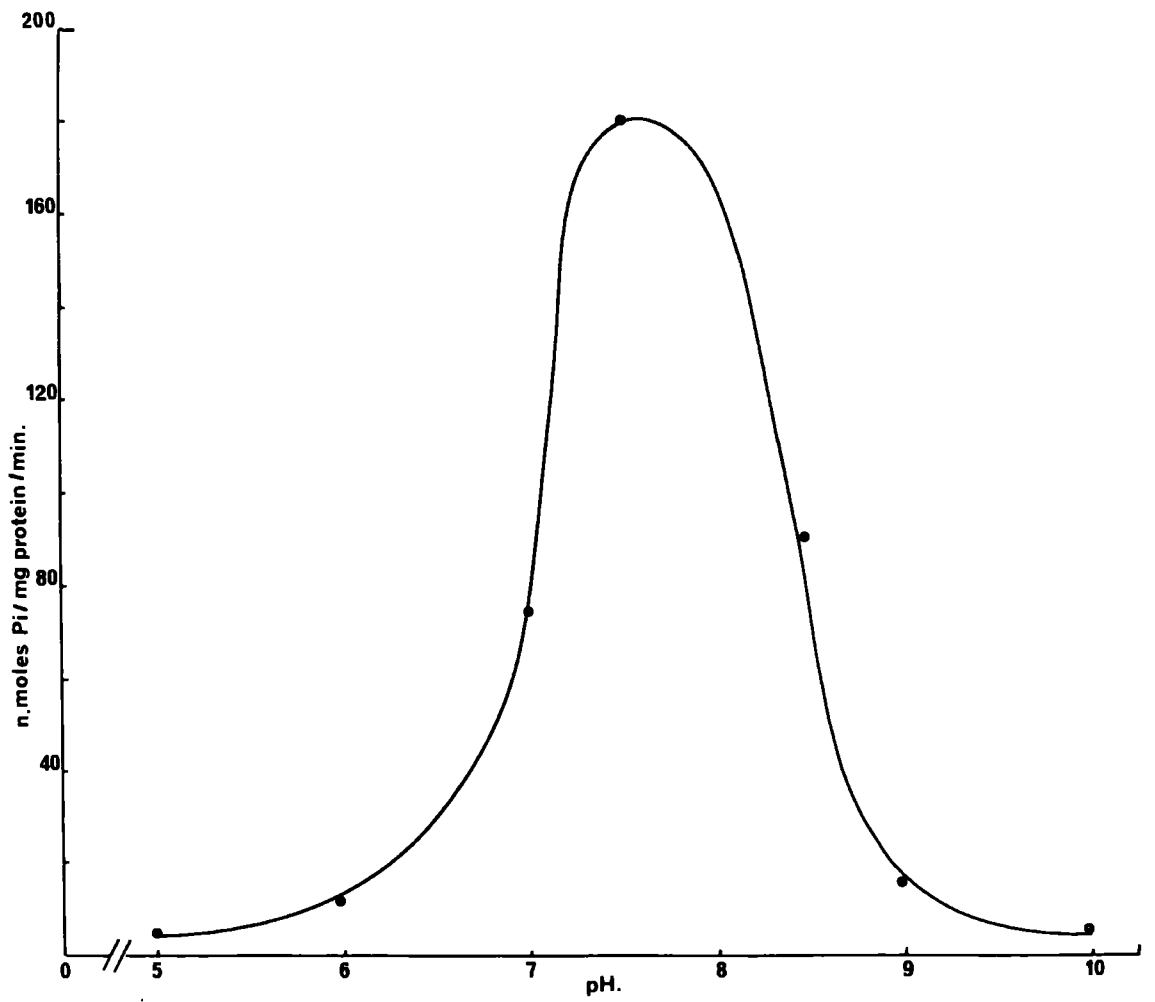
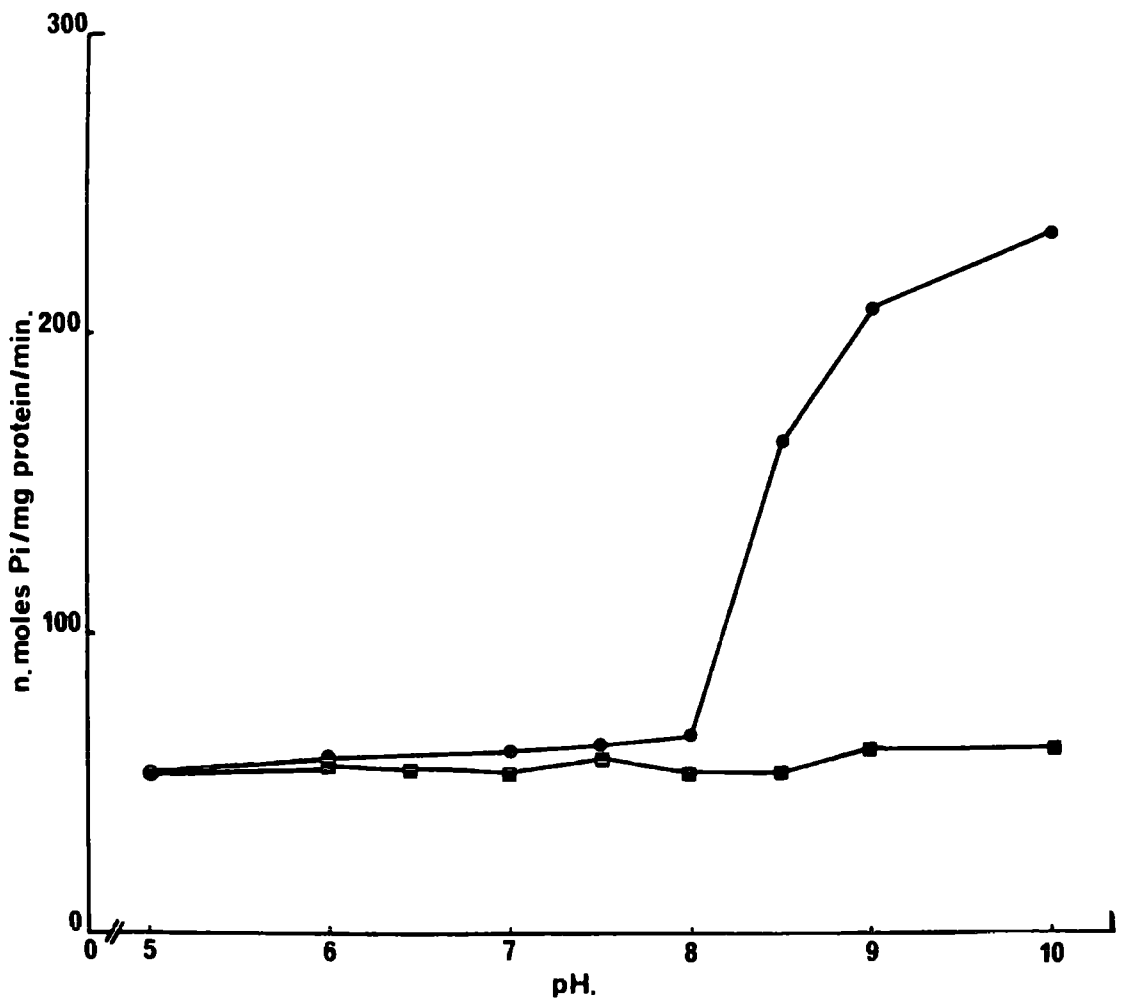

tubules at various pH's in the presence of Mg^{2+} alone and when Na^+ and K^+ are also present. This problem was overcome by the use of tubes containing Mg^{2+} , Na^+ , K^+ and ouabain to produce the ATPase level when the $Na^+ - K^+$ ATPase was inhibited. Results using this method (Fig. 4:7) showed that the $Na^+ - K^+$ ATPase shows maximum activity at approximately pH 7.5, with a fairly sharp peak.

5. The effect of Mg^{2+} concentration on $Na^+ - K^+$ ATPase activity

Assays for Mg^{2+} ATPase and $Na^+ - K^+$ ATPase enzyme activity were carried out in reaction media with the Mg^{2+} concentration ranging from 0-10mM. The concentrations of ATP, Na^+ and K^+ were as described in Materials and Methods (section ii). Enzyme activity was determined at 20°C, 30°C and 40°C for each preparation. In these and the subsequent experiments the reaction times were as follows; 10°C-60minutes, 20°C-40 minutes and 30°C and 40°C-30 minutes. Fig. 4:8(a) shows that the activity of the $Na^+ - K^+$ ATPase enzyme was dependent on the Mg^{2+} level. In the absence of Mg^{2+} there was no activity. A steady increase in activity was observed with increasing Mg^{2+} concentration up to 4mM Mg^{2+} above which the activity declined indicating an inhibitory effect of high concentrations of Mg^{2+} on $Na^+ - K^+$ ATPase activity. This result was observed at all 3 temperatures. Fig. 4:8b shows the effect

FIG. 4:8

Effect of Mg^{2+} concentration on the $Na^+ K^+$ ATPase activity, and the Mg^{2+} ATPase activity from the same preparation at $20^\circ C$ (\circ), $30^\circ C$ (\blacktriangle), $40^\circ C$ (\bullet)

A= $Na^+ K^+$ ATPase

B= Mg^{2+} ATPase

Ordinate: ATPase activity (n. moles Pi/mg. protein/min).

Abscissa: Mg^{2+} concentration m Molar.

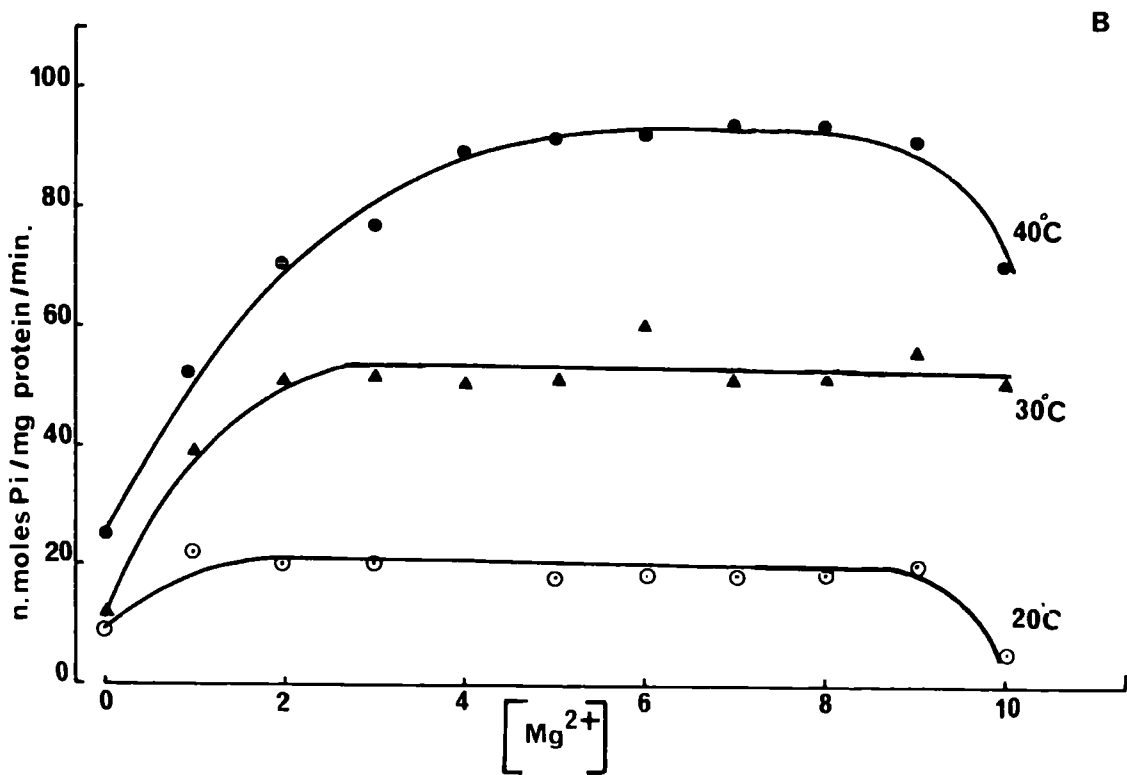
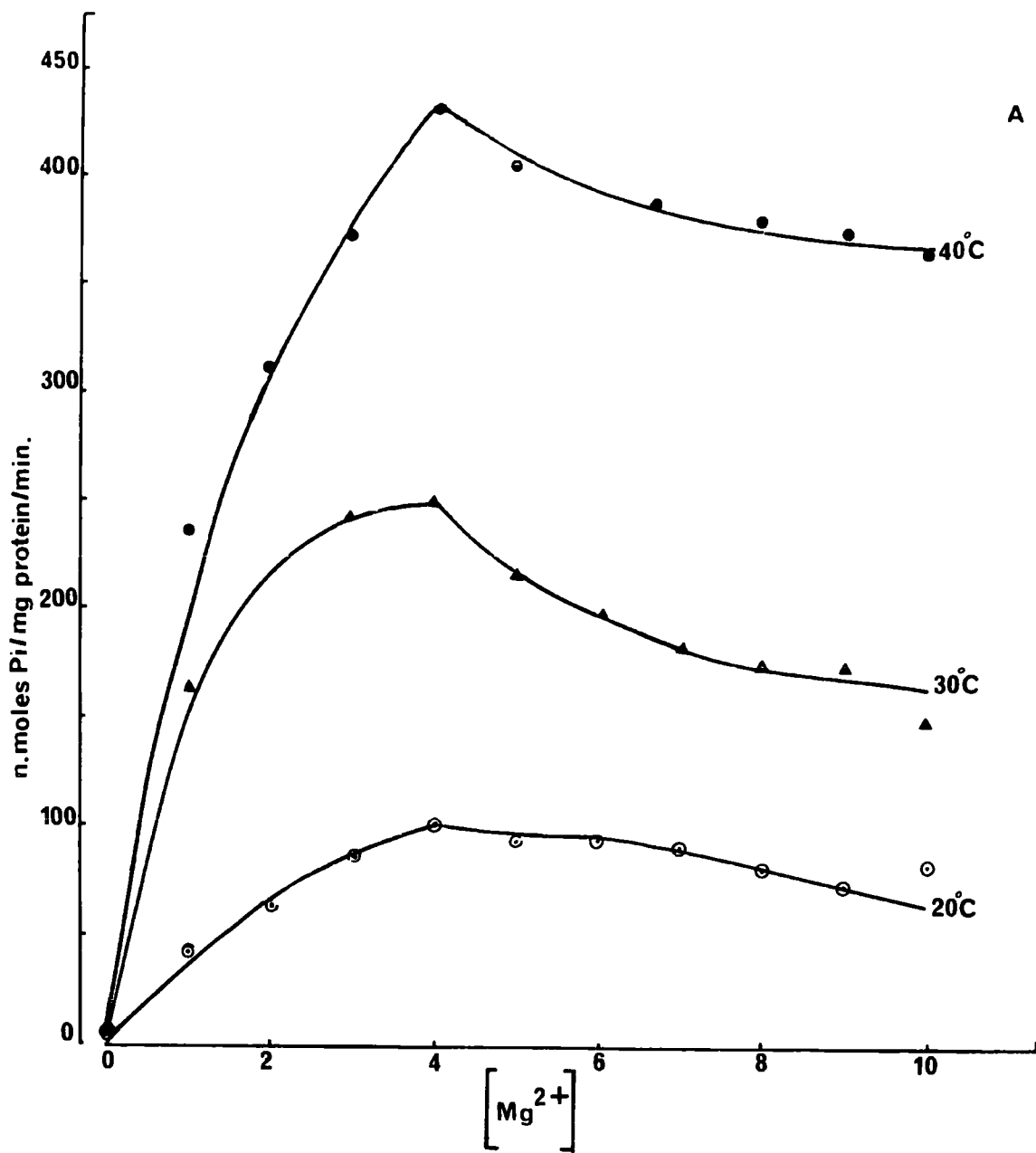

of varying Mg^{2+} concentrations on the activity of the Mg^{2+} ATPase. The activity of this enzyme seemed to be relatively unaffected by the concentration of Mg^{2+} once it exceeded 2mM. However, the activity generally was low (see also Appendix 4 (v) a and b).

6. The effect of K^+ concentrations on Na^+-K^+ ATPase activity

Na^+-K^+ ATPase activity was assayed in reaction media containing 100mM Na^+ and 4mM Mg^{2+} , but with K^+ concentrations ranging between 0-50mM. Experiments were carried out at 10°C, 20°C, 30°C and 40°C. The results are shown in Fig, 4:9. At all temperatures K^+ concentrations below 10mM clearly inhibited Na^+-K^+ ATPase activity. Greatest activity occurred at 20mM K^+ at all temperatures, although the peak was much more marked at the higher temperatures. Not surprisingly at 10°C activity was very low, and consequently the exact maximum was difficult to identify being reached at both 10mM and 20mM K^+ .

7. The effect of altering Na^+ and K^+ concentrations on Na^+-K^+ ATPase activity

ATPase assays were carried out in media of constant Mg^{2+} and ATP concentrations but with varying Na^+ and K^+ composition. Five different Na^+ concentrations were used, 150mM, 100mM, 50mM, 25mM and 10mM. From each of these 6 solutions containing the following K^+ concentrations

FIG. 4:9

Effect of K^+ concentration on the activity of the $Na^+ - K^+$ ATPase in a medium containing 100mM Na^+ , at $10^\circ C$ (\blacktriangle), $20^\circ C$ (\circ), $30^\circ C$ (\times), $40^\circ C$ (\bullet).

Ordinate: $Na^+ - K^+$ ATPase activity
(n. moles Pi/mg. protein/min).

Abscissa: K^+ concentration m. Molar.

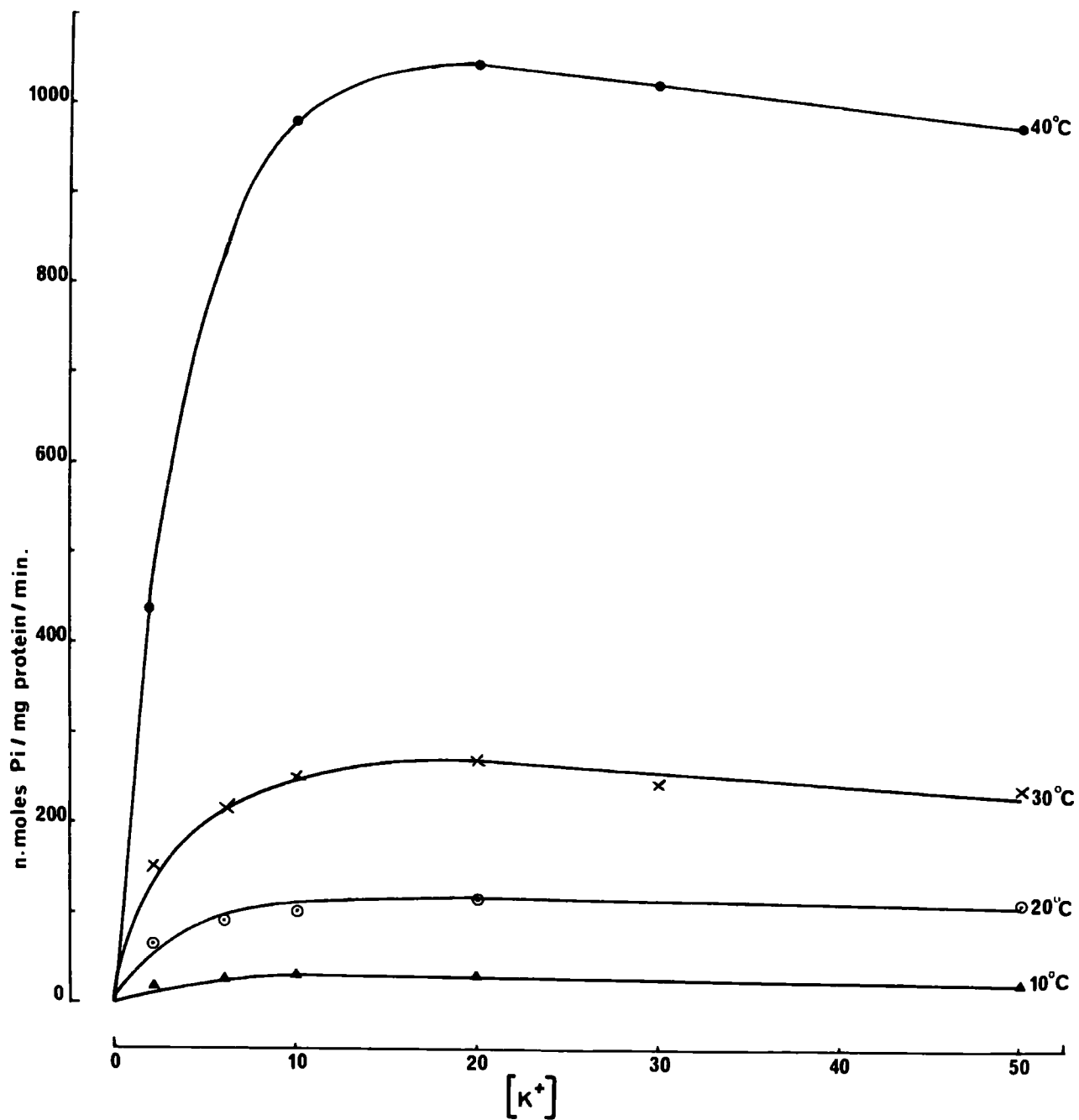

were prepared: 50mM, 30mM, 20mM, 10mM, 6mM and 2mM. Enzyme assays were carried out comparing the values in these solutions with those obtained with solutions containing Mg^{2+} alone. The experiments were carried out at $10^{\circ}C$, $20^{\circ}C$, $30^{\circ}C$ and $40^{\circ}C$. From the results in Fig. 4:10 (a,b,c,d) it can be seen that over a range of Na^{+} concentrations the $Na^{+}-K^{+}ATP-$ ase activity was clearly dependent on the K^{+} levels in the medium. There was little activity at very low K^{+} concentrations, but it increased directly with increase in K^{+} up to a certain level beyond which it declined. The amounts of K^{+} necessary to give maximal stimulation varied depending on the strength of the Na^{+} . For example at 10mM Na^{+} peak was observed between 2 and 6mM K^{+} , but at 150mM Na^{+} the peak was between 20-30mM K^{+} . The overall maximum activity recorded for all temperatures was at 100mM Na^{+} : 20mM K^{+} . The $Na^{+}:K^{+}$ ratio being 5:1 (see also Appendix 4 (vi) (a,b,c,d)).

8. Kinetic constants relating to ATP concentration

Enzyme assays were carried out in media in which the ATP concentration varied from 3mM to 0.1mM. Assays were performed at $20^{\circ}C$, $30^{\circ}C$ and $40^{\circ}C$ using the same homogenate. It was essential to establish initially that the breakdown of ATP by the ATPase action was not too great at any temperature or concentration making the availability of ATP to the enzyme a rate limiting factor. A preliminary run was carried out before each experiment using 0.1mM ATP at $40^{\circ}C$ as this is the

FIG. 4:10

The effect of Na^+ and K^+ concentrations on $\text{Na}^+ \text{K}^+$ ATPase activity.

Na^+ concentrations: 10mM (\blacksquare), 25mM (\blacktriangle), 50mM (\times)
100mM (\odot), 150mM (\blacktriangledown)

A=10°C

B= 20°C

C= 30°C

D= 40°C

Ordinate: $\text{Na}^+ \text{K}^+$ ATPase activity
(n. moles Pi/mg. protein/min).

Abscissa: concentration of K^+ m. Molar.

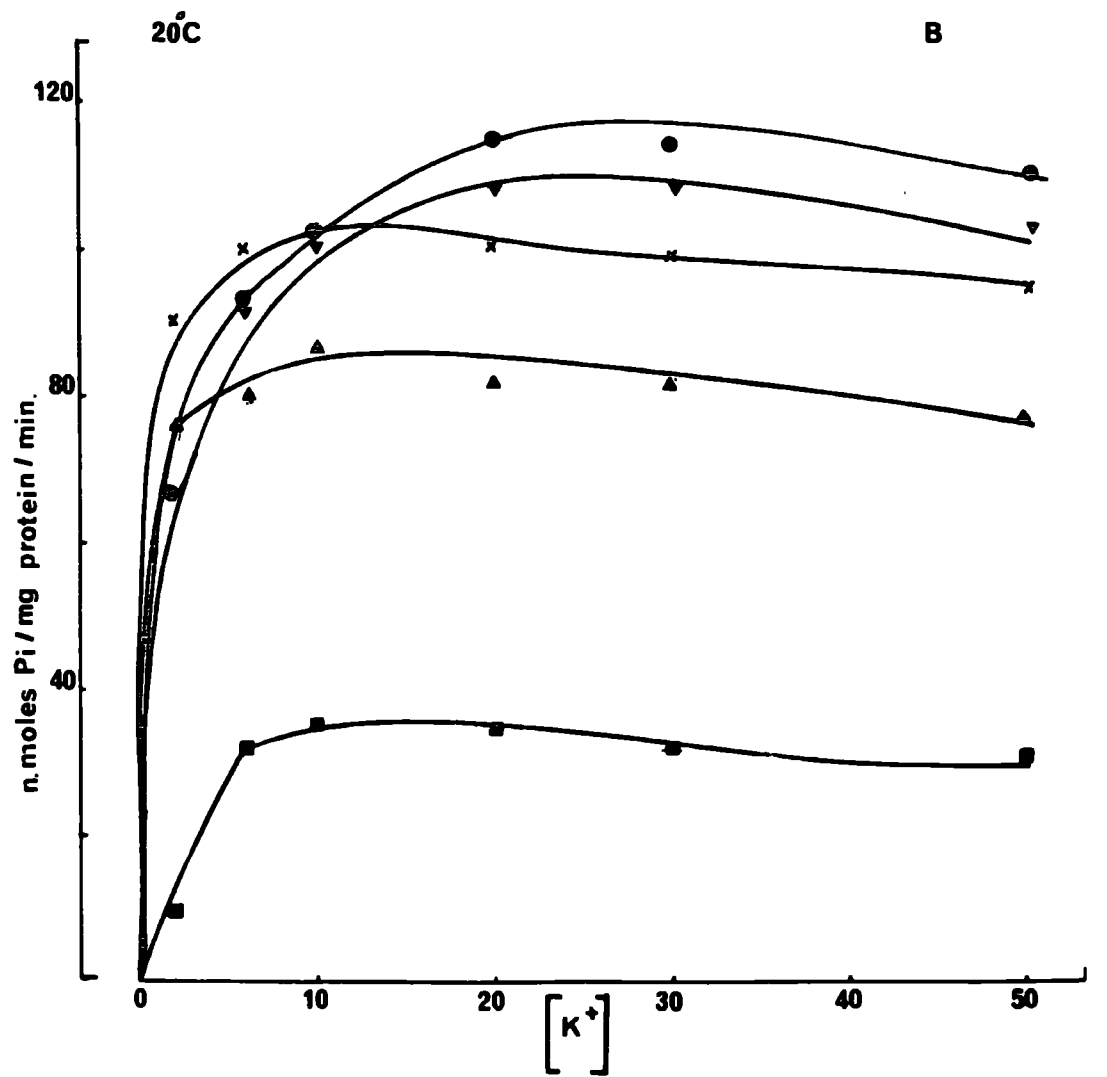
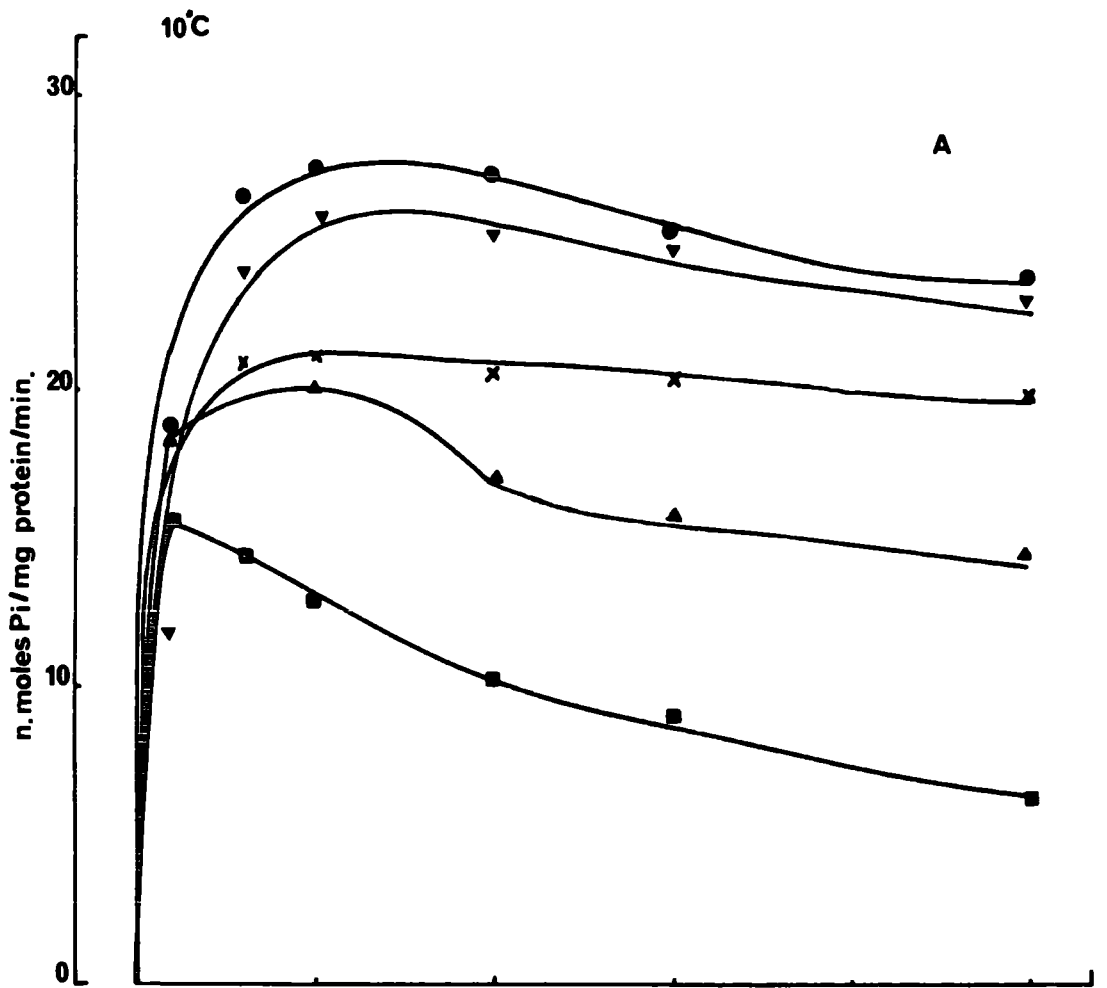

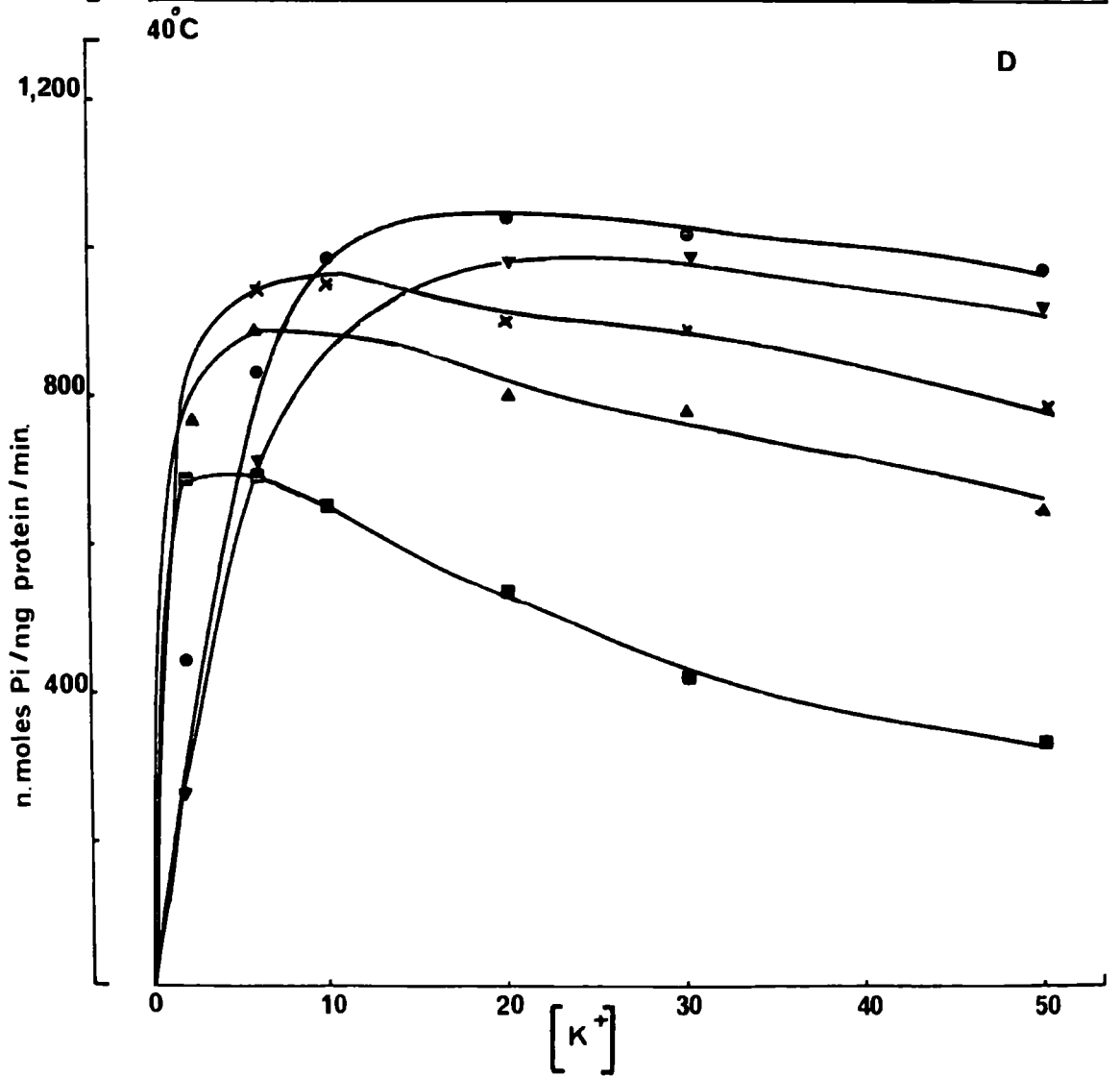
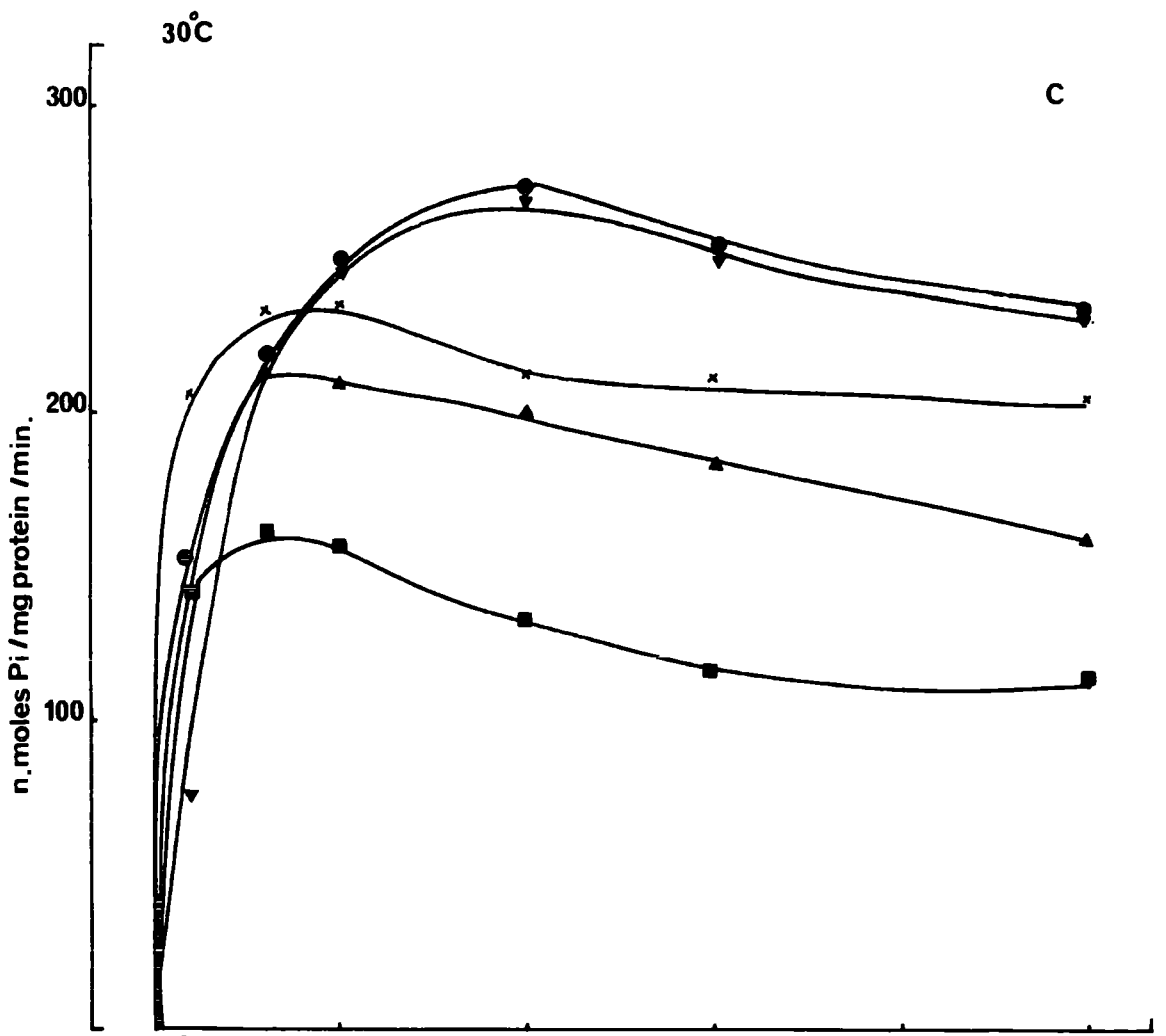

condition likely to be most affected by excessive ATP breakdown. The ATP used by the total ATPase enzyme (i.e. the Mg^{2+} and the Na^+-K^+ ATPase components) was estimated a typical result is shown in Fig. 4:11. From these preliminary studies an incubation time was chosen to ensure that the data was collected within the linear range. In some cases it was necessary to dilute the homogenate to ensure that excessive ATP breakdown did not occur. Generally reactions were run for 10 minutes at $40^{\circ}C$, 15 minutes at $30^{\circ}C$ and 20 minutes at $20^{\circ}C$. LINEWEAVER and BURKE plots of the reciprocal activity against reciprocal ATP concentrations were drawn using regression analysis and from these the values of K_m and V_{max} were calculated.

TABLE 4:6

K_m and V_{max} values for whole hindgut plus Malpighian tubule Na^+-K^+ ATPase

Temp.	K_m mMolar \pm S.E.	V_{max} (nmoles Pi/mg protein/min \pm S.E.)	number
$20^{\circ}C$	0.12 ± 0.017	113.6 ± 42	3
$30^{\circ}C$	0.18 ± 0.006	213 ± 53	3
$40^{\circ}C$	0.15 ± 0.013	373 ± 109	5

These results showed that K_m values varied between 0.09mM-0.19mM and that there was no significant difference in

FIG. 4:11

Phosphate release by $\text{Na}^+ \text{K}^+$ ATPase plus
 Mg^{2+} ATPase enzyme activity at 40°C using 0.1mM ATP
as a substrate.

Ordinate: ATPase activity indicated by the
n. moles Pi released.

Abscissa: time in minutes.

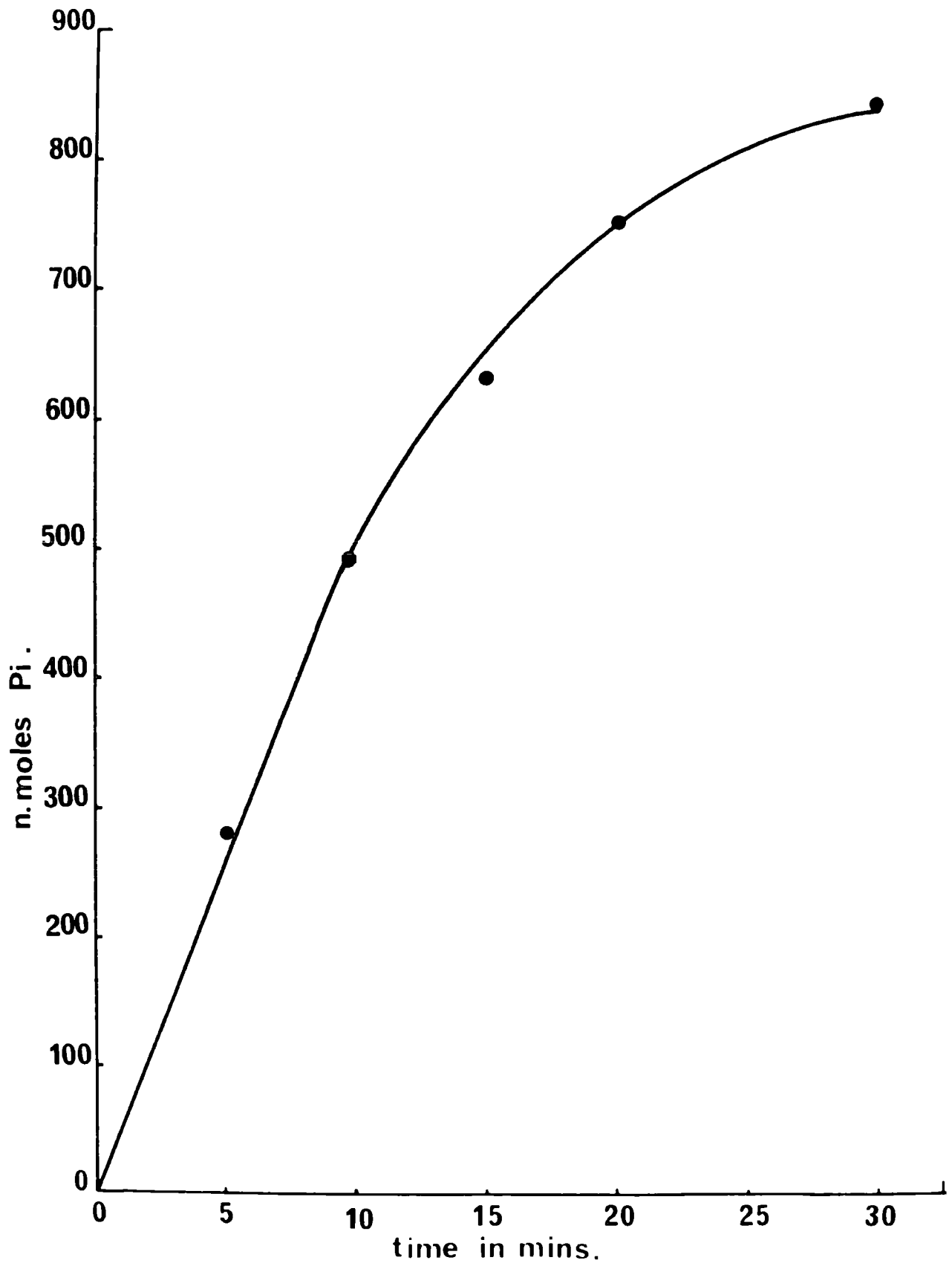

FIG. 4:12

Lineweaver - Burke plot of $\text{Na}^+ \text{K}^+ \text{ATPase}$ activity against ATP concentration at 20°C (\blacktriangle), 30°C (\odot), 40°C (\bullet).

Ordinate: reciprocal of $\text{Na}^+ \text{K}^+ \text{ATPase}$ activity
(n. moles Pi/mg. protein/min) $\times 10^3$

Abscissa: reciprocal of ATP concentration (mM).

(lines fitted by regression analysis).

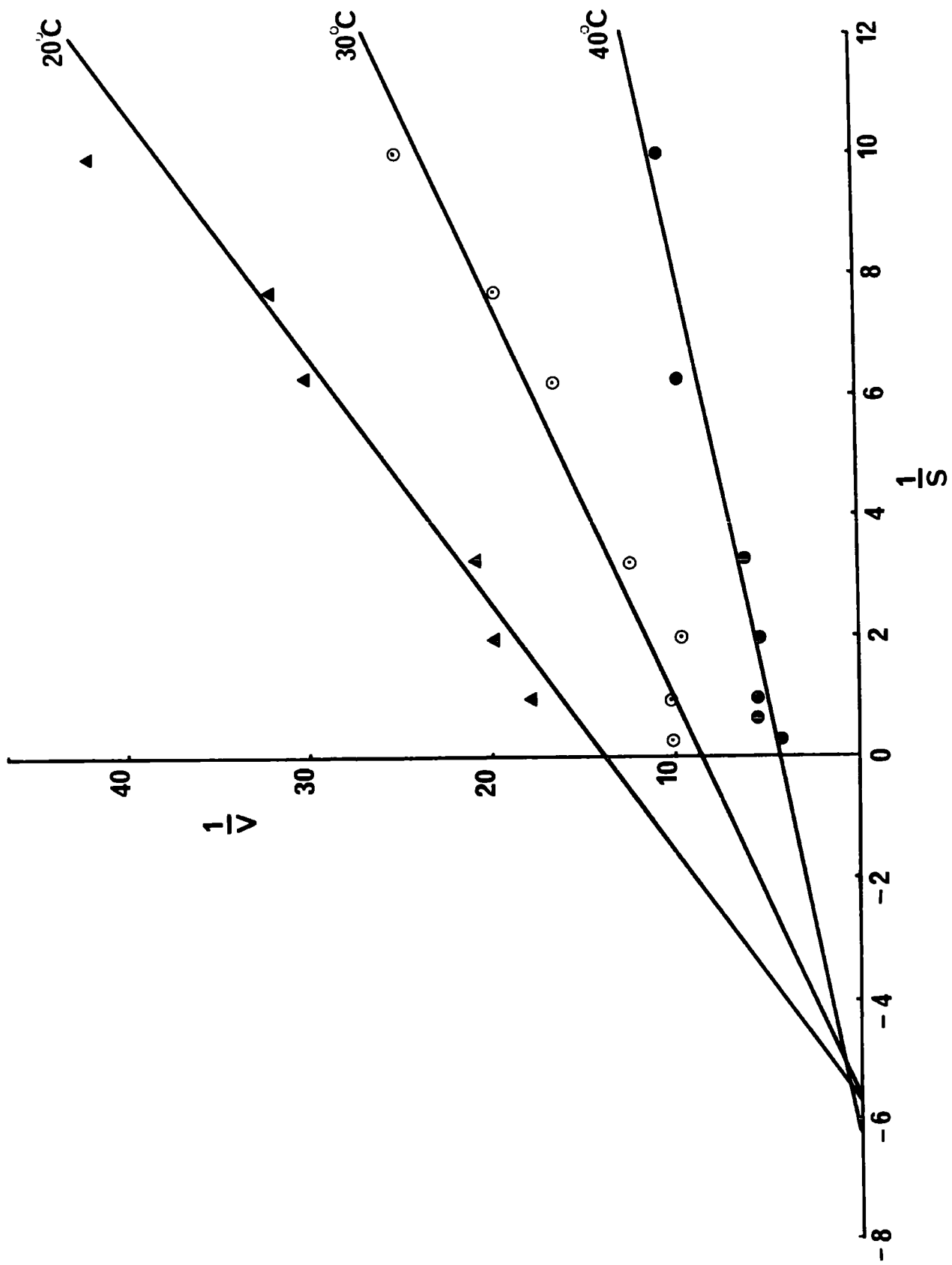

enzyme/substrate affinity at the 3 temperatures. V_{max} was shown to approximately double with each 10°C rise in temperature. (See also Appendix 4(vii)).

Discussion

The results clearly show the presence of a Mg^{2+} dependent $\text{Na}^{+} \text{K}^{+}\text{ATPase}$ enzyme in microsomal preparations from the hindgut, rectal sac and Malpighian tubules of Locusta migratoria. The ATPase fulfils the characteristics outlined by SKOU (1965) for an enzyme actively involved in cation transport across cell membranes. It is situated on the membranes, and is capable of hydrolysing ATP thus converting this form of potential energy into cation movement. It is inhibited by ouabain at concentrations greater than 10^{-7}mM ; Mg^{2+} ions are essential for $\text{Na}^{+} \text{K}^{+}\text{ATPase}$ activity, and the enzyme is synergistically stimulated by Na^{+} and K^{+} ions. In the absence of either Na^{+} or K^{+} less than 20% of the full stimulation occurs. A slightly greater activity was recorded in the presence of Mg^{2+} and K^{+} than with Mg^{2+} and Na^{+} . This agrees with results obtained by SCHONER et al (1967) using ox brain ATPase, but BONTING (1966), and RIDDERSTAP and BONTING (1969) working on rectal gland of elasmobranchs and dog pancreas respectively found the opposite with greater activity in the presence of Mg^{2+} and Na^{+} . The reason for these slight increases is

uncertain but may reflect the alternative cations remaining in the tissue which enable a certain amount of $\text{Na}^+ \text{K}^+ \text{ATPase}$ activity to occur (BONTING 1966). Characteristically a second, ouabain insensitive enzyme ($\text{Mg}^{2+} \text{ATPase}$) was also identified. Due to the deoxycholate/sodium iodide extraction method employed the levels of this enzyme were very low (less than 20% of the $\text{Na}^+ \text{K}^+ \text{ATPase}$ levels). The ratio of $\frac{\text{Na}^+ \text{K}^+ \text{ATPase}}{\text{Mg}^{2+} \text{ATPase}}$ activity varied considerably, and although a value of 7.01 was given from the initial experiments with Malpighian tubules, mean ratios taken from the Arrhenius μ plots at 30°C were 3.47 for the Malpighian tubules (n=4) 10.42 for the whole hindgut plus the Malpighian tubules (n=6) and 8.5 for the rectal sacs (n=3). These values might appear a little high when compared to that of 3.4 obtained by GRASSO (1967) for cockroach nerve cord, and 3.04 by JØRGENSEN (1969) for rabbit kidney, however they agree with the values obtained by PEACOCK (1975) for Jamaicana Malpighian tubules, and rectum; also for Locusta Malpighian tubules, but PEACOCK'S values for Locusta rectum are considerably higher (59.73 n=3). Due to the very low levels of the $\text{Mg}^{2+} \text{ATPase}$ together with the fact that the role of the $\text{Mg}^{2+} \text{ATPase}$ is uncertain, the $\text{Mg}^{2+} \text{ATPase}$ has not formed an important part of this study.

The ouabain binding characteristics of

$\text{Na}^+ \text{K}^+ \text{ATPase}$ from Locusta Malpighian tubules are similar to those observed in tissues from other species (GLYNN 1964). The inhibition curve was sigmoidal giving a pI_{50} value of 6.1. It can be seen from the table below that this compares favourably with values obtained by other workers.

TABLE 4:7

pI values from a range of species

Reference	Enzyme Source	pI_{50}
GRASSO 1967	Cockroach Nerve	6.4
SKOU 1962	Mammalian Kidney	6.0
KINSOLVING et al., 1963	Guinea Pig Kidney	6.7
WHITTAM and WHELLER, 1961	Rabbit Kidney	5.7
RIDDERSTAP 1969	Dog Pancreas	6.8
BONTING 1966	Dogfish Rectum Shark Rectum	6.8 6.8

The values shown in table 4:7 were all measured with ouabain binding in the presence of K^+ ions. The work of AKERA (1971) and TOBIN and BRODY (1972), demonstrates that ouabain will bind more efficiently in the absence of K^+ , and with a short incubation period of 10 minutes as much as 12 fold difference in pI_{50} value can occur depending on the

presence or absence of K^+ . They suggest that determination in the presence of K^+ may give artificially high pI_{50} values. ALLEN and SCHWARTZ (1970) have, however, shown that the binding of ouabain in the presence of K^+ is directly proportional to time and temperature, and that the maximum amount of ouabain to be bound in the presence or absence of K^+ is identical. As all the workers cited gave long incubation periods (20-30 minutes) at temperature greater than $30^{\circ}C$ it is unlikely that the results would be severely affected by K^+ competing for ouabain binding sites. However even if K^+ did affect the pI_{50} values slightly all the results quoted are directly comparable.

The Mg^{2+} requirements for the locust $Na^+ K^+ ATPase$ are essentially the same as for other $Na^+ K^+ ATPase$ systems. No activity occurs in its absence and a peak is reached at 4mM, beyond which inhibition occurs. As 3mM ATP was used peak activity was observed at an ATP/Mg^{2+} ratio of 1:1.3. Comparison with other workers is difficult as there is a direct correlation between the Mg^{2+} concentration yielding maximum activity and the ATP concentration. (SCHONER et al 1967) indicating the formation of an ATP/Mg^{2+} complex. However other workers using 3mM ATP have produced similar results: GRASSO (1967) using cockroach nerve found maximal activity between 4-5 mM Mg^{2+} (ATP/Mg^{2+} - 1:1.5) SKOU (1957) with crab nerve found a 1:1 maximum as

did SCHONER et al.(1967) for ox brain. SKOU (1962) using kidney produced a 1:2. Workers using different ATP concentrations also generally obtained maxima between 1:1 and 1:2 (PEACOCK et al 1976, BAKERREN and BONTING 1968, and RIDDERSTAP and BONTING 1969).

Clearly both Na^+ and K^+ were essential for stimulation of the locust $\text{Na}^+ \text{K}^+$ ATPase with maximum activity occurring at 100mM Na^+ and 20mM K^+ irrespective of temperature. This is identical with the requirements for cockroach nerve (GRASSO,1967) and for hindgut and Malpighian tubule ATPases from Locusta migratoria, and the tettigoniid, Homorocoryphus nitidulus vicinus (PEACOCK 1975; PEACOCK et al., 1976), AKERA et al. (1969) also found a similar peak at 100mM Na^+ , 15-25mM K^+ for heart ATPases from several mammalian species. Slight variations have been observed by other workers, but the results have usually been in the same range eg. CHARNOCK and POST (1963b) 80mM Na^+ : 20mM K^+ (4:1) and RATANABANKOON et al. (1973) 120mM Na^+ : 20mM K^+ (6:1).

Most recorded $\text{Na}^+ \text{K}^+$ ATPase enzymes show maximum activity between pH 7 and 8, and Locusta hindgut and Malpighian tubule tissue is no exception with a value of approximately 7.5. This closely resembles the 7.6 recorded for cockroach nerve (GRASSO, 1967) and the 7.25-7.5 for Homorocoryphus hindgut and tubules (PEACOCK et al., 1976).

The study of the affinity of the $\text{Na}^+ \text{K}^+$ ATPase for ATP is complex as it is likely that the true substrate is an $\text{ATP}/\text{Mg}^{2+}$ complex. Some workers, including the present study, have held the Mg^{2+} levels constant and only altered ATP concentration. From this group a range of K_m values have been reported ranging from 0.1mM recorded by NEUFIELD and LEVY (1969) using calf brain to the 0.4mM of MOAKE et al., (1970) using human platelets. The overall mean value for Locusta hindgut and Malpighian tubules was $0.15 \pm 0.01\text{mM}$ ($n=11$) with no significant difference between 20° and 30° and 40°C . This agrees well with the 0.14mM reported by PEACOCK et al., (1976) for Homorocoryphus hindgut and Malpighian tubules. A certain amount of caution must, however, be exercised when comparing results. Some workers have altered the Mg^{2+} concentration as well as the ATP keeping a 1:1 ratio, and they obtained much higher values, e.g. WHITTAM and WHEELER (1961) obtained a K_m of 0.8mM for rabbit kidney using this method, and similarly WALD et al., (1974) produced K_m values of 1.34mM, 1.21mM and 0.55mM for kidney cortex, medulla and papilla respectively. It has also been shown that enzyme purity can greatly effect the K_m values (KLINE et al., 1971) as can the relative concentrations of Na^+ and K^+ (ROBINSON, 1967). It is clear, though, that the affinity of

the $\text{Na}^+-\text{K}^+\text{ATPase}$ for ATP is very high when compared to other enzyme/substrate complexes. In Locusta migratoria for example the affinity of gut enzymes such as αD -glucosidase and αD -galactosidase for their substrates has been shown to be at least ten times lower (CHARNLEY, 1976).

The Arrhenius μ curves for locust $\text{Na}^+-\text{K}^+\text{ATPase}$ with their characteristic break at 21°C , closely resembles those reported by other workers using tissue from homeotherms e.g. rabbit kidney (CHARNOCK et al., 1971), lamb kidney (GRISHAM and BARNETT, 1973) and rat brain (BOWLER and DUNCAN, 1968b). The curves obtained by BOWLER and DUNCAN (1968a) for the frog were very different with a break at 16°C . The Arrhenius μ values for Locusta hindgut and Malpighian tubules of 59.8 ± 2.7 above 21°C and 121.6 ± 4.5 below 21°C are compared with these obtained by other workers in table 4.8.

There is a close similarity between Locusta hindgut and Malpighian tubules and mammalian kidney especially at temperatures above 20°C where they would both normally be functional. The Arrhenius μ plots for the $\text{Mg}^{2+}\text{ATPase}$ were not as curvilinear although a break still occurred around 21°C . The activation energies were lower especially at temperatures below 20°C suggesting the $\text{Mg}^{2+}\text{ATPase}$ is less temperature sensitive than the $\text{Na}^+-\text{K}^+\text{ATPase}$. A similar result was recorded by BOWLER and DUNCAN (1968b) from rat brain. It has been shown that membrane lipids are essential for ATPase activity (SCHATZMAN, 1962; HEGYVARY and POST, 1969), and

TABLE 4:8 Arrhenius μ . values from a variety of sources

Values expressed a K. joules Mole⁻¹

Reference	Enzyme Source	Above 20°C	Below 20°C
CHARNOCK <u>et al.</u> , 1973	Rabbit Kidney	57.4	118.6
GRISHAM and BARNETT, 1973	Lamb Kidney	63.6	135.7
BOWLER and DUNCAN, 1968b	Rat Brain	83.2	173.6
GRUENI and AVI-DOR, 1966	Rat Brain	32.5	160.4
BOWLER and DUNCAN, 1968a		Above 16°C	Below 16°C
	Frog Brain	40.37	91.5

it is generally believed that ATPase temperature sensitivity is related to lipids, the break in the Arrhenius μ plots being due to lipid phase transition (GRISHAM and BARNETT, 1973). TANAKA and TERUYA (1973) have further shown that the lipids are solely responsible for the temperature characteristics and not the animal source of the ATPase enzyme. The lipids must be fluid to function properly (GRISHAM and BARNETT, 1973), and so it is probable that at the transition point the lipids enter a more fluid phase enabling the ATPase to function with a much lower activation energy. It would appear likely, therefore, that the lipid phase transition temperature of the locust ATPase is similar to that of the vertebrate kidney tissue. This is presumably related to the fact that they are adapted to work at maximum efficiency over a similar temperature range carrying out essentially the same function.

A $\text{Na}^+ \text{K}^+$ stimulated Mg^{2+} dependent ATPase enzyme has, therefore, been identified in the hindgut and Malpighian tubules of Locusta migratoria, and its characteristics resemble those of other $\text{Na}^+ \text{K}^+$ ATPase preparations. In subsequent chapters the role of the $\text{Na}^+ \text{K}^+$ ATPase enzyme in the control of cation and water movement in locust Malpighian tubules will be investigated. Its involvement in these processes seems extremely likely in view of the known role of $\text{Na}^+ \text{K}^+$ ATPases in a wide variety of tissues involved in ion and water transport:

kidney (EPSTEIN and SILVA, 1974; NECHAY, 1974)
salivary gland (AUGUSTUS, 1976) toad bladder (CRABBE
et al, 1974) adrenal glands (BLAINE et al , 1975) and
intestine (CSAKY, 1961).

CHAPTER 5

Relationship between Na^+ - K^+ ATPase activity and Respiratory Rate in the Malpighian Tubules of *Locusta Migratoria*

Introduction

It is now generally recognised that fluid transport across a variety of epithelia results from the active pumping of cations (generally Na^+ and K^+) against a concentration gradient (reviews WHITTAM and WHEELER, 1970; USSING and THORN, 1972). Water flows passively as a result of the osmotic imbalance produced by this process. Early studies with kidney tissue (MUDGE, 1951a and b; WHITTAM and DAVIES, 1953) showed that energy from respiration was essential for the maintenance of active Na^+ and K^+ transport. The main evidence for this was the fact that active transport was decreased if respiration was inhibited with substances such as cyanide. These early works, however, did not reveal what fraction of the total energy produced by respiration was expended on ion movement, or whether the latter in turn influenced the rate of respiration. This information was provided by a series of studies on kidney cortex (WHITTAM and WILLIS, 1962; 1963) which showed that a 35-40% drop in oxygen consumption occurred if active transport was inhibited by ouabain or by the absence of Na^+ . Thus it was concluded that active transport appears to regulate part of the respiration of the kidney cortex. Similar conclusions have been reached using brain tissue

(WHITTAM, 1961; YOSHIDA et al., 1962; SWANSON and McILWAIN, 1965; SEDLACEK, 1972), heart (WHITTAM, 1962) and rat diaphragm (CZACZES et al. , 1969). As the enzyme responsible for active cation transport in most animal cells has been shown to be the $\text{Na}^+ \text{K}^+$ ATPase enzyme (SKOU, 1965; 1969) it follows that the activity of this enzyme would regulate part of the respiration rate (and thus oxygen consumption) in tissues where it is active.

Oxygen consumption by living tissue is directly proportional to the rate of oxidative phosphorylation in the mitochondria. The rate of oxidative phosphorylation (and thus the rate of ATP production) is, in turn, primarily determined by the relative concentrations of ADP:ATP in the cytoplasm. (LEHNINGER, 1972). When the supply of respiratory substrate is ample, the maximal rate of oxygen consumption occurs when the ADP and phosphate concentration in the medium are high, and the concentration of ATP low. On the other hand when the concentration of ATP is high and that of ADP and phosphate is essentially zero, mitochondria show only a very low respiratory rate. Of the three components, the ADP concentration is the most critical in setting the respiratory rate because of the high affinity of the mitochondria for ADP. It would follow, therefore, that in tissue where active transport by the $\text{Na}^+ \text{K}^+$ ATPase is an important process, the activity of the $\text{Na}^+ \text{K}^+$ ATPase would clearly effect oxidative phosphorylation. The $\text{Na}^+ \text{K}^+$ ATPase enzyme

continually splits ATP as it functions to provide the energy for active cation transport. This produces ADP and phosphate which accumulates and in turn, stimulates oxidative phosphorylation by the mitochondria to regenerate ATP. Increased oxidative phosphorylation necessitates greater oxygen uptake by the tissue. Thus $\text{Na}^+ - \text{K}^+$ ATPase activity is linked to oxygen consumption by a series of feedback mechanisms that are in direct relation with the ratio of ADP:ATP (BLOND and WHITTAM, 1964).

Precise determinations indicating the amount of oxygen consumed for each sodium ion moved have been carried out by a few workers. ZERHAN (1956) using frog skin found that 16-20 equivs. Na^+ were transported per mole O_2 . Similar results were obtained by LEAF and RENSHAW (1957a and b). LASSEN and THAYSEN (1961) and LASSEN et al., (1961) using kidney cortex quote figures of 25 and 28 equivs. Na^+ /mole O_2 . All these workers conclude that a substantial proportion of the total oxygen consumed is utilised for the processes underlying active Na^+ transport.

In some cases, however, the relationship between $\text{Na}^+ - \text{K}^+$ ATPase activity and oxygen consumption is not as clearly defined and certain anomalies have emerged in the literature. NISSEN et al., (1966) were able to demonstrate that with rat diaphragm increased respiration resulted from increasing the Na^+ levels and consequently the active transport. SILVA et al., (1976) were, however, unable to always show parallel increases of oxygen consumption

resulting from increased $\text{Na}^+ - \text{K}^+$ ATPase activity using rat kidney. The method of stimulation of the enzyme appeared to effect the result, but the reason for this is uncertain. Although ouabain clearly inhibited respiration in kidney cortex (WHITTAM and WILLIS, 1962; 1963) it was shown to increase oxygen consumption in brain tissue in the presence of calcium ions (WHITTAM et al., 1965; SWANSON and ULLIS, 1966). In the absence of calcium, however, ouabain inhibited respiration in brain (SWANSON and ULLIS, 1966). No satisfactory explanation has been produced to explain this effect of calcium.

As a $\text{Na}^+ - \text{K}^+$ ATPase enzyme has been demonstrated in the Malpighian tubules of Locusta migratoria by biochemical means (see Chapter 4), it was of interest to discover to what extent this enzyme influenced the respiration of the tubules. The following study was carried out to establish the extent to which the activity of the $\text{Na}^+ - \text{K}^+$ ATPase enzyme in Locusta migratoria Malpighian tubules is related to the oxygen consumption, and to measure the proportion of the total energy produced by respiration which is expended on cation movement.

Materials and Methods

Oxygen consumption was measured by means of a polarographic electrode (Yellow Springs Instrument Co. Inc., Ohio, USA, Model 53). This is a design based on the Clark oxygen electrode (CLARK, 1956). The principle of the oxygen electrode has been described by DAVIES and BRINK (1942). In

this model the electrodes (a 0.025 " diameter platinum cathode and a silver anode) are situated at the tips of the probes cased in an epoxy block. KCl solution is placed on the electrodes, and is tightly covered with a thin teflon membrane held in position with a rubber "O" ring. Before each experiment the membrane was examined with a x10 lens for physical damage and a probe test was carried out according to the method outlined in the handbook to ensure the probe and membrane were working correctly.

The apparatus included a constant temperature bath surrounding 4 incubation chambers and the temperature stability within these chambers was $\pm 0.02^{\circ}\text{C}$. All experiments were run at 30°C . The amount of oxygen in the Ringer solution in the incubation chamber was monitored on a Servoscribe pen recorder (Goerz Electro) which was calibrated to give maximum deflection for 100% air saturation at the beginning of each experiment. The Ringer in the chamber was stirred continuously during the recordings using a small magnetic stirrer (Y.S.I.) (Fig. 5:1).

Experimental results were expressed as μ moles O_2 consumed per hour. (For the method of calculation see Appendix 5: (i)).

Sexually mature Locusta migratoria of both sexes were used. Animals were killed by decapitation and the Malpighian tubules quickly dissected out under ice-cold Ringer

FIG. 5:1

Diagram of a Y.S.I. oxygen electrode sample chamber with the probe in position.

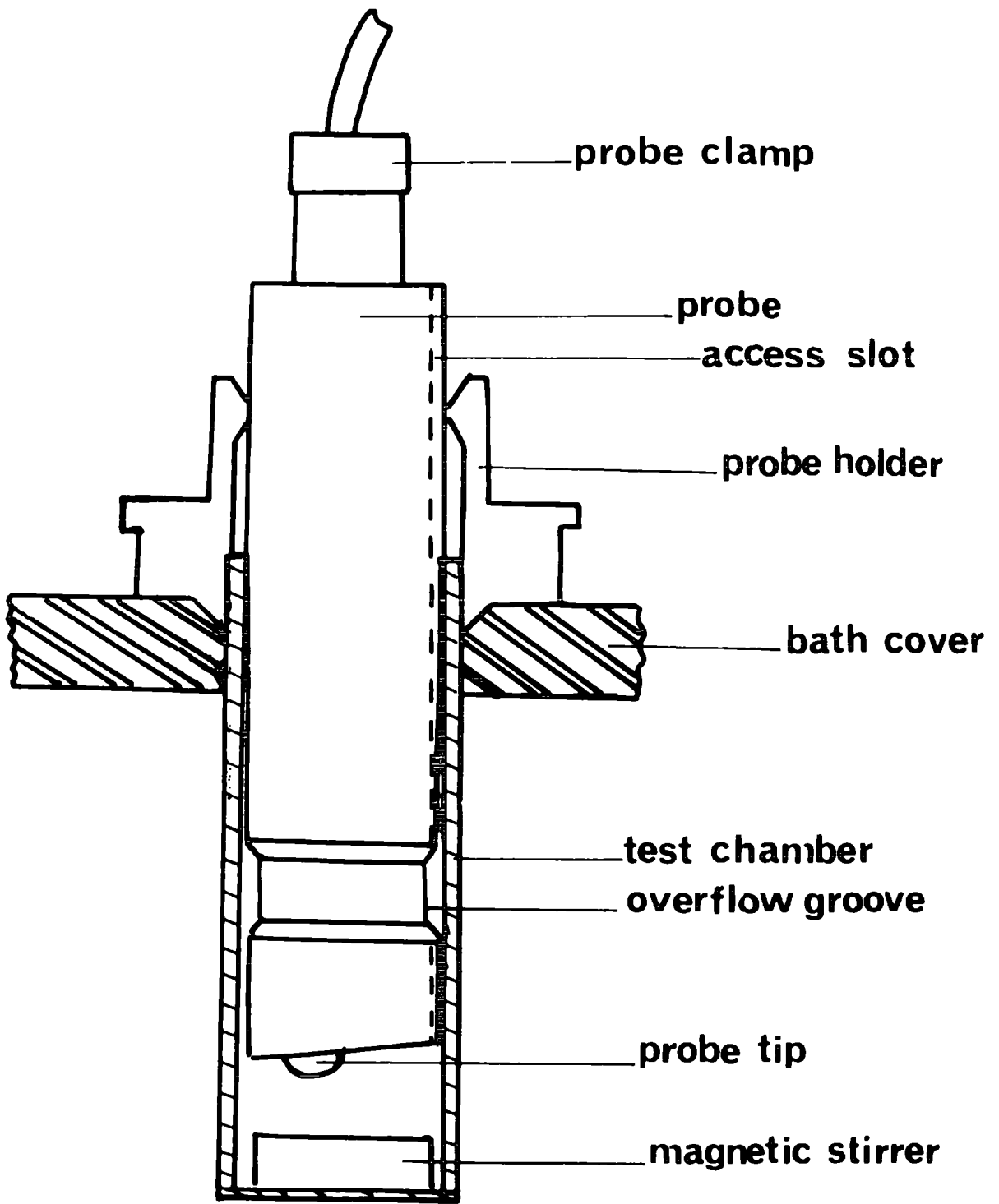

PROBE, PLUNGER & SAMPLE CHAMBER

solution. They were then subjected to one of two different experimental procedures.

a) The tubules were placed in an incubation chamber containing 3mls of air-saturated Ringer solution at 30°C, and were allowed to equilibrate for 10 minutes before the rate of oxygen uptake was determined polarographically as described above. The tubules were then removed from the chamber, rinsed in ice cold K⁺ free Ringer, and left to soak in fresh ice cold K⁺ free Ringer for 60 minutes. This was to deplete the tissue of K⁺ ions. At the end of this time the tubules were once more placed in an incubation chamber which contained 3mls of air-saturated K⁺ free Ringer at 30°C. Following a 10 minute incubation period the rate of oxygen consumption was determined. The tubules were then removed from the incubation chamber, once again soaked in "normal" ice cold Ringer for a further 60 minutes and their oxygen consumption subsequently redetermined. A series of control experiments were carried out where the procedure was as described above except that "normal" Ringer was used throughout.

b) The tubules were placed in incubation chambers containing 3mls of "normal" Ringer and allowed to equilibrate for 10 minutes at 30°C before the initial reading was taken. One ml of Ringer solution was then removed using an Oxford Macroset sampler pipette (1-5mls). This was replaced with 1ml

of "normal" Ringer solution containing 3mM ouabain. The solution was stirred making a final concentration of 1mM. ouabain in the chamber, The tubules were left in the incubation chamber, and the rate of oxygen consumption measured after 30 minutes. Control tubules were treated in exactly the same manner except that ouabain was omitted from the replacement Ringer.

The composition of the K^+ free Ringer solution used was as follows : NaCl 137.6mM, $MgCl_2$ 8.5mM, $CaCl_2$ 2.0mM, $NaHCO_3$ 10.2mM, NaH_2PO_4 4.3mM, Glucose 34mM. pH 7.2. The composition of the "normal" Ringer is described in the general Materials and Methods (Chapter 2).

Results

1) The effect of K^+ on oxygen consumption by the Malpighian Tubules

Soaking the Malpighian tubules in K^+ free Ringer for 60 minutes effected a significant decrease in the rate of oxygen consumption when compared to the original rate in "normal" Ringer ($P < 0.001$) (Fig. 5:2). In the control tubules no comparable decrease was observed and rate 2 was not significantly different from rate 1 (Table 5:1, Fig. 5:3). When the tubules from the K^+ free Ringer were resoaked in "normal" Ringer for a further hour the rate of oxygen consumption by the tubules showed a slight recovery. It is difficult, however, to determine accurately the extent of the "recovery" as a decrease

FIG. 5:2

Typical example of the effect of the absence of K^+ on the rate of oxygen consumption by Malpighian tubules.

Rate 1 (●) Immediately after dissection.

Rate 2 (▲) After 1 hour in K^+ free Ringer solution at $0^{\circ}C$.

Rate 3 (◻) After a further hour in 'normal' Ringer solution at $0^{\circ}C$.

Ordinate: rate of oxygen consumption μ moles O_2 /hour.

Abscissa: time in seconds.

FIG. 5:3

Typical example of the rate of oxygen consumption in control experiments where the tubules were soaked in 'normal' Ringer solution.

Rate 1 (●) Immediately after dissection.

Rate 2 (▲) After 1 hour in 'normal' Ringer at $0^{\circ}C$.

Rate 3 (◻) After a further hour in 'normal' Ringer solution at $0^{\circ}C$.

Ordinate: rate of oxygen consumption
 μ moles O_2 /hour.

Abscissa: time in seconds.

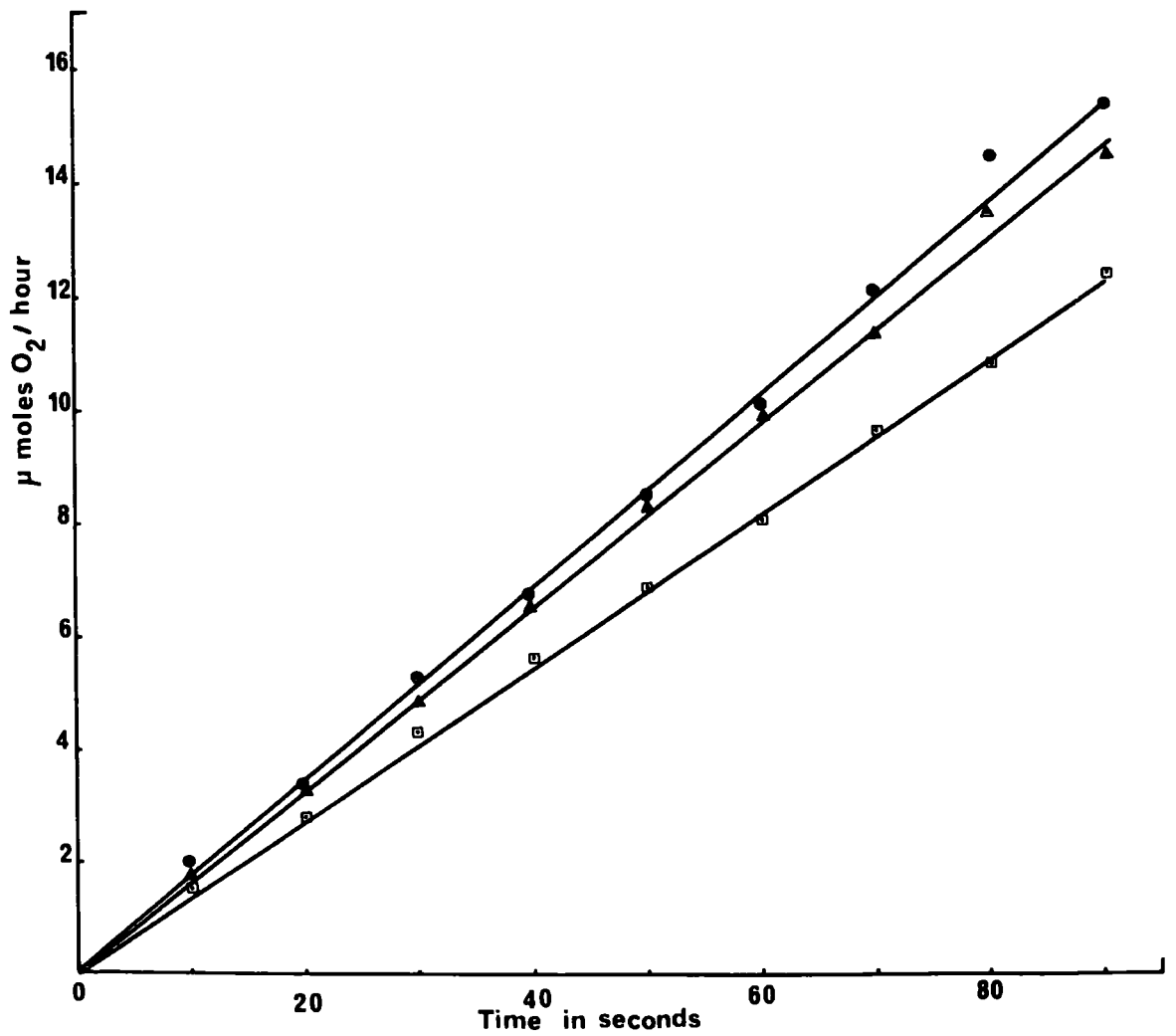
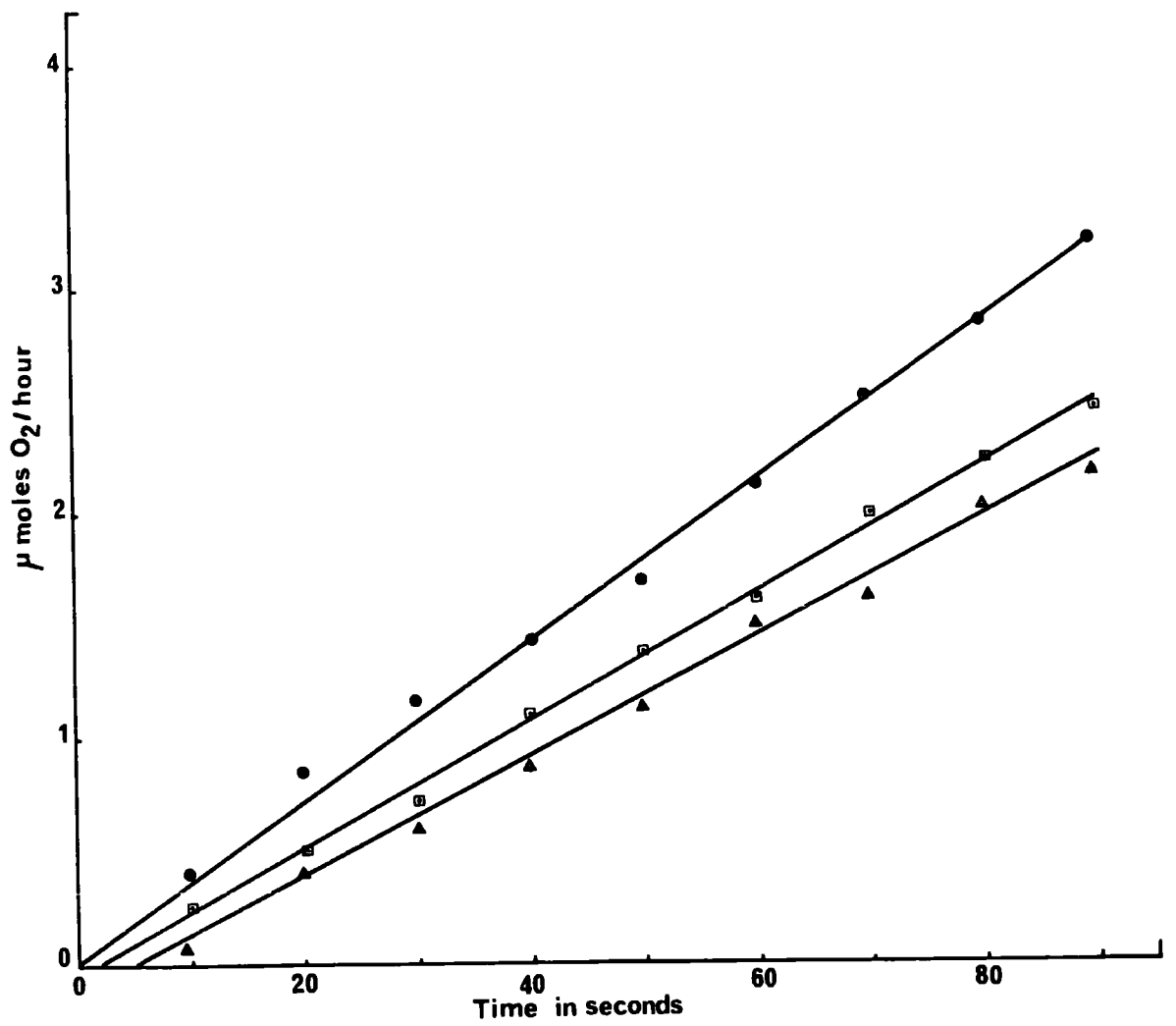

in the rate of oxygen consumption was also recorded in the control tubules after 2 hours (Table 5:1); presumably the result of an ageing effect. Comparison with the control values suggest that the recovery was more or less complete; this is especially clear when considering the rate of oxygen consumption as a % of the original rate (Table 5:2).

TABLE 5:1

Rate of oxygen consumption expressed as $\mu\text{moles O}_2/\text{hr}$.

	Rate 1 (normal)	Rate 2 (experimental)	Rate 3 (normal)	n
Experimental (K ⁺ free)	3.04 ± 0.22	1.94 ± 0.14	2.14 ± 0.21	18
Control	3.6 ± 0.25	3.10 ± 0.12	2.7 ± 0.23	17

TABLE 5 : 2

Rates of oxygen consumption expressed as % of the original rates

	Rate 2 as % of Rate 1	Rate 3 as % of Rate 1
Experimental (K ⁺ free)	62.63 ± 2.5	75.56 ± 6.3
Control	91.79 ± 5.8	76.74 ± 7.5

From Table 5:2 it can be seen that in the absence of K^+ ions there is an approximately 30% decrease in oxygen consumption.

2) The effect of ouabain on oxygen consumption by Malpighian Tubules

An initial series of experiments were carried out in which the rate of oxygen consumption by the Malpighian tubules was measured at 10 minute intervals after the addition of 1mM ouabain. Respiration rates were followed in this manner for 90 minutes. A series of control experiments were also carried out omitting the ouabain. The results on Table 5:3 show typical examples of control and ouabain treated values for the rate of oxygen consumption. (Further results Appendix 5(ii)). These are expressed as a % of the original rate in Fig. 5:4.

TABLE 5 : 3

Rate of oxygen consumption μ moles O_2 /hr

Time in Minutes	1mM Ouabain treated	Control
0	12.2	10.8
10	7.76	10.3
20	8.08	10.1
30	8.03	9.6
40	8.0	9.0
50	7.68	7.0
60	7.32	8.5
70	7.6	7.5
80	7.2	7.7
90	7.6	6.5

From the results in Table 5:3 and in fig. 5:4 it can be seen that an approximately 40% decrease in the rate of oxygen consumption by the Malpighian tubules occurred in the presence of 1mM ouabain. The effect of ouabain was maximal after 10 minutes. In the control tubules, a marked reduction in the rate of oxygen consumption occurred after 30 minutes. This is thought to be due to a tissue ageing effect which was more rapid at 30°C than at 0°C in the previous experiments. As no comparable ageing effect was observed in the ouabain treated tissue, it might suggest that it is the ouabain sensitive portion of tubule respiration which is susceptible to ageing.

A series of experiments were then carried out measuring the rate of oxygen consumption by tubules which had been soaked for 30 minutes in 1mM ouabain and comparing them with those soaked in normal ringer for the same time period. The mean results are shown in Table 5:4, and a typical example shown in Fig. 5:5.

TABLE 5 : 4 Rate of Oxygen consumption expressed as $\mu\text{moles O}_2/\text{hr}$

	Rate 1 (normal)	Rate 2 1mM ouabain	Rate 2 as % of Rate 1	n
Ouabain treated	4.28 \pm 0.44	3.03 \pm 0.39	70.74 \pm 3.36	21
Control	4.79 \pm 0.62	4.47 \pm 0.53	93.32 \pm 2.6	14

These results show that a significant 23% reduction in the rate of oxygen consumption by the Malpighian tubules occurred in the presence of 1mM Ouabain ($P < 0.001$)

FIG. 5:4

A typical example showing the rate of oxygen consumption as a function of time by Malpighian tubules soaked in 'normal' Ringer solution (●), or Ringer containing 10^{-3} M ouabain (⊙).

Ordinate: Oxygen consumption expressed as a % of the original rate (immediately after dissection).

Abscissa: time in minutes.

FIG. 5:5

Typical example of the effect of ouabain (10^{-3} M) on the rate of oxygen consumption by Malpighian tubules.

Rate 1. (●) in 'normal' Ringer solution immediately after dissection.

Rate 2. (⊠) After 30 minutes in Ringer solution containing 10^{-3} M ouabain at 30° C.

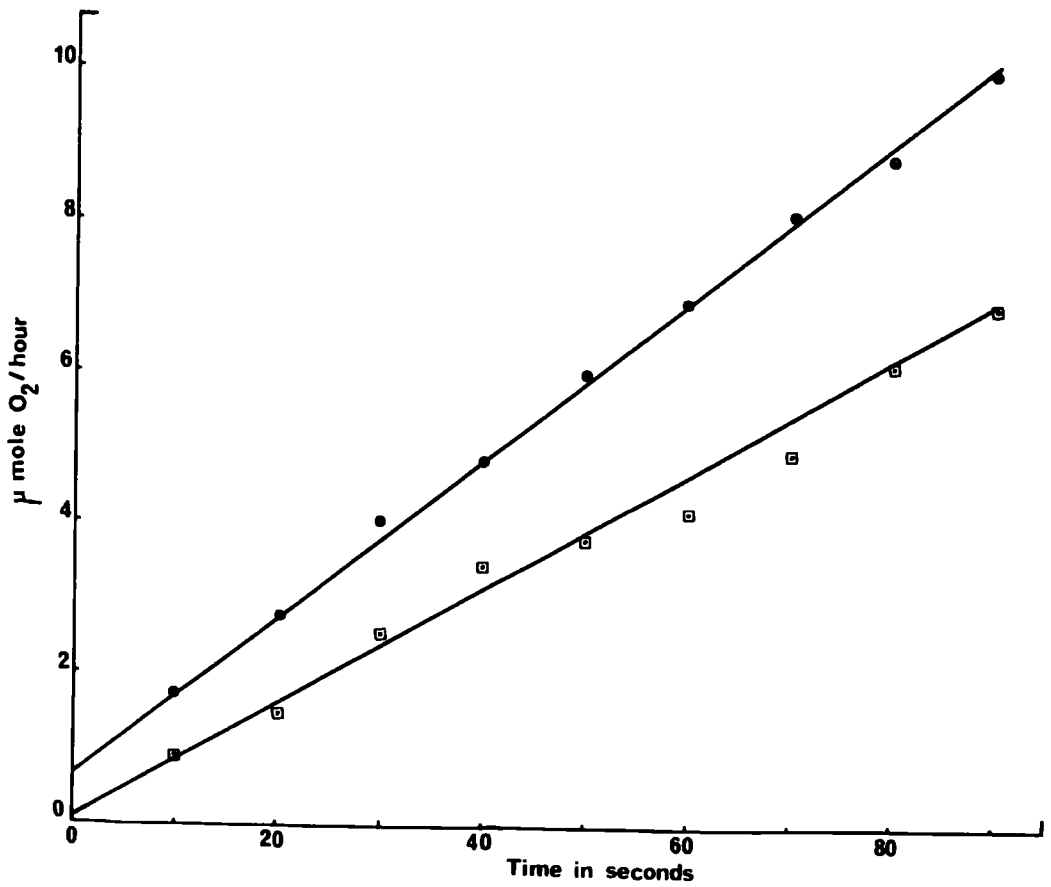
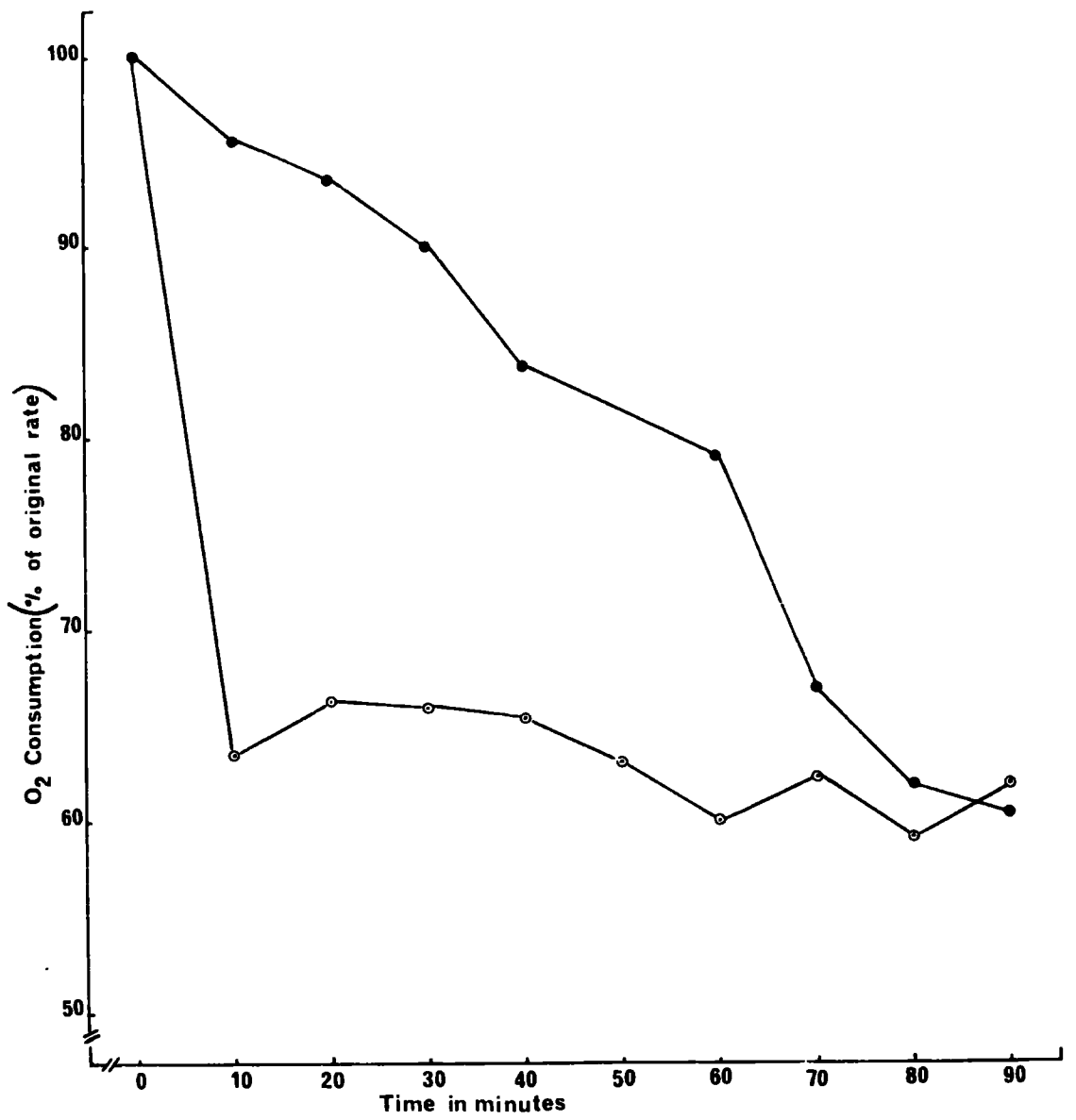

Discussion

From the oxygen electrode studies it would appear that approximately 33% of the oxygen consumed by the Malpighian tubules is involved in an active process requiring K^+ ions, and which is inhibited by ouabain. Since ouabain is a specific inhibitor of the $Na^+ - K^+$ ATPase enzyme, and as this enzyme has been shown to be present in the tubules (See previous chapter) the results presented here suggest the involvement of the enzyme in active cation transport across the membrane. These results agree with those obtained for kidney tissue (WHITTAM, 1961; 1962; WHITTAM and WILLIS 1962; 1963) where the presence of ouabain or absence of Na^+ have been shown to reduce oxygen consumption by as much as 40%. These results are directly comparable as Na^+ is the major cation transported in kidney tissue, but K^+ is of prime importance in Locusta tubules, (See Chapter 6). It seems, therefore, that the process of active transport ($Na^+ - K^+ -$ ATPase activity) appears to regulate part of the respiration in Locusta Malpighian tubules as it does in mammalian kidney, thereby ensuring the availability of energy in the form of ATP for its own activity.

The proposed interrelationship between $Na^+ - K^+$ ATPase activity and oxidative phosphorylation in Malpighian tubules is illustrated in Fig. 5:6.



FIG. 5:6

Diagram showing the proposed relationship between $\text{Na}^+ \text{K}^+$ ATPase activity on the cell membrane of a Malpighian tubule, and oxidative phosphorylation within a mitochondrion.

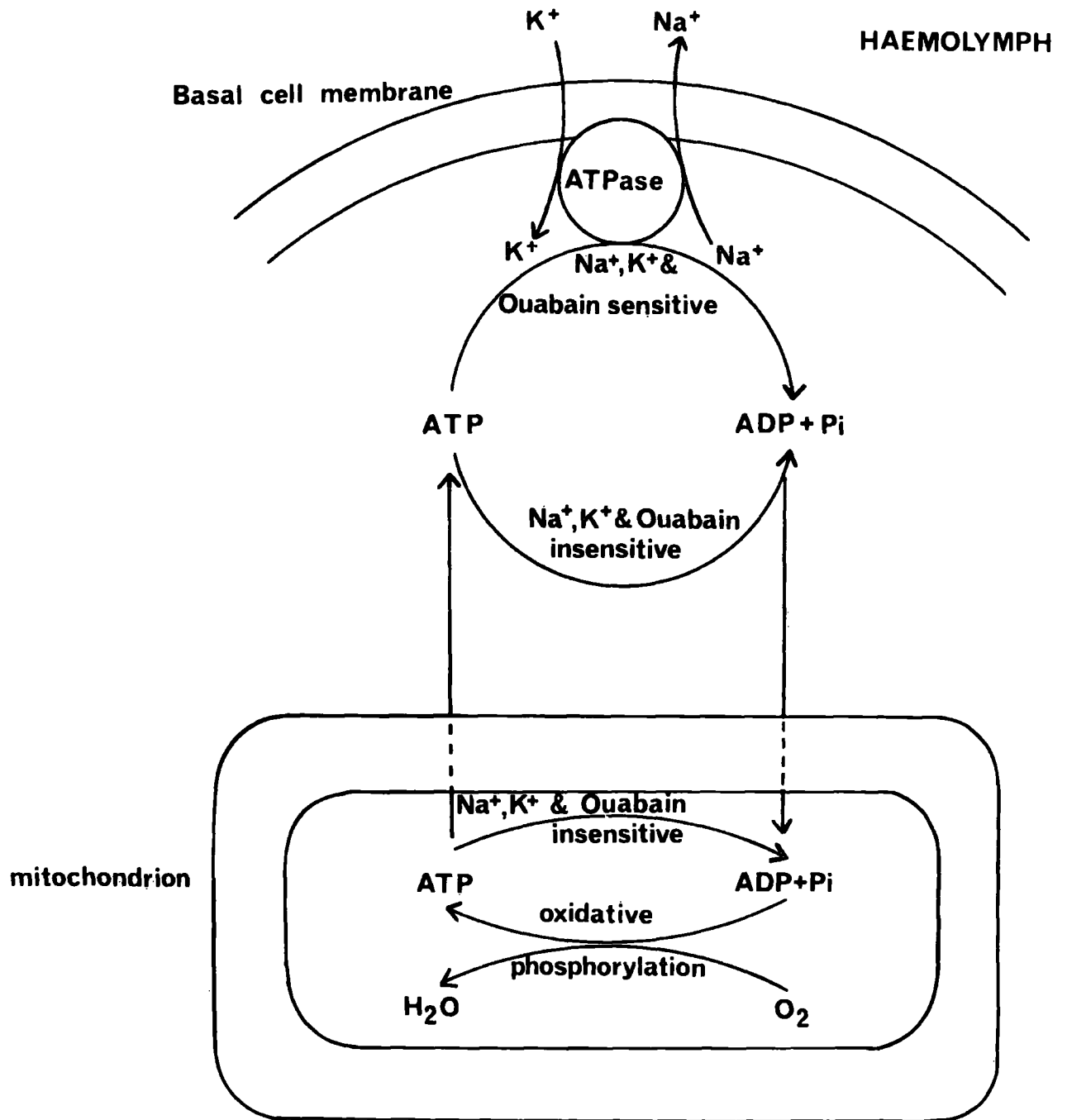

The $\text{Na}^+ \text{K}^+$ ATPase enzyme actively transports K^+ ions from the haemolymph into the cytoplasm across the cell membrane and Na^+ is transported in the opposite direction. The energy for this process is obtained from splitting ATP to ADP and phosphate. As ADP and phosphate accumulate they pass into the mitochondria and stimulate oxidative phosphorylation which results in the replenishment of the supply of ATP. $\text{Na}^+ \text{K}^+$ ATPase activity can therefore continue as there is always sufficient ATP available to provide the energy for active transport.

BLOND and WHITTAM (1964) carried out respiration studies on kidney homogenates instead of whole tissue. They found that the response to Na^+ free media and ouabain was the same as in whole tissue. They conclude that "The mechanism regulating this component of respiration in slices is still operative in disrupted tissue". This also agrees with the fact that in the present study the $\text{Na}^+ \text{K}^+$ ATPase enzyme has been shown to be active in tissue homogenates from Malpighian tubules (See previous chapter).

It would seem clear, therefore, that active transport, respiration and $\text{Na}^+ \text{K}^+$ ATPase activity are very closely coupled in Locusta Malpighian tubules. These results strongly suggest the involvement of the $\text{Na}^+ \text{K}^+$ ATPase enzyme in active cation transport across the Malpighian tubules of Locusta migratoria.

CHAPTER 6

Studies on fluid secretion by the Malpighian Tubules of Locusta migratoria in vitro

Introduction

RAMSAY (1954) devised an ingenious method for studying the secretion of urine by the isolated Malpighian tubules of Carausius, and he was able to show how urine production was affected by varying the composition of the bathing medium. This technique, with minor modifications, has been widely adapted and extensive studies have been carried out on a variety of insects. (reviews BERRIDGE, 1967; MADDRELL, 1971). For most insects it has been found that K^+ ions are essential for urine production by the tubules and it is thought that the active "pumping" of these ions from the haemolymph to the lumen creates the osmotic imbalance necessary for water to flow passively (RAMSAY 1953; 1954; BERRIDGE, 1968; MADDRELL and KLUNSUWAN, 1973). However, not all species of insect which have been investigated use K^+ as the "prime mover". For example Rhodnius (MADDRELL, 1969) uses both Na^+ and K^+ whereas Glossina (GEE, 1976) uses Na^+ .

BERRIDGE (1967) and BERRIDGE and OSCHMAN (1969) proposed a model to explain fluid transport across the Malpighian tubules of Calliphora.

They suggest that two active K^+ pumps exist, one on the basal surface, and one on the apical surface of the tubule cells. Due to the fact that in most species the in vitro rate of urine secretion is enhanced when Na^+ ions are present as well as K^+ (PILCHER, 1970b), they propose that at least one of the "pumps" is a $Na^+ K^+$ ATPase enzyme. However since fluid secretion continues in the absence of Na^+ in Calliphora they suggest that the "pump" on the apical surface of the cells is an electrogenic K^+ "pump", and that it is the rate at which K^+ is delivered to this second "pump" which determines the rate of urine production. Thus, in the event that the $Na^+ K^+$ ATPase was unable to function, urine could still be produced at a much reduced rate, due to the diffusion of K^+ to the apical "pump". If this model is correct, and a $Na^+ K^+$ ATPase is involved in fluid transport it would be expected that ouabain, a specific inhibitor of $Na^+ K^+$ ATPase would inhibit urine formation by the tubules. Several workers have tried, without success, to demonstrate this effect on isolated Malpighian tubules from a variety of different insects species (BERRIDGE, 1968; MADDRELL, 1969; PILCHER, 1970b; GEE, 1976) and consequently this has thrown doubt on the involvement of the $Na^+ K^+$ ATPase "pump". FARQUHARSON (1974b) however, has shown that fluid secretion by the Malpighian tubules of the pill millipede Glomeris marginata is inhibited by ouabain, and ATZBACHER et al (1974) have also shown that in Drosophila hydei ouabain reduces the rate

at which certain dyes are excreted via the Malpighian tubules.

The presence of a $\text{Na}^+ \text{K}^+$ ATPase enzyme has clearly been demonstrated in microsomal preparations from Malpighian tubules of Locusta (Chapter 4), and its possible involvement in fluid transport has been implicated by the effect of ouabain on tubule respiration (Chapter 5). The following study has been carried out to provide a clearer understanding of the factors involved in controlling cation and water transport across the Malpighian tubules of Locusta , and in particular to determine the extent to which the $\text{Na}^+ \text{K}^+$ ATPase enzyme characterised in Chapter 4 is involved.

Materials and Methods

Sexually mature locusts of both sexes were used throughout all the following experiments.

i) The determination of the rate of tubule secretion in vitro

In vitro measurements of fluid secretion by the Malpighian tubules were carried out using essentially the same technique as that described by MADDRELL and KLUNSUWAN (1973) with a few minor modifications. The gut of an experimental animal, with the head still attached, was immersed in a small volume of Ringer solution in a hollow in a perspex dish. The head remained outside the trough to prevent contamination by regurgitated fluid, and the rectum was ligated to prevent leakage of gut contents. The preparation was covered with liquid paraffin. Individual Malpighian tubules were drawn out of the Ringer trough into the liquid paraffin and looped around a small stainless steel peg (Fig.6:1). The tubule was then partially severed at a convenient point along its length using a tungsten needle, and the rate of secretion determined by measuring the rate of increase in the diameter of the approximately spherical droplet secreted from the cut.

The secretion rate for each tubule was determined by measuring the diameter of the secreted droplet at 5 minute intervals over a period of 40 minutes. At the end of this time the Ringer solution was replaced by a fresh solution which had either the same or a different

FIG. 6:1

Experimental arrangement involved in setting up in vitro preparations of Malpighian tubules.

Note : The hollow in the perspex dish containing Ringer in which the gut is placed. Individual Malpighian tubules looped around pegs out of the Ringer solution. The entire preparation is covered with liquid paraffin.

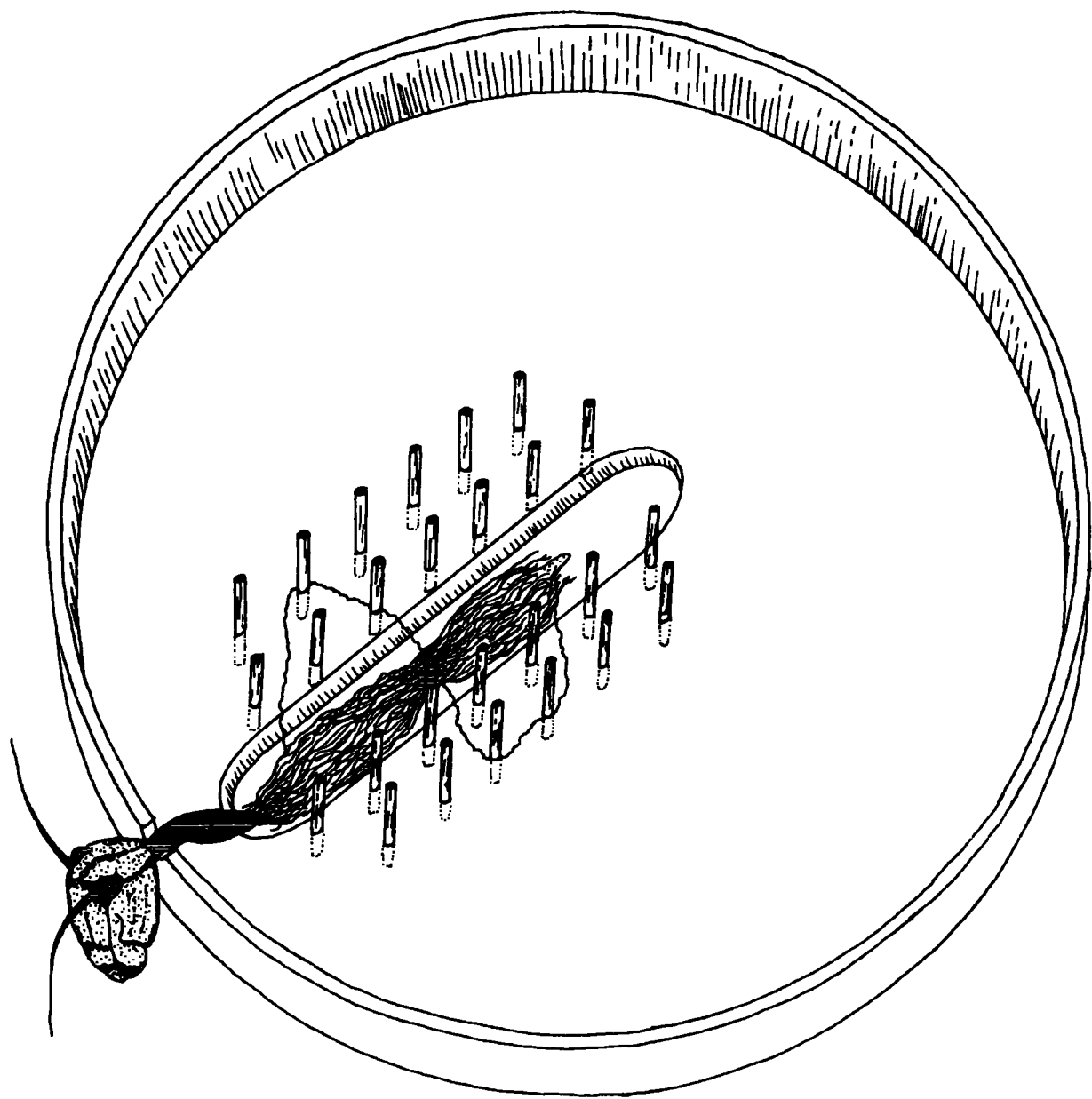

composition. After an equilibration period of 20 minutes the rate was re-determined for a further 40 minutes. The volume of fluid secreted was calculated in nls, by assuming the droplet to be a sphere, and the effect of the treatment was estimated by comparing the rates of secretion during the two periods of 40 minutes. Paired "t" tests were carried out to compare the two rates. It was found to be essential for each tubule to act as its "own control" in the manner described because considerable variation occurred in the rate of fluid secretion from individual tubules.

The temperature throughout was maintained at $30 \pm 0.5^{\circ}\text{C}$ by placing the perspex dish inside a water heated temperature chamber.

Experimental conditions varied from these described above in certain experiments and where this is so the variation in method will be described in the text.

ii) The determination of the Na^+ and K^+ composition of the urine.

The gut preparations were set up as outlined above either using 'normal' or modified Ringer solutions. After the initial 10 minute period the droplets were removed and discarded. This was to ensure that the 'urine' which was subsequently to be analysed was formed from the Ringer solution and not from the haemolymph prior to the dissection. The 'urine' secreted over the next 30 minutes

was collected from individual tubules using a 1 μ l microcap, transferred to a glass cavity slide which had been siliconized with "SILICLAD" (Clay Adams), and 'pooled' under liquid paraffin.

Na⁺ and K⁺ concentrations were determined on 0.5 μ l samples of "urine" in 3mls of deionized water by atomic emission spectroscopy, using a Pye Unicam SP90 spectrophotometer. Emission readings were referred to standard calibration curves constructed with known concentrations of NaOH and KOH (See Appendix 6. Figs. A:6:1, A:6:2).

AnalaR nitric acid washed pyrex glassware was used throughout.

iii) The determination of the effect of ouabain on the Na⁺ and K⁺ concentrations in the urine.

Urine samples from gut preparations in 'normal' Ringer solution were collected over an initial period of 30 minutes and analysed in the manner described in (ii) above. The 'normal' Ringer solution was then replaced with a fresh solution of 'normal' Ringer containing 1mM ouabain. Following an equilibration period of 10 minutes, at the end of which any droplets were discarded, urine was collected for the subsequent 30 minutes and its Na⁺ and K⁺ concentration determined. Control experiments were carried out in which 'normal'

Ringer was used throughout.

iv) The determination of the osmotic pressure of the 'urine'

The osmotic pressure was determined by the cryoscopic method of RAMSAY and BROWN (1955). 'Urine' samples were placed in 1 μ l microcaps both ends of which were blocked with liquid paraffin. The samples were frozen by immersion in a freezing mixture of 98% ethanol and solid CO₂, and the melting points determined. The results were converted from $\Delta^{\circ}\text{C}$ to m.osmoles by comparison with a standard curve (Appendix 6: Fig. A:6:3).

v) The determination of the effect of temperature on fluid secretion by the Malpighian tubules

The rate of urine secretion by in vitro Malpighian tubules was determined for 30 minutes at 30 $^{\circ}\text{C}$ in the manner described in (i) above. The temperature was rapidly re-adjusted to a desired level, the tubules allowed 15 minutes to equilibrate to the new temperature, and the rate of secretion was redetermined. The temperature was monitored continuously using a calibrated ITT bead thermostat connected into a Wheatstone bridge arrangement. (See Appendix 6. Fig. A:6:4 for calibration curve). The thermistor tip (diameter 0.5mm) was fixed into a hypodermic needle of 0.63mm bore with Araldite, and the needle inserted inside the gut. A continual flow of pure oxygen was

bubbled through the bathing medium throughout to ensure that oxygen depletion did not become rate-limiting at the higher temperatures.

An alternative Ringer solution buffered with H.E.P.E.S. (N.2-Hydroxy ethyl piperazine N2 ethansulfonic acid) pH7.2 was used instead of the 'normal' Ringer used elsewhere. This was found to be necessary because the pH of 'normal' Ringer varied considerably with temperature whereas that buffered with H.E.P.E.S. has been shown to be virtually independent of temperature (GOOD et al , 1966). The composition of H.E.P.E.S. Ringer solution was 100mM NaCl, 8.6mM KCl, 2mM CaCl₂, 8.5mM MgCl₂, 4mM NaH₂PO₄, 4mM NaHCO₃, 34mM glucose, 25mM H.E.P.E.S., 11mM NaOH (pH 7.2 at 30°C with NaOH). The temperature characteristics of the Ringer solutions are shown in Appendix 6 (Figs. A:6:5 and A:6:6.)

vi) The determination of the effect of ouabain on the ultrastructure of the Malpighian tubules

Locusts were killed by decapitation and the Malpighian tubules quickly removed by dissection. The mass of tubules from each animal was divided into two approximately equal parts. One part was soaked in 'normal' Ringer and the other in Ringer containing 1mM ouabain; both for 30 minutes at 30°C. They were then processed for either scanning or transmission

electron microscopy as described in Chapter 3.

Results

1) The effect of alterations in Na^+ and K^+ concentrations on fluid secretion by the Malpighian tubules

In view of the fact that Na^+ and K^+ ions are necessary for the $\text{Na}^+ \text{K}^+ \text{ATPase}$ enzyme to function, it would be expected that, if this enzyme was involved in fluid secretion by Locusta tubules, both ions would also be required for normal fluid production to occur. To test this, the effects of the presence or absence of these two cations on fluid secretion by the tubules were studied. The various Ringer solutions used are shown in table 6 :1, and the results obtained in Table 6 :2 .

When the tubules were placed in K^+ free Ringer the rate of secretion diminished to 12% of normal within 20 minutes (Fig. 6 : 3), and in over half the experiments fluid production subsequently stopped altogether. Attempts to revive the tubules by re-introducing K^+ ions failed. In Na^+ free, high K^+ Ringer solution fluid secretion, whilst reduced, still occurred at a fairly substantial rate. (Fig. 6:4) In this case, however, the effect was rather more variable than with the other solutions used. By contrast, when sodium was replaced by choline chloride there was a marked decrease in the rate of fluid secretion to 28.9% of the original rate, as measured in normal Ringer (Fig. 6: 5). Whilst the possibility remains that both choline chloride and high levels of K^+

TABLE 6:1

The composition of the experimental solutions (concentrations in mM)

	1	2	3	4
NaCl	129	137.6	-	-
KCl	8.6	-	137.6	8.6
MgCl ₂	8.5	8.5	8.5	8.5
CaCl ₂	2.0	2.0	2.0	2.0
NaHCO ₃	10.2	10.2	-	-
NaH ₂ PO ₄	4.3	4.3	-	-
KHCO ₃	-	-	10.2	10.2
KH ₂ PO ₄	-	-	4.3	4.3
Choline · Cl	-	-	-	129.0
Glucose	34.0	34.0	34.0	34.0

1 = normal; 2 = K⁺ free; 3 = Na⁺ free with excess K⁺; 4 = Na⁺ free with choline. All solutions adjusted to pH 7.2

TABLE 6 : 2

The effect of Na⁺ and K⁺ on the secretion of fluid by the Malpighian tubules

Treatment	No. of tubules	Mean rate of secretion (% of original \pm S.E.	P
Control	12	88.0 \pm 7.2	Not. sig.
K ⁺ free	12	12.0 \pm 6.8	P < 0.001
Na ⁺ free (with high K ⁺)	16	57.5 \pm 14.3	P < 0.01
Na ⁺ free (with Choline)	18	28.9 \pm 6.2	P < 0.001

(P values were obtained by comparing rate 1 and rate 2 by paired 't' tests)

FIG. 6:2

Typical example of a control experiment measuring the rate of fluid secretion by an individual Malpighian tubule during 2 consecutive 40 minute periods in "normal" Ringer solution.

Rate 1 (●).

Rate 2 (▲).

Ordinate: Volume of fluid produced (nl).

Abscissa: time in minutes.

FIG. 6:3

Typical example of the effect of the absence of K^+ on fluid secretion by an individual Malpighian tubule.

Rate 1 (●) in 'normal' Ringer solution.

Rate 2 (▲) in K^+ free Ringer solution.

Ordinate: Volume of fluid produced (nl).

Abscissa: time in minutes.

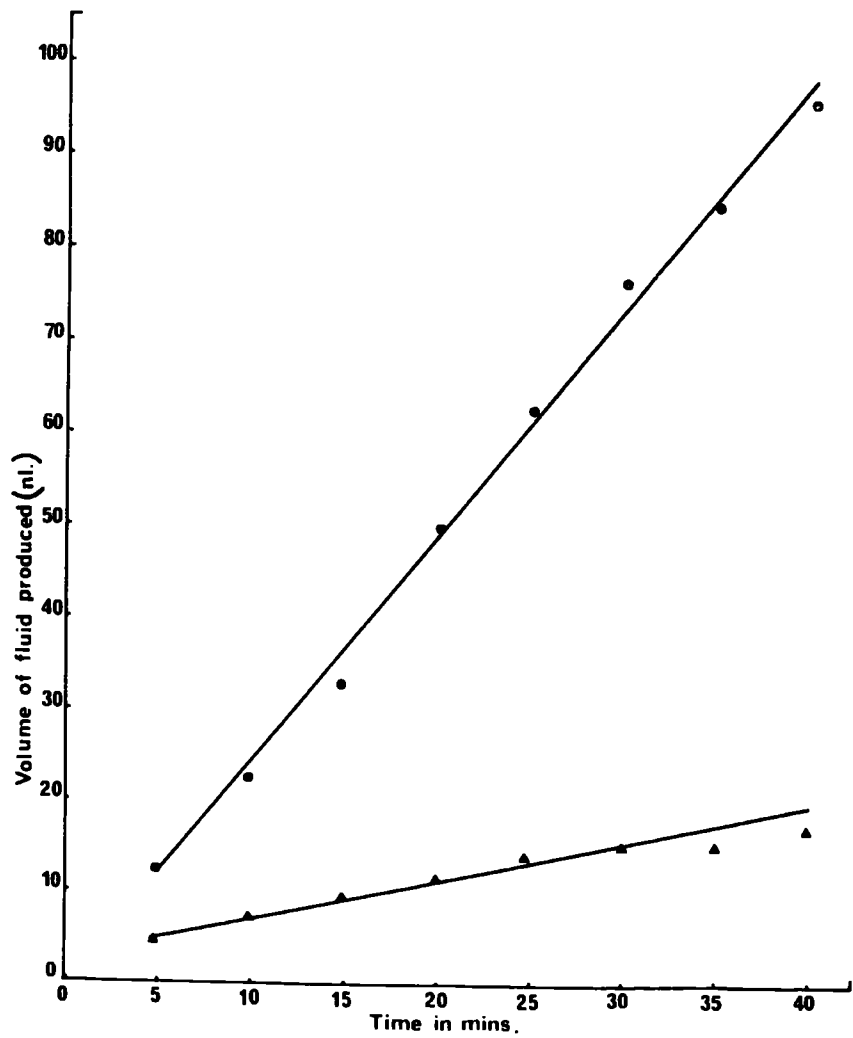
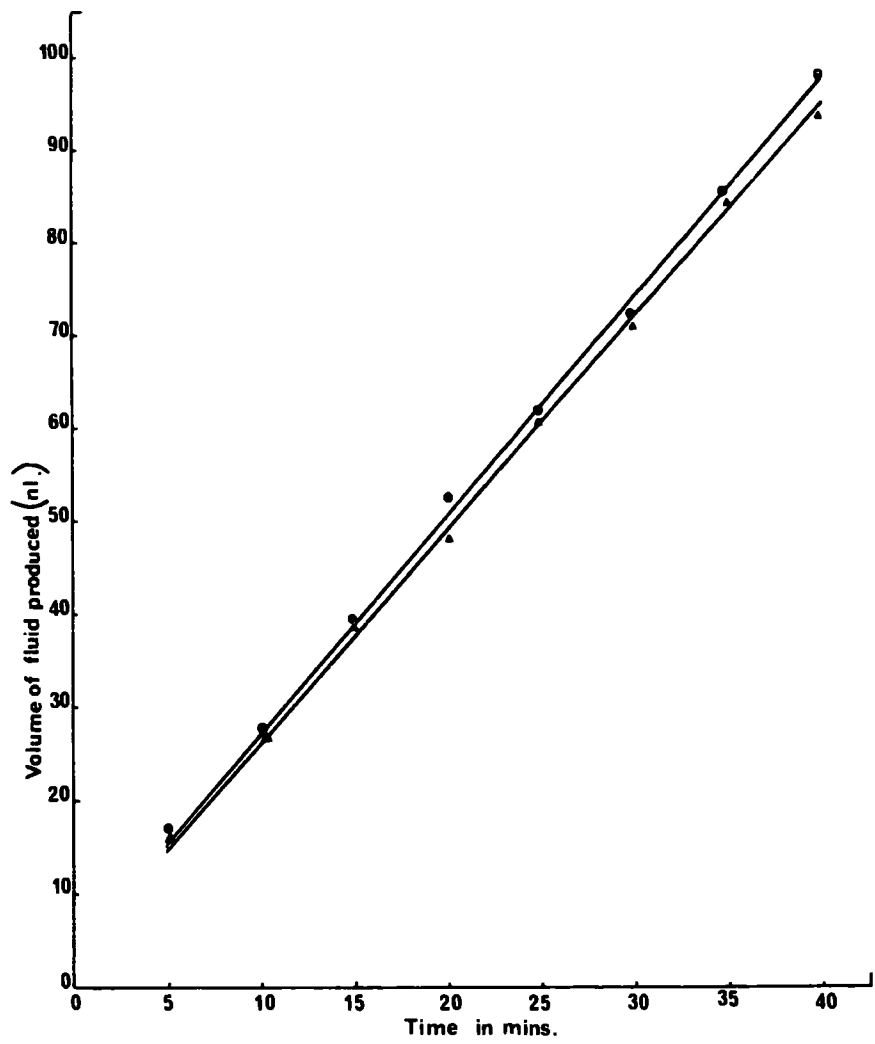

FIG. 6:4

Typical example of the effect of the absence of Na^+ on fluid secretion by an individual Malpighian tubule when Na^+ is replaced by K^+ .

Rate 1 (\circ) in "normal" Ringer solution.

Rate 2 (\blacktriangle) in Na^+ free (high K^+) Ringer solution.

Ordinate: Volume of fluid produced (nl).

Abscissa: time in minutes.

FIG. 6:5

Typical example of the effect of the absence of Na^+ on fluid secretion by an individual Malpighian tubule when Na^+ is replaced by choline.

Rate 1 (\circ) in "normal" Ringer solution.

Rate 2 (\blacktriangle) in Na^+ free (choline) Ringer solution.

Ordinate: Volume of fluid produced (nl).

Abscissa: time in minutes.

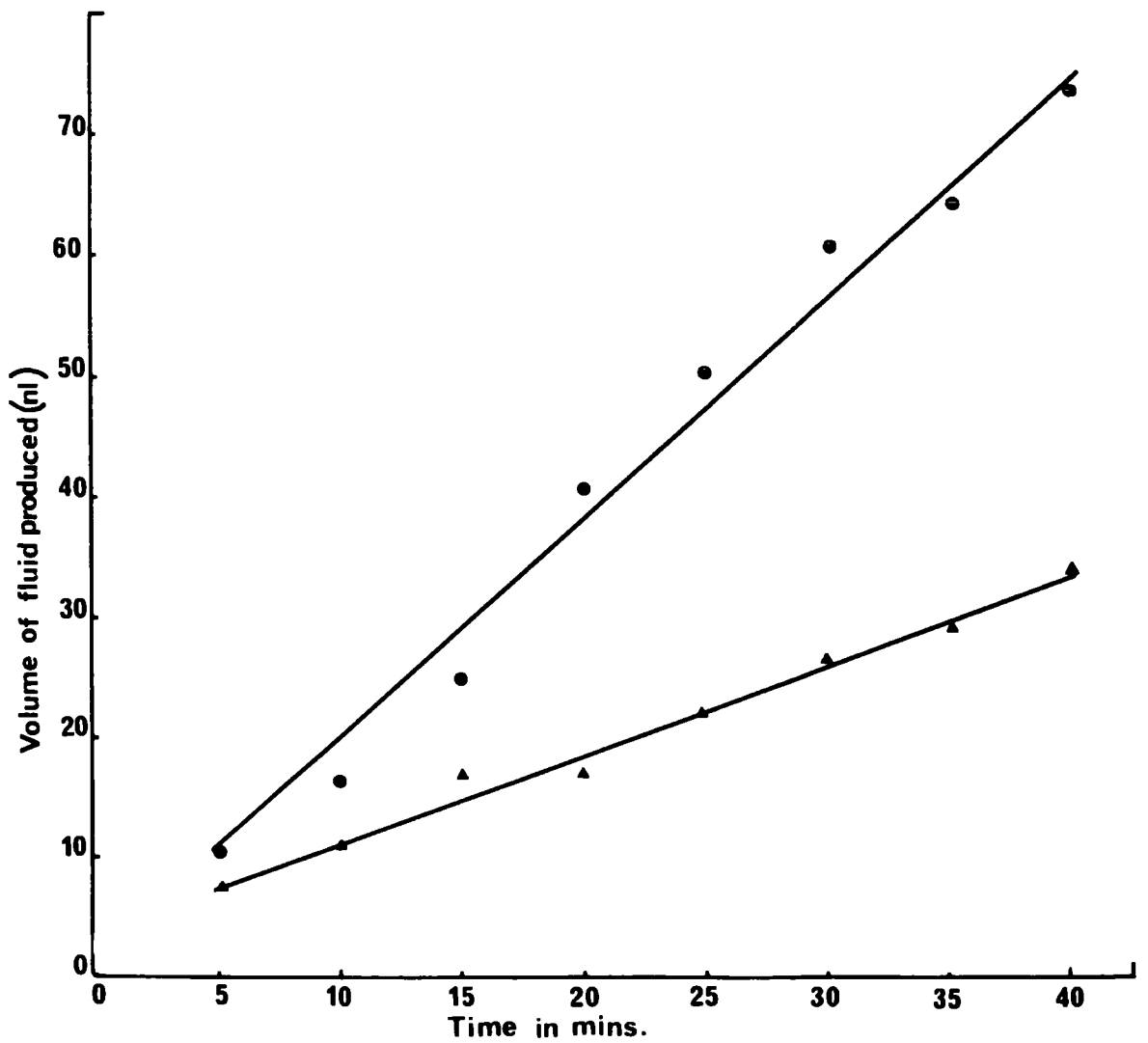
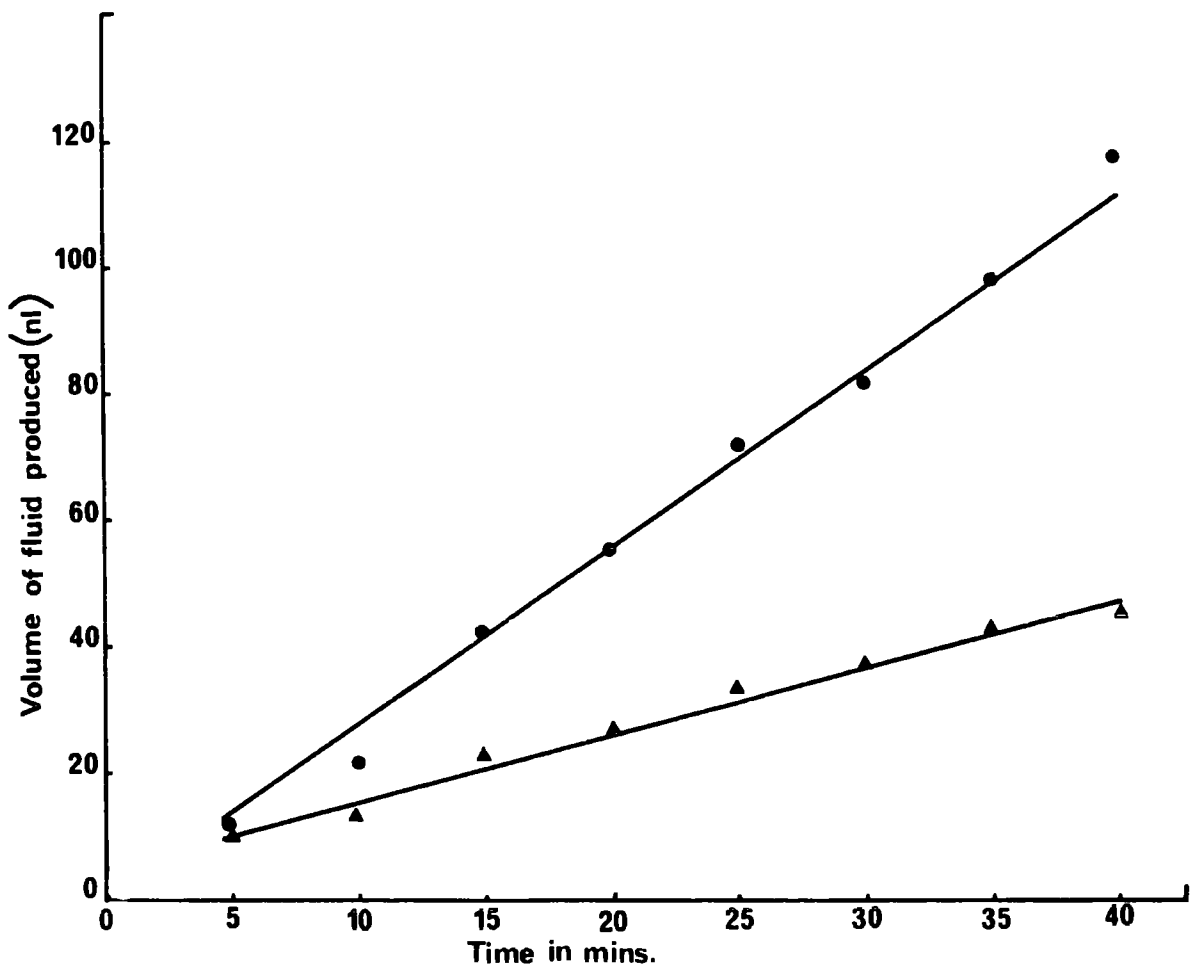

adversely affect fluid secretion per se, it does seem clear that both Na^+ and K^+ are necessary for the normal functioning of the tubules.

2) The effect of ouabain on fluid secretion by the Malpighian tubules

As ouabain has been shown to be a specific inhibitor of the Na^+-K^+ ATPase enzyme (SKOU, 1965) a critical test for the involvement of this enzyme in ion and water transport across Malpighian tubules was to determine whether fluid secretion by the tubules was ouabain sensitive. Experiments were carried out, therefore, to compare the rate of tubule secretion in 'normal' Ringer with that in 'normal' Ringer containing ouabain at concentrations of 10^{-7} to 10^{-3} M. The mean results are shown in table 6:3, and some representative examples of results obtained with individual tubules can be seen in Fig. 6:6.

TABLE 6:3 The effect of different ouabain concentrations on fluid secretion by the Malpighian tubules

Treatment (conc. Molar)	No. of tubules	Mean rate of secretion (original rate \pm S.E.)	P
Control	12	88.0 \pm 7.2	Not sig.
10^{-7} ouabain	16	77.6 \pm 12.7	Not sig.
10^{-6} ouabain	17	31.1 \pm 7.0	$P < 0.001$
10^{-5} ouabain	16	29.7 \pm 8.8	$P < 0.01$
10^{-4} ouabain	17	38.3 \pm 10.8	$P < 0.001$
10^{-3} ouabain	11	6.7 \pm 4.9	$P < 0.001$

(P were obtained by comparing rate 1 and rate 2 values by paired 't' test).

FIG. 6:6

Typical examples of the effect of various concentrations of ouabain on fluid secretion by individual Malpighian tubules. Fluid secretion was initially determined in normal Ringer solution (●) and subsequently in either fresh Ringer solution in the case of the control (■) or in fresh Ringer solution containing the indicated quantity of ouabain (▼).

Ordinate: Volume of fluid produced (nl).

Abscissa: time in minutes.

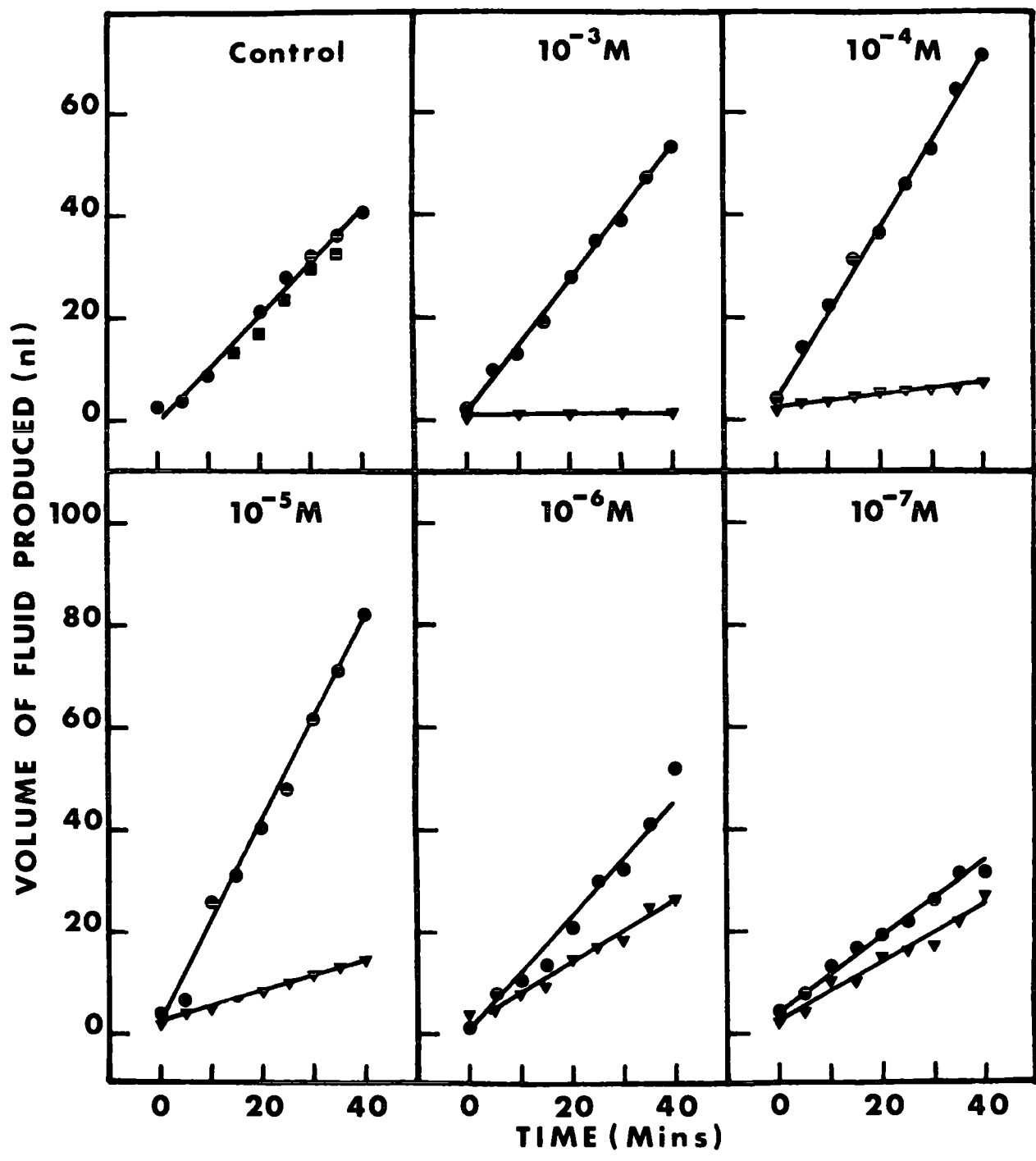

From the results it is evident that fluid secretion by the Malpighian of *Locusta* was inhibited by ouabain at concentrations between 10^{-6} and 10^{-3} M. The threshold for the response was between 10^{-6} and 10^{-7} M. This result clearly implicates $\text{Na}^+ - \text{K}^+$ ATPase action in urine formation. It was also noticeable that the movement of the tubules was also inhibited by ouabain at concentrations greater than 10^{-6} M after 30 minutes.

3) The Na^+ and K^+ composition of the secreted fluid

"Urine" was collected from tubule preparations which had been bathed in solutions with varying K^+ and Na^+ composition. The solutions were adjusted to maintain the total concentration of Na^+ and K^+ at 140mM, but the relative proportions of the two ions were altered. The results are represented graphically in Fig. 6:7 (also see Appendix 6 (i)).

It can be seen that K^+ ions were secreted much more readily than Na^+ even when they were present in much lower concentration in the bathing medium. At K^+ concentrations greater than 20mM (120mM Na^+) there was more than three times as much K^+ secreted as Na^+ . At very low K^+ concentrations, however, the amount of Na^+ increased considerably until it comprised 88% of the total Na^+ plus K^+ concentration in the urine was fairly constant with a mean value of 176.3mM. It would seem, therefore, that although K^+ is the preferred cation, Na^+ can also be secreted in conditions of very low K^+ .

FIG. 6:7

Concentrations of Na^+ and K^+ in the fluid secreted by Malpighian tubules of Locusta as a function of their concentration in the bathing medium. The vertical lines represent ± 1 .S.E. of the mean and the figures in brackets indicate the number of determinations.

Ordinate: Concentration in the urine (m. Molar).

Abscissa: Concentration in the bathing medium
(m. Molar).

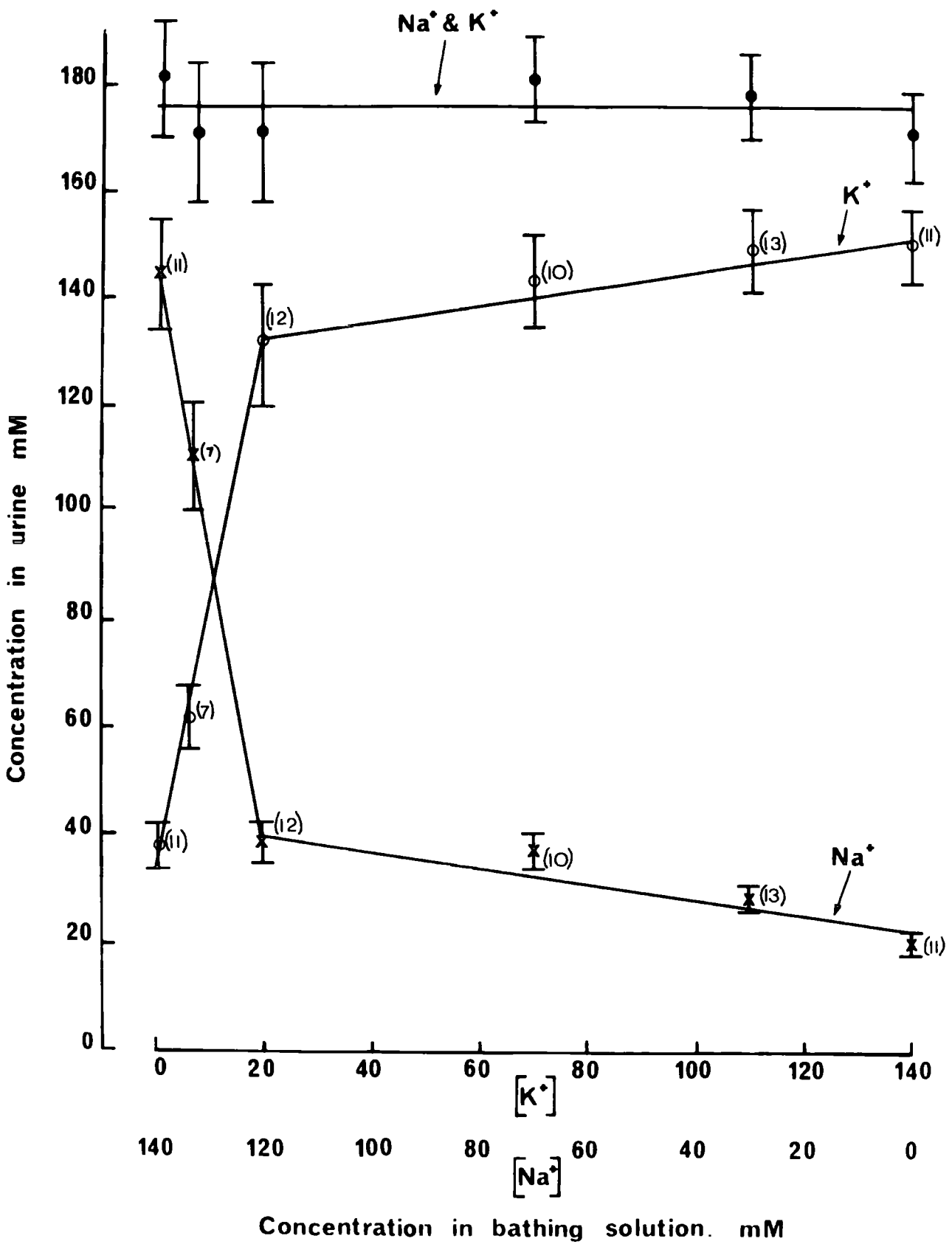

4) The effect of ouabain on the Na^+ and K^+ levels in the urine

The Na^+ and K^+ concentration in samples of urine obtained from tubules immersed in 'normal' Ringer for 30 minutes was compared with the concentrations of these ions after the tubules had been immersed for a second 30 minutes in Ringer solution containing 1mM ouabain.

As shown in (2) above, fluid secretion was inhibited in the presence of ouabain and consequently difficulty was sometimes encountered in obtaining exactly 0.5 μ l samples of urine for analysis. To overcome the variation in sample volume together with the difficulty in determining the exact volume collected, it was necessary to compare the ratio of Na^+ : K^+ in the samples and not the precise amounts of each ion present. The results obtained are shown in table 6:4.

TABLE 6:4 The effect of Ouabain on the $\text{Na}^+:\text{K}^+$ ratio in the urine

	Initial $\frac{\text{Na}}{\text{K}}$ (a)	Final $\frac{\text{Na}}{\text{K}}$ (b)	(b) as a % of (a)	n	P
Control	0.76 ± 0.21	0.78 ± 0.13	104 ± 17.2	12	Not sign.
1mM ouabain	0.6 ± 0.1	1.5 ± 0.34	244 ± 19.9	8	$P < 0.01$

(P values were obtained by comparing the initial ratio (a) with (b) using a paired 't' test)

5) The effect of osmotic pressure on the rate of fluid secretion by the Malpighian tubules

The osmotic pressure of 'normal' Ringer solution was decreased by the addition of deionised water, and it was increased by the addition of sucrose. The rate of urine secretion was determined for 30 minutes in normal Ringer (364mOsmoles) in the manner described previously. The Ringer solution was then replaced with a solution of modified osmotic pressure, the tubules allowed 10 minutes to equilibrate, and the rate of secretion redetermined. The results are presented graphically in Fig. 6:8 (See also Appendix 6(ii)).

It can be seen that the relationship between the rate of fluid production and the osmotic concentration of the bathing medium was sigmoidal; the rate being slow in an osmotically high medium and rapid in a medium with a low osmotic pressure. At osmotic concentrations below 86mOsmoles, however, the rate of secretion was initially very high, but this rate was not sustained and in many cases fluid production stopped completely. This may well have been related to the K^+ level (0.86mM) and to a lesser extent the Na^+ (12.9mM), becoming rate limiting as a result of dilution of the Ringer solution.

FIG. 6:8

Effect of the osmotic concentration of the bathing solution on the rate of fluid secretion by Malpighian tubules. The vertical lines represent \pm 1.S.E. of the mean, and the figures in brackets indicate the number of determinations.

Ordinate: rate of fluid secretion expressed as a % of the rate in "normal" Ringer solution.

Abscissa: osmotic concentrations of the bathing solution (m. Osmoles).

FIG. 6:9

Effect of the osmotic concentration of the bathing solution on the osmotic concentration of the "urine" secreted by the Malpighian tubules.

Ordinate: osmotic concentration of the secreted fluid (m. Osmoles).

Abscissa: osmotic concentration of the bathing solution (m. Osmoles).

(The line drawn is an iso-osmotic line).

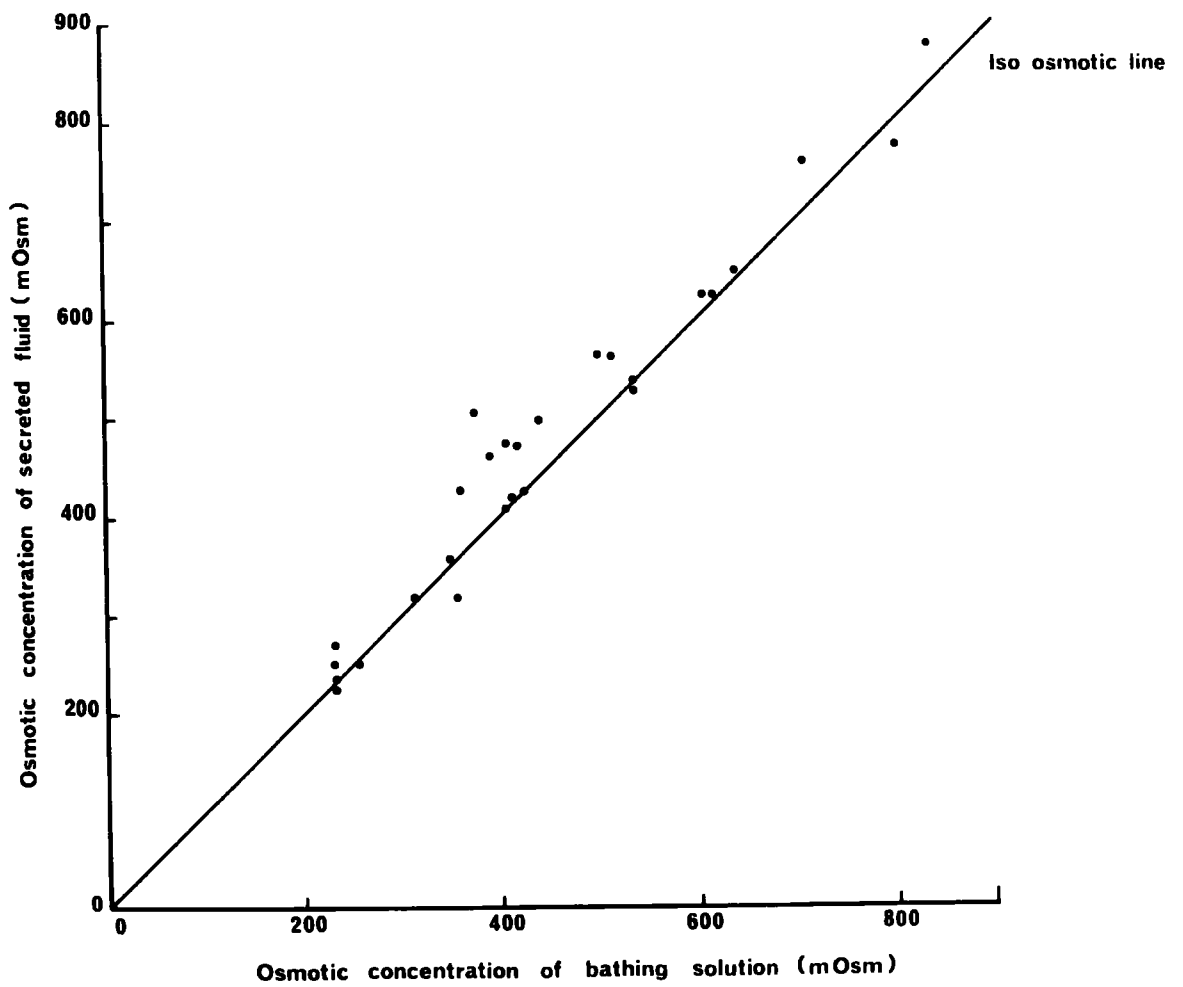
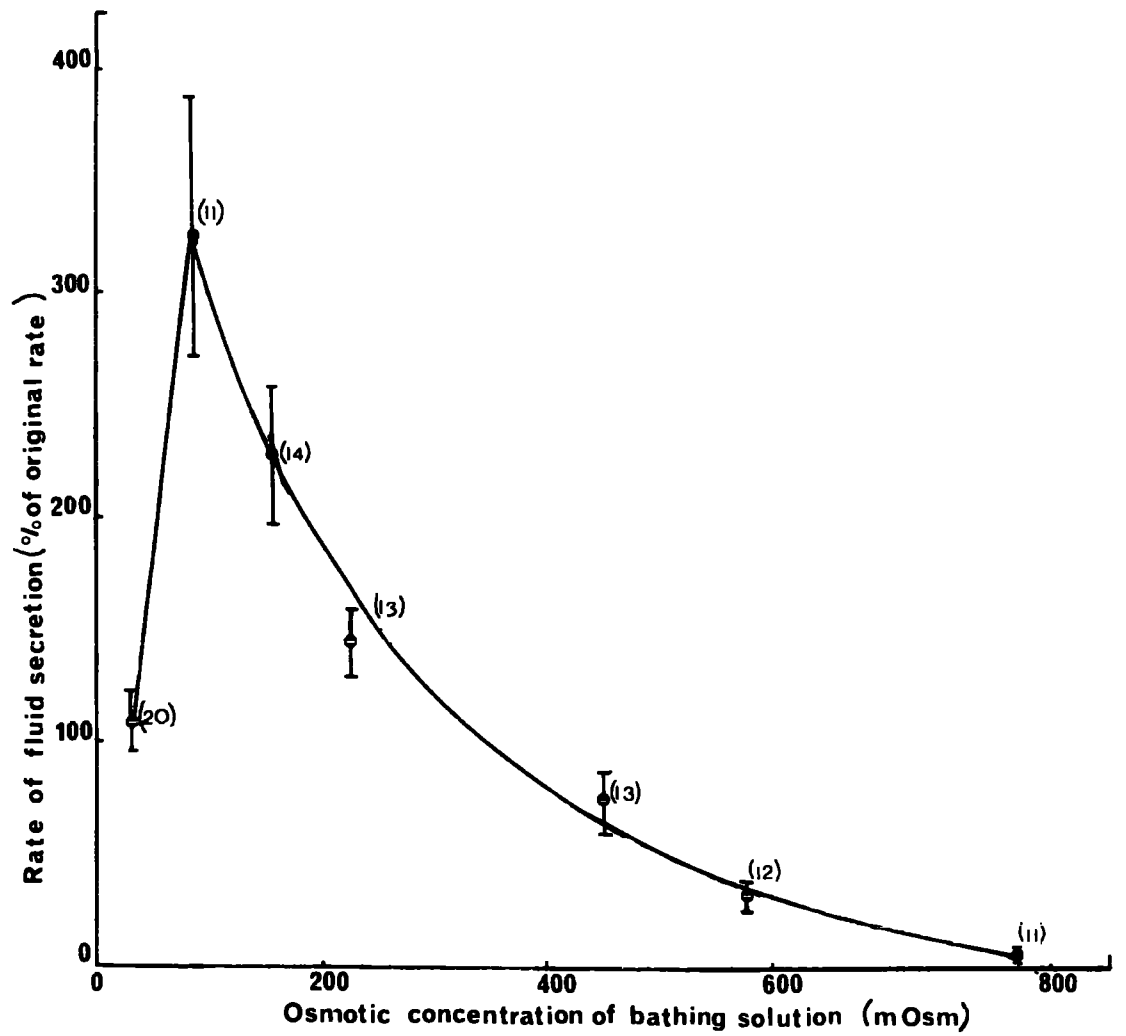

6) The osmotic concentration of the secreted fluid

In a further series of experiments the osmotic pressure of the 'urine' was compared with that of the bathing fluid. The results attained are shown in Fig. 6:9. The 'urine' produced was marginally, but consistently hypertonic to the bathing medium over a wide range of osmotic concentrations by some 22.9 ± 2.6 mOsmoles. Application of χ^2 tests indicate that this hypertonicity is significant ($P < 0.001$).

7. The effect of temperature on fluid secretion by the Malpighian tubules

The results showing the effects of temperature on Malpighian tubule secretion are represented graphically in Fig. 6:10 (see also Appendix 6(iii)). Fluid secretion increased with temperature between 5° - 40° C. Beyond 40° C, however, the effect of temperature became very erratic (hence the large standard error) with many tubules secreting rapidly initially but being unable to support fluid production for more than approximately 10 minutes. At high temperatures the tubule movement was also greater, and many tubules snapped. It would appear, therefore, that 40° C was the maximum temperature for efficient tubule function under these conditions.

An Arrhenius μ plot of the data is shown in Fig. 6:11. Unlike the ATPase graphs there was no "break" point observed

FIG. 6:10

The effect of temperature on the rate of fluid secretion by the Malpighian tubules. The vertical lines represent \pm 1.S.E. of the mean, and the figures in brackets indicate the number of determinations.

Ordinate: rate of fluid secretion expressed as a % of the rate at 30°C.

Abscissa: Temperature °C.

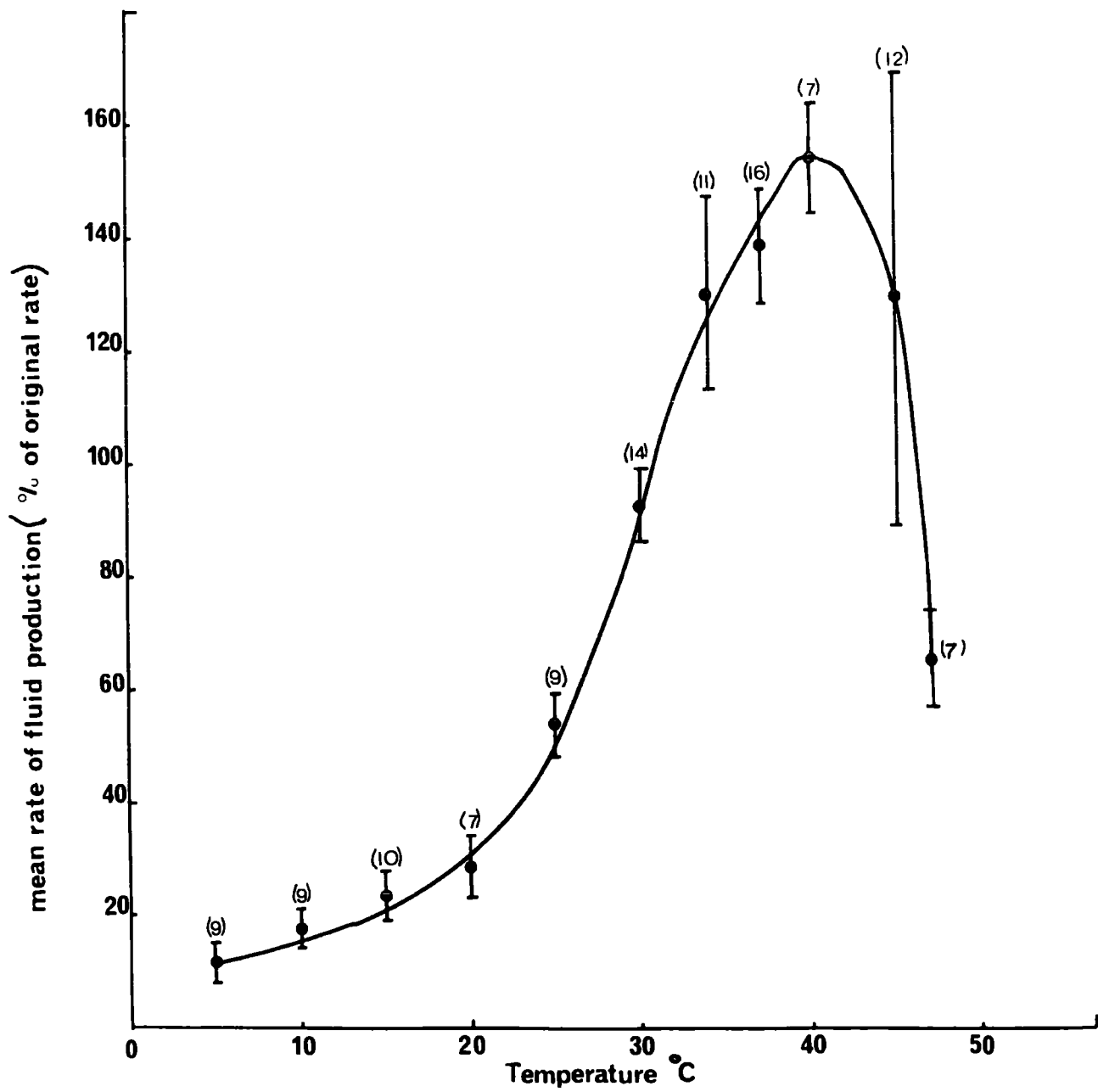

FIG. 6:11

Arrhenius μ plot showing the effect of temperature on fluid secretion by Malpighian tubules.

Ordinate: \log_{10} of the rate of secretion
(expressed as a % of the rate
at 30°C).

Abscissa: reciprocal of temperature in
degrees Absolute $\times 10^3$.

(Line fitted by regression analysis).

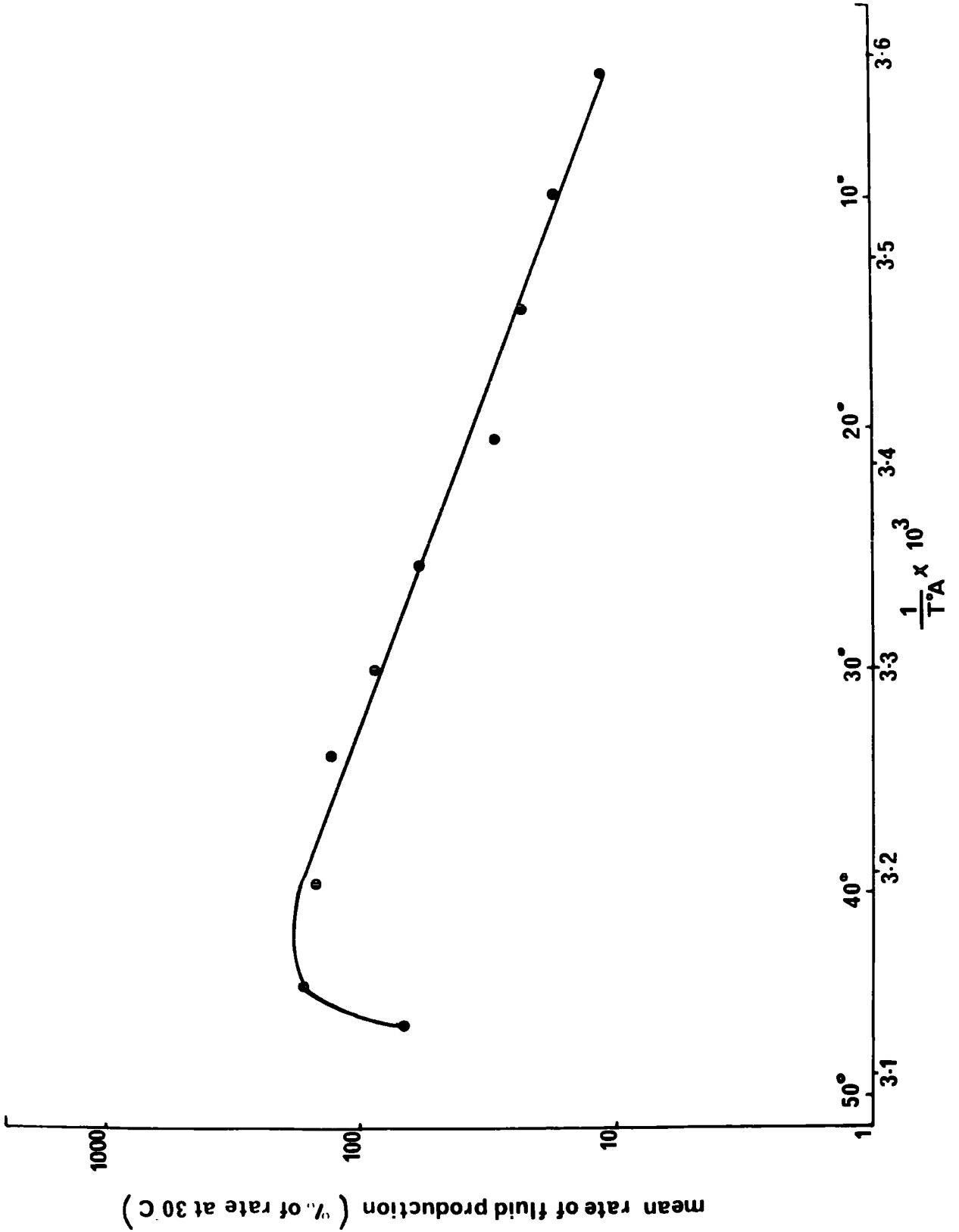

around 20°C and the plot was linear. The Arrhenius μ value for fluid secretion was 58.3 K.joules.

8. The effect of Cyclic AMP on fluid secretion by the Malpighian tubules

After 30 minutes in 'normal' Ringer the preparations were exposed to a Ringer solution containing cyclic AMP at concentrations varying between 10^{-5} - 10^{-2} M. The secretion rate was monitored for 60 minutes following the addition of cyclic AMP.

The effect of cyclic AMP was most marked at 10^{-3} M with a threshold for stimulation between 10^{-4} and 3×10^{-4} M (Fig. 6:12; Appendix 6(iv)). Fig. 6:13 shows the typical response shown by an individual tubule to 10^{-3} M cyclic AMP. Some stimulation was noted almost immediately, however maximum stimulation occurred between 10 and 20 minutes after the addition of cyclic AMP. Thereafter the rate returned to approximately its original level (i.e. rate 1).

9. The effects of 5-Hydroxytryptamine (5HT) on fluid secretion by the Malpighian tubules

The effect of 5HT (creatinine sulphate complex) on fluid secretion was examined. The experimental procedure was identical with that used in 8 above. The results are shown in Table 6:5.

FIG. 6:12

Effect of cyclic AMP on fluid secretion by Malpighian tubules. The vertical lines represent ± 1 .S.E. of the mean, and the figures in brackets indicate the number of determinations.

Ordinate: rate of fluid production (expressed as a % of the rate in 'normal' Ringer solution).

Abscissa: negative \log_{10} cyclic AMP concentration.

FIG. 6:13

A typical example of the effect of 10^{-3} M cyclic AMP on fluid secretion by an individual Malpighian tubule (Arrow indicates change from Normal Ringer solution to Ringer containing cyclic AMP).

Ordinate: rate of fluid secretion (nl/min).

Abscissa: time in minutes.

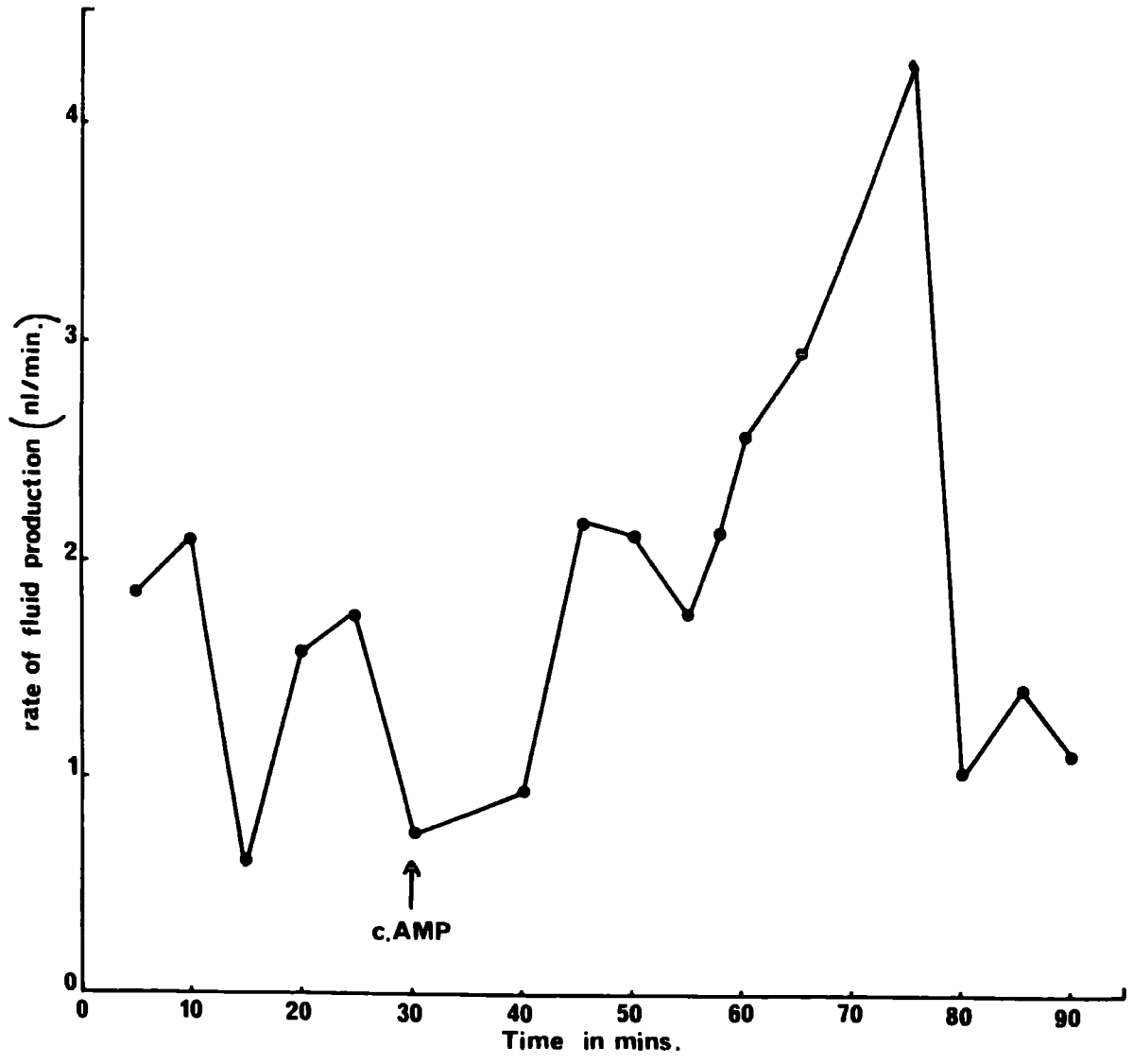
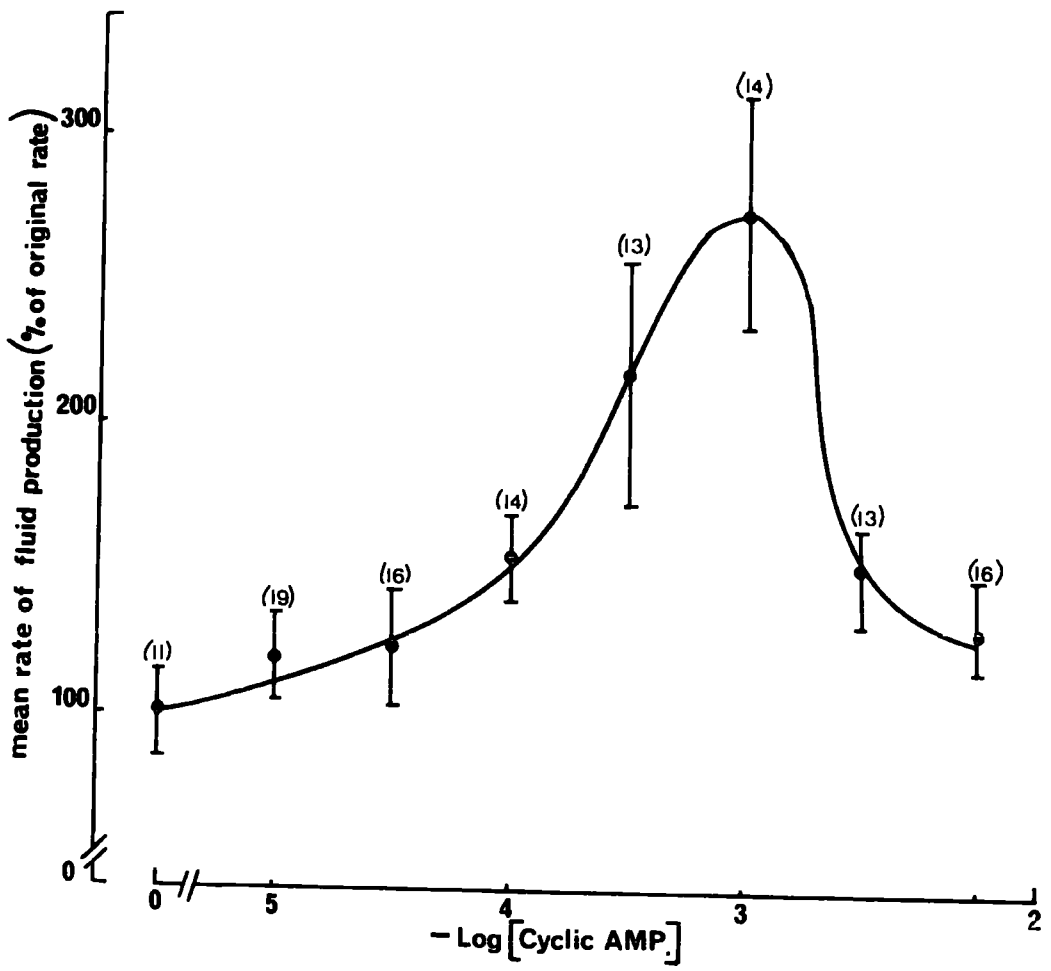

Table 6:5 The effect of 5HT on fluid secretion by the Malpighian Tubules

Conc. 5HT M	Mean rate of fluid secretion as % of original rate \pm S.E.	P	n
0	98.3 \pm 14	not sig.	11
10 ⁻⁸	109.3 \pm 14	not sig.	9
10 ⁻⁷	120.0 \pm 20	not sig.	19
10 ⁻⁶	124.9 \pm 10.4	not sig.	15
10 ⁻⁴	128.1 \pm 19.8	not sig.	12

(P values were obtained by comparing rate 1 and rate 2 by a paired 't' test.)

It can be seen that 5HT had no effect on fluid production by the Malpighian tubules at concentrations between 10⁻⁸ and 10⁻⁴M.

10) The effect on Ouabain and low osmotic pressure on tubule ultrastructure

This study was carried out primarily to determine the effect of 1mM ouabain on the fine structure of the Malpighian tubule cells. Initially tissues soaked in 'normal' Ringer solution for 30 minutes were compared with those soaked in 'normal' Ringer solution containing 1mM ouabain for the same period. Neither scanning nor transmission electron microscopy revealed any

difference in fine structure between the two treatments; nor did either differ from the normal appearance of Malpighian tubule structure described in Chapter 3.

The transmission electron microscopy study was then extended to examine the ultrastructure of rapidly secreting tissue to determine whether fine structural changes were associated with the physiological state of the cells, and the extent to which any such change was ouabain sensitive. To this end the tissue was soaked in either 25% normal Ringer solution or in 25% Ringer solution containing 1mM ouabain. (It had previously been shown that 25% of normal Ringer caused a marked increase in the rate of urine secretion (see section 5)).

The results obtained indicate that soaking the tubules in 25% Ringer solution effected a marked change in fine structure compared with tissue soaked in 'normal' Ringer (c.f. Plates 27, and 28). In particular the extracellular spaces were considerably expanded on the basal cell border with large spaces extending deep into the cytoplasm. In contrast the microvillar border appeared relatively unaffected. Mitochondria and other cell organelles appeared intact and apart from an increased electron density of the cytoplasm no other changes in fine structure were apparent. Once again ouabain had no effect on fine structure. It is clear, therefore, that the effect of ouabain on fluid secretion by Malpighian tubules is not the result of this drug producing changes in cellular fine structure.

PLATE 27 and PLATE 28

Transmission electron micrographs of a T.S. through the basal region of Malpighian tubules.

PLATE 27

The appearance of a tubule which has been previously soaked in "normal" Ringer solution for 30 minutes prior to fixation.

Scale = $2\mu\text{m}$

PLATE 28

The appearance of a tubule which has been previously soaked in 25% "normal" Ringer solution for 30 minutes prior to fixation.

Scale = $2\mu\text{m}$

Comparison between plate 27 and plate 28 shows the considerable distortion of the extracellular spaces (E_s) between the basal infoldings in the tubule soaked in 25% Ringer solution. Note also the substantial increase in the electron density in plate 28 and consequently the loss of definition of the cell organelles.

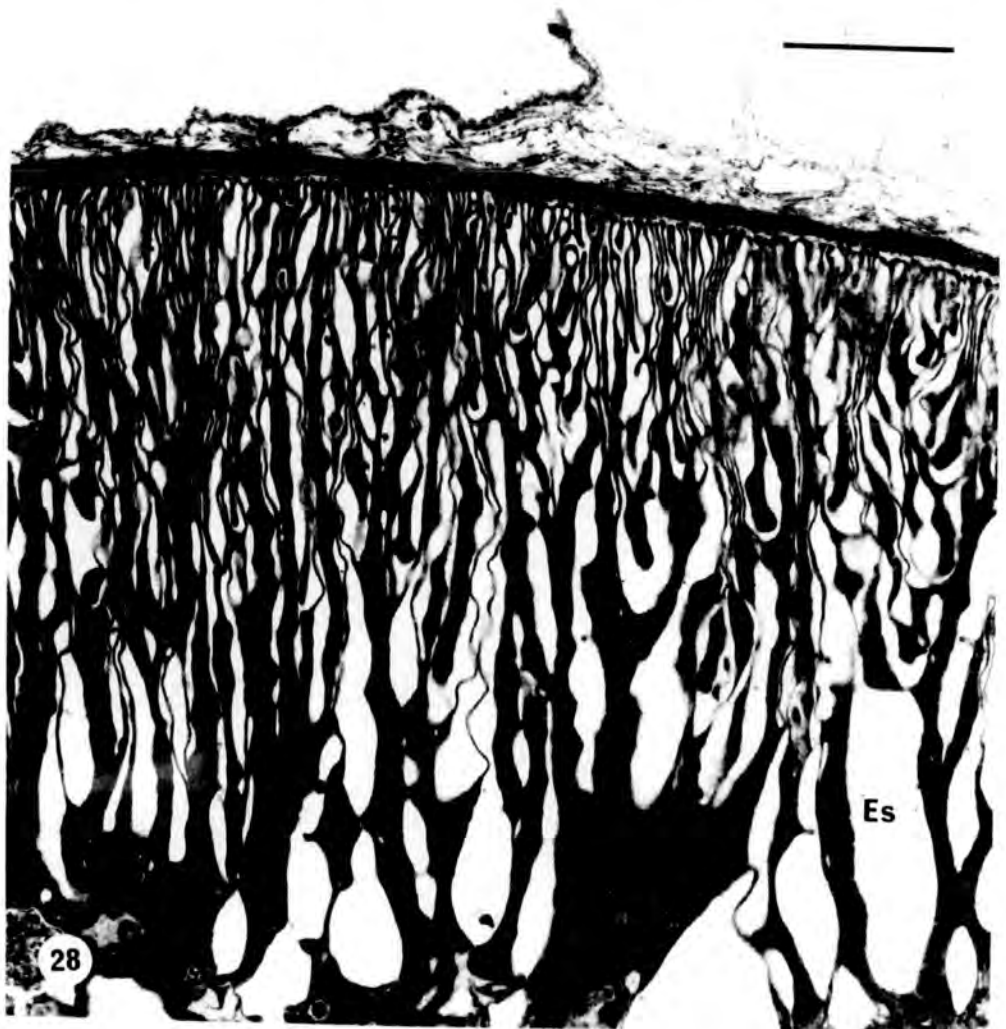
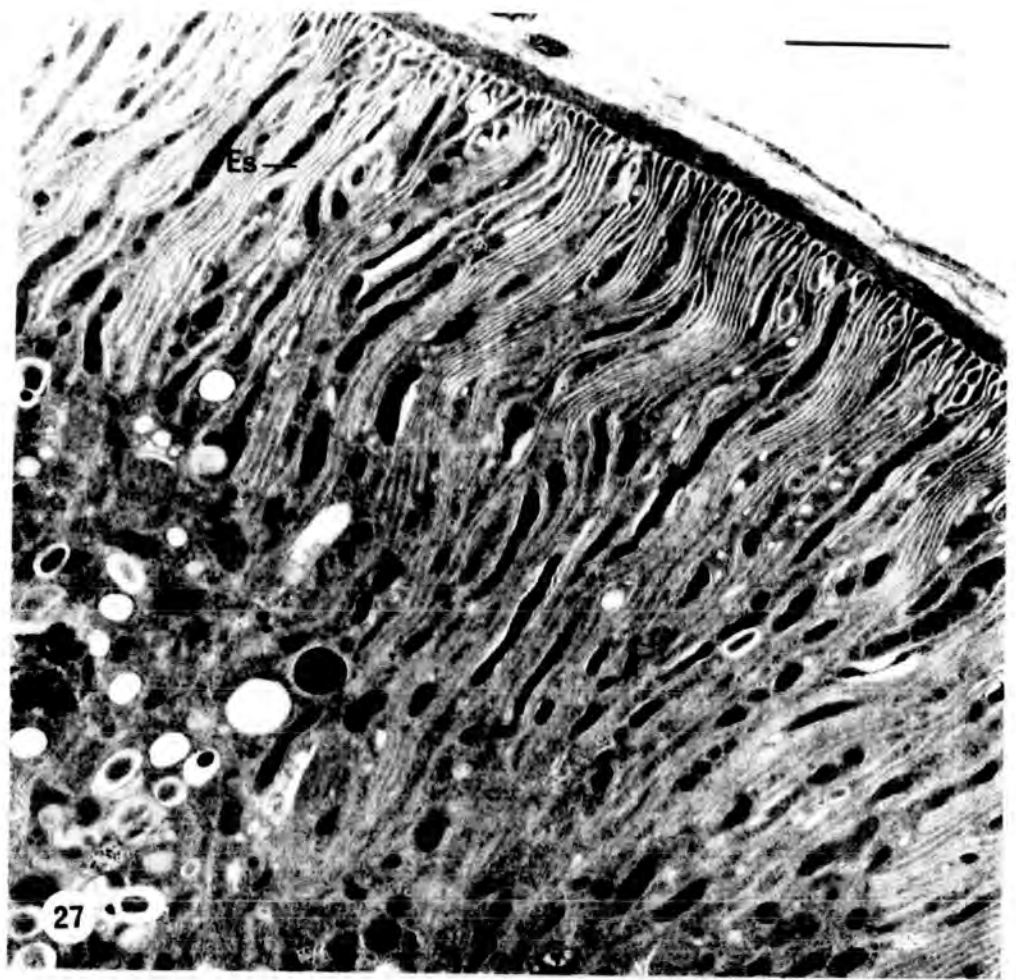

Discussion

Individual tubules of Locusta were able to secrete fluid at a constant rate for several hours when bathed in 'normal' Ringer solution. It was not necessary to stimulate the tubules with either a diuretic hormone or cyclic AMP to induce secretion as is the case with Rhodnius (MADDRELL, 1969) or Glossina (GEE, 1976). The mean rate of secretion from Locusta tubules of 1.7nl/minute agrees with the value of 1-2nl/minute given by MADDRELL and KLUNSUWAN (1973) for Schistocerca gregaria.

The results show that potassium is of prime importance in the urine production of Locusta. The tubules have the ability to concentrate K^+ in the urine, and it is transported in preference to Na^+ even when present at much lower concentrations in the bathing medium. In the complete absence of K^+ in the bathing medium the rate of tubules secretion is drastically reduced. In this way Locusta conforms with RAMSAY'S theory put forward for Carausius (1953, 1955) which suggests the secretion of potassium is the "prime mover" generating a flow of urine. This is also the case in several other insects such as Calliphora (BERRIDGE, 1968); Tipula paludosa (COAST, 1969) and Schistocerca gregaria (MADDRELL and KLUNSUWAN, 1973). The relative importance of Na^+ in the urine appears to vary between insect species. In Locusta as in

Carausius (PILCHER, 1970b) maximum fluid secretion could only occur in the presence of Na^+ as well as K^+ . In Calliphora, however, the maximum rate of urine formation was recorded when K^+ completely replaced Na^+ in the bathing medium, (BERRIDGE, 1968). In the tsetse fly, Glossina morsitans sodium is the ion which is preferentially transported by the tubules (GEE, 1976) although as in Locusta, secretion will only occur at maximum rate in the presence of K^+ as well as Na^+ . The necessity for the concomitant presence of both cations in these insects strongly favours the suggestion that a coupled $\text{Na}^+ \text{K}^+$ ATPase pump is involved in 'urine' secretion.

Fluid secretion by the Malpighian tubules of Locusta was inhibited by ouabain over the concentration range of 10^{-6} to 10^{-3} M. In all other insect tubules studied to date ouabain has had no effect on secretion at concentrations up to 10^{-3} M. (BERRIDGE, 1968; MADDRELL, 1969; PILCHER, 1970; GEE, 1976). FARQUHARSON (1974) however, was able to show that fluid production by the pill millipede, Glomeris marginata was sensitive to ouabain at concentrations as low as 5×10^{-6} M. The only other evidence of ouabain inhibition of Malpighian tubule function comes from the in vivo experiments of ATZBACHER et al. (1974) and HEVERT (1975). They have shown that the rate of excretion of two dyes, azocarmine and indigo carmine is

significantly reduced if ouabain (0.001mls of $3 \times 10^{-4} \text{M}$) is injected into the haemolymph.

The effect of ouabain on secretion by Locusta tubules strongly suggests that at least one ion pump, involved in urine production, is a $\text{Na}^+ \text{K}^+ \text{ATPase}$ enzyme. It is difficult to suggest why the ouabain effect should be clearly seen in Locusta but not in other species. It may be that ouabain was not reaching the enzyme site in sufficient quantities to bring about inhibition. IRVINE and PHILLIPS (1971) working on the rectal sac of Schistocerca were able to show that 10^{-2}M ouabain inhibited water and Na^+ movement, but that there was no effect with 10^{-3}M ouabain. They suggest that a high concentration may be necessary to overcome the long diffusion path to the active site. Other workers such as BLAINE et al (1975) and DIAMOND (1962), examining the effects of ouabain on sheep adrenals and rabbit gall bladder respectively, have noted that it took at least 30 minutes before an effect occurred. There is, therefore, some justification for the suggestion that ouabain may not be reaching the enzyme sites in insects such as Calliphora where urine secretion is said to be ouabain insensitive.

The involvement of the $\text{Na}^+ \text{K}^+ \text{ATPase}$ in 'urine' production is further implicated by the effect of ouabain (10^{-3}M) on the Na^+ and K^+ content of the urine. The application of ouabain effected an increase in the $\frac{\text{Na}^+}{\text{K}^+}$ ratio of

the urine. Several workers have noted changes in Na^+ and K^+ levels as a result of ouabain inhibition, one of the most dramatic results was recorded by ARCHIBALD and WHITE (1974) who showed that ouabain (10^{-3}M) produced a complete reversal of the Na^+ and K^+ content of synaptosomes of rat brain. Studies on insect tissue are somewhat limited although O'RIORDAN (1969) working on cockroach midgut showed a 55% inhibition of Na^+ efflux and 40% inhibition of K^+ outflux with ouabain concentrations between 10^{-6} to 10^{-3}M . TREHERNE (1966) using insect nerve found that approximately 50% of the Na^+ efflux was blocked by ouabain at threshold levels of 10^{-5}M for Periplaneta and 10^{-4}M for Carausius. In vivo experiments carried out by WEBER VON GROTTTHUS et al. (1974) injecting 0.001ml of $2 \times 10^{-4}\text{M}$ ouabain into the body cavity of Drosophila showed significant changes in the Na^+ and K^+ concentration of the haemolymph. In contrast FARQUHARSON (1973b) found no change in the Na^+ and K^+ levels in the urine of Glomeris in response to ouabain despite the fact that secretion was inhibited.

There were no observed ultrastructural differences resulting from treating Locusta tubules with 10^{-3}M ouabain, even when they had been induced to secrete very rapidly in dilute Ringer solution. The only other study on the effects of ouabain on insect tubules is that of WEBER VON GROTTTHUS et al. (1974) using light microscope

only. They observed a dilation of the Malpighian tubules of Drosophila after ouabain had been injected into the haemocoel; in some cases this was followed by a collapse of the distal tubules. Much more information on the effects of ouabain on excretory epithelium has been obtained using vertebrate tissue, for example AMAKAWA and MIZUHIRA (1966) carried out transmission electron microscopical studies on kidney tubules and found that ouabain had no effect on the proximal tubules. Other workers, however, report changes in fine structure associated with ouabain treatment. DIAMOND and TORMAY (1966) and TORMAY and DIAMOND (1967) using rabbit gall bladder have shown a reduction of the intercellular spaces from a mean value of $0.88\mu\text{m}$ in normally secreting tissue to $0.02\mu\text{m}$ in ouabain treated tissue. WALTON (1974) observed that the plasma membranes of ouabain treated kidney and liver cells became highly irregular with long whorled microvilli and also that an accumulation of dense calcium phosphate granules occurred in the mitochondria. Certainly no such difference could be established from the Malpighian tubules of Locusta examined in this study.

The rate of fluid secretion by the Malpighian tubules of Locusta was affected by the osmotic concentration of the media. Secretion was rapid in Ringer solution of low osmotic pressure, (provided sufficient ions were available) and was slow in high osmotic concentration

solutions. This effect has been commonly recorded in insect studies eg. for Calliphora (BERRIDGE, 1968). Rhodnius (MADDRELL, 1969), Tipula paludosa (COAST, 1969); Schistocerca (MADDRELL and KLUNSUWAN, 1973); Glossina (GEE, 1975).

The urine of Locusta is hypertonic to the bathing medium by a mean amount of 22.9m Osmoles ($\Delta 0.044^{\circ}\text{C}$). Similar results have been shown by other workers. (BERRIDGE, 1968) working with Calliphora found that the urine was hypertonic to the bathing medium by $\Delta 0.066^{\circ}\text{C}$ (approximately 38m Osmoles). Similarly MADDRELL (1969) found a slight urine hypertonicity in Rhodnius ($\Delta 0.01-0.015^{\circ}\text{C}$). Measurements obtained by direct cannulation of the hindgut of Schistocerca gregaria (PHILIPS, 1964) show a mean urine osmotic pressure of $\Delta 0.78^{\circ}\text{C}$ (425m Osmoles) and a mean haemolymph osmotic pressure of $\Delta 0.74^{\circ}\text{C}$ (401m Osmoles). This difference of 24m Osmoles is very similar to the in vitro value of 22.9m Osmoles obtained in Locusta in the present study. Some insects such as Carausius (RAMSAY, 1954) and Dysdercus (BERRIDGE, 1965) produce a slightly hypotonic urine. The majority, however, appear to resemble Locusta.

From the two observations that the fluid secreted by the Malpighian tubules is always slightly hyperosmotic to the bathing fluid over a wide range of

osmotic concentrations, and that the rate of fluid secretion is inversely related to the osmotic concentration in the bathing medium, MADDRELL (1972) concluded that the rate of solute transport is unaffected by the osmotic concentration, and all that alters is the rate at which water crosses the tubule wall. This would seem a likely explanation provided the levels of K^+ and Na^+ are sufficiently high in the low osmotic pressure solutions to enable active transport to function efficiently. In the case of Locusta the lack of ions proved rate limiting in Ringer of 10% 'normal' osmotic strength.

The above explanation of variable water flow complies with the structural changes observed when the Malpighian tubules of Locusta were soaked in hypotonic Ringer solution (25% 'normal') in which they were working at maximum rate. The increased size of the extracellular spaces in the basal border clearly suggest large increases in the amount of water being moved into these spaces as a result of active solute transport. BERRIDGE (1968) observed that Calliphora tubules in hypotonic medium were considerably swollen suggesting a similar increase in water uptake. BERRIDGE and GUPTA (1967) carried out electron microscopical studies of the rectal papillae of Calliphora which had been injected with hypotonic solution. If the tissues were fixed 15-30 minutes after injection the intercellular spaces were maximally dilated throughout the

cells. Using gall bladder TORMAY and DIAMON (1967) were able to show that tissue in isotonic medium had intercellular spaces of $0.88\mu\text{m}$ mean diameter, this was reduced to $0.17\mu\text{m}$ in a hypertonic medium. However, OSCHMAN and BERRIDGE (1970) did not observe any structural changes in the basal membrane of Calliphora salivary gland when the tissue was stimulated with 5HT and the secretion rate had increased 60 fold. This clearly poses the question as to whether the observed dilation in 25% Ringer solution was in fact due to osmotic disruption of the tissue and not a result of increased active transport. If this is so it would certainly account for the effect of 25% Ringer solution being ouabain insensitive.

The rate of fluid production by the Malpighian tubules increased with increasing temperature up to a maximum rate which occurred around 40°C . This result is similar to that of MADDRELL (1964) for Rhodnius tubules. The Arrhenius μ plot produced from the secretion results showed no break at 21°C as was found with the $\text{Na}^+ \text{K}^+\text{ATPase}$ enzyme (Chapter 4), and yet the Arrhenius μ value for secretion of 58.3 K joules closely resembles the 58.9 K joules recorded for the enzyme at temperatures above 21°C . These results pose an interesting question as to the relationship between the $\text{Na}^+ \text{K}^+\text{ATPase}$ enzyme and fluid transport. It would seem that at low temperatures the $\text{Na}^+ \text{K}^+\text{ATPase}$ is relatively

inactive but this is not reflected in a proportional decrease in fluid transport. This may be due to the fact that at low temperatures, the secretion rate is slow and sufficient K^+ can diffuse to the apical surface to supply the proposed electrogenic pump. Certainly the secretion rate below $21^{\circ}C$ of 23% of the rate at $30^{\circ}C$ is similar to the reduction in rate recorded in the presence of ouabain. If BERRIDGE (1967) is correct in suggesting that the rate of urine formation depends on the rate at which K^+ can be presented to the second (electrogenic K^+) pump; the rate of the $Na^+ K^+ATPase$ enzyme plus the proportion it contributed to the total K^+ flow would be critical in secretion characteristics related to temperatures. Over the normal temperature range encountered by the locust (above $21^{\circ}C$) there is a distinct similarity between the Arrhenius μ values for the $Na^+ K^+ATPase$ (58.9 K joules) and fluid secretion (58.3 K joules) this strongly suggests that at these temperatures $Na^+ K^+ATPase$ action is intimately linked with fluid secretion. An interesting experiment would have been to test the inhibitory effect of ouabain on fluid secretion at temperatures below $21^{\circ}C$, in order to monitor to what extent the $Na^+ K^+ATPase$ is involved in fluid secretion at low temperatures.

Cyclic AMP is a very effective stimulant of fluid secretion by the tubules of Locusta with a threshold for stimulation between 10^{-4} and $3 \times 10^{-4}M$ and

maximum stimulation at 10^{-3} M. This is similar to the results observed in Schistocerca (MADDRELL and KLUNSUWAN, 1973) where maximum stimulation occurred at 5×10^{-3} M. MADDRELL et al. (1971) showed stimulation with tubules from Carausius and Rhodnius at thresholds of 1×10^{-4} M and 4×10^{-5} M respectively, and GEE (1976) observed an increase at a threshold of 3×10^{-5} M. It has also been shown that Calliphora salivary glands respond in a similar fashion with 10^{-3} cyclic AMP (BERRIDGE and PATEL 1968, BERRIDGE, 1970). The levels of cyclic AMP required to produce stimulation in all cases are very high when compared to the intra-cellular levels which are generally between 10^{-8} and 10^{-5} M. (HENION et al., 1967). BERRIDGE (1970) suggests this is probably due to the low permeability of the basal membrane to this negatively charged molecule.

As cyclic AMP is generally accepted as a "2nd. messenger" in hormone action (reviews PASTAN and PERLMAN, 1971; ROBISON et al. 1968; BERRIDGE, 1975) it would seem likely that fluid secretion by the Malpighian tubules is under hormonal control.

The presence of a diuretic hormone which affects tubule secretion has been clearly demonstrated in Locusta by CAZAL and GIRARDIE (1968) and MORDUE (1970). The diuretic factor is thought to be produced by the pars intercerebralis, and is stored in the

storage lobes of the corpora cardiaca. The release of the hormone is thought to be a result of feeding and MORDUE (1972) suggests that it acts by increasing the intracellular levels of cyclic AMP. This has subsequently been shown to occur in Rhodnius (ASTON, 1975). An antidiuretic hormone has also been identified in Locusta (MORDUE, 1970, 1972) but this only affects the rectal sac. Diuretic hormones have been identified in many other insects such as Rhodnius (MADDRELL, 1963, 1964), Dysdercus (BERRIDGE, 1966), Schistocerca (HIGHNAM *et al*, 1965; MORDUE, 1969), Carausius (PILCHER, 1970a and b) and Glossina (GEE, 1975).

In Rhodnius and Carausius the action of diuretic hormone can be mimicked by 5HT in low concentrations (MADDRELL *et al* , 1969, 1971). This effect has also been seen with Calliphora salivary glands (BERRIDGE and PATEL , 1968; BERRIDGE, 1970; BERRIDGE and PRINCE, 1972). It was, perhaps, surprising that 5HT produced no effect on tubule secretion by Locusta tubules. However, this was also found to be the case with Schistocerca (MADDRELL and KLUNSUWAN, 1973) and the pill millipede Glomeris (FARQUHARSON 1973a). It would seem therefore, that 5-HT is not sufficiently analogous to the diuretic hormone of these insects to mimic its action.

BERRIDGE (1975) suggests a model for the stimulation of salivary gland secretion by 5HT acting via

cyclic AMP (see Fig. 6:14). This may be analagous to the situation with Malpighian tubule stimulation. Cyclic AMP is thought to have two functions: it directly stimulates the ion pump (electrogenic) on the apical surface and also promotes Ca^{2+} release which is thought to increase the membrane permeability to Cl^- ions. As a result of cyclic AMP activity, therefore, ion and water flow is greatly increased. The actual method of stimulation of the ion pump is unknown.

In the present study biochemical experiments were carried out on the microsomal preparation of Locusta hindgut and Malpighian tubules (using the methods outlined in Chapter 4) to see if any direct links could be observed between cyclic AMP and $\text{Na}^+ \text{K}^+ \text{ATPase}$ enzyme. (Results shown in Appendix 6:5). The results failed to show any stimulation at concentrations between 10^{-7} and 10^{-3} M. This result might agree with the suggestion of PRINCE (1976) that cyclic AMP acts on the electrogenic pump on the apical membrane, and not on the $\text{Na}^+ \text{K}^+ \text{ATPase}$ enzyme.

The results of this chapter taken as a whole clearly implicate the involvement of the ouabain sensitive $\text{Na}^+ \text{K}^+ \text{ATPase}$ enzyme in fluid production by the Malpighian tubules of Locusta migratoria. Potassium would appear to be the "prime mover" in water flow, but Na^+ is also required for the ATPase enzyme pump. The stimulation of secretion by cyclic AMP might be taken as an indication of its involvement as a '2nd. messenger' in the hormonal control of diuresis.

FIG. 6:14

Model proposed by BERRIDGE (1975) to explain stimulation of secretion by Calliphora salivary gland using 5-HT. The model demonstrates the proposed dual effect of cyclic AMP : to directly stimulate K^+ transport, and also to effect the calcium level which in turn produces an increase in Cl^- transport across the cell.

HAEMOLYMPH

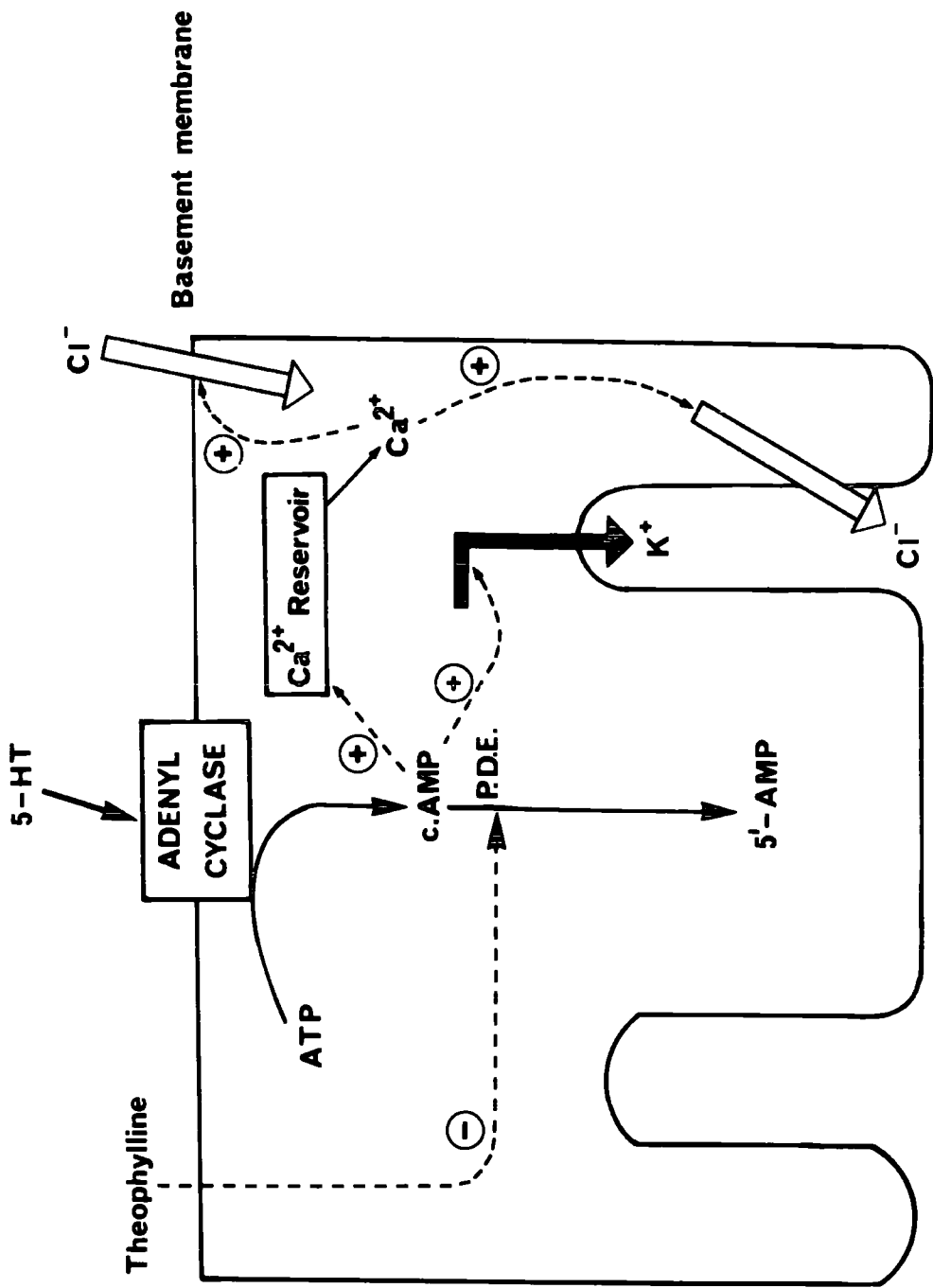

LUMEN

CHAPTER 7

Relationship between Na⁺-K⁺ATPase activity and the trans-wall potential across isolated Malpighian tubules of Locusta

In any multi-ion system in which concentration gradients exist across selectively permeable membranes, the equations of DONNAN and NERNST are applicable. The NERNST equation may be expressed as follows :-

$$E = \frac{RT}{zF} \log_e \frac{\text{ion activity side A}}{\text{ion activity side B}}$$

Where E = P.D. in volts, R = the gas constant, T = temperature in absolute units, F = the Faraday number and z = valency. In general ion activity can be taken to be equal to the ion concentration at either side of the membrane. Thus it is possible to estimate the theoretical potential difference across a membrane which would result if the membrane was selectively permeable to a single ion, given the concentration of that ion on either side of the membrane. In situations involving more than one ion the selective permeability of the membrane to the separate ions may affect the potential, and so for strict accuracy the constant field equation proposed by GOLDMAN (1943) and HODGKIN and KATZ (1949) which is a modification of NERNST

should be applied. For example when considering both Na^+ and K^+ the equation is as follows:-

$$E = \frac{RT}{zF} \log_e \frac{p [\text{K}^+]_{\text{out}} + p [\text{Na}^+]_{\text{out}}}{p [\text{K}^+]_{\text{in}} + p [\text{Na}^+]_{\text{in}}}$$

Where p is the permeability coefficient for each ion. In the present study, however, permeability measurements were not carried out, and consequently the NERNST equation has been applied. Any deviation of potential from the predicted NERNST value may be taken as indicative of either active transport of an ion across the membrane, or alternatively of membrane permeability to more than one ion species.

USSING and ZERAHN (1951) and KOEFOED - JOHNSON and USSING (1958) were able to demonstrate with frog skin that the "butter" membrane was selectively permeable to Na^+ , and behaved as a "sodium electrode" with a potential close to the NERNST value. Selective K^+ permeability has been demonstrated across the midgut epithelia of the silkworm, Hyalophora cecropia (HASKELL et al. ., 1965; ZERAHN, 1971; HARVEY and ZERAHN, 1971; WOOD and HARVEY, 1975 and HARVEY et al. ., 1975).

Trans-wall potentials have been measured across many tissues from a variety of insects. These include the intestine of the cockroach, Byrostria fumigata (DATTA 1971, et al. ., 1969) and Schistocerca (HIERRA et al. ., 1976); the

salivary glands of Calliphora (BERRIDGE and PRINCE, 1972a; BERRIDGE et al., 1975; 1976); and numerous studies on Malpighian tubules in a variety of insects (RAMSAY, 1953; COAST, 1969; IRVINE, 1969; PILCHER, 1970b; MADDRELL, 1971; MADDRELL and KLUNSUWAN, 1973), values recorded by these workers are indicated in Table 7:1.

RAMSAY (1953) demonstrated that all the values obtained in his studies irrespective of charge, did not obey the NERNST equation for K^+ . On this basis he proposed that active transport of K^+ was taking place across the Malpighian tubules of these insects. However, PILCHER (1970b) and MADDRELL (1971) working with Carausius and Rhodnius respectively have shown that for a 10-fold increase in K^+ in the bathing medium the recorded increase in trans-wall potential was close to the value of 58mV predicted by NERNST. Whilst this is not the only interpretation of these results this has been taken to indicate that the basal cell membrane of these insects is more permeable to K^+ than Na^+ suggesting that K^+ may enter the cell passively. No attempt has been made to solve the apparent disagreement with RAMSAY'S calculations with the same insect species.

In the present study it has been shown that K^+ is transported against a concentration gradient from the haemolymph to the lumen by the Malpighian tubules of Locusta migratoria (Chapter 6). The electrophysiological work was, therefore, carried out to measure the trans-wall potential of the

TABLE 7:1

Trans-wall potential across the Malpighian tubules of
a varitey of insects

Reference	Year	Insect	Potential with respect to the haemolymph (mV)
RAMSAY	1953	<u>Carausius</u>	+ 21
		<u>Pieris</u>	+ 28
		<u>Tenebrio</u>	+ 45
		<u>Dysdercus</u>	+ 22
		<u>Aedes</u>	+ 21
		<u>Locusta</u>	- 16
		<u>Rhodnius</u>	- 35
COAST	1969	<u>Tipula</u>	+ 32
IRVINE	1969	<u>Calpodes</u>	+ 25
PILCHER	1970 (b)	<u>Carausius</u>	+ 64 to -20
MADDRELL	1971	<u>Rhodnius</u>	- 30
MADDRELL and KLUNSUWAN,	1973	<u>Schistocerca</u>	+ 16.6

Malpighian tubules, to show how this was affected by varying the composition of the bathing medium, and to determine how closely the trans-wall potential obeyed the NERNST equation.

Materials and Methods

Sexually mature locusts of both sexes were used throughout. The experimental chamber (see Chapter 6) was modified to enable the electrical potential across actively secreting tubules to be measured (Fig. 7:2). Individual tubules were arranged in the manner described previously. When it had been established that a tubule was actively secreting, that part of the tubule which had been severed was lowered into one of the fluid filled cavities adjacent to the pegs (Fig. 7:2Y). Since the lumen of the tubule was now electrically continuous with the solution in cavity Y, the potential difference could be measured across its wall, by placing one electrode in cavity Y and the other in cavity X (Fig. 7:2).

The potential was measured using calomel electrodes connected to 3M KCl via KCl/Agar bridges. A high input impedance differential amplifier with a gain of 10x was used. This incorporated a zero back-off facility and a voltage calibrator was used in the input circuit of the amplifier. Trans-wall potentials were recorded by placing the non-inverting electrode in contact with the lumen (i.e. in Y. Fig. 7:2) and the inverting (reference) electrode

FIG. 7:1

Diagram of circuit used to measure the trans-wall potential across individual Malpighian tubules. AB= agar bridge; CE= calomel electrode; cal= calibrator; Amp=Amplifier; pen= pen recorder. X and Y represent the two chambers containing the gut, and an individual severed tubule respectively.

FIG. 7:2

Modified chamber used to measure the trans-wall potential across individual Malpighian tubules. The method is outlined in the text. The arrows indicate the flow of Ringer solution when the bathing medium surrounding the gut preparation is changed.

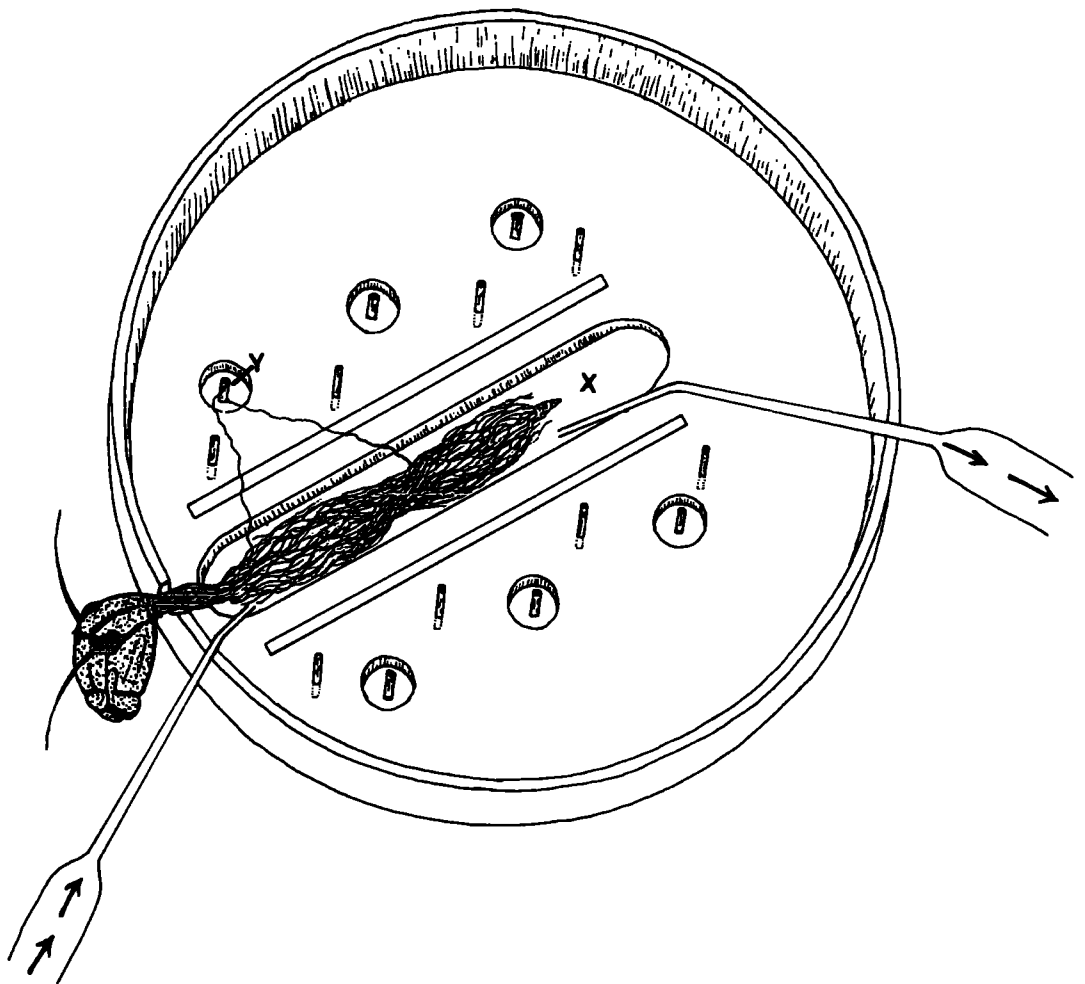
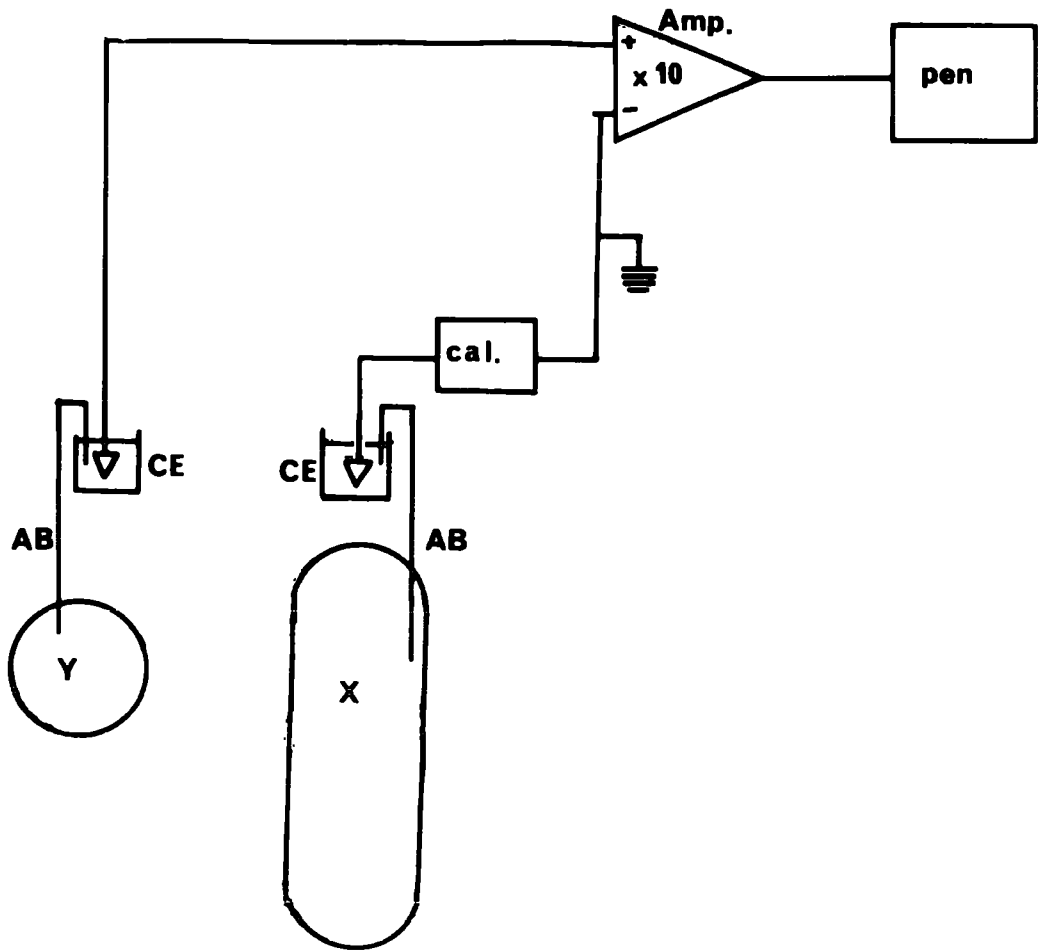

on the outside of the tubule (i.e. in X Fig. 7:2). The initial potential was adjusted to zero with the electrodes in the same Ringer pool. (The circuit diagram is shown in Fig. 7:1). Initially the potential across a tubule wall was measured with the gut surrounded by 'normal' Ringer solution. Continuous recordings were taken for 15 minutes to ensure that the potential was stable. The 'normal' Ringer solution surrounding the gut was then carefully changed for an experimental solution using two glass pipettes which were attached to the dish (Fig. 7:2). The trans-wall potential was then recorded continuously for the next 50 minutes. Control experiments were also carried out in which the procedure was exactly the same except that 'normal' Ringer solution was used throughout. In some cases it was possible to record from more than one tubule in any experimental run by altering the positions of the agar bridges at timed intervals thus monitoring the potentials of several tubules successively.

Results

When the Malpighian tubules were set up in 'normal' Ringer solution the lumen was found to be $10.8 \pm 2.1\text{mV}$ positive with respect to the haemolymph (n=74). The potentials would generally remain stable for 2-3hours provided the Ringer solution surrounding the gut was changed regularly (approximately every 15 minutes). Experimental Ringer solutions were also

renewed with the same regularity to maintain directly comparable conditions.

1. The effect of ouabain on the trans-wall potential

When 'normal' Ringer solution was replaced by Ringer solution containing 10^{-3} M ouabain the potential decreased and eventually the lumen became negative with respect to the bathing medium. The average time for the maximal effect was 15.2 ± 1.9 minutes. In some cases there was a slight overshoot of 1 or 2mV after which a stable level was reached (Fig. 7:3). The potential obtained in the presence of ouabain was irreversible on return to 'normal' Ringer solution. The mean results of these experiments are shown in Table 7:2, and the application of paired 't' tests to the data for the initial and final potentials showed that the ouabain effect was highly significant ($P < 0.001$).

2. The effect of cyclic AMP on the trans-wall potential of the Malpighian tubules.

10^{-3} M cyclic AMP, in the Ringer solution effected an increase in lumen positivity with respect to the bathing medium by 5.3 ± 1.1 mV. The effect of cyclic AMP was gradual taking a mean time of 15.9 ± 2.1 minutes to establish a stable potential, but once established, the potential remained at the higher level for the 50 minute period during which recording was carried out. Several of the tubules developed regular oscillations in potential of 1-2mV amplitude and of

TABLE 7:2
Effect of 1mM Ouabain on the trans-wall potential of the Malpighian tubules

	Initial potential mV	Final potential mV	Difference in Mean	n
Ouabain	+ 11.89 ± 0.86	- 3.22 ± 0.94	- 15.11	9
Control	+ 9.5 ± 0.96	+ 8.2 ± 3.0	- 1.3	7

FIG. 7:3

A typical example of the effect of 10^{-3} M ouabain on the trans-wall potential of a Malpighian tubule (●). The black arrow indicates the point of introduction of Ringer solution containing ouabain. A typical example of a control experiment (x) where normal Ringer solution is used throughout is also shown. Arrow indicates point of change of Ringer solution.

Ordinate: trans-wall potential (mV)

Abscissa: time in minutes.

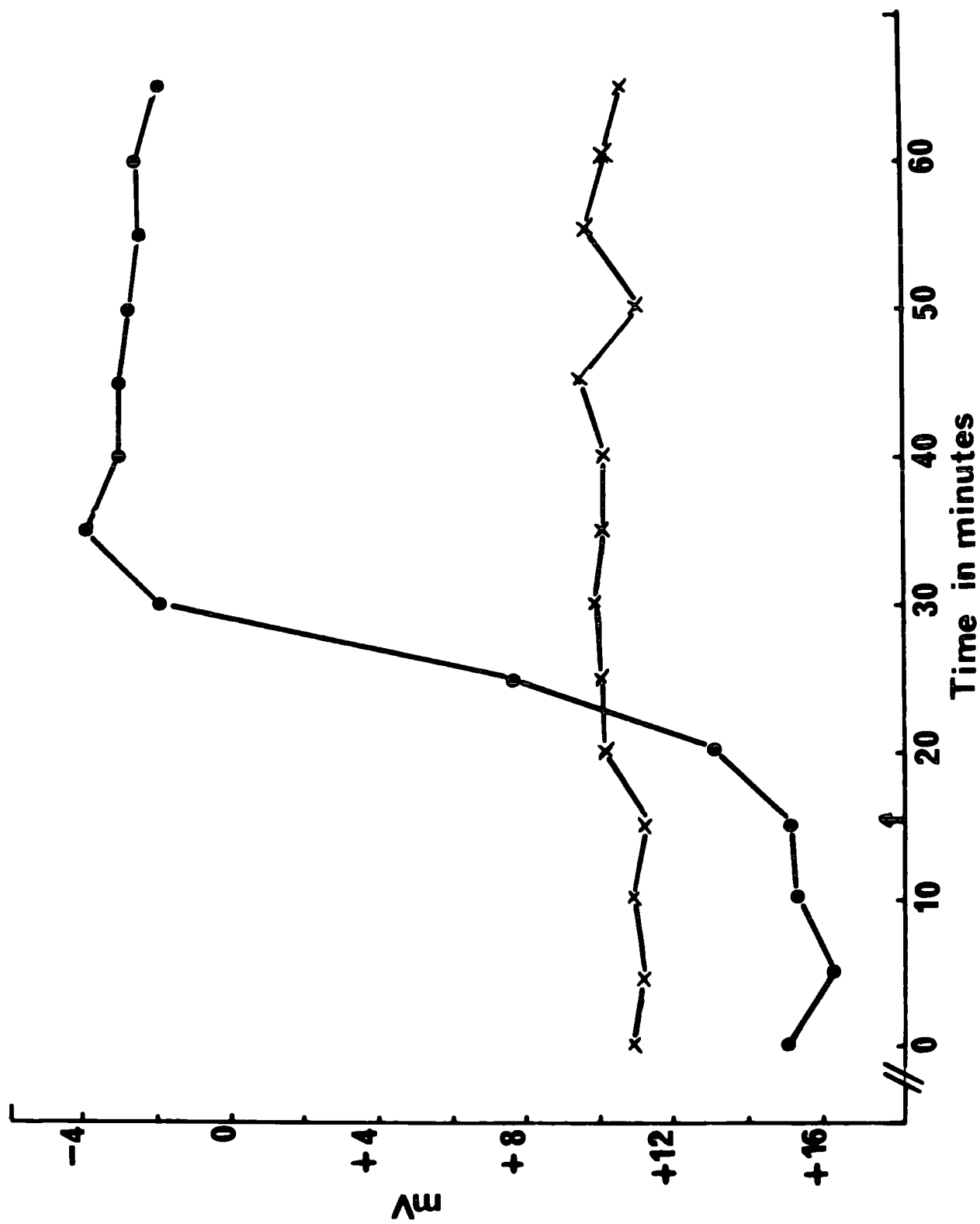
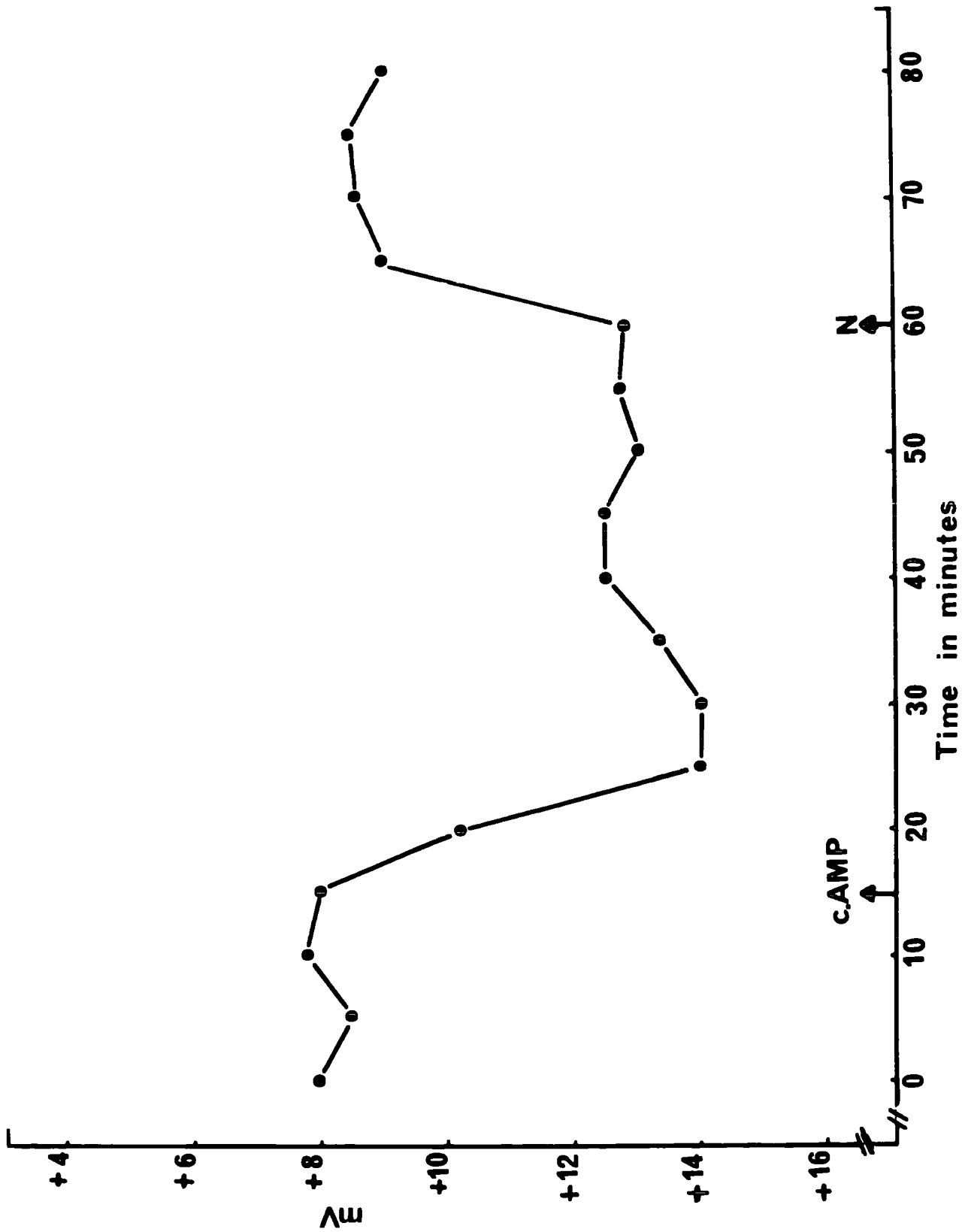

FIG. 7:4

A typical example of the effect of cyclic AMP on the trans-wall potential of a Malpighian tubule. The black arrows indicate the point of introduction of Ringer solution containing cyclic AMP, and also the return to 'normal' Ringer solution (N).

Ordinate: trans-wall potential (mV).

Abscissa: time in minutes.



approximately a 30 second period when treated with cyclic AMP. Table 7:3 shows the mean results of 14 experiments, and application of paired 't' tests indicated that the effect of cyclic AMP was significant ($P < 0.01$). On the return to 'normal' Ringer solution the potential showed a substantial return to the unstimulated level within 5 minutes (see Fig. 7:4).

3. The effect of Na^+ and K^+ on the trans-wall potential of the Malpighian tubules

In a further series of experiments, the trans-wall potentials across the Malpighian tubules, bathed in 'normal' Ringer solution, were compared to those obtained with Ringer solutions of varying Na^+ and K^+ concentrations. The sum of the Na^+ and the K^+ concentrations used was maintained at 140mM. The results together with the various Na^+ and K^+ concentrations used, can be seen in Table 7:4.

In the absence of K^+ , the trans-wall potential of the tubules fell rapidly, and within 2-3 minutes the lumen became negative with respect to the bathing medium. When the K^+ concentration in the Ringer solution was increased above that of normal Ringer solution (8.6mM), the lumen positivity increased. The relationship between the external K^+ concentration and the increase in positivity of the tubule lumen was not linear (see Fig. 7:5). Increases in K^+ concentration above 70mM did not effect a further increase in lumen positivity. Indeed, at very high K^+ concentration (minimal Na^+) the increased potential was significantly reduced.

TABLE 7 : 3

Effect of 1mM Cyclic AMP on the trans-wall potential of the Malpighian Tubules

	Initial potential mV	Final potential mV	Difference in Mean	n
Cyclic AMP	+ 8.78 ± 1.61	+ 14.11 ± 1.98	+ 5.33	14

TABLE 7 : 4

The effect of varying [K⁺] and [Na⁺] on the trans-wall potential

Concentration mM	Initial Potential mV	Final Potential mV	Difference in Mean mV	n
<u>K⁺</u>				
0.4	+ 10.57 ± 0.7	- 5.5 ± 2.5	- 16.07	12
35	+ 11.3 ± 2.8	+ 23.1 ± 2.8	+ 11.8	8
70	+ 7.23 ± 0.9	+ 29.4 ± 4.0	+ 22.2	13
105	+ 11.78 ± 3.0	+ 30.0 ± 3.7	+ 18.22	9
137	+ 5.0 ± 1.0	+ 15.04 ± 1.4	+ 10.0	11

FIG. 7:5

Effect of K^+ concentration on the trans-wall potential of Malpighian tubules. The vertical lines represent ± 1 .S.E. of the mean.

Ordinate: mean difference in the P.D. across the tubules compared to that recorded for the same tubules in 'normal' Ringer solution.

Abscissa: $\log_{10} K^+$ concentration.

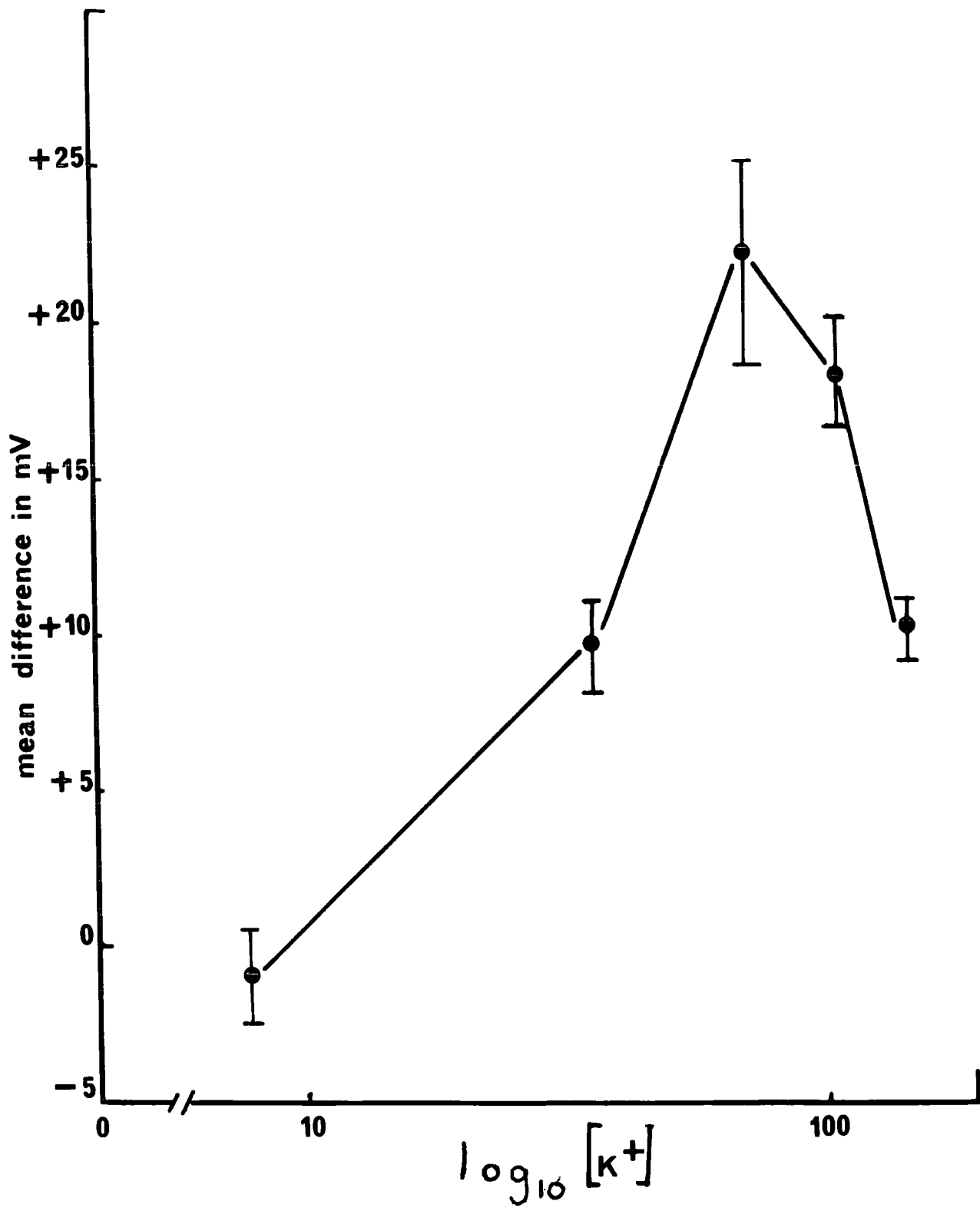

Discussion

The theoretical trans-wall potential for the Malpighian tubules of Locusta bathed in 'normal' Ringer solution could be calculated for both Na^+ and K^+ ions by applying the NERNST equation as

$$E = -60 \log_{10} \frac{\text{concentration in the bathing medium}}{\text{concentration in the lumen}}$$

The concentrations of Na^+ and K^+ ions were obtained by atomic emission spectroscopy (see Chapter 6) and are outlined in Table 7:5 below.

TABLE 7:5

Concentrations of Na^+ and K^+ in the urine and bathing medium (mM)

	Bathing Medium	Urine
K^+	7.9	61.4
Na^+	132.5	110.0

The results obtained by applying the NERNST equation to the above data are shown in table 7:6 where they are compared to those obtained by RAMSAY (1953) for Locusta.

It can be seen from Table 7:6 that for K^+ in both the present work and that of RAMSAY (1953) the recorded potential was considerably more positive than would be predicted on the basis of the NERNST equation. Clearly, therefore, the

TABLE 7:6

Trans-wall potentials across the Malpighian tubules calculated by Nernst (potentials in mV)

Recorded P.D.	Na ⁺ Calc. P.D.	K ⁺ Calc. P.D.	Na ⁺ Calc. P.D. - recorded P.D.	K ⁺ Calc. P.D. - recorded P.D.
Present work + 10.8 ± 2.1	+ 4.8	- 53.4	+ 6.0	- 64.2
RAMSAY - 16	+ 5	- 46	+ 21	- 30

Malpighian tubules do not obey NERNST for K^+ , and the potential is not the result of passive K^+ permeability. It may be that the potential results from active ion pumping, or it may result from membrane permeability to a variety of other ions. In the case of Na^+ the potential value obtained is close to that calculated by NERNST. This might suggest that the trans-wall potential is purely the result of selective Na^+ permeability, although this may be ruled out as the potential does not fall below the level in 'normal' Ringer solution when the tubule is placed in a medium lacking Na^+ . The other possibility is that the result is purely coincidental, and is perhaps due to the active pumping of some other ion which results in a redistribution of Na^+ ions such that they appear to agree with the potential predicted by NERNST.

Since the lumen positivity with respect to the bathing medium increased with increasing K^+ concentration, and as the tubule is not passively permeable to this ion, it would suggest that an active K^+ pump may be responsible for the potential. This would appear to be compatible with the observation that the potential did not increase beyond 70mM K^+ suggesting either that the "pump" became saturated or that Na^+ concentration became rate limiting. This was not observed in Carausius (PILCHER, 1970b) or Rhodnius (MADDRELL, 1971) in both of which the potential across the Malpighian tubules increased linearly with K^+ concentration in a manner closely following the NERNST equation (PILCHER, 1970b; MADDRELL, 1971). It was suggested, on this basis that the basal membrane was selectively permeable to K^+ .

Ouabain was shown to induce a significant reduction in the trans-wall potential across Locusta Malpighian tubules. This result clearly substantiates the suggestion made earlier that active K^+ transport is at least partially responsible for the maintenance of the trans-wall potential, and in particular that a Na^+-K^+ ATPase enzyme is involved on at least one of the surfaces. Ouabain has been shown to decrease the potential across other tissues where Na^+-K^+ ATPase enzymes have been implicated. DATTA (1971) showed a 15% decrease in the potential across cockroach intestine when 10^{-4} M ouabain was applied on the haemolymph side, and AUGUSTUS (1976) using rabbit submaxillary gland observed a rapid decrease in potential across the ductal epithelium following the application of 5×10^{-4} M ouabain. Similar observations have been made with toad bladder (CRABBÉ et al., 1974) and frog-skin (HERRERA, 1965; CIVAN, 1972; WASLER et al., 1973 and CRABBÉ and DECONE, 1974). In contrast PILCHER (1970b) found that 10^{-4} M ouabain had no effect on the trans-wall potential of Carausius.

The increase in lumen positivity observed with 10^{-3} M cyclic AMP suggests that it may act by stimulating cation transport. This is consistent with the observation that the rate of fluid production is stimulated by cyclic AMP (Chapter 6). In addition the time for the change in potential to occur (15.88 minutes) agrees closely with the time taken for fluid production to be stimulated. Similar increases in lumen positivity were

observed by BERRIDGE and PRINCE (1972a and b) with Calliphora salivary glands, they also observe a corresponding increase in fluid production. In the present study and those of BERRIDGE and PRINCE (1972a and b) small oscillations in potential were observed with approximately half the Malpighian tubules. It is uncertain why this should occur although it may be connected to increasing calcium levels induced by cyclic AMP (BERRIDGE, 1975) which may in turn alter the permeability of the membranes to anions, and thus bring about fluctuations in the potential (PRINCE, 1976). It is of interest that the tubule potential remained at a high level for 50 minutes until 'normal' Ringer replaced the cyclic AMP whereas fluid secretion was only stimulated for a period of about 20 minutes.

BERRIDGE et al., (1975) have shown with Calliphora salivary gland that cyclic AMP stimulates an electrogenic K^+ pump on the apical surface of the membrane. It may be, therefore, that this is also the case in the locust Malpighian tubule although this cannot be proved from the present study. If so one might suggest that in Locusta two ion 'pumps' are responsible for the maintenance of the trans-wall potential: a Na^+-K^+ ATPase which is ouabain sensitive, and an electrogenic K^+ pump which is stimulated by cyclic AMP.

It can be seen, therefore, that active K^+ transport is involved in the maintenance of the trans-wall potential across the Malpighian tubules of Locusta. A Na^+-K^+ ATPase enzyme is involved in the K^+ pumping, and it may be that a second electrogenic K^+ pump, is also involved.

CHAPTER 8

Discussion

As was mentioned in the introduction a number of objections have been raised concerning the involvement of a $\text{Na}^+ \text{K}^+ \text{ATPase}$ enzyme in fluid production by the Malpighian tubules of insects. BERRIDGE and GUPTA (1968) have failed to demonstrate the presence of this enzyme in the Malpighian tubules of Calliphora using histochemical or biochemical methods. MADDRELL (1971) has suggested also that such a Na/K exchange pump would not produce a net movement of ions into the cell and therefore would not produce an osmotic gradient along which water movement could occur. In addition he quotes the failure of previous studies to demonstrate that ouabain inhibits fluid secretion by the Malpighian tubules of several insect species eg. Calliphora (BERRIDGE, 1968), Carausius (PILCHER, 1970b) and Rhodnius (MADDRELL, 1969). Ouabain is a specific inhibitor of the $\text{Na}^+ \text{K}^+ \text{ATPase}$ enzyme, and the absence of any effect was taken to be strongly indicative that the pump was not of the conventional $\text{Na}^+/\text{K}^+ \text{ATPase}$ type.

Throughout the present study, however, evidence has been accumulating which strongly suggests the involvement of a $\text{Na}^+ \text{K}^+ \text{ATPase}$ enzyme in fluid secretion by the Malpighian tubules of Locusta migratoria migratorioides (R+F). A $\text{Na}^+ \text{K}^+ \text{ATPase}$ enzyme was demonstrated in microsomal preparations from the Malpighian tubules of Locusta, and the properties of

this enzyme closely resembles those of $\text{Na}^+ - \text{K}^+$ ATPases from a variety of other sources (SKOU, 1965) . This being so it is relevant to point out that the exchange of Na^+ for K^+ need not necessarily be on a 1 : 1 basis. To reiterate the example given previously, in red blood cells 3Na^+ ions are moved from the inside to the outside, and 2K^+ ions are moved in the opposite direction for each ATP split (POST and SEN, 1967). This being the case it is difficult to accept that a $\text{Na}^+ - \text{K}^+$ ATPase would not necessarily produce a suitable osmotic gradient. In contrast to other insects, ouabain at 10^{-3} M produced three pronounced physiological effects on the Malpighian tubules of Locusta. There was a 35% reduction in oxygen uptake by the tubules suggesting decreased demand for ATP; the potential across the tubule wall fell with the lumen becoming increasingly negative compared to the bathing medium, suggesting a reduction in cation transport, and finally the rate of fluid secretion by the tubules was decreased considerably.

Potassium was found to be the major cation transported across the tubules against a strong concentration gradient, and in this respect Locusta resembled several other insects studied to date (RAMSAY, 1953; BERRIDGE, 1968; COAST, 1969; PILCHER, 1970b; MADDRELL and KLUNSUWAN, 1973). In Locusta, however, maximum rates of urine production and of cation transport (indicated by increased lumen positivity) could only occur in the presence of Na^+ as well as K^+ ; this has also been shown to be the case in Carausius (PILCHER, 1970b), and

Glossina (GEE, 1976). The necessity for the presence of both Na^+ and K^+ further substantiates the evidence for Na^+-K^+ ATPase involvement in fluid secretion. The decrease in the increased trans-wall potential observed in Ringers' solutions containing less than 70mM Na^+ despite increased K^+ would also appear to be consistent with the properties of the Na^+-K^+ ATPase enzyme which was shown to work at a maximum efficiency in a medium containing 100mM Na^+ and 20mM K^+ . Any reduction in Na^+ or K^+ ions below this value resulted in reduced enzyme activity. It would appear, therefore, that the trans-wall potential reflects Na^+-K^+ ATPase activity.

An apparent anomalous result was that a very high rate of urine production was observed in tubules bathed with 25% Ringer solution (approximately 2mM K^+ : 37mM Na^+). On the basis of the properties of the Na^+-K^+ ATPase, the enzyme should have displayed very low activity under these ionic conditions, and yet fluid secretion was stimulated when compared to the rate in 'normal' Ringer solution. Electron microscopical studies revealed that in 25% Ringer the extracellular spaces between the infoldings of the basal cell membranes were considerably dilated. In addition tubules soaked in 25% Ringer solution showed some disruption of cellular integrity, and it would appear likely that this increased fluid production was a result of osmotic forces drawing water from the very dilute Ringer solution into the cytoplasm, and then into the lumen. One must conclude, therefore, that this increase in fluid secretion was not 'normal', and was in fact

independent of $\text{Na}^+ \text{K}^+ \text{ATPase}$ activity. To check that this was in fact the case one might test the effect of ouabain on the rate of fluid production in 25% Ringer solution to determine to what extent the $\text{Na}^+ \text{K}^+ \text{ATPase}$ pump was involved in maintaining the fluid secretion under these conditions.

The trans-wall potential was shown to increase in lumen positivity in relation to the haemolymph with increasing K^+ concentrations up to 70mM $\text{Na}^+ : 70\text{mM } \text{K}^+$ beyond which it decreased. Application of the Nernst equation by plotting $\log \left[\frac{K_o}{K_i} \right]$ (where $K_o = [\text{K}^+]$ in the bathing medium and $K_i = [\text{K}^+]$ in the urine recorded by emission spectroscopy Chapter 6) against the trans-wall potential, shows a non-linear relationship (Fig. 8:1). An attempt to place a straight line by regression analysis through the first four points yielded a slope of $22.64 \pm 4.13\text{mV}$ for a tenfold change in $[K_o]$. Clearly this result differs from the value of 58mV predicted by Nernst and suggests either that K^+ enters by active transport, or that the membrane is permeable to more than one ion. Taken with the other evidence it would seem likely that the deviation from Nernst is because K^+ ions are actively pumped by a $\text{Na}^+ \text{K}^+ \text{ATPase}$ enzyme situated on at least one surface of the tubule. In contrast PILCHER (1970b) working with Carausius reported Nernst slope values near to the predicted 58mV. Whilst this is not the only interpretation of these results this has been taken to indicate that the basal cell membrane of the tubules is more permeable to K^+ than Na^+ . Thus suggesting that passive K^+

FIG. 8:1

The relationship between the trans-wall potential of Malpighian tubules, and the ratio of external to internal K^+ concentration. The vertical lines represent ± 1 .S.E. of the mean.

Ordinate: mean difference in P.D. across the tubules when compared to that recorded for the same tubules in 'normal' Ringer solution.

Abscissa:

$$\log_{10} \frac{\text{external } K^+ \text{ concentration (Ringer solution)}}{\text{internal } K^+ \text{ concentration (urine).}}$$

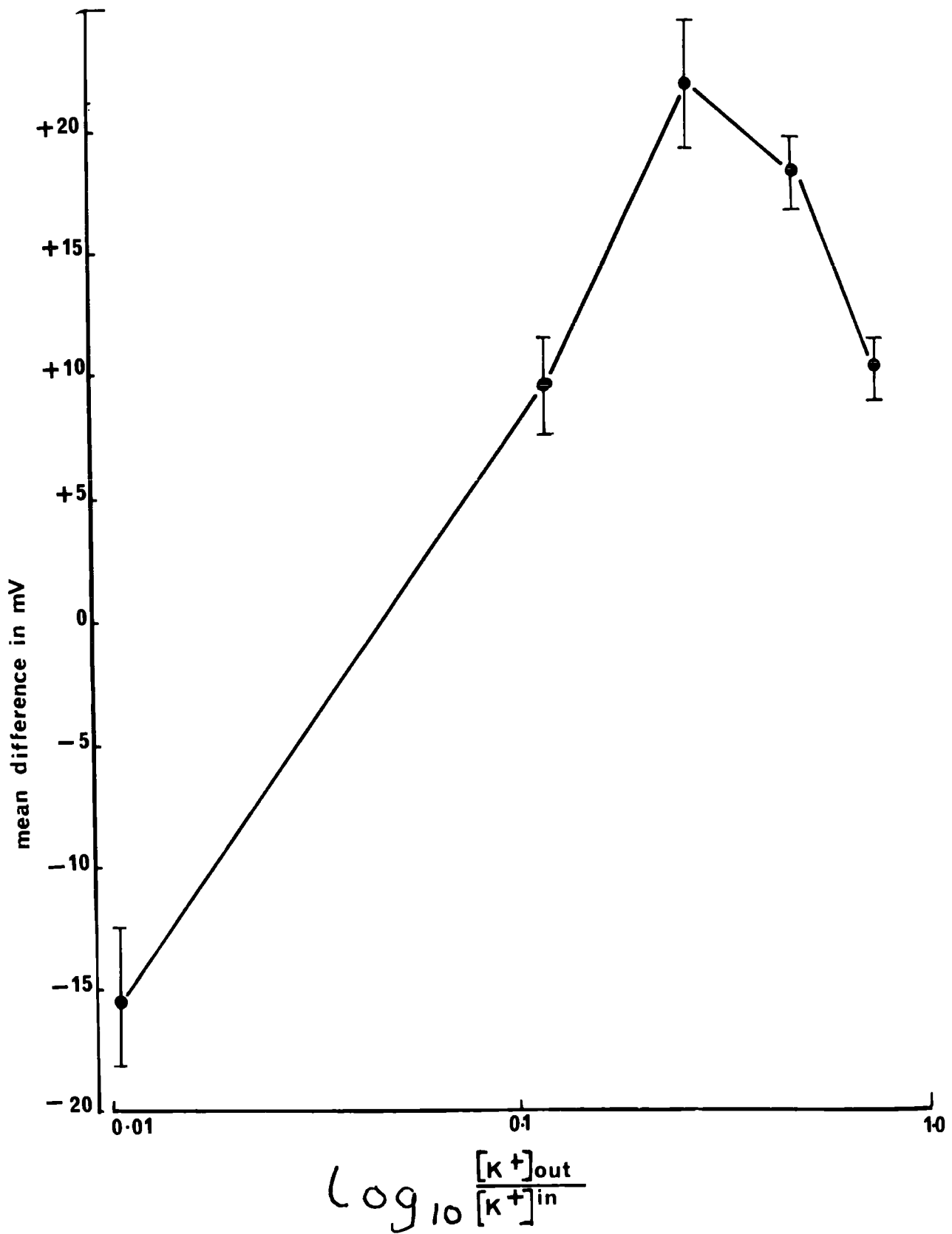

permeability is an important factor in the maintenance of the trans-wall potential. However, application of regression analysis to 4 of the 7 graphs shown by PILCHER (1970b) gave a mean slope of -30.56 ± 3.03 for a tenfold change in $[K_o]$ and not a -58mV change suggested by PILCHER. Four curves were employed rather than all seven because less than 4 points were available for the remaining three. It seems, therefore, that the statement that the slopes obtained are "similar" to that predicted by the Nernst equation for a potassium diffusion potential" is perhaps unrealistic, and that the basal membrane does not in fact, obey the Nernst equations. Certainly this interpretation is more in line with the findings of RAMSAY (1953) and indeed of PILCHER herself when the recorded potentials are compared to those predicted by Nernst calculated by the formula

$$E = -58 \log 10 \frac{\text{concentration } [K^+] \text{ in the bathing medium}}{\text{concentration } [K^+] \text{ in the Ringer}}$$

Both workers report potentials which are in fact more positive than the Nernst predicted values. RAMSAY (1953) interprets this as being indicative of active transport. This observation taken together with the fact that fluid secretion by the Malpighian tubules of Carausius is maximal in the presence of Na^+ as well as K^+ (PILCHER, 1970a) might suggest that a Na^+ stimulated ATPase pump is also operative here. Contradictory evidence to this

theory is the fact that ouabain had no inhibitory effect on tubule secretion or trans-wall potential in Carausius (PILCHER, 1970b). This might suggest that an alternative active "pump" is in operation, and indeed PILCHER (1970b) interprets her results as indicative of either an electrogenic K^+ pump which is stimulated by external Na^+ , or that a Na^+ stimulated electrically neutral pump working together with selective K^+ permeability may provide the trans-wall potential. It is, however, equally possible that ouabain was not reaching the active site in sufficient quantities to effect a change in Carausius, and the other species where no effect was observed. (BERRIDGE, 1968; MADDRELL, 1969; GEE, 1976). Certainly in the present study the trans-wall potential of Locusta Malpighian tubules was not effected until some 15.9 minutes after the application of ouabain. More recently FATHPOUR (personal communication) has shown that full inhibition of Locusta tubule secretion will only occur after 20 minutes soaking in 10^{-3} M ouabain. 60% inhibition occurs after a 15 minute period whereas no significant inhibition occurred within 10 minutes.

Despite being unable to demonstrate the presence of a $Na^+ K^+$ ATPase enzyme in Calliphora BERRIDGE (1968) felt that this enzyme was extremely likely to be involved in fluid transport across Malpighian tubules. Consequently he proposed a model for fluid transport by Calliphora Malpighian tubules consisting of a $Na^+ K^+$ ATPase enzyme situated on the basal surface which supplies K^+ to an electrogenic K^+ pump on

the apical surface. It is tempting to suggest that a similar situation may exist in the locust. Fluid secretion in Locusta can still occur albeit at a much reduced rate, in the absence of Na^+ or the presence of ouabain suggesting that when the $\text{Na}^+ \text{K}^+$ ATPase is inhibited sufficient K^+ might diffuse across the basal membrane to supply an apical electrogenic K^+ pump. This interpretation must, however, be considered with caution as one cannot be certain that there is not sufficient Na^+ in the system to enable low level $\text{Na}^+ \text{K}^+$ ATPase activity, and similarly it cannot be proved that the $\text{Na}^+ \text{K}^+$ ATPase activity is totally inhibited by ouabain. The presence of an electrogenic pump in addition to a $\text{Na}^+ \text{K}^+$ ATPase is, however, substantiated by the marked stimulation in the tubule secretion observed in the presence of 10^{-3} M cyclic AMP. Cyclic AMP has been shown by BERRIDGE *et al* (1975, 1976) to stimulate an electrogenic K^+ pump in Calliphora salivary gland. Since in the present study cyclic AMP had no effect on the $\text{Na}^+ \text{K}^+$ ATPase *in vitro*, one might conclude that its action is elsewhere. It may well be that the increased rate of secretion observed in Locusta was also a result of stimulation of an electrogenic K^+ pump. From the present study it is not possible to state the position of the 'pump' or 'pumps' with respect to the surfaces of the tubule cells, however the explanation of BERRIDGE (1968) that a $\text{Na}^+ \text{K}^+$ ATPase lies on the basal surface and supplies the apical electrogenic pump with K^+ would seem to fit the data for Locusta. PRINCE (1976) using microelectrodes was able to show

that the electrogenic pump in Calliphora salivary gland was on the apical surface, which would also add weight to the theory. Further studies would have to be carried out on Locusta using either microelectrodes or autoradiographical studies using H^3 ouabain to locate the two pumps.

The mechanism of linkage between solute and water transport across secretory epithelia has been the subject of much controversy in the past, especially when the fluid secreted is nearly isotonic with the bathing medium. (reviews USSING, 1949; FAWCETT, 1962; OSCHMAN et al 1974). No conclusive proof has been obtained for any of the theories, but some of the ideas will be discussed briefly in relation to Locusta. Pinocytosis and vesicle production are generally disregarded as being of prime importance in urine production across insect tubules as it has been calculated (TAYLOR, 1971) that the rate of vesicle formation and flow would have to be impossibly rapid to maintain the rates of urine production observed. RIEGALS 'formed body' theory (1966) (described in Chapter 3) has also been shown to be unlikely in Locusta as no 'formed bodies' could be observed in the tubule lumen.

TAYLOR (1970) suggests that fluid movement across the Malpighian tubules of Carausius may occur as a result of frictional forces between transported solute and water (co-diffusion). This theory, originally proposed by KEDEM (1965), suggests that the diffusion of solute through pores in the membrane drags water molecules along by frictional force. In the

case of an active ion transport system, however, it would seem that water could only pass across the membrane at the site of active transport. TAYLOR (1970) suggests that if a Na^+/K^+ exchange pump is involved, solute drag could be exerted by the passive back diffusion of Na^+ ions into the cytoplasm and water movement could thus occur throughout the region. In the case of Locusta however, it would appear unlikely that water movement results from co-diffusion with passively back diffusing Na^+ , because the tubules were able to secrete in a medium entirely lacking Na^+ . The concept of fluid movement through pores is also subject to doubt, and recent studies (reviewed by OSCHMAN et al , 1974) suggest that the pores may well not be involved in fluid movement. It would appear unlikely, therefore, that co-diffusion plays an important role in secretion by the tubules of Locusta .

The most widely held theory is that water movement is passive, and results from an osmotic force created by active ion "pumping" across a membrane. The development of the necessary osmotic gradients has also been the subject of much controversy. The ultrastructure of Locusta Malpighian tubules revealed numerous infolds on the basal and apical surfaces. Extensive infolding has been shown to be a characteristic of secretory epithelium (review BERRIDGE and OSCHMAN, 1972) and much debate has centered around the functional significance of the infolds. DIAMOND and BOSSERT (1967, 1968), and BERRIDGE and OSCHMAN (1969) feel that the

structure of the infolds enable the formation of standing gradients (described in Chapter 3) which provide the osmotic force necessary for fluid flow. Whilst the ultrastructure of Locusta tubules would clearly enable standing gradients to form in theory, a certain amount of doubt has been raised as to whether these gradients could be entirely responsible for fluid flow. TAYLOR (1970, 1971a) argues strongly against standing gradients being of prime importance in Carausius tubules. One of his main objections is that the dimensions of the infolds on the basal surface (which closely resemble the dimensions for Locusta) are such that the osmotic permeability of the membrane would have to be impossibly high to allow enough water to cross the membrane to account for fluid flow. This objection is also made by HILL (1975a+b) from a series of mathematical calculations. Another strong objection to the DIAMOND and BOSSERT model put forward recently (GUPTA et al , 1976) results from their work using electron probe X-ray microanalysis to measure the ion concentrations in Rhodnius Malpighian tubules. They show that the concentrations between the microvilli are the opposite to those proposed by the model with, Na^+ , K^+ and Cl^- being more concentrated towards the lumen than at the closed end of the channels. It seems, therefore, that although attractive in theory the standing gradient hypothesis is unlikely to be responsible for secretion by Locusta tubules. The fact that ouabain which inhibits fluid secretion has no effect on the extracellular spaces would further substantiate this suggestion.

As the urine of Locusta is always slightly hypertonic to the bathing medium it is possible that a simple 'local osmosis' (DIAMOND, 1964) may be responsible for water movement across the tubule. The theory of local osmosis is that the cytoplasm is marginally hypertonic to the bathing medium as a result of solute pumping across the basal membrane, and similarly the lumen becomes marginally hypertonic to the bathing medium. Water flows passively from the haemolymph to the tubule lumen as a result of this osmotic gradient. This theory has been favoured by MADDRELL (1972) for all insects which produce a hypertonic urine, he agrees with TAYLOR (1971a) that the invaginations merely increase the surface area for ion and water movement on both sides of the cell. TAYLOR quoted by MADDRELL (1972) calculates that with an osmotic difference of 10m Osmoles from haemolymph to lumen, and an effective osmotic permeability of $10^{-4} \text{ cm sec}^{-1} \text{ Osm}^{-1}$ would be sufficient to account for the measured rates of water transport recorded for most insects. Whilst the osmotic permeability of Locusta tubules is unknown from the present study, the osmotic difference of $22.9 \pm 2.6 \text{ m Osmoles}$ suggests that local osmosis may account for fluid movement.

Therefore, the present study on Locusta has established that water movement follows active K^+ transport across the Malpighian tubules probably as a result of 'local osmosis'. A $\text{Na}^+ \text{K}^+ \text{ATPase}$ enzyme is clearly involved on at least one surface of the tubule, most probably the basal surface

and an electrogenic K^+ pump may exist on the apical surface. The results further suggest that the endocrine control of diuresis is mediated via cyclic AMP.

APPENDIX 4 (i)

Preparation of the Tris salt of adenosine triphosphate (ATP)

The disodium salt of ATP was converted into tris ATP using an ion exchange Dowex resin. Before it could be used the Dowex had to be converted into its H^+ form (re-charged). The Dowex resin was well rinsed with distilled water in a Buchner funnel and the wet weight was noted. It was then washed in 3N HCl (AnalaR), using 30mls of acid per 5g wet weight of resin. This was followed by washing in distilled water until the effluent had a pH between 3-4. At this stage all the residual acid was removed from the resin and it was in its "charged" form. It was resuspended in its own volume of distilled water and stored at $0-4^{\circ}C$ until required.

A known quantity of disodium ATP was dissolved in a known small volume of distilled water (approx. 10mls) and this was added to a small quantity of the H^+ Dowex resin and thoroughly mixed using a "Whirlmixer" (Fisons scientific apparatus) for a few minutes. The resin was allowed to sediment and the supernatant removed and retained. The resin was washed three times with a little distilled water mixing thoroughly each time thus ensuring the removal of all the H^3 ATP from the Dowex. The supernatant was pooled each time. By now the ATP was in its H^+ form and it was converted to the tris salt by the addition of drops of 2M Tris until the pH was 7.2. It was then made up to the required volume and was stored at $-20^{\circ}C$.

APPENDIX 4 (ii)

Construction of a standard calibration curve for inorganic phosphate

A stock solution containing $20\mu\text{g}$ phosphorus (as $\text{KH}_2\text{PO}_4/\text{ml}$) was serially diluted to give 20, 15, 10, 5, 2.5, $0\mu\text{g}$ Pi/ml. Two mls of the standard solutions were pipetted into MSE centrifuge tubes followed by 4mls of lubrol mix (see Chapter 4, Materials and Methods section ii). The tubes stood for 10 minutes at room temperature for the development of the yellow colour, and then the optical density was measured on a Pye Unicam S.P. 1800 Dual Beam Spectrophotometer at 390nm slit with 10mm. Standard curves were produced using mixtures prepared with Lubrol W and Cirrasol ALN-F, and they were found to be identical (COSSINS, 1975), consequently the Cirrasol curve only is shown in Fig. A.4.1.

FIG. A: 4 : 1

Standard curve for phosphate concentration against optical density.

Ordinate: optical density 390nm.

Abscissa: phosphate concentration (n.moles).

(lines drawn by regression analysis).

FIG. A: 4 : 2

Standard curve for protein concentration against optical density. (B.S.A. fraction V used to provide the standard concentrations).

Ordinate: optical density 500nm.

Abscissa: protein concentration $\mu\text{g/ml}$.

(lines drawn by regression analysis).

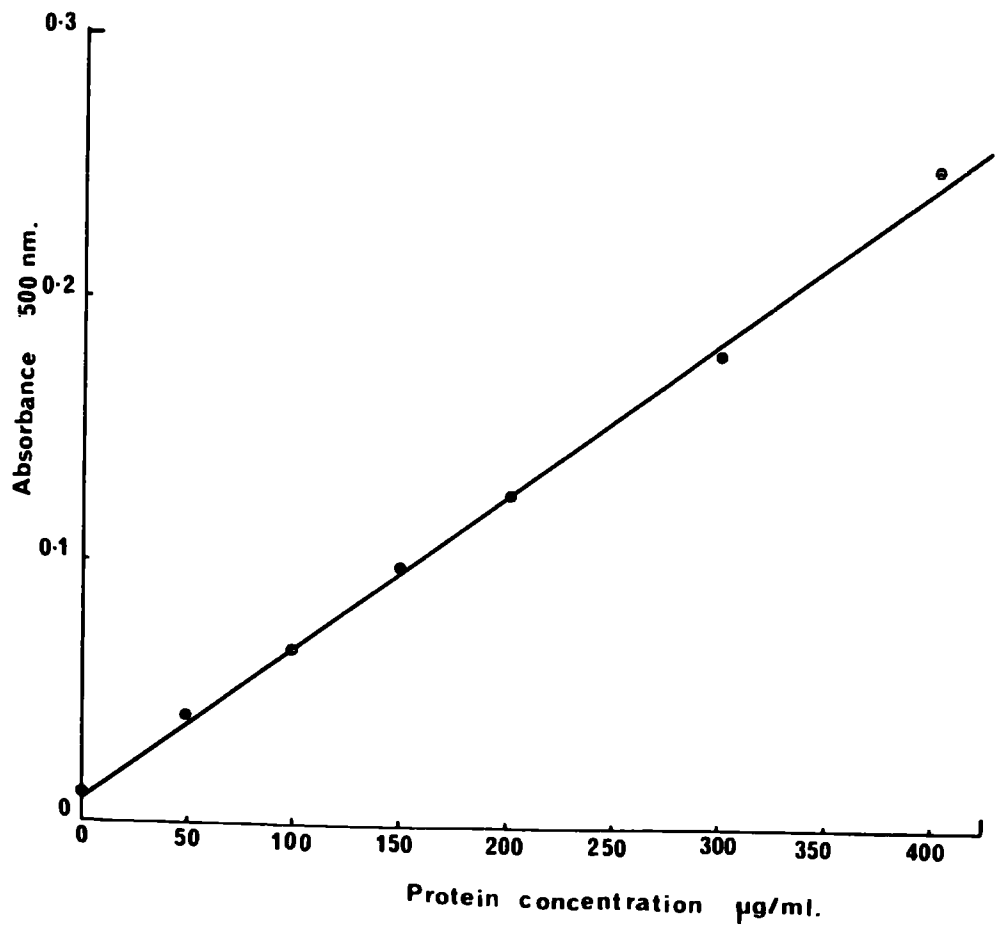
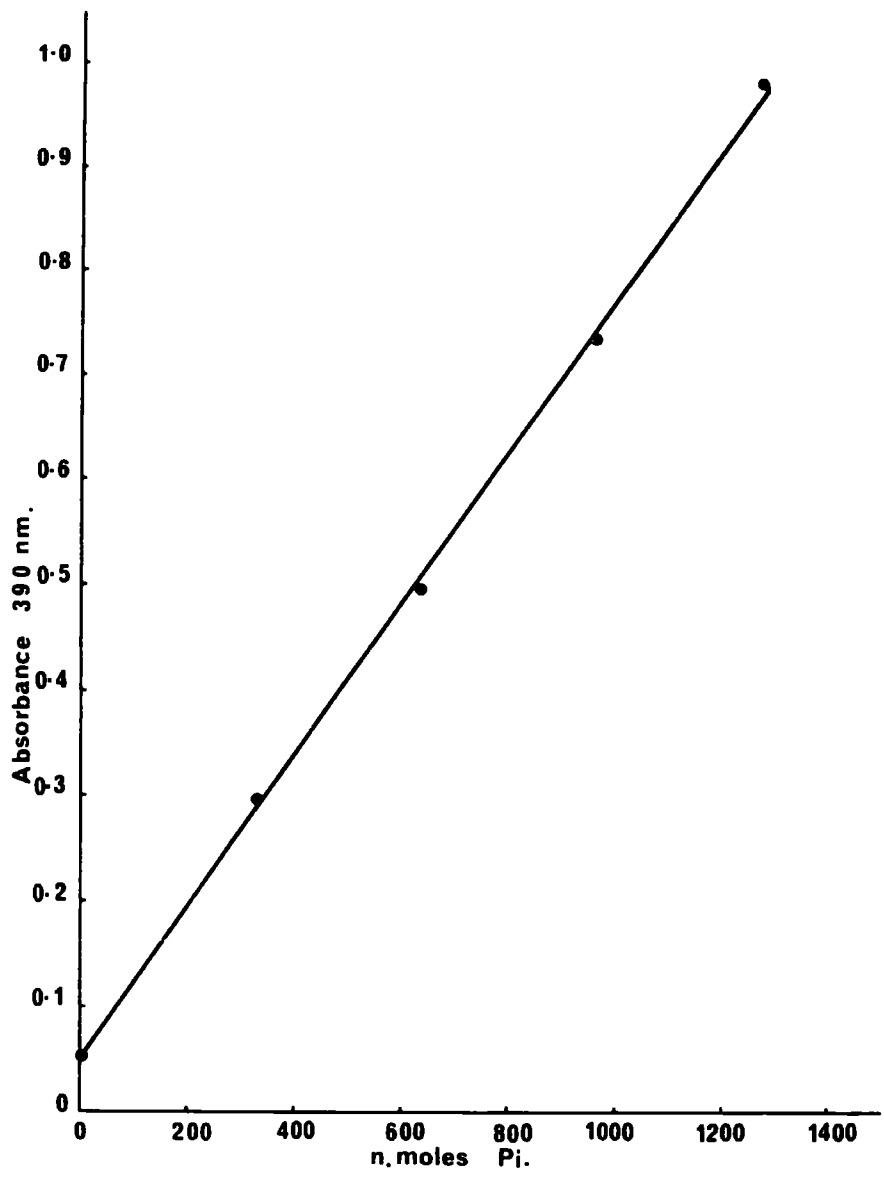

APPENDIX 4 (iii)

Folin-phend method of Protein assay (LOWRY et al., 1951)

Bovine serum albumen (B.S.A.) Fraction V (Sigma Chemicals Ltd.), was used to provide standard solutions containing 0.50, 100, 150, 200, 300, 400 μ g/ml.

Reagents

- i) 2% wt/Vol Sodium Carbonate
- ii) 0.5% CuSO_4
- iii) 1% Potassium Sodium Tartrate

Folin A Mixture was prepared by mixing equal volumes of solutions (ii) and (iii) and one volume of this mixture was added to 50mls of solution (i).

Folin B Mixture was prepared by diluting four volumes of Folin's Ciocalteaus phenol reagent with six volumes of water.

Method

Three mls of Folin solution A was added to 0.2mls of protein solution in a boiling tube and it was allowed to stand at room temperature for 30 mins. 0.3mls of Folin solution B was then added and the resulting mixture was allowed to stand a further 60 mins at room temperature. The solutions were poured into glass cuvettes and the optical density at 500nm was measured on an S.P. 1800 Pye Unicam Spectrophotometer. A calibration curve could be constructed from the standards from which the unknowns could be determined. A new calibration

curve was constructed every time a protein assay was carried out. A typical curve is graph A:4:2:

APPENDIX 4 (iv)

a) $\text{Na}^+ - \text{K}^+$ ATPase enzyme. Arrhenius μ values

temp. range	tissue	activation energy E_a Kjoules Mole ⁻¹	slope	r.
6.3-21°C	1 Malpighian tubules	95.92	-5.01	0.98
	2 " "	140.33	-7.33	0.98
	3 " "	132.11	-6.95	0.99
	4 Rectal Sacs	97.26	-5.05	0.97
	5 " "	134.60	-7.03	0.98
	6 " "	125.79	-6.57	0.91
	7 Hindgut + Malpighian tubules	117.56	-6.14	0.97
	8 " "	121.39	-6.34	0.97
	9 " "	143.6	-7.5	0.90
	10 " "	114.5	-5.98	0.99
	11 " "	129.4	-6.76	0.95
	12 " "	106.8	-5.79	0.99
21°C-42°C	1 Malpighian tubules	75.86	-3.96	0.98
	2 " "	53.40	-2.79	0.97
	3 " "	57.01	-2.98	0.99
	4 Rectal Sacs	49.43	-2.58	0.98
	5 " "	73.29	-3.83	0.96
	6 " "	62.22	-3.26	0.92
	7 Hindgut + Malpighian tubules	66.06	-3.45	0.99
	8 " "	47.10	-2.46	0.97
	9 " "	64.71	-3.38	0.89
	10 " "	48.44	-2.53	0.98
	11 " "	58.08	-3.09	0.99
	12 " "	63.19	-3.30	0.95

APPENDIX 4 (iv)

b) Mg^{2+} ATPase enzyme. Arrhenius μ values.

temp. range	tissue	Activation energy Ea Kjoules Mole ⁻¹	slope	r
6.3-21°C	1 Malpighian tubules	98.2	-5.13	0.97
	2 " "	97.6	-5.10	0.99
	3 " "	99.3	-5.20	0.98
	4 Rectal Sacs	91.1	-4.76	0.95
	5 "	88.7	-4.63	0.92
	6 Hindgut + Malpighian tubules	98.4	-5.14	0.90
	7 " "	87.3	-4.56	0.97
	8 " "	105.8	-5.53	0.97
	9 " "	96.1	-5.02	0.95
	10			
21.0-42°C	1 Malpighian tubules	58.0	-3.03	0.97
	2 " "	66.8	-3.49	0.98
	3 " "	47.86	-2.51	0.99
	4 Rectal Sacs	45.9	-2.4	0.7
	5 "	55.3	-2.85	0.99
	6 Hindgut + Malpighian tubules	45.9	-2.4	0.7
	7 " "	42.12	-2.26	0.95
	8 " "	41.54	-2.17	0.94
	9 " "	39.44	-2.06	0.95
	10 " "	65.10	-3.4	0.97

APPENDIX 4 (v)

Effect of Mg^{2+} concentration on Activity

a) Na-K ATPase nmoles Pi/Mg protein/min

Mg^{2+} conc mM	30°C	30°C	30°C	40°C	40°C
0	9.5	5.5	4.76	12.45	11.43
1	42.5	164.7	390	235.3	519
2	73.0	121.6	466	309.8	534
3	86.5	242.4	520	371	579
4	99.0	248.6	519	431	643
5	92.5	215.7	481	414	628
6	93.5	200	443	400	619
7	91.5	188.2	443	386.7	623
8	78	174.1	426	380	617
9	72	173.3	405	376.9	548
10	86.5	145.1	363	365.7	581

b) Mg^{2+} ATPase nmoles Pi/Mg protein/min.

Mg^{2+} conc nM	20°C	30°C	30°C	40°C	40°C
0	8.4	11.8	25.7	25.0	66.6
1	21	39.2	66.6	63.5	91.4
2	20	50.9	76.2	70.6	144.7
3	20	51	71.4	77.6	132.4
4	10	50	75.2	90.2	133.3
5	17.4	51	83.8	92.5	133.3
6	17.0	61.2	66.6	92.5	90.47
7	17.4	50.9	66.6	94.1	119.0
8	18.0	50.8	60	94.1	102.8
9	20.5	56.4	58.1	90.6	92.4
10	5.0	52.0	60.9	70.6	73.8

APPENDIX 4 (vi)

Effect of Na⁺ and K⁺ concentration on activity of Na-K ATPase (activity n.moles Pi/mg protein/min)

a) 20°C

K ⁺	10mM Na ⁺	25mM Na ⁺	50mM Na ⁺	100mM Na ⁺	150mM Na ⁺
i)					
2mM	75.24	98.41	120.63	112.06	138.68
6mM	106.98	112.06	131.21	151.43	169.21
10mM	84.44	132.38	174.60	170.48	181.9
20mM	66.67	169.21	180.0	264.44	213.65
30mM	56.19	-	177.78	180	204.13
50mM	34.92	105.71	192.38	200.95	-
ii)					
2mM	9.72	74.77	88.32	66.36	41.12
6mM	32.71	79.44	100.93	91.59	89.34
10mM	36.45	85.05	93.46	101.31	102.80
20mM	35.51	80.93	101.87	115.89	108.41
30mM	32.15	80.37	98.13	114.93	108.41
50mM	31.78	75.23	93.46	111.77	114.95
iii)					
2mM	7.25	31.3	38.7	44.9	21.74
6mM	11.01	24.2	44.9	72.46	68.12
10mM	13.33	24.2	50.7	78.26	72.46
20mM	3.33	24.2	57.9	98.55	81.16
30mM	3.33	22.17	57.9	98.55	105.79
50mM	3.33	11.01	50.72	76.26	81.6

APPENDIX 4 (vi) (continued)

b) 10°C

K ⁺	10mM Na ⁺	25mM Na ⁺	50mM Na ⁺	100mM Na ⁺	150mM Na ⁺
2mM	15.52	18.42	23.27	18.42	11.73
6mM	14.48	18.42	23.85	26.67	24.05
10mM	12.89	19.9	24.07	27.25	26.67
20mM	10.28	17.07	23.85	27.25	25.21
30mM	9.02	15.8	22.91	25.2	25.21
50mM	6.3	14.55	19.88	24.0	24.05

c) 30°C

K ⁺	10mM Na ⁺	25mM Na ⁺	50mM Na ⁺	100mM Na ⁺	150mM Na ⁺
2mM	85.43	136.96	121.74	121.74	65.22
6mM	107.17	163.04	158.70	158.70	155.65
10mM	95.65	177	177	197.83	176.09
20mM	101.3	175.57	175.75	211.52	202.17
30mM	95.63	173.13	173.13	210.87	208.7
2mM	141.16	193.02	205.34	153.49	83.02
6mM	169.07	212.32	232.56	218.6	214.65
10mM	155.12	208.60	233.95	250.2	248.84
20mM	132.56	200.70	213.95	272.09	270.46
30mM	116.98	190.0	210.70	248.14	247.21
50mM	114.65	156.51	203.72	241.16	242.56

ii)

APPENDIX 4 (vi) (continued)

d) 40°C

	K ⁺	10mM Na ⁺	25mM Na ⁺	50mM Na ⁺	100mM Na ⁺	150mM Na ⁺
i)						
	2mM	201.25	298.33	220.83	195.83	266.67
	6mM	240	375.0	379.16	317.92	291.67
	10mM	262.5	377.5	376.25	781.67	406.67
	20mM	196.67	345.83	400	947.08	475.0
	30mM	147.08	276.25	381.50	750	500
	50mM	125.0	309	441.67	470.83	469.17
ii)						
	2mM	679.24	804.30	760.25	437.21	260.76
	6mM	700.51	885.32	943.54	834.68	711.4
	10mM	649.87	852.40	941.78	978.99	844.57
	20mM	538.48	742.53	896.2	1038.74	972.91
	30mM	422.02	789.23	886.07	1021.01	990.63
	50mM	338.48	649.87	848.86	970.38	895.19

APPENDIX 4(vii)

Kinetic Constants of $\text{Na}^+ \text{K}^+ \text{ATPase}$

Temp.	Km.mMolar	V Max (n moles Pi/ mg/Protein /min)	Slope	r
20°C	0.09	70	1.39	0.99
	0.12	198	0.60	0.98
	0.15	73	2.46	0.88
30°C	0.18	198	0.96	0.96
	0.19	129	1.58	0.97
	0.17	312	0.56	0.99
40°C	0.11	411.5	0.68	0.95
	0.16	769	0.14	0.93
	0.15	138	1.24	0.98
	0.15	228	0.24	0.99
	0.19	319	0.54	0.99

Appendix 5 (i)

Calculation of oxygen content of 3mls of Ringer in oxygen electrode apparatus. (Chapter 5).

Oxygen content of 1ml of reaction medium saturated with air at $30^{\circ}\text{C}=0.445\mu\text{g atoms O}_2$. This value was calculated by CHAPPELL (1964) and confirmed by DAVIDSON (1970). 3mls of reaction medium was used in the experiments:-

Therefore oxygen content of 3mls= $0.445 \times 3=1.335\mu\text{g atoms O}_2 =0.668\mu \text{ moles O}_2$.

The ringer solution was saturated with air prior to each experiment, therefore 100% saturation contains $0.668\mu \text{ moles O}_2$. Each 1% unit on recorder is therefore equivalent to $0.00668\mu \text{ moles O}_2$.

APPENDIX 5 : (ii)

Effect of 1mM ouabain on the rate of oxygen consumption by the Malpighian tubules of Locusta.

Rate of consumption expressed as $\mu\text{moles O}_2/\text{hr}$

Time in mins	Ouabain treated	Ouabain treated	Control (no Ouabain)	Control no Ouabain
0	26.6	6.0	7.4	10.8
10	15.5	3.92	7.6	10.3
20	15.32	4.24	7.6	10.1
30	14.4	4.4	7.0	9.6
40	14.4	4.42	6.5	9.0
50	15.2	4.68	4.8	7.0
60	14.0	4.52	3.0	8.5
70	14.4	3.92	5.4	6.5
80	13.8	4.0	4.6	6.7
90	13.4	4.0	4.2	7.7

FIG. A: 6: 1

Calibration curve for NaOH concentration against % emission, estimated using an S.P. 90 spectrophotometer wavelength 570nm.

Ordinate : % emission

Abscissa : Na⁺ concentration (m.molar)

FIG. A: 6: 2

Calibration curve for KOH concentration against % emission, estimated using an S.P. 90 spectrophotometer wavelength 750nm.

Ordinate : % emission

Abscissa : K⁺ concentration (m.molar)

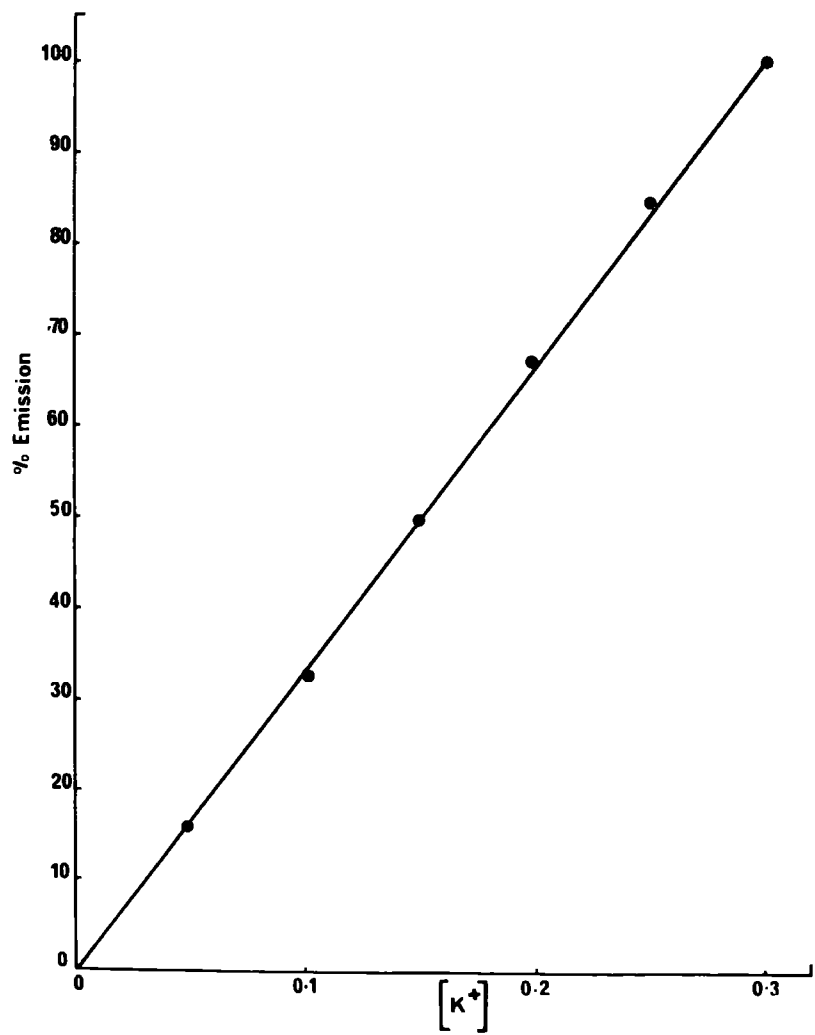
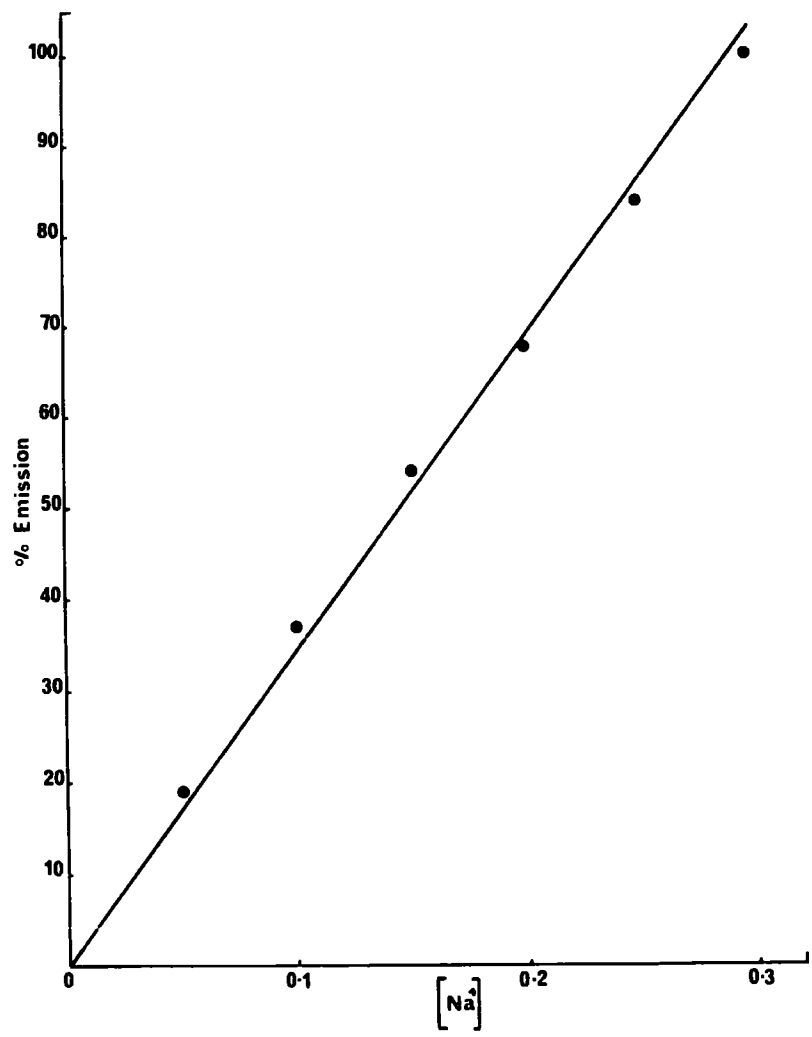

FIG: A: 6: 3

Calibration curve relating osmotic concentration (m.Osmoles) to the $\Delta^{\circ}\text{C}$ value obtained by the cryoscopic method of RAMSAY and BROWN (1955). The range of osmotic concentrations were produced using NaOH solutions.

Ordinate: osmotic concentration $\Delta^{\circ}\text{C}$.

Abscissa: osmotic concentration (m.Osmoles).

FIG. A: 6: 4

Calibration curve for ITT bead thermister.

Ordinate: mV value recorded on pen recorder.

Abscissa: temperature $^{\circ}\text{C}$.

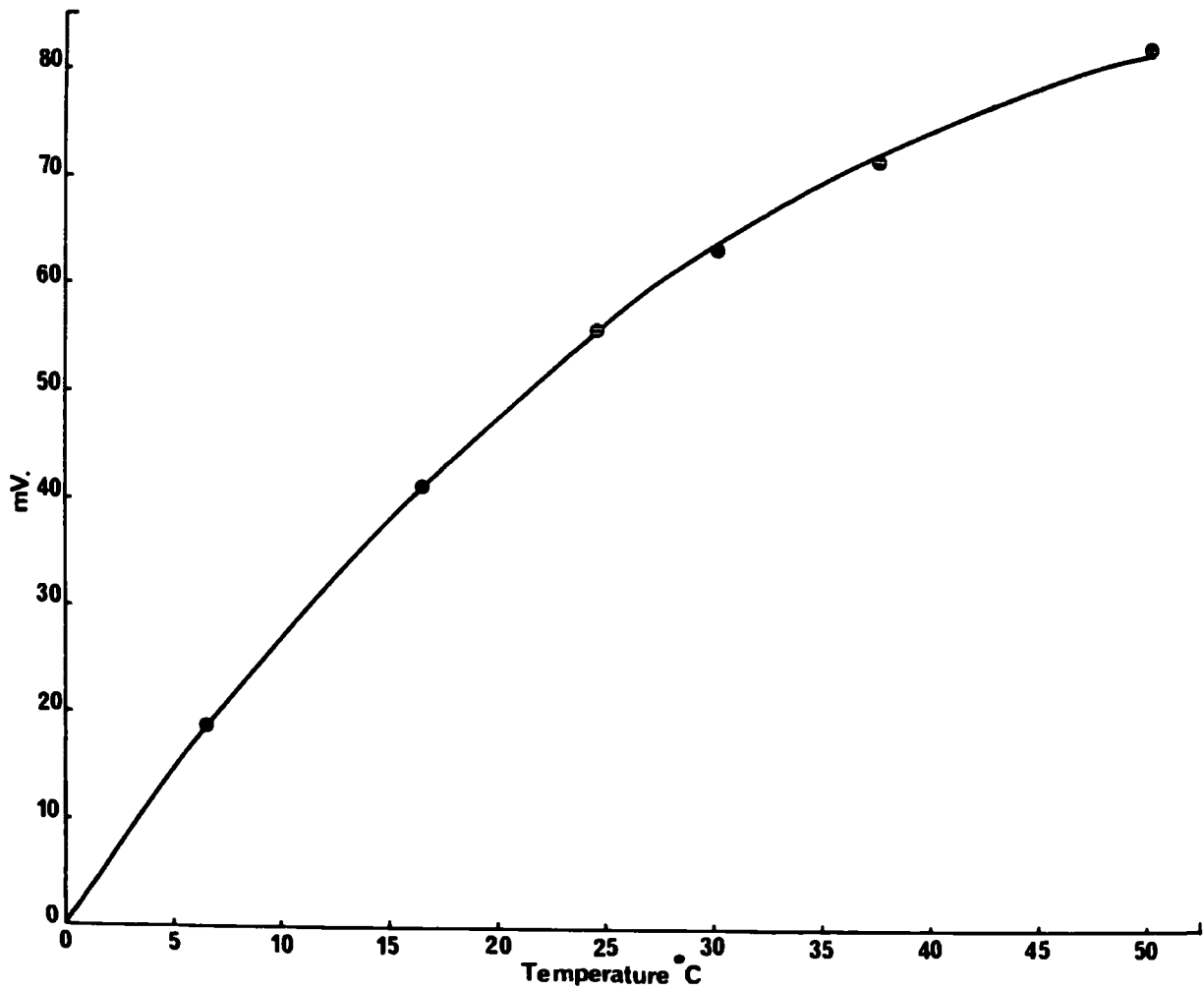
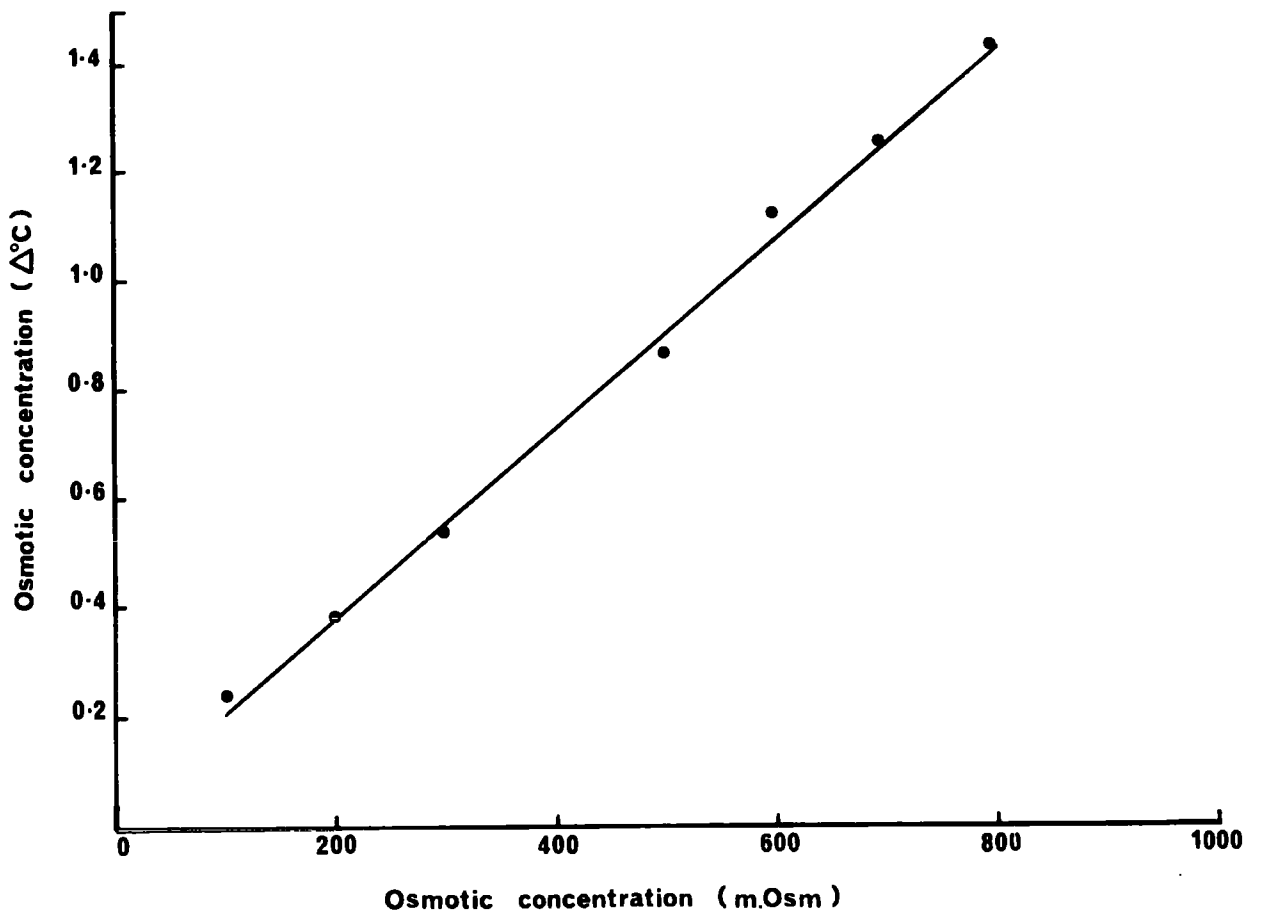

FIG. A: 6: 5

Effect of temperature on the pH of Ringer solution buffered with HEPES.

Ordinate: pH.

Abscissa: temperature °C.

FIG. A: 6: 6

Effect of temperature on the pH of 'normal' Ringer solution. The arrow indicates the beginning of precipitate formation.

Ordinate: pH.

Abscissa: temperature °C.

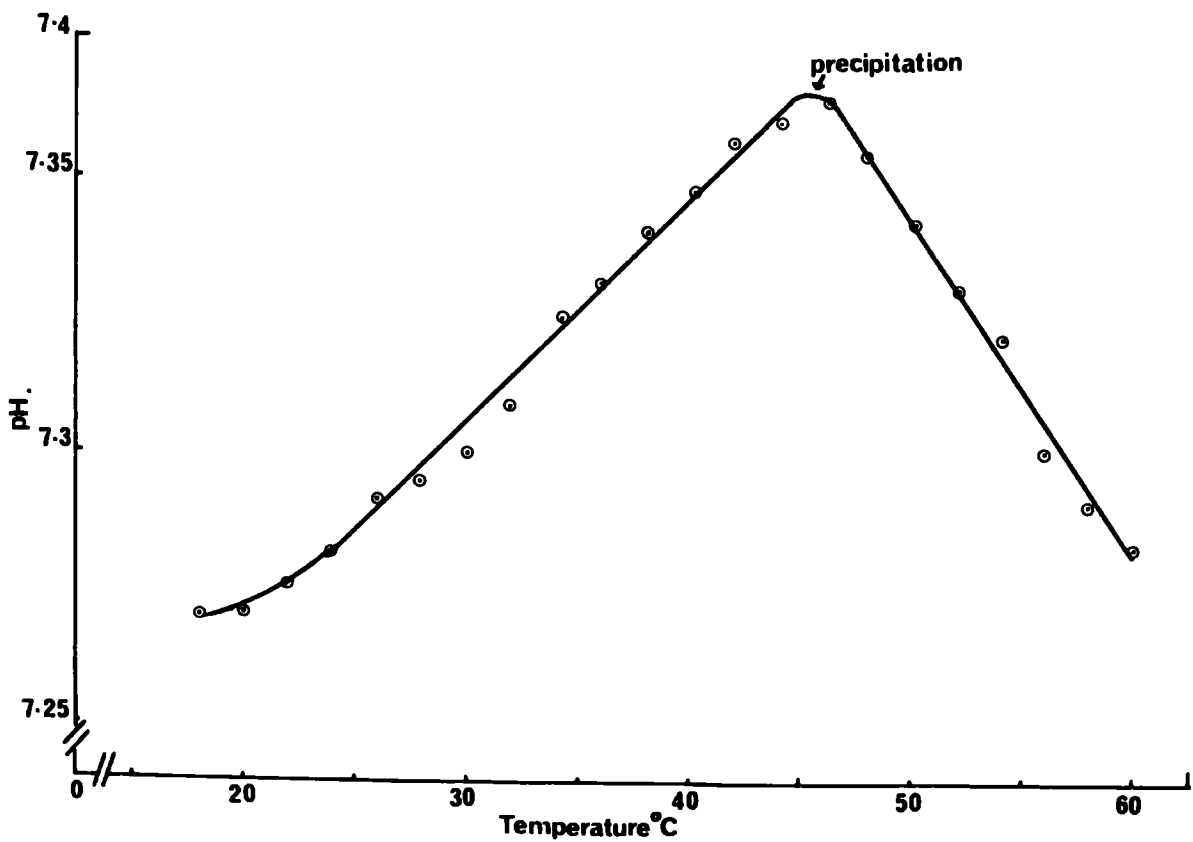
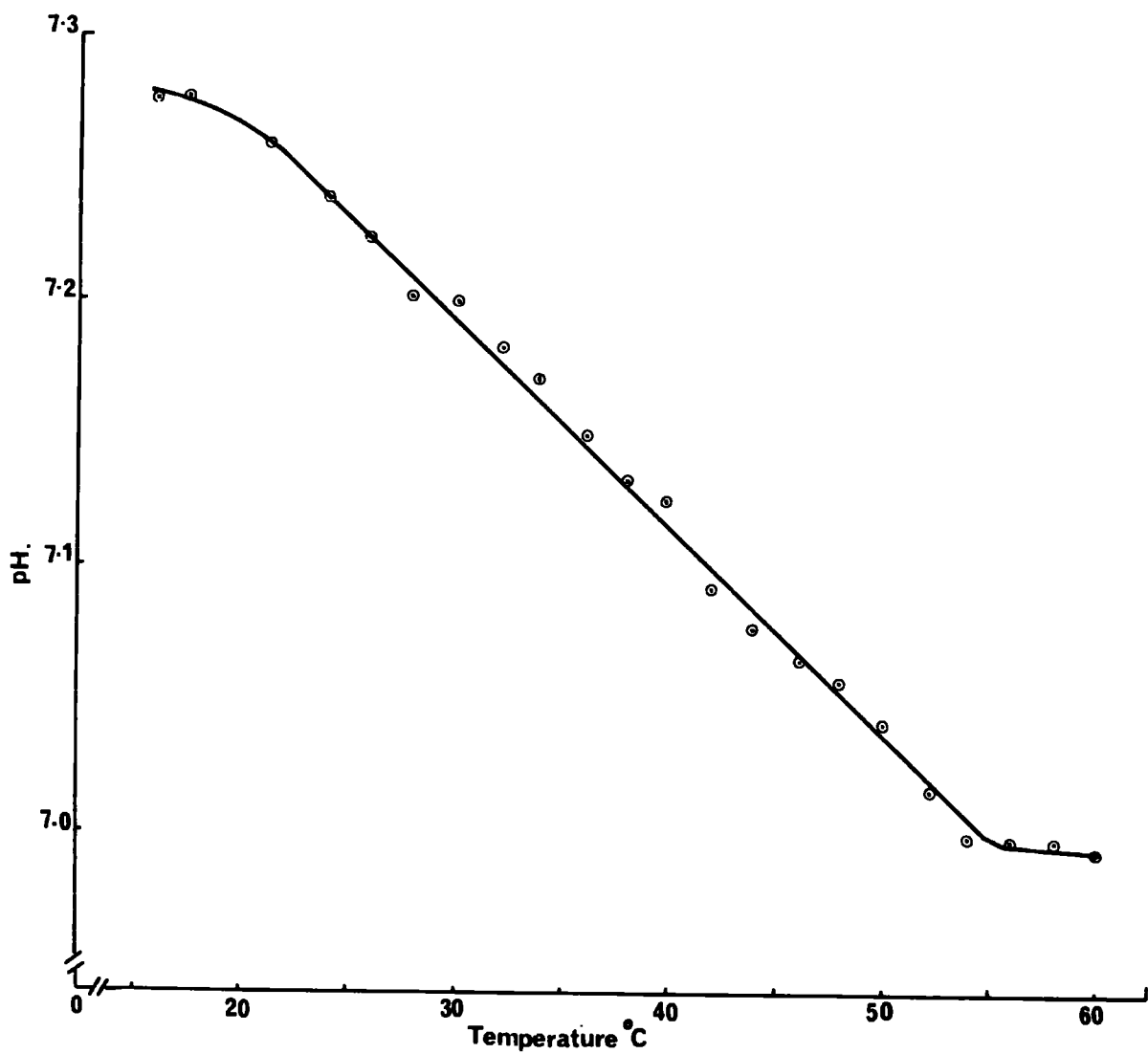

APPENDIX 6: (i)

Na⁺ and K⁺ concentrations of fluid secreted by Malpighian tubules bathed in media of varying Na⁺ and K⁺ concentrations

RINGER		URINE					n	
Na ⁺	and K ⁺	Na ⁺	K ⁺ mM	total Na ⁺	and K ⁺	Na	K	
139.6	Na ⁺ : 0.4 K ⁺	144.68 ± 10.1	37.94 ± 3.8	181.7 ± 11.6		4.41		11
132.5	Na : 7.5 K ⁺	110.43 ± 9.6	61.39 ± 6.4	171.8 ± 13.7		1.89		7
120	Na : 20 K ⁺	39.1 ± 3.6	132.33 ± 11.3	170.8 ± 13.5		0.39		12
70	Na ⁺ : 70 K ⁺	37.74 ± 3.03	142.95 ± 8.5	180.8 ± 7.9		0.27		10
30	Na ⁺ : 110 K ⁺	29.01 ± 2.5	149.14 ± 7.6	178.2 ± 8.0		0.19		13
3	Na : 137 K ⁺	20.51 ± 1.74	150.24 ± 7.2	170.8 ± 8.0		0.13		11

APPENDIX 6 : (ii)

Effect of osmotic pressure on the rate of fluid secretion by the Malpighian tubules

m.Osmoles.	% of original rate	P	n
33	108.0 \pm 13	not sig	20
86	328 \pm 66	<0.001	11
256	228 \pm 33	<0.01	14
328	145 \pm 16	<0.05	12
440	75 \pm 14	not sig	13
580	28 \pm 8	<0.05	12
820	6 \pm 2	<0.001	11

(P values were obtained by comparing rate 1 and rate 2 by a paired 't' test).

APPENDIX 6 : (iii)

The effect of temperature on fluid secretion by the Malpighian tubules

Temperature °C	Rate as % of rate at 30°C	No of tubules	P
5	11.32 ± 3.2	9	<0.01
10	17.2 ± 3.4	9	<0.001
15	23.45 ± 4.6	10	<0.01
20	28.4 ± 5.05	7	<0.05
25	53.81 ± 5.2	9	<0.05
30	92.7 ± 5.95	14	Not sig.
34	130 ± 17.0	11	Not sig.
37	138 ± 10.5	16	<0.05
40	153.8 ± 9.2	7	<0.05
45	129 ± 40	12	Not sig.
47	66.7 ± 7.8	79	Not sig.

(P values were obtained by comparing rate 1 and rate 2 by a paired 't' test)

APPENDIX 6 : (iv)

The effect of cyclic AMP on fluid secretion by the Malpighian tubules

Cyclic AMP	Stim. rate as % of original	P. value	n
0	98.3 ± 14.0	not sig.	11
10 ⁻⁵	119. ± 14.0	not sig.	19
3 x 10 ⁻⁵	112.2 ± 20.0	not sig.	16
7 x 10 ⁻⁵	117.5 ± 20.0	not sig.	6
10 ⁻⁴	153.3 ± 14.6	not sig.	14
3 x 10 ⁻⁴	216.0 ± 40.0	P < 0.05	13
10 ⁻³	273.1 ± 40.0	P < 0.001	14
3 x 10 ⁻³	151.4 ± 20.0	P < 0.05	13
10 ⁻²	130.4 ± 17.8	not sig.	15

(P values were obtained by comparing rate 1 and rate 2 by a paired 't' test).

APPENDIX 6: (v)

The effect of Cyclic AMP on Na⁺-K⁺ ATPase activity of
microsomal preparations of hindgut and Malpighian tubules
of *Locusta migratoria*

[Cyclic AMP] Molar	Na ⁺ -K ⁺ ATPase Activity n. moles Pi/mg Protein/ hr	Mg ²⁺ ATPase activity n. moles Pi/mg protein/ hr
0	284.9	52.6
10 ⁻⁷	284.2	42.5
10 ⁻⁶	278.8	46.4
10 ⁻⁵	284.0	54.27
10 ⁻⁴	284.9	33.4
10 ⁻³	278.6	42.7

BIBLIOGRAPHY

The abbreviations are taken from the World List of Scientific Periodicals.

- AHMED, K. and JUDAH, J.D. (1964). Preparation of lipo-proteins containing cation-dependent ATPase. Biochim. biophys. Acta. 93: 603-613.
- AKERA, T. (1971). Quantitative aspects of the interaction between ouabain and (Na^+ and K^+)-activated ATPase in vitro. Biochim. biophys. Acta. 249: 53-61.
- AKERA, T., LARSEN, F.S. and BRODY, T.H. (1969). The effect of ouabain on sodium and potassium activated adenosine triphosphatase from the hearts of several mammalian species. J. Pharmac. exp. Ther. 171: 17-76.
- ALLEN, J.C. and SCHWARTZ, A. (1970). Effects of potassium, temperature and time on ouabain interaction with the cardiac Na^+ , K^+ -ATPase: Further evidence supporting an allosteric site. J. Molecular and cellular cardiology. I: 39-45.
- AMAKAWA, T., and MIZUHIRA, V. (1966). The electron microscope studies on ion-detection in the cell. 6th Int. Congress for electron microscopy. Kyoto. 2: 87-88.

- ANDREWS, P. (1973). A scanning electron microscopic study of the uriniferous tubules. 31st Ann. Proc. Electron Microscopy Soc. Amer. New Orleans, Los Angeles, Ed. ARCENEUX, C.J.
- ANDREWS, P. (1974). A scanning electron microscopic study of the nephrotic kidney. 32nd Ann. Proc. Electron Microscopy Soc. Amer. St. Louis Missouri, Ed. ARCENEUX, C.J.
- ANDREWS, P. (1975a). Scanning electron microscopy of the nephrotic kidney. Virchows Arch. B. cell Path. 17 : 195-211.
- ANDREWS, P. (1975b). Scanning electron microscopy of human and rhesus monkey kidneys. Lab. Invest. 32 : 610-618.
- ANSTEE, J.H. and BELL, D.M. (1975). Relationships of Na^+ K^+ activated ATPase to fluid production by Malpighian tubules of Locusta migratoria. J. Insect Physiol. 21 : 1779-1784.
- ARCHIBALD, J.T. and WHITE, T.D. (1974). Rapid reversal of internal Na^+ and K^+ contents of synaptosomes by ouabain. Nature Lond. 252 : 595-596.
- ASHURST, D.E. (1968). The connective tissues of insects. Ann. Rev. Ent. 13 : 107-134.
- ASTON, R.J. (1975). The role of adenosine 3'5' cyclic monophosphate in relation to the diuretic hormone of Rhodnius prolixus. J. Insect Physiol. 21 : 1873-77.

- ATKINSON, A., GATENBY, A.D. and LOWE, A.G. (1973).
The determination of inorganic orthophosphate in
biological systems. Biochim. biophys. Acta. 320 :
195-204.
- ATZBACHER, U., HEVERT, F., WEBER-VON GRÖTTHUSS,
E. and WESSING, A. (1974). The influence of
ouabain on the elimination of injected and orally
applied dyes in Drosophila hydei. J. Insect
Physiol. 20 : 1989-1997.
- AUGUSTUS, J. (1976). Evidence for electrogenic sodium
pumping in the ductal epithelium of rabbit salivary
gland, and its relationship with $(\text{Na}^+ + \text{K}^+)$ ATPase.
Biochim. biophys. Acta. 419 : 63-75.
- BADER, H., SEN, A.K. and POST, R.L. (1966). Isolation
and characterization of a phosphorylated
intermediate in the $(\text{Na}^+ + \text{K}^+)$ system-dependent
ATPase. Biochim. biophys. Acta. 118 : 106-115.
- BAKER, P.F. (1972). The sodium pump in animal tissues and
its role in the control of cellular metabolism and
function. In Metabolic Pathways VI, 243-267,
Academic Press.
- BAKKEREN, J.A. and BONTING, S.L. (1968). Studies on
 $(\text{Na}^+ - \text{K}^+)$ activated ATPase. XX. Properties
of the $(\text{Na}^+ - \text{K}^+)$ activated ATPase in rat liver.
Biochim. biophys. Acta. 150 : 460-466.

- BEAMS, H.W., TAHMISIAN, T.N. and DEVINE, R.L. (1955).
Electron microscope studies on the cells of the
Malpighian tubules of the grasshopper Melanoplus
differentialis (Orthoptera acrididae). J. biophys.
biochem. Cytol. I : 197-202.
- BERKALOFF, A. (1958). Les grains de sécrétion des tubes
de Gryllus domesticus (Orthoptère Gryllidae).
C.r. Acad. Sci. Paris 246 : 2807-2809.
- BERKALOFF, A. (1959). Transformations mitochondriales
et formation de pigment dans les tubes de Malpighi
de Gryllus domesticus (Orthoptère Gryllide). C.r.
Acad. Sci. Paris 249 : 2120-2121.
- BERKALOFF, A. (1960). Contribution à l'étude des tubes de
Malpighi et de l'excrétion chez les insectes.
Observations au microscope électronique. Annls.
Sci. Nat. Zool. XII. 2 : 869-947.
- BERRIDGE, M.J. (1965). The physiology of excretion in the
cotton stainer Dysdercus fasciatus (Signoret) I.
Anatomy, water excretion and osmoregulation. J.
exp. Biol. 43 : 511-521.
- BERRIDGE, M.J. (1966). The physiology of excretion in the
cotton stainer Dysdercus fasciatus (Signoret). IV.
Hormonal control of excretion. J. exp. Biol. 44 :
553-566.

- BERRIDGE, M.J. (1967). Ion and water transport across epithelia. In Insects and Physiology, Ed. BEAMONT, J.W.L. and TREHERNE, J.E. Oliver and Boyd. Edinburgh and London. 329-347.
- BERRIDGE, M.J. (1968). Urine formation by the Malpighian tubules of Calliphora. I. Cations. J. exp. Biol. 48 : 159-174.
- BERRIDGE, M.J. (1970). The role of 5HT and cyclic AMP in the control of fluid secretion by isolated salivary glands. J. exp. Biol. 53 : 171-186.
- BERRIDGE, M.J. (1975). The interaction of cyclic nucleotides and calcium in the control of cellular activity. Advances in cyclic nucleotide research, 6 : 1-98.
- BERRIDGE, M.J. and GUPTA, B.L. (1967). Fine-structural changes in relation to ion and water transport in the rectal papillae of the blowfly, Calliphora. J. Cell Sci. 2 : 89-112.
- BERRIDGE, M.J. and GUPTA, B.L. (1968). Fine structural localization of adenosine triphosphatase in the rectum of Calliphora. J. Cell. Sci. 3 : 17-32.
- BERRIDGE, M.J., LINDLEY, B.D. and PRINCE, W.T. (1975). Membrane permeability changes during stimulation of isolated salivary glands of Calliphora by 5-Hydroxytryptamine. J. Physiol. Lond. 244 : 549-567.

- BERRIDGE, M.J. . LINDLEY, B.D. and PRINCE, W.T. (1976).
Studies on the mechanism of fluid secretion by
isolated salivary glands of Calliphora. J. exp. Biol.
64 : 311-312.
- BERRIDGE, M.J. and OSCHMAN, J.L. (1969). The structural
basis for fluid secretion by Malpighian tubules.
Tissue and Cell, I : 247-272.
- BERRIDGE, M.J. and OSCHMAN, J.L. (1972). Transporting
Epithelia, Academic Press, New York.
- BERRIDGE, M.J. and PATEL, N. (1970). Insect salivary
glands : stimulation of fluid secretion by 5HT and
3'5' cyclic AMP. Science, N.Y. 162 : 462-463.
- BERRIDGE, M.J. and PRINCE, W.T. (1972a). Transepithelial
potential changes during stimulation of isolated
salivary glands with 5HT and cyclic AMP. J. exp.
Biol. 56 : 139-153.
- BERRIDGE, M.J. and PRINCE, W.T. (1972b). The role of
cyclic AMP in the control of fluid secretion. Adv.
Cyclic. Nucleotide Res. I : 137-147.
- BLAINE, E.H., COGHLAN, J.P., DENTON, D.D., HARDY,
K.J., and SCOGGINS, B.A. (1975). Effect of
ouabain on adrenal potassium balance in sheep.
Proc. Soc. exp. Biol. Med. 150 : 257-260.
- BLOND, D.M. and WHITTAM, R. (1964). The regulation of
kidney respiration by sodium and potassium ions.
Biochem. J. 92 : 158-167.

- BONTING, S.L. (1966). Studies on the $\text{Na}^+ - \text{K}^+$ activated adenosine triphosphatase. XV. The rectal gland of the elasmobranchs. Comp. Biochem. Physiol. 17 : 953-966.
- BOWLER, K. and DUNCAN, C.J. (1967). Evidence implicating a membrane ATPase in the control of passive permeability of excitable cells. J. Cell Physiol. 70 : 121-125.
- BOWLER, K., and DUNCAN, C.J. (1968a). The temperature characteristics of the ATPase from a frog brain microsomal preparation. Comp. Biochem. Physiol. 24 : 223-227.
- BOWLER, K. and DUNCAN, C.J. (1968b). The effect of temperature on the Mg^{2+} dependent and $\text{Na}^+ - \text{K}^+$ ATPases of a rat brain microsomal preparation. Comp. Biochem. Physiol. 24 : 1043-1054.
- BUTCHER, R.W., ROBINSON, G.A. and SUTHERLAND, E.W. (1970). In Hormones in biology. Ed. EITWACK; G. Chap. 2. 'Cyclic AMP and hormone action.' Academic Press. New York and London.
- CAZAL, M. and GIRARDIE, A. (1968). Controle humeral de l'equipe hydrique chez locusta migratoria migratorioides. J. Insect Physiol. 14 : 655-688.
- CHAPPELL, J.B. (1964). The oxidation of citrate, isocitrate and cisaconitate by isolated mitochondria. Biochem. J. 90 : 225-237.

- CHARNLEY, A.K. (1975). Some effects on the removal of the frontal ganglion on metabolism in Locusta migratoria migratorioides R. and F. Ph.D. Thesis Durham University.
- CHARNOCK, J.S., COOK, D.A. and CASEY, R. (1971). The role of cations and other factors on the apparent energy of activation of $(\text{Na}^+ + \text{K}^+)$ ATPase. Arch. Biochem. Biophys. 147 : 323-329.
- CHARNOCK, J.S. and POST, R.L. (1963a). Evidence of the mechanism of ouabain inhibition of cation activated adenosine triphosphatase. Nature Lond. 199 : 910-911.
- CHARNOCK, J.S. and POST, R.L. (1963b). Studies of the mechanisms of cation transport. I. The preparation of a cation stimulated adenosine-triphosphatase from guinea pig kidney cortex. Aust. J. exp. Biol. 41 : 547-560.
- CHENG, E.V. and CUTKOMP, L.K. (1972). Ageing in the honey-bee Apis mellifera, as related to brain ATPase and their DDT sensitivity. J. Insect Physiol. 18 : 2285-2291.
- CIVAN, M.M. (1970). Effects of active sodium transport on current-voltage relationship of toad bladder. Amer. J. Physiol. 219 : 234-245.
- CLARK, L.C. Jr. (1956). Monitor and control of blood and tissue oxygen tensions. Trans. Am. Soc. Artif. Internal Organs. 2 : 41-65.

- COAST, G.M. (1969). Formation of urinary fluid by Malpighian tubules of an insect. J. Physiol. Lond. 202 : 102p - 103p.
- COSSINS, A.R. (1975). A study of some factors involved in the adaptation to temperature in the freshwater crayfish Austropotamobius pallipes, with an appendix. Ph.D. Thesis, University of Durham.
- CRABBÉ, J. and DECOENE, A. (1974). Persistence of an aldersterone influence on active sodium transport upon exposure of frog skin to ouabain. Arch. int. Physiol. Biochim. 82 : 343-346.
- CRABBÉ, J., FANESTIL, D.D., PELLETTIER, M. and PORTER, G.A. (1974). Effect of ouabain on sodium transport across hormone-stimulated toad bladder and skin. Pflügers Arch. 247 : 275-296.
- CROWDER, L.A. and SHANKLAND, D.L. (1972). Structure of the Malpighian tubule muscle of the American cockroach Periplaneta americana. Ann. Ent. Soc. America. 65 : 614-619.
- CSAKÁY, T.Z. (1961). Effects of cardiac glycosides on the active biological transport of non-electrolytes. Biochem. Pharmac. 8 : 38.
- CURRAN, P.F. and MACINTOSH, J.R. (1962). A model system for biological water transport. Nature, Lond. 193 : 347-348.

- CZACZKES, J.W., AVIRAM., A., NISSAN, M.D. and ULLIMAN, M.D. (1969). Influence of ouabain and lack of potassium on $\dot{V}O_2$ of rat diaphragm in hypertonic sodium chloride solutions. Israel J. Med. Sci. 5 : 1044-1047.
- DAHL, J.L. and HOKIN, L.E. (1974). The sodium-potassium adenosine triphosphatase. A. Rev. Biochem. 43 : 327-356.
- DANILOVA, L.V., ROKHLENKO, K.D. and BODRYAGINA, A.V. (1969). Electron microscopic activity on the structure of septate and comb desmosomes. Z. Zellforsch. mikrosk. Anat. 100 : 101-117.
- DATTA, S. (1971). Effects of inhibitors and tonicity on the hindgut potential across the isolated intestine of the cockroach Byrostria fumigata. Indian J. exp. Biol. 9 : 36-39.
- DATTA, S. (1972). Electrical potential across isolated intestine of the cockroach, Byrsotria fumigata (Guerin-Meneville). Indian J. exp. Biol. 10 : 118-121.
- DAVIDSON, T.F. (1970). The investigation into the factors involved in acclimatization to temperature and death at high temperatures in Calliphora erythrocephala. (MEIG). Ph.D. Thesis, University of Durham.

- DAVIES, P.W. and BRINK, F. (1942). Microelectrodes for measuring local O_2 tension in animal tissues. Rev. scient. Instrum. 13 : 524-533.
- DEGANI, C. and BOYER, D. (1973). A borohydride reduction method for characterization of the acyl phosphate linkage in proteins and its application to sarcoplasmic reticulum adenosine triphosphatase. J. biol. Chem. 248 : 8222-8226.
- DIAMOND, J.A. (1962). The reabsorbtive function of the gall bladder. J. Physiol. Lond. 161 : 442-473.
- DIAMOND, J.D. (1964). The mechanism of isotonic water transport. J. gen. Physiol. 48 : 15-42.
- DIAMOND, J.M. and BOSSERT, W.H. (1967). Standing-gradient osmotic flow : a mechanism for coupling water and solute transport in epithelia. J. gen. Physiol. 50 : 2061-2083.
- DIAMOND, J.M. and BOSSERT, W.H. (1968). Functional consequences of ultrastructural geometry in 'backwards' fluid transporting epithelia. J. Cell. Biol. 37 : 694-702.
- DIAMOND, J.M. and TORMAY, J.H. (1966). Role of long extracellular channels in fluid transport across epithelia. Nature Lond. 210 : 817-820.
- EICHELBERG, D. and WESSING, A. (1975). Morphology of the Malpighian tubules of insects. Fortschr. Zool. Band 23 : Heft 2/3 : 124-147.

- EPSTEIN, F.H. and SILVA, P. (1974). Role of sodium, potassium-ATPase in renal function. Ann. N.Y. Acad. Sci. 242 : 519-526.
- FAHN, S., KOVAL, G.T. and ALBERS, R.W. (1966). Sodium-potassium-activated adenosine triphosphatase of Electrophorus electric organ. I. An associated sodium-activated transphosphorylation. J. Biol. Chem. 241 : 1882-1889.
- FARQUHARSON, P.A. (1974a). A study of the Malpighian tubules of the pill millipede Glomeris marginata (Villers). I. The isolation of the tubules in a Ringer solution. J. exp. Biol. 60 : 13-28.
- FARQUHARSON, P.A. (1974b). A study of the Malpighian tubules of the pill millipede Glomeris marginata (Villers). II. The effect of variations in osmotic pressure and sodium and potassium concentrations on fluid production. J. exp. Biol. 60 : 29-39.
- FAWCETT, D.W. (1962). Physiologically significant specialisations of the cell surface. Circulation 26 : 1105-1125.
- FISCHER, R.A. and YATES, F. (1963). Statistical tables for Biological, Agricultural and Medical Research. 6th Ed. Oliver and Boyd.
- FUJITA, T., TOKUNAGA, J. and EDANAGA, M. (1976). Scanning electron microscopy of the glomerular filtration membrane in the rat kidney. Cell Tiss. Res. 166 : 299-314.

- GABE, M. (1962). in Handbuck der Histochemie, Bd. II/1, Ed. GRAUMANN, W. and NEUMANN, K.G. Stuttgart, Fischer.
- GEE, J.D. (1975a). Diuresis in the tsetse fly Glossina austeni. J. exp. Biol. 63 : 381-390.
- GEE, J.D. (1975b). The control of diuresis in the tsetse fly: a preliminary investigation of the diuretic hormone. J. exp. Biol. 63 : 391-401.
- GEE, J.D. (1976). Active transport of sodium by the Malpighian tubules of the tsetse fly, Glossina morsitans. J. exp. Biol. 64 : 357-368.
- GLYNN, I.M. (1964). The action of cardiac glycosides on ion movements. Pharmac. Rev. 16 : 381-407.
- GOLDMAN, D.E. (1943). Potential, impedance and rectification in membranes. J. gen. Physiol. 27 : 37-60.
- GOOD, N.E., WINGET, G.D., WINTER, W., CONNOLLY, T., IZAWA, S. and SINGH, R.M. (1966). Hydrogen ion buffers for biological research. Biochemistry 5: 467-477.
- GOURANTON, J. (1968). Composition, structure et mode de formation des concrétions minérales dans l'intestin moyen des homoptères cecropides. J. Cell Biol. 37 : 316-328.
- GRASSO, A. (1967). A sodium and potassium stimulated adenosine triphosphatase in the cockroach nerve cord. Life Sci. 6 : 1911-1918.

- GRISHAM, C.M. and BARNETT, R.E. (1973). The role of lipid-phase transitions in the regulation of the (sodium + potassium) adenosine triphosphatase. Biochemistry 12 : 2635-2637.
- GRUENI, N. and AVI-DOR, Y. (1966). Temperature-dependence of activation and inhibition of rat brain adenosine triphosphatase activated by sodium and potassium ions. Biochem. J. 100 : 762-767.
- GUPTA, B.L., HALL, T.A., MADDRELL, S.H.P. and MORETON, R.B. (1976). Distribution of ions in a fluid-transporting epithelium detected by electron probe X-ray. Nature Lond. 264 : 284-287.
- HART, W.M. Jr., and TITUS, E.O. (1973). Sulfhydryl groups of sodium potassium transport adenosine triphosphatase. J. biol. Chem. 248 : 4674-4681.
- HARVEY, W.R., WOOD, J.L., QUATRALE, R.P. and JUNGREIS, A.H. (1975). Cation distributions across the larval and pupal midgut of the lepidopteran Hyalophora cecropia in vivo. J. exp. Biol. 63 : 321-330.
- HARVEY, W.R. and ZERAHN, K. (1971). Active transport of sodium by the isolated midgut of Hyalophora cecropia. J. exp. Biol. 54 : 269-274.
- HASKELL, J.A., CLEMONS, R.D. and HARVEY, W.R. (1965). Active transport by the Cecropia midgut. I. Inhibitors, stimulants and potassium transport. J. Cell. and Comp. Physiol. 65 : 45-56.
- HEGYVARY, C. and POST, R.L. (1969). Reversible inactivation

of $(\text{Na}^+ + \text{K}^+)\text{-ATPase}$ by removing and restoring phospholipids. In The molecular basis of membrane function: Ed. TOSTESON, D.C. Prentice Hall, New Jersey, 519-528.

HENION, W.F., SUTHERLAND, E.W. and POSTERNAK, T.H. (1967). Effects of derivatives of adenosine 3'5' phosphate on liver slices in intact animals. Biochim. biophys. Acta. 148 : 106-113.

HERRERA, F.C. (1965). Action of ouabain on sodium transport in the toad urinary bladder. Am. J. Physiol. 209 : 819-824.

HEVERT, F. (1975). Physiological mechanisms of urine formation by Malpighian tubules. Fortschr. Zool. Band 23, Heft 2/3 : 173-192.

HIERRERA, L., JORDANNA, R. and PONZ, F. (1976). Chloride dependent transmural potential in the rectal wall of Schistocerca gregaria. J. Insect Physiol. 22 : 291-297.

HIGHNAM, K.C., HILL, L. and GINGELL, D. (1965). Neurosecretion and water balance in the male desert locust Schistocerca gregaria. J. Zool. 147 : 201-207.

HILL, A.E. (1975a). Solute-solvent coupling in epithelia: a critical examination of the standing gradient osmotic flow theory. Proc. R. Soc. B. 190 : 99-114.

- HILL, A.E. (1975b). Solute-solvent coupling in epithelia :
an electro-osmotic theory of fluid transfer.
Proc. R. Soc. B. 190 : 115-134.
- HODGKIN, A.L. and KATZ, B. (1949). The effect of
sodium ions on the electrical activity of the giant
axon of the squid. J. Physiol., Lond. 108 : 37-77.
- HOKIN, L.E. (1974). Purification and properties of the (Sodium
and Potassium)-activated adenosine triphosphatase
and reconstitution of sodium transport. Ann. N.Y.
Acad. Sci. 242 : 12-23.
- HOKIN, L.E., DAHL, J.L., DEUPRÉE, J.D., DIXON, J.F.,
HACKNEY, J.F. and PERDUE, J.F. (1973).
Studies on the characterization of the sodium-
potassium transport adenosine triphosphatase. X.
Purification of the enzyme from the rectal gland
of Squalus acanthias. J. biol. Chem. 248 : 2593-
2605.
- HOKIN, L.E., SASTRY, P.S., GALSWORTHY, P.R. and
YODA, A. (1965). Evidence that a phosphorylated
intermediate in a brain transport adenosine tri-
phosphatase is an acyl phosphate. Proc. Nat. Acad.
Sci. U.S.A. 54 : 177-184.
- IRVINE, H.B. and PHILLIPS, J.E. (1971). Effects of
respiratory inhibitors and ouabain on water transport
by isolated locust rectum. J. Insect. Physiol. 17 :
381-393.
- JEAN, D.H., ALBERS, R.W. and KOVAL, G.J. (1975). Sodium-

- potassium activated adenosine triphosphatase of Electrophorus electric organ. X. Immunochemical properties of the lubrol-solubilized enzyme and its constituent polypeptides. J. Biol. Chemistry. 250 : 1035-1040.
- JOLY, P. and JOLY, L. (1953). Resultats de greffe de corpora allata chez Locusta migratoria L. Ann. Sci. nat. zool. ser. 15 : 331-345.
- JØRGENSEN, P.L. (1974a). Purification and characterization of $(\text{Na}^+ + \text{K}^+)\text{-ATPase}$. III. Purification from the outer medulla of mammalian kidney after selective removal of membrane components by sodium dodecylsulphate. Biochim. biophys. Acta. 356 : 36-52.
- JØRGENSEN, P.L. (1974b). Purification of $(\text{Na}^+ + \text{K}^+)\text{-ATPase}$. Active site determinations and criteria of purity. Ann. N.Y. Acad. Sci. 242 : 36-51.
- JØRGENSEN, P.L. and SKOU, J.C. (1969). Preparation of highly active $(\text{Na}^+ + \text{K}^+)\text{-ATPase}$ from the outer medulla of rabbit kidney. Biochem. biophys. Res. Commun. 137 : 39-46.
- KAHLENBERG, A., GALSWORTHY, P.R. and HOKIN, L.E. (1968) Studies on the characterization of the sodium-potassium transport adenosine triphosphatase. II. Characterization of the acyl phosphate intermediate as an L-glutamyl- γ -phosphate. Archs. Biochem. Biophys. 126 : 331-342.
- KAYE, G.I., WHEELER, H.O., WHITLOCK, R.T. and LANE, N. (1966). Fluid transport in the rabbit gall bladder. J. Cell. Biol., 30: 237-268.

- KEDEM, O. (1965). Water flow in the presence of active transport. Symp. soc. exp. Biol. 19 : 61-73.
- KINSOLVING, C.R., POST, R.L., and BEAVER, D.L. (1963). Sodium plus potassium transport. Adenosine triphosphatase activity in the kidney. J. Cell Comp. Physiol. 62 : 85-93.
- KLEIN, M. and APPLEBAUM, S.W. (1975). The surface morphology of locust hindgut cuticle. J. Ent. (A). 50 : 31-36.
- KLINE, M.H., HEXUM, T.D., DAHL, J.L. and HOKIN, L.E. (1971). Studies on the characterisation of the sodium-potassium transport adenosine triphosphatase. VII. Comparison of the properties of the membrane-bound and partially purified soluble and insoluble forms of the enzyme. Arch. Biochem. Biophys. 147 : 781-787.
- KOEFOED-JOHNSEN, V. and USSING, H.H. (1958). The nature of the frog skin potential. Acta physiol. scand. 42 : 298-308.
- KYTE, J. (1971a). Purification of the sodium and potassium dependent adenosine triphosphatase from canine renal medulla. J. biol. Chem. 246 : 4157-4165.
- KYTE, J. (1971b). Phosphorylation of a purified ($\text{Na}^+ + \text{K}^+$) adenosine triphosphatase. Biochem. biophys. Res. Commun. 43 : 1259-1265.
- KYTE, J. (1972). Properties of the 2 polypeptides of sodium

- and potassium dependent adenosine triphosphatase.
J. biol. Chem. 247 : 7642-7649.
- LASSEN, N.A., MUNCK, O. and THAYSEN, J.H. (1961).
Oxygen consumption and sodium reabsorption in
kidney. Acta Physiol. scand. 51 : 371-384.
- LASSEN, U.V. and THAYSEN, J.H. (1961). Correlation
between sodium transport and oxygen consumption
in isolated renal tissue. Biochem. biophys. Acta.
47 : 616-618.
- LEAF, A. and RENSHAW, A. (1957a). Ion transport and
respiration of isolated frog skin. Biochem. J. 65 :
82-90.
- LEAF, A. and RENSHAW, A. (1957b). The anaerobic active
ion transport by isolated frog skin. Biochem. J.
65 : 90-93.
- LEHNINGER, A.L. (1970). Biochemistry. Worth publishers
Inc., N.Y.
- LINEWEAVER, H. and BURKE, D. (1934). The determinations
of enzyme dissociation constants. J. Am. chem.
Soc. 56 : 658-666.
- LOWRY, O.H., ROSEBROUGH, N.J., FARR, A.L. and
RANDAL, R.J. (1951). Protein measurement
with the Folin phenol reagent. J. biol. Chem.
193 : 265-275.
- MADDRELL, S.H.P. (1963). Excretion in the blood-sucking

- bug Rhodnius prolixus stal. I. The control of diuresis. J. exp. Biol. 40 : 247-256.
- MADDRELL, S.H.P. (1964). Excretion in the blood-sucking bug Rhodnius prolixus stal. II. The normal course of diuresis and the effect of temperature. J. exp. Biol. 41 : 163-176.
- MADDRELL, S.H.P. (1969). Secretion by the Malpighian tubules of Rhodnius. The movements of ions and water. J. exp. Biol. 51 : 71-97.
- MADDRELL, S.H.P. (1971). The mechanism of Insect Excretory systems. Adv. Insect. physiol. 8 : 199-331.
- MADDRELL, S.H.P. (1972). The functioning of insect Malpighian tubules. In Role of Membranes in secretory Processes. North-Holland - Amsterdam 338-356.
- MADDRELL, S.H.P. and KLUNSUWAN, S. (1973). Fluid secretion by in vitro preparations of the Malpighian tubules of the desert locust Schistocerca gregaria. J. Insect Physiol. 19 : 1369-1376.
- MADDRELL, S.H.P., PILCHER, D.E.M. and GARDINER, B.O.C. (1969). Stimulatory effect of 5-hydroxy-tryptamine (serotonin) on secretion by Malpighian tubules of insects. Nature, Lond. 222 : 784-5.
- MADDRELL, S.H.P., PILCHER, D.E.M. and GARDINER, B.O.C. (1971). Pharmacology of the Malpighian tubules of Rhodnius and Carausius. The structure activity relationship of tryptamine analogues and the role of cyclic AMP. J. exp. Biol. 54 : 779-804.

- MARTOJA, R. (1956). Mise en évidence d'une sécrétion muqueuse dans les tubes de Malpighi de quelques orthoptères et d'un phasmoptère. Bull. Soc. Zool. Fr. 81 : 172-173.
- MARTOJA, R. (1959). Données cytologiques et histochimiques sur les tubes de Malpighi et leurs sécrétions muqueuses chez locusta migratoria R. and F. Acta histochem. (Jena) 6 : 187-217.
- MARTOJA, R. (1961). Caractéristiques histologiques du segment muqueux de l'appareil excréteur des orthoptères. C.r. Acad. Sci. (Paris). 253 : 3063-3065.
- MOAKE, J.L., AHMED, K., BACHUR, N.R. and GUTFEUND, D.E. (1970). Mg^{2+} dependent, $(Na^{+} + K^{+})$ stimulated ATPase of human platelets. Biochim. biophys. Acta. 211 : 337-344.
- MORDUE, W. (1969). Hormonal control of Malpighian tubule and rectal function in the desert locust Schistocerca gregaria. J. Insect Physiol. 15 : 273-285.
- MORDUE, W. (1970). Evidence for the existence of diuretic and antidiuretic hormones in locusts. J. Endocr. 46 : 119-120.
- MORDUE, W. (1972). Hormones and excretion in locusts. Gen. Comp. Endocrinol. 3 : 289-298.
- MUDGE, G.H. (1951a). Studies on potassium accumulation by rabbit kidney slices : effect of metabolic activity. Amer. J. Physiol. 165 : 113-27.

- MUDGE, G.H. (1951b). Electrolyte and water metabolism of rabbit kidney slices : effect of metabolic inhibitors. Amer. J. Physiol. 167 : 206-223.
- NAGANO, K., KANAZANA, T., MIZUNO, N., TASHIMA, Y., NAKAO, T. and NAKAO, M. (1965). Some acyl phosphate like properties of P32 labelled sodium-potassium activated adenosine triphosphatase. Biochem. biophys. Res. Commun. 19 : 759-764.
- NAKAO, T., NAGANO, K., ADACHI, K. and NAKAO, M. (1963). Separating of two adenosine triphosphatases from erythrocyte membrane. Biochem. biophys. Res. Commun. 13 : 444-448.
- NAKAO, T., TASHIMA, Y., NAGANO, K. and NAKAO, M. (1965). Highly specific sodium-potassium activated adenosine triphosphatase from various tissues of rabbit. Biochem. biophys. Res. Commun. 19 : 755-758.
- NECHAY, B.R. (1974). Relationship between inhibitors of renal $\text{Na}^+ + \text{K}^+$ ATPase and natriuresis. Annls. N.Y. Acad. Sci. 242 : 501-518.
- NEUFIELD, A.H. and LEVY, H.H. (1969). A second ouabain sensitive sodium dependent adenosine triphosphatase in brain microsomes. J. biol. Chem. 244 : 6493-6497.
- NISSAN, S., AVIRAM, A., CZACZKES, J.W., ULLMANN, L. ULLMANN, T.D. (1966). Increased O_2 consumption of the rat diaphragm by elevated NaCl concentrations. J. Amer. Physiol. 210 : 1222-1224.

- O'RIORDAN, A.M. (1969). Electrolyte movements in isolated midgut of the cockroach (Periplaneta americana). J. exp. Biol. 51 : 699-714.
- OSCHMAN, J.L. and BERRIDGE, M.J. (1970). Structural and functional aspects of salivary fluid secretion in Calliphora. Tissue and cell. 2 : 281-310.
- OSCHMAN, J.L., WALL, B.J. and GUPTA, B.J. (1974). Cellular basis of water transport. In Transport at Cellular level. Soc. exp. biol. Symposium. 28 : 305-350.
- PALM, N.B. (1946). Studies on the peristalsis of the Malpighian tubules of insects. Acta. Univ. lund. Nr.II : 3-39.
- PASTAN, I. and PERLMAN, R.L. (1971). Cyclic AMP in metabolism. Nature, Lond. New Biol. 229: 5-7
- PEACOCK, A.J. (1975). . Studies on the excretion and neuro-endocrine systems of some orthopteran insects, with particular reference to Jamaicana flava (Caudell). Ph.D. thesis, Durham University.
- PEACOCK, A.J. (1976). Distribution of Na^+ - K^+ - activated ATPase in the alimentary tract of Locusta migratoria. Insect Biochem. 6 : 529-533.
- PEACOCK, A.J., BOWLER, K. and ANSTEE, J.H. (1972). Demonstration of a Na^+ - K^+ - Mg^{2+} dependent ATPase in a preparation from hindgut and Malpighian tubules of two species of insect. Experientia 28 : 901-902.

- PEACOCK, A., BOWLER, K. and ANSTEE, J.H. (1976).
Properties of Na^+ - K^+ dependent ATPase from the
Malpighian tubules and hindgut of Homorocoryphus
nitidulus. Insect Biochem. 6 : 281-288.
- PHILLIPS, J.E. (1964a). Rectal absorption in the desert
locust, Schistocerca gregaria, Forskål. I. Water.
J. exp. Biol. 41 : 15-38.
- PHILLIPS, J.E. (1964b). Rectal absorption in the desert
locust Schistocerca gregaria Forskål III. The
nature of the excretory process. J. exp. Biol.
41 : 69-80.
- PILCHER, D.E.M. (1970a). Hormonal control of the Malpighian
tubules of the stick insect Carausius morosus. J.
exp. Biol. 52 : 653-665.
- PILCHER, D.E.M. (1970b). The influence of the diuretic
hormone on the process of urine secretion by the
Malpighian tubules in Carausius morosus. J. exp.
Biol. 53 : 465-484.
- POST, R.L. and KLUME, S. (1973). Evidence for an aspartyl
phosphate residue at the active site of sodium and
potassium ion transport adenosine triphosphatase.
J. biol. Chem. 248 : 6993-7000. .
- POST, R.L. and SEN, A.K. (1967). Sodium and potassium
stimulated ATPase. Methods of enzymology. X :
762-768. Ed. ESTABROOK, R.W. and PULLMAN,
M.E. Academic Press. N.Y. and London.

- POST, R.L., SEN, A.K. and ROSENTHAL, A.S. (1965). A phosphorylated intermediate in adenosine triphosphate-dependent sodium and potassium transport across kidney membranes. J. biol. Chem. 240 : 1437-1445.
- PRINCE, W.T. (1976). A model for studying the control of epithelial transport in the salivary gland of the blowfly. Perspectives in experimental biology, Vol. I. Ed. SPENCER DAVIES, P. Pergamon Press.
- PRINCE, W.T., BERRIDGE, M.J. and RASMUSSEN, H. (1972). Role of calcium and adenosine 3'5'-cyclic monophosphate in controlling fly salivary gland secretion. Proc. natn. Acad. Sci. U.S.A. 69 : 553-557.
- RAMSAY, J.A. (1953). Active transport of potassium by the Malpighian tubules of insects. J. exp. Biol. 30 : 79-89.
- RAMSAY, J.A. (1954). Active transport of water by the Malpighian tubules of the stick insect Dixippus morosus (Orthoptera Phasmidae). J. exp. Biol. 31 : 104-113.
- RAMSAY, J.A. (1955). The excretion of sodium, potassium and water by the Malpighian tubules of the stick insect, Dixippus morosus (Orthoptera Phasmidae). J. exp. Biol. 32 : 200-216.
- RAMSAY, J.A. (1956). Excretion by the Malpighian tubules

- of the stick insect, Dixippus morosus (Orthoptera, Phasmidae). J. exp. Biol. 33 : 698-709.
- RAMSAY, J.A. and BROWN, R.H.J. (1955). Simplified apparatus and procedure for freezing-point determinations upon small volumes of fluid. J. Scient. Inst. 32 : 372-375.
- RATANABANANGKON, K, DIXON, J.F. and KOKIN, L.E. (1973). Studies on the characterization of the sodium-potassium transport adenosine triphosphatase. XI. Comparison of kinetic properties of the purified with the impure membrane-bound enzyme from Squalus acanthias. Arch. Biochem. Biophys. 156 : 342-349.
- REYNOLDS, E.S. (1963). The use of lead citrate at high pH as an electron opaque stain. J. Cell Biol. 17 : 208-212.
- RHEE, H.M. and HOKIN, L.E. (1975). Inhibition of the purified sodium-potassium activated adenosine triphosphatase from the rectal gland of Squalus acanthias by antibody against the glycoprotein subunit. Biochem. biophys. Res. Commun. 63 : 1139-1145.
- RHODIN, J. (1958). Anatomy of kidney tubules. Int. Rev. Cytol. 7 : 485-534.
- RIDDERSTAP, A.S. and BONTING, S.L. (1969). Na-K-activated adenosine triphosphatase and pancreatic secretion in the dog. Amer. J. Physiol. 216 : 547-553.

- RIEGEL, J.A. (1966). Micropuncture studies of formed-body secretion by the excretory organs of the crayfish, frog and stick insect. J.exp. Biol. 44 : 379-385.
- RIEGEL, J.A. (1970). A new model of transepithelial fluid movement with detailed application to fluid movement in the crayfish antennal gland. Comp. Biochem. Physiol. 36 : 403-410.
- ROBISON, G.A., BUTCHER, R.W. and SUTHERLAND, E.W. (1968). Cyclic AMP. A. Rev. Biochem. 37 : 149-74.
- ROBINSON, J.D. (1967). Kinetic studies on a brain microsomal adenosine triphosphatase. Evidence suggesting conformational changes. Biochem. N.Y. 6 : 3250-3258.
- SAVAGE, A.A. (1956). The development of Malpighian tubules of Schistocerca gregaria (Orthoptera). Q. Jl. microsc. Sci. 97 : 599-615.
- SAVAGE, A.A. (1962). The development of Malpighian tubules of Carausius morosus (Orthoptera). Q. Jl. Microsc. Sci. 103 : 417-438.
- SCHATZMAN, H.J. (1962). Lipoprotein nature of the red cell adenosine triphosphatase. Nature Lond. 196 : 667.
- SCHATZMAN, H.J. and VINCENZI, F.F. (1969). Calcium movement across the membrane of human red blood cells. J. Physiol. Lond. 201 : 369-395.
- SCHONER, W., von ILBERG, C., KRAMER, R. and SEUBERT, W. (1967). On the mechanism of Na⁺ and K⁺-stimulated hydrolysis of adenosine triphosphate. I. Purification and properties of a Na⁺ and K⁺.

- activated ATPase from ox brain. Eur. Jnl. Biochem. I : 334-343.
- SCHWARTZ, A., LINDENMAYER, G.E. and ALLEN, J.C. (1972). The Na^+ , K^+ -ATPase membrane transport system: importance in cellular function. Curr. Top. Membranes and Transport, 3 : 1-82.
- SEDLÁČEK, J. (1973). Ouabain-sensitive respiration of chick embryo brain tissue. Physiol. bohemoslov 22 : 19-28.
- SILVA, P., TORRETTI, J., HAYSLETT, J.P. and EPSTEIN, F.H. (1976). Relation between Na^+ - K^+ -ATPase activity and respiratory rate in the rat kidney. Amer. J. Physiol. 230 : 1432-1437.
- SKOU, J.C. (1957). The influence of some cations on an adenosine triphosphatase from peripheral nerves. Biochim. biophys. Acta. 23 : 394-401.
- SKOU, J.C. (1962). Preparation from mammalian brain and kidney of the enzyme system involved in active transport of Na^+ and K^+ . Biochim. biophys. Acta. 58 : 314-325.
- SKOU, J.C. (1965). Enzymatic basis for active transport of Na^+ and K^+ across cell membrane. Physiol. Rev. 45 : 596-617.
- SKOU, J.C. (1969). The role of membrane ATPase in the active transport of ions. In The Molecular Basis of Membrane Function. Ed, TOSTEIN, D.C. 455-482. Prentice-Hall, New Jersey.

- SKOU, J.C. (1975). The ($\text{Na}^+ + \text{K}^+$) activated enzyme system and its relationship to transport of sodium and potassium. Quart. Rev. biophys. 7 : 401-434.
- SMITH, D.S. (1968). Insect cells, their structure and function. Oliver and Boyd. Edinburgh 285-297.
- SNEDECOR, G.W. and COCHRAN, W.G. (1967). Statistical methods, 6th Ed. Iowa State University Press, U.S.A.
- SRIVASTAVA, P.N. (1962). Physiology of excretion in the larva of Corcyra cephalonica Stainton (Lepidoptera, Pyralidae). J. Insect Physiol. 8 : 223-232.
- SRIVASTAVA, U.S. and KHARE, M.K. (1966). The development of Malpighian tubules and associated structures in Philosamia vicini (Lepidoptera, Saturnidae). J. Zool. Lond. 150 : 145-163.
- SWANSON, P.D. and McILWAIN, H. (1965). Inhibition of the sodium-ion-stimulated adenosine triphosphatase after treatment of isolated guinea pig cerebral cortex with ouabain and other agents. J. Neurochem. 12 : 877-891.
- SWANSON, P.D. and ULLIS, K. (1966). Ouabain-induced changes in sodium and potassium content and respiration of cerebral cortex slices : dependence on medium calcium concentration and effects of protamine. J. Pharm. and exp. Therap. 153 : 321-328.
- TANAKA, R. and TERUYA, A. (1973). Lipid dependence of activity-temperature relationship of ($\text{Na}^+ - \text{K}^+$)-activated ATPase. Biochim. biophys. Acta. 323 : 584-591.

- TAYLOR, H.H. (1970). Ultrastructural studies on the Malpighian tubules of the stick insect. Ph.D. thesis Newcastle University.
- TAYLOR, H.H. (1971a). Water and solute transport by the Malpighian tubules of the stick insect Carausius morosus. The normal ultrastructure type I cells. Z. Zellforsch. mikrosk. Anat. 118 : 333-368.
- TAYLOR, H.H. (1971b). The fine structure of the type 2 cells in the Malpighian tubules of the stick insect Carausius morosus. Z. Zellforsch. Anat. 122 : 411-424.
- TOBIN, T. and BRODY, T.M. (1972). Rates of dissociation of enzyme-ouabain complexes and $K_{0.5}$ values in $(Na^+ + K^+)$ adenosine triphosphatases from different species. Biochem. Pharmac. 21 : 1553-1560.
- TOLMAN, J.H. and STEELE, J.E. (1976). A ouabain-sensitive $(Na^+ - K^+)$ -activated ATPase in the rectal epithelium of the American cockroach Periplaneta americana. Insect Biochem. 6 : 513-517.
- TORMAY, J.M. and DIAMOND, J.M. (1967). Ultrastructural route of fluid transport in rabbit gall bladder. J. gen. Physiol. 50 : 2031-2060.
- TREHERNE, J.E. (1966). The effect of ouabain on the efflux of sodium ions in the nerve cords of two insect species, Periplaneta americana and Carausius morosus. J. exp. Biol. 44 : 355-362.

- TSUBO, I. and BRANDT, P.W. (1962). An electron microscopic study of the Malpighian tubules of the grasshopper Dissosteira carolina. J. Ultrastruct. Res. 6 : 28-35.
- UESUGI, S., DULAK, N.C., DIXON, J.F., HEXUM, T.D., DAHL, J.L., PERDUE, J.F. and HOKIN, L.E. (1971). Studies on the characterization of the sodium-potassium transport adenosine triphosphatase VI. Large scale partial purification and properties of a lubrol solubilized bovine brain enzyme. J. Biol. Chem. 246 : 531-543.
- USSING, H.H. (1949). Transport of ions across cellular membranes. Physiol. Rev. 28 : 127-55.
- USSING, H.H. (1960). The alkali metal ions in isolated systems and tissues. In Handbuch der Experimentellen Pharmakologie, Springer-Verlag, Berlin.
- USSING, H.H., THORN, N.A. (Ed.) (1972). Transport mechanisms in Epithelia. Proceedings of the Alfred Benzon symposium V. Munksgaard, Copenhagen; Academic Press, N.Y.
- USSING, H.H. and ZERAHN, K. (1951). Active transport of sodium as the source of electric current in the short-circuited frog skin. Acta physiol. scand. 23 : 110-121.
- USHERWOOD, P.N.R. (1975). Ed. in Insect Muscle. Academic Press, London, N.Y. San Francisco,

- VIETINGHOOG, U., OLSZEWSKA, E. and JANISKEWSKI, L. (1969). Measurements of the bioelectric potentials in the rectum of Locusta migratoria and Carausius morosus in in vitro preparations. J. Insect Physiol. 15 : 1273-1277.
- WALD, H., GUTMAN, V. and CZAEZKES, W. (1974). Comparison of microsomal ATPase in the cortex, medulla and papilla of the rat kidney. Pflügers. Arch. 352 : 47-59.
- WALL, B.J. (1965). Regulation of water metabolism by the Malpighian tubules and rectum in the cockroach Periplaneta americana. Zool. Jb. (Physiol.) 71 : 702-709.
- WALL, B.J., OSCHMANN, J.L. and SCHMIDT, B.A. (1975). Morphology and function of Malpighian tubules and associated structures in the cockroach Periplaneta americana. J. Morph. 146 : 265-306.
- WALTON, J. (1974). Ultrastructural changes in cells arising from metabolic inhibitors. Proc. Aust. Biochem. Soc. 7 : 63.
- WAREHAM, A.C., DUNCAN, C.J. and BOWLER, K. (1968). Permeability and excitation of insect muscle. Nature. Lond. 217 : 970-972.
- WASLER, H., HAMMOND, V. and BUTLER, S. (1973). Depolarization increases the susceptibility of toad bladder sodium transport to inhibition by ouabain. J. Pharm. exp. Therap. 185 : 261-271.

- WEBER-VON GROTTTHUS, E., HEVERT, F., ATZBACHER, V. and WESSING, A. (1974). Influence of ouabain on Na^+ and K^+ concentration in haemolymph of Drosophila hydei and appearance of Malpighian tubules. J. Insect Physiol. 20 : 1411-1420.
- WESSING, A. (1965). Die funktion der Malpighischen Gafabe. In. Funktionelle und morphologische organisation der Zelle. II. Sekretion und exkretion. 228-268. Springer; Berlin, Heidelberg, New York.
- WESSING, A. and EICHELBERG, D. (1975). Ultrastructural aspects of transport and accumulation of substances in the Malpighian tubules. Fortschr. Zool. Band. 23, Heft 2-3: 148-172.
- WHITTAM, R. (1961). Active cation transport as a pacemaker of respiration. Nature. Lond. 191 : 603-604.
- WHITTAM, R. (1962). The dependence of the respiration of the brain cortex on active cation transport. Biochem. J. 82 : 205-212.
- WHITTAM, R., BLOND, D.M. and RUSCAK, M. (1965). The influence of ions on the metabolism of brain-cortex slices. Biochem. J. 96 : 47.
- WHITTAM, R. and CHIPPERFIELD, A.R. (1975). The reaction mechanism of the sodium pump. Biochim. biophys. Acta. 415 : 149-171.
- WHITTAM, R. and DAVIES, R.E. (1953). Active transport of water, sodium, potassium and α -oxoglutarate by kidney cortex slices. Biochem. J. 55 : 880-887.

- WHITTAM, R. and WHEELER, K.P. (1961). The sensitivity of a kidney ATPase to ouabain and to sodium and potassium Biochim. biophys. Acta. 51 : 622-624.
- WHITTAM, R. and WHEELER, K.P. (1970). Transport across cell membranes. A. Rev. Physiol. 32 : 21-60.
- WHITTAM, R. and WILLIS, J.S. (1962). Some effects of ouabain and Na^+ on respiration and K^+ uptake in kidney slices. J. Physiol. Lond. 163 : 45-46P.
- WHITTAM, R. and WILLIS, J.S. (1963). Ion movements and oxygen consumption in kidney cortex slices. J. Physiol. Lond. 168 : 158-177.
- WIGGLESWORTH, V.B. and SALPETER, M.M. (1962). Histology of the Malpighian tubules in Rhodnius prolixus Stål (Hemiptera). J. Insect Physiol. 8 : 299-307.
- WILLIS, J.S. (1968a). Ouabain inhibition of ion transport and respiration in renal cortical slices of ground squirrels and hamsters. Biochem. biophys. Acta. 163 : 506-515
- WILLIS, J.S. (1968b). The interaction of K^+ , ouabain and Na^+ on cation transport and respiration of renal cortical cells. Biochim. biophys. Acta. 163 : 516-530.
- WINS, P. and SCHOFFENIELS, E. (1966). Studies on red-cell ghost ATPase systems: properties of a ($\text{Mg}^{2+} + \text{Ca}^{2+}$) dependent ATPase. Biochim. biophys. Acta. 120 : 341-450.

- WOOD, J.L. and HARVEY, W.R. (1975). Active transport of potassium by the Cecropia midgut; tracer kinetic theory and transport pool size. J. exp. Biol. 63 : 301-311.
- YOSHIDA, H., KANIKE, K. and FUJISAWA, H. (1962). Studies on the change in ion permeability of brain slices. Jap. J. Pharmac. 12 : 146-155.
- ZERAHN, K. (1956). Oxygen consumption and active sodium transport in the isolated short-circuited frog skin. Acta. physiol. scand. 36 : 300-318.
- ZERAHN, K. (1971). Active transport of the alkali metals by the isolated mid-gut of Hyalophora cecropia. Phil. Trans. R. Soc. B. 262 : 315-321.

