

University of Warwick institutional repository: <http://go.warwick.ac.uk/wrap>

**A Thesis Submitted for the Degree of PhD at the University of Warwick**

<http://go.warwick.ac.uk/wrap/55929>

This thesis is made available online and is protected by original copyright.

Please scroll down to view the document itself.

Please refer to the repository record for this item for information to help you to cite it. Our policy information is available from the repository home page.

## Library Declaration and Deposit Agreement

### 1. STUDENT DETAILS

Please complete the following:

Full name: JAN CAMBRIDGE

University ID number: 0558451

### 2. THESIS DEPOSIT

2.1 I understand that under my registration at the University, I am required to deposit my thesis with the University in BOTH hard copy and in digital format. The digital version should normally be saved as a single pdf file.

2.2 The hard copy will be housed in the University Library. The digital version will be deposited in the University's Institutional Repository (WRAP). Unless otherwise indicated (see 2.3 below) this will be made openly accessible on the Internet and will be supplied to the British Library to be made available online via its Electronic Theses Online Service (EThOS) service.

[At present, theses submitted for a Master's degree by Research (MA, MSc, LL.M, MS or MMedSci) are not being deposited in WRAP and not being made available via EthOS. This may change in future.]

2.3 In exceptional circumstances, the Chair of the Board of Graduate Studies may grant permission for an embargo to be placed on public access to the hard copy thesis for a limited period. It is also possible to apply separately for an embargo on the digital version. (Further information is available in the *Guide to Examinations for Higher Degrees by Research*.)

2.4 If you are depositing a thesis for a Master's degree by Research, please complete section (a) below. For all other research degrees, please complete both sections (a) and (b) below:

#### (a) Hard Copy

I hereby deposit a hard copy of my thesis in the University Library to be made publicly available to readers (please delete as appropriate) EITHER immediately OR ~~after an embargo period of~~ ..... ~~months/years as agreed by the Chair of the Board of Graduate Studies.~~

I agree that my thesis may be photocopied. YES / ~~NO~~ (Please delete as appropriate)

#### (b) Digital Copy

I hereby deposit a digital copy of my thesis to be held in WRAP and made available via ETHOS.

Please choose one of the following options:

EITHER My thesis can be made publicly available online. YES / ~~NO~~ (Please delete as appropriate)

OR ~~My thesis can be made publicly available only after~~....[date] (Please give date)  
YES / ~~NO~~ (Please delete as appropriate)

OR ~~My full thesis cannot be made publicly available online but I am submitting a separately identified additional, abridged version that can be made available online.~~  
YES / ~~NO~~ (Please delete as appropriate)

~~OR My thesis cannot be made publicly available online.~~ YES / ~~NO~~ (Please delete as appropriate)

Whether I deposit my Work personally or through an assistant or other agent, I agree to the following:

Rights granted to the University of Warwick and the British Library and the user of the thesis through this agreement are non-exclusive. I retain all rights in the thesis in its present version or future versions. I agree that the institutional repository administrators and the British Library or their agents may, without changing content, digitise and migrate the thesis to any medium or format for the purpose of future preservation and accessibility.

#### DECLARATIONS

(a) I DECLARE THAT:

- I am the author and owner of the copyright in the thesis and/or I have the authority of the authors and owners of the copyright in the thesis to make this agreement. Reproduction of any part of this thesis for teaching or in academic or other forms of publication is subject to the normal limitations on the use of copyrighted materials and to the proper and full acknowledgement of its source.
- The digital version of the thesis I am supplying is the same version as the final, hard-bound copy submitted in completion of my degree, once any minor corrections have been completed.
- I have exercised reasonable care to ensure that the thesis is original, and does not to the best of my knowledge break any UK law or other Intellectual Property Right, or contain any confidential material.
- I understand that, through the medium of the Internet, files will be available to automated agents, and may be searched and copied by, for example, text mining and plagiarism detection software.

(b) IF I HAVE AGREED (in Section 2 above) TO MAKE MY THESIS PUBLICLY AVAILABLE DIGITALLY, I ALSO DECLARE THAT:

- I grant the University of Warwick and the British Library a licence to make available on the Internet the thesis in digitised format through the Institutional Repository and through the British Library via the ETHOS service.
- If my thesis does include any substantial subsidiary material owned by third-party copyright holders, I have sought and obtained permission to include it in any version of my thesis available in digital format and that this permission encompasses the rights that I have granted to the University of Warwick and to the British Library.

#### LEGAL INFRINGEMENTS

I understand that neither the University of Warwick nor the British Library have any obligation to take legal action on behalf of myself, or other rights holders, in the event of infringement of intellectual property rights, breach of contract or of any other right, in the thesis.

---

*Please sign this agreement and return it to the Graduate School Office when you submit your thesis.*

Student's signature:     *Jack Carby*     Date:     17<sup>th</sup> May 2013

**Interpreter Output in Talking  
Therapy. Towards a  
Methodology for Good Practice.**

Jan Cambridge MA. FCIL. FITI.  
Thesis Submitted in partial fulfilment of the  
requirements of the award of

DOCTOR OF PHILOSOPHY  
WARWICK UNIVERSITY

September 2012

## **Declaration**

No portion of the work referred to in this thesis has been submitted in support of an application for another degree or qualification of this or any other university or other institute of learning, except where clearly stated in the text.

## **Acknowledgements**

My grateful thanks are due to many people who have been kind to me along the way. Firstly, I thank my supervisors Professor Swaran Singh and Professor Mark Johnson. I am also indebted to Mr Mohammed Anwar of the Liverpool Pakistan Friends Association, to Dr Michael Larkin of Birmingham University and to Dr. Carmen Toledano Buendía, of the University of La Laguna de Tenerife as well as to Dr Keith Richards of the University of Warwick Centre for Applied Linguistics and Dr Piotr Kuhiwczak, former head of the Centre for Translation and Comparative Cultural Studies at the University of Warwick.

The Delphi panellists also gave very generously of their time and expertise and I thank Brooke Townsley, Ann Corsellis, Elsa Cowie, Maria Teresa Grau and Kirsty Heimerl-Moggan; also Raquel de Pedro Ricoy for her advice.

I am indebted to Cécile Clark, Moira and David Fletcher, Margaret and Matthew Jones, Liz Rice, Chris and Linda Weston for their invaluable help.

Finally I pay tribute to my family, especially my husband Clive, for their unstinting support when times were hard and their wholehearted delight in my successes.

## **Table of contents**

### Interpreter Output in Talking Therapy. Towards a Methodology for Good

Practice. ....	1
Declaration .....	4
Acknowledgements .....	4
Table of contents .....	5
Background of the researcher .....	10
Glossary of Acronyms and Terms .....	12
<b>CHAPTER 1. INTRODUCTION, BACKGROUND AND THEORY .....</b>	<b>13</b>
Foreword .....	13
1.1 Background to the study .....	14
1.2 Underlying theory .....	18
1.3 Taxonomy of Models .....	63
1.3.1 Why the model matters .....	70
1.4 Interpreter Education and Training .....	78
1.5 Role of the Interpreter .....	95
1.6 A comparison of ethical codes among interpreting and healthcare professionals. ....	100
<b>CHAPTER 2. LITERATURE REVIEW .....</b>	<b>108</b>
2.1 Search Method .....	108
2.2 Discussion of the literature .....	112
2.4 Clinical considerations .....	122
2.5 What is an Interpreter? .....	141
2.6 Complexity of the input signal – a data driven search .....	149
<b>CHAPTER 3. ORIGINAL STUDY DESIGN METHODOLOGY AND METHOD .....</b>	<b>160</b>
3.1 The Early Plans .....	160
3.2 The Need to adapt .....	168

3.3 Data Processing and Analysis Plan .....	173
3.4 Methodology .....	175
3.5 Method.....	187
CHAPTER 4. ANALYSIS AND RESULTS .....	201
4.1 Introduction .....	201
4.2 The focused interviews.....	206
4.2.1 Professional perspectives. Interviews with clinicians .....	207
4.3 Professional perspectives. Interviews with Interpreters.....	222
4.3 Delphi data .....	252
4.4 Filmed observation data .....	259
4.4 Post hoc satisfaction questionnaires .....	284
CHAPTER 5. DISCUSSION OF RESULTS, FINDINGS .....	292
Strengths and Limitations.....	292
5.1 The fit of the impartial model with what is observed.....	292
5.2 Parallel conversations, face and damaged messages.....	297
5.3 Face and rapport .....	306
5.4 The interchangeable use of the words ‘translation’ and ‘interpreting’ ....	310
5.5 Why is the model not used? .....	323
5.6 Delphi data .....	333
5.7 Education and training.....	340
5.8 Findings .....	344
CHAPTER 6. CONCLUSIONS AND IMPLICATIONS FOR PRACTICE....	351
6.1The interpreting model is poorly taught .....	351
6.2 The Influence of Institution and State .....	354
FRAMEWORK FOR THE PROVISION OF PUBLIC SERVICES ACROSS LANGUAGES AND CULTURES .....	360
6.3 Contribution to knowledge .....	361
6.4 Implications for practice.....	362

7. Bibliography.....	367
APPENDICES TO THESIS.....	379

LIST OF FIGURES

Figure 1 Interlocutor roles: triad with interpreter.....	44
Figure 2 asymmetry of power in transactional talk.....	50
Figure 3 Taxonomy of models .....	65
Figure 4 Families based on the codes of conduct and guides to good practice studied .....	66
Figure 5 Prototype categorisation of communicative activities in an ICE.....	69
Figure 6 Oral Assessment Criteria Grid. Common European Framework (CEFR) .....	83
Figure 7. Equivalence of common tests to CEFR levels.....	85
Figure 8. Language schools and certificate bodies evaluate their own equivalences against the framework .....	86
Figure 9 Simultaneous interpreting - how does it work? .....	90
Figure 10. Search terms used .....	110
Figure 11. Quorum flowchart of review process.....	111
Figure 12. Helman's 'perceptions of social behaviour' .....	129
Figure 13. . Summary: Core elements of “optimum outcome” .....	162
Figure 14. . Spanish Speakers in the UK. Source: Institute for Public Policy Research (IPPR), report on the 2001 UK census .....	164



Figure 15. . Responses from ITALS managers regarding Spanish interpreter use .....	165
Figure 16. Community services approached for patient input contacts .....	166
Figure 17. Access to data timeline .....	167
Figure 18. . Revised Plan of Work .....	169
Figure 19. Original consent procedure .....	171
Figure 20. Simplified Consent Procedure .....	172
Figure 21. . Main inclusion and exclusion criteria for the study.....	187
Figure 22. Thematic development mind map 1 .....	195
Figure 23. Data Analysis. Theme development mind map 2 .....	196
Figure 24. . Sub themes .....	197
Figure 25 Data Analysis flowchart.....	200
Figure 26. Overview of study findings.....	365

**LIST OF TABLES**

Table 1. Results of second literature search .....	152
Table 2. . Clinicians' personal attributes.....	203
Table 3 (1). Interpreters' personal attributes. Note that ID numbers are not contiguous. Ethnicity is self-assessed. ....	204
Table 4. Table 4 Likert votes.....	257
Table 5. Overall panellists' marks for FInterps, Delphi round 3 .....	258
Table 6. Interviewed FInterps' own PHQ scores for a remembered job.....	258
Table 7. . Interpreter satisfaction ratings .....	290
Table 8. Patient & Clinician satisfaction ratings .....	291

## **Abstract**

This thesis investigated current praxis among professional interpreters working in psychiatric outpatient clinics. The research question asked whether there are models of interpreting practice, and whether or not they are being used. A qualitative approach was taken based on hermeneutic phenomenology, and thematic analysis was used to analyse multiple types of data. Two clinicians and eight certified and registered interpreters were interviewed with part of the interpreters' interview consisting of responses to dilemma vignettes. A Delphi process validated responses to these vignettes. Four clinical encounters at routine appointments in psychiatric outpatient clinics were filmed and analysed using thematic analysis; post hoc satisfaction questionnaires were used after the filmed interviews. The complexity of interpreters' work was revealed in the breakdown of the components forming the impartial interpreting model. Taking the model as the cognitive framework for observation of practice provided depth of insight into the whole communication event. A tension between doctors' and interpreters' understandings of each other's roles and professional needs revealed that each believed themselves to be helping the other, when in fact they were working against each other. The impartial model was seen to be in use, but only in part, and interpreting practitioners were revealed to consider close interpreting and the full impartial model as not appropriate for mental health clinics, but only for courts of law. There were noticeable gaps among the interpreters in their education and training for this work. The clinicians declared a lack of training on joint working with interpreters, and this was evidenced in the course of their interviews. This thesis highlights the complexity of need that faces the profession of public service interpreting especially in terms of standardising both training and praxis.

## **Background of the researcher**

I have worked as a public service interpreter in the legal and health sectors as well as in industry and commerce since 1984, having gained distinction in interpreting at the Institute of Linguists' Final Diploma examination (1983). This examination was recognised by the education authorities (the then Burnham Committee) as a vocational bachelor's degree. I hold a postgraduate diploma in teaching foreign languages to adults (1992); two DPSIs, in health (1994) and law (1996); and a Masters Degree in Applied Linguistics from the University of Manchester (1997). As a Fellow of both the Chartered Institute of Linguists (CIOL) and the Institute of Translation and Interpreting (ITI), I have for over a decade volunteered as an unpaid director to help in developing the profession of public service interpreting and serve on the Working Group on Language Support in Health and Social Care (WOLSH), a working group of the CIOL.

Other activities include training interpreters on courses leading to the DPSI examinations; developing training materials; delivering theatre-based communication skills workshops for the Medical Postgraduate Medical Deanery in Liverpool as part of the Certificate in UK Induction (CUKI) for doctors from overseas (mostly from the Indian subcontinent and the Middle East); delivering intensive interpreter training to Kosovars returning to Pristina from their diasporas in October 2000, on behalf of the Organisation for Security and Cooperation in Europe (OSCE) in the Human Rights and Rule of Law Department.

A&E	Accident and Emergency Unit (British English)
AUSIT	Australian Institute of Interpreters and Translators Incorporated
Bilingual	A person who speaks more than one language to a functional level. Interpreters need a professional command of all theirs
CALD	Culturally and Linguistically Diverse
Caseness	In mini mental state examinations (MMSE) threshold scores are used to distinguish cases from non-cases of e.g. dementia
CEFR	Common European Framework (for languages)
CEMACH	The Confidential Enquiry into Maternal and Child Health
CFA	Skills CFA formerly known as the Council for Administration
CfBT	Centre for British Teachers
Chuchotage	Or “whispering”, means Whispered Simultaneous Interpreting
CiLT	The National Centre for Languages, now merged with CfBT Education Trust
CIOL	Chartered Institute of Linguists
CJS	Criminal Justice System
Diglossic	A society in which the two dialects in widespread daily use are so divergent that they are distinct languages as <i>defined</i> by linguists: they are not mutually intelligible
DPSI	Diploma in Public Service Interpreting (either law, health or local government options)
EC	European Community
EIT	Early Intervention Team
ESOL	English for Speakers of Other Languages
FE	Further Education
FGC	Female Genital Cutting
FGM	Female Genital Mutilation
FTA	Face Threatening Act
HADS	Hospital Anxiety and Depression Scale
HE	Higher Education
HRA	Human Rights Act
ICE	Interpreted communicative event
Interpreting	Aural/Oral transfer of meaning across languages
IoLET	Institute of Linguists Educational Trust. Runs professional examinations for linguists.
IPPR	Institute for Public Policy Research
ITALS	Interpreting, Translation and Language Support
L2	Second language
LEP	Limited English Proficient/proficiency
LG	DPSI examination in the field of Local Government
MBBS	Bachelor of Medicine and Bachelor of Surgery
MH	Mental Health
MHFT	Mental Health Foundation Trust
MHP NHS TRUST	Mental Health Partnership Trust
MHT	Mental Health Trust
MMSE	Mini Mental State Examination
Model	The interpreting model refers to the cognitive framework in which an interpreter locates their methods of practice

## Glossary of Acronyms and Terms

Morphology	Study of the structure of a language's morphemes (a meaningful linguistic unit that cannot be divided e.g. cat, un-system-atic)
NAATI	National Accreditation Authority for Translators and Interpreters (Australia)
NCICH	National Council on Interpreting in Healthcare (USA)
NESB	Non-English speaking background
NOSI	National Occupational Standards for Interpreting
NRES	National Research Ethics Service
NRPSI	National Register of Public Service Interpreting (regulator)
Ofqual	Office of the Qualifications and Examinations Regulator
OL	Other Language
Pcm	Per calendar month
PG Dip	Postgraduate Diploma
PHQ	Post Hoc Questionnaire (satisfaction survey)
Prosody	In phonetics, the use of pitch, loudness, tempo, and rhythm in speech to convey information about the structure and <i>meaning</i> of an utterance
PSI	Public service interpreting/ interpreter
PSP	Public service provider (e.g. clinician)
QCA	Qualifications and Curriculum Authority, now replaced by QCDA and Ofqual
QCDA	Qualifications and Curriculum Development Agency
R&D	Research and Development
RPSI	Registered Public Service Interpreter
Sight Translation	Or Translation at Sight. A short text is read and the meaning absorbed by the interpreter who then relays its meaning orally
Translation	Written text to written text transfer of meaning across languages
WWI	Working well with an interpreter

# **CHAPTER 1. INTRODUCTION, BACKGROUND AND THEORY**

## **Foreword**

This thesis is concerned with testing a theory of practice rather than testing a specific hypothesis or intervention. Accordingly I set out the theoretical underpinnings of the study in Chapter 1. This includes concepts in communication studies; concepts in applied linguistics; emerging theories of communication in medicine; power relations; the models described in the practitioner oriented literature; interpreter education and training; the role of the interpreter and interpreters' professional ethics in the medical setting.

Chapter 2 is a review of the literature and also provides information on existing government policy and guidance in the context. The method of literature search and data reduction is described and the papers retained are discussed. Chapter 3 concerns early plans and the need for change; software selection; methodology choice and data processing and collection method. Chapter 4 contains analysis and results. It contains data items - quotations from the data - linked by a simple narrative but without commentary. The major themes and the Delphi process are described. Chapter 5 is a discussion of the results and of the Delphi Data. Education and training are returned to as the whole picture develops. Chapter 6 considers conclusions and implications for practice that can be drawn from the overall thesis as well as the description of an emerging theory for one aspect of practice.

Quotations from the data sets and vignettes taken from my training practice are labelled as either data items or as training materials. All other quotations or citations are followed by the author, date and page number; as a ‘personal communication’; or ‘by kind permission’.

## **1.1 Background to the study**

While research in the discipline of Translation Studies has developed a considerable corpus of knowledge and has been going on in the United Kingdom for many decades, it is only very recently that Public Service Interpreting (PSI) has begun to emerge and develop as a discrete branch of the general discipline of interpreting within Translation Studies. There is a body of knowledge concerning public service interpreting (Pochhacker & Shlesinger, 2002, Wadensjö, 1998, Knapp et al, 1987, Townsley, 2011), as evidenced by the fact that specific channels of communication have been established. There are dedicated national and international academic and professional conferences and peer reviewed journals. These include The Critical Link conferences, which began in Toronto in 1995 (<http://criticallink.org/>) and The International Conference on Public Service Interpreting and Translation, Universidad de Alcala, Madrid, Spain (<http://www2.uah.es/traduccion>). Publications include The International Journal of Research and Practice in Interpreting (<http://benjamins.com/#catalog/journals/intp>) first published in 1996. Other peer reviewed journals which routinely include PSI papers in their pages include *Linguistica Antverpiensia* (<http://www.lans-tts.be/>); the online Journal of

Specialised Translation ([www.jostrans.org](http://www.jostrans.org)); The International Journal of Applied Linguistics and Professional Practice (<http://www.blackwellpublishing.com/journal.asp?ref=0802-6106>); and The Translator (<https://www.stjerome.co.uk/tsa/journal/1/>). Interpreting and communications topics are increasingly being included in conferences held in other fields, for example the European Association for Communication in Healthcare (EACH) (<http://www.each.nl/>); the International Conference on Communication in Healthcare series of conferences; and the first interdisciplinary conference on Applied Linguistics and Professional Practice (<http://www.cardiff.ac.uk/encap/newsandevents/events/conferences/alapp/index.html>) held in 2011; also professional CPD training workshops such as the Group of Trainers in Clinical Psychology (GTiCP) annual event in the UK. These are paralleled by developments in the field of health and social care such as Diversity in Health and Care (<http://www.ingentaconnect.com/content/rmp/dhc>); The Journal of Communication in Healthcare (<http://maneypublishing.com/index.php/journals/cih/>); and NHS Evidence - Ethnicity and Health, formerly the Specialist Library for Ethnicity and Health (SLEH: now subsumed within the general NHS Evidence collection).

According to Pöchhacker and Schlesinger, early PSI's codes of ethics and guidelines for practice tended to be locally produced in response to local need (Pöchhacker & Schlesinger, 2002), some of which appeared in Canada and Australia around the same time. Not until the 1980's with Shackman's handbook



(Shackman, 1984) was there a guide for people working in public service in the UK. The first works published that were specifically aimed at profession building for interpreters in the public services, (Adams et al, 1995); (Gentile et al, 1996) focused on the practicalities of training Public Service Interpreters (PSIs). Conference interpreters such as Christine Adams provided much valuable insight and training in techniques at that time and these techniques have been modified over the years to meet the sometimes differing demands of working in public service. Academic and practitioner research has increased our understanding of the field since then. This body of knowledge continues to grow but is centred principally on legal interpreting and more particularly on court interpreting, in no small part because court proceedings are usually public occasions and there are fewer constraints on researchers' gaining access to recorded data than there are for studying police or medical interviews.

The fundamental works in this field include those by Cecilia Wadensjö (Wadensjö, 1997) concerning questioning strategies i.e. using various ways to formulate a question in pursuit of understanding. This research relates to police work but has relevance to all public service situations, as does her work on interpreting as interaction (Wadensjö, 1998) which takes a comprehensive look at all the elements involved in language switching during authentic face to face interpreter-mediated interaction. She develops a framework for examining the structure of interaction across language and culture and examines the interpreter's role in this. Other important works are edited collections (Mason, 2001);

(Pochhacker & Shlesinger, 2002) as well as the selected papers resulting from the Critical Link series of conference (Carr et al, 1997, Roberts et al, 2000, Brunette et al, 2003, Wadensjö et al, 2007, Hale et al, 2009). The selected papers of the 2011 Critical Link conference held at Aston University, Birmingham will be published in 2014.

Relatively little work in this area has been done on the importance and particularities of interpreting practice in healthcare settings. It is easy, and clinically unsafe, to assume greater language skills in those claiming fluency than actually exist. The work of interpreters in legal settings has required them to be registered, and therefore certified and experienced, since the NRPSI was formed in 1994. There is no such requirement in any other public service domain, resulting in widespread use of paid but untrained interpreters. Documented examples of real harm being done have been published by medical practitioners, (Jacobs et al, 1995); (Flores et al, 2003); (Divi et al, 2007) as well as others. This harm occurred when family members and untrained personnel served as interpreters. The Centre for Maternal and Child Enquiries (CEMACH) report, “Saving Mothers’ Lives”, identifies language difficulties as a factor in death from maternal causes (CEMACH, 2007, CEMACE, 2011).

Interpreters exercise their professional skills in other people’s work domains although this point is rarely made in discussions of multidisciplinary or interprofessional working, in healthcare. They are, by definition, members of a multidisciplinary team. They use their knowledge, skills and expertise as linguists

within many other professionals' fields of knowledge, skills and expertise. For this reason any study of interpreting in the public services requires an interdisciplinary approach involving such disciplines as Diagnostic Psychiatry; Linguistics; Interpreting Studies; Bilingualism; Professional Ethics; Health Studies; and Social Care. Lord Laming indicated that the evidence of inadequate interpreting while Victoria Climbié (Laming, 28th January 2003) was in hospital showed that her death was not a rare aberration, but an extreme example of quotidian events occurring in every PCT in the country, and had contributed to her death. Gill and colleagues reviewed the need for and availability of interpreting services in healthcare:

*There is a great need for effective interpreting services across the country and provision is patchy with access restricted to health professionals. Some of this interpreting is provided by informal interpreters such as family members and general practitioners. However, the latter are due to retire within the next few years and further increasing demand for interpreting services. (Gill et al, 2009:9).*

## **1.2 Underlying theory**

This thesis is pragmatic in its aims and focus and while consideration is given to various theories, fundamentally this work concerns communication. Jakobson developed the original model of communication, which remains useful today for its clarity and simplicity. He defines the functions of the factors in communication, regardless of the type of encounter. Verbal communication requires the addresser to send a written or spoken message to the addressee. Making the message operational involves context, otherwise known as the "referent", and must be capable of being verbalised, to make it comprehensible to

the addressee. This requires a code, that is, a language which addresser and addressee at least partially share. The final element required is a contact; in other words a physical channel and psychological connection so that the interlocutors (addresser and addressee) are able to maintain communicative contact. Jakobson's model effectively covers both dyadic monolingual and triadic bilingual, or interlingual, communication. He uses the term translation because at the time of his writing there was no differentiation between translation and interpreting. Jakobson states that translation takes place even at intralingual level as speakers decode the messages transmitted in the shared language, decoding other signs as well:

*1 Intralingual translation or rewording is an interpretation of verbal signs by means of other signs of the same language.*

*2 Interlingual translation or translation proper is an interpretation of verbal signs by means of some other language.*

*3 Intersemiotic translation or transmutation is an interpretation of verbal signs by means of signs of nonverbal sign systems (Jakobson, 1959) in (Venuti & Baker 2000:114)*

Intralingual translation relies on synonymy and circumlocution to create an equivalent message, sometimes in a higher or lower register. The use of intersemiotic translation or transmutation can arise from lack of synonymy and cross-cultural understandings of some concepts, leading addresser and addressee to support their communication by gestures, hand signals and drawings. Kendon's collection of works on nonverbal communication gives a good overview of the subject, which is not a central part of this study, but will be referenced briefly in later chapters. (Kendon et al, 1981)

Jakobson's schema of the model is:

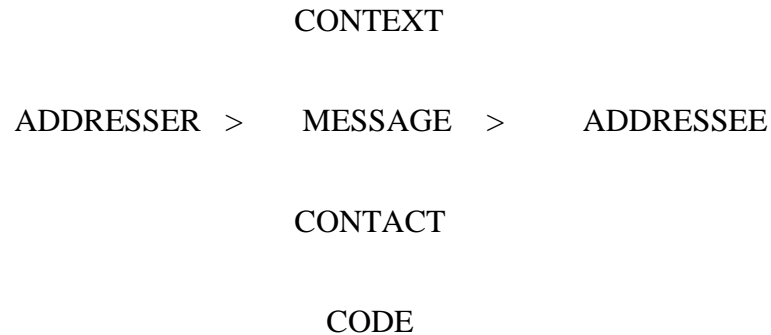

Although these six factors are functions of spoken and written communication they do not operate only in one function each; but they operate in a different hierarchical order according to the predominant function in the encounter. So we see that communication takes place in a context, via a contact, using a code. Wishing to invite Mary to the theatre, (the context), John (using a telephone) speaks with Mary (addresser and addressee alternately) using a code (a shared language).

Translation (subsuming interpretation, for this discussion) is a case of communication:

- *Translation is a case of communication, and it does not require a separate theoretical approach.*
- *In order to understand the message we must interpret it first.*
- *First we identify what is most relevant. We apply the minimal processing effort.*

Dr Piotr Kuhiwczak, personal communication 5/9/12

Even in dyadic intralingual communication there is room for misunderstanding to develop but both parties have multiple mechanisms for rephrasing or repeating questions until they arrive at common ground. This communication model is guided by our identities including our sense of self, our religion, our culture and life experience. Intra-lingual communication may not work for any or all of these reasons. People make an intrinsic selection of the most appropriate and economical expression of what they want to say. They do not rationalise selection and are very economical. We express not what we can express but what it is necessary to express. We use only the words that are necessary in the context.

Interlingual communication, interpreting, is a specialist form of communication but is still dependent upon the process of communication. Introducing an interpreter into a communicative encounter places a third person in it who will be using two different codes:

*[...] translation from one language into another substitutes messages in one language not for separate code-units but for entire messages in some other language. Such a translation is a reported speech; the translator recodes and transmits a message received from another source. Thus translation involves two equivalent messages in two different codes. (Jakobson, 1959:115).*

What happens to communications when there is an interlingual interpreter in the room? The communication model is changed; there is no longer a dyad but a triad. The third person enters the communication only to enable the other two people to communicate with one another and can find themselves in an ambiguous position. He or she is neither person A nor person B but a necessary

intruder. In his chapter on theoretical frameworks for working with interpreters, Hitesh Raval notes that interpreters are conversant with the social mores, religious and cultural taboos of the patient's local community and proposes that:

*The interpreter can therefore play an important role in informing the clinician about factors that may need to be considered in developing a culturally appropriate understanding of the problem (Raval, 2002:129).*

This seems to locate the interpreter in advocacy role, in which the interpreter's opinions and views of reality are consulted, possibly outside the actual consultation with the patient. If working in the impartial model, the interpreter will not claim epistemic authority and deliver information to the doctor, of their own knowledge and without reference to the non-English speaking full interlocutor. They will act as the 'alter ego' or 'other self' of the addresser, not because he or she is pretending to be that speaker but because he or she "transmits equivalent messages" in each language; the same message in different codes, which includes such items as using the same personal pronouns as the addresser used, and paying attention to syntax, name strings and other courtesies, during the consultation.

*Languages differ essentially in what they must convey and not in what they may convey. [...] Naturally the attention of native speakers and listeners will be constantly focused on such items as are compulsory in their verbal code. (Jakobson, 1959:117).*

Interpreting is seen to be a subset of communication and there are differences between intralingual communication and interlingual communication via an interpreter using two different codes. In an intralingual triadic communication which, for example, includes a carer, the clinician may address the carer rather

than the patient. The carer then delivers an equivalent but simpler message to the patient in the same language (code); so there has been a lowering of the register but an equivalent message and only one code in use. In interlingual communication which is carried out through an interpreter, two different codes will be used, but neither addresser nor addressee can use both.

I am using Jakobson's basic model here but then expand it by introducing the work of Goffman (1956, 1979) HH Clark (1996), Balint (1968), Stokes (2006) and others. Jakobson's classic model of communication was written at around the same time as Goffman was working on his ideas about language and social interactions. Balint and Stokes progressed research in this area from the point of view of their medical expertise and experience. Goffman and Clark were among those progressing linguistics theories by describing the tasks performed during the processes of listening and speaking. Jakobson's model provides 'hard standing' for the later addition of a superstructure of applied linguistics to examine the complex details of interactions.

Models of interpreting delivery reflect differences in the roles occupied by interpreters using a specific model. This may be the reason why nomenclature is a widely contested issue in the academic and professional field of interpreting in public service. It is hoped that the taxonomy of models at 1.3 will help to clarify that idea. A necessary distinction has to be made between two types of linguist:



"interpreter" and "bilingual advocate". The term 'mediator' is not usual in Britain as a term for language professionals. However, it is used in other parts of the world and Ozolins provides a comparison of 16 countries' public policy on the subject of ITALS provision, including a detailed discussion of the differing names for what the UK calls Public Service Interpreting. For instance, Ozolins quotes Pöchhacker who writes that:

*[...] In Austria, an initiative in the late 1980s to offer native-turkish 'language assistance' in municipal hospitals deliberately avoided any reference to 'interpreting' for fear of encroaching on an established professional domain. Meanwhile in Italy he also writes that 'mediatore linguistico-culturale' is the description in 1998 immigration legislation. (Pöchhacker 2008) in (Ozolins, 2010:22) [online].*

The function of the interpreter is to convey meaning from one language to the other, and facilitate mutual communication between the parties. The two concepts of bilingual advocacy and interpreting have become entwined to the extent that in parts of Britain the term 'advocacy' is used as a hypernym, with the word 'interpreting' as a hyponym of advocacy. (Baylav, 2002, El Ansari et al, 2009). El Ansari and colleagues limit the work of interpreters to acute situations and ascribe the linguistic model to their activities. Unfortunately no description of what this model consists of is available in their text. Nor do they clarify what they mean by 'acute' though they seem to imply a situation such as the need to establish what a person brought to hospital by ambulance has swallowed. This would call for a concise conversation in simple language between patient and Emergency Unit staff. It is clear from their text that they look on interpreting as a function within bilingual advocacy:

*Service delivery models that balance 'interpreting' and 'advocacy' functions are able to respond to wide ranging and changing physical and mental health needs. On the one hand, the availability of professional interpretation (linguistic model) services is vital and particularly pertinent in acute conditions where timely decisions by care teams rely on an accurate understanding of an individual's symptoms. [...] On the other hand, long-term conditions require understanding between the patient and healthcare professionals, facilitated by (patient-centred) bilingual advocacy models (El Ansari et al, 2009:643).*

In order to represent and explain the activity of interpreting for the public services, a number of performance models and names have been developed throughout the world, but relatively few areas of agreement. The principal performance models used in the UK are usually described as the Impartial Model, Community Model, and Advocacy Model. The impartial model was developed, over more than a decade of consultation with interpreters, service users and service providers, to enable public service providers and their clients to speak to one another directly and develop as nearly as possible a normal service provider-client relationship. It recognises the linguistic and cultural expertise of the interpreter and also the interpreter's lack of training or expertise as, for example, a doctor or lawyer. It states clearly that interpreters relay messages fully and faithfully in as closely as possible the style of the original, without addition, omission or distortion; they do not give personal advice or opinions; they will intervene only to prevent or repair misunderstandings, or to point out missed cultural references which may lead to a misunderstanding.

#### COMMON GROUND. ESTABLISHING MUTUAL UNDERSTANDING

Spoken communication requires common ground to exist between the speakers. In medical practice the concept of patient-centred care relies on the clinician establishing rapport with the patient, based on common ground between them. This rapport must be established quickly and then built upon over time, creating a professional trust within ongoing consultations. In mental healthcare where the patient's ability to communicate may be impaired this vital aspect of diagnosis and treatment is more difficult to create. Interpreters at such encounters are looked upon as the major tool for creating common ground, which clinicians often feel unable to share fully. In Furler's study, one physician interviewed expressed this sense of disempowerment due to the interpreter's relationship with the client:

*I sometimes think it is actually their [interpreters'] manner and their demeanor in the consultation which is as much benefit as the questions that I'm feeding them, because in the end the patient is mostly looking at them when they are answering the question, so the response the interpreter has of the nodding and the acknowledgment and the way they ask the questions and the way they receive the answers really are quite critical in... that sort of therapy... (Physician 5) (Furler et al, 2010:234).*

We are all members of many speech communities, even in our mother tongue. When chatting to family members, speech is full of ellipsis, idiolect, and shared experiences. *"The more such communities people join, the broader and richer is their common ground."* (Clark, 1992:258).

Clark views language use not as a class of human actions but primarily as human activity. *"But in conversation - the cradle of language use - it means something more. Participants also have to collaborate with each other."* He delineates two 'traditions' that he labels 'product tradition' and 'action tradition'. In the product

tradition, experimental psycholinguists sought to show that linguistic structures are a psychological reality. They suggested for example that passive sentences require more steps in processing the grammar, so they should take longer to understand than the same meaning presented in an active construction. Researchers in the ‘action tradition’ included Goffman, Jefferson, Schegloff and Sacks. Grice and others went on to develop what is now known as pragmatics. All this work was based not only on analysis but on observation and experiment.

Clark posits three tenets of language use: that utterances are more basic than sentences; that in language use, the speaker's meaning is primary, and word or sentence meaning are derivative; that speaking and listening are not autonomous activities, but parts of collective activities. (p xv)

Tenet 1. Gave rise to enquiry about how listeners process ambiguity. Using Clark’s example: “*The game warden watched the poacher with binoculars,*” he finds that:

*“it is utterances and not sentences that we actually produce, hear or read. We never hear a piece of language that isn’t produced by a particular speaker for a particular audience on a particular occasion.”* (Clark, 1992:xiii)

Tenet 2. People often utter sentences that are ungrammatical or semantically anomalous by grammatical criteria, such as “*watch out!*” In the ‘product tradition’, Clark says, there is no need to look beyond the meaning of a word or sentence, but this model of understanding cannot be relied on. In the ‘action tradition’, though we cannot draw a speaker’s meaning from the meaning of the sentences they use. For instance “have you done?” can mean “have you finished

complaining/eating/the job you were doing” or “stop doing that, we’re in a hurry” depending on the context. Both legal and clinical professionals, fearing loss of control over their consultations, tend to ask interpreters for “word for word translation” as we shall see in later chapters. In language use however, as Clark points out, “*there is a great deal more to account for than sentence meaning.*”

Tenet 3. Speaking and listening are not held to be autonomous but are two parts of a collective activity, such as dancing a polka or playing singles tennis. Clark describes the coordination of speaking and listening as collaboration between interlocutors. One offers an utterance and the other tries to understand it. Like operating a logging saw, both participants must cooperate - one pushing the other pulling, backwards and forwards; both aiming to achieve joint goals.

Participants also engage in collective actions for the purpose of social processes such as working on joint projects in their society or playing team sports. There can be no conversation without some degree of common ground.

*All language use rests on a foundation of information that is shared by the participants - what is technically called their common ground. For language use to be a collective activity, it couldn't be otherwise. (Clark, 1992:xvii).*

Linguists share common ground and technical vocabulary with professional colleagues, which an outsider listening in might not understand. Everyone is a member of a variety of speech communities. All the members of speech communities have common ground and use specialist terms, jargon, either as a

form of shorthand or as a way to identify non-members, or both. Dentists do it; poultry farmers do it; ballet dancers do it; infant school pupils do it. These communities exist on the basis of very many different groupings: nationality, hobby, cohort, profession, sex, ethnicity and so on. As Schelling put it:

*[...] complete consensus on an issue exists in a group when there is an infinite series of reciprocating understandings between the members of the group concerning the issue. I know that you know that I know, and so on* (Schelling) in (Clark 1996:105).

Clark's work on common ground is described as "*a great mass of knowledge, beliefs, and positions [people] believe they share*". (Clark, 1996:12). This is communal common ground in which members of a community generally hold in common such beliefs as that the sky will not fall on our heads, the Airbus is capable of flight, oysters are edible, sheep eyes are not. Personal common ground draws on mutual experience either perceptual or linguistic. Suppose John attended a public meeting yesterday, at which Mary was not present; there is no common ground there. However if John tells Mary all about the meeting from his own point of view, there is linguistic common ground on the basis of reported experience.

Communal common ground is often expressed in the lexicon used by a self-identifying speech community. This may be on the basis of geographical area, such as use of a specific language, dialect, or set of idioms; or on the basis of jargon related to professional activity, 'legalese' for example. Words which

appear in the lexicon of one group may have a different meaning in another group. In common parlance the word 'contagious' is used very loosely to mean that an illness can easily be caught from other people, making it synonymous, in that lexicon, with the words 'infectious' and 'catching'. Infective conditions can be caught by contagion but doctors do not use the three words interchangeably in their professional lexicon, so it can be useful during medical consultations to know which lexicon is being drawn upon. In the context of the consulting room, doctor and patient belong to different speech communities; they may belong to different cultural communities as well. It is not an easy thing deliberately and consciously to shift in and out of different lexicons for different interlocutors. Neither is it easy to identify potentially confusing jargon and remember to explain it. This is especially so when the word concerned is taken from vernacular language but reserved by the professional group for a special purpose. In a classroom role play during a training session for doctors, a male 'patient' consulted with his doctor about elective hernia surgery and asked what the procedure entailed. He was told, among other things, that "there may be a certain amount of post op ooze into the scrotum". Ooze, to the patient, sounded like slime. He was very alarmed. [Author's classroom materials]

It is obvious from the above that the interpreter relaying messages between a doctor belonging to one set of professional, linguistic, and cultural speech communities and a patient who belongs to a wholly other set of speech communities will need the knowledge and skill to access both. Limited

knowledge of a language's idioms and social formulae can bring risk to communication. In the gynaecology clinic the question "Is your family complete?" is ambiguous in English. Clark's 1<sup>st</sup> tenet is about how listeners process ambiguity: this question could be wrongly rendered into the other language and may elicit the 'wrong' answer. It may be taken to mean "Do you have relatives who will support you and your baby?" It could also be taken to mean "have you finished wanting more babies?" If the patient answers 'yes' to the wrong understanding of the question she could find herself unable to conceive in the future. "Is your family complete?" "Yes." No more babies due to surgical sterilisation. Alternatively, "is your family complete?" meaning "do you have relatives who will support you and your baby?" receiving the answer "yes" could result in more babies, which may have been unwanted. In the questioner's mind this question had a clear, single meaning. Did the interpreter notice the ambiguity in time to check it prior to relay? The difference is subtle and only applies in limited circumstances.

In some cases a doctor and patient may know one another quite well from previous professional encounters, while the interpreter is new to the triad. There are many possible changes in the group but there is not always shared knowledge; both communal and personal common ground. This explains what interpreters are doing when they introduce themselves to their two clients and start to try and create some rapport between them, as will be seen below.



FACE, POLITENESS AND INTERLOCUTOR ROLES. SUGGESTED THEORY OF FACE AND ROLES.

Face is a key theoretical concept in this research; the interpreter's face-saving needs and the techniques they sometimes employ. This theoretical concept is supported by discussion, in monolingual settings, by many researchers especially Goffman. In his theory of footing (Goffman, 1979) he describes the interlocutors' constant negotiation of their footing, or position, within an interaction in order to preserve face. Goffman's work on this whole thread of ideas about social interactions and their links to dyadic talk coincided with a groundswell of study on such topics in other fields (Balint, 1968, Strong, 1979).

Goffman developed a body of work in the latter part of the last century, which broke new ground in developing prototype theories of sociology and linguistics that were later developed by others. Collins' chapter on Goffman's theoretical work calls the presentation of self a ritual; that one's personal self is partly based on other people's deference or otherwise to one's demeanour. Mirror-like, the other person completes the image one has of one's self (Drew & Wooton, 1988).

Goffman himself wrote:

*This secular world is not so irreligious as we might think. Many gods have been done away with, but the individual himself stubbornly remains as a deity of considerable importance. He walks with some dignity and is the recipient of many little offerings.* (Goffman 1967:95) in (Drew and Wooton 1998:49-50).

In Stephen Levinson's essay we find the earlier theory of 'footing' which he claims has been 'partially exhausted' by Goffman's subsequent theory of participation status. The terms 'speaker' and 'hearer', were thought to be inadequate, and

*He [Goffman] suggests the need for "decomposing them into smaller, analytically coherent elements". The notion of hearer should be decomposed into a set of categories for different kinds of recipient, collectively termed participation framework in a later essay. (Levinson) in (Drew & Wooton, 1988:168).*

Like Jakobsen's theory of communication, this lays a foundation for later work and Clark's theory of participant roles was developed from it with a subsequent addition by me. Clark sees conversations not as autonomous activities but as a collaboration, like waltzing or paddling a two-person canoe. *"It takes coordination, even collaboration, to achieve. Speaking and listening are two parts of a collective activity."* (Clark, 1992:xvi). He later clarified the terminology that Goffman had originally employed and described joint action between speaker and hearer. In a foot note to this page he explained that *"to avoid confusion, I have replaced Goffman's terms animator and author by the terms and vocalizer and formulator."*(Clark, 1996:20).

Speaking and listening are themselves composed of actions at several levels:

*As Erving Goffman (1981a, p226) noted, the commonsense notion of speaker subsumes three agents. The vocalizer is "the sounding box from which utterances come." (The corresponding role in written settings might be called the inscriber.) The formulator is "the agent who puts together, composes, or scripts the lines that are uttered." And the principal, the*

*party to whose position, stand, and belief, the words attest." The principal is the agent who means what is represented by the words, the I of the utterance. In Goffman's view, speaking decomposes into three levels of action: meaning, formulating, and vocalizing. (Clark 1996:20).*

Listening is also described as decomposing into at least three levels of action.

*[The listener is] first of all, attending to [the speaker's] vocalizations. She is also identifying his words and phrases. And she is the respondent, the person who is to recognise what he meant and answer the question he asked. [...] One of these joint actions, is privileged, and it is level 3: the speaker's meaning and the addressee's understanding. It is privileged, I suggest, because it defines language use. It is the ultimate criterion we use in deciding whether something is or is not an instance of language use. Language use, I assume, is what John Stuart Mill called a natural kind. It is a basic category of nature, just as cells, mammals, vision, and learning are, one that affords scientific study 'in its own right'. And what makes it a natural kind is the joint action that creates the speaker's meaning and addressee's understanding. (Clark, 1996:21).*

Incorporating the interpreter into a dyad, with a limited role, requires the application of their deontological code to the demands of facilitating rather than initiating or continuing communication. I have used this theory in class for some years, to explain the impartial model to students. See figure 1 on page 40

The dramaturgical aspect of human interaction is complex and encompasses many types of activity. Goffman's theory of Frame analysis is about how we make sense of things. How we understand "what is going on?" In consultation with a doctor, both doctor and patient will 'frame' their understanding of the situation from their own perspective and may shift between frames throughout the encounter.[quote Drew here] And another sentence.

*The underlying message of frame analysis is, then, that the procedures whereby we persuade others that what they see is real, genuine are precisely the same procedures whereby we cheat, deceive, or manipulate*

*them. But in these terms, Frame Analysis appears to be a reworking of themes from The Presentation of Self, which showed people manipulating social situations in order to achieve certain goals. [...] The principal difference is that The Presentation of Self is an extended metaphorical description and social life is a theatrical performance, whereas Frame Analysis analyses the social world without relying on any particular metaphor. (Manning, 1992:120).*

Essentially this private conversation is as much a performance as any other. The story telling element of any interaction uses metaphor, and Manning suggests that:

*Goffman used metaphor as a way to explore a new area of sociology: the study of everyday life and face-to-face interaction. Metaphor served as a preliminary ordering device for this research. (Goffman) in (Manning, 1992:147).*

In their seminal work on face and politeness, Brown and Levinson define face as the public self-image that everyone wants to preserve for themselves. The term has two related aspects. One is negative face, which is the basic right to freedom of action and freedom from imposition. The second is positive face which essentially consists of self esteem and receiving the positive regard of others. Maintaining equity within an encounter is a matter of balancing the speaker's and hearer's face wants, which demands that speech acts which threaten face be mitigated by some threat-reducing strategy. Negative politeness uses mitigation strategies such as indirectness, questions and hedges, impersonal and passive constructions.

If face is damaged by a face threatening act (FTA) some redress must be found; though the extent to which this is true is influenced by power and distance, (see Transaction, below). It is particularly relevant in clinical consultations. Essentially this is “*respect behaviour [and] performs the function of minimizing the particular imposition that the FTA unavoidably effects*” (Brown & Levinson, 1987). Positive politeness offers redress in a wider sense by acknowledging others’ wants, asserting reciprocity of wants, and ‘gift-giving’. The sociological concept of gift giving was introduced by Marcel Mauss in the early 20<sup>th</sup> century:

*Gift giving is an intriguing, universal behavior that has yet to be interpreted satisfactorily by social scientists. Ever since Marcel Mauss' seminal essay (1924), anthropologists have been fascinated by it (Sherry, 1983:157).*

Gifts of praise or help are often offered in conjunction with joking or familiar behaviour. Negative politeness is the more conventionally courteous of the two. Face is closely bound to our identities, and sense of self. In her editorial called “Identity, face and (im)politeness”, Helen Spencer-Oatey says that all self-aspects of identity either individual, relational or collective, are both cognitive and social in nature. People have a fairly stable and lasting idea of who they are but they also construct and negotiate their identities during social contact and interaction:

*[...] people's concerns about face, (im)politeness, and the (mis)management of rapport are closely interconnected with the identities that people claim and/or (co-)construct in interaction (Spencer-Oatey, 2007:6337).*

Politeness is described as being designed to protect one another’s face, as a universal factor in human societies, but with differing manifestations from one

culture to another (Brown & Levinson, 1987). In interpreted encounters, Knapp and colleagues concern themselves with the idea that *“differences in ethnic conversational style which the participants are unaware of very frequently give rise to misunderstandings in intercultural communication”* (Knapp et al, 1987:182). Later, Susan Berk-Seligson (Berk-Seligson, 1990) looked at cross-cultural communication in American federal, state and municipal courts, a situation which routinely challenges the face of people under cross examination, and shows how interpreting style can influence jurors’ evaluations of a witness’s intelligence, competence, convincingness, and trustworthiness.

H. H. Clark took the work of Goffman and further developed the concept of interlocutor roles in *“Using Language”* (Clark, 1996). Taking Goffman’s concept of the roles people occupy when speaking and listening, but using Clark’s nomenclature, a speaker occupies three roles in almost overlapping succession. Firstly he or she acts as "principal", in which they have an idea they wish to convey and which they own as an expression of their whole self (personality, beliefs, preferences, prejudices, needs and wants). Secondly they act as "formulator", arranging a form of words that they believe will carry their idea into the mind of the listener, and be understood. Thirdly, they must speak, in "vocaliser" role.

Meanwhile the listener, if they are paying attention, will receive the stream of sound in "attender" role. If the listener is hearing a language they understand they will move into "identifier" role in which they identify units of meaning within the stream of sound. As the talk flows backwards and forwards each speaker has to wait only one turn in order to correct any misunderstandings. The third role the listener occupies is the role of "respondent". In this role the listener attributes overall meaning and intention to the speaker's words. The attribution of overall meaning and intention expresses the listener's personality, beliefs, preferences, prejudices, needs and wants.

Interpreters are responsible for facilitating communication between people who cannot do more than 'attend' to one another, without the help of an external attender/identifier and formulator/vocaliser: an interpreter. They are engaged in relaying messages for other people; they may not alter, distort or in any way damage the message during the relay. They may not "own" messages or responses. If they engage as full interlocutors, their "principal" and "attender" functions will be fully operational and their own personality, beliefs, preferences, prejudices, needs and wants will inevitably colour the message that is delivered. This usurps the epistemic authority of the interpreter's clients: that of the service provider and service user plus or minus other actors in the two language groups being interpreted for.

#### EPISTEMIC AUTHORITY

The tendency among interpreters practising the advocacy model, or the community model, and also among those without formal training as interpreters is to unquestioningly assume the right to make value judgements of message content and of peoples' positions within a conversation that travels through, but does not include, the presence of a facilitating party. I usually describe the two or more non-interpreter participants to an interpreted interaction by the term "full interlocutors". This means that the interpreter is not, themselves, a participant in the conversation, but is the enabler of it. John heritage is an authority on epistemic authority; his and other authors' work shows that the interpreter is in fact not qualified to assume epistemic authority within an interpreted communicative event, except when they intervene to establish clarity of mutual understanding on the basis of their own direct knowledge of the two languages and cultures. The participants, known from now on as "full interlocutors", are the people with primary rights to their own understandings and meanings, a fact which the interpreter needs to recognise.

*[...] All participants, as Sacks (1984) and Goffman (1983) observed, have primary rights to know and to describe their own thoughts and experiences. (Heritage & Raymond, 2005:36).*

The primary right to express the knowledge that exists in one's own lifeworld and day-to-day experience should be inalienable in medical encounters. This is especially so in mental healthcare, whose patients may nevertheless find it difficult to express themselves. The interpreter cannot have direct access to the patient's lifeworld and experience. Goffman, in his comprehensive and encyclopaedic enquiries into social interactions over a long career, understood that personhood should not be usurped.



*Yet one also may observe that relative epistemic rights to describe and evaluate objects within different knowledge domains are part of basic human rights to experience and its expression. The regulation and sanctioning of such rights is no trivial matter, but is rather a part of the internal "housekeeping" that is a condition of personhood and even sanity). (Goffman 1983) in (Heritage & Raymond, 2005:36).*

In psychiatric assessment intricacy and detail are major features of diagnosis in the clinic but are often glossed over by the abstracted nature of the note taking style. Even if the interpreter were maintaining an impartial role, it seems the particularities of a patient's speech may get lost in the written notes.

*[...] it is important to recognize how much of the doctor-patient relationship is realized interactively in the here and now. Abstract statements about this relationship almost universally gloss the complexity and specificity of the actions and responses that make up the medical interview. (Heritage & Maynard, 2006:353).*

Interpreted communicative events, most particularly in mental healthcare, are all about the words. Not only are the words a patient uses descriptive in their 'home' language but a near fit must be found for the concept and contextual references in the language of the clinic. The diagnosis hangs on the words. Interpreters need, even more than in any other work domains, to step towards 'close interpreting' (see section 5.4), in order to leave clinical assessment to the doctor.

*In addition to the organisation of preference, however, participants' concerns with face can be found in the management of rights and responsibilities related to knowledge and information. For example, conversationalists [full interlocutors] treat one another as possessing privileged access to their own experiences and as having specific rights to narrate them; journalists distinguish between firsthand and derivative access to breaking news as relevant for the rights to describe it; callers to 911 emergency services report matters in quite distinctive terms if they are bystanders to an incident rather than victims; and patients offer medical*

*diagnoses to physicians only under relatively particular circumstances; in each of these cases, the distribution of rights and responsibilities regarding what participants can accountably know, how they know it, whether they have rights to describe it, and in what terms is directly implicated in organised practices of speaking. (Heritage & Raymond, 2005:16).*

This concurs with Jakobson's simple schema in which the functions of language he described operationalise the model according to a flexible hierarchy. As interlingual-level interpreting involves creating an equivalent message in another code (Jakobson 1959), the creator of that equivalent message is in the same position as Heritage's journalists; they have the right to accurately pass on received firsthand information, but not a derivative report. Clark's work springs the Addresser and Addressee, (or Principal and Respondent) roles open to describe the tasks contained in them.

The interpreter must therefore be acutely aware of her own identity or "personality functions" and code of conduct and constantly alert in restricting herself to the attender/identifier and re-formulator/vocaliser roles. My theory on adding a third person to communicative activity described by Goffman's and Clark's work is as follows:

1. Each full interlocutor to any dyadic communication unconsciously and sequentially occupies the six roles listed on the key in figure 1.
2. This allows:

- a. immediate opportunity for message repair and checks on understanding;
  - b. real-time interpretation of all the linguistic, paralinguistic and visual signals that make up meaning, simultaneously, by the two interlocutors themselves.
3. In a triadic encounter where an interpreter is the third full interlocutor (with “personal conversational rights” either covert or overt), 2a and 2b are not possible because the interpreter must be allowed to deliver relayed speech, so:
  - a. there is no opportunity for message repair and checks on understanding until exclusive side conversations end;
  - b. interpretation of the paralinguistic and visual signals that make up meaning are delayed, and may not be interpreted accurately by the “non-comprehending” full interlocutor, due to cultural differences of meaning;
  - c. the spoken relayed message may be so disjointed that it is hard to recompose and make sense of;
  - d. it may be very difficult to re-unite the received spoken message with the meanings carried by visual signals.
4. In a triadic encounter where an interpreter is NOT a third full interlocutor (with no “personal conversational rights” either covert or overt), 2a and 2b are not possible because the interpreter must be allowed to deliver relayed speech, so:

- a. there is no opportunity for message repair and checks on understanding, until after four turns at talk (two exchanges including the interpreter's turns);
- b. interpretation of the paralinguistic and visual signals that make up meaning are delayed, but such elements can be glossed by the interpreter if their meaning differs from that of the dominant culture;
- c. the spoken message will be managed so that it remains as coherent as possible (see description of consecutive with note taking below);
- d. if both professional practitioners present are aware of whispered simultaneous mode and able to use it (see below) the conversational flow can benefit from overall coherence in communication.

In summary, the interpreter must only engage their identity or personality functions of judgement and opinion when there is a need to repair misunderstandings. See figure 1, showing a single exchange, in which the doctor speaks first.

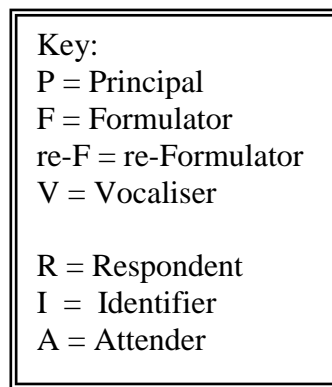
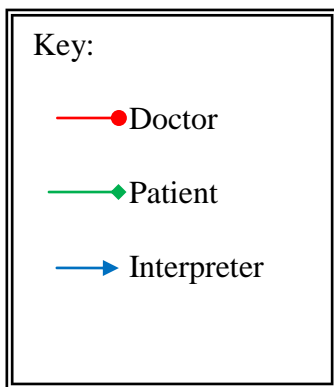
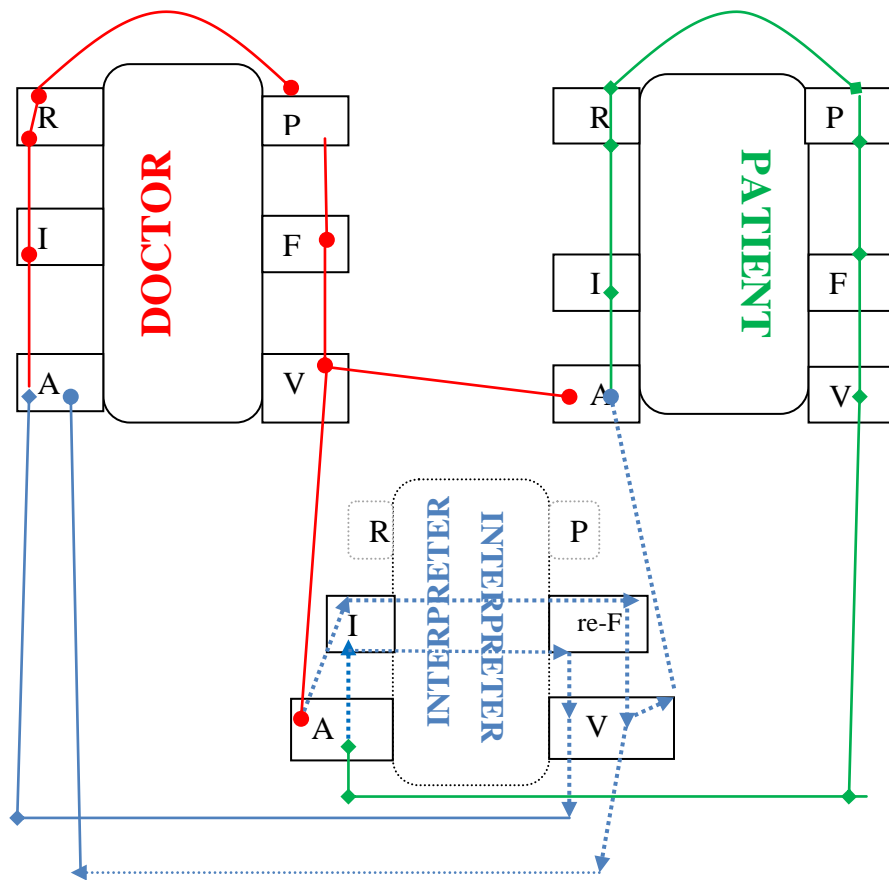

Figure 1 Interlocutor roles: triad with interpreter

In Clark's model of roles within communication we go up and down the levels between Principal, Formulator and Vocaliser when speaking and Attender, Identifier and Respondent when listening; but we don't have to move in and out of different codes. Clark has expanded on the basic dyadic communication model above to develop ideas about the functions of listening and speaking, in which, as noted above, interlocutors are jointly constructing identity and face, in the sense of building rapport between them.

One idea about 'face' as it relates to interpreters is that they should not normally be present in the conversation as full interlocutors in their own right. In order to protect their perceived and actual impartiality, they must protect their face. This idea concerning face and the interpreter arose as part of my MA dissertation and was later published in a peer-reviewed journal. It is suggested that the roles of Principal and Respondent express a person's full personality (Cambridge, 1999). The Principal "owns" the idea for the message sent and the Respondent applies all the aspects of his or her belief system to their understanding of and reaction to the message.

When an interpreter is inserted into this loop, acting as a full interlocutor, they occupy all six of those roles, as do each of the other speakers. However the interpreter should not have full interlocutor rights because this is not their conversation; they act as the serial 'alter ego' for each of the other two. The

interpreter is therefore faced with the dilemma of processing messages without engaging the two "personality" roles until and unless it becomes necessary for them to intervene for clarification, or to correct a misunderstanding of which only they can be aware. If the interpreter should change the content of the message during this process it will be at least four turns at talk before either the doctor or patient can take corrective action. This assumes that the interpreter has not changed the message in both directions so that, although they match, they do not reflect the intentions of either party.

If the interpreter believes they have full interlocutor's rights then their identity is engaged in this conversation and any identification they may have with either of the other parties can cause their face to be threatened, which often leads to distortions of the message as a protective act. Stella Ting-Toomey believes that

*'Face' is really about identity, respect and other-identity consideration issues within and beyond the actual social discourse process. It is tied to the emotional significance and estimated appraisals that we attach to our own social self-worth and the social self-worth of others. When our face image is being threatened in a conflict situation, we would be likely [to] experience identity-based frustration, emotional vulnerability, shame, hurt, anger - to even vengeance. (Ting-Toomey 2009:228-229).*

So using Clark's model for example, when Pablo, speaking Spanish, describes his headaches through the interpreter, Doctor Jones may attend to Pablo's utterances without identifying units of meaning or understanding the message. Although she attends to, identifies meanings in, and understands the interpreter's English, she attributes the meaning expressed by the interpreter to Pablo. This decoupling can

be seen in some of the evidence in the data reported later in this thesis to cause misunderstanding (see consecutive with note taking, below).

Misunderstanding is more difficult to detect than non-understanding. So the fundamental problem is that interpreting is not a joint action between interpreter and interlocutor or between two interlocutors directly. Both listener and speaker roles are decoupled in an interpreted encounter. We can see in the data that the interpreter tends to take over the role of principal covertly, and probably inadvertently, so that inappropriate attribution of meaning may follow. Thus, Pablo, speaking Spanish, may describe intense headaches that cause vomiting and visual disturbance, in that he sees rainbows round lights. An interpreter occupying all three of the listener roles may make the judgement that the final part of the message is fanciful, therefore irrelevant and relay only the first two symptoms. She responds to the doctor in principal role and says that Pablo suffers from vomiting and loss of vision, omitting the rainbows. The doctor attributes this meaning to Pablo, treats him for migraine and fails to check for acute glaucoma. [Teaching materials. This vignette was developed in collaboration with an Optometrist.]

*In the early stages you may see misty rainbow-coloured rings around white lights. But for most people sudden increase in eye pressure is very painful. The affected eye becomes red, the sight deteriorates and you may even black out. You may also feel nauseous and be sick. Acute glaucoma is an emergency and needs to be treated quickly if sight is to be saved. (Royal College of Ophthalmologists, October 2010 (reviewed October 2011)).[online]*



A further aspect of this interaction, implicature, is closely connected with face. In the example above, the interpreter's face may have been threatened by Pablo's inclusion in his story of what she believed to be a fanciful-sounding flourish, that of seeing rainbows. Solidary feelings towards their joint language community, and possibly even cultural community, could have caused a phenomenon that occurs in the data. That is that interpreters occasionally try to protect patients from ridicule or face threat by changing the message. To Pablo, the rainbows were a simple statement of fact; that was what he could see. A Royal College of Ophthalmologists' pamphlet tells us that "*A significant proportion of visually-impaired people suffer visual hallucinations*" (Royal College of Ophthalmologists, undated). Had the rainbows been included in the relayed message, the implication of a serious symptom would have stood out for the doctor, because

*"implicature, a concept first elaborated by the philosopher Paul Grice, attempts to account for how we are able to "read between the lines" in discourse: that is, how we are able to infer information that is not explicitly stated either orally or in writing". (Riley, 1993:180).*

This type of omission is particularly risky, as the interpreter is making a value judgement of the message content thereby usurping the judgement of the doctor. Her action demonstrates the value of Goffman's notion of the nonperson whom he described thus:

*[...]those who play this role [of nonperson] are present during the interaction but in some respects do not take the role either of performer or of audience, nor do they pretend to be what they are not. (Goffman 1959:151) in (Hsieh, 2006:183).*

Clinical discourse is a complex undertaking, and there are various attempts to define how it works, from differing standpoints.

TRANSACTION VERSUS INTERACTION. DISCOURSE STYLE FOR PRACTICAL OUTCOMES.

Brown and Yule developed a definition of transaction which Cheepen and Monaghan followed when they described the processes used in institutional talk. There are three salient features of transaction. The first is asymmetry of power, the second social distance, and the third an external goal (Brown & Yule, 1983, Cheepen & Monaghan, 1990). Asymmetry of power gives one interlocutor power due to knowledge or some other commodity which makes the other person relatively powerless. The goal of transaction is not to hold a conversation, but to achieve some purpose external to the conversation.

Transactional conversations in the high street, in which the customer has the power because he or she has the money, are frequent activities in everyday life. In clinical transaction the power dynamic is inverted because knowledge is power and the doctor is a gatekeeper to care and services. Clinical external goals might be changed behaviour or improved well-being. Even when a doctor offers their patient a chance to contribute, in response to questions such as "what do you think these symptoms mean?", or "how are you feeling today?" the conversation continues to be transactional. It is the doctor who decides when these sections of the conversation will take place, how long they may last, what kind of contributions to them are appropriate. Maximum solidarity between the parties is

the point at which there is minimum asymmetry of power and minimum social distance.

Patients from societies in which the western biomedical model is not common or who are not receiving the supportive comments and verbal gift giving that doctors engage in will find this transactional experience alien.

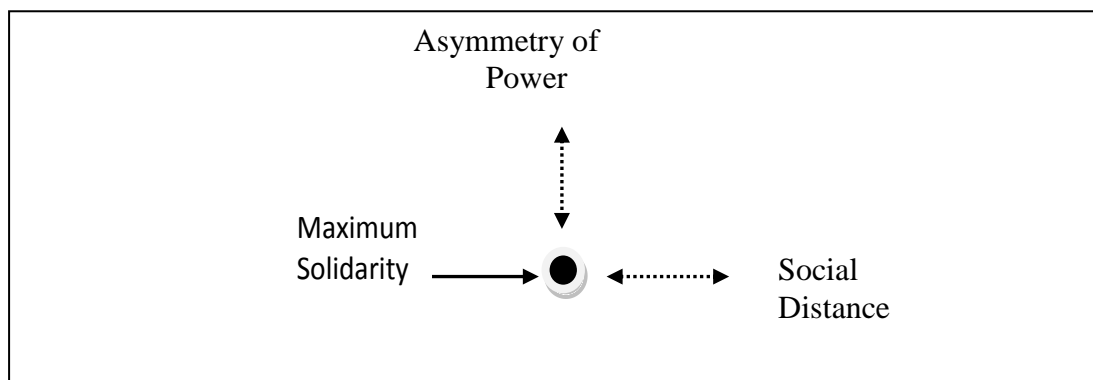

**Figure 2 asymmetry of power in transactional talk**

The goals and time constraints of the consultation dictate that patients' more usual phatic conversational style must be subjugated to the norms of transaction, whose inverted power dynamic may be a surprise to a new patient. Phatic conversation, or "interaction" in Brown and Yule's definition, is designed to create and reinforce solidary relationships. It is "small talk" used to develop and nurture good social relations. Whether they speak English or not, patients from overseas

may be accustomed to a much more paternalistic medical style or to other medical traditions altogether. However, since the fundamental rules of doctor-patient interaction are not written anywhere but are taken for granted, breaches of the rules may be more frequent among immigrant patients and offer considerable face threat to either doctor or patient.

PARALLEL FIELDS OF DEVELOPMENT. COMMUNICATIONS RESEARCH BY LINGUISTS AND DOCTORS

Throughout the 20th century doctors' relationships with their patients underwent a slow but profound change. Around the time of the First World War medical practice in the United Kingdom was deeply paternalistic. By the end of the Second World War deference had waned significantly, and continued to do so; the paternalistic role of doctors has continued to change over the subsequent decades.

Michael Balint's work (1968) was and remains influential in encouraging training for doctors in communication skills. The Balint Society exists to help General Practitioners to gain deeper understanding of the emotional aspects of the doctor-patient relationship. His concept of the positionality of the actors in clinical settings included the notion that people adopt roles in which the doctor takes a paternal role and the patient takes the child role. This echoes the ideas of transaction mooted by Goffman (1956) at around the same time. Not to adopt child role, in Balint's terms, would constitute an identity threat to the doctor, just as, in Goffman's terms, flouting the transactional structure and ignoring the social distance/asymmetrical power dynamic in clinical transaction would be a serious threat to the doctor's face.

Balint wrote of the doctor being like a drug and of how some patients, who found life's problems a great challenge, would lean on their doctor's comforting attention. He described the roles that doctors have available to them:

*Should he be a kind of authoritative guardian, who knows best what is good for his wards, who need give no explanation, but expects loyal obedience? Should he act as mentor, offering his expert knowledge and ready to teach his patient how to adjust himself to changed conditions, how to adopt a new, more useful attitude? Should he be a detached scientist, describing objectively the advantages and drawbacks of the various therapeutic and dietetic possibilities and allowing his patient complete freedom of choice, but also imposing upon him the responsibility for the choice? Should he act the kind protective parent who must spare his poor child-patient any bad tidings or painful responsibility? Or should he be an advocate of 'truth above all', firmly believing that nothing can be worse than doubt, and act accordingly. The answer of course is that the doctor must judge what is best for each patient. (Balint, 1964: 228-229) in (Burke, 2008:63).*

The parallel with Goffman's early work on face, footing and power dynamics is inescapable. At that time there was a groundswell in both medicine and linguistics which developed ideas about linguistic pragmatics and their associations with relationships in medical practice.

In 1956 Goffman began '*to explore some of the senses in which the person in our urban secular world is allotted a kind of sacredness that is displayed and confirmed by symbolic acts*'. He explored the qualities of deference and demeanour by observing hospitalised mental health patients' social interactions with one another. Having been "locked up for spectacularly failing to maintain [social proprieties with the people around them] they still to some extent

*observe the 'social rules' of the place*" (Goffman 1956:473). Goffman identifies two important aspects of deference. Avoidance rituals, such as touch/no touch allow people either to forego or preserve what W. H. Auden described as "the frontier of my person/private pagus or demesne", or personal space. Presentational rituals include "*four very common forms of presentational deference: salutations, invitations, compliments, and minor services*", in other words etiquette. Demeanour describes visual presentation – observing dress codes, modesty, self control; we judge one another's character and reliability on the basis of all these signals. The mental patients Goffman studied were exemplars of what the social rules in that society look like, simply by the fact that the unspoken, unwritten social rules were so often flouted. The rules of demeanour and of deference can be symmetrical or asymmetrical. Among social equals they are generally symmetrical, among unequals they are not:

*The gestures which we sometimes call empty are perhaps in fact the fullest things of all. It is therefore important to see that the self is in part a ceremonial thing, a sacred object which must be treated with proper ritual care and in turn must be presented in a proper light to others. As a means through which this self is established, the individual acts with proper demeanor while in contact with others and is treated by others with deference. (Goffman, 1956:497).*

Strong's work moved the development of ideas along to discuss what he called "*the ceremonial order of the clinic.*" He echoes many of the ideas that Goffman was working on at the same time. Patients will sometimes subvert the rules of interaction, the ceremonial order, so as to get what they want. If they do this

knowingly they have probably calculated the degree of risk to their good relationship with the doctor. Strong notes that:

*[...] the ritual order is simply an overt display, a performance, which may well conceal great covert differences in opinion and power (Strong 1988:234) in (Stokes et al, 2006:27).*

Balint and Strong were concerned about a style of medical practice that had little understanding of communication skills relating to emotional or psychological states and called for greater respect for patients' opinions in consultations. In their paired study of GPs and Patients where the patient had been removed from the doctor's list, Stokes and colleagues found that:

*The distinction between gps and patients lies in the gps' possession of capital: their ability to remove the patient from their list. (stokes et al, 2006:25) and "this is a process that is perceived as an 'abuse of power' by removed patients. [...]Crucially, what determines removal is not the patient's understanding of the rules of the game, but the doctor's. (Stokes et al, 2006:25).*

In 2002 Angela Coulter was still calling for a redefinition of the patient's role within the patient-clinician relationship:

*These principles [of honest, clear communication and participation] apply at all levels of health policy, including the one-to-one encounter in the clinic, the publication of information about quality standards and outcomes among providers, the provision of government advice on public health risks, and the way in which the consequences of mistakes and adverse events are dealt with when they occur. Patients and citizens have a legitimate interest in, and responsibility for, their own safety. It is incumbent on providers and policymakers to take active steps to involve them in efforts to improve the quality and safety of medical care. (Coulter, 2002:61-62).*

For the Limited English Proficiency patient (called LEP patient from now on), already disadvantaged by language and cultural barriers as well as illness, there is

great risk of breaching the ceremonial order by mistake. From the perspective of personal and institutional cultures each party will be making assumptions based on their understanding of what is 'normal'. This can give rise to:

*[...] apparent rule violations [making] the rules explicit and [exposing] patterns of power distribution (Stokes et al 2006:4).*

If an interpreter is part of this consultation as a full interlocutor, their own alignment with one or the other party is likely to inform their understanding of the 'normal' interactional rules. This may not be a conscious understanding and the interpreter may miss signals because they do not know the rules either. Interpreters' status role and patients' face needs are driven by cultural background so they may miss or misinterpret signals. In such subtle and nuanced cultural terrain, bilingualism alone is not enough.

#### DIAGNOSIS ACROSS LANGUAGE AND CULTURE. THE VALIDITY OF STANDARD TESTS.

Doctors must have instruments that offer a systematic method of diagnosis on the basis of the language used to describe one's distress. There is widespread use of the Hospital Anxiety and Depression Scale (HADS) in Western Psychiatry, and there have been important advances in the diagnosis of depression over the last decade or so, but the universal validity of the HADS is not an uncontested matter. This instrument was developed in 1983 by Zigmond and Snaith to assist in identifying cases of anxiety and depression among patients in non-psychiatric hospital clinics. In 1996 Hermann's systematic review concluded that the HADS was "*a reliable and valid instrument for assessing anxiety and depression*" (Hermann, 1996) in (Bjelland et al, 2002:69), but did not include the general population, though a number of subsequent studies have.



Jadhav writes that the diagnosis of depression raises significant issues of cultural validity. The problems include differences between definitions of self across language and culture, as well as cultural variations in language use giving rise to difficulties in the practice of close interpretation (Jadhav, 1996). In contrast, in a systematic review of the literature on the use of the Hospital Anxiety and Depression Scale (HADS) published in 2002 Bjelland and his team reviewed over 747 papers on the subject. They concluded that the HADS was found to be effective in assessing “*the symptom severity and caseness of anxiety disorders and depression in both somatic, psychiatric and primary care patients and in the general population*” (Bjelland et al 2002:69). This is useful and important but seems not to take into account the application of the scale across language and culture. Jadhav argues that psychiatry is not culture-free and it is not necessarily the case that patients of Indian origin can be well diagnosed using the HADS as it stands. He provides a scholarly description of the linguistic origins of ideas about mental illness from Sanskrit and Latin through Saxon, Middle English and other sources to the language of psychiatry and depression as it is used in the West today. He concludes that:

*If depression can be taken as local experiences (of the population) that are clarified and validated on their own terms, then depression can be construed as a culturally valid concept for western settings. (Jadhav, 1996:281).*

But, most importantly, that:

*[..] depression to the culture-free psychiatrist in India is merely a consensus taxonomy amongst health professionals who share a common*

*(Western medical) epistemology, and this is not the same as being culturally 'valid' among the general population. [...] it is likely that some patterns of distress may not fit with western descriptions of psychopathology and disorders (Jadhav, 1996:281).*

There is support for Jadhav's ideas with relation to health outcome measures, as

Collins & Johnson reported in 2008:

*Little attention has been addressed to non-Western cultures or immigrants from non-Western or developing nations (and their descendants) that have resettled in Western societies, such as the United Kingdom. Concern has, however, been raised in the literature concerning the appropriateness and validity of self-report health outcome measures in non-Western cultures. (Collins & Johnson, 2008:23).*

It is, they conclude, clear from the findings of their review that health outcome measures, including the HADS will remain in use in Britain's ever-more culturally diverse population, although

*There is still no convincing evidence either way to support or discourage the use of such 'standardised' health outcome measures in Britain's BME population. (Collins & Johnson, 2008:120).*

Language interpreting is the transfer of concepts, constructs, affect and need across the language and cultural divide in a bilingual medical setting. It is bounded not only by the need for interpreting but, Jadhav suggests especially in psychiatry, by important differences in models of mental distress, not limited to any specific national or language group. Cultural diversity in Western countries, brings with it unfamiliar situations for the host community, including the fact that many British towns, such as Leicester, are now functionally diglossic.

### BILINGUALISM, DIGLOSSIA AND L2 LEARNING.

Many societies in the world are diglossic. People are often bilingual. When many among the population are bilingual, their communities are said to be diglossic. In fact, for an individual to be monolingual puts them in a minority of the global population. One classical example of diglossia is where a community uses two different varieties of the same language; for example standard German and Swiss German in Switzerland; or *Ranmål* (dialectal) and *Bokmål* (formal) Norwegian. The other type of diglossia uses two different languages for example English and Welsh in Wales; Castilian Spanish and Gallego in Galicia, north-western Spain; Hebrew and Yiddish in Israel. Whether the two codes are different varieties of the same language or two different languages, both used by the same group of people, each code is reserved for specific purposes. Most of the members of these communities will be able to use both codes at some level, though not necessarily as competently as others can. Nevertheless there is commonly one code reserved for the marketplace, the home, and everyday social interactions. The other code is reserved for 'higher' things such as science; the practice of law or medicine; rituals and liturgy; politics and education (Holmes, 1992).

Diglossia research is an emerging field, although Ferguson began to map it in 1959 (Ferguson, 1959) and more research is needed. Ideas have progressed about what it is, and how it works. Alan Hudson's literature review (Hudson, 2002) began to move diglossia research on from being just descriptive. He calls on colleagues to look below the surface phenomena at features such as the "*degree of*

*asymmetric functional distribution of codes among their respective communities of bilingual speakers,”* (Hudson, 2002:42). Of Fishman’s (1967) argument that *“the term ‘bilingualism,’ referring to individual linguistic versatility, should be distinguished from the term ‘diglossia,’ referring to societally held norms governing differential functional allocation of codes,”* (Hudson 2002:43) he says it is a crucial one, and, mirroring the confusion in interpreting terminology, calls for consistency in the terminology used about diglossia:

*In the final analysis, what the term ‘diglossia’ should be understood as designating is a matter of linguistic convention within the discipline of sociolinguistics.* (Hudson 2002:41-42).

This is important work in understanding the sociolinguistic complexities of fluid, multi-code societies and one commentator wrote:

*[Hudson's] major innovation is the structural relatedness of codes in diglossia, notably the nature of grammatical relatedness and the idea that the morphology of H [high or formal language] tends to be more complex than that of L [low or vernacular language]. Another major contribution of Hudson concerns the social evolution of diglossia, chiefly the connection that is clearly made between diglossia, literacy, writing, and the mass media.* (Ennahi, 2006:81).

In diglossic societies bilingualism is the norm. However ‘bilingual’ is a broad and notoriously slippery term. When new immigrant communities begin to arrive in the UK a gradual process of language-shift begins in which second and third generation non-English speaking immigrant group members adopt English as their main language (Crystal, 2000).

Learning to speak a second language requires study skills and significant amounts of time. In her 2001 study Schellekens reports that:

*While there appears to be no UK information on the time required to acquire English language skills, Australian data provide an interesting projection: they forecast 1765 hours of teaching to get from no English to the level of competence required for further study or a job. Please note that this figure is only an indication of average language learning and that other factors, such as aptitude for language learning, literacy in own language and exposure to English in daily life are equally important. These factors are not included in this calculation.*

On that basis she comments that the learning trajectory would take:

- *Full-time FE students (450 guided learning hours per year) would need almost four years of study*
- *Adult students who learn English ten hours a week over 30 weeks a year would need five years and seven months of study*
- *Adult students who learn English four hours a week over 30 weeks a year would need 14 and a half years of study (Schellekens, 2001:11).*

Lev Vygotsky (1896-1934) researched how children acquire language. He wrote that :

*"...each new stage in the development of generalization depends on the generalization found in the previous stages. A new stage of generalization arises on a foundation provided by the previous stages." (Vygotsky, 1987:229) in (Lloyd & Fernyhough, 1999:297).*

He felt that this notion of transformation rather than displacement was critical in explaining cognitive development. His theory that social interaction is crucial to the assimilation of learning and his proposal of the “zone of proximal development (ZPD)” where learners construct the new language through socially mediated interaction gave rise to the interactionist approach in modern L2 acquisition. Language acquisition progresses along a learning pathway that often

features what appear to be setbacks. Learning progresses and then seems to slip backward; in fact it is termed 'backsliding' and is seen as a natural part of the assimilation and learning process.

*[...] learning linguistic items is not a linear process, learners do not master one item and then move on to another. In fact, the learning curve for a single item is not linear, either. The curve is filled with peaks and valleys, progress and backsliding. The classic example of this is when beginners acquiring English correctly produce the past tense of irregular and regular verbs. A period of seemingly random suppliance of the -ed follows, often the -ed is over generalised to irregular verbs, e.g., sitted, eated, sleeped, where earlier correct targets were being produced. (Larsen-Freeman, 1997:151).*

It has been said that the instrumental acquirer (a learner who has a specific practical purpose for studying, such as career enhancement) "fossilises", or ceases progress when they perceive that their communicative needs are met. The integrative acquirer (a learner who wishes to know more about the people and culture of a place) fossilises when they perceives that their social needs are met. Teachers impart knowledge of linguistic codes, starting with basic ones for L2 students; but there is a risk that no further interlanguage progress may be made.

*[...] even if simple codes are useful, if the acquirer hears only these codes we can expect fossilization: teacher-talk may be inherently limited due to the limitation of what can be discussed in the classroom, while interlanguage-talk is of course limited by the competence of the speakers. As for foreigner-talk, not all foreign-talkers may be good "language teachers", not all native speakers will lay down the right size "net". (Mark Twain complained that even though he had learned "intermediate French", he found no one who spoke this dialect when he got to Paris.) (Krashen, 1981:131-132).*

So some people might see themselves as bilingual by virtue of having been educated to secondary school level in one language while acquiring the other language at home from parents and grandparents. For home and school purposes that could be sufficient; but languages are dynamic and they change. The

language learned at school and at home can leave lacunae in both the lexical and linguistic knowledge needed for professional interpreting.

When the community has settled in a host country and has resolved its interpreting needs by using community and family members seen as fluent in the host language, it almost goes without saying that those people are informally labelled interpreters. The home country's language is likely to fossilise over the years and also to acquire loan words from the host language. Loan words often undergo some degree of semantic shift as they cross the frontier between one language and another. Their meanings change. For example if in Spain you hear of someone who enjoys going 'footing', that does not mean that they like to dance or that they install the foundations of buildings. It means they like to go jogging. An English speaker hearing the word 'éxito' today could be forgiven for thinking it means the way out, but it doesn't. It means success. These are "false friends" or false cognates, in the 21<sup>st</sup> century, perhaps due in some measure to similar-sounding words. Both ['exit'/'éxito'] and ['success'/'suceso'] derive from Latin with relatively similar meanings connected to ['departure'/'good or bad outcome'] and ['good result'/'good outcome'] respectively. Over the course of time modern usage brings the principal meaning of 'éxito' today to be 'success' and 'suceso' contains the ideas of an occurrence, the passage of time, and a good or bad outcome.

Errors of pronunciation, syntax and grammar acquired when learning a language by ear are very difficult to get rid of later on. In the world of interpreting the word ‘bilingual’ has to mean fully competent at a professional level in all the languages offered. See figures 5, 6 and 7 on pages 69 to 72.

### **1.3 Taxonomy of Models**

#### **PROFESSIONAL PRACTICE MODELS**

As stated earlier, most professional groups use the idea of the performance model to structure the way they work so as to improve consistency in practice. In some professional groups there are more names than models and multiple models are sometimes used in conjunction with one another. In a PhD study of models of midwifery practice during third stage labour, Tina Harris found that there was a plethora of models in the literature, many very similar to each other except for their different names. However her observational data showed that what midwives said they did and what they actually did were not the same and multiple approaches were employed as circumstances changed during parturition (Harris, 2005). This may not be a parallel for interpreting except insofar as there are a number of named models of practice, since interpreters are not autonomous within any work environment, confining themselves to maintaining a full and accurate flow of communication between other people.

The models named in public service interpreting are described below. It should be borne in mind while reading the chart at figure 4 that the models in which



interpreters give their opinions, offer advice or may refer patients and service users to other agencies on their own authority, reflect the fact that they enter into the interpreting triad as full interlocutors in their own right. Those who limit themselves to seeking clarification to prevent or repair misunderstandings or non-understanding; and who concentrate on the interlingual rendition of an equivalent message reflecting the intentions of the speaker are following the theory of interlocutor roles in a different way to that adopted by the "full interlocutor" paradigms of interpreting.

## CLASSIFICATION OF INTERPRETING MODELS USED IN PUBLIC SERVICE PROVISION

	A	B	C	D	E	F	G	H	I	J	K	L	M	N	O	P	Q
<b>NORMS</b>	advise	Give own opinion	explain complx terms & concepts	intervene in support of Pt.	Summary	challenge PSP* behaviours	negotiate	refer Pt to other agency	Interp all said	Clarify cultural issues	Linguistic issues clarified	parties speak as they wish	Uses whispered sim.mode	uses Consec mode	uses sight trans.	Reflects speech styles (register)	uses 1st pers.
impartial model	no	no	No	no	Exceptionally	no	no	no	yes	yes	yes	yes	yes	yes	yes	yes	yes
Linguistic model	no	no	No	no	?	no	no	no	yes	no	yes	yes	?	yes	?	yes	yes
community model	yes	yes	Yes	yes	yes	yes	yes	yes	?	yes	yes	no	?	yes	?	?	?
advocacy model	yes	yes	Yes	yes	?	yes	yes	Yes	?	yes	yes	no	?	yes	?	?	?
link-worker	yes	no	Yes	yes	?	no	No	yes	?	yes	yes	?	no	yes	yes	yes	?

Figure 3 Taxonomy of models

\*PSP = Public Service Provider

	Community model used by	Advocacy model used by
Impartial model used by		
NRPSI	NCIHC	
IMIA	NHS	NHS
AUSIT		
Aequitas		
Language Line		
Freedom from Torture (formerly The Medical Foundation for the Care of Victims of Torture)		

**Figure 4 Families based on the codes of conduct and guides to good practice studied**

The taxonomy above can be divided into two parts. In figure 3 above, columns A through H can be classified as administrative functions; those requiring the full engagement of the interpreter's own self as described in Clark's explanation of the Principal and Respondent roles. Meanwhile columns I through Q relate to message relay, the interlingual process of formulating and delivering an L2 message equivalent to the one transmitted in L1. It seems apposite to consider a combined model comprising core activities with outliers for occasional use under specific circumstances, when an interpreter judges it necessary and has gained the consent of the two interlocutors.

There is limited information about some aspects of the models described in practitioner-oriented literature and set out above. There are more gaps in these models on the relay side (I through Q) than on the administrative side (A through H). The fullest description across the board is that of the impartial model which has not many elements in common with the other models, except the linguistic model. In the debate that follows, Benis and his discussants show that the linguistic model is a phantom, seeming to be the impartial model by another name. 'Advocacy' seems to have been subsumed into the term 'community model'. This shows in the taxonomy diagram; it can be seen that the community and advocacy models are identical except where information in the practitioner-oriented literature was lacking.

In any case, it might be helpful to consider a broader approach, since in specialist workplaces there may be occasions for tailored, described responses in unusual

situations that are mutually agreed to and documented in the moment. For example, when working across language and culture in court, a short intervention for clarification might be of assistance when only the interpreter's knowledge of both languages in use can prevent a misunderstanding. The same applies when an intractable difficulty must be overcome such as a person detained by the police mixing four languages in every utterance, of which the interpreter is only trained for two. The same situation can arise in medicine; interpreters must be aware of the clinical goals of doctor in the speciality concerned and not disrupt the diagnostic process. See figure 5 for a proposed categorisation of the activities performed during interpreted communicative events in the public services. (Rosch, 1999).

PROTOTYPE MODEL OF INTERPRETER OUTPUT AND ADMINISTRATION DURING INTERPRETED COMMUNICATIVE EVENTS (ICE)

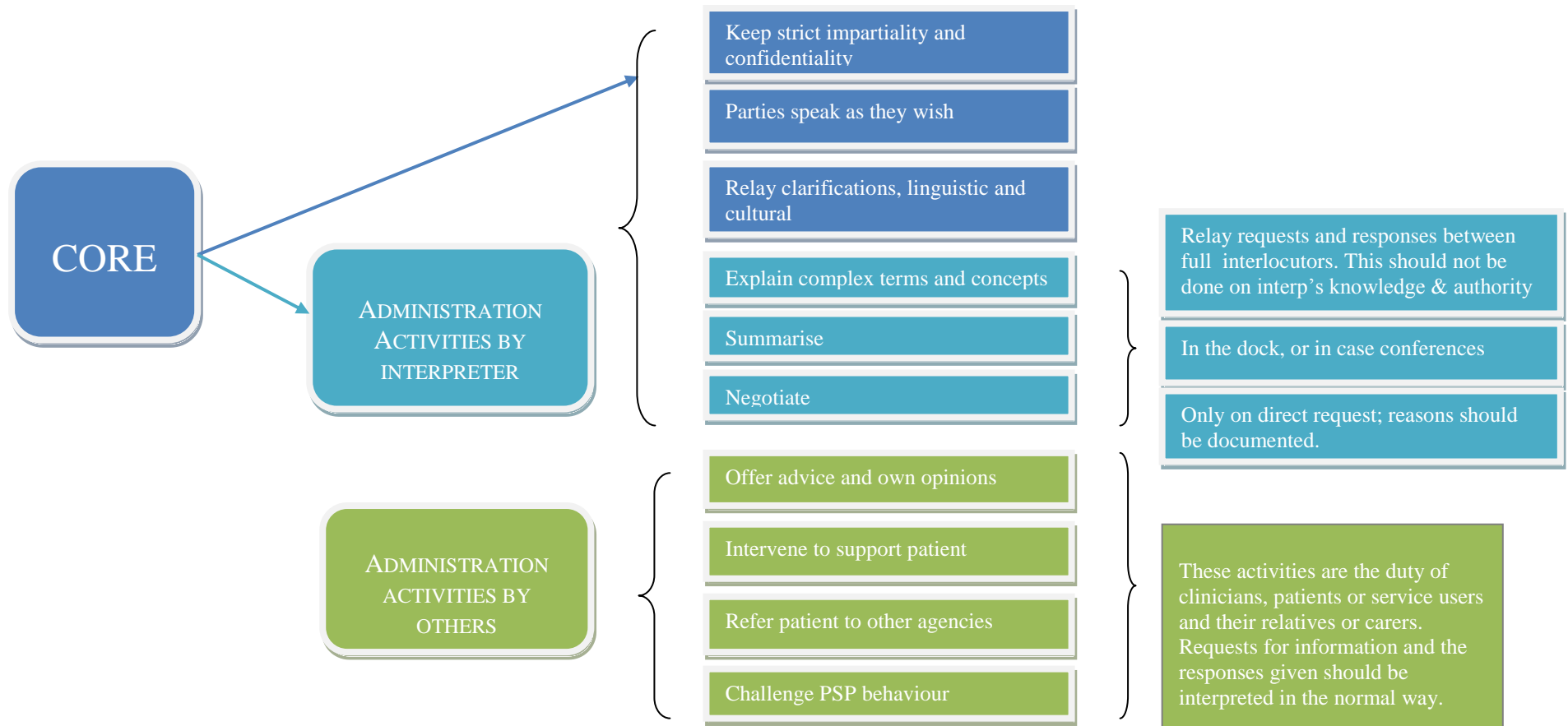

**Figure 5 Prototype categorisation of communicative activities in an ICE**

### **1.3.1 Why the model matters**

Delivery models provide a cognitive framework for interpreters to structure their management of information flow, and remain within their ethical and practical performance guidelines. A model offers consistency of practice and message protection. The integrity of the message, rendered fully and faithfully in as closely as possible the style of the original, is the goal. It was necessary to begin by identifying the models, as shown in figures 3 and 4 above. It is difficult to separate out a description of a discrete performance model from general references to domain except in the case of what is known in the UK as the ‘impartial model’, which is described in the NRPSI code of conduct and guide to good practice.

Community interpreting is used as an umbrella term worldwide, but seems to include various performance models, in some countries. The January-February 2005 issue of the Institute of Translation and Interpreting Bulletin (Benis, 2005) carried an article discussing the similarities and differences between community, linguistic, impartial and advocacy models. Various service providers and practitioners contributed. Benis interviewed interpreters, advocates and interpreting agencies to establish what each group saw as their remit within the performance model they espoused. The article concludes that the community and impartial models, as practiced in UK health care, are one and the same thing and that ‘advocacy’ and ‘linguistic’ seem to be ‘phantom’ terms, in that they have

been subsumed into ‘impartial’ and ‘community’ respectively. It is, however, obvious from the taxonomy that the community model as described in practitioner-oriented literature is, in significant ways, not the same as the impartial model.

As stated earlier, the principal performance models used in the UK are labelled the Impartial Model, Community Model, and Advocacy Model. Many healthcare institutions in the UK have a health advocacy service available to all patients especially in mental health care, where there are issues of mental capacity and vulnerability. Bilingual advocates operating across language and culture also operate as interpreters. To what extent, and how, they separate these functions is not described in the literature or in published guides to good practice. The Impartial model is described, however, in a code of conduct and guide to good practice. Some descriptions of interpreting models are the same, with different names, and those shown in the taxonomy above are described in greater detail here.

#### ADVOCACY MODEL

Figure 3 shows the attributes of this model as follows, interpreters/advocates:

DO	DO NOT
Advise and give their own opinions	Parties do not speak as they wish
Explain complex terms and concepts autonomously	
Intervene in support of the patient	
It is not known if they use summarizing as a technique	
Challenge service provider behaviours	
Negotiate	
Refer patients to other agencies	
It is not known if they interpret everything they hear	
Clarify issues of comprehension and add contextual cultural information (cultural briefing) autonomously and unidirectionally	
Consecutive mode is used but note taking is not mentioned	
Simultaneous, sight translation and first person speech are not mentioned	
Reflecting register of speech is not mentioned	



The British government was keen on health advocacy in 2006, and this term is mentioned again under Codes of Practice, below. In a speech, the then Health Minister, Rosie Winterton (Winterton, 2006) said, “Advocacy is a way of making sure that the voices of those people most in need are heard, thereby enabling everyone to access the services and support to which they are entitled.” She went on to talk about the advantages of such a service:

*Advocates, for instance, can help doctors and nurses and other health and social care professionals understand service users’ wishes by:*

- *helping them prepare for consultations and care planning meetings;*
- *helping them to feel less intimidated;*
- *helping them ask the right questions; and thereby helping them to come to the right care and treatment decisions in co-operation with the professionals responsible for their care and treatment.*

She stated that users of advocacy services wanted their advocates to be people who:

- *are accessible;*
- *are able to communicate well;*
- *are willing to listen to and understand what the service users have to say;*
- *are able to talk to users in their first language;*
- *have the knowledge to challenge professionals, when necessary; and who are culturally sensitive.*

Rosie Winterton, Minister of State for Health Services, 2006

On the face of it, this sounds very similar to the impartial and community models, in that it could describe the use of interpreter interventions to clear up non-understanding and prevent or repair misunderstandings. The minister declared, “*I want to see advocacy provision mainstreamed and encouraged*”, though in fact the Minister was not necessarily talking about bilingual advocacy. Advocacy services to English speaking patients are also commonly used in healthcare (see below). Yet among practicing interpreters the debate continues.

El Ansari and colleagues subsume what they call 'literal translation' into their definition of bilingual health advocacy:

*The functions of literal translation (i.e. interpreting) and giving people a voice (i.e. advocacy) overlap and is termed bilingual advocacy. It functions to interpret between English and the client's language, so that client's needs / wishes are well understood. This broader role (than the literal translation of what is said) communicates 'cultural, religious and social messages about clients'. (Silvera & Kapasi 2000 in (El Ansari et al, 2009:637).*

Benis says of bilingual advocacy: *"not all advocacy organisations are agreed about what advocacy itself entails, although they are all clear that the advocate plays a support role"* (Benis,2005:26). He quotes Action for Advocacy as saying *"Advocacy is taking action to help people say what they want, secure their rights, represent their interests"* and the Aberdeen Advocacy Service as saying *"Advocacy is about helping you to have more control.... We can help you to speak up for what you want... help you work out what choices you have and explore options with you"* (Benis, 2005:26-7). Advocacy is *"in all cases considered to involve the provision of support not advice"* (Benis, 2005:27).

Baylav explains how she sees the difference. She defines a health advocate as someone who *"challenges discrimination, negotiates, gives advice and information to enable choice and informed decisions, supports and empowers the service user"* (Baylav 2003) in (Tribe and Raval 2003:70). She seems to draw a distinction between interpreters and community interpreters, but does not comment on what it is. In her definition an interpreter will only interpret for the

two parties directly involved, but will not ensure mutual comprehension between them, restricting herself to relaying the meanings of words. This seems to describe the linguistic model (see below).

IMPARTIAL MODEL

The impartial model is clearly laid out in the code of conduct laid down by the The National Register of Public Service Interpreters (from now onwards referred to as NRPSI) and its accompanying guide to good practice. (NRPSI, 2011). It is a generic code which applies to interpreting practice in all public service arenas.

In sum, and as shown in the taxonomy at figure 3, in this model interpreters

<b>DO</b>	<b>DO NOT</b>
Interpret everything they hear	Give advice or their own opinions
Interpret conversations between the parties for clarity and contextual cultural information (cultural briefing), as necessary	Explain complex terms and concepts themselves, without reference to the relevant party
Facilitate the interlocutors in speaking as they wish	Intervene in support of the patient
Use simultaneous whispered mode	Summarise without permission
Use consecutive mode with note taking	Challenge service providers' behaviour
Use sight translation	Negotiate
Respect the register of speech	Refer a patient to any other agency
Use the first person form of address	

There are operational restrictions that apply to certain work domains specifically; court work for instance forbids unsupervised contact with a defendant or witness. In speech therapy, sounds must be reproduced in a way which informs the therapist of the appropriateness of word choice and the accuracy of speech sounds used. Interpreters may be involved prior to the appointment in helping to select visual prompts that will elicit words containing the sounds being tested. The interpreter considers that she has at least two clients, (e.g. doctor and patient; doctor and care team plus patient and family) whose communication needs she

serves equally. She strives to be the ‘alter ego’ or ‘other self’ of each in turn, relaying the whole of the message, including prosodic features, affect and embedded cultural messages. A fuller description of it can be found in chapter 7 of the Aequitas Report (Hertog (Ed.) 2001). Benis remarks: *“I can imagine interpreters in many fields objecting to a model that describes itself as the “impartial model”, as if it was somehow more impartial than others”* (Benis, 2005:28). It is, in fact, more impartial than, say, the advocacy model described above in which advocates are actively partisan. Impartial model interpreters maintain a professional distance from all interlocutors and concentrate on their duty to maintain the integrity of the message.

#### LINGUISTIC MODEL

Sanders (Sanders, 2000) describes what she refers to as the Linguistic model as representing the training offered to Public Service Interpreters, and tested by the Chartered Institute of Linguists’ DPSI exams which are the major, though not the sole route to being listed on the National Register of Public Service Interpreters. In fact the CIOL has always promoted the use of the Impartial Model. She refers to attempts

*to redress this situation [of fragmented qualifications and no career path] by formalising interpreting as a profession [...] through [...] the NVQ the National Language Standards and the Register of Public Service Interpreters. [...] these standards.... are so high that they are unattainable for many community based interpreters.* (Sanders, 2000:45).

She does not make it clear why such standards are unattainable for the groups she names. The Linguistic Model, she says, means that the interpreter only transmits language, using the “first person technique”. This model is said only to be appropriate when the client understands the NHS, knows their rights and is articulate and assertive.

Since that time, the National Centre for Languages (CiLT) has developed and subsequently reviewed National Occupational Standards for Interpreting (NOSI) (CiLT, 2005 updated 2010), for Translating, and for Intercultural Working. CiLT was a victim of government cuts in 2011 and has merged with the Centre for British Teachers Education Trust, (CfBT) and is now focusing on primary and secondary education. The National Occupational Standards remain. CFA Business Skills at Work [www.cfa.uk.com](http://www.cfa.uk.com) has picked up responsibility for NOSI. These provisions are not statutory however and not widely implemented. Following much work by CiLT in Europe, a Common European Framework Reference for languages was developed. It is shown below followed by the 2004 map of comparative qualification levels, to help those employing linguists understand what it would be reasonable to expect someone holding a given level of qualification to be able to do (See figures 5, 6 and 7).

#### COMMUNITY MODEL

As early as 1985 people were writing about interpreting services for public service clients, and the term community interpreter was being used. Shackman (1984) describes it as: *“explaining the thinking of each side to the other and [guiding] both sides towards a successful conclusion”* (Shackman, 1984). She says that interpreters should give advice about rights and opportunities and encourage a client to ask the right questions. She adds that the interpreter should challenge racially prejudiced statements or conclusions and explain to the client that the professional’s power to act is limited. Shackman’s is a rare description of the role, which she seems to think of as being all that the Impartial Model

includes plus an advocacy function. She certainly portrays the interpreter as being in control of the conversation.

In terms of what Gentile describes as *“the meagre literature on the subject”* (Gentile, 1995) the community model is, as the name suggests, more of a description of where such work takes place than the behaviours that define it. Gentile concludes that the term is *“too general for the kinds of elements of practice which it contains”* and that its continued use will condemn the practice of interpreting to second-rate status, low pay, poor training and insufficient research. He speculates that *“this definition has arisen from a consideration of “problem clients” in “problem contexts”* rather than from an understanding of the complexity and difficulties inherent in the actual practice of interpreting in this field. The model is laid out in Sanders (Sanders 2000:97-98). She says that community interpreters will interpret, will interview the client beforehand, will challenge discriminatory behaviour and will report on work to the project coordinator.

Organisations that train community interpreters seem to be somewhat sensitive about the term advocacy: *“following years of misunderstanding, the Community Interpreting training organisations were particularly sensitive to the drawbacks of the term ‘advocacy’, which was inherited from healthcare contexts”* (Benis, 2005:28). “So-called advocacy skills” says Ann Hayes, National Community Interpreting Project Manager of the Workers Education Association, *“are not taught on the Community Interpreting course; training time is spent on*

*appropriate intervention skills [.....] there are separate courses for bilingual advocates” (Benis, 2005:28).*

Education and training for interpreters, particularly among cohorts of students with a traumatic past and limited study skills, can be very difficult to deliver. Mixed ability classes are not necessarily a good idea, but lack of facilities and resources make them a common reality.

## **1.4 Interpreter Education and Training**

### EARLY APPROACHES TO INTERPRETER SUPPLY

In the 1980s, in the United Kingdom, interpreting activity was sharply divided between two poles. On one hand were conference interpreters; a small, elite, university trained group who worked mainly at international conferences and high-level business and diplomatic meetings. On the other were the people thought of by public service workers and community members as being interpreters, because they had some command of English alongside a mother tongue whose quality and competence nobody could assess. At that time many public service workers thought it perfectly appropriate to bring in such "bilingual" people from taxi offices, cleaning agencies, and kebab shops in order to manage their communications with a non-English speaker. There was no check on language skills or personal integrity and no questions were asked about their relationship to the person being interpreted for.

The British government was becoming aware that Court Services were in need of review. Lord Runciman was commissioned to head this in 1993 and his report called, among other things, for a register of properly qualified persons to interpret in courts. Then, on the 25th February 2000, a child of eight named Victoria Climbié from the Ivory Coast was murdered by her aunt following years of physical abuse, sparking national anger. Among other failings in the child protection system was the fact that this child, who spoke only French, had never been given access to an interpreter, the Aunt filling that need without official challenge. A decade after the Runciman report, Lord Justice Auld also criticised the lack of standards and regulation in the public service areas of interpreting in his review of the criminal courts in England and Wales (Auld, 2001).

The practice of simply engaging a foreign person to act as interpreter had not entirely died out when, in the matter of *Cuscani v The United Kingdom* in 2002, a man of Italian origin claiming to speak little English, appealed to the European Court of Human Rights against a 1996 conviction for tax evasion. Only at the trial was the original trial Court informed by Counsel that his client had:

*[...] considerable difficulty in communicating, save in very simple concepts, in English. Now for the purpose of consultation we can get by, but one of the difficulties is that his English is very poor and his Italian is very Southern (Cuscani v The United Kingdom, 2002).*

The Court ordered that an interpreter be present on the next occasion but none arrived. Counsel pointed out that the defendant's brother was in Court and could be asked to translate when necessary. Mr Cuscani later wrote to the Home Secretary complaining of not having had an interpreter at trial and saying that the QC had misled the trial court by stating that his brother would be able to act as a



‘translator’, when his brother was unable either to speak or write in English. The Court held that the applicant’s request for costs against the United Kingdom should be met and held that there had been a violation of Article 6§1 of the Convention taken in conjunction with Article 6§3(e) of the Convention; but dismissed the remainder of the applicant’s claim for just satisfaction. Lord Laming’s report on the Climbié case of 2000 echoed all these criticisms

#### NATIONAL REGISTER AND DIPLOMA IN PUBLIC SERVICE INTERPRETING

The national register of public service interpreters (NRPSI) had been established in 1994 in response to the Runciman Report. At the start it recruited interpreters who could prove they had a certain number of hours' working experience in public service interpreting. They had to undergo a Criminal Records Bureau check, sign the code of conduct and good practice, and work towards gaining the relevant Diploma in Public Service Interpreting (DPSI) or another of the accepted academic routes. This group were the first registered public service interpreters (RPSI), and like all newly emerging professional groups they gained registration under a ‘grandfather’ system. This system meant that if you were already working and experienced, you could register so long as you met the CRB checks; you were given 5 years to gain a qualification. From then on registration became more difficult and national professional examinations have become more rigorous. This was in 1994, fewer than twenty years ago. Many of those early registrants had no formal qualifications, only the self-training of experience. Many are still in practice and have not in practice been required to undergo any revalidation.

#### DEVELOPMENTS IN INTERPRETER TRAINING

Since then, university-based training courses have developed. Established Professional Associations such as the Chartered Institute of Linguists and the Institute of Translation and Interpreting, among others, welcome public service interpreters as members. European initiatives have led to collaborative development of codes of ethics and of training materials such as the "Building Mutual Trust" initiative (Townesley, 2011). Raising the bar on interpreting standards needs the informed collaboration of the professional groups that interpreters work alongside.

It is very important that doctors, especially, are aware of what the qualifications interpreters claim to have actually mean. In her book "As good as your word", Sanders claimed that the qualifications were unattainable by her interpreters (Sanders, 2000). A glance at figures 5, 6 and 7 will show that either such interpreters had a very low level of basic education or a very low level of self esteem (or both). All practitioners of the "learned professions" working in the public service, i.e. doctors, lawyers and theologians, must meet very high standards of competence and probity because the quality of their work cannot be evaluated at the point of delivery, by either clinician or patient. Not only the patient is at risk if the interpreter's work is substandard: there will be no record of what the interpreter said to either party. Their contribution to a consultation cannot be re-examined for accuracy. If there is an adverse event attributable to the interpreter's work the likelihood of repercussions on that interpreter are small. There will be a direct negative effect on patients and doctors, however. The charts that follow show what a doctor can expect their interpreter to be

capable of doing, on the basis of their stated qualifications. For example, the ability to relay nuance would be very limited below level C1. The data in this thesis contain examples of interpreting practice that would put patient, clinician and institution at risk of repercussions if complaints were to be made about their work. Doctors who are alert to the signals of poor interpreter performance should be familiar with the European standards shown below, because patients who are doubly vulnerable due to illness coupled with poor English deserve better than treatment via unqualified interpreters.

	RANGE	ACCURACY	FLUENCY	INTERACTION	COHERENCE
C2	Shows great flexibility reformulating ideas in different linguistic forms to convey finer shades of meaning precisely, to give emphasis, to differentiate and to eliminate ambiguity. Also has a good command of idiomatic expressions and colloquialisms.	Maintains consistent grammatical control of complex language, even while attention is otherwise engaged (e.g. in forward planning, in monitoring others' reactions).	Can express him/herself spontaneously at length with a natural colloquial flow, avoiding or backtracking around any difficulty so smoothly that the interlocutor is hardly aware of it.	Can interact with ease and skill, picking up and using non-verbal and intonational cues apparently effortlessly. Can interweave his/her contribution into the joint discourse with fully natural turn taking, referencing, allusion making etc.	Can create coherent and cohesive discourse making full and appropriate use of a variety of organisational patterns and a wide range of connectors and other cohesive devices.
C1	Has a good command of a broad range of language allowing him/her to select a formulation to express him/herself clearly in an appropriate style on a wide range of general, academic, professional or leisure topics without having to restrict what he/she wants to say.	Consistently maintains a high degree of grammatical accuracy; errors are rare, difficult to spot and generally corrected when they do occur.	Can express him/herself fluently and spontaneously, almost effortlessly. Only a conceptually difficult subject can hinder a natural, smooth flow of language.	Can select a suitable phrase from readily available range discourse functions to preface his remarks in order to get or to keep the floor and to relate his/her own contributions skilfully to those of other speakers.	Can produce clear, smoothly-flowing, well-structured speech, showing controlled use of organisational patterns, connectors and cohesive devices.
B2+					
B2	Has sufficient range of language to be able to give clear descriptions, express viewpoints on most general topics, without much conspicuous searching for words, using some complex sentence forms to do so.	Shows a relatively high degree of grammatical control, does not make errors which cause misunderstanding, and can correct most of his/her mistakes.	Can produce stretches of language with a fairly even tempo; although he/she can be hesitant as he or she searches for patterns and expressions, there are few noticeably long pauses.	Can initiate discourse, take his/her turn where appropriate and end conversations when he/she needs to, though he/she may not always do this elegantly. Can help the discussion along on familiar ground confirming comprehension, inviting others in, etc.	Can use a limited number of cohesive devices to link his/her utterances into clear, coherent discourse, though there may be some "jumpiness" in a long contribution.

Figure 6 Oral Assessment Criteria Grid. Common European Framework (CEFR)

Continues on next page

B1+					
B1	Has enough language to get by, with sufficient vocabulary to express him/herself with some hesitation and circumlocutions on topics such as family, hobbies and interests, work, travel, and current events.	Uses reasonably accurately a repertoire of frequently used "routines" and patterns associated with more predictable situations.	Can keep going comprehensibly, even though pausing for grammatical and lexical planning and repair is very evident, especially in longer stretches of reproduction.	Can initiate, maintain and close simple face-to-face conversational topics that are familiar or of personal interest. Can repeat back part of what someone has said to confirm mutual understanding.	Can link a series of shorter, discrete simple elements into connected, linear sequence of points.
A2+					
A2	Uses basic sentence patterns with memorised phrases, groups of a few words and formulae in order to communicate limited information in simple everyday situations.	Uses some simple structures correctly, but still systematically makes basic mistakes.	Can make him/herself understood in very short utterances, even though pauses, false starts and reformulation is very evident.	Can answer questions and respond to simple statements. Can indicate when he/she is following but is rarely able to understand enough to keep conversation going of his/her own accord.	Can connect groups of words with simple connectors like "and", "but" and "because".
A1	Has a very basic repertoire of words and simple phrases related to personal details and particular concrete situations.	Shows only limited control of a few simple grammatical structures and sentence patterns in a memorised repertoire.	Can manage very short, isolated, mainly pre-packaged utterances, with much pausing to search for expressions, to articulate less familiar words, and to repair communication.	Can ask and answer questions about personal details. Can interact in a simple way but communication is totally dependent on repetition, rephrasing and repair.	Can link words or groups of words with very basic linear connectors like "and" or "then".

CEFR for languages 2001 Source: Council of Europe website [http://www.coe.int/T/DG4/Portfolio/?L=E&M/main\\_pages/illustrationse.html](http://www.coe.int/T/DG4/Portfolio/?L=E&M/main_pages/illustrationse.html)

Accessed 14.02.2010 see CEFR and related documents, Comments to legitimate the assigned levels for each of the spoken performances.

City and Guilds	NQF (UK only)	Cambridge exam	IELTS	UNicert	ALTE level	TOEFL (IBT)	British General Qualifications
vocational education from basic to doctoral level	National Qualifications Framework. Similar to City and Guilds	Up to Cambridge Proficiency test. English Language (ESOL)	Vocational language tests for professionals from outside UK.	International system of certification and accreditation for various <u>languages</u> learnt in a <u>university</u> context.	The five-level scale used by ALTE (Association of Language Testers in Europe) in the European Union.	Evaluates the ability of an individual to use and understand <u>English</u> in an academic setting.	Secondary education only.

Figure 7. Equivalence of common tests to CEFR levels

CEFR level	City and Guilds	NQF (UK Only)	Cambridge exam	IELTS	UNICert (different languages)	ALTE level	TOEFL (IBT)	British General Qualifications
C2	Mastery	Level 7-8	CPE grade A, B or C / CAE grade A ]	8.5 to 9.0	UNICert IV	Level 5	-	-
C1	Expert	Levels 4-6	CPE (45 to 59) / CAE grade B or C / FCE grade A	6.5-7.0 to 8.0	UNICert III	Level 4	110 to 120	-
B2	Communicator	Level 3	CAE (45 to 59) / FCE grade B or C / PET Pass with Distinction	5.5 to 6.0-6.5	UNICert II	Level 3	87 to 109	-
B1	Achiever	Level 2	FCE (45 to 59) / PET Pass with Merit, Pass / KET Pass with Distinction	4.0 to 4.5-5.0	UNICert I	Level 2	57 to 86	GCE A-Level / AS-Level
A2	Access	Level 1	PET (45 to 59) / KET Pass with Merit, Pass			Level 1	-	Higher Tier GCSE
A1	Preliminary	Entry Level	KET (45 to 59)			Breakthrough level	-	Foundation Tier GCSE

[http://en.wikipedia.org/wiki/Common\\_European\\_Framework\\_of\\_Reference\\_for\\_Languages#Common\\_reference\\_levels](http://en.wikipedia.org/wiki/Common_European_Framework_of_Reference_for_Languages#Common_reference_levels). Adapted to fit, by removal of some columns. The whole is available at this website. Accessed 4.5.2012

Figure 8. Language schools and certificate bodies evaluate their own equivalences against the framework

Much has been said about performance models. Within that there is mention of 'modes of delivery'. These are in some ways common to all interpreters, whether they work at conferences, in commerce and industry or in the public service. In the public service there are some differences in the opportunities for use, and constraints upon deploying, these techniques or modes of delivery. A description of each one might be useful, with a short commentary on the pros and cons of their use in public service settings.

#### AD HOC LIAISON MODE

In PSI this technique consists of pausing for interpreting at the end of each unit of meaning. A unit of meaning is not necessarily a sentence but is a free-standing phrase or group of phrases which can (or should be) understood in the context independently of whatever may come next. Ad hoc liaison interpreting is quite difficult to listen to, being very "chopped up", and hard to reassemble as the turn at talk goes on. It can be difficult for either primary interlocutor to keep control of their turn at talk. The necessarily frequent pauses for interpretation provide equally frequent opportunities for the other interlocutor to interject as the interpreter finishes the current unit of meaning; this may not coincide with the end of the current speakers' communicative intentions. Its major area of usefulness is in situations where "translating word for word" is actually necessary, or where the exchange of information involves very short contributions by either party. For example, this may occur where a speaker is incoherent or brief personal information is being collected prior to taking a history.



### CONSECUTIVE MODE WITH NOTE TAKING

This technique is in some ways similar to the one above as it consists of the serial interpretation of what the parties say, by turns. Using this mode of delivery the interpreter listens to several minutes' speech, while taking notes. When the speaker has completed what they wanted to say the interpreter, using the notes as an aid to memory, provides an interpretation of it. Consecutive interpreting with note taking is the most commonly used method in many medical settings. The technique allows for much longer turns at talk by each speaker, without loss of accurate recall, and reduces the incidence of either speaker's turn being cut off due to the pause for interpreting. It has the disadvantage of decoupling the two major elements that compose the input signal. While the interpreter is listening to interlocutor A speaking, interlocutor B can only access the paralinguistic and visual signals available. The speaker will naturally attribute meanings to these signals which may or may not be appropriate. Speaker B gains access to the semantic content of what speaker A was saying when the interpreter delivers the interpreted version. The result is that it is very difficult for speaker B to re-compose the two halves of the message (spoken and visual) in order to make a comprehensible whole. False attribution during the visual-signal-only stage may not be picked up. If either speaker claims an over-long turn at talk this situation is exacerbated and the other speaker may begin to feel excluded. In situations where one of the speakers is significantly less powerful or knowledgeable than the other and may also be feeling unwell, this can be unhelpful.

### A NOTE ON NOTE-TAKING

Note-taking is a sign of competence and professionalism and trained interpreters are taught to do it. It takes many forms; some write whole words, some use

ideogram exclusively, some use a mixture of the two or even some form of shorthand. Each will have their own view about which is the best method but most will make a point of noting down proper names and numbers. Good practice guidelines indicate that interpreters should come into the interview room with a clean notepad and leave it with a clean notepad. The reason is the need to reassure the patient of confidentiality at all times and the patient should be aware that the interpreter has removed all used pages from the notebook at the end of the interview and either destroyed them or handed to them to the clinician for shredding. Other members of staff should never rely on the interpreters' notes for future reference as they are likely to be unintelligible, even to the interpreter themselves, after quite a short time. The meaning of the notes relies entirely on the context of the specific conversation.

#### WHISPERED SIMULTANEOUS MODE

This technique, also known as 'chuchotage', involves the interpreter listening, changing the language and speaking all at the same time. This mode of delivery is often used at conferences, but is also used, with some adaptation, in public service settings. The differences are that in conference booths, which are a differently pressured environment to work in, the interpreters have audio equipment and a colleague to help and take turns at interpreting. They will almost always have the speaker's text in front of them. They often get a day or two's preparation time. None of these conditions is possible in public service settings, except occasionally in court. This technique is routinely taught on university based courses and for some students is a difficult concept to grasp at first. Figure 8 is taken from one of my lectures and shows a metaphor explaining it. It has also been used to explain it to members of collaborating professions.

The name of the technique and a brief description of procedures do not convey the complexity of the technique from the point of view of the interpreter. A more concrete metaphor may be helpful.

Whispered simultaneous interpreting is like close order marching.

Soldiers on a public parade march very close together; shoulder to shoulder and barely a pace behind the rank in front. They turn to left and right, stop, start, salute, as one person. Why don't they fall over? It's because:

- They have drilled this for many hours
- They know the route
- They are *led*, from the front or the side, via visual and verbal instructions
- Each trusts the others to perform as expected

The instructions are designed to warn of a change of direction or pace. So when they must all look to the left the parade commander issues an order, *within a syntax of pauses*, for instance: "paraaaade" (two, three, four) "eyes" (two, three, four) "left" (two, three, four) (everybody looks to the left).

So far so good.

Interpreters delivering whispered simultaneous interpreting in public service settings are only half a pace (half a sentence) behind the leader (the speaker). *And they have no idea where he is going.* Most of the time the speaker doesn't know either – this is spontaneous speech. If the speaker changes pace or topic suddenly the interpreter will be metaphorically flat on their back – leaving the speaker on their own. The sudden disruption to cognitive processing will empty the interpreter's short term memory completely, causing a need for repetition.

Speakers can give interpreters the equivalent of the parade commander's signals by using discourse markers such as: (end of previous idea) (minimal pause ....) "Now then . let's talk about your medicines" (minimal pause....) "I'm going to explain to you how to use them."

**Key:** Alert > Operation > Initiate Action

Figure 9 Whispered simultaneous interpreting. How does it work? Author's Classroom materials

The ability to take advantage of simultaneous technique requires the interpreter to have been trained in it, and at least one of the other two parties to be practised at collaborating in it. It is not a difficult thing for clinicians to learn to do, but it is a good plan to spend the necessary 10 minutes on learning how to do it outside the clinical encounter. Patients can quickly become accustomed to the technique and once it has been explained to them and they have experienced it they often prefer it.

"Whispered" simultaneous interpreting is a misnomer in that actually whispering for any length of time is known to damage the vocal chords. The interpreter therefore murmurs, or speaks very quietly. The result is that speaker A speaks at a steady pace but without pausing for interpretation until they have finished what they wanted to say. If the interpreter needs to change pace, or needs to stop, a hand signal will alert speaker A to that fact. Speaker B meanwhile will be receiving the semantic content murmured into their ear while at the same time observing the visual input and paralinguistic signals. The technique saves considerable time; research has shown that it reduces interpreter errors significantly; and it gives greater immediacy as well as more direct contact between the two principal interlocutors (Elderkin-Thompson et al, 2001). On the other hand interpreters find it tiring, need the speakers to speak loudly enough for them to hear properly, as the interpreter's own voice is also audible to them, and some patients will not tolerate it. The technique is used regularly and often in courts of law and in conferences but is rarely used in medicine and is only taught on formal courses leading to certification.

## TRANSLATION

Translation happens when the translator reads a text with understanding and insight and then creates a new text conveying the same meaning in a different language. Translation is from text to text. Interpreters are taught translation skills on DPSI courses though not to professional translator level. Translation is a different skill set and career from interpreting and professional MA courses in translation are available. However translation is part of basic language skills training and promotes literacy, understanding of formal lexicons, grammar and spelling in both languages as well as the discipline of transferring meaning from one linguistic code to another. Translations of short documents are sometimes requested from interpreters by public service personnel. For example police officers will ask for a written translation to English of a foreign witness' statement for their own use, having taken the statement in the witnesses' own language, through the interpreter. Doctors sometimes ask for simple letters to be translated.

## SIGHT TRANSLATION

Sight translation is used when short, relatively non-technical written information that only exists in English must be relayed to an Other Language speaker, such as an LEP patient or carer. The interpreter will read the entire text to themselves before starting to translate it so that any potential problems of structure, or terminology, can be taken into account. Should there be anything in the text that needs clarification that will be sought prior to sight translation. The whole meaning of the text can then be delivered orally in the other language. Disadvantages are mainly the result of length and technical or linguistic complexity of the original text. Patients from cultures with a strong oral tradition

of information sharing may have an advantage in benefitting from this technique; but all patients, under pressure from anxiety or illness, may find completely new information difficult to absorb and retain by this method alone.

#### DEVELOPMENT OF A PARADIGM FOR RELAYING STRONG EMOTION

What follows is the method that I as a trainer have adopted and describes a method of reinforcing student interpreters' understanding of the theories and modes of interpreting above and the concurrent development of a framework of practice for them to use in face-threatening situations such as the requirement to relay strong emotion.

For years it has been my practice to teach interpreting students about common ground; politeness, face and interlocutor roles; transaction versus interaction. The importance of register, and its accurate relay, may be even more significant in mental health care than anywhere else, given that the style and type of language chosen for emotional outbursts is a factor in assessing patients' condition.

Propositional cursing can be a symptom:

*[...] emotional language and verbal aggression are oral behaviours symptomatic of obscene phone calls (OPC), conduct disorders, anti-social personalities, and schizophrenia. All of these disorders are characterised by abnormal verbal aggression and emotional language. [...] Surprisingly, the role of cursing in these disorders has not been researched. The use of terms such as "emotional language" or "verbal aggression" in DSM IV needs to be operationalized and described, and the emotional and/or aggressive cursing lexicon that is considered symptomatic remains to be defined (Jay, 1999:71).*

Cursing is deeply embedded in memory along with other automatic speech such as counting:

*Swearing is a significant issue in a mental health context. It plays a prominent role in various neuropathologies of language. For example, it is one of a small set of speech functions – automatic speech – selectively preserved in the severely aphasic patient (Van Lancker & Cummings 1999) in (Stone & Hazelton, 2008:209).*

Ideas about the linguistic pragmatics of cursing arose from discussions with students and colleagues over time and led to the development of a theory of the interpreter's location within the interpreting triad. These ideas are briefly set out in *The Translator* (Cambridge, 1999). I describe below a further development which occurred while working with students and finding that many of them were unwilling to relay strong emotional language in a form that reflected its original expression. A paradigm for relaying curses was included in training. The students needed a cognitive framework within which to understand how strong emotional language can be interpreted and which allowed them to fulfil their duty of fidelity to the message. We explored what cursing is, and they discovered how to avoid using blasphemy or expressions that were abhorrent to them while still properly conveying the emotional weight of the locution. The paradigm was based on three pragmatic features of cursing: emotional weight, semantic equivalence and pragmatic function. Pragmatic function further divides into three groups: descriptors, exclamations and name-calling. The "rudeness register" (Cambridge, 2003); (Cambridge, 2008) became my principal tool for overcoming students' reluctance to relay curses rather than 'tidy them up' with an arch little description. "You bloody bastard!" is not equivalent to "give my regards to mademoiselle, your mother". To divert the emotional power behind the speaker's intention by referring to the listener's mother as unmarried, using a French word, is likely to damage the speaker's credibility.

Real harm can be done by subverting a speaker's need to express strong emotion, especially if the chosen replacement phrase causes amusement.

At a Home Office Substantive interview as part of his asylum application, the Immigration Officer asked Mr X why he chose to flee his country, when he had successfully avoided his persecutors for two years. Mr X replied "they found me, and five men came to my place of work. They dragged me into the street and beat me, and said terrible things to me." The officer asked him the obvious next question, "what did they say?" Mr X repeated what the men had said, using the violent and abusive language they had employed. The interpreter relayed this lengthy tirade as, "they said I'm a horrible person and my mother wasn't married." The officer laughed.

**Author's Classroom materials**

This applicant's case would have been seriously damaged due to lost credibility as the seriousness of the abuse would not have been apparent. His application may have been refused causing his repatriation. The interpreter's role is to facilitate communication by delivering equivalent messages interlingually, so that an environment of mutual trust can develop between clinician and patient. Delivering equivalent messages in emotionally charged situations is a vital part of establishing the patient's trust in the clinician and both parties' trust in the interpreter, as will be seen below.

### **1.5 Role of the Interpreter**

Over and above the power asymmetry in doctor-patient relationships there are power considerations in the institutional management of the service. Interpreters, too, are affected by the institution. A PCT is a huge institution and many hospitals are the size of small towns. The organisational and management task is very complex and as Pahl argued:



*[...] there can be a sociology of the organisation of urban resources and facilities; the controllers (or gatekeepers), be they planners or social workers, architects or education officers, estate agents or property developers, representing the market or the plan, private enterprise or the state all impose their goals and values on the lower participants in the urban system. (Pahl, 1974) in (Williams, 1978:236).*

All employed and independent workers in the system exert their influence, but this is the first instance of the term “gatekeeper” being used to describe someone who controls access to resources to “lower participants in the urban system”. Doctors, from the GP to the hospital consultant, are gatekeepers to treatment and resources. Interpreters, too, have a gatekeeper role in the sense that they control access to the ideas and messages that pass between the people they work alongside. So when interpreters summarise messages, the ideas and nuance contained in them can be denied to the other participants. When they hold parallel, or side, conversations, as we shall see in the data, they completely exclude one or the other of the full interlocutors from a large amount of information about the conversation.

The interpreter’s role is complex and multifaceted as the data will show. Building rapport is the first stage in creating a degree of mutual trust. It usually starts when a trained interpreter introduces themselves and explains their methods of working, in both languages, to both parties. There may be some opening pleasantries offered by the clinician which must not be treated as an irrelevance and left out. The interpreter will relay everything she hears into the other language and if an intervention is necessary to achieve clarity it will be made in both languages.

There have been many metaphors for the work of interpreters in public services. There was a time when we were labelled machines and this persists in some places. The label was based on a misunderstanding of the "translation device" proposition that arose as a jurisprudential construct allowing interpreters to work in courts. Until this notion was developed in Papua New Guinea in the early 1960s, interpreters were not permitted to work in court because everything they relayed from the witness or defendant was treated as hearsay, inadmissible as evidence (*Gaio v The Queen* (1960) 104 CLR 419); (Roberts Smith, 2007) in (Hale, Ozolins & Stern, eds, 2009). There have been many other attempts to find an easily-grasped idea of what interpreting is. A favourite one is the bridge. However the interpreting process is not a static, fixed, stone structure leading always to and from a single pair of villages. Interpreters offer people a pontoon bridge. A simple, robust, rapidly deployed temporary structure, the pontoon anchors mid-river facing upstream; bridge decks are extended to either bank. Information may cross this imaginary bridge however deep the tide. As the information crosses the pontoon the message it carries is converted for consumption on the other bank. When the conversation is ended the pontoon moves on. The next time the same two people need such a structure they will be at a different place along the river bank. On each occasion the routine of dropping anchor and extending the bridge decks represents the interpreter's introductions and rapport-building.

#### GOOD COMMUNICATION AND THE IMPORTANCE OF TRUST

The ultimate goal of any medical interaction is to communicate, so that diagnoses, treatment plans and outcome measures can be agreed between clinician and service user. The interpreter is part of that activity, and so are the

other two members of the triad. This triadic communication depends in large degree on trust. In a study based on empirical data, Robb and Greenhalgh explore the theme of trust between the three parties and cite a paper by Greener about patient choice in the NHS which sets out a power-focused taxonomy of trust in three categories. He labels his first category “*voluntary trust: a consensual absence of calculation, where we voluntarily forego calculating in a relationship*” as within a family or close friendship. Voluntary trust may also be extended on the basis of other common attributes such as shared ethnicity and/or language (Greener 2003) in (Robb & Greenhalgh, 2006:436). Trust may arise between individuals, who may also put their trust in institutions; relationships between individuals and relationships between an individual and the institution are interlinked and reinforce each other.

Greener describes the trust we put into institutions such as the NHS as being an enforced, perhaps coercive, dependency, there being no alternative available to us. The coercive element of trust arises whenever people consult an expert, since they do not have the knowledge or skills to directly assess that expert’s knowledge, skills or motivation. This concurs with theories of transaction explained earlier in this chapter. Robb and Greenhalgh propose that:

*The critical importance of voluntary trust for open and effective communication, and the dependence of the latter on a positive interpersonal relationship and continuity of care, should be acknowledged in the design and funding of interpreting services and in the training of both clinicians, interpreters and administrative staff. (Robb & Greenhalgh, 2006:434).*

Greener's third category is hegemonic trust, in other words unquestioning trust in a more powerful person or organisation; again, there being no alternative. In this case trust is often given to the practitioner simply on the grounds of the high status awarded them by society, which as Greener points out, can lead to abusive practices such as those of the GP Harold Shipman. One of the most prolific serial killers in modern history, he was successful in covering up his crimes for many years because even his professional colleagues were unwilling to believe he would do anything wrong, and did not question him. Putting unconditional trust in the PCT and thereby in its entire clinical staff means that:

*[...] "where we trust without considering there is even an alternative. [...] The relationship is no longer voluntary, but carries a hegemonic, unconditional element". Not only does the patient have no choice but to trust the clinician, but his or her propensity to trust has been shaped by an imperfect system. (Greener 2003) in (Robb & Greenhalgh, 2006:436).*

Trust will be discussed in later chapters, as it is a major theme in the data. Patients' involvement and doctors' stratagems for encouraging trust depend upon how the interpreter relays or does not relay affect. When affect is not relayed a distance is created between the patient and the doctor:

*[...] while support and appreciation are expressed by interlocutors towards each others' actions and experiences, failure to share such support and appreciation leads to distance between healthcare providers and patients and eventually to the construction of differentiated in-group cultural identities (institutional identity and minority identity). (Baraldi & Gavioli, 2007:159).*

Baraldi and Gavioli see this failure to relay the supportive part of a message as creating an asymmetric relationship between the institutional culture and the majority culture, underlining unequal power distribution and favouring a return to the doctor-centred approach of times past.

Mental illness combined with little or no command of the dominant language also impedes communication if the patient is attempting to communicate through a second language. A second language in this instance is "*language that a person acquires during later childhood or adulthood, usually outside of the family*" (Westermeyer & Janca, 1997:297) and which often gives the speaker sense of distance from the content of their speech, in such a way that they appear less disturbed than they may actually be. Conversely, the struggle to communicate in their second language may provoke even greater distress (Westermeyer & Janca 1997:297). Communication between the doctor and the interpreter can also be a casualty during an interpreted encounter:

*As professionals in diverse but collaborating professional disciplines we are often at cross-purposes with each other, because we use jargon which has prevented us from thinking clearly about what we mean. (Cambridge, 2007:79).*

Many of the difficulties that show up in the data, particularly regarding mutual trust, creating and sustaining rapport, are in fact rooted in shared ignorance of the interpreters' codes of conduct and good practice.

## **1.6 A comparison of ethical codes among interpreting and healthcare professionals.**

A report for the National Council on Interpreting in Healthcare (NCIHC) "The Interpreter's World Tour. An Environmental Scan of Standards of Practice for Interpreters" (Bancroft, 2005) yields the most comprehensive overview available of standards worldwide. These are few, and there are even fewer that are not

applicable across the whole public service field. One of the few in this latter category may be that of the International Medical Interpreters' Association (IMIA), until 2007 the Massachusetts Medical Interpreters' Association, which has published a Code of Ethics that is almost identical to that of the NRPSI (see appendix).

The NCIHC Code of Ethics for Interpreters in Health Care (National Council on Interpreting in Health Care, 2004), requires:

- *Confidentiality*
- *Full, Accurate relay of meaning*
- *Impartiality, no counselling, no personal opinions*
- *Remaining within role boundaries, no personal involvement*
- *Cultural awareness*
- *Respect for all parties*
- *May act as advocate if patient at risk*
- *CPD*
- *Professional and ethical behaviour*

Whether or not permission to 'act as an advocate if the patient is at risk' is implemented in the same way as the interventions provided for by the impartial model is unclear as the NCIHC code does not elaborate on how this advocacy would be done. As earlier discussion in this chapter has shown there is a lack of clarity about what the nomenclature means and what the practice of advocacy actually involves. This confusion appears not to be confined to Britain. Item 7 of the NCIHC guidelines discusses the controversy over advocacy:

*When the patient's health, well-being, or dignity is at risk, the interpreter may be justified in acting as an advocate. Advocacy is understood as an action taken on behalf of an individual that goes beyond facilitating*

*communication, with the intention of supporting health outcomes. Advocacy must be undertaken only after careful analysis of the situation and other less intrusive actions have not resolved the problem.* (National Council on Interpreting in Health Care, 2004) [online]

The discussion basically points out a moral responsibility, if a wrong is done and has not been righted through intervention by the interpreter, for that to be reported through the proper channels. The interpreter should first discuss it in anonymised form with a superior or other colleague. This should be done according to the norms and procedures in force in the relevant institution. Essentially, this definition of advocacy means an obligation to “bear witness”, or “bring forth evidence of the wrongdoing” if a wrong has been done. In this respect it could be seen as being akin to the NRPSI code in which, as a last resort, interpreters take their concerns to a senior figure in the department or organisation, just as any other professional would do; doctors’ “Duties of a Doctor” direct them to “*Act without delay if you have good reason to believe that you or a colleague may be putting patients at risk*” (General Medical Council, 2006 updated 2009) [online].

This is very different from the idea of advocacy in the NHS, or the term discussed earlier. NHS Nurses advocate for patients when they “*act as emissary between the cultures of the patient and the physician. Implicit in this role of interpreter is the need for nurses to act as advocate for the patient*” (MacIntyre, 1983) in (Gates, 1994:11). In this, of course, the assumption is of a monolingual conversation in which the Nurse Emissary ‘interprets’ needs and remedies between institutional and service-user cultures. Gates espouses the opposite position and states that by acting as advocates nurses put themselves in

a conflicted position between their professional role and the advocate role which, according to Williams, includes “*representing a person as if that person were the advocate’s own*” and “*being prepared to put at risk one’s job and one’s health during the process of advocacy*” (Williams, 1989) in (Gates 1994:12). Wolfenberger, an American academic, identified the need for the caring services, for example those serving people with learning disabilities, to have access to impartial helpers who would advocate for them and in their best interests as an impartial friend (Wolfenberger 1983) in (Gates 1994:12). This has been adopted in Britain as Citizen Advocacy Services which offer an impartial link between service-users and service providers, enabling service-providers’ needs to be better understood and met. Interpreters acting as advocates in the NCIHC or the Citizen Advocate models would seem to be in the same position of conflict as applies to nurses.

NAATI is the Australian national standards body owned by the Commonwealth, State and Territory Governments of Australia, that was established in 1977. It combines the functions of NRPSI and the CIOL’s Educational Trust (IoLET) in that it runs accreditation testing and sets criteria for listing on a national register of suitably qualified people. It is Australian health service policy that Limited English Proficiency (LEP) foreign born patients and service users must have an accredited interpreter when they interact with healthcare professionals. The only similar policy in Europe is that of Sweden which states “*In all government communications, an immigrant or asylum seeker has the right to an interpreter if they need one*” S8[1], though ‘interpreter’ is not defined, nor does the word ‘accredited’ feature (Swedish Ministry of Justice, 1986). In this sense, Australia



is a long way ahead of the UK and probably the whole of Europe. NAATI professional accreditation is of a similar standard to that of NRPSI, which is not a government body and was established in 1994. NAATI uses the AUSIT Code of Ethics, a generic code, widely used in hospitals and clinics (AUSIT, 1995). The Australian Institute of Interpreters and Translators Incorporated (AUSIT) requires NAATI accreditation for entry, and sets its own code of ethics for interpreters and translators. This fits into the framework above (figure 4) in the Impartial family, and is a generic code. The code in force with the National Register of Public Service Interpreters (NRPSI) in the UK was developed in collaboration with interpreter groups, advisors working in the criminal justice system, local government, health and social care. It was first described by Corsellis in her seminal work (Corsellis, 1995:20-21), and represents the impartial model. Over time, more descriptive guides to good practice have developed as teaching materials for DPSI classes, but have yet to be formalised as an official publication.

The Aequitas report (Hertog, 2001) arose out of the first of an ongoing series of EU projects to introduce parity of interpreter service provision across the public services throughout the European Union. This first tranche of work took place within the Justice and Home Affairs department, in line with efforts to protect vulnerable defendants and witnesses as more people travel for work and personal reasons. This is another generic code, however, and can be found in chapter 7 of the report, at [www.cordis.europa.eu/infosec/src/study11.htm](http://www.cordis.europa.eu/infosec/src/study11.htm).

Language Line is a national commercial provider of interpreting services whose core business is telephone interpreting, though they are moving towards supplying face to face interpreters to the public services. Their company's code of conduct for interpreters includes impartiality and confidentiality and proscribes personal opinions (Language Line, 2007) [online].

Local authorities in the UK appear not to have published any codes for healthcare interpreting that are aimed at the interpreter. Freedom from Torture, formerly known as The Medical Foundation for Care of Victims of Torture, have a "Code of Practice and Ethics for Interpreters and Practitioners in Joint Work." (Freedom from Torture, 2005). This combines a code of conduct with guidelines to good practice for both interpreter and therapist. Their practitioners are mainly engaged in mental health work with traumatised asylum seekers and refugees, and their families. The good practice aspect of this code goes beyond the impartial model in its written form, in that it lays down in writing a formal requirement for briefing the interpreter beforehand, as well as supporting the interpreter after the session if they are upset. The emotional content of a session may have a disturbing effect on the interpreter, in which case, it is the responsibility of the practitioner to counsel and support the interpreter at the time of the session or at a mutually agreed time. Where it becomes apparent that this support is insufficient, practitioners and interpreters are advised to discuss both alternative sources of support and implications for future work with that particular client (Freedom from Torture, code p6). All PSIs in all fields of public service would benefit from such support but there is as yet no evidence base for developing or supplying it.

NHS Scotland has issued interpreting guidelines, published online in 2008 at (<http://www.healthscotland.com/uploads/documents/7697-Nowwe%27retalkinginterpretingguidelines.pdf>). It is set out in clear language and with good presentation, explaining the need for, role of and working practices of the various ITALS services available. These guidelines do not constitute a code of conduct for interpreters in any way but are an excellent example of how to explain interpreters' work to staff. Northern Ireland Health and Social Services Interpreting Service (NIHSSIS) issued a comprehensive document in June 2004, drawing on the resources of many pre-existing codes, guides to good practice and procedures. It is a synthesis of the impartial model and the advocacy model, while instructing interpreters that they are not health advocates and must not take on that role. It is difficult to classify because it makes no mention of the techniques to be used, for example whether simultaneous whispered or consecutive modes of delivery can be used. All the codes place emphasis on the importance of confidentiality but those published by service providers tend to be aimed at NHS staff and are more of a 'how to work with an interpreter' guide than a code of practice for interpreters, the majority of whom are not affiliated to any representative body and therefore not governed by a code of conduct.

#### STANDARDS POLICIES. A POLICY FOR LEGAL BUT NOT OTHER PUBLIC SERVICES.

While the needs and constraints of the various public services may differ in some ways, Interpreting, Translation and Language Support (ITALS) practitioners engaged in interpreting services provision have many commonalities across the whole public sector. The demands of managing the varying, huge lexical fields

and understanding the structures, hierarchies and systems of the differing institutional settings are challenges for interpreters within specialist areas. Nevertheless all interpreters need to have generic skills, education and knowledge at a high level; to be supported by a code of conduct and good practice; and to be externally regulated by an overarching organisation that sets and upholds standards in the public interest. Thus far the United Kingdom government has only put in place the policy decisions that support the development of such professionals in the Criminal Justice System (CJS). The National Agreement on Arrangements for the Use of Interpreters (Home Office, 2002 (revised 2006)) made standard requirements for interpreters working in the Court and Police Services and offered standard Terms and Conditions of Employment setting out pay structures which allowed a free-lance worker to make a living. While not all the CJS services, e.g. Immigration, Customs and Excise, signed up to this agreement, their rates of pay were influenced by those in court and police work. All this was swept aside in 2011 by a framework contract awarding all aspects of Interpreter supply management, as a monopoly, to a single large commercial agency. This agency was intended to act as agent, professional regulator and assessor of competence. None of the advances in quality assurance in the CJS described prior to 2011 applied to health, social care, education or local government interpreting services, not because the necessary level of knowledge, skill and judgement in interpreters is lower – it is not – but because there was and still is no specific government policy in place. However, this change in policy and practice took place after the research described in the remainder of this thesis, and is not therefore reflected in the data or its discussion.

## **CHAPTER 2. LITERATURE REVIEW**

This study looks at communication in interpreted diagnostic mental health encounters. A search of the literature was conducted.

### **2.1 Search Method**

#### RESEARCH QUESTIONS

The literature was searched on the basis of the following questions:

1. Is there a common model or set of models?
2. Is/are it/they being applied?

and of two secondary questions

1. Does whichever performance model chosen and properly applied allow for optimum outcomes in the communication process?
2. To what extent do issues of face and implicature impact on interpreters' output?

The literature was searched using the OVID and CINAHL databases from 1974 to 2008; studies were assessed against the following criteria for inclusion: research into oral communication through professional interpreters (not family members or bilingual staff). From this 29 studies were kept and other relevant Translation Studies papers were drawn from reference searches, hand searching and the Practitioner-oriented literature.

Searches were made in both clinical and translation studies databases, in the date range 1974-2008, as well as in the practitioner-oriented literature. In supplementary searches, bibliographies including those published by the National Council for Interpreting in Health Care and John Benjamins were identified and searched. Hand searching was done of the reference books such as *The Interpreting Studies Reader* and *Linguistica Antverpiensia*. Colleagues were asked for information and references.

A search of the literature on communication through interpreters was made in the CINAHL database, using the OVID site. This search revealed 87 articles, and the full papers of 43 were read. Subsequently 3 papers were discarded as not fitting the inclusion criteria. The practitioner-oriented literature yielded reports, codes of conduct, UK National Occupational Standards for Interpreters, and DPSI exam criteria (Northern Ireland Health and Social Services Interpreting Service, 2004, National Council on Interpreting in Health Care, 2004, IMIA, 2006, Language Line, 2007, HMCS, 2007); (The National Centre for Languages, 2006 (revised), IoL Educational Trust, 1994 updated 2007, Chartered Institute of Linguists, 2007, Nursing and Midwifery Council, 2008, Hertog, 2001, AUSIT, 1995). Three interpreting delivery models were found described in the practitioner-oriented literature and a taxonomy of models was produced on the basis of those (Chartered Institute of Linguists; 2007; (Benis, 2005).

Translat\$	Communicat\$
Interpret\$	Communicat\$ process
Communicat\$ outcomes	Interpreting model (no relevant results)
Mental health	

**Figure 10. Search terms used**

29 Searches	Results
1 translats\$.mp. [mp=title, subject heading word, abstract, instrumentation]	11827
2 limit 1 to (abstracts and english and yr="1974 - 2008")	6256
3 interpret\$.mp. [mp=title, subject heading word, abstract, instrumentation]	17380
4 limit 3 to (abstracts and english and yr="1974 - 2008")	15175
5 interpret\$ model.mp. [mp=title, subject heading word, abstract, instrumentation]	12
6 limit 5 to (abstracts and english and yr="1974 - 2008")	9
7 communicat\$.mp. [mp=title, subject heading word, abstract, instrumentation]	48792
8 limit 7 to (abstracts and english and yr="1974 - 2008")	28185
9 communicat\$ process.mp. [mp=title, subject heading word, abstract, instrumentation]	168
10 limit 9 to (abstracts and english and yr="1974 - 2008")	133
11 comunicat\$ outcomes.mp. [mp=title, subject heading word, abstract, instrumentation]	0

Combining 4, 7 and 2 brought 87 abstracts. These were scanned and 29 retained on the basis of the following criteria:

1. If research does not refer to spoken languages, exclude.
2. If research does not refer to oral communication through professional interpreters, exclude.
3. If research refers to purely technological solutions e.g. online translation, medical technology, data analysis, exclude.
4. If not research, exclude.

The list and brief description of studies read is bound in the Appendix.

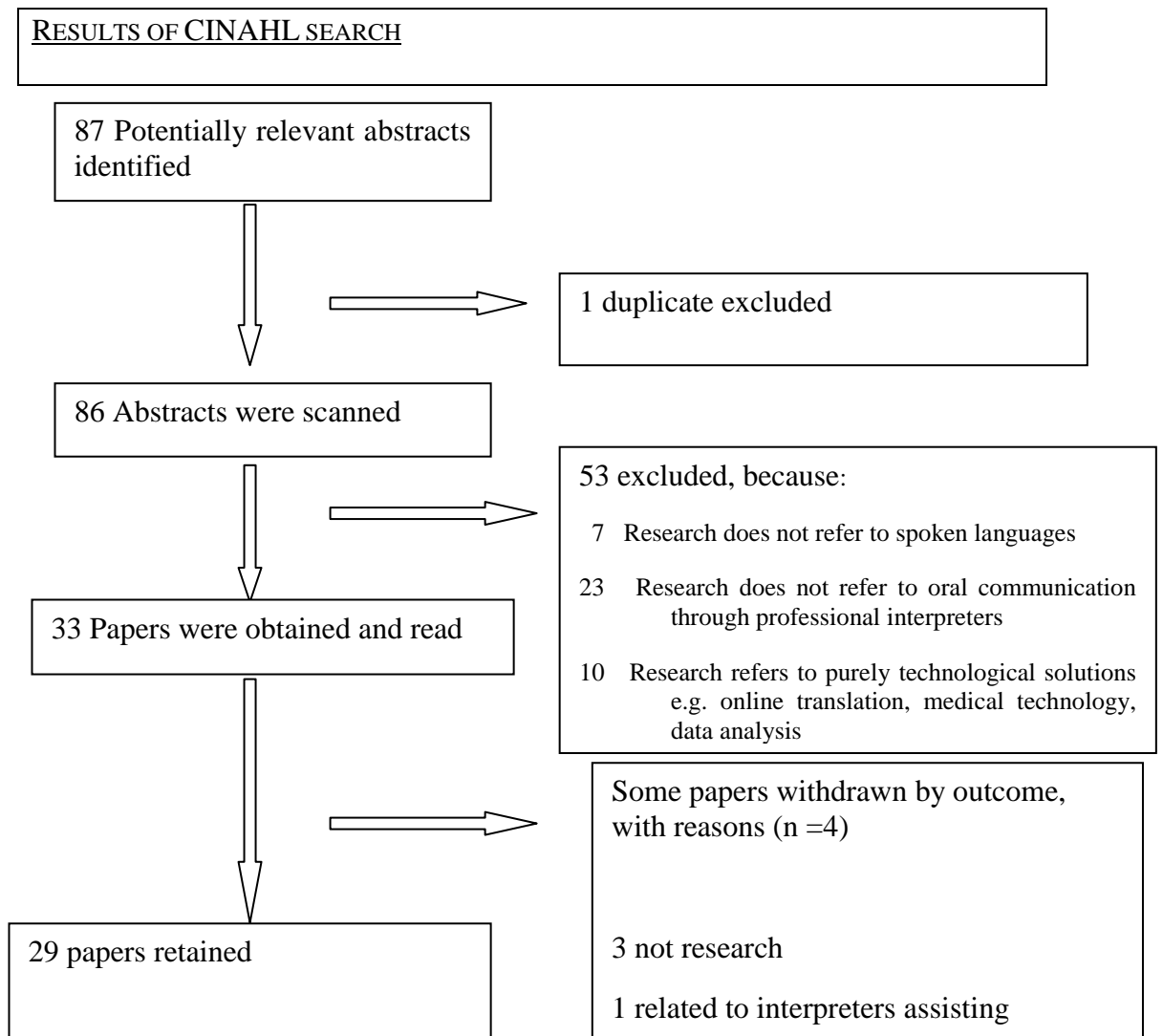

Figure 11. Quorum flowchart of review process



## **2.2 Discussion of the literature**

I now discuss the findings of the literature review and subsequent searches made necessary by the changes to the study design described in Chapter 3. I describe the ongoing development of the new profession of public service interpreter. This is followed by discussion of the challenges inherent in communicating across language and culture in a medical setting. There is some overlap of themes across the discussion, as they apply to separate dimensions in slightly different ways.

### MIGRATION PATTERNS

Europe is one of the richer parts of the world, with a high level of wellbeing and social mobility compared to other world regions. It is an attractive prospect to those of poorer backgrounds, and Britain attracts its share of economic migrants arriving to seek work. It is known that immigrants play a vital part in Britain's economy; it is also known that our health services must respond to the differing health beliefs and needs that many migrants bring with them.

*Emigration has also become one of the main transformation forces of contemporary societies. (Fernandes & Miguel, 2009:13).*

Many migrants arrive in Britain as asylum seekers having suffered trauma and long, often dangerous journeys. The many settled immigrant communities in Britain are growing, and so the nature of British towns continues to change as it has always done; except that change is faster now. The most vulnerable group is that of undocumented migrants, especially unaccompanied minors, and a survey on their access to health care in Europe showed that:

*despite some methodological difficulties due to the diversity of the situations encountered, local legislation and types of programmes implemented in the field, it was possible to gather global and coherent knowledge on the most vulnerable migrants', the 'undocumented migrants' difficulties to access healthcare.[...] During the survey we observed a lack of data on the situation*

*of children and pregnant women. Children are always the most vulnerable, whether in terms of exclusion, poverty and health. (Fernandes & Miguel, 2009:136).*

National health services have been responding to multi-lingual and multicultural health needs for a long time, and will continue to do so. This is encouraged by the EU directive on cross-border healthcare provision (European Union, 2011).

A report written for the Department of Health in 2010 identifies poor uptake of health services by migrants in general as often being due to a lack of knowledge of the system, of entitlement to care and to language and cultural barriers. Many do not even know that they must be registered with a GP and therefore over-use A&E services. It is particularly noticeable that BME groups' access to mental health care services is very low. The key findings of the report were:

- *A wide range of organisations is providing services to improve migrant health in the SE region, in addition to NHS service provision.*
  - *Qualitative research identified several wider determinants of health which affect the health of migrant groups in the SE region.*
  - *Different cultural expectations among migrants can contribute to health seeking behaviour which is perceived as inappropriate.*
  - *Discrimination and abuse, and reluctance by hospitals or health workers, were identified by some respondents as barriers to access.*
  - *Confusion over entitlement to services, and language/interpreting issues, were consistently identified as barriers to access, for migrants as well as for organisations commissioning and providing services.*
- Furthermore, they will also miss out on opportunities to access preventive, diagnostic and therapeutic services delivered through primary care, including vaccine and screening services (Health Protection Agency, 2010) [online].*

Patterns of forced migration inevitably follow crisis and war. British troops in Iraq used local people to interpret for them in very dangerous conditions but many of those who survived were brought to safety when our forces left. The same has happened in Afghanistan; the pattern seems unavoidable. Language learning is

discussed elsewhere in this thesis but the point to consider here is that there are many reasons why forced migrants display widely varying ability to learn English. Torture and prolonged terror produce psychological symptoms and reduce a person's capacity to learn. Unaccompanied minors may have learned to live on the street and lost the ability to trust. Economic migrants may speak English to some degree but very few new arrivals, and very many long-term residents with limited access to language learning, have a grasp of the dominant language that will allow them to express their deepest fears and emotions in it. Mental health patients may only be able to access and express their feelings in their mother tongue, even though they can function well in English in other spheres. This means that interpreters will always be needed in the public services, especially healthcare; that need is likely to increase. Languages of limited diffusion in Britain will always be the most difficult to source when planning interpreter training and other language support.

#### ETHNIC MINORITIES AND MENTAL HEALTH OUTCOMES

Interpreters work across language and culture. In mental healthcare the non-English speaking party to the consultation is particularly vulnerable. While clinicians' and social workers' professional codes impose on them a duty to protect the patient, preserve their dignity, and ensure their full possession of any information relevant to decision making and informed consent, no such obligations appear in any code of conduct that applies to interpreters. Their duty is universally held to be to the message and its accurate and complete relay from language to language. Where cross-cultural complications may cause non-understanding or, possibly even worse, misunderstanding, an interpreter must intervene appropriately to point this out.

Bauer and Alegría's 2010 systematic review of evidence on the impact that patient language proficiency and interpreter service use has on the quality of psychiatric care gives a useful overview of studies done in the field of psychiatry and interpreting between 1973 and 2009 (Bauer & Alegría, 2010). There has been some discussion of methodology and comparability as the field has developed, for example work by Price and Cuéllar in the *Hispanic Journal of Behavioural Sciences* (Price & Cuellar, 1981) is critiqued by Vázquez (Vázquez, 1982). Vázquez challenges the authors' claim that raters had not been informed about the purpose of the study, saying that although the control procedure was that subjects had been interviewed first in English and then in Spanish, both interviews were rated by the same evaluator making the claim unsustainable and introducing rater bias. Overall, however, they conclude that there are many possible sources of failed communication and distortions in the area of psychiatric care, particularly when there is either no interpreter or a family or community member has been used as the interpreter. They do not think that there is sufficient evidence in the 46 papers they evaluated to say whether overall quality of care is compromised and ask how high-quality care can be provided across language and culture. There is a small body of work suggesting that if a professional interpreter is working in psychiatric encounters sensitive information is more likely to be revealed and patients report more positive feelings about those interviews, which tends to favour the provision of better quality care.

#### PROFESSIONAL INTERPRETERS OR BAREFOOT INTERPRETERS?

In Britain we still use informal interpreters, i.e. family and community members, on grounds of cost and convenience and because there is no requirement for such 'interpreters' to be qualified. There is an unofficial policy in some Trusts to encourage the use of family and community members as interpreters in psychiatric

outpatients' clinics on those grounds. In their qualitative study on young peoples' experience of interpreting in primary care, Free and colleagues interviewed a group of 77 nine to eighteen year old subjects and report that:

*[they] are sometimes used as interpreters. Research on young people interpreting in healthcare settings has previously focused on the views of healthcare professionals and adult members of community groups. This has identified a number of problems, including young people's limited language skills, the difficulties for young people in interpreting complicated or sensitive subjects, and the inappropriateness of young people taking on adult responsibilities for accessing health care. (Free et al, 2003:530).*

NHS personnel are not in a position to make quality judgements of an interpreter's accuracy, completeness of the message received, or fidelity to the patient's truth. Certified interpreters' education and training are described in chapter 1 and discussed elsewhere in this thesis.

Interpreters are not new to the NHS, but many of them are unqualified, as other modern professional groups once were. Prior to the inception of the National Health Service 'handywomen' delivered babies in socially deprived areas, where the services of a professional midwife could not be afforded. Then in 1902 clinical professions were obliged to be qualified to agreed national standards, and listed on the appropriate national register of qualified persons.

*[the Midwives Act 1902's] effect was to prohibit midwifery by the untrained 'handywomen' (Fox, 1995:17).*

Like the handywomen, 'barefoot interpreters' are persons with minimal, if any basic training in interpreting. Their performance cannot be assessed while they are working because neither of their two clients – clinician and service user – is competent to do so in both languages.

It is not uncommon for people to suppose that interpreting is simply a matter of dual literacy (Cambridge et al, 2012). The levels of linguistic and technical skill and competence necessary are described in chapter 1. Hospital staff who deploy their command of a second language acquired for the purpose of work can certainly increase their rapport with patients and that is important. Interpreters' command of their working languages is rigorously tested; dispensing with the services of a professional interpreter on the basis of an untested second language may not be appropriate. In the UK, North America, Australia and Western Europe interpreters in the public services have been researching the field over the last decade or two; Hsieh (2006) describes five types of interpreter. She includes in her list clinical professionals who have learned a second language for the purposes of work. She points out that:

*[...] health care providers may overestimate their language skills or may have limited language abilities that just meet their own perceived information needs but that are inadequate for understanding and delivering information needed by the patient* (Baker et al) in (Hsieh, 2006:180).

This reflects comments made by Glenn Flores about what he describes as “*false fluency*” in which the speaker believes themselves to have a better command of the language than they actually do. If bilingual workers’ language skills are untested then they are as unreliable as family members whose language skills are also untested. Furthermore as Hsieh (2006:180) herself points out “*simply assuming that bilingual health care providers are better than professional interpreters may lead to problematic consequences*”.

As the figure of the public service interpreter emerged, national groups developed systems of training, certification, registration and codes of conduct for this specialist group of linguists, along with the other elements that provide and support the structure of a profession. (AUSIT, 1995, National Council on Interpreting in Health Care, 2004, Northern Ireland Health and Social Services Interpreting Service, 2004, CiLT, 2005, IMIA, 2006, IoL Educational Trust, 1994 updated 2007, Chartered Institute of Linguists, 2007).

Although much progress has been made towards the professionalisation and acceptance of trained interpreters as necessary to multi-disciplinary teams, there is still a great deal of casual interpreting happening across the range of public services in the United Kingdom. A 2004 Scottish study by Isabelle Perez and Christine Wilson proposes the idea of establishing an "Observatory" to remedy the lack of information available on true service needs..

*Most of the provision is not recorded and is not declared, which means that much of the real demand for TICS services [which stands for translating, interpreting and communication support, referred to as ITALS in this thesis] is hidden below the surface. (Perez & Wilson, 2009:29).*

The authors suggest that such a unit would carry on needs analyses by region, by sector, type of provision, and even by new emerging trends such as telephone interpreting, video interpreting, relay interpreting, machine translation and so on. The resulting data would make service planning and provision easier to tailor to actual demand.

## DEVELOPING A PROFESSIONAL STRUCTURE

If there is an identifiable starting point for the professionalisation of public service interpreting in Britain it must be the Runciman Report in 1993 (Royal Commission on Criminal Justice, 1993). Criminal justice was the first area in the United Kingdom to begin the process of professionalisation of interpreters. It was Lord Runciman who called for a register of properly qualified interpreter practitioners to be set up and maintained. This job was given to the then Institute of Linguists (now the Chartered Institute of Linguists). The national register of public service interpreters (NRPSI) was founded in 1994 as a wholly-owned subsidiary of IOL. It is now a fully independent regulator covering all specialisms within public service interpreting on its open access website. Nevertheless

*[...] it has not been possible to manage change and expectations satisfactorily, so that some public services, [...] are better served than others (Corsellis, 2008:14.*

Education and training remain inconsistent, but academic and interpreter practitioner research has increased significantly. Development of theories, delivery models and techniques started around the time of the Nuremberg trials. Since then a body of knowledge has been built up as discussed in chapter 1.

## PATIENT CENTRED CARE AND THE QUALITY OF COMMUNICATION SKILLS

One widely accepted definition of patient-centred care is offered by the Institute of Medicine. They describe it as providing

*[...] care that is respectful of and responsive to individual patient preferences, needs, and values and ensuring that patient values guide all clinical decisions.*

(At [http://www.kingsfund.org.uk/topics/patientcentred\\_care/](http://www.kingsfund.org.uk/topics/patientcentred_care/))

Patient-centred care is multi-dimensional; it encompasses all aspects of how services are delivered to patients.



*The quality of clinical communication can have an effect on outcome. Patients who are well informed about prognosis and treatment options, including benefits, harms and side-effects, are more likely to adhere to treatments, leading to better health outcomes. (Coulter, 2002:54).*

The quality of clinical communication across language and culture depends to a high degree on the quality of the ITALS service provided.

#### PATIENTS' NEEDS AND WANTS

There have been studies on the patient's perceptions and wants. (Gerrish, 2001, Hennings, 1996, Greenhalgh et al, 2006). In their 2005 report, Edwards and her colleagues asked patients who accessed public services through interpreters whether they preferred a family member or a professional to interpret for them. (Edwards et al, 2005) Their report identified that patients have emotional needs, and that those include a need to trust. They showed how *“personal character and trust are important in people's understandings of good interpreting, leading them to prefer interpreters drawn from their own informal networks”* (page 77). They don't define what they mean by 'interpreter' in the context of 'professional' and sweep the whole of a hugely diverse group in terms of training and certification into a single category. The only unifying factor seemed to be that they received a fee for their work, but there is no indication how the 'professional interpreters' referred to were qualified.

By no means all paid interpreters are members of a professional body and so bound by a code of conduct. The problems highlighted say more about inconsistency of interpreter training and certification as well as poor performance by intermediaries (no outreach to the communities, no explaining of interpreters' role, no induction for healthcare professionals) than about family members being the best suppliers of language support. The authors assert that *“There are no clearly established national*

*guidelines or standards for interpreting service provision, although many providers set their own*” (Edwards et al 2005:14). In fact there are UK National Occupational Standards for Interpreters (The National Centre for Languages, 2006 (revised)). These are not a matter of statute, however, and are therefore widely ignored. Edwards and colleagues (Edwards et al 2005) claim that an interpreter should give advice and advocate for a patient, and no doubt patients who have not had the benefit of good outreach by PCTs will see that as necessary. However, while they mentioned the interpreters’ code of conduct, they seemed not to have examined the codes of conduct that apply to doctors, nurses and social workers and which impose upon them precisely that duty of advocacy and protection they would have interpreters fill. These professionals can of course only comply with such requirements if they are fully included in a conversation that is genuinely between them and their patient or client, supported by a competent interpreter.

#### ERROR AND INFORMATION LOSS, THE PATIENTS’ VIEWPOINT

Asking the patient how they feel about interpreted medical conversations was among the earliest of research interventions and continues. Brooks and colleagues found that in one acute NHS trust in their study some LEP patients were unable to communicate with staff at all, and half of them regularly communicated through family members (Brooks et al, 2000). This was because only half the patients responding to the survey knew that there were professional interpreting services available. Most of those who did access healthcare through professional interpreters found the service useful.

Patients want good relationships with their healthcare providers and with their interpreters (Greenhalgh et al, 2006:117). The qualities that they value in an interpreter can be described: “*with expressions such as ‘lovely’, ‘gentle’, ‘caring’, and ‘on my side’, respect for the patient as a person, and trust in the interpreter’s confidentiality*”. They want to feel that the interpreter is empathetic towards their lifeworld and experiences. They are largely unaware of the constraints of the system in terms of shortage of time and the doctor’s need to follow a particular agenda. They often need support in knowing how the system works, and prefer to have continuity with an interpreter so that some sense of relationship can be developed. It can be difficult for patients to make choices on the basis of comparing a known with an unknown and those who were unaware of professional interpreter services will not have experienced them. Grant found that some patients want to have professional interpreters.

*[...] some parents in the same study considered that professional interpreters enabled them to express themselves more freely and provided confidentiality from family and friends. (Grant, 2006:570).*

However the district nurses in the study often did not offer patients a choice, believing that when a family member was available to interpret it was not necessary to send for a professional.

## **2.4 Clinical considerations**

### **A BRIEF LOOK AT MOOD DISORDERS**

The scope of this study is limited to interviews concerning potential mood disorders to limit the potential number of variables and confounding influences that might arise from the presence of psychosis or other aspects of mental health conditions.

Such interference would distract from observation of the techniques being deployed by the interpreter. The researcher is not a clinician and does not have professional medical knowledge in any area. However, it was necessary to know something about the subject and a brief literature search was conducted to provide a limited introduction to the subject. A search was made of the Warwick Medical School library.

In his discussion of mood disorders, as defined in the Classification of Mental and Behavioural Disorders, Gournay comments on the lack of widespread agreement about definitions both within the UK and internationally. He notes that the International Classification of Diseases (ICD-10) published by the World Health Organisation differs in its definition of a mood disorder from the Diagnostic and Statistical Manual Edition IV (DSM IV) (1994).

*Depression and its opposite state, mania, have been recognised for literally thousands of years, and along the way there have been many attempts to define, categorise and account for causation. (Gournay, 2009:76).*

Konstantinos Fountoulakis' 2010 review paper in the Annals of General Psychiatry offers a brief, clear overview of the historical and modern views of mood and affective disorders (Fountoulakis, 2010). He gives brief descriptions of a range of conditions and their principal symptoms, sketching the possible development and treatments that may be involved. Amy Byers and her team, using DSM-IV definitions and statistics, concluded that *"prevalence rates of DSM-IV mood and anxiety disorders in later life tend to decline with age but remain very common, especially in women"*; and that these are usually *"hidden and undertreated but treatable disorders"* (Byers et al, 2010:489). Fountoulakis quotes WHO figures

which show the wide prevalence of mood disorders, demonstrating that interpreter training in this area needs to be evidence-based:

*Combined, affective disorders are the most disabling neuropsychiatric conditions and one of the four leading disability causes according to the World Health Organization (WHO), which ranked psychiatric disorders as the most disability-inducing cause worldwide; more disabling than cancer and cardiovascular diseases and equal to injuries from all causes. (Fountoulakis 2010:1).*

This may seem too brief an excursion into the clinical aspects of what is going on during the interviews filmed. The main interest however is in the communication aspects of the interaction.

The information offered concerning patients' use of language in some situations is the most useful part of Fountoulakis' paper. Styles of speech such as logorrhoea, grandiose and uninhibited self-expression in expansive mood or the punning and rhyming of "clang association" in thought disorder are likely to offer serious challenges to an interpreter and need to be taken into account in training. Potentially shocking or taboo subjects likely to offer face threat and challenge an interpreter's impartiality include suicidal ideation and its expression. This may be an area which makes it difficult for inexperienced interpreters to remain in role. It is interesting to note that Bauer and Alegría conducted a systematic review of the evidence concerning the effect of limited English proficiency on the quality of psychiatric care and commented that:

*Little systematic research has addressed the impact of language proficiency or interpreter use on the quality of psychiatric care in contemporary U.S. settings. Findings are insufficient to inform evidence-based guidelines for improving quality of care among patients with limited English proficiency. (Bauer & Alegría, 2010:76).*

The reason for limiting the patient cohort to adults of Pakistani origin was to try to limit the range of cultural influences in play. Two papers have been informative about patients' conceptual models of depression, and how they differ across cultures. Alison Karasz (2009) conducted a comparative study into the attitudes and beliefs of three groups of patients about their depression. The groups studied were African-American, Hispanic, and White and were attending a New York City primary health care centre. She remarks that survey studies have found many members of the public view depression as a variant of common misery (Karasz et al, 2009) and that the scientific basis of many of the propositions in the biopsychiatric model is weak. Assertions of strong genetic or neurochemical basis for depression are not well supported and large scale studies have not found there to be great success in pharmacological treatments. Her team proposes that differences in conceptual model of depressive illness amongst the three groups of patients are based on ethnicity and social context.

The authors discuss the reasons for these differences. Firstly, they describe the "centre to periphery" diffusion of psychological knowledge, outward from the centres of cultural prestige to groups on the periphery, and down the status scale within modern societies. This may mean that group differences in the present study would reflect the more "peripheral" cultural position of ethnic minority/working-class participants. These individuals might be described as having a low level of mental health literacy, having been insufficiently exposed to the biopsychiatric model of depression. Secondly, they explore the possibility that an individual's receptiveness to this model may depend on the underlying social context of their depressive illness; the underlying social and institutional forces shaping their lives.

There was wide variation amongst the overall group studied; from the fragmented life of the drug addict, the exploitative labour market that the Hispanic-American patients experienced and the relatively weak family ties in the lives of European-American patients. So European American participants in the study tended to look *inward* for strategies to improve their performance and rationality, while BME participants tended to see their depression as being linked to social difficulties and were less confident in treatments focused on the individual. They valued psychotherapy more for its ability to offer healing through the comforting relationship with the therapist than for the technical aspects of treatment.

However, this thesis is looking at Pakistani patients living in the UK, and research specific to that group was sought. Penny and colleagues studied the experiences of Pakistani families receiving support from an early intervention service for first-episode psychosis (Penny et al, 2009). Remarking that there is risk in presuming that "Pakistani" is the only cultural framework available to service users or even that there is a single coherent "Pakistani" culture, they refer to Suhail and Cochrane's work on cross-cultural delusional beliefs. In this comparison of delusional beliefs among Pakistanis living in Britain, those living in Pakistan, and White Britons living in Britain, the authors found that 'local cultural resources' such as country of residence explained more of the differences in content than did ethnic cultural resources such as country of origin (Suhail and Cochrane, 2004 in (Penny et al:971). The aim of Penny and colleagues' work is to move beyond comparisons based on membership of a certain category and explore culture from the perspective of the individual person. The families they interviewed did describe early intervention as being principally about medicine and although most of the families felt that

medication was necessary, they laid emphasis on the need for social activity and support. Since the participants in the study, like those in Karasz's work, tended to prefer social explanations for their problems, it is unsurprising that they should favour social interventions. These are precisely the sort of interventions that early intervention teams (EITs) offer. It was unclear whether Pakistani families were not accessing these interventions due to lack of information or whether they were rejecting them as culturally inappropriate.

Penny's team were working with interpreters at every stage. And yet, a number of participants in the study described a lack of communication in their general experience of EIT. This seems to have been a mutual dissatisfaction in that participants perceived the use of interpreters as being merely to gain information, not to inform or support their families. On the other hand, it emerged that:

*[...] staff were unhappy with the consistency, accuracy, and mental health training of many of the external interpreting services that were available.* (Penny et al, 2009:983).

The problem of stigma being connected with mental health conditions is widely reported in all communities. The more powerless the community feels itself to be the more they feel the need to disguise mental distress as something else. Athena Peglidou reports on the considerable lengths that Greek women will go to in order to avoid medical diagnosis of a mental health condition. This is exacerbated by the disapproval of both psychiatrists and priests. If the patient were to mention to a psychiatrist that she has visited any other kind of practitioner, the psychiatrist would



tell her that he was going to confine her to the psychiatric hospital if she kept "going any old where to visit any kind of charlatan". Another woman found:

*[...] each of her visits to Saint Raphael's monastery was accompanied by an enlarged dose of Stalazin, a strong antipsychotic medicine, 'in order to allow her to confront the great stress of this difficult condition', according to her psychiatrist. (Peglidou, 2010:51).*

The need to protect face, to avoid stigma and public opprobrium drives the complex strategies that people suffering mental distress engage in for safety:

*[...] 'lies reverse power relationships. It is a strategy to survive unbearable and disgraceful situations. It is a resistance against exclusion. By making theatre of the lie, people safeguard themselves, against hopelessness, degradation and moral judgement [...] Lying makes the unspeakable speakable'. (van Dongen and Fainzang 2005:119) in (Peglidou, 2010:52).*

#### CULTURAL VIEWS OF NORMALCY

Helman identifies and discusses the issue of cultural considerations as they affect cross cultural communications in healthcare.

*Each culture (and to some extent each gender, social class, region and even family) has its own language of distress, which bridges the gap between subjective experiences of impaired wellbeing and social acknowledgement of them. Cultural factors determine which symptoms or signs are perceived of as abnormal; they also help shape these diffuse emotional and physical changes into a pattern that is recognizable to both the sufferer and those around him. (Helman, 2007:128).*

Johnson suggests that the definition of normalcy and mental health is itself not uncontested even inside a single culture - 'I'm normal, you are a little strange, he must be mad to disagree with me' - and refers to the punitive use of psychiatric diagnosis in the former Soviet Union, and the English burning Jean d'Arc as a witch when she said she spoke to God who told her to expel the British from France: the French viewed her behaviour entirely differently (Johnson, 1994).

(Helman, 2007) says there is a range of possible perceptions of normalcy within a society and that all societies choose to permit abnormal behaviour in some circumstances, but that strict rules are in place whether spoken or unspoken and behaviour that is not in accordance with ‘the rules’ is often seen as ‘mad’ or ‘bad.’ Just as the phenomenon of semantic shift refers to changes in the meanings of words over time, the rules of what is permissible as ‘normal’ change over time even within a single cultural group. The illustrative figure below is from Helman (2007:246).

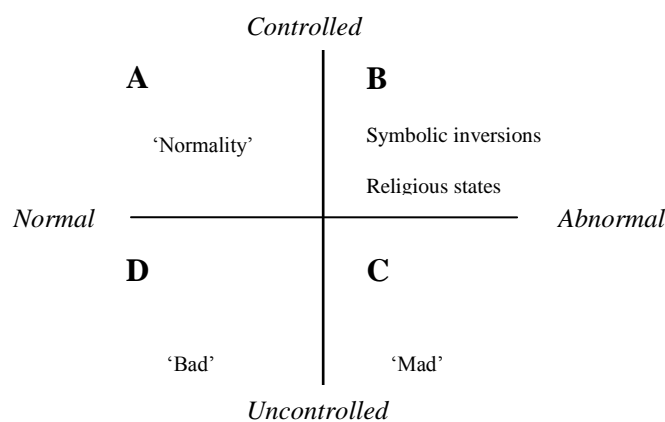

**Figure 12. Helman's 'perceptions of social behaviour'**

He describes how:

*[...] in the case of ‘controlled normality’ (A), ‘uncontrolled normality’ (D), and ‘controlled abnormality’ it is assumed that the individual is at least aware (consciously or not) of what the social norms are, whether they conform to them or not. That is, that they have some degree or self-awareness, or insight, into their own behaviour. (Helman 2007:246).*

Nadirshaw goes further and identifies some of the ways that different societies think about mental illness:

*In the West mental illness is seen as a disease of the mind or the body, whereas in the East, mental illness is seen as a ‘dis-ease’/imbalance between the mind and body. Awareness of the role of physical symptoms within this*

*framework has implications for appropriate assessment and treatment, and that a holistic approach would be needed not only for treatment but also in the early stages of identification of the problems. It would be useful for mental health workers to have a broad understanding of cross-cultural views related to the intervention/promotion of mental health well-being. (Nadirshaw, 2009:42).*

Interpreting in mental health clinics is an intricate undertaking and culture is one aspect of communication. Language however is the overarching, and unifying structure. Gadamer argues that language is fundamental to our understanding of the world and works in two ways. Not only does it “*transpose our concepts into a form we can comprehend in the written text it also becomes an object of interpretation*” (Maggs-Rapport, 2001:12). Language, spoken and written, is how we experience our lifeworlds; concepts on the other hand are bound in our experiences and cultures.

#### A CULTURAL VIEW OF HEALING AND INTERPRETING

Kleinman writes at the beginning of his book that he is making an attempt to contribute to medical anthropology theory by

*[...] examining structures and functions of medical systems and working out ways for more precisely defining and operationalizing culture as a variable in health-related research. (Kleinman, 1980:xiii).*

The patient’s journey of transformation, from being a ‘well person’ through being an ‘ill person’ to a ‘recovered person’ threatens identity even in patients accustomed to Western medical practices. Kleinman’s seminal work notes the different lexicons and approaches patients will encounter during that journey.

*The sick person encounters different medical languages as he moves between the health-care system's sectors. He must translate from one language to another... [This] is crucial in the interaction between patients and practitioners, in the process of healing, and in the creation and resolution of communication problems that are "endemic" to clinical care. (Kleinman, 1980:53).*

ITALS professionals interpreting across language and culture must know and account for their own limitations and qualifications. They must recognise a lack of direct personal knowledge of another person's religious and cultural beliefs and understandings, limiting their "cultural briefing" to generalities, outside the consultation session, if such information is requested.

*We simply do not now possess valid conceptual frameworks for comparing indigenous and Western forms of clinical praxis or for testing hypotheses about healing mechanisms, or for precisely determining therapeutic outcome. (Kleinman, 1980:375-6).*

In the overlapping and interlocking networks and social contexts, the social norms of the community one lives in now/ has lived in before now, with all those relationships, opinions, hopes and fears, the only person who can explain a specific patient's religious and cultural beliefs as they affect daily life is that patient. Nobody else has the right to describe those things. They should be part of a fully interpreted enquiry and response interaction between the full interlocutors: doctor and patient.

#### THE NEED FOR COMPETENT INTERPRETERS: LANGUAGE BARRIERS

Language barriers to the safe and effective delivery of health care across language and culture have probably always existed. It is hard to quantify the scale of the problems, however, as data are not routinely or consistently kept on BME or LEP patients' English language abilities, strongest language or language support needs (Aspinall, 2007). Szczepura and colleagues found in 2005 that provision of ITALS could hardly be described as 'designed':

*Despite substantial evidence in favour of providing proper language support, and demonstration of adverse effects linked to its absence, there is a lack of consistent, universal provision or adequate resourcing of such services in the UK. Indeed, there is little research into cost-effectiveness internationally, or into the direct clinical implications of introducing adequate services (Szczepura et al, 2005:9).*

Over the last few decades these barriers have been a real cause for concern. Clinicians began to be aware that language is not an exact science and that lack of precise semantic equivalents across languages could be a problem (Hatton, 1992), as non-family interpreters began to work in health care more frequently. Nurses felt they needed the support of bilingual health care workers, whom Cioffi saw as a separate group to interpreters (Cioffi, 2003). This distinction was widespread and persists, though there is little consistency in nomenclature.

#### THE CROSS-LINGUISTIC CHALLENGE OF SOCIAL TABOO AND EUPHEMISM

More subtle than semantic equivalence, the problem of social taboos in certain cultures can render the necessary use of euphemism in one language a real impediment to effective communication with people rooted in another language and culture. Khoei and Richters describe the struggle to find clarity of meaning in discussing gynaecology with Iranian women, who mistrust the interpreter and doubt their commitment to confidentiality (Khoei & Richters, 2008).

Jay and other researchers' work has shown that taboo language is widely used across the social spectrum of every language group.

*The ubiquity of taboo words throughout the lifespan, across all known languages, demands a reformulation of theories of human language toward a more central role for taboo speech. (Jay, 2009:159).*

Jay claims however that members of religious groups do not swear, but limit themselves to euphemism,

*One can also observe the presence of euphemisms, which replace taboo counterparts. Euphemisms evidence the existence of problematic references to sexuality, death, illness, body products and so forth in conversations. For example, in polite company people say shoot or sugar instead of shit. [...] we have difficulty*

*with sex talk: we use slang, which seems too offensive for polite conversation, but, on the other hand, clinical terms seem odd and too formal.* (Jay, 2009:154).

In medical settings euphemism is a problem, and is closely linked to how people of a particular group have been socialised as children. Both sexual and emotional references may lead to periphrasis and confusion.

The language barrier operates in both directions and in 2000 Davidson had noted that some doctors do not trust interpreters and are reluctant to talk to them, even though the need for their service is great. Davidson commented that physicians “*lament the difficulties of diagnosing patients, establishing a clinical relationship, or providing adequate care to patients when using an interpreter*” (Davidson, 2000:384) in (Hsieh, 2006:178). Hsieh herself proposes that “*health care providers in particular, can adjust their communication strategies accordingly [according to whether a family or trained professional interpreter is used] in order to achieve quality care*”, (Hsieh, 2006:178).

Given the difficulties of communicating with limited English proficiency (LEP) patients in general, it cannot be a surprise that poor uptake of the language support services that are available (Kuo et al, 2007, Hennings, 1996) results from many LEP groups being unaware that culturally sensitive services exist (Davies & Bath, 2001); (Ng et al, 2007).

## UPTAKE OF SERVICES, LANGUAGE BARRIERS

Although considerable reliance is still placed upon informal interpreting services provided by family, untested bilingual workers and others, studies have shown that professionally trained interpreters improve outcomes. In 1998 Dias and O'Neill carried out a review of the literature which came to the conclusion that nursing staff can develop trusting relationships with clients and patients on the basis of good communication if they work with professionally competent interpreters (Dias & O'Neill, 1998). Bernstein and colleagues wanted to understand the impact of the language barrier on the uptake and delivery of services in Emergency Departments (EDs) in Massachusetts. They conducted a patient satisfaction survey which suggested that non-English speakers were less satisfied with their care, were less likely to return for any follow-up, and reported more problems with emergency care than their English-speaking counterparts. They examined the effects of language barriers on patients at the index visit and over the following three months and found that:

*[...]indices of satisfaction reported by previous researchers do clearly indicate that many patients feel that their needs are not being met, and survey respondents have targeted communication barriers as a source of inadequate care (Bernstein et al, 2002:174).*

Some doctors also feel that patient encounters across language and culture go more smoothly and are less stressful to the doctor when the interpreter they are working with is a professional. Rosenberg (2007:289) remarks:

*when you have a professional interpreter you don't really care about the interpreter's feelings because their role is not to be involved. You don't have to think of the impact of the question you're going to be asking on the interpreter as much as when it's a family interpreter (MD 1,Case 24).*

Training was looked upon as an important factor of an interpreter's claim to professionalism. Woloshin and colleagues (1995) reported that:

*[...] bilingual staff members, after 70h of professional interpreter training, made significantly fewer interpretive errors after training than did untrained bilingual staff. Consequently, some training for all interpreters appears justified regardless of the nurses' bilingual capabilities (Woloshin et al 1995) in (Elderkin-Thompson et al, 2001:1355).*

All this is borne out by Ramirez, Engel, and Tang (2008) in their literature review of ED interpreter use and practice. They also found that LEP patients said they had less satisfactory medical encounters, and that there were differences in the rate of diagnostic testing that LEP patients received. They also reported being given less information or explanations and less follow-up:

*Although existing research clearly identifies a need for interpreter services in emergency care, providers widely under-utilize these resources (Ramirez, Engel and Tang 2008:356).*

They assert that:

*the implementation and utilization of professional interpreter services will not only increase patient satisfaction but also enhance health care and health outcomes for our LEP patient communities (Ramirez et al, 2008:360).*

They discuss all the disadvantages of using untrained interpreters in comparison with the advantages of interpreter training. The use of family or community members risks loss of privacy; loss of confidentiality; distorted family dynamics; editing and distortion of messages; potential emotional impact on the "interpreter" of certain types of information.

The literature displays the parallel paths of discovery trodden by collaborating professions. Nevertheless there is very little research written on working together as



part of multidisciplinary teams that includes interpreters. The quality of interpreters' training and certification is in many cases dubious. In some medical institutions an interpreter who receives payment for their services will be described as professional whether they have training or not. Link workers retained to help at single-language BME ante-natal clinics were routinely underused even though staff members had no command of the language spoken by the LEP mothers (Hennings, 1996). This seems to have been due to mistrust and inexperience but may also be related to the level of training of the Link Workers and their own view of their role.

#### ERROR AND INFORMATION LOSS, CLINICIANS' VIEWPOINT

Poor uptake of ITALS services is also the result of clinicians being ill-informed and unaware of what is available to them. To some extent it is also due to their not knowing how to utilise such services. Atkin's survey of Australian GPs found that professional interpreters were very rarely used; that clinicians were reluctant to use the freely available, free-of-charge, telephone interpreting service available to them; and that for the most part family members were still being used to interpret (Atkin, 2008). Hatton discovered, in 1992, that far from being a matter of simply replacing one word with another, interpreting is a process and is complex (Hatton, 1992). At that low base of linguistic awareness this was a step forward. Gerrish found that:

*District nurses need to appreciate their responsibility to provide equitable services irrespective of a patient's linguistic and cultural background and adopt strategies which seek to overcome the disadvantage experienced by ethnic minority patients. (Gerrish, 2001:566).*

UK Nursing staff's code of conduct (Nursing and Midwifery Council, 2008:2), requires them to protect the interests of the patient, while the Human Rights Act (1950), Article 14 (Council of Europe, 1950), forbids discrimination on grounds that include language. The provisions of the more recent Equality Act, while they do not

specify that interpreters should be used, would make it difficult for an authority to claim compliance with their duties were they to have neglected to provide an interpreter for an LEP patient (Equality and Human Rights Commission, 2010). Davidson found that doctors were of the same mind as nurses on the matter, and complained of the interpreter being a gatekeeper, owing to their propensity for overt "advocacy" interpreting which made diagnosis and building professional relationships difficult p178 (Davidson 2000 quoted in (Hsieh, 2006)). The doctors' major concern in interpreted encounters seems to be fear of losing control.

Rosenberg and colleagues report that doctors prefer to work with professional interpreters rather than family interpreters as the former are more skilled and their skills allow the doctor to keep control. One aspect that this group of doctors found troublesome was:

*[...] gathering information via interpreters performing consecutive translation. The delays incurred because [of] the translation process affected their train of thought and thus their ability to test hypotheses. (Rosenberg et al, 2007:289).*

This tends to indicate ignorance of the different techniques professionally trained interpreters are able to deploy, and/or a low skill base in the doctors in terms of working effectively through an interpreter. It may also be due to a misunderstanding of the phrase 'consecutive translation'. Consecutive interpreting delivers whole units of meaning: multiple full sentences. In public service interpreting the delivery of very short chunks of speech is called 'ad hoc liaison interpreting' and it is difficult not to render disjointed and hard to re-assemble other-language versions of the original message by this method.

Greenhalgh, Robb and Scambler's study (Greenhalgh et al, 2006) also shows that doctors value professionalism in their interpreters. However they describe their wish for Western style professionalism (punctuality, confidentiality, accuracy) which does not necessarily feel appropriate or comfortable to a patient from another culture. For the doctor, this is a major component of being able to have trust in an interpreter. Doctors' major concern is "*conveying their agenda to the patient and working towards their expected outcome*" (Greenhalgh et al 2006:1181). What Fatahi and colleagues are describing in their 2008 paper as being doctors' preferred practical performance model of interpreting sounds like the impartial model (Fatahi et al, 2008). In normal monolingual interaction, where two persons are involved, i.e. a dyadic interaction, there will be no need for an interpreter. Where the members of the dyad do not share a language, the presence of an interpreter converts the group into a triad. This imposes different constraints on the interaction and requires different methods of managing the flow of conversation (Wadensjö, 1998). Here Fatahi provides a very basic description of the triad and how to work with interpreters effectively, in which the GPs in the study describe what they want from interpreters. These are the ingredients of the impartial performance model of interpreting, as laid out in the National Register of Public Service Interpreters (NRPSI) code of conduct. Yet Flores describes a situation of scant professional interpreter services, poor training for the clinicians in working effectively with interpreters and poor hospital signage for the guidance of LEP patients and their families using the hospitals in New Jersey, USA (Flores, 2008). It would seem that, although doctors on the whole want to work through professional interpreters and

know what the ingredients of "professionalism" would be in their eyes, the system works against them. (Greenhalgh, Robb and Scambler, 2006).

Richardson, Thomas and Richardson (2006) are clear that the message being sent and delivered via the interpreter should include all the signals that compose a message:

*The ability of the interpreter to transmit the physician's expressions of emotion, empathy etc. through paralinguistic cues, such as tone of voice, gestures, and encouragement was seen as uncommon, but when it occurred, as beneficial to the creation of a good patient-physician relationship. (Richardson, Thomas and Richardson 2006:289).*

#### CONFLICTING UNDERSTANDING OF PROFESSIONAL ROLE BOUNDARIES

Even before public service interpreters began to emerge as a professional group, there was an obvious need in some areas for language support services. Because those in the public services tasked with designing and developing such systems had minimal if any knowledge of what interpreters do, or what it takes to do it, support systems were developed ad hoc. There was no research and no inter-disciplinary communication that involved linguists' professional groups; everybody was feeling their way. At about the same time as the UK Diploma in Public Service Interpreting (DPSI) was piloted Hatton was writing about interpreters working with nurses in the community (Hatton, 1992). This early research shows the low knowledge base on the subject that existed at the time, as she 'discovers' that translation is not the same as interpreting. She noticed that the interpreters were appraising both provider and client and giving themselves executive roles as full interlocutors within the triad; effectively, they were editing and guiding the conversation. She comments that "*In so doing they took on some of the charges of the provider.*" (Hatton, 1992:57).

Interpreters liked being able to discover lapses in one or other party's contribution and provide supplementary information; they saw it as helping. As codes of conduct have developed (see chapter 1) this type of role conflict has begun to be addressed. However it has not disappeared altogether. (Angelelli, 2004) in (Hsieh, 2007), gives an anthropological description of what interpreters do, rather than looking at what it is ethical or effective for them to do, and reports that interpreters give advice that was not offered by the clinician, thus taking on a provider's role. This taking on of a care provider's role is outside any of the established interpreters' codes cited in chapter 1. An examination of the codes of other professions such as nursing (Nursing and Midwifery Council, 2008) shows their duty of care to include protecting the patient and providing full and accessible information. Nowhere in interpreters' codes do those duties appear. Interpreters' duties are to impartiality, confidentiality and the integrity of the message (Chartered Institute of Linguists, 2007).

Greenhalgh, Robb and Scambler felt that:

*In practice, the interpreter's 'translator' role had to be juggled judiciously with other potentially conflicting roles, including interpersonal mediator (promoting clinician-patient trust); system mediator (helping to control the use of time and keep the patient to the biomedical agenda); educator (increasing health literacy via explanations of medical terms and concepts); advocate (negotiator and cultural broker for the patient's lifeworld); and link worker (boundary worker across different sectors including lay-professional, primary-secondary and healthcare-social care) (Greenhalgh, Robb and Scambler. 2006:1182-3).*

Rosenberg (2007), on the other hand, sees interpreters attempting to keep in role and summed up the conflicting pressures on their role boundaries:

*Professional interpreters were noted to attempt to remain within the limits of their role of interpreter and not to become an interlocutor. However, patients did not perceive interpreters as inanimate conduits. [...] “Patients don’t understand that the interpreter’s role is to permit the doctor and the patient to communicate. They see interpreters as their personal agent” (MD 1, Case 1) (Rosenberg 2007:288).*

Observing one’s professional role boundaries therefore requires that all parties know what those boundaries are. A description of the practical performance models of interpreting commonly claimed in the UK will be found in the taxonomy of models in chapter 1.

## **2.5 What is an Interpreter?**

### PROFESSIONALISATION OF PUBLIC SERVICE INTERPRETING

Research work done in the 1980’s and onwards remains influential, and a review of the literature available to researchers, but with which I was already familiar, is pertinent to this study with particular reference to its notable scarcity in the field of medicine. In the 1980’s practitioners of interpreting in the public services in general began to professionalise. Academic and practitioner researchers began work on scoping the size of the problem and identifying the components of it. Questions about whether there was a need for interpreters began to be addressed; Rader found that salaried, in-house interpreters were a cost-effective solution to management problems (Rader, 1988). In their 1995 paper Woloshin and colleagues identified both risk -

*Since it is the physician’s duty to perform a proper medical interview, the failure to do so can constitute negligence for which the physician may be held liable if the patient suffers some subsequent injury attributable to this failure. Thus, questions about the accuracy or completeness of medical histories obtained across language barriers without interpreters (or interpreters of unknown quality) raise concerns about potential malpractice litigation. The same problem may apply to informed consent, in which the*

*validity of consent obtained across a language barrier could be subject to legal challenge (Woloshin et al, 1995:725).*

- and the benefits of training interpreters.

*An unpublished study from New York City's Health and Hospital Corporation Office of Mental Hygiene suggested that staff selected for good bilingual skills (on the basis of standardized written and oral examinations) could, after 70 hours of training, function effectively as interpreters. In this before-after study, ad hoc interpreters who were trained made significantly fewer errors after training (Woloshin et al 1995:726).*

#### INTERPROFESSIONAL JOINT WORKING

Richardson, Thomas and Richardson's recommendations (2006) on improving the services available in hospitals for language support are very clear and pragmatic. Were they to be implemented nationally, all BME and LEP patients' experiences of healthcare and probably the uptake of healthcare services would improve. These recommendations include language skills audit of all staff including interpreters; training healthcare staff in how to work effectively with interpreters and advocates; having information resources available to LEP patients in print and other media and in their languages; acknowledging and supporting stressful aspects of the work such multi-disciplinary teams engage in. Training for both groups about identifying and acknowledging one's own cultural assumptions is flagged up as being of particular importance.

Elderkin-Thompson's team (2001) offer the solution to the difficulty Rosenberg (2007) encountered with collecting information through consecutive interpreting. The solution is a technique which has to be learned by the doctor involved, but the small effort involved is richly rewarded. Difficulties arise, Rosenberg says, when working in consecutive mode, because:

*[...]the delay between the time at which the patient spoke and the translation, [meant that] physicians could not link non-verbal cues to the verbal context of what the patient said (Rosenberg et al, 2007:289).*

The technique referred to is called whispered simultaneous interpreting, which is very similar to the technique used by conference interpreters except that in the public services it has to be practised into and out of both languages and without any equipment:

*Professional interpreters use “simultaneous interpreting”, a challenging method that can produce word salad if used by untrained personnel. When used by medically trained experts, simultaneous interpreting produces fewer errors and greater satisfaction among both physicians and non-English-speaking patients. (Woloshin 1995) in (Elderkin-Thompson et al, 2001:1356).*

#### LACK OF EQUIVALENT CONCEPTS

Research has shown what interpreters knew, that equivalent concepts do not necessarily exist across any pair of languages, in any sphere of life, but Nazroo's 1997 study points out the challenges facing interpreters of south Asian languages, specifically, in respect of depression:

*Nazroo's survey (Nazroo 1997) [...] highlighted the importance of distinguishing ethnic groups within the “Asian” population. [...] Nazroo acknowledged that the assessment/measuring tools used in this population were not culturally or linguistically appropriate in all cases [...] The measures were insensitive in conceptualising and translating terms into south Asian languages which do not have words to describe/diagnose depression in Western terminology (Nazroo 1997:47-8).*

The problem of cross-cultural psychiatric assessment and culturally appropriate instruments challenges the medical professions even more:

*Psychiatric assessment exists within cultural contexts, so that any cross-cultural comparison psychiatric diagnosis must take culture into account was an important factor. Thus, assessment instruments applicable in one culture may not be applicable in another culture. Even items within instruments may be acceptable in one culture but not in another. Assessment of such critical cultural variables depends heavily qualitative research methods: i.e. key informant interviews, focus groups of indigenous persons discussing their responses to particular items, and ethnographic fieldwork to ascertain*



*indigenous attitudes and vocabularies the psychiatric disorder* (Westermeyer & Janca, 1997:305).

These difficulties may have contributed to inequalities in accessing mental health care among different sectors of the population, as the linguistic and cultural challenges to interpreters came to the attention of the medical establishment relatively recently. Interpreters have techniques for dealing with these difficulties, which some psychiatrists find helpful. Bolton noted that:

*It is sometimes held that the interpreter should simply translate the denotative sense of the statements made by doctor and patient. Actually, this is hard to do and is frustrating for both parties. Instead, the interpreter tries to privilege conceptual equivalence above the linguistic equivalence of statements so as to convey the connotative meanings of the statements”* (Bolton, March 2002:108).

This principle of ‘same effect’ underpins accuracy, particularly in figurative or strong language. The interpretation of what one speaker says should have the same effect on the listener as the speaker intended. On the other hand, the interpreter’s necessary activity will be something that the psychiatrist has to accommodate, and the two professionals need to proceed on the basis of mutual understanding of roles and needs:

*Ordinarily, the psychiatrist relies on sensing the emotional timbre of exchanges, and on his or her own countertransferential reactions to the patient, to understand the situation and the patient's problems. When these feelings are dampened or distorted by the protection of the interpreter, the doctor's interpretation will likewise be affected.*(Bolton, 2002:109).

This problem is not limited to the United Kingdom either:

*[...] research has consistently identified that the incidence of psychological disorder is often unrecognised, misdiagnosed or inadequately managed in primary care. This problem is not restricted by national boundaries but is an international phenomenon, with variations in the proportions of depressed patients recognised as such by primary care doctors ranging from 19%*

*(Nagasaki) to 70% (Manchester) (Lecubrier 2001)* (Haddad & Plummer, 2009) in (Newell & Gournay, 2009:245).

In the acute sector Carranza and Parshall carried out an evaluation of the referral, admission, treatment, and outcome of overseas patients admitted to a psychiatric hospital in central London. 19% of admissions were overseas patients. 84% were white, 71% from European countries but only 45% spoke “fluent English” (an imprecise term). The paper does not discuss how language and cultural barriers were addressed but only repatriation and the involvement of consulates (Carranza & Parshall, 2005).

#### RISK FACTORS, MEDICAL ERROR

Research attention has continued to focus on risks to the patient from medical error and poor treatment plans or outcomes (Cambridge, 1999). Divi and colleagues (2007) identified considerable risk to patients posed by non-understanding of instructions for using their medication. Their study showed that “*about 49.1% of limited English proficient (LEP) patient adverse events involved some physical harm [...] only 29.5% of adverse events for patients who speak English [caused] physical harm.*” (Divi et al, 2007). There are also professional risks to the clinician (Haslam, 2007) and work on the training needs of the interpreter (Hsieh, 2006, Hale, 2007, Gentile, 1995, Flores et al, 2003) – though rarely on the training needs of clinicians or management (Corsellis, 2008).

#### RISK FROM POOR COMMUNICATION

Clinicians working with untrained interpreters on a routine basis worry about error and omission of information as patient risk factors (Cambridge, 1999). Bilingual staff members are commonly asked to interpret for patients and the performance of bilingual nurses who acted as interpreters Elderkin-Thompson’s team showed that:

*[...] approximately one-half of the encounters had serious miscommunication problems that affected either the physician's understanding of the symptoms or the credibility of the patient's concerns. (Elderkin-Thompson et al, 2001:1343).*

Hatton cites an example of confusion during a nurse's encounter with a female patient which led her to investigate possible cardiac problems. On physical examination of the woman it was immediately obvious that the problem was a lump in her breast. This resulted from an ambiguity in Spanish that was not followed up immediately (*pecho* means either chest or breast. The author reports that the patient had said she had a pain '*en la pecha*' [sic]) (Hatton, 1992:53).

Patient-centred care is central to modern western medicine but is a major casualty of poor communication between clinician and client or patient. Greenhalgh, Robb and Scambler looked at the impact on the quality of care of limited in-house language support services and talk of:

*[this example illustrates how] system imperatives deriving from economy and state can so circumscribe behaviours in medical settings as to render communicative action all but impossible. (Greenhalgh et al, 2006:1179).*

This may, for example, mean that bureaucracy makes interpreters unavailable outside office hours. This may in part be due to limited information being available for service planning and delivery. It is not only the UK where community staff attend appointments in domiciliary settings, unaware that the patient has LEP, much less which language they speak best (Grant, 2006).

Although errors and omissions are obviously patient risks in clinical consultations, it was some time before they came to prominence in other fields. Pharmacies are also

sources of risk as described by (Bradshaw et al, 2007). The lack not only of interpreters but of the in-pharmacy technology to print labels in other languages has led to potentially serious errors such as a 10 month old child whose “*parents reported giving 15 mL of iron elixir based on the prescription label that read: “15 mg per 0.6 mL, 1.2 mL daily”*” (Bradshaw et al: [online]). Dosage instructions had been given entirely in English.

#### INTERPRETERS’ ATTITUDES AND NEEDS AS RISK FACTORS

Fatahi’s 2008 work was preceded by a study in 2005 (Fatahi et al, 2005) in which he looked at interpreters’ attitudes and needs. This highlighted problems common among interpreters: time pressure due to inadequate planning of appointment times; uncertainties within the triad concerning role boundaries; language-based and culture-based misunderstandings and the need to gloss them. This latter is closely connected to a lack of clarity on role and role boundaries, as some clinicians will not permit such interventions even if the interpreter attempts them. Richardson, Thomas and Richardson also place emphasis on the functions within the triad in terms of difficulties in working with GPs and other practice staff who do not understand the interpreter’s role or constraints (Richardson et al, 2006) , and identifies the scarcity of professional interpreters as “*a particular problem*”. As already described, Davidson (2000) talks of interpreters taking an "advocacy role". The advocacy performance model of interpreting is described in the taxonomy of interpreting models. Davidson’s ‘co-diagnostician’ engages in activities which make it basically the advocacy performance model.

*[The researcher] noted instances in which interpreters gave advice that was not given by the physician and assumed the provider’s role in obtaining medical history and giving medically related instructions. (Angelelli 2004), in (Hsieh, 2007:925).*

Angelelli argued that these behaviours were necessary to successful provider–patient interactions. Interpreters themselves are divided on this point (Cambridge, 1999, Hale, 2007).

#### CONFLICTING UNDERSTANDINGS WITHIN THE TRIAD OF WHAT ‘ACCURACY’ IS

There is asymmetry of power and social distance between the actors in a clinical encounter. These factors influence the triad members’ behaviour. Hsieh takes up the idea that the hierarchy within the triad causes a variety of errors to creep in to the interpreter's output (Hsieh, 2007). These include what could be called editing, filtering, addition and omission. Filtering is leaving something out because it is judged to be irrelevant. Omission is leaving something out due to memory failure. She describes the interpreter as a co-diagnostician and comments that the codes of conduct for both doctors and interpreters predicate the "conduit" role of performance, describing the attributes of the impartial performance model. Greenhalgh, Robb and Scambler (2006) are clear that, in spite of the injunction for the interpreter not to take on a full interlocutor role, patients have a fundamental need for a relationship and see the interpreter as the only person with whom they can easily make one. Hsieh (2007) speaks of interpreters, in the role of conduit, being trained to avoid verbal, physical or emotional interactions unless the service provider is present. She reports that “*Interpreters’ failure to follow a conduit model often is viewed as a transgression that may warrant termination of their jobs*” (Kaufert & Koolage, 1984) in (Hsieh, 2007:925). Reporting in 2006 Richardson, Thomas and Richardson wrote that

*[...] there is currently little empirical work on the issues involved with triadic communication, whether this involves a bilingual advocate, link worker or interpreter,[...] Emphasis also needs to be placed on enhancing health professionals’ ability to work effectively with these different types of workers.* (Richardson et al, 2006:99).

Some clinical staff would actually welcome such training input, and joint training of the professional groups could only enhance the multidisciplinary team's performance.

## **2.6 Complexity of the input signal – a data driven search**

As data were collected it became clear that the visual component of speech communication could not be ignored altogether. Language teachers know that in sighted listeners it makes a large contribution to listening comprehension (Kellerman, 1990). Interpreters can experience comprehension difficulties during clinical encounters, particularly when they do not have line of sight on the speakers' faces; this may not have been written up but is a common experience in practice among public service and other interpreters. It is a subject of complaint in interpreters' waiting rooms and classrooms. It must be remembered that interpreters in the public services do not have the benefit of equipment such as headphones and microphones and must work into and out of two languages with little or no preparation. In the world of conference interpreting practitioners have equipment, time to prepare and work in only one direction - *into* their 'A language' (often the mother tongue). Working conditions in hospitals are such that the interpreter is often coping with an echo (due to large spaces, high ceilings and few textiles to absorb sound). Other conversations going on in nearby cubicles may be fully audible and general "noise interference" can also lead to confusion. Interpreters' concentration levels are high when language switching and such distractions can cause hiatus in mental processing of the message.

LINE OF SIGHT ON SPEAKERS' FACES IS IMPORTANT

Two examples may help to understand why this matter is touched upon. Firstly, when interpreting in a hospital setting, the visual part of the input signal is removed if a doctor is wearing a clinical mask, or is stooped over the patient with their back to the interpreter, or the interpreter has been required to stand outside the curtain round the bed. Many such situations are intimate, so awareness of poor acoustic insulation in the ward can lead doctor and patient to lower their voices. Neither doctor nor patient is likely to have been trained in public speaking and their diction and the breath support behind their speech reflect that. In the criminal and other courts the same thing occurs: a secure dock may have a low ceiling but they are all surrounded by impact resistant glass. The interpreter will be seated in the dock beside the defendant. Those permitted to speak in the court stand some distance away from the dock with their backs to it. They make little if any sustained effort to speak loudly and clearly. The dock is not equipped with audio equipment of any sort, except sometimes for a loop system which is entirely unsuitable for interpreting purposes. These are the author's and many colleagues' frequent personal experiences over years. Line of sight is important, especially where two languages are in use. Visual input also aids the mental switch between one language and another. The filmed data shows interpreters turning to watch patients' and doctors' faces intently as they speak. It seemed appropriate to consider this factor and its potential for interfering with speech comprehension by a brief look at some research, including the McGurk experiment which has been successfully repeated. (McGurk & McDonald, 1976)

#### A BRIEF SECONDARY LITERATURE SEARCH

Accordingly a cross-search of electronic resources was made using Research Pro 2.02 and keywords: sight; comprehension of speech in hearing people. Ebsco yielded

50 hits of which 6 were selected and Google Scholar yielded 301 hits of which 13 were selected; of the 19 papers selected 9 were read as well as 2 others found in references while reading; 7 were retained. Those rejected were irrelevant being related only to speech recognition IT systems.

<b>Author</b>	<b>Type</b>	<b>Content</b>	<b>Comment</b>
Neely 1956	Research	Looking at intelligibility of speech in noisy circumstances	visual cues resulted in a significant increase in listener-intelligibility scores
Kellerman 1990	article	Contribution of visible modality to speech perception	Research into the speech perception of the blind reveals the significance of visual input
Kellerman 1992	Review	Contribution of kinesic behaviour, discussion of monolingual cross-cultural mis-communication due to unrecognised listening signals.	Focused on language teaching and learning in which culturally appropriate behavioural cueing is discretely taught to language learners.
Chen & Rao 1998	Research	Speech recognition in IT	Explores and replicates McGurk. Examines factors affecting lip reading and how vision aids comprehension of acoustic speech
Calvert and Campbell 2003	Review	Discusses audiovisual signals as equally important in comprehension of spoken language	Describes the McGurk illusion
Woodhouse 2009	Systematic review	Interpreters in hospital ITALS service	Concludes that they give advice, sometimes covertly.



Jesse & Masaro 2010	Research	Looking at improved comprehension when a singer's face is visible	Significant improvement in comprehensibility even though other facial gestures are part of the visual input
---------------------	----------	---	---

**Table 1. Results of second literature search**

The audio-visual nature of the input signal in face to face spoken communication has long been recognised among researchers in language and communication (Kellerman, 1990). Its influence on speech perception has become the subject of research in connection with speech recognition systems in IT (Chen & Rao, 1998). It was not understood until recently how vital to sighted listeners the visual part of that signal is. Calvert and Campbell tell us that spoken communication is processed both orally and visually at the same time. They report that "*previous studies have shown that in hearing people, natural time-varying silent seen speech can access the auditory cortex (left superior temporal regions).*" (Calvert & Campbell, 2003:57). There is some controversy over whether such communications can be classified as bimodal, reflecting the aural and visual components as separate but of equal weight; or whether in fact such communications are amodal, the aural and visual aspects being part of a seamless whole. When visual signals are available, it is held to be "mandatory" from the cognitive standpoint to process them and is largely unconscious (Woodhouse et al, 2009).

FACIAL AND BODY GESTURES COMMUNICATE

This 'lip reading' part of the visual input is related to gesture - facial expressions and body language, all of which reflect culturally bound codes of communication to some extent. In a seminal work, Albert Mehrabian analysed the meanings of various nonverbal behaviours, and described them as constituting the semantic space for non-verbal communication.(Mehrabian, 1972) Kendon's edited collection of work

from “Semiotica”, Journal of the International Association for Semiotic Studies, brings together research on non verbal interaction as communication (Kendon et al, 1981). Mehrabian, and Kendon’s contributing authors, are all describing behaviours which carry meaning in the same way that language carries meaning, making them expressive of personality and culture (Mehrabian, 1972). Kellerman’s review of work done on what she terms ‘kinesic behaviour’ recounts an experiment in cross-cultural communication showing how miscommunication can result, even when the interchange is monolingual:

*Erickson (1979) observed interracial counselling sessions (white counsellor, black interviewee) and found that the black system of signalling listening attention is different from the white system. Because the white speaker does not recognize the listening cues from the black listener, this apparent absence of attention is interpreted as lack of interest, concern, or understanding. Equally, the black listener does not pick up on cues for feedback in the intonation and body movements of the white speaker. As a result, the white speaker resorts to hyperexplanation, which in turn is interpreted by the black person as being 'talked down to'. (Kellerman, 1992:248).*

#### EXPRESSING OUR FEELINGS THROUGH PARALINGUISTIC SIGNALS

People express emotion through language, prosody and physical expression. Signals of loudness, pitch, pace, rate and fluency colour the words in an utterance adding information about how the speaker is feeling. The task of the interpreter is to relay the whole of a message, so they must pay attention to these indicators of speakers’ feelings. In the filmed data collected this naturally applies less to the clinician’s than to the patient’s speech, since psychiatrists are unlikely to display irritation or impatience but maintain an appearance of professional empathy during a consultation. The patients in the filmed data were not expressing strong emotion either. They were consulting their psychiatrist about a possible mood disorder such as depression and presented with an even tone, little facial expression and few body

signals. Two were garrulous and one almost monosyllabic but they did not display much emotion, though their companions occasionally did. Examples of discomfort were also apparent in the interpreters at times, when they experienced face threat in the patient's speech. For example OInterp2 found herself uncomfortable during the long parallel conversations between mother and daughter or daughter and clinician. She did not relay these but her demeanour was anxious and embarrassed. The subject of expressed emotion is of limited importance to this study since little was displayed, perhaps due to illness. However, it needed to be briefly explored.

Anna Wierzbicka's 1999 book explores the close links between emotions, language, culture and associated physical manifestations of emotion. Emotion itself is a concept that varies across cultures.

*First, words provide clues to other people's conceptualizations. [...] It is words, more than anything, which allow us access to the "emotional universe" of people from another culture. Second, it is only by studying words that we can go beyond words. For example, if we are interested in "emotions" and uninterested in words, [...] we still have to take enough interest in words to notice that English words such as sadness, enjoyment, or anger are no more than the cultural artifacts of one particular language. [...] "Emotion" is "expressed" or communicated at every level of language, including grammar and intonation; it is also expressed in facial gestures such as frowns and raised eyebrows or in bodily gestures such as kisses or foot-stamping (Wierzbicka, 1999:29).*

She examines the distinction sometimes made between 'feelings' and 'emotions' and shows that there is reciprocal influence by each upon the other:

*Since in common human experience the content of feeling-provoking thoughts influences the actual feeling, one can legitimately say that not only "emotion-concepts" but feelings themselves are also influenced by culture. Since, furthermore, in common human experience cognitively based feelings often trigger or influence bodily feelings, it makes sense to suggest that bodily*

*feelings, too (and perhaps even some bodily processes associated with them), may be indirectly influenced by culture* (Wierzbicka, 1999:29).

#### VISUAL CLUES FROM THE FACIAL MUSCLES

In contrast to the gestural component of facial expression, the visual component or aspect of bimodal or amodal communication refers to visible movements of the speech apparatus (muscles in the cheeks and chin; the tongue, lips, jaw and teeth) which, in any language, provide those who understand that language with clues about the sounds being made. One of the major challenges for interpreters working in the public services is the fact of their reliance on audiovisual signals to bolster comprehension. In courts of law, interpreters working for the court frequently have to sit in the dock with the defendant. This places them at considerable professional disadvantage, as described above. Interpreting by telephone is beset by all the difficulties described earlier and can be compounded by an echo on the line or other interference with the signal. This modality of interpreting is held by its adherents not to suffer from the lack of visible input. Natalie Kelly states firmly that no research has been done showing that the visual component has any effect on comprehension and remarks "*Only the visual element is missing in telephone interpreting. And just how vital is that?*" (Kelly, 2008:83). This is not an unusual stance among practitioners of telephone interpreting, a modality which is becoming increasingly common. That is not to say that this modality 'does not work' but that in the author's personal experience of it, it is not universally appropriate. Work done on the predictive value of watching a speaker's lower face provides insight into why the barristers and doctors described above can be difficult to understand even though one may hear their voices.

### MCGURK AND MACDONALD'S EXPERIMENT

The movements of the lower face were studied in an experiment by McGurk and MacDonald in 1976. It has been successfully repeated since then, by Chen and Rao in 1998. In order to test how visual perception influences speech comprehension a person was videoed pronouncing the phoneme /ga/. Only the lower half of the face was filmed, since the speech apparatus was the focus; the eyes express affect but do not indicate what sounds are about to be made. The researchers were looking specifically at the communication of speech sounds. When the video was played to volunteers, it had been dubbed with the phoneme /ba/. Respondents overwhelmingly *heard* /da/ (McGurk and McDonald 1976) in (Woodhouse 2009) p256. So we have a series of three voiced plosive sounds, /g/, /d/ and /b/, each sound being produced further forward in the mouth than the last. The first sound is velar, the second alveolar and the third bilabial. In spite of the dubbed aural cue being bilabial, /ba/, what respondents thought they had heard was alveolar /da/ i.e. with the mouth open. In other words they had *heard* a sound that begins with the mouth closed and opens with the vowel; but the sound they *saw* was made with the mouth open. This led the observers of the video to change one mouth-open sound for another that is made further forward, in spite of what they could see. They did not hear a mouth-closed sound because the movements of the lips, teeth and tongue were indicative of open-mouth sounds being made; the visual signal reinforced their belief that they had heard /da/. This mismatch between audio and visual cues caused a comprehension error. In the concentrated work of listening, language switching and speaking a different language, such a comprehension error forming a non-word can trip interpreters up.

## NON-WORDS AND INTERPRETERS' CONCENTRATION

Concentration is key to interpreters' management of the cognitive flow of information, which requires listening for meaning; paraphrasing; reformulating; noting and remembering; word finding; changing the syntax; and other language speech production. These tasks are carried out almost simultaneously, occupying the interpreter's full attention and short term memory.

*[...] short-term memory operations fall under the category of nonautomatic operations because they include the storage of information for later use. One might add that stored information changes both from one speech to another and during every speech as it unfolds, and that both stored information quantities and storage duration can vary from moment to moment, so that there is little chance for repetition of identical operations with sufficient frequency to allow automation of the process. (Gile, 1995:169).*

Poor pronunciation, coupled with no, or poor, line of sight on the speaker's lower face means that the visual checking mechanism offered by the speaker's lip and jaw movements is unavailable, causing the interpreter to mentally 'replay' what they perceived as a non-word, or the whole sentence it was in. This means a break in concentration, and the whole utterance containing that non-word will be lost. Taking gash/dash as an example, while context will usually indicate meaning the momentary confusion caused by a non-word or what seems to be a wrong word in the context will cause sufficient hiatus in comprehension for an interpreter to 'lose' the next section of speech. Pausing in simultaneous mode interpreting to seek to replace an apparently nonsense word or phrase embedded in fluid speech causes an effect similar to jolting the power cable connection to a printer while it is handling a document; the buffer memory will empty and the data in it will need to be re-transmitted. As Gile identified "*During interpretation, short-term memory operations (up to a few seconds) occur continuously*".(Gile, 1995:168). This means that to stop the continuous processing of fluent speech in progress, in order to seek to

replace a non-word for the sake of coherence, can mean the loss of an important point the speaker may be trying to make.

On the other hand a wrong word may sound appropriate in the context and the relay will therefore be inaccurate. For example, Spanish speakers who have learned English by ear will often fail to make a word-medial bilabial sound in words such as ‘coming’, (“I’m coming”), ‘communication’ or ‘Birmingham’. Instead they substitute /n/, resulting in ‘cunning’ (“I’m cunning”), ‘connunication’, and ‘bɪərniŋhæŋ’, showing that substitution error is not necessarily a problem of perception (or *comprehension*) but of production (Hawkins, 1984). Phonologically, the production of /n/ adjacent to a vowel, such as /u/, is easier and quicker to say than closing the mouth to form the bilabial /m/. There are many native-speaker examples of this verbal behaviour all around us, as in “Wɒs a? abɑ:?” with /s/ and two glottal stops (/ʔ/) meaning “what’s that about”. If, in the “I’m coming” example, the ‘McGurk Illusion’ is overridden by the hearer, who replaces the /m/ to give sense to the utterance (having sight of the speaker’s face) it may be that there is no misunderstanding. However, even in monolingual communications the visual component has an important effect on comprehensibility. This phenomenon is not specific to the English language and has been reported for various different native languages, for example, by Massaro and colleagues in 1993 (in (Woodhouse et al, 2009), who cited languages that included Japanese.

Clarity of speech is a central part of interpreter performance. It is the case that conference interpreters, who work in a differently pressured but in some ways better managed environment than public service interpreters (PSIs), do so in an

environment focused on promoting good interpreting performance. They have listening and speaking equipment, work into their strongest language and are supported by a colleague, a “second pair of eyes and ears”. They normally have the text of what the speaker wants to say in front of them and have had time to study and prepare to interpret it. Public Service interpreters in any setting are at the disadvantage of not having equipment; not knowing what the speakers will say until they say it; not knowing beforehand what the conversation will be about; relaying both vernacular and very technical language; poor acoustics and poor sightlines. Nevertheless the PSI is engaged in public speaking with clear diction, even if the other people present are not. They need their two clients to understand what they hear from the interpreter the first time, without repeats. This is made easier if they understand their clients’ speech the first time. The process and circumstances surrounding interpreting in mental health care is a subject overdue for investigation.



## **CHAPTER 3. ORIGINAL STUDY DESIGN** **METHODOLOGY AND METHOD**

This research examines the performance of paid professional interpreters in their work of interpreting in a psychiatric clinical environment. The naturalistic setting of the routine psychiatric clinic encounter provided an opportunity to observe reality as distinct from simulated versions of reality, such as role-plays, with actors playing the patients.

Past research has looked at failed cross-linguistic medical communications on the basis of poor interpreting by untrained interpreters, family and community members. The present research project aims to examine the actual process of switching a message from one language to another and observe the key elements of that process as expressed in the performance model used. These performance models are described in chapter 1 along with interpreting techniques.

### **3.1 The Early Plans**

#### **PILOT OF QUESTIONNAIRE**

During the Critical Link Conference of 2007, (see [www.criticallink.org](http://www.criticallink.org)) a colleague and I co-facilitated a workshop on interpreter role boundaries. The 50 participants were asked to fill in a short questionnaire before the session for their own use during the session and leave it behind them, anonymously, if they were willing to share it. There were 18 respondents (36%). There was a single question, to be answered from the standpoint of the client/patient; the other professional; and the interpreter. The

question was “in an interpreted encounter in the public services, what are the core elements of an “optimum outcome” for each party?” After they had filled that in, to bring their own point of view to the front of their minds, there was a short presentation on the codes of conduct governing the work of doctors, nurses and social workers, with reference to their responsibilities for protecting and informing patients and clients. We also looked at the codes of conduct relevant to interpreters, which emphasise their responsibility for accurate relay of the message. We then split the audience into 4 groups. Groups 1 and 2 were given scenario A to discuss. Group 1 looked at it from the point of view of the interpreter and other professional using the impartial performance model (IM). Group 2 looked at it from the point of view of the community performance model (CI). Groups 3 and 4 were given scenario B, and did the same thing. The groups were randomly constituted by allowing people to sit wherever they chose on arrival, and then grouping them by “dividing the room in four”. The scenarios were handed out, and one or two group members in all four groups were heard remarking “I can’t do this from the impartial viewpoint, I’m a community interpreter”, or the other way about.

**Scenario A:** you have come to believe during this interpreting assignment that your non-English-speaking client is pregnant and is choosing not to tell the doctor so. What will you do?

**Scenario B:** You are interpreting for a client making a claim for housing benefit. You are aware that the housing officer is not explaining the claimant’s rights and options fully. What will you do?

<b>INTERPRETER</b>	<b>CLIENT</b>	<b>OTHER PROFESSIONAL</b>
Good relationship between clients	Feeling heard	
Preparation given	Information exchanged easily	Information exchanged easily
Goals achieved	Goals achieved	Goals achieved
Understanding and able to interpret well	Feel respected, equal to English-speaking people	Understands work with Interpreter: role, limits
Professional, accurate, impartial job	Mutual understanding and clarity	Patient understand me, in depth
Good communication between parties	Understanding of wider issues	Understand patient in depth
My professional needs met	Own voice/ own reality expressed	Can treat as easily as English-speaking patient
No own opinions given	Cultural matters explained	Cultural matters explained
Checking for understanding	Full relay of what is meant	Full relay of what is meant
Interpreter's role respected	Confidentiality	Impartiality and confidentiality
	Trust in the interpreter and clinician	Trust established

**Figure 13. . Summary: Core elements of "optimum outcome"**

The value of this pilot was that both clinical and interpreting practitioners as well as academics taking part wrote down what they thought an optimum outcome would be like, for each of the three participants in the triad. The tabulated responses informed the next part of the study by guiding the design of the post hoc satisfaction questionnaires that were eventually applied.

The three sets of responses in figure 13, reflecting the perceived needs of clinician, interpreter and patient, were turned into the questions that appear on the three separate participants' questionnaires; these were later piloted with other researchers, resulting in their being slightly reworded and re-ordered before use.

#### POPULATION SEARCH AND STUDY LANGUAGE

The study requires three particular individuals to be present at each recorded observational interview: a patient, a clinician, and an interpreter. The obvious course to follow at the outset was that I should record conversations between Spanish-speaking Limited English Proficiency (LEP) patients and non-Spanish speaking clinicians, because Spanish is the language in which I work as an interpreter myself. Had this been possible it would have brought me some potential advantages. For example I would have had direct access to everything said during the interview, and would have been in a position to do all the transcription, translation, and back translation necessary to the original plan myself, for use in conversational analysis. I spent considerable time searching for a suitable cohort to populate the study, without success.

The figures showed that 4,280 Spanish speakers were living in the West Midlands at the time the Institute for Public Policy Research (IPPR) report on the 2001 UK census was written. However, conversations with the managers of Interpreting, Translation and Language Support (ITALS) services supplying interpreters to local mental health trusts (MHTs) reported that they "rarely" or "never" sent Spanish interpreters into those clinical settings. Among the London boroughs, Kensington and Chelsea had almost 4% of schoolchildren who spoke Spanish, Lambeth just over 2%, and Camden approximately 2.75%, which suggests the presence of at least one Spanish speaking adult per household as well. Figure 14 shows that 76,412 people who were born in South America lived in the UK at the time of the 2001 census. 0.62% of London's population was born in South America and 0.13% of the British population came from South America.

In 2001:	
54,105 Spain-born people lived in the UK, 42% in London plus 18% more in the South West.	
76,412 people born in South America lived in UK in 2001 Census	
0.62% of London's population was born in South America and 0.13% of the British population came from South America.	
Spain-born,	West Midlands, 2,184
S. America-born,	West Midlands, <u>2,096</u>
Total Spanish speakers	<u>4,280</u>

Figure 14. . Spanish Speakers in the UK. Source: Institute for Public Policy Research (IPPR), report on the 2001 UK census

Question to ITALS managers: “Do you supply MH interpreters in Spanish?”

Answers were:

It’s very rare. Numbers are not logged.

It’s not a common language. We do more Spanish translation than interpreting.

I cannot recall a single case in recent years. We mostly supply Bengali, Punjabi, Urdu, Arabic, Kurdish, Farsi. 1 or 2 Spanish bookings a month but not for mental health.

Figure 15. . Responses from ITALS managers regarding Spanish interpreter use

#### CHANGE OF STUDY LANGUAGE

It was clear that it would not be possible to populate a study on this basis, in the time available. It had become necessary to change the study language, which would impact on transcription and translation costs. However two of the languages named as most often called for in mental health work were accessible to my clinical supervisor, namely Urdu and Punjabi. Making a virtue of necessity, this change also meant that I would be in the same "Observer" position as the clinicians in the study and also any other non-Urdu or Punjabi speaking researcher or examiner. It would give me some distance from the messages being relayed, allowing me to reflect on visual and other signals such as posture, pauses and repetition, and the general position of interpreter and clinician within the triad. My language policy therefore changed and I sought Urdu or Punjabi speaking patients of Pakistani origin in line with the revised overall study design.

#### HELP FROM THE COMMUNITY

Various organisations were contacted for help, both community based and those run by PCTs, to seek help with the study design and participant information leaflets for

patients. It was striking how different the responses were. Repeated calls were made to several organisations in an effort to speak with local community groups and enlist their support. At one end of the spectrum a hospital advocacy service in London said I would never be allowed to film in mental health clinics and wouldn't be able to populate the study. Their manager was slightly mollified when I said I would not be filming in London but resolute that "it just isn't going to happen". At the other end of the spectrum, the Pakistan Association and the Friends Information Centre in Liverpool took the study to their hearts and enthusiastically offered their support and help. It was they who offered advice and translated the information and consent texts into Urdu.

<b>Community groups consulted:</b>							
<b>Group</b>	<b>Warwick County Council ITALS</b>	<b>Newham Language Shop</b>	<b>Medical Foundation for Victims of Torture</b>	<b>CEIMH*</b>	<b>NOVAS Scarman ITALS, Liverpool</b>	<b>Friends Information Centre Liverpool</b>	<b>Pakistan Association, Liverpool</b>
<b>Date</b>	<b>30.6.09</b>	<b>24.6.09</b>	<b>24.6.09</b>	<b>30.6.09</b>	<b>5.8.09</b>	<b>12.08.09</b>	<b>12.08.09</b>
<b>Notes</b>	<b>No suitable groups</b>	<b>No suitable groups, leads were offered; yielded nothing</b>	<b>Very few Urdu or Punjabi speaking clients. Mostly work in family therapy</b>	<b>No Pakistani user groups known</b>	<b>referred me to the Director, Friends Information Centre Liverpool</b>	<b>The Director gave practical support, providing translation.</b>	<b>Sister organisation to the Friends Information Centre</b>

**Figure 16. Community services approached for patient input contacts**

\*The *Centre of Excellence in Interdisciplinary Mental Health (CEIMH)*

Figure 17. Access to data timeline

25.11.2009	NRES favourable ethical opinion received	Commenced contacting doctors for support of project and access to patients.
March 2010	Discussions on applying for local R & D approval opened. Visited	Coventry to present study. They run transcultural teams and don't use interpreters in my study languages.
February to March 2010	Submitted an application under the SPEAR system whereby a single application is made to one of the associated trusts which then circulates it to all the others.	Cumbria Greater Manchester West Lancashire care Manchester Mental Health and Social Care Pennine Care
04.03.2010	Approval refused by GMWMHFT. The Trust refused saying role play would be more appropriate than a real situation with satisfactory result	The use of actors and artificial consultations had been considered as a research strategy, and rejected, in consultation with my supervisors.
24.03.2010	Presentation of project to Lancashire Care Trust	This application for R & D approval was rejected in April 2010 due to restructuring in the trust. It was expected to be completed by Christmas that year.
17.05.2010	NRES substantial amendment to favourable ethical opinion received	Changes made to protocol allowing for "clinician" to replace "psychiatrist" and "mood disorder" to replace "depression"
25.05.2010	Occupational health, research passport, CRB clearance and honorary contract with BSMHFT all complete	
03.09.2010	Coventry and Warwickshire second attempt	Cannot help because of transcultural teams in that area
June to October 2010	Contact with Dudley and Walsall. A presentation was made at a trust research governance meeting.	The study was adopted. Letter of access received on 31.08.2010. No data was collected.
June to December 2010	Much correspondence with doctors and medical secretaries in Birmingham and Solihull.	Delay due to questions of interpreters being funded by a different PCT. No data was collected.

Continues on next page



December 2010	I contacted a charity in Leeds, offering counselling services.	No patients that fitted my approved criteria
December 2010	I contacted a multilingual counselling service.	They thought my protocol unethical
March 2011	Second attempt to get R&D approval at Lancashire care	A further application, encouraged by a Doctor working in the Trust, was rejected in April 2011 on the same grounds as before. Refused April 2011.
October 2010 to April 2011	Presentation in Birmingham. One doctor was enthusiastic and a system for contacting the clinic was arranged.	By persistent phoning and e-mailing I was eventually able to film 3 appointments.
01.04.2011	Another doctor in Birmingham undertook to help me.	Only one patient out of a potential 5 was filmed.
25.05.2011	Initial agreement negotiated pending R&D approval for access in Bradford.	No data collected.

### **3.2 The Need to adapt**

#### ADDITIONAL DATA COLLECTION

By the spring of 2011 it was becoming clear that I would not have sufficient video recorded data to provide a robust sample. I began to accept follow-up appointments of 20 minutes in an effort to increase the success rate at getting film. The reasons for this are shown above in figure 17. It became necessary to ask for an extra year of study. It was decided that data collection would cease in December of 2011 and the revised plan of work is shown in figure 18. A search of the National Institute for Health Research (NIHR) database was made on 06.05.2011 using the terms: mental health; depression; language barriers; interpreting; in the date range 2000-06. This yielded 29 hits including 1 duplicate. The information found was used to contact

authors in search of already recorded interviews through interpreters that may have been audiotaped during their research. None of the recordings still existed. Additional measures were necessary in order to answer the research question and these took the form of in-depth semi structured interviews with interpreters and clinicians who had not been involved in the video recordings. Attempting to interview service users in depth was rejected as a research strategy, given that all of them were mentally unwell and mostly unused to the services of a professional interpreter being available. The interview guides are included in the appendix; a substantial amendment to the ethical approval originally granted was applied for and obtained.

May to August 2011	September to December 2011	January to March 2012	April to June 2012	July 2012	August 2012
Data collection and coding	finalise coding and analysis	write-up analysis	write discussion	Supervisors' review and feedback	final submission of thesis
Start analysis	write research methodology up-to-date	update literature review	write conclusions	corrections	
	End of literature search & review		Make revisions		

Figure 18. . Revised Plan of Work

#### CHANGE OF RECRUITMENT AND CONSENT PROCEDURES

The original plan for recruiting patients to the study and gaining the consent of all the participants presented major difficulties which took a long time to resolve. I am grateful for the help and advice I received in drafting those documents from Dr Liz England, Clinical Lecturer in Primary Care Clinical Sciences at the University of Birmingham. Patients were needed to join the study by persuading them that the

study was something they would support. Making a direct approach to patients would have breached patients' rights under the data protection act and intruded on their privacy. Leaflets were designed, running to eight different versions, and consent forms written with a view to recruiting GPs to help populate the study. In conversation with GPs it became apparent that they were unlikely to be willing to give very much practice time to this undertaking, or to answer patients' questions about the study. That is the reason that the pack shown in the appendix and the flow chart below were devised. Due to the difficulties encountered in locating suitable patients and obtaining Research Governance approval, a substantial amendment to the ethical approval originally granted was applied for. The revised plan was that clinicians in outpatient clinic settings could recruit patients to the study instead of GPs. This led to minor alterations of the wording in all the recruitment and consent documents which were subsequently used in the study.

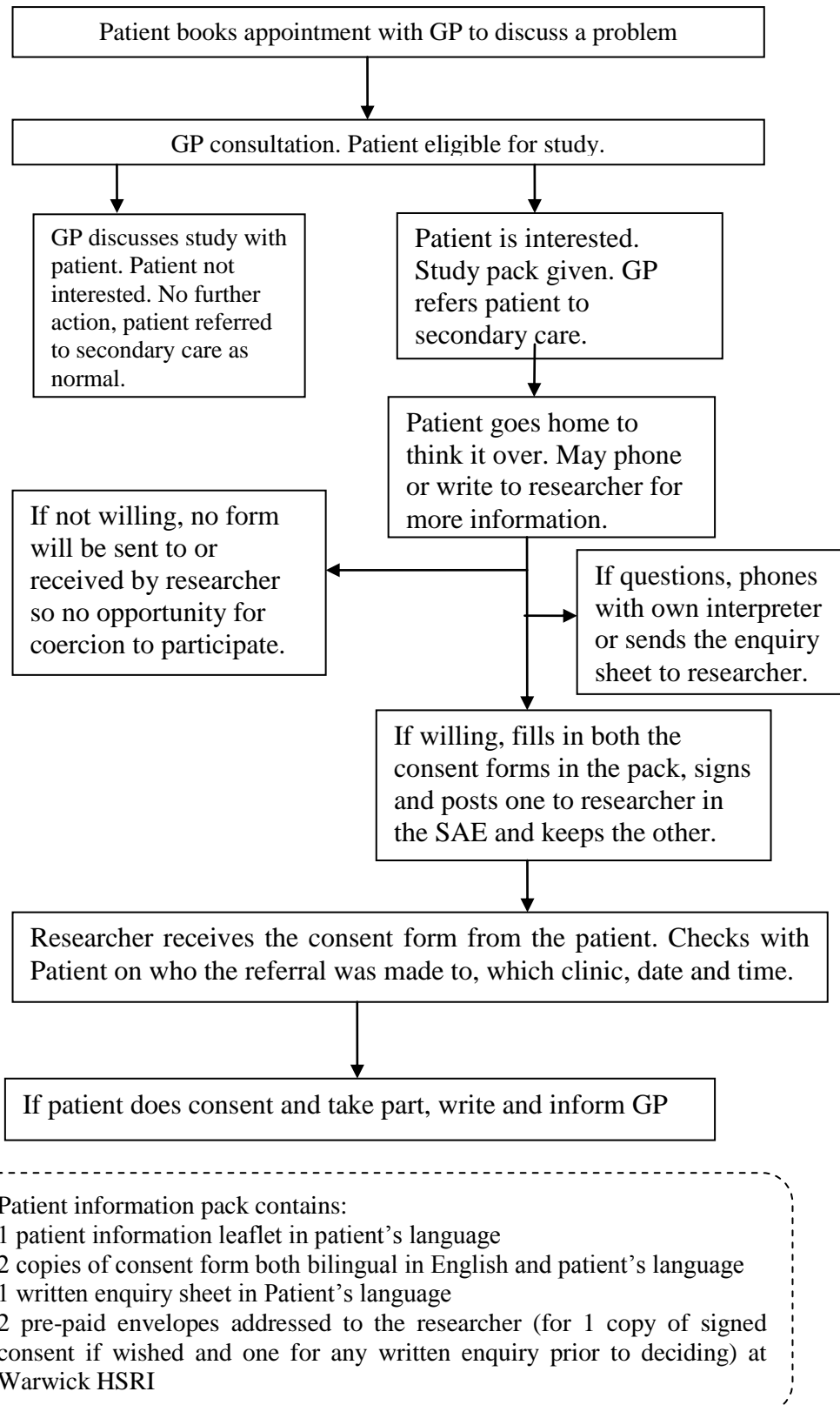
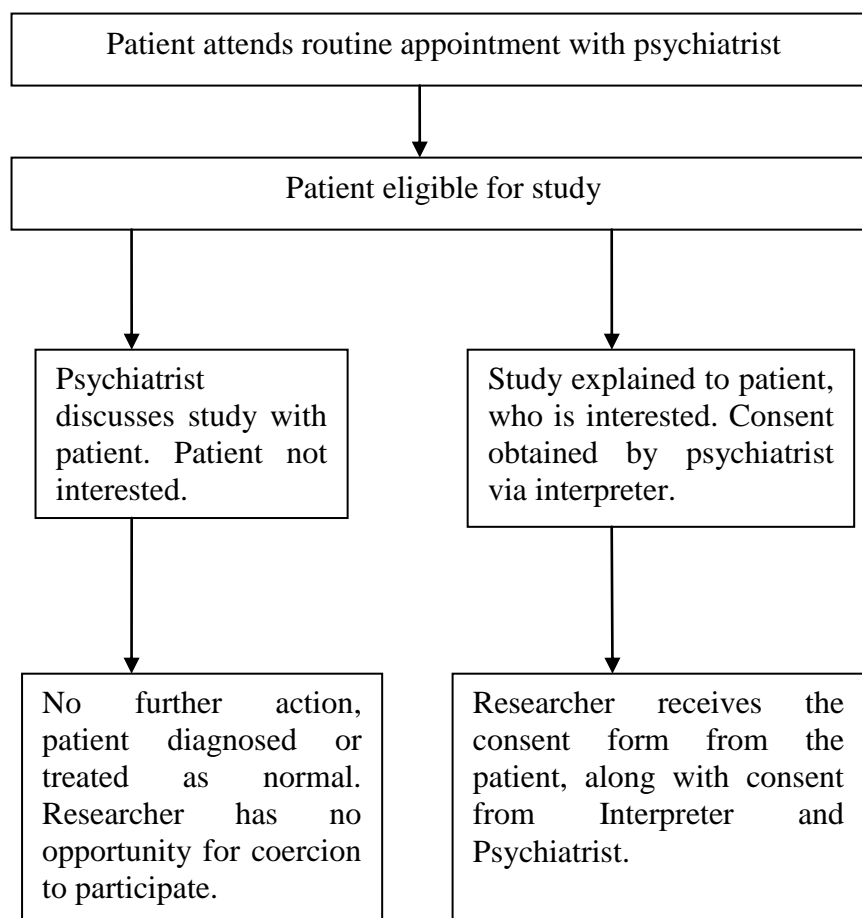

Figure 19. Original consent procedure

The patient is not the only participant however. Interpreting takes place in a triad, at the minimum, and the video recordings therefore include both a clinician and an interpreter. Further information leaflets, consent forms and letters of invitation were devised for them. Along with the leaflet and letter of invitation for the GP this comprised 4 sets of consent and recruitment material. Examples of them all will be found in the appendix although in the event the GP ones were not used and the simplified consent procedure that was run in the clinics is shown in Figure 20.



Patient information pack contains:

- 1 patient information leaflet in patient's language
- 2 copies of consent form one in English and one in patient's language

**Figure 20. Simplified Consent Procedure**

### **3.3 Data Processing and Analysis Plan**

#### SOFTWARE SELECTION

Transcription software is now commonplace for data analysis. Some of it is very complex and there is little compatibility between systems on the market. In their paper advocating a formal framework for the annotation of transcripts Bird and Liberman (Bird & Liberman, 2000) reviewed a wide variety of databases and described and evaluated seven specialist ones: TIMIT, Partitur, LACITO, LDC telephone speech transcriptions, NIST universal transcription format, Switchboard (extensions to existing program) and MUC-7 Coreference Annotation. The authors also looked briefly at three general purpose systems: the Emu speech database system, the Festival speech synthesis system and the MATE dialogue annotation workbench. All ten are very complex and detailed ways of recording speech and provide great depth of data on speech sounds and usage. The authors proposed an overarching system that could be accessed as a stand-alone or used to share data created in the other systems. This article was written at a time when the authors chose to reserve their judgment on how to deal with MPEG-4 (MP4)

format which was then very new. The camera I used records in MP4 format. I decided that my needs were much simpler than the work the programs above are designed for and that it was not necessary for me to come to grips with the computational linguistics needed to master such systems. I had done some training on NVivo but decided against its use because it, too, was more complex than I needed. In their 2003 review Blismas and Dainty found that:

*Paradoxically, computer-aided approaches often restrict rather than aid the analytical process (Blismas & Dainty, 2003:445).*

The relative simplicity of Atlas.ti recommended it to me for transcription and basic coding of my data. The transcription facility is easy to use, allowing text and voice

recordings to be synchronised. This software is widely used in qualitative data analysis for example in Rosenberg's 2007 study of doctor-patient communications in primary care with an interpreter, and in Higginbottom and colleagues' systematic review of Immigrant women's experiences of maternity-care services in Canada published in 2012 (Rosenberg et al, 2007; (Higginbottom et al, 2012).

#### STANDARD GUIDELINES AS A BENCHMARK

One of the qualities of a trained professional interpreter is their ability to intervene effectively and in a consistently unbiased and bilingual way when it is necessary to clarify concepts, request repetitions, or repair misunderstandings. To evaluate the quality and validity of interpreter interventions and to avoid bias a single authoritative description was needed of how such interventions should be made. In fact descriptions of this procedure are largely consistent throughout the practitioner-oriented literature. Versions of these guidelines, which differ slightly in wording though not intention, appear in several professional members' associations' documentation internationally, including the ones used by NRPSI (shown in the assessment criteria document in the appendix). They are also included in the report of the EU Grotius Project 98/GR/131 (Hertog, 2001:152-9) (European Union, 2010) which was accepted by the European Commission. Along with the subsequent six related projects, this work has led to a European Directive on the right to interpretation and translation in criminal proceedings (European Union, 2010), which passed into EU law in October 2010 giving member states 36 months in which to adopt it into domestic legislation. Parallel work on the needs of patients accessing health services in the EU passed into law as the directive on cross-border healthcare provision in March 2011(European Union, 2011).

### **3.4 Methodology**

#### **RESEARCH AIM**

The aim of this research was to examine the performance of paid, professional interpreters in their work of interpreting in a psychiatric clinical environment. A naturalistic approach was needed to reflect the style of communication used in mental health consultations. Various suggestions were made when I applied for access to clinics in which it was claimed that the use of actors and role-play would be just the same as observing reality and would give the same results. In a scripted or semi-scripted contrived situation however it would have been impossible to 'blind' interpreters and clinicians to the fact that the 'patient' was an actor and that they were all taking part in a role-play or simulation. It would have been entirely artificial to ask clinicians to model consultations in that way. To be able to observe and describe communication during a genuine consultation, watching real interpreters at work in genuinely routine psychiatric clinic encounters was indispensable. While role plays with actors are useful tools for clinicians' and interpreters' classroom training, they do not provide researchers with the natural reality of a genuine consultation.

The principal diagnostic and non-pharmaceutical therapeutic tool in psychiatry is language. Language expresses concepts, attitudes, beliefs and a sense of self; all these things have different forms of expression in different languages where equivalent concepts exist. Clinicians working in psychiatry use terminology such as 'suicidality', 'capacity', 'ruminations', 'preoccupations', 'delusions', 'overvalued ideas' in very specific ways (MacSuibhne, 2012). Linguists also use terminology in very specific ways. The use of jargon can cause confusion across professional



boundaries when both professional groups use a particular word in their own jargon, but with a quite different meaning to each group. For example, the word "face" has a very specific meaning in anatomy, and an equally specific, but different, meaning in linguistics and sociology. Similarly, the word "translation" is used by clinicians and linguists to mean different things, as explained in Chapter 5.

*Primarily, communication enters into the consultation when the diagnosis of a health-related issue is made and for which the clear communication of information, including descriptions of symptoms, is essential. If patients describe their needs or symptoms using culturally specific terms--perhaps relying on some metaphor that is well understood in their culture or religion but which may be alien to the clinician--the stage is set for misunderstanding. (Johnson, 2004:50).*

This present research project examined the actual process of switching a message from one language to another and observed the key elements of that process as expressed in the performance model used. The common performance models claimed as the basis of practice by some interpreters and the agencies that employ them are described in chapter 1 along with further detail on interpreting techniques.

#### RESEARCH QUESTIONS

The research questions that developed were:

1. Is there a common model or set of models?
2. Is/are it/they being applied?

This gave rise to two secondary questions

1. Does whichever performance model chosen and properly applied allow for optimum outcomes in the communication process?
2. To what extent do issues of face and implicature impact on interpreters' output?

## ETHICAL CONSIDERATIONS

The National Research Ethics Service (NRES) has a dual mission:

- to protect the rights, safety, dignity and well-being of research participants;  
and
- to facilitate and promote ethical research that is of potential benefit to participants, science and society.

The main focus of this research was the interpreting process as a communication tool so the presence of an interpreter, patient and clinician together was vital. An Integrated Research Application System (IRAS) application was submitted to NRES and discussed by the Coventry Research Ethics Committee (REC) at a meeting in November 2009.

The study was considered to be non-invasive and the major ethical considerations were related to informed consent, confidentiality and patient protection. From the NRES and R&D perspective data protection was a major consideration. Data containing patient-identifiable information such as names and faces had to be the subject of stringent protection including encryption of files and the secure storage of recorded media. Provision of appropriate participant information to inform patients' consent was also an important factor. Informed consent was also obtained from all the interpreters and clinicians in the study. Patients' privacy and dignity were further protected by the fact that the researcher was not present during their clinic appointment, having placed discreet recording equipment in the room, so that no outside observer needed to intrude into the clinical relationship during the observational part of the study. A post hoc satisfaction questionnaire was

administered to clinicians and interpreters as a paper based Likert scale. The patients completed this element by means of an audio survey; however, several patients were too unwell, or were unwilling, and chose not to take the survey.

The clinicians and interpreters who took part in the focused interviews on the telephone were also asked to return signed information and consent forms prior to the interview. Personal information was destroyed once the data had been coded. It was helpful that the one-to-one focused interviews were carried out on the telephone as it gave the flexibility for respondents to be interviewed at their own convenience, when they could be in private and not overheard. Much unnecessary travelling time was saved, and respondents were relaxed and spoke freely.

#### NEW APPROACH AND CHANGE OF METHODOLOGY

At the outset, difficulties connected with gaining access to data, and the subsequent discovery that the data were not telling me what I had been expecting, resulted in a change of approach to analysis. It was no longer appropriate to use Conversation Analysis, as the focus of the study had switched to the communication theories of Jakobson (1959), Goffman (1956) and Clark (1996). Another approach might be the use of Bourdieu's habitus (Bourdieu, 2005) however I have not used that because it is traditionally used where we are talking about liminality. Bourdieu speaks of the clashes and intersections of different lifeworlds and world views, the habitus, and liminal people, for instance interpreters, who occupy both worlds. The doctor's habitus is the institution and the patient's is his cultural and linguistic world. I chose not to use this approach and a new one was sought, the data being so rich that it deserved to be examined in great depth. This led me to hermeneutics which Van

Manen describes as the ‘theory and practice of interpretation’, a powerful tool for examining lived experience through language.

*Moreover, even the "facts" of lived experience need to be captured in language (the human science text) and this is inevitably an interpretive process. (Van Manen, 1989:181).*

#### HERMENEUTIC PHENOMENOLOGY

Hermeneutics are widely used in sociological and anthropological/ethnomethodological enquiries to explore meaning and motivation in human actions. The literature traces the progression in hermeneutic research methods from a focus on knowing as intellectual enquiry to a focus on intuiting as a function of examining lived life. The development of modern hermeneutic phenomenology leads from Husserl (Edmund Husserl, 1859-1938) via Heidegger (1889-1976) to Gadamer (1900-2002, whose insight was that language is inextricably bound in lived experience and that people experience their lives through language, which expresses the world and makes it concrete.

*What is the great paradox of language? That it always abstracts from the concreteness of the world, which it was responsible for creating in the first place (Van Manen, 1989:8).*

Husserl’s argument was that people are always conscious of something, and therefore that our consciousness has to be directed at an object, meaning that he believed consciousness to be implicit in everything spoken about or referred to. For him, the use of phenomenology as a research tool demanded the application of three things: phenomenological reduction; description; and a search for the essences of phenomena. He saw these three steps as being interconnected. He wrote about phenomenological reduction as:

*[...] suspending [...] the natural world, physical and psychological, all objectivities which are constituted through the functional activities of*

*consciousness in valuation and in practice* (Husserl, 1931:171) in (Maggs-Rapport, 2001:7).

Husserl's pupil Heidegger (1889-1976) broke away from his mentor's ideas about the relationship between subject and object. He believed that the way people relate to things is not normally as subject to object but that it is integral to external reality. In other words we are all of us in the world of being, "*a priori to conscious knowing*" (Heidegger, 1996 in (Maggs-Rapport, 2001:10). His focus was on understanding rather than describing. He believed not only in the value of phenomena but also in the importance of their interpretation. Only through language and speech can our 'being-in-the-world' become manifest and be understood. This 'being-in-the-world' explains how human beings attach meaning to their experiences and actions:

*The sick person encounters different medical languages as he moves between the health-care system's sectors. He must translate from one language to another... [This] is crucial in the interaction between patients and practitioners, in the process of healing, and in the creation and resolution of communication problems that are "endemic" to clinical care. (Kleinman, 1980:53).*

Husserl's and Heidegger's approaches differed in that Heidegger did not believe in suspending presupposition, because we are already always in the world. He also believed our knowing precedes conscious knowing, rather than being achieved through a state of pure consciousness. Husserl thought of phenomenological reduction as "*free imaginative variation*" and the search for essence as the "*shedding of light on the essential connections.*" (Husserl, 1931:385) in (Maggs-Rapport, 2001:7).

Gadamer (1900-2002) thought that understanding depends entirely on language; that language, understanding and interpretation are inextricably bound and cannot be free of the world. He wrote:

*Not only is the world 'world' only insofar as it comes into language, but language, too, has its real being only in the fact that the world is represented within it. Thus the original humanity of language means at the same time the fundamental linguistic quality of man's being-in-the-world* (Gadamer, 1996:401), in (Maggs-Rapport, 2001:12).

Linking language to ontology, or being, shifted researchers' focus from 'knowing' which had been a strong theme in nineteenth and twentieth century philosophy, to being, and being in the world. "*We possess the world through language*" (Anderson et al 1986:74) in (Maggs-Rapport, 2001:12); and that is why Gadamer's work gives particular insights into the in-the-moment meaning of interactions between patient and psychiatrist. When communicative action (Habermas in (Greenhalgh et al, 2006) via spoken language interpreting is needed in mental health care, communicating one's lived reality and the interpretive nature of the psychiatric diagnostic interview itself can no longer be the sum of all communicative action in the moment; a third discourse comes into play through the activity of the linguist.

In a small-scale study such as this one a quantitative method is not appropriate. Even within qualitative methodologies, counting things is used to describe phenomena and this study has quantified the post hoc satisfaction questionnaire and Delphi scores. The satisfaction scores lend weight to evaluation of whether optimum outcome was achieved or not, as will be seen in Chapter 4. The analysis of these several data sets used a variety of analytical techniques including thematic analysis, a Delphi process, and scored Likert scales used for rating participants' opinions numerically. The

subject matter is best investigated using a qualitative methodology appropriate to investigating patients' lived lives and communications across language and culture in stressful situations. Van Manen describes the phenomenological approach to researching human sciences as requiring "*sensitivity to lived experience.*" (Van Manen, 1990:2). Braun and Clark remark that:

*Qualitative approaches are incredibly diverse, complex and nuanced and thematic analysis should be [...] the first qualitative method of analysis that researchers should learn* (Braun & Clarke, 2006:78).

Description of the data, rather than interpretation, allows in-depth understanding of the many strands of meaning in an interaction. Interpretive research methods are popular in the fields of nursing and social science as well as some branches of medicine. The basis of Taylor and Ussher's approach to their 2006 study was that:

*It assumes that our experience and internal constructions of reality are constituted in and through discourse, the aim of its analysis being to unravel the processes through which this discourse and the 'subject's internal world' is constructed* (Taylor & Ussher, 2001:296).

Interpreters work alongside other professionals in every field of human activity when there is a need for somebody to transfer messages across language and culture. In this study interpreting is located within a medical field that bases its activities on the use of language, and the examination of word choices. It is all about the process of spoken language interpreting within that clinical field. Hermeneutic phenomenology offers a view of the subject through the prism of themes. Van Manen describes phenomenological themes as being "*structures of experience*" but warns that themes cannot represent categorical statements. When analysing the data items found in the text we are trying to identify themes that force the researcher to get to grips with the

particular - ‘*this* interaction’, ‘*this* aspect of the model’ - in light of an understanding of the universal – ‘what does the code of conduct or description of the model say’?

*Thematic analysis is a method for identifying, analysing and reporting patterns (themes) within data. It minimally organises and describes your dataset in (rich) detail (Van Manen, 1990:79) p79.*

Braun and Clarke, writing in 2006, further divide and label the parts of this procedure. They refer to a data item, in other words an interview transcript for example from which a data extract refers to a coded chunk of data - a quotation in the case of this present study. These data extracts must be studied until themes begin to be discerned. Themes that arise, say Taylor and Ussher (2001), could be taken to mean that they are objects embedded in the data that we can hunt for. In fact however, they emerge from our intuition and the understandings that come out of our reflective thinking.

Not all analysis methods with the word ‘thematic’ in their title are the same. In methods such as Thematic Discourse Analysis, as one example, researchers look for certain themes across an entire data set, rather than within a data item such as an individual interview. Inductive analysis is not a matter of deciding on themes and imposing them on the data but rather a question of immersing oneself in the data, making notes while reading, and allowing themes to emerge along the way. In other words the researcher starts coding without preconceptions or a preconceived coding frame. The analysis of the data will therefore be data-driven. While at semantic level analysis would focus mainly on the surface of the text and meanings of data, at latent level analysis would go beyond that. The semantic content of the data is formed or shaped by identifying and examining underlying ideas, assumptions and



conceptualisations, even ideologies. Latent level analysis would concentrate on a single theme or group of themes across the whole set. A rich description of the whole data set may lose a certain amount of depth and complexity but the richness of the whole will remain.

*This might be a particularly useful method when you are investigating an under-researched area (Braun & Clarke, 2006:83).*

The area of interpreting praxis in mental health care is under-researched, and the Delphi technique provided an agreed set of criteria by which to evaluate responses to one section of the focused interviews.

#### THE DELPHI TECHNIQUE

The Delphi technique is a structured process to gain consensus among a panel of experts in a field. It has been found that decisions from a structured group of individuals are more accurate than those from unstructured groups (Goodman in (Keeney et al, 2001). The process consists of a series, or rounds, of questionnaires and aims to maintain the anonymity of its panellists to protect those taking part from feeling unduly influenced by the opinions of others. It is an iterative process aimed at combining expert opinion into group consensus, using a series of intensive questionnaires. This methodology does not use members of a target population, but employs 'experts'. An expert is defined as an informed individual with knowledge of the subject being researched. In a wide field of practice such as nursing these experts may be drawn from several disciplines within the field. There are disadvantages to this, as it can risk recruiting panel members whose expertise is not all they claim. The field of public service interpreting is smaller, the outstanding experts fewer; so geographical spread is useful as experts' practice will not bring them into frequent personal contact. There is potential for bias if the composition of a panel from either

field is not selected with care, so that they are relatively impartial. It is usual for the panel to be heterogeneous so that a wide spectrum of opinion is discussed.

Anonymity may enable respondents to be open and honest in their opinions but may also lead to their not feeling accountable for the view they express. In any case anonymity cannot be completely guaranteed since the field of professional activity involved may be small and the facilitator of a large study will need to know who the respondents and non-respondents are if there is an agreed response rate as an outcome measure.

The Delphi process often consists of four rounds. Too many rounds can cause respondents to drop out. Too few can fail to explore the questions in sufficient depth. Typically, round one is used to generate ideas or present existing information for ranking or response. The discussions in subsequent rounds are analysed and re-circulated for comment and amendment.

Reliability has been questioned, but Ono and Wedemeyer (1994) in (Keeney et al, 2001) repeated a 16 year old Delphi study to see if it could be replicated. Their findings reflected those of the earlier work, and were accurate in their forecasts. Goodman wrote in 1987 that if the panellists represent the group or area of knowledge being studied then content validity can be assumed (Goodman) in (Keeney et al, 2001:198).

Thematic Analysis was used to understand the data. It is a flexible approach but does not allow claims to be made about language use, particularly in view of the cross-linguistic nature of this study. It is not a complex method, but is well suited to the differing data sets obtained and the "*potential range of things that can be said about your data is broad*" (Braun & Clarke, 2006:97). The Delphi technique was used to validate the vignette section of the focused interviews with interpreters.

#### THE DELPHI PANEL

The first part of the focused interview topic guide for interpreters consisted of a fairly free ranging conversation about their own perspectives and experiences of working as interpreters in mental health clinics. The second part of the topic guide presented a series of vignettes designed to see how interpreters, imagining themselves to be in a working situation, would respond to situations and conversations that offered the interpreter specific challenges that included face threat. Five panellists took part in the Delphi process and there were three rounds involved, although round two ran to three iterations.

The data in the second half of the interview changed its focus. In the first part interpreter interviewees were responding to open questions about their work. In the second part they were presented with vignettes and the question "if you were interpreting and this happened, what you would do?" So they were responding to prompts designed to test their understanding of the code of conduct and some of the things they had talked about doing earlier on. In order to validate discussion arising from the vignette section, a Delphi panel was convened. There were five panellists, all of them chosen for a track record including high academic achievement; long

public service interpreting practice; published work; research and development work; expertise in training public service interpreters. They were drawn from all over the United Kingdom. The results of this exercise are presented in chapter 4.

### **3.5 Method**

The inclusion criteria for the three participants in the observational part of the study were:

	<b>Inclusion criteria</b>	<b>Exclusion criteria</b>
<b>Patient</b>	<ul style="list-style-type: none"> <li>○ Adult.</li> <li>○ Urdu or Punjabi or Punjabi speaking of Pakistani origin.</li> <li>○ Using ITALS to access the service.</li> <li>○ Consulting about possible diagnosis of depression at assessment interview.</li> </ul>	<ul style="list-style-type: none"> <li>○ Not adult.</li> <li>○ Not using ITALS to access the service.</li> <li>○ Not consulting about possible depression.</li> <li>○ Not of Pakistani origin.</li> <li>○ Not Urdu or Punjabi or Punjabi speaking.</li> <li>○ Not able to give informed consent.</li> </ul>
<b>Clinician</b>	<ul style="list-style-type: none"> <li>○ Not sharing a language with the patient.</li> <li>○ Consulting about a possible diagnosis of depression in the patient at assessment interview.</li> </ul>	<ul style="list-style-type: none"> <li>○ Sharing language with the patient.</li> <li>○ Not consulting about a diagnosis of depression and the patient.</li> </ul>
<b>Interpreter</b>	<ul style="list-style-type: none"> <li>○ Professional, with relevant training and certification.</li> <li>○ Working in Urdu or Punjabi or Punjabi with English.</li> </ul>	<ul style="list-style-type: none"> <li>○ Not professional, no relevant training or certification.</li> <li>○ Not working in the patient's strongest language with English.</li> </ul>

**Figure 21. . Main inclusion and exclusion criteria for the study.**

In order to examine the different performance models and styles of interpreting used by the individual practitioners, other elements in the interaction were controlled i.e. diagnostic consultations about possible mood disorder.

Interpreter mediated psychiatric consultations were video-recorded and the questionnaire described in 3.1 was completed post hoc by each member of the triad.

The patients' questionnaire was applied using audio survey equipment on which the questions were recorded in Urdu or Punjabi and the patient recorded their responses on it without the need for any assistance except in so far as some required a little help in understanding that the researcher would operate a tape recorder to play the question tape which could be paused and re-wound at the patient's request. The recording device collecting the sounds of the question tape plus the patient's responses simply ran throughout the duration of the short survey. Once that had been achieved there was no need for the interpreter who assisted in the consultation to remain with the patient while they completed the questionnaire. One inclusion criterion for patients was that they should be Urdu or Punjabi speaking and of Pakistani origin (Figure 21): Main inclusion and exclusion criteria for the study. This was to avoid or reduce the possibility of confounding that would arise from very divergent cultural backgrounds, both Urdu and Punjabi being widely spoken languages. The type of consultation chosen was the first assessment interview, as this consultation is long enough to give sufficient data for analysis. Interpreters who took part in the study were not family members, or casual interpreters. Two were untrained. The study aimed to look at reality and so the patients recruited were attending a normal, routine clinic appointment. The interpreters were booked through the usual agency, in the ordinary way and the researcher had no contact with them outside the clinic.

The overall framework and approach to answering the research questions was qualitative. Conversational and observational data were collected, analysed and discussed with a major focus on communication. Negotiating access to clinics meant gaining approval of the project by the National Research Ethics Service (NRES),

followed by a long series of applications for Research and Development Approval (R&D) in a variety of PCTs between September 2009 and September 2011. An honorary contract and CRB check were obtained to work in one PCT and a letter of access was provided for another.

The study was considered to be non-invasive and the major ethical considerations were related to informed consent, confidentiality and patient protection. From the NRES and R&D perspective data protection was a major consideration. Data containing patient-identifiable information such as names and faces had to be the subject of stringent protection including encryption of files and secure storage of recorded media. Provision of appropriate participant information to inform their consent was also an important factor. Informed consent was obtained from all the participants, the patient, the clinician and the interpreter. Patients' privacy and dignity were further protected by the fact that the researcher was not present during the clinic appointment, having placed discreet recording equipment in the room, so that no outside observer needed to intrude into the clinical relationship during the observational part of the study. A post hoc paper-based Likert scale satisfaction questionnaire was completed by clinicians and interpreters. Patients completed this element by means of the audio survey; however, several patients were too unwell, or were unwilling, and chose not to take the survey.

Observational data collection took place over the period between January and June 2011; interview data collection occurred between August and October 2011. Sampling interpreters for the observational part of the study (OInterps) was done by

leaving it to the agency ordinarily employed by the PCT to supply interpreters at clinics, on a 'normal rules' basis. Inclusion criteria for interpreters in the interview section of the study were as shown in the figure below.

- Must work in mental health and in Urdu and/or Punjabi
- Select scattered group
- Avoid interpreters living in Birmingham or Bradford (may already be in the study/want geographical spread to avoid undue influence of local custom)
- If no postcode listed, avoid
- Note that each NRPSI database search throws up names at random

**Figure 22. Inclusion Criteria, Interpreters Recruited to Interview Group**

#### SEARCHING FOR INTERVIEWEES

The search for interpreters to interview was done by contacting interpreters' networks in Birmingham, Bradford; the Sheffield area; the London boroughs of Camden and Wandsworth; and Merseyside. I would have liked to talk to non registered interpreters as well as registered ones. These are very difficult people to recruit as no remuneration would be possible within the budget of a self-financing postgraduate student, and the validity of their contribution may have been questioned if they were paid. The search for clinicians involved obtaining R&D approval from Leeds Partnerships Foundation Trust and, following this, two doctors made contact offering to help. Other Trusts were approached and the RCGP and RCPsych Ethnicity and Diversity leads were telephoned to see if they would circulate a recruiting email, without success. The rules on research interviews had changed in September 2011 allowing contact with doctors to ask about their professional expertise and perspectives on specific aspects of practice to be treated as service evaluation. This removed the need for site specific information forms for each Trust. However my study pre-dated this change and permissions to use each trust as a Participant Identification Centre were still needed. All this slowed things down and limited the number of doctors that could be contacted.

### SAMPLING INTERPRETERS LISTED ON NRPSI

NRPSI was by then an open access database supplying the names of interpreters fitting any search, in random name order. There were two interpreters with no qualifications among those in the filmed data. A sample was also drawn from the National Register of Public Service Interpreters. One search list was generated for those listed in Urdu and one for those listed in Punjabi. Having removed Birmingham and Bradford postcodes and listings that showed no postcode, the remainder of those two lists was copied to a single document. Many of the interpreters listed in Urdu were also showing a listing in Punjabi. The Punjabi list was further screened for interpreters who had dual language listing. This resulted in 12 Punjabi-only listings; 21 Urdu-with-Punjabi listings; 131 Urdu-only listings, giving 164 total listings in these languages, which were printed. Sampling was done by selecting one listing per page that showed a telephone number as well as a post code, 33 in all and, where possible, taking a different postcode from each page. This generated a list for a first attempt at making contact. The NRPSI database has as yet no facility to filter searches by specialty (law, health, local government) so each interpreter I telephoned was asked specifically if they worked in mental health. Those who said they did not were excluded.

Interpreters on the contact list were phoned and acceptances followed up. Appointments were made to interview clinicians and interpreters on the telephone, leaving enough time for the information and consent form to have been emailed or posted to them, read, signed and returned to me by post. Two of the interpreters with whom I had appointments had changed their minds when I rang to conduct the interview. For this reason the focused interview interpreters' ID numbers are not



consecutive. A pilot of the interpreters' focused interviews was carried out on 17 August 2011 with FInterp1, whose data was included in the analysis.

Of the list of 164 interpreters extracted from the NRPSI database 45 listed their title as Mrs, 10 as Ms and 109 as Mr. So approximately a third of the registered interpreter sample taken in these language pairs (Urdu<>English, Punjabi<>English) were women. Of the 33 interpreters phoned, 9 were interviewed; 7 women and 2 men. 14 male and 10 female contacts refused to take part, citing pressure of work, little or no experience in mental health work, or simply saying "no".

The interviews with 2 practicing clinicians and 8 interpreters were carried out over the telephone between August and October 2011. They were recorded on a digital recording device using a telephone pickup cable. This meant that I had my hands free to take field notes while interviewing and could have the topic guide on my PC screen at the same time. The resulting recording was stored to PC and transcribed in Atlas.ti. Interviews were conducted in English. Topic guides will be found in the appendix.

#### METHOD OF ANALYSIS

The difficulty and delay involved in gaining data meant that there was not as much of it as had been hoped for, so that thick descriptions of observational case studies would need to be supported by the examination of other data.

The filmed observational data was supported by a Likert scale satisfaction survey. Both observational and interview data were supported by the Rating Scale, developed on the basis of the taxonomy of models and the Assessment Criteria used by the Institute of Linguists Educational Trust, an accredited awarding body, in their Ofqual recognised professional Diploma In Public Service Interpreting Examinations. These are in the Appendix. The data from focused telephone interviews with clinicians and interpreters included transcripts of the interview; the results of the same post hoc questionnaire used in the clinics, derived from their responses during the telephone interview; and a Delphi process to validate the findings of the vignette section of the interview. The resulting data was very rich and the remaining time very short; a hermeneutic phenomenological approach to analysis offered access to the full richness of the overall data. In view of this the most appropriate analytical method was thematic analysis, immersing myself in the data and working with data items, both filmed and audio recorded, as well as the text based material to identify explicit, named themes and sub-themes. Once grouped into clusters these give insight into commonalities and differences between linguists' and clinicians' communicating style.

#### THEMATIC ANALYSIS

The interviews conducted by telephone followed the topic guide used, to ensure that all the ground was covered while leaving opportunities for respondents to add whatever they wished to say.

*Whilst trying to avoid directive or closed questions or interpretations the interviewer did adopt a stance of 'talking back' to the interviewee (Griffin, 1990). In this way, questions were used to promote a two-way dialogue with which to explore key themes (Taylor & Ussher, 2001:296).*

The interviews were fully transcribed and checked against the audio tapes for completeness then they were read carefully and repeatedly. The transcription reflects the extempore natural speech of both interviewer and interviewee and is sufficiently detailed to show hedges, hesitations, self corrections and other features of spoken language. Notes were made in the margins of printed transcripts during repeated readings of the texts. The margin notes were then transferred from the printed transcripts to post-it notes. Some of the post-it notes were duplicated because, as they accumulated, early themes began to suggest themselves and some notes merited space in more than a single theme. These notes were sorted, considered, and sorted again in an iterative process of clustering them into emerging themes; this activity became known as my talking wall. A simple audit trail was kept in the form of a photographic record of the process. This could have allowed a return to a previous classification/categorisation of data items were that to have been apposite. Coding then followed the themes and subthemes that had emerged. This photographic record and code book are bound in the appendix. Descriptions of codes were written during coding, to ensure consistency of application. During the process some themes' names were changed, or themes were amalgamated into other themes as being too small, a duplication, or redundant.

Mind maps of the main themes to emerge are in figures 22 and 23 and show how ideas changed during the sorting process.

MIND MAP 1

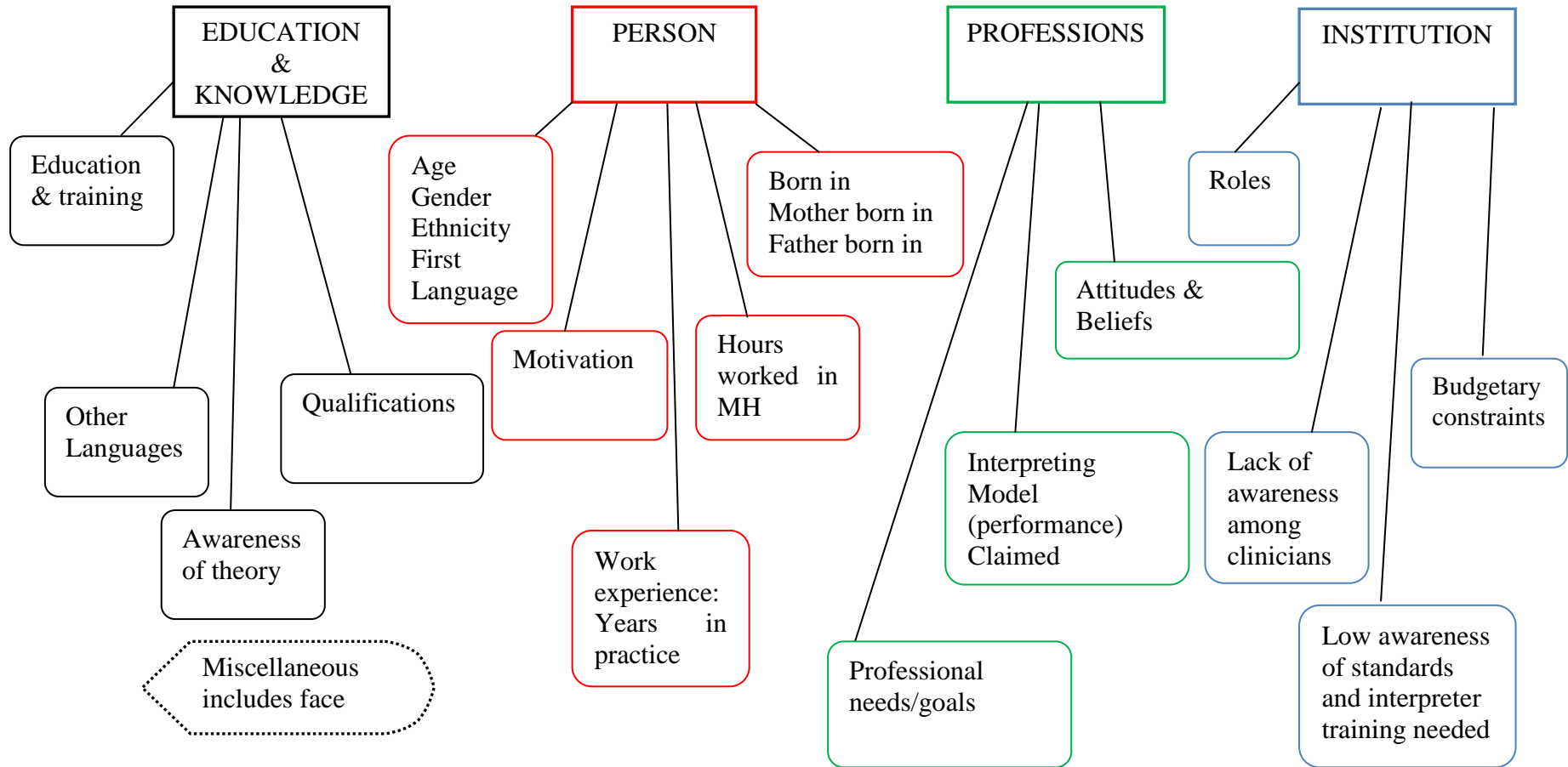

Figure 22. Thematic development mind map 1

MIND MAP 2

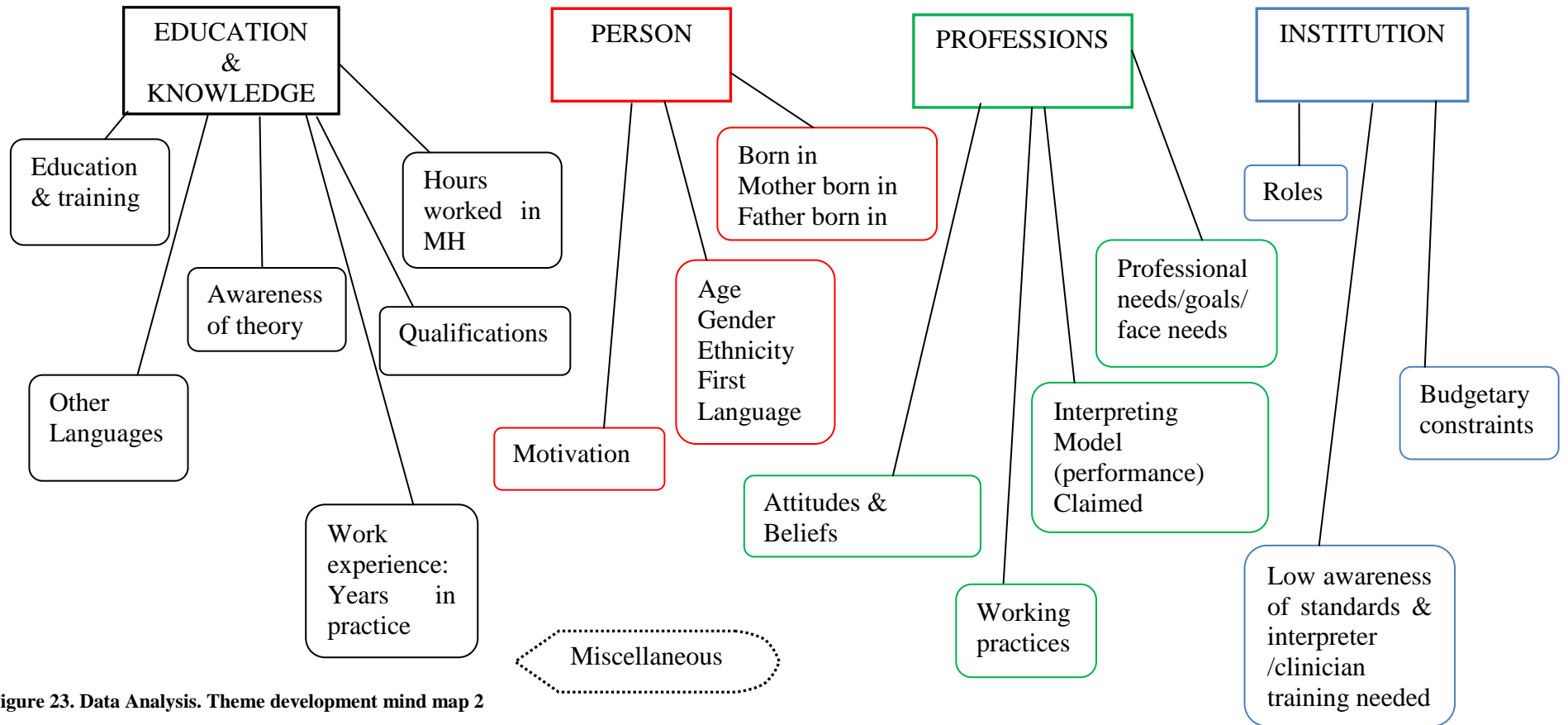

Figure 23. Data Analysis. Theme development mind map 2

The resulting themes and sub themes are internally coherent, consistent and distinctive. Sub themes that arose from examining the data included:

<b>Sub themes named</b>	<b>Brief description</b>
Discomfort – feeling vulnerable	Inappropriate use of interpreter, may put them at risk
Discomfort – threat to face	Personal questions or intimate conversations
Legal is different	Distinction made between court and health interpreting & language use.
Interpreter’s role: building rapport	Interpreters should do this, 6 ways (see Ch 6)
Interpreter’s role: explain work practices	Part of building rapport on both sides
Interpreter’s role: relaying messages	All the elements of the model
Interpreter’s role: setting limits	Defence of role boundaries
Parallel conversations	Interpreter in full interlocutor role

**Figure 24. . Sub themes**

The next stage of analysis was to lay out exemplars of examples i.e. example quotations taken from the texts, each a data item representing the spectrum of opinion, perspective and practice among interviewee and observation data, interpreters and clinicians. These are linked in the text so as to illustrate aspects of the model as described by the research question and underlying factors that influenced or were thought to be important by clinical and interpreter practitioners.

Setting out the quotations from the interviews and the examples taken from the observation data involved data reduction, and codes or themes developed as described above.

*There is overwhelming agreement that data reduction is an important strategy for qualitative researchers. In this context, coding is regarded as a*

*helpful, though by no means unique or indispensable, technique in qualitative analysis* (Attride-Stirling, 2001:390).

The results of the Delphi process are set out, and analysed in Chapter 4.

#### LEARNING AND REFLECTING

I have learned many new techniques during this exercise. Annotating transcripts was not a major challenge as I used the note taking style taught on many conferences interpreting courses which is very rapid and graphic to produce, conveying information to their author in concentrated form. When transferring quotes and comments to post-its there were more words, as their meanings would potentially need to be intelligible to me some time later. I have not seen the photographic audit trail method written up anywhere but it was a helpful thing to do. Even basic coding was a struggle for me to engage with but once I had coded all the transcripts in Atlas.ti, writing descriptions of my codes as I went along, the patterns began to emerge clearly and the descriptions I had written aided consistency of use.

Handling the various data sets in multiple ways offered robustness of findings. I started with data items (quotations) making notes in the transcript margins, transferring the notes to the 'talking wall' where I could stand and consider, move things about in a tactile and visual sorting process. Themes emerged and those kept were not what I had started out with. Finally a spread sheet showed me the quotations by interviewee and theme. I was tracking attitudes and approaches through the spoken word and through observed behaviours, moving away from data items into thematic areas. Compiling the Delphi and other documentary data in charts reinforced what the observational and interview data had been telling me.

Though not an overt ‘voice’ in the whole enterprise, the institution emerged as a major influence on communicative activity and outcomes.

If I do this again I will seek training with Atlas.ti and Excel for modelling the data and making relationships graphic. The way I handled this data only worked because the data sets were small and could be handled in this way, allowing time for reflection in search of the whole picture. I found the physical sorting of data items encouraged intuitive insight and, another time, I would take more care to label changed theme headings clearly enough for the camera to pick them up better. A larger study would need to be more computer-based, but the technology I have started with has plenty more capabilities to offer me and a training course prior to starting a new project would be a must.

I followed an iterative process of transcribing, reading, making notes, sorting the notes on a ‘talking wall’ (shown in the appendix). I returned to the recordings and transcripts repeatedly while coding the transcripts and laying out the data items in chapter 4. I watched the films repeatedly, identifying clips to examine and transcribing them returning to the films repeatedly, just as I did with the audio recordings, immersing myself in the filmed and audio recorded data. Mind maps helped to concretise themes and sub themes. The Delphi results were analysed and described to form their own data set, as were the results of the satisfaction surveys. Data collection unavoidably lasted over many months, meaning that the whole process of data collection, data reduction, data analysis and writing up took place as the progressive, overlapping process shown below.



**Figure 25 Data Analysis flowchart**

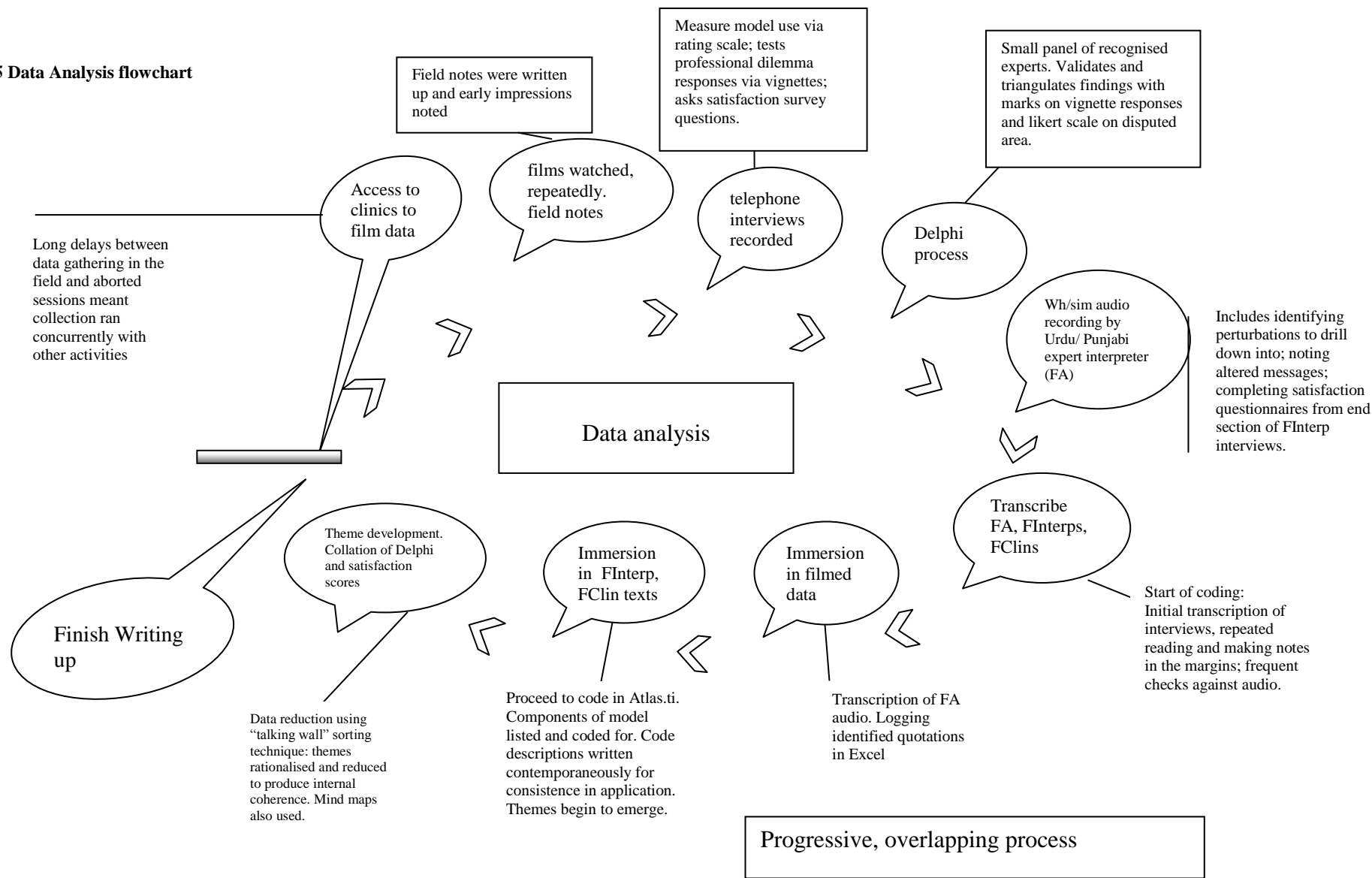

## CHAPTER 4. ANALYSIS AND RESULTS

### **4.1 Introduction**

The data present an unexpectedly complex picture of interpreted psychiatric interviews. Clinicians have a low level of awareness about interpreters, what they do and how they do it. Role boundaries are unclear, and the terminology used to discuss interpreting is inconsistent and confusing. This is evidenced in section 4.2.1. Interpreters who took part in focused interviews and interpreters observed at work were either not trained or qualified at all, or else the qualifications they held were not relevant to mental health care, as can be seen from Table 3 below and is described in section 4.2.2. Some interpreters report that recent cost saving policies in the NHS mean family members are again being used to interpret.

The data consist of:

- 1) The two focused interviews with psychiatrists are described below.

See code book in Appendix

Clinicians' personal attributes (table 2)

Interpreters' personal attributes (table 3)

These show interpreters' and clinicians' personal attributes including:

- Interpreters' education, training and qualifications (table 3).
- Interpreters' experience in the job (years, hours of MH work per year).

The labels given to the two types of interpreter and clinician in the study were chosen to distinguish between the data sets that they appeared in. FInterp1 and FClin1 are the first interpreter and clinician to be the subjects of focused interviews. OInterp1 and OClin1 are the first interpreter and clinician to be the subjects of

filmed observation data. The interpreters' ID numbers in the study are not contiguous because two appointments were made for interviews where consent was subsequently either not received or was withdrawn.

- 2) The data validated by the Delphi process, analysing focused-interview interpreters' responses to the second half of the interview. This consisted of presenting them with a series of prompts in the form of vignettes and asking them to comment on their likely responses. There were 8 interpreters, all drawn from the national Register of Public Service Interpreters (NRPSI).
- 3) The data emerging from filmed psychiatric outpatient interviews in clinics. There are 2 clinicians and 4 interpreters recorded in two one-hour sessions and two half-hour sessions.
- 4) Post hoc satisfaction questionnaires based on the pilot study described in chapter 3 were applied after the filmed interviews. Due to technical failure, there is no film of 5 clinical interviews, and 3 patients in the whole study were not well enough to respond to the questionnaires. Questionnaires were collected from all 3 participants where possible. The questions used in the post hoc questionnaires were built into the focused interviews and paper versions of that section and responses were analysed. The results are displayed in Table 3 on pages 199-200.

The personal attributes of the clinicians who took part in this phase of the study are shown in 2 below, followed by the personal attributes of the interpreters who were interviewed, shown in table 197.

<b>Clinician 1</b>		<b>Clinician 2</b>	
Study ID number	FClin1	Study ID number	FClin2
Age	30-40	Age	30-40
Gender	M	Gender	M
Ethnic origin (self assessed)	White British and Caribbean	Ethnic origin (self assessed)	Bangladeshi
Place of birth	Stirling, Scotland	Place of birth	Manchester
Place of Parents' birth	Father – London, white British. Mother – Guyana, South America. Both English speaking from birth	Place of Parents' birth	Father – Bangladesh Mother – India
First language	English	First language	English (Bengali, Hindi)
Current post	ST6 trainee, Crisis and home team	Current post	Specialist registrar in psychiatry

Table 2. . Clinicians' personal attributes

ID	Age	Gender	Ethnicity	Birthplace	Parents' birthplace	First lang	Qualifications	Model (claimed or by rating scale)
FInterp1	40-50	F	British Asian	Pakistan	Pakistan	Urdu	DPSI,(health and LG) GCSE≈ exams	Impartial (≈3hrs MH work pcm) >10 years working
FInterp3	40-50	F	British Pakistani	Pakistan	Pakistan	Punjabi	2xDPSI: in LG, 1 in Urdu and 1 Punjabi. Studying for law degree.	Impartial (≈8hrs MH work pcm)< 20 years working
FInterp4	30-40	F	Asian, British Asian	Pakistan	India	Urdu	DPSI (health) (LG)	Impartial (≈5hrs MH work pcm) 9 years working
FInterp5	40-50	F	Asian, Pakistani (brought up in Iran)	Pakistan, Karachi	India (before partition)	Urdu	BSc Biology. Wanted to study but arranged marriage	None. Method depends on circumstances. (very little MH work now) >20 years working
FInterp6	40-50	M	Pakistani British Asian	Pakistan	Pakistan	1 Urdu 2 Punjabi 3 Mirpuri	MA Eng lit, MA journo both in Pakistan DPSI (law, health,) PG Dip Human rights	Impartial (very little MH work now) 8 years working

Table 3 (1). Interpreters' personal attributes. Note that ID numbers are not contiguous. Ethnicity is self-assessed.

\*London Open College Federation

FInterp7	30-40	M	Asian British	Pakistan	India Father Punjabi speaking, mother Urdu speaking	Urdu and Punjabi jointly	DPSI law MA Eng lit	Impartial (≈3-4hrs MH work pcm) years working not stated
FInterp9	40-50	F	Pakistani	Pakistani	India pre-partition	Urdu	DPSI health	Impartial (≈12-13hrs MH work pcm in past much less now) >12years working
FIntrp10	60-70	F	Pakistani	Pakistan	Pakistan (also husband)	Urdu Hindi Punjabi	MA in social work (Pakistan). PGCE, Cert cross-cultural counseling, LOCF* diploma health (UK)	Cannot name a model or approach. (≈0.66 hrs MH work pcm). Years working not stated.

**Interpreters' personal attributes. Note that ID numbers are not contiguous. Ethnicity is self-assessed.**

\*London Open College Federation

## **4.2 The focused interviews**

In the description of data which follow there are many quotations taken from the transcripts of both focused interviews and the observation data in the videos. The italicised transcriptions of quotations reflect the natural speech of those interviewed or observed. I have therefore chosen not to insert [sic] where ungrammatical forms or other errors of speech appear, as it would become very difficult to read the text if [sic] were used in every instance. This transcription style is sufficient for the purposes of the thesis which is to compare issues emerging from different types of data. It is intended that readers not expert in linguistics may be able read this thesis with ease. In future a Jeffersonian transcription could be made of some sections to provide the basis for producing training materials.

The quotations used in chapters 4 and 5 are verbatim transcriptions of the English versions, in some cases facilitated by an expert Urdu/Punjabi interpreter who worked from the recordings (FA). Occasionally FA's interpretation is offered alongside that of the interpreter in the clinic as a comparator. Quotations from the data and vignettes from training practice are labelled as in the table below. All other quotations or citations are followed either by the author, date and page number or as a 'personal communication' or 'by kind permission'.

Label	Description
Data item	A quotation taken from verbatim transcripts of interviews and filmed ICE interactions.
Author's own classroom materials	Metaphors and vignettes that are used in interpreter training

Both clinicians interviewed were males in their thirties; both were practising psychiatry and interviewing patients through interpreters some of the time. Both worked in training grades. Both were born in the United Kingdom; one speaks only English, the other speaks English plus Bengali and Hindi.

Of the 8 interpreters interviewed 2 were male and 6 female. Two were in the age range 30 to 40, five were in the age range 40 to 50 and one in the age range 60 to 70. 3 of the interpreters declared Asian ethnicity and the remainder British Asian or Asian British ethnicity. The number of years interpreters had been in professional practice was not a specific question in the topic guide but emerges in several of the conversations. 2 interpreters made no mention of the number of hours they usually worked in mental health clinics, though that was a specific question, and while they all found it difficult to estimate, their responses ranged between 0.66 hours per month and 12 to 13 hours per month. All were born in Pakistan, and all their parents were born in Pakistan or India. All of them learned either Urdu or Punjabi as a first language, and came to the UK with varying degrees competence in English. 4 of them are qualified to high levels of academic achievement such as bachelors' and masters' degrees, and a PGCE. All but FInterp5 hold at least one Diploma in Public Service Interpreting (DPSI), however only 4 of the interpreters hold a DPSI in the health option. The other four hold DPSIs in law and/or Local Government.

#### **4.2.1 Professional perspectives. Interviews with clinicians**

Clinicians were interviewed on the basis of a topic guide to draw out and compare the perceptions and understanding of what interpreters can be expected to do, and



how the service they are accustomed to fits with their own professional needs and goals. The data is grouped according to the interview topic guide's questions in the order they were asked. The data items represent a verbatim transcription of responses for thematic analysis; see figures 22, 23, and 24 in this chapter.

#### HOW MUCH DO CLINICIANS KNOW ABOUT INTERPRETERS AND THEIR ROLE?

The questions in this section were about the interpreter's role, as described in their code of conduct, to assess the level of knowledge they had about what trained interpreters should be capable of doing. Both were junior doctors on rotation. FClIn1 had experience of working with Urdu and Punjabi interpreters two or three years previously and, asked if he had received any training in working with them, he said that he had not but would have valued it. FClIn2 had worked for twelve months with two specific patients, using interpreters at every session. FClIn2 had received briefing from his consultant, which was

*"[...] basically to emphasise on direct translations of what the patient is saying, um, and not necessarily always having an interpretation of what they're saying . and to. to ask the interpreter to give verbatim at times."*  
FClIn2 [Data item]

Asked what the briefing consisted of he replied:

*"The kind of things I should be looking out . so the difference between translating and interpreting. And particularly in mental health you know the kind of thing we need to ask them to do for us."* FClIn2 [Data item]

Neither clinician in the study had heard any of the terminology that linguists use to describe the ways they work. They were unaware of performance models, or the different modes of interpreting. Neither had heard the phrase "whispered simultaneous interpreting"; neither knew what it entailed or saw it as potentially useful. They thought it could be confusing. They seemed unfamiliar with the idea of

interpreters' codes of conduct, apart from the requirement for confidentiality and impartiality.

Asked what he knew about certification, FClín2 had some information:

*"I was told, I asked, because I know that there's a special mental health certification. I don't know what it's called. But I do ask if they have it, I can't tell you the name."* FClín2 [Data item]

If the interpreter did not have such a certificate he felt he had to continue with the consultation anyway. FClín1 was also asked what he knew about interpreters' training and certification and replied:

*"Um I must say I don't know anything, really, I um the impression I've got is that some have received um obviously, obviously some things like sign language that would need specific training but interpreters who are interpreting from their own first language or their own second language I would've thought received less training. But I don't know anything about it."* FClín1 [Data item]

The clinicians had differing experiences of interpreters staying in role. FClín2 was aware that some interpreters were not relaying the questions he asked in the way he had framed them.

*"Researcher: Do you think they take over the session then, by sort of directing turn taking and topic choice and that sort of thing?  
Clinician: It has happened. It has happened. I think it's a very difficult thing because we have certain questions which we want to ask and these questions are sort of very . you know, you learn to question with experience."* FClín2 [Data item]

FClín1 by contrast had not noticed interpreters stepping out of role and controlling turn taking during his consultations although he conceded it might occur.

*"Um not, I can see that that is possible. It hasn't happened with the interpreters that I've worked with, I don't think."* FClín1 [Data item]

#### CLINICIANS' VIEW OF THEIR OWN PROFESSIONAL NEEDS.

The clinicians interviewed were asked about their professional needs and purposes and felt that their goals were not being fully met. FClín2 reported that when

interpreters were from the same small community as the patient it was more difficult to achieve trust and openness.

*“[...] it’s really vital really I think, like I said earlier for them to be neutral and impartial is very very important. I know that we’ll have some clients, not myself, but in the service who have come from a rather small community and the interpreters are from the same community and that’s caused problems because patients haven’t been able to open up as much because the person is from their own community. And that’s caused a bit of difficulty in the past. I haven’t had that personally.”* FClin2 [Data item]

His principal goal was to achieve understanding of the patient’s needs

*“I think the most important thing that we always need to do is to be able to get a proper history. And I think that’s the main goal and then that leads to the rest of it but first and foremost just to be able to get a proper history.”* FClin2 [Data item]

This part of the interview considered how easy it was to exchange information with patients. FClin1 reported that:

*“The impression that I get is that the things that I’m saying to the patient aren’t, or in some cases can’t be, translated word for word. So the information that is coming back to me isn’t translated word for word either.”* FClin1 [Data item]

His comments concur with those of FClin2 above in that without a relationship the information received cannot be built on.

*“[...] obviously the information that we get is very important but if we don’t feel like we can build up a relationship with the patient then it, then that sometimes that rela. That information isn’t worth anything really because we then can’t, can’t move forward with it or build upon it.”* FClin1

*“And obviously we would struggle if we were working with somebody that had moderate to severe learning disability we would struggle with phrasing questions and things.”* FClin1 [Data item]

The doctors interviewed had some awareness of interpreting theory and interpreter training. They distinguished between translation and interpreting and wished for ‘word for word’ or ‘verbatim translation’ as the preferred method of message relay. They were keen that interpreters be very precise in their rendering of messages,

drawing a distinction between ‘translation’ by which they meant precision and ‘interpretation’ meaning something much looser.

*[...] to emphasise on direct translations of what the patient is saying, um, and not necessarily always having an interpretation of what they’re saying.* FClIn2 [Data item]

When asked about the role and role boundaries of an interpreter in an interpreted communicative event, FClIn1 described his idea of what translation means in an interpreted event. That role is:

*“I would see the role [of the interpreter] as being a, as purely translational as possible so taking the words of the clinician and patient as closely to [what] is being said as possible and relaying between the two.”* FClIn1 [Data item]

And the interpreter’s goal should be:

*“I would think that their, their primary goal is to translate the information as closely as they can and to avoid putting in additional information or skewing the, the conversation, um in a way that wouldn’t happen if it wasn’t being interpreted.”* FClIn1 [Data item]

The interpreters’ role boundaries were not specifically mentioned but both doctors were aware that interpreters were not always delivering messages with the necessary precision:

*“It probably varies from interpreter to interpreter, I’ve had one that was really good and then another one that tended to drift off more so I did have to say well can you, is that what they said, you know, sort of thing, [...]I think it’s very important for them to be very, very neutral. I think what tends to happen is that interpreters tend to be of the same ethnicity or similar culture and they often act as a cultural interpreter rather than a vocal one which is not necessarily what we’re wanting at that time, even though that information can be useful as a sort of add-on to the interview but not as a part of it.”* FClIn2 [Data item]

Cultural briefing, or adding contextual social information, is discussed in the Delphi process section of this chapter.

Medically trained personnel acting as interpreters can impede the work of the triad as much as an interpreter would do, when they step out of interpreter role and insert their own opinion.

*"[...] one interpreter who was actually a doctor from abroad [and] was doing his conversion to be able to work in this country. [...] had got the interpreting qualifications and [...] was obviously trying to talk to me in medical terms but that wasn't what I wanted (laughs). I wanted interpretation, I wanted translation, so that was quite difficult. He kept telling me what he thought, his medical opinion was, that was very difficult."* FClIn2 [Data item]

The question about needing in-depth understanding produced responses about needing the semantic value of the original word in the original language. This is difficult to balance against preserving coherence and fluency in the interpreted version, where coherence and fluency are present in the patient's speech.

*"We use a lot of verbatim, you know, because, so the effect of thought, and the process of thought as well. So it's not just the meaning of what they're saying but it, actually what they're saying and whether it makes sense. Whether it has a flow."* FClIn2 [Data item]

FClIn2 explained that the essence of understanding a patient's problems lies in the words they choose and the structures they build.

*"[...]it's not just what they're saying but how they're saying it. It's very important not to disguise the particular. So that sort of thing, intricacy is, is vital."* FClIn2 [Data item]

The Researcher remarked that the patient's ability to understand the doctor in as much depth as the doctor believed them capable of was also an important factor, *"Exactly, exactly so."* FClIn2 [Data item]

The question and answer sequence on other aspects of the professional needs of the doctor are summed up in the following extract.

*"Researcher: [...] Yes. Do you think they're impartial, the interpreters? On the whole."*

Clinician: *Um yea, on the whole, yea. They're, I did have, going back to the same experience I mentioned before, I did feel in that situation that the interpreter was, seemed to be clear what the patient was, what the patient meant even though I didn't think that that was what the, that was, that my point had got across and therefore the patient's point hadn't come back.*

Researcher: *Yes, almost as though they're answering a different question.*

Clinician: *Yeah. yea, but the interpreter in that situation seemed to be very sure that the question had been, that both sides of things had gone, had been accurate.*

Researcher: *Yes, so that's not so much about impartiality really as about linguistic nuance.*

Clinician: *Yes but yeah I think that in terms of, yeah, I don't think there's been any partiality as such.*

Researcher: *Right, OK. What about confidentiality do you feel that they can be relied upon to be, to remain confidential?*

Clinician: *Um, yes, I mean certainly the professional interpreters, I've not seen any problems with that.*

Researcher: *Right, but you don't sound as though you feel you can treat the patient that you have an interpreter for as easily as you could with a similar English speaker.*

Clinician: *Er no. I wouldn't say so, no.*

Researcher: *But do you think there was trust established between you and the patient?*

Clinician: *Um. No. I don't, well, I, I think a um, a very kind of formal, superficial trust. But not the kind of, going back to rapport, not that kind of trust where you feel like you can necessarily open up to somebody or tell people you know very intimate things about yourself?*

Researcher: *But what about the interpreter, did you feel there was trust between you and the interpreter?*

Clinician: *Yeah I think so. A kind of, again, a kind of very professional trust, not, not, not um . not a trust beyond that. I, I think that's mainly due to my own level of experience um and knowledge about interpreters rather than anything specific that they did or said?" FClin1 [Data item]*

#### WHAT ARE THE MAIN ADVANTAGES OF HAVING A PROFESSIONAL INTERPRETER PRESENT?

Establishing an atmosphere of trust and rapport is important to gaining information:

*"I think otherwise we'd be able to get very little information [...] So I think it's a similar thing [to working with someone that has a moderate to severe learning disability] that we get as much information as we can and we have, somebody in the room has some kind of rapport with the patient even if we can't ourselves." FClin1 [Data item]*

FClin1 sees the advantages of having a professional interpreter present as:

*"[...]it feels more ethical to do it but I think actually if the translation has been provided by a family member I think that there would be, I think that*

*that can actually be beneficial sometimes in terms of the family member knowing more of what the patient means by something. If it's a particular, a way of saying something that's particular to that patient or phraseology that that family uses that other outsiders might not be so familiar with."* FClin1 [Data item]

For the clinician to trust the interpreter there must be a degree of understanding of their role and code of practice; that they:

*"[...] have that objective point of view. To be able to be impartial. To be able to, to not get emotionally involved. I mean we've had to use family in sort of emergency situations, but it always feels as if you're getting sort of a collateral history rather than a real history so um you know there's a lot of agendas that you don't know about and so we try and get a professional interpreter whenever possible."* FClin2 [Data item]

It was not felt that the trust developed between clinician and patient in an interpreted situation is as profound as the trust achieved in non-interpreted situations.

*"I think a um, a very kind of formal, superficial trust. But not the kind of, going back to rapport, not that kind of trust where you feel like you can necessarily open up to somebody or tell people you know very intimate things about yourself."* FClin1 [Data item]

This superficial trust is echoed in the trust developed between clinician and interpreter.

*"A kind of, again, a kind of very professional trust, not, not, not um . not a trust beyond that. I, I think that's mainly due to my own level of experience um and knowledge about interpreters rather than anything specific that they did or said."* FClin1 [Data item]

With trust established, patients will find it easier to talk about themselves and deeper levels of meaning may be more accessible to the clinician.

#### WHAT ARE THE MAIN DISADVANTAGES OF HAVING A PROFESSIONAL INTERPRETER PRESENT?

It is very difficult to establish trust and gain a history when the intricacy and complexity are missing from what the patient says. The doctors interviewed responded:

*“I think what I've said about the fact that they sometimes might clarify things for themselves that you don't necessarily know the clarification process of. It might be information that you're trying to get across gets lost in interpreters saying what they think is the right question when in fact the phrasing of that question might be very important to what it means.” FClin1 [Data item]*

*“Yes, definitely, definitely, um I think for us it's a big issue. It is almost everything the patients say in psychiatry, there's always a complexity with it and to be able to get that through the interpreter is very very difficult. No I definitely do experience that.” FClin2 [Data item]*

#### THE TRUST FACTOR IS DELICATE

*“Ideal is we wouldn't want anybody there. But, and I guess it's a problem because it's very easy to start talking to the interpreter and not the patient. The patient feels left out. So it's very important to be able to . but then we don't form our relationship with the patient. It's a lot more difficult with a third person in the room, to do that. So I mean even though we really are treating, we're not really doing therapy but the patient-doctor relationship is very very fraught in our work. Which can be more challenging with an interpreter there but are ways, I think with a bit of experience there are ways around that.” FClin2 [Data item]*

Many difficulties arise from the need to clarify terminology and other information, leading to long parallel conversations.

*“And then when, so you sort of pose the question to the interpreter, they ask the patient, the patient gives a puzzled look. They then have to try then to put the question and they ask two or three questions and then have to then go and take the answer and then ask another question and it gets quite, it's like you said, it often seems as if well they're interrogating.” FClin2 [Data item]*

Information can be lost even though the patient has tried to convey it

*“I think what I've said about the fact that they sometimes might clarify things for themselves that you don't necessarily know the clarification process of. It might be information that you're trying to get across gets lost in interpreters saying what they think is the right question when in fact the phrasing of that question might be very important to what it means.” FClin1 [Data item]*

The interpreter is also an influence in garnering nuanced information.

*“[...] there was one experience that I had with an interpreter [...] it was a very important point of the particular case and it just couldn't be quite translated clearly and that caused some difficulties but I don't think it was the fault of the interpreter themselves I think it was the, I think partly the*



*experience of the interpreter in terms of working with mental health patients. I don't know that she'd worked with them before."* FClin1 [Data item]

IS THERE A QUALITATIVE DIFFERENCE BETWEEN THE WORK OF INTERPRETERS PAID BY THE NHS TRUST AND OTHERS?

We discussed interpreter training and FClin2 remarked that there is a qualitative difference between family or community members' interpreting skills and those of some professionals.

*"Oh, of course, I think definitely. Particularly interpreters who have the qualifications and the experience of working in mental health. I think there's a big difference because, I think just having the experience when you come across a good interpreter and the patient's voices have said something which is quite unusual you know you don't get that puzzled face which I spoke of and I think patients find it easier to open up if they have that training."* FClin2 [Data item]

By contrast FClin1 had found that interpreters' understanding of mental health and command of medical terminology and concepts was lacking, which made explanations to the patient tortuous.

*"But sometimes things just can't be gotten across. One, one I mean the example that I remember most clearly is um, is when there was a patient who was, he was said to be displaying aggression, anger and aggression but it seemed to be that she was having some kind of neurological episode like an epileptic seizure and it was very hard to differentiate between the two. And there were, and it, and the interpreter was, the interpreter couldn't give across a differentiation between problems with people's emotional health and problems with people's um, so problems, the difference between the mind and the function of the brain."* FClin1 [Data item]

Establishing doctor-patient trust is fraught in any case, but more so when working across language and culture. Clinicians find that a third or fourth presence is an intrusion.

Clinician: *"Well, definitely. Ideally we don't want a third person to get involved."*

Researcher: *"You don't want an interpreter at all."*

Clinician: *"Yeah. Ideal is we wouldn't want anybody there."* FClin2 [Data item]

Accessing the information is also related to trust in that the interpreter can prevent or obscure, or “disguise the particular”. In this regard one clinician had insight to the interpreter’s work while working with Urdu speakers.

*“I had one experience where there was a, ‘cos I understand Urdu but I don’t speak it. So I worked with one patient for a year, who used an Urdu interpreter so I would, I was sort of aware of what was being asked but I still went through the interpreter so that I didn’t lose anything that was said. But that gave me a good insight to be able to . realise what was being questioned.”* FClin2 [Data item]

Clinicians talked about the checking procedures that interpreters engage in, which they experience as being predominantly between interpreter and patient, rather than interpreter and clinician.

*“[...]the interpreter was, seemed to be clear what the patient was, what the patient meant even though I didn’t think that that was what the, that was, that my point had got across and therefore the patient’s point hadn’t come back.”* FClin1 [Data item]

FClin1 noted that the interpreter carried out their own line of questioning before relaying any patient response to the doctor. This exercise was referred to as “*it often seems as if, well, they're interrogating*”. FClin2 [Data item]

*“[...]usually by kind of, the patient would seem to ask a question that the interpreter would then kind of clarify themselves and get the meaning of, and then come back to me. And then I would try and clarify something and that would go back to the patient and have further clarification and they seemed to do it in a lot of detail. I wouldn’t always know what the kind the, what the exact first question was but it would usually be clarified by the interpreter.”* FClin1 [Data item]

The Clinicians acknowledged the contribution to rapport that interpreters can make:

*“I think for all of us to feel comfortable it has to be a three way thing. But I have, I think that’s probably why I felt comfortable because they were able to be comfortable amongst themselves as well. So yeah I think it’s very important for the person to be personable and to able to, be warm, I think, receptive.”* FClin2 [Data item]

For the patient to trust the clinician there must be a relationship built on paying attention. FClIn2 was aware of this and had developed the habit of speaking to the patient.

*"I think, what I try to do and I don't know whether it's right or wrong but I always talk to the patient so even though, I try to interact with the patient so I will ask the question to the patient, and not to the interpreter, and then so I try and make it seem as if I am having a conversation with the patient."*  
FClIn2 [Data item]

IS THERE A DIFFERENCE IN STYLE OF WORK FROM ONE PROFESSIONAL INTERPRETER TO ANOTHER?

(Looking for evidence of a model being used)

Interpreters working in consecutive mode will deliver chunks of relayed speech by one or the other party to the conversation. In an attempt to understand how the interpreters were working, either listening and taking notes or delivering very short chunks, the doctors were asked to describe the working practice they witnessed.

*"The chunks as long as they're reasonable I am happy with, if they're too short then you don't get the flow, if they're too long then I start feeling left out and I don't think I get the true picture because it gets filtered."* FClIn2 [Data item]

When asked if he felt that interpreters insert their own opinions into their interpreting Clinician 2 responded: *"I think so. I think that it's very difficult not to."* [Data item]

*"The impression that I get is that the things that I'm saying to the patient aren't, or in some cases can't be, translated word for word. So the information that is coming back to me isn't translated word for word either."*  
FClIn1 [Data item]

Asked if interpreters interrupt to interpret when their mental buffer is full

*"Clinician: I think once again it varies usually. But I have had interpreters who have stopped the patient saying 'well let me get the doctor up to speed' and then they'll bring me up to date and then said 'we'll now carry on'. And so I have had that yeah.  
Researcher: Do you think it has a detrimental effect on what's going on when they do it like that?"*

Clinician: *It can do. It can do. Sometimes I think it's necessary if the patient's rambling on a bit.*

Researcher: *Yes, it's [time limited]. Have you ever noticed an interpreter taking notes while they're listening?*

Clinician: *Eeerrrr. . No. No.*” FClin2 [Data item]

Other elements of the models shown in the taxonomy include giving advice and opinions, and FClin2 responded to the question:

“Clinician:*Um. I don't think, I haven't had any experience where they're giving advice about what to do, but I've had interpretations of what they think the patient is saying or experiencing. [...] So I don't think they're actually saying 'well go and have a paracetamol' or something like that but, or 'go and see so and so' but I think they'll tell me 'well actually I think that they're hallucinating' or whatever. I have had that.*” FClin2 [Data item]

The doctors were asked if interpreters explain complex terms to patients.

“*Oh, I think they try. But sometimes things just can't be gotten across. One, one I mean the example that I remember most clearly is um, is when there was a patient who was, he was said to be displaying aggression, anger and aggression but it seemed to be that she was having some kind of neurological episode like an epileptic seizure and it was very hard to differentiate between the two. And there were, and it, and the interpreter was, the interpreter couldn't give across a differentiation between problems with people's emotional health and problems with people's um, so problems, the difference between the mind and the function of the brain.*” FClin1 [Data item]

In answer to the question “do interpreters ever ask you to clarify terms?” FClin1

replied “*Yeah, they would sometimes but usually for very technical concepts.*” [Data

item] and when prompted to say if the interpreter intervened in both languages or

not, said

“*It hasn't seemed that way. It seemed more like, it's been the interpreter has paused, turned to me, asked me a question, I've clarified it and then she's gone back to the patient. Rather than explaining the pause.*” FClin1 [Data item]

Rendering register accurately is important to understanding. Complexities in patients' speech mean doctors need to tease out exact meaning.

*“I think that would come through our attempts to clarify. I don’t know that that would come across straight away. I think that they would probably initially say something quite basic, if that makes sense, and then we would try and tease out the exact meaning of it, the exact content of it.” FClIn1 [Data item]*

Idiomatic expressions are very difficult to relay simply.

*“I think it completely varies depending on the interpreter. I’ve had once again the Arabic lady trying to explain things, I can’t think of any examples but I remember her saying ‘oh that’s an expression that they use’ kind of a thing. And then say, you know ‘cos there’d be a bit of a smile and a smirk and I wouldn’t really understand so I’d ask and she’d say ‘well, that’s a kind of expression that they use for this’.” FClIn2 [Data item]*

The taxonomy on page 54 shows that both the advocacy and community models include interpreters challenging doctors if they perceive racism or other behaviour to object to. Both doctors reported that they had not experienced such an event. Nor had either of them needed or experienced the use of sight translation.

#### A QUESTION SEEKING THE TREATMENT OF AMBIGUITY OR IMPLICATURE.

Question: Do you find that there are sometimes difficulties in the consultation when deeper levels of what the patient says seem to be left out or simplified? (looking for ambiguity or implicature.)

This question seeks to understand how interpreters deal with ambiguity and implicature; the difference between what was said and what was meant.

*“Yes, Yeah. I think there is a lot that can be lost. Because the, when you're clarifying a symptom there's often quite a few questions that you can ask about it. Sometimes we ask fewer and sometimes we ask more. But with the cu.. It's mainly I think a time factor with using an interpreter that you just don't have time to answer, to ask that level, that number of questions to clarify things and people, anyway people won't necessarily put up with being asked that many questions in that, over that space of time. I think that's the main difficulty that you have to narrow your questions down to ask very specific things. And sometimes you get to a point where the questions that you're asking you're just not getting enough answers, enough, clear enough answers in order to then move on to the next question. So I do think that something can be lost.” FClIn1 [Data item]*

Both doctors found it challenging to clarify ideas through an interpreter.

*“Yes, definitely, definitely, um I think for us it's a big issue. It is almost everything the patients say in psychiatry, there's always a complexity with it and to be able to get that through the interpreter is very very difficult. No I definitely do experience that.” FClin2 [Data item]*

A QUESTION SEEKING RESPONSES TO FACE THREAT.

Question. Have you ever felt that the interpreter is defensive of the cultural group they share with the patient, or for some other ‘face’ reason, leading to the patient’s message being changed or shortened? (looking for face threat)

The question of potential face threat causing circumlocution or altered messages was recognised by FClin2 but not as direct experience

*“I think so. I think so. It's definitely a possibility whenever, yeah, I'm just trying to think of an example. I don't think it's happened to me that blatantly but I've heard of it happening as such. But when it has happened it tends to be 'but well, these kind of things will happen in our community' kind of a thing. But it hasn't happened to me personally.” FClin2 [Data item]*

FClin1 had not experienced it either, *“No. Not in my experience no.”* [Data item]

A QUESTION ON THE SUCCESS OR OTHERWISE OF THE CLINICAL ENCOUNTER.

Question. When you reflect on a typical interpreted interview, how well do you feel it met your professional needs and the needs of the patient?

The quality of outcome is made of several variables; for FClin1 the journey to an appropriate conclusion was not optimal.

*“I would say about, probably about . 60 percent. If the aim was for, kind of, I, it's very difficult to meet all needs on both sides, but if the aim was kind of 80 to, 70 or 80 percent I would say 50 to 60 percent. I think that the conclusion was the right conclusion, but the journey getting to it could have been better on both sides.” FClin1 [Data item]*

It seems to depend on the interpreter.

*“Clinician: Once again it depends on the interpreter. But I think overall my experience has been quite satisfactory. I haven't had, other than one or two, I haven't had bad experiences and they've often, you know, often it's taken a lot longer and we've come back and started again on a different day but um overall we've been able to get where we wanted. And then ..*

*Researcher: .. So you've been able to diagnose and you've been able to discuss a care plan*

*Clinician: Yes.*

Researcher: *and all the things that you feel you need to achieve during those sessions - eventually*

Clinician: *yes. Eventually; eventually we've got there but it has taken a lot longer than it would've taken with an English speaking patient.*" FClin2. [Data item]

Interpreters' views have a different focus to those of clinicians, but there is also some synergy. For example FClin1 declared:

*"And sometimes the, a diagnosis or a set of symptoms can hang very much on the way that people word things and the way that people describe things and sometimes that's difficult to get across."* FClin1 [Data item]

### **4.3 Professional perspectives. Interviews with Interpreters.**

The Clinician's summary of need expressed above is mirrored by the interpreter's statement of intent:

*"You know actually this is a complex phenomenon basically . translating in the mind, [...] to give the right expression. The right essence of the thing that a person wants to convey to the other person."* FInterp7 [Data item]

The focused interviews conducted with interpreters were arranged in 3 sections a) personal perceptions and understandings of their professional practice b) vignettes as prompts for reactions to stressful situations c) the same satisfaction questionnaire as was applied to the filmed observation interpreters (OInterps). The topics covered are set out here in the order of the topic guide (in the appendix) although the conversation was not rigidly controlled by it. The interpreters in the focused interviews are identified as FInterp1–10, though the numbers are not contiguous, 2 potential interviewees (numbered 2 and 8) having dropped out. All the interpreters in

this group were generous with their time and willing to talk. Their length of experience in public service interpreting provided considerable insight.

#### SECTION 1.

##### HOW DID YOU COME TO WORK IN THIS FIELD?

Entry into the profession followed a pattern across the range of interpreters interviewed. There were domestic and childcare issues for the women; the fact of being brought up to speak more than one language was common to them all; as was working through local interpreting agencies and being listed on the NRPSI.

FInterp1 mentioned motivation 5 times and spoke of her domestic situation as an influence in her decision to train as a public service interpreter.

*“Thing is I got three children so I need to keep a job I couldn't live on just interpreting.”* FInterp1

*“Something I could do on an ad hoc basis and this advertise [sic] came up so I thought well you know I'm bilingual why not try it?”* FInterp1 [Data item]

FInterp1 was very enthusiastic about her work and used the phrase “I love...” twice while talking about the job:

*“I love every single time I go out because you always come back with a new knowledge you know.”* FInterp1

*“I love working, because I learn and it's really new things and it's broadened my knowledge and improved my vocabulary as well.”* FInterp1 [Data item]

FInterp3 made a very short, pragmatic response and talked only of her first job:

*“So I went out to see her and that was the start and she then asked for me again the second time.”* FInterp3 [Data item]

FInterp4, like FInterp1, saw her choice of professional occupation in part as controlled by domestic and childcare constraints.

*“I had my babies and everything. And then in about 2003 this advertisement in the paper that they're looking for bilingual people.”* FInterp4 [Data item]



She took satisfaction from the different kinds of interpreting work offered her,

*"[...] obviously as I became an interpreter there are all sorts of assignments that are offered to you and um mental health is one of them and yeah I quite enjoy doing that."* FInterp4 [Data item]

and was motivated to some extent by familial mental health associations,

*"My father actually has bipolar so I think that was part of, it became more of an interest in mental health then [.....] and then my brother is a psychiatrist."* FInterp4. [Data item]

FInterp5 was motivated and inspired by close contact with mental health patients in her family. Her uncle suffered a mental health problem and her brother has also overcome a mental health problem of his own and gone on to become a doctor:

*"My uncle, one of my uncle [sic] was, had a mental health problem. My mum's brother."*FInterp5 [Data item]

*"[...]my own brother he was, he doesn't have very sort of serious kind of mental health issues but he has some sort of mental health issues which are because of his illness when he was very young. [...] and the way he has lived his life [...] he worked so hard, so hard that he was like day and night working and he did qualify as a doctor."* FInterp5 [Data item]

FInterp6 also spoke only briefly of how he came into the interpreting profession and into mental health work, saying simply:

*"[M]y first assignment probably was with (agency). [...] They actually deal with the (city) area's interpretation services or something like that and then first time they gave me a job in (town), and I went there and then the social services people took me to a house of a person who was basically mentally ill. Basically he was depression, a very chronic patient of depression. So that was my first opportunity to actually do interpretation in the mental health sector."* FInterp6 [Data item]

FInterp7 made a single short statement listing all the public services bodies and related medical organisations with which his name was registered as an interpreter and said, *"Anybody can call me anytime."* [Data item]

FInterp9 said only:

*"When I came to this country, I started, I was learning the . I went to college to improve my English, my spoken English wasn't, you know, I was a bit shy in speaking. I could understand but I couldn't . speak as good, I would say so I went to college and from there it was the first diploma I did called 'Bilingual Employment Diploma Course', from there it came to my attention that there is a need for interpreters."* FInterp9 [Data item]

FInterp10 had been training and working in a variety of professional and voluntary occupations for well over a decade. For nine years she was a social worker, having qualified in Pakistan. Then she went into the voluntary sector in various capacities.

Eventually she discovered public service interpreting:

*"I joined the interpreting because it's quite flexible hours and that is suitable for me, now that I want to work I'll work and when I don't want to work I don't work. And that was the main reason. And I stick with that and it's been a long time and I still enjoy it after such a long, long time I've got a lot, a lot of experiences. And you know just I am enjoying that and this is something which is your choice. This is quite er you know suitable for me."* FInterp10 [Data item]

There was a belief among interpreters that being bilingual was the only linguistic knowledge they needed.

*"I went into the health side of it because I was native speaker you get the knowledge and the research so that's how."* FInterp1 [Data item]

*"[...] for most of the community who need actually language help is Punjabi. Now Punjabi is not written quite often in Pakistan. Very rarely. In India it is written. So those people whose sort of written language or national language is Urdu but the main spoken language is Punjabi so their level of Urdu is very low. So obviously you have to try and explain the words."* FInterp5 [Data item]

*"Cos there's no, apart, Punjabi is not a kind of a language it's just a spoken thing."* FInterp9 [Data item]

They talked about how big an influence the presence of the interpreter or the lack of an interpreter is in causing patients to withhold information.

*"My own opinion for mental health is that the people, specially the Asian community hide things a lot. They don't express, and sometimes they are embarrassed as well. Especially when they are with the partners, and they probably say "oh, well no, no she's alright and this is just the doctor saying*

*these thing that she's depression [inaudible] and that."* FInterp10 [Data item]

*"Just going that one step further to make sure that the patient is at ease therefore she'll be more likely to express her opinion and basically just trust us a bit more."*FInterp3 [Data item]

*"[...] yes, yes they can yeah because it's like, I said professional people sometimes do get more from them and if they are not interested in anything then obviously I say they don't want to talk about that."* FInterp10 [Data item]

This part of the interview provided some understanding of why people chose this career and what keeps them working in it.

#### APPROXIMATELY HOW MANY HOURS' WORK A MONTH DO YOU DO IN MENTAL HEALTH?

The interpreters declared between 3 and 12 hours work a month, as shown in Table 3 on pages 194-5

#### A QUESTION ABOUT WORKING PRACTICE AND MODEL USED.

Question. Please describe your approach to interpreting for mental health interviews. [model used – against rating scale, technical skills].

In response to a question about sight translation, which forms 30% of the DPSI exam, it was a technique only one of the interpreters practised. One replied that there is no material available in Punjabi; another said there are translation services available.

*"I do. For mental health it's mostly reading the rights of the patient under the mental health act. They are long documents."* FInterp4 [Data item]

*"Women and men. Some men are, well quite a few men are like that as well but what happens is when it comes to the leaflets, the patients are provided with the leaflets they are trying to give them the leaflets in their own language, which is useless. If they can't read and write how they gonna use that? And sometimes some people have a, like we have a Punjabi, Pakistani-side Punjabi, and they have an Indian Punjabi as well. But their writing*

*version is completely different even though the spoken language is quite similar. So they are trying to give them same written version of Punjabi for everybody which is the Indian Punjabi.*" FInterp9 [Data item]

*"I always correct them, saying you won't be able to find the written Punjabi for Pakistani community because it's not available."* FInterp9 [Data item]

*"Oh, no, sight translations are not there, we, there are translation services which do these kind of jobs."* FInterp10 [Data item]

*"There's a computerised thing and if somebody wants a translation of the letter that's something we tell them. Before that, in the beginning, there were no computer, er no disk available, so I used to translate some of the letters as well. But since this computerised things and disks are available there are special people who do it. And they get a translation course which I haven't done it. So it's only interpreting courses I have done."* FInterp10 [Data item]

#### MODALITIES OF INTERPRETING IN USE

Whispered simultaneous mode had greater recognition among the interpreters than among the clinicians and some interpreters had received specific training in it.

FInterp3 would not use it in mental health work.

*"Not in a mental health setting no because most of those are conversations either at the hospital and the other person will stop. The whispered simultaneous is mainly for court work."* FInterp3 [Data item]

FInterp5 would not use it in mental health either but was familiar with the idea.

*"I haven't. I think it might be difficult as well because simultaneous can, does work sometimes, sitting in the back of the court but I think in a mental health situation it might be a bit difficult. Because there depending what kind of mental health they have the problem, it might be difficult for them to pick up. And because if people in normal health obviously if you miss out something or they want to ask questions they would but mental health patients they might not be able to grab all of it. It might be a bit difficult but I haven't come across that side of it, no."* FInterp5 [Data item]

FInterp10 seemed to confuse simultaneous mode with consecutive mode. After a short explanation of simultaneous mode she said:

*"Interpreter: Aaaahh. Mmmm mmm. Nnot really no. If I don't understand anything, I don't [change them all] I ask the professional to explain in a simple way so that the clients can understand because sometimes their language is difficult [...]"*

Researcher: [...] yeah so would you be able to, or do you ever deliver that at the same time as the patient is speaking?

Interpreter: Yeah, no mostly I had to wait until the sentences is finished on both side. One or two sentences because then I said I can't remember more than that." FInterp10 [Data item]

FInterp9 had tried to use it in a case conference setting but had been defeated by lack of appropriate equipment.

*"I have done that in the past and I find a bit difficult. Especially I have done that in a group session. There's no microphones there's no listening devices there's nothing; there's just a open group and you have to simultaneously interpret for everybody and they can't hear you . They can't do . you know it's no setting for simultaneously but they try to."* FInterp9 [Data item]

She had not used it in a consultation.

*"I never been, never been given the chance. Never been asked to do that."* FInterp9 [Data item]

Others said they have, or do use the technique and like it:

*"Sometimes I have used yes. And obviously I wouldn't advise it in mental health act assessment that if there has been cases where they've been talking and I have used it. I would say it's very um probably the best method in mental health, and would recommend it."* FInterp1 [Data item]

*"I have for one of my cases, there was a lady who was really, she had paranoid schizophrenia and she was talking about that there is a television in her brain and she sees movies of such and such people and she hears voices. And she was just storming ahead with all these ideas and I was whispering I was doing whispered simultaneous for the psychiatrist at that point."* FInterp4 [Data item]

*"Yes, I did. I did simultaneous as well because the officer who was with me at that time he said to me 'whatever he has to say you have to translate it whether it's relevant or not'. So when he was saying something irrelevant, different things, that was nothing to do with that specific interview, but I continued to talk and I continued to interpret you see."* FInterp6 [Data item]

*"[whispered simultaneous mode is] well accepted yes it is well accepted as long as they are talking at the pace you can keep up with yes it works"* FInterp1 [Data item]

*"Yes actually in mental health the situation is not that of conflict. There are no two parties fighting over something so it's very sympathetic and nice. Each person talk. So there is no . not many times I think. Might be a few. So mostly there is no purpose of conflict."* FInterp7 [Data item]

It was well received in one clinic

*"Well you know because the psychiatrist was just sitting there listening and this patient was just going on, and on, and on and she had all these vivid things she was talking about and her dreams and her children were not her children and they actually wearing masks and you know she was going in great details about this so I was just doing whispered interpreting for the doctors there. And I think it was really, they were finding it really helpful, they were firing questions back and forth."* FInterp4. [Data item]

Consecutive mode was the most widely used in the interpreters' working practices.

*"[...] no mostly I had to wait until the sentences is finished on both side. One or two sentences because then I said I can't remember more than that."* FInterp10 [Data item]

*"No there it's consecutive mostly I use. I just listen from one, go to to the other."* FInterp7 [Data item]

*"Uuum no well I would stop them and say 'I haven't finished yet'. So I will ask the question, the person will stop, I will give the answer."* FInterp3 [Data item]

*"Yes we do consec. I do consecutive as well, while I'm taking notes."* FInterp4 [Data item]

Some technical skills are obviously taught but the data shows inconsistency in the training received.

IF YOU TAKE NOTES, PLEASE SAY WHAT SORT OF THINGS YOU NOTE? WHICH LANGUAGE DO YOU MAKE NOTES IN? [Indicates professional training].

Some of the interpreters reported taking notes while listening, as an aid to memory, others did not take notes:

*"We, I do three languages and the main language is Urdu so I always take notes in Urdu if the person with depression he was saying something, so I was taking notes in Urdu, and when the social service officer was talking at that time obviously I was taking notes in English. So the other languages like Mirpuri and Punjabi. Mirpuri is a dialect so if you want to write something Mirpuri you always have to write in Urdu you see. So I was basically taking notes in Urdu you see. Punjabi is also written in Urdu."* FInterp6 [Data item]

*"No notes, no we don't do anything in writing until it's necessary. No writing. [...] well until we want to remember something want something to you know explain to the doctor, er, professional, then I just note in case you know sometime I have to tell him because after that sometime in a counselling session, they want my opinion as well. And then I write few things and I tell*

*the client that I will tell this professional about it. And then I explain that, that's in only counselling some social services settings." FInterp10 [Data item]*

*"I don't actually take notes a lot, I only take notes if I have to write numbers and days and times a lot of them kind of thing." FInterp5 [Data item]*

*"I mean notes are a key thing when you're interpreting you must have notes. I mean I take less notes than I used to because as you gradually become experienced you seem to take more on board. And it always helps if you got continuity of the, that person you've worked for you know, if you've worked for that person you know the background history, it helps, you know to have the smooth conversation, you can say, or smooth meeting." FInterp1 [Data item]*

*"So in that sense when I process, as I said I am constantly making notes, of course if I compare two situations - if I have been working with that patient then of course if a conversation goes slightly longer then of course I would still take notes and I would be well on board because I do know the previous history of that person because I've worked. But if I was the first time working with that person then of course I will make sure the notes." FInterp1 [Data item]*

There are perceived constraints however and some interpreters are cautious about notes.

*"[... ] the thing is within the interpreting sort of training, the thing is if you do take notes you can jot things down for yourself but you are not to give it to anybody, you are not a, you know as a . and it can bounce back on you later on. Because we are not health advocates in other words, we are interpreters there is obviously a difference if you're working as an advocate for them in a mental health circumstances um end of the day you've just got to do what you've got to do. Because health advocates, we've had other people getting trained on health advocacy actually go and say things on behalf of the patient rather than what the patient is saying themselves. So yea, so that's why I don't often take notes. Very occasionally I have jotted things down for myself if there was a for example the . , if anything legal comes up of the section, of law or something or whatever because we are not experienced in that and we can't memorise all those things because that's the kind of thing I would write down. But not normal spoken conversation or for example if there's a name of a medication or how much to give to the patient or whatever, to tell them. Then I would jot that down to be sure that I'm telling the right thing and it's for them to take, yeah." FInterp5 [Data item]*

## DIFFERENCES IN APPROACH IN DIFFERENT WORK DOMAINS.

The interpreters differentiated between the techniques and practices they use in different work domains:

*"[when producing written translations] we can just stop, open a dictionary go to dictionary.com on computer and try to find the right word and put that on the translation but while interpreting you don't have any help like this so you have to put some word in place whether that is fully expressing what . , but this, this expresses the impression. The thing. " FInterp7 [Data item]*

It was clear that of recent time several of the interpreters had been earning the bulk of their livings in court work.

*"Before I became a MET [Metropolitan Police] interpreter then I used to be more or less all the time like with mental health teams with social services as well as the mental health hospitals you know." FInterp5 [Data item]*

*"I do take um occasional bookings now for hospital appointments in mental health but not very often because obviously when you are working for the police and in the courts, with my language I'm quite busy as well and it all depends on finances and this and that you know whatever the rates are." FInterp5 [Data item]*

FInterp5 drew a distinction between relaying the meaning and relaying a “proper translation.” The remark about the use of “proper Urdu language” and the perceived need for “translating the meaning” instead of “word to word” could indicate some change in the message and a different attitude to output as a result of the setting.

*" If I, because, with our language if I speak Urdu to people obviously it's er, proper Urdu language the level is quite high even for our own community. And so what we do is we try to obviously translate the meaning rather than proper translation word to word." FInterp5 [Data item]*

To this interpreter ‘word for word translation’ is only appropriate in certain domains:

*"Well the thing is with regards to interpreting obviously when we do interpreting in different fields it's a different sort of a things that we keep in mind because example like courts and stuff and the police and stuff you know you have to sort of see that legally you know word for word and whatever.*



*But in mental health sort of environment I think it is quite different." FInterp5 [Data item]*

She seems to take personal responsibility for gauging a patient's level of comprehension without reference to the doctor.

*"Because first of all I personally think that a language can not be done, translated word for word because with regard to mental health ability and the illness or whatever the situation is of the person they might not be able to understand the words we are translating." FInterp5 [Data item]*

Several interpreters referred to their belief that interpreting in mental health is a different undertaking, perhaps a less rigorous or demanding activity than interpreting before the courts; or perhaps the need for detailed accuracy in medical work is sacrificed to a fluency and coherence that is not always present in the original speech, as occurred with OInterp4. This idea features in the discussion in Chapter 5.

The fact that whoever is speaking stops speaking when the interpreter begins to use simultaneous modality suggests that there was no introduction of working practice at the outset.

*"[Whispered simultaneous mode is not appropriate] in a mental health setting no because most of those are conversations either at the hospital and the other person will stop. The whispered simultaneous is mainly for court work." FInterp3 [Data item]*

Indeed, this same interpreter drew a distinction between the protocols of legal work and those in health interpreting:

*"So I'll [introduce myself and explain how I work] in any setting. Except in court, because it's being tape recorded obviously so we don't have to introduce ourselves in that way." FInterp3 [Data item]*

Court work seems to impose a much clearer focus on process and the need for accuracy than medical work does:

*“And then when we go into court I will explain just before we go in that if there is anything you don't understand you can ask me again, it doesn't matter how many number of times but then I will always go back to the person asking the question, whichever counsel it is, to say 'I don't understand the question', then it's up to counsel to re-phrase it's not for me to explain again. But I think that comes with years of experience when I've been in situations when I've had to swear at the Crown Court Judge, which wasn't very nice.” FInterp3 [Data item]*

It appears that what interpreters expect of legal professionals *“[...] then it's up to counsel to re-phrase it's not for me to explain again”* [Data item] is not applied to doctors' questions which are routinely rephrased in this data, without reference to the speaker, during the parallel conversations reported by clinicians. Rephrasing of doctors' questions is reported by only two interpreters as something they would proactively seek:

*“I would keep, obviously keep interpreting but um or if there is some misunderstanding between the patient and the clinician I will point that out 'I think my client hasn't really understood, hasn't grasped - can you explain' or I would try to explain what my client is trying to say.” FInterp4 [Data item]*

*“I ask the professional to explain in a simple way so that the clients can understand because sometimes their language is difficult.” FInterp10 [Data item]*

Parallel conversations that exclude one of the interlocutors did take place,

*“And with obviously with the mental health you always end up having um two or three different types of conversation.” FInterp1 [Data item]*

It was not exclusively so however.

*“Yes, I will, I've not been pulled up on it as such but I will try to get the other party involved and say 'look, this is what we're discussing so please don't feel left out, this it's what it's about but I'll come back and explain'.” FInterp3 [Data item]*

On this evidence, the interpreter's role is understood by interpreters with some differences in practice.

PLEASE DESCRIBE THE INTERPRETER TRAINING AND CERTIFICATION YOU HAVE.

(Table 3 shows the qualifications held)

Interpreting requires a high-level command of both language and technical skills, as well as an understanding of ethics and good practice. There are nationally recognised and accredited examinations available, and courses leading to those examinations. The focused interviews aimed to elicit information on the interpreters' educational background and professional training.

All the interpreters interviewed began their education in Pakistan. FInterp3 spoke about her schooling there. Asked what the first language she learned was, FInterp3 replied:

*"[My] youngest memory is speaking dual because I was sent to an English school even in Pakistan as a youngster. I moved to the UK when I was 8. I was 8 three days after we arrived here. So I can remember speaking English even when I arrived. Doing English lessons at primary school but I still went to a grammar school at age 11. So my English must've been good because I was only one of 2 children that went to a grammar school in those days."* FInterp3 [Data item]

FInterp 5 had 20 years' experience in the profession which means that she could have been listed on the NRPSI on the simple basis of hours worked and a BSc.

*"I haven't [had interpreter training], I've had small training sessions like with the health with Council departments and this and that but they are just one day training sessions like people come and they talk about, like for example mental health training for interpreters we talk about you know how do they want us to do what and this was like about 15 years back. [...] but it's more knowledge rather than a qualification I would say."* FInterp5 [Data item]

The setting up of NRPSI in 1994 saw the introduction of nationally agreed criteria requiring training prior to professional practice.

#### COLLEGE TRAINING. WHAT CERTIFICATION WAS GAINED?

*"I did my GCSEs and my A levels and I was studying to be a doctor. And I did two years of MBBS and then I got married and I moved to England."*  
FInterp4 [Data item]

Then she moved on to motherhood and interpreter training.

*"Okay what happened was I came over to England and I had my babies and everything. And then in about 2003 this advertisement in the paper that they're looking for bilingual people. And I decided to apply, I applied and had an interview, got selected and you know obviously I did my training and the DPSI."* FInterp4 [Data item]

The Local Government option of the DPSI exam was referred to by the interpreters, 4 of them holding a DPSI in that option. This interpreter also held the DPSI in health.

*"[...] then there was some sort of, an element of that was covering mental health and because it was in public service interpreting in the local government setting."* FInterp4 [Data item]

#### HIGHER EDUCATION. WHAT CERTIFICATION WAS GAINED?

Table 2 shows a BSc, 3 MAs and 3 PG diplomas degrees in English-based subjects.

#### DO YOU HAVE ANY OTHER TRAINING OR QUALIFICATION THAT YOU FIND USEFUL IN YOUR WORK?

Interpreters' mindset is important to keeping them in the profession, and those who took part in ongoing training worked hard at it. This group of interpreters demonstrated a willingness to engage in lifelong learning as we can see by the educational achievements in Table 2.

FInterp9 spoke some English on arrival.

*"When I came to this country, I started, I was learning the . I went to college to improve my English, my spoken English wasn't, you know, I was a bit shy*

*in speaking. I could understand but I couldn't . speak as good, I would say so I went to college and from there it was the first diploma I did called 'Bilingual Employment Diploma Course', from there it came to my attention that there is a need for interpreters."* FInterp9 [Data item]

*"I have, through NHS I have done child protection and all these sort of little trainings they put, trainings they provide us with past few years like working in palliative care and I've got quite a few of those certificates."* FInterp9 [Data item]

FInterp10 arrived in the UK with an MA in social work, and she continued to develop her skills by a variety of means.

*"[...] in the UK yes, I did a lot of courses here. The first one was in 1990, I did the PGCE, in education actually."* FInterp10 [Data item]

*"And then I did the diploma in public service commission, for interpreting in the health service".* FInterp10 [Data item]

*"[...] then I got the cross cultural Certificate for counselling, cross-cultural approach."* FInterp10 [Data item]

*"And then I did a lot of courses while in-service training, like mental health, special need."* FInterp10 [Data item]

FInterp1 studied British Sign Language and gained insight into deaf culture as well as different linguistic forms and the physical representation of language.

*"I mean I've completed level one of BSL British sign language I wanted to train that but I have entered to level II and am finding it really difficult with um work, full-time work and study and that demands huge amounts of your time and commitment and to be er, actually working with that community to be able to gain the skills, so that was interesting gave me kind of insight to how we see um and how what perception we have of them and what perception they have of us you know."* FInterp1 [Data item]

She and FInterp4 enthused about their work and the new knowledge it constantly brought them.

*"I love working, because I learn and it's really new things and it's broadened my knowledge and improved my vocabulary as well."* FInterp1 [Data item]

*"You have to sort of keep reading books, you know you have to be inquisitive and always wanting to learn."* FInterp4 [Data item]

FInterp5 was curious about what her cognitive processes were, when she interpreted.

*"So on the other hand when he's finished and I turn my head round to the other person who I'm interpreting for and obviously visualising him then automatically the, that language, because that's his language, so I transfer myself into that language. I think it's more visual, the way you are sitting and the way you are looking kind of thing, because well otherwise I don't know what I think really because that's a kind of different or difficult question."*  
FInterp5 [Data item]

#### A FURTHER QUESTION ABOUT A MODEL BEING USED.

Question. Thinking about the process of changing the language while you are working, do you follow any code of ethics or conduct, or keep to any particular procedures? [Seeking a model being used – against rating scale].

The role of the interpreter is not uncontested in the general field but this group showed understanding of their role boundaries. The clinicians mentioned rapport with their patients as being very important even if, in an interpreted triad, it could only be established between the interpreter and the patient. Interpreters are also aware of this.

*"[...]yes, yes they can [speak as they wish] yeah because it's like, I said professional people sometimes do get more from them and if they are not interested in anything then obviously I say they don't want to talk about that."* FInterp10 [Data item]

It was suggested that establishing a rapport with a patient one has never met before, in just a couple of minutes, takes empathy and skill. The word 'intimate' was used by FInterp7 who clearly saw this opening part of the interview as his opportunity to establish a trusting relationship:

*"First thing that I always find very useful, Jan, is in this respect is just . I try to be very intimate with the patient. So that helps a lot. Even if they can . I mean in their subconscious they put it at what I think that 'he is my friend, he*

*is for me, he' . So they take me like a friend. They do not show any aggression behaviour."* FInterp7 [Data item]

*"Yeah I go with a very sympathetic and very friendly with them, with the person who I am going to interpret for."* FInterp7 [Data item]

However there was recognition of the fact that this is also a professional relationship:

*"I'm very conscious of the person who I am interpreting for because obviously they have to be reasonably in stable mind to be able to answer the questions being asked."* FInterp1 [Data item]

*"That would put her at ease, so I personally feel that that's not part of interpreting however if it's going to put the patient at ease and it works both ways that is something that I feel I ought to be doing anyway. Just going that one step further to make sure that the patient is at ease therefore she'll be more likely to express her opinion and basically just trust us a bit more."* FInterp3 [Data item]

FInterp5 indicated personal feelings of being responsible to her community:

*"[...] you're working basically for the community, you're working for your own community and for their sort of um for them to get better basically and you are - I feel like this is being half doctor rather than just an interpreter."* FInterp5 [Data item]

Explaining working practices to the patient was believed to be part of the interpreter's job:

*"Right at the beginning of interpreting I will explain who I am, what my role is, who I work for and if there's anything they don't understand they can ask me again and if they don't understand the question to please say so."* FInterp3 [Data item]

*"We know, we make it kind of clear as soon as we start interpreting I introduce myself I tell them that it, obviously impartial and confidential and anything they are going to say in the room will be interpreted and I'll be speaking in the first person. And those are the kind of rules that I follow."* FInterp4 [Data item]

*"And I always tell them 'I'm not here to give you advice'. It's not my life or it's not my illness or it's not my anything. It's for you, what you think is important. So I've been asked number of times 'oh what do you think, I want to have an abortion, what do you think'. Nothing to do with me, for goodness' sake. (Laughs)"* FInterp9 [Data item]

Interpreters showed some awareness of their role boundaries:

*"I mean obviously you've got empathy and you've got all that but you have to keep professional boundaries. Basically you're there to do a job as an interpreter. And I think the best thing would be to just keep it as a job, you know. "* FInterp4 [Data item]

*"Because we are not health advocates in other words, we are interpreters there is obviously a difference."* FInterp5 [Data item]

Role boundaries were not necessarily confined to interpreters however. One interviewee felt that patients complaining about collaborating professionals were overstepping theirs:

*"But sometimes these [complaints] are not related to the real matter and she wastes your time. [...] I know what is to be interpreted and what is useless or selfish."* FInterp7 [Data item]

FInterp1 commented on the different number of words needed to express the same idea across languages of different structures, using the word 'clarification' to describe her intervention to explain:

*"But sometimes I find it easier when I'm listening from Urdu to English because English is a very complex language and even if they're talking it 10 minutes you could say it all that in probably 7 minutes whereas Urdu is longer language to English so it seems like if you're taking out saying 3,4 lines and you're sitting there thinking 'oh God, he's gone on longer' so that also sometime I give them a clarification that Urdu has double the wording of your English so I realise I'm taking longer to explain. It would be same amount of words which you said in English but because it's double the language it would take a few extra sentences or a bit more time. So that's another thing I suppose and makes a difference."* FInterp1 [Data item]

FInterp3 also reported linguistic difficulties such as the lack of semantic equivalents, and cultural differences both of which she will intervene to gloss:

*"I have had certain issues, slight little concerns with, particularly with the mental health along with the other interpreting that I do when we come to cultural issues which the doctor or the social worker may not be aware of. So when they use such a phrase which may be non-existent in English, I will say well, I will try to go that one step further and explain 'this is the true meaning, this is what it means'. As in rather than doing it just a direct translation. And trying to explain the cultural differences."* FInterp3 [Data item]



The interpreters in the study reported proactively offering cultural briefing to doctors though there is no mention of their doing so to patients:

*"They wouldn't know the religious views on certain things and how the professionals basically should approach the patient or the way of talking and stuff."* FInterp4. [Data item]

*"I, if there is anything which I can help them with, if there is some sort of tradition which a requester doesn't understand, or a health professional does not understand or a, again I do sometimes tell them, it does happen in our community or it does go on like they told. Something like that in Pakistani community."* FInterp9 [Data item]

FInterp9 added:

*"No it's not my opinion, if it happens in our community like that if it's something goes on then I will say that which is, a client is trying to tell the. the patient is trying to tell them though obviously I do say that 'yeah, obviously this is how we go by.'" FInterp9 [Data item]*

Cultural briefing included protecting patients' modesty:

*"Until it's necessary like some cultural aspects. And just like somebody, doctor is saying "oh you need to take your your hijab out, you have to expose your body parts" or, we have to tell them that this is their culture and their religion and then obviously they are not allowed to do that from these beliefs that they have. So these are the only interventions normally otherwise we don't do it."* FInterp10 [Data item]

At least one Interpreter made proactive interventions:

*"[...] and then you ask the question that 'have you understood what I have said, do you have any questions?'" FInterp1 [Data item]*

Some interpreters reported that linguistic difficulties arose in interviews due to there being no equivalent concept, and therefore no semantic equivalent across languages.

*"Ah, yeah, because you see there are words like depression, [inaudible], all these words they are very difficult to translate in Urdu. Because even mental health people will say, 'you know that person is mad'. In Urdu you would say 'that person is mad'. There isn't any sort of, you have to explain that you know. If a normal person, ttch, normal!, I mean if a, somebody is telling you something they say 'my son goes mad'. That is the kind of word that is used."* FInterp4 [Data item]

Some of the interpreters mention explaining their interventions in both languages:

*"Yeah I just tell him. Then I express . I mean I tell the other party too that what I told him. So there must not be any misunderstanding that what I told to the patient . then I tell in English to the . whatever the other person is that 'I told him this, that you are here for his or her benefit for his or her welfare, you are helping them, you are helping them'. I try to tell them as well."* FInterp7 [Data item]

Only one interpreter made reference to handling non sequiturs in a patient's speech:

*"It makes you how shall I say, makes us look sometimes fool. You are asking something else, and you get told a random answer and everybody just looks at you and thinking 'well I did not translate this way, I asked something else' but I know the answer has come totally differently."* FInterp1 [Data item]

#### A QUESTION ASKING ABOUT KNOWLEDGE OF INTERPRETING MODELS.

Question. Have you heard of any of the interpreting models? Can you tell me about them? [Taxonomy of models; names of models were listed when questioning]

Enquiries about educational attainment led to talk of professional training, and explored interpreters' understanding and use of delivery models. Interpreters had varying degrees of awareness and knowledge of the theory of interpreting and interpreting practice. For example when asked if they used or could describe a model of interpreting delivery they said:

*"I mean yes that some use symbols some use notes, that kind of thing I don't know if you heard of anything else?"* FInterp1 [Data item]

*"I've never heard of those [names of models] I mean I do work in those capacities but I mean I've never come across the word model."* FInterp3 [Data item]

*"Yes, well obviously we are impartial we have been told about the impartiality model and we stick to that in what we are doing. We don't take either side. We are not advocating."* FInterp4 [Data item]

*"I have heard the names but like community interpretation you said? [...] I got my first diploma in 2003 and I always you know work for the police and for courts or immigration, I heard the community interpretation, but I know what the community interpretation it's just a very informal sort of interpretation I think. That's what I know about the community interpretation."* FInterp6 [Data item]

*“So you think that some people are trained to be a model into certain areas of interpreting is that what you're asking. [...]Oh, so mostly what do I do. Which area do I cover.”* FInterp9 [Data item]

*“I don't know anybody use model or something.”* FInterp10 [Data item]

There is some evidence of a delivery model being used, albeit a de facto one, rather than a formally taught one.

#### SEEKING EVIDENCE OF COMPONENTS OF MODELS DESCRIBED IN THE TAXONOMY

Exploration of the data showed components of the interpreting delivery models described in the taxonomy of models being used as shown in Chapter1. FInterps9 and 10 firmly believed that advice and opinions from interpreters were not admissible.

*“Not advice, not. I will not say anything to them that the health professional won't know what I'm saying.”* FInterp9 [Data item]

*“Actually, normally when we're interpreting we don't give any advice, even they ask.”* FInterp10 [Data item]

FInterp4 was aware that giving one's opinion or advice was not thought to be good practice,

*“We are taught all the time that as interpreters we can't really say anything of our own accord.”* FInterp4 [Data item]

but sometimes found herself faced, outside the interpreted interview, with such questions as *“can Muslim clients work with Hindu social workers?”*, [Data item]

*“I can't really speak on behalf of the whole Pakistani community or the whole Muslim community. I have my opinion and this is what it is.”* FInterp4 [Data item]

and reported that she would respond to other questions from the clinician in private, if guidance were sought:

*“Because if there are issues, if there are cultural issues, sometimes what happens is that after the client goes away and the service provider wants to*

*find out 'oh, is this something that happens in your culture quite often' so you know you can give some sort of indication there." FInterp4 [Data item]*

The male interpreters, interpreters FInterp6 and FInterp7, were clear in their minds on the matter of advising or giving their opinions. To FInterp6 this was simply outside his remit,

*"No. It's not my job to give advice or negotiate. The professional interpreter, my job is to translate, and correctly and impartially and I do. Apart from that I don't do any, I don't give any advice or suggestions because that's not part of my job." FInterp 6 [Data item]*

whereas his colleague thought it appropriate to hold a quiet private conversation with the patient,

*"Yeah. I mean if they try to . I just try to calm them down and tell them that 'this is not the thing that you are feeling actually he is for your benefit, for your benefit' and so they calm down. [...] I say this to the patient if they are not . they try to lose their control . in expressing and using bad language." FInterp7 [Data item]*

Three of the interpreters agreed that it was not their function to negotiate for the patient unless directly asked to do so by the clinical practitioner:

*"[...] It's if the professional ask us to negotiate something then I do, otherwise not." FInterp10 [Data item]*

*"No. It's not my job to give advice or negotiate. The professional interpreter, my job is to translate, and correctly and impartially and I do. Apart from that I don't do any, I don't give any advice or suggestions because that's not part of my job." FInterp6 [Data item]*

*"I would try and maybe use a different word and I would say 'this is what my client's trying to say'. If I feel they've got the wrong end of the stick or something." FInterp4 [Data item]*

Asked if they ever refer patients to other agencies, FInterp6 was sure and simply said “no”. Another said “*No, we don't have the authority to*”. FInterp9. FInterp10 would refer it if the matter seemed trifling,

*“But if somebody asks me just a little thing or oh I want an appeal or something and then I just say tell them that there is a local citizen advice bureau you can go there and find out that there is a library where you can find information. That's the only thing I tell them.”* FInterp10 [Data item]

While FInterp4 expressed ambivalence regarding advocacy and interpreting, shared with FInterp10:

*“I, I think that's where there is a difference between interpreters and advocates. So we are basically - our agency tells us not to sort of get involved and not to refer. So what I might do because if I know that there are sort of ESOL classes happening in the area, I'll tell the clinician or the care coordinator for example.”* FInterp4 [Data item]

Inappropriate use is made of interpreters both by service users and service providers.

FInterp3 felt she should protect the children.

*“He was expecting me to help him because I was Asian and he was Asian. And the social worker who was supervising contact was a white. So therefore I didn't have to tell her everything that was being said. Well, I did because there'd been incest in the family the children were in care and my role was to protect the children.”* FInterp3 [Data item]

*“I have been asked [to take notes] only in the supervising of a contact have I taken a note and that's because I'm not speaking at all. I'm just sitting there listening.”*FInterp3 [Data item]

This same interpreter reported being put into ‘social worker role’.

*“So we have been there with the children to, in that capacity my role was as interpreter just to see that he wouldn't say anything inappropriate to the children 'cos the social worker didn't speak the language. So I have done that as well but in that setting I was supervising contact with the social worker because he was going round the grounds or in the park spending time with the children but then I had to be within earshot to hear what he was saying.”* Finterp3 [Data item]

One other reported making third person interventions to supply information which may otherwise only be available to the interpreter.

*"If I feel the patient is not understanding or patient is not putting the full attention to things. Or she is just hearing and but not listening carefully what we are trying to say. Because sometimes when you are talking your own language you can gather that from the patient and I always tell them I don't think she's understanding or I don't think she's paying any attention to us."* FInterp9. [Data item]

She also noted the influence of a fourth person trying to control what the interpreter said:

*"But sometimes I do feel that people, a patient's relatives are, er, try to interfere with things, they try to add or subtract things, er, when you are interpreting they are trying to budge in you know like if you are interpreting they will um say exactly the same thing, what you're saying, or they will say it in a different manner like trying to make you look that you're not interpreting right."* FInterp9 [Data item]

The concept of an interpreter challenging clinicians' behaviour or questioning a treatment plan only elicited comment from two of the interpreters.

*"I just tell him or her that 'you know his or her mental condition or situation at the time you know better than everybody that if you are losing temper, you are not the patient and he is the patient and he will lose temper as well. And there is then a reason for that.' So mostly they understand and they say sorry in such situations."* FInterp7 [Data item]

FInterp10 saw challenging clinicians as outside her remit.

*"Challenging, well not really. No, no. Because that's the job I have to do and [...] and sometimes the people are racist as well, obviously, but I am quite a patient person and polite as well so I take it easy and then they are easy as well because if you confront them then you know they can be more aggressive, you can say."* FInterp10 [Data item]

When asked about preserving the style of speakers' utterances FInterp3 and 4 were aware of the need to preserve register where possible. They linked it specifically to

what is thought of as "bad language". Both were willing to try and render bad language accurately in English by using swear words themselves.

*"I try and keep to the register. Sometimes you have to use swear words if the patient's using swear words as well."* FInterp4 [Data item]

FInterp9 had a little difficulty with the question.

*"Researcher: [...] whether you shift between what the doctor was saying at the level they say it and what the patient is saying at the level they're saying it.*

*Interpreter: You lost me there. I'm sorry. Do you mean, what level their speech is, how they, whether they are interacting with each other, is that what you're trying to say?*

*Researcher: Um, it's the way they express themselves, the sorts of words they use. [...]*

*Interpreter: Yeah, they are using in their own language so they are fine with that, the way they use the language, what they are saying I try to match up the English wording exactly with that so they are getting the maximum benefit, the doctors or nurses or whoever I'm interpreting for."* FInterp9 [Data item]

*"But I think that comes with years of experience when I've been in situations when I've had to swear at the Crown Court Judge, which wasn't very nice."* FInterp3 [Data item]

Five of the interpreters reported working in first person speech, and only two felt that it caused the patient to become confused.

*"I will just say 'how old are you?', um, in that kind of setting."* FInterp 3 [Data item]

*"[I] Always [work in] the first person."* FInterp4 [Data item]

*"It depends really because some people get confused with the direct speech. I used to work in the direct speech but not any longer. I find it, specially the patient gets confused. Specially in mental health settings."* FInterp9 [Data item]

*"Well it's like you are talking on behalf of the doctor obviously but you are making sound like you are speaking like a doctor if you know what I mean, yeah? But I don't because patients, I find patients get confused with that."* FInterp9 [Data item]

*"So this is my way of, um I mean my approach is just to "he says that", "she says" and "professional says" yeah. That's it. Because we can't be professional and at the same time that "I am saying this" as being the professional and the client, "I am saying this" as being the client. Because that would be a bit difficult situation so it's always three-way and this is a more understandable in my experience for both sides."* FInterp10 [Data item]

Using first person speech was considered to allow the interlocutors to speak with their own voice.

*"But obviously if it's a mental health problem and they think that you know they have been possessed by an evil spirit or whatever then obviously I will interpret that as the client is saying it."* FInterp4 [Data item]

*"I do always tell them, yeah. If I feel anything or how she or he is are describing their emotions I always try to [put] that across."* FInterp9 [Data item]

*"Yeah, because I think it's very important for a, I mean sometimes people's emotions are not shown from their face it's the wording they're using. [...] or how they are using and I think it's very important for them to know. Specially in a mental health environment."* FInterp9 [Data item]

*"They are, they do speak as they wish, they try to make, I try to stop them if they are going on for very long period. But otherwise they are, if they are . they say whatever they wanna say and I interpret how they have how they have said things."* FInterp9 [Data item]

Overall, all the components of the model were used but not by all of the interpreters.

Education and training has been shown, through the richness of the data, to be varied in quality and scope.

#### THE INFLUENCE OF THE INSTITUTION ON FRONTLINE WORKERS

The influence of the institution is noticeable by an absence of training on successful collaborative working with interpreters and also present in a variety of other ways.

Inappropriate demands can be made on interpreters that may push them beyond their professional boundaries.

FInterp3 had developed ways of avoiding being drawn into a client's family situation as a surrogate family member:



*"And when you are with a family for that number of four hours a week over a year they expect a certain amount of trust both ways so then they were offering a cup of tea after we'd finished, can we go to the shops, you know, whatever, which you have to say no to. And yes there's excuses 'I'm sorry I'm running late, I can't do that' but you can't always set the mark in that kind of situation." FInterp3 [Data item]*

FInterp10 made it clear that, when she finds that she doesn't share a language or dialect with the client she was booked to support, an appropriate interpreter should be called:

*"And if something with a different dialect is here then I ask the professional to call somebody else. This is what, my way of doing it. Until I really understand everything what I will see, yeah he, she is saying, I don't do the translation. No." FInterp10 [Data item]*

Besides being asked to accompany clients to the shops and refusing to take part in conversations they don't really understand, interpreters are sometimes faced with other inappropriate demands on their professional expertise by professionals, patients and their families.

FInterp3 had experienced feeling vulnerable in some situations:

*"It made me feel a bit vulnerable because I had previous, I didn't know this person, I didn't know what he was - how bad his mental health was or what he may be capable of or what he had done. [...] I was concerned slightly because of the children but [the social worker] wouldn't have asked him to come out of the hospital and walk round the grounds if there was anything like that." FInterp3 [Data item]*

*"He was expecting me to help him because I was Asian and he was Asian. And the social worker who was supervising contact was a white." FInterp3 [Data item]*

FInterp3 also reported being put in a position of deciding what constitutes inappropriate speech between a parent and his children:

*"So we have been there with the children to, in that capacity my role was as interpreter just to see that he wouldn't say anything inappropriate to the children 'cos the social worker didn't speak the language. So I have done that as well but in that setting I was supervising contact with the social worker because he was going round the grounds or in the park spending time with*

*the children but then I had to be within earshot to hear what he was saying."*  
FInterp3 [Data item]

FInterp9 had been placed in emotional guardian role by a family attempting to shield a loved one from information they saw as distressing:

*"I've been asked to keep the information from the patient, not to give them the whole information by the family. But I have even explained to them I can't do that. You"* FInterp9 [Data item]

She had also been undermined by frequent unhelpful interventions from family members:

*"But sometimes I do feel that people, a patient's relatives are, er, try to interfere with things, they try to add or subtract things, er, when you are interpreting they are trying to budge in you know like if you are interpreting they will um say exactly the same thing, what you're saying, or they will say it in a different manner like trying to make you look that you're not interpreting right."* FInterp9 [Data item]

Interpreters noted briefing as a key need:

*"If I am the interpreter yes. I tell them that I will be the interpreter, could I have the briefing please."* FInterp1 [Data item]

*"Uuumm, procedures um I don't know if it's procedures it's just whatever it comes there. It has to be with that straightaway and sometime we ask, specially for the mental health, for some briefing as well. And they call me about 10, 15 minutes early . to get the idea what I have to do. And what is some background and, what, how long it's happening and whatever the family is saying and whatever their clients wa[nt], I do a little bit briefing specially. For the mental health. That's very important."* FInterp10 [Data item]

Interviewees reported that budgetary constraints had wide-ranging effects on service delivery and the ability of interpreters to remain in the profession:

*"At the moment there's not much [work] with all the cutbacks. I think they have a team member who speaks the same language so in the last year I haven't done much. But previous it was 2 hours or maybe 3 hours a week."*  
FInterp3 [Data item]

*"Thing is I got three children so I need to keep a job I couldn't live on just interpreting."* FInterp1 [Data item]

*"I do take um occasional bookings now for hospital appointments in mental health but not very often because obviously when you are working for the police and in the courts, with my language I'm quite busy as well and it all depends on finances and this and that you know whatever the rates are."* FInterp5 [Data item]

*"So that's why you get few appointments. This year it's gone quite down I would say. [due to some interpreters having regular repeat appointments with patients]"* FInterp9 [Data item]

*"Because [aggressive behaviour is] very common nowadays where there are people are coming from other countries and they are making problems for us and we have to spend money on the translation and interpreting. And now because of the funding, it's less funding now, so they are not very happy and sometimes they take, or they pick on us as well. That oh, we are there to, you know, to grab their money."* FInterp10 [Data item]

Budget constraints can also affect clinical interactions where an interpreter has been booked:

*"And then there are some times in the national health now I'm looking at recent this is examples in this year, I've noticed that the nurses who let the interpreters go. It happened to me few times recently and they're 'no it's okay, they have got a relative, I'm happy with that and you can leave'."* FInterp9 [Data item]

The institution is shown to have effects on service delivery which also affect professional interpreting services.

## SECTION 2.

### SECTION 2.

#### INTERPRETERS' RESPONSES TO VIGNETTES.

Section 2 of the focused interview consisted of responses to prompts in the form of vignettes describing dilemmas in practice, and how the interviewees thought they would have handled them in a real life situation. The Delphi process involved experts in their field in discussions of the interviewees' responses to the prompts.

The vignettes were designed to offer face threat and produced a variety of tactics in interpreters' responses. Regarding homosexuality FInterp3 was matter-of-fact:

*"If you are there to interpret you are there to interpret whatever they're saying. So if they are asking for your personal advice I would say 'I am not allowed to give personal advice because I am here just for you to explain to the doctor but I will ask the doctor for you'."* Though she would step out of role and try to negotiate external support, *"I would then go a step further and ask the English speaker if they knew of any groups in that area or whatever that could perhaps speak to the person."* FInterp3 [Data item]

FInterp4, mentioned her lack of expertise in medical matters, but would simply continue interpreting each party's speech in either whispered simultaneous or consecutive mode; and FInterp7 was a little brisk and said,

*"Right. . I listened to you. [...] I mean, what he will say, I will tell the other . the doctor, the nurse or the consultant whatever."* [Data item]

There was a three second pause before FInterp5 answered the question on female circumcision. Then she talked around the question, commented on the words for 'hit' and 'kill' in her language being synonyms and the lack of other-language equivalent concepts. She followed this by acknowledging sensitive and difficult issues.

*"So it's all kind of circumstances where there is very sensitive issues about being either homosexual or being the second problem with females and this and that."* FInterp5 [Data item]

She said that *"all the professionals should have some sort of this kind of training"*.

[Data item] It was not clear whether she included herself among professionals.

FInterp6 prevaricated for a five part exchange, starting his reply by asking for a repeat of the question and then for an explanation of the question before saying that he would simply interpret messages as voiced.

SECTION 3.  
SATISFACTION QUESTIONNAIRES

Post hoc satisfaction questionnaires, based on evaluating interpreters' own recall of a specific job of work completed in the past, were analysed and satisfaction ratings are shown in figures 25 and 26.

### **4.3 Delphi data**

Four panellists were conference and PSI interpreters as well as senior interpreter trainers. The fifth, a senior member of the Chartered Institute of Linguists (CIOL) led development of the codes of conduct, has set examinations, and has wide experience of the field of development in this profession. They were:

- Vice President of the Chartered Institute of Linguists
- Academic Lead for Public Service Interpreting at Cardiff University
- Senior Lecturer in Interpreting at London Metropolitan University
- Senior Lecturer in Interpreting at the University of Central Lancashire
- Senior Lecturer Interpreting and Translation at Middlesex University
- Advice was also sought from the Languages and Intercultural Studies Research Coordinator/Senior Lecturer at Herriot Watt University.

Six vignettes were designed to elicit more detail about the interpreters in the focused interviews' approaches to their work and these are shown in chapter 3 on methods.

The first round showed that 80% of the panel (4 out of 5) agreed with each other completely. 1 person had strongly contrary views on the matter of cultural briefing

and was the only one to mention it in round 1. Discussion of responses continued in round 2; there were 3 separate attempts to gain full agreement. It was not possible to gain complete full agreement as one person continued to hold a different point of view. In round 3, the final round, panellists were sent the vignettes again, this time with the response made by each interviewee beside the text of each vignette. They were asked to mark the interpreters' responses. There were 6 vignettes, scoring 1-5 per interpreter. This gives each interpreter a maximum possible score of 30 per panellist making a possible top score of 150 overall. FInterp10 scored lowest with 33 and FInterp4 scored highest with 106. FInterp1, 5 and 6 were between 80 and 89, the remainder were between 46 and 48.

#### ROUND ONE RESPONSES, TEXT OF VIGNETTES

Panellists were sent the document explaining the process with a set of the six vignettes attached. Their instructions were to imagine themselves to be the interpreter during a triadic situation in a mental health clinic and describe how they would manage interpretation in each of the six situations described. Briefly, these six situations were:

- a) The patient is making very critical and personal remarks about the last doctor they saw at this clinic.
  
- b) The patient has been upset by talking about her miscarriage and how she felt her family had not understood her feelings of bereavement and grief. During this she asks the interpreter if she (or if a male interpreter, his wife) has ever lost a baby.
  
- c) The patient is talking about their homosexuality, love for a same sex other

person, and their anguish over coming out to the family, who want the patient to marry.

d) The patient talks about the time when her parents took her from the UK to the home country “to a party”. This turned out to be her circumcision ritual. Brought up in the UK, she does not understand why this was done to her. Her parents are seeking a husband for her. The doctor is a white Englishman.

e) At a meeting to discuss going home, the patient is asked if she has support at home. She talks of her husband and other male relatives but...

f) A receptionist gives a female patient an urgent appointment with the doctor on 31<sup>st</sup> August 2011 but the woman replies that she can't attend because she will be too busy.

4 of the 5 panellists agreed that in vignette a) they would interpret everything that was said. 1 said that it was not the interpreter's role to interpret critical remarks. Vignette b) elicited the word ‘empathy’ in some of the answers. One panellist said that they would not have answered the question and one said that she would have relayed the question in the third person "the patient is asking me if..." while displaying empathy with her facial expression. To vignette c) four panellists said they would simply interpret fully, one of them adding that tone of voice and the relay of affect were important in such matters. One said that they would be empathetic, try to change the topic, and would give cultural briefing to the doctor if necessary. Vignette d) drew similar responses to vignette c) in which the dissenting panel

member said that they would give balanced and impartial cultural briefing. Vignette e) drew the same responses from all the panellists that interpreting should be full and faithful with no addition, or omission; most especially the word 'but...', expressing doubt, must be present and heard. In vignette f) the four panellists in full agreement said that this conversation should be fully interpreted, leaving the receptionist to make any clarifications felt necessary, while the dissenting panellist would again have offered the receptionist necessary cultural briefing because of the religious festival implied.

#### ROUND TWO, SUMMARY RESPONSES.

Panellists were presented with a summary of the responses in round one. Each set of responses was edited together without loss of meaning or repetition and shown beside the wording of the relevant vignette. The panellists were asked to either agree with, or comment on each one. The only disagreements were concerning the use of the third person when relaying a question directed at the interpreter. The dissenting voice however changed their previous response and said that they would interpret the question and let the doctor reply to it. The same dissenting voice, though continuing in their opinion regarding c) agreed with the views expressed in the previous round on d) and e). This panellist continued, however, to assert that they would include the cultural briefing and that the doubt at the end of the patient's speech should be reflected. Another panellist agreed with the early responses to c) and remarked that in their experience UK clinicians are not generally ignorant of the fact that other cultures may have issues with homosexuality.



#### ROUND TWO, CLARIFICATION OF RESPONSES

Opinions came closer together as discussion included the suggestion that the homosexuality question was not necessarily culturally specific; that there would be a wide range of possible reactions within any cultural group, for example homophobic African and US Christians. It was also pointed out by one panellist, with regard to the FGM vignette, that no interpreter would be in a position to explain the essential medical facts to the patient and that the doctor would be most likely either to already know what the ethical and medical implications were or be in a much better position to find out than the interpreter was. This was seen as a question of role boundaries. Strong opinions were expressed in this round against the use of cultural briefing. One panel member strongly believed that the practice is an open invitation to a set of behaviours that are not suitable to an interpreter.

#### ROUND TWO, FULL AGREEMENT ATTEMPT WITH LIKERT SCALE

The remaining impasse centred on cultural briefings. This was largely resolved by the ideas described in 4.3.2.1. One panellist having pointed out that in vignette b) the really important matter was not the grammatical person used but the patient's real need of skilled psychological support. This panel member distinguished between interventions for clarity or understanding and cultural briefing which they saw as "adding social contextual information." They further remarked that truly relevant cultural information of this sort is only available from the individual concerned and therefore can only be provided through the interpreter, rather than by the interpreter. The dissenting panellist did shift following this discussion to acknowledging that interventions for clarity and understanding are useful and important but adding that sometimes cultural briefing is necessary.

Table 4 below and the above description of the data show that there was a range of opinions upon the use of “cultural briefing”; but there was a four out of five (80%) agreement that it is entirely appropriate to intervene in order to clarify something not fully understood before attempting to relay a message. The shades of opinion about additional contextual information are compared with the interview data and observation data in Chapter 5.

	<b>Totally appropriate</b>	<b>Somewhat appropriate</b>	<b>Would discourage</b>	<b>Discourage</b>	<b>Totally inappropriate</b>
<b>Cultural briefing of doctors by interpreters is:</b>		<b>1vote</b>	<b>1vote</b>	<b>2 votes</b>	<b>1vote</b>
<b>Interventions for clarification by interpreters</b>	<b>4 votes</b>				
<b>Any other remarks</b>	<b>There were other remarks made, supporting people’s individual positions.</b>				

Table 4. Table 4 Likert votes

ROUND THREE. PANELLISTS’ MARKS FOR FOCUSED INTERPRETER INTERVIEW

RESPONSES

Following the above discussions the panellists were sent the whole set of vignettes alongside the responses of each of the interpreters, taken from the transcripts of their recorded telephone interviews. They were asked to place a mark between one and five, in which five is the best, beside each response. There are six vignettes so each interpreter is being marked out of 30 by each of the 5 panellists giving an overall possible total of 150. The results are in table 5.

FInterp number	Overall mark (150)	FInterp number	Overall mark (150)
FInterp1	80 (53.3%)	FInterp6	85 (56.6%)
FInterp3	47 (31.3%)	FInterp7	48 (32%)
FInterp4	106 (70.6%)	FInterp9	46 (30.6%)
FInterp5	89 (59.3%)	FInterp10	33 (22%)

**Table 5. Overall panellists' marks for FInterps, Delphi round 3**

The interviewed interpreters themselves were asked to recall a specific interpreting job in the past and answer the PHQ questions about it. Their overall scores were as follows.

FInterp number	Overall mark (50)	FInterp number	Overall mark (50)
FInterp1	43 (86%)	FInterp6	46 (92%)
FInterp3	46 (92%)	Interp7	41 (82%)
Interp4	46 (92%)	FInterp9	37 (74%)
FInterp5	40 (80%)	FInterp10	30 (60%)

**Table 6. Interviewed FInterps' own PHQ scores for a remembered job**

Interpreters' self-scoring was based on an interpreting job they remembered doing, so it is possible that some chose a job that had been challenging and others chose one that they had felt was relatively easy. This may have influenced their self-scoring which shows a notable disparity between their opinions of outcomes and the marks

the panellists awarded them on the basis of their responses to the vignettes included in the focussed interview.

The final data set is the filmed observation data, recorded during routine appointments in psychiatric outpatient clinics.

#### **4.4 Filmed observation data**

The clinics filmed offer rich data and an opportunity to observe interpreters in their working environment. These interpreters were not all registered on the NRPSI and their training and knowledge of the profession differed markedly from those interpreters in the interview data. OInterp, followed by a number, refers throughout to the interpreters in the filmed observation data to distinguish them from those who took part in focused interviews, referred to as FInterp, followed by a number. The clinicians are similarly coded as OClin# and FClin#.

The quotations that follow represent carefully transcribed reproductions of what was said in English. I am constrained by i) the fact that I was filming live, real-life, unscripted interactions and ethical constraints make further access to any of those taking part impossible; ii) I do not understand the study languages (Urdu and Punjabi) and relied on the words of the interpreter present in the room and the additional work of an interpreter during analysis; iii) I cannot afford to have this material transcribed, nor is there time.

I chose to analyse the whole clinic session and the joint participation in an interpreted communicative event in mental healthcare. I therefore describe not only the performance of the interpreter but those of patient, doctor and the fourth presences represented by the daughter of one patient and the husband of another. I am aware that this does not fulfil the normal expectations of AL, CA or Discourse Analysis, and I appreciate that fine researchers have carried out investigations into various aspects of interpreted discourse. Many of them are cited in this thesis (Wadensjö, Hale, Pöchhacker, Morris, Berk-Seligson, Bot and many besides) but my thematic analysis of each whole event has delivered insights not otherwise available. Each clinic session is treated here as a complete entity. In the discussion in Chapter 5 I will use the unifying scheme of the components of the model.

Findings will be drawn together in chapter 5 but it would be to overstretch the results of the Delphi exercise to apply them to this section of observed extempore real-life interactions. The Delphi exercise was developed simply to validate responses to vignettes (prompts rather than personal reflections) in interviews with a cohort of interpreters who volunteered to talk about their personal experiences of interpreting in mental health care. This was a different research approach and was divided into three sections as has been described in chapter 3.

The interpreter output reflects the (un)trained status of some interpreters and (in)experience of one of the doctors. The purpose of the clinical interviews was

precisely to diagnose and/or treat the patient, though not the companion. Nevertheless the outcomes were two collateral histories and two interactions that reflect the reasons for the FClins' earnest desire for forensic clarity in interpreter output.

- At Clinic 1, Patient 1 and OInterp1, filmed data collection was successful. The patient was accompanied by her British educated adult daughter.
- At Clinic 1, Patient 2 data collection did not take place because the patient was a Bengali speaker and the interpreter sent by the agency was an Urdu speaker. Attempts to replace her quickly were unsuccessful, and the interview went ahead via the patient's Bengali and Urdu speaking companion, and an Urdu speaking member of staff using a relay method. I chose not to film this encounter.
- At Clinic 2 patient 1 returned with her daughter. No interpreter had been booked because the daughter was known to speak English. An interpreter was booked on the morning of the clinic and filmed data collection took place.
- At Clinic 3 an interpreter had been booked and confirmed but did not arrive. A second interpreter was sent for and had just arrived when patient 3 declined to stay any longer.
- At Clinic 4, Patient 4, OInterp4, filmed data collection took place.
- At Clinic 4, Patient 5, OInterp5 was present and interpreted but no filming took place.

- At Clinic 4, Patient 6, OInterp4 was present and interpreted but I was not able to change the batteries in the video cameras and no filming took place.
- At Clinic 4, Patient 7, OInterp5 was present and interpreted but I was not able to change the batteries in the video cameras and no filming took place.
- At Clinic 4, Patient 8, OInterp4 was present and interpreted but I was not able to change the batteries in the video cameras and no filming took place.
- At Clinic 4, Patient 9, OInterp4 was present and interpreted but I was not able to change the batteries in the video cameras and no filming took place.
- At Clinic 5, Patient 10, OInterp6 was present and filmed data collection took place, also using a digital voice recorder as backup.
- There was one further patient booked at Clinic 5 who did not attend.

2 interpreters were present at clinic 4 but were not filmed, except for OInterp4 with Patient 4, for the reasons given above. At clinic 3 the replacement interpreter said that her first language was English, that she held a GCSE in Urdu, and had received basic administrative induction from the agency in managing her bookings and invoices. She had no other relevant training. FInterp4 held a DPSI in both law and health options. FInterp5 held a DPSI in the health option.

Four interpreters were filmed and are identified as OInterp 1, 2, 4, 6. Data collection was complicated by operational problems throughout.

At clinic 1, the interpreter, OInterp1, had not been warned that he would be taking part in a research study and retired to the car park to phone his agency for permission to take part. This delayed the patient's appointment by about ten minutes. The expert who later interpreted the film (FA) informed me that Patient 1, who spoke Assami, would not have understood Punjabi. In the event patient and interpreter seemed to manage in Punjabi.

The expert interpreter (FA) subsequently recorded an English interpretation of the whole video data set, recording simultaneous interpretation on a digital voice recorder, leaving spaces for English language speech. After a short trial at our first meeting we decided the procedure would be to record close interpretation and comments. This was because of mumbled speech and other acoustic influences. Discussion and observation of other communicative signals were also recorded. The post hoc questionnaires completed by audio survey were filled in on paper from the voice recordings, by FA.

#### OINTERP1

Patient 1 was female in the age range 50 to 60; there was some confusion over her actual age. She did not know how old she was. She was born in the Assam region of India and spoke Assami; the daughter gave her mother's ethnicity as Indian, Assami. The patient said that she did receive two or three years of schooling but left school at the age of six or seven. She was a housewife. Her daughter normally interpreted for her.



The interpreter was male in the age range of 50 to 60 and ethnic origin Pakistani (Punjabi). He was born in Pakistan and his parents were born in India prior to partition. One parent was an Urdu speaker and the other a Punjabi speaker meaning that their child grew up speaking both languages from birth. He held a DPSI in law, only, but had been working in health care for the last three years. Asked about the interpreting model used, he could not say.

The doctor was male, in the age range of 30 to 40, of South African ethnicity but born in London. One parent was born in South Africa and the other in Kenya. His first language was English and he worked with interpreters routinely.

The chairs were arranged along the wall opposite the doctor. The patient was accompanied by her eighteen year old daughter who was born and educated in England. The patient sat between the interpreter and her daughter. At the outset the interpreter attempted to improve his sightlines and physical positioning by pulling his chair slightly away from the wall and attempting to form the apex of a triangle so that he can see both the patient's and doctor's faces at once. His manner was calm, empathetic and professional. He had a good voice, good clarity of diction and good English vocabulary both medical and vernacular.

At v00:50 the interpreter took a couple of minutes to chat and drink tea with the patient. They were both smiling and engaged in conversation about the language of Assam. In other words he carried out a language compatibility test and established

some rapport with the patient before the session. He was obviously aware of the camera until about v03:00. The patient was less so and she seemed relaxed and alert all the time she was discussing physical ailments.

OInterp1 was not taking any notes and seemed to be able to reproduce quite long chunks of speech from memory (consecutive mode). At other times he relayed in short chunks (ad hoc liaison) sometimes appearing to either ask his own question or prompt her to continue, following relay of the part message. His turn-taking strategy was simply to start talking. At first he demonstrated respect for the register of the language used and interpreted into the first person, but first person usage was not consistent throughout the interview.

*"[...] and I've got a problem with my, I keep leaking. [...] Like if I pick something up it would be just like I was sitting on the toilet and having a wee."* OInterp1. [Data item]

The doctor was proactive in picking up visual signals. He noticed a brief hand gesture by the patient while she was speaking to the interpreter.

*"Yes, like I mentioned earlier, headaches. I'll ask her again."* OInterp1 [Data item]

There followed a short conversation between interpreter and patient which was delivered to the doctor, in the third person. At v07:07 the interpreter changed his mode of delivery again from first to third person. There was a fairly long overlapping conversation between the interpreter and the patient followed by the interpreter supplying a summary:

OInterp1: *"[...] yes, it does. She gets better with that when she put that on her head because the feeling she gets is like when you're ill, the tiredness, the weakness [inaudible] the feeling sick is like when you haven't had something to eat for days."*

OClin1: *"What feeling is like that?"*

OInterp1: (checks the patient's reply and reports) *"That is during the headaches, and while that lasts, those things are during that period. She does not eat, she does not - but there's also the sensation [inaudible] that she gets during headaches and once she applies the lemon juice...."* (The patient has disengaged and looks withdrawn). [Data item]

At other times the interpreter used first person speech, for example:

*"I couldn't go to sleep at night because as soon as I lay down I couldn't breathe."* OInterp1 [Data item]

However, under the stress of face threatening language, the interpreter changed in mid reply from first to third person as the use of the word faeces became necessary.

Nevertheless he did relay the doctor's topic-changing remark that follows.

Ointerp1: *"At one point I didn't have no control over my (patient continues talking) she just used to leak urine, um number one, and number two, faeces as well."*

OClin1: *"She sounds as though she's got a lot that she wants to talk about".* [Data item]

This pattern of flipping in and out of first and third person reporting continued, and the listening phase tended to be a conversation that was delivered as ad hoc liaison verging on voiced simultaneous interpreting. Pragmatically it is difficult to see what else he could have done.

Discussions of a long list of physical ailments and treatments of various sorts continued for about ten minutes until the doctor brought this section to a close, addressing her in the first person: *"okay, so all of these physical problems, they often make you feel, inside, quite sad"*. [Data item] At v23:47 he moved the conversation on to the topic of mood. He asked a third person question *"how does she feel, inside. Can she tell me whether she is sad, happy, angry"* [Data item] and the interpreter listed that vocabulary but checked the additional word 'pain' with the

daughter, resulting in a discussion of nuance between him and the patient's daughter. The daughter had been quiet up until this time but now began to interject as an interlocutor, party to the conversation (out of shot).

The doctor asked the patient to report on her sadness and anger. The interpreter relayed that, but she did not at first understand the question. The interpreter repeated it, as a proactive clarification of the doctor's words, saying "*you feel angry, you feel sad. Tell me about it.*" leading towards a deeper discussion.

OInterp1: "*She just says to God that what is this life, what am I doing here, this is such a pain and everything.*"

Daughter: "She just said that she felt suicidal."

OInterp1: checks with the patient and says "*she was suicidal.*"

OInterp1: "*I feel suicidal then, but I didn't because I felt for my (indicates the daughter with a hand gesture) daughter, she was young at that time.*"

[Data item]

Being language aware, the doctor asked if there is a word for 'suicidal'. The interpreter replied that there was and said it. At this point the daughter, who was seated beside her mother, appeared to have placed her hands behind her head briefly; her right elbow appeared in shot at head height. Mother had become suddenly more serious and quiet, less strength in her voice, as the doctor asked if she had suicidal thoughts. The interpreter's relay of the patient's reply to the suicide question was delivered in a mixture of first person and third person speech. He then delivered a first person section between v33:09 and 33:55 as voiced simultaneous interpreting.

The daughter was invited by the doctor to explain the circumstances of accompanying her mother on a traumatic visit to her violent father in India. This

lasted from 35:38 to 36:58 with much overlapping talk between two principal interlocutors (daughter, doctor) in English and no interpreting of this parallel conversation delivered to the patient. The patient was withdrawn, apparently with her eyes closed and with her head on her hand.

Shortly after this the interpreter apologised and said that he must leave because the interview was taking longer than he was booked for and he has another appointment to go to.

#### OINTERP2

Patient 1 returned to the clinic to see the same doctor, accompanied by her 18-year-old, British educated daughter. There was a different interpreter this time. She was female, in the age range 30 to 40, born in Pakistan as were her parents. She described her ethnicity as Muslim and her first language as Punjabi. She had GCSEs and A-levels but no relevant professional education or training. When asked which model she used, she said she did not know. She spoke English clearly, and made a brief introduction of herself to the patient. This was not the friendly conversational style of the previous interpreter with whom the patient had sat smiling and drinking tea; it was a brief, professional but pleasant explanation. The interpreter sat between the patient and her daughter, so that they were in a straight line opposite the doctor.

The doctor's first objective was to draw a family tree of the patient's relatives. The patient's mood was not as buoyant as at the last visit. During the opening exchange

of short, closed questions and answers the interpreter used the ad hoc liaison mode of delivery. The patient seemed to be in lower mood on this occasion.

OClin1: *"What I'd like to know is a little bit about her parents."*

OInterp2 put the question, which is replied to by the patient.

OClin1: prompts for interpretation. OInterp2 *"Back home, farmers."*

OClin1: *"Oh, right, they're farmers are they?"*

OInterp2 asks a short checking question and says, *"Yeah, they own their own land, farming."*

[...]

OClin1: *"Okay. And when did she last see them?"*

Ointerp2: puts the question.

Ointerp2: (summarising the patient) *"Loooong time ago"*

Interjection in Punjabi by daughter not interpreted by either FA or OInterp2.

OInterp2 (summarising the patient) *"33 years ago."* [Data item]

The doctor was using the third person form of address, routing the message through the interpreter as an interlocutor in her own right. He asked a question and then paraphrased it to the interpreter which made it complex. He was trying to establish the order of events surrounding the trip to India.

OClin1: *"[...] but ten years later, it, it you know it was around that time she separated from her husband as well, about 10 years later she went back to India to do what with her son, was it to take the ashes or"*

Daughter: *"Take the ashes"*

OClin1: *"To take the ashes"*

OInterp2: asked the patient the question and responded, *"To take the ashes."* [Data item]

The daughter interjected again at v08:43 to clarify a relationship and at v09:09 the doctor asked about other relations such as siblings. What the patient said took 34 seconds; the interpreted reply took 10 seconds. What OInterp2 left out was:

OClin1: (FA's English): *"Do you have any other siblings."*

Patient: (FA's English): *"Yes I have, yes I have but I don't know where they are. I don't know where they are. Long time ago I never been to see my parents, my family, no contact, no letters nothing so I don't know. It was a long time ago. Don't know where they live now."* [Data item]

In the sequence starting at v11:58/a11:40 the doctor set up a query in the third person and left the interpreter to formulate a question:

OClin1: "She seems very um . accepting of the fact that she, that she's hardly seen, hasn't seen her parents for so many years that, that, you know, her son . passed away, that she is separated from her husband. She seems very stoic about that now, she is very accepting that that's just the way it is. Could you ask about that?"

OInterp2: (FA's English) "Can you understand, can you expect this, that your parents do not have any contact with you. Can you accept all this? And your husband have left you he is not with you, your son is gone. Can you understand all this?"

OClin1: "Are there times that she feels very sad about all this?"

OInterp2 formulates a question.

OInterp2: (FA's English) "Is there any time when you feel very sad about all this, that you have lost all these things?"

The patient: replies.

OInterp2: "She's accepting it as it goes doctor and sometimes her heart hurts. She's missing out on a few things." [Data item]

So the relay to the patient was being conducted in the first person, while relay of messages to the doctor happened in the third person. The doctor occasionally addressed the patient in the first person, but most of the time he worked in third person speech by addressing the interpreter instead of the patient.

At v 13:55/a 13:33 OClin1: asks "And when she does feel hurt by it how does she express that hurt. Is she crying or angry..."

OInterp2: (FA's English): "When you feel sad, when you feel very sad when you you feel upset about it how do you feel upset. What do you do?"

OInterp2: (interprets for patient). "Doesn't cry. Just keeps it inside."

FA: (interprets for patient) "Nah. Nothing. I just keep it in. No, nothing, no." [Data item]

At v23:31 the patient began a description of how she met her husband which lasted for 22 seconds and was summed up by the interpreter in five seconds.

At v25:44 there was a discussion lasting just under 2 min between the doctor, the daughter, and the interpreter, all in English, concerning how old the patient would have been when she married. There was only one short interjection in Punjabi by the interpreter during this. The patient was being talked about, but not talked to or with during this time. At v28:00 the doctor requested cultural briefing on whether

marriages in the patient's village, followed by there being absolutely no contact with her family, was seen as normal and acceptable. The patient replied that her husband couldn't afford the bus fares to travel to her family home for visits.

The daughter continued at some length, in English, to supply contextual information about her father's immigration problem which had prevented him from returning to the UK from a business trip and then:

v33:23 Daughter: "She said that she felt, because she was rowing with my dad that it would be dangerous to go back to India as well and that me and my sister should stay in school here and that's two reasons[for the family not to return to India to join the father there]." [Data item]

OInterp2 made no attempt to relay this, though the patient may have understood the gist of it as she continues the thread:

OInterp2: (interpreting for the patient). "*And [the girls] studied at school and at university as well. [...] when they were in India the eldest daughter had no time to go to school. They couldn't afford for her to go to school or anything.*" [Data item]

There was an animated parallel conversation between the interpreter and the patient, which the interpreter relays in a series of very brief third person summaries, as though she were commentating on a public event.

The mother was visibly distressed, sighing and fidgeting during a long English-language parallel conversation between her daughter and the doctor in which the interpreter did not provide any relay. This lasted from v39:18 to v42:00 (02:82 minutes) and concerned fractured relationships between herself and her daughters, most specifically the elder daughter who had married out of their culture. The two



women were no longer on speaking terms. This meant that the patient was left listening for just under 3 minutes to her younger daughter speaking in English, clearly about her, but having limited if any access to what was said. The interpreter also looked uncomfortable. Nor was a summary of it provided afterwards, though the interpreter was requested to ask the patient what her relationship with her younger daughter was like. The patient's reply was "*good*". A subsequent description by the daughter at v45:14-47:31, regarding what she saw as her mother's paranoia, followed a similar pattern during which the mother was almost entirely still. The patient was uncomfortable, the daughter was providing her own collateral history, but this time there was a short post hoc summing up to the patient prompted for by the doctor. The doctor later asked the interpreter to relay to the patient her younger daughter's comments on her own plans regarding University and marriage and a summary was given.

From v56:10-v01:03:50 (4:40 minutes) doctor and daughter held a private parallel conversation as before with no relay. The patient, having ceased to be animated and engaged, was passive and closed with an uncomfortable looking interpreter sitting beside her in silence.

#### OINTERP4

Patient 4 was accompanied to the clinic by his wife. In the waiting room it was she who supplied the information about his language background and told me that she was normally the person who interpreted for him. She was glad that there was a qualified interpreter present but concerned that her husband did not normally talk to strangers, including doctors he had not met before. She was also concerned that he

might not be willing to talk to an interpreter he did not know. The doctor running this clinic was somebody he had not met before. When they were called through, the wife voluntarily left the room again. The interview lasted for 33 minutes. The patient was aware of the camera all the way through the session but the interpreter forgot about it quite quickly.

The patient was born in Pakistan; his parents were born in Pakistan and Mirpur. He was in the age range of 50 to 60, his wife said his ethnicity was Asian, that his first language was Punjabi and that he had left full-time education at about the age of 18 or 19. He had worked in a manual job in a factory but was at that time unemployed. He appeared to have a small command of English and code mixed freely.

OInterp4 was in the age range 40 to 50; male, born in Kashmir as were both his parents. He claimed joint first languages of Urdu and English, having arrived in the United Kingdom at the age of 18 months but spent the years between the ages of eight and sixteen living in Kashmir. He held the DPSI in health and law options and was listed on the National Register of Public Service Interpreters. His registered language was Urdu. He stated that he used the impartial model. His clarity of accent and diction in English were good and his manner pleasant and empathetic. His English vocabulary and command of idiom were less good e.g., *"I just got on one side"* [Data item] to mean *"I passed him by"*, or *"I ignored him"*.

He had at the outset chosen a chair in apex position within the triad but the shape of the room made it if necessary for him to sit alongside the patient in order to be in

shot. Due to the interpreter being taller than the patient, and seated on a slightly higher chair, the patient was looking up at him, so the interpreter's sight lines of the other interlocutors' faces were made more difficult than usual.

OClIn2, a female consultant in the age range 40 to 50, declared her ethnicity as Chinese, born in South Africa as were both parents. Her first language is English. She routinely worked with interpreters and conducted most of this interview using first person speech and addressing the patient by name.

Right at the beginning of the video the wife is heard leaving the room to wait in the waiting room. The clinician began the interview by speaking directly to the patient using first person speech. The patient was code mixing from the beginning using English words and phrases such as *"family problems"*, *"my mother's brother"*, *"third time family problem"* [Data item]. The interpreter was using the ad hoc liaison method in very short chunks and during his interpretation made very frequent verifications with the patient of what he had said. The story of the family relationship difficulties was complex, involving multiple generations and branches of the family. The patient was unwell and his speech perhaps not very clear. It is quite possible that this Punjabi speaking patient and Urdu speaking interpreter had communication difficulties between them that were exacerbated by incomplete language match. Their speech often overlapped and the patient occasionally interjected, speaking English directly to the doctor at the same time as the interpreter, which broke the interpreter's train of thought. The patient occasionally interjected to answer the doctor's question himself. The description of making all

these marriage arrangements became so complex that the interpreter, who was not taking any notes, began to lose the thread. There was a long parallel conversation between the interpreter and the clinician into which the patient attempted to interject but was prevented by a peremptory hand signal from the interpreter<sup>1</sup>.

(v06:56) OInterp4: *“When they found out that there is a possibility that they will arrange his son’s wedding with the sister-in-law’s daughter, that’s why they wanted to block that path by making their own arrangement, putting their own arrangement in place (having relayed the question and reply, he then speaks for himself) So basically what I’m saying is... (Attempted interjection by patient fended off with a shrug) that he wanted to marry his brother to his sister-in-law’s daughter. When they found out about this they put an arrangement in place that okay your brother will marry his daughter and our . er . her brother will marry who . They put that arrangement in place just to block that so that that it wouldn’t go ahead. That’s what I’m trying to say.”* [Data item]

The patient had been cut out of the picture as the clinician and interpreter attempted to arrive at a joint understanding of the marriage blocking manoeuvres.

The interpreter was conscientious about making sure the patient had understood the questions put to him. The patient became repetitive and having listened to 37 seconds of continuous rapid speech concerning the complicated story of the marriages the interpreter interrupted and said to the doctor: *“this is just a repeat of what we’ve already discussed, but I will repeat it again”*, [Data item] which he did. He dealt with the patient’s using a mixture of English and Punjabi by repeating the whole utterance in English. The patient’s explanations of difficulties at work were dealt with in a similar way. The interpreter made a hand signal [Data item], appeared to ask something along the lines of *“may I interpret up to there?”*, and did so while the patient waited. He did not however remember the whole of the utterance he had

---

<sup>1</sup> Hand signals are commonly used by interpreters and were used by this interpreter either when his short-term memory was full or when the patient attempted to interrupt.

listened to and had to prompt for repeated information. The patient seemed to a large extent aware of what was being said in English, interjecting and commenting throughout the session in an English-Punjabi pidgin. Several of the parallel conversations were quite animated, as the interpreter checked his understanding and memory.

The interpreter only proactively intervened once to clarify the complexities surrounding arranged marriages for the doctor and once to check on his understanding of a question, almost at the end of the film. In other words he did offer advice or opinions, cultural briefing or interventions for explanations of working practice or linguistic difficulties. On the other hand his interventions with the patient were for clarification and asking for space to interpret, and were frequent. At v31:55, the interpreter did ask the doctor to clarify her question, and repeated the second version to the patient. Interventions for clarity were not repeated in both languages.

The doctor addressed the patient directly throughout using direct speech. In between moments of confusion and ad hoc liaison interpreting there were some passages of consecutive interpreting. The interpreter was controlling turns at talk by beginning to speak before the patient had completed what he wanted to say.

The expert, FA, explained that some of the time he had difficulty in hearing what the patient had said. He was mumbling and unclear, and I asked if this was to do with the illness. He thought not, he thought that OInterp4 could hear it but because of overlapping speech and the patient mumbling, it was not clear to FA. The whole

conversation about the complex web of relationships and weddings being arranged; some marriages completed, one prevented; consists of a series of parallel conversations in which the interpreter negotiated a degree of mutual understanding. This took over twelve minutes.

One brother did not want to go ahead with the marriage arranged. Listening to the patient during recording his interpretation, FA told me, "*he says here something such as 'my brother was interested in someone else' but he's talking too quick, the sentence is not clear at all [...] he's saying first word and then last word, and just mixing letters, so he's not saying clearly*". OInterp4 did not look confident of having understood the message either. The same negotiating and complications were repeated through the rest of the consultation.

(v07:53) FA: (interpreting the words of the Patient) "*No he doesn't. I have a son. Daughter. Here. We wanted. We wanted his daughter to bring to our house. But we change the system before.*" (Close interpretation by FA at a20:40)

(v07:54) OInterp4: "*They already had one son whose marriage they had arranged and who had come over to this country and they want to do the same for the other son. (Turns to patient) so they could arrange the marriage that he could come over here?*" (Patient confirmed with a grunt.) [Data item]

In our subsequent discussion of this section of the conversation FA and I wondered about the phrase "changed the system". I suggested the patient thought one of his children was going to be married to somebody but that the "system" could refer to our immigration system. FA was confused because the patient had been talking at first about his brother and sister not his daughter or son. In short, the patient may have been confused.

At v24:18, there is a conversation about a planned Hajj trip, which the interpreter rendered as

OInterp4: *"I had paid them the money and they told me that 'you're gonna lose the money' and then I took my wife with me and they told me 'if you cancel your tickets you're gonna lose the money.'" [Data item]*

FA pointed out that the patient had said he had cancelled the trip himself. Perhaps he had changed his mind but the fact that he did the cancelling was not relayed to the clinician.

FA: (interpreting the words of the patient): *"They pushed me down. They said you are going to lose the money. They pushed me down. I cancelled it. They pushed me down. Actually they took me. They could not find my passport." (Close interpretation by FA at a24:27) [Data item]*

The clinician doesn't ask about the word Hajj, either because she already knows what it means, or thinks it irrelevant to her clinical purposes. It is noticeable here and all through the session that there is subtle eye and hand signalling going on between the interpreter and the patient both coordinating speech and confirming understanding.

The interpreter did proactively check his own understanding of the clinician's question at one point. At v31:29 the doctor asks:

OClin2: *"Why do you think your family feel that not all of this is as you may think it is?"*

OInterp4: (having relayed the question, doubts, asks the clinician a checking question) *"Why does it happen in your family?"*

OClin2: *"No. His wife says that he tends to imagine these things. They are not quite as he is saying they are."*

FInterp4: relays amended question to patient. [Data item]

This exchange was followed at v33:04 by the first and only instance of the clinician addressing the patient using the third person, making the interpreter a full interlocutor in the triad.

*"So does he think that certain people swearing at him or maybe [inaudible], may that be possibly because he is ill?"* OClin2 [Data item]

The clinician had made various attempts to suggest to the patient that much of his trouble may be imaginary, because he is ill. All these attempts were couched in first person speech and were met with a firmly negative response.

#### OINTERP6

Patient 10 was accompanied by her husband who went in to see the doctor with her. No audio survey was completed as the patient was too unwell and when I played them to him, her husband said she would not understand the questions. He was not willing to give his impressions of the interpreting though he had been in the room throughout and contributed to the discussions. The interpreter reported that the patient had been making two-syllable responses. The doctor reported that he had gained only a collateral history from the husband who did most of the talking. The patient hardly spoke.

Patient 10 was female, in the age range 40 to 50, born in England of Pakistani ethnicity her parents were born in Pakistan and first language was Punjabi.

OInterp6 was female in the age range 40 to 50, born in England of British Asian ethnicity, her parents were born in Pakistan and her first language was Punjabi. She held a diploma in child psychology but had no relevant professional training or



qualifications. She told me however that she has "worked here for years". She was a smiling, cheerful and proactive interpreter with good diction, accent and vocabulary.

The doctor was male, in the age range 30 to 40, born in England of South African ethnicity. One parent was born in South Africa, the other in Kenya. His first language was English and he routinely worked with interpreters.

The interpreter started work using the ad hoc liaison method because the opening sequence consisted of a series of short, closed questions. The doctor began by addressing the patient directly, "*please tell me how you are feeling*" [Data item] but quite quickly changed to putting questions via the interpreter, using the third person. The interpreter was using first person speech to both interlocutors. So if the doctor's question were for example "*does she get up during the night*" the interpreter would say to the patient "*do you get up during the night*". She was receiving a third person message and delivering it in the second person, "*do you get up during the night*". If the patient says "*I do sometimes*" the interpreter will relay "*I do sometimes.*"

By about 6 minutes into the interview both doctor and interpreter first and third person forms of address to the patient, with the interpreter changing the focus from third to second person in her message relay to the patient.

OClin1: "*That's why there's a change, what I want to know is what is the change. Was she unhappy before?"*

OInterp6: to Patient in Punjabi (FA's English) "*Were you feeling sad before, were you sad before, were you concerned before, was you worried before*"

FA: (interprets Patient into English) "*I was upset*"

OInterp6: “*She was upset before, but not now*”. [Data item]

The interpreter was very proactive asking clarifying questions and reporting them although she did not relay the doctor’s explanation of his intentions “not what the change, but why the change”. The patient was almost monosyllabic; nevertheless reports of what was said between the interpreter and the doctor were not relayed so that the patient and her husband could understand them.

The patient’s husband told the doctor that there had been an incident the previous week in which his wife saw somebody dancing on her bed. This whole conversation between the husband and wife was run and managed by the interpreter who provided brief summaries in the third person for the doctor. The patient was reluctant to speak of this incident at all.

OClin1: “*(name) is, feeling maybe a bit shy to say this.*”

OInterp6: to Patient in Punjabi (FA’s English) “*(name) you cannot talk about it openly.*”

OInterp6: (in English) “*She said ‘I’m talking.’*”

FA: (interprets Patient into English) “*I was talking.*”

OClin1: “*Yes you are. You’re doing a lot. You’re doing very well actually. Yeah? So let me get this straight [...].*” [Data item]

The supportive comment made by the doctor was not relayed to the patient and husband, as the doctor moved on to clarify, or begin to clarify the matter of what the patient may or may not have seen. The interpreter did not offer the patient the doctor’s expression of support.

There was a nine part sequence about what the patient had experienced.

OClin1: “*Did she see him jumping on the bed or did she think that, like, there were marks on the bed from him jumping?*”

OInterp6: to Patient in Punjabi (FA’s English) “*Did you see with your eyes that your son is jumping on the bed? What did you feel about it?*”

Patient: appeared to say some word which was not interpreted.

OInterp6: to Patient in Punjabi (FA's English) "*did you see it? Did you see with your eyes that he is jumping on the bed? Did you see your boy?*"

Patient: appeared to say some word.

OInterp6 (in English, to doctor) "*She said 'no I didn't see anything'. I said 'how did you know he was jumping on your bed?'"*

OInterp6 to Patient in Punjabi (FA's English) "*Then how, how can you say that he was jumping on your bed?*"

The patient remained silent. [Data item]

The doctor phrased questions simply and clearly but the interpreter presented the patient with multiple questions and spoke quite quickly.

As the conversation progressed the doctor wanted to know:

OClin1: "[...] if she's seeing these things with her eyes or if she's thinking that this is what is happening?"

OInterp6: to Patient in Punjabi (FA's English) "*Only want to prove that you see it or you feel it. Did you see with your eyes, if you see whatever happened? Can you see what's doing, what [inaudible] are doing or do you just feel it. You tell us what happened.*" [Data item]

On the other hand the interpreter seemed to reduce the husband's contributions by summarising. He speaks from v19:30 until v19:55 (25 seconds) but the third person summary to the doctor lasted from 19:56 to 20:04 (4.4 seconds) which suggests significant information loss.

OInterp6 mostly addressed interpreted speech to the patient directly. However, when emphasising the doctor's opinion she used his formal title in the third person.

OClin1: "It's very important to me to know the difference between the two."

OInterp6: to Patient in Punjabi (FA's English) "*Doctor says it's very important for me to find out whether you see the more you feel it. Doctor says it is important to see the, to know the difference whether you feel it or you see it.*" [Data item]

Exploring ways in which the patient might be encouraged to engage in activities and improve her mood, the doctor began the following sequence.

OClin1: "What does (name) like to do?"

OInterp6: to Patient in Punjabi (FA's English) "*What you do to be happy?*"  
Patient speaks, but is not interpreted for.

OInterp6: to Patient in Punjabi (FA's English) "*Like some people sew it, some people knit it, some people do different things [patient says something] some people like cooking, what would you like to do? What do you do better?*"

OInterp6: (Patient's response) "*I enjoy just cooking. Er, she, er she goes cooking I like but lot of times my daughter does it.*"

FA: (interprets Patient into English) "*I do different things. I like cooking.*"

OInterp6: to Patient in Punjabi (FA's English) "*Cooking I like, but a lot of the time my daughter does it.*" [Data item]

The interpreter's manner was brisk, and she asked multiple questions at a time, putting words into the patient's mouth.

The patient's husband volunteered remarks about a deterioration in his wife's mental health he has noticed recently.

FA: (interprets husband into English) "*Since last five, six months, I used to take her out but now she don't like to go out with me, since last five, six months.*"

OInterp6: "*5 to 6 months if he takes (name) out to the family's houses, you know, says "let's go out" she doesn't wanna go.*" [Data item]

The interpreter had in fact started to talk during the husband's speech, twice in quick succession, taking the turn at her second attempt, and stopping his contribution.

The observation data is very rich, with many examples of good practice and areas for concern which go to answering the research questions and will be discussed in the next chapter.

## 4.4 Post hoc satisfaction questionnaires

Post hoc questionnaires (PHQS) were completed after clinic appointments, regarding participants' perceptions of the interpreted interaction they had just taken part in. The two doctors concerned answered the PHQs on all the patients they saw. All the interpreters involved completed their own PHQs, and those relating to consultations in the study that were not filmed were included. All the patients at the clinics were asked to fill in a questionnaire by audio survey; the responses were later transferred to hard copy. Not all of the patients were well enough to complete the audio survey. The interpreters who responded to the focused interviews were also asked the questions, with reference to a specific mental health interpreting job which they had done and could call to mind. These responses were also transferred to paper copy.

The post hoc questionnaires (PHQs) for the interpreters contained 10 questions. The Likert scale questions were given scores from 1 to 5 in which 5 represented "definitely", and 1 represented "definitely not". The highest possible score therefore was 50. Sample questionnaires are bound in the appendix. OInterp1, 2, & 6 say that they do not use a delivery model. OInterp4 & 5 say that they do. OInterp4 & 5 saw multiple patients during clinic 4. All the interpreters' PHQs showed confidence of successful communications having been achieved during the immediately prior clinical interview, scores of 4 and 5 being recorded for most of the responses. Every interpreter scored 2 (no) to the question "were you given enough information before the assignment to prepare for it?" except for OInterp1 who answered "definitely yes" (scores 5).

#### OBSERVATION DATA INTERPRETERS' SATISFACTION SCORES

OInterp1 rated the interpreted interaction just completed at 47/50 the only negative score being a 2 ("no") to the question "do you use an interpreting model?" This interpreter worked with patient 1 and OClin1.

OInterp2 rated the interpreted interaction just completed at 38/50 giving 2 "no" responses to the questions "do you use a model" and "did you have enough prior information".

OInterp4 rated the interpreted interaction just completed with patient 4 and OClin2 at 44 having. There were no negative, 1-3, responses.

OInterp4 rated the interpreted interaction just completed with patient 6 and OClin 2 at 40 having marked "no", score 2 ("did you have enough information?"). He had written that his model was "other - just make sure the other person understands, i.e. interventions for clarity."

OInterp5 rated the interpreted interaction just completed with patient 5 and OClin 2 at 40. She had scored 1 "definitely not" to the question on sufficient information and 2 "no" to the question of whether there was a good relationship between the other two parties. This interpreter claims to use the impartial model.

OInterp5 rated the interpreted interaction just completed between patient 7 and OClin2 at 43, saying 2 "no" to sufficiency of information and 3 "don't know" to whether there was a good relationship between the other two parties. OInterp6 rated the interpreted interaction just completed between patient 10 and OClin1 at 40. She had marked "no" twice, to sufficiency of information and use of a model; her other responses were all positive.

#### OBSERVATION DATA PATIENTS' SATISFACTION SCORES

There were 11 questions in the audio survey/post hoc questionnaire that the patient took. This gave a top potential score of 54.

Patient 1 rated the interpreted interaction just completed with OClin1 and OInterp2 at 35/54. She had said "no, I don't know about this" to the question about the interpreter being confidential and "no" to the question "can you trust the interpreter?"

Patient 5 rated the interpreted interaction just completed with OInterp5 and OClin2 at 42 having recorded a score of 2, "no", to the question "did the doctor understand your home circumstances?"

Patient 6 rated the interpreted interaction between OInterp4 and OClin2, just completed, at 38. The negative responses were a score of 3 "don't know" for both "could you speak to the doctor about things easily?", and "do you believe the

interpreter will keep what you said confidential?" There was also a score of zero (question not answered) recorded against the question "were your needs met?"

Patient 7 rated the interpreted interaction with OClin2 and OInterp5, just completed, at 44, recording scores of 4 "yes" in response to every question.

Patient 10 rated the interpreted interaction with OClin1 and OInterp6, just completed, at 40. There was no response, scored at zero, to the question "were your needs met?", and to the signoff question "is there anything you would like to add?" The patient had replied "yes" to this, but did not add anything more.

#### OBSERVATION DATA CLINICIANS' SATISFACTION SCORES

There were 13 questions in the PHQ completed by clinicians, giving a maximum possible score of 64.

#### Clinic 1:

The OClin1 did not give a PHQ due to administrative error. Patient 1 refused the audio survey. The triad included OInterp1 and patient1.

#### Clinic 2:

OClin1 rated the quality of the interpreted interaction between himself, patient 1 and OInterp2 at 46/65, there being three "don't no" replies" (question 2, able to exchange information with patient easily; question 11, trust established between doctor and patient; question 13 trust established between patient and interpreter;), three "no" replies (questions 4, in-depth understanding of what patient said to you; 5, patient understood you in depth; 7, full meaning relayed both ways;) and one "definitely



not” question10, able to treat this patient as easily as similar English-speaking patient).

Clinic 4:

OClin2 worked with OInterp4 and OInterp5 at this clinic which contained two defective sets. Patient 4 did not take the audio survey, being too unwell to answer the questions. Patient 8 had asked for the camera to be turned off at an early stage and left the appointment soon after. There is therefore no PHQ for either OInterp5 or patient 8 for this appointment.

OClin2 rated her interview with patient 4 and OInterp4 percent overall 48/65, there being four "don't knows" (question 2, able to exchange information easily; question 4, in-depth understanding of what patient said; question 5 patient understood you in depth).

OClin2 rated the interview with patient 5 through OInterp5 with an overall score of 50 all the responses being "yes" except for one "no" response to the question "can you treat this patient as easily as a similar English-speaking patient?"

OClin2’s interview with patient 6 through OInterp4 rated an overall 33 there being only 6 positive responses, "yes", 5 "don't knows" and 2 "no" responses.

OClin2 had a more positive meeting with patient 7 via OInterp5, rating it at 52, all “yes” responses.

OClin2’s final patient, patient 8, did not give an audio survey, and left early, as did the interpreter. The clinician rated this interview at 43: 7 “yes” responses; “don’t

know” to “did the patient understand you in depth”, “trust established patient/Dr” and “trust established patient/interpreter”; “no” to “goals achieved”; “exchange information easily”; “could treat as easily as similar English-speaker”.

#### Clinic 5:

OClin1 interviewed patient 10 through OInterp6 and rated it as a global score of 43 there being 3 “don't knows” (full meaning relayed both ways; trust between you and patient; trust between patient and interpreter) and 1 “no” (treat as easily as English-speaker).

The two clinicians agreed that all the interpreters they worked with were impartial and confidential, that trust was established between the clinician and interpreter (“yes” across the board) and that they had understood cross cultural issues (1 “definitely yes” and 6 “yes”).

The number of datasets in this study allows for a rounded view of what was happening in clinics; the views and approaches of doctors, interpreters and, to some extent, patients and the institution. The data will be explored and considered in the next chapter. Graphs showing the satisfaction ratings are below.

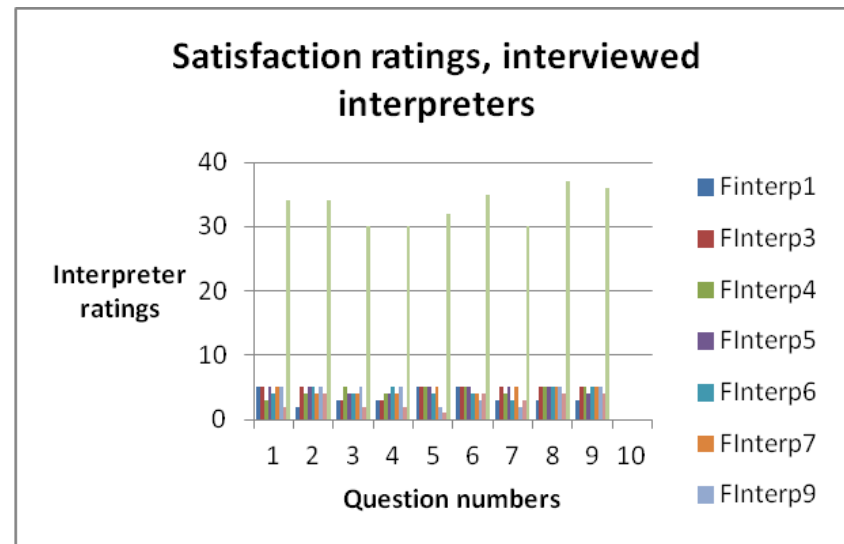
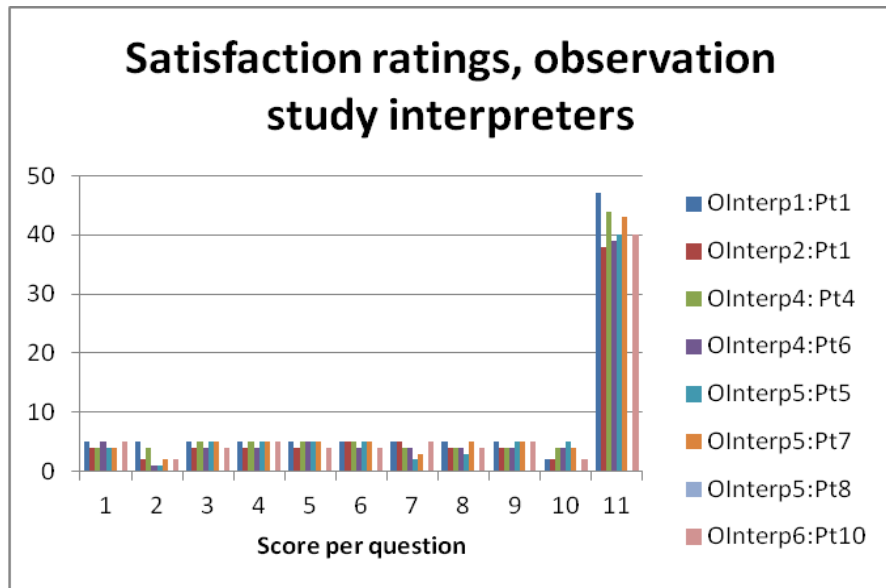

Q1	Were your goals achieved?
Q2	Were you given enough information before the job to prepare for it?
Q3	Were you able to understand all the parties and interpret well?
Q4	Did you feel you achieved accurate relay of all that was meant?
Q5	Did you feel there was good communication between the parties?

Q6	Did you feel you were able to avoid taking sides?
Q7	Do you think a good relationship developed between the parties?
Q8	Were you given all the support you needed to perform your role in this job?
Q9	Do you feel you were treated as a professional?
Q10	Do you use a particular interpreting model?

Table 7. . Interpreter satisfaction ratings

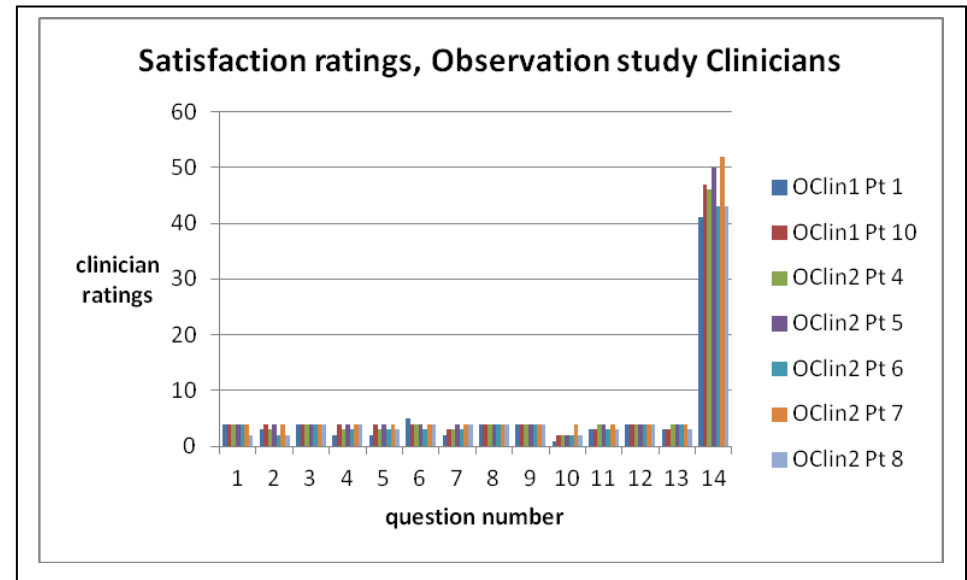
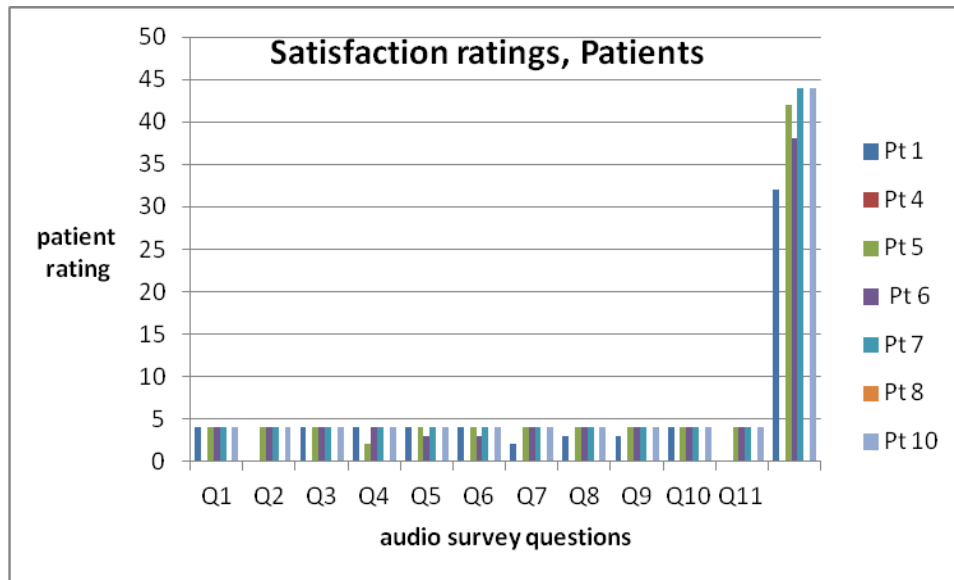

1. Did you feel respected and equal?
2. Was there complete understanding between you?
3. Could you give and receive information easily?
4. Did the doctor understand your home circumstances?
5. Do you feel you were able to talk with the doctor about things easily?
6. Did you think the full meaning of what you were saying was relayed?
7. Do you believe the interpreter will keep what you said confidential?
8. Do you feel you can trust the doctor?
9. Do you feel you can trust the interpreter?
10. Do you feel you have been listened to and heard?

1. Were your goals achieved?
2. Do you think you were able to exchange information with your patient easily?
3. Do you think you understand the interpreter's role and role boundaries?
4. Do you feel that you achieved an in-depth understanding of what the patient was saying to you?
5. Do you think the patient understood you in depth?
6. Did you feel you were able to understand any cultural issues that affected the consultation?
7. Do you think the full meaning of what was said was relayed both ways?
8. Do you believe the interpreter was confidential?
9. Do you feel you can treat this patient as easily as you could a similar English-speaking patient?
10. Do you feel that trust was established between you and the patient?
11. Do you feel that trust was established between you and the interpreter?
12. Do you feel that trust was established between the patient and the interpreter?

**Table 8. Patient & Clinician satisfaction ratings**

## **CHAPTER 5. DISCUSSION OF RESULTS, FINDINGS**

### **Strengths and Limitations**

This is the first study of its kind. It uses a multi-pronged approach to understand the problem, using a mixed methods design. The limitations are those imposed by the small sample and all that follows from that. The clinicians who volunteered to take part in both observation and interview parts of the research were, with one exception, junior doctors with limited experience of clinical work. Some of the rooms used to interview patients were narrow, meaning that interpreters were obliged to sit beside the patient, resulting in poor sight lines on the speakers' faces. The camera also imposed restrictions due to the need for participants to be in shot. The cameras were limited in their performance because in an effort to keep them small and unobtrusive, they ran on batteries not mains power. The interpreters in the focused interviews were all sourced from the national regulator's list (NRPSI) as the large pool of unlisted interpreters, some of whom were sent to the observation clinics by agencies supplying PCTs, were impossible to contact directly. Nevertheless the study data was rich, and the detailed analysis of it revealed much information about the process of interpreting in psychiatric outpatient clinics as well as the influences shaping these triadic encounters.

### **5.1 The fit of the impartial model with what is observed**

Five delivery models of interpreting for the public services were identified in Chapter 1 as described in the practitioner-oriented literature. The three most frequently used labels were the impartial, community, and advocacy models. The

impartial and community models look quite different on paper and will be seen in the taxonomy of models in Chapter 1. The NHS codes of conduct for frontline staff working with interpreters describe the community model, but when the interpreters in this study espoused a specific model they named the impartial model. The advocacy model is significantly different but not so widely used. The table of families (see figure 4 in Chapter 1) shows that the impartial model is widely used, at least by name. The community model is named by the NHS and recommended by the National Council on Interpreting in Health Care (NCIHC), an American-based organisation. The advocacy model appears to be used only in the NHS. The impartial model having, at least on paper, the widest support amongst professional bodies and organisations, is the one being tested.

The principles of the impartial model are that the interpreter does not give advice or opinions; the interpreter is impartial and confidential; the interpreter will intervene only a) if the speaker is inaudible, b) for clarification of something not understood, c) to point out possible misunderstandings d) to point out possible missed cultural inferences which may lead to misunderstandings. Interpreters' interventions will be brief, clear and to the point. There is no mention of advocacy in any interpreters' code, or of interpreters' being responsible for the well-being of any person in the triad. The interpreter's role is to act as the 'alter ego', or 'other self' of each speaker, interpreting each message fully and faithfully in as closely as possible the style of the original. The duty to remain impartial involves the application of the good practice recommendations in the appendix, such as making a clear introduction of oneself, one's role, and methods of working. Interpreters are not responsible for the content of messages or speakers' intentions; they are only responsible for accurate interpreting.

The research question can be split into two parts:

1. Is there a common model or set of models?
2. Is/are they being applied?

With two secondary questions:

1. Does whichever performance model chosen and properly applied allow for optimum outcomes in the communication process?
2. To what extent do issues of face and implicature impact on interpreters' output?

The interpreters in the study who claimed to use a particular model said that they used the impartial model. All of them displayed some adherence to elements of the impartial model and there is some evidence of face impacting on output. Implicature is closely linked with face but few examples of it arose.

What seemed to be happening was that three important things were going wrong. These were distortion, omission or addition to the message. Examples of all three problems occur in the following sequence.

O Clin1: "Did she see him jumping on the bed or did she think that, like, there were marks on the bed from him jumping?"

O Interp6: to Patient in Punjabi (FA's English) "*did you see with your eyes that your son is jumping on the bed? What did you feel about it?*" [Data item]

The marks on the bed were omitted; a second question was added; the question was distorted by the addition of feelings. The interpreter is acting as a full interlocutor with the right to ask her own questions. Following that question the patient spoke,

but what she said was omitted. Instead of relaying the patient's response, the interpreter persisted, repeating the question twice and adding another new question:

OInterp6: to Patient in Punjabi (FA's English) "*did you see it? Did you see with your eyes that he is jumping on your bed? Did you see your boy?*" [Data item]

The patient appeared to speak, but was inaudible on the tape, though the interpreter seems to have heard and reports it after her own next turn:

OInterp6: to Patient in Punjabi (FA's English) "*No, did you not see? Then how, how can you say that he was jumping on your bed? . . . How can you say?*" [Data item]

Having ridden down what the patient said she follows up with a challenge to the patient that did not originate with the doctor. She is pursuing her own line of questioning with vigour. The report to the doctor begins with the patient's intervention and then her own personal question "how can you say that he was jumping" was put to the doctor as "how did you know ...".

OInterp6: (in English, to doctor) "*She said 'no I didn't see anything'. I said 'how did you know he was jumping on your bed?'"*" [Data item]

The interpreter was speaking quite loudly and close to the patient's face. The patient seemed withdrawn but had been trying to say something on her own behalf only to be cut off twice by the interpreter's insistent questioning. In his interview, Fclin2 used the word "interrogate", "it often seems as if well they're interrogating", which does seem to describe this interpreter's methods, as Sandra Hale so aptly remarked "*by disregarding any notion of accuracy or impartiality*" (Hale, 2007:49).

Oclin1: "(name) is, feeling maybe a bit shy to say this."

OInterp6: to Patient in Punjabi (FA's English) "(name) you cannot talk about it openly"

OInterp6; (in English) "She said 'I'm talking'"

Patient: in Punjabi (FA's English) "I was talking"



OClin1: "Yes you are. You're doing a lot. You're doing very well actually. Yeah?  
So let me get this straight [...]."[Data item]

The clinician's supportive comment was not relayed to the patient. The interpreter is seen to be interrupting and cutting across the speech of both the patient and also her husband, later on. She does not interrupt the doctor, however, to interpret his gift of a compliment to the patient. This is a very good example of selective omission: supportive remarks from doctors are a vital component of establishing therapeutic trust and rapport discussed in Chapter 1. It appears that the interpreter considered this offer of a verbal gift to be an irrelevance, a serious omission, and one that the doctor probably does not know about. Holtgraves' discussion of person perception and impression management explains that:

*Although, politeness levels may reflect a speaker's perceived power, interactants may actively manipulate politeness levels as a means of impression management. An important issue in this process is the fact that politeness is determined by at least three social variables: power, relationship distance and degree of imposition. (Holtgraves, 2009:197)*

In this interchange the classic Brown and Levinson transaction formula of asymmetry of power, social distance and external goal can be clearly seen. Doctor and patient are negotiating through a gatekeeper, the interpreter. As gatekeeper to the message her identity within the triad at this moment is high-status in Holtgraves's terms because she is relatively the most powerful member of the group, resulting in a part of the doctor's message being omitted. She is completely controlling the conversation and reporting to the doctor in the third person, thus framing herself as his surrogate or agent, free to add, omit, and rearrange messages at will. It is worth noting that this interpreter has no training or qualifications as an interpreter, as shown in Chapter 4. There is neither any evidence of a delivery model being used even partially, nor any awareness or understanding of interpreters' professional code

of conduct. This is a 'barefoot interpreter', of the kind written about in Chapter 2: willing, keen to be helpful, but ignorant of the system, doctors' procedures and goals, or her own interlocutor role (described in Chapter 1.)

## **5.2 Parallel conversations, face and damaged messages**

Failure to apply the model as it is described in Chapter 1, and above, was seen to damage the accuracy of communication. Face is an aspect of projecting one's identity in any interaction and what constitutes a face threat in one culture may not do so in another. Damage to messages may result from interpreters' face being threatened, (Holtgraves, 2009:193), leading to poorly-managed interventions for clarity and the much complained-of parallel conversations, some of them lengthy. Such conversations exclude one of the principal interlocutors from accessing discussion between the other interlocutor and the interpreter.

### OMISSIONS

There were three ways in which the message was damaged. One was by information being omitted. Approximately 25 min into the interview the Oclin1 made a second attempt to discuss emotion with Patient 1. The change of topic was introduced by the comment "*okay, so all of these physical problems, they often make you feel, inside, quite sad*".[Data item] Like all the other interpreters filmed, this one was not taking any notes and the patient's response to the doctor's suggestion that she may feel angry or sad was a long one. The interpreter offered a summary, but had failed to hear the word suicide, or had perhaps left it out due to face threat. The daughter interjected to make sure that this idea was clearly expressed.

OInterp1: *“She just says to God that what is this life, what am I doing here, this is such a pain and everything”*

Daughter: *“She just said that she felt suicidal”*

OInterp1 checks with the patient and says *“she was suicidal”*.

OInterp1: *“I feel suicidal then, but I didn’t because I felt for my (indicates daughter with a hand gesture) daughter, she was young at that time.”* [Data item]

The patient’s daughter has replaced missing information on this occasion, and offered an opening for discussing the uncomfortable matter of emotion. She is in effect acting as an unacknowledged ‘silent interpreter’, a practice in formal use in medicine in some parts of the USA, where the ‘silent interpreter’ is trained and certified while the ‘interpreter’ is a family or community member. Until quite recently ‘silent interpreters’, some of them certified and registered, sat in on interviews interpreted by professional colleagues in the UK immigration Service, as explained below. The patient’s daughter has taken this role upon herself covertly, undermining the position of the paid interpreter, and without any constraints upon her interventions as would be the case if some ‘silent interpreting’ protocol were in acknowledged operation. As a fourth presence in the room, she disrupts the consultation several times, seemingly to protect her mother but perhaps also to show she is a dutiful daughter.

Information was also omitted by Ointerp2, at a second consultation with Patient1 and her daughter.

OClin1: "Okay. And when did she last see them [her family]?"

Ointerp2 puts the question.

Patient<sub>1</sub> in English “Looooong time”

There followed an interjected conversation in Punjabi between patient and daughter which was not interpreted by either OInterp2 or FA, but was summarised as:

OInterp2 for the patient: “*33 years ago.*” [Data item]

The patient clearly had some English, albeit rudimentary and only used this one phrase, possibly because her daughter was present. She had understood the question unaided and had replied, resulting in the interpreter’s brusque offering of the length of the time lapse. Perhaps the interpreter, a young and inexperienced untrained female, felt that the content of the two other women’s exchange was private and not suitable for the doctor to hear. What the daughter said to her mother remained a secret to the doctor. This “fourth presence” was a very controlling influence in her mother’s consultation.

#### ADDITIONS

A second way of damaging communication was to insert additional information. Sometimes this consisted of the intrusive transmission of social contextual information, or cultural briefing, not requested or sent by a primary interlocutor but interpolated by the interpreter. The practice was reported both by the clinicians and by the interviewed interpreters, in which the interpreter proactively offered such information. At other times, in the observation data, family members intruded into the conversation to add material regarding the patient’s history or condition from their own perspective. For example patient one’s daughter made repeated interventions to correct or expand upon her mother's version of her history, conducting a conversation with the doctor lasting 3 min and 90 seconds. This excluded her mother entirely as the interpreter offered no interpreted version of any

of it. At clinic 1, OInterp1 held a discussion with the patient's daughter about the nuances of the Punjabi word for pain which was a challenge to the interpreter by the daughter, thus offering him face threat. As Holtgraves reminds us “politeness is determined by [...] power, relationship distance and degree of imposition” (Holtgraves, 2009:197); the daughter’s interruptions interfere with the interpreter’s self-determination and impression management. At clinic 5 OInterp6 talked across the patient's husband who had volunteered remarks about a deterioration in his wife's mental health that he had recently noticed, losing most of what he said and relaying in the third person only a short summary, *"5 to 6 months if he takes (name) out to the family's houses, you know, says "let's go out" she doesn't wanna go."* [Data item]

At clinic 4 OInterp4 succumbed to the temptation to tidy up, and added grammatical elements. The patient actually said:

Patient4: (FA’s English) "No he doesn't. I have a son. Daughter. Here. We wanted. We wanted his daughter to bring to our house. But we change the system before." (Close interpretation by FA) [Data item]

OInterp4 delivered a smooth and grammatically correct rendering, in the third person. This distorts the message by misrepresenting the patient’s stumbling speech as being fluent and grammatically correct.

OInterp4: *"They already had one son whose marriage they had arranged and who had come over to this country and they want to do the same for the other son. (Turned to patient) so they could arrange the marriage that he could come over here?"* (Patient confirmed with a grunt) [Data item]

#### REASONS FOR MESSAGE CHANGES

Omission of parts of the message can be due to the interpreter's not taking any notes, or not taking notes effectively and so forgetting parts of what was said. It can be due to repetitive or confused speech in which case an interpreter may deliver a summary of what they believe to have been meant. This is clearly observable during the talk

about marriage arrangements when OInterp4 becomes confused, and recaps in his own voice: “*So basically what I’m saying is...*” followed by a brief chronological account of the tactics to prevent a marriage, [Data item] seen in Chapter 4.

Omission can be caused by face-threatening speech which causes the interpreter to omit or change something in an attempt to mitigate the face threat offered them by words such as faeces, or suicide, as occurred with OInterp1. OInterp2 may have felt her face threatened by the conversations between mother and daughter which, perhaps, she did not like to relay to the doctor, as though it were not her business to do so. All the interpreters in the observation data are seen to wrest the turn at talk from either principal interlocutor, simply by talking across them, because their working memory is full. As a result they cannot hear the remainder of what the full interlocutor was trying to say and it is lost, like the dangling word, ‘but’...., that features in vignette 5, and which only FInterp7 of the interviewed interpreters picked up without prompting from the researcher, saying that he would report the patient’s uncertainty. None of this fits with the requirement to interpret fully and faithfully in as closely as possible the style of the original.

#### CHANGING THE FOCUS

A third way to damage the message is by switching focus. Using the first person form of address keeps the ownership of what is said with the two main interlocutors. Continually changing the focus regarding "principal addressee" keeps the interpreter firmly in Principal rather than alter ego role throughout the conversation. OClin1 used more third person than second as a form of address and so spoke to the interpreter as though they were a responsible adult in charge of the patient. This can

cause false attribution of meaning and intention to the interpreter instead of to the primary interlocutor being addressed, resulting in muddle and misunderstanding. The basis of the argument over third person use centres on the shift in focus caused by changing the grammatical person, thereby changing the position of the interpreter within the triad. Third person use indicates that the interpreter is not interpreting somebody else's speech, but needs to clarify meaning or intention. When a patient attempts to draw the interpreter into his or her life world, on his or her side, making a confidante of the interpreter, their impartial positioning is at risk. In Clark's terms she is in Principal and Respondent roles, an interlocutor in her own right, and she is vulnerable to face threat.

Third person usage impedes clarity in the following exchange:

OInterp1: *"Yes it does. She gets better with that when she put that on her head because the feeling she gets is like when you're ill [...] it's like when you haven't had something to eat for days."*

OClin1: *"What feeling is like that?"*

OInterp1: *"that is during the headaches [...] she does not eat, [...] but there's also the sensation [inaudible] that she gets during the headaches and once she applies the lemon juice..."* [Data item]

The clinician's carefully phrased question was aimed at moving the patient from her physical symptoms to her emotions but was derailed by the interpreter acting as a reporter. (Sullivan & Rees, 2008). Third person usage made him sound as though this information was of his own knowledge. The skill and care in the doctor's question was sabotaged by the interpreter not grasping its purpose. This supports Newmark's 1991 proposition that there is no reason not to interpret truthfully, in other words, closely. It was more than twenty minutes later that the clinician made a further attempt at discussing the patient's emotional life.

There are many instances of changing focus by OClin1, who fluctuates between first and third person address apparently at random. This can put the interpreter, especially an inexperienced one, in the position of being alternately the doctor's agent or the impartial relayer of messages between interlocutors speaking on their own authority. This can be seen in the data as an oddly mismatched pair where the doctor is in fact using first person speech but the interpreter renders it in the third person, using his title, perhaps to make it more authoritative.

OClin1: *"it's very important to me to know the difference between the two."*

OInterp6: to Patient in Punjabi (FA's English) *"Doctor says it's very important for me to find out whether you see or you feel it. Doctor says it is important to see the, to know the difference whether you feel it or you see it."*  
[Data item]

Interestingly, the other clinician in the film, senior to OClin1, and more experienced, seems to use the third person form of address as a tactic, but only does so on one occasion. She has been scrupulously careful to use the patient's name and talk to him directly until the end of the consultation. Having failed to get him to answer the same question, put in first person speech several times, she says

*"So does he think that certain people swearing at him or maybe [inaudible], may that be possibly because he is ill?"* OClin2 [Data item]

The response is still negative, but it is striking that this third person usage seems deliberately deployed, perhaps to offer the patient some distance between the question and his feelings or perhaps in the hope that the interpreter may have gleaned some clue as to the answer from the foregoing conversation.



#### PARTIAL USE OF THE MODEL

None of the interpreters filmed offered a full introduction of themselves before they started work. All but one had to be asked for their names by the doctor but seemed not to feel a proactive introduction was called for. Had they made one, both patient and doctor would have been aware of interpreters' methods of working which should include the scrupulous use of the first person form of address, which OClín2 actually did in the only film obtained. This does represent a socially unusual situation and many courteous people would not wish to exclude the interpreter by using them as a conduit to relay first person communication with the patient. However, interpreters using the impartial model necessarily perform as what Goffman described as a non-person. He described acting as a non-person as a working practice in which, while physically present during a conversation, the interpreter is not an active participant in it, "*nor do they pretend to be what they are not*". (Goffman 1959) in (Hsieh, 2006:151). They do not pretend to have medical or other knowledge for which they have neither training nor professional accountability. More critically there is a risk of threat to the interpreter's face if they are 'present in person' while interpreting, as OInterp1 demonstrated when dealing with the words 'faeces' and 'suicide'. He dealt with 'faeces' by using both the formal and vernacular words for it, one after the other, and either did not hear or was unable to use the word 'suicide' which seemed to have come out of the blue. A short briefing with the doctor before the appointment may have circumvented the need for a 'silent' interpreter, who knew the patient well, to intervene. When an interpreter engages as a full interlocutor in their own right in these ways, as explained in Chapter 1, and their face is threatened, they may retreat behind the barrier of third person usage or they may simply leave things out including such lexical items as curses or self harm. Third person usage can cause

attribution of meaning to the wrong individual although it is only evidenced in the data by the Delphi panellists' discussions surrounding the hypothetical patient's asking a direct personal question of the interpreter, "have you ever lost a baby?" in one of the vignettes. All the interviewed interpreters talked about their methods of intervention, although most were talking about what they saw as cultural briefing, but only one of the filmed interpreters intervened for clarity and none of them gave cultural briefing. Most of the filmed interpreters incorporated their requests for clarity in the general flow of the interview as unreported parallel conversations. Such interventions should always be explained in both languages, but none were seen and few were reported to have been handled in this way. The only evidence of interventions occurring in the data lies in two examples in the observation data, though there is some mention of interventions for clarity in the interview data.

FInterp3 explained her practice as:

*"I will try to get the other party involved and say 'look, this is what we're discussing so please don't feel left out, this it's what it's about but I'll come back and explain'".*FInterp3 [Data item]

OInterp4 intervened to explain the patient's family marriage arrangements to the clinician when he summarised after interpreting what had been a long, muddled conversation involving repetition by the patient:

*"This is just a repeat of what we've already discussed, but I will repeat it again"* OInterp4 [Data item]

He does this of his own accord and on the basis of his understanding. He later checks the meaning of the doctor's question at the end of the interview, "*Why does it happen in your family?*" In neither case does he signal at the outset that he is not interpreting for the patient, but speaking on his own behalf, by using a phrase such as

“the interpreter needs to stop” in order to place a clear boundary between his own speech and the interpreted speech of another.

### **5.3 Face and rapport**

The task of rapport building will fall on the interpreter to some extent. However, building mutual trust is something the clinician needs to do and they will often engage in gift giving to foster a good clinical relationship, as OClin1 attempted to do in the consultation interpreted by OInterp6. Mauss viewed this type of ‘gifting’ (his term) as a prototypical contract (Sherry, 1983). Helen Spencer-Oatey remarks:

*"Behaviour itself is not polite, politic (Watt's term) or impolite; it is instead an evaluative label attached as a result of subjective judgements about social appropriateness" (Spencer-Oatey, 2005:97).*

Chapter 2 sets out the theory behind politeness in relation to monolingual dyadic interaction. Interpreters are not paid to be polite or impolite they are paid to reflect the courtesy or discourtesy of other speakers. Trust within the triad is stronger when a professional interpreter is present and facilitates, as OInterp1 did with Patient1, talking about their shared language over a mug of tea. The interpreter is usually the person who makes the greatest contribution to building a relationship of rapport with and between the parties and this has an impact on outcomes.

*"I think for all of us to be comfortable [trust] has to be a three way thing."*  
FClin2 [Data item]

There are face threats to interpreters if they are working in the third person and acting as messenger rather than being the alter ego, or other self, of each principal interlocutor. This was seen in the filmed data; in the following clip the interpreter changes from first to third person in mid sentence when faced with words for excreta

and uses both vernacular and technical language. This was mirrored in physical terms, as he turned away from the patient at this point and hunched forwards looking straight ahead.

OInterp1: (for patient) “*at one point I didn’t have no control over my (patient has continued talking) she just used to leak urine, um number one, and number two, faeces as well.*” [Data item]

Rapport building is critical to trust but is difficult to build quickly. Some of the behaviours described above will influence the building of rapport.

In a triadic situation trust should ideally be created six ways:

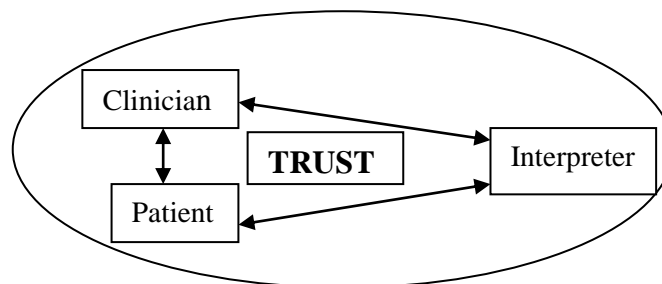

The interpreters in the observation data consistently displayed poor hosting skills in their rapport building. Communicating an identity explicitly is the first stage in making connections with interactants,

*it is important to note that face does not refer to the content of an identity that one might wish to project in an interaction (e.g. friendly, witty, intelligent, etc). Rather face is entailed in the projection of any identity one might wish to project in an interaction (e.g. friendly, witty, intelligent, et cetera.).(Holtgraves, 2009:193).*

None made clear introductions to doctor and patient or carer of who they were, or their methods of working and professional constraints. It is not known what OInterp1 did in that respect, as that part of the appointment took place while cameras were being set up, so there is no information about what the patient and her daughter

knew of his methods of working. FInterp7 described how he made a practice of introducing himself, albeit in a sketchy way.

*“First thing that I always find very useful, Jan, is in this respect is just . I try to be very intimate with the patient. So that helps a lot. Even if they can . I mean in their subconscious they put it at what I think that 'he is my friend, he is for me, he' so they take me like a friend. They do not show any aggression behaviour.”* FInterp7 [Data item]

The parallel conversations and cultural briefings described above are not repeated in both languages, so one party or the other is excluded from access to information. Interpreters in the interviews mentioned giving briefings, often unsolicited, as corroborated by the clinicians.

*“I do a little bit briefing specially. For the mental health. That's very important.”* FInterp10

*“I've had once again the Arabic lady trying to explain things, [...] I remember her saying 'oh that's an expression that they use' kind of a thing. [...] there'd be a bit of a smile and a smirk and I wouldn't really understand so I'd ask and she'd say 'well, that's a kind of expression that they use for this.’”* FClIn1 [Data item]

This gratuitous cultural briefing is a strand of practice that doctors told me they experience as inappropriate during a psychiatric consultation; it diverts their attention from their patient's own present reality and dilutes the doctor's ability to follow a hypothesis, diagnose and treat. Under the NRPSI interpreter's code of conduct, interpreters may not add anything to the message; though, exceptionally, they may *“provide additional information when requested and with the agreement of all parties”* (NRPSI code of conduct 5.9 at <http://www.nrpsi.co.uk/pdf/CodeofConduct07.pdf>). The ‘Arabic lady’ was summarising the message and reporting in the third person. She had located herself in the triad as a full interlocutor with ‘conversational rights’, and was abusing her power as gatekeeper to meanings. It is possible that she did not have sufficient

command of English to gloss whatever the expression was that “they use for this.” It is equally possible that she did not judge the expression relevant to the conversation, or withheld it because the expression was vulgar and its relay would pose a face threat to her. In any case, in view of the doctor’s direct request, the expression should have been accurately glossed in English. All these practices subvert the model and render it useless as praxis. All of this is discussed at length in Chapter 1.

#### INAPPROPRIATE USE OF INTERPRETERS

Interviewed interpreters reported having been asked to accompany patients to the shops or to act in social worker role, supervising parent-child visits:

*“[...] only in the supervising of a contact have I taken a note and that's because I'm not speaking at all. I'm just sitting there listening. And at the beginning we were told that if there's anything inappropriate to write it down and then to just hand it over rather than stopping the parents from speaking, and as the case progressed we were told to take down everything that had been said in Punjabi which would include things which the social worker didn't hear.”*FInterp3 [Data item]

They were responding to inappropriate demands which they could have avoided by making their role boundaries clear at the outset. There is a tension between the two groups of participants in the ICEs represented here. On the one hand the clinical staff, trained in the Western biomedical model, favour a culture of individual identity and small power distance. When these cultural values meet those of a collectivist culture - a ‘we’ identity conflict and misunderstanding can arise.

All parties’ face is challenged as a result of porous role boundaries, and it is sometimes difficult to defend them. Part of the problem is that there are no clear distinguishing signs that mark an interpreter out, such as a uniform, prominent badge or other sign of office. Clinical staff may assume that sharing a language and

appearing to be friendly with the patient means that this bilingual person must be a relative of the patient. Inappropriate requests for services beyond interpreting may be made, such as accompanying a patient to the toilet or acting as their chaperone.

## **5.4 The interchangeable use of the words ‘translation’ and ‘interpreting’**

It is clear from my data that there is still confusion between the skills and terms of translation versus interpreting. It is true that there is one unifying factor which applies to both skills:-

*“[T]he better written a unit of the text, the more closely it too should be translated, whatever its degree of importance, provided there is identity of purpose between author and translator. [...] If the details and nuances are clearly expressed, they should be translated closely, even though they could just as well be paraphrased. There seems no good reason not to reproduce the truth, even when the truth is not particularly important.” (Newmark, 1991:2)*

There seems no good reason for interpreters who serve public service users and providers not to ‘reproduce the truth’, i.e. interpret closely, even when the content of the spoken message seems not to be particularly important to an interpreter unaware of what the patient or the other professional may see as vital. (Raval, 2002) p132.

“Close” translation or interpreting is not an uncontested or uncomplicated idea (Harkness & Schoua-Glusberg, 1998). Linguists use the words ‘translation’ and ‘interpreting’ as technical terms. Clinicians use the term translation to describe a forensic use of spoken language i.e. striving for the closest possible semantic equivalence across languages; though Newmark believes it *"fruitless to try to define*

*equivalence – a common academic dead-end pursuit – or to pronounce where equivalence ends and where correspondence, or adequacy, begins"* (1991:3). Morris suggests that the ideal of 'close' interpreting in courts is not always realised.

*In court interpreting, the law distinguishes between the prescribed activity of what it considers translation – defined as an objective, mechanistic, transparent process in which the interpreter acts as a mere conduit of words – and the proscribed activity of interpretation, which involves interpreters decoding and attempting to convey their understanding of speaker meanings and intentions. [If interpreters are] recognized professionals, court interpreters can more readily assume the latitude they need in order to ensure effective communication in the courtroom. (Morris, 1995:25).*

It is a confused picture; lawyers want words to mean what they would like the words to mean, as did Humpty Dumpty in "Alice Through the Looking Glass" who said, 'When I use a word, it means just what I choose it to mean — neither more nor less.' Word for word 'equivalence' is not a reliably standard measure of meaning. Consider "they are cooking apples" vs. "they are cooking apples"; vocal stress changes meaning, as do irony and many other influences. Morris points out that lawyers are inclined to face both ways on this matter, taking the liberty of phrasing a question imprecisely while insisting on complete adherence to 'translation' from others.

*Hence the need to adopt a rigorous distinction between interpreting as an interlingual process and interpretation as the act of conveying one's understanding of meanings and intentions within the same language in order to avoid misunderstanding in the judicial context. (Morris 1995:25).*

In the view of the interviewed interpreters there is a distinction between the manner in which interpreting is practiced before the courts, and a looser, freer use of language in mental health care to express an overall message. This is clearly expressed by the clinicians interviewed. The psychiatrists interviewed and observed want the same standards as the courts require.



*"[ ... ] To emphasise on direct translations of what the patient is saying, um, and not necessarily always having an interpretation of what they're saying."* FClin2 [Data item]

INTERPRETERS' ATTITUDES TO USING THE FULL IMPARTIAL MODEL IN COURT BUT NOT IN HEALTHCARE

*"It is important that the interpreter's translations are equivalent to the original utterances."* (Bot, 2005:291).

Hanneke Bot echoes Jakobson's description of good interpreting, *interlingual* communication, written forty years earlier; and as Newmark repeated with regard to written translation, *'There seems no good reason not to reproduce the truth, even when the truth is not particularly important.'* (Newmark, 1991). Interpreters may not make value judgments of message content, deciding what is 'not particularly important' or otherwise. That decision lies with the institutional service provider. The interpreters interviewed talked of their work in mental health as being a different praxis to that in the law. They described a requirement for 'word for word translation' in legal settings while claiming that their mental health clients needed 'interpretation' because they would not be able to understand the doctors' words due to their condition. How they arrive at that decision is not described but they don't seem to believe that a close interpretation that facilitates a checking exchange between psychiatrist and patient is appropriate.

*"Because first of all I personally think that a language can not be done, translated word for word because with regard to mental health ability and the illness or whatever the situation is of the person they might not be able to understand the words we are translating."* FInterp5 [Data item]

Checking exchanges are evidenced in both Berk-Seligson's and Hale's research data, both in the courts of the USA and Britain and the healthcare system.

*Yeah. Well the thing is with regards to interpreting obviously when we do interpreting in different fields it's a different sort of a things that we keep in mind because example like courts and stuff and the police and stuff you know you have to sort of see that legally you know word for word and whatever.* FInterp5 [Data item]

As Hale points out in her 2007 book

*There are undeniable differences between the court and medical settings which may warrant different interpreter roles. The courtroom is a public setting, governed by strict rules of evidence, whereas the medical consultation is a private, informal setting where there is no real need for strict impartiality. [...] Medical consultations are not adversarial [...]. The two settings, therefore, have one major factor in common: the importance of language in the interaction. [...] The way health care providers ask questions can also have an impact on the answers proffered. (Hale 2007:41).*

Interpreters who work in courts are required by members of the legal professions acting in a case to provide a very accurate rendition of their questions and the responses of defendants and witnesses. They also require equally accurate rendering of responses; not paraphrased, shortened or added to. Very strict protocols surround interpreters' interventions to clarify speech they are not confident of having fully understood. Everything said must be interpreted as well as possible, differences in legal systems notwithstanding. This is made more challenging by the range of registers used and research by Miguélez showed that, far from forensic precision in their speech, lawyers and expert witnesses were often difficult to follow, even in English. This was shown to be true in both American and British legal language. She found American expert witness's evidence to be '*often grammatically faulty, convoluted, imprecise, repetitive and lacking in coherence.*' (Miguélez, 2001), in (Mason, 2001:4) and cites Crystal and Davy (1969) on British legal language.

*Legal language was found to be replete with passives, nominalizations, multiple negatives, misplaced or intrusive phrases, unusual and complex embeddings and unusual prepositional phrases and clauses. Other characteristics included lengthy sentences, and limited verbal groups, and frequent post-modification in nominal groups. On the discourse level, legal language was found to be lacking in cohesion due to the unusual use of anaphora, confusing repetition, and a mix of extreme precision and intentional ambiguity. (Miguélez 2001) in (Mason 2001:4).*

The complexity of the task in court is described further by Berk-Seligson over a decade later, in research on functional English proficiency testing. She

*[...] studied speech styles and how they affect the outcome of legal proceedings. These studies show that the testimony given in courtrooms and the language used in other legal settings (police stations, detention centres, county jails, attorneys' offices) for other legal purposes (arrest, booking, initial attorney-client interview, depositions) spans the range of registers from the highly frozen and formulaic language often used by judges and attorneys to the highly colloquial language used by defendants and witnesses to describe individuals and recount events. Slang, regionalisms, jargon, dialectical variations and even idiolectal idiosyncrasies appear frequently in spoken language. Moreover participants in court proceedings or legal interactions often make use of and mix several registers or speech styles in their discourse. Other paralinguistic elements of speech such as hedges, hesitations, false starts, self-corrections, inconsistencies and mis-speaks are all common in the language used in court. (Berk-Seligson 1987, 1988, 1990 cited by Miguélez) in (Mason 2001:5).*

It emerges that precision in the use of language is not a constant even among legal practitioners and expert witnesses, Miguélez quotes from an expert testimony:

*Witness: I checked the speedometer reading from the general reading to the decimal indicator at the end of the reading from one point to the next and then in sequence and then got at the mileage by subtraction. (Miguélez 2001) in (Mason, ed. 2001:18).*

She uses this to illustrate the difficulties imposed on the interpreter by the loss of cohesion in the source text.

*In these cases, the interpreter has no choice but to render an ongoing interpretation of what she/he hears as it is virtually impossible spontaneously to correct or improve the quality of spoken language when cohesion and coherence are so totally lacking. (Miguélez 2001) in (Mason, ed. 2001:18).*

Interpreters are, “*for the occasion, officers of the Court*” as described by Lord Justice Auld in his review of the criminal courts in England and Wales published in 2001. (Auld, 2001) §159. This status and the demands put upon the interpreter are

reflected in how they report those experiences; the phrase they choose to describe forensic use of language is “word for word” or “word to word” translation.

*“If I, because, with our language if I speak Urdu to people obviously it's er, proper Urdu language the level is quite high even for our own community. And so what we do is we try to obviously translate the meaning rather than proper translation word to word.”* FInterp5 [Data item]

This is “proper translation” or proper interpreting to FInterp5. FInterp3 also thinks required standards are different in court. In a medical setting she will introduce herself and explain her working practice.

*“Right at the beginning of interpreting I will explain who I am, what my role is, who I work for and if there's anything they don't understand they can ask me again and if they don't understand the question to please say so.”* FInterp3 [Data item]

But in a court of law she does things differently, assuming perhaps that the LEP client has less right to know what is going on, or simply because everything is being recorded by the digital audio recording equipment (DARTS). Why she makes this reference to recording as a justification for omitting normal introductions is not known. It must be said here that in many of the courts of England and Wales tape recordings are still made of proceedings though transcripts of either type of recording are only produced on request and at a cost. The future aim is that all courts will make digital recordings of all speech in a courtroom, encompassing all that interpreters and OL witnesses say. This should improve accountability among court interpreters.

*So I'll do that [make an introduction to the LEP client] in any setting. Except in court, because it's being tape recorded obviously so we don't have to introduce ourselves in that way.* FInterp3 [Data item]

An interpreter acting for the defence will have direct contact with the client while he or she is instructing their legal team. The interpreter booked for the court will not have contact with anybody but the prosecution team, for legal reasons, so no opportunity for introductions.

Susan Berk-Seligson's 1990 research in courts in the USA (Berk-Seligson, 1990) reminds the reader that court interpreters are required to supply a verbatim account of all that is said. This means that:

*if an attorney or judge has made any linguistic errors in the formulation of a question or statement, theoretically it is the interpreter's duty to interpret the erroneously worded English utterance into as close an equivalent as possible in the target language' [...] Similarly, if a witness or defendant in reply to a question answers improperly (e.g., tangentially, off-target), the interpreters' obligation is to interpret that response in the nearest English equivalent, even though the outcome potentially may sound evasive or even nonsensical to those in the courtroom. (Berk-Seligson, 1990:65).*

Question/answer/checking routines are as prevalent in courts as they are in medical consultations. The examples quoted below show two instances of interpreters intervening in their own right rather than enabling direct checking between interlocutors by relaying each interlocutor's utterance as it was voiced:

Prosecuting Attorney: Had you expected that you would have to pay another eight hundred dollars?

Interpreter: *¿Esperaba Ud. Tener que pagar ochocientos dólares adicionales, señora?*

Witness: *Adicionales, cómo?*

Interpreter: Uh, I said, "Were you ups-, were you, uh, did you expect to pay, uh, eight hundred additional dollars?" and she doesn't understand the word "additional" in Spanish that I used.

Prosecuting Attorney: Eight hundred more dollars?

Interpreter: *Ah, ¿esperaba Ud. tener que pagar ochocientos dólares más, además de lo que ya había pagado?* [Example from Berk-Seligson 1990:71]

What we see is that instead of interpreting the witness's own response to the question, which revealed her non-understanding of it, the interpreter reports her interpretation to show that the witness had not understood. Had she simply

interpreted “Additional ones, how’s that?” the attorney would have re-phrased the question and the exchange would have been shorter. Shortening the interchange meant the interpreter stepped out of her role; tacitly asking the attorney to approve her wording and exchanging an aside with him. The example above mirrors the same phenomenon in mental health clinics, when interpreters engage in dyadic monolingual conversations with one or other party that are not explained in the other language. Hale posits a further plausible reason why interpreters may omit what they consider to be ‘irrelevant’. It is that interpreters may not realise the importance of the question’s *form*; they just concentrate on translating the propositional content alone. Looking back at the filmed data we can see that OInterp1 did not recognise the doctor’s question, “*What kind of feeling is that?*” as a “clean language” (neuro-linguistic programming or NLP) attempt to ask the patient to talk about her personal metaphors for her feelings.

OInterp1: “[...] *yes, it does. She gets better with that when she put that on her head because the feeling she gets is like when you’re ill, tie tiredness, the weakness [inaudible] the feeling sick is like when you haven’t had something to eat for days.*”

OClin1: “what feeling is like that?”

OInterp1: (checks the patient’s reply and reports) “*That is during the headaches, and while that lasts, those things are during that period. She does not eat, she does not – but there’s also the sensation [inaudible] that she gets during the headaches and once she applies the lemon juice...*” (The patient has disengaged and looks withdrawn). [Data item]

By failing to relay the form as well as the content of the question to the patient, the interpreter has subverted the clinician’s intentions. (Sullivan & Rees, 2008) Clean language is a technique within NLP described thus:

*The client’s actual words have a precise personal meaning that can be lost if the counselor tries to substitute words or add what is not there, leading to reduced rapport. A particular set of rules for asking certain very simple questions has been developed in a way that lets the client to go deeper into inner experience. That set of rules and questioning procedures was called*

“Clean Language.” See <http://www.nlpworld.co.uk/nlp-and-clean-language/> accessed 21.03.2013.

Other commonalities between the two professional interpreting arenas include the face-threatening moment when a term is used – perhaps dialectal or technical – that the interpreter is unfamiliar with or does not recognise within the context of its use.

Berk-Seligson remarks that:

*Most codes of ethics for court interpreters specify that whenever such a linguistic problem arises, it is the interpreter's duty to inquire as to the meaning of the word, so that she may interpret it correctly. It is usually only the most competent interpreters who do so, however, since it requires a great deal of self-confidence to admit to a lack of knowledge in public, and on the record. (Berk-Seligson 1990:76).*

She concludes that the impact of the interpreter's work is greater on the English speaking listeners who must rely entirely on the rendition of messages into English to understand a witness's testimony. She says that the intrusion by interpreters into attorneys' lines of thought and reasoning such as introducing hedges or making messages excessively formal, is not as influential as alterations made in some pragmatic aspects of a witness's answer. All this rings true for medical interpreting as well, when doctors are trying to test a hypothesis on which to base a diagnosis.

#### MEDICAL INTERPRETING MAKES THE SAME DEMANDS FOR ACCURACY AS LEGAL INTERPRETING DOES

Sandra Hale's 2007 study includes a report of research in Sweden carried out in 1997 analysing the work of a professional, trained medical interpreter. This interpreter always works in the first person and interprets every turn accurately. The focus in this study is on turn-taking, feedback and overlapping speech which are ever present in the speech relayed in public service or community interpreting.

*Unlike the examples of the untrained interpreters, where the interpreters monopolise the interactions, in Englund Dimitrova's study the doctor is*

*clearly in control and takes most of the turns, a finding that corroborates studies into doctor-patient monolingual discourse. In her words, 'doctors take the initiative and basically maintain it throughout the encounters. The fact that there is a third speaker present, the interpreter, does not change this relationship (Englund Dimitrova 1997:156) in (Hale 2007:57-8).*

Englund Dimitrova raises the possibility that interpreters might take charge of turn-taking control, rather like a police officer directing the communication traffic. This risks the loss of spontaneous confidences from patients because of the editing effect imposed by untrained interpreters' memory limitations. The practice among untrained interpreters is to use face or hand signals when short term memory is full, or where simultaneous speech is too fast. These practical expedients may sometimes form part of praxis when note taking is not available. However intrusion into an interlocutor's train of thought as a standard practice usurps both interlocutors' right to speak as they choose.

Helen Tebble also argues for accurate interpreting in medical consultations, arising from good rapport between the interlocutor - the doctor and the patient.

*The outcome of the consultation with all its attendant costs can depend considerably on the nature of the rapport that prevails between doctor and patient. So it is up to the medical interpreter to live up to the interpreter's code of ethics and convey what is said accurately. Conveying what is said means not just the content of the message but also the way the message is expressed. This means that the medical interpreter needs to relay the interpersonal features of each speaker's turn at talk. (Tebble, 1999:186) in (Hale 2007:59)*

Cecilia Wadensjö's exploration of interpreting in mental health (Wadensjö, 2001) found "*interpreters and interpreting sometimes mentioned [in the medical literature] and then basically as a methodological problem in the practice of the medical expert.*" (Wadensjö, 2001) in (Mason, 2001:72).



She proposes that the *possibilities* of the interpreter-mediated mode of communication be further explored. In support of her own early observations and thoughts on turn-taking, she cites Apfelbaum's 1998 study in which ten hours of video recorded instruction data in French and German showed that "the synchronisation of interaction is highly dependent on the interpreter's anticipation of turn-taking and turn allocations". (Wadensjö2001) in (Mason 2001:83)

There is a tension between the perceptions of the two professional groups in this study. Clinicians were clear that they needed close interpretation even though they called it translation, after the style of lawyers. The interpreters interviewed believed that 'word for word translation' should only be used in court. They reserved 'word for word translation' and 'whispered simultaneous mode' for the high-status world of law alone:

*"Not in a mental health setting no because most of those are conversations either at the hospital and the other person will stop. The whispered simultaneous is mainly for court work."* FInterp3 [Data item]

Yet a competent introduction of working practices will at least provide the clinician with an opportunity not to stop, but to carry on delivering the message. Finterp1 and FInterp4 had found this method to work. FInterp5 seems to see 'word for word' as too difficult for patients to understand.

*"[...] and so what we do [in mental health clinics] is we try to obviously translate the meaning rather than proper translation word to word [as we do in court]"* FInterp5 [Data item]

Interpreters also appeared to believe that the court is a much more exacting workplace than medicine, requiring a particular rigour not necessary elsewhere. They deferred to the legal professionals far more readily than to clinicians.

*"[...] then it's up to counsel to re-phrase [the question] not for me to explain again."*FInterp3 [Data item]

Interpreting praxis is seen as being very different between court and interpreting in mental health.

*"I think it depends, every model or circumstances depend on the situation itself. Because depending where you're working, how you're working, who you're working for and I think you have to become that model kind of thing because not everything applies on one situation, you see, on mental health all these laws and clause don't apply on that about interpreting. And similarly on the other side on the when you're working on a legal environment it's a bit different."* FInterp5 [Data item]

Only FInterp10 and FInterp4 spoke of asking a doctor to rephrase a question and there was only one instance of it happening in the observation data.

*"I would keep, obviously keep interpreting but um or if there is some misunderstanding between the patient and the clinician I will point that out 'I think my client hasn't really understood, hasn't grasped - can you explain' or I would try to explain what my client is trying to say."* FInterp4 [Data item]

In the interviews, the interpreters talked of how they simplify the language for patients as though the clinicians were speaking at too high a register, meaning that carefully phrased and nuanced questions were being reconstructed.

OClin1: How is your mood, how are you feeling?

OInterp6: *What mood (Urdu word)? FA interprets it back as "how is your mood?"*

Patient10: (Single Urdu word) *FA interprets it as "okay"*. OInterp6 does not relay it.

OClin1: Are you happy?

OInterp6: *Are you happy?*

Patient10: (whispers) yeah

OClin1: Yeah? Okay. Is this different from how you were feeling before?

OInterp6: *(FA's rendering of interpreter's Urdu) Are you feeling any different than you used to feel before?*

Patient 10: Yes. [Inaudible due to traffic noise. Possibly, "this is"] different

OClin1: Feeling different. How are you feeling different?

OInterp6: *She said at first 'I don't know' but then I said 'from before and now what's the difference?', and she said 'maybe taking the tablets?'*

OClin1: Okay. That's why there's a change, what I want to know is what is the change. Was she unhappy before?" [Data item]

This interchange has only produced the answer to why. The doctor's enquiry was what change there is in the patient's mood. In his third turn, the doctor asks if 'this' (feeling happy) is different to how she felt before. The framing of the question changes in the relay, leaving out the idea of 'this' meaning 'feeling happy' and referencing feelings in general. Like many Urdu speakers from established communities this patient can understand and speak a little English, and does so twice. She does not mention the tablets however. These are mentioned prior to this interchange when the doctor asks the patient firstly if, and then why she is taking her tablets (she says it is because she does not get enough sleep) but there is no further mention of them by the patient in her subsequent contributions. It appears that in her final turn in this excerpt the interpreter attributes her own conjecture to the patient, and brings it forward as what she may perceive as the *cause* of change: taking the tablets. Doctors in this study were not consulted on the ways interpreters treated their messages, either on the evidence of interviews or observation.

The tension lies in opposing beliefs among interpreters and clinicians. While interpreters believe they are interpreting well, when they insert unlooked for cultural briefings, clinicians are looking at the individual person, and their whole life.

*"[...] the challenge for cultural psychiatry is to identify genuine differences between populations, without being misled by ethnic stereotyping. Individual differences are as great as ethnic ones, and the clinician treats the individual within the larger socio-economic context, not the ethnic group" (Bhugra & Mastrogianni, 2004:18).*

As explained in Chapter 1, and demonstrated here in the observational data, the two groups have minimal common ground. There is no shared, informed viewpoint on the linguistic form of medical interviews and therefore no formalised strategy for joint working. The perceived differences between types of practice are not rooted in the setting but may lie in unconscious attitudes to clients.

## 5.5 Why is the model not used?

### SELF-PERCEPTION

As discussed in Chapter 1, interpreting models developed in pockets where people recognised the need for a structure to support interpreters' work. The models were influenced by the professional service provider and the service user. For example, two different models might arise from a mental health case worker interviewing a service user and a clinician doing so. These are two different world views and approaches. The case worker has a wide range of skills and training in mental health advocacy. The clinician is focused within his specialty, constrained by the institutional framework and systems, and lacks understanding of the service user's lifeworld.

<b>Case worker</b> <ul style="list-style-type: none"> <li>• holistic understanding (law, health, welfare)</li> <li>• advocacy</li> </ul>	<b>Service user</b> <ul style="list-style-type: none"> <li>• need</li> <li>• lack of linguistic and cultural competence</li> <li>• vulnerability</li> </ul>
<b>Interpreter – model 1</b>	
<b>Clinician</b> <ul style="list-style-type: none"> <li>• specific expertise</li> <li>• lack of communication training</li> <li>• lack of cultural expertise</li> </ul>	<b>Service user</b> <ul style="list-style-type: none"> <li>• need</li> <li>• lack of linguistic and cultural competence</li> <li>• vulnerability</li> </ul>
<b>Interpreter – model 2</b>	

Figure 29. possible influences affecting development of early models

DW Winnicott (1896-1971) wrote that *holding*, the adaptive care of the infant: "*leads on to the idea of the casework that is at the basis of social work*" (Winnicott in Dwyer, 2006:85). In inter-professional working in the 21st century case workers have a fundamental advocacy role that shows how the gulf in professional viewpoints between specialist clinicians and holistic case workers can be bridged by the work of the interpreter operating in the Jakobson/Clark system (Jakobson 1959, Clark 1996) which represents the Impartial Model.

In an earlier chapter the arguments over the respective merits or otherwise of emerging models showed that uncoordinated work went on in different institutions so that interpreters who were working across the whole healthcare system may easily have become confused. None of this work was written up except in the case of the impartial model which became the basis for the model set out in the NRPSI code of conduct. The interpreters in this thesis appear to be using an eclectic mix of elements of multiple models.

One reason for the model not being used, or being used only partially, was that the interpreters did not seem to look upon themselves as expert linguists. All the interviewed interpreters learned either Urdu or Punjabi as a first language, and came to the UK with varying degrees of competence in English. Of the filmed interpreters, one was born in Britain; two were born in Pakistan and the other in Kashmir. While two of them held a DPSI there is no evidence that any of the interpreters had studied either English or their other language in a systematic way to a professional standard. They believed themselves to be bilingual, but in a professional sense most of them

were not. Mental health care deals with people's whole lives and lived experiences. Interpreters therefore require very broad general knowledge, lexical range and command of register in all the languages they can offer, including English. It is worth noting that English is spoken as an official or co-official language in many ex-colonial countries. There is significant varietal difference between the varieties of the English language is spoken around the world. These include structural and grammatical differences as well as differences between some speech sounds in the phonetic inventory of British English and the sounds made in other varieties of English. The fact that this group of interpreters sees itself as bilingual is an impediment to their choosing to use a systematic and coherent model for interpreting. They do not seem to see their bilingualism as a skill, to be cherished, enhanced, and give them expert status. They speak of 'my language' and 'our culture' with reference to the non-British English language and culture. Their identity, on the basis of self-reported ethnicity, is Asian and while most of them have trained as interpreters they do not experience language switching as an acquired skill. Perhaps to compensate for undervaluing linguistic skills, they reserve to themselves expertise in cultural and religious nuances within their communities and deploy that as evidence of professional standing.

*“And just like somebody, doctor is saying “oh you need to take your hijab out, you have to expose your body parts or,” we have to tell them that this is their culture and their religion and then obviously they are not allowed to do that from these beliefs that they have.” FInterp10 [Data item]*

There is no mention of prior discussion with the patient to ascertain their views. A person's cultural perspective is, as the Delphi panel agreed, not something to generalise about. Penny et al, reporting on Pakistani families' experience of early interventions for first-episode psychosis, sum up the risk involved in assuming homogeneity of culture in any group.

*People's positions in culture are not fixed: "Multiple interpretations are often available and provide flexibility in the understanding and interpretation of serious illness" (Good, 1997) p234. We may identify participants as (for example), people of Pakistani origin, but this risks presuming that "Pakistani" is the only salient cultural framework present for them—or indeed that there is a single, coherent "Pakistani culture" (Penny et al, 2009:971).*

The interpreters were deeply committed to the wellbeing of the communities they served, quietly making the point that they view this profession as a way to be of service to their client and their community.

*"[...] because you're working basically for the community, you're working for your own community and for their sort of um for them to get better basically and you are - I feel like this is being half doctor rather than just an interpreter." FInterp5 [Data item]*

They spoke of "my client" to the clinician when intervening, as in, *"what my client is trying to say..."* (FInterp4). They rarely proactively sought to help the doctor understand or ask him or her for clarification and guidance. Only OInterp4 stopped to clarify a doctor's question,

OInterp4: *"'why does it happen in your family?'"*

OClin2: *"No. His wife says that he tends to imagine these things. They are not quite as he is saying they are." [Data item]*

The interpreters' low self esteem evidenced above leads to their not being confident of their role boundaries being respected:

*"[...] so then they were offering a cup of tea after we'd finished, can we go to the shops, [...], which you have to say no to. And yes there's excuses 'I'm sorry I'm running late, I can't do that' but you can't always set the mark in that kind of situation." FInterp3 [Data item]*

Pressure on interpreters to perform as quasi family members can jeopardise both the family's and the clinician's perception of interpreter impartiality. The NRPSI code of conduct (2011) requires at 4.2 that interpreters must *"immediately disclose to the principal any factor which might jeopardise such impartiality."* (NRPSI, 2011) The

difficulty lies with families' eagerness to give a favoured interpreter ersatz family status. As we can see from FInterp3's statement above, interpreters are aware of the importance of not being too closely involved in their clients' daily lives. Intimate knowledge of those lives and relationships can make it very difficult indeed to focus on the interpreted conversation in hand without allowing any subliminally held information to colour their rendition of what is said. Interpreters should not interpret for their own family members because of their partiality, nor become closely involved with other families they interpret for. The situation could be likened to the unsuspected presence of a rogue red sock in the washing machine with the whites wash; the result is that colour leaks and stains the whites in random, uncontrollable ways. Erosion of perceived impartiality due to over-familiarity with either a family or a clinician can affect the interpreter's performance and may actually damage their claim to be impartial, and lead to mistrust of them.

#### FACE AND STATUS

In the introductory chapter, face and status were identified as crucial factors in determining whether or not the model was fully implemented. The data demonstrate the truth of this assertion and illustrate the risks to patient, clinician and institution from a wrong diagnosis or treatment. The observation data clearly shows all the interpreters filmed summarising messages, forgetting parts of messages (such as leaving out the word 'suicide'), not taking any notes, and using a verbal barging technique to gain the floor while an interlocutor was speaking. The interpreters interviewed did not see themselves as expert linguists in health care; they seemed to reserve the role of 'cultural expert' as their area of professional standing. In contrast, they saw court work as being of higher status, perhaps because most trials are conducted in public and the setting is an especially formal one. Interpreters



interviewed in the study drew a clear distinction between the forensic language used in court and language used elsewhere. In court they were paying attention to the semantic equivalence of words across languages and yet dealing with ambiguity, evasion, lies and even varietal differences between the languages in use. The fallacy of ‘forensic’ language in court being restricted to formal registers and calm delivery is not borne out in practice. In a drug smuggling case in which I acted as interpreter for the lorry drivers, one of them was asked during his evidence in chief what the vehicle he was driving looked like.

Counsel: “was your vehicle painted in the company livery?”

Defendant: (interpreted from Spanish) “*No it was painted plain grey*”

Counsel: “You’re joking, aren’t you?”

Defendant: (in Spanish) “*At no time since my arrest, not during detention and not in this court, have I ever . made . a . JOKE. I am a serious man!*”  
[Author’s personal experience]

This speech ended at high volume, with great chopping up and down gestures of the arms and hands.

FInterp3 had also experienced moments when vernacular language had to be relayed in court, demonstrating a tension that was identified in Chapter 1:

*“I’ve been in situations [in court] when I’ve had to swear at the Crown Court Judge, which wasn’t very nice.”* FInterp3 [Data item]

What the original Punjabi utterance from the witness was, and what this interpreter actually relayed is open to surmise but she clearly felt uncomfortable about being obliged to use words that she would not utter on her own behalf.

The interviewed interpreters saw language switching in court as having higher status and being more important, as well as better paid. FInterp3, in particular, illustrated several points she made about interpreting with stories from her work in the criminal justice system; stories about assisting or being congratulated in some way. These were her ‘trophy’ stories.

*“And one of the barristers in that case, the person who was defending him, was Asian and he spoke Punjabi and I remember him commenting afterwards because I still do cases with him now that not everybody would have done that in that situation.”* FInterp3 [Data item]

It is apparent in the next quote that she is aware of the seriousness of interpreting in court, using court terminology to indicate her higher standing there than in a mental health clinic. It may be that she sees her role as superior to those of the lawyers and judge. Judges and Barristers conduct cases; Interpreters assist in cases. It is also clear that she sees the non-English speaker as her client, rather than the court. This reflects findings noted from the interview data that interpreters do not consider the doctor or lawyer to be a client.

*“I conducted a murder case for a defendant in Crown Court and this particular one was very nasty [...] And in that setting we had a Queen's Counsel who spoke Punjabi, the public gallery was full of Asians ‘cos it was such a major case.”* FInterp3 [Data item]

The work these interpreters do in mental health clinics is viewed by them as a different type of praxis. But in fact the language used there demands exactly the same level of rigour as court work does, yet they engage in interpreting in its loosest sense. They insert unsolicited and often irrelevant information and cultural briefings because they are asserting their right to an area of expertise to the clinician.

*“They wouldn't know the religious views on certain things and how the professionals basically should approach the patient or the way of talking and stuff.”* FInterp5 [Data item]

*“I do sometimes tell them, it does happen in our community or it does go on like they told. Something like that in Pakistani community.”* FInterp9 [Data item]

The clinicians were not uninterested in this information, but simply preferred to receive it at a more appropriate time.

*“I think what tends to happen is that interpreters tend to be of the same ethnicity or similar culture and they often act as a cultural interpreter rather than a vocal one which is not necessarily what we’re wanting at that time, even though that information can be useful as a sort of add-on to the interview but not as a part of it.”* FClin2 [Data item]

Certainly they were looking for close interpretation and attention to detail.

*“I would think that their, their primary goal is to translate the information as closely as they can and to avoid putting in additional information or skewing the conversation, um in a way that wouldn’t happen if it wasn’t being interpreted.”* FClin1 [Data item]

This clinician has apparently not conducted a pre-consultation briefing with the interpreter, in line with the commitment to high standards required of interpreters in the NRPSI code of conduct. It is unfortunate that none of the doctors, interviewed or observed, made any attempt to brief the interpreter on the purpose of the forthcoming conversation and the outcomes hoped for. It is worth noting that FInterp1 said she always asked for briefing notes when accepting a booking by telephone. This practice allows the interpreter to ask questions, do necessary desk research on terminology, and mentally prepare for the ideas and terminology likely to arise. In this way briefing can save consultation time and improve the quality of clinical enquiry by reducing extraneous input from an interpreter who believes themselves to be helping, in some cases ‘educating’ the doctor with cultural and religious points not relevant to the current clinical purpose.

As suggested in Chapter 2, there is discussion among clinical professionals about the cultural validity of the DSM to non-Western cultural groups:

*“[...] it is likely that some patterns of distress may not fit with Western descriptions of psychopathology and disorders, and may therefore need separate and distinct class category representation”* (Jadhav, 1996:281).

However there is also recognition of the difficulties interpreters face:

*“It is sometimes held that the interpreter should simply translate the denotative sense of the statements made by doctor and patient. Actually, this is hard to do and is frustrating for both parties. Instead, the interpreter tries to privilege conceptual equivalence above the linguistic equivalence of statements so as to convey the connotative meanings of the statements”* (Bolton, 2002:108).

It is clear that the model is known about to some extent, but that it is not being used in a consistent or coherent way in practice, for the variety of reasons, described above.

#### POOR PRACTICE GOES UNCHALLENGED

Interpreter behaviours observed in the filmed data, as well as some of those reported or recognisable in the interview data, have been shown to represent poor practice. Among these are reported incidents of unsolicited cultural briefing. Some examples are OInterp6 summarising and taking a very vigorous approach to questioning the patient; OInterp2 seeming unwilling to relay conversations between the patient's daughter and her mother or between the daughter and the doctor; FInterp7 deliberately editing messages and reporting, *“I know what is to be interpreted and what is useless or selfish”* [Data item]. Given the gatekeeper-to-messages status of the interpreter it does seem unlikely that poor practice or faulty interpreting will come to light easily.

Face issues influence patients for many reasons which include the stigma attached to mental illness and their obvious need for linguistic support, especially if they have lived in the UK for some time, and may feel that they should be more linguistically able. Given the current economic climate in many countries the probability is that being supported by professional, paid interpreters will not be their normal experience. Privacy is inevitably invaded when non-professional family and community members help with language. Patients may not ever have encountered a fully professional interpreting service, and may not know what interpreters are supposed to do (Hertog, 2001). How and through whose agency would they complain?

During the course of my field work I observed that PCTs are using community and family members to interpret again due to cost cutting. The clinicians interviewed reported no or minimal training in understanding what interpreters ought to be doing according to the model and code, and within their role and constraints. Interpreters themselves are observed in the data to demonstrate ignorance of the model, code, their role and its constraints. In these circumstances neither patient nor doctor is likely to get what they need:

*"Obviously the information that we get is very important but if we don't feel like we can build up a relationship with the patient [...] That information isn't worth anything really because we [...] can't move forward with it or build upon it." Fclin1 [Data item]*

It is the relationship between the clinician and the patient, not the clinician and the family or community member, that is so important to improved mental well-being. Research has shown that properly trained interpreters improve trusting

communications, and is discussed in Chapter 2. Evidence from the Delphi exercise supports the ideas concerning cultural briefing.

## **5.6 Delphi data**

The Delphi panel was set up to consider the interviewed interpreters' responses to the vignettes presented to them (the text of the vignettes is in Chapter 4). The panel was necessary due to the dearth of literature on the matters that emerged from panellists' responses and discussions and a need to validate a standard set of responses among acknowledged leading experts in practice and training. Three main areas of dissent emerged immediately and the ensuing discussions concerned:

1. The propriety or otherwise of using the third person form of address.
2. Whether or not the interpreter should respond to direct questions of a personal nature made to them by the patient.
3. Whether or not cultural briefing is permissible during consultations.
  - a. Whether or not interventions for clarity are permissible during consultations.

The use of the third person form of address arose when the patient directed a question directly to the interpreter, "have you ever lost a baby?", in vignette 2; this also gave rise to discussion of who should respond to the question and how. The matter of cultural briefing, by far the most polemical of all, arose from two of the three potential face-threat questions, vignettes 3 and 4, in which the imaginary patients were talking about homosexuality and female genital cutting or mutilation.

At the outset panellists were offered the vignettes without any comment and asked to imagine themselves to be interpreting in these situations. 4 of the 5 panellists would not use the third person as in “the patient is asking me if I have ever lost a baby”, but would interpret the question as it was voiced and let the clinician respond to it. At the start of round two the vignettes were re-circulated alongside the edited-together first responses of all the panellists, asking for comment. This produced three areas of disagreement named above. A second, clarification question was asked and produced the idea that a third person rendition could be acceptable or a first person rendition with hand signals to indicate that the question was directed at the interpreter. Objections included the assertion there is no reason for changing to the third person, as it would cause confusion. Conversely it was suggested that once the interpreter is addressed directly the encounter has changed and is no longer a dialogue between the two parties with an interpreter as a communication aid. In other words, this question should be treated as an intervention by the interpreter.

At this stage a panellist altered their position and said that they would use the 3<sup>rd</sup> person on this occasion in order to make it clear that the question was addressed to the interpreter. In a final attempt to reach agreement a further round of the vignettes and edited-together comments was circulated. One panellist pointed out that the matter of the form of address was a great deal less important to the patient than the patient's real need for skilled psychological support. On the other hand the form of address, indicating the direction of the question, should not be allowed to cause confusion. The dissenting panellists had shifted their positions a little, from absolute

opposition to 'worrying a little bit' about who was saying what to whom. In fact the use of hand signals by interpreters is very common during interpreted communicative events and can be observed in my filmed data, particularly by OInterp4, referred to in Chapter 4. The suggestion here that they may be used to clarify the direction of the question echoes the not uncommon practice, when relaying in the first person, of pointing to a speaker who starts cursing and using strong language so that everybody is clear about where a sudden change of speech style has come from. So the use of the third person form of address to indicate the intended destination of the question directed at the interpreter by a patient is not uncontested. On the second matter, who should respond to the question and how, the majority opinion was "just interpret the question and let the doctor answer it."

The third area of discussion and disagreement applied to both vignettes 3 and 4. There was strong disagreement concerning the use, and later the meaning, of two phrases: "interventions for clarity" and "cultural briefing". The phrase cultural briefing was introduced by the dissenting panellist at the outset, in round one, as something that should be done if the clinician were unaware of the cultural issues relating to these scenarios in some cultures. Others felt that cultural briefing was not appropriate; one remarking that in their experience clinicians in the UK are not generally ignorant of the fact that other cultures may have problems with homosexuality. Another suggested that if the clinician seems to be ignorant of the facts regarding FGM, one course would be to suggest, outside the meeting, that a better informed medical colleague may be able to offer information should that be necessary. The overall response from 80% of the panellists on these two scenarios was that an interpreter will never be in a position to explain essential medical facts;



that there will be a range of reactions on these matters within any one cultural or religious grouping; and some strongly worded objections describing cultural briefing in general as "*deeply suspect, an open invitation to a set of behaviours that are not suitable for an interpreter*" which can turn into stereotyping or even prejudice. Another said that such actions should only be taken when there is a misunderstanding that no-one but the interpreter can be aware of and that can be rectified by giving factual information; even if that has to be prefaced with "sometimes" or "in my experience". The opposing position was that if an individual does not share a language with their interlocutor it should not be assumed that they understand the culture either. Helman had this to say about labelling the 'culture' of other people:

*Each culture (and to some extent each gender, social class, region and even family) has its own language of distress, which bridges the gap between subjective experiences of impaired wellbeing and social acknowledgement of them. Cultural factors determine which symptoms or signs are perceived of as abnormal; they also help shape these diffuse emotional and physical changes into a pattern that is recognizable to both the sufferer and those around him. (Helman, 2007:128).*

In the final discussion round prior to offering panellists the interviewees' responses to all the vignettes, the majority affirmed the idea that cultural briefing is the addition of social or culturally contextual information but that, since each individual has their own unique culture, they should be the person to explain it. This is referred to in Chapter 4. Panellists questioned the need for interpreters to engage in this practice at all, asking what obstructions there were to the interpreter's simply delivering a full interpretation of what the patient had said. An intervention for clarification was defined by them as asking an interlocutor to explain something that

the interpreter was not confident of having understood, and is described in both the NRPSI Code of Conduct, at <http://www.nrpsi.co.uk/pdf/CodeofConduct07.pdf>) point 5.12, and the taught good practice guidelines in the appendix. Cultural briefing does not appear in either document. So what we see in my data is similar to that observed by Claudia Angelelli (Angelelli, 2004), upon which Sandra Hale's comment is:

*These well-intentioned interpreters believe they are helping by disregarding any notion of accuracy or impartiality and deliberately changing, omitting or adding to the original utterances. On the other hand, the proponents of accurate interpreting would argue that in order to be accurate, cultural gaps need to be filled and nuance and style communicated, which, according to Angelelli, are characteristics of the 'visible' interpreter. Angelelli's definition of the 'visible' interpreter, therefore, mixes characteristics from the mediator approach and the direct interpreting approach (Hale, 2007:49).*

On the basis of the data, psychiatrists seem to disagree with the notion that cultural gaps need to be filled during a consultation, though they welcome attempts to communicate nuance and style, as has been shown in the interviews with clinicians, who ask for "attention to the particular" and respect for the "intricacy" of patients' talk.

Again there was a shift in position by the panellist who had raised the matter of cultural briefing and who now acknowledged that whether or not to engage in cultural briefing or interventions for clarity would depend on the specifics of the situation and that cultural briefing is appropriate in some cases but not in all. This round included a Likert scale, shown in Chapter 4, in which cultural briefing had one "somewhat appropriate" vote in its favour but 4 votes against it. Interventions for clarification by the interpreter had 5 "totally appropriate" votes in its favour. The discussion of cultural briefing versus interventions for clarity highlights the somewhat inconsistent use and understanding of terminology within the profession.

It is interesting that the interviewed interpreters stated they give cultural briefing, and that clinicians stated that they would rather receive it outside the consultation, if at all. This can be seen in data extracts shown above, showing both clinicians and interpreters stating their points of view.

In responding to vignettes 3 and 4 several of the interpreters interviewed were sufficiently uncomfortable with the scenarios presented to use evasive tactics in their replies. Taking the 'lost baby' vignette first, FInterp1's reply was lengthy and after an irrelevant story about epilepsy she said, "*I will make sure that that message is conveyed in the same tone of voice as it's come across to me.*" [Data item]. Three of the interpreters said they would answer the question the patient had put to them and they would relay the conversation in direct speech. There does seem to be some correlation between an interpreter's L2 spoken communicative competence and their ability to understand some of these vignettes which were explained to them on the telephone. One appears to see herself in a motherly role which leads her to offer advice.

*"I mean professional people, who are bereavement counsellors, or somebody, can help you but you've got to tell them. If you don't, then obviously nobody can help and then you will suffer and you will be more and more depressed. So that will be my advice"* FInterp10 [Data item]

With regard to the face-threat situations represented by the vignettes about homosexuality and female genital cutting or mutilation, the interpreters all responded with some degree of face protecting behaviour. FInterp1 prevaricated at some length but then said "*I would interpret exactly what they had been saying, how, what are their worries and what are their concerns*". [Data item]

FInterp9 told me that female circumcision doesn't happen in Pakistan, and went on to talk instead about forced marriages, saying:

*"[I] give them advice or whatever you call it, because we, when we were trained we were asked, we can give that, that's in our contract, we can if we know the background, we know the traditions then we should advise both parties."* [Data item]

So it seems that an advocacy role was at least touched upon in her training, and she feels she has the epistemic authority to give advice. FInterp10 was trenchant on the matter:

*"Right. I belong to Muslim community, in Muslim communities they don't circumcise anybo. . any girl, no."* [Data item]

Researchers have in fact described the practice of female genital cutting or mutilation in India and Pakistan, albeit as a minority practice. Echalal et al include Bohra, India and Pakistan, in their 1999 paper on the subject (Elchalal et al, 1999) and the U.S. Department of Health and Human Services' Office on Women's Health report that:

*"To a lesser degree, [than in other countries] FGC is practiced in Indonesia, Malaysia, Pakistan, and India. Some immigrants practice various forms of FGC in other parts of the world, including Australia, Canada, New Zealand, the United States, and in European nations"*(U.S. Department of Health and Human Services, 2009 [online] accessed 16.01.2012).

It should be borne in mind that the ages of the interpreters in this study range between 30 and 70, predominantly in the band between 40 and 50 years old, and this particular situation was presented in order to offer serious face threat rather than to test their knowledge of these practices. It seems to have been successful in that they were all put off balance, and were unwilling to address it as can be seen in the data presented in Chapter 4.

The responses from interviewed interpreters to those face threats are echoed in the observation data in the presence of milder face threats than the ones in the vignettes, but the principle remains that maintaining the use of the model offers protection not only to individual interpreters' face but thereby it offers protection to the interpreted message.

## **5.7 Education and training**

As has been described in some detail in Chapter 1, training for interpreters in the public services is scarce, of patchy quality, and very expensive for prospective students in light of what they are likely to earn. There is no national oversight of the quality of any course syllabus or training outside the courses now run by universities. Of the filmed interpreters, none had been trained on a university-run course. Two of them held the DPSI, two did not. Two of the interviewed interpreters did not hold the DPSI or other relevant qualification though one held a BSc in Biology and the other an MA in social work, both qualifications gained outside the UK. None of those with the DPSI had studied at a university but had attended vocational courses at local colleges, or run by their agency. National occupational standards are not mandatory and are therefore widely ignored. There are interpreters working in the public services who were listed on the national register of public service interpreters at the inception of the national regulator (NRPSI), and therefore came into the profession under the "grandfather" system described in Chapter 1. They have never been required to go through any revalidation process. The examinations have improved, but some of the "grandfather" generation remains.

Universities did not begin to train public service interpreters until approximately 2004.

#### HIGHER LANGUAGE SKILLS

Interpreters interviewed did not all speak competent English. FInterp1 spoke English fluently but not well, as did FInterp6. FInterp10 spoke it confidently but badly, as evidenced in the data, shown in Chapter 4. The spoken English of the interpreters observed was of reasonable quality. This may be the case because the interviewees were responding on their own behalf, using entirely extempore speech in response to questions and prompts. The interpreters observed on the other hand were relaying the speech and ideas of others, so that the topic and to a large extent the vocabulary were defined for them by the original speaker.

A poor command of either of the languages an interpreter works in (that of the host or dominant culture as well as their native one) has implications for interpreters' praxis. Both an interpreter's comprehensibility to one or other of their two clients, as well as for their own comprehension of the second language (L2) spoken to them affect their efficacy. For example, in a study focused on the extent to which L2 listening comprehension is a function of L1 listening comprehension ability, L2 proficiency, or both, Vandergrift wrote:

*"Listeners, unlike readers, need to comprehend spoken language; therefore, they must pay attention to additional factors that can complicate the process of listening comprehension considerably in comparison to reading and render it more cognitively demanding ."* (Vandergrift, 2006:9)

And that *"listening is more contextsensitive than reading, with "socially coded acoustic cues"* (Swaffar & Bacon, 1993:136 in Vandergrift 2006:9)

Swaffar and Bacon have identified a problem with some of the study interpreters' spoken English, which is that intonation changes meaning, and faulty grammar does as well. There are examples of these problems in the interviews:

*“While one is talking I just try to take notes and always give [inaudible] and then that’s very helpful. ‘Cos sometimes they repeat again and again, so that’s easy way of taking that thing very . in your mind that what date or what time, so they are used again and again so that’s helpful thing” FInterp7 [Data item]*

It is not possible to reproduce the diction and intonation here but the speech is slow, with retroflex /r/ and plosives /p/ and /t/ unaspirated, for instance, making it difficult to listen to, even allowing for the lack of visual cues. Given that interpreters are in effect engaged in public speaking, they need both primary interlocutors to understand what they say the first time. The remarks above are not about accent, but diction, as described in Chapter 2.

Nobody knows what the correlation is, if any, between L2 listening comprehension competence and L2 spoken language comprehensibility as no research seems to have been done. Those whose spoken English is difficult to listen to do seem to demonstrate difficulty in understanding native-speakers of English, as shown in the data by speakers/listeners such as FInterp7 and FInterp10. Lacking any specific, formal study of English (as distinct from studying other topics through the medium of English), the bilingual person's lexical range in English may be very limited. In the Chapter 2 section on diglossia I set out the idea that societies in which many people are bilingual, to at least some extent, keep the 'lower status' language of home, family and social interaction separate from the 'higher status' language of university, work, medicine and law. People who learn two languages will only have

the lexical set that relates to the environment in which they learned them, unless they have studied them in a systematic way and with a specific vocational focus. That is why “languages for business” and “languages for engineering” modules form part of many university degree courses. Those who were educated at schools in the UK may speak similarly impoverished Urdu or Punjabi with equal implications for their comprehension of those languages at higher registers.

#### CLINICIANS’ TRAINING

The Clinicians in the study had received little or no training in how interpreters work, why they work in those ways, and what their role boundaries and ethical constraints are. Assumptions were made on both sides in this regard since interpreters knew equally little about the professional goals and needs of clinicians. Interpreters were therefore free to believe that they were helping the clinician, and clinicians were free to believe that their speech output was easy to relay across the boundary of language and culture.

*All the terminology of which psychiatric assessments are constructed – ‘suicidality’, ‘capacity’, ‘ruminations’, ‘preoccupations’, ‘delusions’, ‘overvalued ideas’, and so on – depend on language for their assessment and articulation. And they depend on a confidence in the ability of the psychiatrist to understand what the person is saying. (Mac Suibhne, 2012:124).*

Neither group appears to have given consideration to the fact that ordinary lay language may also have a specialist application. Mac Suibhne’s insight above is not built in to the professional education of either group.



## 5.8 Findings

The key theoretical concept in this study is that a performance model is necessary to give coherence and discipline to the communicative work of the interpreter. The impartial model represents and explains the ethics and working practices of the professional interpreter to trainee interpreters, to the clients and to other professionals that fully qualified interpreters work with. Five main criteria are used to evaluate interpreters' performance in formal testing: accuracy, completeness, fluency, appropriate register and vocabulary. These are used alongside the code of conduct and guide to good practice which, to complete the model, requires: confidentiality, impartiality, using direct speech, intervening to prevent or repair misunderstandings.

One interesting finding of the research underpinning this thesis was that the Delphi panel, consisting entirely of experts in the field of interpreting, could not entirely agree on the place of cultural briefing by interpreters in interpreted clinical encounters. Interventions to repair misunderstandings, or to ask for clarification of something not understood, are among the criteria listed above. The taxonomy of models in Chapter 1 shows that impartial model interpreters will clarify a cultural issue but will not offer their own opinion. This presupposes that cultural clarification has been requested by one principal interlocutor of the other principal interlocutor, and the interpreter remains in interpreter role to relay the discussion. The types of intervention being discussed by the Delphi panel, and described as "cultural briefing", clearly fall into the advocacy model in which the insertion of the interpreters' own opinions and advice are admissible. Four out of the five panellists

(80%) did not believe that cultural briefing (adding contextual social and cultural information without reference to the patient) was an appropriate thing for an interpreter to do. The fifth, having shifted their position slightly, still dissented. In the context of a newly emerging professional group this could be seen as a reflection of real life.

#### EDUCATION AND TRAINING NEEDS

On the whole both the interviewed and observed interpreters displayed an inadequate education and training for the profession as it is laid out in the idealised models or academic and professional literature (Cambridge, 2004; Hale, 2007; de Pedro Ricoy, 2010). There is very low awareness of interpreting theory and of the model among the interpreters. They only use parts of it and the parts they choose are not consistent across the sample. Most of them would benefit from formal language training to bring both their languages up to professional level. Interpreting in any medical field requires a broad and deep knowledge of the vocabulary of peoples' lived lives in both languages. But more than that, there seems to be no understanding among this sample of why mental health clinicians phrase questions in the way they do and why it is important to respect the form and wording of the question. There is also a great need for formal, systematic training in interpreting techniques: clear diction, competent note taking, consecutive mode, whispered simultaneous mode and sight translation as described in chapter 7 (Gile, 1995). All these techniques can be usefully deployed to improve the interpreting service delivered providing the interpreter is aware of and able to make use of them. As has been seen in earlier chapters, few if any of them are able to take reliable notes to support the consecutive mode of interpreting (Rozan, 2005, Heimerl-Moggan & Ifeoma John, 2007). Several of them were entirely unable to operate in whispered simultaneous mode or to

deliver sight translations. In part this is due to their level of training. In part it is due to the institutions' ignorance of what professional interpreters should be able to do. In part it is due to clinicians' lack of training in how to support professional interpreters in delivering high levels of competence.

#### TRAINING THE TRAINERS

In Chapter 1 the shortcomings of interpreter training are also seen as linked to the shortcomings of training courses for interpreter trainers. Many groups of student PSIs in Britain have students who speak a wide variety of non-English languages. The language of instruction must therefore be English, but as Prodromou points out if imposing a native model on one or many non-native contexts – on the basis of ‘authenticity’ – the learners’ own authenticity will be limited by the ‘authority’ of the native speaker. However, the reverse can apply:

*The non--native teacher's authority also suffers in the native-dominated scheme of things because it is precisely in the area of the learners' culture that non-native teachers are at their best. While, on the one hand, the non-native speaker is expected to apply the linguistic, pragmatic and cultural features of the native speaker, their own strengths - their knowledge of English grammar, the students' language and culture – are peripheralised. (Prodromou, 2006:52)*

One advantage of a native teacher is that they are more likely than the students to be aware of new lexical items entering the local English language and enable them to develop strategies when hearing these for finding out what they mean. Vernacular and ‘new’ language such as ‘bling’ or ‘gobsmacked’ is a constant challenge to PSIs.

*There is no mechanism for regulated change in English. Change comes about by mechanisms we do not fully understand. New words are not seen as an issue in English: a word can go from dialectal to standard usage in the space months or even weeks. (Gupta, 2006:98).*

Community-based training courses are often led by experienced interpreters whose only qualification is a DPSI and who are of the same cultural group as the majority

of students in the class. This does not necessarily enable them to increase their students' proficiency either in spoken and written English or their other working languages. There are significant phonetic, phonological and pragmatic differences between varieties of English. The wide variety of accents, dialects and lexicons but relative homogeneity of the written word and varietal difference among all the widely dispersed classroom languages would be an enlightening early topic for classroom discussion. (Crystal, 2000). Speakers of other Englishes may find the interpreters' speech difficult to understand unless they have been trained to speak clearly.

Face issues do impact on the output of an interpreter who is located within the interpreted clinical interaction as a fully participating interlocutor. As suggested earlier, politeness strategies exist in every culture and Stella Ting-Toomey posits a face negotiation theory first mooted by her in 1985 which includes:

1. *People in all cultures try to maintain and negotiate face in all communication situations;*
2. *The concept of face is especially problematic in emotionally vulnerable situations (such as embarrassment, request, or conflict situations) the situated identities of the communicators are called into question; (Ting-Toomey, 2005:73).*

Her maxim that communication should be “appropriate, effective and satisfactory” indicates mutual accommodation between the parties – facework. Face and facework are widely acknowledged as being a) collaborative and b) impacting favourably or otherwise on the trust and rapport established in a communication.

Trust is discussed in section 1.5 about the role of the interpreter. One of Greener's categories of trust is described by him as being consensual, in which one voluntarily foregoes calculating in a relationship. (Greener in Robb & Greenhalgh 2006). Ting-Toomey's model of intercultural communication suggests that 'mindfulness' in such contacts should cover three main targets. The first is knowledge of the cultural and personal values of the other person or group; verbal and nonverbal communication; in-group and out-group boundaries; knowledge of relationship development strategies, conflict management and intercultural adaptation. Secondly, being mindful of identity domains, needs and ethnocentric tendencies, both clinician and interpreter should display good observation and listening skills, empathy and flexibility. Thirdly, meeting the criteria of appropriateness, effectiveness and satisfaction will result in full interlocutors feeling understood, respected and supported. (Ting-Toomey, 1999:49). In Greener's terms this is the most equally-balanced of his power focused taxonomy of trust described in section 1.5. Trust allows rapport. Rapport allows good mutual communication outcomes in emotionally demanding situations.

The vignettes concerning homosexuality and FGM presented a threat to the interpreters' face to which they all responded with some delay or evasion tactic. This demonstrates that they were all themselves situated as full interlocutors with conversational rights in the imaginary interpreted clinical interactions presented to them in the interviews. In other words they were not using the impartial model, as they should have been trained to do. Face threat was also evident in the observation data.

## REFLECTIONS

During the data collection phase of this study there were repeated occasions when interpreters booked did not arrive, or the agency sent an interpreter who spoke the wrong language. Multiple opportunities for filming were lost because of what is described as “churn” in the clinic office. Churn in this context means a rapid turnover of staff, so that messages and instructions either get lost or are not attended to. I rang clinics on several occasions to be told that there were no appointments suitable for the study booked that month, only to find later that I had missed five possible data collection opportunities. One doctor warned me that their clinic relied heavily on temporary office staff some of whose performance was so poor that they had to be sent away. Greenhalgh and colleagues said of their own study that an example of theirs:

*illustrates how system imperatives deriving from economy and state can so circumscribe behaviours in medical settings as to render communicative action all but impossible.*(2006) p1179.

There does seem to be poor scrutiny of the quality of interpreters supplied. Of the small sample of seven interpreters arriving from the usual agencies to take part in the filmed clinics four had no relevant training at all, one held a DPSI in law but not health, and two held the DPSI in health though one national registration appeared to have lapsed.

The influence of the institution, and therefore of the clinicians and staff who work in it, is all pervasive. The difficulties reported in Chapter 4 on gaining access to data clearly illustrate NHS attitudes towards interpreters, interpreting, and the people interpreted for. The authorities are unwilling to engage with ITALS even as a risk

management matter. There is a disconnect between the formal requirements and expectations of practice guidance and the structural implementation of procedures to execute them, coupled with the organisational disruption of high staff turnover ('churn') in frontline administrative jobs. The result was that messages were lost or not delivered, the supply of interpreters was unreliable, and the research was generally unwelcome.

A brief review of the chart and description of the difficulty encountered during more than a year spent in collecting less than 3 hours of film, illustrates that most institutions contacted to ask for access used strategies to prevent filming. This is triangulated at every approach, by every method: observations, interviews, vignettes, even by the experimental evidence of testing represented by the business of gaining access to PCTs. The reasons given for refusal exactly reflect an attitude and evidence a structure designed to exclude and confuse, for the protection of professional and institutional face. Lack of the evidence I had hoped to obtain is in itself evidence of this. I could do no other than change the method and type of analysis, falling back on hermeneutic phenomenology.

## **CHAPTER 6. CONCLUSIONS AND IMPLICATIONS FOR PRACTICE**

The influences that shape interlingual communication services in mental health care, as in all health care, trickle down from both government and NHS senior management, permeating all aspects of the organisation. On the basis of this small doctoral project, it can be said that the impartial model itself is serviceable if it is used consciously and carefully in all its aspects, as has been demonstrated by the way interpreters talked about their approach when working before the courts, in Chapter 4. It is not tenable to suggest that the community members for whom they interpret in court would deserve a lower standard of service were they to fall ill.

This chapter will consider how the model is used and the implications for good practice. It will propose that all interpreter basic training should be of the same standard. It will also discuss the implications for training and inter-professional communication.

### **6.1 The interpreting model is poorly taught**

The impartial model is used in courts of law, but was seen by the interpreters observed and interviewed as not appropriate in mental healthcare, as discussed in Chapter 5. Various researchers' work has examined both medical and court



interpreters' output and the influences which impact on the accuracy of their work (Berk-Seligson, 1990; Hale, 2001; Hale 2007; Wadensjö, 2001; Miguélez, 2001; Bot, 2005; Morris 1995). Extracts of their data have yielded examples to support my own, showing that there is little difference in practice between the accuracy, cohesion and coherence of speech or the variety of speech styles and registers used in the two domains of practice. When they spoke of their work, FInterps repeatedly said that they used simpler language when talking to patients, that they 'interpreted the meaning' rather than what FInterp5 called "*proper translation, word for word*"; the style they thought of as appropriate to the courts but not to mental healthcare. A pertinent remark made by Morris,

*"In court interpreting, the law distinguishes between the prescribed activity of what it considers translation – defined as an objective, mechanistic, transparent process in which the interpreter acts as a mere conduit of words – and the proscribed activity of interpretation, which involves interpreters decoding and attempting to convey their understanding of speaker meanings and intentions". (Morris, 1995:25).*

describes the 'conduit of words' clinicians I interviewed say they need in order to follow hypotheses and diagnose. The distinction between work domains or the needs of doctors and lawyers is between the working practices of interpreters, according to domain, but with no shared common ground between themselves and the doctors concerned. This was in spite of the interviewed clinicians' stated wish for a more forensic, close interpreting style, echoed by clinicians taking part in several of the studies cited. So the model is in partial use, that is, it is used in part. The interpreters observed were cherry picking the aspects they employed according to the setting. For instance in mental healthcare they held long, exclusive side conversations which were not reported in the other language. Such a practice would not be tolerated in a legal setting. This led to the unsatisfactory situation of nobody in the triad

succeeding in their aim to communicate in a way that might lead to a good diagnosis or treatment plan. Interpreter output is negatively impacted by the whole parcel of influences discussed in this chapter.

This problem is not the fault of the interpreters. It is mainly the result of two factors; face threat and lack of adequate training of both clinicians and interpreters. The low value the interpreters interviewed seem to place on their bilingual skills and language switching ability is a face threat, which leads them to seek a different expert identity: that of culture broker. Lacking appropriate theoretical knowledge to support the technical instructions given in interpreting training, interpreters can slip into assuming an advocacy role, being protective of the patient; or wanting to please or impress the clinician with their expertise by proffering contextual information about the service user's local community. They may also summarise because they have no notes and their memory is poor.

Interpreters who have appropriate professional training have also learnt some science; applied linguistics is the bedrock of what they do, it is the anatomy and physiology of communication. There is a double-helical downward pathway that clinician and interpreter take, consisting of the interpreter being a member of a BME community and wanting to be of service to the LEP members of it; lack of sufficient theoretical underpinning to promote good practice by clinician and interpreter; lack of mutual insight into professional goals and needs; lack of a requirement for interpreters to undertake mandatory CPD; and lack of revalidation of interpreters' fitness to practice at set intervals. The double helix leads downwards from good

intentions to suboptimal performance. The two professionals follow this route together. The impartial model itself is serviceable if it is used consciously and consistently in all its aspects, as has been demonstrated by the way interpreters talked about their approach when working before the courts. It is not tenable to suggest that the community members for whom they interpret in court would deserve a lower standard of service were they to fall ill.

### CONSISTENCY IN TRAINING

While there are nationally accredited examinations for all interpreters, and the uptake of the DPSI exams for healthcare interpreting is increasing, there is no national oversight of training quality. As a first step towards raising overall standards I propose that we need a National Curriculum for public service interpreters' training. A local syllabus should be developed in line with the National Curriculum, aimed at meeting the National Occupational Standards for Interpreting. Older professions have long-established formal routes into their careers and these should be examined carefully by government and professional bodies seeking coherent, consistent, sufficient and safe ITALS services that meet nationally agreed standards.

## **6.2 The Influence of Institution and State**

Apart from the interplay between the parties to interpreted interviews there are other influences impacting on service delivery across language and culture. At micro level training and mutual understanding within the multidisciplinary team have a negative impact on interpreter output as described above. At macro level, the unregulated market makes training as an interpreter for the public services unattractive. In this unregulated market, there can be no real accountability of interpreters because there

is such a low level of expectation among clinicians. By definition, interpreters' services cannot be reliably evaluated by those employing them or using their services, because each speaks only one of the languages concerned and no bilingual record is made of the conversation. On that basis any interpreter must be taken on trust, potentially putting patient, clinician and institution at risk (Haslam, 2007). It would therefore seem appropriate for NRPSI listed interpreters to be preferred on the grounds that they have satisfied nationally agreed registration criteria for qualifications, signed a code of conduct, are CRB checked, and subject to a disciplinary code.

All interpreters, whether qualified or completely untrained, are gatekeepers. In the practice of medicine, the gatekeeper to the vital intricate details of messages is the interpreter. That, of itself, is a position of great power and influence. In view of the vulnerabilities outlined in the paragraph above I believe that this constitutes what Stanley Baldwin described in 1931<sup>2</sup> as "power without responsibility". Interpreters lacking any affiliation to a nationally recognised professional body and not listed with the national regulator are not bound by any known ethical or disciplinary code. Given the low numbers of interpreters who hold such membership and registration in Britain, it can be said that the majority of people working as interpreters in medicine hold power without accountability. That is an intolerable situation for all concerned.

## RESEARCH

Research work has been done, and continues to be done in Europe to develop the area of medical interpreting, following the example set by the first Grotius project

---

<sup>2</sup> Stanley Baldwin served three terms as the Prime Minister of Britain between 1923 and 1937. He used this phrase in a speech attacking the press.

which resulted in the Aequitas report on interpreting in criminal justice in Europe (Hertog, 2001). Examples include Ertl and Pöllabauer's project to develop a curriculum for training medical interpreters (Ertl & Pöllabauer, 2010), a project led by Brooke Townsley at the University of Middlesex to create a bank of training materials for interpreters working in legal services (Townsley, 2011) and ongoing work on interpreting via video conference (Braun & Taylor, 2011). The first should be a useful resource in the field of healthcare interpreter training. The second may usefully be emulated in a further EU project, for the benefit of healthcare. The third may benefit hospital in-patients and consultants during ward rounds and other routine interactions.

Interpreters in public service work in other people's fields of professional expertise, usually alone, as the only practitioner present with their particular skills and knowledge. More robust research into the practical process of interpreting clinician-patient interaction in widely differing specialities is a field in need of development and would offer greater insight and useful comparisons. For instance ESOL research on the correlation, if any, between L2 spoken competence and L2 listening comprehension could make a useful contribution to raising standards. It could perhaps offer a simple benchmark for service users when they are obliged to accept community or family members as 'interpreters'.

New initiatives from charities in promoting standards are a promising sign. *Mothertongue's* code of practice amplifies and explains good practice requirements, but is describing all the elements of the impartial model. The booklet is easy to read

and has a separate crib sheet. It is good so see a proactive approach to interpreter education from this organisation (Mothertongue, 2012). Freedom from Torture, formerly the Medical Foundation for the care of victims of torture, has a precursor and very similar code of conduct for interpreters working in family therapy (Freedom from Torture, 2005).

#### PARTICULARITY OF NEEDS AND PURPOSES IN MENTAL HEALTH SERVICES

The clinicians interviewed and observed all laid emphasis – either explicitly or by example – on their need to access the intricacy and particularity of word choice and metaphor in their patients’ speech. This aspect of interpreters’ work is challenging and needs greater development in training programmes. The old axiom that ‘you can’t know what you don’t know until you need to know it’ means that the under-trained can believe they know all there is to know. Continuing professional development (CPD) diploma-level courses are needed.

Drennan and Swartz’s detailed examination of how discourse shapes both psychiatric clinical interviews and outcomes shows the fundamental risks run by institutions when either no interpreter or a barefoot interpreter is used. They note that patients’ native language and/or interpreter availability or use (including barefoot interpreters) do not usually feature on patients’ notes.

*In this study, symptoms that were particularly likely to be attributed to the patient, where language difficulties were not apparently accounted for, were impaired intellectual ability and types of thought disorders. [...] it could be seen as a cruel irony that the patients who are not completely unable to communicate in the language of the clinician, but who are able to use a few words or phrases of English or Afrikaans [...] may be compromised through this capacity. We would argue that these comments are profoundly stigmatising in this context. The nature of this stigma operates at a number of levels. In the first instance at the clinical level, Berg (1996) has shown how patient records are not simply historical documents of clinical work, but rather that they are dialectically involved in shaping practice. He argues that the recording or inscription of observations contributes to the facticity of*

*these clinical judgements, which then become part of the informational resources available to the clinician. Thus, such judgements become reference points for the clinician in subsequent interactions and assessments. [...] Observations made by one clinician have a way of becoming self-fulfilling prophecies. (Drennan & Swartz, 2002) p1857*

Doctors are calling for better service

*This article examines problems of foreign language interpreting in psychiatric practice. It is demonstrated how an interpreter's apparent competence may readily be mistaken for true competence and that it is well worthwhile formally assessing an interpreter's command of his second language. In interpreting from patient to psychiatrist, the omission of important material was found to be a noteworthy feature. Here the meaninglessness of material not only favoured its omission but also often indicated important psychopathology. It was found that the more psychotic the patient the more likely it was that mistakes in interpreting from patient to doctor would occur. (Price, 1975) p263.*

Linguists cannot complain that they are not at the negotiating table when interpreting in mental health is planned unless they form interdisciplinary alliances to develop joint working.

#### SERVICE PLANNING

I have described in this thesis how little has changed over the last two decades in respect of designing ITALS services in a way that fosters good interpreting practice and joint working. The United Kingdom is not a large country, but it is a crowded one and migration will increase. Those made doubly vulnerable by language barriers and illness will continue to need to access services. ITALS services nationally should be reliable, consistent, safe and free at the point of use. Training interpreters and training their trainers as well as the service providers is a key challenge for all the professional groups involved.

The poor record keeping regarding interpreter use that Drennan and Swartz describe reflects the British situation shown in section 2.3 (Drennan & Swartz, 2002). Uptake of services by immigrants is poor. The experiential evidence of collecting data in outpatient clinics shows that local management is wasteful due to high staff turnover and poor internal communications. Records of when an interpreter was used, details of their professional affiliations, qualifications and languages worked in should be part of routine case notes. Otherwise, “*the absence of interpreter utilisation has significant effects on the minutiae of clinical assessments,*” (Drennan & Swartz, 2002:1858) with consequent impact on successful diagnosis. These difficulties are likely to drive up costs and can be seen to be the cause of suboptimal outcomes for patients in many cases.

Linking back to the seminal work of Ann Corsellis, in which the impartial model of interpreting and the code of conduct were originally described, there follows her schematic description of how ITALS services can be planned and managed, which may inform future planning.



# **FRAMEWORK FOR THE PROVISION OF PUBLIC SERVICES ACROSS LANGUAGES AND CULTURES**

(extract from Non- English Speakers and the English Legal System, Ann Corsellis; published by Institute of Criminology, University of Cambridge)

**A. Providing a service includes the following tasks, which are the responsibility of the public service in question:**

1. Finding out about the client(s) and their requirements
2. Preparing the service to meet those requirements
3. Giving information about the service to the client(s)
4. Exchanging information and negotiating decisions with client(s)
5. Delivering an appropriate service
6. Quality Assurance
7. Researching and developing the service

**B. by using, at each stage, the combination of professional skills below:**

COMMUNICATION	SERVICE DELIVERY	MANAGEMENT
<ol style="list-style-type: none"> <li>1. Interpreters</li> <li>2. Translators</li> <li>3. Language aware personnel</li> <li>4. Bilingual service personnel</li> </ol>	<ol style="list-style-type: none"> <li>5. Service professionals with relevant expertise</li> </ol>	<ol style="list-style-type: none"> <li>6. Planners, organisers, researchers with relevant expertise</li> </ol>

**C. each skill (in B above) is made available through consistent, transparent:**

1. Selection
- +
2. Training
- +
3. Assessment at appropriate levels
- +
4. Observance of code of ethics and good practice
- +
5. Appropriate employment arrangements
- +
6. Deployment
- +
7. Support and Continuous Professional Development

By kind permission of Ann Corsellis (1995)

### **6.3 Contribution to knowledge**

#### **WORK ON RUDENESS AND REGISTER**

My teaching practice in the last decade has made me aware that many students and practitioners of interpreting in the public services alter messages in very specific ways, claiming that they are protecting the listener from offence and the speaker from opprobrium. There is reluctance among many to make an accurate relay of strongly emotional language, reportedly on modesty and morality grounds. Blasphemy can be described as the profanation of sacred things, impiety, reviling or cursing God. Many religious groups, Christians, Jews and Muslims among them find blasphemy at least repellent if not, at the other extreme, outrageous. Blasphemy is a particularly challenging aspect of emotional language for some groups. Such is the taboo that some individuals are not willing to relay it accurately, or even to relay it at all. Inaccurate relay can cause harm. It is not necessary for interpreters to blaspheme if the message they are required to interpret contains blasphemy, but the requirement to deliver the same sense of offence and rage remains. It is not only in reporting angry speech that this aspect of accuracy is important. Mental health patients can lose their linguistic inhibitions and display similar symptoms across cultures and nations for example in obsessive compulsive disorder (OCD)

*Characteristic features of the obsessive-compulsive disorder (OCD) occur with remarkable consistency in different cultural settings. The content of symptoms, however, seems to vary across cultures. [...] blasphemous thoughts and orderliness compulsions were more common in men. [...] With minor differences, the pattern of symptoms with various contents in this sample was similar to that in Western settings. (Ghassemzadeh et al, 2002:20).*

Blasphemy, then, is the biggest challenge for accurate relay but all forms of cursing must be relayed truthfully, as described in section 2.2.

Over time, while teaching ethics in practice, a theory has evolved through a series of experimental classes. This has been written up and published in peer reviewed publications, some of them bound at the back of this thesis.

#### CONTEXT-SPECIFIC PRACTICE NEEDS

Interpreters working in the public services are serving a different constituency than conference, business or diplomatic interpreters do. A high level command of both languages should be common to all interpreter groups, as should skill in the techniques or ‘modes’ of delivery and an understanding of their ethical codes. The LEP clients PSIs serve are often the poor and underserved; recent forced immigrants in fear, pain and culture shock. Interpreters themselves, especially those working in languages of limited diffusion in the UK, may be immigrants with culture shock or alienation issues of their own. There was a need for a cognitive framework within which to structure the output of relayed strong emotional language in a way that does not dilute the message, but in Jakobson’s terms delivers an equivalent message, which will have the speaker’s intended effect.

### **6.4 Implications for practice.**

#### CONTINUING DEVELOPMENT OF THE PROFESSION

The profession of public service interpreter is young. It has many of the elements of a Profession in place already but still needs refining, reinforcing and extending. In the forward and backward way of progress towards a goal, there will always be a ‘to do’ list. We have an independent national regulator which sets and upholds standards in the public interest and runs an open access list of registrants on its website. We have well established Ofqual regulated national examinations. We have CPD

training and professional associations. We have research; research journals; national and international conferences; EU projects. What PSI professionals still need are:

- Nationally agreed definitions of terms.
- Development of a National Curriculum.
- Independent oversight of local syllabuses.
- Protection of the title for all PSIs spanning all public services.
- Clear career pathways through ongoing education and training, reflected on professional organisations' websites.
- Better interdisciplinary communications between relevant professional bodies as well as between individual collaborating professionals, aiming for improved mutual understanding and joint working.

Currently the field is fragmented, with many local initiatives but little coherence, the needs and challenges are shown in the overview of study findings at figure 26 below.

### OVERVIEW OF STUDY FINDINGS

The figure below shows the influences and pressures on ITALS delivery that are preventing consistent, coherent and safe services in NHS mental healthcare. On the institutional side there are widespread inefficiencies and budgetary pressures. Institutional perceptions and misperceptions of what interpreting is and the professional knowledge and skills necessary to do it safely form a vicious circle, resisting non-invasive research and its application to service improvements. Institutional resistance to coherent service planning leaves qualified and affiliated interpreting professionals undifferentiated from barefoot interpreters. BME community groups' LEP members, needing emotional support from community

members in their interactions with NHS institutions, often do not understand the role of the interpreter. Interpreters themselves are shown in this study to be either barefoot or using the components of a cognitive model for consistency in delivery in a very selective way, their professional needs are not recognised or understood.

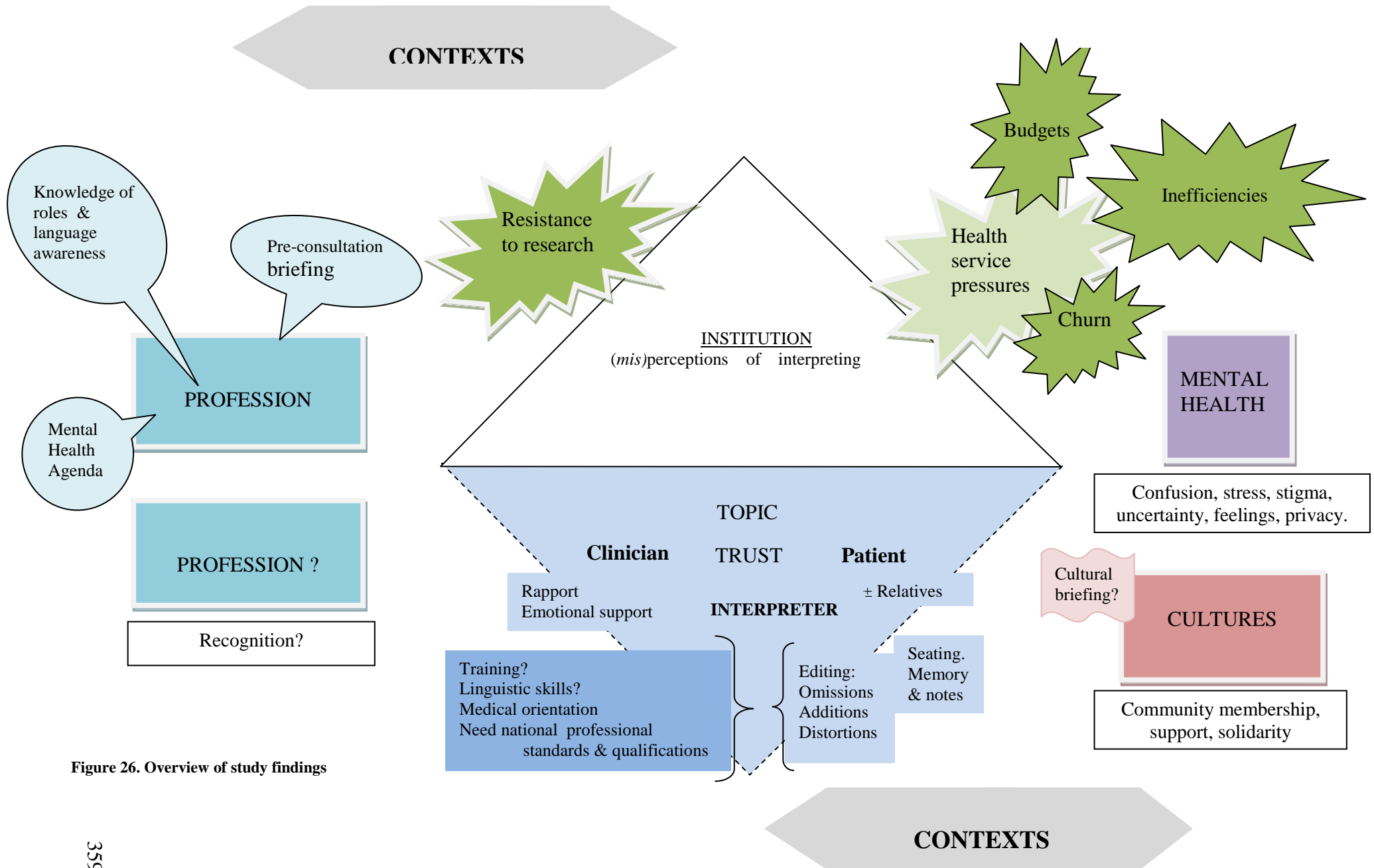

Figure 26. Overview of study findings

## CHANGE NEEDED IN APPROACH TO INTERPRETING IN HEALTHCARE RESEARCH

Keating, cited in Chapter 2, noted “*Our evidence also shows that there are a range of impediments to change that include bureaucratic service arrangements and entrenched service cultures*” (The Sainsbury Centre for Mental Health, 2004)

Institutional bureaucracy means several layers of gatekeepers, from governance personnel to clinicians and interpreters themselves.

It is important to bring healthcare research on interpreting to the forefront of the interpreting research effort. Access to data is very difficult and raises opposition in some quarters. However, ethical constraints on data sharing are now so stringent that the anonymity of all parties will be preserved. Training materials such as role plays, even unscripted role plays, are useful for training but not for research into the real-life interpreting process. Change will come, new research initiatives and approaches to change will be assessed and drive change. As Sarah Bowen remarked of just one new approach:

*This [Knowledge Translation] initiative also reflects how integration of research and contextual evidence can help reposition an issue of 'low awareness' from being perceived as just one more demand for funding in an already overstretched system, to a potential solution for addressing multiple organisational risks, and helping achieve organisational goals* (Bowen et al, 2010).

Apart from my own proposals above, these changes imply a mammoth task ahead, and it can only be achieved if all the agencies and bodies involved make a long term commitment to cultural change and development of an evidence base upon which to base ITALS services and interlingual, cross-cultural multidisciplinary team working.

## **7. Bibliography**

- Adams, C., Corsellis, A. and Harmer, A. (1995) *Basic Handbook for Trainers of Public Service Interpreters*. Cambridge: Nuffield Interpreter Project.
- Angelelli, C. V. (2004) *Medical Interpreting and Cross-cultural Communication*. Cambridge: Cambridge University Press.
- Aspinall, P. J. (2007) Language ability: A neglected dimension in the profiling of populations and health service users. *Health Education Journal*, 66 (1): 90-106.
- Atkin, N. (2008) Getting the message across - Professional interpreters in general practice. *Australian Family Physician*, 37 (3): 174-176.
- Auld, R. E. (2001) Review of the criminal courts of England and Wales : report / Lord Justice Auld.
- AUSIT (1995) *Code of Ethics for Interepters & Translators*. [online] Available from: <http://www.ausit.org/eng/showpate.php?id=650> (Accessed May 2007).
- Balint, M. (1968) *The Doctor, his Patient and the Illness*. Second. London: Pitman Medical Publishing Company Limited.
- Bancroft, M. (2005) *The Interpreter's World Tour. An Envirnomental Scan of Standards of Practice for Interpreters*. [online] Available from: [www.ncihc.org](http://www.ncihc.org) (Accessed November 2012).
- Baraldi, C. and Gavioli, L. (2007) Dialogue interpreting as intercultural communication. An analysis in healthcare multicultural settings. In: Marion Grein and Edda Weigand eds. *Dialogue and culture*. Amsterdam: John Benjamins: 155-175.
- Bauer, A. M. and Alegría, M. (2010) Impact of Patient Language Proficiency and Interpreter Service Use on the Quality of Psychiatric Care: A Systematic Review. *Psychiatric Services*, 2010 (61): 8.
- Baylav, A. (2002) Issues of language provision in health care services. In: Tribe, R. and Raval, H. eds. *Working with Interpreters in Mental Health*. Hove and New York: Brunner-Routledge: 69-76.
- Benis, M. (2005) Model Interpreters: a debate on the thorny issue of the community interpreting model. *Bulletin of the Institute of Translating and Interpreting*, ( January-February 2005): 26-33.
- Berk-Seligson, S. (1990) *The Bilingual Courtroom. Court Interpreters in the Judicial Process*. Chicago: University of Chicago Press.
- Bernstein, J., Bernstein, E., Dave, A., Hardt, E., James, T., Linden, J., Mitchell, P., Oishi, T. and Safi, C. (2002) Trained medical interpreters in the emergency department: effects on services, subsequent charges, and follow-up. *Journal of Immigrant Health*, 4 (4): 171-176.
- Bhugra, D. and Mastrigianni, A. (2004) Globalisation and mental disorders Overview with relation to depression *The British Journal of Psychiatry* 184 (1): 10-20.
- Bjelland, I., Dahl, A. A., Haug, T. T. and Neckelmann, D. (2002) The validity of the Hospital Anxiety and Depression Scale An updated literature review. *Journal of Psychosomatic Research*, 52 69- 77.



- Bolton, J. (2002) The Third Presence: A Psychiatrist's Experience of Working with Non-English Speaking Patients and Interpreters. *Transcultural Psychiatry*, 39 (1): 97-115.
- Bolton, J. (March 2002) The Third Presence: a Psychiatrist's Experience of Working with Non-English-speaking Patients and Interpreters. *Transcultural Psychiatry*, 39 (One): 97-11 94.
- Bot, H. (2005) *Dialogue Interpreting in Mental Health*. Amsterdam Rodopi BV.
- Bourdieu, P. (2005) Outline of the theory of practice: structures and the habitus. In: Speigl, G. M. eds. *Rewriting Histories. New directions in historical writing after the linguistic turn*. New York: Routledge: 272.
- Bowen, S., Gibbens, M., Roy, J. and Edwards, J. (2010) From 'multicultural health' to 'knowledge translation'—rethinking strategies to promote language access within a risk management framework. *Journal of Specialised Translation*, 14 20.
- Bradshaw, M., Tomany-Korman, S. and Flores, G. (2007) Language Barriers to Prescriptions for Patients With Limited English Proficiency: A Survey of Pharmacies. *Pediatrics*, 120 (2): e225-235.
- Braun, S. and Taylor, J. L. ed. (2011) *Videoconference and Remote Interpreting in Criminal Proceedings*. Guildford: University of Surrey.
- Braun, V. and Clarke, V. (2006) Using thematic analysis in psychology. *Qualitative Research in Psychology*, 3 77 - 101.
- Brooks, N., Magee, P., Bhatti, G., Briggs, C., Buckley, S., Guthrie, S., Moltesen, H., Moore, C. and Murray, S. (2000) Asian patients' perspective on the communication facilities provided in a large inner city hospital. *Journal of Clinical Nursing*, 9 (5): 706-712.
- Brown, G. and Yule, G. (1983) *Discourse Analysis*. Cambridge: Cambridge University Press.
- Brown, P. and Levinson, S. C. (1987) *Politeness: Some Universals in Language Usage*. Cambridge: Cambridge University press.
- Brunette, L., Bastin, G. L., Hemlin, I. and Clarke, H. ed. (2003) *The Critical Link 3. Interpreters in the Community. Selected papers from the Third International Conference on Interpreting in Legal, Health and Social Service Settings, Montréal, Quebec, Canada 22–26 May 2001*. Amsterdam: John Benjamins Publishing Company.
- Burke, S. E. (2008) The Doctor-Patient Relationship: An Exploration of Trainee Doctors' Views.
- Byers, A. L., Yaffe, K., Covinsky, K. E., Friedman, M. B. and Bruce, M. L. (2010) High Occurrence of Mood and Anxiety Disorders Among Older Adults. The National Comorbidity Survey Replication. *Archive of General Psychiatry*, 67 (5): 8.
- Calvert, G. A. and Campbell, R. (2003) Reading Speech from Still and Moving Faces: the Neural Substrates of Visible Speech. *Journal of Cognitive Neuroscience*, 15 (1): 57-70.
- Cambridge, J. (1999) Information Loss in Bilingual Medical Interviews through an Untrained Interpreter. *The Translator*, 5 (2): 202-219.
- Cambridge, J. (2003) Unas ideas sobre la interpretación en los centros de salud. In: Garcés, C. V. eds. *Traducción e Interpretación en los Servicios Públicos. Contextualización, Actualidad y Futuro*. Granada: Editorial Comares:
- Cambridge, J. (2007) There is no such thing as a routine conversation. *Puentes. Hacia nuevas investigaciones en la mediación intercultural*, 7 (October 2007): 79-87.

- Cambridge, J. (2008) Interpreters, Interpreting: Practical Issues and Challenges. *Journal of Communication in Healthcare*, 1 (iii):
- Cambridge, J., Singh, S. P. and Johnson, M. (2012) The need for measurable standards in mental health interpreting: a neglected area. *The Psychiatrist*, 36 (4): 121-124.
- Carr, S. E., Roberts, R. P., Dufour, A. and Steyn, D. ed. (1997) *The Critical Link: Interpreters in the Community. Papers from the 1st international conference on interpreting in legal, health and social service settings, Geneva Park, Canada, 1-4 June 1995*. Amsterdam: John Benjamins Publishing Company.
- Carranza, F. J. and Parshall, A. M. (2005) Psychiatric morbidity of overseas patients in inner London: a hospital based study. *Annals of General Psychiatry*, 4 (4):
- CEMACE (2011) Saving Mothers' Lives: Reviewing maternal deaths to make motherhood safer: 2006–2008. *BJOG: An International Journal of Obstetrics & Gynaecology*, 118 1-203.
- CEMACH (2007) *Saving Mothers' Lives: reviewing maternal deaths to make motherhood safer - 2003-2005. The Seventh Report on Confidential Enquiries into Maternal Deaths in the United Kingdom*. [online] Available from: <http://www.publichealth.hscni.net/sites/default/files/Saving%20Mothers%27%20Lives%202003-05%20.pdf> (Accessed October 2011).
- Chartered Institute of Linguists (2007) *Code of Conduct*. [online] Available from: <http://www.iol.org.uk/Charter/CLS/CodeofProfConductCouncil17Nov07.pdf> (Accessed January 2009).
- Cheepen, C. and Monaghan, J. (1990) *Spoken English: A Practical Guide*. London: Pinter.
- Chen, T. K. and Rao, R. R. (1998) Audio visual integration in multimodal communication. *Special Issue on Multimedia Signal Processing* 34.
- CiLT (2005) National Standards in Interpreting.
- CiLT (2005 updated 2010) *National Standards in Interpreting*. [online] Available from: [http://www.cilt.org.uk/home/standards\\_and\\_qualifications.aspx](http://www.cilt.org.uk/home/standards_and_qualifications.aspx) (Accessed 07.07.2009, 15.12.2010).
- Cioffi, R. N. J. (2003) Communicating with culturally and linguistically diverse patients in an acute care setting: nurses' experiences. *International Journal of Nursing Studies*, 40 (3): 299-306.
- Clark, H. H. (1992) *Arenas of Language Use*. Chicago: The University Of Chicago Press.
- Clark, H. H. (1996) *Using Language*. Cambridge: Cambridge University Press.
- Collins, G. S. and Johnson, M. R. (2008) *Addressing Ethnic Diversity in Health Outcome Measurement - a Systematic and Critical Review of the Literature*. . [online] Available from: [http://www2.warwick.ac.uk/fac/med/research/csri/ethnicityhealth/research/ethtom\\_final\\_draft.pdf](http://www2.warwick.ac.uk/fac/med/research/csri/ethnicityhealth/research/ethtom_final_draft.pdf) (Accessed August 2010).
- Corsellis, A. (1995) *Non-English Speakers and the English Legal System*. Cambridge: The Institute of Criminology, University of Cambridge.
- Corsellis, A. (2008) *Public Service Interpreting. The First Steps*. Basingstoke: Palgrave Macmillan.
- Coulter, A. (2002) *The autonomous patient. Ending paternalism in medical care*. London: The Nuffield Foundation.
- Council of Europe (1950) European Convention for the Protection of Human Rights and Fundamental Freedoms (1950) and its five protocols.

- Crystal, D. (2000) *Encyclopedia of the English Language*. Cambridge: Cambridge University Press.
- Cuscani v The United Kingdom (2002) [2002] *All ER (D) 139 (Sep)*. [online] Available from: <http://www.worldlii.org/eu/cases/ECHR/2002/630.html> (Accessed September 2011).
- Davies, M. M. and Bath, P. A. (2001) The maternity information concerns of Somali women in the United Kingdom. *Journal of Advanced Nursing*, 36 (2): 237-245.
- Dias, M. R. and O'Neill, E. O. (1998) Examining the role of professional interpreters in culturally-sensitive health care. *Journal of Multicultural Nursing & Health (JMCNH)*, 4 (1): 27-31.
- Divi, C., Koss, R. G., Schmaltz, S. P. and Loeb, J. M. (2007) Language proficiency and adverse events in US hospitals: a pilot study. *International Journal for Quality in Health Care*, 19 (2): 60-67.
- Drennan, G. and Swartz, L. (2002) The paradoxical use of interpreting in psychiatry. *Social Science & Medicine*, 54 (12): 1853-1866.
- Drew, P. and Wooton, A. ed. (1988) *Erving Goffman. Exploring the Interaction Order*. Cambridge: Polity Press.
- Edwards, R., Temple, B. and Alexander, C. (2005) Users experiences of interpreters: The critical role of trust. *Interpreting*, 7 (1): 77-95.
- El Ansari, W., Newbigging, K., RothCarolyn and Malik Farida (2009) The role of advocacy and interpretation services in the delivery of quality healthcare to diverse minority communities in London, United Kingdom. *Health and Social Care in the Community*, 17 (6): 636-646.
- Elderkin-Thompson, V., Cohen Silver, R. and Waitzkin, H. (2001) When nurses double as interpreters: a study of Spanish-speaking patients in a US primary care setting. *Social Science & Medicine*, 52 (9): 1343-1358.
- Ennahi, M. (2006) Outline of a theory of diglossia. *International Journal of the Sociology of Language*, (157):
- Equality and Human Rights Commission (2010) *Equality Act 2010 Code of Practice. Services, public functions and associations. Statutory Code of Practice*. [online] Available from: [http://www.equalityhumanrights.com/uploaded\\_files/EqualityAct/employercode.pdf](http://www.equalityhumanrights.com/uploaded_files/EqualityAct/employercode.pdf) (Accessed February 2011).
- Ertl, A. and Pöllabauer, S. (2010) *Training (Medical) Interpreters-the Key to Good Practice. MedInt: A Joint European Training Perspective*. [online] Available from: [http://www.jostrans.org/issue14/art\\_ertl.php](http://www.jostrans.org/issue14/art_ertl.php) (Accessed September 2010).
- European Union (2011) *Directive 2011/24/EU of the European Parliament and of the Council of 9 March 2011 on the application of patients' rights in cross-border healthcare*. [online] Available from: The text of the EU Directive is available here: <http://www.europarl.europa.eu/sides/getDoc.do?type=TA&reference=P7-TA-2011-0007&language=EN&ring=A7-2010-0307#BKMD-1> Further information can be accessed via the NHS Confederation: <http://www.nhsconfed.org/NationalAndInternational/NHSEuropeanOffice/OurWork/Pages/CrossBorderHealthcare.aspx> (Accessed January 2012).
- Fatahi, N., Hellström, M., Skott, C. and Mattsson, B. (2008) General practitioners' views on consultations with interpreters: a triad situation with complex issues. *Scandinavian Journal of Primary Health Care*, 26 (1): 40-45.
- Fatahi, N., Mattsson, B., Hasanpoor, J. and Skott, C. (2005) Interpreters' experiences of general practitioner-patient encounters. *Scandinavian Journal of Primary Health Care*, 23 (3): 159-163.

- Ferguson, C. A. (1959) *Diglossia*. Word New York.
- Fernandes, A. and Miguel, J. P. ed. (2009) *Health and Migration in the European Union: Better Health for All in an Inclusive Society*. Instituto Nacional de Saúde Douto Ricardo Jorge.
- Flores, G. M., Laws, M. B., Mayo, S. J., Zuckerman, B., Abreu, M., Medina, L. and Hardt, E. J. (2003) Errors in Medical Interpretation and Their Potential Clinical Consequences in Pediatric Encounters. *PEDIATRICS*, 111 (1): 6-14.
- Flores, G. T., Sylvia; Holmes, Linda J; Salas-Lopez, Debbie; Youdelman, Mara K; - Tomany-Korman, Sandra C. (2008) Access to Hospital Interpreter Services for Limited English Proficient Patients in New Jersey: A Statewide Evaluation. *Journal of Health Care for the Poor and Underserved*, 19 (2): 26.
- Fountoulakis, K. N. (2010) The emerging modern face of mood disorders: a didactic editorial with a detailed presentation of data and definitions. *Annals of General Psychiatry*, 9 (14): 22.
- Fox, E. (1995) Midwifery in England and Wales before 1936: handywomen and doctors. *Int Hist Nurs J*, 1 (2): 17-28.
- Free, C., Green, J., Bhavnani, V. and Newman, A. (2003) Bilingual young people's experiences of interpreting in primary care. *British Journal of General Practice*, 53 6.
- Freedom from Torture (2005) *Code of Practice and Ethics for Interpreters and Practitioners in Joint Work*. [online] Available from: <http://www.freedomfromtorture.org/> (Accessed October 2012).
- Furler, J., Kokanovic, R., Dowrick, C., Newton, D., Gunn, J. and May, C. (2010) Managing Depression Among Ethnic Communities: A Qualitative Study. *Annals of Family Medicine*, 8 (3): 6.
- Gates, B. (1994) *Advocacy. A Nurses' Guide*. London: Scutari.
- General Medical Council (2006 updated 2009) *Good Medical Practice: Duties of a doctor*. [online] Available from: [http://www.gmc-uk.org/guidance/good\\_medical\\_practice/relationships\\_with\\_patients/good\\_communication.asp](http://www.gmc-uk.org/guidance/good_medical_practice/relationships_with_patients/good_communication.asp)  
[http://www.gmc-uk.org/guidance/good\\_medical\\_practice/duties\\_of\\_a\\_doctor.asp](http://www.gmc-uk.org/guidance/good_medical_practice/duties_of_a_doctor.asp)  
 (act without delay)
- Gentile, A. (1995) Community Interpreting or Not? Practices, Standards and Accreditation. In: Silvana E Carr; Roda Roberts; Aideen Dufour ; Dini Steyn eds. *The Critical Link: Interpreters in the Community. Papers from the First International Conference on Interpreting in Legal, Health and Social Service Settings*. Amsterdam/Philadelphia: John Benjamins Publishing Company: 322.
- Gentile, A., Ozolins, U. and Vasilakakos, M. (1996) *Liaison Interpreting: a Handbook*. Melbourne: Melbourne University Press.
- Gerrish, K. (2001) The nature and effect of communication difficulties arising from interactions between district nurses and South Asian patients and their carers. *Journal of Advanced Nursing*, 33 (5): 566-574.
- Ghassemzadeh, H., Mojtabai, R., Khamseh, A., Ebrahimkhani, N., Issazadegan, A.-A. and Saif-Nobakht, Z. (2002) Symptoms of Obsessive-Compulsive Disorder in a Sample of Iranian Patients. *International Journal of Social Psychiatry*, 48 (1): 20-28.
- Gile, D. (1995) *Basic Concepts and Models for Interpreter and Translated Training*. John Benjamins B.V.
- Gill, P., Shankar, A., Quirke, T. and Freemantle, N. (2009) Access to interpreting services in England: secondary analysis of national data. *BMC Public Health*, 9 (1): 12.

- Goffman, E. (1956) The Nature of Deference and Demeanor. *American Anthropologist*, 58 (3): 473-502.
- Goffman, E. (1979) Footing. *Semiotica*, 25 1-29.
- Gournay, K. (2009) Mood disorders: depression and mania. In: Newell, R. and Gournay, K. eds. *Mental Health Nursing. An evidence-based approach*. Edinburgh: Churchill Livingstone Elsevier: 419.
- Grant, T. (2006) Problems of communicative competence in multi-cultural medical encounters in South African health services. *Curationis*, 29 (4): 54-60.
- Greenhalgh, T., Robb, N. and Scambler, G. (2006) Communicative and strategic action in interpreted consultations in primary health care: A Habermasian perspective. *Social Science & Medicine*, 63 (5): 1170-1187.
- Gupta, A. F. (2006) Standard English in the World. In: Rubdy, R. and Saraceni, M. eds. *English in the World*. London: Continuum: 95-109.
- Haddad, M. N. and Plummer, S. E. (2009) Mental health in primary care. In: Newell, R. and Gournay, K. eds. *Mental Health Nursing. An evidence-based approach*. Edinburgh: Churchill Livingstone Elsevier: 419.
- Hale, S. (2007) *Community Interpreting*. Basingstoke: Palgrave Macmillan.
- Hale, S., Ozolins, U. and Stern, L. ed. (2009) *The Critical Link 5. Quality in interpreting - a shared responsibility*. Amsterdam: John Benjamins.
- Harkness, J. A. and Schoua-Glusberg, A. (1998) Questionnaires in translation. *ZUMA-Nachrichten Spezial*, 3 87-127.
- Harris, T. (2005) *Midwifery Practice in the third stage of Labour*. [online] Available from: <https://www.dora.dmu.ac.uk/bitstream/handle/2086/3350/pdf%20thesis%20draft%20five.pdf?sequence=1> (Accessed September 2011).
- Haslam, J. (2007) Lost in Translation. *Medical Protection Society*, 2 (1): 4.
- Hatton, D. C. (1992) Information Transmission in Bilingual, Bicultural Contexts. *Journal of Community Health Nursing*, 9 (1): 53-59.
- Hawkins, P. (1984) *Introducing Phonology*. London: Routledge.
- Health Protection Agency (2010) *Understanding the health needs of migrants in the South East region: A Report by the South East Migrant Health Study Group on behalf of the Department of Health*. [online] Available from: [http://www.hpa.org.uk/webc/HPAwebFile/HPAweb\\_C/1284475770868](http://www.hpa.org.uk/webc/HPAwebFile/HPAweb_C/1284475770868) (Accessed June 2011).
- Heimerl-Moggan, K. and Ifeoma John, V. (2007) *Note-taking for Public Service Interpreters*. [online] Available from: [www.interp-right.com](http://www.interp-right.com) (Accessed 2010).
- Helman, C. G. (2007) *Culture, health and illness*. 5. London: Hodder Arnold.
- Hennings, J. (1996) *The Maternity Care Experiences of Bangladeshi Women in One NHS Trust Hospital: A Case Study*. [online] Available from: [http://books.google.co.uk/books/about/The\\_Maternity\\_Care\\_Experiences\\_of\\_Bangla.html?id=0rf7cQAACAAJ&redir\\_esc=y](http://books.google.co.uk/books/about/The_Maternity_Care_Experiences_of_Bangla.html?id=0rf7cQAACAAJ&redir_esc=y) (Accessed February 2012).
- Heritage, J. and Maynard, D. W. (2006) Problems and prospects in the study of physician-patient interaction: 30 years of research *Annual Review of Sociology*, 32 351-374.
- Heritage, J. and Raymond, G. (2005) The Terms of Agreement: Indexing Epistemic Authority and subordination in Talk-in-Interaction. *Social Psychology Quarterly*, 68 (1): 15-38.
- Hertog, E. ed. (2001) *Aequitas. Access to Justice across Language and Culture in the EU*. Antwerp: Lessius Hogeschool.

- Higginbottom, G. M., Morgan, M., Dassanayake, J., Eyford, H., Alexandre, M., Chiu, Y., Forgeron, J. and Kocay, D. (2012) Immigrant women's experiences of maternity-care services in Canada: a protocol for systematic review using a narrative synthesis. *Systematic Reviews*, 1 (27): 28.
- HMCS (2007) *National Agreement on Arrangements for the Use of Interpreters*. [online] Available from: <http://www.hmcourts-service.gov.uk/infoabout/interpreters/index.htm> (Accessed 10.12.2007).
- Holmes, J. (1992) *An Introduction to Sociolinguistics*. London: Longman.
- Holtgraves, T. (2009) Face, politeness and interpersonal variables: implications for language production and comprehension. In: Bargiela-Chiappini, F. and Haugh, M. eds. *Face, Communication and Social Interaction*. London: Equinox: 192-208.
- Home Office (2002 (revised 2006)) *Agreement on Arrangements for the use of Interpreters*. [online] Available from: <http://police.homeoffice.gov.uk/news-and-publications/publication/operational-policing/national-agreement-interpret.pdf> (Accessed
- Hsieh, E. (2006) Understanding Medical Interpreters: Reconceptualizing Bilingual Health Communication. *Health Communication*, 20 (2): 177-186.
- Hsieh, E. (2007) Interpreters as co-diagnosticians: overlapping roles and services between providers and interpreters. *Social Science and Medicine* 64 (4): 924-937.
- Hudson, A. (2002) Outline of a theory of diglossia. *International Journal of the Sociology of Language*, 157 49.
- IMIA (2006) *Code of Ethics*. [online] Available from: <http://www.mmia.org/standards/CodeofEthics.asp> (Accessed April 2008).
- IoL Educational Trust (1994 updated 2007) *Diploma in Public Service Interpreting Handbook*. [online] Available from: <http://www.iol.org.uk/qualifications/DPSI/DPSIHandbook.pdf> (Accessed 2009).
- Jacobs, B., Kroll, L., Green J. and David, T. J. (1995) The hazards of using a child as an interpreter *Journal of the Royal Society of Medicine*, 88 474P-475P.
- Jadhav, S. (1996) The Cultural Origins Western Depression. *International Journal of Social Psychiatry*, 42 (4): 269-286.
- Jakobson, R. (1959) On Linguistic Aspects of Translation. In: Venuti, L. and Baker, M. eds. *Translation Studies 2000*. New York: Routledge: 524.
- Jay, T. (1999) *Why We Curse. A Neuro-Psycho-Social Theory of Speech*. Philadelphia: John Benjamin's publishing company.
- Jay, T. (2009) The Utility and Ubiquity of Taboo Words. *Perspectives on Psychological Science*, 4 (2): 153 -161.
- Johnson, M. R. D. (1994) Culture, Race and Discrimination. In: Tantam, D. and Birchwood, M. eds. *Psychology and Social Science in Psychiatry*. London: Gaskell Press & Royal College of Psychiatrists: 300-314.
- Johnson, M. R. D. (2004) Cross-cultural communication in health. *Clinical Cornerstone*, 6 (1): 50-52.
- Karasz, A., Garcia, N. and Ferri, L. (2009) Conceptual Models of Depression in Primary Care Patients: a Comparative Study. *Journal of Cross-Cultural Psychology*, 40 (6): 20.
- Keeney, S., Hasson, F. and McKenna, H. P. (2001) A critical review of the Delphi technique as a research methodology for nursing. *International Journal of Nursing Studies*, 38 (2): 195-200.

- Kellerman, S. (1990) Lip Service: The Contribution of the Visual Modality to Speech Perception and its Relevance to the Teaching and Testing of Foreign Language Listening Comprehension. *Applied Linguistics*, 11 (3): 272-280.
- Kellerman, S. (1992) 'I See What You Mean': The Role of Kinesic Behaviour in Listening and Implications for Foreign and Second Language Learning. *Applied Linguistics*, 13 (3): 239-258.
- Kelly, N. (2008) *Telephone interpreting. A comprehensive guide to the profession*. Trafford Publishing.
- Kendon, A., Sebeok, T. A. and Umiker-Sebeok, J. ed. (1981) *Non Verbal Communication, Interaction and Gesture: Selections from Semiotica*. The Hague: De Gruyter.
- Khoei, E. M. and Richters, J. (2008) Concepts of sexuality and health among Iranian women in Australia. *Australian Family Physician*, 37 (3): 190-192.
- Kleinman, A. (1980) *Patients and Healers in the Context of Culture*. Berkely, Los Angeles, London: University of California Press.
- Knapp, K., Enninger, W. and Kapp-Potthoff, A. (1987) *Analysing Intercultural Communications*. Berlin: Mouton De Gruyter.
- Krashen, S. D. (1981) *Second Language Acquisition and Second Language Learning*. [online] Available from: (Accessed 29.03.2013).
- Kuo, D. Z., O'Connor, K. G., Flores, G. and Minkovitz, C. S. (2007) Pediatricians' Use of Language Services for Families With Limited English Proficiency. *Pediatrics*, 119 (4): e920-927.
- Laming, W. H. (28th January 2003) *The Victoria Climbié Inquiry: report of an inquiry by Lord Laming*. [online] Available from: [http://www.dh.gov.uk/en/Publicationsandstatistics/Publications/PublicationsPolicyAndGuidance/DH\\_4008654](http://www.dh.gov.uk/en/Publicationsandstatistics/Publications/PublicationsPolicyAndGuidance/DH_4008654) (Accessed December 2010).
- Language Line (2007) *Interpreter Code of Ethics*. [online] Available from: [www.language.com/page/code\\_of\\_ethics/](http://www.language.com/page/code_of_ethics/)
- Larsen-Freeman, D. (1997) Chaos, Complexity, Science and Second Language Acquisition. *Applied Linguistics*, 18 (2): 25.
- Lloyd, P. and Fernyhough, C. ed. (1999) *Lev Vygotsky. Critical Assessments*. London: Routledge.
- Mac Suibhne, S. (2012) Interpreting in psychiatry: a clinician's perspective. *The Psychiatrist*, 36 (4): 124-125.
- Maggs-Rapport, F. L. (2001) *Selected Annotated Bibliography of Phenomenological Sources*. Leicester: De Montfort University.
- Manning, P. (1992) *Erving Goffman and modern sociology*. Cambridge: Polity Press.
- Mason, I. ed. (2001) *Triadic Exchanges. Studies in Dialogue Interpreting*. Manchester: St Jerome Publishing.
- McGurk, H. and McDonald, J. (1976) Hearing lips and seeing voices. *Nature*, 264 (5588): 746-748.
- Mehrabian, A. (1972) *Nonverbal Communication*. Chicago, New York: Aldine Atherton.
- Morris, R. (1995) The Moral Dilemmas of Court Interpreting. *The Translator*, 1 (1): 25-46.
- Mothertongue (2012) Code of Practice and Ethics for Interpreters and Practitioners in Joint Work.

- Nadirshaw, Z. (2009) Race, culture and ethnicity in mental health care. In: Newell, R. and Gournay, K. eds. *Mental Health Nursing. An evidence-based approach*. Edinburgh: Churchill Livingstone Elsevier: 419.
- National Council on Interpreting in Health Care (2004) *A National Code of Ethics for Interpreters in Health Care*. [online] Available from: <http://www.ncihc.org/assets/documents/NCIHC%20National%20Code%20of%20Ethics.pdf> (Accessed 2010).
- Newell, R. and Gournay, K. ed. (2009) *Mental Health Nursing. An evidence-based approach*. Edinburgh: Churchill Livingstone Elsevier.
- Ng, J., Popova, S., Yau, M. and Sulman, J. (2007) Do culturally sensitive services for Chinese in-patients make a difference? *Social Work in Health Care*, 44 (3): 129-143.
- Northern Ireland Health and Social Services Interpreting Service (2004) Code of Ethics and Good Practice Guidelines for Interpreters.
- NRPSI (2011) National Register of Public Service Interpreters Code of Conduct.
- Nursing and Midwifery Council (2008) *The Code. Standards of conduct, performance and ethics for nurses and midwives*. [online] Available from: <http://www.nmc-uk.org/aArticle.aspx?ArticleID=3057> (Accessed 2009).
- Ozolins, U. (2010) *Factors that determine the provision of Public Service Interpreting: comparative perspectives on government motivation and language service implementation*. [online] Available from: [http://www.jostrans.org/issue14/art\\_ozolins.php](http://www.jostrans.org/issue14/art_ozolins.php)
- Peglidou, A. (2010) Therapeutic itineraries of 'depressed' women in Greece: power relationships and agency in therapeutic pluralism. *Anthropology & Medicine*, 17 (1): 41 - 57.
- Penny, E., Newton, E. and Larkin, M. (2009) Whispering on the Water: British Pakistani Families' Experiences of Support from an Early Intervention Service for First-Episode Psychosis. *Journal of Cross-Cultural Psychology*, 40 (6): 19.
- Perez, I. A. and Wilson, C. W. (2009) A TICS Model from Scotland. A Profile of Translation, Interpreting & Communication Support in the Public Services in Scotland. In: De Pedro Ricoy, R., Perez, I. and Wilson, C. eds. *Interpreting and Translating in Public Service Settings. Policy, Practice, Pedagogy*. Manchester: St. Jerome Publishing: 198.
- Pochhacker, F. and Shlesinger, M. ed. (2002) *The Interpreting Studies Reader*. London and New York: Routledge.
- Price, C. and Cuellar, I. (1981) Effects of language and related variables on the expression of psychopathology in Mexican Americans. *Hispanic Journal of Behavioural Sciences*, 3 145 – 160.
- Price, J. (1975) Foreign Language Interpreting in Psychiatric Practice. *Australian and New Zealand Journal of Psychiatry*, 9 (4): 263-267.
- Prodromou, L. (2006) Defining the 'Successful Bilingual Speaker' of English. In: Rubdy, R. and Saraceni, M. eds. *English in the World*. London: Continuum: 51-70.
- Rader, G. S. (1988) Management decisions: do we really need interpreters? *Nursing Management*, 19 (7): 46-48.
- Ramirez, D., Engel, K. G. and Tang, T. S. (2008) Language interpreter utilization in the emergency department setting: a clinical review. *Journal of Health Care for the Poor and Underserved*, 19 (2): 352-362.
- Raval, H. (2002) Applying theoretical frameworks. In: Tribe, R. and Raval, H. eds. *Working with interpreters in mental health*. Brunner-Routledge: 122-134.



- Richardson, A., Thomas, V. N. and Richardson, A. (2006) "Reduced to nods and smiles": Experiences of professionals caring for people with cancer from black and ethnic minority groups. *European Journal of Oncology Nursing*, 10 (2): 93-101.
- Riley, K. (1993) Telling More than the Truth: Implicature, Speech Acts, and Ethics in Professional Communication. *Journal of Business Ethics*, 12 (3): 179-196.
- Robb, N. and Greenhalgh, T. (2006) "You have to cover up the words of the doctor": mediation of trust in interpreted consultations in primary care. *Journal of Health Organisation and Management*, 20 (5): 434-455.
- Roberts, R. P., Carr, S. E., Abraham, D. and Dufour, A. ed. (2000) *The Critical Link 2 Interpreters in the Community. Selected papers from the Second International Conference on Interpreting in legal, health and social service settings, Vancouver, BC, Canada, 19-23 May 1998*. Amsterdam: John Benjamins Publishing.
- Roberts Smith, L. W. (2007) Forensic Interpreting -Trial and Error. In: Hale, S., Ozolins, U. and Stern, L. eds. *Critical Link: Interpreters in the Community. Quality in Interpreting - a shared responsibility*. Sydney, Australia: John Benjamins Publishing Company: 262.
- Rosch, E. (1999) Principles of Categorization. In: Margolis, E. and Laurence, S. eds. *Concepts. Core Readings*. The MIT Press.:
- Rosenberg, E., Leanza, Y. and Seller, R. (2007) Doctor-patient communication in primary care with an interpreter: Physician perceptions of professional and family interpreters. *Patient Education and Counselling*, 67 (3): 286-292.
- Royal College of Ophthalmologists (October 2010 (reviewed October 2011)) *Understanding Glaucoma*. [online] Available from: <http://www.rcophth.ac.uk/page.asp?section=365> (Accessed November 2012).
- Royal College of Ophthalmologists (undated) Low Vision. The Essential Guide for Ophthalmologists.
- Royal Commission on Criminal Justice (1993) Report of the Royal Commission on Criminal Justice (Runciman Report).
- Rozan, J.-F. (2005) *Note-taking in Consecutive Interpreting*. Cracow: Cracow Tertium Society for the Promotion of Language Studies.
- Sanders, M. (2000) *As Good As Your Word*. London: Maternity Alliance.
- Schellekens, P. (2001) English Language as a Barrier to Employment, Education and Training.
- Shackman, J. (1984) *The Right to be Understood: A Handbook on Working with, Employing and Training Community Interpreters*. . Cambridge: National Extension College.
- Sherry, J. F., Jr. (1983) Gift Giving in Anthropological Perspective. *Journal of Consumer Research*, 10 (2): 157-168.
- Spencer-Oatey, H. (2007) Theories of identity and the analysis of face. *Journal of Pragmatics*, 39 (4): 639-656.
- Stokes, T., Dixon-Woods, M. and Williams, S. (2006) Breaking the ceremonial order: patients' and doctors' accounts of removal from a general practitioner's list. *Sociology of Health & Illness*, 28 (5): 611-636.
- Stone, T. E. and Hazelton, M. (2008) An overview of swearing and its impact on mental health nursing practice. *International Journal of Mental Health Nursing*, 17 (3): 208-214.
- Strong, P. M. (1979) *The Ceremonial Order of the Clinic. Parents, doctors and medical bureaucracies*. London: Routledge and Kegan Paul limited.
- Sullivan, W. and Rees, J. (2008) *Clean Language. Revealing Metaphors and Opening Minds*. Carmarthen: Crown House Publishing Ltd.

- Swedish Ministry of Justice (1986) *The Administrative Procedure Act (including subsequent amendments)*. [online] Available from: <http://www.sweden.gov.se/content/1/c6/06/48/92/a02dc523.pdf> (Accessed 09.11.11).
- Szczepura, A., Johnson, M., Gumber, A., Jones, K., Clay, D. and Shaw, A. (2005) An Overview of the Research Evidence on Ethnicity and Communication in Healthcare.
- The National Centre for Languages (2006 (revised)) National Standards in Interpreting.
- The Sainsbury Centre for Mental Health (2004) Delivering Race Equality: A Framework for Action – Consultation - Mental Health Services Department of Health. October 2003. Response from the Sainsbury Centre for Mental Health (SCMH).
- Ting-Toomey, S. (1999) *Communicating across cultures*. New York: Guilford Press.
- Ting-Toomey, S. (2009) Face, norms and society. In: Bargiela-Chiappini, F. and Haugh, M. eds. *Face, Communication and Social Interaction*. London: Equinox: 227-249.
- Townsley, B. (2011) Building Mutual Trust: A Framework Project For Implementing EU Common Standards In Legal Interpreting And Translation.
- Van Manen, M. (1989) Pedagogical Text as Method. Phenomenological Research As Writing. *Saybrook Review*, 17 (2): 23.
- Van Manen, M. (1990) *Researching Lived Experience. Human Science for an Action Sensitive Pedagogy*. London, Ontario: State University of New York press.
- Vázquez, C. A. (1982) Research on the Psychiatric Evaluation of the Bilingual Patient: a Methodological Critique. *Hispanic Journal of Behavioural Sciences*, 4 (1): 75 – 80.
- Wadensjö, C. (1997) Recycled information as a questioning strategy. Pitfalls in interpreter-mediated talk. In: Silvana E Carr, R., Roda P, Aideen Dufour, Dini Steyn, eds. *The Critical Link: Interpreters in the community. Papers from the first international conference on interpreting in legal, health, and social service settings*. Amsterdam: John Benjamins: 322.
- Wadensjö, C. (1998) *Interpreting as Interaction*. London: Longman.
- Wadensjö, C. (2001) Interpreting in Crisis. The Interpreter's Position in Therapeutic Encounters. In: Mason, I. eds. *Triadic Exchanges. Studies in Dialogue Interpreting*. Manchester: St Jerome Publishing: 208.
- Wadensjö, C., Englund Dimitrova, B. and Nilsson, A.-L. ed. (2007) *The Critical Link 4: Professionalisation of interpreting in the community. Selected papers from the 4th International Conference on Interpreting in Legal, Health and Social Service Settings, Stockholm, Sweden, 20-23 May 2004*. Amsterdam: John Benjamins Publishing Company.
- Westermeyer, J. and Janca, A. (1997) Language, Culture and Psychopathology: Conceptual and Methodological Issues. *Transcultural Psychiatry*, 34 (3): 22.
- Wierzbicka, A. (1999) *Emotions across Languages and Cultures. Diversity and Universals*. Paris: Cambridge University Press.
- Williams, P. (1978) Urban Managerialism: A Concept of Relevance? *Area*, 10 (3): 236-240.
- Winterton, R. (2006) Sainsbury Centre Conference "Mental Health Advocacy: Facing the Future".
- Woloshin, S., Bickell, N., A., Schwartz, L., Gany, F. and Welch, G. (1995) Language Barriers in Medicine in the United States. *Journal of the American Medical Association*, 273 (9): 724-728.

Woodhouse, L., Hickson, L. and Dodd, B. (2009) Review of visual speech perception by hearing and hearing-impaired people: clinical implications. *International Journal of Language & Communication Disorders*, 44 ( 3): 253-270.

## **APPENDICES TO THESIS**

<b>Sample codes of conduct and guide to good practice</b>	<b>374</b>
<b>Thematic grid of CINAHL literature search</b>	<b>377</b>
<b>Participant information and consent documents</b>	<b>379</b>
<b>Questionnaires research instruments</b>	<b>392</b>
<b>National Research Ethics Service favourable opinion and other permissions</b>	<b>397</b>
<b>Code book</b>	<b>407</b>
<b>‘Talking wall’</b>	<b>428</b>
<b>Work published during the period of the study</b>	<b>429</b>

## **IMIA Code of Ethics**

IMIA Code of Ethics (established in 1987 and revised in 2006)

- I. Interpreters will maintain confidentiality in all assignment-related information.
- II. Interpreters will select the language and mode of interpretation that most accurately conveys the content and spirit of the messages of their clients.
- III. Interpreters will refrain from accepting an assignment when professional skills, family, or close personal relationships affect impartiality.
- IV. Interpreters will not interject personal opinions nor counsel patients.
- V. Interpreters will not engage in interpretations that relate to issues outside the provision of health care services unless qualified to do so.
- VI. Interpreters will explain their roles and cultural differences or practices to health care providers and patients when appropriate.
- VII. Interpreters will use skillful unobtrusive interventions so as not to interfere with the flow of communication in a triadic setting.
- VIII. Interpreters will keep abreast of their evolving working languages and medical terminology.
- IX. Interpreters will participate in continuing education programs as available.
- X. Interpreters will seek to maintain ties with relevant professional organizations in order to be up-to-date with the latest professional standards and protocols.
- XI. Interpreters will refrain from using their position to gain favors from clients.

NRPSI Ltd

t/a National Register of Public Service Interpreters

## **CODE OF CONDUCT**

### **1 INTRODUCTION**

Public Service Interpreters appearing in the National Register are expected to abide by the Code of Conduct to which they are signatories. The standards in the Code set a framework for interpreting in the public services, upheld if necessary by professional and impartial disciplinary procedures. The objective of the Code of Conduct is to make sure that communication across language and culture is carried out consistently, competently and impartially, and that all those involved in the process are clear about what may be expected from it.

This Code of Conduct is registered with the Office of Fair Trading under the Restrictive Practices Act 1976.

### **2 COMPETENCE**

Interpreters admitted to the register are expected to:

- 2.1 have a written and spoken command of both languages, including any specialist terminology, current idioms and dialects;
- 2.2 possess the ability to interpret and translate accurately, fluently and appropriately between both languages using the correct techniques
- 2.3 understand the relevant procedures of the particular context in which they are working;
- 2.4 maintain and develop their written and spoken command of English and the other language;
- 2.5 be familiar with the cultural backgrounds of both parties.

### **3 PROCEDURE**

Interpreters will:

- 3.1 interpret truly and faithfully what is said, without anything being added, omitted or changed; in exceptional circumstances a summary may be given if requested, and consented to by both parties;
  - 3.2 disclose any difficulties encountered with dialects or technical terms and, if these cannot be satisfactorily remedied, withdraw from the assignment;
  - 3.3 not enter into the discussion, give advice or express opinions or reactions to any of the parties;
  - 3.4 intervene only:
-

### **The Interpreter's Role:**

To be the 'alter ego' of each speaker

#### Aims:

- To put each speaker on the same footing as they would be if they shared a language with the others.
- To have the same effect on the hearer as the original speaker intended
- To relay information as fully and accurately as possible in the same register

### **The Impartial Model:**

The interpreter does not give advice or opinions

The interpreter is impartial and confidential

The interpreter will intervene only in the following situations

- If a speaker is inaudible
- For clarification of something not understood
- To point out possible misunderstandings which may arise in spite of good interpreting
- To point out possible missed cultural inferences which may lead to misunderstandings
- Interpreters' interventions will be brief, clear, and to the point.

### **Remaining impartial involves:**

- Using the first person form of address, which helps each interlocutor to keep ownership of, and responsibility for what they are saying; and
- Intervening in the third person- both these strategies keep the interpreter's impartiality in the frame, and help her/him not to 'own' the words being said, or their meaning.
- Not taking on a full interlocutor role during interpreting activity
- The notebook helps, as it offers an escape from eye contact
- In non-booth settings a triangular seating or standing arrangement is helpful where possible.
- Not taking on others' responsibilities. Interpreters are not responsible for the content or intention of messages – only for relaying them

**The author's teaching handout on role and impartiality**

## Thematic grid of CINAHL search

Theme	Authors (dates)
Language (interpreters needed)	<p><i>Aspinall</i> (2006) says it's hard to know what need is, due to lack of language data.</p> <p><i>Cioffi</i> (2003) nurses need help with language, cf Hennings 1996.</p> <p><i>Davies</i> (2001) Somali women need professional interpreters; poor understanding, lack of trust.</p> <p><i>Hatton</i> (1992) works with bilingual nurses; notes they take over &amp; make errors.</p> <p><i>Hsieh</i> (2006) comments on doctors' communication strategies.</p> <p><i>Khoei</i> (2008) doctors and interpreters need awareness of euphemism; distrust among Iranian women about interpreter confidentiality.</p> <p><i>Kuo</i> (2008) survey of paediatric service, stats on interpreter use; only one third use interpreters.</p> <p><i>Ng</i> (2007) LEP patients vulnerable esp because they may not know of culturally sensitive services available.</p>
Interpreters professionalise	<p><i>Grant</i> (2006) Interpreter vs barefoot interpreter – patient not offered the choice.</p> <p><i>Greenhalgh</i> (2006) Interpreter and institutional pressures.</p> <p><i>Hatton</i> (1992) interpreters appraise provider and client; take executive role</p> <p><i>Hsieh</i> (2007) describes conduit role of clinicians and interpreter ethical codes.</p> <p>Describes co-diagnostician role.</p> <p><i>Angelelli</i> (2004) in <i>Hsieh</i> (2007) gives an anthropological description of “what they do” rather than look at whether it works or not. In this case they give advice</p> <p><i>Rosenberg</i> (2007) interpreters attempt to keep in role. On the other hand doctors could feel excluded as patient and interpreter form a relationship between them.</p>
Triad	<p><i>Fatahi</i> (2008). A study on GP practices and the work in a triad.</p> <p><i>Greenhalgh</i> (2006) patients' fundamental need for a relationship.</p> <p><i>Richardson</i> (2006) on functions within the triad.</p>
Guidance on WWI	<p><i>Richardson</i> (2006) recommendations to improve practice, includes training all round especially about one's own cultural assumptions.</p> <p><i>Rosenberg</i> (2007) guidelines needed for working with both interpreters and barefoot interpreters. Need for whispered simultaneous mode to be used more.</p>
Error/info	<p><i>Elderkin-Thompson</i> (2001) on reasons for interpreting error by nurses.</p> <p><i>Hatton</i> (1992) relates errors, example of “pecho” being ambiguous</p>
Interpreters' experiences	<p><i>Fatahi</i> (2005) Interpreters' experiences of working with GPs.</p> <p><i>Davidson</i> (2000) in <i>Hsieh</i> (2006) interpreters take an advocacy role.</p> <p><i>Hsieh</i> (2007) on the effect of hierarchy causing editing and filtering.</p>
Patient	<p><i>Brooks</i> (2000) Asian patient knowledge of service, uptake, family</p>



interpreters.

*Grant (2006)* some patients want trained interpreters; more research needed.

*Greenhalgh (2006)* Patients want a good relationship with someone in the triad.

Patient risk

*Bradshaw (2007)* pharmacies not good – monolingual staff and medicine labels.

*Grant (2006)* insufficient information on language ability of patient.

*Greenhalgh (2006)* absence of patient-centred care.

Clinician

*Atkin (2008)* says GPs still ill informed and poor ITALS uptake.

*Fatahi (2008)* says doctors like the impartial model, describes triad.

*Flores (2008)* scant ITALS service, poor training WWWI, poor signage.

*Gerrish (2003)* nurses must take responsibility to engage an interpreter. Discrimination on grounds of language (HRA sect.14)

*Greenhalgh (2006)* doctors want professionalism; want to follow their own agenda.

*Hatton (1992)* discovers that interpreting is a process, and is complex.

*Davidson (2000)* in *Hsieh (2006)* doctors lament interpreter as gatekeeper.

*Rosenberg (2007)* doctors think interpreters more skilled than barefoot interpreters prefer working with the former, who allow doctors to keep control.

ITALS

*Bernstein (2002)* A&E audit on percentage tests/treatments/re-visits and interpreter availability.

*Ramirez (2008)* on patient satisfaction of clinician attitudes and ITALS available.

*Dias (1998)* nurses need skilled interpreters.

## Participant information and consent

### **PARTICIPANT INFORMATION**

**Study Title:**

INTERPRETER OUTPUT IN "TALKING THERAPIES": TOWARDS A METHODOLOGY FOR GOOD PRACTICE.

**Short Title:**

"TESTING INTERPRETING METHODS"

**Researcher:** Jan Cambridge MA  
Health Sciences Research Institute,  
University of Warwick Medical School.

This is a doctoral study supervised by Swaran Singh, Professor of Social and Community Psychiatry and Mark Johnson, Professor of Diversity in Health and Social Care. The resulting thesis will be presented at the University of Warwick.

**What are my responsibilities?**

You are simply asked to work in the normal way throughout the consultation; to assist staff in supporting the patient if necessary due to filming and to complete a short, simple questionnaire afterwards about the interpreting.

**Are there any risks?**

There are no known risks and you should not be inconvenienced in any way.

**Benefits of the study.**

With your help the researcher can study how interpreters do their job in real-life situations. This will help to make interpreting better and safer. It should improve our knowledge of training needs for both linguists and clinicians.

**Complaints**

If you have concerns about the conduct of the study, or your rights as a study participant, you may contact:

Dr M Glover, School Secretary  
The University of Warwick  
Medical School Building  
Coventry CV4 7AL  
Telephone 024 7567 3809.

Dr Glover is independent of the research team

V8 12.04.10

info

Testing interpreting methods Study

**What is the purpose of the study?**

*The research aims to help develop better training methods and guidelines for interpreters and clinicians who work together.*

*The research will focus on the interpreting. What the patient and the clinician say to each other must be repeated in the other language. The researcher wants to know how you cope with the challenges of the interpreting task. Your opinion of the interpreted session will be important to the study.*

**Who will be invited to enter the study?**

You have been invited to enter the study because you are a full status RPSI and have been booked to interpret at a clinic consultation.

**Taking part in the study is voluntary**

Taking part in this study is entirely voluntary. You don't have to take part unless you want to. If you choose not to join the study, or you wish to withdraw from it at any time, your payment and future employment will not be affected.

**What will happen during the study?**

You will be asked for some basic descriptive information about your language background and professional education. The medical consultation will take place as usual. You are only asked to allow us to make a video of this one consultation. You will be asked some questions about yourself and there will be a short questionnaire afterwards, about your impressions of the interpreted consultation. Nothing you say on the questionnaire will be shared with the clinician, the patient or your employer. The questionnaire should not take longer than a normal interpreted consultation. The researcher will not be in the room during your consultation. You may be asked to assist the patient by explaining how to use an audio-survey tool.

**What will happen after the study?**

All aspects of this study, including results, will be strictly confidential and only the researchers will have access to your personal information. Nobody will be able to tell who took part from anything about the study that is published. You will remain anonymous. The information collected will be stored in a secure location so that nobody can access it without authority. The video will not be shown to anyone outside the research team. Your details and the video will be destroyed when the study is finished. A video may be made using actors and your own words taken from the transcripts, for educational purposes.

**Will future work be withheld if I don't take part?**

No. Whether you take part or not is your choice. If you do not wish to take part another interpreter will be invited to take this work assignment and join the study. Your not taking part in the study should not affect any future work assignments you receive.



**PARTICIPANT  
INFORMATION**

**Study Title:**

INTERPRETER OUTPUT IN "TALKING  
THERAPIES": TOWARDS A  
METHODOLOGY FOR GOOD PRACTICE.

**Short Title:**

"TESTING INTERPRETING METHODS"

**Researcher:** Jan Cambridge MA  
Health Sciences Research Institute,  
University of Warwick Medical School.

This is a doctoral study supervised by  
Swaran Singh, Professor of Social and  
Community Psychiatry and Mark  
Johnson, Professor of Diversity in  
Health and Social Care. The resulting  
thesis will be presented at the  
University of Warwick.

PCT local  
contact Address  
should be here

**What are my responsibilities?**

You are simply asked to speak and behave in  
whatever way comes naturally while you are talking  
with your clinician. You will also be asked to  
complete a short, simple questionnaire afterwards  
about the interpreting.

**Are there any risks?**

There are no known risks and you should not be  
inconvenienced in any way.

**Benefits of the study.**

With your help the researcher can study how  
interpreters do their job in real-life situations. This  
will help to make interpreting better and safer.

**Complaints**

If you have concerns about the conduct of the  
study, or your rights as a study participant, you may  
contact:

Dr M Glover, School Secretary  
The University of Warwick  
Medical School Building  
Coventry CV4 7AL  
Telephone 024 7567 3809.

Dr Glover is independent of the research team

VB 12.04.10

Local NHS PCT logo  
**info**  
Testing Interpreting methods Study

**What is the purpose of the study?**

*The research aims to help develop better training methods and guidelines for interpreters and clinicians who work together.*

*The research will focus on the interpreting. What you and your clinician say to each other must be repeated in the other language. The researcher wants to know how our interpreter manages that task. Your opinion of the interpreted session will be important to the study.*

**Who will be invited to enter the study?**

You have been invited to enter the study because you are concerned about your emotional wellbeing, and you will need the services of an interpreter at the clinic.

**Taking part in the study is voluntary**

Taking part in this study is entirely voluntary. You don't have to take part unless you want to. If you choose not to join the study, or you wish to withdraw from it at any time, your medical care will not be affected.

**What will happen during the study?**

Your consultation with your clinician will take place as usual. You are only asked to allow us to make a video of this one consultation. There will be a short questionnaire after that, about your impressions of the interpreted consultation. Nothing you say on the questionnaire will be shared with the clinician or the interpreter. The questionnaire should not take more than 10 minutes and the consultation with your clinician should not take longer than a normal interpreted consultation. The researcher will not be in the room during the consultation.

**What will happen after the study?**

All aspects of this study, including results, will be strictly confidential and only the researchers will have access to your personal information. Nobody will be able to tell who took part from anything about the study that is published. You will remain anonymous. The information collected will be stored in a secure location so that nobody can access it without authority. The video will not be shown to anyone outside the research team. Your details and the video will be destroyed when the study is finished. A video may be made using actors and your own words taken from the transcripts, for educational purposes.

**Will treatment be withheld if I don't take part?**

No. Whether you take part or not is your choice and will not affect the care you receive in any way.



**CLINICIAN  
INFORMATION**

**Study Title:**

INTERPRETER OUTPUT IN "TALKING  
THERAPIES": TOWARDS A  
METHODOLOGY FOR GOOD PRACTICE.

**Short Title:**

"TESTING INTERPRETING METHODS"

**Researcher:** Jan Cambridge MA  
Health Sciences Research Institute,  
University of Warwick Medical School.

**Jan.Cambridge@warwick.ac.uk**

This is a doctoral study supervised by  
Swaran Singh, Professor of Social and  
Community Psychiatry and Mark  
Johnson, Professor of Diversity in  
Health and Social Care. The resulting  
thesis will be presented at the  
University of Warwick.

PCT local  
contact  
Address should

**What are my responsibilities?**

You are simply asked to speak and behave as normal during an interpreted consultation. In the event of patient distress, arising from their taking part in the study, you are asked to support them, to turn off the recording equipment and call the researcher to take it away. The consultation will be taken out of the study and data destroyed. You will be asked to complete a short, simple post hoc questionnaire about the interpreting.

**Are there any risks?**

There are no known risks to your patient and they should not be inconvenienced in any way.

**Benefits of the study.**

With your help the researcher can study how interpreters do their job in real-life situations. This will help to make interpreting better and safer. It should improve our knowledge of training needs for both interpreters and clinicians.

**Complaints**

If you have concerns about the conduct of the study, or your rights as a study participant, you may contact:

Dr M Glover, School Secretary  
The University of Warwick  
Medical School Building  
Coventry CV4 7AL  
Telephone 024 7567 3809.

Dr Glover is independent of the research team

V8 12.04.10

Local NHS PCT logo

info

Testing Interpreting methods Study

### **What is the purpose of the study?**

*The research aims to help develop better training methods and guidelines for interpreters and clinicians who work together.*

*The research will focus on the ways interpreters manage subtlety of language and other communication difficulties when they work in mental health settings. It seeks to establish whether currently applied methods support best outcomes in post-referral mental health interviews about mood disorders.*

### **Who will be invited to enter the study?**

You have been invited to enter the study because you are concerned that your patient may be suffering from a mood disorder, and you will need the services of an interpreter during the consultation. The patient will be an Urdu or Punjabi speaking adult of Pakistani origin.

### **Taking part in the study is voluntary**

Taking part in this study is entirely voluntary. If you choose not to join the study, or you wish to withdraw from it at any time, the consultation will be withdrawn from the study and any data destroyed.

### **What will happen during the study?**

Your consultation with your patient will take place as usual. You are only asked to allow us to make a video of this one consultation with your patient. The researcher will ask you beforehand for some basic biographical information about language knowledge. There will be a short questionnaire afterwards about your impressions of the interpreted consultation. Nothing you say on the questionnaire will be shared with the patient or the interpreter. The questionnaire should not take more than 10 minutes and the consultation with your patient should not take longer than a normal interpreted consultation. The researcher will not be in the room during the consultation.

### **What will happen after the study?**

All aspects of this study, including the results, will be strictly confidential and only the researchers will have access to personal information. Nobody will be able to tell who took part from anything about the study that is published. You will remain anonymous. The information collected will be stored in a secure location so that nobody can access it without authority. The video will not be shown to anyone outside the research team. Your details and the video will be destroyed when the study is finished.

ریسرچ میں حصہ لینے والوں پہلے

## معلومات

### ریسرچ کا عنوان

بانت چیت کے ذریعہ ملامت کا لہجے کا  
ایک اجماع طریقہ، جو رشتہ کرنے کے  
لیے مشورہ ہے کہ اسے روکا جائے۔

### مختصر عنوان

ترجمانی کے طریقوں کی آزمائش۔

ریسرچر جان کیمبرج ایم اے۔

انٹیلیجنس سائنسز میں ریسرچ اسٹینڈیٹ۔  
یونیورسٹی آف واروک، میڈیکل سکول۔

یہ ایک ایسا ہیڈ لائن ہے جسے چھپنے کے لیے استعمال کیا گیا ہے۔  
یہ فیصلہ ہرگز نہیں کیا گیا ہے کہ اسے شائع کیا جائے یا نہیں۔  
یہ فیصلہ ہرگز نہیں کیا گیا ہے کہ اسے شائع کیا جائے یا نہیں۔  
اس تحقیق کے نتیجے میں یہ فیصلہ کیا گیا ہے کہ اسے شائع کیا جائے یا نہیں۔  
یہ فیصلہ ہرگز نہیں کیا گیا ہے کہ اسے شائع کیا جائے یا نہیں۔

داہلے کا یہ بیان پورا کیا جائے۔

یہ فیصلہ ہرگز نہیں کیا گیا ہے۔

آپ کو اپنے ہم نواؤں کے ساتھ اپنے قدرتی انداز میں بولنے اور پیش آنے کو کہا جائے گا۔ اس کی بجائے ایک مختصر سا ہالانہ پر کرنے کو  
کہا جائے گا۔ جو کیا جائے تو مزہم بہت کے بارے میں ہوگا۔

کیا اس میں کوئی خدو ہے؟

اس میں کوئی خدو نہیں ہے۔ اور آپ کو اس میں کسی قسم کی کوئی تکلیف نہیں ہونی چاہیے۔

اس کے کیا فوائد ہیں؟

آپ کی مدد سے تحقیق کرنے والا جان سکتا ہے کہ ایک مزہم ہر طور پر کیے جا رہا ہے۔ اس سے ترجمانی کے کام میں بہتر اور محفوظ بنایا  
جاسکتا ہے۔

شکایات!

اگر آپ کو مزہم کے بارے میں یا اگر تحقیق شرکت دارا بچانے کے حق میں کوئی بھی شک یا شبہ ہو تو آپ

درج ذیل سے رابطہ کریں۔

Dr M. Glover, School Secretary

The University of Warwick

Medical School Building

Coventry CV4 7AL

Telephone 024 7567 3809

Dr Glover is independent of research

ت

یقینہ کارگی

رے میں

ج



میں نے اس بات پر رضامندی ظاہر کی ہے کہ میں نے اس تحقیق میں حصہ لیا ہے اور اس سے حاصل ہونے والے نتائج سے باخبر ہوں۔

میں نے اس بات پر رضامندی ظاہر کی ہے کہ میں نے اس تحقیق میں حصہ لیا ہے اور اس سے حاصل ہونے والے نتائج سے باخبر ہوں۔

میں نے اس بات پر رضامندی ظاہر کی ہے کہ میں نے اس تحقیق میں حصہ لیا ہے اور اس سے حاصل ہونے والے نتائج سے باخبر ہوں۔

میں نے اس بات پر رضامندی ظاہر کی ہے کہ میں نے اس تحقیق میں حصہ لیا ہے اور اس سے حاصل ہونے والے نتائج سے باخبر ہوں۔

میں نے اس بات پر رضامندی ظاہر کی ہے کہ میں نے اس تحقیق میں حصہ لیا ہے اور اس سے حاصل ہونے والے نتائج سے باخبر ہوں۔

میں نے اس بات پر رضامندی ظاہر کی ہے کہ میں نے اس تحقیق میں حصہ لیا ہے اور اس سے حاصل ہونے والے نتائج سے باخبر ہوں۔

میں نے اس بات پر رضامندی ظاہر کی ہے کہ میں نے اس تحقیق میں حصہ لیا ہے اور اس سے حاصل ہونے والے نتائج سے باخبر ہوں۔

میں نے اس بات پر رضامندی ظاہر کی ہے کہ میں نے اس تحقیق میں حصہ لیا ہے اور اس سے حاصل ہونے والے نتائج سے باخبر ہوں۔

**Participant consent forms, Urdu & English**

اس ریسرچ میں حصہ لینے سے پہلے درج ذیل چیزوں کا جاننا ضروری ہے۔

آپ کو اس ریسرچ میں حصہ لینے کی دعوت دی جا رہی ہے۔ اس میں شرکت کے لیے جو اجازت نامے کا فارم دیا جا رہا ہے وہ آپ کی مدد کیلئے ہے۔ اگر آپ اس ریسرچ میں حصہ لینا چاہتے ہیں تو اسے غور سے پڑھیں۔ ریسرچ میں حصہ لینے کیلئے آپ کو اپنی اجازت دینا ہوگی۔ یہ رضامندی درج ذیل امور پر مشتمل ہے۔

□ اس اجازت نامے کو غور سے پڑھنا۔

□ آپ کے معالجہ کا اس ریسرچ کی بارے میں وضاحت کرنا۔

□ سوالات کی وضاحت کرنا۔

□ دستخط کرنے سے پہلے اس اجازت نامے کی سادہ نقل گھر لے جانا۔ اس سے آپ کو وقت ملے گا تاکہ آپ اپنے رشتہ داروں اور دوستوں سے مشورہ کر سکیں۔ کوئی نتیجہ اخذ کریں۔ آپ کو اس وقت تک اس ریسرچ کا حصہ نہیں بننا چاہئے جب تک آپ کو تمام سوالات کے جوابات نہیں مل جاتے۔

□ اس ریسرچ کا اہم مقصد مستقبل میں مریضوں کی مدد کے لئے معلومات حاصل کرنا ہے۔

□ کوئی شخص یہ وعدہ نہیں کر سکتا کہ ریسرچ آپ کو ذاتی طور پر فائدہ دے گی۔

□ ریسرچ میں حصہ لینا رفاہ عامہ کا کام ہے۔ اس میں حصہ لینے کے کیلئے کوئی آپ کو مجبور نہیں کر سکتا۔

□ اگر آپ اس میں حصہ لینے کا سوچتے ہیں تو آپ کسی وقت بھی اسے چھوڑ سکتے ہیں۔

□ خواہ آپ ریسرچ کا حصہ نہیں یا نہ نہیں۔ اس سے آپ کے علاج معالجے کے حقوق پر کوئی اثر نہیں پڑے گا۔ اگر آپ سمجھتے ہیں کہ آپ کو اس میں حصہ نہیں لینا چاہئے۔ تو پھر بھی آپ کے ڈاکٹر کا رویہ آپ کے ساتھ بدستور ٹھیک رہے گا۔

بزرگ کے پرچے میں دی گئی معلومات پڑھنے اور ضروری مشورے کے بعد آپ کو یہ جاننا چاہیے کہ

□ یہ ریسرچ کیوں کی جا رہی ہے۔

□ ریسرچ کے دوران کیا ہوگا۔

□ آپ کیلئے ممکنہ فوائد

□ آپ کیلئے ممکنہ خطرات

اگر آپ کو مزید معلومات درکار ہوں تو اس سے پہلے کہ آپ اس میں شرکت کا فیصلہ کریں آپ ریسرچ میں مزاجان کیمبرج سے ٹیلیفون نمبر

387

078333439485 پر رابطہ کر سکتے ہیں۔ اگر آپ انگلش میں بات نہیں کر سکتے تو آپ کو چاہئے کہ آپ اردو زبان میں مزید

فارم پر کر کے ریسرچ کو دیں۔ وہ کسی اردو مترجم سے اردو میں لکھوا کر آپ کو واپس جواب مہیا کریں گی۔ تاکہ آپ اپنا ذہن

استوار کر سکیں۔ اگر آپ اجازت نامہ نہیں سمجھیں گے وہ آپ سے اس ضمن میں پھر بھی رابطہ نہیں کریں گی۔

کاغذات کے جنڈل میں ڈاک کا ٹکٹ لگے دو لٹا فے شامل ہیں۔ جن پر ریسرچ کا پتہ پہلے سے لکھا ہوا ہے۔ ایک اس لیے ہے کہ

اگر آپ کو مزید معلومات درکار ہوں تو اس سے پہلے کہ آپ اس میں شرکت کا فیصلہ کریں آپ ریسرچ میں مزاجان کیمبرج سے ٹیلیفون نمبر

*You are being asked to be in a research study. The purpose of this consent form is to help you decide if you want to be in the research study. Please read this form carefully. To be in a research study you must give your informed consent. "Informed consent" includes:*

- *Reading this consent form,*
- *Having the study doctor explain the research study to you,*
- *Asking questions about anything that is not clear, and*
- *Taking home an unsigned copy of this consent form. This gives you time to think about it and to talk to family or friends before you make your decision.*

*You should not join this research study until all of your questions are answered.*

*Things to know before deciding to take part in a research study:*

- *The main goal of a research study is to learn things to help patients in the future.*
- *No one can promise that a research study will help you individually.*
- *Taking part in a research study is entirely voluntary. No one can make you take part.*
- *If you decide to take part, you can change your mind later on and withdraw from the research study.*
- *The decision to join or not join the research study will not cause you to lose any medical benefits. If you decide not to take part in this study, your doctor will continue to treat you in the normal way.*

*After reading and discussing the information in the green information leaflet you should know:*

- *Why this research study is being done;*
- *What will happen during the research;*
- *Any possible benefits to you;*
- *The possible risks to you;*

*If you want more information about the study before you make up your mind you can contact the researcher, Mrs Jan Cambridge, by telephone on 07833 439485 but you will need somebody to speak to her in English for you. Alternatively you can fill in the attached Request for Further Information in your own language and she can have that translated by a confidential professional and then reply to you, so you can make up your mind. She will not contact you again unless you send her a consent form.*

*There are two pre-paid envelopes in the pack, addressed to the researcher. One is in case you want to request further information. The other is for you to send your consent if you are happy to go ahead with joining the study. Both the consent forms are bilingual. You should sign and date one of them and post it in the pre-paid envelope. Keep the other for your own records. Once the researcher receives your consent form she will contact you to know when and where you will be going to consult the hospital doctor.*

**Permission to video-record the consultation: Patient**

Name		
Address		
Phone no.		Email:
Name of contact person		
Email/phone number		

I consent to take part in the study "testing interpreting methods". Yes  No

I give my permission for the consultation I am taking part in to be video recorded. Yes  No

I understand that the information recorded will be used for the purposes of writing a report about the interpreting in the consultation. Yes  No

I understand that I will remain anonymous in the report and any other publication there may be. Yes  No

I understand that the video will not be passed on to anybody and will be destroyed after 7 years. Yes  No

I understand that actors may be used to make a new video to show parts of this consultation, using my actual words taken from the transcripts. This would be used for educational purposes. Yes  No

I agree I can be re-contacted by the researcher at the above telephone number or email. Yes  No

I understand that I may withdraw from the study at any time even after the consultation is ended and the recording will be stopped and the video recording destroyed. Yes  No

I give you permission to contact the person named above to arrange to video a suitable consultation between me and my clinician. Yes  No

<b>Signed:</b>	
<b>Print name:</b>	<b>Date:</b>

## Information about a semi structured interview

**Study title:** Interpreter Output in "Talking Therapies": towards a methodology for good practice.

**Short Title:** Testing Interpreting Methods.

### **The purpose of the interview**

To investigate beliefs, attitudes and approaches among both clinicians and interpreters engaged in mental health work.

### **Why have I been asked to take part?**

You are asked to take part in this interview because you have experience of working either as an interpreter or through an interpreter with patients who are suffering from a mood disorder and speak Urdu, Punjabi or Mirpuri.

### **How will the interview be conducted?**

The interview will be conducted in English, over the telephone. The interview will be recorded on a digital recording device and stored on a PC. When the contents of the interview have been analysed they will be used as part of a doctoral thesis. Any quotations used will be anonymous. All personal data will be removed after analysis; all references to people and places including interviewees will be removed or disguised. All digital recordings will be destroyed seven years after the thesis submission. All participants will remain anonymous.

### **Do I have to take part?**

No. It is entirely up to you whether you grant me an interview or not.

### **What will happen to the results of this research?**

They will form part of a doctoral thesis submission, will be used in academic publications and for educational purposes.

### **Who has reviewed this study?**

The study has National Research Ethics Service (NRES) favourable opinion and has been reviewed by the University of Warwick Medical School.

### **Who do I complain to if something goes wrong?**

Contact Wendy Coy, School Secretary, the University of Warwick, Medical School Building, Coventry, CV4 7AL. Tel. 24767 3829.

## Testing Interpreting Method Study

Participant information for focused Interview

### Permission to audio - record the interview form

**Name**

**Address**

**Telephone Number**

**email**

I consent to take part in the study "testing interpreting methods". Yes   
No

I give my permission for the interview I am taking part in to be audio recorded. Yes   
No

I understand that the information recorded will be used for the purposes of writing a report about the interpreting in clinical consultations. Yes   
No

I understand that I will remain anonymous in the report and any other publication there may be. Yes   
No

I understand that the audio recording will not be passed on to anybody and will be destroyed after 7 years. Yes   
No

I understand that my responses may be quoted anonymously, using my actual words taken from the transcripts. This would be used for educational and reporting purposes. Yes   
No

I agree I can be re-contacted by the researcher on the above telephone number or email. Yes   
No

I understand that I may withdraw from the study at anytime even after the consultation is ended and the recording will be stopped and destroyed. Yes   
No

Signed:

Print name:

Date:



This Questionnaire will not be shown to anybody else at the clinic. The researcher will keep it confidential and destroy it when it has been analysed.

Thinking about the consultation you have just engaged in:

<u>Interpreter</u>	<u>Definitely</u>	<u>Yes</u>	<u>Don't know</u>	<u>No</u>	<u>Definitely not</u>
Were your goals achieved?					
Were you given enough information before the assignment to prepare for it?					
Were you able to understand the parties and interpret well?					
Do you feel that you achieved an accurate relay of all that was meant?					
Do you feel that there was good communication between the parties?					
Did you feel you were able to avoid taking sides?					
Do you think a good relationship developed between the two parties?					
Were you given all the support you needed to perform your role in this assignment?					
Do you feel you were treated as a professional?					
Do you use a particular interpreting model e.g. impartial, community, advocacy or another? If so, please say which one below.					

I work in the \_\_\_\_\_ model of interpreting

Thank you very much for helping me with this study.

V4. 12<sup>th</sup> April 2010

## Testing Interpreting methods study

---

"This is the questionnaire for the service user

This questionnaire will not be shown to anybody else in the clinic and won't be shown to the interpreter either. The researcher will keep it confidential and will destroy it when it has been analysed. I'm going to ask you eleven questions, and after each question I want you to choose one of the following five replies. Definitely, Yes, I don't know, No, Definitely not.

If you need to hear a question again you can rewind the tape. When you hear the question, say the answer aloud for the tape recorder. Okay? Alright. Off we go.

Question 1. Did you feel respected and equal? (record a pause here of 8-10 seconds) Thank you.

Question 2. Was there complete understanding between you? (record a pause here of 8-10 seconds) Thank you.

Question 3. Could you give and receive information easily? (record a pause here of 8-10 seconds) Thank you.

Question 4. Did the doctor understand your home circumstances? (record a pause here of 8-10 seconds) Thank you.

Question 5. Do you feel you were able to talk with the doctor about things easily? (record a pause here of 8-10 seconds) Thank you.

Question 6. Did you think the full meaning of what you were saying was relayed? (record a pause here of 8-10 seconds) Thank you.

Question 7. Do you believe the interpreter will keep what you said confidential? (record a pause here of 8-10 seconds) Thank you.

Question 8. Do you feel you can trust the doctor? (record a pause here of 8-10 seconds) Thank you.

Question 9. Do you feel you can trust the interpreter? (record a pause here of 8-10 seconds) Thank you.

Question 10. Do you feel you have been listened to and heard? (record a pause here of 8-10 seconds) Thank you.

Question 11. Do you feel your needs were met? (record a pause here of 8-10 seconds) Thank you.

Finally: is there anything you want to add?

That's all the questions. Thank you very much for helping me with this study."

*[Please record the above text on two cassette tapes - one in Urdu and one in Punjabi - using simple, direct language. Many thanks, Jan Cambridge]*



## Language background information and rating scale

INTERPRETER OUTPUT IN "TALKING" THERAPIES: TOWARDS A METHODOLOGY FOR GOOD PRACTICE

### Personal Information

<b>Patient</b>		<b>Interpreter</b>		<b>Clinician</b>	
Study ID no	P 1	Study ID number	L 1	Study ID number	C 1
Age		Age		Age	
Gender		Gender		Gender	
Ethnic origin (self assessed)		Ethnic origin (self assessed)		Ethnic origin (self assessed)	
Place of birth		Place of birth		Place of birth	
Place of Parents' birth		Place of Parents' birth		Place of Parents' birth	
First language		First language		First language	
Age at leaving formal education		Qualification		Works with interpreters routinely?	
Occupation		Model used (own opinion)		Diagnosis	

Rating scale - for interview observation

Interpreter number

Clinic number

NORMS	Band A Mark range 10-12	Band B Mark range 7-9	Band C Mark range 4-6	Band D Mark range 1-3	COMMENTS / EXAMPLES
Accuracy					
Interpret all said					
Completeness					
Omissions					
Additions					
Changes					
Summary					
Terminology					
Reflects speech styles (register)					

2. Message (product) measured against Chartered Institute of Linguists' criteria\*

Rating scale - for interview observation

Interpreter number

Clinic number

NORMS	Band A Mark range 10-12	Band B Mark range 7-9	Band C Mark range 4-6	Band D Mark range 1-3	COMMENTS / EXAMPLES
Accuracy					
Interpret all said					
Completeness					
Omissions					
Additions					
Changes					
Summary					
Terminology					
Reflects speech styles (register)					

2. Message (product) measured against Chartered Institute of Linguists' criteria\*

## NRES favourable ethical opinion, contracts, letter of access

**Dudley and Walsall**   
Mental Health Partnership NHS Trust

<b>Our Ref</b>	JCLOA01	<b>Clinical Governance Department</b>
<b>Date</b>	31 <sup>st</sup> August 2010	<b>76 Ida Road</b>
<b>Direct Line Tel:</b>	01922 604747	<b>Walsall</b>
<b>Direct Line Fax:</b>	01922 604750	<b>WS2 9SS</b>
<b>E-mail</b>		<b>Telephone: 01922 604745</b>

Dear Mrs Cambridge

### Letter of access for research

As an existing NHS employee you do not require an additional honorary research contract with this NHS organisation. We are satisfied that such checks as are necessary have been carried out by your employer and that the research activities that you will undertake in this NHS organisation are commensurate with the activities you undertake for your employer. This letter confirms your right of access to conduct research through Dudley and Walsall Mental Health Partnership NHS Trust for the purpose and on the terms and conditions set out below. This right of access commences on 31<sup>st</sup> August 2010 and ends on 31<sup>st</sup> March 2011 unless terminated earlier in accordance with the clauses below.

You have a right of access to conduct such research as confirmed in writing in the letter of permission for research from this NHS organisation.

You are considered to be a legal visitor to Dudley and Walsall Mental Health Partnership NHS Trust premises. You are not entitled to any form of payment or access to other benefits provided by this organisation to employees and this letter does not give rise to any other relationship between you and this NHS organisation, in particular that of an employee.

While undertaking research through Dudley and Walsall Mental Health Partnership NHS Trust, you will remain accountable to your employer Warwick University but you are required to follow the reasonable instructions of your nominated manager Dr Iftikhar Ahmad in this NHS organisation or those given on his behalf in relation to the terms of this right of access

Where any third party claim is made, whether or not legal proceedings are issued, arising out of or in connection with your right of access, you are required to co-operate fully with any investigation by this NHS organisation in connection with any such claim and to give all such assistance as may reasonably be required regarding the conduct of any legal proceedings.

You must act in accordance with Dudley and Walsall Mental Health Partnership NHS Trust policies and procedures, which are available to you upon request, and the Research Governance Framework.

You are required to co-operate with Dudley and Walsall Mental Health Partnership NHS Trust in discharging its duties under the Health and Safety at Work etc Act 1974



and other health and safety legislation and to take reasonable care for the health and safety of yourself and others while on Dudley and Walsall Mental Health Partnership NHS Trust premises. Although you are not a contract holder, you must observe the same standards of care and propriety in dealing with patients, staff, visitors, equipment and premises as is expected of a contract holder and you must act appropriately, responsibly and professionally at all times.

You are required to ensure that all information regarding patients or staff remains secure and *strictly confidential* at all times. You must ensure that you understand and comply with the requirements of the NHS Confidentiality Code of Practice (<http://www.dh.gov.uk/assetRoot/04/06/92/54/04069254.pdf>) and the Data Protection Act 1998. Furthermore you should be aware that under the Act, unauthorised disclosure of information is an offence and such disclosures may lead to prosecution.

Dudley and Walsall Mental Health Partnership NHS Trust will not indemnify you against any liability incurred as a result of any breach of confidentiality or breach of the Data Protection Act 1998. Any breach of the Data Protection Act 1998 may result in legal action against you and/or your substantive employer.

You should ensure that, where you are issued with an identity or security card, a bleep number, email or library account, keys or protective clothing, these are returned upon termination of this arrangement. Please also ensure that while on the premises you wear your ID badge at all times, or are able to prove your identity if challenged. Please note that this NHS organisation accepts no responsibility for damage to or loss of personal property.

We may terminate your right to attend at any time either by giving seven days' written notice to you or immediately without any notice if you are in breach of any of the terms or conditions described in this letter or if you commit any act that we reasonably consider to amount to serious misconduct or to be disruptive and/or prejudicial to the interests and/or business of this NHS organisation or if you are convicted of any criminal offence. Your substantive employer is responsible for your conduct during this research project and may in the circumstances described above instigate disciplinary action against you.

If your circumstances change in relation to your health, criminal record, professional registration or any other aspect that may impact on your suitability to conduct research, or your role in research changes, you must inform the NHS organisation that employs you through its normal procedures. You must also inform your nominated manager in this NHS organisation.

Yours sincerely

**Roger Abnett**

**Clinical Governance Facilitator**

**Cc: Peter Hedges  
Swaran Singh  
Iftikhar Ahmed**

**NHS**  
National Research Ethics Service  
NRES Committee West Midlands - Coventry & Warwickshire

Prospect House  
Fishing Line Road  
Enfield  
Redditch  
B97 6EW

Tel: 01527 582532  
Fax: 01527 582540

26 July 2011

Mrs Jan Cambridge  
Dinorben  
Park West  
Heswall  
Wirral  
Merseyside  
CH60 9JE

Dear Mrs Cambridge

**Study title:** INTERPRETER OUTPUT IN "TALKING" THERAPIES.  
TOWARDS A METHODOLOGY FOR GOOD PRACTICE.  
**REC reference:** 09/H1210/103  
**Amendment number:** AM03 (our reference)  
**Amendment date:** 15 July 2011

The above amendment was reviewed by the Sub-Committee in correspondence.

**Ethical opinion**

The members of the Committee taking part in the review gave a favourable ethical opinion of the amendment on the basis described in the notice of amendment form and supporting documentation.

**Comments from the Sub-Committee:**

Regarding your question relating to the use of an electronic signature on the consent form, or the use of scanning the signed document back to you the sub-committee "**considered the return of the signed consent as the current accepted practice.**"  
(Therefore receiving the original copy back with an ink signature).

**Approved documents**

The documents reviewed and approved at the meeting were:

Document	Version	Date
Semi structured interview topic guide: interpreter	1	12 July 2011
Semi structured interview topic guide: clinician	1	12 July 2011
Participant Consent Form: (page 2 of Information sheet)	1	07 July 2011

This Research Ethics Committee is an advisory committee to West Midlands Strategic Health Authority  
The National Research Ethics Service (NRES) represents the NRES Directorate within the Research Ethics  
Committees in England

**NRES Committee West Midlands - Coventry & Warwickshire**

**Sub-Committee of the REC**

<i>Name</i>	<i>Profession</i>	<i>Capacity</i>
Dr Helen Brittain	Clinical Psychologist (Retired)	Lay
Mr Roger Cross	Senior Clinical Pharmacist	Expert

This Research Ethics Committee is an advisory committee to West Midlands Strategic Health Authority  
The National Research Ethics Service (NRES) represents the NRES Directorate within the Research Ethics  
Committees in England

Participant Information Sheet: Information about a semi structured interview	1	07 July 2011
Protocol	6	12 July 2011
Notice of Substantial Amendment (non-CTIMPs)	AM03	15 July 2011
Covering Letter		15 July 2011

**Membership of the Committee**

The members of the Committee who took part in the review are listed on the attached sheet.

**R&D approval**

All investigators and research collaborators in the NHS should notify the R&D office for the relevant NHS care organisation of this amendment and check whether it affects R&D approval of the research.

**Statement of compliance**

The Committee is constituted in accordance with the Governance Arrangements for Research Ethics Committees (July 2001) and complies fully with the Standard Operating Procedures for Research Ethics Committees in the UK.

<b>09/H1210/103:</b>	<b>Please quote this number on all correspondence</b>
----------------------	---

Yours sincerely



**Dr Helen Brittain**  
Chair

E-mail: [rosa.downing@westmidlands.nhs.uk](mailto:rosa.downing@westmidlands.nhs.uk)

*Enclosures:* List of names and professions of members who took part in the review

This Research Ethics Committee is an advisory committee to West Midlands Strategic Health Authority  
The National Research Ethics Service (NRES) represents the NRES Directorate within the Research Ethics Committees in England





## National Research Ethics Service

### Coventry Research Ethics Committee

Osprey House  
Albert Street  
Redditch  
Worcestershire  
B97 4DE

Tel: 01527 587528  
Fax: 01527 587501

21 April 2010

Mrs Jan Cambridge  
Dinorben  
Park West, Heswall  
Wirral  
CH60 9JE

Dear Mrs Cambridge

**Study title:** INTERPRETER OUTPUT IN "TALKING" THERAPIES.  
TOWARDS A METHODOLOGY FOR GOOD PRACTICE.  
**REC reference:** 09/H1210/103  
**Protocol number:** Version 4  
**Amendment number:** AM01 - Minor  
**Amendment date:** 07 April 2010

Thank you for your letter of 07 April 2010, notifying the Committee of the above amendment.

The amendment has been considered by the Vice-Chair.

The Committee does not consider this to be a "substantial amendment" as defined in the Standard Operating Procedures for Research Ethics Committees. The amendment does not therefore require an ethical opinion from the Committee and may be implemented immediately, provided that it does not affect the approval for the research given by the R&D office for the relevant NHS care organisation.

#### Documents received

The documents received were as follows:

Document	Version	Date
Notification of a Minor Amendment	AM01 - Minor	07 April 2010

#### Statement of compliance

The Committee is constituted in accordance with the Governance Arrangements for Research Ethics Committees (July 2001) and complies fully with the Standard Operating Procedures for Research Ethics Committees in the UK.

This Research Ethics Committee is an advisory committee to West Midlands Strategic Health Authority

*The National Research Ethics Service (NRES) represents the NRES Directorate within the National Patient Safety Agency and Research Ethics Committees in England*

09/H1210/103:

Please quote this number on all correspondence

Yours sincerely



**Mrs Karen Green**  
**Committee Co-ordinator**

E-mail: [Karen.Green@westmidlands.nhs.uk](mailto:Karen.Green@westmidlands.nhs.uk)

Copy to: *Peter Hedges, University of Warwick*  
*R&D office for Coventry & Warwickshire Mental Health Partnership Trust @*  
*West Midlands South CLRN*



## National Research Ethics Service

### Coventry Research Ethics Committee

2nd floor West Wing  
University Hospital  
Clifford Bridge Road  
Coventry  
CV2 2DX

19 January 2010

Telephone: 024 7696 7529  
Facsimile: 024 7696 5033

Mrs Jan Cambridge  
Dinorben  
Park West, Heswall  
Wirral  
CH60 9JE

Dear Mrs Cambridge

**Study Title:** Interpreter Output In "Talking" Therapies. Towards A  
Methodology For Good Practice.  
**REC reference number:** 09/H1210/103  
**Protocol number:** Version 4

Thank you for your communication responding to the Committee's request for further information on the above research and submitting revised documentation.

The further information has been considered on behalf of the Committee by the Chairman.

#### Confirmation of ethical opinion

On behalf of the Committee, I am pleased to confirm a favourable ethical opinion for the above research on the basis described in the application form, protocol and supporting documentation as revised, subject to the conditions specified below.

#### Ethical review of research sites

The favourable opinion applies to all NHS sites taking part in the study, subject to management permission being obtained from the NHS/HSC R&D office prior to the start of the study (see "Conditions of the favourable opinion" below).

#### Conditions of the favourable opinion

The favourable opinion is subject to the following conditions being met prior to the start of the study.

Management permission or approval must be obtained from each host organisation prior to the start of the study at the site concerned.

For NHS research sites only, management permission for research ("R&D approval") should be obtained from the relevant care organisation(s) in accordance with NHS research governance arrangements. Guidance on applying for NHS permission for research is available in the Integrated Research Application System or at <http://www.rdforum.nhs.uk>.  
*Where the only involvement of the NHS organisation is as a Participant Identification*

This Research Ethics Committee is an advisory committee to West Midlands Strategic Health Authority

*The National Research Ethics Service (NRES) represents the NRES Directorate within the National Patient Safety Agency and Research Ethics Committees in England*

Centre, management permission for research is not required but the R&D office should be notified of the study. Guidance should be sought from the R&D office where necessary.

Sponsors are not required to notify the Committee of approvals from host organisations.

**It is the responsibility of the sponsor to ensure that all the conditions are complied with before the start of the study or its initiation at a particular site (as applicable).**

#### Approved documents

The final list of documents reviewed and approved by the Committee is as follows:

Document	Version	Date
REC application	IRAS	04 September 2009
Protocol	Version 4	31 August 2009
Participant Consent Form: Psychiatrist	Version 2	01 May 2009
Invitation letter to GP	Version 1	06 July 2009
Summary/Synopsis	Flowchart Version 1 Data Handling	01 May 2009
Questionnaire: Interpreter	Version 3	08 March 2009
Questionnaire: Psychiatrist	Version 3	01 March 2009
Questionnaire: Patient	Version 3	01 March 2009
Personal Information Sheet	Version 1	16 April 2009
Summary/Synopsis	Flowchart Recruiting & Consenting Process Version 1	
Participant Information Sheet: GP Information	Version 7	31 December 2009
Participant Information Sheet: Requires Interpreter	Version 7	31 December 2009
Participant Information Sheet: GP referred you depression	Version 7	31 December 2009
Participant Information Sheet: Clinic Consultation	Version 7	31 December 2009
Participant Information Sheet: Participants	Version 3	31 December 2009
Participant Consent Form	Version 3	31 December 2009
GP/Consultant Information Sheets	Dear Psychiatrist Version 2	31 December 2009
Letter to Pals Manager	Version 2	31 December 2009
Response to Request for Further Information		

#### Statement of compliance

The Committee is constituted in accordance with the Governance Arrangements for Research Ethics Committees (July 2001) and complies fully with the Standard Operating Procedures for Research Ethics Committees in the UK.

#### After ethical review

Now that you have completed the application process please visit the National Research Ethics Service website > After Review

You are invited to give your view of the service that you have received from the National Research Ethics Service and the application procedure. If you wish to make your views known please use the feedback form available on the website.

The attached document "After ethical review – guidance for researchers" gives detailed guidance on reporting requirements for studies with a favourable opinion, including:

- Notifying substantial amendments
- Adding new sites and investigators
- Progress and safety reports
- Notifying the end of the study

The NRES website also provides guidance on these topics, which is updated in the light of changes in reporting requirements or procedures.

We would also like to inform you that we consult regularly with stakeholders to improve our service. If you would like to join our Reference Group please email [referencegroup@nres.npsa.nhs.uk](mailto:referencegroup@nres.npsa.nhs.uk).

09/H1210/103

Please quote this number on all correspondence

Yours sincerely

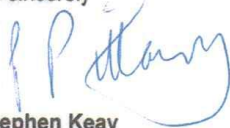

**Mr Stephen Keay**  
Chairman

Email: [pauline.pittaway@uhcw.nhs.uk](mailto:pauline.pittaway@uhcw.nhs.uk)

Enclosures: "After ethical review – guidance for researchers SL- AR2

Copy to: *Peter Hedges, University of Warwick*  
*R&D office for Coventry & Warwickshire Mental Health Partnership*  
*Trust @ West Midlands South CLRN*

## Code Book

CODES-PRIMARY-DOCUMENTS-TABLE (CODE BOOK)

Report created by Super - 25/09/2012 15:21:58

HU: [C:\Users\Jan Cambridge\Documents\Jan...\Testing Interpreting Methods Study updated 04.09.12.hpr7]

Code-Filter: All [78]. PD-Filter: All [40]. Quotation-Filter: All [625]

	<b>FClin1 transcrip t 21/9/11</b>	<b>FClin2 transcrip t 11/10/1 1</b>	<b>FInterp1 transcrip t 10/10/1 1</b>	<b>FInterp3 transcrip t 26/09/1 1</b>	<b>FInterp4 transcrip t 27/9/11</b>	<b>FInterp5 transcrip t 28/9/11</b>	<b>FInterp6 transcrip t 29/9/11</b>	<b>FInterp7 transcrip t 29/9/11</b>	<b>FInterp9 transcrip t 08/10/1 1</b>	<b>FInterp1 0 transcrip t 6/12/11</b>	<b>TOTALS :</b>
# advice to patient	0	2	0	1	0	1	2	1	2	0	<b>9</b>
# challenge PSP behaviours	1	1	0	0	0	0	0	1	0	2	<b>5</b>
# consecutive mode	3	1	0	1	1	1	0	2	0	1	<b>10</b>
# direct speech	0	0	0	1	1	0	1	1	5	2	<b>11</b>
# effective listening	0	0	1	3	1	2	2	2	0	0	<b>11</b>
# negotiates	0	0	2	0	3	0	2	1	4	2	<b>14</b>
# opinions	1	3	3	0	3	1	0	0	1	1	<b>13</b>
# protects patient	0	0	0	0	0	0	0	0	1	0	<b>1</b>

# refers patients	1	1	0	3	2	0	1	0	1	1	<b>10</b>
# register	0	2	0	1	1	0	0	0	2	0	<b>6</b>
# speaking with own voice	0	0	5	3	8	4	4	6	5	0	<b>35</b>
# use sight translation	1	1	0	0	1	0	1	1	1	1	<b>7</b>
# whispered simultaneous mode	1	1	1	2	3	1	1	2	2	0	<b>14</b>
# protects patient	0	0	0	3	1	2	0	0	1	0	<b>7</b>
398 appropriate use of interpreter	0	0	0	3	0	0	0	0	3	0	<b>6</b>
\$ non sequiturs	0	0	1	0	0	0	0	0	0	0	<b>1</b>
\$ parallel conversations	2	6	4	2	1	0	0	0	0	0	<b>15</b>
\$ proactive checks on understanding	0	1	3	0	0	0	0	0	0	0	<b>4</b>
\$ proactive explanations, crosscultural	1	1	4	4	3	5	1	1	2	1	<b>23</b>
\$ proactive explanations, linguistic	0	1	1	2	1	1	2	6	2	0	<b>16</b>
\$ Rapport building	4	2	1	2	0	3	0	4	2	1	<b>19</b>
\$ setting limits	0	1	1	1	3	5	0	2	0	5	<b>18</b>

\$ setting limits; effective listening; speak with own voice	0	0	0	0	0	0	0	0	0	0	0	<b>0</b>
\$ setting limits; speaks with own voice; discomfort: face	0	0	0	0	0	0	1	0	0	0	0	<b>1</b>
\$ setting limits; speaks with own voice; face	0	0	0	0	0	0	0	0	0	0	0	<b>0</b>
\$explanation of working practice	2	3	2	1	1	0	2	1	3	2	2	<b>17</b>
\$proactive seeking of explanation from Dr	4	1	0	2	3	0	0	0	0	2	2	<b>12</b>
\$relaying messages	2	3	11	2	3	4	0	7	4	4	4	<b>40</b>
% Discomfort; face	2	1	4	1	0	1	1	0	3	0	0	<b>13</b>
% discomfort; feels comfortable	0	0	0	2	0	0	0	0	0	0	0	<b>2</b>
& Access to information	8	4	0	0	0	0	0	0	0	0	0	<b>12</b>
& attention to nuance	8	3	0	0	0	0	0	0	0	0	0	<b>11</b>
& attention to nuance; effective listening	0	0	0	0	0	0	1	0	0	0	0	<b>1</b>
& Attitudes, beliefs	5	2	10	1	1	4	1	0	2	1	1	<b>27</b>



& goals and needs	10	9	3	1	0	0	0	0	2	1	<b>26</b>
& Impact of illness	1	1	0	0	0	0	0	0	0	0	<b>2</b>
& Trust	6	4	1	0	0	0	0	0	0	0	<b>11</b>
* 3rd language learned	0	0	0	0	0	1	0	0	0	0	<b>1</b>
* awareness of training	4	3	0	0	0	0	0	0	0	0	<b>7</b>
* 2nd language learned	0	0	1	0	0	1	0	0	0	0	<b>2</b>
* 4th language learned	0	0	0	0	0	0	0	0	0	0	<b>0</b>
* Awareness of theory	1	1	2	2	1	0	2	0	2	2	<b>13</b>
* education	0	0	7	4	1	0	0	0	1	2	<b>15</b>
* MH hours interpreted per year	0	2	3	1	1	0	0	1	1	1	<b>10</b>
* other training	0	1	6	0	2	1	0	0	1	2	<b>13</b>
* qualification	0	0	1	3	0	0	0	0	0	0	<b>4</b>
* years in practice	0	0	0	2	0	0	1	0	1	0	<b>4</b>
*\$ clarification	0	1	1	2	1	1	2	6	2	0	<b>16</b>
*Institution + Model of delivery	13	16	13	20	22	10	13	17	26	11	<b>161</b>
*It's not Legal + Model of delivery	10	14	11	21	22	18	15	19	24	12	<b>166</b>



roles

~ awareness of standards	3	2	0	0	0	0	0	0	0	0	5
~ budget constraints	1	1	2	2	0	1	0	0	2	1	10
~ inappropriate interpreter	0	4	0	0	0	0	0	0	0	0	4
~awareness of training	4	5	1	1	2	1	0	0	2	1	17
£ legal is different	0	0	0	4	0	6	1	0	0	0	11
£ translation vs. interpreting	1	4	0	0	0	1	0	2	0	2	10
£ word for word	1	2	0	0	0	2	1	0	0	0	6
discomfort	2	1	4	3	0	2	1	0	3	0	16
Education and training	5	7	20	12	5	3	3	1	6	7	69
Institution	5	7	2	2	0	1	0	0	2	1	20
It's not Legal	2	4	0	4	0	9	2	2	0	2	25
Model of delivery	8	10	11	18	22	9	13	17	24	10	142
Personal attributes	0	0	0	0	0	0	0	0	0	0	0
Professional perspective	34	18	14	2	1	4	1	0	4	2	80
Role of Interpreter	15	17	27	18	15	17	5	21	16	15	166

Way in to MH Interpreting	0	0	7	2	4	4	3	1	1	2	<b>24</b>
<b>TOTALS:</b>	<b>184</b>	<b>189</b>	<b>210</b>	<b>189</b>	<b>166</b>	<b>150</b>	<b>104</b>	<b>145</b>	<b>191</b>	<b>114</b>	<b>1642</b>

## All current codes (code comments)

---

HU: Testing Interpreting Methods Study updated 04.09.12  
File: [C:\Users\Jan Cambridge\Documents\Jan...\Testing Interpreting Methods Study updated 04.09.12.hpr7]  
Edited by: Super  
Date/Time: 2012-09-25 15:55:38

---

Created: 2012-04-27 18:26:04 by Super  
Modified: 2012-04-27 18:26:04

Quotations: 1

---

### # advice to patient

Created: 2012-01-20 10:28:57 by Super  
Modified: 2012-09-04 18:42:01

Families (1): Model of delivery

Quotations: 9

Comment:

Interpreter gives patient advice without reference to clinician OR  
advice is sought from interpreter but not given

---

### # challenge PSP behaviours

Created: 2012-01-20 10:26:38 by Super  
Modified: 2012-02-08 12:35:14

Families (1): Model of delivery

Quotations: 5

Comment:

Interpreter challenging clinician's verbal or other behaviour

---

### # consecutive mode

Created: 2012-01-20 10:34:56 by Super  
Modified: 2012-04-27 19:12:46

Families (1): Model of delivery

Quotations: 10

Comment:

the interpreter works in consecutive mode: listens to a block of speech and then repeats it in the other  
language

---

### # direct speech

Created: 2012-01-20 10:35:45 by Super  
Modified: 2012-09-04 18:36:58

Families (1): Model of delivery

Quotations: 11

Comment:

the interpreter relays the speaker's words in the same style i.e. using the first person

---

### **# effective listening**

Created: 2012-04-27 17:46:46 by Super

Modified: 2012-04-28 13:00:08

Families (1): Model of delivery

Quotations: 11

Comment:

The interpreter has failed to hear something said by an interlocutor. OR  
The interpreter has heard something said indistinctly or quietly.

---

### **# negotiates**

Created: 2012-01-20 10:31:06 by Super

Modified: 2012-09-04 18:53:21

Families (1): Model of delivery

Quotations: 14

Comment:

Interpreter negotiates on behalf of the patient

---

### **# opinions**

Created: 2012-01-20 10:29:44 by Super

Modified: 2012-04-28 12:10:00

Families (1): Model of delivery

Quotations: 13

Comment:

Interpreter offers their own opinions to patient without reference to the clinician or the reverse

---

### **# protects patient**

Created: 2012-01-20 10:30:34 by Super

Modified: 2012-09-04 18:09:32

Quotations: 1

Comment:

Interpreter intervenes with clinician in support of the patient

---

### **# refers patients**

Created: 2012-01-20 10:33:13 by Super

Modified: 2012-04-27 18:23:07

Families (1): Model of delivery

Quotations: 10

Comment:

the interpreter offers the patient contact details of other professionals e.g. another doctor, a solicitor, etc.  
Or else they don't get involved

---

### **# register**

Created: 2012-01-20 10:34:19 by Super

Modified: 2012-09-04 18:08:22

Families (1): Model of delivery

Quotations: 6

Comment:

The interpreter tries to reflect linguistic register

---

### **# speaking with own voice**

Created: 2012-01-20 10:31:48 by Super

Modified: 2012-09-04 18:48:47

Families (1): Model of delivery

Quotations: 35

Comment:

the patient and clinician feel able to speak as they wish, i.e. that their words are relayed fully and accurately OR NOT and other interlocutor's words are not relayed.

---

### **# use sight translation**

Created: 2012-01-20 10:25:38 by Super

Modified: 2012-02-08 12:46:10

Families (1): Model of delivery

Quotations: 7

Comment:

technique for reading written text aloud in the other language

---

### **# whispered simultaneous mode**

Created: 2012-01-20 10:37:06 by Super

Modified: 2012-04-27 19:12:56

Families (1): Model of delivery

Quotations: 14

Comment:

the interpreter works in wh.sim mode, i.e. listening, changing the language and speaking at the same time. This is similar to the conference interpreters' style of work but without equipment or a text.

---

### **#protects patient**

Created: 2012-01-19 15:47:08 by Super

Modified: 2012-04-28 12:02:49

Families (1): Model of delivery

Quotations: 7

Comment:

the interpreter sees it as their duty to protect either the client or another person

---

### **\$ inappropriate use of interpreter**

Created: 2012-01-19 15:40:00 by Super

Modified: 2012-04-27 18:10:39

Families (1): Role of Interpreter

Quotations: 6

Comment:

Patient and others trying to involve interpreter as part of the family.  
Client etc sees interpreter as personal agent.  
Client sees interpreter as part of "Asian clan" against "others".

---

### **\$ non sequiturs**

Created: 2012-01-21 15:08:39 by Super

Modified: 2012-02-06 19:01:48

Families (1): Role of Interpreter

Quotations: 1

Comment:

Handling replies that do not relate to the question asked

---

### **\$ parallel conversations**

Created: 2012-01-20 11:17:59 by Super

Modified: 2012-04-27 19:15:45

Families (1): Role of Interpreter

Quotations: 15

Comment:

conversations between the interpreter and the doctor, the interpreter and the patient, the interpreter and the carer.

---

### **\$ proactive checks on understanding**

Created: 2012-01-21 14:24:37 by Super

Modified: 2012-02-06 18:57:31

Families (1): Role of Interpreter

Quotations: 4

Comment:

in which the interpreter intervenes without being asked to check that the patient understands the message

---

### **\$ proactive explanations, crosscultural**

Created: 2012-01-19 15:48:42 by Super

Modified: 2012-04-28 12:02:34

Families (1): Role of Interpreter

Quotations: 23

Comment:

in which the interpreter intervenes without being asked to explain cultural issues he or she thinks appropriate  
or the clinician asks for cultural information from the interpreter

---

### **\$ proactive explanations, linguistic**

Created: 2012-01-19 15:49:19 by Super

Modified: 2012-04-28 12:01:08

Families (1): Role of Interpreter

Quotations: 16

Comment:

in which the interpreter intervenes to explain technical terminology to the patient or other linguistic difficulties to either party

---

### **\$ Rapport building**

Created: 2012-01-20 11:15:46 by Super

Modified: 2012-09-04 18:26:54

Families (1): Role of Interpreter

Quotations: 19

Comment:

empathetic behaviour

---



### **\$ setting limits**

Created: 2012-01-19 15:39:27 by Super

Modified: 2012-04-28 13:02:38

Families (1): Role of Interpreter

Quotations: 18

Comment:

Interpreter makes excuses to not comply with certain requests from a client.

Interpreter makes clear introduction of him/herself and methods of working.

Interpreter asks for professional needs to be met e.g. not working in a language or dialect they are not familiar with.

---

### **\$ setting limits|effective listening|speak with own voice**

Created: 2012-04-28 12:57:28 by Super

Modified: 2012-04-28 12:59:23

Quotations: 0

---

### **\$ setting limits|speaks with own voice|discomfort: face**

Created: 2012-04-28 12:17:51 by Super

Modified: 2012-04-28 12:17:52

Quotations: 1

---

### **\$ setting limits|speaks with own voice|face**

Created: 2012-04-28 12:17:20 by Super

Modified: 2012-04-28 12:17:51

Quotations: 0

---

### **\$explanation of working practice**

Created: 2012-01-20 11:19:05 by Super

Modified: 2012-04-27 18:18:18

Families (1): Role of Interpreter

Quotations: 17

Comment:

includes introductions of self and method of working

---

### **\$proactive seeking of explanation from Dr**

Created: 2012-01-23 17:09:26 by Super

Modified: 2012-04-27 18:44:29

Families (1): Role of Interpreter

Quotations: 12

Comment:

interpreter asks doctor to explain to or check on information with the patient

---

### **\$relaying messages**

Created: 2012-01-20 12:18:54 by Super

Modified: 2012-03-16 12:08:18

Families (1): Role of Interpreter

Quotations: 40

Comment:

note taking is an aid to memory and accuracy  
asking for simpler language, shorter chunks etc

---

### **% Discomfort| face**

Created: 2012-01-19 15:37:51 by Super

Modified: 2012-09-04 18:39:16

Families (1): discomfort

Quotations: 13

Comment:

face threat causing discomfiture and evasion

---

### **% discomfort| feels vulnerable**

Created: 2012-01-20 11:02:34 by Super

Modified: 2012-04-28 11:44:19

Families (1): discomfort

Quotations: 2

Comment:

Feels the situation to be risky in physical terms

---

### **& Access to information**

Created: 2012-01-24 17:09:26 by Super

Modified: 2012-01-30 06:52:24

Families (1): Professional perspective

Quotations: 12

Comment:

Clinicians need to be sure their own point or question was communicated without distortion, prompting a relevant response (or not).

Summarising a parallel conversation

---

### **& attention to nuance**

Created: 2012-01-24 17:12:53 by Super

Modified: 2012-04-28 12:25:10

Families (1): Professional perspective

Quotations: 11

Comment:

careful attention to the meaning in context of e.g. the language of affect

---

### **& attention to nuance|effective listening**

Created: 2012-04-28 12:25:10 by Super

Modified: 2012-04-28 12:25:10

Quotations: 1

---

### **& Attitudes, beliefs**

Created: 2012-01-20 12:14:06 by Super

Modified: 2012-09-23 17:08:35

Families (1): Professional perspective

Quotations: 27

Comment:

Beliefs include e.g. that  
being a "native speaker" of a language is a qualification;  
interpreters' beliefs about what the community's attitude to mental health problems is;  
That Punjabi is only a spoken language, or has little medical terminology

Clinicians: that  
native speakers need less training  
professional interpreters offer ethics, quality and confidentiality

Attitudes:  
Willingness to upgrade or add skill sets  
commitment to ethics

---

### **& goals and needs**

Created: 2012-01-20 12:15:21 by Super

Modified: 2012-09-23 17:08:35

Families (1): Professional perspective

Quotations: 26

Comment:

interpreter needs include:  
prior briefing and sometimes post hoc debriefing  
audibility

Clinician needs include:  
training or briefing on working with interpreters  
in-depth understanding of patient's talk  
control of the environment and interview

Goals:  
a good history  
feeling that the transfer of messages was successful  
working with professional interpreters (at assessments)

---

### **& Impact of illness**

Created: 2012-01-24 17:17:52 by Super

Modified: 2012-01-25 10:20:45

Families (1): Professional perspective

Quotations: 2

---

### **& Trust**

Created: 2012-01-24 17:38:31 by Super

Modified: 2012-09-23 17:08:35

Families (1): Professional perspective

Quotations: 11

Comment:

professional relationships. Trust meaning confidence (in another) vs. Rapport meaning a sympathetic relationship or understanding

---

**\* 3rd language learned**

Created: 2012-01-19 15:34:40 by Super  
Modified: 2012-01-24 19:21:14

Families (1): Education and training

Quotations: 4

Comment:

language acquired after the mother tongue

---

**\* awareness of training**

Created: 2012-01-19 15:29:19 by Super  
Modified: 2012-09-23 17:08:35

Families (1): Education and training

Quotations: 7

Comment:

refers to either clinicians' or interpreters' awareness of the training available to them or to the other

---

**\* 2nd language learned**

Created: 2012-01-19 15:34:11 by Super  
Modified: 2012-01-31 15:19:28

Families (1): Education and training

Quotations: 5

Comment:

language acquired after the mother tongue

---

**\* 4th language learned**

Created: 2012-01-19 15:35:05 by Super  
Modified: 2012-01-20 09:58:14

Families (1): Education and training

Quotations: 0

Comment:

language acquired after the mother tongue

---

**\* Awareness of theory**

Created: 2012-01-19 15:32:12 by Super  
Modified: 2012-02-08 12:40:31

Families (1): Education and training

Quotations: 13

Comment:

indicates some interpreter education during training or acquired as a result of experience

---

**\* Education**

Created: 2012-01-19 15:33:08 by Super  
Modified: 2012-02-10 18:27:17

Families (1): Education and training

Quotations: 16

Comment:

refers to all education up to tertiary and including higher degrees

---

**\* MH hours interpreted per year**

Created: 2012-01-19 15:33:51 by Super

Modified: 2012-02-07 07:05:03

Families (1): Education and training

Quotations: 10

Comment:

interpreters' own best guesstimate  
note that some are quoting per month

clinician's own estimate of how many interpreted interviews they do per month

---

**\* Other training**

Created: 2012-01-19 15:36:07 by Super

Modified: 2012-02-08 12:14:31

Families (1): Education and training

Quotations: 14

Comment:

any professional training e.g.  
CPD activities like reading in OL  
improvement of skills in either language  
specific subject lectures such as child protection

---

**\* Qualification**

Created: 2012-01-19 15:35:51 by Super

Modified: 2012-02-07 09:30:50

Families (1): Education and training

Quotations: 11

Comment:

professional certification, bachelor and postgraduate degrees e.g. teacher training, MAs, DPSIs.

---

**\* Years in practice**

Created: 2012-01-19 15:33:31 by Super

Modified: 2012-01-24 14:31:34

Families (1): Education and training

Quotations: 4

Comment:

interpreter's own best guesstimate

---

**\*\$ clarification**

Created: 2012-01-27 09:21:13 by Super

Modified: 2012-01-27 09:21:13

Quotations: 16

Codes: 0

Term: "\$ proactive explanations, linguistic"

---

**\*Institution + Model of delivery**

Created: 2012-01-27 09:00:04 by Super

Modified: 2012-01-27 09:00:04

Quotations: 161  
Codes: 0  
Term: ("Institution" | "Model of delivery")

---

### **\*It's not Legal + Model of delivery**

Created: 2012-01-27 06:44:44 by Super  
Modified: 2012-01-27 06:44:44

Quotations: 166  
Codes: 0  
Term: ("It's not Legal" | "Model of delivery")

---

### **\*It's not Legal+discomfort**

Created: 2012-01-27 07:05:06 by Super  
Modified: 2012-01-27 07:05:06

Quotations: 25  
Codes: 0  
Term: "It's not Legal"

---

### **\*Model of delivery! education and training**

Created: 2012-02-09 09:20:00 by Super  
Modified: 2012-02-09 09:20:00

Quotations: 142  
Codes: 0  
Term: "Model of delivery"

---

### **@ ID Interp**

Created: 2012-01-20 10:14:00 by Super  
Modified: 2012-01-25 14:55:00

Families (1): Personal attributes

Quotations: 8

Comment:

ID number in study

---

### **@ Age**

Created: 2012-01-20 10:14:31 by Super  
Modified: 2012-01-30 12:35:43

Families (1): Personal attributes

Quotations: 10

Comment:

interviewee's age

---

### **@ Birthplace**

Created: 2012-01-20 10:15:29 by Super  
Modified: 2012-01-30 12:35:43

Families (1): Personal attributes

Quotations: 9

Comment:

interviewee's place of birth

---

### **@ Birthplace of parents**

Created: 2012-01-20 10:16:08 by Super

Modified: 2012-01-30 12:35:43

Families (1): Personal attributes

Quotations: 9

Comment:

interviewee's parents' place/s of birth

---

### **@ Current post**

Created: 2012-01-24 16:43:54 by Super

Modified: 2012-01-30 14:55:29

Families (1): Personal attributes

Quotations: 2

Comment:

clinicians' current post within NHS

---

### **@ Ethnicity**

Created: 2012-01-20 10:15:01 by Super

Modified: 2012-01-30 14:57:03

Families (1): Personal attributes

Quotations: 10

Comment:

self assessed ethnicity

---

### **@ Female**

Created: 2012-01-25 17:56:01 by Super

Modified: 2012-04-27 16:44:04

Quotations: 0

---

### **@ First language**

Created: 2012-01-20 10:16:31 by Super

Modified: 2012-01-30 12:35:43

Families (1): Personal attributes

Quotations: 10

Comment:

first language learned

---

### **@ Gender**

Created: 2012-01-20 10:14:44 by Super

Modified: 2012-01-30 12:35:43

Families (1): Personal attributes

Quotations: 10

Comment:

gender of interviewee

---

### **@ ID Clin**

Created: 2012-01-24 16:40:09 by Super

Modified: 2012-01-30 12:35:43

Families (1): Personal attributes

Quotations: 2

Comment:

ID number in study

---

### **@ Male**

Created: 2012-01-25 17:59:18 by Super

Modified: 2012-04-27 16:43:42

Quotations: 0

---

### **^ Circumstance**

Created: 2012-01-19 15:54:31 by Super

Modified: 2012-02-08 12:15:13

Families (1): Way in to MH Interpreting

Quotations: 12

Comment:

circumstances that first brought this interpreter into mental health interpreting

---

### **^ Motivation**

Created: 2012-01-19 15:51:02 by Super

Modified: 2012-02-08 12:15:37

Families (1): Way in to MH Interpreting

Quotations: 14

Comment:

what motivates this interpreter to practice in mental health settings

---

### **~ Awareness of others' roles**

Created: 2012-01-19 15:29:41 by Super

Modified: 2012-01-25 09:50:20

Families (1): Institution

Quotations: 2

Comment:

refers to either clinicians' or interpreters' awareness of what the other's role is in the interpreting triad.

---

### **~ Awareness of standards**

Created: 2012-01-19 15:28:59 by Super

Modified: 2012-09-23 17:08:35

Families (1): Institution

Quotations: 5

Comment:

refers to either clinicians' or interpreters' awareness of what appropriate standards in interpreting are

---



### **~ Budget constraints**

Created: 2012-01-19 15:28:29 by Super

Modified: 2012-02-08 12:36:12

Families (1): Institution

Quotations: 10

Comment:

this refers to the institution and/or interpreter agency and factors resulting from reduced budgets that affect the interpreters' work

---

### **~ Inappropriate interpreter**

Created: 2012-01-25 11:22:36 by Super

Modified: 2012-01-30 12:05:03

Families (1): Institution

Quotations: 4

Comment:

interpreter not suitable for this job e.g. speaks wrong language or dialect, is not competent, is not trained

---

### **~ Awareness of training**

Created: 2012-01-20 10:24:30 by Super

Modified: 2012-03-16 11:40:18

Quotations: 24

Comment:

model claimed or described by interpreter or clinician

confidentiality

impartiality

no distortions

---

### **£ Legal is different**

Created: 2012-01-20 11:22:26 by Super

Modified: 2012-03-16 12:08:18

Families (1): It's not Legal

Quotations: 11

Comment:

The distinction is drawn by the interpreter between legal interpreting and other kinds

---

### **£ Translation vs. interpreting**

Created: 2012-01-19 15:56:37 by Super

Modified: 2012-03-16 13:19:59

Families (1): It's not Legal

Quotations: 10

Comment:

interpreters and clinicians draw a distinction between "translation" and "interpreting"

Translation used to mean "close interpretation".

---

### **£ Word for word**

Created: 2012-01-19 15:57:26 by Super

Modified: 2012-02-08 08:58:09

Families (1): It's not Legal

Quotations: 6

Comment: "verbatim" or close interpreting.

---

**Discomfort:face|setting limits|speak with own voice|rapport**

Created: 2012-04-28 11:39:17 by Super

Modified: 2012-04-28 11:42:57

Families (1): discomfort

Quotations: 1

---

**Female Role+Model**

Created: 2012-01-25 18:13:35 by Super

Modified: 2012-01-25 18:13:35

Quotations: \*

Codes: 0

Term: (("Role of Interpreter" | "Model of delivery") WITHIN "@ Female")

---

**Male Role+Model**

Created: 2012-01-25 18:17:41 by Super

Modified: 2012-01-25 18:17:41

Quotations: \*

Codes: 0

Term: (("Role of Interpreter" || "Model of delivery") WITHIN "@ Male")

---

# Talking Wall: example of audit trail during theme development



**WORK PUBLISHED DURING THE PERIOD OF THE  
STUDY**

