

# Modeling Human-Machine Interaction in Production Systems for Equipment Design

by

Micah Thomas Collins

B.S.E. Mechanical Engineering and Applied Mechanics  
University of Pennsylvania, 1997

SUBMITTED TO THE DEPARTMENT OF MECHANICAL ENGINEERING  
IN PARTIAL FULFILLMENT OF THE REQUIREMENTS FOR THE DEGREE OF

MASTER OF SCIENCE IN MECHANICAL ENGINEERING  
AT THE  
MASSACHUSETTS INSTITUTE OF TECHNOLOGY

JUNE 1999

© 1999 Massachusetts Institute of Technology  
All rights reserved.

Signature of Author: \_\_\_\_\_  
Department of Mechanical Engineering  
May 7, 1999

Certified by: \_\_\_\_\_  
David S. Cochran  
Thesis Supervisor

Accepted by: \_\_\_\_\_  
Ain A. Sonin  
Chairman, Graduate Committee

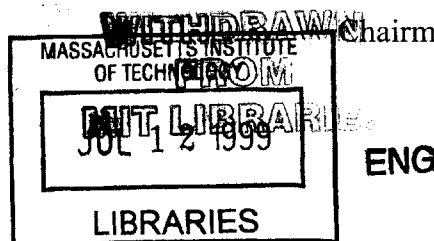

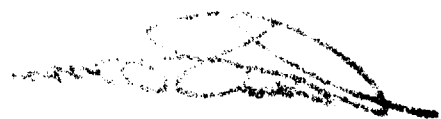

# Modeling Human-Machine Interaction in Production Systems for Equipment Design

by

Micah Thomas Collins

Submitted to the Department of Mechanical Engineering on  
May 7, 1999 in Partial Fulfillment of the Requirements for  
the Degree of Master of Science in Mechanical Engineering  
at the Massachusetts Institute of Technology

## ABSTRACT

A production system design decomposition is applied to the synthesis of a supervisory control based human-machine interaction (HMI) model that characterizes the performance in a manufacturing work-cell and satisfies the goals of a production enterprise. The model specifies and describes the behavioral roles that an operator assumes as a supervisor of multiple semi-automated production processes. The model captures the functional human-machine interaction that enables process control and continuous improvement to the manufacturing process. A model of HMI is useful for designing production subsystems, particularly the design of manufacturing equipment, which determines the human-machine interaction in a cell and thus directly impacts the system's performance. The HMI model is related to the equipment design process to demonstrate how the design of cellular manufacturing equipment is aided by such a model. The HMI model is shown to be a computational aid for design decisions that involve generating functional requirements for an axiomatic design based equipment design methodology.

Thesis Supervisor: David S. Cochran

Title: Assistant Professor of Mechanical Engineering



# Acknowledgements

---

I'll try to stick to a chronological order as I thank people. This seems appropriate since the longer I've known someone, the more likely it is that I owe them something. In this case a *thanks*, for something they've either knowingly or unknowingly contributed.

I cannot go back any further than birth to count all the accomplishments that I owe entirely to my mom, dad, and sister, Lee. Without their unending support, guidance, and love, I could never have accomplished anything, from riding a bike to writing a thesis. My gratefulness to them is magnitudes above all others.

I want to thank my good friend since fourth grade, William S. Mathews, a Ph.D. candidate at UIUC. We grew up in Northern Virginia as neighborhood pals and then shared many interests that landed us in two of the nation's top M.E. graduate programs. There is nothing like a little friendly competition to help raise the bar now and again, and Will was always good for that.

To my very good friends from Penn – Thanks to my study partners, we worked our way through MEAM together: Mel Tang, Rob Wong, Arun Gupta, and Hetal Jariwala. And thanks to an amazing group who I take great pride in calling friends: Adam Illfelder, Daniel Shub, Osamu Saito, Ricky Santiago, Trooper Merriam, Tina Ponce and my MEAM pals.

Finally, to my compatriots here at MIT. Thanks to those friends I've met in the Production System Design Lab who shared many of my good and bad times: Andrew Wang, Dan Dobbs, Jim Duda, Jochen Linck, John Hull (honorary PSD member), Johnny Chang, Jorge Arinez, José Israel Castañeda-Vega, Michael Dobson, Vicente Reynal, Yong Suk Kim, and Yu-Feng Wei. I wish the best of luck to PSD's newer students, and wish I had more time to get to know them: Deny Gomez, Alex Chu, David Estrada, Ania Mierzejewska, Cecilia Prieto, Brandon Carrus, and Kristina Kuest. I especially enjoyed the times spent with some of the visiting students who were so enthused to join our lab, and equally so enthused to depart it: Staffan Bröte, Hauke Roeschmann, Martin Weidemann, Sascha Ratzeburg, and currently Carlos Lobo and Richard Lenz. Special thanks to the elders, Jim, Jochen, Jorge, Jose and Staffan whose academic "seasoning" helped put many of my frustrations with research and academia in perspective. Jorge was a special compadre, at first guiding me through our shared industry "research" project, then tolerating me as a sometimes bossy and impatient research partner. Jorge was immeasurably helpful as a mentor for my research.

As for the aforementioned industry project at Visteon Automotive Systems (an Enterprise of Ford Motor Company), I'd like to thank my counterpart, Melissa Uhl from Visteon, for all her help and camaraderie while I worked as a guest on that project team. I'd also like to thank Mark Price from Advanced Assembly Automation, and Roberto Valadez from Visteon's Coclisa Plant in Cd. Juarez for making the work we shared more

enjoyable. Thanks also to John Barkley of Visteon who supported our work on that project and provided very stimulating conversations during our time there.

I also want to thank Professor Thomas Sheridan for his very interesting courses on human factors engineering and human supervisory control. These courses accelerated my interest in design and made me appreciate what value can come from good design practice. I also thank him for his support of me in this department.

Professor Paulo Lima, a visiting professor from Campinas University in Brazil, was an extremely refreshing presence in PSD. I enjoyed our many conversations about manufacturing systems and his home country. I really respected and appreciated the time he took to get to know the students with whom he worked.

And finally I thank my advisor, Professor David S. Cochran, for giving me this great opportunity to be at MIT and study design and manufacturing. I've really appreciated his encouragement and his enthusiasm in relating to me his knowledge of manufacturing systems. I've enjoyed working in his lab and learning under his instruction. Also, the work I've done and the people I've met are in large part due to his support, and for that I am very thankful.

– Micah Thomas Collins

# Table of Contents

---

<b>Acknowledgements .....</b>	<b>5</b>
<b>Table of Contents.....</b>	<b>7</b>
<b>Table of Figures .....</b>	<b>9</b>
<b>Introduction .....</b>	<b>13</b>
<b>Chapter 1. Background .....</b>	<b>15</b>
Production Systems .....	15
<i>Axiomatic Design Approach for Designing Production Systems .....</i>	<i>15</i>
<i>Lean Manufacturing.....</i>	<i>17</i>
<i>"Lean" Production System Design Decomposition .....</i>	<i>18</i>
Manufacturing Equipment Design .....	20
Human-Machine Systems .....	23
<i>Humans and Their Work Environment.....</i>	<i>26</i>
<i>Humans and Automation.....</i>	<i>28</i>
<i>Human Error in Systems .....</i>	<i>30</i>
Summary .....	32
<b>Chapter 2. Cell Design Case Study: Automotive AC Compressor Manufacturing .....</b>	<b>33</b>
Purpose.....	33
Introduction.....	33
Production System Design Guidelines.....	34
Resulting Production System Design.....	36
Examples from Design Guidelines.....	39
<i>Example 1 – Cell Design.....</i>	<i>40</i>
<i>Example 2 – Equipment Design .....</i>	<i>43</i>
<i>Example 3 – Material Handling.....</i>	<i>45</i>
<i>Example 4 – Quality.....</i>	<i>48</i>
<i>Example 5 – Operator Ergonomics and Safety .....</i>	<i>50</i>
Conclusion and Lessons Learned.....	52
<b>Chapter 3. Human-Machine Interaction in Manufacturing Cells.....</b>	<b>55</b>
Introduction.....	55
Manufacturing Cells.....	55
Work Content in Cells.....	58
<b>Chapter 4. Application of a Production System Design Decomposition to Human-Machine Interaction .....</b>	<b>61</b>
Production System Design Decomposition.....	61
Quality.....	64
<i>Process Control.....</i>	<i>65</i>
<i>Human Error .....</i>	<i>70</i>
Reduce Throughput Time Variation .....	73
<i>Identifying and Resolving Problems.....</i>	<i>74</i>
<i>Predictable Output .....</i>	<i>78</i>
Throughput Time Reduction .....	81
<i>Process Delays from Human Operators.....</i>	<i>81</i>

Reduce Labor Costs.....	82
<i>Direct Labor</i> .....	83
<i>Indirect Labor</i> .....	86
Summary .....	87
<b>Chapter 5. Model for Human-Machine Interaction in Manufacturing Cells .....</b>	<b>89</b>
Introduction .....	89
Supervisory Control .....	90
<i>Five Supervisory Functions</i> .....	92
<i>Iterative Supervisor Function Loops</i> .....	93
Synthesis of Human-Machine Interaction Model.....	95
<i>The Nature of Mental Models</i> .....	98
Model – Part 1 of 4, Skill-Based HMI (BL-0) .....	98
Model – Part 2 of 4, Rule-Based HMI (BL-1) .....	102
Model – Part 3 of 4, Knowledge-Based HMI (BL-2).....	104
Model – Part 4 of 4, Nested Interaction of Behaviors .....	105
Summary .....	106
<b>Chapter 6. Application of the HMI Model to an Axiomatic Design Framework .....</b>	<b>109</b>
Equipment Design Methodology.....	109
<i>Example 1 – Use of HMI Model in Obtaining High-Level Sub-FR</i> .....	111
<i>Example 2 – Design for Human-Machine Separation Using HMI Model</i> .....	112
<i>Example 3 – Poka-Yoke for Manual Work Tasks</i> .....	115
<i>Example 4 – Design of Station Structure and Layout</i> .....	117
Applicability of HMI for Other Production Subsystem Design Processes.....	119
Other Applications of HMI Model .....	121
<b>Conclusion and Recommendations .....</b>	<b>123</b>
<b>References.....</b>	<b>125</b>



# Table of Figures

Figure 1. Design equations that quantitatively map the functional domain to physical domain.....	16
Figure 2. Axiomatic design domains [Suh, 1990].....	16
Figure 3. Schematic of the production system design decomposition –showing the separate functional requirement and design parameter hierarchies [PSD Lab, 1999] .....	19
Figure 4. High-level decomposition for production system design leading to lower level decompositions dealing with specific aspects of production systems [PSD Lab, 1999].....	20
Figure 5. Decomposition of ED DP into ED sub-FRs. Some sub-FRs are derived from PSD and others from PD [Arinez and Cochran, 1999a].....	21
Figure 6. The relationship between equipment design frameworks and resulting human-machine interaction. Model is useful to equipment designers .....	23
Figure 7. Control modes of human and task/process interaction. [Sheridan, 1992].....	24
Figure 8. Rasmussen’s human behavior model [Rasmussen, 1983] .....	26
Figure 9. Modern (optimal) control paradigm using a model-based estimator of process state, $x$ [Sheridan, 1992] .....	29
Figure 10. Six major components of the automotive compressor. In order from left to right: Rear Cover, Rear Plate, Rotor, Shaft, Center Housing, Front Head.....	34
Figure 11. Applying production system design decomposition to a new system using guidelines [Arinez, et al., 1999].....	35
Figure 12. Production System DPs map to design guidelines by category [Arinez, et al., 1999].....	36
Figure 13. Overview of actual production system design [Arinez, et al., 1999].....	37
Figure 14. Two machining cells for the fabrication of six components [Arinez, et al., 1999].....	38
Figure 15. Compressor final assembly cell [Arinez, et al., 1999].....	39
Figure 16. Level 6 Decomposition of “FR – Enable Worker to Operate More than One Machine or Station” [Cochran and Lima, 1998].....	40
Figure 17. U-shaped compressor assembly cell with sample work-loops [Arinez, et al., 1999] .....	41
Figure 18. Varying work-loop patterns in assembly [Arinez, et al., 1999].....	42
Figure 19. Planned cycle-times for each cell operator under different work-loop configurations [Arinez, et al., 1999].....	43
Figure 20. Level 6 Decomposition of “FR - Eliminate Common Cause Disruptions to the Production Flow” [Cochran and Lima, 1998].....	44
Figure 21. Side view of vertical lathe showing systems access from rear of machine [Arinez, et al., 1999] .....	45
Figure 22. Top view of vertical machining center showing access to controls and subsystems from rear of machine [Arinez, et al., 1999] .....	45
Figure 23. Level 6 Decomposition of “FR – Reduce Tasks that Tie the Operator to the Machine” [Cochran and Lima, 1998] .....	46
Figure 24. Standard work height and reduced walking distances for operating multiple machines [Arinez, et al., 1999].....	47
Figure 25. Interface between operator, machine and fixture to help achieve cost effective machine loading [Arinez, et al., 1999].....	48
Figure 26. Level 5 Decomposition of “FR – Produce With A Predictable Quality Output” [Cochran and Lima, 1998].....	48
Figure 27. Poka-yoke on compressor assembly pallet to error-proof the insertion of outer vane into center housing [Arinez, et al., 1999] .....	49
Figure 28. Example of successive check logic from compressor vane assembly station [Arinez, et al., 1999] .....	50
Figure 29. Level 6 Decomposition of “FR – Reduce Tasks that Tie Operator to the Machine” [Cochran and Lima, 1998].....	51

Figure 30. Ergonomic work envelope for assembly station. Material slides position incoming material at point of use for operator [Arinez, et al., 1999]..... 52

Figure 31. Physical integration, yet functional independence, through cell design..... 56

Figure 32. Cellular layout with varying operator work-loop patterns allowing flexible work content..... 57

Figure 33. Man-machine chart for a 4-operator cell with a mixture of manual and semi-automatic stations ..... 58

Figure 34. High-level portion of production system design decomposition [PSD Lab, 1999]..... 62

Figure 35. Process of mapping PSD FR/DPs to the HMI element that the DP describes..... 63

Figure 36. Relating production system design FR/DPs to human-machine interaction..... 64

Figure 37. Section of production system design decomposition that is related to quality. Highlighted boxes show FR/DPs relating to process control implementation [PSD Lab, 1999]. ..... 66

Figure 38. Classical control system view of SPC implementation [DeVor, et al. 1992] ..... 67

Figure 39. Statistical basis for control chart formulation [DeVor, et al. 1992]..... 68

Figure 40. Summary of FR/DPs for controlling process quality ..... 69

Figure 41. Section of production system design decomposition that is related to quality. Highlighted FR/DPs detail the stabilization of operator output [PSD Lab, 1999]. ..... 70

Figure 42. Functions of a poka-yoke device in a manufacturing system [*Poka-yoke*, 1987]..... 72

Figure 43. Summary of FR/DPs for stabilizing human operator output through human error mitigation... 73

Figure 44. Sub-FRs for reducing throughput time variation [PSD Lab, 1999]..... 74

Figure 45. Section of production system design decomposition that is related to identifying and resolving problems. Highlighted FR/DPs relate to human-machine interaction [PSD Lab, 1999]...... 75

Figure 46. Fishbone structure for cause-and-effect diagram ..... 77

Figure 47. Summary of FR/DPs for identifying and resolving problems ..... 78

Figure 48. Section of production system design decomposition that is related to predictable output. Highlighted FR/DPs relate to human work content and management [PSD Lab, 1999]..... 79

Figure 49. Summary of FR/DPs for predictable output..... 81

Figure 50. Section of production system design decomposition that is related to delay reduction. Highlighted FR/DPs relate to manual work content [PSD Lab, 1999]..... 82

Figure 51. Summary of FR/DP for reducing process delays due to human work content ..... 82

Figure 52. Section of production system design decomposition that is related to direct labor work content and cost reduction [PSD Lab, 1999] ..... 83

Figure 53. Schematic of machine layout to facilitate efficient operator workloops ..... 85

Figure 54. Summary of FR/DPs for direct labor cost reduction ..... 86

Figure 55. Section of production system design decomposition that is related to indirect labor cost reduction [PSD Lab, 1999]..... 87

Figure 56. Summary of FR/DP for indirect labor cost reduction..... 87

Figure 57. Schematic of telerobotic supervisory control. Barrier represents time, distance, or inconvenience [Sheridan, 1992] ..... 91

Figure 58. Top-level model of human-machine interaction in a semi-automated, supervisory control manufacturing environment ..... 92

Figure 59. Five supervisory control functions [Sheridan, 1992] ..... 92

Figure 60. The three supervisory behavior loops. This iterative feature of supervisory control is how processes are controlled and the system is improved. .... 94

Figure 61. Process of taking production system design FR/DPs and mapping them first as in Chapter 1, then to the supervisory control functional behaviors..... 96

Figure 62. FR/DPs that apply to skill-based HMI model ..... 99

Figure 63. Annotated interaction between human and machine during skill-based behavior, where supervisor is a monitor of process as well as process operator ..... 100

Figure 64. Common conceptual model of operator in a manufacturing cell handling multiple automated machines..... 101

Figure 65. Operator that receives manufacturing process-state information ..... 101

Figure 66. FR/DPs that apply to rule-based HMI model ..... 102

Figure 67. Annotated interaction between human and machine during rule-based behavior, where supervisor intervenes and follows procedures to rectify problem and inputs any adjustments or performs required servicing activity (teach)..... 103

Figure 68. FR/DPs that apply to rule-based HMI model ..... 104

Figure 69. Annotated interaction between human and machine during knowledge-based behavior, where supervisor draws on lessons learned and executes plans for improving work/capability .....	105
Figure 70. Nested supervisory control HMI model for three behavioral HMI models. Parts 1, 2, and 3 of the HMI model reside in the three boxes that describe each of the three nested loops .....	106
Figure 71. HMI model benefits equipment designers when determining sub-FRs for an ED DP. ....	110
Figure 72. Assembly station design for aligning and fastening front head to rear plate/center housing subassembly .....	111
Figure 73. First level decomposition of an assembly station to attach the Front Head to the Rear Plate/Center Housing subassembly .....	111
Figure 74. ED DP-1 is decomposed into FR-11 through FR-15 where FR-12 is a function of PSD FR/DP-D2 that is acquired through considering HMI model .....	112
Figure 75. Decomposing ED DP-15 using an HMI model yields a design that enable human-machine separation .....	113
Figure 76. Decomposition of <i>ED DP-15</i> without HMI model may lead to a common design using palm-buttons that tie an operator to a machine .....	114
Figure 77. ED decomposition for the branch that pertains to fixture design .....	116
Figure 78. Part aligning poka-yoke on chucking component of fixture design .....	116
Figure 79. ED decomposition for the branch that pertains to station architecture/structure design.....	117
Figure 80. Station sub-frame configured to reduce walking distances once integrated into a cellular layout .....	118
Figure 81. Ergonomic work envelope analysis performed on assembly station to ensure local population anthropometry is accommodated.....	119
Figure 82. Process Failure Mode and Effect Analysis on previously discussed assembly station.....	120
Figure 83. Sample standard work routine for previously discussed assembly station .....	120



# Introduction

---

Design has long been considered an art more so than a science. Design methodologies strive to systematize the design process in order to make the practice more efficient and effective. The design of production systems is a complex process that is in need of structured design methodologies, such as the one based on axiomatic design prescribed by Cochran [1994; 1999; Suh et al., 1998], in order to better satisfy the goals of a production enterprise.

Designing equipment for production subsystems includes the design of the process dependent functional components (i.e. bearings, motors, coolant lines), architecture (i.e. size, shape, component layout), work-holding fixtures, controls, displays, etc. Manufacturing equipment design must also consider that the machine is a component of a large manufacturing system consisting of many processes and interacting resources – namely personnel. Equipment design results in a human-machine interaction that directly impacts the system's performance. Incorporating many issues related to human-machine interaction is one of the burdens placed on designers of subsystems for production systems. The area of human-machine systems is extensively discussed in practice and literature, but there exists a need to address the basic principles with regard to specific types of systems. A manufacturing system is an example, and even more specifically is a cellular manufacturing system.

This work focuses on applying a production system design methodology [Cochran, 1994; Cochran, 1999; Suh et al., 1998] to better define and model the human-machine interaction in manufacturing cells, one form of production subsystem. The application of the PSD design framework can improve the resulting design of subsystems by structuring the way designers consider human-machine interaction during design. A better understanding of human-machine interaction enables equipment designers to create manufacturing equipment that better satisfies the goals of a production system. The human-machine interaction (HMI) in a manufacturing cell is modeled based on the

supervisory control paradigm incorporating design requirements from the production system design decomposition.

When designing production equipment, designers may follow structured design methodologies and attempt to satisfy a set of design requirements that include considerations for meeting enterprise goals, incorporating a human's presence, achieving product specifications, etc. This HMI model is related to a structured equipment design methodology to demonstrate how the design of cellular manufacturing equipment is aided by such a model.

# Chapter 1. Background

---

## Production Systems

When designing equipment that operates in a production system environment, designers attempt to satisfy a set of design requirements that stem from high-level production system goals. It is valuable to understand the sources of these requirements, as well as the process of converting PSD goals to the actual design of subsystems that satisfy the numerous high-level goals.

### *Axiomatic Design Approach for Designing Production Systems*

Axiomatic design [Suh, 1990] is a general design theory based on two fundamental axioms: *minimize the information content of the design* and *maintain the independence of functional requirements*. Using axiomatic design leads to a design solution where these two axioms hold true. The first axiom emphasizes simplicity in design whereas the second axiom means that where possible one design parameter should uniquely satisfy one functional requirement.

The design of a system using the axiomatic design approach consists of the identification of high level functional requirements (FRs), based on customer wants, and mapping them to corresponding design parameters (DPs). Functional requirements are objectives that the design must satisfy and they are said to exist in the functional domain. FRs are mapped to the physical domain yielding a set of DPs which can satisfy these requirements. Mapping requirements in the functional domain to the physical domain produces the quantitative relations necessary for carrying out manufacturing and engineering design. These relations are design equations that express FRs in terms of DPs with a design matrix (DM) containing the multiplicative coefficients (Figure 1).

$$\{FR1\} = [DMI]\{DP1\}$$

$$\begin{Bmatrix} FR11 \\ FR12 \end{Bmatrix} = \begin{bmatrix} 3 & 0 \\ 0 & 3 \end{bmatrix} \begin{Bmatrix} DP11 \\ DP12 \end{Bmatrix}$$

Figure 1. Design equations that quantitatively map the functional domain to physical domain

Once the relationship between FRs and DPs at a given level has been derived, lower level FRs and DPs may be determined through the process of “zig-zagging” (shown by the arrows in Figure 2). This term is used to describe the decomposition process of upper level FRs (into lower level FRs) by moving from upper level DPs to lower level FRs. For example, once DP-1 has been designed, it is then decomposed into FR-11 and FR-12. Tate describes the method for decomposing designs using the axiomatic design approach [Tate, 1999].

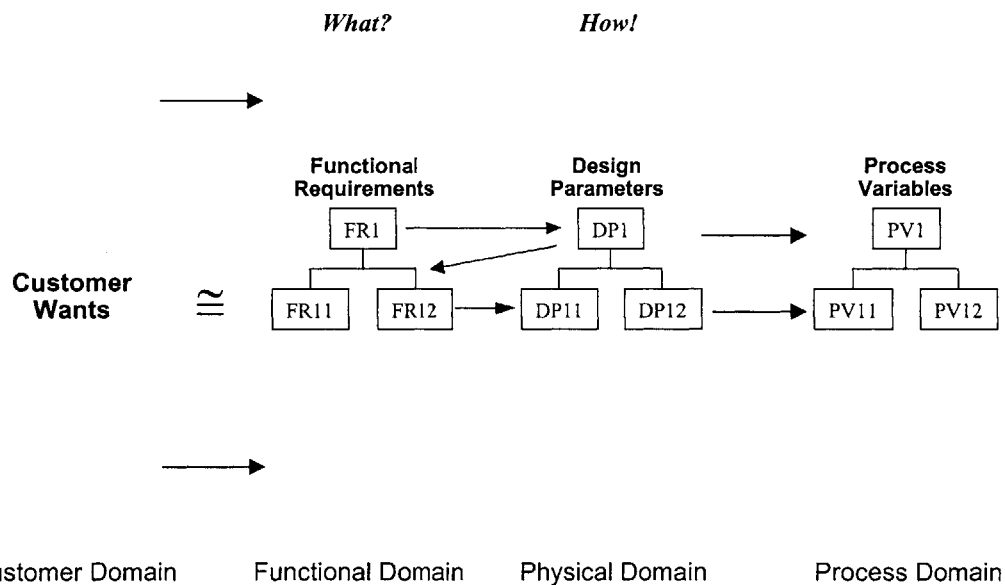

Figure 2. Axiomatic design domains [Suh, 1990]

This design methodology is applicable to the design of systems as well as products [Suh, 1990]. A large number of possible decompositions can result depending on the approach taken for the design of a specific system or product [Tate, 1999]. A brief background of the “lean” manufacturing mindset is useful before formally discussing the application of this axiomatic design methodology to manufacturing system design.



## *Lean Manufacturing*

Lean Manufacturing is a term used to describe a broad set of management and manufacturing methods first used by Toyota to achieve a system for high-quality, responsive, and low-cost production of automobiles. The term was coined in a study by the International Motor Vehicle Program and MIT [Womack et al., 1990]. Being “lean” focuses on the continuous improvement of systems through the elimination of wastes:

### **Production Wastes**

---

#### 1. Overproduction

Any production that is not in demand is considered a waste. This is usually a result of producing in batches and the waste manifests itself in the subsequent need for storage. In cases where production processes exceed tolerances, overproducing practices lead to more defect production and higher scrap costs.

#### 2. Inventory or Work In Process (WIP)

Inventory has negative effects in many areas of production systems. It increases material capital costs, extends throughput time, occupies space in storage or floor-space, and it is also a means for tolerating high variation in processes. This last effect results in symptoms of larger systematic problems to be hidden.

#### 3. Making Defective Products

The production of defects is pure waste as it results in wasted time and material. Poorly controlled processes and quality assurance methods contribute to the production of defects.

#### 4. Processing Waste (poor process design)

An example of processing waste may be poor path planning for a robot that increases processing time. A poorly sequenced assembly task may result in unnecessary part orientation changes.

#### 5. Transportation of Parts

Moving parts is not a value-adding activity. Transporting parts requires resources -- typically expensive people or automation.

#### 6. Motion of the workers, machines, and transport (e.g. due to the inappropriate location of tools and parts) is waste.

Poor work place design and machine layout result in inefficiencies due to wasted motion and effort.

#### 7. Humans Waiting for Machines to Process

This is a common form of direct labor waste in manufacturing systems. Operator vigilance is often used to monitor automated

process in the place of smarter automation that is engendered with some level of disturbance control systems.

---

Numerous sources [Shingo, 1989; Monden, 1998; Womack and Jones, 1996; Womack et al., 1990; Black, 1991] provide commentary and examples on efficient manufacturing and describe ways to achieve operational improvements in many aspects of a firm. Manufacturing companies use many of these methods while attempting to emulate the success of Toyota and become “lean.” Some of these methods are:

- 
- Just-In-Time
  - Single Piece Flow
  - Kaizen, Continuous Improvement
  - Kanban
  - SMED
  - Poka-Yoke
  - 5S
  - Cellular Manufacturing, etc...
- 

There is a need to capture these “lean elements” from an integrated systems perspective and thus create a systematic methodology for designing components of a production system.

#### *“Lean” Production System Design Decomposition*

A design decomposition, based on the axiomatic design methodology [Suh, 1990] and the procedure for decomposing systems [Tate, 1999], was formulated and applied to the design of production systems [Cochran, 1994; Cochran, 1999; Suh et al., 1998]. When axiomatic design is applied to production system design (PSD), the two axioms can be used to develop simpler and easier to operate systems. Applications of this methodology are described in [Arinez et al., 1999; Bröte et al., 1999; Charles et al., 1999; Duda et al., 1999].

The importance of such a design decomposition is that it links high level functional requirements of the production system (i.e. maximize return on investment) to lower level subsystem design parameters (i.e. cellular manufacturing, machine and station design).

These design parameters are choices available to product and manufacturing engineers that ultimately determine how well the system can achieve product performance, profitability, and customer satisfaction requirements.

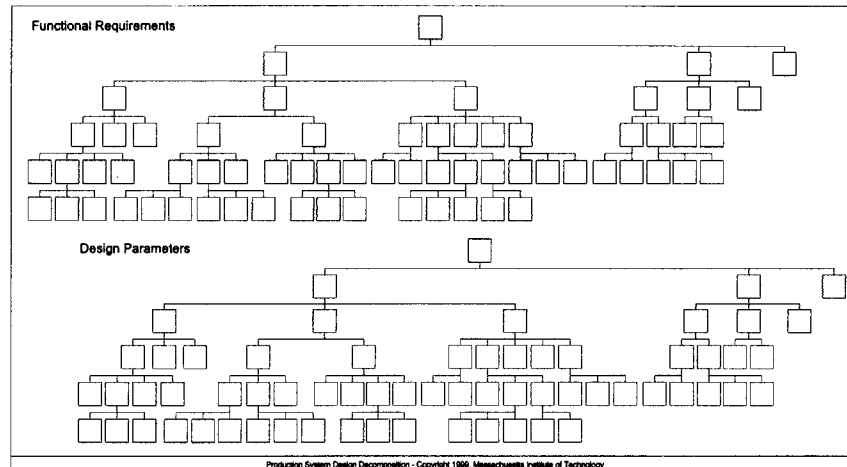

Figure 3. Schematic of the production system design decomposition –showing the separate functional requirement and design parameter hierarchies [PSD Lab, 1999]

The high level FRs and DPs decompose into various aspects of production system design (Figure 4) that are further decomposed to yield more specific design parameters that distinguish the system design. The highest level *FR-1 maximize return on investment* and the corresponding DP is *DP-1 manufacturing system design*. At the next level in the hierarchy, the FRs are sales revenue, manufacturing cost, and manufacturing investment objectives. The corresponding DPs are production that satisfies the customer, eliminating non-value adding sources of cost, and long term investment strategies. These first two tiers of the decomposition are quite general, and they organize the more detailed third tier that includes key elements of lean production systems, namely: perfect quality, reduction in time variation, reduced throughput time, reduce wastes in labor resource activities, etc.

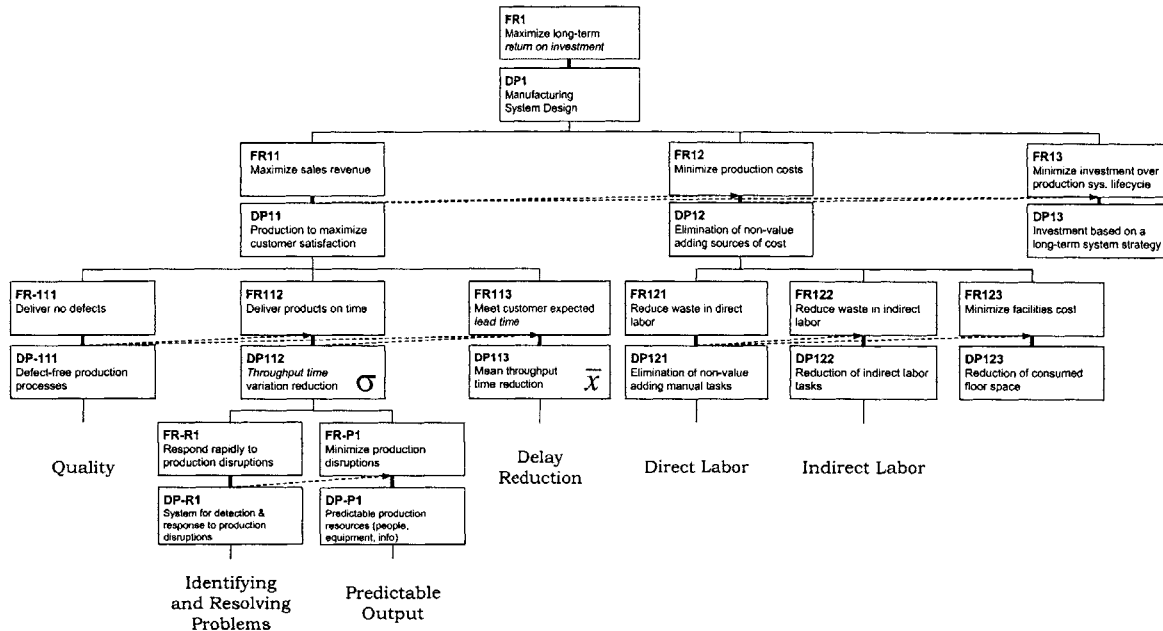
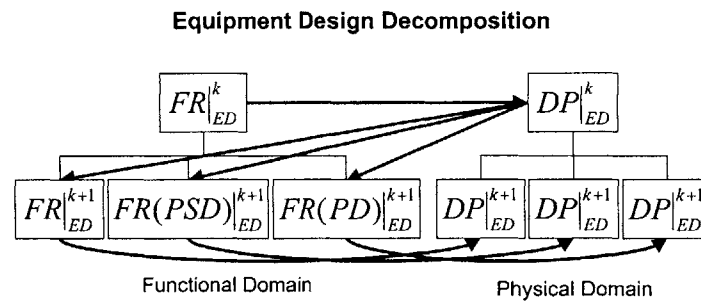

Figure 4. High-level decomposition for production system design leading to lower level decompositions dealing with specific aspects of production systems [PSD Lab, 1999]

The complete decomposition is presented in Chapter 4 in a discussion of the requirements for human-machine interaction in a production system. The areas addressed there are: quality (i.e. process control, human error), identifying and resolving problems, predictable output, production delay reduction, and general cost reduction methods for direct and indirect labor.

### Manufacturing Equipment Design

A methodology for acquiring equipment design (ED) requirements has been described [Arinez and Cochran, 1999a]. In this axiomatic design based methodology, the “lean” production system design decomposition, whose sub-FRs contain requirements on equipment design, is used to generate sub-FRs for ED DPs. The requirements translate to the ED decomposition during the process of decomposing a ED DP, where both PSD and PD FR/DPs influence the resulting ED sub-FRs (Figure 5).



$$DP_{ED}^k \rightarrow \left\{ FR_{ED}^{k+1}, FR(PSD)_{ED}^{k+1}, FR(PD)_{ED}^{k+1} \right\}$$

Figure 5. Decomposition of ED DP into ED sub-FRs. Some sub-FRs are derived from PSD and others from PD [Arinez and Cochran, 1999a]

When performing unique equipment design decompositions, both design processes – PSD and Product Design (PD) – influences the formulation of ED FRs. Depending on the level of concurrency in product and production system design, the ED FRs may translate from separate decompositions (separate PSD and PD, low concurrency), or from the same design decomposition (PD within PSD, high concurrency). A single PSD decomposition inclusive of PD and manufacturing system design contributes a distributed set of ED FRs. In the case of separate design decompositions, PSD lends ED FRs that ensure the design satisfies production system goals relating to capability, reliability, operation, etc.

Arinez and Cochran [1999b] describe the case of low concurrency between PD and PSD in more detail. It is shown how a relationship exists between PD and PSD methodologies through a shared process domain. As a result, the PD FRs are translated into ED FRs through the process variables that follow from PD FRs. The ED FRs that result from PD FR/DPs deal specifically with process design and specification of machine components to achieve specific product features. The process variables pertain to specific part geometry that need to be controlled by the operator. The equipment should be configured so those process variables that affect critical part geometry can be monitored effectively.

When applying axiomatic design methodology, the requirement flow-down described here is how an equipment designer can receive the guidelines for configuring a piece of production equipment. Ideally, if the operator satisfies all the functional requirements,

the machines produce the product with acceptable function and quality while performing well under all production system performance measures. The ED process could also occur through an alternate design framework, however the heuristics could differ, and the results may not be the same. Applying the two axioms leads to simpler designs that are easy to control because of functional independence. This study of equipment design focuses on the application of an axiomatic design-based methodology that generates design requirements for equipment, production systems, and products.

The source of requirements and the design process are important to understand because the resulting equipment design ultimately effects the human-machine interaction (Figure 6). Efforts to focus on human-machine interaction pertaining to manufacturing equipment are often geared towards the organization, implementation, and use of such pre-designed equipment, and tend to focus less on the design and technological development of the equipment itself to enhance the human-machine relationship. Developing the area human-machine interaction in manufacturing needs to relate more to the technological development and design process for manufacturing equipment in order to better serve the human-machine system requirements [Corbett, 1996].

The idea of human-machine interaction (HMI) is something designers may or may not have a concept of as they design machines and subsystems. Designers might not possess knowledge of the production system that the machines operate within. It is common that equipment designers work for suppliers from whom the manufacturing firm purchases the equipment. The level of communication of the requirements when designing equipment is a function of the level of concurrency that exists between the engineering teams of the buyers and sellers of the equipment [Arinez and Cochran, 1999a].

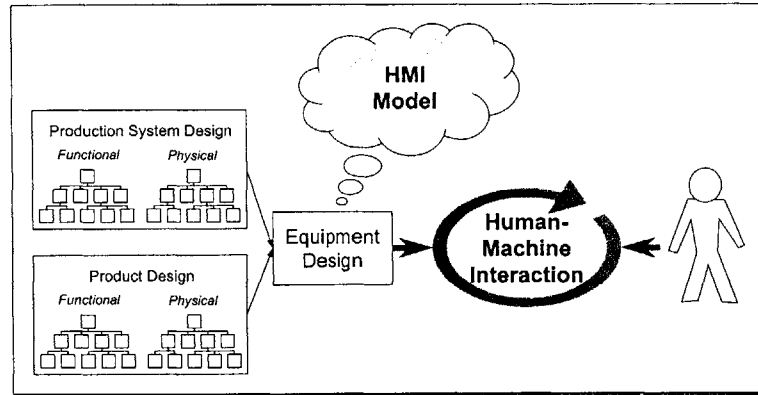

Figure 6. The relationship between equipment design frameworks and resulting human-machine interaction. Model is useful to equipment designers

Manufacturing systems are complex human-machine systems but design parameters pertaining to human-machine interaction satisfy requirements that come from broader goals of production system design rather than a specific model of a desired human-machine operating relationship. A framework should exist for relating production system design to human-machine interaction and then to equipment design. A better system model aids designers of equipment who have little point of reference when dealing with system design issues.

### Human-Machine Systems

A system that involves humans in planning and/or operation can be termed a human-machine system. The system generally contains automated processes that the human must monitor and in most cases control at some level of abstraction. By this, it is meant that a human may perform manual control of the process, supervisory control, or simply monitor fully automated processes. In manufacturing, operational activities usually require physical control inputs from a human operator. In addition to physical input, cognitive efforts are also employed which tend to result in physical control efforts [Sage, 1992]. Both areas, physiological and cognitive, must be considered when designing systems.

The extent of human involvement can vary greatly in any given human-machine system (Figure 7). A given human-machine system includes a human operator and a process or

task. Between the two exists a set of displays and controls that the operator interacts with, as well as a set of sensors and actuators that the process interacts with. The level of automation, and conversely the amount of direct human control, is dependent on how much closed loop decision processing occurs without the operator being in the information loop.

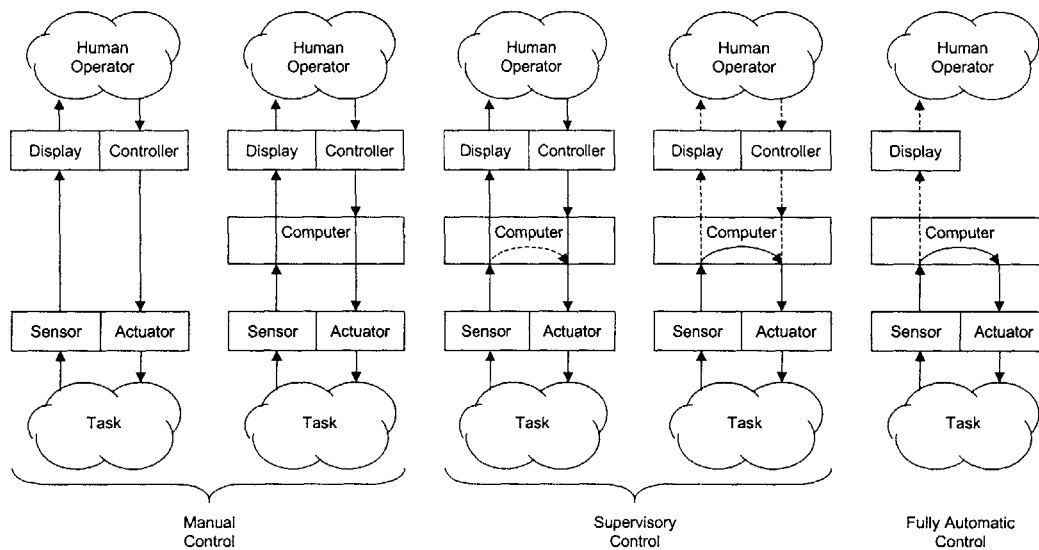

Figure 7. Control modes of human and task/process interaction. [Sheridan, 1992]

An example of manual control may be one of driving an automobile where the task is controlling the speed of the vehicle. A driver has direct manual control of speed through the use of the gas pedal. A change in speed results when the driver depresses the accelerator. If the vehicle’s electronic cruise control is engaged, the speed is now maintained by the cruise control system in a fashion similar to the second depiction of supervisory control.

An analogy can be made to many types of *semi*-automated systems - particularly manufacturing. Frequently, production processes employ automation that performs operations on material with varying levels of operator involvement. Sometimes an operator must be in the control loop for each cycle, and in other extreme cases the factory may operate “lights-out” without the need for human assistance. These issues are discussed in Chapter 3 and Chapter 4 to understand what types of systems should be designed to satisfy the goals of a production enterprise.



Quantitative research has been done to address the question of how often humans should obtain information, or sample the process. In supervisory control environments, the frequency that an operator obtains system state information can be measured against the costs of not having the information. A one-dimensional model for determining sampling behavior was developed by Sheridan [1970]. Given the cost of making a process adjustment, if the cost of sampling is significantly less than the cost of the adjustment, then the operator should sample the process more often than make adjustments. Adjustments should only be made then in instances where the payoff associated with the adjustment is greater than the cost of making the adjustment.

The amount as well as the type of information is important to ensure that the operator has an updated internal model of the process. Situation awareness is a term related to how an operator understands the environment in which she is involved. For systems operation, the level of process state awareness is critical if cell operators are expected to maintain quality and continuous improvement efforts. A higher level of accurate situation awareness improves process control [Endsley, 1995a] by increasing the operator's ability to detect and predict disturbances. In a manufacturing system, this facilitates quality control and continuous system improvements. Endsley characterizes the information that an operator receives about a process. Level 1 SA is acquired through perception, frequently of disjointed pieces of information. In manufacturing this could be information cues on machine status, line rate, delays, etc. Level 2 SA is the achievement of comprehending the information. Assembling the disjointed Level 1 elements is an ability of the operator, or possibly AI computer processes that puts separate pieces of information into a state more pertinent to system goals. Level 3 SA is a projection of future state – it is achieved through both Level 1 and Level 2 SA along with reasoning and understanding of system dynamics. The design of displays and information transmitters that communicate Level 2 and Level 3 SA can positively affect an operator's SA, and thus improve process-controlling activities. In order to design systems for improved SA, a measurement technique is required to measure the level of SA achieved by an operator. Endsley [1995b] describes such a technique called, Situation Awareness Global Assessment Technique (SAGAT). The measurement technique is useful when

attempting to improve SA. With a good SA measurement system, the benefits of one design over another can be quantified.

When operators are making adjustments and controlling processes, they are performing more than just manual work. Humans, in fact, contribute in ways that require significantly more complex approaches if the same adjustment and control processes are performed by machines. The cognitive resources of the human can elicit higher level behavior whereby humans can deal with uncertainties and solve problems that arise during system operation. Rasmussen [1983] classifies human behavior in systems into three categories: skill-based, rule-based, and knowledge-based. Skill-based behavior is a well-learned response to continuous stimuli. Rule-based behavior is based on protocols or procedures that operators draw on and execute planned responses to a given state of information. Knowledge-based behavior is based on a high-level assessment of experiences and information and generally affects goal-setting activities and planning. These behavior classes interact in a way shown in Figure 8. Low-level behaviors receive stimuli that trigger higher-level responses. A human then resumes low-level behavior to implement decisions that are made at higher levels of behavior.

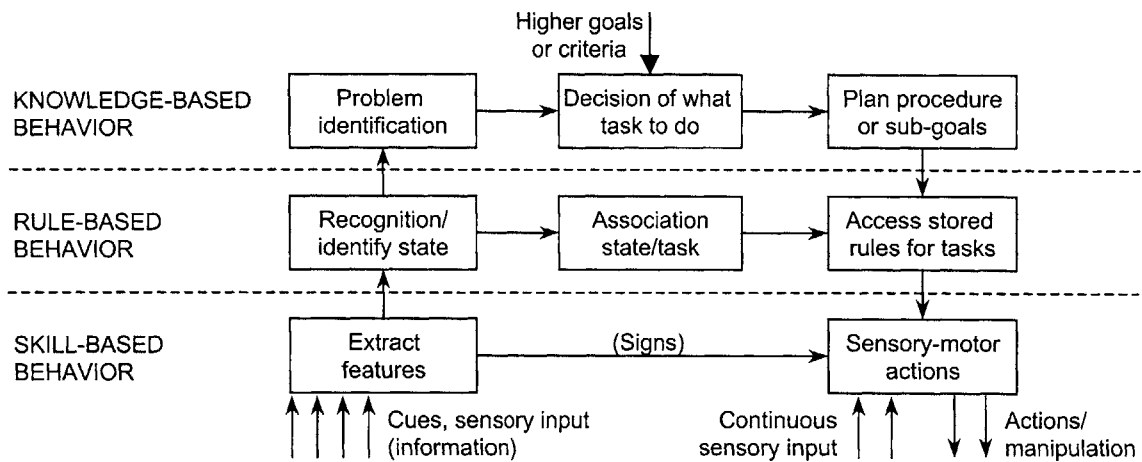

Figure 8. Rasmussen's human behavior model [Rasmussen, 1983]

### *Humans and Their Work Environment*

The physiological demands on humans are typically greater in skill-based roles, especially in manufacturing systems that require human operators to perform tasks at

machines. Human Factors Engineering, sometimes called *ergonomics*, is the study of skill-based behavioral actions, the physiological considerations that pertain to such behavior, and the resulting design requirements of components and systems at the human-machine interface [Sage, 1992]. This area yields an understanding of issues associated with work task definition, anthropometry, work-place design, and training requirements.

### **Human-Centered Design**

Methods for designing human-machine systems are usually some form of human-centered – or user-centered – design methodology. The purpose of these methods is to center the design process on the human user. This means taking the time to determine the user needs that are specific to the system being designed. Usually the voice of the user is included at each stage of the design process and the designer elicits responses pertaining to the human user's preferences and requirements.

Research has expressed the need for human-centered methods to fully envelop the design of manufacturing subsystems. The complex work environment that exists on a shop floor is a focal area that is effected by the design of subsystems. Human-centered methods tend to focus on long-term performance and benefits of human presence in systems, and therefore it is beneficial to integrate them into a structured design methodology for production systems [Fan and Gassmann, 1997].

### **Ergonomics**

The human factors and ergonomics component of design requirements can be obtained through user-centered methods, but certain types of information are available as published guidelines or design standards. One of the most referenced standards in human factors is the military standard MIL-STD-1472D (U.S. Department of Defense, 1989) that provides detailed requirements on numerous areas such as controls, displays (visual and audio), labeling, anthropometry, work space design, environmental factors, and designing for maintenance, hazards, and safety. Numerous other standards are appearing that define requirements for software interfaces, namely ANSI/HFES-100&200 VDT (Reed & Billingsley, 1996). These standards do not act as rigid rules per se, and therefore they should be applied with careful consideration to the specific cases and

resulting impacts on individual systems. Descriptions of specific types of human-machine interactions can aid designers when implementing general standards and guidelines [Wickens, 1998].

### *Humans and Automation*

The presence of automation in human-machine systems has a variety of shortcomings and benefits when considering system performance and human work content. Some of the negative effects of automation are less than perfect reliability, misplaced trust, and misunderstood complexities [Wickens, 1998]. Some real benefits of automation are the improved speed, strength, precision, and stamina of machinery compared to human control actions. Safety can be considered a benefit if it alleviates the need for humans to perform hazardous tasks, but automation itself can be a source of hazard in some industrial settings.

Frameworks for allocating tasks between machine and human are prescribed for robots in manufacturing [Ghosh and Helander, 1986] and for integrated assembly systems [Kamali, et al., 1982], the latter applied to FMS [Hwang, et al., 1984]. The same reasoning exists for other manufacturing subsystems in general. Sometimes, the benefits of automation can be over-emphasized and lead to over-ambitious deployment resulting in the alienation of workers and the degradation in quality of work, and even poorly effect system dynamics. Careful consideration of the psychology of human operators must also be included in the decisions to employ heavily automated subsystems [Niimi, et al., 1997]. In general automation should be considered an aid to humans, relieving them of performing mundane tasks, or supporting them in performing complex ones.

The operator's natural requirements on work in automated systems has been described as: having a versatile work content; having responsibility and participation; information processing; contact and cooperation with colleagues; and competence development [Mårtensson, 1996]. The design and configuration of manufacturing subsystems should understand and consider these needs to ensure a long-term psychological well-being and sustainable morale in the workforce.

Work in human-machine systems attempts to improve the impact of humans on systems when automation is present. This includes keeping humans in the information loop to facilitate process control and system management, which is subject to the barriers that automation creates through increased machine complexity.

The human supervisory control paradigm describes the functional roles that a human plays in a human-machine system [Sheridan, 1992]. The human operator's involvement as a supervisor is characterized by five functions: plan, teach, monitor, intervene, and learn. In doing so, the operator transitions through skill, rule, and knowledge based behavior. This paradigm has been applied to numerous types of human-machine systems, namely nuclear power plants, submersible vehicles, space telerobots, flexible manufacturing systems, etc. Supervisory control is used to describe the work in manufacturing systems later in Chapter 5.

Much of the recent research in human-machine systems is focused on the areas of system monitoring, error detection, and problem solving routines. *Cognitive ergonomics* is the study of the design of information technology-based support systems to aid human performance. Numerous cognitive models of humans interacting with systems are described in both [Sage, 1992] and [Sheridan, 1992]. The models for human behavior range from simple manual control models to – one of the more widely validated – optimal control models (Figure 9).

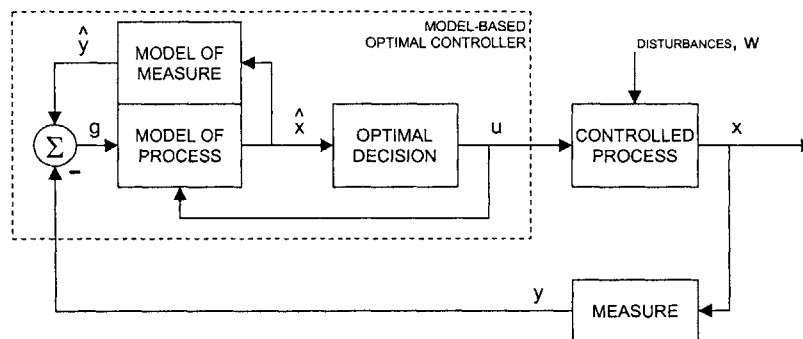

Figure 9. Modern (optimal) control paradigm using a model-based estimator of process state,  $x$  [Sheridan, 1992]

Maintaining systems at a desired operating state is the primary goal of improving human involvement [Sage, 1992; Sheridan, 1992]. Human presence in systems is vital for the

detection and resolution of problems. The ability to detect problems and the effectiveness of solving methods are subject to both the adequacy of machine design and the limitations of human behavior (rule- and knowledge-based). Humans introduce instability in a system as much as they provide flexibility and intuition. It is the responsibility of machine designers and system planners to account for both these features of human physiology and cognition.

### *Human Error in Systems*

Most aspects of human involvement in systems are prone to the pitfalls of human error. Human presence in systems and the contributing variability not only affects detection and diagnosis of problems, but also the execution of planned tasks and the achievement of goals. In manufacturing, this applies to everything an operator does, from manual work tasks to process control as well as management.

Performance shaping factors (a term coined by Swain, 1967) for human error are any factors that influence human performance and cause error [Miller and Swain, 1987]. Some of these factors that are related to system design and management are:

- 
1. Inadequate work space and work layout
  2. Poor environmental conditions
  3. Inadequate human engineering design
  4. Inadequate training and job aids procedures
  5. Poor supervision
- 

Some performance shaping factors that are internal to the human operators and may contribute to the commission of human error are:

- 
1. training and experience
  2. task knowledge
  3. skill level
  4. intelligence
  5. motivation and attitude
  6. stress level
  7. emotional state
  8. perceptual abilities

9. social factors and interactions
  10. physical condition
  11. gender
  12. physical strength and endurance
- 

Each of the factors can contribute to the occurrence of human error. There are various methods for classifying types of human error. A simple classification is the error of commission versus omission. Norman [1981] classifies errors by differentiating between *carrying out incorrect intentions* and *incorrectly carrying out appropriate intentions*. New taxonomies are constantly being developed which creates problems when attempting to model or quantify error [Sheridan, 1992]. The importance of human error in human-machine system design should not be diminished for lack of a widely accepted classification. Designers should already be able to determine and anticipate instances of errors and take corrective actions that either correct improper actions or help operators prevent them from occurring [Sheridan, 1983].

For the problem of process control, which is very important for manufacturing process monitoring and intervention, failures in the detection and diagnosis of system problems due to human error comes in different forms, namely:

- 
1. The human sets improper thresholds in determining what is, and isn't a problem.
  2. The human fails to generalize a problem resulting in the treatment of symptoms rather than culprits.
  3. The human fails to anticipate problems and perform preventative steps.
  4. The human may fail to search for and process information that is potentially available.
- 

System design must account for the sources and types of human error, and aim to reduce the impact of human error through three main strategies. Firstly, improving the worker through better instructions, increased training or more education should reduce human error. Secondly, the work situation should be improved through revised methods, supervision, or an augmented work environment that reduces the occurrence of human errors – this includes hardware and software devices that prevent errors as well as aid operators. Thirdly, systems should be designed so that the occurrence of human error

does not immediately translate into a problem or disturbance, or that the injection of an error results in gradual degradation instead of catastrophe [Sheridan, 1983; Miller and Swain, 1987].

### **Summary**

The area of human-machine systems is extensively discussed, but there is still a need to address the same issues with regard to specific types of systems. The design of production systems is a complex process that is in need of structured design methodologies, such as the axiomatic design methodology prescribed by [Cochran, 1994; Cochran, 1999; Suh et al., 1998]. A focus on applying this production system design methodology to better define and model the human-machine interaction can help equipment designers design subsystem components that become part of a complex human-machine system.



# **Chapter 2. Cell Design Case Study: Automotive AC Compressor Manufacturing**

---

## **Purpose**

The participation in this design case study was for applying the production system design decomposition to the design and selection of new production equipment. The author was a member of a project team composed of product and manufacturing engineers at an automotive component and systems supplier. Participation included involvement in the design of the production process, the equipment vendor selecting process, and the specification of design guidelines for production equipment that was communicated to suppliers during numerous design-reviews. Equipment validation and hands-on feedback was also part of this author's involvement. After experiencing this design process there are numerous observations that provide clues for more work in developing a structured production system design process. These observations are highlighted at the end of the case study review, and further emphasize the motivation for explicitly modeling the human-machine interaction in a production system.

## **Introduction**

A production system was designed based on guidelines derived from the design decomposition, described in 0, for a recently developed automotive compressor. This new type of rotary vane compressor is comprised of a total of 74 parts with six major components produced in-house and the remainder purchased from outside vendors (Figure 10). The general production requirements for the compressor were low volume (100-200k/yr) and a high degree of flexibility to customer requirements (different geometrical configurations depending on the vehicle application). The latter requirement

is especially important for acquiring new customers because the potential for other additional low volume applications depends on the changeover and reconfiguration capability of the production system.

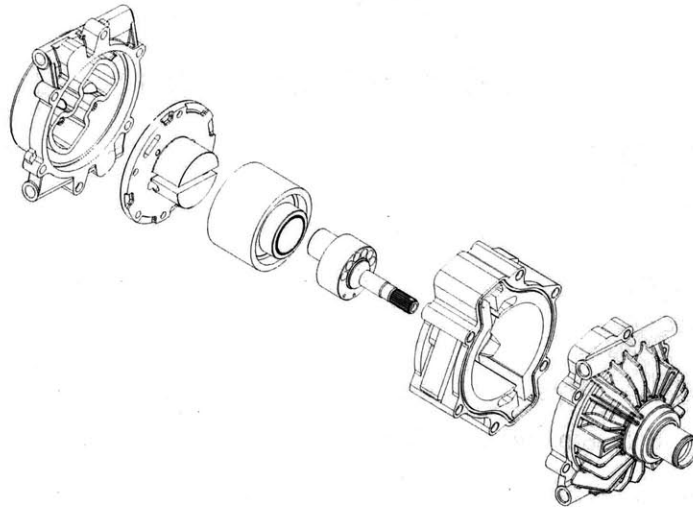

Figure 10. Six major components of the automotive compressor. In order from left to right: Rear Cover, Rear Plate, Rotor, Shaft, Center Housing, Front Head

### **Production System Design Guidelines**

In addition to its use as a general design tool for designers of production systems, another purpose of the decomposition is to provide a means to communicate system requirements to subsystem (component) designers.

Generally, the most common communication method for system requirements is through detailed manufacturing specification documents that include such items as how equipment must be configured for acceptance by the plant. In addition, suppliers are expected to understand and satisfy specifications that originate from many areas such as safety, purchasing, and product engineering. Since these documents are often quite lengthy and detailed, much engineering resources are consumed to generate a view for suppliers of how equipment must be configured and operated within the system. In addition, these individual documents often do not convey the necessary system perspective needed during the initial conceptual design phase (i.e. during vendor lineup meetings where quotations represent early concept design selection). Thus, these

production system design guidelines can aid in communicating system objectives because they incorporate the link between high as well as low level requirements (Figure 11).

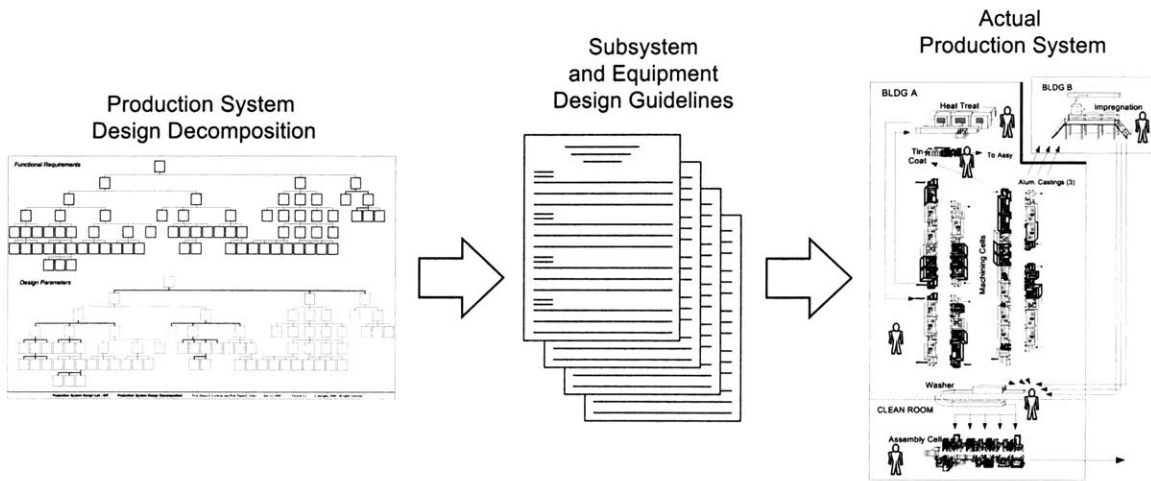

Figure 11. Applying production system design decomposition to a new system using guidelines [Arinez, et al., 1999]

The guidelines comprise five distinct categories that were generated by selecting the appropriate FR/DP pairs from the decomposition that belonged to each category. This is graphically shown in Figure 12 where the specific connection between the DP in the decomposition and the guideline category is indicated by the blackened boxes. These categories were chosen because they reflect the different level of design activities that vendors participate in. Some vendors (i.e. assembly cell vendor) require knowledge of higher level requirements because they are systems integrators as well as equipment designers. In this case, the first three categories of guidelines: *Cell Design*, *Equipment Design*, and *Material Handling* are of interest to this type of production system vendor. The fourth category – *Quality* – addresses the operational requirements of subsystems (i.e. single piece flow within a cell) that support reducing variation throughout the production system. The fifth category – *Operator Ergonomics and Safety* – includes such requirements as load heights and reach distances that affect low level equipment design parameters as well as higher level requirements such as man/machine separation.

Finally, depending on the level at which they are extracted, guidelines can be understood by more designers than just the component designers. In this manner, design across different engineering disciplines is facilitated.

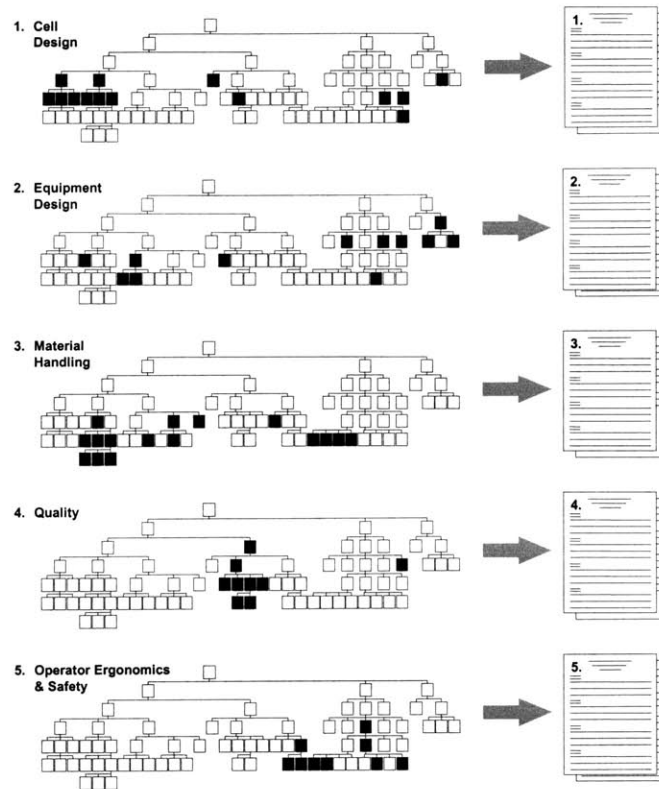

Figure 12. Production System DPs map to design guidelines by category [Arinez, et al., 1999]

### Resulting Production System Design

The production system design consists of two machining cells, one final assembly cell, and intermediate batch processes (Figure 13). The overall system is designed as a linked-cellular system [Black, 1990] in which machining cells feed final assembly cells. Parts requiring machining arrive either as castings (iron and aluminum) or forgings (steel and aluminum) into one of six locations at the machining cells. After machining, three aluminum die cast parts move to a batch impregnating process located in a separate building and then are washed through a flow-batch washer prior to arrival in final assembly. The other three parts are machined and also proceed to the flow washer prior to final assembly.

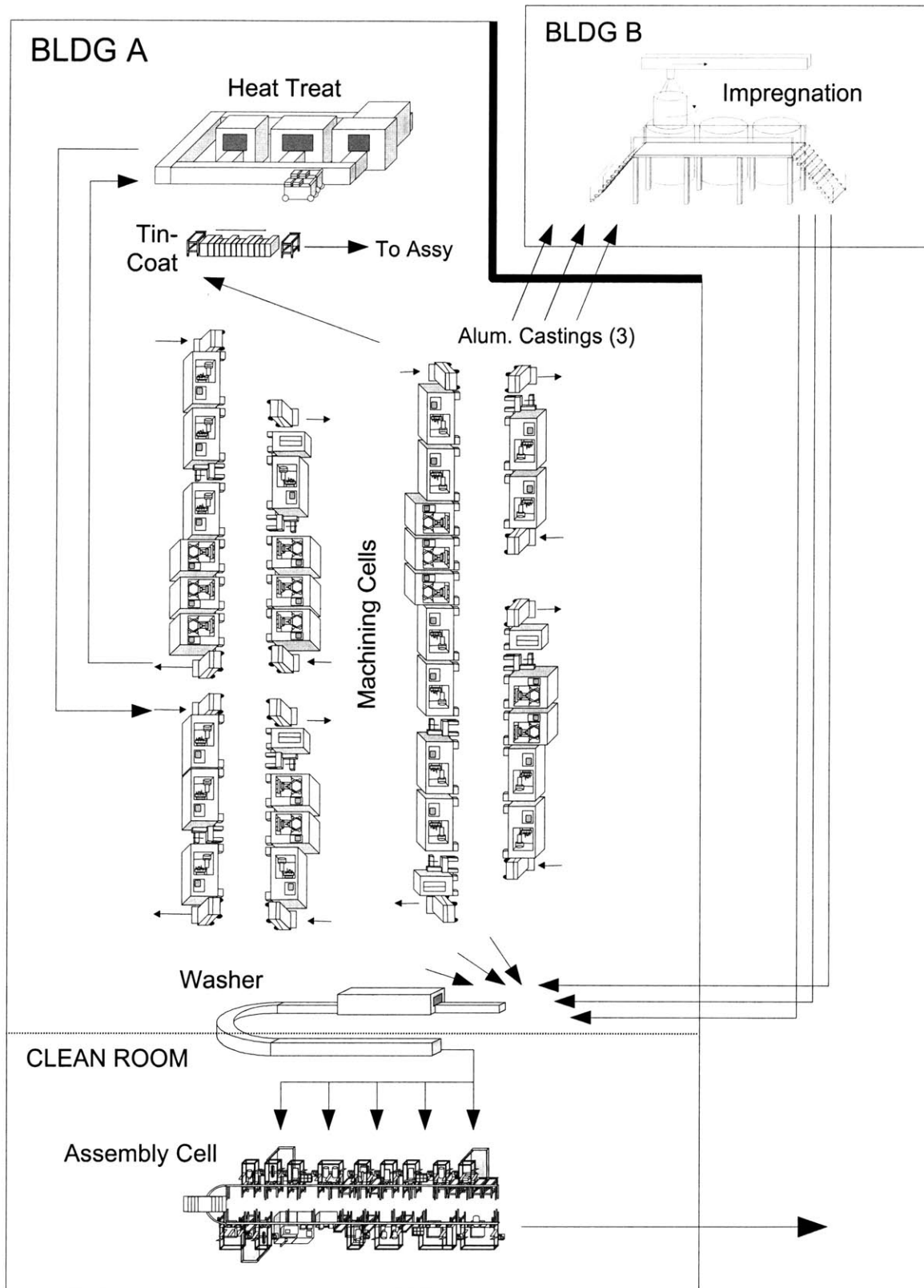

Figure 13. Overview of actual production system design [Arinez, et al., 1999]

The machining cells (Figure 14) consist of CNC milling, turning, grinding, and deburring machines. Milling and turning machines were standardized with both machine types made by one vendor. Standard narrow footprint machines allow easy cell reconfiguration for improvements to operator work motion and permits the addition of machines or inclusion of in-cell gauge stations. Fixtures and tooling on each machine were designed to process one part at a time (single-piece-flow). The operator transferred the part from machine to machine. Operators in the cell are multi-skilled and capable of running and setting up any given machine in the cell. Operators trained in this manner permit work to be redistributed within the team of operators for varied production volumes.

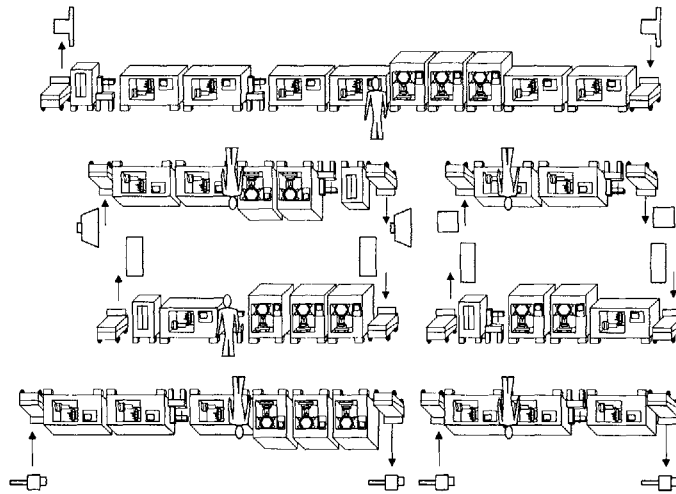

Figure 14. Two machining cells for the fabrication of six components [Arinez, et al., 1999]

The assembly cell is a mixture of semi-automatic and manual subassembly stations as well as in-line leak and functional test stations. All stations support single piece flow and are managed by a team of operators who all work within the U-shaped cellular configuration. The operators pace the production by following standardized work loops that include the manual advance of pallets along a low-friction non-powered conveyor. The operators are multi-skilled and can manage any number of stations within the cell, where error proofing and standard work help the operator produce with predictable quality. Stations were designed with flexibility in mind so that the simple frame structure can be easily modified by the plant to improve process sequencing and the work environment of the operators.

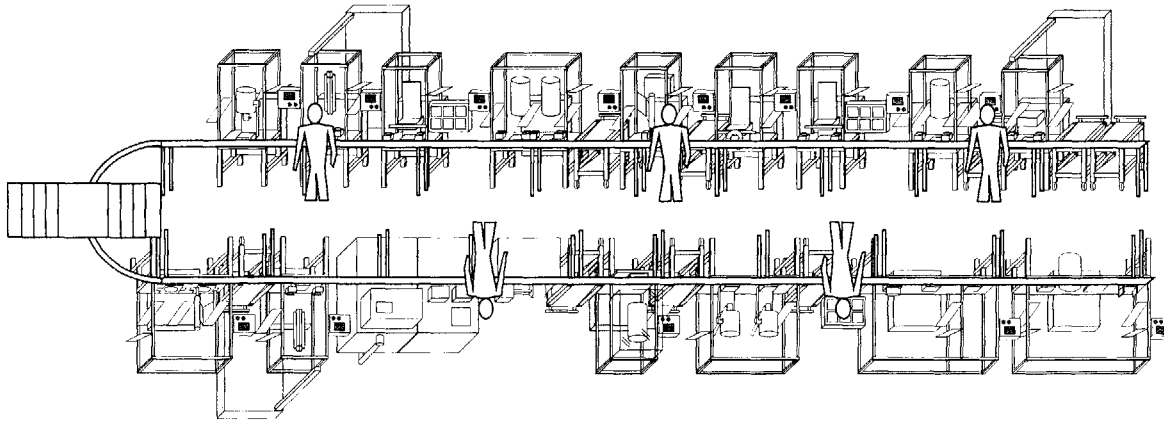

Figure 15. Compressor final assembly cell [Arinez, et al., 1999]

In addition to the machining and assembly cells, there are four batch processes in the production system: impregnation, heat treatment, tin coating, and washing. The impregnation process is for sealing die cast aluminum parts (porosity is a major source of leaks). Heat treatment is a three-station carburization process that is performed on the forged steel part. Heat treatment occurs in the middle of the machining process, which means that the part must leave the machining cell for heat-treating and then it returns to the cell for the remaining machining steps. Tin coating consists of a number of small stations that process small batches of aluminum forged parts and the batches are manually advanced by a dedicated operator. The above batch processes do not conform to guidelines as single piece processing is not possible with the above equipment. However, for impregnation and tin coating, the existing plant capability and availability was used to utilize proven existing process knowledge at reduced investment.

### Examples from Design Guidelines

The following examples illustrate a design example from each of the five categories in the design guidelines generated from the design decomposition. Each example presents features of the actual production system design within the context of satisfying numerous functional requirements.

*Example 1 – Cell Design*

Cells are dynamic combinations of man and machines that should always be capable of being changed whenever improved, alternate methods of manufacturing are discovered. They are also an important tool for improving quality, reducing cost and complexity, and allowing simpler production control methods. In the compressor assembly cell, each operator is able to operate more than one machine or station. This ensures greatest utilization of labor resources (Figure 16).

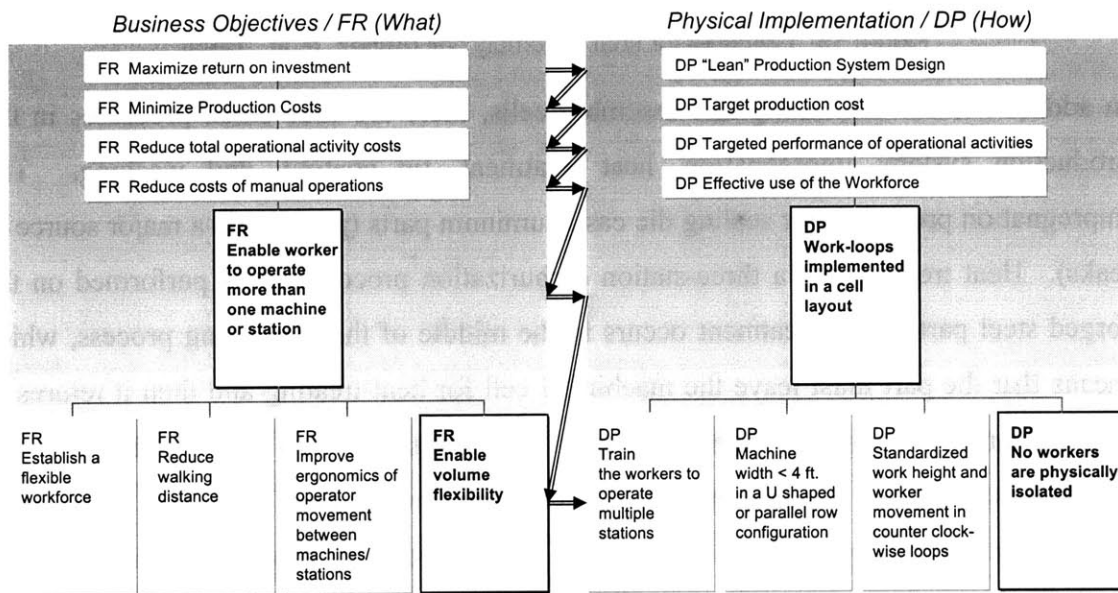

Figure 16. Level 6 Decomposition of “FR – Enable Worker to Operate More than One Machine or Station” [Cochran and Lima, 1998]

Cell layouts (Figure 17) enable workers to operate more than one station. They contain many features that promote cost reduction associated with manual operations. Because of the narrow station width and cell width, an operator can man any number of adjacent or opposing stations, being only limited by available cycle-time. By not isolating the worker and improving accessibility of all the stations, work content becomes flexible.



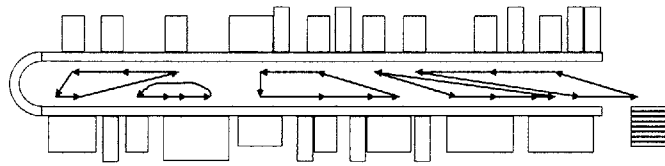

Figure 17. U-shaped compressor assembly cell with sample work-loops [Arinez, et al., 1999]

The design parameter, stating that the use of work-loops in a cell layout enables multi-machine operation, places more requirements on the production system design: the workforce must now be flexible; walking distances should be reduced; ergonomics of worker motions between stations needs to be improved; and volume flexibility should be enabled. Volume flexibility in cells requires that the number of operators be variable to match the specified takt time range of the cell. This means that operators must be able to reallocate their efforts, and be prepared to execute any number of standard-work routines.

If a worker operating a specific group of equipment is physically separated from other workers in the same area, then work re-balancing amongst operators to achieve volume flexibility is not possible. Allowing for the work content of one operator to be physically reached by another operator promotes teamwork that helps operators to rebalance the cell themselves. A cell with only one operator can either produce at the rate of one operator or not at all. Cells that are designed to run with a variable number of operators enable volume flexibility provided workers can physically share work.

Another advantage of workers not being physically isolated is that it promotes teamwork and facilitates rapid response to problems. Typical operating procedures in the case of a production stoppage is for every worker in the cell to converge on the station or machine experiencing downtime and resolve the problem as a team. Sharing the responsibility of problem resolution is important since any operator may be called upon to operate any station in the cell. The more knowledge they have about each station's process the better prepared they are when they are called upon to operate it.

The ability to produce at different production volumes with the available system resources helps reduce the cost due to manual operations. System design should provide the means for labor resources to produce over a range of volumes, i.e. provide volume

flexibility. It is important to plan this ahead of time so that there is not a lag in adjusting the work content of the operators. Standardized work-loops were designed for different production volumes (Figure 18). This provides the operators with numerous standard work routines, that when followed, results in different production rates.

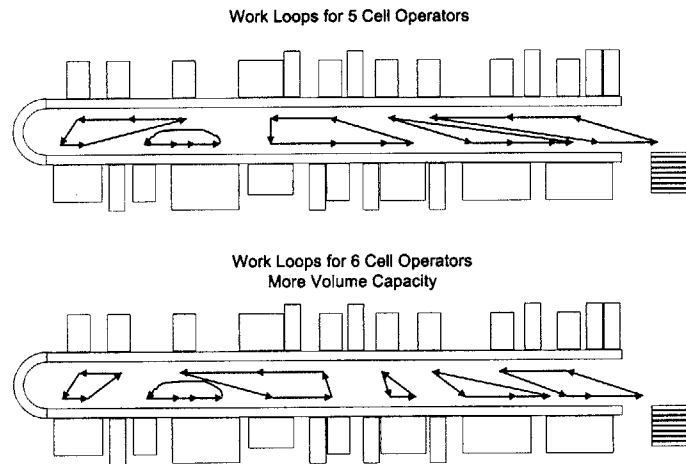

Figure 18. Varying work-loop patterns in assembly [Arinez, et al., 1999]

As the number of workers in the cell is increased, it becomes harder to balance the cycle-times for the various work loop configurations (Figure 19). This makes it difficult to provide the operators with sufficient work to match takt time. This highlights why it is important to design stations with flexible process content. During operation, it may be possible to partially redistribute the work tasks to different stations depending on the stations involved and thus balance the work-loop cycle times more effectively.

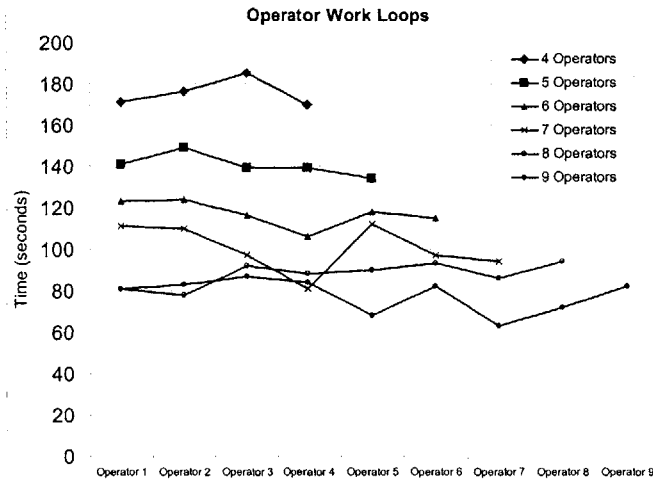

Figure 19. Planned cycle-times for each cell operator under different work-loop configurations [Arinez, et al., 1999]

*Example 2 – Equipment Design*

This example illustrates equipment design guidelines that lead to the reduction of production flow disturbances due to common causes. Production flow is the movement of parts along a predetermined path at a specified takt time. Rerouting the path or interrupting the flow of parts degrades the capability of the system to be responsive to customer demand. Common causes of disruptions to the production flow include performing routine maintenance, removing by-products of the manufacturing process, supplying material to the sub-system or individual station/machine (Figure 20). Disruptions to production can occur when the path of parts or cell operators intersects the path of maintenance or support personnel.

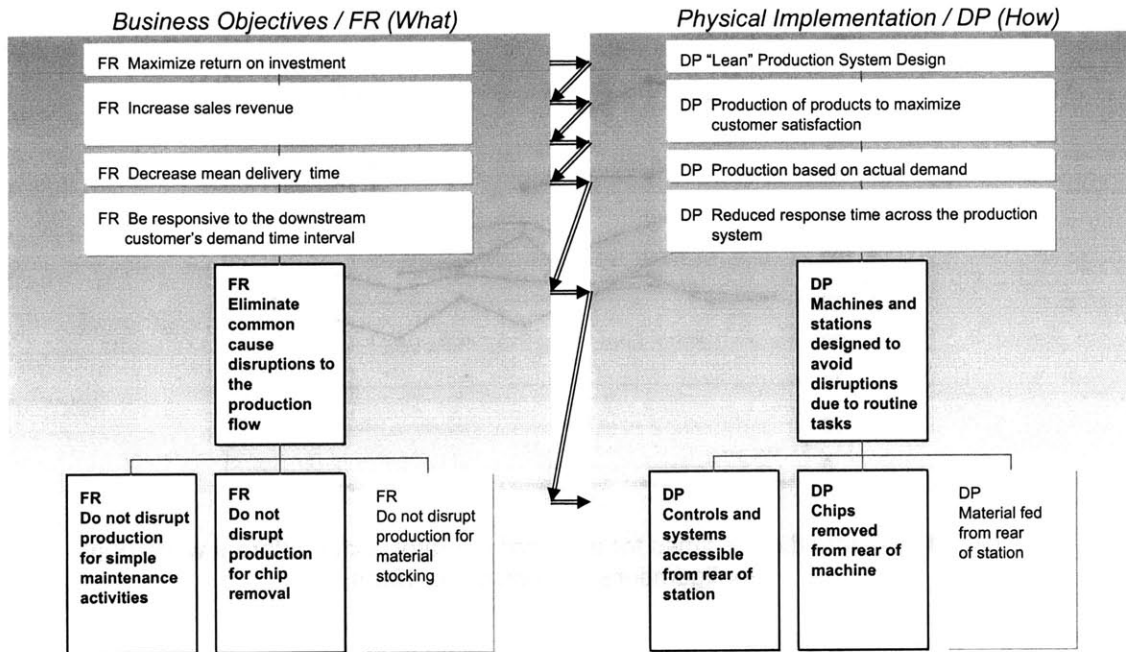

Figure 20. Level 6 Decomposition of "FR - Eliminate Common Cause Disruptions to the Production Flow" [Cochran and Lima, 1998]

Simple maintenance activities should not be a cause for production disturbance. Cells involve operators whose interaction with the machines is crucial during every cycle in order to maintain production output. Intruding in an operator's walk-path and workspace can cause immediate production disturbances.

One approach to prevent routine maintenance from interfering with an operator's work is to provide access for maintenance personnel at the rear of the station (Figure 21 and Figure 22). A cell layout dictates that the rear of each station is accessible from outside the cell, and therefore clear of operator work paths. This includes controls and electronics maintenance, cutting fluid service, waste removal, etc.

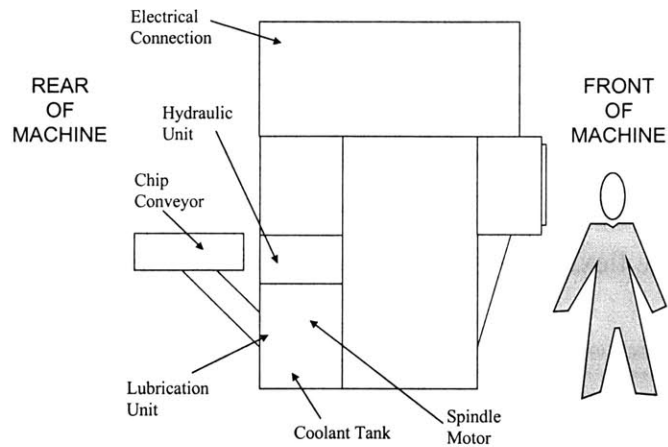

Figure 21. Side view of vertical lathe showing systems access from rear of machine [Arinez, et al., 1999]

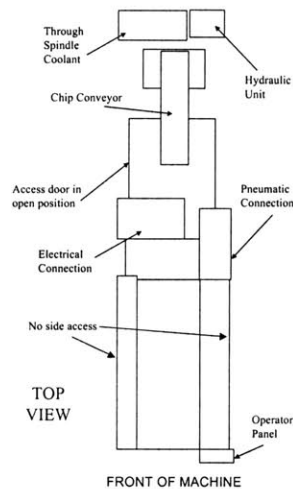

Figure 22. Top view of vertical machining center showing access to controls and subsystems from rear of machine [Arinez, et al., 1999]

### *Example 3 – Material Handling*

The loading of parts into processing equipment is a material handling functional requirement that significantly affects operational activity costs. Operational activity costs related to design choices in material handling technology are evident in maintenance, setup, and quality costs. Complex material handling requirements often can lead to the design of elaborate material handling equipment that carries high maintenance costs over its operating life.

In general, a cost-effective approach for material handling is to have the operator load the part directly to the work-holding device and have another simple device automatically unload it. A human operator can load parts as quickly and reliably as many types of material handling automation without the need for ongoing maintenance. Also, the ability of the operator to handle different parts is less costly than automation that has to be designed with the flexibility to handle a wide variety of product features.

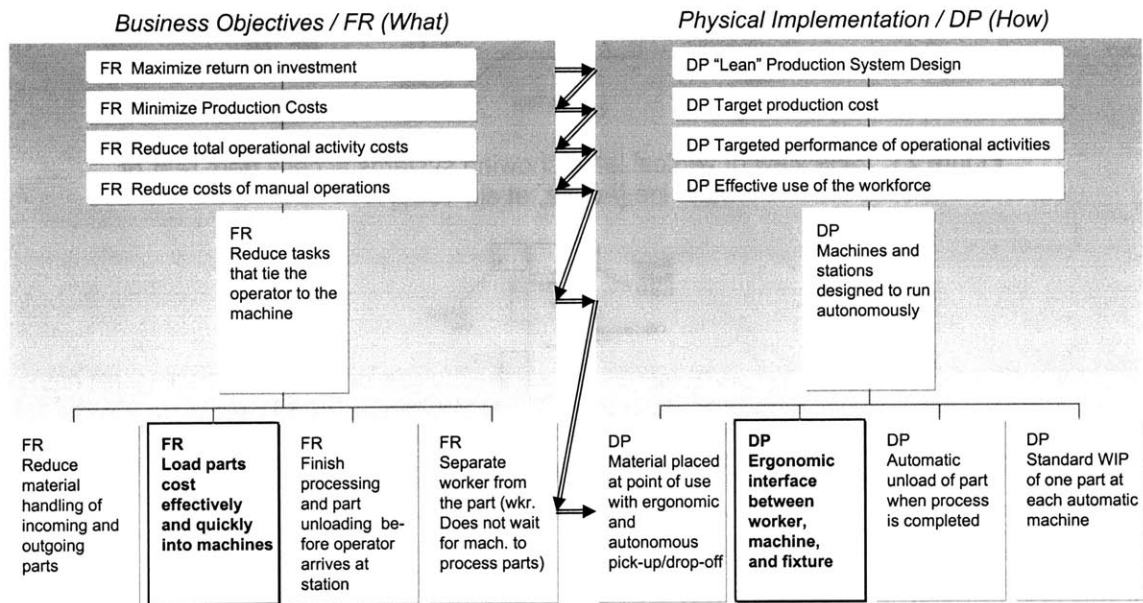

Figure 23. Level 6 Decomposition of “FR – Reduce Tasks that Tie the Operator to the Machine” [Cochran and Lima, 1998]

The material handling work sequence at each machine in a cell should follow these guidelines for operation<sup>1</sup>:

1. The operator approaches machine with part from previous operation and loads the part into empty fixture inside machine. This activates a part detection sensor.
2. The operator then stands clear of machine so that the light curtain or similar safety sensor recognizes that the operator is safely clear of the machine. The operator then activates a walk-away switch<sup>2</sup> that initiates automatic part clamping and the start of the machine cycle.

<sup>1</sup> Steps 2 and 3 may vary slightly depending on where the part is unloaded. If the part is unloaded inside the workspace of the machine, the logic must check for both conditions, part removed and no person inside machine.

<sup>2</sup> A walk-away switch is a switch located outside the machine on the left hand side at approximately part load height that facilitates easy activation as the operator moves right to left.

3. The operator then removes the previously processed part from the auto-unload part holder outside of machine and takes it to the next machine for processing.

Note that since material handling is being done by the operator, ergonomic requirements must also be considered in the design of material handling devices. This close relationship between material handling and ergonomics is shown in Figure 23 by the outlined FR/DP pair. The interface should incorporate standard ergonomic principles such as proper load heights, minimal transport and reach distances, and good line of sight for manual tasks (see Figure 24). These requirements are described in greater detail in Example 5.

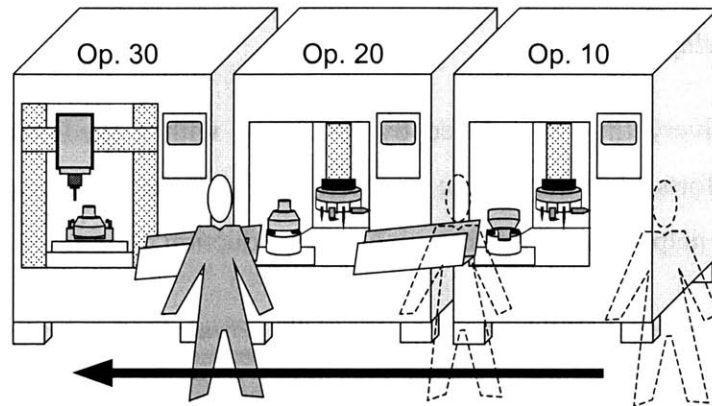

Figure 24. Standard work height and reduced walking distances for operating multiple machines [Arinez, et al., 1999]

Also, in designing the interface, visual cues can be created based on product design characteristics as well as the load and unload orientations of the manufacturing process plan. Good visual aid from product design characteristics comes from symmetrical or anti-symmetrical features that the operator can quickly distinguish when handling the part.

Finally, material-handling design is integrated into the manufacturing process plan and includes the orientation of the part as it is clamped in the work-holding fixture at each operation. The orientation of the part as it leaves one operation should not require reorientation by the operator to load it into the next station. Figure 25 shows the process orientation and the unload orientation for one of the six parts that has a consistent interface for the operator from machine to machine.

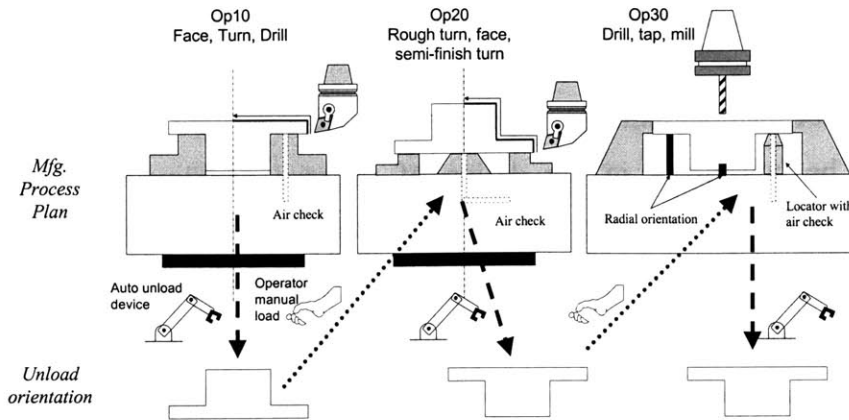

Figure 25. Interface between operator, machine and fixture to help achieve cost effective machine loading [Arinez, et al., 1999]

*Example 4 – Quality*

Variation in delivery time is reduced by producing with a predictable quality output (Figure 26). Efforts to eliminate the production of defects and to catch defects if and when they occur helps achieve perfect quality in production output.

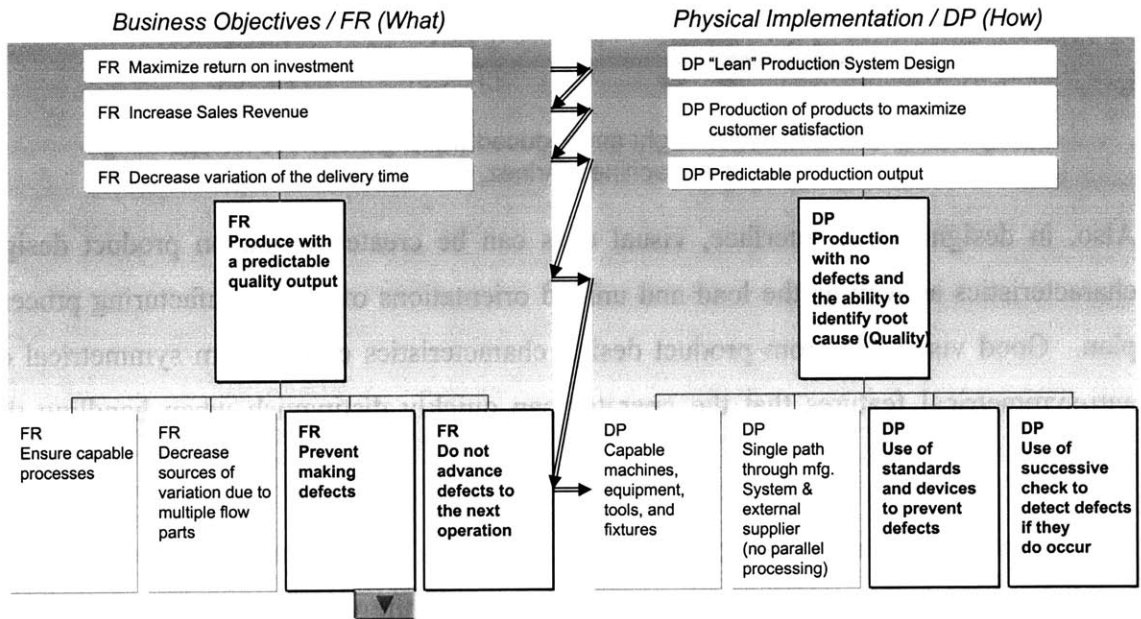

Figure 26. Level 5 Decomposition of “FR – Produce With A Predictable Quality Output” [Cochran and Lima, 1998]

During the process design, attempts should be made to anticipate sources of defects (e.g. process failure-modes, human error) and then mistake proof them using devices called



poka-yokes. A good poka-yoke acts transparently to the operator yet prevents her from making a mistake. Poka-yokes can be physical elements or electromechanical devices with links to station or machine control.

One example of a poka-yoke from the compressor assembly is a physical feature designed into the pallets (Figure 27). For the housing part, the nest on the pallet has two small features that protrude into slots in the housing when it is seated. At one point in assembly, vanes are inserted into the slots. The vanes are asymmetric such that if the vanes are inserted upside-down, the pallet features prevent complete insertion. The subsequent assembly task fails if the vane orientation is not corrected. This makes it unreasonable for the operator to continue the process and alerts her to the defect.

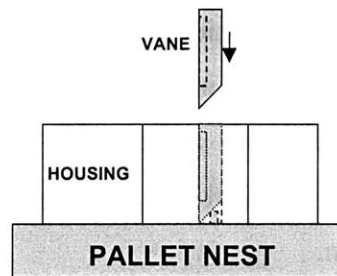

Figure 27. Poka-yoke on compressor assembly pallet to error-proof the insertion of outer vane into center housing [Arinez, et al., 1999]

Machines should be equipped with sensors, or successive checks, that identify defects and prevent the machine from running when they are detected. Successive checks can be used to verify that the task is performed properly. In the case that a mistake happens, the successive check notifies the operator that she has made a bad part and either the operator must correct the error, or reject the part.

One example of a successive check from the compressor assembly takes place at the insertion of the vanes (Figure 28). After insertion, a sensor device is manually placed into the subassembly to verify the orientation of the vanes. In order to do this, the device senses the presence of certain features on the vanes. This vane orientation is critical to the function of the compressor, without which the internal flow passages would be blocked. If this check fails, then the station controls do not lower the pallet stop to release the assembly pallet.

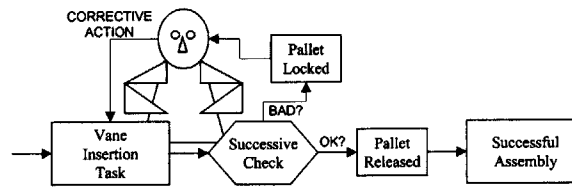

Figure 28. Example of successive check logic from compressor vane assembly station [Arinez, et al., 1999]

Incorporating error-proof processes in automation, also termed autonomation [Shingo, 1989], allows the operator to be separated from the machine. This permits multi-machine handling and improved flexibility and operator utilization.

#### *Example 5 – Operator Ergonomics and Safety*

Operator ergonomics and safety is considered throughout the design of equipment and sub-systems. Designing the work-space in assembly used guidelines that reduce operator stress and wasted motion by ensuring all necessary objects were within reach. In assembly, this reduces unwanted material handling, or wasted part transportation internal to each pick-and-place operation.

Material should be placed so that the operator has minimal material handling (Figure 29). With proper ergonomic layout of assembly stations, and good machine fixture load/unload positioning, excess manual effort can be reduced from the operators' routine.

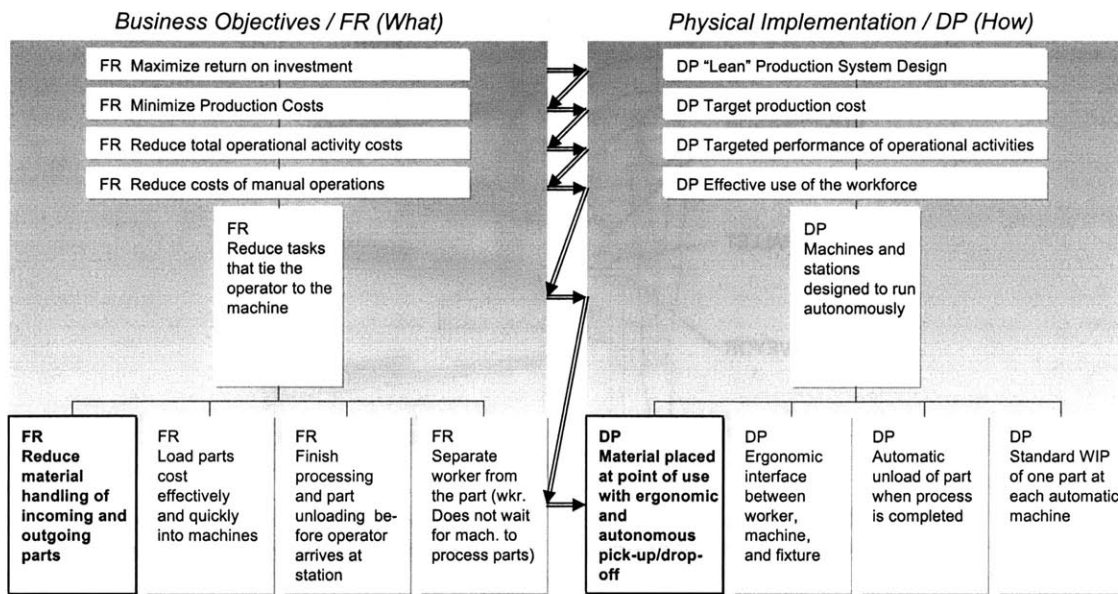

Figure 29. Level 6 Decomposition of “FR – Reduce Tasks that Tie Operator to the Machine” [Cochran and Lima, 1998]

The compressor assembly stations are designed with in-feed slides that present the part within an operator’s ergonomic work envelope (Figure 30). The out-feed slide that is used for the empty bins could be placed at the upper limit of an operator’s reach because the movement is not repetitive. Placing an empty bin down the slide is an occasional motion occurring only as material stock runs out. It was also important to make the position easily adjustable. The material slides are connected to the base’s aluminum extrusions using fasteners that can be loosened and tightened by hand. This way, operators can make changes to the configuration if they find a better way to arrange incoming parts.

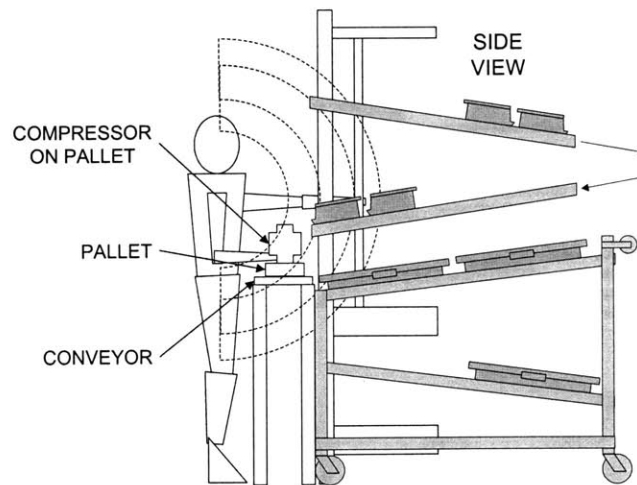

Figure 30. Ergonomic work envelope for assembly station. Material slides position incoming material at point of use for operator [Arinez, et al., 1999]

In order to ease the transitions from one station to another, a standard work height and working envelope should be employed. As operators move from station to station in their work loops they should not be encumbered by awkward or changing interface configurations. Work loops should be in the counterclockwise direction to take advantage of the majority of workers who are right-handed. Stations and machines should be designed knowing that the operator works from right to left. This dictates the location of switches, material supply, and visual cues.

A standard work-height, sensitive to local workforce anthropometry, was fixed across every station. This distance was measured from the floor to the middle of the compressor resting on a pallet. A typical ergonomic work envelope study was done on each station (Figure 30) to ensure that the operator could easily reach the material, tools and controls. This is especially important due to the number of offline fixtures present in the assembly cell. Strong attention to ergonomic layout minimizes the exertion required of the operator when lifting the compressor on and off-line.

### Conclusion and Lessons Learned

The process of designing subsystems and equipment for an automotive compressor production system was aided by lean manufacturing design guidelines. The guidelines were derived from an axiomatic design decomposition of a “lean” production system.

They communicated the design parameters to engineers and equipment vendors so that the resulting designs would satisfy high-level functional requirements for a “lean” production system. The communication of system functional requirements and design parameters, across multi-disciplined engineering teams can thus lead to improved system design and performance.

During the design process, many types of engineers played an active role in determining what the equipment design would be. This greater design team had limited experience in designing subsystems of the type prescribed by the lean production system design decomposition, and thus questions frequently arose about the system design. One area in particular was the elevated amount of human involvement in the actual production process. The perception of humans was typically as a direct labor resource that in turn is costly, and in the system design process, they are treated as such and minimized wherever possible. A system that employs humans as a critical element for managing, controlling, and improving processes throughout the system life-cycle was a concept that needed to be explicitly understood during the design process. The need for conceptually relating the benefits of humans in a system and the resulting equipment design decisions and provisions had to be communicated fairly inefficiently and in a general manner. A tool or framework for describing this human-machine system that incorporates production system best-practices, with a focus on the human-machine interaction, could lead to a more efficient design process with improved results.



# Chapter 3. Human-Machine Interaction in Manufacturing Cells

---

## Introduction

Manufacturing cells, like those designs that are documented in Chapter 2, are typically a U-shaped or parallel row configuration of machines and equipment [Black, 1991]. Equipment is laid out so that processing is done sequentially as the part moves from station to station through the cell. Since numerous types of manufacturing operations are required to process material into a finished part, various types of operations can be grouped together within a cell. Workers perform tasks from the inside of the cell, and typically operate more than one operation and invariably more than one *type* of operation. The operator must be capable of managing all processes in the cell. This means the operator must be multi-skilled and less specialized than traditional skilled-labor. The operations in a cell may also differ with respect to the level of automation. Stations can be arranged in such a way that completely manual operations are adjacent to semi or fully automated processes. The operator may move between different control modes during the path of normal work cycles. Operator flexibility and diversity of process knowledge is critical to the efficient operation of cells. This chapter describes the manufacturing cell from a human-machine interaction standpoint, distinguishing what characterizes this type of manufacturing system as a human-machine system per se.

## Manufacturing Cells

Cellular manufacturing is a method of grouping processes to enable lower volume, higher variety production systems capable of single-piece production with a reduction in work-in-process, transportation, and information [Black, 1991; Cochran, 1994]. The use of cells is supported by the production system design decomposition, as it incorporates

numerous design parameters that satisfy separate functional requirements of a production system in one physical subsystem (Figure 31). This is called physical integration in terms of axiomatic design because it integrates separate elements from the physical domain yet independently satisfies requirements from the functional domain [Suh, 1990]. Improvements in system performance metrics through more efficient part flow, improved operator efficiencies through layout and machine configuration, flexibility, etc. are manifested in the design of a cellular subsystem.

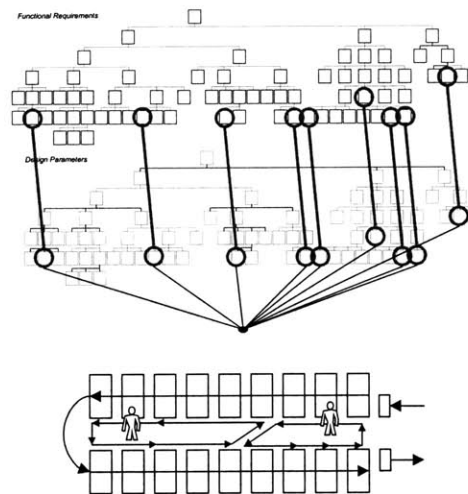

Figure 31. Physical integration, yet functional independence, through cell design

In terms of the control modes described on page 24, a cell is considered to be a hybrid control environment that is composed of equipment with varying levels of control mode, falling in range between full manual control and complete automation. The operator's flexibility is what enables this operating condition, and it adds further design flexibility to the cell in terms of automating appropriate processes while keeping some manual for reasons of flexibility or complexity.

A characteristic of cellular manufacturing is the increased importance of the human cell operators. The operators pace the production in a cell by performing standard work loops. Work loops may vary depending on cycle-time requirements or work content time leveling (Figure 32). The bottleneck in process cycle-time should be the time it takes for an operator to finish a work-loop. This concept of manual work time pacing a cell attempts to eliminate cases of operators waiting on machines. Automated processes are



subdivided into single-cycle steps of automated processing that can be completed at the maximum required production rate. Different operator work-loop scenarios exist for changing production rate demands providing volume flexibility. The benefit of human operators in this capacity is that they are flexible to operate a number of different processes at the same time providing the benefits of cognition and dexterity that are difficult or costly to automate.

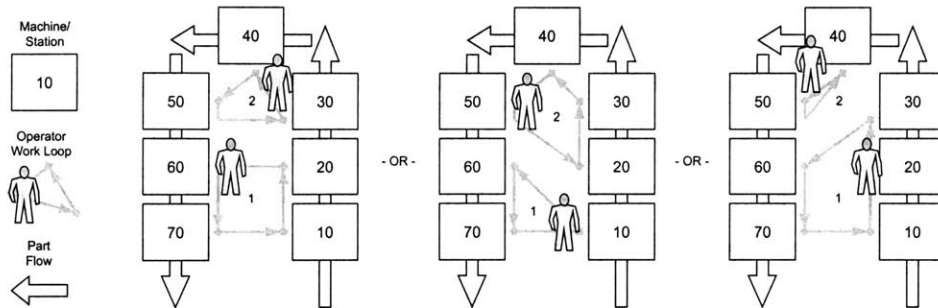

Figure 32. Cellular layout with varying operator work-loop patterns allowing flexible work content

The cycle-time capability for the entire cell is equal to the maximum total manual work loop time of any one operator:

$$t_j = \sum_{i=1}^n \text{Time}(\text{manual}_i)$$

$$\max_{j=1}^N [t_j] \leq \text{TaktTime}$$

This is true when  $t_j$  is the total loop-time for operator  $j$ ,  $N$  is the number of operator loops in a cell, and  $n$  is the number of manual tasks for an operator in any given loop.

The flexibility in operator work content allows the savings in improvement measures to be realized. In a two-man cell, if operation 20 is improved to reduce cycle-time, the total work loop's cycle time is also reduced. This time reduction can now be allocated across both operators by re-balancing the content in the work-loops. This means that  $t_j$  for  $1 \dots N$  can all be reduced. In doing so, the capacity of the entire cell is improved. This is compared to the case where operators are dedicated to individual stations/processes. If one process step is improved and time reduction is realized, the overall capacity of the

system cannot be improved since the improvement is isolated to only one of the operators, i.e. only one  $t_j$  is reduced. This only increases the line's capacity if the time reduced is the bottleneck operator. Otherwise, the improvement remains a local improvement without increased capacity realization at the system level.

The standard operating procedures in a cell are divided into manual and automatic work times and the manual tasks are allocated to the different operators. Human-machine separation allows the automated processing time to be external to the operators' work routines, thus increasing the amount of time that the operator can spend on value adding tasks. Man-machine charts graphically represent the work routines in a cellular layout incorporating the operator's walking time between stations, underscoring the importance of better workspace layouts (Figure 33). This type of analysis also helps allocate work to operators to reduce unbalanced work-loop times and eliminate cases of waiting for machines to process.

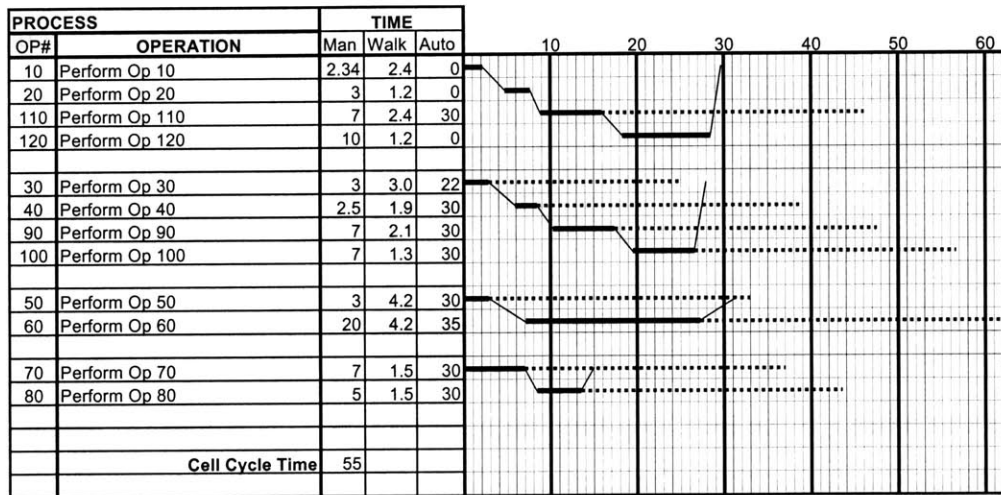

Figure 33. Man-machine chart for a 4-operator cell with a mixture of manual and semi-automatic stations

### Work Content in Cells

The type of work that operators should be given in cells are those that are commensurate to the operators inherent skills. Necessarily, operators should be performing problem solving routines and conducting improvement efforts [Shingo, 1999], but are frequently called on to perform manual tasks. Furthermore, these manual tasks are generally ones

that are complex or difficult to automate. Also, with flexibility being such a large factor in today's manufacturing systems, the possibility of varying work tasks from week-to-week or sometimes even hour-to-hour make automation an impediment to flexibility capability. Some of the tasks that an operator may perform in a cell are:

- 
- Subassembly steps
  - Inspections
  - Setting machine process
  - Transporting parts
  - Load/unload fixtures, etc.
- 

The operator is also the supervisor for numerous pieces of semi-automated equipment. She also monitors the entire cell, which at one level of abstraction is a large semi-automated subsystem. In multi-operator cells, the team is responsible for the monitoring of the cell. The operator, as supervisor is the first point of contact for process disturbance alerts. Process state information should be seamlessly communicated to the operator. As Sheridan [1970] concludes about sampling (Chapter 1), if the cost of sampling information is significantly less than the cost of the adjustment, then the operator should sample the process more often than make adjustments. If the machines in a cell are designed to efficiently communicate information to the operator, better process knowledge can be obtained. The actions that an operator takes based on these disturbances determine the performance of the entire production subsystem. Disturbances result from out-of-control processes, machine breakdowns, regular maintenance intervals, and other unforeseen causes that delay production or degrade quality.

Human-machine system analysis of cellular manufacturing work environment should integrate the notion that humans are supervisors of cellular subsystems. These subsystems are the equipment components of a cell as well as the integration of these components. Together, this constitutes the overall performance of the cellular subsystem.



# Chapter 4. Application of a Production System Design Decomposition to Human-Machine Interaction

---

## **Production System Design Decomposition**

An axiomatic design-based decomposition of a production system design contains the functional-physical relationships between high-level goals and low-level design solutions. Some of the FR/DPs for production system design deal with the design of the human-machine interaction in the system. Suh [1998] states that from the axiomatic design point of view, the human-machine interface in any system design can factor into all levels and branches of a design hierarchy. Eichener [1996], Fan and Gassmann [1997], and Plonka [1997] underscore the importance of recognizing user-centered issues at many levels of subsystem configuration. The FR/DPs that are discussed in this chapter are used in Chapter 5 to construct a model of human-machine interaction (HMI) that incorporates the overall goals of a production system. The model is useful to integrate the numerous FR/DPs so that equipment designers may satisfy production system goals by designing machines that can fit within the HMI model.

Figure 34 is a schematic of the decomposition composed of the functional requirements (FR) and design parameters (DP) for a production system design (PSD). It was constructed using the axiomatic design methodology described in Chapter 1.

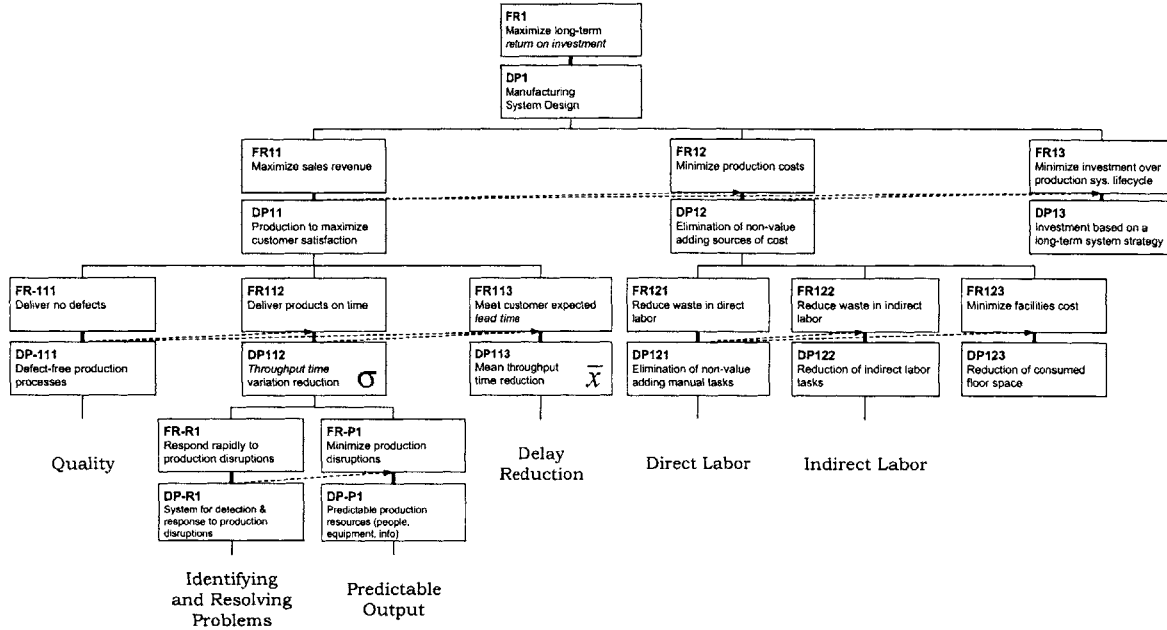

Figure 34. High-level portion of production system design decomposition [PSD Lab, 1999]<sup>3</sup>

The top level FR is *FR-1 maximize return on investment* and the corresponding DP is *DP-1 manufacturing system design*. Using the zigzag methodology for decomposition yields three sub-FRs that must be satisfied in order to implement *DP-1*. These sub FRs are *FR-11 maximize sales revenue*, *FR-12 minimize production costs*, and *FR-13 minimize investment over production system lifecycle*. The DPs for these second-level FRs are *DP-11 production to maximize customer satisfaction*, *DP-12 elimination of non-value adding sources of cost*, and *DP-13 investment based on a long-term system strategy* respectively.

These FR/DP pairs can be further decomposed into a strategy for implementing the high level DPs. *DP-11 production to maximize customer satisfaction* is addressed by looking at three production system design areas that determine the level of customer satisfaction. Perfect output quality, reduced variation in delivery time, and meeting customer-expected

<sup>3</sup> The production system design decomposition that is applied in this chapter is the recent version 5.0, developed by the Production System Design Lab at MIT [PSD Lab, 1999]. Contributors: Prof. David Cochran, Jorge Arinez, Staffan Bröte, Jose Castaneda-Vega, Micah Collins, Dan Dobbs, Jim Duda, Yong Suk Kim, Kristina Kuest, Jochen Linck, and Andrew Wang

lead-time are three focus areas for satisfying the customer. *DP-12 elimination of non-value adding sources of cost* is addressed by focusing on the direct and indirect labor activities and reducing wasteful activities associated with these activities, as well as minimizing the floor space consumption. *DP-13 investment based on a long-term system strategy* focuses on reducing the investment costs that a firm has throughout the system lifecycle. Over the long term, machines that are flexible for improvements/modifications yields less reinvestment in equipment assets. This particular DP is left without further decomposition mainly because it is difficult to address individual firms' investment strategies in a general treatment of system design

The following sections describe in better detail the sections of the decomposition that result in FR/DPs that relate to human-machine interaction in production systems. The DPs that are chosen to satisfy each FR influence how the human work content and machine design interact with one another through physical or information-based interaction. Each DP describes the design of an element of human-machine interaction – human work content, information supplied to the operator, and/or machine design. This chapter considers a production system design decomposition and maps relevant FR/DPs to these elements of HMI (Figure 35).

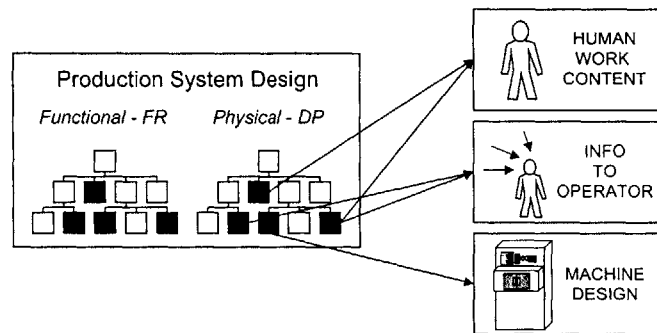

Figure 35. Process of mapping PSD FR/DPs to the HMI element that the DP describes

A summary at the end of each discussion-area describes the related FR/DP pairs and specifies whether the FR is satisfied by a DP that includes a feature of human work content, machine design, and/or information (Figure 36).

		Human	Machine	Information
Functional Req.-#1	Design Parameter-#1	X		
Functional Req.-#21	Design Parameter-#21			X
Functional Req.-#22	Design Parameter-#22		X	

Figure 36. Relating production system design FR/DPs to human-machine interaction

## Quality

Quality is a broad term that is defined numerous ways. Crosby [1979] defines quality by how well requirements – set by external and internal customers – are satisfied. Taguchi et al. [1989] relates quality inversely to the loss that results from functional variation and harmful effects. Functional variation is composed of variation from manufacturing, product wear, and product use and leads to performance that is not intended by the design specifications. The loss is incurred due to these deviations of product characteristics from their target values. Together, these definitions communicate the two main aspects of quality. Firstly, variation is the source for degraded quality both in process and product. Secondly, customers bear the burden of poor quality, and when operating a production system, the customers are both internal and external to the system. Thus poor quality adversely effects system performance as well as perceived product quality.

In systems, incremental improvements usually contributes miniscule impact in the short term, but when aggregated over time can significantly affect the performance of production and product [Cole and Mogab, 1995]. Improvements in quality over time improves a manufacturing system's efficiency and increase the customer satisfaction. The concept of total quality management (TQM) for the deployment of improvement methods can be applied to many aspects of a system. Its tools and methods can be applied to multiple areas of an organization including production processes, product design, payroll, employee hiring and training, maintenance, management, etc. TQM refers to the efforts of managers of organizations to design systems and manage employees to pursue the enhancements of customer value in all forms [Cole and Mogab, 1995]. How well TQM methods are implemented relies on the system by which managers and production personnel strive to meet their common goals. The system



design process affects the way production employees contribute to process improvements and how human presence affects the maintenance of process capability.

The focus in the next section is quality control for production processes. Other aspects of TQM where applicable are addressed in other sections of the production system design decomposition.

### *Process Control*

The production system design decomposition includes within it the design of subsystems and operational guidelines that are consistent with total quality management (TQM). However, they are decomposed from high level goals of a production enterprise rather than a prescribed TQM program.

For the problem of process quality and control, statistical process control methods are outlined to affect process capability and help achieve defect-free production that increases customer satisfaction. Process control alone cannot achieve zero-defects. In manufacturing the main way to achieve zero-defects is through 100% inspection methods. This is a matter of distinguishing between product and process quality. Sampling methods such as SPC can help improve *process* quality by identifying sources of variation. However, the very nature of sampling means that defects could make it through a system. Only 100% *product* inspection can eliminate the production of defects.

The decomposition of process control methods satisfies the high-level goals for production system design discussed in the previous section. The axiomatic design decomposition shows the functional and physical means by which a company can achieve defect-free production, and positively affect customer satisfaction (Figure 37).

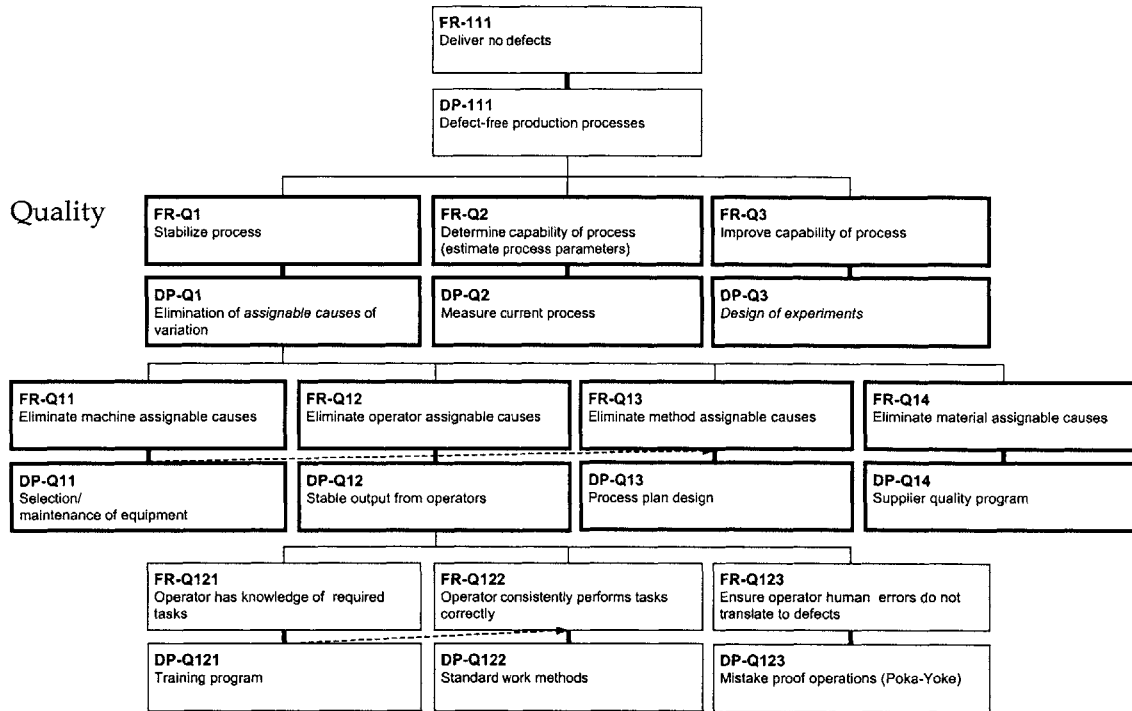

Figure 37. Section of production system design decomposition that is related to quality. Highlighted boxes show FR/DPs relating to process control implementation [PSD Lab, 1999].

There are three main requirements for performing process control and improvements. The first is *FR-Q1 stabilize process* satisfied by *DP-Q1 elimination of assignable causes of variation*. Assignable causes, also called special causes, are problems that arise periodically but in an unpredictable fashion. The operator or immediate supervisor can usually deal with them effectively at the machine or process. Assignable causes are attributable to one of four sources – machines, operators, methods, and materials (requirements *FR-Q11*, *FR-Q12*, *FR-Q13*, and *FR-Q14*). Eliminating these assignable causes of variation (through design parameters *DP-Q11*, *DP-Q12*, *DP-Q13*, and *DP-Q14*) is a fundamental step in achieving stable processes required to measure capability and address the more routine sources of variation that *FR/DP-Q3* addresses.

The second requirement for process control is *FR-Q2 determine capability of process* that is satisfied by *DP-Q2 measure current process*. The estimation of process parameters through sample means and ranges provides a measure of process capability. Process capability is defined as the ability of the process to meet design specifications [Dooley,

1994]. Having a stable process is the only means to assess true process capability. A stable process is subject only to the variation that is present due to common-causes. A stable process can be charted and process parameters can be established.

The classical control system approach to SPC implementation is shown in Figure 38. The observation step is where measuring current process takes place and the determination of capability occurs during the evaluation step with the analysis of collected process data.

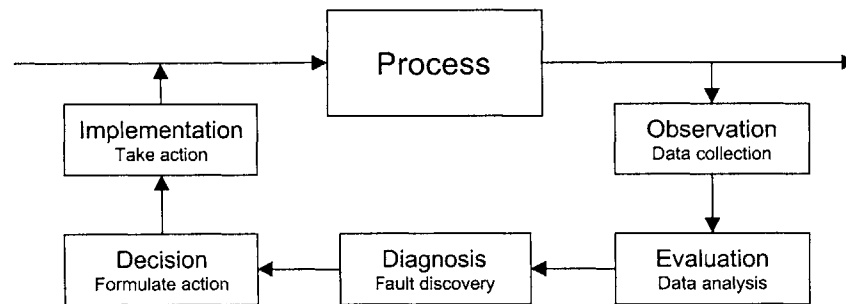

Figure 38. Classical control system view of SPC implementation [DeVor, et al. 1992]

In the evaluation step, control charts are constructed by plotting means and ranges for samples of production output taken over time. By practicing SPC, a hypothesis test is performed on each sample to test whether or not the sample mean and range fall within a 3 sigma control limit range (Figure 39). If so, it means that with 99.73% confidence, the parts were made without the influence of a special cause disturbance. Special cause disturbances can also be detected by monitoring the trends in the data over time. There are numerous tests to identify these trends.

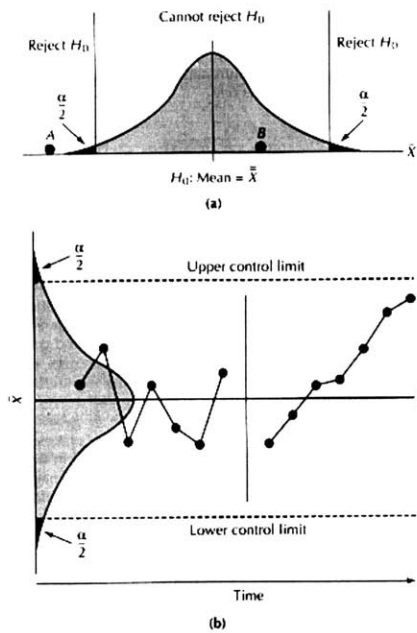

Figure 39. Statistical basis for control chart formulation [DeVor, et al. 1992]

DeVor et al. [1992] and Dooley [1994] provide adequate step-by-step methodologies for constructing control charts and calculating process capability.

The third requirement for process control is *FR-Q3 improve capability of process* and it is satisfied by *DP-Q3 design of experiments (DOE)*. Through DOE methods, the process capability can be increased as sources of common-cause variation are identified and eliminated [Tang and Pruett, 1994]. The value of the human in this process is important since human operators of the production process possess unique knowledge about the factors that affect output. The voice of the operator can help pinpoint areas of sensitivity in the process, and lead to better experimental design and capability improvements.

The human plays an important role in the classical control system for SPC (refer back to Figure 38). The human operator is a key component of the diagnosis and decision steps where process knowledge and deductive skills are vital for formulating a process improvement action. The operator in a manufacturing workshop may adjust the process and cause shifts in the process-mean. This control of the process-mean helps mitigate the adverse affects of special-cause disturbances. This can be an argument for collecting and displaying SPC-related data to the operator. One concern is whether an operator is

trained properly to not only correct the process-state through adjustments, but to also interpret data characteristics and translate them to root-cause identification and corrective actions.

Tracking process parameters over time requires resources that may prove costly when applied over-ambitiously. Some processes are deemed capable and sometimes ignored as far as documenting process control through charting methods. A strategy should be employed to target those areas of the process where stability or capability problems exist, but to not ignore other areas of the process. Building process parameter tracking into the standard work of operators can alleviate some of the overhead and planning for these tasks. The practice of continuous improvement must be rigorously encouraged to solve problems that arise from the discovery of special causes. Further, the instances of human operator’s feedback must be valued and acted upon. This can lead to further capability improvements at frequently low capital expenditure as well as contribute to operator safety, better ergonomics, improved process cycle-times, lower inventory, etc. Further, these efforts should be applied even to processes that are deemed sufficiently capable, for continuous knowledge of process state and capability leaves a system better prepared to address potentially rapid increases in demanded capability [Dooley, 1994].

FR/DP #	Functional Requirement	Design Parameter	DP Affects:		
			Human	Machine	Information
Q1	stabilize process	elimination of assignable causes of variation	X	X	
Q2	determine capability of process	measure current process			X
Q3	improve capability of process	design of experiments	X		

Figure 40. Summary of FR/DPs for controlling process quality

Figure 40 shows the FR/DPs that describe process control implementation methodology. Each FR/DP pair has an “X” under the category of human, machine, and/or information depending on which element is specified by the design parameter. Summary tables like this appear after each FR/DP discussion.

*Human Error*

To ensure defect free production (*DP-111*), processes must be stabilized. Once this is achieved, the capability of the process can approach perfect quality through design of experiment methods (*DP-Q3*). As mentioned in the previous section, stabilizing processes means that the assignable causes of variation – those that can be attributed to known variation sources – must be eliminated, including those attributable to the human operator. The FRs that describe the hierarchical justification for stabilizing operator output are shown highlighted in Figure 41.

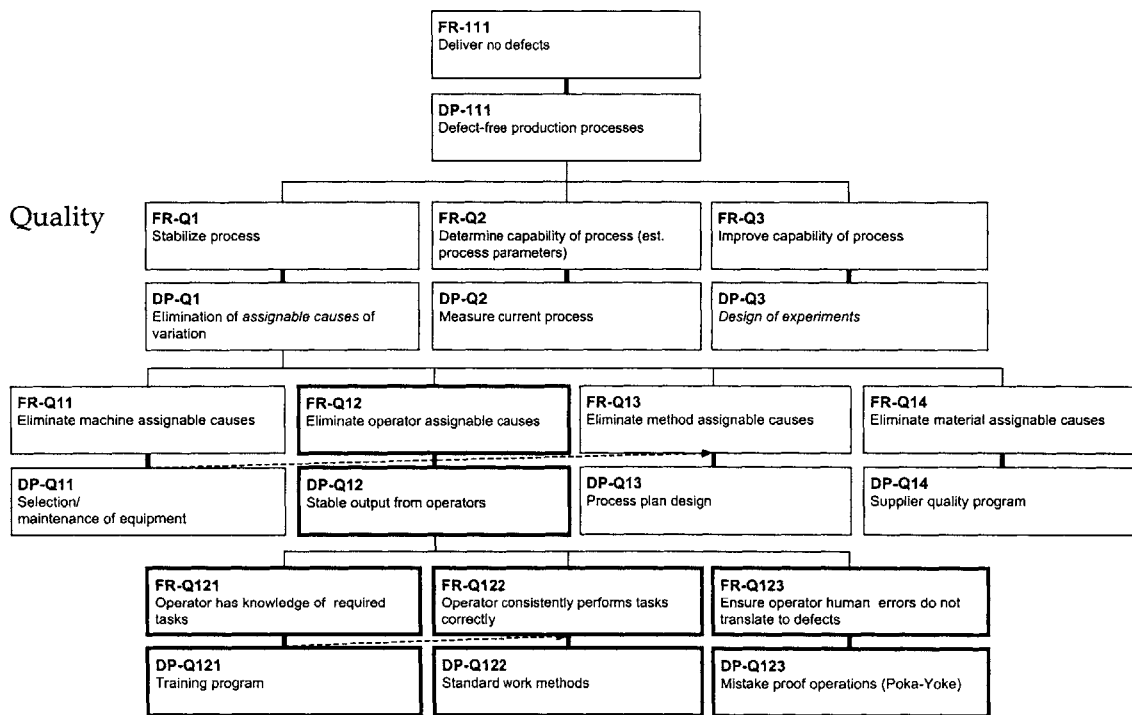

Figure 41. Section of production system design decomposition that is related to quality. Highlighted FR/DPs detail the stabilization of operator output [PSD Lab, 1999].

*FR-Q12 eliminate operator assignable causes* is satisfied by *DP-Q12 stable output from operators*. *DP-Q12* decomposes into three sub-FRs that determine a method for stabilizing human behavior in manufacturing systems.

*FR-Q121 operator has knowledge of required tasks* is satisfied by the implementation of *DP-Q121 training program*. A training program ensures that an operator has the skills and background required for performing the tasks that are required during production.

*FR-Q122 operator consistently performs tasks correctly* is satisfied by the implementation of *DP-Q122 standard work methods*. Standard work methods prescribe the methodology and sequence that an operator must use when completing the assigned tasks. When followed, standard work methods ensure that steps are not forgotten, performed at the wrong time, or done incorrectly.

*FR-Q123 ensure operator human errors do not translate to defects* is satisfied by *DP-Q123 mistake proof operations*. This is important when humans are present in the system. As discussed in Chapter 1, many factors contribute to the occurrence of human error and not all of these can be controlled in an often complex manufacturing work environment. Therefore, it must be ensured that these occurrences of human error do not translate into defective output. Mistake proofing devices, often referred to as poka-yokes, are tools for eliminating repetitive tasks or actions that depend on a human operator's vigilance, and/or memory, to achieve perfect quality [*Poka-Yoke*, 1987]. This may also free the operator to pursue other value-adding activities (man-machine separation). Poka-yoke devices ensure that operations cannot be performed incorrectly, or alternately, they can only be performed one way, i.e. correctly. Poka-yokes also alert operators and prevent the continued processing in the event of a detected defect.

The preventative measures that a poka-yoke can exert to prevent defective production are classified into three separate types of functions – shutdown, control, and warning (Figure 42). As mentioned before, these functions can be used to prevent the occurrence of defects, as well as weed out and prevent the repeated occurrence of defects when they do occur.

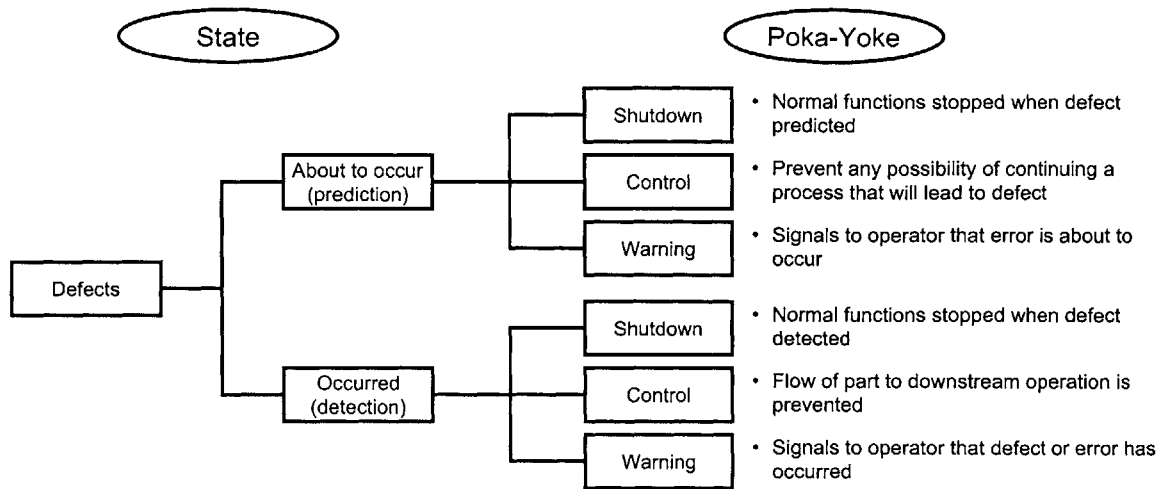

Figure 42. Functions of a poka-yoke device in a manufacturing system [*Poka-yoke*, 1987]

Poka-yoke is an important element of *jidoka*, a Toyota production system term for automation with a human touch or autonomous defect control [Monden, 1998]. The poka-yoke device intelligently stops a machine from processing a part that may become defective due to an initial condition not being satisfied. A device can also passively prevent incorrect procedures or work methods in an operator’s manual work. An example of this was shown in Chapter 2 for the assembly fixture design. The poka-yoke should also provide warning to serve as processing feedback in the case of defect prediction or detection.

In order to achieve defect-free production, the methods described here should be implemented to create stable and improvable processes. Designing systems that are robust in coping with human error helps stabilize processes that include operator tasks. Adequate training, standard work, and poka-yoke methods help achieve this stability in worker output. Improving quality helps improve the level of customer satisfaction of production output.



FR/DP #	Functional Requirement	Design Parameter	DP Affects:		
			Human	Machine	Information
Q12	eliminate operator assignable causes	stable output from operators	X		
Q121	operator has knowledge of required tasks	training program	X		
Q122	operator consistently performs tasks correctly	standard work methods	X		X
Q123	ensure operator human errors do not translate to defects	mistake proof operations		X	X

Figure 43. Summary of FR/DPs for stabilizing human operator output through human error mitigation

Another means for satisfying the customer is improving the nature of the time output, i.e. time variation, and mean throughput times.

### Reduce Throughput Time Variation

Variation in throughput time decreases the chance of goods to be delivered on time. There are two sub-FRs for implementing *DP-112 throughput time variation reduction* (Figure 44). The first is *FR-R1 respond rapidly to production disruptions* and it is satisfied by *DP-R1 system for detection and response to production disruptions*. The second sub-FR is *FR-P1 minimize production disruptions* and it is satisfied by *DP-P1 predictable production resources*.

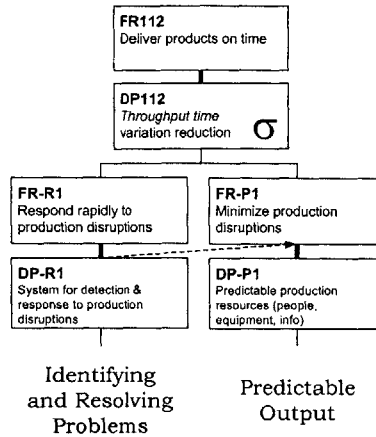
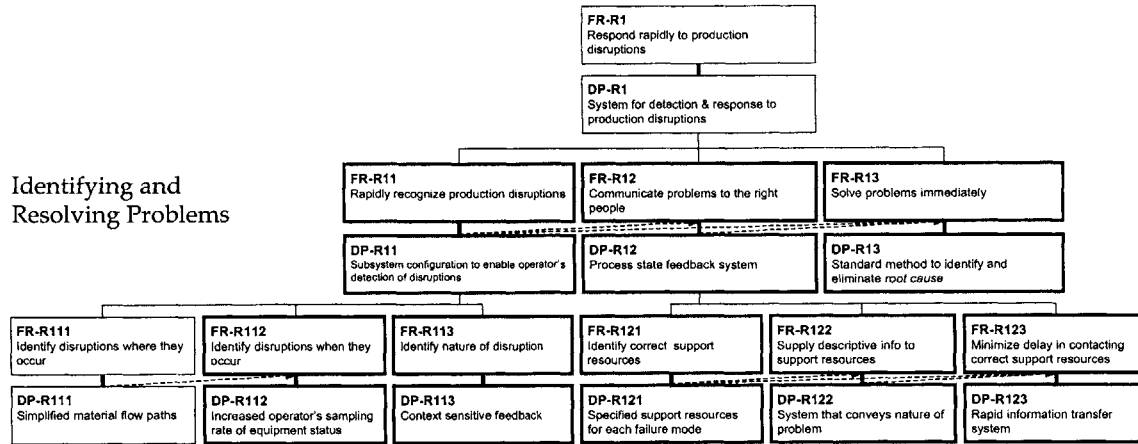

Figure 44. Sub-FRs for reducing throughput time variation [PSD Lab, 1999]

These two FR/DP pairs promote the rapid response to instances of disruptions to production flow, and the system management techniques for ensuring that disruptions do not occur. Designing and configuring subsystems for reduced time variability results in lower time-variation in total throughput time and customers can receive their orders on time. The elimination of variability in time output of a system is also a first step in achieving controllability – this is analogous to the SPC methodology of having to stabilize the process before process control methods may be applied. The next two sections discuss the human-machine considerations in the decompositions of *FR/DP-R1* and *FR/DP-P1*.

#### *Identifying and Resolving Problems*

The identification and resolution of production disruptions is a primary component for eliminating variability in production sub-systems. *DP-R1* is decomposed into three sub-FRs that must be satisfied in order to implement a detection and response system.



Identifying and Resolving Problems

Figure 45. Section of production system design decomposition that is related to identifying and resolving problems. Highlighted FR/DPs relate to human-machine interaction [PSD Lab, 1999].

*DP-R1's first sub-FR is FR-R11 rapidly recognize production disruptions and it is satisfied by DP-R11 subsystem configuration to enable operator's detection of disruptions. A subsystem should be designed with a focus on easy and timely detection and description of a disruption. Failure diagnostics is enabled by control automation whose designed aim should be, through an intelligent sensor and actuator subsystem, to stop the machine, give an alarm, point out the faulty operation and the components that have to be checked [Kuivanen, 1996]. This ensures that the operator can make rapid remediation of the problem. DP-R11's first sub-FR is FR-R111 identify disruptions where they occur that is satisfied by DP-R111 simplified material flow paths. This improves traceability of errors and increases the chances of identifying the source of disruption. The sub-FRs that affect human-machine interaction are primarily the second and third sub-FR for DP-R11. FR-R112 identify disruptions when they occur is satisfied by DP-R112 increased operator sampling of equipment status. This ensures that an operator has timely notification of a problem that may exist in a machine. As mentioned in Chapters 1 and 3, increasing the sampling rate by which the operator gains state information improves the responsiveness in resolving an instance of disruption. The operator also possesses more recent information on processing behavior that may in turn help solve the problematic cause of the disruption. FR-R113 identify nature of disruption is satisfied by DP-R113 context sensitive feedback. This means that a disrupted subsystem should communicate as much as possible relative to the reason for a*

production flow disruption, be it a malfunctioning component, lack of material supply, etc. In these cases, the communication of the information should provide the least ambiguity in communicating disruption to the operator.

*DP-R1*'s second sub-FR is *FR-R12 communicate problems to the right people* and it is satisfied by *DP-R12 process state feedback system*. This FR/DP ensures that the occurrence of a problem is communicated rapidly and accurately to the individual or supporting team that can address the disruption. *DP-R12* has three sub-FRs that must be satisfied in order to implement a state feedback system that communicates the need for support for a production disruption. *DP-R12*'s first sub-FR is *FR-R121 identify correct support resources* and it is satisfied by *DP-R121 specified support resources for each failure mode*. The support resources that are required to address types of disruptions should be pre-determined as part of a failure mode analysis. A failure mode and effects analysis should also be maintained throughout the life of the manufacturing system as part of a process knowledge-base. Operators that detect problems should be equipped with this information so that they may call for suitable support. *DP-R12*'s second sub-FR is *FR-R122 supply descriptive information to support resources* and it is satisfied by *DP-R122 system that conveys nature of problem*. The means of communicating a problem should be as descriptive as possible in communicating the nature of the disruption. For example, sometimes an improvement can be made to a single red indicator that only states the presence of a problem. A display such as this could be improved to provide better information on what subsystem triggered the alert. *DP-R12*'s third sub-FR is *FR-R123 minimize delay in contacting support resources* and it is satisfied by *DP-R123 rapid information transfer system*. Information must move very rapidly within a system to ensure that problems are resolved with least amount of delay in production. Rapid information flow for triggering a response results in faster disturbance resolution, and a lower impact on time variation.

*DP-R1*'s third and final sub-FR is *FR-R13 solve problem immediately* and it is satisfied by *DP-R13 standard method to identify and eliminate root cause*. In order to ensure that a problem does not reoccur, the root-cause of the problem must be eliminated. Otherwise, the result is a lot of wasted time and effort in treating recurring symptoms. In

general, the approach to seek out and eliminate root-cause is to consider all known contributing factors to a problem. In terms of diagnostic reasoning, this is known to occur in the *diagnostic field* [Rasmussen, 1993]. The field is composed of a normal as-designed system with causal input-output relationships for each individual subsystem, as well as normal operating instructions. In this diagnostic field lies the groundwork where abnormalities can be traced through in order to determine the course-of-events that could lead to a disturbance. The benefit of good system knowledge when performing root-cause analysis within a diagnostic field is that the diagnostician does not have to rely on empirical evidence from prior occurrences. It is possible to arrive at a correct diagnosis and solve the problem permanently without having prior instances and iterating. This aids a diagnostician, in this case a cell operator, to arrive at a conclusion of root cause.

The Ishikawa fishbone diagram is a common tool used for finding sources of problems (Figure 46). The main factors that could give rise to a manufacturing disturbance are typically man, machine, method, or material. The fishbone diagram is a cause and effect analysis that associates with the symptoms all the possible factors that drive it. This is a top-down approach to seeking root-cause, i.e. start with the problem and consider all the possible causes.

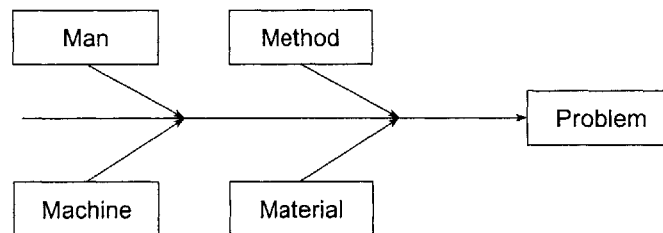

Figure 46. Fishbone structure for cause-and-effect diagram

Another method that is considered bottom-up, i.e. starting with the possible failure modes and considering the effects or symptoms is called failure mode and effect analysis, or FMEA. A FMEA starts with possible failures and considers the possible outcomes. This enables the planning of resources to address failures when they occur and prescribe methods for dealing with the failures. Experience and lessons learned from prior operation of certain processes can be applied to a new system's FMEA for similar processes. Using top-down approaches in combination with bottom-up approaches

creates a system for seeking root-causes. A running FMEA can provide a knowledge base for producing and understanding the cause-and-effects that are used to run a fishbone-style, top-down analysis.

FR/DP #	Functional Requirement	Design Parameter	DP Affects:		
			Human	Machine	Information
R11	rapidly recognize production disruptions	subsystem configuration to enable operator's detection of disruptions			X
R112	identify disruptions when they occur	increased operator sampling of equipment status	X		X
R113	identify nature of disruptions	context sensitive feedback		X	X
R12	communicate problems to the right people	process state feedback system			X
R121	identify correct support resources	specified support resources for each failure mode			X
R122	supply descriptive information to support resources	system that conveys nature of problem			X
R123	minimize delay in contacting support resources	rapid information transfer system			X
R13	solve problem immediately	standard method to identify and eliminate root cause	X		X

Figure 47. Summary of FR/DPs for identifying and resolving problems

*Predictable Output*

The next requirement for reducing the variation in throughput time is the minimization of production disruptions. Through a system of rapid detection and response to production problems, the elimination of disturbances over time reduces variation. Eliminating disruptions in a system also includes targeting resources that are the sources of variation. The predictability of resources – information, machines, people, and material – permits better planning and control of systems. Human-machine interaction in a system affects how predictable the machines and people can be. Figure 48 shows the FR/DPs that the design of human-machine interaction affects.

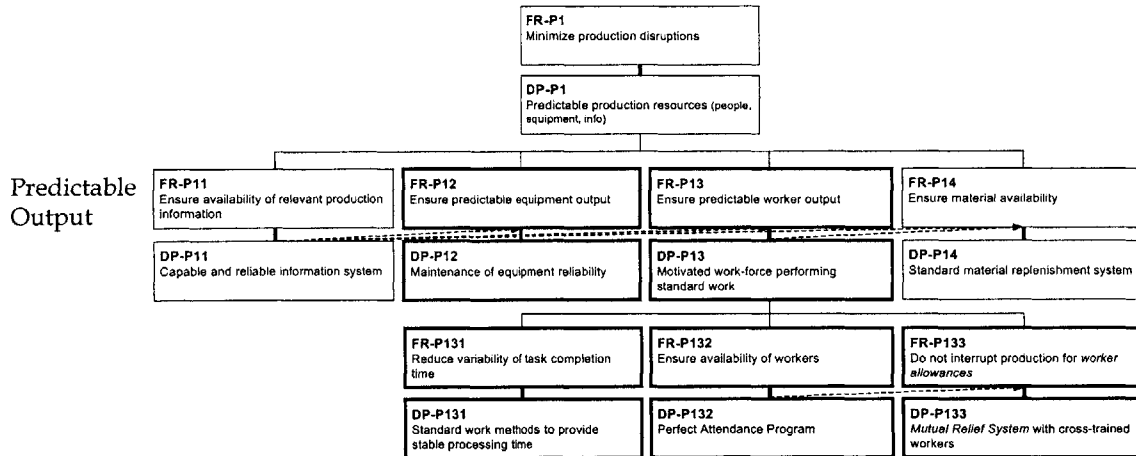

Figure 48. Section of production system design decomposition that is related to predictable output. Highlighted FR/DPs relate to human work content and management [PSD Lab, 1999].

The *FR-P12 ensure predictable equipment output* is satisfied by *DP-P12 maintenance of equipment reliability*. Preventative maintenance programs provide regimens for the maintenance of equipment. Operators are called upon to perform routine maintenance activities (e.g. tool changes), which means machines should be designed so that routine maintenance activities are made clear and straightforward. Operators should be supplied with instructions to trigger procedures for completing maintenance activities.

The *FR-P13 ensure predictable worker output* is satisfied by *DP-P13 motivated workforce performing standard work*. Motivational techniques are generally geared toward providing more job satisfaction for workers. Some techniques include: adjusting group size for areas of production to give workers better feeling of contribution; allocating complete-processes to a group of worker to give the satisfaction of completing a job; and giving a group of workers more autonomy to monitor processes and manage their own subsystem's area [Niimi et al., 1997]. Further, the assurance that a worker is present at the instant that a manual task must be completed is necessary to ensure production rate is maintained without variation. There are three sub-FRs to ensure that the worker is in place performing standard work. The first sub-FR for *DP-P13* is *FR-P131 reduce variability of task completion time* and it is satisfied by *DP-P131 standard work methods to provide stable processing time*. Standard work methods when followed reduce the variability that is associated with operators performing tasks using

normal/varying methods. Standard work also serves as a reference for an operator to alleviate uncertainty that may arise while processing. For example, as model variety increases in a manufacturing system, specific tasks change for each model that is produced. If the operator must commit these tasks to memory, it is very possible they could be forgotten which then causes delays as the operator seeks proper instructions. Prescription of standard work for all work contingencies ensures the smooth change-over of work-tasks without interruption. The second sub-FR for implementing *DP-P13* is *FR-P132 ensure availability of workers* and it is satisfied by *DP-P132 perfect attendance program*. Incentive programs are part of many TQM programs and when successfully executed ensures the availability of workers when they are needed. A North American vehicle final assembly plant claimed 60% perfect attendance on a yearly basis among its production employees using such an incentive program [Toyota, 1998]. The third sub-FR for implementing *DP-P13* is *FR-P1332 do not interrupt production for worker allowances* and it is satisfied by *DP-P132 mutual relief system with cross-trained workers*. A mutual relief system provides a regimen where a worker or line supervisor temporarily takes over the tasks of another so that an allowance can be taken without disrupting production output. This means that workers should be cross-trained and have the ability to perform tasks that they may be required to perform.



FR/DP #	Functional Requirement	Design Parameter	DP Affects:		
			Human	Machine	Information
P12	ensure predictable equipment output	maintenance of equipment reliability	X	X	X
P13	ensure predictable worker output	motivated workforce performing standard work	X		
P131	reduce variability of task completion time	standard work methods to provide stabilized processing times	X		X
P132	ensure availability of workers	perfect attendance program	X		
P133	do not disrupt production for worker allowances	mutual relief system with cross-trained workers	X		

Figure 49. Summary of FR/DPs for predictable output

### Throughput Time Reduction

Reducing mean throughput time is a primary means for meeting lower customer expected lead-times. The other component of customer lead-time is order lead-time that is considered an external activity to manufacturing in the design decomposition. The system must be capable of satisfying customer demands for rapid time to delivery. The reduction of throughput time is accomplished by minimizing the delays in the manufacturing system. The sources of delays are large run sizes, unbalanced cycle-times between up and downstream processes, large transportation lot sizes, transportation steps in production, and systematic interference that disrupt production flow.

#### *Process Delays from Human Operators*

Process delay occurs when a downstream process is fed parts too quickly and a queue develops. The time that parts spend in a queue results in throughput time delay. The takt time for a system is defined as the customer demanded cycle-time. A production system that operates at takt time produces at exactly the rate that the customer demands product. This means that all cyclic processes should match takt time. This includes the manual work content that humans must perform in the production system. Figure 50 illustrates the hierarchy of FR/DPs that leads to this time requirement on human work content.

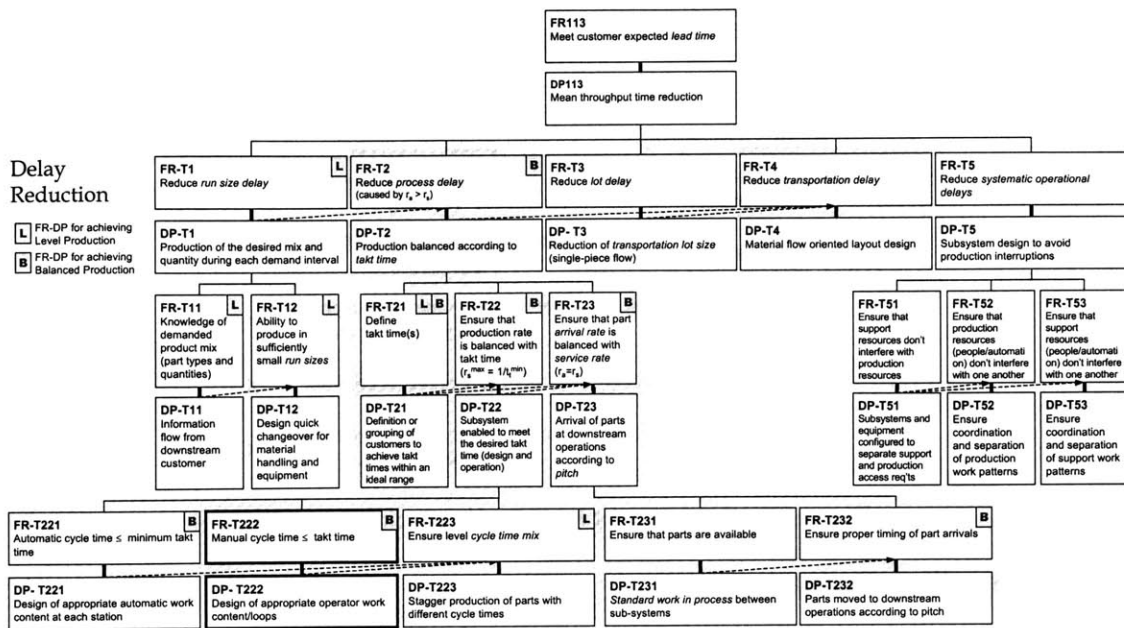

Figure 50. Section of production system design decomposition that is related to delay reduction. Highlighted FR/DPs relate to manual work content [PSD Lab, 1999].

The requirement, *FR-T222 manual cycle-time ≤ takt time*, is satisfied by *DP-T222 design of appropriate operator work content/loops*. The work must be capable of being completed in time less than or equal to takt time. Standardizing the work an operator performs also ensures that for every cycle of manual work the operator consistently finishes the tasks.

FR/DP #	Functional Requirement	Design Parameter	DP Affects:		
			Human	Machine	Information
T222	manual cycle-time ≤ takt time	design of appropriate operator work content/loops	X		

Figure 51. Summary of FR/DP for reducing process delays due to human work content

### Reduce Labor Costs

We now switch branches of the decomposition from increasing sales to reducing production cost. Reducing production costs is one component of the highest level goal, maximize long-term return on investment. We examine in the following sections the sub-

FRs of *DP-12 elimination of non-value adding sources of cost*, which satisfies *FR-12 minimize production costs*. Two large components of non-value adding sources of cost are direct and indirect labor. The design of a human's work environment and the human-machine interaction affect how efficiently the direct labor is utilized. Indirect labor cost reduction also improves the cost-efficiency of the production organization. This affects how much support resources are available for the production lines as well as how information is transferred between resources.

*Direct Labor*

In order to reduce waste in direct labor (*FR-121*), non-value added manual tasks must be eliminated from direct labor work content. *DP-121* has two sub-FRs that should be satisfied in order to more efficiently use direct labor resources. The two main wastes associated with direct labor are operators waiting on machines and wasted motion of operators.

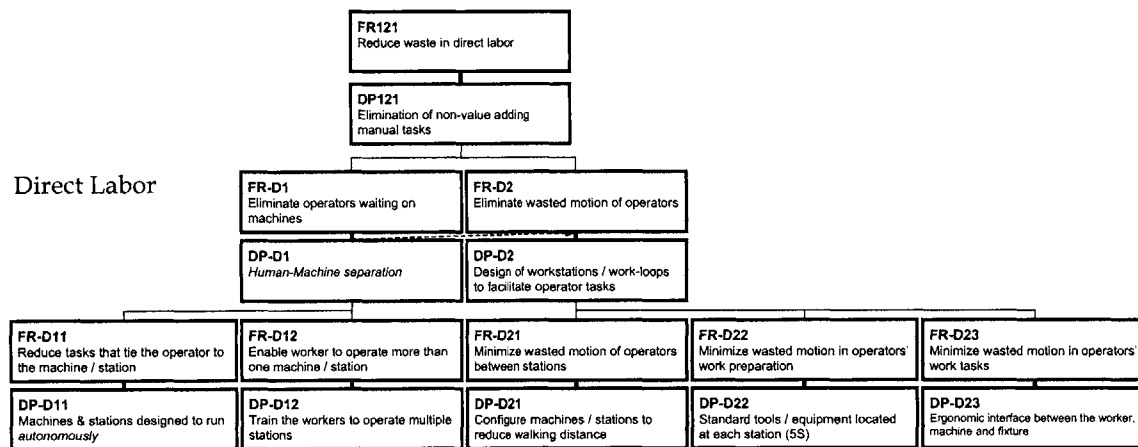

Figure 52. Section of production system design decomposition that is related to direct labor work content and cost reduction [PSD Lab, 1999]

The first sub-FR of *DP-121* is *FR-D1 eliminate operators waiting on machines* and it is satisfied by *DP-D1 human-machine separation*. Instances of operators waiting on machines are very common in manufacturing facilities and it is usually a result of poor machine design. The first sub-FR of *DP-D1* is *FR-D11 reduce tasks that tie operator to the machine/station* and it is satisfied by *DP-D11 machines and stations designed to run autonomously*. Autonomous machines are designed to detect abnormalities and defects

and stop the machine or line when they occur. Machines that do not have this ability to detect abnormalities require human operator's presence to stand vigil over the process to catch abnormal occurrences. This is the first step in achieving true human-machine separation on the production floor. The second sub-FR of *DP-D1* is *FR-D12 enable worker to operate more than one machine/station* and it is satisfied by *DP-D12 train the worker to operate multiple stations*. Multi-skilled workers provide the flexibility that is needed to achieve fully functional human-machine separation. The main benefit of separation is that when an operator leaves an autonomously cycling process he/she would move on and manage a different machine. The other machine could be a completely different process that the operator must be capable of managing. Flexibility in the workforce must be sufficient to meet whatever combination of work the operator may be called upon to complete.

The second sub-FR for *DP-121* is *FR-D2 eliminate wasted motion of operators* and it is satisfied by *DP-D2 design of workstations/work-loops to facilitate operator tasks*. This DP addresses the design of the operator's workspace and the method by which the operator must move in the work environment to provide motion efficiency. The first sub-FR that helps accomplish this is *FR-D21 minimize wasted motion of operators between stations* and it is satisfied by *DP-D21 configure machines/station to reduce walking distance*. This is a specification for machine architecture as well as how the machine is laid out on the floor. The walking distances the operators must walk as they move between machines must be reduced. If there are numerous machines arranged in a line, a narrow frontal area creates less walking distance that an operator must cover. Further, machines placed in a parallel row configuration surrounds the operator with closely spaced machine access points and give the greatest flexibility for work configuration with reduced walking distances (Figure 53).

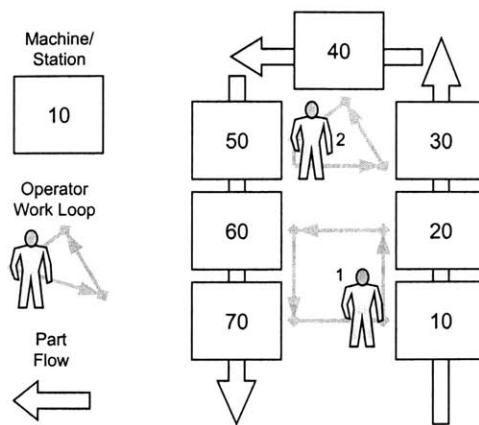

Figure 53. Schematic of machine layout to facilitate efficient operator workloops

The second sub-FR of *DP-D2* is *FR-D22 minimize wasted motion in operators' work preparation* and it is satisfied by *DP-D22 standard tools/equipment located at each station (5S)*. The 5S methods [Monden, 1998] of workplace organization are an effective way to improve efficiency. Tools and equipment should be consistently placed in the same convenient location. Standardizing this activity ensures that other operators are able to use machines that they are less accustomed to. The final sub-FR for *DP-D2* is *FR-D23 minimize wasted motion in operators' work tasks* and it is satisfied by *DP-D23 ergonomic interface between the worker, machine, and fixture*. The layout of the interface for machines should follow good ergonomic guidelines related to clearance, reach, adjustability, visibility and line of sight, and component arrangement [Wickens, 1998] to ensure that unnecessary worker motions do not result. Interface consistency across machines is important as well. This is sometimes difficult to achieve since machines can be supplied from different machine builders and then integrated into a single subsystem. This scenario can result in very different interface characteristics as operators manage these differing machines.

DP Affects:

FR/DP #	Functional Requirement	Design Parameter	Human	Machine	Information
D1	eliminate operators waiting on machines	human-machine separation	X	X	
D11	reduce tasks that tie operator to the machine/station	machine and stations designed to run autonomously		X	
D12	enable worker to operator more than one machine/station	train the worker to operator multiple stations	X		
D2	eliminate wasted motion of operators	design of workstations/work-loops to facilitate operator tasks		X	
D21	minimize wasted motion of operators between stations	configure machines/stations to reduce walking distance		X	
D22	minimize wasted motions in operator's work preparation	standard tools/equipment located at each stations (5S)		X	
D23	minimize wasted motion in operators' work tasks	ergonomic interface between the worker, machine, and fixture		X	

Figure 54. Summary of FR/DPs for direct labor cost reduction

*Indirect Labor*

In order to reduce waste in indirect labor (*FR-122*), the elimination of indirect labor tasks wherever possible should be pursued. Indirect labor is typically non-value-added work and it should be eliminated if it does not actively benefit the process. Some indirect labor may serve a support function that adds value and in that case should exercise efficient activities. Other middle-managerial roles and redundant supporting services should be eliminated to reduce operational costs. *DP-122* has two sub-FRs that should be satisfied in order to further reduce indirect tasks and create a more lean operational organization. The first sub-FR deals with the role production workers play in the system.

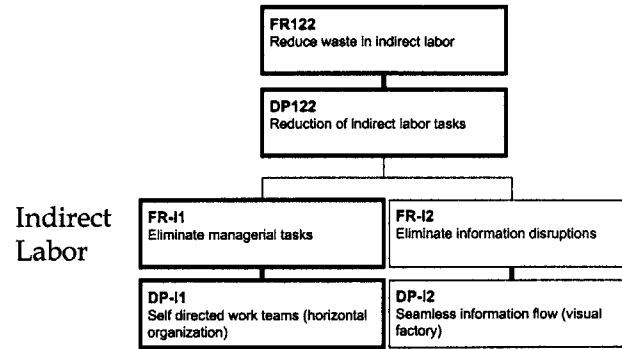

Figure 55. Section of production system design decomposition that is related to indirect labor cost reduction [PSD Lab, 1999]

*FR-11 eliminate managerial tasks* that is satisfied by *DP-11 self-directed work teams (horizontal organization)*. This FR/DP is discussed here because it gives reason to the increasing responsibility of production employees. As organizations become more horizontal, a greater range of responsibility exists at each level of the organization, including the production employees who operate equipment in the classically direct labor role.

FR/DP #	Functional Requirement	Design Parameter	DP Affects:		
			Human	Machine	Information
11	eliminate managerial tasks	self-directed work teams (horizontal organization)	X		

Figure 56. Summary of FR/DP for indirect labor cost reduction

### Summary

The production system design decomposition is useful to describe the requirements on machine, human work, and information in a production system. Each design requirement and design solution is related to high-level production system goals. Extracting the requirements that relate to human-machine interaction can be useful for generating requirements during the equipment design process. Further, the requirements are used in the following section when constructing a model of human-machine interaction for a specific form of production subsystem design.





# Chapter 5. Model for Human-Machine Interaction in Manufacturing Cells

---

## Introduction

Designing equipment for manufacturing systems requires consideration of a broad range of design requirements. The goals of a production system design (PSD) [Suh, et al., 1998] as well as particular process specifications derived from product design (PD) determine the design requirements for manufacturing equipment [Arinez and Cochran, 1999]. Since equipment ultimately ends up in the hands of production employees who manage it as cell operators, the equipment design determines how well an operator may observe and manage the manufacturing process. Better consideration of the worker in system design is needed to achieve broader production system goals [Plonka, 1997]. Therefore equipment designers can benefit from a model that describes the nature of this human-machine interaction, and which captures best practices within a framework for human-machine systems behavior.

This section describes the process by which a human-machine interaction model based on supervisory control is developed. A model of such an environment relates to the equipment design process by explicitly capturing the design requirements that are handed down from both PSD and PD methodologies. Such a model helps equipment designers satisfy requirements so that they may improve the quality of work and the quality of output due to improved human-machine interaction.

Supervisory control [Sheridan, 1992] has been demonstrated as representative of the human-machine system in flexible manufacturing work environments [Hwang et al., 1984; Mårtensson, 1996]. Human-machine interaction (HMI) in manufacturing cells is modeled using the supervisory control paradigm as a basis for describing the operator's

work content. The model describes the operator's functions and the mechanisms by which the operator receives process-state feedback, and takes action based on feedback. This model can be valuable to equipment designers who require explicit knowledge of the desired HMI in order to configure machines and processes properly.

One of the pundits of the Toyota Production System, Shigeo Shingo, states that "under normal conditions there is no need to have an operator stand by the machine." Further, he believes this can be achieved when "functions of the human mind, in addition to functions of the human hand, are transferred to machines" [Shingo, 1989]. This can be taken to mean that more autonomous, closed-loop processing must occur internal to the machine. Eliminate not only arduous tasks, but also some of the tasks that require unnecessary amounts of operator vigilance. In response to these notions, manufacturing equipment needs to become, not just automated, but intelligently automated. This notion of automating failure diagnostics, or trouble detection, is sometimes called *autonomation*. How humans interact with *autonomated* machines, and groupings of *autonomated* machines, can be related to studies in man-machine systems, specifically human supervisory control.

### **Supervisory Control**

Supervisory control is the study of the human-machine system where a person supervises a machine with some element of autonomous, closed-loop, decision-making capability. Some of the primary goals for the continued development of supervisory control are "to achieve the accuracy and reliability of the machine without sacrificing the cognitive capability and adaptability of the human" and "to eliminate the demand for continuous human attention and reduce the operator's workload" [pp. 11-12, Sheridan, 1992]. These ideas agree with Shingo's notions of automation design, and in doing so, support the operational philosophy of the Toyota Production System.

Sheridan describes supervisory control in its most basic form as a type of teleoperator control. A teleoperator is a machine that extends a person's sensing and/or manipulating capability to a location remote from that person. In the model, a human operator interacts with a computer (HIC, Human Interactive Computer) that links, through a barrier, to

another computer (TIC, Task Interactive Computer) that instructs a teleoperator how to complete a task. A barrier can consist of time, space, or even inconvenience.

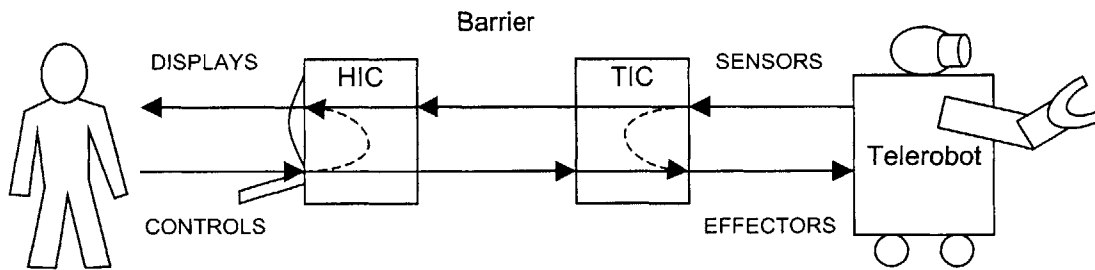

Figure 57. Schematic of telerobotic supervisory control. Barrier represents time, distance, or inconvenience [Sheridan, 1992].

The link between the computers communicates instructions that trigger programmed teleoperator action. The TIC is able to make pre-programmed, feedback-based decisions without relying on the HIC or human operator. This way, the human is out of the control loop for completion of the task. In this most basic scenario, the operator relies on automation and computers to facilitate the completion of a task. This operating scenario assumes certain requirements on the HIC and TIC. The HIC must be operator friendly and, in its design, be considerate of the skills and capabilities of the operator. The TIC must be process capable. This means that it must be able to perform an instructed task in a closed-loop fashion with sufficient combination of actuation and sensing. This scenario was originally conceived for describing the remote control of teleoperated lunar exploration vehicles whose barrier is that of distance and the inherent signal time delay that is close to three seconds.

The application of the supervisory control paradigm to manufacturing systems requires the consideration of the analogous system of HICs and TICs. In manufacturing systems, the barrier may be a result of work hazards associated with the process, but typically the TIC and HIC are integrated into the controller subsystem of the entire piece of production equipment. The human operator receives state information from the machine displays, physically interacts with the machine through control inputs, and performs manual tasks. The operator also has supporting information and instructions to rely on when needed, and possesses skills gained through training and prior experience (Figure 58).

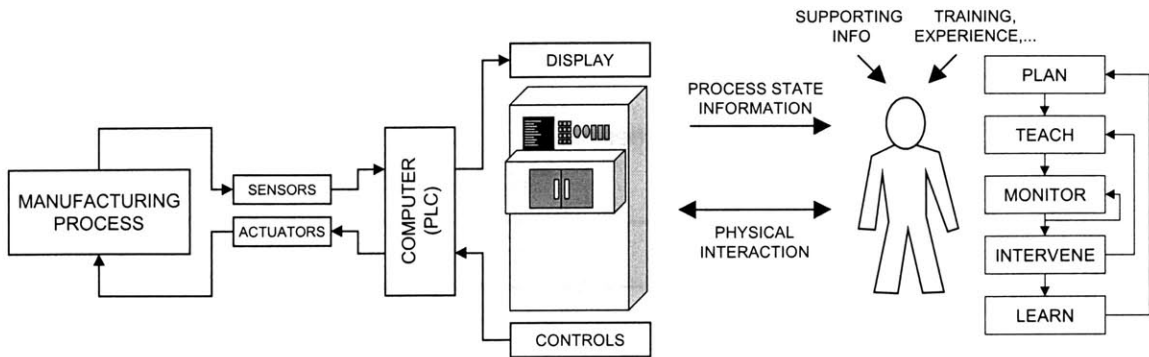
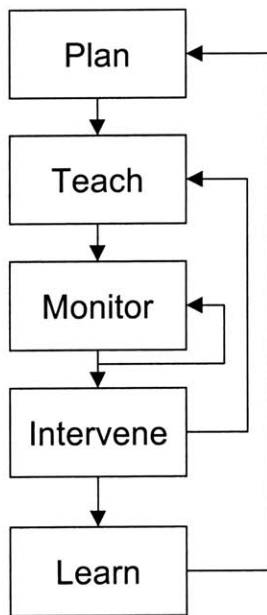

Figure 58. Top-level model of human-machine interaction in a semi-automated, supervisory control manufacturing environment

### Five Supervisory Functions

The supervisory control paradigm consists of five supervisory functions that an operator performs during its interaction with automated equipment (Figure 59).



1. Planning – includes understanding the physical process to be controlled, setting goals and tradeoffs, and the formulation of the strategy for achieving the goal-state.
2. Teaching – involves programming computers and setting the automation to perform the set of goals set forth in the planning stage.
3. Monitoring – the operator ensures that the task is completed properly performs monitoring. She may observe the task directly or through sensing and display aids, and she must be capable of detecting and responding to failures or conflicts in achieving the goal.
4. Intervening – should take place if the automation performs a task improperly or detects a need for operator assistance. The human should be capable of assuming manual control if possible, or updating the instructions to correct for undesired system behavior.
5. Learning – is a result of collecting information on how the system performs continuously and analyzing it to predict and account for future abnormalities.

Figure 59 Five supervisory control functions [Sheridan, 1992]

*Iterative Supervisor Function Loops*

The five supervisory functions can be viewed as nested control loops [Sheridan, 1992]. Monitoring closes back on itself and represents the immediate interaction that an operator has with her task. Tasks usually consist of reacting to cues from the environment in order to carry out and perceive normal system operation. The second loop shows how intervening should lead to teaching or rather reprogramming the process to correct for a disturbance. This comes when the operator finds the process is not optimal and must be adjusted to better match the intended process. The third and outer-most loop takes lessons learned from data observation and memory, and feeds them back into the planning or redefinition of goals and strategies. This is a higher level improvement, or optimization process based on what was learned from operating in the old system.

In the supervisory control-based HMI model for manufacturing cells, the operator assumes each of the five supervisory functions. The functions have a nested feedback relationship that correspond to an operator's behavioral role – skill-based, rule-based, and knowledge-based. These loops are herein referred to as behavior loops (BL). These behavior loops (Figure 60) represent the iterative nature of the five functions that the operator performs. This iterative process is the key in understanding how this HMI model accounts for process control and continuous improvement. It is through this iterative process that system correction and improvements are implemented.

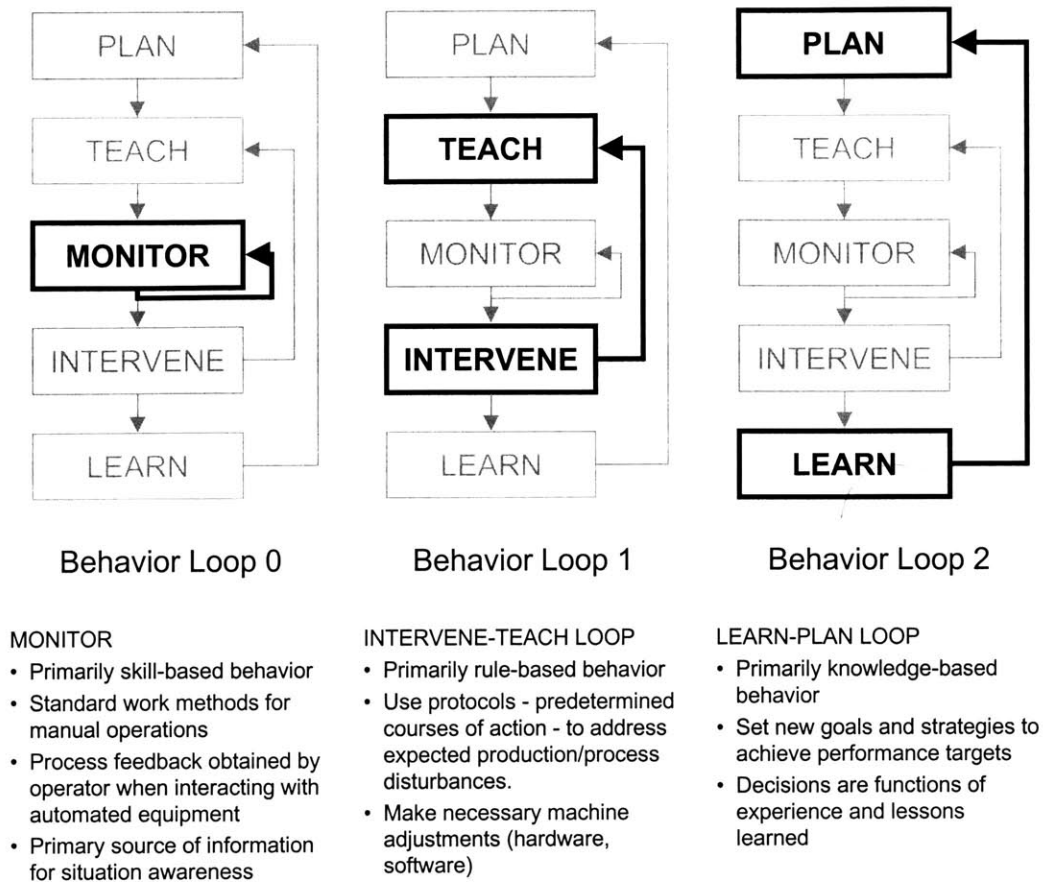

Figure 60. The three supervisory behavior loops. This iterative feature of supervisory control is how processes are controlled and the system is improved.

In a production environment, the operator frequently follows standard work-routines. These tasks adhere to standard work patterns. Inherent in the performance of the prescribed work is an operator's familiarity and functional capability to operate specific types of equipment. Monitoring, BL-0, is typically a skill-based function where the skill is acquired through training regimens and experience where once methods that were consciously executed become more routine and a natural response to environmental cues.

The intervene-teach loop, BL-1, is primarily rule-based behavior. The operator falls into BL-1 at the occurrence of a process disturbance at which point she follows a protocol or procedure for repairing or rectifying the disturbance. In a production setting, these disturbances are likely to have been predicted by a failure mode and effect analysis (FMEA), and have solutions prescribed that an operator simply needs to follow. There are numerous instances where a process may be disturbed, that committing all the

responses to operator memory is not practical. Further, automating BL-1 can prove costly due to the number of possible response algorithms needed. As a rule-based activity, a human has the flexibility to respond quickly and carry out a wide range of corrective actions ranging from simple maintenance, hardware adjustments, or software-based adjustments.

The learn-plan loop, BL-2 is where the benefits of an operator's cognitive ability are realized. The operator is able to draw on intuition and observation based on data recorded through the learn function. After collecting and understanding this information, the operator is well suited to make decisions in the plan stage. Planning is the process through which an operator can affect change in the system goals and strategy, drawing from the experience learned during system operation. The human's role of observing recorded data, looking for trends and abnormalities, and determining new strategies for operation based on the observances is the key element of knowledge-based behavior contained in BL-2.

Supervisory control is a generalized model for describing some types of human-machine systems. Much of the work in human-machine systems is focused on applying generalized paradigms to specific types of human-machine systems. The following discussion elaborates on the interaction between human and machine in a manufacturing work-cell, like those described in Chapter 3, and presents the work in the form of a model. The model is a synthesis of production system design requirements, product design process variables, and the supervisory control paradigm. The design parameters from Chapter 4 are mapped into categories that are practical for the modeling of BL-0, BL-1, BL-2, and these loops' nested behavior.

### **Synthesis of Human-Machine Interaction Model**

The HMI model is constructed with the goal of capturing system design features that are unique to production systems. The synthesis of the model includes the integration of a production system design methodology, specific product design processing requirements, and a framework for human-machine interactions (Figure 61). The axiomatic design methodology for system design allows the functional requirements and design parameters

to be allocated across the constituents of human-machine system, capturing the production system goals. This is analogous to the process of *knowledge engineering* that is described as a critical component of a methodology for human-machine systems research [Jones, et al., 1995]. The goal is to acquire first hand insight into how humans perform work in a particular complex system. The knowledge engineering process is also used to uncover the components and system configuration specific to the environment being analyzed.

The FR/DPs that affect human work content, machine design, and information to the operator were discussed in Chapter 4. A FR/DP is categorized under human-work content if the DP influences the operator’s ability to perform the tasks associated with operator functions. A FR/DP is categorized under machine design if the DP describes a feature or characteristic that must be designed into equipment. A FR/DP is categorized under information of the DP concerns the content and type of information or supporting knowledge the operator needs to complete a task. These FR/DPs are then subcategorized across Rasmussen’s human behaviors, which translate to the supervisory behavior loops (Figure 61).

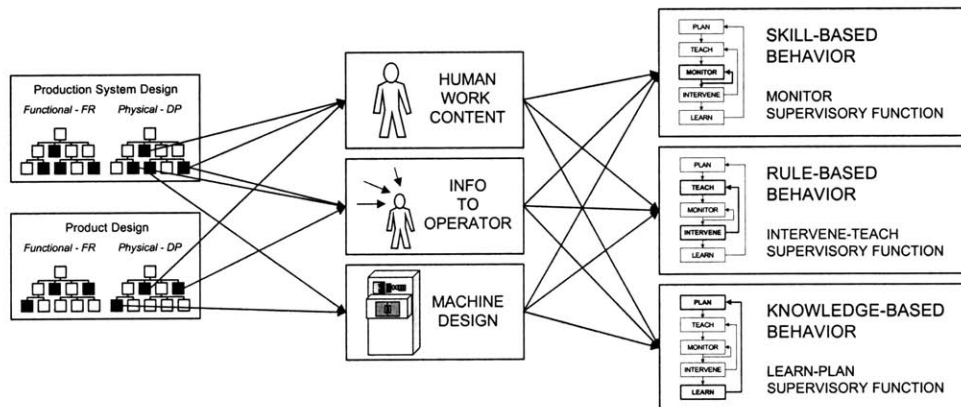

Figure 61. Process of taking production system design FR/DPs and mapping them first as in Chapter 1, then to the supervisory control functional behaviors

Using the behavioral abstraction as a basis for describing the work environment is consistent with other methodologies that require such a framework, such as ecological interface design [Vicente and Rasmussen, 1992]. It is useful because it is both psychologically relevant and focuses on the efforts of humans to deal with disturbances, a key system performance driver.



Jones, et al. [1995] describes another key component for researching man-machine systems is the construction of a *normative model of operator function*. Four conceptual dimensions are proposed for constructing such a model – purpose (descriptive or normative/prescriptive), structure (conceptual or computational), content (cognitive or behavioral), and specificity (general or case-specific). Jones argues that for a model to be useful for design it should be normative, i.e. it should specify a type of human operative scheme. The model should also be computational in nature, i.e. the model should be useful for taking inputs and fielding a deterministic output. The model should also be task-relevant, i.e. it should communicate an operating scheme for the specific system being designed. Finally the model should blend both behavioral and cognitive elements of the operator's work.

The modeling efforts described in this work satisfy each of Jones' specifications to ensure that the model is useful for design. Each BL, and their nested behavior, is described using various modeling techniques. At a fairly high level is an annotated description of human work content that is desired in a cellular manufacturing system along with machine features/characteristics, the physical interaction, and desired information flow to the operator. System block diagrams are used to show the type of interaction that should exist between an operator and multiple machines over time. System block diagrams are also used to show how the supervisory functions interact directly with a manufacturing process, and how that scenario is related to the optimal control model of human-machine process control.

A key component of the optimal control model described in Chapter 1 is the operator's internal process model. Each manufacturing process contained in a manufacturing work-cell is modeled by an operator, either subconsciously or consciously. The operator of a process maintains her own internal process models. These models are formed through a combination of acquired state knowledge, training, and experience. As internal process models, or *mental models*, they reside within an operator and serve as the model that the operator compares to the observed state, a form of state estimator, while carrying out the functional roles.

### *The Nature of Mental Models*

A mental model, as it applies to human-machine systems, represents the human reasoning about a process. [Williams et al, 1993] describe the primary features of a mental model. They believe mental models should be autonomous, connected, runnable, and decomposable. Autonomous means that the model must be composed of objects that have their own internal calculus. Connected implies that the interaction of the objects needs to be lawfully constrained. Runnable means that following a chain of consistent logic can draw a set of conclusions. And finally, a mental model should be decomposable in that its higher level object can be derived by the behavior of lower level objects. A simple notion of a mental model is some transfer function that resides in the brain of an operator that takes a set of inputs which the operator perceives and translates them to outputs that the operator then acts to carry out. The mental models may be qualitative in nature, these being used to describe cause and effect relationships with no direct mathematical relation to draw on. An example of a qualitative mental model would be a schematic of a machining center that describes the controls and the actuators that are effected by each one. Quantitative mental models describe cause-effect relationships between proportional output variables and incremental inputs. An example of a qualitative mental model for metal cutting would be a table of tool feed-rates to process cycle-time. An operator could understand how changing a process parameter has implications on production rate.

### **Model – Part 1 of 4, Skill-Based HMI (BL-0)**

The FR/DPs for human, machine, and information that pertain to the human-machine interaction under BL-0 are shown in Figure 62. The FR/DPs were allocated across the human behavior loops by considering how the DP influenced the human-machine interaction. The FR/DPs that are associated with skill-based tasks are those whose DPs – either through machine design, human work content, or information – affect how an operator performs processing tasks and monitors automated processes.

FL0 - Human Work Content			FL0 - Machine Design		
D1	eliminate operators waiting on machines	human-machine separation	D1	eliminate operators waiting on machines	human-machine separation
D12	enable worker to operator more than one machine/station	train the worker to operator multiple stations	D11	reduce tasks that tie operator to the machine/station	machine and stations designed to run autonomously
P12	ensure predictable equipment output	maintenance of equipment reliability	D2	eliminate wasted motion of operators	design of workstations/work-loops to facilitate operator tasks
P13	ensure predictable worker output	motivated workforce performing standard work	D21	minimize wasted motion of operators between stations	configure machines/stations to reduce walking distance
P131	reduce variability of task completion time	standard work methods to provide stabilized processing times	D22	minimize wasted motions in operator's work preparation	standard tools/equipment located at each stations (5S)
P132	ensure availability of workers	perfect attendance program	D23	minimize wasted motion in operators' work tasks	ergonomic interface between the worker, machine, and fixture
P133	do not disrupt production for worker allowances	mutual relief system with cross-trained workers	P12	ensure predictable equipment output	maintenance of equipment reliability
Q122	operator consistently performs tasks correctly	standard work methods	Q123	ensure operator human errors do not translate to defects	mistake proof operations
R112	identify disruptions when they occur	increased operator sampling of equipment status	FL0 - Information		
T222	manual cycle-time <= takt time	design of appropriate operator work content/loops	P12	ensure predictable equipment output	maintenance of equipment reliability
Q121	operator has knowledge of required tasks	training program	P131	reduce variability of task completion time	standard work methods to provide stabilized processing times
			Q122	operator consistently performs tasks correctly	standard work methods
			Q123	ensure operator human errors do not translate to defects	mistake proof operations
			Q2	determine capability of process	measure current process
			R112	identify disruptions when they occur	increased operator sampling of equipment status

Figure 62. FR/DPs that apply to skill-based HMI model

Human-machine interaction is described as the physical interaction as well as the information that is transferred from the environment to the operator. The human operator must also receive adequate training for the tasks and responsibilities that they are required to perform. The machine should possess certain characteristics that aid the operator both in receiving process state information and in physical interactions. Figure 63 shows the human-machine environment and labels the features of human-machine interaction that result from the FR/DP analysis. This interaction describes the relationship of an operator with one particular piece of equipment.

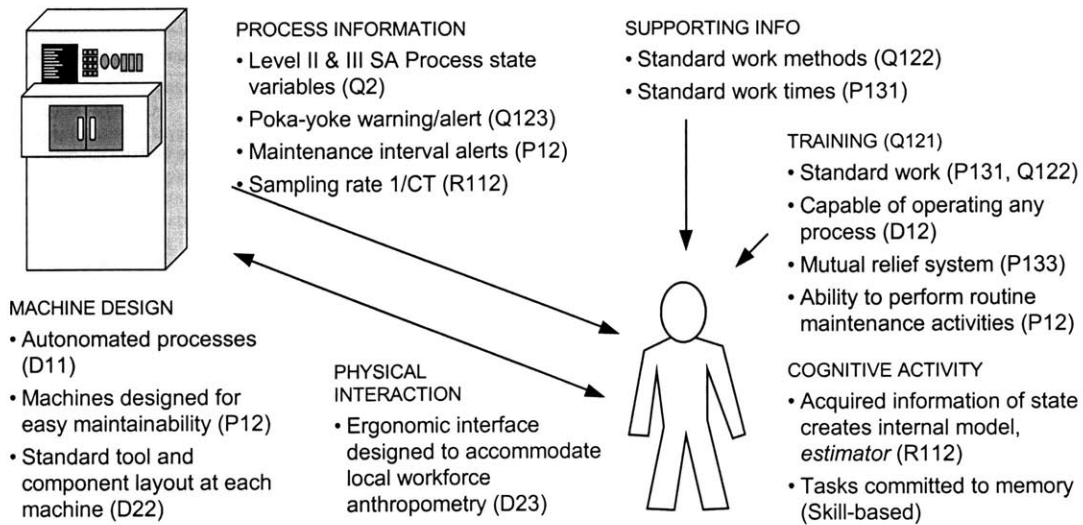

Figure 63. Annotated interaction between human and machine during skill-based behavior, where supervisor is a monitor of process as well as process operator

This relationship can be multiplied by as many machines or pieces of automated production equipment that an operator may manage. The operator may perform manual tasks at the station before initializing an automated process. Once the automated processing is complete, the operator may then resume some manual work tasks before the part is transferred to the next step.

This relationship of an operator that manages multiple automated processes is describe by a common concetual model (CCM) [Vakil and Hansman, 1998]. These types of models are useful for describing automation, and in this case the concept of humans interacting with multiple units of automation. This CCM (Figure 64) describes the concept of human-machine separation and illustrates the use of autonomated processes. Autonomated processes are ones that are self-diagnostic. If a disturbance arises, they halt processing – avoiding defect production – and alert the operator to the disturbance, initiating a response for resolving the problem. The manual work tasks are also error proofed and unless acceptable quality is achieved, the manual work cannot, and should not, proceed. Once the operator completes the manual work tasks and initiates the autonomated process at one station, then the operator moves to another piece of equipment that would employ the same operating scenario, and would repeat until returning to the first process and completing the workloop. The requirement is that the

sum of manual work time – from the entire workloop – must be less than or equal to the operating takt time of the sub-system.

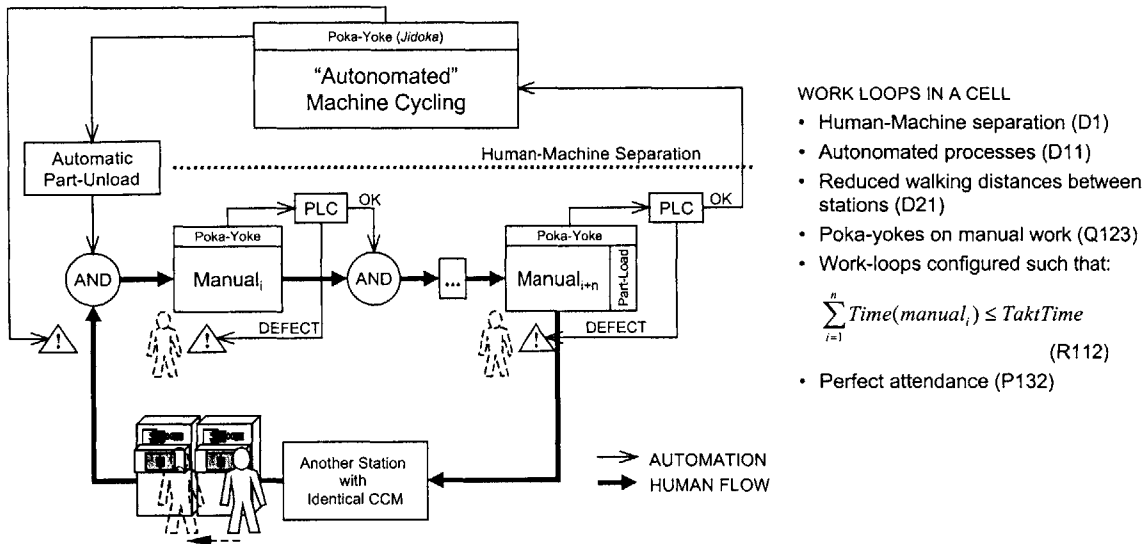

Figure 64. Common conceptual model of operator in a manufacturing cell handling multiple automated machines

The operator is not only a part of the process, as shown by the manual work tasks, but also a monitor of the process. As the operator moves from station to station, and interacts with the equipment, the opportunity exists for state information to be communicated to the operator (Figure 65).

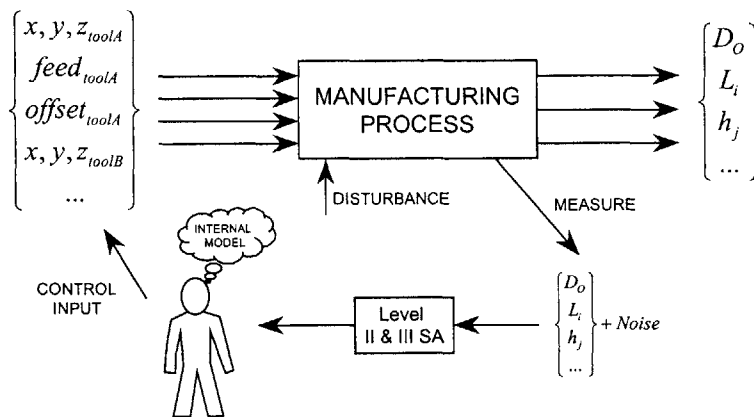

Figure 65. Operator that receives manufacturing process-state information

The information when possible should be presented in Level 2 or Level 3 SA forms. This means that the automation should perform some measure of applying context to the raw process state information. The hypothesis is that by doing so, the operator has more goal-

oriented information that can more readily be compared to the internal model. In this case, the operator compares the process's state – as estimated through observed state variables – against her own internal model of what the process's state should be. The internal model is influenced by the amount of supporting information that is supplied to the operator. This includes standard work sheets that communicate process steps as well as specific goals for each task, i.e. a product's specifications and control plan. The operator also possesses a history of prior control inputs due to disturbances. The internal process model that an operator possesses guides the actions of an operator as she monitors the process. If a discrepancy exists between observed process-state and expected process-state, then the operator intervenes and moves into rule-based BL-1.

**Model – Part 2 of 4, Rule-Based HMI (BL-1)**

The FR/DPs for human, machine, and information that pertain to the human-machine interaction under BL-1 are shown in Figure 66. The FR/DPs that are associated with rule-based tasks are those whose DPs – either through machine design, human work content, or information – affect how an operator recognizes disturbances, intervenes, and then resolves the disturbance by interacting with the affected subsystem.

FL1 - Human Work Content			FL1 - Information		
P12	ensure predictable equipment output	maintenance of equipment reliability	P12	ensure predictable equipment output	maintenance of equipment reliability
R13	solve problem immediately	standard method to identify and eliminate root cause	Q123	ensure operator human errors do not translate to defects	mistake proof operations
Q121	operator has knowledge of required tasks	training program	R11	rapidly recognize production disruptions	subsystem configuration to enable operator's detection of disruptions
FL1 - Machine Design			R113	identify nature of disruptions	context sensitive feedback
D23	minimize wasted motion in operators' work tasks	ergonomic interface between the worker, machine, and fixture	R12	communicate problems to the right people	process state feedback system
P12	ensure predictable equipment output	maintenance of equipment reliability	R121	identify correct support resources	specified support resources for each failure mode
Q123	ensure operator human errors do not translate to defects	mistake proof operations	R122	supply descriptive information to support resources	system that conveys nature of problem
R113	identify nature of disruptions	context sensitive feedback	R123	minimize delay in contacting support resources	rapid information transfer system
			R13	solve problem immediately	standard method to identify and eliminate root cause

Figure 66. FR/DPs that apply to rule-based HMI model

Figure 67 shows the human-machine environment and labels the features of human-machine interaction, integrating the FR/DPs from production system design that primarily deal with *identifying and resolving problems*, but also some from *quality and predictable output*.

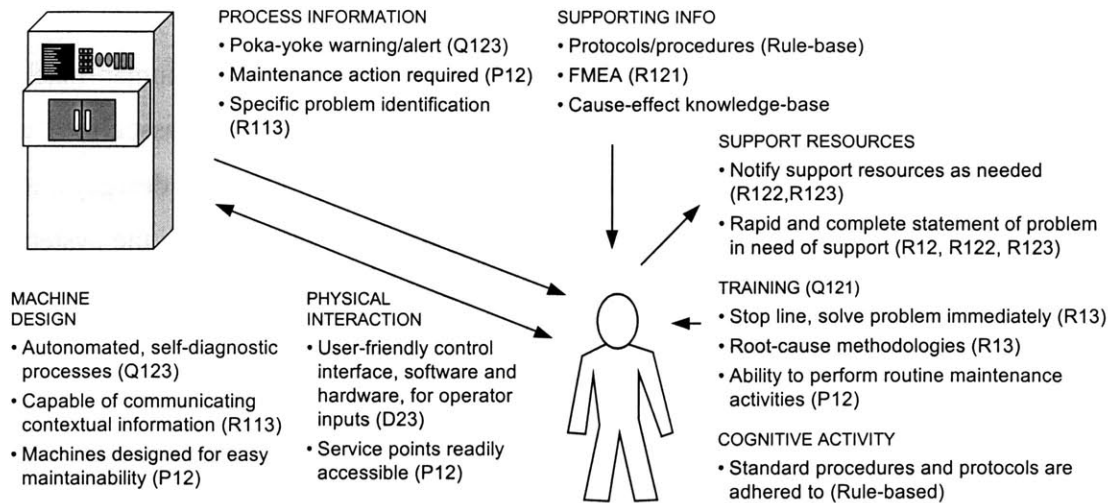

Figure 67. Annotated interaction between human and machine during rule-based behavior, where supervisor intervenes and follows procedures to rectify problem and inputs any adjustments or performs required servicing activity (teach)

A very important piece of the rule-based behavior model is that a significant amount of supporting information is required for an operator to perform the intervention and teaching functions. Procedures and protocols must be available to the operator so that action can be taken in a timely manner. Part of a manufacturing system design process should include the creation of supporting documentation in order to support these activities. In order to support an operator's assessment of the process disruption, some information on cause-and-effect relationships should be provided. Failure mode and effect analyses contain this type of information. FMEAs, or similar records, should be maintained as new failure modes are encountered in order to aid in dealing with recurrences.

Machines should be designed with user-friendly interfaces so that reprogramming the logic or making an adjustment is completed with minimal effort. Maintainability of the machines should be considered a primary way to improve efficiencies. A machine that is easy to maintain – efficient user interface for control inputs, easy access to service points, minimal tooling required for adjustments, etc. – reduces the amount of time an operator spends in the “teaching” function.

**Model – Part 3 of 4, Knowledge-Based HMI (BL-2)**

The FR/DPs for human, machine, and information that pertain to the human-machine interaction under BL-2 are shown in Figure 68. The FR/DPs that are associated with knowledge-based tasks are those whose DPs – either through machine design, human work content, or information – affect how operators approach their role in the system as the primary source of improvement ideas and how they seek to make improvements based on experiences and lessons learned.

FL2 - Human Work Content		FL2 - Information	
Q121	operator has knowledge of required tasks	training program	R13
Q3	improve capability of process	design of experiments	standard method to identify and eliminate root cause
R13	solve problem immediately	standard method to identify and eliminate root cause	

Figure 68. FR/DPs that apply to rule-based HMI model

A fine distinction lies between BL-1 and BL-2. BL-1 is how an operator departs from normal operation to fix a problem that may have been predicted or accounted for through good system design. BL-2 is how an operator solves problems that were not expected or predicted, discovers why they occurred, records/learns, and sets new goals/strategy/methods for avoiding recurrence. BL-2 can also initiate improvements based on experiences accrued over a long period of time, where an operator can adjust goal, strategies, and methods to better their work environment or improve the system’s performance. Figure 69 shows the operator with the equipment, however some of this activity may be done with the support of other operators and manufacturing engineers possibly as part of a continuous improvement (*kaizen*) program [Monden, 1998].



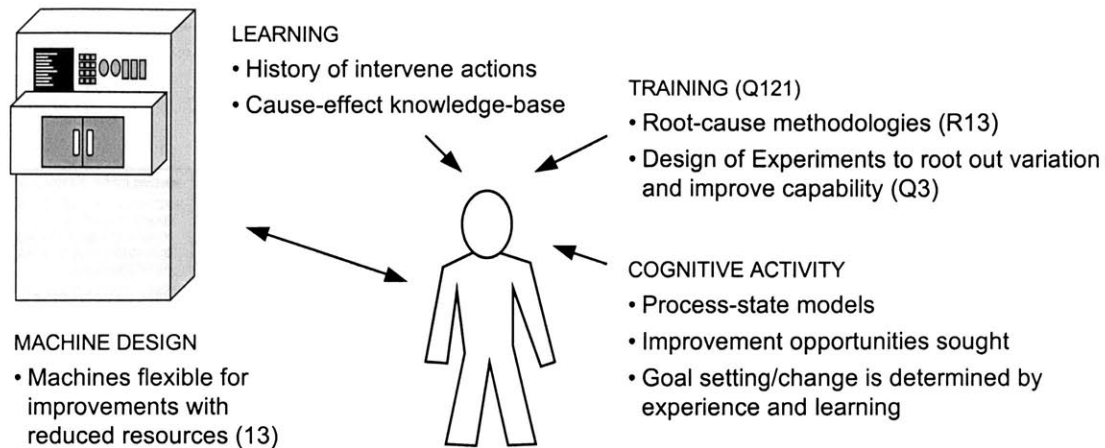

Figure 69. Annotated interaction between human and machine during knowledge-based behavior, where supervisor draws on lessons learned and executes plans for improving work/capability

The operator should possess basic skills in root-cause identification methodologies, as well as design-of-experiments [DeVor, et al., 1992; Tang and Pruett, 1994] methods that can help to identify sources of variation and disturbances in a manufacturing process. Sometimes these activities are guided by senior engineers, but with the operator as a key component of the human-machine system, the voice of the operator is critical to their success in guiding improvements. From this model of human-machine interaction, it can be seen how the operators possess experiences and insight into the manufacturing process and system, which makes them valuable components of kaizen activities, and even system design.

#### **Model – Part 4 of 4, Nested Interaction of Behaviors**

The first three components of the HMI model describe human-machine interaction for Rasmussen's three human behaviors within the framework of supervisory control functions. The integration of these three interaction models is done by looking further at the nested behavior of the BLs for the five supervisory functions (Figure 70).

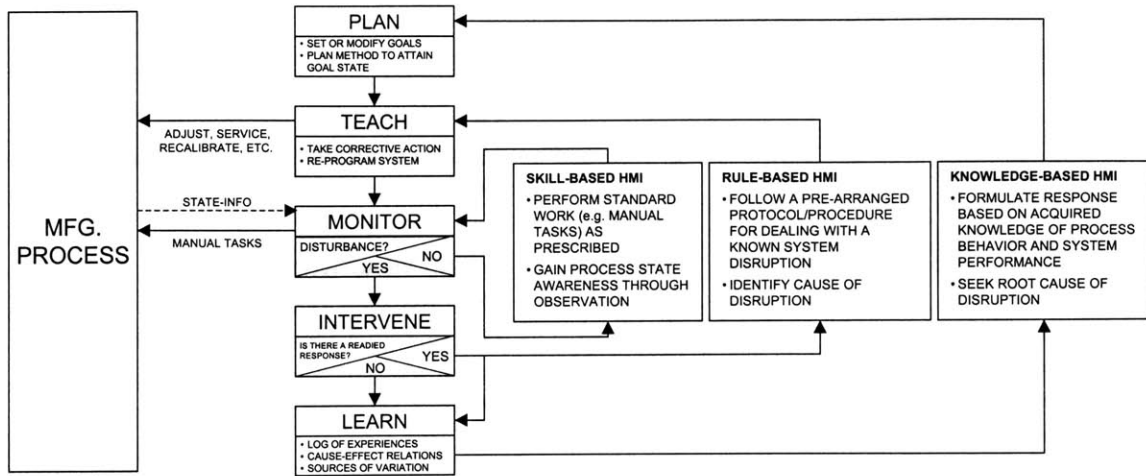

Figure 70. Nested supervisory control HMI model for three behavioral HMI models. Parts 1, 2, and 3 of the HMI model reside in the three boxes that describe each of the three nested loops

Under normal processing in a manufacturing cell, the operator is a monitor of the production system processes as well as an operator for manual work-tasks. During this process (BL-0), the cell operator gains process-state awareness and performs value-adding operations. If a disturbance is detected by the automated processes, poka-yokes, or through direct observation, the operator stops normal operation (Intervenes) and executes a procedure for dealing with the disturbance to production flow (Teach). If there is not a readied procedure for solving the problem, the operator documents the occurrence and trouble-shoots to identify root cause (Learn). Then the operator performs/participates in a process to formulate a corrective action (Plan), and then implement the plan through adjusting the system settings (Teach). At this point the operator becomes a monitor of the system that has once again resumed normal function.

### Summary

An axiomatic design based production system design decomposition is part of a systematic methodology to synthesize a model of the human-machine interaction in manufacturing work-cells that satisfies a firm’s high-level production system design goals. The production system design requirements are superimposed against the supervisory control paradigm to model the HMI specific to manufacturing work-cells. The model captures the methods and functions that enable an operator to control process

quality, deal with variable system behavior, and provide value to the continuous improvement process.



## Chapter 6. Application of the HMI Model to an Axiomatic Design Framework

---

### Equipment Design Methodology

A methodology for generating an equipment design decomposition is described by Arinez and Cochran [1999a]. The process conforms to the general axiomatic design decomposition methodology [Tate, 1999], but also considers the means by which an equipment designer obtains sub-FRs for the decomposition of an equipment design parameter. Arinez and Cochran assert that equipment design sub-FRs are influenced by the production system and product designs' functional and physical decompositions. This conceptualization is reviewed in Chapter 2, (page 20) and [Arinez and Cochran, 1999a].

The integration of a model for human-machine interaction into this process supports the usefulness of such a model for equipment designers. It is also a demonstration of the computational value [Jones et al., 1995] of the HMI model developed in the last chapter. An equipment designer can consider the HMI model in the process of generating sub-FRs for ED (Figure 71). This "consideration" may be rigorous and quantitative, but it may also be "considered" more qualitatively as a designer exercises better judgement about any given decomposition/design decision. In either case, the model yields a greater understanding and awareness to equipment designers of human-machine interaction in a specific type of production environment. This process is applicable for various types of HMI models, but is discussed here in the context of supervisory control manufacturing work-cells.

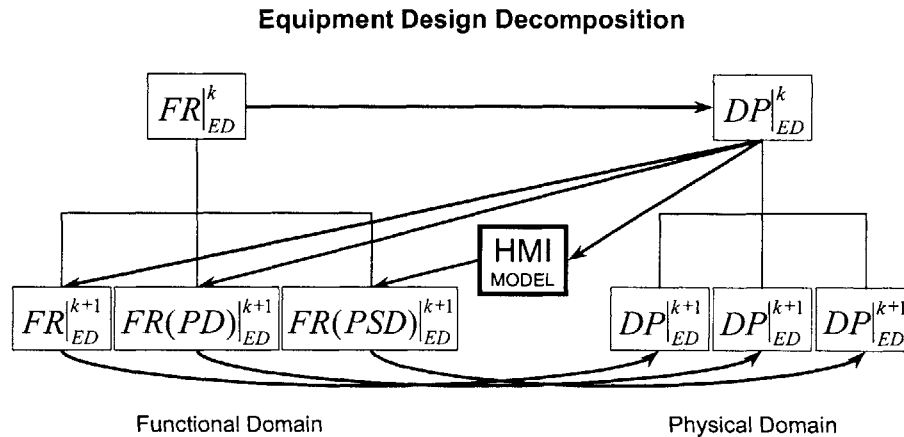

Figure 71. HMI model benefits equipment designers when determining sub-FRs for an ED DP.

Since the HMI model incorporates PSD DPs in order to satisfy production system goals, the consideration of the model in ED decomposing spawns sub-FRs that define the design of equipment more suitable to production system goals. If the HMI model represents a cellular manufacturing system, the equipment is designed with functional requirements that dictate how the machine integrates into a cell. The resulting machine can be characterized by its conformance to production system goals and representative of machines needed to achieve human-machine interaction approaching the model.

The applicability of an HMI model to the ED process is illustrated in the following examples that pertain to the axiomatic design of an assembly station. Suh's claim that human-machine interaction occurs at many levels of a design [Suh, 1998] are supported by the station's resulting design decomposition. The station (Figure 73) is one in a series of stations that are arranged into a cell for the sequential, single-piece-flow assembly of AC compressors like the one described in Chapter 2. The station's primary function is to align and mate the front head (FH) to the rear plate-center housing (RP-CH) subassembly.

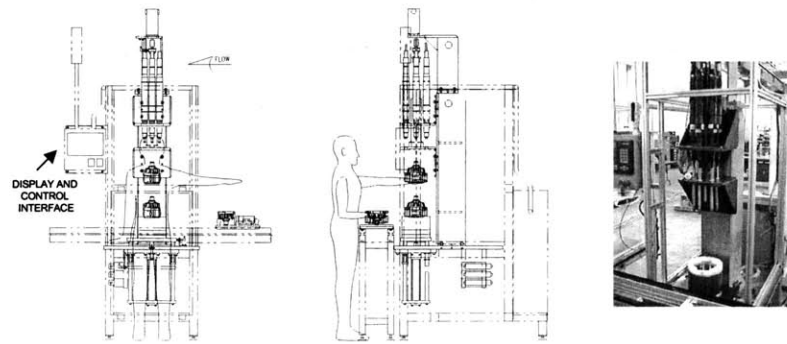

Figure 72. Assembly station design for aligning and fastening front head to rear plate/center housing subassembly

*Example 1 – Use of HMI Model in Obtaining High-Level Sub-FR*

The top-level functional requirement for equipment design is to ensure the performance of the specified process, in this case  $FR-1|_{ED}$  join FH to RP-CH subassembly. The HMI model is used to decompose the top-level DP for the assembly station,  $DP-1|_{ED}$  semi-automated assembly station (Figure 73). The process of decomposing  $DP-1|_{ED}$  yields five sub-FRs. The sub-FRs are decomposed into branches that further describe the user-centered design of components, material handling system, fixture design, torque driver design, and station architecture/structure.

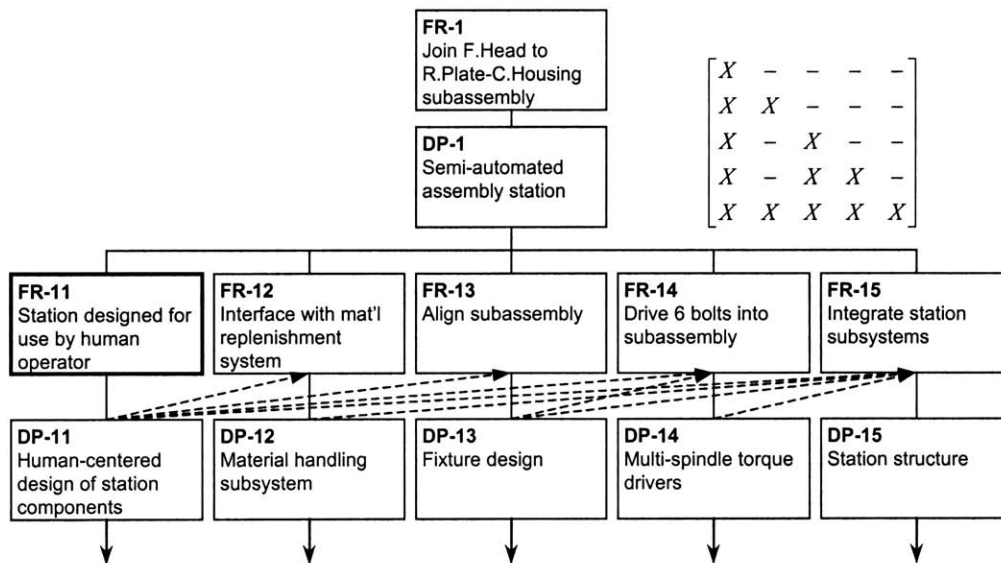

Figure 73. First level decomposition of an assembly station to attach the Front Head to the Rear Plate/Center Housing subassembly

The first sub-FR,  $FR-11|_{ED}$ , is a product of decomposing while using the HMI model. The FR states that the station must be designed for use by a human operator. This is consistent with the PSD FR/DPs that relate to the design of equipment to reduce wasted motion in direct work tasks ( $FR/DP-D2|_{PSD}$ ).

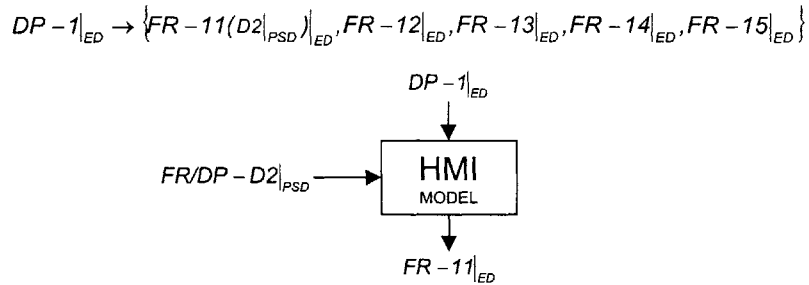

Figure 74. ED DP-1 is decomposed into FR-11 through FR-15 where FR-12 is a function of PSD FR/DP-D2 that is acquired through considering HMI model

The consideration of human-machine interaction at a high level ensures that the design incorporates user-centered methods for designing components. The design matrix conveys the fact that the  $DP-11|_{ED}$  influences the satisfaction of  $FR-12|_{ED}$  through  $FR-15|_{ED}$ , which means that HMI issues can influence the design and layout of components for the entire station.

#### Example 2 – Design for Human-Machine Separation Using HMI Model

The HMI model is used once again to create an ED decomposition for the branch that describes the bolt driving mechanism (Figure 75). In order for there to be human-machine separation in the assembly cell ( $FR/DP-D1|_{PSD}$ ), the machine must not require, for any reason, that the operator watch over automatic processes ( $FR-142|_{ED}$ ). The DP that satisfies this is  $DP-142|_{ED}$  *automated process*. The process also must be safe ( $FR-143|_{ED}$ ) which is directly related to designing a good ergonomic interface ( $FR/DP-D23|_{PSD}$ ).  $DP-143|_{ED}$  *light curtain that can stop automation* ensures that the process stops if ever a hand, or other body part, breaks the plane of the light-curtain. This ensures that injuries do not occur due to the machine’s moving parts. Further, each process must be self-diagnostic ( $FR/DP-D11|_{PSD}$ ), therefore each torque gun should ensure that the final torque is achieved. Self-diagnostic torque guns are employed, which alert the operator if a non-conforming operation occurs. The influence of PSD FR/DPs on the



design of the automated elements in the assembly station is communicated through the HMI model, which describes the concept of human-machine separation as part of BL-0 (page 98).

The resulting standard work that incorporates the human-machine separation is shown in Figure 75. The operator’s manual task time does not include the cycle time of the automation. This demonstrates a more efficient employment of human-machine interaction, one that eliminates wasteful activities such as waiting on machines.

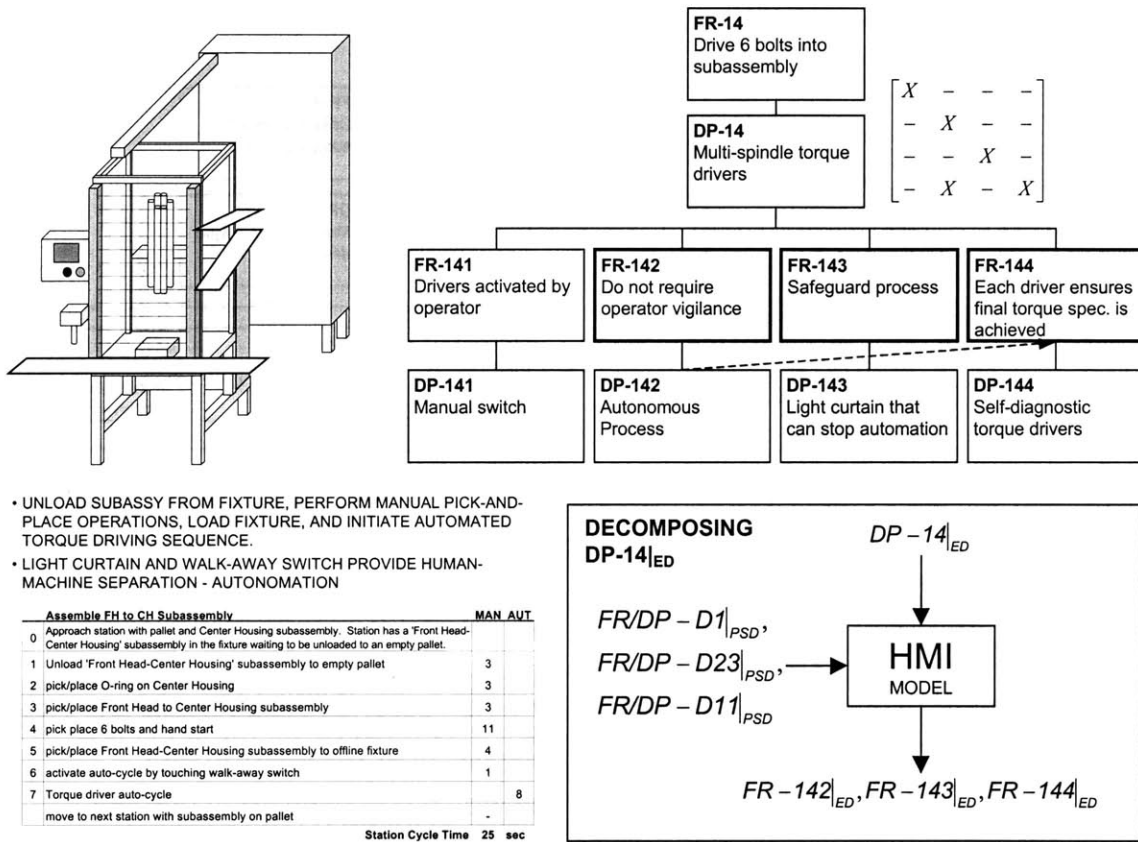

$$DP - 14|_{ED} \rightarrow \{FR - 141|_{ED}, FR - 142(D1|_{PSD})|_{ED}, FR - 143(D23|_{PSD})|_{ED}, FR - 144(D11|_{PSD})|_{ED}\}$$

Figure 75. Decomposing ED DP-15 using an HMI model yields a design that enable human-machine separation

The case of using HMI to design processes that separate human from machine is compared to the case where human-machine separation is not an understood operating scheme. Figure 76 shows the machine design that can result from the use of a very common form of manual switches, palm buttons. If palm buttons are used to initiate an

automated cycle, the operator simply depresses the buttons, one with each hand. Frequently the buttons are employed in a functionally coupled way. In order to ensure that the operator’s hands are clear of moving parts on the station, the station is programmed to halt the automation if the palm buttons are released. This creates a condition where the operator must wait on the machine to cycle. This means there is a non-value adding dead-spot in the middle of an operator’s standard work. This results in a waste of an operator’s time resources, which is demonstrated by the longer cycle-time that exists without human-machine separation, 33 sec. station cycle-time (vs. 25 sec. for the case of human-machine separation).

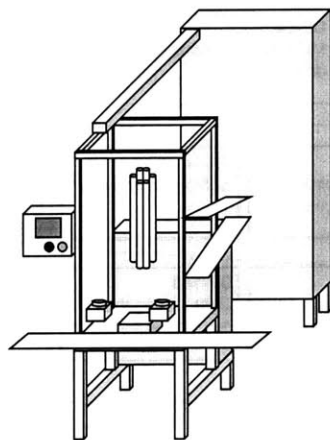

- PERFORM MANUAL PICK-AND-PLACE OPERATIONS, LOAD SUBASSY TO FIXTURE, START AND WAIT FOR AUTOMATED TORQUE DRIVING SEQUENCE, UNLOAD SUBASSY FROM FIXTURE
- OPERATOR IS REQUIRED TO HOLD PALM BUTTONS FOR DURATION OF AUTOMATED CYCLE - TIED TO THE MACHINE.

Assemble FH to CH Subassembly		MAN	AUT
1	pick/place O-ring on Center Housing	3	
2	pick/place Front Head to Center Housing subassembly	3	
3	pick place 6 bolts and hand start	11	
4	pick/place 'Front Head-Center Housing' subassembly to offline fixture	4	
5	depress and hold palm buttons	1	
6	Torque driver auto-cycle		8
7	pick/place Front Head-Center Housing subassembly to empty pallet	3	
	move to next station with subassembly on pallet	-	

Station Cycle Time 33 sec

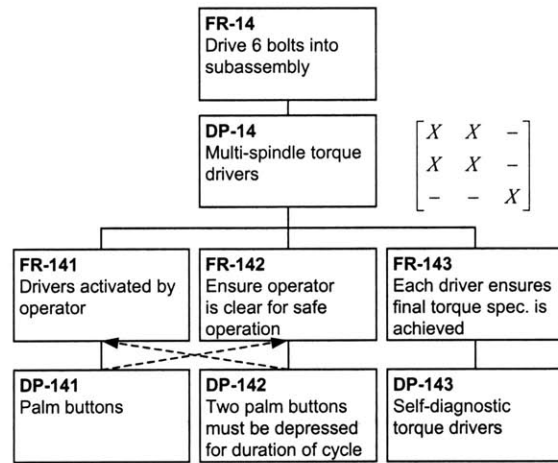

**DECOMPOSING ED DP-14**

WITHOUT REGARD FOR CONFORMING TO HMI MODEL, RESULTING DESIGN IS COUPLED. PALM BUTTONS SATISFY BOTH THE ACTIVATION REQUIREMENT AS WELL AS SAFETY.

HOWEVER, RESULTING OPERATION TIES OPERATOR TO THE MACHINE AND PREVENTS HUMAN-MACHINE SEPARATION, A PRODUCTION SYSTEM DESIGN REQUIREMENT

$$DP - 14|_{ED} \rightarrow \{FR - 141|_{ED}, FR - 142|_{ED}, FR - 143|_{ED}\}$$

Figure 76. Decomposition of ED DP-15 without HMI model may lead to a common design using palm-buttons that tie an operator to a machine

This example illustrates how the consideration of a specific type of operating scheme between human and machine may yield potentially different station designs. The use of an HMI model – derived from a PSD decomposition – in ED sub-FR generation can help achieve designs that better satisfy production system goals.

It is appropriate to make a brief comment on the impact of design standards and regulating bodies on the ability of equipment designers to exercise design freedom. Frequently decision-making bodies for safety and workplace standards create standard as a result of bargaining techniques and less so on satisfying real workplace needs. As the importance of regulations rises, as it is now, the increased sensitivity the bodies must have with regard to workplace design issues. Some design decisions such as the decision to use palm-buttons (in the example above, the palm-buttons could potentially have been chosen as a result of adhering to plant specifications) are a result of conformance to a guideline that was created without adequate perspective on good human-machine interface design. Once regulations impact the human's work content adversely, the awareness of the social importance of technical standards must be increased. This is an argument for better technical representation of users, workers, and safety and health interests in the standardization bodies [Eichener, 1996]

### *Example 3 – Poka-Yoke for Manual Work Tasks*

The design of a semi-automated assembly station includes the design of features that enable an operator to perform manual work tasks. A decomposition for the design of the fixture reveals that an error proofing device is required to aid the operator perform a task consistently (Figure 77).

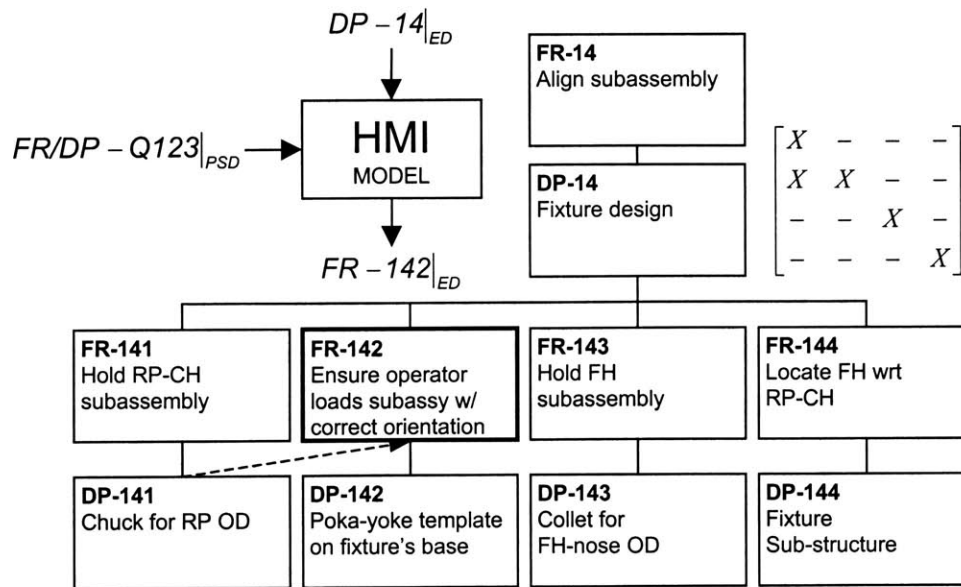

Figure 77. ED decomposition for the branch that pertains to fixture design

The HMI specifies that the subassembly is manually loaded on the fixture base before the rest of the fixture clamps down.  $FR-142|_{ED}$  *ensure operator loads subassembly with correct orientation* is to make sure that radial orientation is correct when the operator manually loads the part to the fixture. Without the use of an HMI model to realize that the manual loading of fixtures is part of the operating scheme, this manual task may go without error proofing ( $FR/DP-Q123|_{PSD}$ ).  $DP-142|_{ED}$  *poka-yoke template on fixture's base* (Figure 78) ensures that the subassembly is loaded in the same orientation each time.



Figure 78. Part aligning poka-yoke on chucking component of fixture design

The template that is mounted on top of the chuck is an outline of the part and it ensures that the part is aligned with respect to the torque-drivers' spindles. It eliminates the chance of an operator's error to become a defect. This is an example of a *control* poka-yoke.

*Example 4 – Design of Station Structure and Layout*

The design of the station's architecture and component layout is determined by the design of the supporting structure. The structure integrates the station's subsystem components. This includes the location and attachments of displays, controls, fixtures, automation, service panels, etc. The use of an HMI model to determine sub-FRs is beneficial for designing a station layout that integrates into a manufacturing work-cell. Figure 79 is the design decomposition of  $DP-15|_{ED}$ . The highlighted sub-FRs in the figure result from applying knowledge of HMI in cells to the selection of appropriate component design requirements.

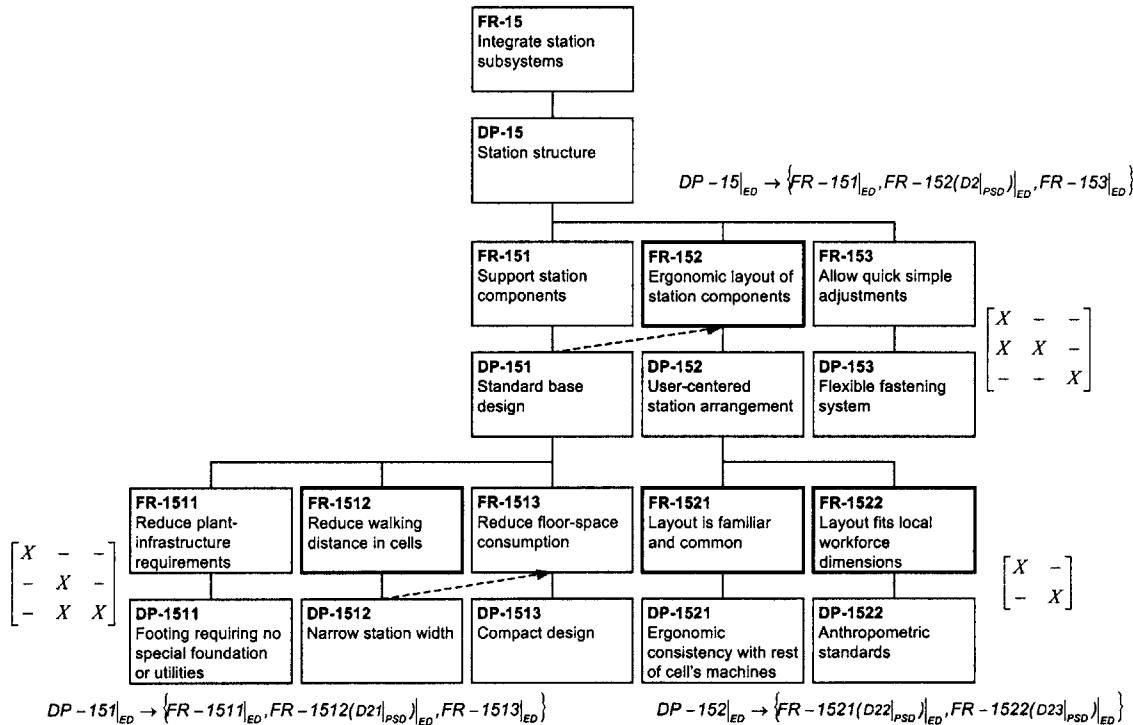

Figure 79. ED decomposition for the branch that pertains to station architecture/structure design

The decomposition of *DP-151 standard base design* is aided by the HMI model to translate PSD requirements on reducing walking distances. *The FR-1512<sub>|ED</sub> reduce walking distances in cells* is satisfied by *DP-1512<sub>|ED</sub> narrow station width*. Figure 80 shows that the station base was configured with very narrow frontal width (approximately 2 feet) to reduce walking distances between adjacent stations in a cell.

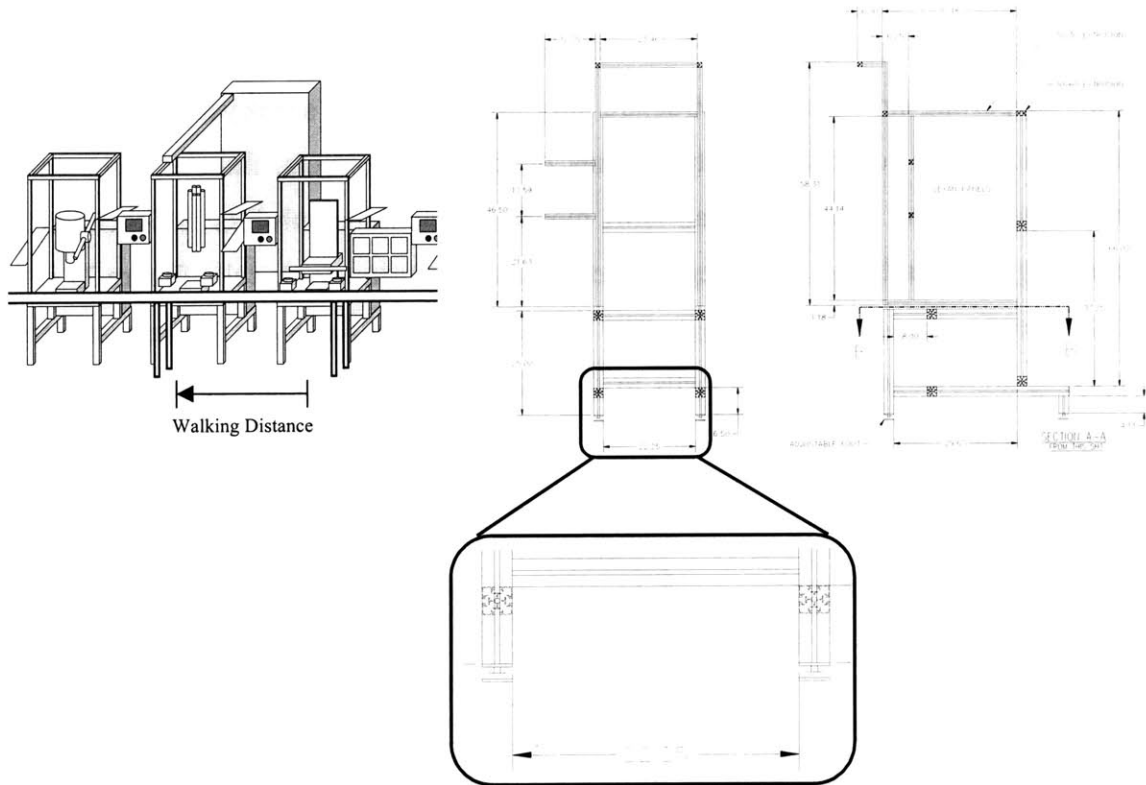

Figure 80. Station sub-frame configured to reduce walking distances once integrated into a cellular layout

The decomposition of *DP-15<sub>|ED</sub>* results in a requirement *FR-152<sub>|ED</sub> ergonomic layout of station components* that is satisfied by *DP-152<sub>|ED</sub> user-centered station arrangement*. Further, sub-FRs for *DP-152<sub>|ED</sub>* result in more HMI-based requirements that specify consistency and compatibility of the machine’s component layout. *FR-1521<sub>|ED</sub> layout is familiar and common* stems from the *FR/DP-D21<sub>|PSD</sub>* that describes the minimization of waste in operator task preparation through standard layouts and organization of workplace (5S techniques).

$FR-1522|_{ED}$  layout fits local workforce dimensions means that  $FR/DP-D23|_{PSD}$  should be applied so that the stations dimensionally accommodate the local population which composes the cell's workforce (Figure 81). Ergonomic standards exist to determine the proper sizing of work areas.

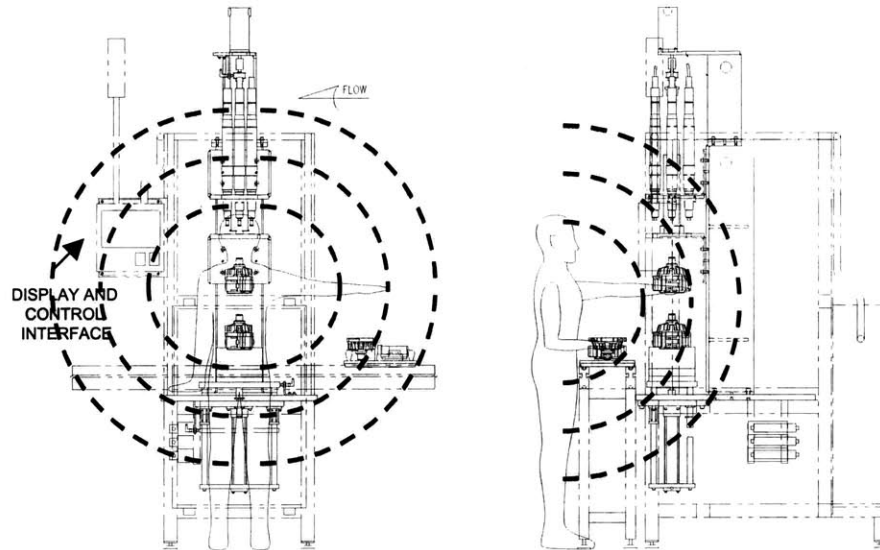

Figure 81. Ergonomic work envelope analysis performed on assembly station to ensure local population anthropometry is accommodated

### Applicability of HMI for Other Production Subsystem Design Processes

The HMI is shown to be useful in communicating PSD goals to equipment designers in order to improve the operation of the equipment within a production system. The same process may be done for the design of other production subsystems. The HMI explicitly describes the information requirements between human and machine as well as between human and support resources. The **design of information systems** for production systems may benefit from a model's characterization of human information needs. An HMI model is useful for explaining the information required during decision making in a supervisory-control-like production environment. Supporting information such as process FMEAs (Figure 82) and standard work routines (Figure 83) are also types of information that an operator requires to perform BL-0 and BL-1 functions in a supervisory control, manual work and problem solving work environment.

Process Failure Mode and Effects Analysis							
Process Function	Potential Failure Mode	Potential Effect(s) of Failure	Potential Cause(s)/ Mechanism(s) of Failure	Current Process Controls	Recommended Action(s)	Responsibility	Actions Taken
Align front head to center housing and torque bolts	- missing o-ring	- external compressor leakage	- operator error - part not installed	- visual inspection - leak check	- leak test 100%	Manufacturing Engineer	
	- incorrect part orientation	- compressor will not fit together	- part oriented improperly	- poka-yoke fixture - leak check	- directional assembly fixtures - leak test 100%	Manufacturing Engineer	
	- bolts not tightened to proper torque specification	- internal or external compressor leakage - non-performance - compressor failure	- assembly fixture not properly adjusted - torque gun not properly calibrated	- fixture does not allow front head alignment if not adjusted correctly - weekly calibration	- update process sheets to reflect daily calibration	Manufacturing Engineer	- process sheets updated to reflect daily calibration

Figure 82. Process Failure Mode and Effect Analysis on previously discussed assembly station

Assemble FH to CH Subassembly		MAN	AUT
0	Approach station with pallet and Center Housing subassembly. Station has a 'Front Head-Center Housing' subassembly in the fixture waiting to be unloaded to an empty pallet.		
1	Unload 'Front Head-Center Housing' subassembly to empty pallet	3	
2	pick/place O-ring on Center Housing	3	
3	pick/place Front Head to Center Housing subassembly	3	
4	pick place 6 bolts and hand start	11	
5	pick/place Front Head-Center Housing subassembly to offline fixture	4	
6	activate auto-cycle by touching walk-away switch	1	
7	Torque driver auto-cycle		8
	move to next station with subassembly on pallet	-	

**Station Cycle Time 25 sec**

Figure 83. Sample standard work routine for previously discussed assembly station

The HMI model also describes the type of skills that an operator must possess to perform each behavioral loop function. This can be applied to the **design of training programs** for operators. For instance, standard work routines include a description of each task an operator should be capable of. These tasks would be part of the training content. Root-cause methodologies, maintenance procedures, repair protocols may also be introduced to the operator so that the information supplied to the operator during supervisory function may be put to effective use. The use of an HMI model can detail the roles an operator must play in a specified production system, and thus skills and knowledge can be transferred to the operator through an improved training program.



## **Other Applications of HMI Model**

The HMI model for manufacturing cells characterizes the relationship between human and machine that includes direct tasks, process control activities, and system improvement actions. System analyses often fail to consider the capability and requirement that performance improves over time. Automatic machinery may be programmed with intelligent algorithms to detect and correct for process disturbance, however, if disturbances occur that programmers had not foreseen, then detection and improvement may not likely occur.

The characterization of machine process quality and reliability can be measured and specified. On the other hand, human capability for maintenance and improvement is more difficult to assess and therefore the advantages of human operators are more difficult to quantify. A supervisory control model includes the operator as a key element in maintaining and improving a system. In the functional representation of the cellular HMI, BL-1 and BL-2 show the pathways for quality control and continuous improvement. By modeling cellular production as a supervisory control environment, we can treat human presence as a value beyond a manual task resource.

System modeling and simulation can benefit from this characterization of system improvements. Empirical observations and task analyses of BL-1 and BL-2 operator behavior that lead to measurable (time scale, effect on performance, etc) system improvements can then be modeled and incorporated into a system simulation that accounts for continuous improvement and maintenance routines. With a supervisory control-based HMI model, we can begin to answer questions within the context of a human acting as a supervisor.



## Conclusion and Recommendations

---

The application of the production system design decomposition to the development of a supervisory control based human-machine interaction model was useful in characterizing a human-machine system that satisfies the goals of a production enterprise. The model characterizes the human behavioral roles that an operator assumes as supervisor of semi-automated production processes. The model captures the functional human-machine interaction that enables process control and continuous improvement to the manufacturing process. The model is useful for designing production subsystems, particularly manufacturing equipment. The HMI model is shown to be a computational aid for design decisions that involve generating functional requirements for an axiomatic design based equipment design methodology.

Further development of the model can be achieved by more discretely characterizing cellular manufacturing subsystems. Taking the model to lower levels of abstraction more fully characterizes the human-machine interaction for the various tasks an operator must perform. The model can also be applied to the design of other production subsystems analogous to the method described for equipment design. A structured design process for information systems, training programs, material handling systems, etc. could be aided by the HMI model during the process of functional requirement specification.

This broader approach of modeling HMI can also be applied to other types of manufacturing systems. This HMI model is presented for manufacturing work-cells that employ manual and semi-automatic equipment, but models can also be constructed for systems that are geared more towards mass customization systems, crafting assembly systems, and even more automated FMS or transfer lines. The benefits in achieving well-designed subsystems are manifested by improved long-term system performance and a better quality of work for humans.



## References

---

- Arinez, Jorge F. and David S. Cochran, "Application of a Production System Design Framework to Equipment Design," 32nd CIRP International Seminar on Manufacturing Systems, Belgium, May, 1999a.
- Arinez, Jorge F. and David S. Cochran, "Integration of Product Design and Production System Design," *Proceedings of the International CIRP Design Seminar*, Enschede, the Netherlands, March, 1999b.
- Arinez, Jorge F., Micah T. Collins, David S. Cochran, Melissa D. Uhl, Paul Cook, "Design of an Automotive Compressor Production System Using Lean Manufacturing Design Guidelines," *Proceedings of the 1999 SAE International Automotive Manufacturing Conference*, IAM99-34, Detroit, U.S.A. May, 1999.
- Black, J. T., *The Design of a Factory with a Future*, McGraw Hill, 1991.
- Bröte, Staffan, David S. Cochran, Ania Mierzejewska, Brandon Carrus, Steve Rupp, Jeff Smith, "Integrating the Production Information System with Manufacturing Cell Design – A Lean, Linked Cell Production System Design Implementation," *Proceedings of the 1999 SAE International Automotive Manufacturing Conference*, IAM99-28, Detroit, U.S.A. May, 1999.
- Charles, Michael, David S. Cochran, Daniel Dobbs, "Design of Manufacturing Systems to Support Volume Flexibility," *Proceedings of the 1999 SAE International Automotive Manufacturing Conference*, IAM99-27, Detroit, U.S.A. May, 1999.
- Cochran, David S. "The Production System Design and Deployment Framework," *Proceedings of the 1999 SAE International Automotive Manufacturing Conference*, IAM99, Detroit, U.S.A. May, 1999.
- Cochran, David S., *The Design and Control of Manufacturing Systems*, Ph.D. Thesis, Auburn University, 1994.
- Cochran, David S. and Paulo C. Lima, *The Production System Design Decomposition, Version 4.2*, Internal Document of the Production System Design Laboratory, Massachusetts Institute of Technology, 1998.
- Cole, William E. and John W. Mogab, *The Economics of Total Quality Management: Clashing Paradigms in the Global Market*, Cambridge, MA: Blackwell Publishers 1995.
- Corbett, J. Martin, "The Development of User-Centered Advanced Manufacturing Technology: New Design Practice or New Marketing Rhetoric?" *The International Journal of Human Factors in Manufacturing*, 6(2), 79-87, 1996.
- Crosby, P., *Quality is Free*, New York: McGraw-Hill, 1979.
- DeVor, Richard E., Tsong-how Chang, John W. Sutherland, *Statistical Quality Design and Control*, New Jersey: Prentice Hall, 1992.
- Dooley, Kevin J., "Quality Engineering," *Handbook of Design, Manufacturing and Automation*, Edited by Richard C. Dorf and Andrew Kusiak, New York: John Wiley & Sons, 619-648, 1994.
- Duda, James W., David S. Cochran, Jose Castaneda-Vega, Mike Baur, Ron Anger, Shahram Taj, "Application of a Lean Cellular Design Decomposition to Automotive Component

- Manufacturing System Design,” *Proceedings of the 1999 SAE International Automotive Manufacturing Conference*, IAM99-26, Detroit, U.S.A. May, 1999.
- Eichener, Volker, “The Impact of Technical Standards on the Diffusion of Anthropocentric Production Systems,” *The International Journal of Human Factors in Manufacturing*, 6(2), 131-145, 1996.
- Endsley, Mica R., “Toward a Theory of Situation Awareness in Dynamic Systems,” *Human Factors*, 37(1), 32-64, 1995a.
- Endsley, Mica R., “Measurement of Situation Awareness in Dynamic Systems,” *Human Factors*, 37(1), 65-84, 1995b.
- Fan, Ip-Shing, Robert Gassmann, “The Effects of Allocation of Functions on the Long-Term Performance of Manufacturing Cells – A Case Study” *Human Factors and Ergonomics in Manufacturing*, Vol. 7 (2) 125-152 (1997).
- Ghosh, Biman Kumar, and Martin G. Helander, “A Systems Approach to Task Allocation of Human-Robot Interaction in Manufacturing,” *Journal of Manufacturing Systems*, 5(1), 1986.
- Hwang, Sheue-Ling, Woodrow Barfield, Tien-Chen Chang, Gavriel Salvendy, “Integration of Humans and Computers in the Operation and Control of Flexible Manufacturing Systems,” *International Journal of Production Research*, 22(5), 841-856, 1984
- Jones, Patricia M., Rose W. Chu, Christine M. Mitchell, “A Methodology for Human-Machine Systems Research: Knowledge Engineering, Modeling, and Simulation,” *IEEE Transactions on Systems, Man, and Cybernetics*, SMC-25(7), 1025-1038, July, 1995.
- Kamali, Jila, Colin L. Moodie, Gavriel Salvendy, “A Framework for Integrated Assembly Systems: Humans, Automation, and Robots,” *International Journal of Production Research*, 20(4), 431-448, 1982.
- Kuivanen, R., “Disturbance Control in Flexible Manufacturing,” *The International Journal of Human Factors in Manufacturing*, Vol. 6 (1) 41-56 (1996).
- Mårtensson, Lena, “The Operator's Requirements for Working with Automated Systems,” *The International Journal of Human Factors in Manufacturing*, 6(1), 29-39, 1996.
- Miller, Dwight P. and Alan D. Swain, “Human Error and Human Reliability,” *Handbook of Human Factors*, Edited by Gavriel Salvendy, New York: John Wiley & Sons, 219-250, 1987.
- Monden, Yasuhiro, *Toyota Production System*, Third Edition, Norcross, Georgia: Engineering & Management Press, 1998.
- Niimi, Atsushi, Toshio Sata, Kousuke Siramizu, Takashi Matsuura, Nobutoshi Hisada, “Development of the New Human-Conscious Automobile Assembly Plant,” *Annals of the CIRP*, 46(1), 381-384, 1997.
- Norman, D. A., “Categorization of Action Slips,” *Psychology Review*, 88, 1-15, 1981.
- Plonka, Francis E., “Developing a Lean and Agile Work Force,” *Human Factors and Ergonomics in Manufacturing*, 7(1), 11-20, 1997.
- Poka-Yoke, Improving Product Quality by Preventing Defects*, Edited by Nikkan Kogyo Shimbun, Ltd./Factory Magazine, Portland, OR: Productivity Press, 1987.
- PSD Laboratory, *Production System Design Decomposition version 5.0*, Internal Document of the Production System Design Laboratory, Massachusetts Institute of Technology, 1999.

- Rasmussen, Jens, "Skill, Rules and Knowledge: Signals, Signs, and Symbols, and Other Distinctions in Human Performance Models," *IEEE Transactions on Systems, Man, and Cybernetics*, SMC-13(3), 257-267, 1983.
- Rasmussen, Jens, "Diagnostic Reasoning in Action," *IEEE Transactions on Systems, Man, and Cybernetics*, SMC-23(4), 981-992, 1993.
- Sage, Andrew P., *Systems Engineering*, USA: John Wiley & Sons, 1992.
- Sheridan, Thomas B. "On How Often the Supervisor Should Sample," *IEEE Transactions on Systems Science and Cybernetics*, SSC-6(2), 140-145, April, 1970.
- Sheridan, Thomas B., "Measuring, Modeling, and Augmenting Reliability of Man-Machine System," *Automatica*, 19(6), 637-645, 1983.
- Sheridan, Thomas B., *Telerobotics, Automation, and Human Supervisory Control*, The MIT Press, 1992.
- Shingo, Shigeo, *A Study of the Toyota Production System*, Portland, OR: Productivity Press, 1989.
- Suh, Nam P., *The Principles of Design*, Oxford University Press, 1990.
- Suh, Nam P., *Axiomatic Design: Advances and Applications*, Pre-published Edition, will be available from Oxford University Press, 1998.
- Suh, Nam P., David S. Cochran, Paulo C. Lima, "Manufacturing System Design," *48th General Assembly of CIRP, Annals of the CIRP*, 47(2), 627-639, 1998.
- Taguchi, Genichi, Elsayed A. Elsayed, Thomas C. Hsiang, *Quality Engineering in Production Systems*, New York: McGraw-Hill, 1989.
- Tang, Kwei and James M. Pruett, "Manufacturing Process Quality Control and Improvement," *Handbook of Design, Manufacturing and Automation*, Edited by Richard C. Dorf and Andrew Kusiak, New York: John Wiley & Sons, 649-671, 1994.
- Tate, Derrick, *A Roadmap for Decomposition: Activities, Theories, and Tools for System Design*, Ph.D. Thesis, Massachusetts Institute of Technology, 1999.
- Toyota Motor Manufacturing Kentucky*, Plant Visit, Open Discussion Forum, August 20, 1998.
- Vakil, Sanjay S. and R. John Hansman, "Applying a Common Conceptual Model Approach to Vertical Navigation Automation," 2<sup>nd</sup> Workshop on Human Error, Safety, and System Development, Seattle, WA, April 1-2, 1998.
- Vicente, Kim J. and Jens Rasmussen, "Ecological Interface Design: Theoretical Foundations," *IEEE Transactions on Systems, Man, and Cybernetics*, SMC-22(4), 589-606, July/August, 1992.
- Wickens, Christopher D., Sallie E. Gordon, Yili Liu, *An Introduction to Human Factors Engineering*, Addison-Wesley, 1998.
- Williams, Michael D., James D. Hollan, Albert L. Stevens, "Human Reasoning about a Simple Physical System," *Mental Models*, Edited by Dedre Gentner and Albert L. Stevens, Hillsdale, NJ: Lawrence Erlbaum Associates, 1983.
- Womack, James P., Daniel T. Jones, and Daniel Roos, *The Machine that Changed the World*, New York: HarperCollins, 1990.
- Womack, James P. and Daniel T. Jones, *Lean Thinking*, New York, NY: Simon and Schuster, 1996.