

Superharmonic Solutions of Nonlinear Differential Equations

Colm McGuinness

*B.Sc. (Hons) in Applied Science
Honours Diploma in Applied Science*

Submitted in Partial Fulfillment for the Degree of
Doctor of Philosophy

to

The School of Mathematical Sciences,
Dublin City University.

August 1991

Thesis Supervisor: Dr. D. W. Reynolds

This thesis is my own work. It has not been previously submitted to any University.

This thesis is dedicated, with love, to my parents, Eileen and Paddy, to my sister Annette, and to Susan.

Acknowledgements

I am indebted to David Reynolds for the constant help and advice given to me during the course of my postgraduate studies. This thesis owes its heart and soul to many challenging and fruitful *discussions* between David and I.

I am grateful to Pauline O’Gorman and Pat Fogarty, who aided the production of the diagrams in this thesis.

Thanks to all my fellow postgrads, especially Joe Crean, Neal Brazel and Pauline McCarthy, for their friendship and advice.

My postgraduate studies were partially funded by Dublin Corporation, and Dublin City University Research and Postgraduate Studies Committee.

"I dislike arguments of any kind. They are always vulgar, and often convincing."
— Lady Bracknell, *"The Importance of Being Earnest"*
Oscar wilde

Contents

1	Introduction	1
2	Derivation of the Mathematical Problem	5
2.1	The Physical Problem	5
2.2	The Non-dimensional Problem	7
2.3	The Scaled Problem	8
3	Reduction of Problem to a Pair of Bifurcation Equations	12
3.1	Introduction	12
3.2	Lyapunov-Schmidt	12
3.3	Properties of $w^*(t)$	14
3.4	Properties of the Bifurcation Equations	19
4	Analysis of Bifurcation Equations	22
4.1	Introduction	22
4.2	Problems with Standard Scaling Techniques	23
4.3	Main Result	24
4.4	Alternative Scaling Methods	27
4.4.1	Explicit Change of Variables	28
4.4.2	Implicit Change of Variables	28
5	Calculation of Leading Terms in Bifurcation Equations	30
5.1	Introduction	30
5.2	Mathematical Method	31
5.3	Duffing's Equation	32
6	TAYLOR: A User Guide	34
6.1	Introduction	34
6.2	Installation Instructions	34
6.3	Setting up the Problem for TAYLOR	34
6.4	Notation	39
6.5	Using TAYLOR	39
6.6	Example: Duffing's Equation	41
6.6.1	Mathematical Preliminaries	41
6.6.2	USER0(), USER1() and USER2()	42
6.6.3	Getting Results	44
6.7	Including Special Operators in TAYLOR	44
6.8	Example: Sloshing Problem	45
6.9	Improvements	47

7	Macsyma Implementation of TAYLOR	49
7.1	Introduction	49
7.2	Macsyma	49
7.3	Some Functions Discussed	50
7.3.1	EXPAND_WRT	50
7.3.2	FACTOROUT_TRIG	51
7.3.3	TRIGEXPAND_WRT	52
7.3.4	MN_COMBINE	53
A	Sloshing Problem: Perturbations of the Nonlinear Problem	A1
A.1	Introduction	A1
A.2	The Bifurcation Equation	A1
A.3	Numerical Computation of $\hat{\beta}$	A4
A.3.1	The BVPs	A4
A.3.2	Calculating p_m	A4
A.3.3	The Numerical Method	A5
A.3.4	Results: $m = 1, 2, 3, 4$	A6
A.4	Analysis of the Bifurcation Equation	A7
A.5	Comparison with Main Results	A9
B	Bifurcation Surfaces for Other Forms of Damping	B1
B.1	Leading Coefficients from the Bifurcation Equations	B1
B.2	Bifurcation Equation Symmetries when $(\mathbf{D}u') = u$	B2
C	Numerical Calculation of Bifurcation Curves using AUTO	C1
C.1	Introduction	C1
C.2	Numerical Results for the Undamped Problem	C2
C.3	Numerical Results for the Damped Problem	C9
D	Macsyma Bugs	D1
D.1	Introduction	D1
D.2	Bugs	D1
D.2.1	Common Factors	D1
D.2.2	INTSCE	D1
D.2.3	LAMBDAs	D2
D.2.4	ASSUME	D2
	Macsyma Copyright Notice	E1
	Bibliography	
	TAYLOR Diskette	

Abstract

This thesis is a study of the structure of superharmonic solutions of order m , to the sloshing equation introduced by Chester and Ockendon & Ockendon, and to a lesser extent, Duffing's equation. We use the Lyapunov-Schmidt procedure to reduce these problems to two bifurcation equations. We elucidate the form and leading terms of the bifurcation equations. The usual scaling techniques fail when superharmonics of order 4 or greater are sought. An alternative scaling method is provided, which works for superharmonic solutions of all orders. The method is rigorous, and naturally provides an explicit approximation to the bifurcation surface.

To produce a formula for the approximate bifurcation surface it is necessary to explicitly calculate coefficients in the bifurcation equations. A simple algorithm, which calculates the terms which may be required, is given. The method is implemented using Macsyma. The program, TAYLOR, produces the information for superharmonic and subharmonic solutions for a large class of nonlinear oscillation problems.

Chapter 1

Introduction

Many important problems in the theory of nonlinear oscillations can be reduced to that of finding solutions u with period 2π of an equation of the form

$$(1.1) \quad u'' + m^2 u = g(\mu, u, t),$$

where $t \mapsto g(\mu, u, t)$ is a nontrivial function with period $2\pi/n$, and μ is a vector of parameters. Duffing's equation can be written as (1.1) with

$$(1.2) \quad g(\mu, u, t) = -u^3 + \mu_1 u + \mu_2 u' + \mu_3 \cos nt.$$

Here we are concerned with perturbation techniques, which generally only yield results which are valid for μ small.

Solutions of (1.1) with $m = n = 1$ are called *harmonics*, and solutions with $n > 1$, *subharmonics*. Standard textbooks such as Stoker [45], Hale [16], Hale [17], Nayfeh & Nook [31], Iooss & Joseph [23] and Jordan & Smith [25], concentrate on these kinds of solutions. Solutions of (1.1) with $m > 1$ and $n = 1$ are called *superharmonics* (or *ultraharmonics*) of order m , because to a first approximation such solutions have period $2\pi/m$.

Several methods have been used to investigate superharmonic solutions of the *undamped*, $\mu_2 = 0$, Duffing's equation. Hale [17], in order to find the superharmonic solutions of order 3, reduces the problem to an approximate bifurcation equation, which is cubic, using the Lyapunov-Schmidt procedure. This is essentially equivalent to the Poincaré-Linstedt method. Nayfeh & Nook [31] use multiple time scales to solve the same problem, and give extensive references for the more general problem. Schmitt & Mazzanti [43] and Schmitt [44] obtain results for the undamped Duffing's equation, which do not require μ_1 and μ_3 to be small. The analysis is rigorous, relying strongly on the symmetries of the Duffing equation. However, it does not give approximations to the solutions etc., as a perturbation method would. Hayashi [22] uses the method of dominant balance, which is a spectral method, to find superharmonic solutions of order 3. The papers of Tamura et al [46], Sato [41] and Tamura et al [47] all use this method on the damped problem.

The method we prefer here is to use the Lyapunov-Schmidt procedure to reduce the problem of solving the damped Duffing equation to that of solving two scalar bifurcation equations. Then the bifurcation equations are analysed using scaling techniques. This is the approach taken by Hale & Rodrigues [18,19] to find harmonic solutions of Duffing's equation. One new aspect of their work is that the vector parameter $\mu = (\mu_1, \mu_2, \mu_3)$ varies over a full neighbourhood of the origin. These papers greatly influenced this thesis. The method is entirely rigorous and

naturally provides an approximation to the stability boundaries in parameter space. We see that there is different behaviour depending on whether m is odd or even. Moreover, in order to obtain a rational approximation to the stability surfaces better approximations to one of the terms in one of the bifurcation equations are required, as m increases. This phenomenon, which is delicate, only becomes apparent for $m \geq 4$. It also shows the advantage for a rigorous analysis. Interestingly, cross-sections of the stability surface have a markedly different shape for $m \geq 4$. The resonance horns protrude below the plane $\mu_1 = 0$.

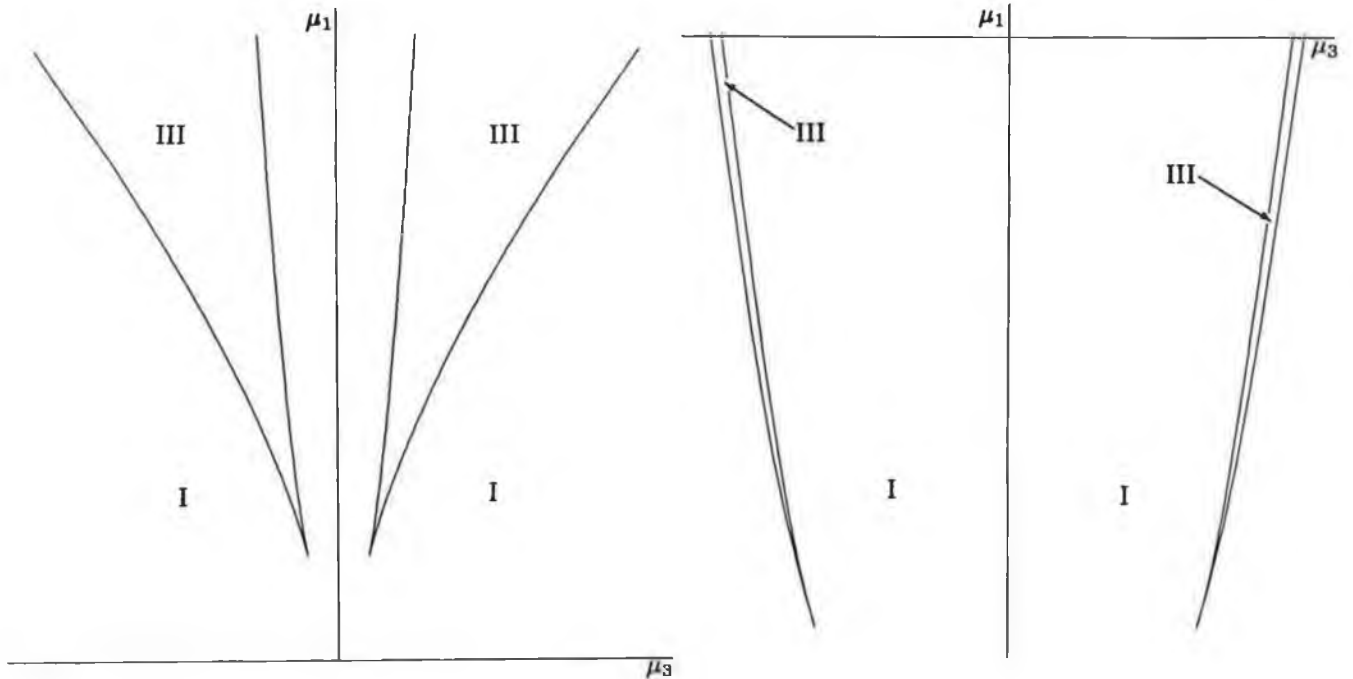

(a) $m = 1$

(b) $m = 5$

Figure 1.1: Stability curves for Duffing's equation, with $\mu_2 = 10^{-2}$ and $\mu_1 \leq 0.1$. There are 3 solutions if μ is in region III, and 1 solution if μ is in region I. On the stability curves there are two solutions, one of which exchanges stability there.

The problem that we concentrate on in this thesis is not Duffing's equation, but the sloshing equation introduced by Chester [6] and Ockendon & Ockendon [33], though we indicate in Chapter 5 how the problem of superharmonic solutions of Duffing's equation is solved.

Sloshing is the term used to describe the motion of a liquid in an oscillating tank. Here we consider a rectangular tank which is oscillating horizontally near the primary resonance frequency. The mean depth of the liquid is assumed small compared to the length of the tank. We are interested in the long time behaviour of the fluid, after transients have been damped out.

Lepelletier & Raichlen [28] claim that the main engineering application of such work relates to the excitation of containers by long period motion, for example the oscillation of liquid in containers aboard a ship hit by waves. An important practical question is whether such oscillations could cause a ship to become unstable and capsize. In [24], Jones & Hulme study water sloshing on deck due to a vessel's rolling motion. An understanding of sloshing also assists in determining the mechanics of nonlinear wave-induced motions in harbours and bays, where significant reflections take place from boundaries.

Chester [6] and Ockendon & Ockendon [33] derived an integro-differential equation to model periodic surface gravity waves in a tank oscillating longitudinally near the primary resonance frequency. The mathematical problem is to find 2π -periodic solutions with mean zero of the integro-differential equation

$$(1.3) \quad u'''(t) + m^2 u'(t) = 2u(t)u'(t) + \mu_1 u'(t) + \mu_2 (\mathbf{D}u')(t) + \mu_3 \sin t,$$

where \mathbf{D} is formally defined by the singular integral

$$(1.4) \quad (\mathbf{D}u')(t) = \sqrt{\frac{2}{\pi}} \int_0^\infty \frac{u'(t-s)}{\sqrt{s}} ds.$$

Of course $u' = du/dt$, etc. We allow the parameter $\mu = (\mu_1, \mu_2, \mu_3)$ to vary in a full neighbourhood of the origin. Once u has been determined from (1.3), the velocity potential of the flow and the surface profile are easily determined.

Reynolds [38] showed that (1.3) always has at least one solution, in a suitable space, as long as $\mu_2 \neq 0$. We now seek to clarify the number of solutions and their structure if μ is small. Our analysis considerably expands and elucidates comments in Appendix A of Ockendon & Ockendon [33]. In Chapter 3 we look for solutions of the form

$$(1.5) \quad u(t) = r \cos m(t - \phi) + w(t - \phi),$$

where $w(t)$ is orthogonal to $\cos mt$ and $\sin mt$ over $[-\pi, \pi]$. Thus $w(t)$ contains all the terms in the Fourier series expansion except two. w is the unique solution of an integro-differential equation, and is determined once r , ϕ and μ are known. In fact¹

$$(1.6) \quad w(t) = -\frac{(1 - \delta_{1,m})}{m^2 - 1} \mu_3 \cos(t + \phi) - \frac{r^2}{6m^2} \cos 2mt + \text{h.o.t.}$$

r and ϕ are then determined from two bifurcation equations of the form

$$(1.7a) \quad 0 = (-1)^m \kappa \mu_3^m \cos m\phi + A(\mu)r - \frac{r^3}{6m^2} + \text{h.o.t.},$$

$$(1.7b) \quad 0 = (-1)^{m+1} \kappa \mu_3^m \sin m\phi + \frac{\mu_2 r}{\sqrt{m}} + \text{h.o.t.},$$

where

$$(1.8) \quad A(\mu) = \mu_1 + \frac{\mu_2}{\sqrt{m}} + \frac{2(1 - \delta_{1,m})}{(m^2 - 1)^2(4m^2 - 1)} \mu_3^2 + \text{h.o.t.}$$

Scaling arguments like those used in Hale & Rodrigues [18,19] break down for $m \geq 4$. Therefore we had to find new ways to analyse (1.7). One is given in detail in Chapter 4, and two more are outlined there. The methods rely on κ being nonzero. Therefore we expend considerable effort in Section 3.4 to prove that $\kappa > 0$.

The conclusion is roughly that there is a bifurcation surface Σ near the origin in parameter space, which divides a neighbourhood into two sets W_1 and W_3 . If $\mu \in W_1$, then (1.3) has one small solution u ; but if $\mu \in W_3$, there are three small solutions. The result for $m = 1$ was shown by Ockendon & Ockendon [33] for (1.3), with $\mu_2 \mathbf{D}u'$ replaced by $-\mu_2 u''$. The result in the case $m = 1$ for (1.3) was proved by Reynolds & Cox [40], in the spirit of the papers [18,19].

The explicit approximation (4.21) to Σ requires knowledge of more terms in the expansion (1.8) for A , as m increases. Also κ , which depends on m , must be calculated. The size of the calculations involved is prohibitive for $m \geq 4$. Therefore

¹ $\delta_{i,j}$ is the usual Kronecker delta.

a general program TAYLOR was written, which would do these tasks, and many others. It employs the symbolic manipulator Macsyma². It should be emphasised that TAYLOR tackles problems which have the form (1.1), and not just (1.2) or (1.3). Hence it would give the relevant terms in the bifurcation equations appropriate to the nonlinear Mathieu equation.

A user guide to TAYLOR is provided in Chapter 6.

The sloshing equation (1.3) can also be regarded as a perturbation of

$$(1.9) \quad p''' + (m^2 - \mu_1)p' - 2pp' = 0.$$

This was done for $m = 1$ in Reynolds [39], and for Duffing's equation by Greenspan & Holmes [15]. The generalization to $m > 1$ is given in Appendix A.

We fix $\mu_1 > 0$. Then there is a solution p_m of (1.9) with period $2\pi/m$ and mean zero, which satisfies $p_m(0) > 0$ and $p'_m(0) = 0$. Every other solution is obtained by a change of phase. We seek solutions to (1.3) of the form

$$(1.10) \quad u(t) = p_m(t - \phi) + w(t - \phi),$$

where $w'(0) = 0$. Again the Lyapunov-Schmidt procedure shows that w is the unique solution of an integro-differential equation, and is determined once ϕ , μ_2 and μ_3 are known. There is a single bifurcation equation of the form

$$(1.11) \quad \mu_2 = \hat{\beta}\mu_3^m \sin m\phi + \text{h.o.t.},$$

from which to determine ϕ . This is easily done if $\hat{\beta} \neq 0$.

Unfortunately the expression for p_m is complicated, involving Jacobi elliptic functions. We cannot prove that $\hat{\beta} \neq 0$, except when $m = 1$. However, extensive numerical experiments using a sophisticated program strongly suggests that $\hat{\beta} \neq 0$ for $m = 2, 3, 4$.

All the diagrams in this thesis were produced using original software, designed and developed by myself, operating on a DEC-VAX 6230, VMS 5.1, and were printed on a Hewlett Packard *LaserJet Series II* printer. The text was typeset using L^AT_EX version 2.09, and T_EX version 2.1, on a Prompt 286 personal computer.

²See page E1.

Chapter 2

Derivation of the Mathematical Problem

2.1 The Physical Problem

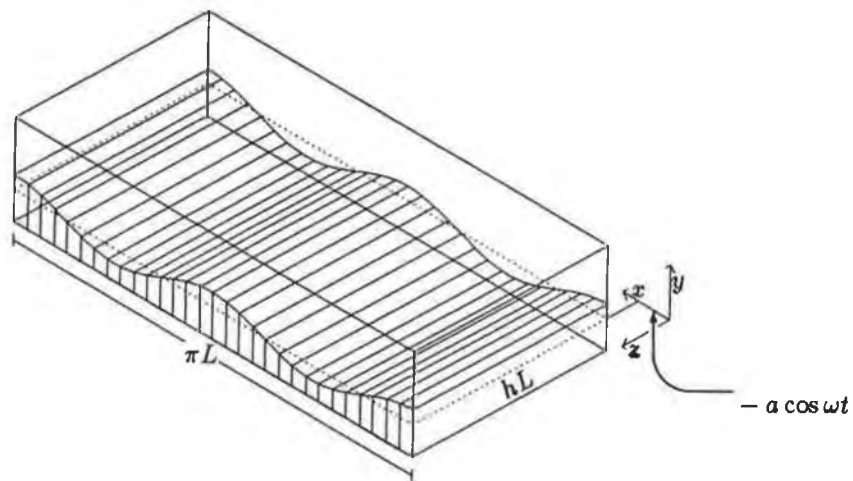

Figure 2.1: Model for the sloshing problem.

We consider the irrotational motion of a uniform, incompressible, inviscid liquid (e.g. water) of quiescent depth hL in a tank of length πL . The tank is forced to oscillate horizontally, with amplitude a and frequency ω , and is assumed wide enough that no interaction occurs at the sides of the tank. Hence no cross waves are present. The plane cartesian coordinate system is located so that $y = 0$ corresponds to the surface of the fluid when it is stationary.

Denote the density of the fluid by $\rho = \rho(x, y, t)$, the velocity by $\mathbf{v} = \mathbf{v}(x, y, t)$, the pressure by $p = p(x, y, t)$ and the conservative external body force by $\rho \mathbf{grad} \chi = \rho(x, y, t) \mathbf{grad} \chi(x, y, t)$. The equations determining the irrotational motion of a uniform, incompressible, inviscid liquid, are

$$(2.1) \quad \frac{\partial \mathbf{v}}{\partial t} + (\mathbf{v} \cdot \mathbf{grad}) \mathbf{v} = -\frac{1}{\rho} \mathbf{grad} p + \mathbf{grad} \chi,$$

$$(2.2) \quad \mathbf{curl} \mathbf{v} = 0,$$

$$(2.3) \quad \operatorname{div} \mathbf{v} = 0,$$

$$(2.4) \quad \rho = \text{constant.}$$

Due to (2.2) there exists a velocity potential ϕ such that

$$(2.5) \quad \mathbf{v} = \operatorname{grad} \phi.$$

This combines with (2.3) to yield Laplace's equation,

$$(2.6) \quad \nabla^2 \phi = 0,$$

in the liquid.

Next we determine the conditions that hold on the free surface, $y = \eta(x, t)$. The external body force is assumed to be gravitational, and thus $\chi(x, y, t) = -gy$. Then (2.1) simplifies to

$$(2.7) \quad \operatorname{grad} \left\{ \frac{\partial \phi}{\partial t} + \frac{1}{2} |\operatorname{grad} \phi|^2 \right\} = \operatorname{grad} \left\{ -\frac{p}{\rho} - gy \right\}.$$

Therefore Bernoulli's equation,

$$(2.8) \quad \frac{\partial \phi}{\partial t} + \frac{1}{2} |\operatorname{grad} \phi|^2 + \frac{p}{\rho} + gy = f(t),$$

holds in the liquid. Here $f(t)$ is a constant of the integration. At the free surface the pressure is assumed to have the constant value p_0 . Therefore on $y = \eta(x, t)$,

$$(2.9) \quad \frac{\partial \phi}{\partial t} + \frac{1}{2} |\operatorname{grad} \phi|^2 + gy = -\frac{p_0}{\rho} + f(t).$$

By adding to the potential a suitable time-dependent function, the right hand side can be assumed to vanish. Hence on $y = \eta(x, t)$,

$$(2.10) \quad \frac{\partial \phi}{\partial t} + \frac{1}{2} |\operatorname{grad} \phi|^2 + gy = 0.$$

Also, since the free surface is a material surface, a particle on the surface with coordinates $(x(t), y(t))$ satisfies

$$(2.11) \quad \frac{dy}{dt} = \frac{\partial \eta}{\partial t} + \frac{\partial \eta}{\partial x} \frac{dx}{dt}.$$

Since $dx/dt = \partial \phi / \partial x$ and $dy/dt = \partial \phi / \partial y$,

$$(2.12) \quad \frac{\partial \phi}{\partial y} = \frac{\partial \eta}{\partial t} + \frac{\partial \eta}{\partial x} \frac{\partial \phi}{\partial x},$$

on $y = \eta(x, t)$.

Next we examine the boundary conditions that hold at the bottom and ends of the tank. At the impermeable bottom

$$(2.13) \quad \frac{\partial \phi}{\partial y}(x, -hL, t) = 0,$$

and at the moving ends we have

$$(2.14) \quad \frac{\partial \phi}{\partial x}(x, y, t) = a\omega \sin \omega t,$$

$x = -a \cos \omega t$ and $x = \pi L - a \cos \omega t$.

We look for solutions with period $2\pi/\omega$, so

$$(2.15) \quad \phi(x, y, t + 2\pi/\omega) = \phi(x, y, t), \quad \eta(x, t + 2\pi/\omega) = \eta(x, t).$$

In this chapter, we follow closely the work of Ockendon & Ockendon [33], and Ockendon, Ockendon & Johnson [34]. Different approaches are taken in Miles [29] and Cox & Mortell [9] but they produce the same governing differential equations. Cox & Mortell [9] in fact consider the evolution problem, and therefore do not make the periodicity assumption (2.15).

2.2 The Non-dimensional Problem

We introduce the dimensionless variables

$$(2.16) \quad \epsilon = \frac{a}{L}, \quad \bar{x} = \frac{x}{L}, \quad \bar{y} = \frac{y}{L}, \quad \bar{t} = \omega t,$$

and the dimensionless functions

$$(2.17) \quad \bar{\phi}(\bar{x}, \bar{y}, \bar{t}) = \frac{1}{\epsilon L^2 \omega} \phi(L\bar{x}, L\bar{y}, \bar{t}/\omega), \quad \bar{\eta}(\bar{x}, \bar{t}) = \frac{1}{\epsilon L} \eta(L\bar{x}, \bar{t}/\omega).$$

Once a transformation has been made, the bars will be dropped, since it is obvious which set of variables is being referred to.

The parameter δ , defined by $1 + \delta = L\omega^2 \coth(h)/g$, is a detuning parameter, and the first natural resonance frequency is $\omega_0^2 = g \tanh(h)/L$. Thus $\delta \rightarrow 0$ as $\omega \rightarrow \omega_0$. The velocity potential and the surface elevation are determined by the dimensionless system:

$$(2.18) \quad \nabla^2 \phi = 0,$$

in $-\epsilon \cos t < x < \pi - \epsilon \cos t$, $-h < y < \epsilon \eta(x, t)$,

$$(2.19) \quad (1 + \delta) \tanh(h) \left\{ \frac{\partial \phi}{\partial t} + \frac{\epsilon}{2} \left[\left(\frac{\partial \phi}{\partial x} \right)^2 + \left(\frac{\partial \phi}{\partial y} \right)^2 \right] \right\} + \eta = 0,$$

on $y = \epsilon \eta(x, t)$, and

$$(2.20) \quad \frac{\partial \phi}{\partial y} = \frac{\partial \eta}{\partial t} + \epsilon \frac{\partial \eta}{\partial x} \frac{\partial \phi}{\partial x},$$

on $y = \epsilon \eta(x, t)$, subject to the boundary conditions

$$(2.21) \quad \frac{\partial \phi}{\partial y}(x, -h, t) = 0,$$

for $-\epsilon \cos t < x < \pi - \epsilon \cos t$, and

$$(2.22) \quad \frac{\partial \phi}{\partial x}(x, y, t) = \sin t,$$

on $x = -\epsilon \cos t$ and $x = \pi - \epsilon \cos t$, and the periodicity conditions

$$(2.23) \quad \phi(x, y, t + 2\pi) = \phi(x, y, t), \quad \eta(x, t + 2\pi) = \eta(x, t).$$

A second change of variables is now made. The effect is that the tank is now viewed from a moving coordinate system fixed to the ends of the tank. Let

$$(2.24) \quad \bar{\phi}(x, y, t) = \phi(x - \epsilon \cos t, y, t) - x \sin t, \quad \bar{\eta}(x, t) = \eta(x - \epsilon \cos t, t).$$

Dropping the bars again, the transformed problem is then to find ϕ and η such that

$$(2.25) \quad \nabla^2 \phi = 0,$$

in $0 < x < \pi$, $-h < y < \epsilon\eta(x, t)$,

$$(2.26) \quad (1 + \delta) \tanh(h) \left\{ \frac{\partial \phi}{\partial t} + x \cos t + \frac{\epsilon}{2} \left[\left(\frac{\partial \phi}{\partial x} \right)^2 + \left(\frac{\partial \phi}{\partial y} \right)^2 - \sin^2 t \right] \right\} + \eta = 0,$$

on $y = \epsilon\eta(x, t)$, and

$$(2.27) \quad \frac{\partial \phi}{\partial y} = \frac{\partial \eta}{\partial t} + \epsilon \frac{\partial \eta}{\partial x} \frac{\partial \phi}{\partial x},$$

on $y = \epsilon\eta(x, t)$, subject to the boundary conditions

$$(2.28) \quad \frac{\partial \phi}{\partial y}(x, -h, t) = 0,$$

for $0 < x < \pi$, and

$$(2.29) \quad \frac{\partial \phi}{\partial x}(x, y, t) = \sin t,$$

on $x = 0$ and $x = \pi$, and the periodicity condition

$$(2.30) \quad \phi(x, y, t + 2\pi) = \phi(x, y, t), \quad \eta(x, t + 2\pi) = \eta(x, t).$$

2.3 The Scaled Problem

Continuing to follow Ockendon & Ockendon [33] and Ockendon, Ockendon & Johnson [34], we introduce the 'Korteweg-de-Vries' scalings, which match those used by Moiseyev [30] when $h = O(1)$. The scaled depth and detuning parameters

$$(2.31) \quad \kappa = h\epsilon^{-1/4}, \quad \lambda = \delta\epsilon^{-1/2},$$

are both assumed to be $O(1)$. We assume $\epsilon \ll 1$, and rescale our problem by writing

$$(2.32) \quad \psi(x, y, t, \epsilon) = \epsilon^{1/2} \phi(x, \epsilon^{1/4} y, t), \quad \xi(x, t, \epsilon) = \epsilon^{1/4} \eta(x, t).$$

The scaled problem then consists in finding $\psi(x, y, t, \epsilon)$ and $\xi(x, t, \epsilon)$ such that

$$(2.33) \quad \frac{\partial^2 \psi}{\partial y^2} + \epsilon^{1/2} \frac{\partial^2 \psi}{\partial x^2} = 0,$$

in $0 < x < \pi$, $-\kappa < y < \epsilon^{1/2} \xi(x, t, \epsilon)$,

$$(2.34) \quad \kappa(1 + \lambda\epsilon^{1/2}) \left(1 - \frac{\kappa^2 \epsilon^{1/2}}{3} + \dots \right) \left\{ \frac{\partial \psi}{\partial t} + \epsilon^{1/2} x \cos t \right. \\ \left. + \frac{1}{2} \left[\epsilon^{1/2} \left(\frac{\partial \psi}{\partial x} \right)^2 + \left(\frac{\partial \psi}{\partial y} \right)^2 \right] - \frac{\epsilon^{3/2}}{2} \sin^2 t \right\} + \xi = 0,$$

on $0 < x < \pi$, $y = \epsilon^{1/2} \xi(x, t, \epsilon)$, and

$$(2.35) \quad \frac{\partial \psi}{\partial y} = \epsilon^{1/2} \frac{\partial \xi}{\partial t} + \epsilon \frac{\partial \xi}{\partial x} \frac{\partial \psi}{\partial x},$$

on $0 < x < \pi$, $y = \epsilon^{1/2}\xi(x, t, \epsilon)$. The boundary and periodicity conditions are

$$(2.36) \quad \frac{\partial \psi}{\partial y}(x, -\kappa, t, \epsilon) = 0, \quad 0 < x < \pi,$$

$$(2.37) \quad \frac{\partial \psi}{\partial x}(0, y, t, \epsilon) = 0, \quad -\kappa < y < \epsilon^{1/2}\xi(0, t, \epsilon),$$

$$(2.38) \quad \frac{\partial \psi}{\partial x}(\pi, y, t, \epsilon) = 0, \quad -\kappa < y < \epsilon^{1/2}\xi(\pi, t, \epsilon),$$

and

$$(2.39) \quad \psi(x, y, t + 2\pi, \epsilon) = \psi(x, y, t, \epsilon), \quad \xi(x, t + 2\pi, \epsilon) = \xi(x, t, \epsilon).$$

It is now a relatively simple matter, using perturbation methods, to derive asymptotic approximations for ψ and ξ in terms of the small parameter ϵ . To do this we write

$$(2.40) \quad \psi(x, y, t, \epsilon) = \psi_0(x, y, t) + \epsilon^{1/2}\psi_1(x, y, t) + \epsilon\psi_2(x, y, t) + \dots,$$

$$(2.41) \quad \xi(x, t, \epsilon) = \xi_0(x, t) + \epsilon^{1/2}\xi_1(x, t) + \epsilon\xi_2(x, t) + \dots,$$

where the $\psi_i(x, y, t)$ are defined in $0 < x < \pi$, $-\kappa < y < \epsilon^{1/2}\xi(x, t, \epsilon)$, and $\xi_i(x, t)$ on $0 < x < \pi$, $y = \epsilon^{1/2}\xi(x, t, \epsilon)$. These expressions are substituted into (2.33)—(2.39), and terms of the same order collected together.

O(1) Terms: From (2.33) and (2.36) we obtain

$$(2.42) \quad \psi_0(x, y, t) = \theta_0(x, t).$$

Then (2.37) and (2.38) give $\partial\theta_0/\partial x = 0$ on $x = 0, \pi$, and the periodicity condition (2.39) shows that $\theta_0(x, t + 2\pi) = \theta_0(x, t)$. Also, by (2.34),

$$(2.43) \quad \xi_0 = -\kappa \frac{\partial \theta_0}{\partial t}.$$

O($\epsilon^{1/2}$) Terms: Using (2.33) and (2.36), we see that

$$(2.44) \quad \psi_1(x, y, t) = \theta_1(x, t) - \frac{1}{2}(\kappa + y)^2 \frac{\partial^2 \theta_0}{\partial x^2}(x, t).$$

(2.37) and (2.38) show that $\partial\theta_1/\partial x = 0$ on $x = 0, \pi$, and (2.39) forces $\theta_1(x, t)$ to have period 2π . Consideration of (2.35) on $y = \epsilon^{1/2}\xi$ leads to

$$(2.45) \quad \frac{\partial^2 \theta_0}{\partial x^2} - \frac{\partial^2 \theta_0}{\partial t^2} = 0,$$

and hence

$$(2.46) \quad \theta_0(x, t) = f(t + x) + g(t - x).$$

Since $\partial\theta_0/\partial x = 0$ on $x = 0$, $f'(t) = g'(t)$ and

$$(2.47) \quad \theta_0(x, t) = f(t + x) + f(t - x),$$

where an arbitrary constant has been incorporated into f . Furthermore, f has period 2π . Since (2.34) holds on $y = \epsilon^{1/2}\xi$,

$$(2.48) \quad \xi_1 = -\kappa \left\{ \left(\lambda - \frac{\kappa^2}{3} \right) \frac{\partial \theta_0}{\partial t} - \frac{\kappa^2}{2} \frac{\partial^3 \theta_0}{\partial x^2 \partial t} + \frac{1}{2} \left(\frac{\partial \theta_0}{\partial x} \right)^2 + \frac{\partial \theta_1}{\partial t} + x \cos t \right\}.$$

$O(\epsilon)$ Terms: (2.33) and (2.36) give

$$(2.49) \quad \frac{\partial \psi_2}{\partial y}(x, y, t) = -(\kappa + y) \frac{\partial^2 \theta_1}{\partial x^2}(x, t) + \frac{1}{6}(\kappa + y)^3 \frac{\partial^4 \theta_0}{\partial x^4}(x, t),$$

and (2.35) leads to

$$(2.50) \quad -\xi_0 \frac{\partial^2 \theta_0}{\partial x^2} - \kappa \frac{\partial^2 \theta_1}{\partial x^2} + \frac{1}{6} \kappa^3 \frac{\partial^4 \theta_0}{\partial x^4} = \frac{\partial \xi_1}{\partial t} + \frac{\partial \xi_0}{\partial x} \frac{\partial \theta_0}{\partial x}.$$

Substituting for ξ_0 and ξ_1 from (2.43) and (2.48) into this equation gives

$$(2.51) \quad \frac{\partial^2 \theta_1}{\partial x^2} - \frac{\partial^2 \theta_1}{\partial t^2} = -\frac{\kappa^2}{3} \frac{\partial^4 \theta_0}{\partial x^4} + \left(\lambda - \frac{\kappa^2}{3} \right) \frac{\partial^2 \theta_0}{\partial x^2} + 2 \frac{\partial \theta_0}{\partial x} \frac{\partial \theta_0^2}{\partial x \partial t} + \frac{\partial \theta_0}{\partial t} \frac{\partial^2 \theta_0}{\partial x^2} - x \sin t,$$

where (2.45) has been used. If (2.47) is put into this equation, we see that θ_1 satisfies the inhomogeneous wave equation

$$(2.52) \quad \begin{aligned} \frac{\partial^2 \theta_1}{\partial x^2} - \frac{\partial^2 \theta_1}{\partial t^2} = & -\frac{\kappa^2}{3} \{ f^{(4)}(t+x) + f^{(4)}(t-x) \} \\ & + \left(\lambda - \frac{\kappa^2}{3} \right) \{ f^{(2)}(t+x) + f^{(2)}(t-x) \} \\ & + 2 \{ f^{(1)}(t+x) - f^{(1)}(t-x) \} \{ f^{(2)}(t+x) - f^{(2)}(t-x) \} \\ & + \{ f^{(1)}(t+x) + f^{(1)}(t-x) \} \{ f^{(2)}(t+x) + f^{(2)}(t-x) \} - x \sin t. \end{aligned}$$

The inhomogeneous wave equation

$$(2.53) \quad \frac{\partial^2 \zeta_1}{\partial x^2} - \frac{\partial^2 \zeta_1}{\partial t^2} = k(x, t)$$

has the particular solution

$$(2.54) \quad \zeta_1(x, t) = \frac{1}{2} \int^x \int_{t-(x-s)}^{t+(x-s)} k(s, \tau) d\tau ds.$$

Using this formula, we find that the general solution to (2.52) is

$$(2.55) \quad \begin{aligned} \theta_1(x, t) = & p(t+x) + q(t-x) \\ & + \frac{\kappa^2}{6} \left\{ \frac{1}{2} [f^{(2)}(t+x) + f^{(2)}(t-x)] - x [f^{(3)}(t+x) - f^{(3)}(t-x)] \right\} \\ & - \left(\lambda - \frac{\kappa^2}{3} \right) \left\{ \frac{1}{4} [f(t+x) + f(t-x)] - \frac{x}{2} [f^{(1)}(t+x) - f^{(1)}(t-x)] \right\} \\ & - \frac{3}{4} \left\{ \int^x \{ f^{(1)}(t-x+2s)^2 - f^{(1)}(t+x-2s)^2 \} ds - x [f^{(1)}(t+x)^2 - f^{(1)}(t-x)^2] \right\} \\ & + \frac{1}{4} \{ f(t+x)f^{(1)}(t-x) + f^{(1)}(t+x)f(t-x) \} - x \sin t, \end{aligned}$$

where p and q are arbitrary functions. In order to apply the boundary conditions we need the formula

$$(2.56) \frac{\partial \theta_1}{\partial x} = p'(t+x) - q'(t-x) - \frac{\kappa^2}{6} \left\{ \frac{1}{2} [f^{(3)}(t+x) - f^{(3)}(t-x)] + x [f^{(4)}(t+x) + f^{(4)}(t-x)] \right\} + \left(\lambda - \frac{\kappa^2}{3} \right) \left\{ \frac{1}{4} [f^{(1)}(t+x) - f^{(1)}(t-x)] + \frac{x}{2} [f^{(2)}(t+x) + f^{(2)}(t-x)] \right\} + \frac{3}{4} \left\{ f^{(1)}(t+x)^2 - f^{(1)}(t-x)^2 + 2x [f^{(1)}(t+x)f^{(2)}(t+x) + f^{(1)}(t-x)f^{(2)}(t-x)] \right\} - \frac{1}{4} \left\{ f(t+x)f^{(2)}(t-x) - f^{(2)}(t+x)f(t-x) \right\} - \sin t,$$

where use has been made of the formula

$$(2.57) \quad \frac{\partial}{\partial x} \int^x F(x,s) ds = F(x,x) + \int^x \frac{\partial}{\partial x} F(x,s) ds.$$

The evaluation of (2.56) at $x = 0$ gives

$$(2.58) \quad 0 = p'(t) - q'(t) - \sin t.$$

Since f , p and q have period 2π , the boundary condition $\partial \theta_1 / \partial x = 0$ at $x = \pi$ gives

$$(2.59) \quad 0 = p'(t+\pi) - q'(t-\pi) - \frac{\kappa^2}{3} \pi f^{(4)}(t+\pi) + \left(\lambda - \frac{\kappa^2}{3} \right) \pi f^{(2)}(t+\pi) + 3\pi f^{(1)}(t+\pi)f^{(2)}(t+\pi) - \sin t.$$

Putting $s = t + \pi$ and using (2.58), we get

$$(2.60) \quad 0 = -\frac{\kappa^2}{3} \pi f^{(4)}(s) + \left(\lambda - \frac{\kappa^2}{3} \right) \pi f^{(2)}(s) + 3\pi f^{(1)}(s)f^{(2)}(s) + 2 \sin s.$$

Defining $v(s) = f'(s)$, and rearranging shows that

$$(2.61) \quad \frac{2}{\pi} \sin s = \frac{\kappa^2}{3} v^{(3)}(s) - \left(\lambda - \frac{\kappa^2}{3} \right) v^{(1)}(s) - 3v(s)v^{(1)}(s),$$

and v has period 2π and mean zero. This nonlinear equation determines f up to an arbitrary constant, and hence θ_0 , ψ_0 and ξ_0 .

Ockendon & Ockendon [33] provide a brief derivation of the fact that, when the Reynolds number $Re \sim \epsilon^{-3/2}$, the boundary layer at the base of the tank causes a term

$$(2.62) \quad \frac{\bar{\mu}}{\sqrt{2}\kappa} \left(\frac{2}{\pi} \right)^{1/2} \int_0^\infty \frac{u'(s-\tau)}{\sqrt{\tau}} d\tau = \frac{\bar{\mu}}{\sqrt{2}\kappa} (\mathbf{D}u')(s)$$

to be included in (2.61). A similar term appears in Chester's equation, in [6].

Setting $v(s) = 2\kappa^2 u(s)/9$ in (2.61), and replacing s by t , leads to the equation

$$(2.63a) \quad u'''(t) + m^2 u'(t) = 2u(t)u'(t) + \mu_1 u'(t) + \mu_2 (\mathbf{D}u')(t) + \mu_3 \sin t,$$

$$(2.63b) \quad \int_{-\pi}^{\pi} u(s) ds = 0, \quad u(t) = u(t+2\pi),$$

where

$$(2.64) \quad \mu_1 = m^2 - 1 + \frac{3\lambda}{\kappa^2}, \quad \mu_2 = \frac{3\bar{\mu}}{\sqrt{2}\kappa^3}, \quad \mu_3 = \frac{27}{\pi\kappa^4},$$

and m is a positive integer.

Chapter 3

Reduction of Problem to a Pair of Bifurcation Equations

3.1 Introduction

In this chapter we will use the method of *Lyapunov-Schmidt* to find necessary and sufficient conditions for the existence of solutions (μ, u) , with mean zero and period 2π , of the integro-differential equation

$$(3.1) \quad u'''(t) + m^2 u'(t) = 2u(t)u'(t) + \mu_1 u'(t) + \mu_2 (\mathbf{D}u')(t) + \mu_3 \sin t,$$

which is derived in Chapter 2. The integral operator \mathbf{D} is formally given by

$$(3.2) \quad (\mathbf{D}u)(t) = \sqrt{\frac{2}{\pi}} \int_0^\infty \frac{u(t-s)}{\sqrt{s}} ds.$$

We allow the parameter $\mu = (\mu_1, \mu_2, \mu_3)$ to vary in a full neighbourhood of the origin in \mathbf{R}^3 . Equation (3.1) does not determine the stability of solutions¹.

For an extensive treatment of the method of Lyapunov-Schmidt see for example Golubitsky and Schaeffer [14]. Other good references include Hale [16], Chow and Hale [8] and Vanderbauwhede [48].

3.2 Lyapunov-Schmidt

We begin this section by introducing some definitions that will be needed later. Let \mathcal{H}^k be the space of functions with mean zero and period 2π , whose first k derivatives are square integrable. If u is in \mathcal{H}^0 then

$$(3.3) \quad u(t) = \sum_{n=1}^{\infty} (a_n \cos nt + b_n \sin nt),$$

and we define

$$(3.4) \quad \|u\|_k^2 = \sum_{n=1}^{\infty} (a_n^2 + b_n^2) n^{2k}.$$

Clearly

$$(3.5) \quad \|u\|_0^2 = \frac{1}{\pi} \int_{-\pi}^{\pi} u^2(s) ds.$$

¹See Cox & Mortell [9] for a discussion of the evolution problem.

Reynolds & Cox [40] show that if $u(t)$ is given by (3.3) and \mathbf{D} is defined by

$$(3.6) \quad (\mathbf{D}u)(t) = \sum_{n=1}^{\infty} n^{-\frac{1}{2}} \left\{ (a_n - b_n) \cos nt + (a_n + b_n) \sin nt \right\},$$

then (3.2) holds in a mean squared sense. Proposition 1 of [40] states that for $u \in \mathcal{H}^1$

$$(3.7) \quad \int_{-\pi}^{\pi} u'(s)(\mathbf{D}u)(s) ds = -\pi \|u\|_{\frac{1}{4}}^2,$$

and

$$(3.8) \quad (\mathbf{D}u)' = \mathbf{D}u'.$$

Furthermore it is shown that

$$(3.9) \quad (\mathbf{D}u)(t + \phi) = [\mathbf{D}u(\cdot + \phi)](t).$$

Theorem 1 of [40] gives the bound

$$(3.10) \quad \|u\|_0 \leq \|u\|_{\frac{1}{4}} \leq \left| \frac{\mu_3}{\mu_2} \right|,$$

on solutions (μ, u) of (3.1) with $\mu_2 \neq 0$.

We will use the orthogonal projection operator $\mathbf{P} : \mathcal{H}^0 \mapsto \mathcal{H}^0$, defined by

$$(3.11) \quad (\mathbf{P}u)(t) = \frac{\cos mt}{\pi} \int_{-\pi}^{\pi} u(s) \cos ms ds + \frac{\sin mt}{\pi} \int_{-\pi}^{\pi} u(s) \sin ms ds.$$

It follows from the definition of \mathbf{P} and the series representation for \mathbf{D} given in (3.6) that

$$(3.12) \quad \mathbf{P}\mathbf{D} = \mathbf{D}\mathbf{P}.$$

Making use of (3.8), (3.1) can be integrated term by term, to give

$$(3.13) \quad u''(t) + m^2 u(t) = u^2(t) + \mu_1 u(t) + \mu_2 (\mathbf{D}u)(t) - \mu_3 \cos t + C.$$

Applying the conditions that u has mean zero and period 2π , shows that

$$(3.14) \quad C = -\frac{1}{2} \|u\|_0^2.$$

We look for solutions to (3.1) of the form

$$(3.15) \quad u(t) = r \cos m(t - \phi) + w(t - \phi)$$

where

$$(3.16) \quad \mathbf{P}w = 0.$$

Then w contains all the terms in a Fourier series for u except $\cos mt$ and $\sin mt$.

Substituting (3.15) into (3.13) and replacing t by $t + \phi$, we find that $w(t)$ satisfies

$$(3.17) \quad w''(t) + m^2 w(t) = f(r, \mu, \phi, w)(t),$$

where

$$(3.18) \quad f(r, \mu, \phi, w)(t) = \frac{r^2}{2} \cos 2mt + w^2(t) + 2rw(t) \cos mt - \frac{1}{2} \|w\|_0^2 \\ + \mu_1 \left\{ r \cos mt + w(t) \right\} + \mu_2 \mathbf{D} \left\{ r \cos(m \cdot) + w \right\} (t) - \mu_3 \cos(t + \phi).$$

Applying the Fredholm Alternative to (3.17) we get

$$(3.19a) \quad w''(t) + m^2 w(t) = (\mathbf{I} - \mathbf{P})f(r, \mu, \phi, w)(t),$$

$$(3.19b) \quad 0 = \mathbf{P}f(r, \mu, \phi, w),$$

where (3.19b) represents a solvability condition on the existence of periodic solutions of (3.17).

The Implicit Function Theorem applied to (3.19a) about $(r, \mu, w) = (0, 0, 0)$ implies that there is a neighbourhood U of $\mathbf{0}$ in $\mathbf{R} \times \mathbf{R}^3$, a neighbourhood \mathcal{U} of 0 in $(\mathbf{I} - \mathbf{P})\mathcal{H}^2$, and a unique analytic function $w^* : U \times S^1 \mapsto \mathcal{U}$, such that $w^*(r, \mu, \phi)$ is the unique solution of (3.19a). Furthermore, w^* is the limit of the sequence $\{w_n\}$ defined by

$$(3.20a) \quad w''_{n+1}(t) + m^2 w_{n+1}(t) = (\mathbf{I} - \mathbf{P})f(r, \mu, \phi, w_n)(t), \quad n = 0, 1, 2, \dots,$$

$$(3.20b) \quad w_0 = 0,$$

for r, μ sufficiently small.

By (3.19b), $w^*(r, \mu, \phi)$ must satisfy

$$(3.21) \quad \mathbf{P}f(r, \mu, \phi, w^*(r, \mu, \phi)) = 0,$$

which combined with the definition of \mathbf{P} gives us the bifurcation equations

$$(3.22a) \quad 0 = B_1(r, \mu, \phi) \stackrel{def}{=} -\delta_{1,m} \cos \phi + \mu_1 r + \frac{\mu_2 r}{\sqrt{m}} \\ + \frac{1}{\pi} \int_{-\pi}^{\pi} \left\{ w^*(s)^2 + 2r w^*(s) \cos ms \right\} \cos ms \, ds,$$

$$(3.22b) \quad 0 = B_2(r, \mu, \phi) \stackrel{def}{=} \delta_{1,m} \sin \phi + \frac{\mu_2 r}{\sqrt{m}} \\ + \frac{1}{\pi} \int_{-\pi}^{\pi} \left\{ w^*(s)^2 + 2r w^*(s) \cos ms \right\} \sin ms \, ds.$$

Every solution (r, μ, ϕ) of the bifurcation equations, with (r, μ) in a neighbourhood of the origin and $\phi \in S^1$, corresponds to a solution u of the original problem (3.1), with

$$(3.23) \quad u(t) = r \cos m(t - \phi) + w^*(r, \mu, \phi)(t - \phi).$$

There is not a one-to-one correspondence between solutions of (3.1) and (3.22), since (3.22) can have different solutions which lead to the same solution of (3.1).

3.3 Properties of $w^*(t)$

Here we detail some symmetries of the solution $t \mapsto w^*(r, \mu, \phi)(t)$ of (3.19a). These will help in the analysis of the bifurcation equations, and will force many of the terms in these equations to vanish. (3.13) does not have as much symmetry as Duffing's equation, due to the integral operator \mathbf{D} and the nonlinearity u^2 .

Proposition 3.1 *The function $t \mapsto w^*(r, \mu, \phi)(t)$ satisfies the following:*

$$(i) \quad w^*(0, (\mu_1, \mu_2, 0), \phi) = 0,$$

$$(ii) \quad w^*(r, (\mu_1, 0, \mu_3), \phi)(t) = w^*(r, (\mu_1, 0, \mu_3), -\phi)(-t),$$

$$(iii) \quad w^*(r, (\mu_1, \mu_2, \mu_3), \phi)(t) = w^*(r, (\mu_1, \mu_2, -\mu_3), \phi + \pi)(t),$$

- (iv) $w^*(r, (\mu_1, \mu_2, \mu_3), \phi)(t) = w^*((-1)^m r, (\mu_1, \mu_2, -\mu_3), \phi)(t + \pi)$,
(v) $w^*(r, (\mu_1, \mu_2, \mu_3), \phi)(t) = w^*(-r, (\mu_1, \mu_2, \mu_3), \phi + \pi/m)(t - \pi/m)$,
(vi) $\frac{\partial w^*}{\partial r}(0, (\mu_1, \mu_2, 0), \phi)(t) = 0$.

The proofs of these properties depend on the fact that $w^*(r, \mu, \phi)$ is the *unique* solution of (3.19a). As examples, we prove (i)—(iii).

The unique solution $w \in (\mathbf{I} - \mathbf{P})\mathcal{H}^2$ of

$$(3.24) \quad w'' + m^2 w = (\mathbf{I} - \mathbf{P})f(0, (\mu_1, \mu_2, 0), \phi, w) = (\mathbf{I} - \mathbf{P}) \left[w^2 - \frac{1}{2} \|w\|_0^2 \right],$$

is $w = 0$. Therefore (i) holds. To prove (ii), let $v(t) = w^*(r, (\mu_1, 0, \mu_3), -\phi)(t)$ and $w(t) = v(-t)$. Since v satisfies

$$(3.25) \quad v''(t) + m^2 v(t) = (\mathbf{I} - \mathbf{P})f(r, (\mu_1, 0, \mu_3), -\phi, v)(t),$$

and

$$(3.26) \quad f(r, (\mu_1, 0, \mu_3), -\phi, v)(-t) = f(r, (\mu_1, 0, \mu_3), \phi, w)(t),$$

we have

$$(3.27) \quad w''(t) + m^2 w(t) = (\mathbf{I} - \mathbf{P})f(r, (\mu_1, 0, \mu_3), \phi, w)(t).$$

By the uniqueness, $w(t) = w^*(r, (\mu_1, 0, \mu_3), \phi)(t)$, and (ii) follows. Similarly to show (iii), put $v(t) = w^*(r, (\mu_1, \mu_2, -\mu_3), \phi + \pi)(t)$. Because

$$(3.28) \quad \begin{aligned} v''(t) + m^2 v(t) &= (\mathbf{I} - \mathbf{P})f(r, (\mu_1, \mu_2, -\mu_3), \phi + \pi, v)(t) \\ &= (\mathbf{I} - \mathbf{P})f(r, (\mu_1, \mu_2, \mu_3), \phi, v)(t), \end{aligned}$$

uniqueness again forces $v(t) = w^*(r, (\mu_1, \mu_2, \mu_3), \phi)(t)$.

Proposition 3.2 *The expansion*

$$(3.29) \quad w^*(0, (0, 0, \mu_3), \phi)(t - \phi) = \sum_{n=1}^{\infty} \frac{\mu_3^n}{n!} v_n(t),$$

holds, where²

$$(3.30) \quad v_n(t) = \sum_{k=0}^{[(n-1)/2]} \gamma_k^n \cos(n - 2k)t.$$

The constants γ_k^n depend on m , and

$$(3.31) \quad \text{sign } \gamma_k^n = (-1)^n,$$

for $k = 0, \dots, [(n-1)/2]$, if $n < m$.

Proof: The function defined by

$$(3.32) \quad v(t) = w^*(0, (0, 0, \mu_3), \phi)(t - \phi),$$

satisfies

$$(3.33) \quad v'' + m^2 v = (\mathbf{I} - \mathbf{P}) \left[v^2 - \frac{1}{2} \|v\|_0^2 - \mu_3 \cos \cdot \right],$$

² $[p]$ denotes the greatest integer $\leq p$.

and is therefore independent of ϕ . The analyticity of w^* and (i) from Proposition 3.1 ensure that (3.29) holds. It remains to show that v_n is a trigonometric polynomial of the kind claimed. The proof is by induction.

We see from (3.29), (3.32) and (3.33) that

$$(3.34) \quad v_1'' + m^2 v_1 = (\mathbf{I} - \mathbf{P})[-\cos \cdot].$$

Hence v_1 has the form (3.30), with

$$(3.35) \quad \gamma_0^1 = -\frac{1 - \delta_{1,m}}{m^2 - 1},$$

and $\gamma_0^1 < 0$ if $m > 1$.

Now suppose that (3.30) and (3.31) hold for every $n \leq N$. v_{N+1} is the unique solution in $(\mathbf{I} - \mathbf{P})\mathcal{H}^2$ of

$$(3.36) \quad v_{N+1}'' + m^2 v_{N+1} = (\mathbf{I} - \mathbf{P}) \left[\frac{\partial^{N+1}}{\partial \mu_3^{N+1}} \left(\tilde{v}^2 - \frac{1}{2} \|\tilde{v}\|_0^2 \right) \Big|_{\mu_3=0} \right],$$

where

$$(3.37) \quad \tilde{v}(t) = \sum_{k=1}^N \frac{\mu_3^k}{k!} v_k(t).$$

Clearly for $1 \leq k \leq N$,

$$(3.38) \quad \frac{\partial^k \tilde{v}}{\partial \mu_3^k} \Big|_{\mu_3=0} = v_k.$$

Introducing $v_0 = 0$, Leibniz's theorem says that

$$(3.39) \quad \begin{aligned} \frac{\partial^{N+1}}{\partial \mu_3^{N+1}} \tilde{v}^2 \Big|_{\mu_3=0} &= \sum_{k=0}^{N+1} \binom{N+1}{k} \frac{\partial^k \tilde{v}}{\partial \mu_3^k} \frac{\partial^{N+1-k} \tilde{v}}{\partial \mu_3^{N+1-k}} \Big|_{\mu_3=0} \\ &= \sum_{k=1}^N \binom{N+1}{k} v_k v_{N+1-k}. \end{aligned}$$

Consider the product

$$(3.40) \quad \begin{aligned} v_k v_{N+1-k} &= \sum_{i=0}^{N_1} \sum_{j=0}^{N_2} \gamma_i^k \gamma_j^{N+1-k} \cos(k-2i)t \cos(N+1-k-2j)t \\ &= \frac{1}{2} \sum_{i=0}^{N_1} \sum_{j=0}^{N_2} \gamma_i^k \gamma_j^{N+1-k} \cos(N+1-2i-2j)t \\ &\quad + \frac{1}{2} \sum_{i=0}^{N_1} \sum_{j=0}^{N_2} \gamma_i^k \gamma_j^{N+1-k} \cos(N+1+2i-2j-2k)t, \end{aligned}$$

where $N_1 = [(k-1)/2]$ and $N_2 = [(N-k)/2]$.

Using the change of variable $l = i + j$, the first term in (3.40) can be written as

$$(3.41) \quad \sum_{l=0}^{N_1+N_2} c_l \cos(N+1-2l)t,$$

where

$$(3.42) \quad c_l = \begin{cases} \frac{1}{2} \sum_{i=0}^l \gamma_i^k \gamma_{l-i}^{N+1-k}, & 0 \leq l \leq M_1, \\ \frac{1}{2} \sum_{i=L_1(l)}^{L_2(l)} \gamma_i^k \gamma_{l-i}^{N+1-k}, & M_1 < l \leq M_2, \\ \frac{1}{2} \sum_{i=l-N_2}^{N_1} \gamma_i^k \gamma_{l-i}^{N+1-k}, & M_2 < l \leq N_1 + N_2, \end{cases}$$

where $M_1 = \min\{N_1, N_2\}$, $M_2 = \max\{N_1, N_2\}$, and

$$(3.43a) \quad L_1(l) = \begin{cases} 0, & N_1 \leq N_2, \\ l - N_2, & N_1 > N_2, \end{cases}$$

$$(3.43b) \quad L_2(l) = \begin{cases} N_1, & N_1 \leq N_2, \\ l, & N_1 > N_2. \end{cases}$$

Clearly, by (3.31),

$$(3.44) \quad \text{sign } c_l = (-1)^{N+1},$$

for $l = 0, \dots, N_1 + N_2$.

A similar approach to the second term in (3.40), with $q = j + k - i$, shows that it equals

$$(3.45) \quad \sum_{q=k-N_1}^{N_2+k} d_q \cos(N+1-2q)t,$$

where

$$(3.46) \quad d_q = \begin{cases} \frac{1}{2} \sum_{j=0}^{q+N_1-k} \gamma_{j+k-q}^k \gamma_j^{N+1-k}, & k - N_1 \leq q \leq K_1, \\ \frac{1}{2} \sum_{j=Q_1(q)}^{Q_2(q)} \gamma_{j+k-q}^k \gamma_j^{N+1-k}, & K_1 < q \leq K_2, \\ \frac{1}{2} \sum_{j=q-k}^{N_2} \gamma_{j+k-q}^k \gamma_j^{N+1-k}, & K_2 < q \leq N_2 + k, \end{cases}$$

where $K_1 = \min\{k, k - N_1 + N_2\}$, $K_2 = \max\{k, k - N_1 + N_2\}$, and

$$(3.47a) \quad Q_1(q) = \begin{cases} q - k, & N_1 \leq N_2, \\ 0, & N_1 > N_2, \end{cases}$$

$$(3.47b) \quad Q_2(q) = \begin{cases} q + N_1 - k, & N_1 \leq N_2, \\ N_2, & N_1 > N_2. \end{cases}$$

Again (3.31) implies that

$$(3.48) \quad \text{sign } d_q = (-1)^{N+1},$$

for $q = k - N_1, \dots, N_2 + k$.

The principle of superposition means that we need only verify that the solution of

$$(3.49) \quad \hat{v}'' + m^2 \hat{v} = (\mathbf{I} - \mathbf{P}) \left[v_k v_{N+1-k} - \frac{1}{2} \int_{-\pi}^{\pi} v_k v_{N+1-k} \right],$$

has the required properties. The subtraction of the integral removes terms with nonzero mean. The solution of (3.49) is therefore

$$(3.50) \quad \hat{v}(t) = \sum_{l=0}^{N_1+N_2} \frac{c_l(1 - \delta_{N+1,2l} - \delta_{N+1-2l,m})}{m^2 - (N+1-2l)^2} \cos(N+1-2l)t \\ + \sum_{q=k-N_1}^{N_2+k} \frac{d_q(1 - \delta_{N+1,2q} - \delta_{|N+1-2q|,m})}{m^2 - (N+1-2q)^2} \cos(N+1-2q)t.$$

The first term is clearly in the form of (3.30). To show that the second term is in this form it is sufficient to see that

$$(3.51) \quad \sum_{q=k-N_1}^{N_2+k} = \sum_{q=k-N_1}^{[N/2]} + \sum_{q'=N+1-N_2-k}^{[N/2]},$$

where $k - N_1 > 0$, $N + 1 - N_2 - k > 0$, and we have implemented the change of variable $q = N + 1 - q'$. The analogue of (3.31) follows for $k \leq [N/2]$, if $N + 1 < m$. ■

Proposition 3.3 *The expansion*

$$(3.52) \quad w^*(r, \mu, \phi)(t) = \sum_{n=0}^{\infty} \frac{\mu_3^n}{n!} w_n(t)$$

holds, where

$$(3.53) \quad w_n(t) = a_0^n(t) + \sum_{k=1}^n (a_k^n(t) \cos k\phi + b_k^n(t) \sin k\phi).$$

Here a_k^n and b_k^n depend on r and μ , but not on ϕ .

Proof: Using (3.19a) and (3.52) we see that $w_n(t)$ is the unique analytic solution in $(\mathbf{I} - \mathbf{P})\mathcal{H}^2$ of

$$(3.54) \quad w_n'' + m^2 w_n = (\mathbf{I} - \mathbf{P}) \left\{ \frac{\partial^n}{\partial \mu_3^n} f(r, \mu, \phi, \bar{w}) \Big|_{\mu_3=0} \right\},$$

where

$$(3.55) \quad \bar{w}(t) = \sum_{k=0}^n \frac{\mu_3^k}{k!} w_k(t).$$

Then $w_0(t)$ satisfies

$$(3.56) \quad w_0'' + m^2 w_0 = (\mathbf{I} - \mathbf{P}) f(r, (\mu_1, \mu_2, 0), \phi, w_0).$$

Clearly $w_0(t)$ is independent of ϕ and satisfies (3.53).

Suppose that (3.53) holds for every $n \leq N$. w_{N+1} solves

$$(3.57) \quad w_{N+1}'' + m^2 w_{N+1} = (\mathbf{I} - \mathbf{P}) \left\{ \frac{\partial^{N+1}}{\partial \mu_3^{N+1}} \left(\bar{w}^2 - \frac{1}{2} \|\bar{w}\|_0^2 \right) \Big|_{\mu_3=0} \right. \\ \left. + 2r w_{N+1} \cos(m \cdot) + \mu_1 w_{N+1} + \mu_2 \mathbf{D} w_{N+1} - \delta_{1,N+1} \cos(\cdot + \phi) \right\}.$$

Since (3.57) holds for all $\phi \in \mathbf{R}$, and

$$(3.58) \quad \frac{\partial^{N+1}}{\partial \mu_3^{N+1}} \bar{w}^2 \Big|_{\mu_3=0} = \sum_{k=0}^{N+1} \binom{N+1}{k} w_k w_{N+1-k},$$

can be written as

$$(3.59) \quad \tilde{a}_0 + \sum_{k=1}^{N+1} (\tilde{a}_k \cos k\phi + \tilde{b}_k \sin k\phi),$$

then it is clear that w_{N+1} has the required form. ■

3.4 Properties of the Bifurcation Equations

When the properties of w^* in Proposition 3.1 are substituted into (3.22), we obtain the following results:

Proposition 3.4 *The bifurcation equations satisfy for $i = 1, 2$:*

- (i) $B_i(0, (\mu_1, \mu_2, 0), \phi) = 0,$
- (ii) $B_i(r, (\mu_1, 0, \mu_3), \phi) = (-1)^{i+1} B_i(r, (\mu_1, 0, \mu_3), -\phi),$
- (iii) $B_i(r, (\mu_1, \mu_2, \mu_3), \phi) = B_i(r, (\mu_1, \mu_2, -\mu_3), \phi + \pi),$
- (iv) $B_i(r, (\mu_1, \mu_2, \mu_3), \phi) = (-1)^m B_i((-1)^m r, (\mu_1, \mu_2, -\mu_3), \phi),$
- (v) $B_i(r, (\mu_1, \mu_2, \mu_3), \phi) = -B_i(-r, (\mu_1, \mu_2, \mu_3), \phi + \pi/m),$
- (v) $\frac{\partial B_1}{\partial r}(0, (\mu_1, \mu_2, 0), \phi) = \mu_1 + \mu_2/\sqrt{m}, \quad \frac{\partial B_2}{\partial r}(0, (\mu_1, \mu_2, 0), \phi) = \mu_2/\sqrt{m}.$

We now prove a sequence of results which will establish an important representation for B_1 and B_2 .

Proposition 3.5 *B_1 and B_2 satisfy*

$$(3.60a) \quad B_1(0, (0, 0, \mu_3), \phi) = (-1)^m \kappa \mu_3^m \cos m\phi + O(|\mu_3|^{m+2}),$$

$$(3.60b) \quad B_2(0, (0, 0, \mu_3), \phi) = (-1)^{m+1} \kappa \mu_3^m \sin m\phi + O(|\mu_3|^{m+2}),$$

where $\kappa > 0$ is a constant which only depends on m .

Proof: By (3.22), we know that

$$(3.61a) \quad B_1(0, (0, 0, \mu_3), \phi) = -\delta_{1,m} \cos \phi + \frac{1}{\pi} \int_{-\pi}^{\pi} v(s)^2 \cos m(s - \phi) ds,$$

$$(3.61b) \quad B_2(0, (0, 0, \mu_3), \phi) = \delta_{1,m} \sin \phi + \frac{1}{\pi} \int_{-\pi}^{\pi} v(s)^2 \sin m(s - \phi) ds,$$

where v is as defined in (3.32). By Proposition 3.2,

$$(3.62) \quad v(t)^2 = \sum_{n=1}^{\infty} \mu_3^n \sum_{k=1}^{n-1} \frac{v_k(t) v_{n-k}(t)}{k! (n-k)!}.$$

For $m > 1$, we want to determine the smallest value of n for which $v_k(t)v_{n-k}(t)$ contains a term $\cos mt$ or $\sin mt$, for some $1 \leq k \leq n-1$. By (3.30),

$$(3.63) \quad v_k(t)v_{n-k}(t) = \frac{1}{2} \sum_{i=0}^{[(k-1)/2]} \sum_{j=0}^{[(n-k-1)/2]} \gamma_i^k \gamma_j^{n-k} \{ \cos(n-2i-2j)t + \cos(n+2i-2j-2k)t \}.$$

Thus we seek the smallest value of n such that

$$(3.64) \quad n - 2i - 2j = \pm m \quad \text{or} \quad n + 2i - 2j - 2k = \pm m$$

holds for any appropriate values of i, j and k . Clearly $n = m$ answers the problem.

The coefficient of $\mu_3^m \cos m\phi$ in (3.61a) is

$$(3.65) \quad -\delta_{1,m} + \sum_{k=1}^{m-1} \frac{\gamma_0^k \gamma_0^{m-k}}{2k!(m-k)!}.$$

By (3.31), this equals $(-1)^m \kappa$, with $\kappa > 0$. The assertion about the coefficient of $\mu_3^m \sin m\phi$ in (3.61b) follows similarly.

The order relations in (3.60a) and (3.60b) follow from symmetry (iv) of Proposition 3.4. ■

We can now prove the major theorem of this chapter.

Theorem 3.6 *The bifurcation equations (3.22) can be represented as*

$$(3.66a) \quad B_1(r, \mu, \phi) = rG_1(r, \mu) + \mu_3^m H_1(r, \mu, \phi),$$

$$(3.66b) \quad B_2(r, \mu, \phi) = r\mu_2 G_2(r, \mu) + \mu_3^m H_2(r, \mu, \phi).$$

Here G_i satisfy

$$(3.67a) \quad G_i(r, \mu) = G_i(-r, \mu),$$

$$(3.67b) \quad G_i(r, (\mu_1, \mu_2, \mu_3)) = G_i(r, (\mu_1, \mu_2, -\mu_3)),$$

$$(3.67c) \quad \frac{\partial^k G_i}{\partial \mu_3^k}(r, \mu) \equiv 0,$$

for every $k \geq m$. Also H_i obey

$$(3.68a) \quad H_i(r, \mu, \phi) = -H_i(-r, \mu, \phi + \pi/m),$$

$$(3.68b) \quad H_i(r, (\mu_1, \mu_2, \mu_3), \phi) = H_i((-1)^m r, (\mu_1, \mu_2, -\mu_3), \phi),$$

and

$$(3.69a) \quad H_1(0, \mathbf{0}, \phi) = (-1)^m \kappa \cos m\phi,$$

$$(3.69b) \quad H_2(0, \mathbf{0}, \phi) = (-1)^{m+1} \kappa \sin m\phi.$$

Proof: The symmetry (v) in Proposition 3.4 implies that $\phi \mapsto B_i(r, \mu, \phi)$ has period $2\pi/m$. A similar argument to the one used in proving Proposition 3.3 shows that

$$(3.70) \quad B_i(r, \mu, \phi) = \sum_{n=0}^{\infty} \frac{\mu_3^n}{n!} \bar{B}_{in}(r, \mu_1, \mu_2, \phi),$$

where

$$(3.71) \quad \bar{B}_{in} = a_0^{in} + \sum_{k=1}^{[n/m]} (a_k^{in} \cos km\phi + b_k^{in} \sin km\phi).$$

Hence $\bar{B}_{in}(r, \mu_1, \mu_2, \phi)$ is independent of ϕ for $n < m$. We define

$$(3.72) \quad \mu_3^m H_i(r, \mu, \phi) \stackrel{\text{def}}{=} \sum_{n \geq m} \frac{\mu_3^n}{n!} \bar{B}_{in}(r, \mu_1, \mu_2, \phi).$$

Due to the symmetry (i) of Proposition 3.4, we can define G_1 by

$$(3.73) \quad rG_1(r, \mu) \stackrel{\text{def}}{=} B_1(r, \mu, \phi) - \mu_3^m H_1(r, \mu, \phi).$$

Similarly, because of (i) and (ii), we can define G_2 ,

$$(3.74) \quad r\mu_2 G_2(r, \mu) \stackrel{\text{def}}{=} B_2(r, \mu, \phi) - \mu_3^m H_2(r, \mu, \phi).$$

(3.67c) follows from the construction of H_i , and the remaining parts of the theorem are corollaries of Propositions 3.4 and 3.5. ■

It is convenient to put

$$(3.75) \quad E_i(r, \mu, \theta) = B_i(r, \mu, \theta/m),$$

$$(3.76a) \quad G_1(r, \mu) = A(\mu) - B(\mu)r^2 + r^4 R_1(r, \mu),$$

$$(3.76b) \quad G_2(r, \mu) = C(\mu) + r^2 R_2(r, \mu),$$

$$(3.77a) \quad H_1(r, \mu, \theta/m) = (-1)^m \kappa \cos \theta + S_1(r, \mu, \theta),$$

$$(3.77b) \quad H_2(r, \mu, \theta/m) = (-1)^{m+1} \kappa \sin \theta + S_2(r, \mu, \theta).$$

In order to analyse the bifurcation equations in Chapter 4 it is important to know some coefficients in the above expressions. It is easy to show that

$$(3.78) \quad \frac{\partial A}{\partial \mu_1}(\mathbf{0}) = 1, \quad \frac{\partial A}{\partial \mu_2}(\mathbf{0}) = \frac{1}{\sqrt{m}}, \quad B(\mathbf{0}) = \frac{1}{6m^2}, \quad C(\mathbf{0}) = \frac{1}{\sqrt{m}}.$$

Moreover, TAYLOR³, (3.67c) and (vi) from Proposition 3.4 show that

$$(3.79) \quad A(\mu) = \mu_1 + \frac{\mu_2}{\sqrt{m}} + \mu_3^2 \frac{2(1 - \delta_{1,m})}{(m^2 - 1)^2(4m^2 - 1)} + \mu_1 \mu_3^2 \frac{2(1 - \delta_{1,m})(4m^4 + 5m^2 - 3)}{(m^2 - 1)^3(4m^2 - 1)} \\ - \mu_3^4 \left\{ \frac{(1 - \delta_{1,m})}{4(m^2 - 1)^4(m + 1)(2m + 1)^2} - \frac{(1 - \delta_{1,m} - \delta_{2,m})(4m^6 + 6m^5 - 30m^4 + 16m^3 + 16m^2 - 130m + 145)}{8(m^2 - 4)^2(m^2 - 1)^5(4m^2 - 1)(2m - 1)} \right\} \\ + \underbrace{\sum_{i=0}^{\infty} \sum_{j=0}^{\infty} \sum_{k=1}^{[m/2]} A_{ijk} \mu_1^i \mu_2^j \mu_3^{2k}}_{3i+8j+3k>8},$$

and

$$(3.80) \quad \kappa = \delta_{1,m} + \frac{\delta_{2,m}}{18} + \frac{\delta_{3,m}}{5120} + \frac{\delta_{4,m} 11}{81648000} + \frac{\delta_{5,m} 59}{2022633897984} + \frac{\delta_{6,m} 2269}{88326362234880000} \\ + \frac{\delta_{7,m} 869}{8011651218784911360000} + \frac{\delta_{8,m} 6117347}{2486562122463365287614873600000} + \dots$$

³Cf. Chapter 5

Chapter 4

Analysis of Bifurcation Equations

4.1 Introduction

In this chapter we solve, for $(r, \theta) \in \mathbf{R} \times \mathbf{R}$, equations of the form

$$(4.1a) \quad 0 = E_1(r, \mu, \theta) \stackrel{def}{=} (-1)^m \kappa \mu_3^m \cos \theta + A(\mu)r - B(\mu)r^3 \\ + r^5 R_1(r, \mu) + \mu_3^m S_1(r, \mu, \theta),$$

$$(4.1b) \quad 0 = E_2(r, \mu, \theta) \stackrel{def}{=} (-1)^{m+1} \kappa \mu_3^m \sin \theta + \mu_2 r C(\mu) \\ + \mu_2 r^3 R_2(r, \mu) + \mu_3^m S_2(r, \mu, \theta),$$

for all μ near $\mathbf{0} \in \mathbf{R}^3$. We make the following hypothesis:

[H₁] A, B, C are analytic.

[H₂] $A(\mathbf{0}) = 0, \quad \partial A / \partial \mu_1(\mathbf{0}) \neq 0,$

$$(4.2) \quad A(\mu_1, \mu_2, \mu_3) = A(\mu_1, \mu_2, -\mu_3).$$

[H₃] $B(\mathbf{0}) \neq 0.$

[H₄] $C(\mathbf{0}) \neq 0.$

[H₅] $\kappa \neq 0.$

[H₆] $E_i(r, \mu, \theta) = -E_i(-r, \mu, \theta + \pi).$

[H₇] $E_i(r, (\mu_1, \mu_2, \mu_3), \theta) = (-1)^m E_i((-1)^m r, (\mu_1, \mu_2, -\mu_3), \theta).$

[H₈] R_i and S_i are analytic, and

$$(4.3) \quad R_i(r, \mu) = O(|r| + |\mu|), \quad S_i(r, \mu, \theta) = O(|r| + |\mu|).$$

It is clear from Section 3.4 that the bifurcation equations for the sloshing problem fit into this framework.

Later, it will be useful to have defined \bar{A} by

$$(4.4) \quad A(\mu_1, \mu_2, \mu_3) = \bar{A}(\mu_1, \mu_2, \mu_3) + \sum_{i+l+mj+3k>m} A_{ijk} \mu_1^i \mu_2^j \mu_3^{2k},$$

where l is the minimum of 3 and m .

We shall analyse the solutions of (4.1) by making appropriate scalings. In Chapter 7 of Chow & Hale [8], some scaling techniques are presented in a way well suited to bifurcation problems. Moreover, Hale & Rodrigues [18,19] analyse the bifurcation equations for harmonic solutions of Duffing's equation using these methods. However, we shall see in Section 4.2 that these methods fail for (4.1), if $m \geq 4$. Two different methods of solving the problem are presented in Sections 4.3 and 4.4.

4.2 Problems with Standard Scaling Techniques

If $1 \leq m \leq 3$, (4.1) can be solved by the kind of analysis in Hale & Rodrigues [18,19]. For example, we could use the scalings

$$(4.5) \quad r = \epsilon^m, \quad \mu_2 = \beta\epsilon^{2m}, \quad \mu_3 = \alpha\epsilon^3,$$

and $\mu_1 = \gamma\epsilon^{2m}$. However, if $m \geq 4$, $r\mu_3^{2i} = O(\epsilon^{m+6i})$ is lower order than either $\mu_3^m = O(\epsilon^{3m})$ or $r^3 = O(\epsilon^{3m})$, for $3i < m$. Thus the lowest order terms are independent of the phase θ , and we fail to capture the multiple solutions of (4.1). The reduced problem obtained by cancelling the lowest order powers of ϵ , and neglecting all higher powers, must be such that the Implicit Function Theorem can be used.

We illustrate some of the difficulties with the example

$$(4.6) \quad 0 = K(r, \lambda_1, \lambda_3) \stackrel{\text{def}}{=} r^3 + (\lambda_1 + \lambda_3^2)r + \lambda_3^4.$$

Multiple solutions satisfy

$$(4.7) \quad 0 = \frac{\partial K}{\partial r} = 3r^2 + \lambda_1 + \lambda_3^2.$$

Hence the solutions are given by

$$(4.8) \quad r^2 = -\frac{\lambda_1 + \lambda_3^2}{3},$$

if λ_1 and λ_3 satisfy

$$(4.9) \quad 27\lambda_3^8 = -4(\lambda_1 + \lambda_3^2)^3.$$

Now we try to solve this problem using some scalings. Firstly we try

$$(4.10) \quad r = \rho\epsilon^4, \quad \lambda_1 = \delta\epsilon^8, \quad \lambda_3 = \alpha\epsilon^3.$$

This scaling is chosen so that the r^3 , $\lambda_1 r$ and λ_3^4 terms in (4.6) balance. Then

$$(4.11a) \quad 0 = \rho\alpha^2 + (\rho^3 + \delta\rho + \alpha^4)\epsilon^2,$$

$$(4.11b) \quad 0 = \alpha^2 + (3\rho^2 + \delta)\epsilon^2.$$

The reduced problem has solution $\alpha = 0$, and all the relevant Jacobians vanish for $\epsilon = 0$.

Another scaling, which causes the r^3 and $r\lambda_3^2$ terms in (4.6) to balance, is

$$(4.12) \quad r = \rho\epsilon, \quad \lambda_1 = \delta\epsilon^2, \quad \lambda_3 = \alpha\epsilon.$$

Then (4.6) and (4.7) become

$$(4.13a) \quad 0 = \rho^3 + (\delta + \alpha^2)\rho + \epsilon\alpha^4,$$

$$(4.13b) \quad 0 = 3\rho^2 + \delta + \alpha^2.$$

This system has solutions $\rho = 0$ and $\delta = -\alpha^2$, when $\epsilon = 0$. But again all the relevant Jacobians vanish at these solutions.

Lastly, we might try

$$(4.14) \quad r = \rho\epsilon^4, \quad \lambda_1 = \delta\epsilon^6, \quad \lambda_3 = \alpha\epsilon^3,$$

which leads to

$$(4.15a) \quad 0 = (\delta + \alpha^2)\rho + (\rho^3 + \alpha^4)\epsilon^2,$$

$$(4.15b) \quad 0 = \delta + \alpha^2 + 3\rho^2\epsilon^2.$$

Again this system cannot be solved with the Implicit Function Theorem.

The proof in Section 4.3 is based on the following method of solving (4.6) and (4.7). We use the scalings

$$(4.16) \quad r = \epsilon^4, \quad \lambda_3 = \alpha\epsilon^3,$$

and obtain

$$(4.17a) \quad 0 = \lambda_1 + \alpha^2\epsilon^6 + (1 + \alpha^4)\epsilon^8,$$

$$(4.17b) \quad 0 = \lambda_1 + \alpha^2\epsilon^6 + 3\epsilon^8.$$

First, (4.17a) can be solved for λ_1 , to get

$$(4.18) \quad \lambda_1 = \bar{\lambda}_1(\alpha, \epsilon) \stackrel{def}{=} -\alpha^2\epsilon^6 - (1 + \alpha^4)\epsilon^8.$$

This can be substituted into (4.17b) to obtain

$$(4.19) \quad \alpha^4 = 2.$$

Therefore we obtain the bifurcation curve (4.9) in the parametric form

$$(4.20a) \quad \lambda_1 = -2^{1/2}\epsilon^6 - 3\epsilon^8,$$

$$(4.20b) \quad \lambda_3 = \pm 2^{1/4}\epsilon^3.$$

4.3 Main Result

In this section we prove the following result.

Theorem 4.1 *Suppose that $[H_1]$ – $[H_3]$ hold. Then there is a neighbourhood V of $\mathbf{0} \in \mathbb{R}$, a neighbourhood W of $\mathbf{0} \in \mathbb{R}^3$ and a surface Σ , given approximately by*

$$(4.21) \quad \frac{27}{2}B(\mathbf{0})\kappa^2\mu_3^{2m} = \bar{A}(\mu) \left\{ \bar{A}(\mu)^2 + 9C(\mathbf{0})^2\mu_2^2 \right\} \pm \left\{ \bar{A}(\mu)^2 - 3C(\mathbf{0})^2\mu_2^2 \right\}^{3/2},$$

such that $W \setminus \Sigma$ consists of two sets W_1 and W_3 , with the following properties:

- (i) *(4.1) has one solution $(r, \theta) \in V \times [-\pi/2, \pi/2)$, if $\mu \in W_1$ and $\mu_3 \neq 0$.*

(ii) (4.1) has two solutions $(r, \theta) \in V \times [-\pi/2, \pi/2)$, if $\mu \in \Sigma$ and $\mu_3 \neq 0$.

(iii) (4.1) has three solutions $(r, \theta) \in V \times [-\pi/2, \pi/2)$, if $\mu \in W_3$ and $\mu_3 \neq 0$.

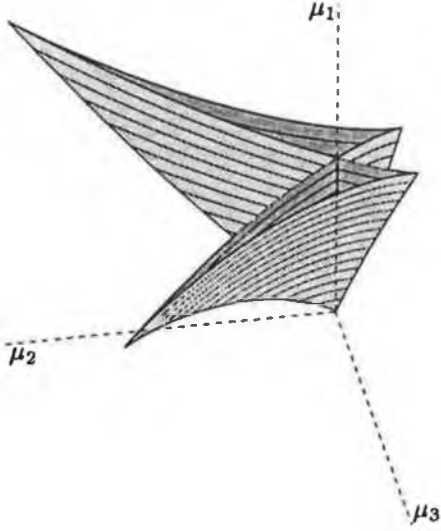

Figure 4.1: Approximate bifurcation surface for sloshing problem, $m = 1$.

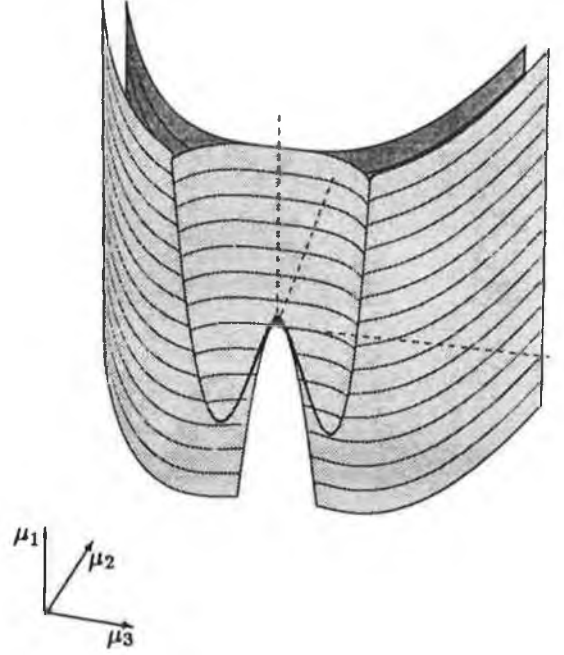

Figure 4.2: Approximate bifurcation surface for sloshing problem, $m = 4$.

Proof: The periodicity and symmetry of S_i in $[H_6]$ imply that if (r, θ) is a solution of (4.1) for a particular μ , then so is $((-1)^k r, \theta + k\pi)$, for every integer k . Hence it is sufficient to look for solutions (r, θ) in $\mathbf{R} \times [-\pi/2, \pi/2)$.

We seek solutions with $\mu_3 \neq 0$. Suppose that $r = 0$. Then

$$(4.22a) \quad 0 = (-1)^m \kappa \mu_3^m \cos \theta + \mu_3^m S_1,$$

$$(4.22b) \quad 0 = (-1)^{m+1} \kappa \mu_3^m \sin \theta + \mu_3^m S_2,$$

which implies that

$$(4.23) \quad 0 = -\kappa^2 + S_1^2 + S_2^2.$$

Since $S_i = O(|\mu|)$, there is a neighbourhood W_0 of $\mathbf{0} \in \mathbf{R}^3$ such that $-\kappa^2 + S_1^2 + S_2^2 < 0$, for every $\mu \in W_0$. Hence there are no solutions of (4.1) with $r = 0$, for $\mu \in W_0$.

We now look for multiple solutions of (4.1), with $r \neq 0$ and $\mu_3 \neq 0$. An easy calculation shows that the Jacobian

$$(4.24) \quad \frac{\partial(E_1, E_2)}{\partial(r, \theta)}(r, \mu, \theta) = (-1)^m \kappa \mu_3^m E_3(r, \mu, \theta),$$

where

$$(4.25) \quad E_3(r, \mu, \theta) = [3B(\mu)r^2 - A(\mu)] \cos \theta + \mu_2 C(\mu) \sin \theta + (r^4 + \mu_3^m + r^2 \mu_2) O(1).$$

Multiple solutions of (4.1), with $\mu_3 \neq 0$, satisfy (4.1) and

$$(4.26) \quad 0 = E_3(r, \mu, \theta).$$

We first employ the scaling

$$(4.27) \quad r = \sigma \epsilon^m, \quad \mu_3 = -\alpha \epsilon^3,$$

where $\sigma = -\text{sign}[B(\mathbf{0})/\kappa]$. We obtain the equivalent problem

$$(4.28a) \quad 0 = \tilde{E}_1(\mu_1, \mu_2, \alpha, \epsilon, \theta) \stackrel{\text{def}}{=} \sigma \kappa \epsilon^{2m} \alpha^m \cos \theta + \bar{A} - \epsilon^{2m} \bar{B} + \epsilon^{2m} O(|\mu_1| + |\mu_2| + \epsilon^l),$$

$$(4.28b) \quad 0 = \tilde{E}_2(\mu_1, \mu_2, \alpha, \epsilon, \theta) \stackrel{\text{def}}{=} \sigma \kappa \epsilon^{2m} \alpha^m \sin \theta - \mu_2 \bar{C} + \epsilon^{2m} O(|\mu_1| + |\mu_2| + \epsilon^l),$$

$$(4.28c) \quad 0 = \tilde{E}_3(\mu_1, \mu_2, \alpha, \epsilon, \theta) \stackrel{\text{def}}{=} (3\bar{B}\epsilon^{2m} - \bar{A}) \cos \theta + \mu_2 \bar{C} \sin \theta + \epsilon^{2m} [\epsilon^m + \mu_2] O(1),$$

where

$$(4.29) \quad \bar{A}(\mu_1, \mu_2, \alpha, \epsilon) \stackrel{\text{def}}{=} A(\mu_1, \mu_2, -\alpha \epsilon^3), \quad \bar{B}(\mu_1, \mu_2, \alpha, \epsilon) \stackrel{\text{def}}{=} B(\mu_1, \mu_2, -\alpha \epsilon^3), \\ \bar{C}(\mu_1, \mu_2, \alpha, \epsilon) \stackrel{\text{def}}{=} C(\mu_1, \mu_2, -\alpha \epsilon^3).$$

Observe the identity

$$(4.30) \quad \tilde{E}_3 + \tilde{E}_1 \cos \theta + \tilde{E}_2 \sin \theta = \epsilon^{2m} \left\{ \sigma \kappa \alpha^m + 2\bar{B} \cos \theta + O(|\mu_1| + |\mu_2| + \epsilon^l) \right\}.$$

Next we introduce the set

$$(4.31) \quad \Delta \stackrel{\text{def}}{=} \left\{ (\alpha_0(\theta), 0, \theta) : \theta \in [-\pi/2, \pi/2] \right\},$$

where

$$(4.32) \quad \alpha_0(\theta)^m = 2 \left| \frac{B(\mathbf{0})}{\kappa} \right| \cos \theta.$$

The motivation for this will appear soon.

$[\mathbf{H}_2]$ and $[\mathbf{H}_4]$ imply that at $(\mu_1, \mu_2) = (\mathbf{0}, \mathbf{0})$ and $\epsilon = 0$,

$$(4.33) \quad \frac{\partial(\tilde{E}_1, \tilde{E}_2)}{\partial(\mu_1, \mu_2)}(\mathbf{0}) = \frac{\partial A}{\partial \mu_1}(\mathbf{0}) C(\mathbf{0}) \neq 0.$$

The Implicit Function Theorem says that there are functions $\tilde{\mu}_i(\alpha, \epsilon, \theta)$ defined in a neighbourhood of $(\alpha_0(\theta_0), 0, \theta_0)$, for each $\theta_0 \in [-\pi/2, \pi/2]$, such that

$$(4.34) \quad \tilde{E}_i(\tilde{\mu}_1(\alpha, \epsilon, \theta), \tilde{\mu}_2(\alpha, \epsilon, \theta), \alpha, \epsilon, \theta) = 0,$$

for $i = 1, 2$. Moreover,

$$(4.35a) \quad \tilde{\mu}_1(\alpha, \epsilon, \theta) = O(\epsilon^{2l}),$$

$$(4.35b) \quad \tilde{\mu}_2(\alpha, \epsilon, \theta) = O(\epsilon^{2m}).$$

Due to the compactness of $[-\pi/2, \pi/2]$, we can extend the domain of each $\tilde{\mu}_i$ to be a neighbourhood N of the set Δ .

The substitution of $\tilde{\mu}_1$ and $\tilde{\mu}_2$ into (4.30) shows that we need only now consider the problem

$$(4.36) \quad 0 = G(\alpha, \epsilon, \theta) \stackrel{\text{def}}{=} \kappa \alpha^m + 2\sigma B(\mathbf{0}) \cos \theta + O(\epsilon^l),$$

in N . We note that the solutions of (4.36) with $\epsilon = 0$ lie in Δ , and that

$$(4.37) \quad \frac{\partial G}{\partial \alpha} = m \kappa \alpha^{m-1}, \quad \frac{\partial G}{\partial \theta} = -2\sigma B(\mathbf{0}) \sin \theta,$$

when $\epsilon = 0$. Therefore, there is a solution $(\bar{\alpha}(\epsilon, \theta), \epsilon, \theta)$ in a neighbourhood of each $(\alpha_0(\theta), 0, \theta)$ with $-\pi/2 < \theta < \pi/2$, and $\bar{\alpha}(0, \theta) = \alpha_0(\theta)$. In a neighbourhood of the points $(\alpha(0), 0, \pm\pi/2)$ there is a solution $(\alpha, \epsilon, \bar{\theta}(\alpha, \epsilon))$ etc. These parameterizations define a surface.

The *bifurcation surface* Σ is then defined parametrically by

$$(4.38a) \quad \mu_1 = \bar{\mu}_1(\bar{\alpha}(\epsilon, \theta), \epsilon, \theta),$$

$$(4.38b) \quad \mu_2 = \bar{\mu}_2(\bar{\alpha}(\epsilon, \theta), \epsilon, \theta),$$

$$(4.38c) \quad \mu_3 = -\bar{\alpha}(\epsilon, \theta)\epsilon^3,$$

except near $(\epsilon, \theta) = (0, \pm\pi/2)$, where the modification is obvious.

Retaining terms up to order ϵ^{2m} in (4.28) gives

$$(4.39a) \quad 0 = \sigma\kappa\epsilon^{2m}\alpha^m \cos\theta + \bar{A}(\mu_1, \mu_2, -\alpha\epsilon^3) - \epsilon^{2m}B(\mathbf{0}),$$

$$(4.39b) \quad 0 = \sigma\kappa\epsilon^{2m}\alpha^m \sin\theta - \mu_2C(\mathbf{0}),$$

$$(4.39c) \quad 0 = \left(3B(\mathbf{0})\epsilon^{2m} - \bar{A}(\mu_1, \mu_2, -\alpha\epsilon^3)\right) \cos\theta + \mu_2C(\mathbf{0}) \sin\theta,$$

where we have used (4.35). Using (4.27), and eliminating θ and ϵ from these produces (4.21). Because of $[\mathbf{H}_7]$ the surface Σ is invariant under a reflection in the plane $\mu_3 = 0$.

It only remains to show that the surface Σ is a bifurcation surface. We show that the number of solutions, with $\theta \in [-\pi/2, \pi/2)$ and $\mu_3 \neq 0$, changes as we cross Σ in the plane $\mu_2 = 0$. Of course, $\theta = 0$ if $\mu_2 = 0$. In this case, (4.1) becomes

$$(4.40) \quad 0 = (-1)^m \kappa \mu_3^m + A(\mu_1, 0, \mu_3)r - B(\mu_1, 0, \mu_3)r^3 + O(|r|^5 + |\mu_3|^m).$$

A simple analysis shows that the number of solutions changes from one to three as we cross Σ , since $B(\mathbf{0}) \neq 0$.

It is clear that the symmetries of E_i do not play a crucial role in the scaling analysis. The method is applicable if (4.2), $[\mathbf{H}_6]$ and $[\mathbf{H}_7]$ are discarded, and (4.3) is replaced with

$$(4.41) \quad R_i(r, \mu) = O(1), \quad S_i(r, \mu, \theta) = O(|r| + |\mu|).$$

4.4 Alternative Scaling Methods

We will briefly present two alternative approaches to solving the bifurcation problem (4.1). Both methods involve deriving a change of variables which transforms (4.1) into a system to which classical scaling techniques can be applied. Here the change of variables transforms the leading terms of (4.1), for each $m \in \mathbf{N}$, into the leading terms for $m = 1$. The result for $m = 1$ is easily obtained as a modification of the work by Hale & Rodrigues [18,19] on Duffing's equation.

Lemma 4.2 *Let $m=1$, and suppose that $[\mathbf{H}_1]$ — $[\mathbf{H}_8]$ hold. There is a neighbourhood V of $0 \in \mathbf{R}$, a neighbourhood W of $\mathbf{0} \in \mathbf{R}^3$ and a set Σ , given approximately by*

$$(4.42) \quad \frac{27}{2}\kappa^2 B(\mathbf{0})\mu_3^{2m} = (\gamma_1\mu_1 + \gamma_2\mu_2) \left\{ (\gamma_1\mu_1 + \gamma_2\mu_2)^2 + 9C(\mathbf{0})^2\mu_2^2 \right\} \\ \pm \left\{ (\gamma_1\mu_1 + \gamma_2\mu_2)^2 - 3C(\mathbf{0})^2\mu_2^2 \right\}^{3/2},$$

where $A(\mu) = \gamma_1\mu_1 + \gamma_2\mu_2 + O(\mu_1^2 + |\mu_1\mu_2| + \mu_2^2 + \mu_3^2)$, such that $W \setminus \Sigma$ consists of two sets W_1 and W_3 , with the following properties:

- (i) (4.1) has one solution $(r, \theta) \in V \times [0, \pi)$, if $\mu \in W_1$ and $\mu_3 \neq 0$.
- (ii) (4.1) has two solutions $(r, \theta) \in V \times [0, \pi)$, if $\mu \in \Sigma$ and $\mu_3 \neq 0$.
- (iii) (4.1) has three solutions $(r, \theta) \in V \times [0, \pi)$, if $\mu \in W_3$ and $\mu_3 \neq 0$.

Proof: Let $m = 1$ and $\mu_3 \neq 0$. Substituting the scaling

$$(4.43) \quad r = \epsilon \rho, \quad \mu_1 = \lambda_1 \epsilon^2, \quad \mu_2 = \lambda_2 \epsilon^2, \quad \mu_3 = \epsilon^3,$$

into (4.1) and (4.26) gives

$$(4.44a) \quad 0 = -B(\mathbf{0})\rho^3 + (\gamma_1 \lambda_1 + \gamma_2 \lambda_2)\rho - \kappa \cos \theta + \epsilon O(1),$$

$$(4.44b) \quad 0 = C(\mathbf{0})\lambda_2 \rho + \kappa \sin \theta + \epsilon O(1),$$

$$(4.44c) \quad 0 = \left[-3B(\mathbf{0})\rho^2 + (\gamma_1 \lambda_1 + \gamma_2 \lambda_2) \right] \cos \theta - C(\mathbf{0})\lambda_2 \sin \theta + \epsilon O(1).$$

An intricate but straight forward analysis of (4.44) proves the lemma. ■

4.4.1 Explicit Change of Variables

There exist unique constants c_k such that the nonsingular change of variable

$$(4.45) \quad \mu_1 = \bar{\mu}_1 + \sum_{k=1}^{[m/3]} c_k \mu_3^{2k},$$

and the scaling

$$(4.46) \quad r = \epsilon^m \rho, \quad \bar{\mu}_1 = \lambda_1 \epsilon^{2m}, \quad \mu_2 = \lambda_2 \epsilon^{2m}, \quad \mu_3 = \epsilon^3,$$

change (4.1) and (4.26) to a system whose leading terms are in one-to-one correspondence with those in (4.44). Hence using Lemma 4.2 we obtain a similar result to Theorem 4.1. The approximate bifurcation surface is given by (4.42), with μ_1 replaced by $\bar{\mu}_1$.

The c_k can be calculated directly by requiring that

$$(4.47) \quad \frac{A \left(\sum_{k=1}^{[m/3]} c_k \epsilon^{6k}, 0, \epsilon^3 \right)}{\epsilon^{2m}}$$

be defined at $\epsilon = 0$. Another approach is to use the Implicit Function Theorem. Because of $[H_2]$ the equation

$$(4.48) \quad A(\mu_1, 0, \mu_3) = 0$$

can be solved uniquely for $\mu_1 = \bar{\mu}_1(\mu_3)$. In writing (4.45) we have included from $\bar{\mu}_1(\mu_3)$ terms up to $\mu_3^{2[m/3]}$, since this is all that is needed to eliminate negative powers of ϵ in (4.47).

4.4.2 Implicit Change of Variables

Using $[H_2]$ and $[H_4]$,

$$(4.49) \quad \frac{\partial(A(\mu), C(\mu)\mu_2, \mu_3)}{\partial(\mu_1, \mu_2, \mu_3)}(\mathbf{0}) = \frac{\partial A}{\partial \mu_1}(\mathbf{0})C(\mathbf{0}) \neq 0.$$

Then the Inverse Function Theorem implies that

$$(4.50) \quad \sigma_1 = A(\mu), \quad \sigma_2 = C(\mu)\mu_2, \quad \sigma_3 = \mu_3,$$

is a nonsingular change of variables. This and the scaling

$$(4.51) \quad r = \epsilon^m \rho, \quad \sigma_1 = \lambda_1 \epsilon^{2m}, \quad \sigma_2 = \lambda_2 \epsilon^{2m}, \quad \sigma_3 = \epsilon^3,$$

trivially reduce the leading terms in (4.1) and (4.26) to those in (4.44). Again using Lemma 4.2 we obtain a similar result to Theorem 4.1.

Chapter 5

Calculation of Leading Terms in Bifurcation Equations

5.1 Introduction

In this chapter we describe the method used to find the leading order terms¹, given in (3.78) to (3.80), of the bifurcation equations (3.22). The Macsyma program TAYLOR, which is supplied on a diskette with this thesis, implements the algorithm. TAYLOR was partly motivated by a code in Rand & Armbruster [37], which applies Lyapunov-Schmidt to a two point boundary value problem, with a scalar parameter.

TAYLOR has been developed to work, not only on the sloshing problem, but any functional-differential equation of the form

$$(5.1) \quad u^{(l+2)}(t) + m^2 u^{(l)}(t) = F(\mu, u, t),$$

where² $\mu = (\mu_1, \mu_2, \mu_3)$,

$$(5.2) \quad F(\mathbf{0}, 0, t) = 0, \quad \frac{\partial F}{\partial u}(\mathbf{0}, 0, t) = 0,$$

and $t \mapsto F(\mu, u, t)$ has least period $2\pi/n$. Here l is a nonnegative integer, and m and n are positive integers. A solution $u(t)$ of (5.1) with least period 2π is termed a *subharmonic* (or *subultraharmonic*) of order m/n . For ease of exposition, we suppose that solutions satisfy the additional condition

$$(5.3) \quad 0 = \int_{-\pi}^{\pi} u(s) ds.$$

TAYLOR does not require this.

The algorithm used by TAYLOR is described in Section 5.2.

Duffing's equation can be written as

$$(5.4) \quad u''(t) + m^2 u(t) = -u^3(t) + \mu_1 u(t) + \mu_2 u'(t) + \mu_3 \cos nt,$$

which is in the form (5.1). In Section 5.3 we present results obtained by TAYLOR on superharmonic solutions of (5.4). Chapter 6 details how TAYLOR was used to get these results.

¹By *leading order terms* we mean the terms whose coefficients explicitly appear in the approximate bifurcation surface (4.21).

²TAYLOR can handle up to nine parameters.

5.2 Mathematical Method

Let T_n be the set of 2π -periodic trigonometric polynomials of the form

$$(5.5) \quad u(t) = \sum_{k=1}^n (a_k \cos kt + b_k \sin kt),$$

and $T = \cup_{n \geq 1} T_n$. The function F in (5.1) maps $\mathbf{R}^3 \times T \times \mathbf{R}$ into T , and satisfies

$$(5.6) \quad F(\mu, u, t + \frac{2\pi}{n}) = F(\mu, u, t).$$

The projection³ $\mathbf{P} : T \rightarrow T$ satisfies

$$(5.7) \quad (\mathbf{P}u)(t) = a_m \cos mt + b_m \sin mt,$$

if

$$(5.8) \quad u(t) = \sum_{k=1}^n (a_k \cos kt + b_k \sin kt).$$

The Lyapunov-Schmidt procedure can be formally applied to (5.1), as it was applied in Chapter 3, to (3.13). We do not attempt to justify Lyapunov-Schmidt in this context. The solution to (5.1) can be written as

$$(5.9) \quad u(t) = r \cos m(t - \phi) + w(t - \phi).$$

Then $w(t) = w^*(r, \mu, \phi)(t)$ is the solution of⁴

$$(5.10) \quad w^{(l+2)}(t) + m^2 w^{(l)}(t) = (\mathbf{I} - \mathbf{P})F(\mu, r \cos(m \cdot) + w, \cdot + \phi)(t).$$

We assume that

$$(5.11) \quad w^*(r, \mu, \phi)(t) = \sum_{i=0}^{\infty} \sum_{j_1=0}^{\infty} \sum_{j_2=0}^{\infty} \sum_{j_3=0}^{\infty} w_{i,j_1,j_2,j_3}(\phi)(t) r^i \mu_1^{j_1} \mu_2^{j_2} \mu_3^{j_3}.$$

The coefficients in this expansion are obtained by applying the differential operator

$$(5.12) \quad \frac{\partial^{i+j_1+j_2+j_3}}{\partial r^i \partial \mu_1^{j_1} \partial \mu_2^{j_2} \partial \mu_3^{j_3}}$$

to each side of (5.10), evaluating at $(r, \mu) = (0, 0)$ and solving the resulting inhomogeneous equations, of the form

$$(5.13) \quad w^{(l+2)}(t) + m^2 w^{(l)}(t) = f(t).$$

Approximations to the bifurcation equations are obtained by applying (5.12) to each side of⁵

$$(5.14) \quad 0 = B(r, \mu, \phi) \stackrel{def}{=} \mathbf{P}F(\mu, r \cos(m \cdot) + w^*(r, \mu, \phi), \cdot + \phi).$$

For the algorithm to work, we require that:

- (i) $(\mu, u) \mapsto F(\mu, u, t)$ be analytic,

³Cf. (3.11).

⁴Cf. (3.17) & (3.19).

⁵Cf. (3.21).

(ii) for each $n \in \mathbf{N}$, there is $N \in \mathbf{N}$, such that $t \mapsto F(\mu, u, t)$ is in T_N for every $u \in T_n$.

The algorithm produces expressions which are linear combinations of sines and cosines with arguments $(im + jn)t$, where i and j are integers. When \mathbf{P} acts on $\sin(im + jn)t$ or $\cos(im + jn)t$, these terms are annihilated unless $im + jn = \pm m$. This equation is solved to find the relevant values for m and n . For these values $\sin(im + jn)t$ and $\cos(im + jn)t$ are retained. Thus, for example,

$$(5.15) \quad \mathbf{P} [\cos 2(m-1)t] = \delta_{2,m} \cos 2(m-1)t,$$

$$(5.16) \quad \mathbf{P} [\cos 2(m-n)t] = \{\delta_{2n,m} + \delta_{2n,3m}\} \cos 2(m-n)t.$$

5.3 Duffing's Equation

In this section we use our method to find the bifurcation equations for Duffing's equation (5.4). In this case $l = 2$ and

$$(5.17) \quad F(\mu, u, t) = -u^3 + \mu_1 u + \mu_2 u' + \mu_3 \cos t.$$

The techniques employed in Sections 3.3 and 3.4 lead to the result that the bifurcation equations $B_i(r, \mu, \phi) = 0$ have the form

$$(5.18a) \quad B_1(r, \mu, \phi) = rG_1(r, \mu) + \mu_3^m H_1(r, \mu, \phi),$$

$$(5.18b) \quad B_2(r, \mu, \phi) = r\mu_2 G_2(r, \mu) + \mu_3^m H_2(r, \mu, \phi),$$

for m odd. Here,

$$(5.19) \quad G_i(r, \mu) = G_i(-r, \mu), \quad G_i(r, (\mu_1, \mu_2, \mu_3)) = G_i(r, (\mu_1, \mu_2, -\mu_3)), \quad \frac{\partial^k G_i}{\partial \mu_3^k}(r, \mu) \equiv 0,$$

for $k \geq m$, and

$$(5.20) \quad G_1(r, \mu) = A(\mu) - B(\mu)r^2 + O(r^4).$$

Some simple calculations show that

$$(5.21) \quad \frac{\partial A}{\partial \mu_1}(0) = 1, \quad B(0) = \frac{3}{4}, \quad G_2(0, 0) = -m.$$

Also,

$$(5.22a) \quad H_i(r, \mu, \phi) = -H_i(-r, \mu, \phi + \pi/m),$$

$$(5.22b) \quad H_i(r, (\mu_1, \mu_2, \mu_3), \phi) = H_i((-1)^m r, (\mu_1, \mu_2, -\mu_3), \phi),$$

and

$$(5.23a) \quad H_1(0, 0, \phi) = (-1)^{(m+3)/2} \kappa \cos m\phi,$$

$$(5.23b) \quad H_2(0, 0, \phi) = (-1)^{(m+1)/2} \kappa \sin m\phi,$$

where $\kappa > 0$ can be explicitly calculated using TAYLOR. Use of TAYLOR shows that

$$(5.24) \quad \kappa = \delta_{1,m} + \frac{\delta_{3,m}}{2048} + \frac{\delta_{5,m}}{679477248} + \frac{\delta_{7,m}}{3339766569369600} + \frac{\delta_{9,m} 49}{512988145055170560000000} + \dots,$$

and

$$(5.24) \quad A(\mu) = \mu_1 - \mu_3^2 \frac{3(1 - \delta_{1,m})}{2(m^2 - 1)^2} - \mu_1 \mu_3^2 \frac{3(1 - \delta_{1,m})}{(m^2 - 1)^3} - \mu_1^2 \mu_3^2 \frac{9(1 - \delta_{1,m})}{2(m^2 - 1)^4} + \mu_3^4 \frac{81(1 - \delta_{1,m})}{32(m^2 - 1)^5} \\ + \mu_1 \mu_3^4 \frac{9(1 - \delta_{1,m})(m^2 + 177)}{128(m^2 - 1)^6} - \mu_3^6 \frac{27(1 - \delta_{1,m})(m^2 - 9)^2(m^2 + 65) + 48(1 - \delta_{1,m} - \delta_{3,m})(m^2 - 1)(5m^2 - 41)}{256(m^2 - 1)^8(m^2 - 9)^2} \\ + \underbrace{\sum_{i=0}^{\infty} \sum_{j=0}^{\infty} \sum_{k=1}^{[m/2]} A_{ijk} \mu_1^i \mu_2^j \mu_3^{2k}}_{3i+9j+3k>9}.$$

Theorem 4.1 can be applied to yield the structure of small solutions of (5.4), with $|\mu|$ small and m odd.

Now we suppose that m is even. Then the bifurcation equations have the form

$$(5.25a) \quad B_1(r, \mu, \phi) = rG_1(r, \mu) + r\mu_3^{2m} H_1(r, \mu, \phi),$$

$$(5.25b) \quad B_2(r, \mu, \phi) = r\mu_2 G_2(r, \mu) + r\mu_3^{2m} H_2(r, \mu, \phi).$$

Here (5.20) to (5.22) hold,

$$(5.26) \quad G_i(r, \mu) = G_i(-r, \mu), \quad G_i(r, (\mu_1, \mu_2, \mu_3)) = G_i(r, (\mu_1, \mu_2, -\mu_3)), \quad \frac{\partial^{k+1} G_i}{\partial r \partial \mu_3^k}(r, \mu) \equiv 0,$$

for $k \geq 2m$, and

$$(5.27a) \quad H_1(0, \mathbf{0}, \phi) = \kappa \cos 2m\phi + \eta,$$

$$(5.27b) \quad H_2(0, \mathbf{0}, \phi) = -\kappa \sin 2m\phi,$$

where $\kappa, \eta \neq 0$. Use of TAYLOR shows that when $m = 2$,

$$(5.28a) \quad \bar{A}(\mu) = \mu_1 - \frac{\mu_3^2}{6} - \frac{\mu_1 \mu_3^2}{9},$$

$$(5.28b) \quad \kappa = \frac{7}{8640},$$

$$(5.28c) \quad \eta = \frac{1}{96},$$

and when $m = 4$,

$$(5.29a) \quad \bar{A}(\mu) = \mu_1 - \frac{\mu_3^2}{150} - \frac{\mu_1 \mu_3^2}{1125} - \frac{\mu_1^2 \mu_3^2}{11250} - \frac{2\mu_1^3 \mu_3^2}{253125} + \frac{\mu_3^4}{300000} + \frac{193\mu_1 \mu_3^4}{162000000} \\ + \frac{2401\mu_1^2 \mu_3^4}{9720000000} - \frac{5009\mu_3^6}{1190700000000} - \frac{604907\mu_1 \mu_3^6}{250047000000000},$$

$$(5.29b) \quad \kappa = \frac{2119}{18106260480000000},$$

$$(5.29c) \quad \eta = \frac{186079}{26671680000000000}.$$

Here

$$(5.30) \quad A(\mu_1, \mu_2, \mu_3) = \bar{A}(\mu_1, \mu_2, \mu_3) + \sum_{i+mj+k>m} A_{ijk} \mu_1^i \mu_2^j \mu_3^{2k},$$

defines \bar{A} . It is not feasible to present a general representation for terms from A here, when m is even and unspecified, since most of the terms required are large.

The bifurcation equations can be analysed using similar techniques to those in Chapter 4. Such an analysis yields the structure of small solutions of (5.4), with $|\mu|$ small and m even.

Chapter 6

TAYLOR: A User Guide

6.1 Introduction

This chapter details how to use the TAYLOR program. The installation instructions given in Section 6.2 are for a DEC VAX 6230 running VMS 5.1, and Macsyma version 412.61, but should be easily amendable for other systems.

6.2 Installation Instructions

The files which make up TAYLOR are contained in the directory \TAYLOR on the diskette at the end of this thesis. These files should be copied to the directory from which TAYLOR is to be used.

Then from Macsyma, in the appropriate directory, type

```
BATCH('COMP.MAC');
```

This will translate and compile several of the functions which TAYLOR uses. If no problems have occurred¹ then any .LSP or .TWARNS files which have been created by Macsyma can be deleted². If there are any problems translating or compiling files then the .MAC versions will suffice, but the functions will be slower.

To load TAYLOR into Macsyma type

```
BATCHLOAD('TAYLOR.MAC');
```

and to run TAYLOR type

```
INSTALL(INIT-FILE, [M-TYPE, N-TYPE]);
```

where both parameters are optional, as will be explained. **M-TYPE** and **N-TYPE** may be one of: **INTEGER**, **EVENINT**, **ODDINT** or a positive integer. Each time TAYLOR is loaded into Macsyma a **KILL** and **RESET** are executed. This is done to free up memory.

6.3 Setting up the Problem for TAYLOR

The **INIT-FILE** is the name of a Macsyma file which must define the functions **USER0()**, **USER1()** and **USER2()**, whose definitions are described below. These define the mathematical problem for TAYLOR, and give it information about the problem.

¹Note that warnings related to **LAMBDA**s can be ignored. See Appendix D for details.

²Care should be taken not to delete other .LSP files: **EXTEND.LSP** and **FILE2.LSP**.

When `INSTALL` is first executed an `INIT-FILE` must be supplied. Subsequent `INSTALLS` without specifying `INIT-FILE` use the previous `USER0()`, `USER1()` and `USER2()`.

The ODE problem must have the form³ given in (5.1) and (5.2), that is

$$(6.1a) \quad u^{(l+2)}(t) + m^2 u^{(l)}(t) = F(\mu, u, t),$$

$$(6.1b) \quad F(\mathbf{0}, \mathbf{0}, t) = 0, \quad \frac{\partial F}{\partial u}(\mathbf{0}, \mathbf{0}, t) = 0,$$

where μ is a vector of parameters, $t \mapsto F(\mu, u, t)$ has period $2\pi/n$, $l \geq 0$, $m > 0$ and $n > 0$ are integers. Let T_n be the set of 2π -periodic trigonometric polynomials of the form

$$(6.2) \quad u(t) = a_0 + \sum_{k=1}^n (a_k \cos kt + b_k \sin kt).$$

We require that:

- (i) $(\mu, u) \mapsto F(\mu, u, t)$ be analytic,
- (ii) for each $n \in \mathbf{N}$, there is $N \in \mathbf{N}$, such that $t \mapsto F(\mu, u, t)$ is in T_N for every $u \in T_n$

(5.10) and (5.14) give the problem for `TAYLOR`, that is

$$(6.3a) \quad w^{(l+2)}(t) + m^2 w^{(l)}(t) = (\mathbf{I} - \mathbf{P})F(\mu, r \cos(m \cdot) + w, \cdot + \phi)(t).$$

$$(6.3b) \quad \mathbf{0} = B(r, \mu, \phi) \stackrel{\text{def}}{=} \mathbf{P}F(\mu, r \cos(m \cdot) + w^*(r, \mu, \phi), \cdot + \phi),$$

where \mathbf{P} is defined in (5.7).

`TAYLOR` uses the global variables `WSOLN` and `BEQTN` to store the ODE solution $w^*(r, \mu, \phi)(t)$ and the bifurcation equations, respectively. The arrays `WW` and `BB` are used to store the respective Taylor coefficients, as they are calculated. The user must use `T` as the independent variable, and `PHI` for the phase.

The functions `USER0()`, `USER1()` and `USER2()` should be defined as follows⁴:

`USER0()` This function should define the global variables:

`BB_DIMEN`, `WW_DIMEN`

These are lists which specify the size of the arrays `WW` and `BB` and the maximum order of terms which may be calculated. See also `DECLARE_ARRAYS`. If `WW_DIMEN` is not set by the user, it defaults to the same value as `BB_DIMEN`. `BB_DIMEN` must be specified.

`IGNORE_SCALED_HOT` {`FALSE`}, `TRUNCATION_ORDER` {`INF`},
`BALANCE` {`[1]`}

The variables `IGNORE_SCALED_HOT`, `TRUNCATION_ORDER` and `BALANCE` can be used to avoid calculating unnecessary terms from the bifurcation equations, and the ODE solution.

When `IGNORE_SCALED_HOT` is `FALSE`, then `BALANCE` is not used, and terms of order greater than `TRUNCATION_ORDER` from the Taylor series are considered to be higher order terms, and are not calculated.

When `IGNORE_SCALED_HOT` is `TRUE` it is assumed that `PARAMETER[I]` has order $O(\text{EPS} \cdot \text{BALANCE}[I])$, $I=1, 2, \dots$, where `BALANCE` is a list, and any terms of order greater than `TRUNCATION_ORDER` in `EPS` are considered to be higher order terms, and are not calculated. See also `DISPLAY_TRUNCATES`.

³Cf. Chapter 5 for full details.

⁴Default values, if any, are presented in braces.

M_MIN {1}, M_MAX {INF}

These specify the allowed range of values to be considered when calculating the bifurcation equations. They are only relevant for **M** unspecified.

N_MIN {1}, N_MAX {INF}

As above, for **N** unspecified.

DOPROJECTION {FALSE}

When set to **TRUE** **FIND_W_COEF** simultaneously finds terms from **WSOLN** and **BEQTN**. If terms from **WSOLN** only are needed it should be **FALSE** since this avoids a certain, relatively small, amount of unnecessary extra work.

WSOLN_USE_PROJECTION_ZERO TERMS {TRUE}

If set to **FALSE** then **FIND_W_COEF** will calculate $(I - P)F$ each time without using any previously calculated information about PF . Only $PF = 0$ is used.

CHECK_ODE_SOLN {FALSE}

If set to **TRUE** then a check is made on each ODE solution. This check can sometimes help to find internal errors, and as such is intended only as a debugging aid.

If an error occurs then several pieces of information, such as the problem term and the current ODE left and right hand sides, are saved to files **ODEERROR.MAC** and **ERROR.MAC**. This information is intended to help in the detection of bugs.

This check can take a lot of CPU time.

COEFFICIENT_SIMP_FUN {'MN_COMBINE}

COEFFICIENT_SIMP_FUN can be set to the name of a function of one parameter. The function is called by **TAYLOR** to simplify coefficients in the Taylor series as they are calculated.

If **M** and **N** are both specified then setting **COEFFICIENT_SIMP_FUN** to **'XTHRU** may be faster than using **MN_COMBINE**.

DISPLAY_TRUNCATES {FALSE}

If set to **TRUE** then **DISPLAY_W_COEF** and **DISPLAY_B_COEF** will not calculate terms which are higher order, using the conventions described previously.

DECLARE_ARRAYS {TRUE}

If **FALSE** then arrays **BB** and **WW** are hashed, however **BB_DIMEN** and **WW_DIMEN** must still be specified. Hashing is automatically done if the number of parameters is greater than five.

MEANZERO {TRUE}

If **MEANZERO** is **TRUE** then the linearized ODE problem has solutions $r \cos m(t - \phi)$; If **FALSE**, and the ODE problem is not of order two, then the linearized ODE problem has solutions $r_1 \cos m(t - \phi) + r_2$, and a third bifurcation equation is obtained from a projection onto 1.

PROJECT_CHECKS_MEANZERO {TRUE}

If **TRUE** and **MEANZERO** is **TRUE** then a check is made by the projection routines to ensure that the **MEANZERO** condition is maintained. If it will be violated by a term then the project routine may introduce a delta or drop the problem terms. A warning is printed if this happens.

PROJECT_TAGS_HOTS {FALSE}

It is not always possible, using **BALANCE** and **TRUNCATION_ORDER**, to determine when a term is not required before actually calculating its coefficient.

When PROJECT_TAGS_HOTS is TRUE the symbol %HOT is multiplied by terms which are found to be higher order, after the coefficient has been calculated. For example, say $R \cdot \mu^3$ is leading order when $M > 2$. If its coefficient is $D(0, 1, M) \cdot \sin(T)$, it is effectively a higher order term, in which case the coefficient is changed to $\%HOT \cdot D(0, 1, M) \cdot \sin(T)$, if PROJECT_TAGS_HOTS is TRUE.

TAYLOR_VERBOSE {TRUE}

When TAYLOR_VERBOSE is TRUE the program informs the user which terms from WSOLN are being automatically calculated, and shows the form of calculated terms. Also, when a term is zero from symmetry, the symmetry is displayed.

WSOLN_QUESTIONS {FALSE}

If WSOLN_QUESTIONS is TRUE then before TAYLOR calculates a coefficient from WSOLN, it first asks the user if the coefficient is known. The user can at this point type the coefficient or reply NO; in which case the program will calculate the result as usual.

If WSOLN_QUESTIONS is FALSE then no questions are asked.

BEQTN_QUESTIONS {FALSE}

As above, for coefficients from BEQTN.

USER1() This function should define the problem parameters and any symmetries for the ODE solution and the bifurcation equations. In fact patterns of coefficients which are known to be zero can be specified. The method for specifying this information is described below. The variables used in this routine are kept as local to TAYLOR since they will not typically change during a given run of the program.

PARAMETER {[r]}

PARAMETER must be set to a list of the parameters in the problem, e.g. PARAMETER:[R, MU[1], MU[2], MU[3]]. All parameters must be in this list, including R, or R[1] and R[2], as appropriate. Its length cannot be greater than ten.

WSOLN_ZERO_TERMS {[]}, BEQTN_ZERO_TERMS {[]}

These are lists of lists, each of which describes a coefficient or a pattern of coefficients which are known to be zero.

USER2() This function should contain the definitions⁵ for the problem functions, as follows:

LINOP(W) {DIFF(W,T,2)+M²*W}

This defines the linear operator for the problem, i.e. LINOP(w) represents $w^{(l+2)} + m^2 w^{(l)}$.

F1(W) {0}

The function F1(W) should contain terms from $F(\mu, r \cos mt + w, t + \phi)$ which never contribute to the bifurcation equations, i.e. $PF1(W) \equiv 0$.

F2(W) {0}

The function F2(W) should contain terms from $F(\mu, r \cos mt + w, t + \phi)$

⁵The definitions must be in terms of W and not W(T). All parameters must appear explicitly, and any constants used in the definitions should be declared as such, e.g. DECLARE([ALPHA, BETA], CONSTANT).

which (i) may contribute to the bifurcation equations, (ii) don't have mean zero (iii) change any trigonometric arguments, even if the changed terms will not contribute to the bifurcation equations.

Hence, $(\mathbf{I} - \mathbf{P})F(\mu, r \cos(m \cdot) + w, \cdot + \phi) = \mathbf{F1}(\mathbf{W}) + (\mathbf{I} - \mathbf{P})\mathbf{F2}(\mathbf{W})$.

If DOPROJECTION is TRUE then $\mathbf{F2}(\mathbf{W})$ should also contain any terms which always contribute to the bifurcation equations.

PF(W) {0}

This is the function used by the program to determine the bifurcation equations. It should contain the terms from $F(\mu, r \cos mt + w, t + \phi)$ which (i) always contribute, and (ii) may contribute, to the bifurcation equations.

It can take a long time to calculate some coefficients from a problem. Hence any *a-priori* knowledge, such as that derived from symmetries, is useful. The variables `WSOLN_ZERO_TERMS` and `BEQTN_ZERO_TERMS`, declared in `USER1()`, allow the user to tell TAYLOR that certain coefficients are known to be zero. These variables are lists of (sub)lists, where each sublist describes a term which has a zero coefficient in the relevant Taylor series. The entries allowed in the sublists are given in Table 6.1. Each sublist entry refers to the corresponding position in the variable `PARAMETER`.

Say the term under consideration is

$$(6.4) \quad \prod_{j=1}^{N_p} \text{PARAMETER}[j]^{i_j}.$$

Every sublist must be of length N_p . The powers, i_j , are compared against the j^{th} sublist entry. If the comparison returns `FALSE` then the next sublist is tried, otherwise the $(j + 1)^{\text{th}}$ power and entry are compared. If a complete match is found then TAYLOR assumes that the relevant coefficient is zero.

Entry	Description
<code>ANY</code>	Matches anything. Same as <code>COND(TRUE)</code> .
<code>EVEN</code>	True if i_j is an even. Same as <code>COND(EVENP(i_j))</code> .
<code>ODD</code>	True if i_j is an odd integer. Same as <code>COND(ODDP(i_j))</code> .
A list	All of the conditions in the list must be satisfied by i_j .
<code>GT(EXP)</code>	True if $i_j > \text{EXP}$. Same as <code>COND($i_j > \text{EXP}$)</code> .
<code>LT(EXP)</code>	True if $i_j < \text{EXP}$. Same as <code>COND($i_j < \text{EXP}$)</code> .
<code>GE(EXP)</code>	True if $i_j \geq \text{EXP}$. Same as <code>COND($i_j \geq \text{EXP}$)</code> .
<code>LE(EXP)</code>	True if $i_j \leq \text{EXP}$. Same as <code>COND($i_j \leq \text{EXP}$)</code> .
<code>NE(EXP)</code>	True if $i_j \neq \text{EXP}$. Same as <code>COND($i_j \# \text{EXP}$)</code> .
<code>EQ(EXP)</code>	True if $i_j = \text{EXP}$. Same as <code>COND($i_j = \text{EXP}$)</code> .
<code>EVEN(EXP)</code>	True if <code>EXP</code> is <code>EVEN</code> . <code>EXP</code> can be an integer which depends on <code>M</code> and <code>N</code> , but for <code>M</code> and/or <code>N</code> unspecified <code>EXP</code> can only be <code>M</code> , <code>N</code> or an integer.
<code>ODD(EXP)</code>	True if <code>EXP</code> is <code>ODD</code> . Same idea as <code>EVEN(EXP)</code> .
<code>COND(EXP)</code>	This is the most versatile of the entries. Basically <code>EXP</code> , which can contain more than one parameter, is passed to the Macsyma <code>EV</code> function. Hence, for example <code>COND(M=N AND $i_3=1$, EVAL)</code> will be evaluated as <code>IS(EV(M=N AND $i_3=1$, EVAL))</code> . <code>COND</code> is particularly useful when used with the variables <code>I0</code> , <code>I1</code> , ..., <code>I9</code> , which are set to the current entry powers, i.e. <code>I1=i_1</code> , <code>I2=i_2</code> , ...

Table 6.1: Entries known to TAYLOR for specifying zero coefficients.

6.4 Notation

There are two notational devices used in TAYLOR. Firstly, all sines and cosines which do not depend on T , are replaced by functions **SFN** and **CFN**. So, for example, **SIN(PHI)** is replaced by **SFN(PHI)**, and **COS(2 PHI)** is replaced by **CFN(2 PHI)**. These functions appear in output saved from TAYLOR. The function **CHANGEFROMFN(EXP)** changes **EXP** back to **SIN** and **COS** format.

The function **D(I,L,M/N)** is used to concatenate Kronecker deltas required by the projection routines when **M** and/or **N** are unspecified. Let **D(J,K)** represent the Kronecker delta $\delta_{j,k}$, then

$$(6.5) \quad D(0, L1, M/N) = D(L1, M/N),$$

$$(6.6) \quad D(1, L1, L2, \dots, LP, M/N) = 1 - D(L1, M/N) - D(L2, M/N) - \dots - D(LP, M/N).$$

TAYLOR also uses **D(2)** to represent 1, which is for technical reasons.

6.5 Using TAYLOR

Once **INSTALL** has been executed with no errors occurring, TAYLOR displays the screen⁶

1. Save Database
2. Load Database
3. Display/Calculate term from the Bifurcation Equation
4. Display/Calculate term from the ODE Solution
5. Display the current Bifurcation Equation
6. Display the current ODE Solution
7. Save the current Bifurcation Equation
8. Save the current ODE Solution
9. Separate BEQTN components and save results
10. Find the Bifurcation Equation up to a Specified Order
11. Find ODE Solution up to a Specified Order
12. Exit

Enter your option

■

⁶If the screen does not appear as shown then the variable **CR**, defined in the file **TAYLOR.MAC**, may need to be changed. It should define a carriage return for the user's terminal.

Option 1 saves everything that has been calculated, and option 2 allows the user to continue from a previously saved calculation. When a previous database is loaded the same `INIT-FILE` should be used, otherwise subsequent calculations may not be correct. Both these options request the user to supply a filename, and any legal Macsyma filename is allowed.

To explain options 3 to 8 and 10 and 11, it is only necessary to explain 3, 5, 7 and 10, since 4, 6, 8 and 11 are the same idea.

- [3] This option allows the user to calculate and display a single term, or patterns of terms. To display a single term, enter the term required, e.g. `R*MU[3]^2;`. Patterns of terms are obtained using the parameters `I0`, `I1`, ..., `I9` and the function `GEN`.

To calculate the coefficients of R , R^2 and R^3 enter `R^I0;`. The program will then prompt for lower and upper bounds on the parameter `I0`, in reply to which `1;` and `3;` should be typed. The three coefficients will then be calculated and displayed.

If only odd powers of R are required, up to R^5 then `R^GEN(I0,2*I0+1);` should be entered. This tells the program that there is a parameter, `I0` here, and a formula, and the terms to be calculated are generated by using the formula. The program will prompt for lower and upper bounds for `I0`, and `0;` and `2;` will result in the required terms being calculated. The formula in a `GEN` command can depend not only on the declared parameter but also on other parameters, used with other variables in the request. So `R^GEN(I0,I0+I1)*MU[3]^GEN(I1,2*I1);` is allowed. The program will prompt for bounds for `I0` and `I1`.

The variable `DISPLAY_TRUNCATES` affects the terms which will be calculated.

- [5] The current approximation to the bifurcation is displayed. The user is then asked if the current result is to be saved. If this is required the filename supplied can be any legal Macsyma filename.

- [7] Same as option 5, except the equation is not displayed.

- [10] This is similar to option 3. The user is asked explicitly for bounds on the problem parameters, and scaling information, supplied by `IGNORE_SCALED_HOT`, `BALANCE` and `TRUNCATION_ORDER`, is always used.

The maximum power of `PARAMETER[I]` which is allowed when calculating terms is `WW_DIMEN[I]` when calculating terms from the ODE solution, and `BB_DIMEN[I]` for terms from the bifurcation equation.

Option 9 splits the current bifurcation equation into its components. This results in two or three equations, depending on the order of the ODE problem and the value of `MEANZERO`, which are saved to a file. The user is prompted for the filename.

Finally, option 12 temporarily exits `TAYLOR`. The program can be reentered later by typing `INSTALL();`. This can also be typed to recover from any errors which stop the program, or from a Macsyma break. Any break levels entered should be exited before restarting the program.

To change the values for `M` and `N`, after an initial session with `TAYLOR`, type `INSTALL([M-TYPE, N-TYPE]);`, where `M-TYPE` and `N-TYPE` are described in Section 6.2. There is no need to specify the `INIT-FILE` again if the same one is required.

Specifying new values for `M` and `N` is the only way to start a fresh database. Hence, it is possible to do

INSTALL('FILE1.MAC', [2, 1]);

followed later by

INSTALL('FILE2.MAC');

When the second `INSTALL` is executed the previous database remains intact. This means rubbish will be produced unless `FILE2.MAC` contains the same problem as `FILE1.MAC`, perhaps with some new symmetry information. Fundamental changes, such as changing the problem parameters, any changes to `USER2()`, or changes to global parameters in `USER0()` which affect the calculations, are not advised.

6.6 Example: Duffing's Equation

Here we detail how the results in (5.24), (5.28) and (5.29) are obtained using `TAYLOR`.

6.6.1 Mathematical Preliminaries

Consider the Duffing equation,

$$(6.7) \quad u''(t) + m^2 u(t) = \mu_1 u(t) + \mu_2 u'(t) - u^3(t) + \mu_3 \cos nt,$$

where we wish to know the number of 2π -periodic solutions, $t \mapsto u(t)$, as μ varies in a full neighbourhood of the origin.

Applying Lyapunov-Schmidt⁷ to (6.7) shows that

$$(6.8a) \quad w''(t) + m^2 w(t) = (\mathbf{I} - \mathbf{P})F(\mu, r \cos(m \cdot) + w, \cdot + \phi)(t),$$

$$(6.8b) \quad 0 = \mathbf{P}F(\mu, r \cos(m \cdot) + w, \cdot + \phi),$$

where

$$(6.9) \quad F(\mu, r \cos mt + w, t + \phi) = \mu_1 \{r \cos mt + w(t)\} + \mu_2 \{-mr \sin mt + w'(t)\} \\ - \{r \cos mt + w(t)\}^3 + \mu_3 \cos n(t + \phi).$$

It is easy to show that $w^*(r, \mu, \phi)(t)$ satisfies

$$(6.10) \quad w^*(r, (\mu_1, \mu_2, \mu_3), \phi)(t) = -w^*(-r, (\mu_1, \mu_2, -\mu_3), \phi)(t),$$

which implies there are no terms in the Taylor expansion of $w^*(r, \mu, \phi)(t)$ which have odd or even powers on both r and μ_3 .

Let $B_i(r, \mu, \phi) = 0$ ($i = 1, 2$) represent the bifurcation equations. Then for m odd,

$$(6.11) \quad B_i(r, (\mu_1, \mu_2, \mu_3), \phi) = -B_i(-r, (\mu_1, \mu_2, -\mu_3), \phi),$$

and for m even,

$$(6.12a) \quad B_i(r, (\mu_1, \mu_2, \mu_3), \phi) = -B_i(-r, (\mu_1, \mu_2, \mu_3), \phi),$$

and

$$(6.12b) \quad B_i(r, (\mu_1, \mu_2, \mu_3), \phi) = B_i(r, (\mu_1, \mu_2, -\mu_3), \phi).$$

⁷Cf. Chapter 5.

6.6.2 USER0(), USER1() and USER2()

USER2()

From (6.8a),

$$\text{LINOP}(W) := \text{DIFF}(W, T, 2) + M^2 * W.$$

The definitions for $F1(W)$, $F2(W)$ and $PF(W)$ are

$$\begin{aligned} F1(W) &:= MU[1]*W + MU[2]*\text{DIFF}(W, T), \\ F2(W) &:= - (R*\text{COS}(M*T) + W)^3 + MU[3]*\text{COS}(N*(T+PHI)), \\ PF(W) &:= MU[1]*R*\text{COS}(M*T) - M*MU[2]*R*\text{SIN}(M*T) - (R*\text{COS}(M*T) + W)^3 + \\ &MU[3]*\text{COS}(N*(T+PHI)). \end{aligned}$$

Since $Pw = 0$, then $\mu_1 w(t) + \mu_2 w'(t)$ never contributes to the bifurcation equations, and is put in the definition of $F1(W)$. The terms $\mu_1 r \cos mt$ and $-m\mu_2 r \sin mt$ are always in the bifurcation equations, and so are included in the definition of $PF(W)$. The remaining terms from (6.9) define $F2(W)$, and complete the definition of $PF(W)$.

The full definition of $USER2()$ is then,

```
USER2() :=
  BLOCK([],
    LINOP(W) := DIFF(W, T, 2) + M^2 * W,
    F1(W) := MU[1] * W + MU[2] * DIFF(W, T),
    F2(W) := - (R * COS(M * T) + W)^3 + MU[3] * COS(N * (T + PHI)),
    PF(W) := MU[1] * R * COS(M * T) - M * MU[2] * R * SIN(M * T)
              - (R * COS(M * T) + W)^3 + MU[3] * COS(N * (T + PHI))
  )$
```

USER1()

First we declare the problem parameters as

```
PARAMETER: [R, MU[1], MU[2], MU[3]].
```

To include (6.10) set

```
WSOLN_ZERO_TERMS: ' [[EVEN, ANY, ANY, EVEN], [ODD, ANY, ANY, ODD]].
```

Errors can result if the leading apostrophe is omitted.

There are two ways to include (6.11) and (6.12). One is to create different $USER1()$ functions, in different $INIT$ -FILES. Respectively, these would contain

```
BEQTN_ZERO_TERMS: ' [[EVEN, ANY, ANY, EVEN], [ODD, ANY, ANY, ODD]],
```

for M odd, and

```
BEQTN_ZERO_TERMS: ' [[EVEN, ANY, ANY, ANY], [ANY, ANY, ANY, ODD]],
```

for M even. The appropriate $INIT$ -FILE can be $INSTALLED$ depending on whether M is odd or even. However, another approach is to use

```
BEQTN_ZERO_TERMS: ' [[ [ODD(M), EVEN], ANY, ANY, EVEN], [[ODD(M), ODD], ANY, ANY, ODD],
                    [[EVEN(M), EVEN], ANY, ANY, ANY], [EVEN(M), ANY, ANY, ODD]].
```

This is more complicated but requires only a single INIT-FILE, for M odd or even. It is best to put conditions such as `EVEN(M)` in the first position of each sublist, as this produces quicker checking in TAYLOR.

Using the second approach above, the function `USER1()` is

```
USER1():=
  BLOCK([],

    PARAMETER: [R, MU[1], MU[2], MU[3]],

    WSOLN_ZERO_TERMS: '[ [EVEN, ANY, ANY, EVEN], [ODD, ANY, ANY, ODD]],

    BEQTN_ZERO_TERMS: ' [[ [ODD(M), EVEN], ANY, ANY, EVEN], [[ODD(M), ODD], ANY, ANY, ODD],
                        [[EVEN(M), EVEN], ANY, ANY, ANY], [EVEN(M), ANY, ANY, ODD]]

  )$
```

USER0()

We define `USER0()` as

```
USER0():=
  BLOCK([],

    BB_DIMEN: [3, 4, 1, 9],

    IGNORE_SCALED_HOT: TRUE,
    TRUNCATION_ORDER: M,
    BALANCE: [M/3, 2, 2*M/3, 1],
    PROJECT_TAGS_HOTS: TRUE,

    M_MAX: 9,

    MEANZERO: FALSE

  )$
```

All variables not included will take on default values.

`BB_DIMEN` is set to `[3, 4, 1, 9]` from knowledge of the terms we wish to calculate. We want terms up to $R^{-3} \mu_1^{-4} \mu_2 \mu_3^{-9}$. Without prior knowledge about the structure of the bifurcation equations `BB_DIMEN` and `WW_DIMEN` should be set to, perhaps, `[10, 10, 10, 10]`. Note however that arrays of this size will use a substantial amount of memory, so should be avoided if possible.

When M is odd, we only want to calculate terms, $R^{-I_0} \mu_1^{-I_1} \mu_2^{-I_2} \mu_3^{-I_3}$, for which

$$(6.13) \quad \frac{M - I_0}{3} + 2 I_1 + \frac{2 M - I_2}{3} + I_3 \leq M.$$

The settings for `IGNORE_SCALED_HOT`, `TRUNCATION_ORDER` and `BALANCE` achieve this. This requirement comes from *a-priori* knowledge of the bifurcation equations⁸. We choose `PROJECT_TAGS_HOTS` as `TRUE`, so that we can easily delete unnecessary terms from the results.

When M is even, only terms satisfying

$$(6.14) \quad \frac{M - I_0}{3} + \frac{2 I_1}{3} + \frac{2 M - I_2}{3} + \frac{I_3}{3} \leq M,$$

⁸In fact the `MU[1]` component in `BALANCE` should be `MIN(2, 2*M/3)`, but TAYLOR cannot use this, unless M is specified. The setting of `BALANCE` given does not produce the leading terms if $M=1$ or $M=2$, but works fine for the general calculation with M unspecified.

are required. The setting of `BALANCE` needs to be changed to

$$(6.15) \quad \text{BALANCE: [M/3, 2/3, 2*M/3, 1/3],}$$

to achieve this. Since different settings of `BALANCE` are required for `M` odd and `M` even it is necessary to have two `INIT-FILES`, with the second containing (6.15).

We set `M.MAX` to 9 so that we calculate *only* leading terms for `M=1, 3, 5, 7, 9`. For `M` even, we will generate results for `M=2, 4` only, so we do not need to specify `M.MAX`.

Finally, `MEANZERO` is `FALSE` since we do not require solutions of (6.7) to have mean zero.

6.6.3 Getting Results

Call the two `INIT-FILES`, one for `M` odd and the other for `M` even, `ODDDUF.MAC` and `EVEDUF.MAC`, respectively. The details for generating the leading terms of the bifurcation equations when `M < 10` is odd, and when `M=2` and `M=4`, for `N=1`, are as follows.

From Macsyma, with `TAYLOR` loaded, type

```
INSTALL('ODDDUF.MAC', [ODDINT,1])$
```

`TAYLOR` will ask if you want to load a previous database, type `NO;` in response. If there are no errors in `ODDDUF.MAC` the `TAYLOR` menu will appear. Choose option 10. When `TAYLOR` asks for the truncation orders for the problem parameters type `3;`, `4;`, `1;` and `9;`, respectively, at consecutive prompts. `TAYLOR` will display information about which term is being calculated, and it will show the results as they are obtained. This step may take a while.

When `TAYLOR` finishes calculating the required terms the main menu is restored. Choose option 5 to examine the calculated bifurcation equation. Then choose option 9, to save the bifurcation equations. The results in (5.24) are derived from this procedure. The presented terms in (5.24) have been `FACTORED` to shorten the formulae.

To generate the leading terms for `M=2` and `M=4` the procedure is the same as above, except the truncation orders that should be typed after choosing option 10 are `3;`, `2;`, `1;` and `4;` for `M=2`, and `3;`, `4;`, `1;` and `8;` for `M=4`. The `INSTALL` command is

```
INSTALL('EVEDUF.MAC', [2 or 4,1])$
```

The results lead to (5.28) and (5.29).

6.7 Including Special Operators in TAYLOR

It is possible to use *special operators* in the function $F(\mu, u, t)$, from (6.9). We illustrate how this is achieved by implementing the sloshing damping integral,

$$(6.16) \quad \mu_2(Du)(t) = \mu_2 \sqrt{\frac{2}{\pi}} \int_0^\infty \frac{u(t-s)}{\sqrt{s}} ds.$$

First a Macsyma function must be created to evaluate the integral, where $u(t)$ is a finite Fourier series. The function `DODAMP` does this⁹.

⁹This is definitely not the method to use in practice, since we have (3.6).

```

DODAMP(EXP):=
  BLOCK([ASSUME_POS:TRUE, INTANALYSIS:FALSE],

    SUBST(T-S,T,EXP),
    Sqrt(2/%PI)*INTEGRATE(%%/SQRT(S),S,0,INF),

    EXPAND(%%),
    DEMOIVRE(%%),
    EXPAND(%%)
  )$

```

The name of the function must begin with DO.
 To implement (6.16) simply include a term

$$(6.17) \quad \text{DAMP}(\text{MU}[2] * (\text{R} * \text{COS}(\text{M} * \text{T}) + \text{W}))$$

in the definition of $F_1(W)$, since it doesn't contribute to the bifurcation equations. TAYLOR automatically calls DODAMP whenever required.

Note that problem parameters *and W and PHI* must appear explicitly in the function call. So,

$$(6.18) \quad \text{DAMP}(\text{R} * \text{COS}(\text{M} * \text{T}) + \text{W}),$$

were the function DODAMP introduces the parameter MU[2], will not work.

Any special functions should be loaded before the INSTALL command, or can be BATCHED from INIT-FILE.

6.8 Example: Sloshing Problem

The functions USER0(), USER1() and USER2() are

```

USER0():=
  BLOCK(

    BB_DIMEN:[3,4,1,8],

    IGNORE_SCALED_HOT:TRUE,
    BALANCE:[M/3,2,2*M/3,1],
    TRUNCATION_ORDER:M,
    PROJECT_TAGS_HOTS:TRUE,

    M_MAX:8
  )$

/* ++++++ */

USER1():=
  BLOCK(

    ARRAY(MU,3),
    PARAMETER:[R,MU[1],MU[2],MU[3]],

    WSOLN_ZERO_TERMS:'[[0,ANY,ANY,0],[1,ANY,ANY,0]],
    BEQTN_ZERO_TERMS:'[[EVEN,ANY,ANY,LT(M)],[ANY,ANY,ANY,[LT(M),ODD]],
                       [1,GT(1),ANY,0],[1,ANY,GT(1),0]]
  )$

```

```
/* ++++++ */
```

```
USER2() :=
  BLOCK(
    F1(W) :=
      MU[1]*W
      + DAMP(MU[2]*W)
      + 1/2*R^2*COS(2*M*T),
    F2(W) :=
      W^2
      - 1/2*NORM(W^2)
      + 2*R*W*COS(M*T)
      - MU[3]*COS(N*(T+PHI)),
    PF(W) :=
      W^2
      + 2*R*W*COS(M*T)
      - MU[3]*COS(N*(T+PHI))
      + MU[1]*R*COS(M*T)
      + MU[2]*R/SQRT(M)*(COS(M*T)+SIN(M*T))
  )$
```

```
BATCHLOAD("DODAMP.MAC");
BATCHLOAD("DONORM.MAC");
```

The definitions for DODAMP and DONORM follow. DODAMP(EXP) uses (3.6). DONORM(EXP) does not calculate a norm, it finds the constant parts of EXP, i.e. finds the parts which don't have mean zero.

```
DODAMP(EXP) :=
  BLOCK([],
    LOCAL(DSN,DCS),
    IF EXP=0 THEN
      RETURN(0),
    /* The variable GENERAL_MN is TRUE if either of M or N are unspecified,
       and is FALSE if they are both specified. */
    TRIGEXPAND_WRT(EXP,'T,GENERAL_MN),
    SUBST(['SIN=LAMBDA([%1],(DSN(%1)-DCS(%1))/SQRT(SUBST('T=1,%1))),
          'COS=LAMBDA([%1],(DSN(%1)+DCS(%1))/SQRT(SUBST('T=1,%1)))],%%[1]),
    SUBLIS(['DSN='SIN','DCS='COS],%%)
  )$
```

```
DONORM(EXP) :=
  BLOCK([P1,%NUM,%DENOM,XVARX],
    IF EXP=0 THEN
      RETURN(0),
    TRIGEXPAND_WRT(EXP,'T,GENERAL_MN)[1],
    P1:SUBST(['SIN=LAMBDA([%1],0),COS(%ZERO*'T)=1],%%),
    IF M='M AND N='N THEN
      (
        SUBST('COS=LAMBDA([%1],
```

```

        IF LINEAR_MN(SUBST('XVARX*N,M,%1/'T), 'XVARX)#FALSE THEN
        (
            FRACPARTS(XVARX),
            IF ALLOW_M(%NUM) AND ALLOW_N(%DENOM) THEN
                APPLY('D,[0,XVARX,M/N])
            ELSE
                0
        )
        ELSE
            0),P1)*2
    )
ELSE IF M='M THEN
(
    SUBST('COS=LAMBDA([%1],
        IF LINEAR_MN(SUBST('XVARX,M,%1/'T), 'XVARX)#FALSE THEN
        (
            IF ALLOW_M(XVARX) THEN
                APPLY('D,[0,XVARX/N,M/N])
            ELSE
                0
        )
        ELSE
            0),P1)*2
    )
ELSE IF N='N THEN
(
    SUBST('COS=LAMBDA([%1],
        IF LINEAR_MN(SUBST('XVARX,N,%1/'T), 'XVARX)#FALSE THEN
        (
            IF ALLOW_N(XVARX) THEN
                APPLY('D,[0,M/XVARX,M/N])
            ELSE
                0
        )
        ELSE
            0),P1)*2
    )
ELSE
(
    SUBST('COS=LAMBDA([%1],0),P1)*2
)
)$

```

The procedure for calculating the leading terms is the same as that used for Duffing¹⁰, M odd, except do

```
INSTALL('SLOSH.MAC', [INTEGER, 1])$
```

where 'SLOSH.MAC' contains the definitions for USER0(), USER1() and USER2(), and type `3;` `4;` `1;` `8;` as the truncation orders. This gives the leading terms for the sloshing problem, up to $M=8$, for $N=1$, and produces the results given in (3.78) to (3.80). Terms have been FACTORED to produce (3.79).

6.9 Improvements

It can take a considerable time to calculate some coefficients using TAYLOR. Every improvement to TAYLOR which cuts the amount of manipulation required is

¹⁰See footnote on page 43.

worthwhile. It is probable that the efficiency of TAYLOR can be improved, and users are encouraged to experiment.

One possible improvement is to introduce a data structure which stores coefficients in a more efficient way, keeping information about the coefficients more accessible. For example, the term $D(1, 1, M/N) * 2 * \text{COS}(T)$ could be replaced by $\text{CSD}([1, 1], 2, T)$, with an equivalent function for sines. The deltas are stored first, in the list, the coefficient is stored second and the cosine argument is last. A further improvement is not to use Macsyma functions to store the coefficients, but develop a LISP linked list data structure, with individual nodes for each component of a coefficient.

Chapter 7

Macsyma Implementation of TAYLOR

7.1 Introduction

The main purpose of this chapter is to describe and explain some parts of the TAYLOR program. Only the more important functions will be explained.

In Section 7.2 we discuss Macsyma¹ and some of the problems encountered. Many programming problems had to be solved by an arduous process of trial and error. Section 7.3 explains some of the TAYLOR subfunctions.

An excellent introduction to Macsyma is given by Rand [36] and Rand & Armbruster [37].

7.2 Macsyma

Macsyma is a sophisticated and powerful symbolic manipulation program. It has a huge range of facilities and abilities, and is relatively simple to use and program. If a manipulative problem can be solved theoretically by hand, then Macsyma should be able to perform the task.

There were several bugs in the version of Macsyma on which TAYLOR was developed. Some of these did not directly affect the development of TAYLOR, but others did. The size and complexity of the Macsyma code mean that some bugs are expected. Some of the bugs encountered are discussed in Appendix D.

A basic dictum when using Macsyma is to *make use of functions which do only what is required*. This may seem obvious but the discussion which follows shows how important it can be.

The RAT Macsyma function produces a canonical reordering of the terms in an expression. It works quickly on relatively small expressions.

Let $\{a_i\}_{i=1}^5$, represent any Macsyma expressions which are independent of T, and let EXP be

$$(7.1) \quad a_5 \text{ COS}(T) + a_4 \text{ COS}(T) + a_3 \text{ SIN}(T) + a_2 \text{ SIN}(T) + a_1 \text{ SIN}(T).$$

Then

```
RAT(EXP,T);
```

¹Version 412.61 for VAX 6230 machines was used. See page E1 for copyright notice.

produces

$$(7.2) \quad (a_3 + a_2 + a_1) \text{ SIN}(T) + (a_5 + a_4) \text{ COS}(T).$$

In TAYLOR an expression in the form of (7.2) is more desirable than one in the form of (7.1). When it was discovered that RAT could reorder expressions in this way, a version of TAYLOR was written which exploited this feature. When completed the new version took a much longer time than the old to calculate coefficients. This was because RAT can take a very long time on large expressions, involving many terms. As a result, much of the new version of TAYLOR had to be rewritten or scrapped.

The reason that RAT can take so long is simple. RAT does not just simplify the toplevel of an expression, it simplifies and reorders every part² of the expression. So

RAT(A/B*SIN(T)+C/D*COS(T)+E*COS(T),T);

produces

$$(7.3) \quad \frac{A D \text{ SIN}(T) + (B D E + B C) \text{ COS}(T)}{B D},$$

when all we really need is

$$(7.4) \quad \frac{A}{B} \text{ SIN}(T) + \left(\frac{C}{D} + E\right) \text{ COS}(T).$$

In an early version of TAYLOR the test IS(EQUAL(RHS,0)) was included in the ODE solver. It was accidentally discovered that this simple expression was taking up days of CPU time. The test IS(RHS=0), which takes only milliseconds to execute, was sufficient. These are completely different tests. The first actually tests for a mathematical identity, whereas the second checks for syntactic equality.

7.3 Some Functions Discussed

Most of the routines which make up TAYLOR have been specifically written for the purpose. Consequently there are few error checks built into them, which saves CPU time. Many of the routines could be used in other applications with few changes.

A brief discussion of the functions EXPAND_WRT, FACTOROUT_TRIG, TRIGEXPAND_WRT and MN_COMBINE follows. Each of these play a critical role in TAYLOR. The final versions of these functions belie the difficulty involved, and time spent developing and testing earlier versions.

7.3.1 EXPAND_WRT

Most mathematical manipulations involve multiplication. However, we do not want to blindly multiply out everything, as the Macsyma function EXPAND does.

The EXPAND_WRT routine is called as EXPAND_WRT(EXP,VAR). We illustrate the function with an example, where

$$(7.5) \quad \text{EXP} = (A + B) \text{ SIN}(T) + (C + D \text{ COS}(2 T)) \text{ COS}(T),$$

and VAR = T.

The first stage of the routine replaces all parts of EXP which do not depend on VAR with simple function calls of the form 'P(I). This process is not applied to arguments of any functions in EXP, and will not work if T occurs as a power. EXP is thus changed to

$$(7.6) \quad P(1) \text{ SIN}(T) + (P(2) + P(3) \text{ COS}(2 T)) \text{ COS}(T).$$

²This is not quite true. See Macsyma reference manual for an exact description.

The expressions $A + B$, C and D are stored in a list, and $P(I)$ refers to the I^{th} position in the list.

`EXPAND` is now applied. In the example (7.6) becomes

$$(7.7) \quad P(1) \sin(T) + P(2) \cos(T) + P(3) \cos(2 T) \cos(T).$$

Finally, the stored coefficients are reinstated, which gives

$$(7.8) \quad (A + B) \sin(T) + C \cos(T) + D \cos(2 T) \cos(T),$$

for the example.

The `EXPAND_WRT` routine was compared to and found to be faster than the Macsyma `EXPANDWRT` routine, which is more general.

7.3.2 FACTOROUT_TRIG

The calling sequence is `FACTOROUT_TRIG(EXP,VAR,FACTORARGS)`, where `EXP` is a finite Fourier series with independent variable `VAR`, and `FACTORARGS` is `TRUE` or `FALSE`. As an example, consider

$$(7.9) \quad \text{EXP} = a_1 \sin(T) + a_2 \sin(T) + a_3 \cos(T) + a_4 \cos(T),$$

`VAR = T`, `FACTORARGS = FALSE`, and $\{a_i\}_{i=1}^4$ are any Macsyma expressions independent of `T`. Then `FACTOROUT_TRIG(EXP,T,FALSE)` produces the list

$$(7.10) \quad [(a_2 + a_1) \sin(T) + (a_4 + a_3) \cos(T), [\sin(T), \cos(T)]].$$

The first part is the factored result, and the second is a list of the Fourier components in the result. Choosing `FACTORARGS = TRUE` makes `FACTOROUT_TRIG` call the `TAYLOR` function `TRIGSIMP_ARGS` on the arguments of the trigonometric components in the result. This function factors and rearranges its arguments.

`FACTOROUT_TRIG` works by parsing `EXP` from left to right. Each term is `PARTITIONED` with respect to `VAR`, for example

$$(7.11) \quad \text{PARTITION}(a_1 \sin(T), T);$$

gives

$$(7.12) \quad [a_1, \sin(T)].$$

Carrying this out on each term in `EXP` two lists are generated. One is the list of `VAR` dependent parts, such as `SIN(T)` and `COS(T)` in the previous example. The second is a list of the coefficients of the components in the first list. For (7.9) these are

$$(7.13a) \quad [\sin(T), \cos(T)],$$

$$(7.13b) \quad [a_2 + a_1, a_4 + a_3].$$

The dot product of these gives the factored result. The list of trigonometric components is a useful by-product of the method.

Results produced using `FACTOROUT_TRIG` are affected by the setting of the global logical variable `TRIGCONSTANT`. For terms in `EXP` which do not depend on `VAR` a trigonometric component `COS(%ZERO*VAR)` is introduced by the routine. If `TRIGCONSTANT` is `FALSE` then `%ZERO` is set to `0`, otherwise it is unbound.

With `TRIGCONSTANT = FALSE`, `FACTOROUT_TRIG`, although written to factor Fourier series, works equally well as a general factoring routine. For example,

```
FACTOROUT_TRIG(A*X+B*X+C*X^2+D*X^2+X^3+E,X,FALSE);
```

with `TRIGCONSTANT = FALSE`, gives

$$[X^3 + (D + C) X^2 + (B + A) X + E, [X^3, X^2, X, 1]].$$

7.3.3 TRIGEXPAND_WRT

A fundamental requirement in TAYLOR is a function which converts products and powers of Fourier series into Fourier series in normal form. The Macsyma function TRIGREDUCE converts products of trigonometric terms into sums of such terms. However to use TRIGREDUCE in TAYLOR required a lot of extra work to produce the desired form of result.

TRIGEXPAND_WRT uses FACTOROUT_TRIG, a slightly modified version of EXPAND_WRT and a series of trigonometric simplification routines to achieve the desired result. It is called as TRIGEXPAND_WRT(EXP,VAR,FACTORARGS).

The trigonometric simplification routines take an arbitrary product of cosines and sines and return a sum of such terms.

First, all powers are removed from the expression using the formulae,

$$(7.14a) \sin^n a = \begin{cases} \frac{(-1)^{(n-1)/2}}{2^{n-1}} \sum_{r=0}^{(n-1)/2} \binom{n}{r} (-1)^r \sin(n-2r)a, & \text{for } n \text{ odd,} \\ \frac{(-1)^{n/2}}{2^{n-1}} \left\{ \sum_{r=0}^{n/2-1} \binom{n}{r} (-1)^r \cos(n-2r)a + \frac{\binom{n}{n/2}}{2} \right\}, & \text{for } n \text{ even,} \end{cases}$$

and

$$(7.14b) \cos^n a = \begin{cases} \frac{1}{2^{n-1}} \sum_{r=0}^{(n-1)/2} \binom{n}{r} \cos(n-2r)a, & \text{for } n \text{ odd,} \\ \frac{1}{2^{n-1}} \left\{ \sum_{r=0}^{n/2-1} \binom{n}{r} \cos(n-2r)a + \frac{\binom{n}{n/2}}{2} \right\}, & \text{for } n \text{ even.} \end{cases}$$

Then products are simplified using the formula,

$$(7.15) \prod_{i=1}^{N_c} \cos a_i \prod_{j=1}^{N_s} \sin b_j = \begin{cases} \frac{(-1)^{(N_s-1)/2}}{2^{N_s+N_c-1}} \sum_{i=1}^{N_s-1} \sum_{j=1}^{N_c} S_{i,j} \sin(P_{i,j} \cdot V_{ab}), & \text{for } N_s \text{ odd,} \\ \frac{(-1)^{N_s/2}}{2^{N_s+N_c-1}} \sum_{i=1}^{N_s-1} \sum_{j=1}^{N_c} S_{i,j} \cos(P_{i,j} \cdot V_{ab}), & \text{for } N_s \text{ even,} \end{cases}$$

where V_{ab} is the vector $(a_1, a_2, \dots, a_{N_c}, b_1, b_2, \dots, b_{N_s})$, $P_{i,j}$ is a vector of length $N_c + N_s$ and $S_{i,j}$ is the product of the first N_s components of $P_{i,j}$. The k^{th} component of $P_{i,j}$, $(P_{i,j})_k$, is calculated using

$$(7.16) (P_{i,j})_k = \begin{cases} 1, & \text{if } (2^{N_s+N_c} - i - (j-1)2^{N_s-1}) \text{ .AND. } 2^{k-1} \text{ is nonzero,} \\ -1, & \text{otherwise,} \end{cases}$$

where .AND. is the binary operator.

To show how TRIGEXPAND_WRT works we treat a simple example. Let

$$(7.17) \quad \text{EXP} = (A + B) \cos^2(M T) \cos(N T).$$

Then TRIGEXPAND_WRT(EXP,T,TRUE) firstly changes EXP to

$$(7.18) \quad P(1) \cos^2(M T) \cos(N T)$$

using part of the EXPAND_WRT routine, then this is simplified to

$$(7.19) \quad \frac{P(1)}{2} \cos(N T) + \frac{P(1)}{2} \cos(2 M T) \cos(N T).$$

Next, (7.15) is applied to each part, giving

$$(7.20) \quad \frac{P(1)}{2} \cos(N T) + \frac{P(1)}{4} \cos(2 M T + N T) + \frac{P(1)}{4} \cos(2 M T - N T).$$

This result is passed to FACTOROUT_TRIG, which returns

$$(7.21) \quad \left[\frac{P(1)}{2} \cos(N T) + \frac{P(1)}{4} \cos((2 M + N) T) + \frac{P(1)}{4} \cos((2 M - N) T), \right. \\ \left. [\cos(N T), \cos((2 M + N) T), \cos((2 M - N) T)] \right].$$

Finally, the last part of EXPAND_WRT is used, which restores the coefficient (A + B), giving

$$(7.22) \quad \left[\frac{A + B}{2} \cos(N T) + \frac{A + B}{4} \cos((2 M + N) T) + \frac{A + B}{4} \cos((2 M - N) T), \right. \\ \left. [\cos(N T), \cos((2 M + N) T), \cos((2 M - N) T)] \right].$$

7.3.4 MN_COMBINE

The MN_COMBINE function is a variation on the COMBINE and RNCOMBINE Macsyma functions. The idea is to combine terms whose denominators differ by a term $RC \cdot M^{-R1} \cdot N^{-R2}$, over a common denominator, where RC is a constant³ and R1 and R2 are rationals. The function is called as MN_COMBINE(EXP).

For example consider the expression,

$$(7.23) \quad \text{EXP} = \frac{a_1}{RC1 N^{A1} M^{B1} C(M, N)} + \frac{a_2}{RC2 N^{A2} M^{B2} C(M, N)},$$

where a_1 and a_2 are any expressions, RC1 and RC2 are constants, C(M, N) is a function of M and N, and A1, A2, B1 and B2 are rational numbers, with $A1 > A2$ and $B1 > B2$. Then MN_COMBINE(EXP) gives

$$(7.24) \quad \frac{a_1 F1 + a_2 F2}{RC3 N^{A1} M^{B1} C(M, N)}$$

where

$$(7.25a) \quad RC3 = \text{LCM}(RC1, RC2),$$

$$(7.25b) \quad F1 = \text{GCD}(RC1, RC3),$$

$$(7.25c) \quad F2 = \text{GCD}(RC2, RC3) N^{A1 - A2} M^{B1 - B2}.$$

The MN_COMBINE function can use a lot of CPU time as it investigates which terms to combine. Since it not essential for the proper working of TAYLOR, the global variable COEFFICIENT_SIMP_FUN, which defaults to 'MN_COMBINE', is available to replace calls to MN_COMBINE with other user simplification routines. In particular, if M and N are specified then

COEFFICIENT_SIMP_FUN: 'XTHRU\$

may be a better choice.

³Constant means a rational number, or a function of rationals.

Appendix A

Sloshing Problem: Perturbations of the Nonlinear Problem

A.1 Introduction

In Chapter 3 we considered solutions of the integro-differential equation (2.63a) as perturbations from the linearized problem. We used the Implicit Function Theorem to generate approximations to the solutions for μ in a full neighbourhood of the origin in \mathbf{R}^3 . The perturbation technique lead to a pair of bifurcation equations. Here we find a bifurcation surface in parameter space by considering perturbations from the undamped, unforced problem. Reynolds [39] deals with the case $m = 1$.

Let $m \in \mathbf{N}$ be fixed. Write (2.63) as

$$(A.1a) \quad u'''(t) + (m^2 - \mu_1)u'(t) - 2u(t)u'(t) = \mu_2(\mathbf{D}u')(t) + \mu_3 \sin t,$$

$$(A.1b) \quad \int_{-\pi}^{\pi} u(s) ds = 0, \quad u(t + 2\pi) = u(t),$$

where $\mu_1 > 0$, and μ_2 and μ_3 are assumed to be small. We find superharmonic solutions of (A.1) of the form

$$(A.2) \quad u(t) = p_m(t - \phi) + w(t - \phi),$$

where p_m is the solution of

$$(A.3) \quad p_m'''(t) + (m^2 - \mu_1)p_m'(t) - 2p_m(t)p_m'(t) = 0,$$

with least period $2\pi/m$, mean zero and $p_m'(0) = 0$. The perturbation w is chosen so that

$$(A.4) \quad w'(0) = 0.$$

A.2 The Bifurcation Equation

Throughout this section it is assumed that $\mu_1 > 0$. It follows from Proposition 1 of [39] that there is a solution p_m of (A.3) with least period $2\pi/m$, mean zero and $p_m'(0) = 0$. The only other solution with these properties is $t \mapsto p_m(t + \pi/m)$. $p_m(t)$ is even, and

$$(A.5) \quad p_m(t) = m^2 p_1(mt).$$

We define projections $\mathbf{P} : \mathcal{H}^3 \rightarrow \mathcal{H}^3$ and $\mathbf{Q} : \mathcal{H}^0 \rightarrow \mathcal{H}^3$ by

$$(A.6) \quad (\mathbf{P}v)(t) \stackrel{\text{def}}{=} \frac{v'(0)}{p_m''(0)} p_m'(t), \quad (\mathbf{Q}f)(t) \stackrel{\text{def}}{=} \frac{\int_{-\pi}^{\pi} p_m(s) f(s) ds}{\pi \|p_m\|_0^2} p_m(t),$$

and a linear operator $\mathbf{L} : (\mathbf{I} - \mathbf{P})\mathcal{H}^3 \rightarrow (\mathbf{I} - \mathbf{Q})\mathcal{H}^0$ by

$$(A.7) \quad \mathbf{L}v \stackrel{\text{def}}{=} v''' + (m^2 - \mu_1)v' - 2(p_m v)'$$

It is a consequence of Proposition 2 of [39] that the equation

$$(A.8) \quad \mathbf{L}w = f,$$

has a solution $w \in (\mathbf{I} - \mathbf{P})\mathcal{H}^3$ if and only if

$$(A.9) \quad \mathbf{Q}f = 0.$$

When (A.2) is substituted into (A.1), we find that

$$(A.10) \quad \mathbf{L}w = 2ww' + \mu_2 \mathbf{D}(p_m' + w') + \mu_3 \sin(\cdot + \phi).$$

Because of (A.8) and (A.9), this equation can only have a solution if

$$(A.11) \quad 0 = \mathbf{Q} [2ww' + \mu_2 \mathbf{D}(p_m' + w') + \mu_3 \sin(\cdot + \phi)],$$

in which case it becomes

$$(A.12) \quad \mathbf{L}w = (\mathbf{I} - \mathbf{Q}) [2ww' + \mu_2 \mathbf{D}(p_m' + w') + \mu_3 \sin(\cdot + \phi)].$$

By the Implicit Function Theorem this has a unique analytic solution $w^*(\mu_2, \mu_3, \phi) \in (\mathbf{I} - \mathbf{P})\mathcal{H}^3$, defined for all (μ_2, μ_3) in some neighbourhood of $(0, 0)$ in \mathbf{R}^2 , and $\phi \in S^1$.

Theorem A.1 w^* has the following properties:

$$(i) \quad w^*(0, 0, \phi)(t) = 0,$$

$$(ii) \quad w^*(0, \mu_3, \phi)(t) = w^*(0, \mu_3, -\phi)(-t),$$

$$(iii) \quad w^*(\mu_2, \mu_3, \phi)(t) = w^*(\mu_2, -\mu_3, \phi + \pi)(t),$$

$$(iv) \quad w^*(\mu_2, \mu_3, \phi)(t) = w^*(\mu_2, \mu_3, \phi + 2\pi/m)(t - 2\pi/m),$$

$$(v) \quad w^*(0, \mu_3, \phi)(t) = \sum_{k=1}^{\infty} \mu_3^k w_k(\phi)(t), \text{ where}$$

$$(A.13) \quad w_k(\phi)(t) = a_0^k(t) + \sum_{n=1}^{[k/2]+1} a_n^k(t) \cos(k - 2n)\phi + b_n^k(t) \sin(k - 2n)\phi.$$

Proof: Properties (i) to (iv) follow using (A.12) and the uniqueness of w^* . To prove property (v) we outline an inductive argument.

Substituting $w^*(0, \mu_3, \phi)(t) = \sum_{k=1}^{\infty} \mu_3^k w_k(\phi)(t)$ into (A.12), and equating powers of μ_3 , we find that

$$(A.14) \quad \mathbf{L}w_1 = (\mathbf{I} - \mathbf{Q}) \sin(\cdot + \phi)$$

holds for all $\phi \in S^1$. Hence we can write,

$$(A.15) \quad w_1(\phi)(t) = a_{1,1}(t) \cos \phi + b_{1,1}(t) \sin \phi,$$

where

$$(A.16a) \quad \mathbf{L}a_{1,1} = (\mathbf{I} - \mathbf{Q}) \sin(\cdot),$$

$$(A.16b) \quad \mathbf{L}b_{1,1} = (\mathbf{I} - \mathbf{Q}) \cos(\cdot).$$

Then (A.13) holds for $k = 1$.

Assume (A.13) holds for $k \leq N \in \mathbb{N}$, then w_{N+1} satisfies

$$(A.17) \quad \mathbf{L}w_{N+1} = (\mathbf{I} - \mathbf{Q}) \left\{ 2 \sum_{i=1}^N w_i(\phi) w'_{N+1-i}(\phi) + \delta_{1,N+1} \sin(\cdot + \phi) \right\}.$$

Simplification of the right hand side, using (A.13), proves the result. \blacksquare

The bifurcation equation is obtained by substituting $w^*(\mu_2, \mu_3, \phi)$ into (A.11), and integrating by parts to get

$$(A.18) \quad 0 = \int_{-\pi}^{\pi} \left\{ w^*(t)^2 + \mu_2 (\mathbf{D}w^*)(t) + \mu_2 (\mathbf{D}p_m)(t) - \mu_3 \cos(t + \phi) \right\} p'_m(t) dt.$$

By Proposition 1 of [40],

$$(A.19) \quad \int_{-\pi}^{\pi} (\mathbf{D}p_m)(t) p'_m(t) dt = -\pi \|p_m\|_{1/4}^2 = -\pi m^{9/2} \|p_1\|_{1/4}^2,$$

and due to the evenness of p_m ,

$$(A.20) \quad \int_{-\pi}^{\pi} p'_m(t) \cos t dt = 0.$$

Therefore, (A.18) becomes

$$(A.21) \quad \mu_2 = \alpha \mu_3 \sin \phi + F(\mu_2, \mu_3, \phi),$$

where

$$(A.22) \quad \alpha \stackrel{\text{def}}{=} \frac{1}{m^{9/2} \pi \|p_1\|_{1/4}^2} \int_{-\pi}^{\pi} p'_m(t) \sin t dt,$$

and

$$(A.23) \quad F(\mu_2, \mu_3, \phi) \stackrel{\text{def}}{=} \frac{1}{m^{9/2} \pi \|p_1\|_{1/4}^2} \int_{-\pi}^{\pi} \left\{ w^*(\mu_2, \mu_3, \phi)(t)^2 + \mu_2 (\mathbf{D}w^*)(\mu_2, \mu_3, \phi)(t) \right\} p'_m(t) dt.$$

Theorem A.2 *F has the following properties:*

$$(i) \quad F(0, 0, \phi) = 0,$$

$$(ii) \quad F(0, \mu_3, \phi) = -F(0, \mu_3, -\phi),$$

$$(iii) \quad F(\mu_2, \mu_3, \phi) = F(\mu_2, -\mu_3, \phi + \pi),$$

$$(iv) \quad F(\mu_2, \mu_3, \phi) = F(\mu_2, \mu_3, \phi + 2\pi/m),$$

$$(v) \quad F(\mu_2, \mu_3, \phi) = \beta \mu_3^m \sin m\phi + O(\mu_2^2 + |\mu_2 \mu_3| + |\mu_3|^{m+1}), \text{ for some constant } \beta, \text{ depending on } m \text{ and } \mu_1.$$

Proof: Properties (i) to (iv) follow from (A.23), and (i) to (iv) from Theorem A.1. Property (v) is a consequence of (v) from that theorem and (ii) and (iv) above. \blacksquare

β can be written as an integral depending explicitly on $w_k(\phi)(t)$, $k = 1, \dots, m-1$, and $\|p_1\|_{1/4}^2$. It is convenient to define

$$(A.24) \quad \hat{\beta} \stackrel{\text{def}}{=} \delta_{1,m} \alpha + \beta.$$

A.3 Numerical Computation of $\hat{\beta}$

The numerical procedure for calculating $\hat{\beta}$ is difficult. As m is increased the number of BVP problems which need to be solved in order to calculate $\hat{\beta}$ becomes large, and unmanageable. An upper bound on the number of such problems is $(m-1)(m+6)/2$.

The method suggested below was implemented for $m = 1, 2, 3, 4$ and graphs of the results are presented in Section A.3.4.

A.3.1 The BVPs

Calculation of $\hat{\beta}$ requires $w_k(\phi)(t)$, $k = 1, \dots, m-1$, and each w_k requires the solution of $2[k/2] + 3$ boundary value problems, of the form

$$(A.25a) \quad \mathbf{L}v = f,$$

$$(A.25b) \quad \int_{-\pi}^{\pi} v(s) ds = 0, \quad v(t) = v(t + 2\pi), \quad v'(0) = 0.$$

Furthermore, each w_j , $j \in \mathbf{N}$ depends on w_i , $i = 1, \dots, j-1$.

To incorporate the mean zero condition we define

$$(A.26) \quad z(t) = \int_{-\pi}^t v(s) ds,$$

and solve

$$(A.27a) \quad z'''' + (m^2 - \mu_1)z'' - 2(p_m z')' = f,$$

$$(A.27b) \quad z(\pi) = 0, \quad z(t) = z(t + 2\pi), \quad z''(0) = 0,$$

where $v(t) = z'(t)$.

The same idea which led to property (iv) from Theorem A.2 proves that the right hand sides, when calculating the coefficients for w_k , satisfy

$$(A.28) \quad \mathbf{Q}f = 0,$$

if $k < m$.

In order to solve (A.27), and to find $\hat{\beta}$, p_m is required. It is shown in the next section how this was done.

A.3.2 Calculating p_m

We find p_m by solving

$$(A.29a) \quad p_1'''(t) + (1 - \lambda)p_1'(t) - 2p_1(t)p_1'(t) = 0, \quad \lambda > 0,$$

$$(A.29b) \quad \int_{-\pi}^{\pi} p_1(s) ds = 0, \quad p_1(t) = p_1(t + 2\pi), \quad p_1'(0) = 0,$$

and using

$$(A.30) \quad p_m(t) = m^2 p_1(mt), \quad \mu_1 = m^2 \lambda.$$

It is difficult to solve (A.29) for λ large. Furthermore, for λ close to 0 the direct approach to solving (A.29) numerically, gave only the trivial solution. This last problem is eliminated by solving an augmented system, which is not singular. The idea of the augmented system is in Crandall & Rabinowitz [10], and Keller [26].

The Lyapunov-Schmidt procedure leads us to look for solutions to (A.29) of the form

$$(A.31a) \quad p_1(t) = s(\cos t + g(t)),$$

$$(A.31b) \quad \mathbf{R}g = 0,$$

where \mathbf{R} is the projection

$$(A.32) \quad (\mathbf{R}g)(t) \stackrel{\text{def}}{=} \frac{\cos t}{\pi} \int_{-\pi}^{\pi} g(\tau) \cos \tau \, d\tau.$$

By setting

$$(A.33) \quad h_1(t) = \int_{-\pi}^t g(\tau) \, d\tau,$$

and $h_i(t) = g^{(i-2)}(t)$ for $i = 2, 3, 4$, and $h_5(t) = \lambda$, we obtain the system

$$(A.34) \quad \begin{aligned} h_1' &= h_2, \\ h_2' &= h_3, \\ h_3' &= h_4, \\ h_4' &= (\lambda - 1)h_3 - \lambda \sin t + 2s(\cos t + h_2)(-\sin t + h_3), \\ h_5' &= 0. \end{aligned}$$

This is solved on $[0, \pi]$, since $g(t) = g(2\pi - t)$, subject to

$$(A.35) \quad h_1(0) = h_1(\pi) = 0, \quad h_3(0) = h_3(\pi) = 0, \quad h_5(0) = 0.$$

To ensure that (A.31b) holds, we introduce the extra equation

$$(A.36) \quad h_6' = h_2 \cos t,$$

and the boundary conditions

$$(A.37) \quad h_6(0) = h_6(\pi) = 0.$$

Many ODE solvers can solve (A.34) and (A.36) subject to (A.35) and (A.37), to give $(\lambda(s), g(s)(t))$ for each s . It is simple to show that if $(s, g(t))$ is obtained using (A.34) to (A.37), and (A.33), then $(-s, -g(t + \pi))$ yields another solution of (A.34) to (A.37). We only compute solutions with $s > 0$, since $-s$ leads to $p_1(t + \pi)$.

A.3.3 The Numerical Method

COLSYS was used to solve (A.34) to (A.37), which results in a functional representation for $p_m(t)$.

Because of the large numbers of BVP problems to be solved to find the w_k and the way in which these problems are coupled, there are many ways to treat their numerical solution. After extensive trials of different methods, it was found that the *best* approach was to solve each BVP problem using COLSYS. If the problems are solved in the *correct* order, the solution reduces to solving a sequence of 4th order problems over $[0, \pi]$.

First $w_1(\phi)(t)$ is found. Since COLSYS gives a functional representation for the solution, we use this to calculate the right hand sides necessary to find the coefficients from $w_2(\phi)(t)$. Then the right hand sides for $w_3(\phi)(t)$ can be calculated, and so on.

Let v be any coefficient from w_k , with $k \in \mathbb{N}$. Then v satisfies (A.25), for some f . If v is odd then

$$(A.38) \quad v(0) = v'(0) = v''(0) = v'''(0) = 0,$$

and the BVP problem for v can be treated as an IVP. If v is even, we calculate $v(0)$ and $v''(0)$, so that we can treat the problem as an IVP.

Once all initial conditions have been found we calculate $\hat{\beta}$ as part of a large, coupled, IVP system. This system involves fourth order problems for each of the coefficients required for calculating $\hat{\beta}$.

The FORTRAN program COEFF uses two approaches for finding $\hat{\beta}$. First COLSYS is used on individual BVPs. The NAG integration routine D01ANF is used to calculate $\|p_1\|_{1/4}^2$. Then the NAG quadrature routine D01AKF is used to find $\hat{\beta}$. Finally, as a check on the result, EPISODE is used to solve the IVP system.

Because of the number of BVP problems, the program only calculates $\hat{\beta}$ for $m = 1, 2, 3, 4$.

A.3.4 Results: $m = 1, 2, 3, 4$

The points actually calculated by COEFF are marked on the diagrams. From these it appears that $(-1)^m \hat{\beta} > 0$, for $m = 1, 2, 3, 4$.

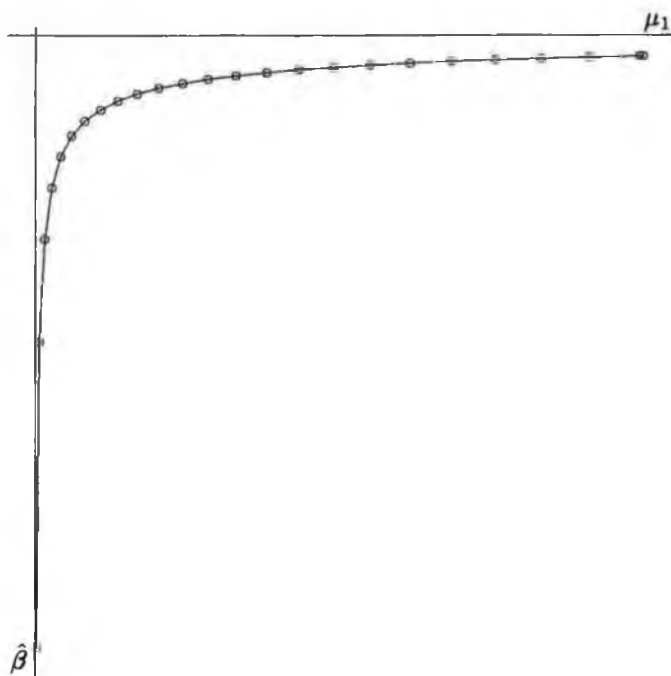

Figure A.1: $\hat{\beta}$ against μ_1 for $m = 1$.

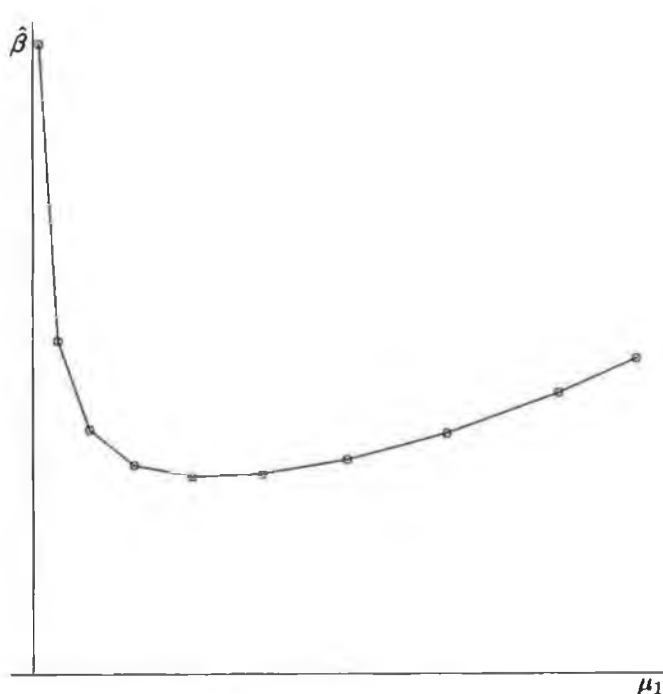

Figure A.2: $\hat{\beta}$ against μ_1 for $m = 2$.

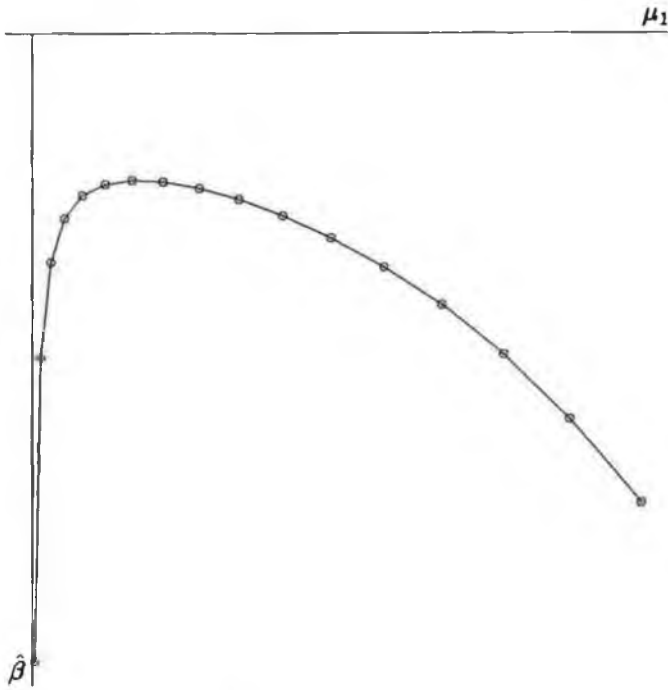

Figure A.3: $\hat{\beta}$ against μ_1 for $m = 3$.

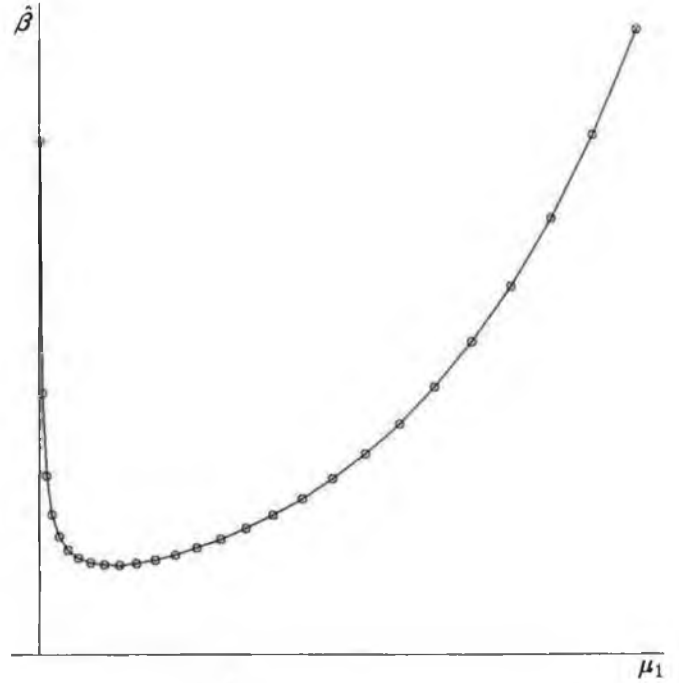

Figure A.4: $\hat{\beta}$ against μ_1 for $m = 4$.

A.4 Analysis of the Bifurcation Equation

Theorem A.3 Let $\mu_1 > 0$, and $m \in \mathbb{N}$. Assume that $\hat{\beta} \neq 0$. There are two bifurcation curves Γ_1 and Γ_2 defined in a neighbourhood U of $0 \in \mathbb{R}^2$, given approximately by

$$(A.39) \quad \mu_2 = \pm \hat{\beta} \mu_3^m + O(|\mu_3|^{m+1}).$$

These curves divide U into two disjoint sets V_0 and V_2 , each with two connected components as shown in Figure A.5. There is a neighbourhood W of $0 \in \mathcal{H}^3$ such that:

(i) (A.1) has no solutions of the form

$$(A.40) \quad u(t) = p_m(t - \phi) + w^*(\mu_2, \mu_3, \phi)(t - \phi), \quad w^*(\mu_2, \mu_3, \phi) \in W, \\ \text{if } (\mu_2, \mu_3) \in V_0,$$

(ii) (A.1) has one solution of the form (A.40) if $(\mu_2, \mu_3) \in \Gamma_1 \cup \Gamma_2 \setminus \{0\}$,

(iii) (A.1) two solutions of the form (A.40) if $(\mu_2, \mu_3) \in V_2$,

(iv) (A.1) has a solution $u(t) = p_m(t - \phi)$ for each $\phi \in S^1$ if $(\mu_2, \mu_3) = (0, 0)$.

Note that $\Gamma_1, \Gamma_2, U, V_0, V_2, W$ and p_m all depend on μ_1 and m .

Proof: The problem of finding solutions of (A.1) of the form (A.2) with w sufficiently small, is equivalent to solving the bifurcation equation (A.21). Due to the symmetries in Theorem A.2, we need only find solutions of (A.21) with $\phi \in [0, 2\pi/m)$.

It is easy to show from the relation

$$(A.41) \quad \mu_2 = \hat{\beta} \mu_3^m \sin m\phi + O\left(\mu_2^2 + |\mu_2 \mu_3| + |\mu_3|^{m+1}\right),$$

that there is a constant $c > 0$ such that

$$(A.42) \quad |\mu_2|^m \leq c|\mu_3|,$$

if (μ_2, μ_3) lies in a sufficiently small neighbourhood of $0 \in \mathbb{R}^2$. Therefore, we introduce the scaling

$$(A.43) \quad \mu_2 = \xi \mu_3^m.$$

Define

$$(A.44) \quad G_1(\xi, \mu_3, \phi) \stackrel{\text{def}}{=} \begin{cases} \xi - \mu_3^{-m} F(\xi \mu_3^m, \mu_3, \phi), & \mu_3 \neq 0, \\ \xi - \hat{\beta} \sin m\phi, & \mu_3 = 0. \end{cases}$$

Next we investigate whether

$$(A.45) \quad 0 = G_1(\xi, \mu_3, \phi) = \xi - \hat{\beta} \sin m\phi + O(|\mu_3| + |\xi \mu_3|),$$

has multiple solutions. Since

$$(A.46) \quad G_2(\xi, \mu_3, \phi) \stackrel{\text{def}}{=} \frac{\partial G_1}{\partial \phi}(\xi, \mu_3, \phi) = -\hat{\beta} m \cos m\phi + O(|\mu_3| + |\xi \mu_3|),$$

the Jacobian

$$(A.47) \quad \Delta(\xi, 0, \phi) \stackrel{\text{def}}{=} \frac{\partial(G_1, G_2)}{\partial(\xi, \phi)} = -m^2 \hat{\beta} \sin m\phi.$$

Suppose that $G_1(\xi, 0, \phi) = G_2(\xi, 0, \phi) = 0$. Then $\cos m\phi = 0$ and $\phi = \phi_k \stackrel{\text{def}}{=} (k + 1/2)\pi/m$, $k = 0, 1$. Then $\Delta(\xi, 0, \phi_k) \neq 0$, and the Implicit Function Theorem says that there are functions $\xi_k(\mu_3)$ and $\phi_k(\mu_3)$ such that $\xi_k(0) = (-1)^k \hat{\beta}$, $\phi_k(0) = \phi_k$ and

$$(A.48) \quad G_i(\xi_k(\mu_3), \mu_3, \phi_k(\mu_3)) = 0,$$

for $i = 1, 2$. Under the scaling (A.43), these curves become

$$(A.49) \quad \mu_2 = \xi_k(\mu_3) \mu_3^m = (-1)^k \hat{\beta} \mu_3^m + O(|\mu_3|^{m+1}),$$

and look as in Figure A.5.

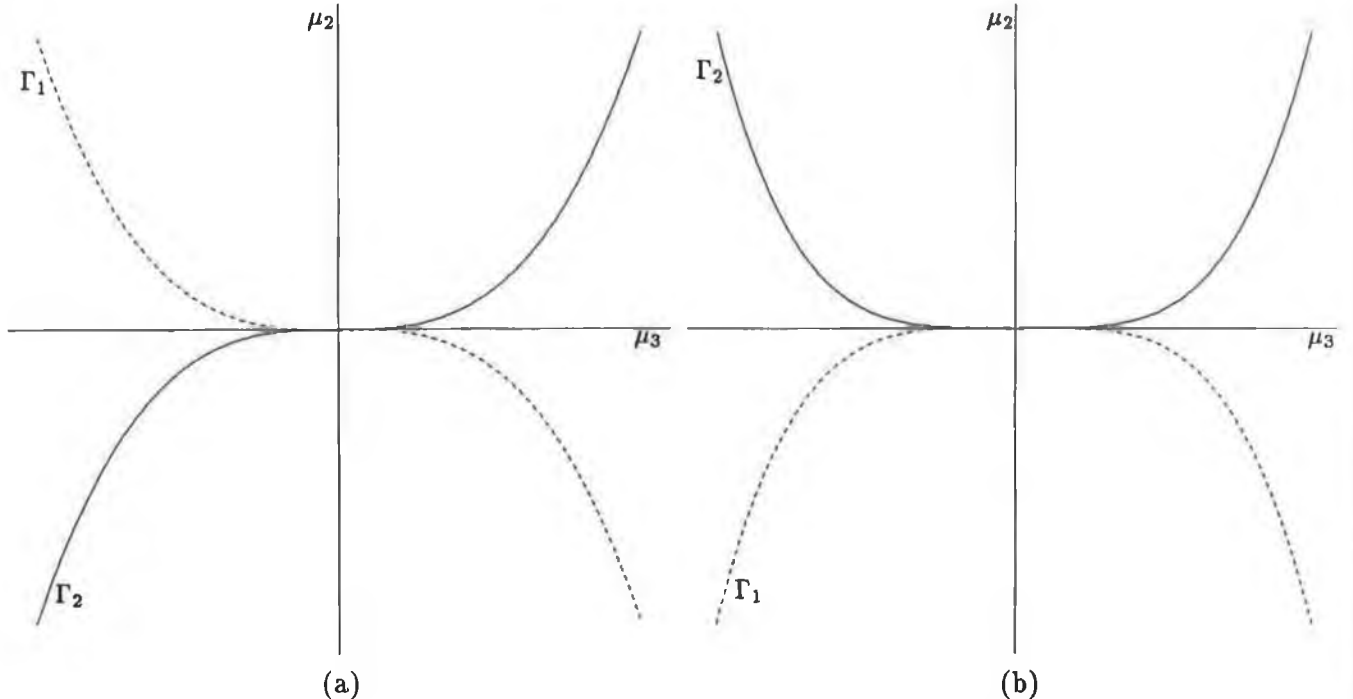

Figure A.5: Approximate bifurcation curves in a neighbourhood of the origin. (a) and (b) show typical curves for m odd and m even, respectively.

It is clear that (A.41) has no solutions if $\mu_2 \neq 0$ and $\mu_3 = 0$. Thus (A.1) has no solutions if $(\mu_2, \mu_3) \in V_0$. However, if $\mu_2 = 0$ and $\mu_3 \neq 0$, there are two solutions with $\phi = 0, \pi/m$.

A.5 Comparison with Main Results

For μ_1 close to 0 the results from Section A.4 should approach the corresponding results from Chapter 4. We show this explicitly for $m = 1, 2, 3, 4$. We generate level curves in (μ_2, μ_3) , at $\mu_1 = 0.1$, using (4.21), and compare with the corresponding curves Γ_1 and Γ_2 from Theorem A.3. Each figure is accompanied by a blowup of a region about $(\mu_2, \mu_3) = (0, 0)$.

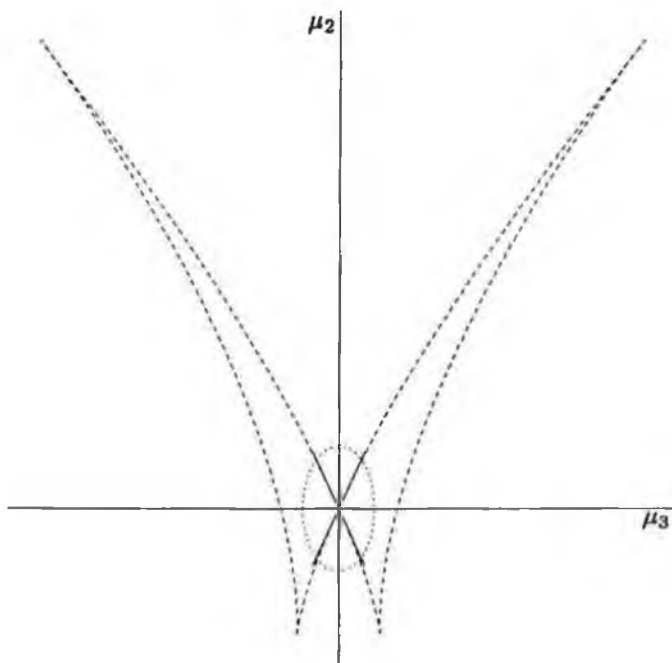

Figure A.6: $m = 1, \hat{\beta} = -1.2641143E + 00$.
 ----- Level curves of (4.21),
 ——— Γ_1 and Γ_2 .

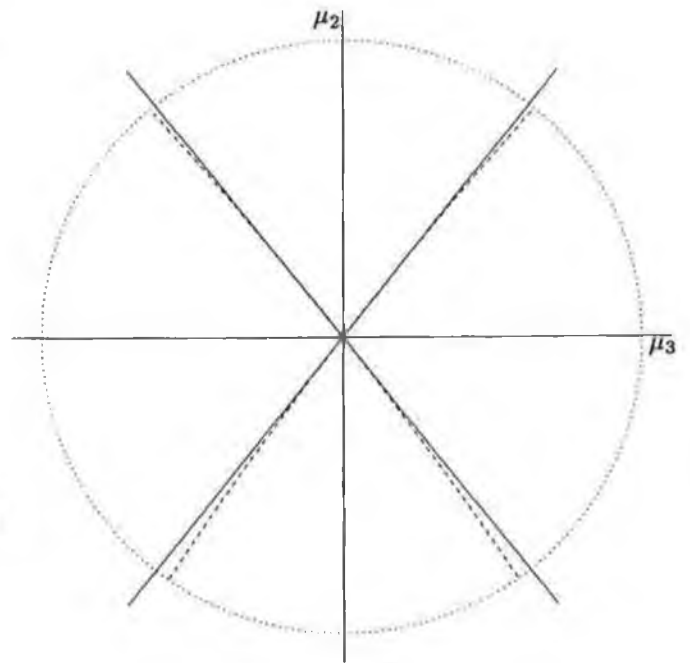

Figure A.7: *Blowup of the encircled region from Figure A.6.*

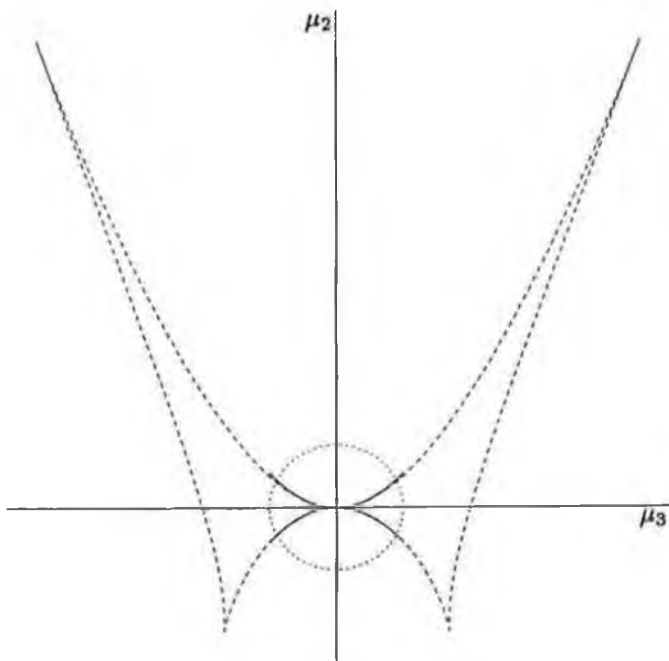

Figure A.8: $m = 2$, $\hat{\beta} = 5.3191057E - 02$.
 ----- Level curves of (4.21),
 ——— Γ_1 and Γ_2 .

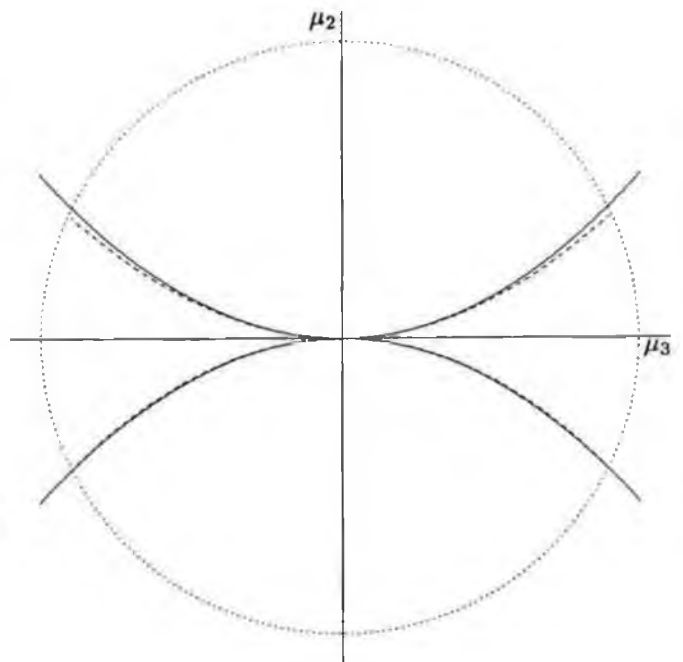

Figure A.9: *Blowup of the encircled region from Figure A.8.*

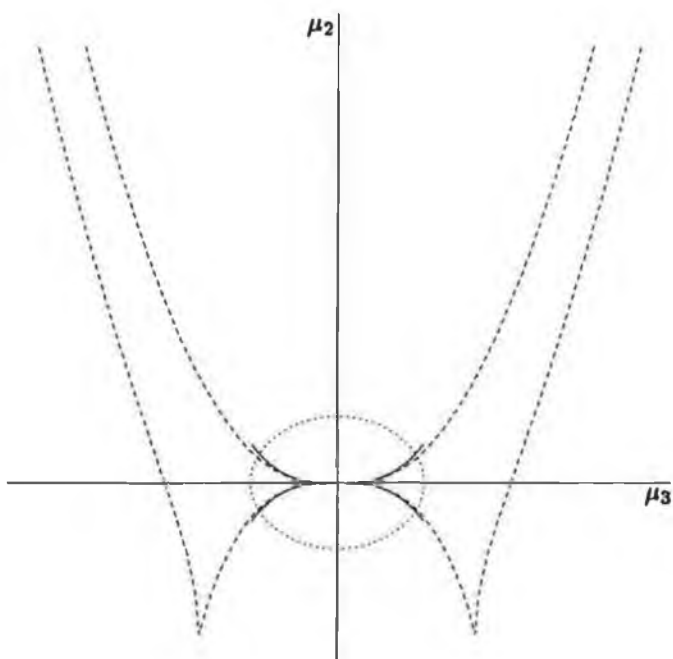

Figure A.10: $m = 3$, $\hat{\beta} = -1.5408173E - 04$.
 ----- Level curves of (4.21),
 ——— Γ_1 and Γ_2 .

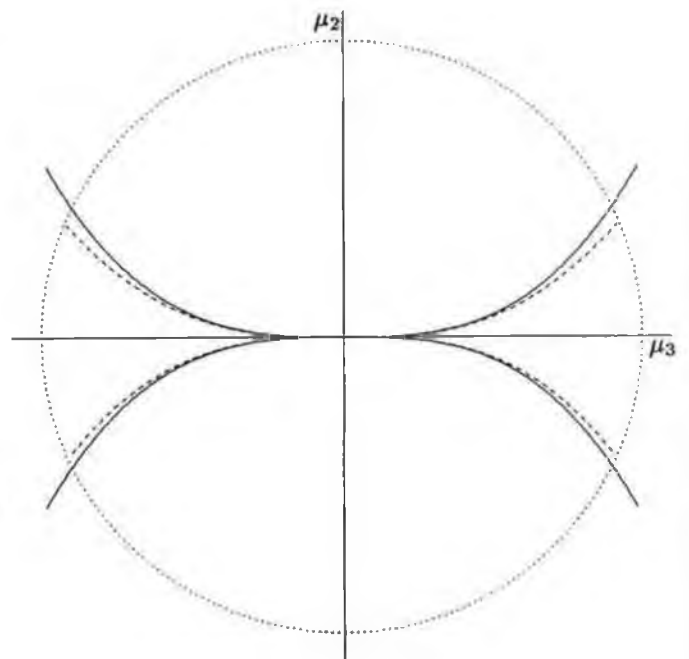

Figure A.11: *Blowup of the encircled region from Figure A.10.*

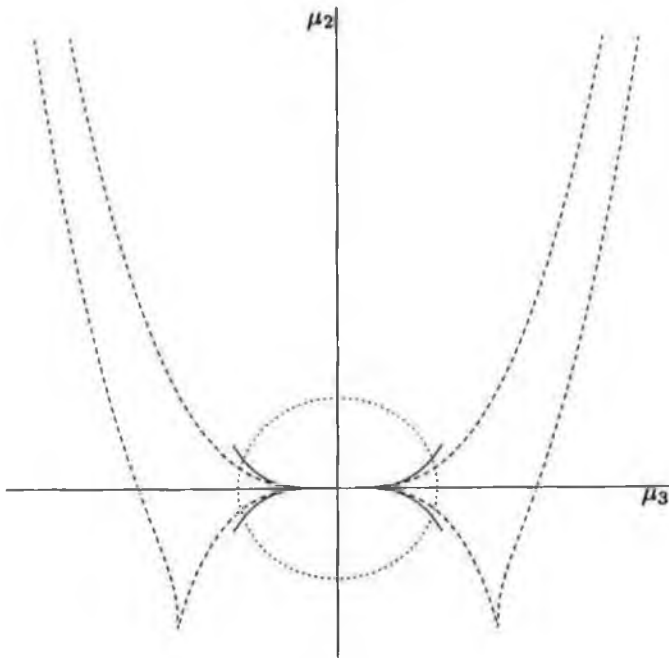

Figure A.12: $m = 4$, $\hat{\beta} = 9.2025077E - 08$.
 ----- Level curves of (4.21),
 ——— Γ_1 and Γ_2 .

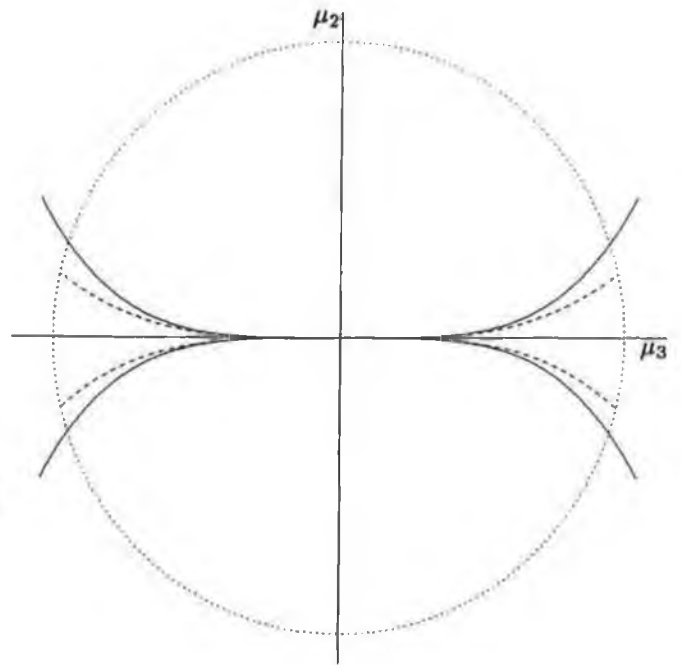

Figure A.13: *Blowup of the encircled region from Figure A.12.*

Appendix B

Bifurcation Surfaces for Other Forms of Damping

Cox and Mortell [9] consider an alternative form of damping, namely

$$(B.1) \quad (\mathbf{D}u')(t) = u(t),$$

because it is more tractable. Then (3.1) becomes

$$(B.2a) \quad u'''(t) + m^2 u'(t) = 2u(t)u'(t) + \mu_1 u'(t) + \mu_2 u(t) + \mu_3 \sin t,$$

$$(B.2b) \quad \int_{-\pi}^{\pi} u(s) ds = 0, \quad u(t + 2\pi) = u(t).$$

Another form of damping was introduced in Ockendon & Ockendon¹ [33], namely

$$(B.3) \quad (\mathbf{D}u')(t) = -u''(t).$$

Again this was used because it is more tractable than the convolution integral in (3.2). Use of (B.3) produces

$$(B.4a) \quad u'''(t) + m^2 u'(t) = 2u(t)u'(t) + \mu_1 u'(t) - \mu_2 u''(t) + \mu_3 \sin t,$$

$$(B.4b) \quad \int_{-\pi}^{\pi} u(s) ds = 0, \quad u(t + 2\pi) = u(t),$$

where (B.4a) can be integrated term by term to give a second order problem.

B.1 Leading Coefficients from the Bifurcation Equations

The techniques used in Chapters 3 can be applied to (B.2) and (B.4), and a pair of bifurcation equations is obtained in each case. Theorem 4.1 can be used to yield the structure of small solutions. The details are omitted.

Using TAYLOR to calculate terms from the bifurcation equations shows that

$$(B.5a) \quad A(\boldsymbol{\mu}) = m\mu_1 + \frac{2m\mu_3^2(1 - \delta_{1,m})}{(m^2 - 1)^2(4m^2 - 1)} + \sum_{3i+5j+3k>5} A_{ijk}\mu_1^i\mu_2^j\mu_3^{2k},$$

$$(B.5b) \quad B(\mathbf{0}) = \frac{1}{6m},$$

$$(B.5c) \quad C(\mathbf{0}) = 1,$$

$$(B.5d) \quad \kappa = \delta_{1,m} + \frac{\delta_{2,m}}{9} + \frac{\delta_{3,m}}{5120} + \frac{\delta_{4,m}11}{20412000} + \frac{\delta_{5,m}295}{2022633897984} + \dots,$$

¹cf. Ockendon, Ockendon & Johnson [34]

for (B.2). The leading coefficients for (B.4) are the same, except that

$$(B.6) \quad C(\mathbf{0}) = m^2.$$

The terms indicated are sufficient to give a first order approximation to the bifurcation surface, using (4.21), up to $m = 5$.

B.2 Bifurcation Equation Symmetries when $(Du') = u$

Setting $u(t-\phi) = r \cos mt + w(t)$ in (B.2a), in the usual way shows that $w(t)$ satisfies a nonlinear third order equation. This can be solved using the Implicit Function Theorem, and the solution $w(t) = w^*(r, (\mu_1, \mu_2, \mu_3), \phi)(t)$ has more symmetry than was found in Section 3.3. We do not investigate these here. We do note that

$$(B.7a) \quad w^*(r, (\mu_1, \mu_2, \mu_3), \phi)(t) = w^*(r, (\mu_1, -\mu_2, \mu_3), -\phi)(-t),$$

$$(B.7b) \quad w^*(r, (\mu_1, \mu_2, \mu_3), \phi)(t) = w^*(r, (\mu_1, \mu_2, -\mu_3), \phi + \pi)(t).$$

In Appendix C we use the fact that the bifurcation surface is symmetric about the μ_2 -axis and the μ_3 -axis. This is justified by the symmetries

$$(B.8) \quad B_i(r, (\mu_1, \mu_2, \mu_3), \phi) = B_i(r, (\mu_1, -\mu_2, \mu_3), -\phi),$$

and

$$(B.9) \quad B_i(r, (\mu_1, \mu_2, \mu_3), \phi) = B_i(r, (\mu_1, \mu_2, -\mu_3), \phi + \pi),$$

which result from (B.7), where $B_i(r, \mu, \phi) = 0$ ($i = 1, 2$) give the two bifurcation equations.

Appendix C

Numerical Calculation of Bifurcation Curves using AUTO

C.1 Introduction

In this chapter we consider the application of numerical continuation techniques to the equation¹

$$(C.1a) \quad u'''(t) + m^2 u'(t) = 2u(t)u'(t) + \mu_1 u'(t) + \mu_2 u(t) + \mu_3 \sin t,$$

$$(C.1b) \quad \int_{-\pi}^{\pi} u(s) ds = 0, \quad u(t + 2\pi) = u(t).$$

We consider only $m = 1, 3, 4, 5$, since $m = 1$ and $m = 2$ are similar, and producing results becomes more difficult as m is increased. Results were obtained for $m = 10$, and these continued the trends shown in the presented diagrams.

The AUTO² continuation package for autonomous ODEs, was used to produce the results in this chapter.

AUTO works with first order autonomous systems with the independent variable $t \in [0, 1]$. We write (C.1a) as

$$(C.2) \quad \begin{aligned} y_1' &= 2\pi y_2, \\ y_2' &= 2\pi y_3, \\ y_3' &= 2\pi \left\{ 2y_1 y_2 + (\mu_1 - \mu_4^2) y_2 + \mu_2 y_1 + \mu_3 \sin(y_4) \right\}, \\ y_4' &= 2\pi, \end{aligned}$$

where $y_1(t) = y_1(t+1)$, $y_1(t) = u(2\pi t)$, $y_2(t) = u'(2\pi t)$, etc., and $\mu_4 = m$. From the periodicity condition we get the boundary conditions

$$(C.3) \quad \begin{aligned} y_1(1) &= y_1(0), \\ y_2(1) &= y_2(0), \\ y_4(0) &= 0. \end{aligned}$$

¹The *simpler* form of damping here was considered previously by Cox & Mortell [9].

²"AUTO: Software for Continuation and Bifurcation Problems in Ordinary Differential Equations." Eusebius Doedel's extensive numerical continuation package.

We use the integral constraints

$$(C.4a) \quad \int_0^1 y_1(s) ds = 0,$$

$$(C.4b) \quad 2 \int_0^1 y_1^2(s) ds - \mu_5 = 0,$$

$$(C.4c) \quad 2 \int_0^1 y_1(s) \cos(2\pi ms) ds - \mu_6 = 0,$$

$$(C.4d) \quad 2 \int_0^1 y_1(s) \sin(2\pi ms) ds - \mu_7 = 0,$$

where (C.4a) implements the mean zero condition, μ_5 measures the L_2 -norm, $\|y_1\|_0^2$, and μ_6 and μ_7 are related to r and ϕ by,

$$(C.5) \quad \mu_6 = r \cos m\phi, \quad \mu_7 = r \sin m\phi.$$

Section C.2 contains results for $\mu_2 = 0$, on which the choice of damping has no effect, and Section C.3 has results for $\mu_2 \neq 0$.

In Appendix B coefficients from the approximate bifurcation equations for (C.1) are given. (B.8) and (B.9) show that the bifurcation surface for (C.1), is even in μ_2 and μ_3 . Hence, only results for $\mu_2 > 0$ and $\mu_3 > 0$ need to be generated, since we can use symmetry to get results for a full neighbourhood of the origin.

We use \tilde{r} to represent the approximation to r found using the approximate bifurcation equations. The results in Sections C.2 and C.3 show that the approximate bifurcation equations yield good approximations to the exact results near $(\mu_1, \mu_2, \mu_3) = (0, 0, 0)$.

C.2 Numerical Results for the Undamped Problem

The AUTO calculations were begun with the exact solution

$$(C.6a) \quad y_1 = 0.0, \quad y_2 = 0.0, \quad y_3 = 0.0, \quad y_4 = 2\pi t,$$

and

$$(C.6b) \quad \mu_1 = 0.1, \quad \mu_2 = 0.0, \quad \mu_3 = 0.0, \quad \mu_4 = m, \quad \mu_5 = 0.0, \\ \mu_6 = 0.0, \quad \mu_7 = 0.0.$$

The choice $\mu_1 = 0.1$ has no significance. The "norm" chosen (in AUTO) was $\|y_1\| = \max\{y_1(t) : 0 < t < 1\}$, which is clearly not a norm in the mathematical sense.

First, continuation was applied in the positive μ_3 direction until a limit point, $\mu_3^L > 0$, was detected. Continuation in the negative μ_3 direction gives another limit point at $-\mu_3^L$, which is a consequence of (B.9). A plot of $\|y_1\|_0^2$ against μ_3 gives Figure C.1, where the limit points are indicated on the figure. Figure C.2 shows the same plot with $\|y_1\|_0^2$ replaced by $|r|$. For $\mu_3 < -\mu_3^L$ and $\mu_3 > \mu_3^L$, these diagrams show that there is only one small amplitude solution. At $\mu_3 = -\mu_3^L$ and μ_3^L there are two small amplitude solutions, and for $\mu_3 \in (-\mu_3^L, \mu_3^L)$ there are three such solutions. The points $-\mu_3^L$ and μ_3^L represent points on a bifurcation curve.

The same procedure for $m = 3, 4, 5$ gives Figures C.3 to C.5, respectively, where we present only plots with $|r|$, in order to make a comparison with $|\tilde{r}|$. Figures C.4 to C.7 show how nonlinear effects, away from $\mu_3 = 0$, become significant for $m = 4, 5$.

When $m \leq 3$ there are no bifurcations for $\mu_1 < 0$. For $m = 4, 5$, Figures C.6 and C.7 show that there are two limit points when $\mu_1 = -0.03$, which give two

points on a bifurcation curve. Figure C.6 shows an *isola* of solutions for $m = 4$. An *isola* also develops when $m = 5$, when μ_1 is sufficiently negative.

Continuing the branches of limit points from the point $(\mu_1, \mu_3) = (0.1, \mu_3^L)$ in the parameters μ_1 and μ_3 , in the negative μ_3 direction as far as $\mu_3 = 0.0$, gives Figures C.8 to C.11. Each point on these curves corresponds to a single limit point solution of (C.1). The approximate results for $m = 4, 5$ differ significantly from the exact results away from $\mu_3 = 0$.

Figure C.12 shows how the projection onto the (μ_1, μ_3) plane of curves of limit point solutions, when $m = 1$, leads to the cusp shape shown in Figure C.8. This is similar to the cusp given in [8] for the Duffing equation.

Graphing the first approximation to the solution surface for $m = 1$, implicitly defined by (B.5), in (μ_1, μ_3, \bar{r}) space, gives Figure C.13. The use of \bar{r} instead of $|\bar{r}|$ gives a clearer view of the surface shape. Each point on this surface corresponds to a first approximation to a solution of the bifurcation equations for $m = 1$, with $\mu_2 = 0, \phi = 0$. Projecting the limit points of this surface onto the (μ_1, μ_3) plane gives the approximation to the bifurcation curves shown with dashed lines in Figures C.8 to C.11.

For a given value of μ_3 , Figure C.13 gives an indication of the amplitude response as μ_1 is varied. A typical cross section is shown in Figure C.14. These are similar to the Duffing response diagrams given in [25].

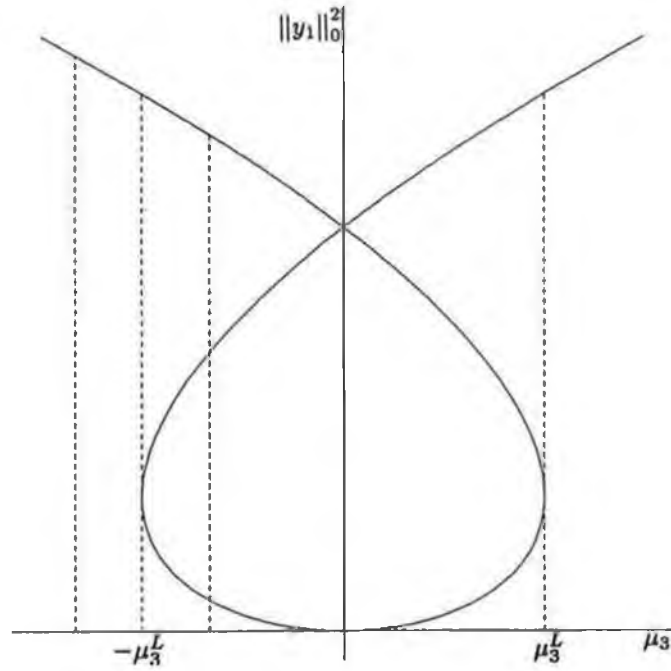

Figure C.1: Plot of $\|y_1\|_0^2$ against μ_3 for $m = 1$, $\mu_1 = 0.1$ and $\mu_2 = 0.0$.

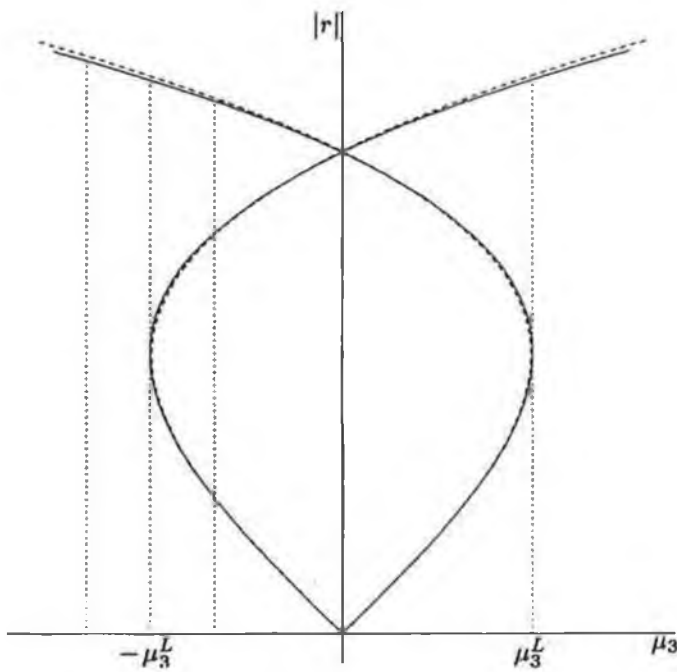

Figure C.2: Plot of $|r|$ against μ_3 for $m = 1$, $\mu_1 = 0.1$ and $\mu_2 = 0.0$.

———— Numerical result,
 - - - - - Approx. using (B.5).

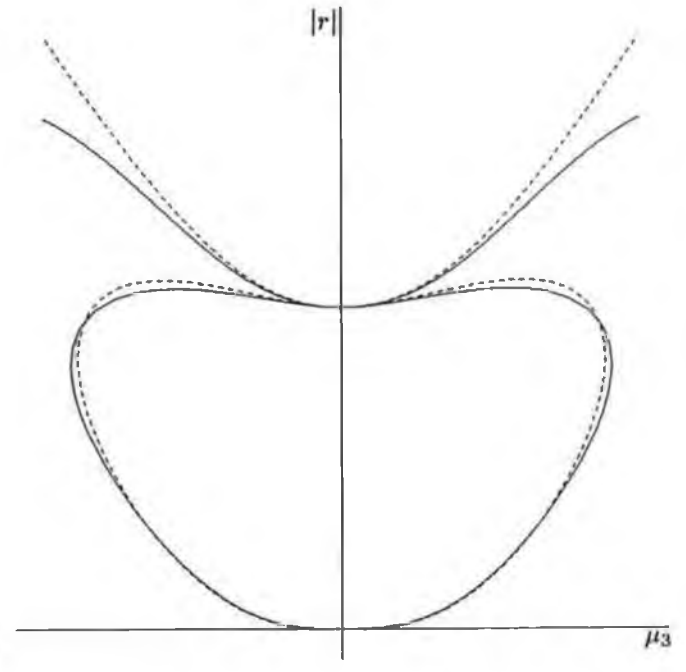

Figure C.3: Plot of $|r|$ against μ_3 for $m = 3$, $\mu_1 = 0.1$ and $\mu_2 = 0.0$.

———— Numerical result,
 - - - - - Approx. using (B.5).

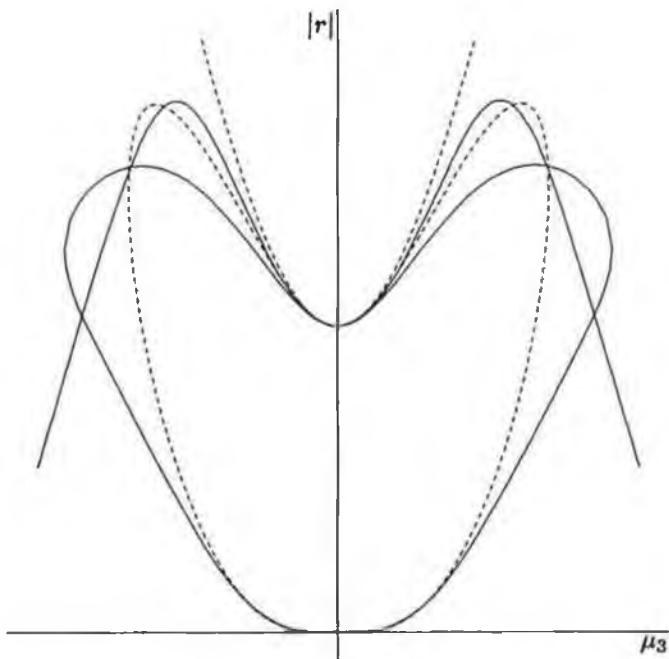

Figure C.4: Plot of $|r|$ against μ_3 for $m = 4$, $\mu_1 = 0.1$ and $\mu_2 = 0.0$.
 — Numerical result,
 - - - - - Approx. using (B.5).

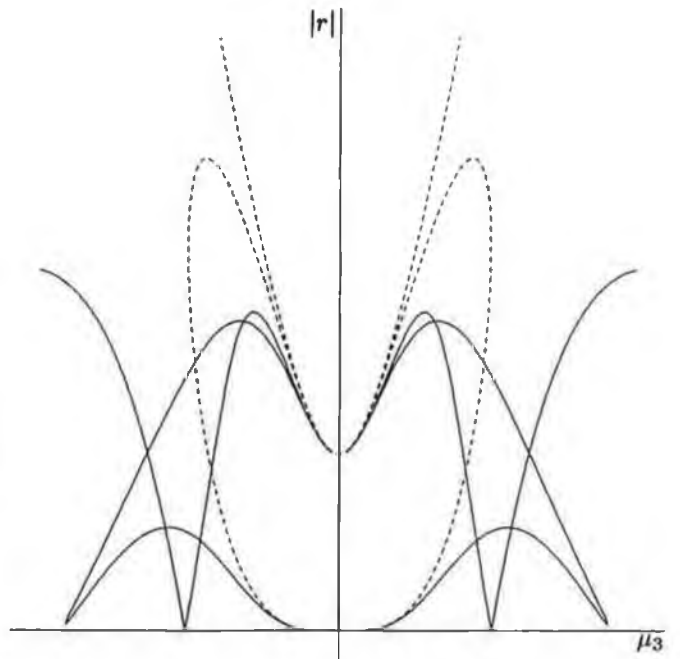

Figure C.5: Plot of $|r|$ against μ_3 for $m = 5$, $\mu_1 = 0.1$ and $\mu_2 = 0.0$.
 — Numerical result,
 - - - - - Approx. using (B.5).

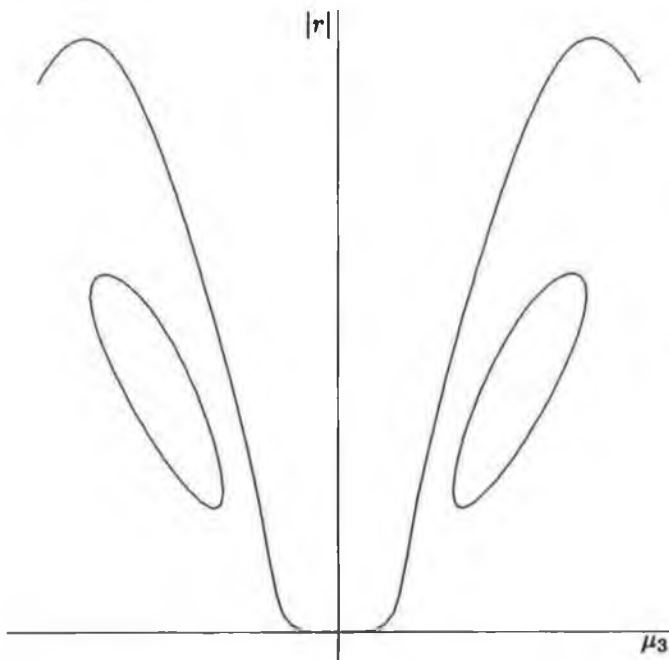

Figure C.6: Plot of $|r|$ against μ_3 for $m = 4$, $\mu_1 = -0.03$ and $\mu_2 = 0.0$.

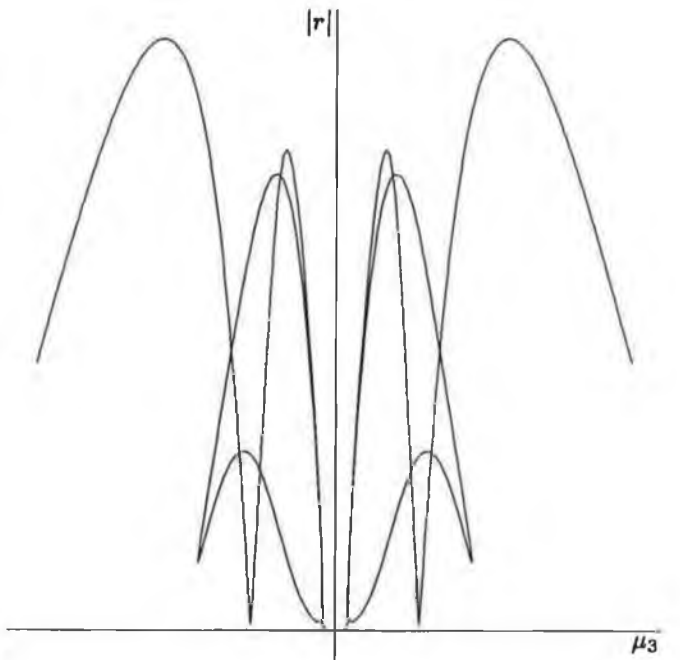

Figure C.7: Plot of $|r|$ against μ_3 for $m = 5$, $\mu_1 = -0.03$ and $\mu_2 = 0.0$.

There is a slight anomaly near the origin, which may be numerical error. There are actually two limit points, although the one nearest the origin is hard to distinguish.

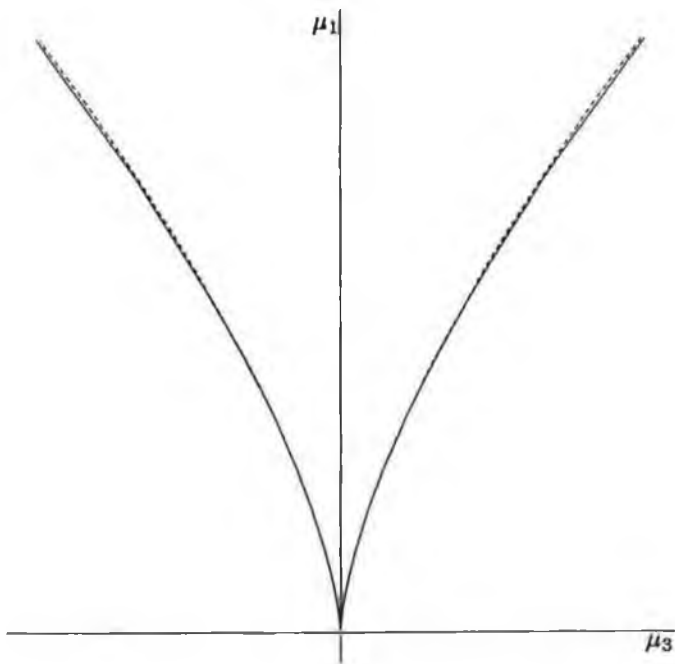

Figure C.8: Bifurcation curves in (μ_1, μ_3) parameter space for $m = 1, \mu_2 = 0.0$.
 — Numerical result,
 - - - - - Approx. using (B.5).

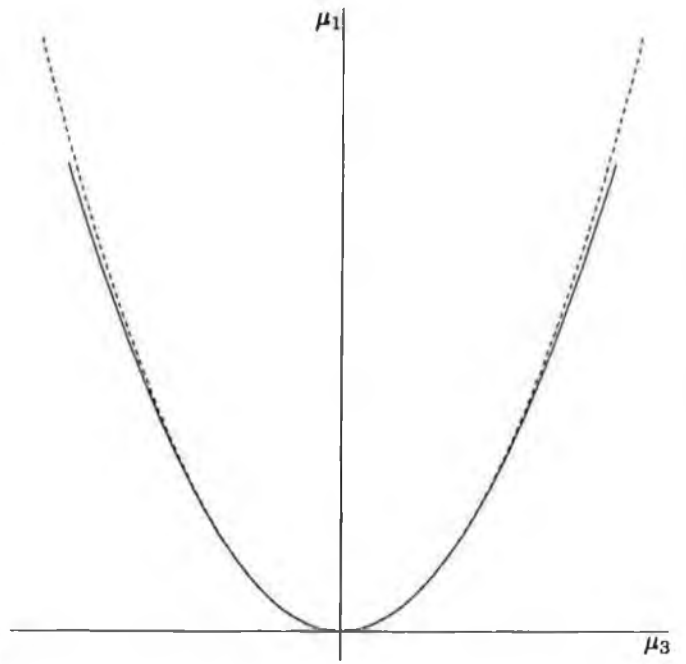

Figure C.9: Bifurcation curves in (μ_1, μ_3) parameter space for $m = 3, \mu_2 = 0.0$.
 — Numerical result,
 - - - - - Approx. using (B.5).

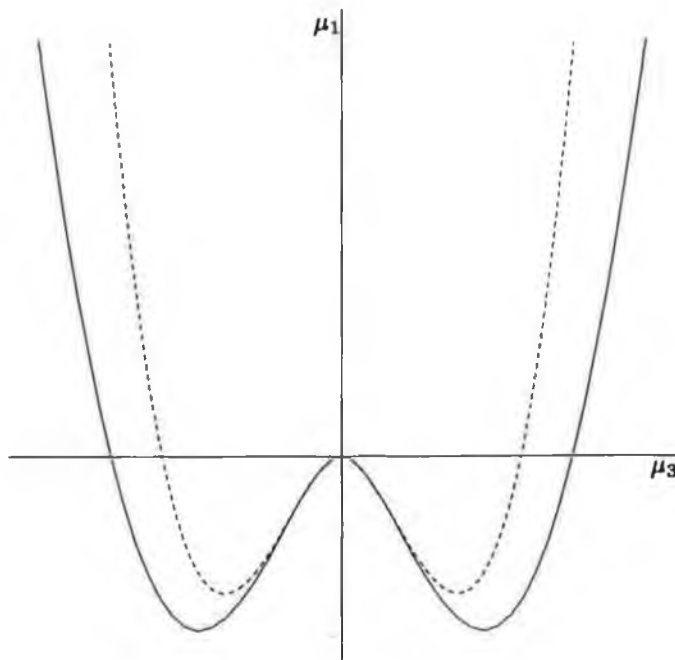

Figure C.10: Bifurcation curves in (μ_1, μ_3) parameter space for $m = 4, \mu_2 = 0.0$.
 — Numerical result,
 - - - - - Approx. using (B.5).

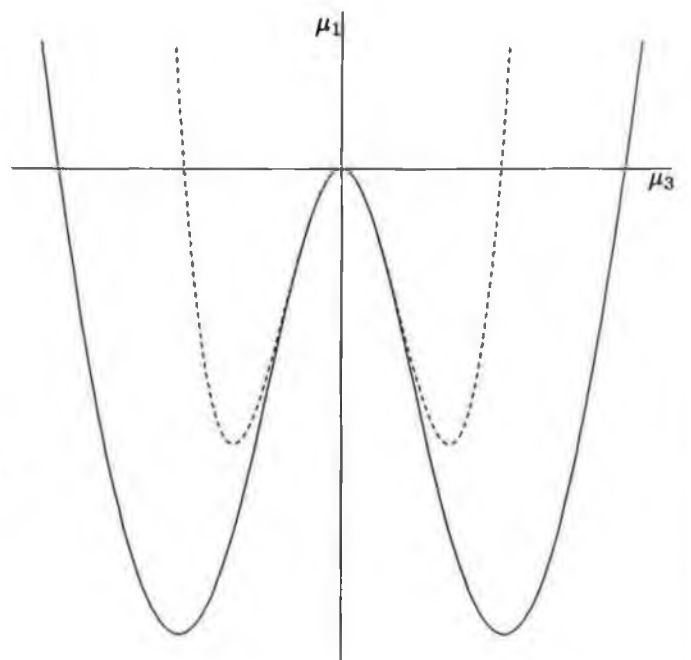

Figure C.11: Bifurcation curves in (μ_1, μ_3) parameter space for $m = 5, \mu_2 = 0.0$.
 — Numerical result,
 - - - - - Approx. using (B.5).

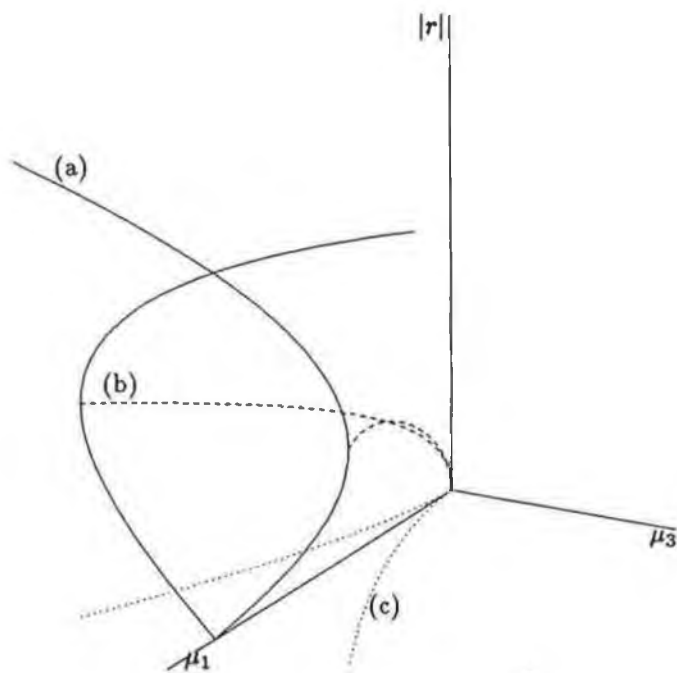

Figure C.12: Curve (a) shows a typical branch of solutions for fixed μ_1 . Curve (b) is the curve of limit point solutions in $(\mu_1, \mu_3, |r|)$ space. Each point on this curve corresponds to a limit point on a curve similar to (a), so (a) and (b) intersect at the limit point associated with (a). Finally curve (c) is the cusp, produced by projecting (b) onto the (μ_1, μ_3) plane.

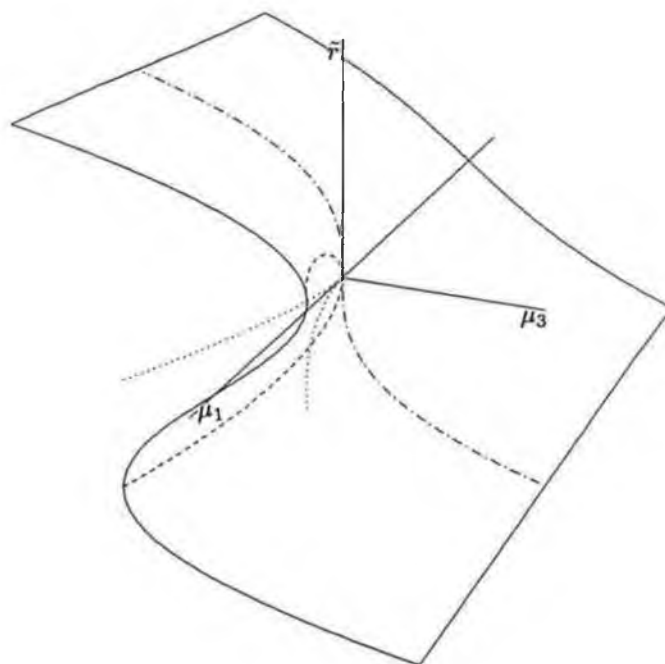

Figure C.13: Approximate solution surface defined implicitly by (B.5), for $m = 1$, corresponding to an unfolded version of Figure (C.12). A slice through this surface for fixed μ_1 , with \tilde{r} replaced by $|\tilde{r}|$, is similar to curve (a) from Figure C.12.

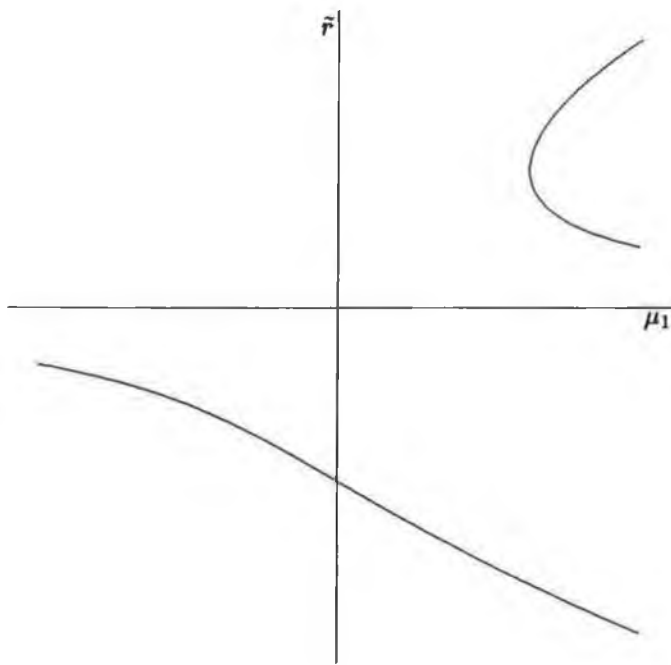

Figure C.14: A cross section from Figure C.13, for fixed $\mu_3 > 0$.

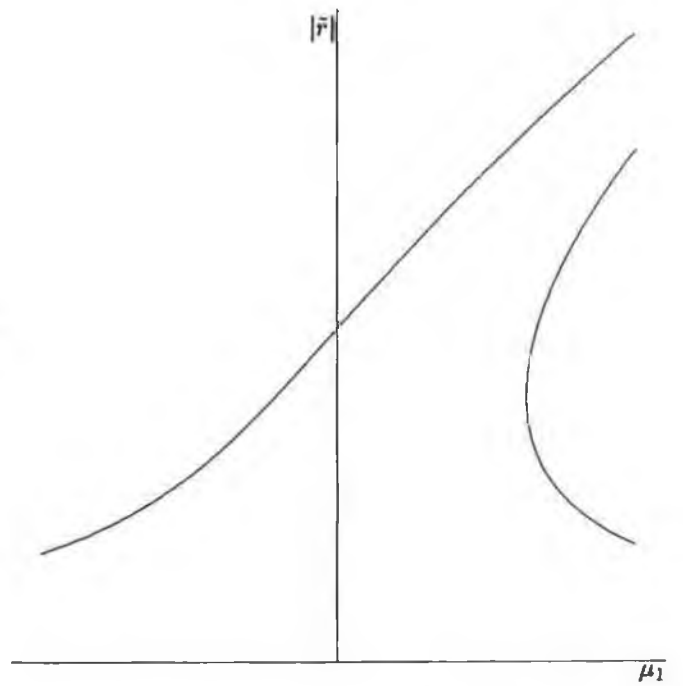

Figure C.15: Replacing \tilde{r} by $|\tilde{r}|$ in Figure C.14, gives an approximate amplitude response diagram, which is shown here.

C.3 Numerical Results for the Damped Problem

Figure C.16 shows a typical approximate amplitude response for $\mu_2 > 0$ and $\mu_3 > 0$.

For small $\mu_2 > 0$ the equivalent of Figure C.1 is Figure C.17. There are now two limit points, $\mu_3^{L_1} > 0$ and $\mu_3^{L_2} > 0$, which are indicated on the figure. Figure C.18 shows the same plot with $\|y_1\|_0^2$ replaced by $|r|$. The equivalent diagrams for $m = 3, 4, 5$ are omitted since it is not difficult to realise how these will look in the light of Figures C.3 to C.5, and Figure C.19. Considering various values of $\mu_2 > 0$ gives Figure C.19. To generate the data for this figure the continuation process was begun with (C.6b) replaced by

$$(C.7) \quad \mu_1 = 0.1, \quad \mu_3 = 0.0, \quad \mu_4 = m, \quad \mu_5 = 0.0, \quad \mu_6 = 0.0, \quad \mu_7 = 0.0,$$

and $\mu_2 = 0.01k$, $k = 0, 1, 2, 3, 4, 5$.

Projecting the limit points onto the (μ_2, μ_3) plane a bifurcation curve is obtained. This is shown in Figure C.20, where the bifurcation curve for $\mu_2 > 0$, $\mu_3 > 0$ is given. Figure C.21 gives the bifurcation curve extended to a full neighbourhood of the origin. The equivalent level curves for $m = 3, 4, 5$, at $\mu_1 = 0.1$, are given in Figures C.22 to C.24 respectively. Figures C.25 and C.26 show that the approximations, when $m = 4, 5$, near $(\mu_2, \mu_3) = (0, 0)$, are good.

When $m = 1, 2, 3$ there are no bifurcations for $\mu_1 < 0.0$. However, for $m > 3$ there are, and Figures C.27 and C.28 show the bifurcation curves in (μ_2, μ_3) space for $m = 4, 5$ and $\mu_1 = -0.03$. The *wing* tips have moved away from the origin, and Figure C.27 shows the onset of the *wings* moving away from $\mu_2 = 0$. The *wings* break apart for μ_1 sufficiently negative.

To show the complete bifurcation surface in parameter space we use the first approximation to each surface, for $m = 1, 3, 4, 5$. These are shown in Figures C.29 to C.32, with Figures C.33 and C.34 showing the surfaces for $m = 4, 5$ from below the plane $\mu_1 = 0$. Figure C.29 shows a surface which is similar to the equivalent surface for the Duffing equation, given in [19].

The bifurcation surfaces are obtained as the projection of limit points in $(\mu_1, \mu_2, \mu_3, \|\cdot\|)$ space onto (μ_1, μ_2, μ_3) space. Outside these surfaces there is a unique solution to (C.1). On them there is a double solution, and inside them there are three possible solutions. We do not allow $(\mu_2, \mu_3) = (0, 0)$, where there are infinitely many solutions to (C.1).

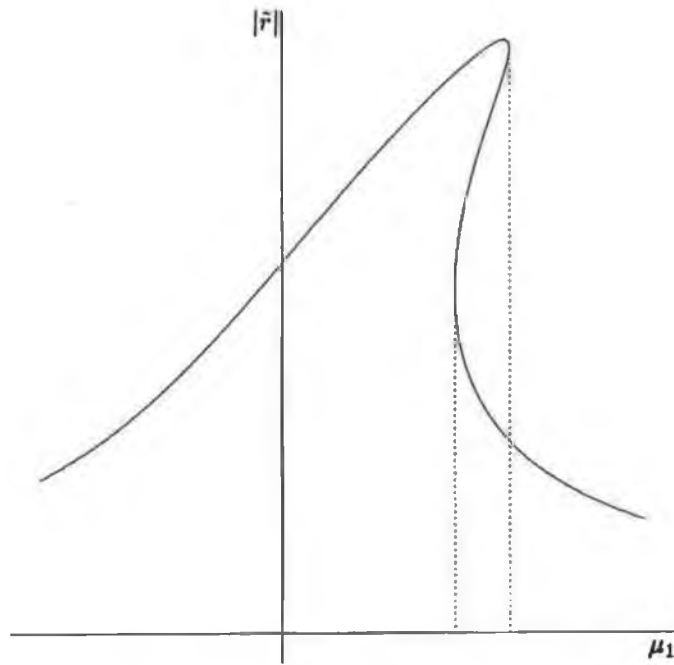

Figure C.16: Approximate amplitude response for $m = 1$, $\mu_2 > 0$ and $\mu_3 > 0$.

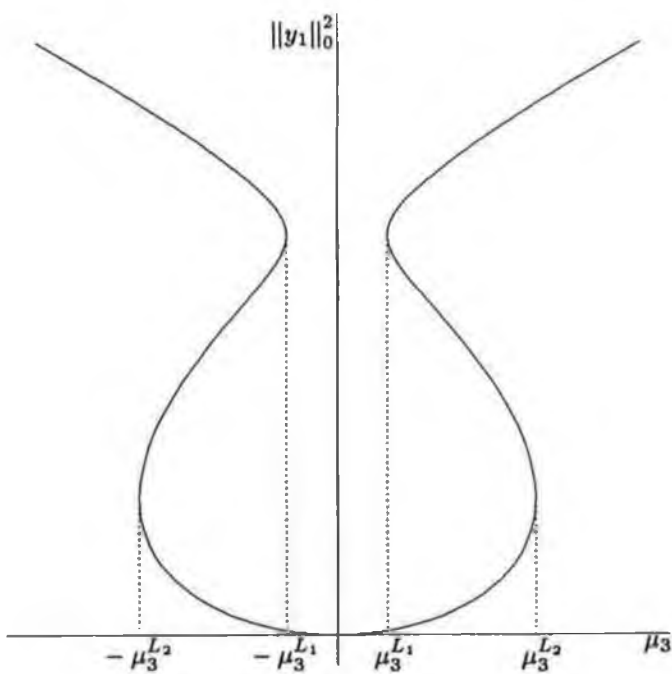

Figure C.17: Plot of $\|y_1\|_0^2$ against μ_3 for $m = 1$, $\mu_1 = 0.1$ and $\mu_2 > 0$.

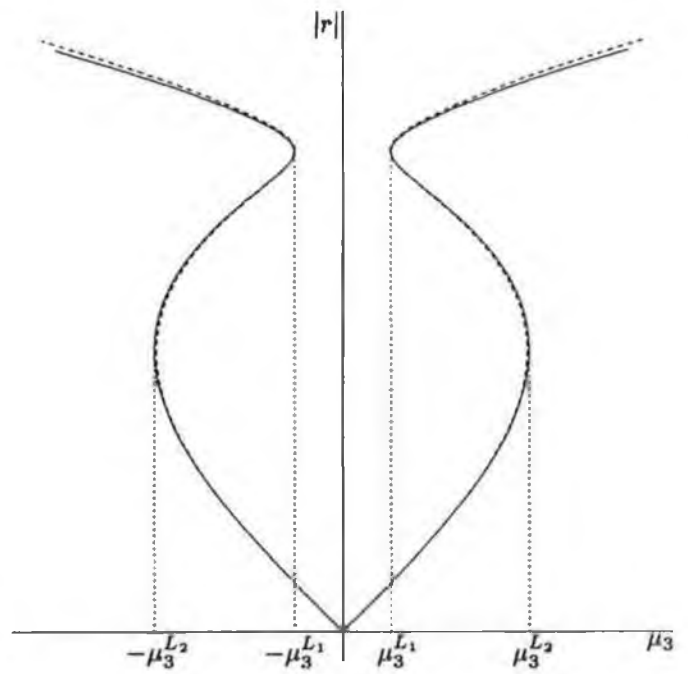

Figure C.18: Plot of $|r|$ against μ_3 for $m = 1$, $\mu_1 = 0.1$ and $\mu_2 > 0$.

———— Numerical results,
 - - - - - Approx. using (B.5).

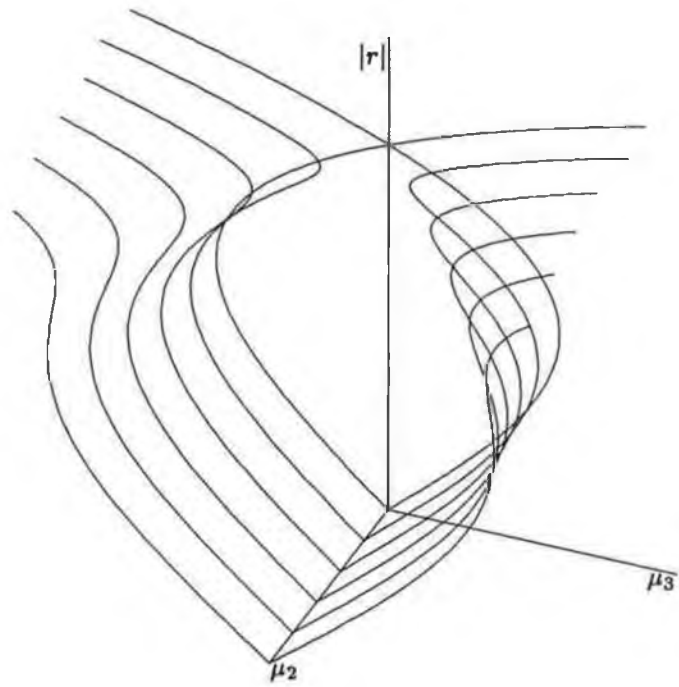

Figure C.19: Solution curves $(\mu_2, \mu_3, |r|)$ for $m = 1$, $\mu_1 = 0.1$ and various $\mu_2 > 0$.

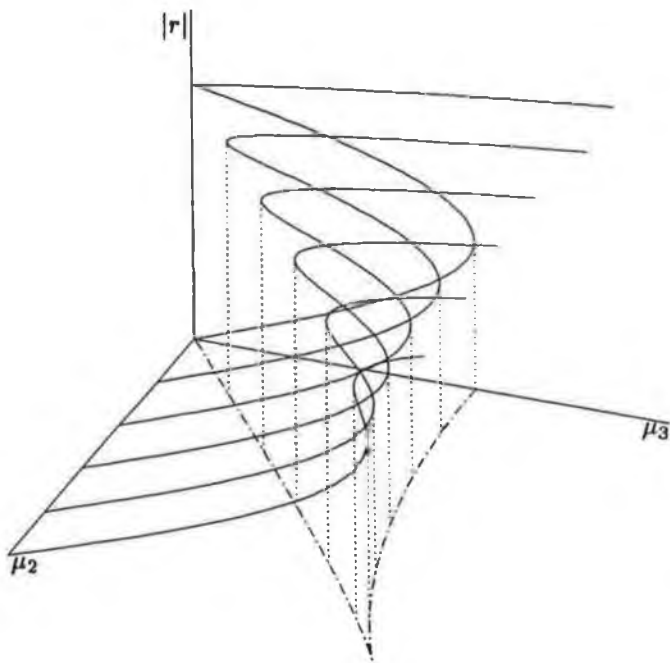

Figure C.20: Diagram showing the projection of the limit points in Figure C.19. The bifurcation curve is shown in the (μ_2, μ_3) plane.

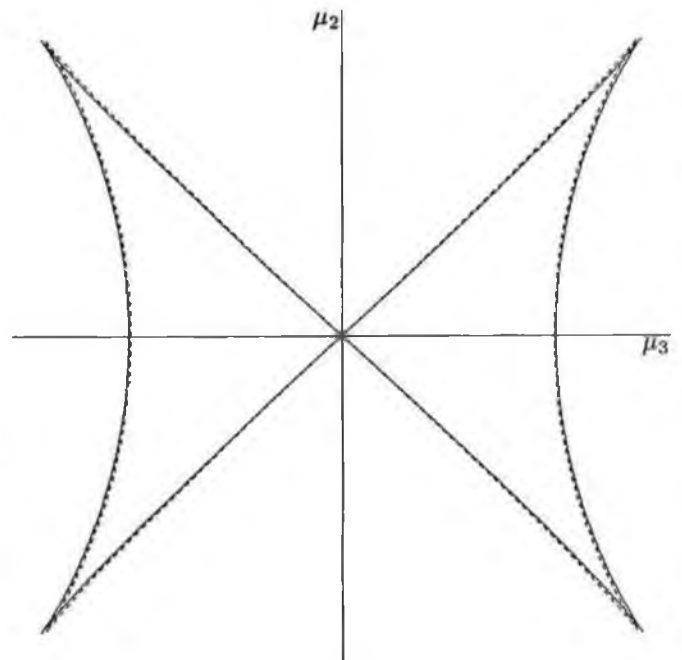

Figure C.21: Applying the symmetry in μ_2 and μ_3 to Figure C.20 gives the full bifurcation curve.

———— Numerical Result,
 - - - - - Approx. from (B.5) and (4.21).

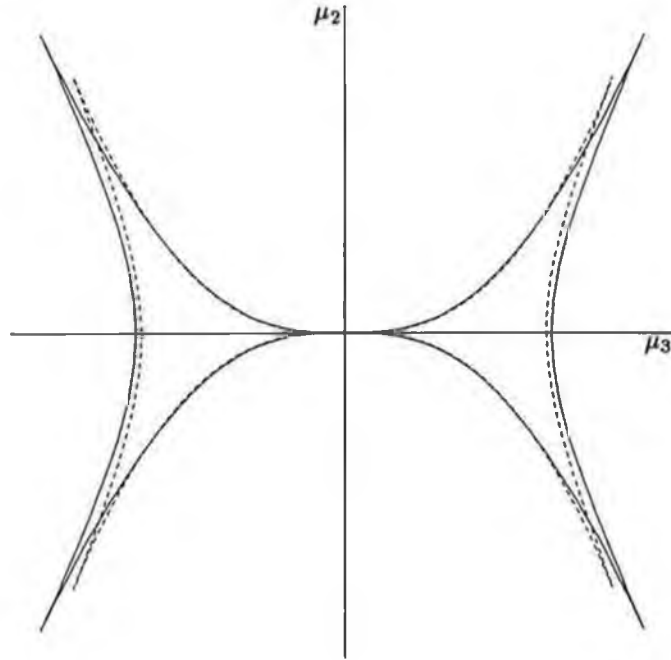

Figure C.22: Level curve of bifurcation surface for $m = 3$, $\mu_1 = 0.1$.
 — Numerical Result,
 - - - - - Approx. from (B.5) and (4.21).

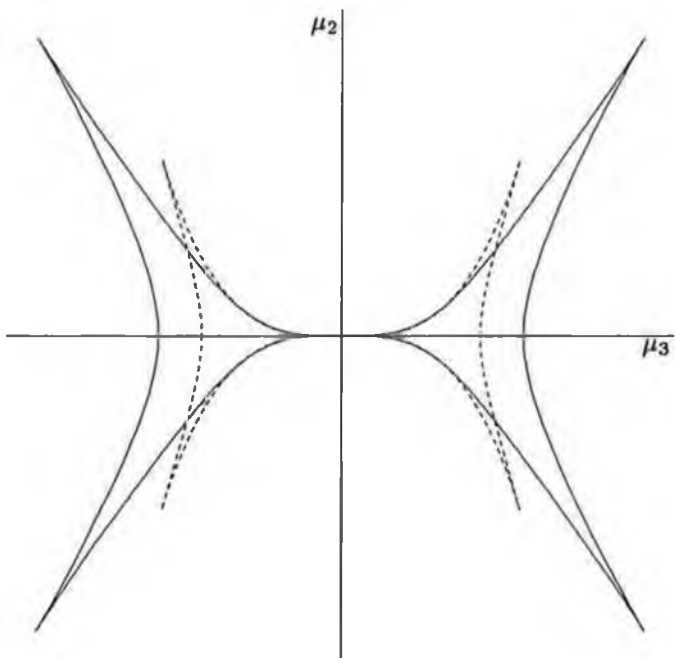

Figure C.23: Level curve of bifurcation surface for $m = 4$, $\mu_1 = 0.1$.
 — Numerical Result,
 - - - - - Approx. from (B.5) and (4.21).

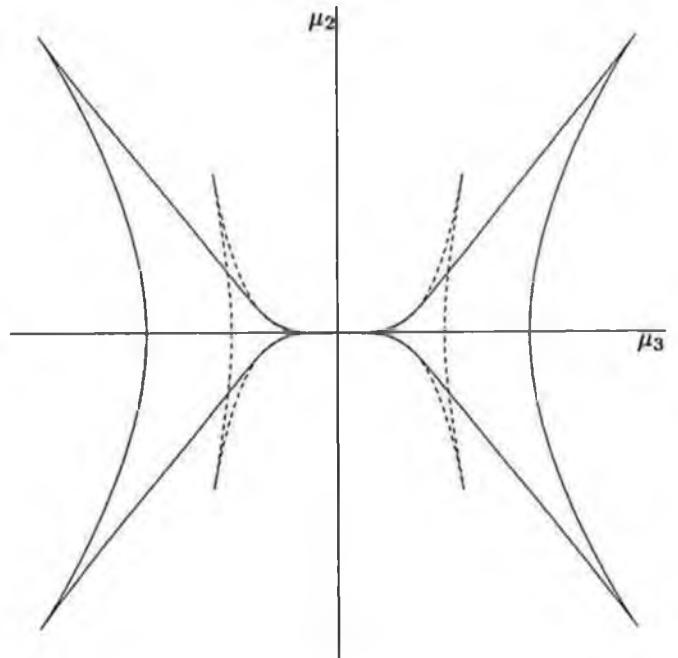

Figure C.24: Level curve of bifurcation surface for $m = 5$, $\mu_1 = 0.1$.
 — Numerical Result,
 - - - - - Approx. from (B.5) and (4.21).

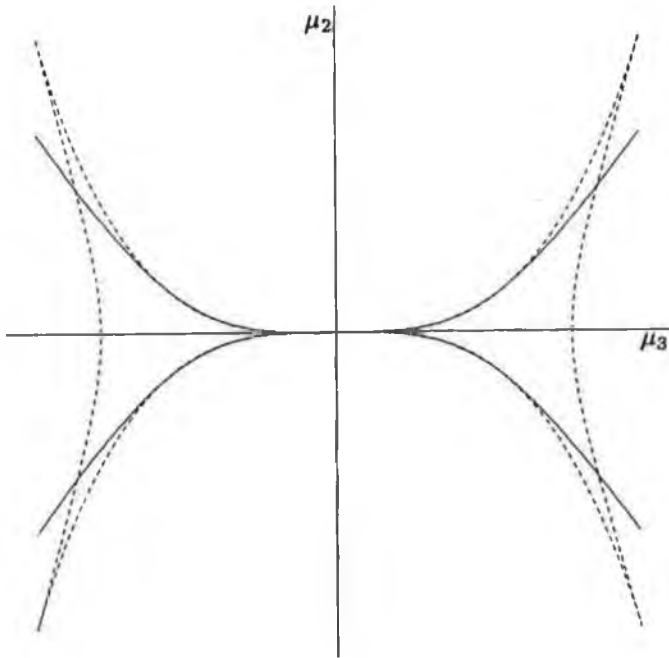

Figure C.25: Same as Figure C.23, but with a smaller μ_3 interval.
 — Numerical Result,
 - - - - - Approx. from (B.5) and (4.21).

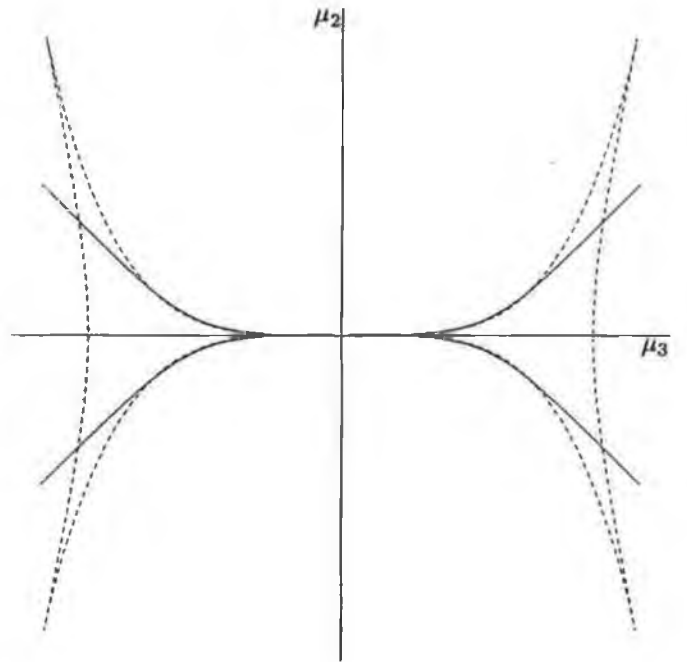

Figure C.26: Same as Figure C.24, but with a smaller μ_3 interval.
 — Numerical Result,
 - - - - - Approx. from (B.5) and (4.21).

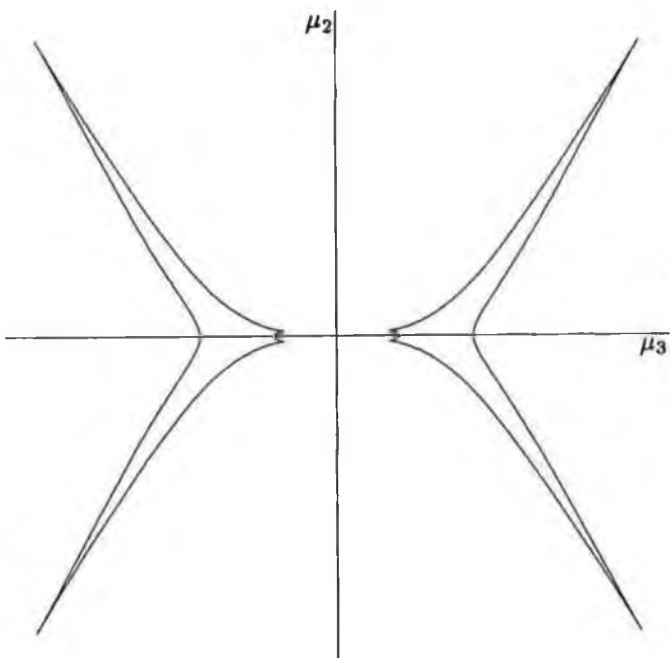

Figure C.27: Level curve of bifurcation surface for $m = 4$, $\mu_1 = -0.03$.

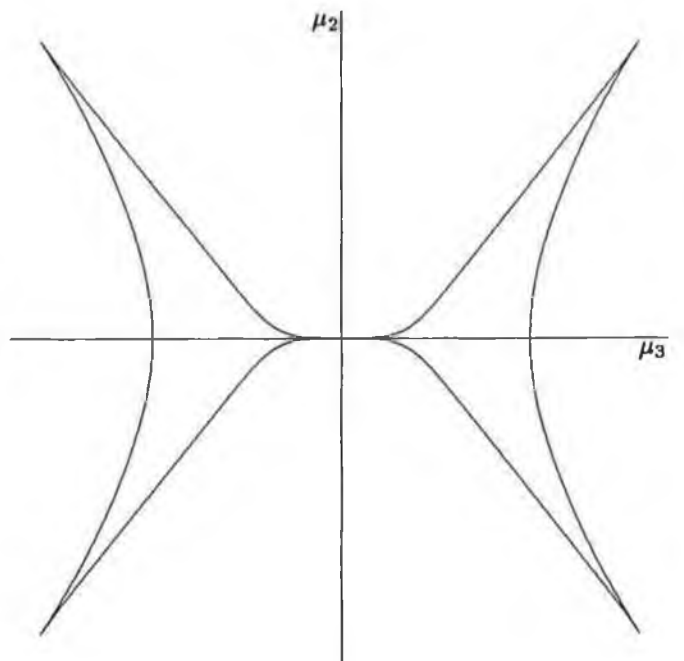

Figure C.28: Level curve of bifurcation surface for $m = 5$, $\mu_1 = -0.03$.

The diagram does not indicate it, but the curves for $\mu_2 < 0$ are no longer connected, via the origin, to those for $\mu_2 > 0$.

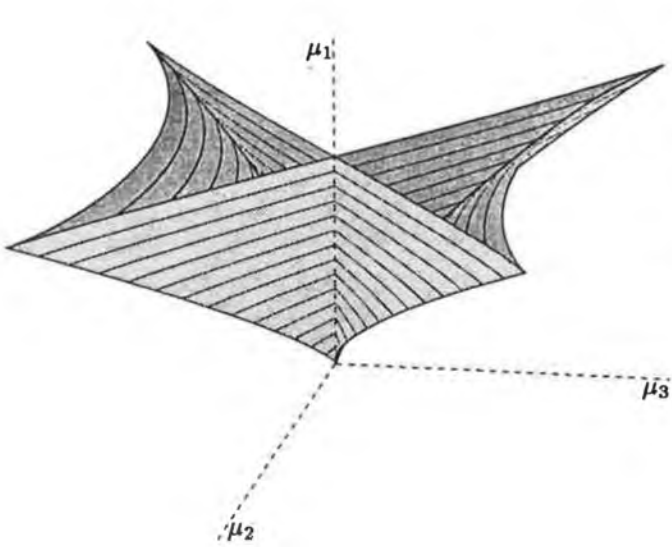

Figure C.29: Approximate bifurcation surface for $m = 1$.

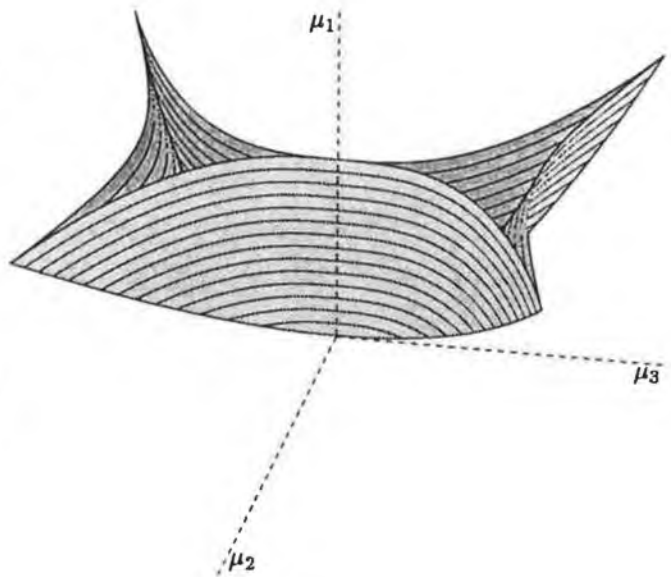

Figure C.30: Approximate bifurcation surface for $m = 3$.

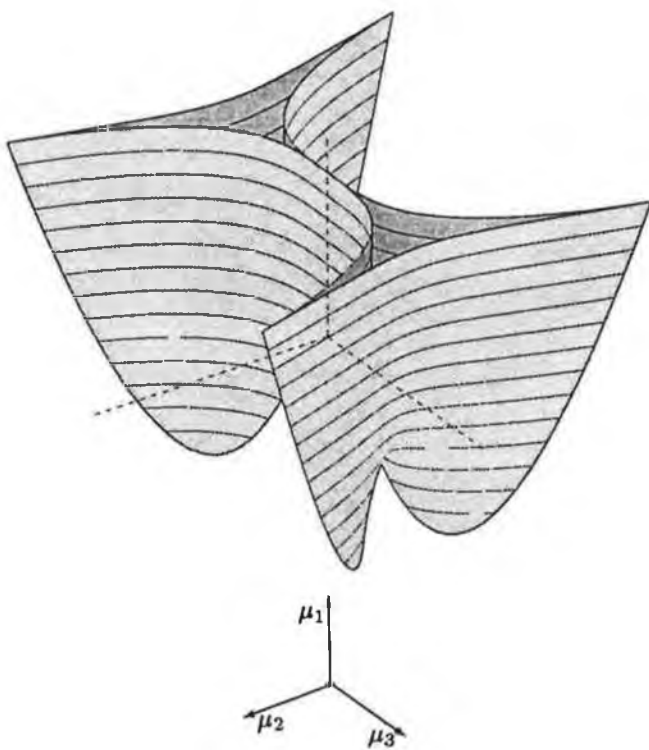

Figure C.31: Approximate bifurcation surface for $m = 4$.

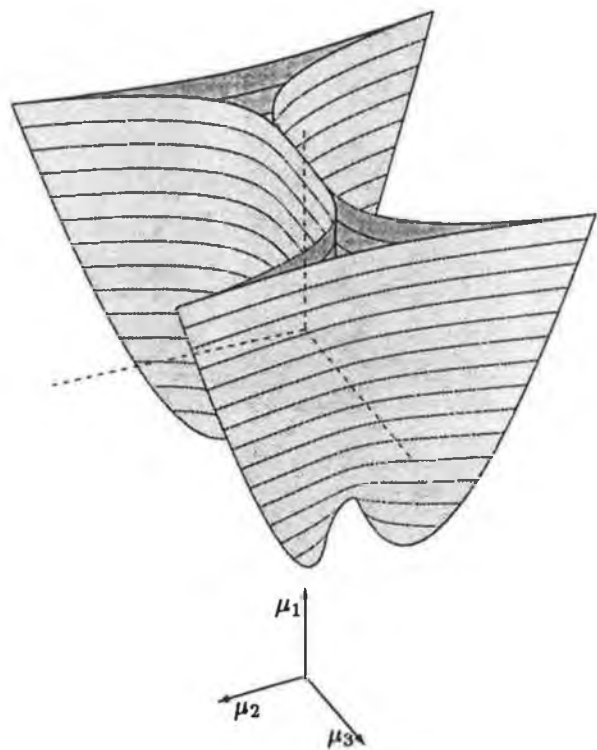

Figure C.32: Approximate bifurcation surface for $m = 5$.

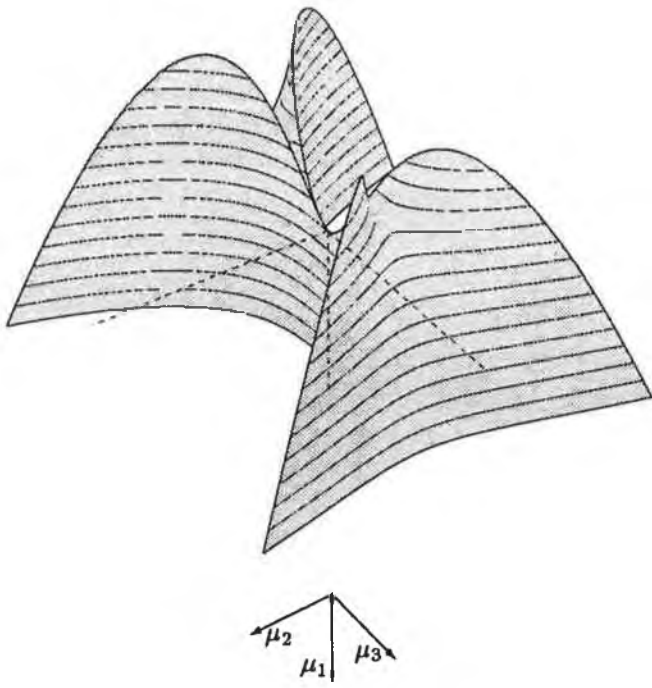

Figure C.33: Approximate bifurcation surface for $m = 4$, viewed from below the plane $\mu_1 = 0$.

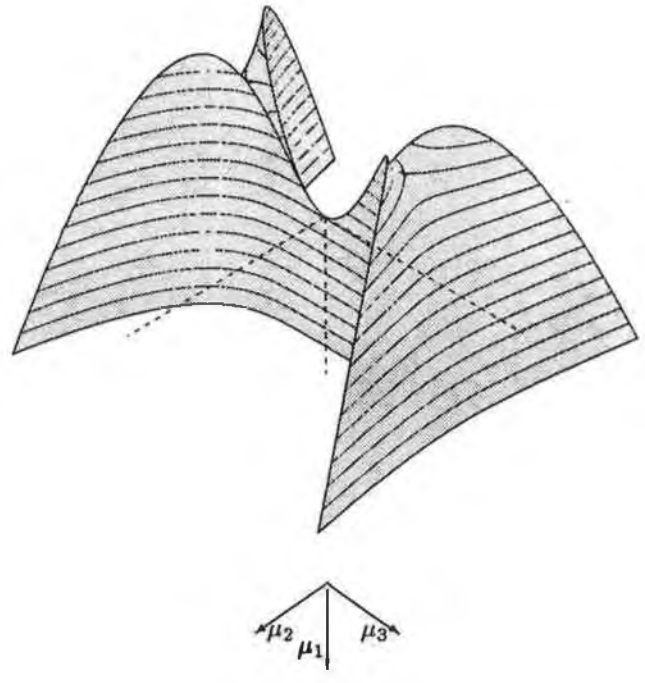

Figure C.34: Approximate bifurcation surface for $m = 5$, viewed from below the plane $\mu_1 = 0$.

Appendix D

Macsyma Bugs

D.1 Introduction

There were several bugs in the version of Macsyma¹ used during the development of TAYLOR. We only discuss here those bugs which directly hindered the development.

D.2 Bugs

D.2.1 Common Factors

Let

$$(D.1) \quad \text{EXP} = \frac{(N + M) (M^2 - (N + M)^2) (M^2 - N^2)}{N (N + M) (M^2 - (N + M)^2) (M^2 - N^2)}.$$

Then $\text{EXP} = 1/N$ after the cancellation of common factors. Denote the numerator by $P1$ and the denominator by $P2$. Simplification of $P1/P2$ resulted in

$$(D.2) \quad \frac{M^2 - N^2}{N (M^2 - N^2)},$$

in which there remains an uncanceled common factor. This problem only occurs inside function subprograms, not when EXP is typed interactively.

Subsequently it was found that if $P1/P2$ is entered as $1/P2*P1$, all factors are simplified. Examination of the LISP representation of (D.2) does not explain the cancellation failure.

D.2.2 INTSCE

The Macsyma SHARE integration functions `INTSCE`, which might have been very useful, produced erroneous results. It seemed to replace cosines by the symbol `CO` and exponentials by the symbol `EX`. For example,

```
INTSCE(SIN(T),T);
```

produces

```
- CO*EX,
```

and

```
INTSCE(SIN(T)^2,T);
```

gives

```

$$\frac{2*RET - 2*SIN(T)*CO*EX}{4}$$

```

¹Version 412.61.

D.2.3 LAMBDA_s

The compiling of Macsyma code, if possible, increases the speed of execution of a program.

If an expression such as

```
LAMBDA([%1], A:{Expression}, ...)
```

is translated, the translator gives a warning about the assignment **A:**, which states that the compiled code may not work. However, the code invariably worked without error. One way to circumvent the warning is to replace the assignment by

```
APPLY(':', ['A', {Expression}]).
```

This works in some instances, but causes problems when the line

```
APPLY(':', ['TA, CONS(%1, TA)])
```

is used in a **LAMBDA**. The translated code makes **TA** local to the **LAMBDA**, which means that the variable **TA** outside the **LAMBDA** is never set.

The best solution is to ignore the translator warnings.

D.2.4 ASSUME

An amusing bug is the following. When

```
ASSUME(X>=1, X<=1)$
```

is executed, followed by

```
IS(EQUAL(X,1));
```

Macsyma correctly returns **TRUE**. However,

```
IS(EQUAL(X,10));
```

or indeed

```
IS(EQUAL(X, {Any constant expression}));
```

also return **TRUE**. The same problem occurs if

```
ASSUME(EQUAL(X,1))$
```

is used.

Work reported in this thesis was done with the aid of **Macsyma**, a large symbolic manipulation program developed at the MIT Laboratory for Computer Science and supported from 1975 to 1983 by the National Aeronautics and Space Administration under grant NSG 1323, by the Office of Naval Research under grant N00014-77-C-0641, by the U. S. Department of Energy under grant ET-78-C-02-4687, and by the U. S. Air Force under grant F49620-79-C-020, and since 1982 by Symbolics, Inc. of Cambridge, Mass. **Macsyma** is a trademark of Symbolics, Inc.

Bibliography

- [1] Ascher, U., Christiansen, J. & Russell, R. D., *COLSYS - A Collocation Code for Boundary Value Problems*, Proc. Conf. for Codes for BVPs in ODEs, Houston, Texas, 1978.
- [2] Ascher, U., Christiansen, J. & Russell, R. D., *A Collocation Solver for Mixed Order Systems of Boundary Value Problems*, Math. Comp., (1979) **33**, pp. 659–679.
- [3] Bader, G. & Ascher U., *A New Basis Implementation for Mixed Order Boundary Value ODE Solver*, tech. rep. 85-11, Dept. Computer Sci., Uni. B.C., Vancouver, Canada, 1985.
- [4] Bender, C. M. & Orszag, S. A., *Advanced Mathematical Methods for Scientists and Engineers*, McGraw-Hill, 1987.
- [5] Chan, Tony F. & Jackson, Kenneth R., *The use of Iterative Linear-Equation Solvers in Codes for Large Systems of Stiff IVPs for ODEs*, SIAM J. Sci. Stat. Comput., (1986)**7**, No. 2.
- [6] Chester, W., *Resonant Oscillations of Water Waves I*, Proc. Roy. Soc. A, (1968) **306**, pp. 5–22.
- [7] Chester, W., & Bones, J. A., *Resonant Oscillations of Water Waves II*, Proc. Roy. Soc. A, (1968) **306**, pp. 23–39.
- [8] Chow, Shui-Nee & Hale, J. K., *Methods of Bifurcation Theory*, Springer-Verlag, 1982.
- [9] Cox, E. A. & Mortell, M. P., *The Evolution of Resonant Water-Wave Oscillations*, J. Fluid Mech., (1986) **162**, pp. 99–116.
- [10] Crandall, M. G. & Rabinowitz, P. H., *Bifurcation from Simple Eigenvalues*, J. Functional Anal., (1971) **8**, pp. 321–340.
- [11] Foley, J. D. & Van Dam, A., *Fundamentals of Interactive Computer Graphics*, Addison-Wesley Publishing Company, 1984.
- [12] Fürkötter, M. & Rodrigues, H. M., *Periodic Solutions of Forced Nonlinear Second Order Equations: Symmetry and Bifurcations*, SIAM J. Math. Anal., (1986) **17**, No. 6, pp. 1319–1331.
- [13] Fürkötter, M. & Rodrigues, H. M., *On Harmonic and Subharmonic Solutions of Nonlinear Second Order Equations: Symmetry and Bifurcation*, To appear in SIAM J. Math. Anal.

- [14] Golubitsky, M. & Schaeffer, D. G., *Singularities and Groups in Bifurcation Theory*, Vol. 1, Springer-Verlag, 1985.
- [15] Greenspan, B. D. & Holmes, P. J., Homoclinic Orbits, Subharmonics and Global Bifurcations in Forced Oscillations, in *Nonlinear Dynamics and Turbulence*, G. Barenblatt, G. Iooss, and D. D. Joseph, eds, Pitman, 1982.
- [16] Hale, J. K., *Ordinary Differential Equations*, Krieger Publishing Company, Inc., 1980.
- [17] Hale, J. K., *Oscillations in Nonlinear Systems*, McGraw Hill, New York, 1963.
- [18] Hale, J. K. & Rodrigues, H. M., *Bifurcation in the Duffing Equation with Independent Parameters I*, Proc. Roy. Soc. Edinburgh, (1977) **78A**, pp. 57–65.
- [19] Hale, J. K. & Rodrigues, H. M., *Bifurcation in the Duffing Equation with Independent Parameters II*, Proc. Roy. Soc. Edinburgh, (1977) **79A**, pp. 317–326.
- [20] Hale, J. K. & Táboas, P. Z., *Interaction of Damping and Forcing in a Second Order Equation*, Nonlinear Analysis, Theory Methods & Applications, (1978) **2**, No. 1, pp. 77–84.
- [21] Hall & Watt, *Modern Numerical Methods for Ordinary Differential Equations*, Oxford Uni. Press, 1976.
- [22] Hayashi, C., *Nonlinear Oscillations in Physical Systems*, McGraw Hill, New York, 1964.
- [23] Iooss, G. & Joseph, D., *Elementary Stability and Bifurcation Theory*, 2nd edition, Springer-Verlag, New York, 1990.
- [24] Jones, Alan F. & Hulme, A., *The Hydrodynamics of Water on Deck*, Journal of Ship Research, (1987) **31**, No. 2, pp. 125–135.
- [25] Jordan, D. W. & Smith P., *Nonlinear Ordinary Differential Equations*, Oxford Uni. Press, 1983.
- [26] Keller, H. B., *Numerical Solution of Bifurcation and Nonlinear Eigenvalue Problems*, in Applications of Bifurcation Theory, P. H. Rabinowitz, ed., Academic Press, 1977, pp. 359–384.
- [27] Landau, L. D. & Lifshitz, E. M., *Fluid Mechanics*, Course in Theoretical Physics, Vol. 6, Pergamon Press, 1982.
- [28] Lepelletier, T. G. & Raichlen, F., *Nonlinear Oscillations in Rectangular Tanks*, J. Eng. Mech., (1988) **114**, No. 1.
- [29] Miles, J., *Resonantly Forced, Nonlinear Gravity Waves in a Shallow Rectangular Tank*, Wave Motion, (1985) **7**, pp. 291–297.
- [30] Moiseyev, N. N., *On the Theory of Nonlinear Vibrations of a Liquid of Finite Volume*, Prikl. Mat. Mekh., (1958) **22**, pp. 612–621.
- [31] Nayfeh, A. H. & Nook, D. T., *Nonlinear Oscillations*, Wiley, New York, 1979.
- [32] Nordsieck, A., *On the Numerical Integration of Ordinary Differential Equations*, Math. Comp., (1962) **16**, pp. 22–49.

- [33] Ockendon, J. R. & Ockendon, H., *Resonant Surface Waves*, J. Fluid Mech., (1973) **59**, pp. 397–413.
- [34] Ockendon, H., Ockendon, J. R. & Johnson, A. D., *Resonant Sloshing in Shallow Water*, J. Fluid Mech., (1986) **167**, pp. 465–479.
- [35] Ott, E. & Sudan, R. N., *Damping of Solitary Waves*, Phys. Fluids, (1970) **13**, pp. 1432–1434.
- [36] Rand, R. H., *Computer Algebra in Applied Mathematics: An Introduction to Macsyma*, Pitman, 1984.
- [37] Rand, R. H., & Armbruster, D., *Perturbation Methods, Bifurcation Theory, and Computer Algebra*, Springer-Verlag, 1987.
- [38] Reynolds, D. W., *Existence of Periodic Solutions of an Integro-Differential Equation Modelling Resonant Water Waves*, Proc. Roy. Irish Acad., (1987) **87A**, No. 2, pp. 155–161.
- [39] Reynolds, D. W., *Bifurcation of Harmonic Solutions of an Integro-Differential Equation Modelling Resonant Sloshing*, SIAM J. Appl. Math., (1989) **49**, No. 2.
- [40] Reynolds, D. W. & Cox, E. A., *Periodic Solutions of an Integro-Differential Equation Modelling Resonant Sloshing*, IMA J. Appl. Math., (1987) **38**, pp. 243–253.
- [41] Sato, H., *Higher-harmonic resonance of Duffing-type Nonlinear Systems*, Bull. JSME, (1986) **29**, pp. 2239–2243.
- [42] Seymour, B. R. & Mortell, M. P., *Resonant Acoustic Oscillations with Damping: Small Rate Theory*, J. Fluid Mech., (1973) **58**, pp. 353–373.
- [43] Schmitt, B. V. & Mazzanti, S., *Solutions Périodiques Symétriques de l'Equation de Duffing sans Dissipation*, J. Diff. Eq., (1981) **42**, pp. 199–214.
- [44] Schmitt, B. V., *Sur la Structure de l'Equation de Duffing sans Dissipation*, SIAM J. Appl. Math., (1982) **42**, pp. 868–894.
- [45] Stoker, J. J., *Nonlinear Vibrations*, Wiley, New York, 1950.
- [46] Tamura, H., Konder, T. & Sueoka, A., *Higher Approximate Solutions of the Duffing Equation (Odd order Superharmonic Resonances in the Hard Spring System)*, Bull. JSME, (1986) **29**, pp. 894–901.
- [47] Tamura, H., Konder, T., Sueoka, A. & Ueda, N., *Higher Approximate Solutions of the Duffing Equation (Primary Resonance in the Soft Spring System)*, Bull. JSME, (1986) **29**, pp. 3075–3082.
- [48] Vanderbauwhede, A., *Local Bifurcation and Symmetry*, Research notes in mathematics, Pitman, 1982.
- [49] Winston, P. H. & Horn, B. K. P., *LISP*, 3rd edition, Addison-Wesley Publishing Company, 1988.