



Electrochemical Potential Monitoring of Corrosion and Inhibitors Protection of Mild Steel Embedded in Concrete in NaCl Solution

C.A. Loto^{1,2,*}, A.P.I. Popoola¹

¹Department of Chemical and Metallurgical Engineering,

Tshwane University of Technology, Private Bag X680, Pretoria, South Africa.

²Department of Mechanical Engineering, Covenant University, Canaan Land, Ota, Nigeria

Received 19 Jan 2012, Revised 15 June 2012, Accepted 15 June 2012.

*E-mail: akinloto@gmail.com; akinloto@yahoo.com

Abstract

The corrosion and protection behaviour of mild steel embedded in concrete, and partially immersed in 3.5% sodium chloride solution, was studied in this investigation at ambient temperature by potential monitoring technique. The work was performed with a digital multimeter and a *Cu/CuSO₄* electrode (CSE) as the reference electrode. Extracts of pawpaw (*carica papaya*) leaves and sodium nitrite in different concentrations were separately and in combination, used as inhibitors. This paper reports the observed electrochemical response from the electrode potential monitoring of the embedded mild steel during the experiments. The results obtained, showed a reduction in the active corrosion reactions behaviour of the embedded mild steel in concrete admixed with different concentrations of sodium nitrite and the pawpaw leaves extracts thus indicating corrosion inhibition characteristic. The observed inhibition was attributed to the protective film provided on the steel's surface in the concrete by the complex chemical compounds of the plant leaves' extracts and the reaction of sodium nitrite with the alkaline environment of the concrete and its constituents. The combination of pawpaw extracts and the NaNO₂ solution provided effective corrosion inhibition of the embedded steel by synergism. The 100% concentration of each of the inhibitors and when in combinations, exhibited the most effective corrosion inhibition performance.

Key words: Inhibitors; corrosion; steel; pawpaw; concrete; sodium chloride; sodium nitrite.

1. Introduction

Investigative research studies of corrosion and protection of steel reinforced concrete as one of the most widely used materials of construction everywhere has generated a lot of interest and is still receiving the keen attention of many researchers worldwide [1- 8]. The 3.5% NaCl solution used in this work simulates the marine and other saline environments where corrosion of reinforced concrete structures remains prominent. The present study is a contribution to the already existing knowledge in this research field.

The present work makes use of extract of pawpaw leaves as an environment friendly 'green' inhibitor from a natural source and also sodium nitrite— a chemical compound that had already been tested in some other works for corrosion inhibition of embedded steel in concrete. It is anticipated that the extracts of *c. papaya* leaves will possess chemical properties through their various chemical constituents/composition that could provide

inhibitive film on the embedded rebar just as the sodium nitrite also in anticipation. The film will then serve as a barrier for the steel – concrete environment interfacial reaction(s) and hence mitigate the corrosion reactions on the steel surface.

Papaya (pawpaw) contains numerous chemical constituents which include the fermenting agent myrosin, alkaloids, rutin, resin, tannins, carpaine, dehydrocarpaines, pseudocarpaine, flavonols, benzylglucosinolate, linalool, malic acid, methyl salicylate, chymopapain, papain, calcium, iron, magnesium, manganese, phosphorus, potassium, zinc, beta-carotene, B-vitamins and vitamins A, C, and E, anthraquinones (bound and free), philobatinins, and saponins [8]. These combined constituents may exhibit electrochemical activity such as corrosion inhibition [9]. Sodium nitrite is expected to form complex chemical compound(s) with the concrete environment constituents that could confer passive corrosion reactions at the steel/ concrete environment interface through the formation of strong adherent film on the steel surface.

A reasonable amount of corrosion inhibition of the embedded metal in the concrete is not unexpected from the sodium nitrite compound; and even more when the very complex structural chemical compounds of the extracts of *carica papaya* is considered.

2. Experimental Procedure

Preparation of pawpaw leaves extract(s) and the sodium nitrite concentrations

Fresh leaves of pawpaw (*c. papaya*) were obtained and oven dried at 110°C for two hours. The dried leaves weighing 0.5kg were ground into powder and put in a container. Ethanol was added to the container. The resulting solution was boiled for two hours and then left overnight to settle while it cooled down. It was filtered with filter papers after about a day and a half. The filtered substance was put into 100ml beaker to make different solutions. From these, three different concentrations of 40, 70 and 100% respectively were made for further use as inhibitors –mixed with concrete.

100g of NaNO₂ was obtained. From this, three different per cent concentrations of 40, 70 and 100 (as received) were made using distilled water.

Preparation of concrete block samples

Preparation of concrete block samples follows the same process as previously reported [2, 5, 1, 7]. Concrete blocks made of Portland cement, Sand, Gravel and Water, each with a reinforcing steel rebar embedded in it were used for the experiment. Each concrete block was 160 mm long, 100 mm wide and 100 mm thick. All the blocks were prepared with 1:2:4 (C: S: G) – cement, sand, gravel ratio. The formulation for the reinforced concrete specimens used, in Kg/m³, was: Cement 320; Water 140; Sand 700 and Gravel 110. The water cement (W/C) ratio was 0.44.

Two sets of reinforced concrete were cast without inhibitors (the control test samples) and 9 sets of steel reinforced concrete were cast with different inhibitor concentrations admixed. The sets were prepared with different percent concentrations of inhibitors as presented below:

- 1) 3.5% sodium chloride and no extracts addition (2 sets)
- 2) Sodium Nitrite (NaNO₂) - 40%
- 3) Sodium Nitrite (NaNO₂) - 70%
- 4) Sodium Nitrite (NaNO₂) - 100%
- 5) Pawpaw Leaves extracts - 40%
- 6) Pawpaw Leaves extracts - 70%
- 7) Pawpaw Leaves extracts - 100%
- 8) Sodium Nitrite (NaNO₂) and Pawpaw Leaves extracts - 40%
- 9) Sodium Nitrite (NaNO₂) and Pawpaw Leaves extracts - 70%
- 10) Sodium Nitrite (NaNO₂) and Pawpaw Leaves extracts - 100%

Set 1, above served as the control test sample. The steel rebar used for the reinforcement was DIN-ST 60mm. It has the chemical composition of: 0.3%C, 0.25%Si, 1.5%Mn, 0.04%P, 0.04%S, 0.25%Cu, 0.1Cr, 0.11%Ni, and the rest Fe. The sodium chloride and sodium nitrite used were of AnalaR grade.

The steel samples were cut into several pieces each with a length of 160mm and 16mm diameter. An abrasive grinder was used to remove any mill scale and the rust stains on the steel specimens before embedded in the concrete. Each steel rebar was symmetrically placed across the length of the block in which it was embedded and had a concrete cover of 42 mm. Only about 140 mm was embedded in each concrete block. The remaining 20mm protruded at one end of the concrete block, and was painted to prevent atmospheric corrosion, Fig.1. This part was also used for electrical connection. The test medium used for the investigation was 3.5% sodium chloride solution.

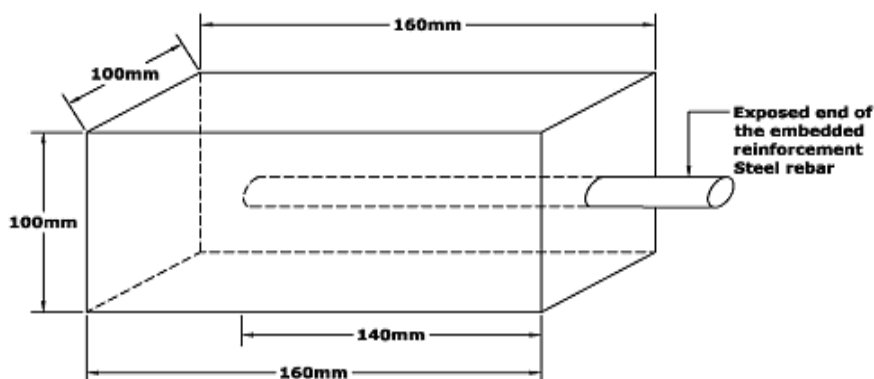

Fig. 1: A sample block (not to scale).

Potential measurement

Each concrete block was partially immersed in 3.5% sodium chloride solution such that the medium level was just below the exposed reinforcing steel but not making any contact with it. The potential readings were obtained by placing a copper sulphate electrode firmly on the concrete block, Fig.2. One of the two terminals of a digital voltmeter was connected to the copper sulphate electrode and the other to the exposed part of the embedded steel rebar to make a complete electrical circuit. The readings were taken at different points on each concrete block directly over the embedded steel rebar. The average of the three readings was computed as the potential reading for the embedded rebar in 3 –day intervals. All the experiments were performed under free corrosion potential and at ambient temperature.

Results and Discussion

Varied Percent Concentrations of NaNO_2 addition

The results obtained for the varied per cent concentrations of sodium nitrite addition – 40, 70 and 100%, mixed with the concrete test samples are presented in Fig.3 All the curves show the variation of potentials (mV) with exposure time (days) for the steel reinforced concrete samples partially immersed in 3.5% sodium chloride solution. In general, a good result was obtained for each of the different concentrations inhibition effect. The curve for the 100% concentration addition remained in the passive state of corrosion reactions throughout the experimental period; an indication that there was no corrosion of the embedded steel inside the concrete within the test duration. The test with the 40% concentration addition of NaNO_2 also gave a very good corrosion inhibition performance as shown by the curve that remained in the passive corrosion reactions state as indicated by the obtained potential values throughout the experimental period.

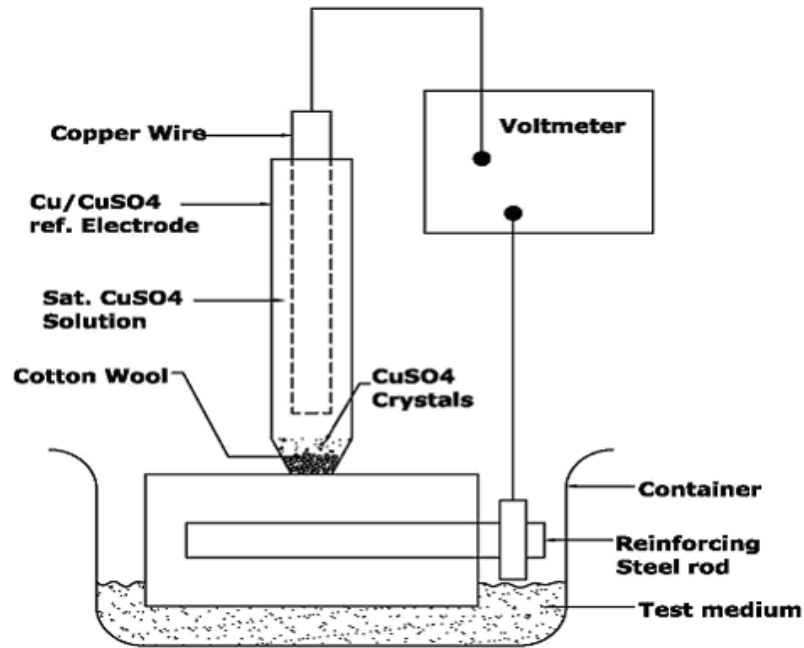

Fig. 2: Schematic representation of experimental set up.

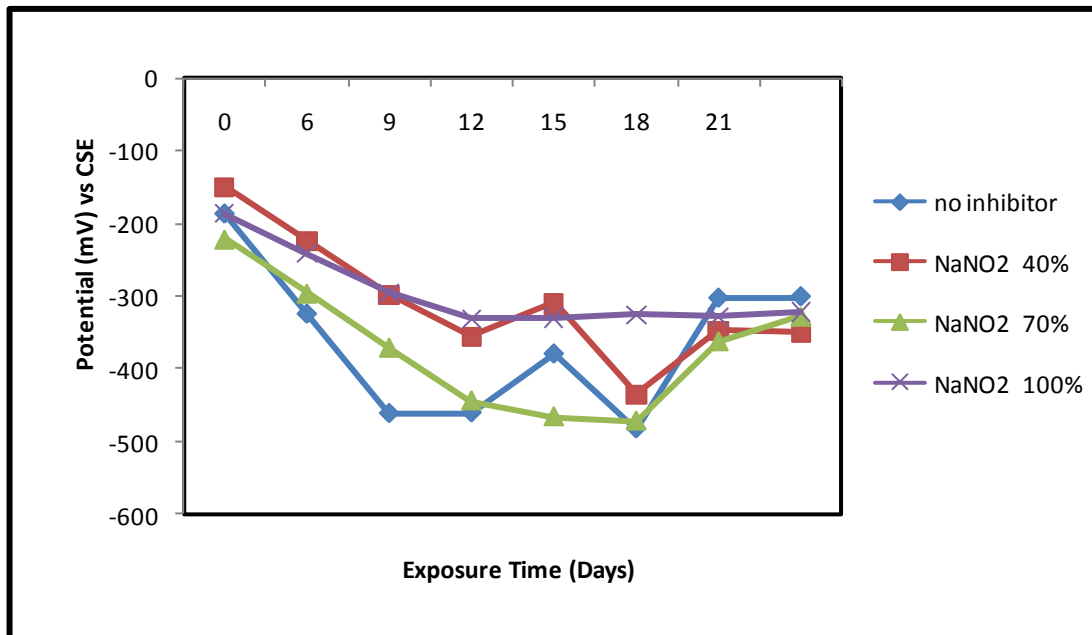

Figure 3: Variation of potential with exposure time for the mild steel specimen embedded in concrete with varied concentrations of NaNO₂ addition.

The curve for the 70% concentration of NaNO₂ also indicated an effective inhibition performance but with a tendency towards active corrosion reactions behaviour between the 12th and 18th day of the experiment. This result is in agreement with that of [4] about the effectiveness of sodium nitrite as inhibitor in concrete in the presence of chloride ions.

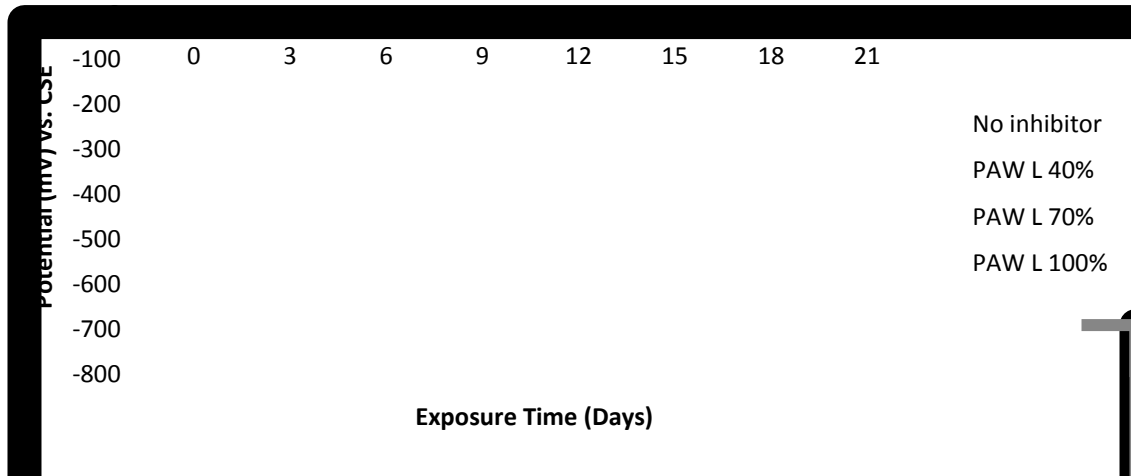

Figure 4: Variation of potential with exposure time for the mild steel specimen embedded in concrete with varied concentrations of pawpaw extracts addition.

Varied Percent Concentrations of Extracts of *C. papaya* addition

As presented in Fig. 4, varied concentrations of 40, 70 and 100% of pawpaw (*carica papaya*) extracts were used as inhibitor for the experiments. The embedded steel specimen in the concrete in which the 100% extract was used, maintained very effective corrosion reactions passivity throughout the experimental period. Potential values that ranged from -238mV at the beginning, through -184 mV on the 9th and 12th day to a value of -301mV on the 21st day of the experiment were recorded.

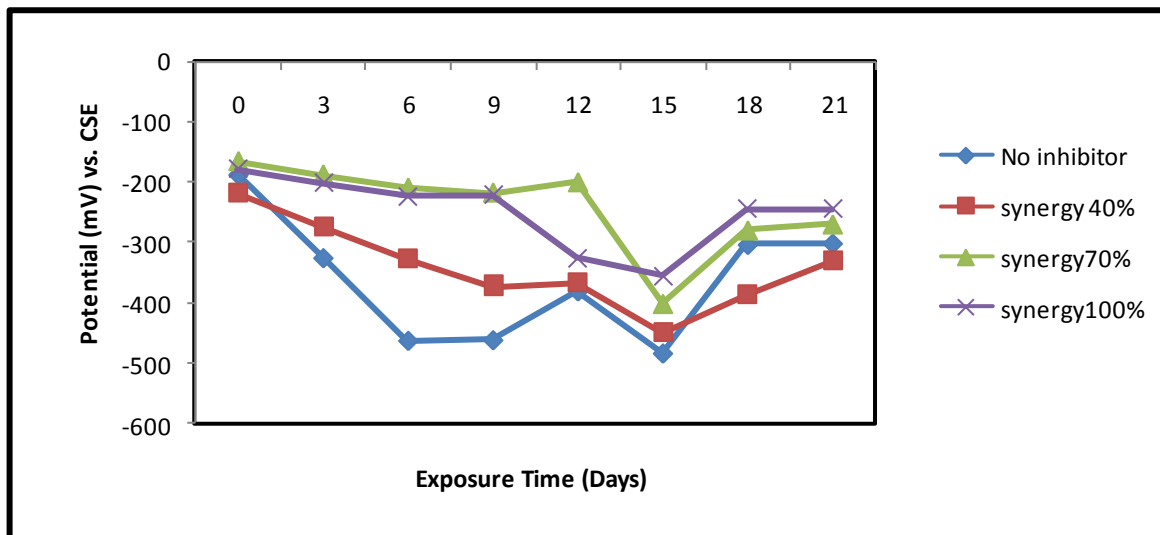

Figure 5: Variation of potential with exposure time for the mild steel specimen embedded in concrete with varied combined concentrations of NaNO₂ and pawpaw extracts addition.

The test performed with the 70% concentration of the added extract also remained in the passive state of corrosion reactions during the experimental period but its effectiveness in corrosion inhibition performance was very much less than that of 100% extract concentration.

The use of 40% concentration of the extract showed unstable passivity for the first 12 days of the experiment. There was increasing active corrosion reactions in the first 6 days of the experiment during which a potential value of -669mV was achieved; an apparent indication of active corrosion reactions behaviour. It showed unstable potential fluctuations throughout, though with improved passive corrosion reaction in the last six days of the experiment.

Obviously, extract of *carica papaya* was concentration sensitive/dependent; its effective corrosion inhibition improves with increase in extract concentration. Its overall performance was very good particularly at very high concentrations with the optimum performance being 100% (undiluted juice extract). The effective performance can be associated with the very complex chemical composition of the extract as mentioned in the introduction. These could react with the alkaline environment of the concrete to form a strongly adherent passive film on the embedded steel surface that hindered the penetration of the corrosive chloride ions (Cl^-) to initiate, perpetrate and sustain continuous active corrosion reactions at the concrete matrix environment/steel's interface.

Combination of sodium nitrite and pawpaw (*c. papaya*) extracts

The results obtained for the combination of different concentrations of NaNO_2 and extracts of pawpaw (*c. papaya*) addition to the concrete are presented in Fig. 5. An apparent synergism of results is shown here. The 70 and 100% concentrations of the combined inhibitors achieved the same potential values of -219, -201, -223, and -220mV, respectively in the first 9 days of the experiment; and thereafter maintained very close potential values of -244mV for the 100% and -270mV for the 70% concentrations at the end of the experiment. The inhibitive performance of the 40% concentration addition was significant as the curve also remained in the passive corrosion reactions state throughout the experimental period with potential values ranging from -219mV at the beginning through -449mV on day 15 (the lowest value) to -330mV on the last day of the experiment. The interesting observation here was that NaNO_2 , an inorganic chemical compound inhibitor synergised with pawpaw extract with very complex multifarious constituents to form an adherent protective film on the embedded steel surface to effectively hinder chloride ions (Cl^-) from initiating active corrosion reactions in all the combined concentrations of the inhibitors.

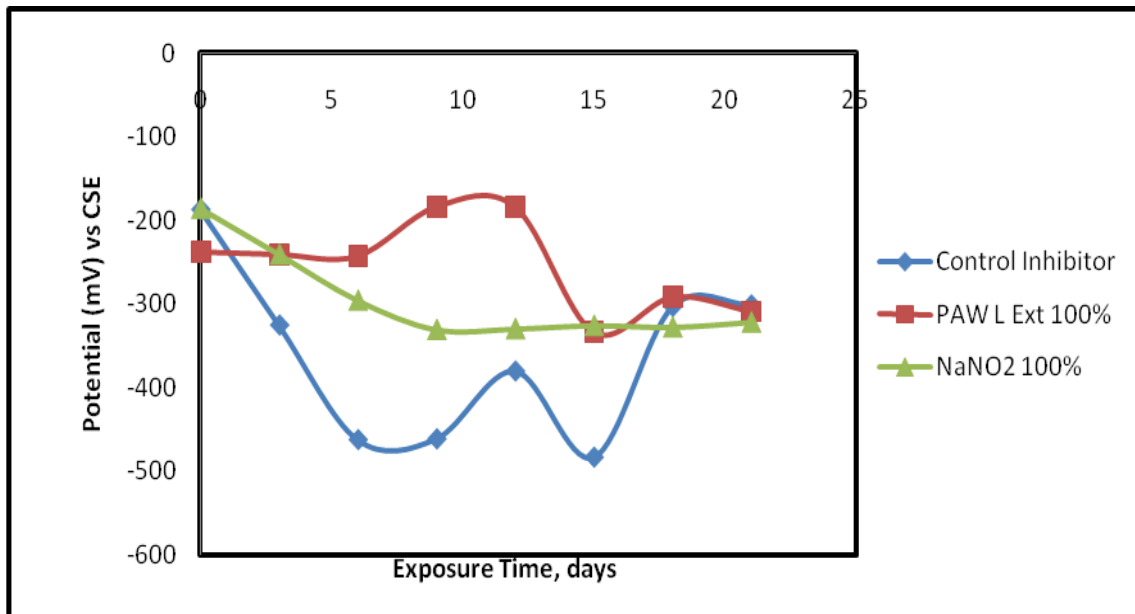

Figure 6: Variation of potential with exposure time for the mild steel specimen embedded in concrete with 100% concentration of each of the NaNO_2 and pawpaw extracts addition.

Comparison of the inhibitors' corrosion inhibition effectiveness

The results obtained for the comparison of the inhibitors effectiveness at each of the different concentrations of 100, 70 and 40% respectively are presented in Figs. 6 to 8.

In Fig. 6, 100% concentration each of NaNO_2 and extracts of pawpaw (c. papaya) inhibitors were compared. Based on the potential values recorded, their inhibition performance or effectiveness was close to achieving the same value of -321mV . However, from the 3rd day to the 12th day of the experiment, the better effectiveness of corrosion inhibition in terms of potential values achieved for the pawpaw extracts was very clear. It must be stated here that a very good result was obtained with the use of the 100% concentration for each of the inhibitors; the curves remained, throughout the experimental period in the passive state of corrosion reactions, indicating, there was no corrosion of the embedded steel during the duration of the experiment.

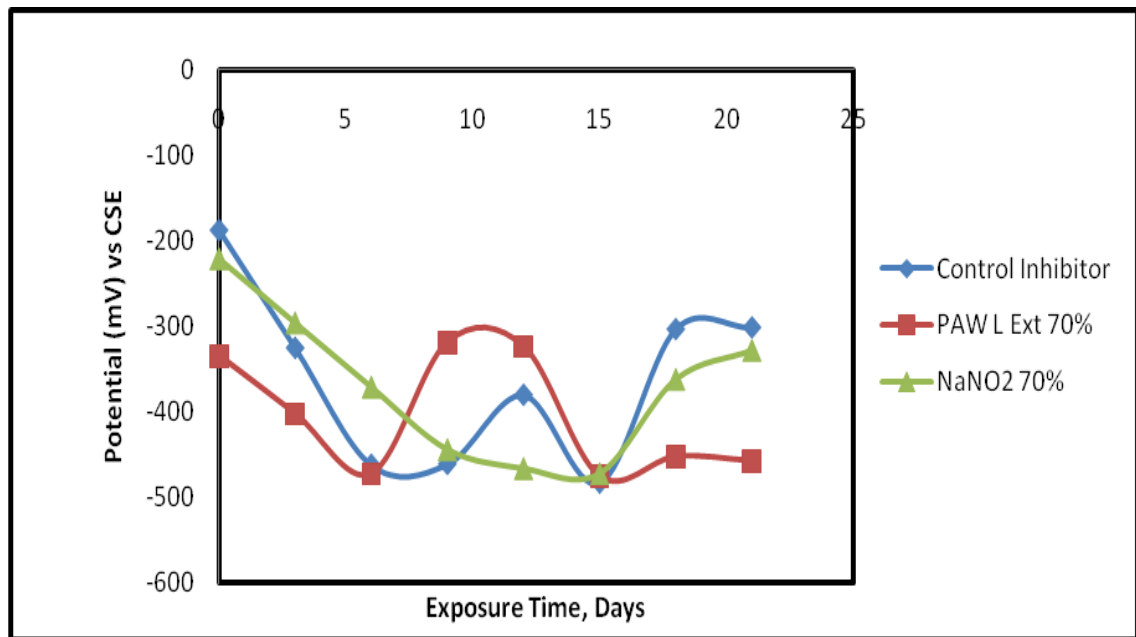

Figure 7: Variation of potential with exposure time for the mild steel specimen embedded in concrete with 70% concentration of each of the NaNO_2 and pawpaw extracts addition.

Fig. 7 shows the curves obtained when 70% concentration of each of the inhibitors was used as addition to the steel reinforced concrete. Here, the pawpaw extract, though remained in the passive state of corrosion reaction for most part of the experimental duration, showed unstable fluctuations. The reason for this is difficult to explain. The NaNO_2 inhibitor also performed fairly well but with a tendency towards active corrosion reactions achieving the same potential value of -483mV on the 15th day of the experiment. Averagely, their corrosion inhibition performance was not clearly better than the protection given by the concrete alkaline environment as indicated by the control curve (for concrete without inhibitor).

The addition of sodium nitrite at 40% to the steel reinforced concrete matrix showed better corrosion inhibition performance than the same concentration of pawpaw extract, as presented in Fig. 8. The former remained stable in the passive state of corrosion reactions throughout the experimental period. But it was not so for the latter. There were potential fluctuations for most period of the experiment and with low values of active corrosion reactions recorded, even reaching -669mV on the 6th day of the experiment, indicating a tendency of likely corrosion initiation through the penetration of chloride ions to the embedded steel surface. However, this was quickly healed by further rebuilding of the passive film. The potential value achieved on the 21st day of the experiment was -384mV which was very encouraging.

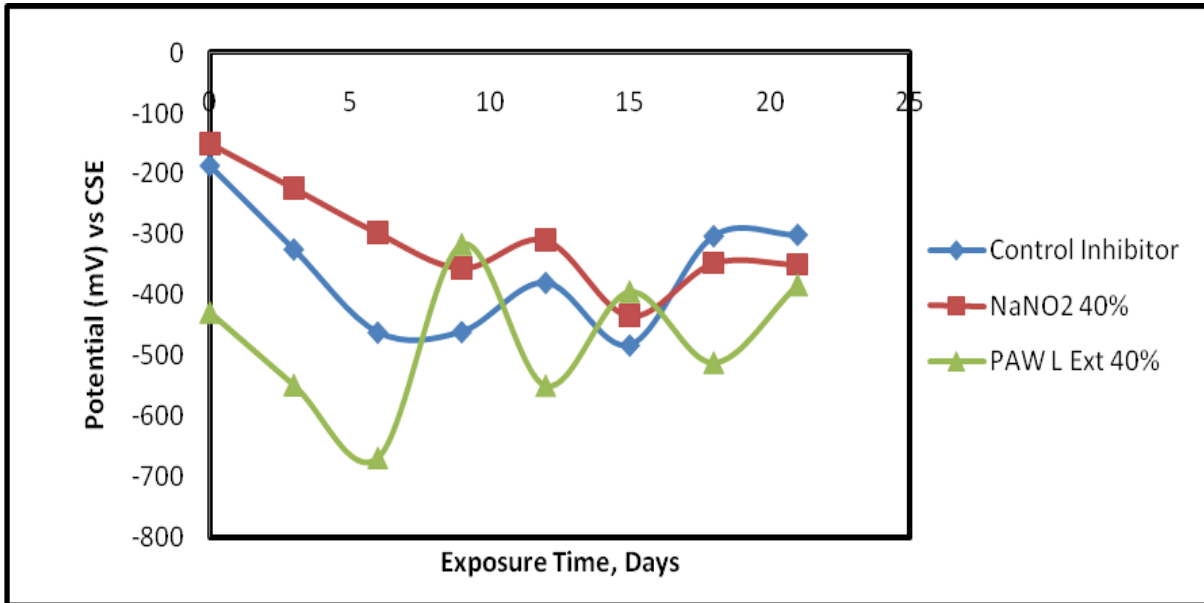

Figure 8: Variation of potential with exposure time for the mild steel specimen embedded in concrete with 40% concentration of each of the NaNO₂ and pawpaw extracts addition.

Effect of pH

The recorded pH values for the whole duration of the experiment are presented in Table 1. The reinforced concrete blocks recorded pH values that decreased from 11.5 from the beginning of the experiment to 9.69 at the end in a period of 21 days. Similar trends were recorded for all the different percent concentrations of inhibitor addition.

Table 1: pH values for the test in NaCl solution

SAMPLES / DAYS	0	3	6	9	12	15	18	21
Concrete (without	11.5	11.3	10.22	9.98	9.82	9.82	9.74	9.69
NaNO ₂ 40%	11.22	11.1	10.18	9.89	9.72	9.58	9.48	9.45
NaNO ₂ 70%	11.39	11.21	10.38	10.08	9.9	9.72	9.68	9.62
NaNO ₂ 100%	11.16	11.04	10.07	9.75	9.56	9.41	9.38	9.43
Pawpaw Leaves 40%	11.08	10.38	9.87	9.63	9.57	9.48	9.45	9.48
Pawpaw Leaves 70%	11.2	10.5	10.18	9.96	9.84	9.73	9.71	9.65
Pawpaw Leaves 100%	11.18	10.34	10.04	9.78	9.75	9.62	9.55	9.44
Pawpaw L + NaNO ₂ 40%	11.41	11.2	10.34	10.02	9.8	9.6	9.49	9.41
Pawpaw L + NaNO ₂ 70%	11.22	10.24	9.94	9.74	9.64	9.55	9.5	9.53
Pawpaw L + NaNO ₂	11.35	11.04	10.2	9.93	9.74	9.43	9.46	9.52

Sodium nitrite at 40% concentration addition, the alkalinity reduced from 11.22 – 9.45. At 70% concentration, it reduced from 11.39 – 9.62; and at 100%, from 11.16 – 9.43. This decrease in alkalinity could be due to the reactions between the concrete constituents, the NaNO₂ chemical and the reactions at the steel/environment interface for the steel reinforced concrete blocks. In addition, since the steel was partially immersed, the

carbon dioxide of the air could have penetrated by diffusion through the concrete pores and reacting with water content of the test medium to form the weak carbonic acid.

The same trend of reduced/decreased alkalinity was recorded with the use of pawpaw extracts addition and also with the use of combined inhibitors.

Though minimal, one clear correlation of this decreasing alkalinity with potential readings was that with the decreasing alkalinity, there was a tendency towards increasing negative values of potentials, though sometimes with random fluctuations, particularly with some of the concentrations of pawpaw extracts. This phenomenon was indication towards active corrosion reactions.

Compressive strength test

The results obtained for the compressive strength test are presented in Table 2. While the concrete sample without inhibitor addition had a compressive strength of 132 KN, the inhibitors with lower percent concentration addition had lower values. The 40% concentration of NaNO₂ addition had a compressive strength value of 120 KN while the same per cent concentration of pawpaw extract even had a lower value of 110 KN. From the table, the trend showed that the compressive strength increased with increase in percent concentrations of each of the two inhibitors used. While the lowest percent concentrations of 40% could be said to be detrimental, to the compressive strength of the concrete samples, highest percent concentration (100%) of the inhibitors addition used, improved the compressive strength significantly, achieving different values of 140 and 150 KN for the sodium nitrite and pawpaw extract respectively. At 70% concentration, the pawpaw extract addition gave a relatively much lower compressive strength of 115KN while the NaNO₂ recorded 135KN. The combined inhibitors gave a clearer trend of increasing and hence better compressive strength with increase in the percent concentrations of added inhibitors and thus exhibiting another form of synergism. At 40% concentration, the combined inhibitors had a very poor comparative compressive strength with the concrete samples without inhibitor. However, with 70 and 100% concentrations of the added combined inhibitors, the recorded values were 135 and 160 KN respectively.

Table 2: Compressive strength test

Reinforced concrete samples	Crushing strength for Reinforced concrete in NaCl medium
Concrete (without inhibitor)	132KN
NaNO ₂ 40%	120KN
NaNO ₂ 70%	135KN
NaNO ₂ 100%	140KN
Pawpaw Leaves 40%	110KN
Pawpaw Leaves 70%	115KN
Pawpaw Leaves 100%	150KN
Pawpaw L + NaNO ₂ 40%	80KN
Pawpaw L + NaNO ₂ 70%	135KN
Pawpaw L + NaNO ₂ 100%	160KN

Conclusion

All the percent concentrations of the pawpaw extracts gave good corrosion inhibition performance of the embedded steel rebar but with an order of 100 > 70 > 40% concentrations. Similarly, the sodium nitrite inhibitor gave effective corrosion inhibition of the embedded steel; and also followed the same trend of corrosion inhibition performance of 100 > 70 > 40% concentrations.

The combinations of the inhibitors were very effective; and in most cases give better performance in corrosion inhibition of the metal substrate. The positive/effective synergy formed by the combined percent

concentrations of an inorganic chemical compound, NaNO_2 , and the extract from the leaves of a plant, pawpaw, (*carica papaya*) was particularly very pleasing and interesting.

The compressive strength of the tested concrete samples increased in most cases and even achieved a very appreciable value increase (160 KN) with the combination of pawpaw extracts and sodium nitrite at 100% concentration.

The overall best results and hence the best corrosion inhibition performance of the steel reinforcement in this work were obtained with the 100% concentration of each of the pawpaw extracts and NaNO_2 and also with their combination at this same concentration.

Acknowledgement

The authors acknowledge the laboratory contribution of Miss Waiyeola Fashade and the provision of laboratory facility of the Department of Mechanical Engineering, Covenant University, Canaan Land Ota, Nigeria.

References

1. Slater, J.E., *Corrosion of Metals in Association with Concrete*, STP 818, Philadelphia, PA, ASTM, 1983.
2. Loto, C.A., *Corrosion*, 48 (1992) **9**, 759-763.
3. Griffin, D.F., *Corrosion of Metals in Concrete* (Detroit M1 A. C. I., (1975) p. 95.
4. Craig, R.J. and Wood, L.E., *Highway Research Record*, No. 328, 1970
5. Loto, C.A. and Okusanya, A., *Corro. Prev. & Control*, 26 (1989) 4, 103 - 109.
6. Treadaway, K.W.J and Russel, A.D., *Highways and Public Works*, 36 (1968) 9, 40.
7. Loto, C.A. and Odumbo, E.T., *Corrosion*, 45 (1989) 7, 553 – 557.
8. Berke, N.S., *Matls. Perf.*, 10 (1989) 41-44
9. <http://www.herbalist.com/wiki/details/93/category/11/>, Papaya Leaf, 2011/08/17
10. Davis, G.D. and Fraunhofer, J.A., *Materials Performance*, 2 (2003) 56 – 60.

(2012) <http://www.jmaterenvirosci.com/>