



Durham E-Theses

A study of the photoinitiated cure of coatings

Richards, Donald Stuart

How to cite:

Richards, Donald Stuart (1982) *A study of the photoinitiated cure of coatings*, Durham theses, Durham University. Available at Durham E-Theses Online: <http://etheses.dur.ac.uk/7658/>

Use policy

The full-text may be used and/or reproduced, and given to third parties in any format or medium, without prior permission or charge, for personal research or study, educational, or not-for-profit purposes provided that:

- a full bibliographic reference is made to the original source
- a [link](#) is made to the metadata record in Durham E-Theses
- the full-text is not changed in any way

The full-text must not be sold in any format or medium without the formal permission of the copyright holders.

Please consult the [full Durham E-Theses policy](#) for further details.

**A STUDY OF
THE PHOTOINITIATED CURE OF COATINGS**

**A thesis submitted for the degree of Master of Science
by
Donald Stuart Richards, B.Sc. (Stirling)
(Graduate Society)**

**UNIVERSITY OF DURHAM
1982**

The copyright of this thesis rests with the author.
No quotation from it should be published without
his prior written consent and information derived
from it should be acknowledged.



To Christine and my parents.

ABSTRACT

This thesis describes an investigation into the photo-initiated cure of epoxide coatings.

Diaryliodonium salt photoinitiators were prepared and characterised in the laboratory. The analysis and characterisation of some industrial epoxide resins was also carried out before they were used in the preparation of coatings. A series of lacquers was prepared and exposed to ultra-violet radiation. The cure characteristics of these coatings were investigated by qualitative and quantitative methods. This aspect of the work yielded some interesting results which are discussed in the final chapter.

ACKNOWLEDGEMENTS

The author is indebted to Dr W.J. Feast for his help and unfailing encouragement during this work. He is also grateful to Dr R.S. Matthews for his aid in recording and interpreting the NMR spectra.

Assistance from members of the technical and laboratory staff is greatly appreciated, as are the efforts of Miss C. Heaney in typing this thesis.

Finally, the author is indebted to the Science and Engineering Research Council for the award of a maintenance grant and to Camrex (Holdings) Limited for their generous financial support.

MEMORANDUM

The work described in this thesis was carried out in the Chemistry Laboratories of the University of Durham between October 1981 and September 1982. This work has not been submitted for any other degree and is the original work of the author, except where acknowledged by reference.

CONTENTS

ABSTRACT	I
ACKNOWLEDGEMENTS	II
MEMORANDUM	III
CHAPTER ONE <u>INTRODUCTION AND BACKGROUND</u>	
1.1 Introduction	1
1.2 Marine Tank Coatings	1
1.3 The Coatings in Use	4
1.4 General Considerations in Tank Coating	6
1.5 Choice of Resins	6
1.6 History of Epoxide Resin Coatings	7
1.7 Characteristics and Applications of Epoxide Resins	8
CHAPTER TWO <u>CATIONIC POLYMERIZATION OF EPOXIDES</u>	
2.1 Types of Initiation	10
2.2 Cationic Polymerization of Epoxides	12
2.3 General Kinetic Scheme for Cationic Polymerization	13
2.4 Energetics of Cationic Polymerization	14
CHAPTER THREE <u>THE PHOTOINITIATORS: PREPARATION AND CHARACTERISATION</u>	
3.1 Photoinitiator Selection	15
3.2 Diaryliodonium Salt Photoinitiation	16
3.3 Onium Salt Sensitizers	18
3.4 Diaryliodonium Salt Photoinitiation Mechanisms	19
3.5 Copper Salt Co-catalysts	20
3.6 Diaryliodonium Salt Photoinitiator Preparation	20
3.7 Characterisation of the Photoinitiators Prepared	24
CHAPTER FOUR <u>THE MONOMERS: ANALYSIS AND CHARACTERISATION</u>	
4.1 Introduction	31
4.2 Infra-red Analysis of the Monomers	32
4.3 Chemical Analysis	32
4.4 Molecular Weight Determination	41
4.5 Qualitative and Quantitative Determination of Alcoholic Impurities in the Resins by ^{19}F NMR	43
4.6 Structural Analysis by ^1H and ^{13}C NMR Spectrometry	48

4.7	Mass Spectral Analysis	57
4.8	Conclusions	57
CHAPTER FIVE <u>THE COATINGS: PREPARATION AND EXAMINATION</u>		
5.1	Introduction	60
5.2	The Conditions of Irradiation	60
5.3	Qualitative Comparison of Cure Rates	62
5.4	Quantitative Comparison of Cure Rates	66
5.5	The Surface Cure Phenomenon	70
	SUMMARY AND SUGGESTIONS FOR FURTHER WORK	74
	APPENDIX 1	76
	APPENDIX 2	81
	REFERENCES	87

CHAPTER ONE

INTRODUCTION AND BACKGROUND

1.1 INTRODUCTION

This thesis is the result of a case study carried out in conjunction with Camrex (Holdings) Limited. The aim is to investigate the photoinitiated cure of coatings with the general application area of marine tank coatings in mind. The main concept behind the development of this new curing system is the elimination of organic solvents. Thus, air pollution, health and fire hazards and energy costs may be reduced. It is, therefore, appropriate to begin with a brief discussion of marine tank coating.

1.2 MARINE TANK COATING

The reason for coating a metal surface, whether internal or external, is to reduce corrosion of that surface. Corrosion is the degradation of a metal by combination with a non-metal such as sulphur, oxygen, halides, etcetera. Because of the difference in chemical potential or free-energy between metals and their oxides (or sulphides and halides), degradation is facile or even spontaneous.

Man has been aware of corrosion and its effects for some time, indeed, methods of corrosion protection date back to the Romans. The protection of bronze and iron was reported by Pliny (c.100 BC); oil and tar being used for the protection of the former, and pitch, gypsum and white lead for the latter. Later, red lead was used which they produced by heating white lead, this more oxidized form of lead oxide being more efficient. The coating of marine tanks is, however, a relatively new development, only becoming common practice in the second half of the century.

Marine tanks were originally coated to reduce steel corrosion and thus increase the working life of the ship. In the process other benefits have manifested themselves, including:

- (i) prevention of damage to pumps and valves by loose material
- (ii) prevention of cargo contamination by iron, rust or former cargoes
- (iii) ease of cleaning and gas-freeing
- (iv) ease of inspection
- (v) improved safety



(vi) reduced scantlings.

All of these have obvious economic benefits derived from greater flexibility, time saving or decreased dead weight.

The rapid expansion of the chemical industry, particularly the petrochemical side, over the last twenty-five years has led to an increase in the variation of cargoes carried and their corrosive properties. Clearly, a protection system which is resistant to the chemical activity of all cargoes over all environmental conditions encountered, is the ultimate goal of the anti-corrosion engineer. In striving to perfect such a coating, systems are produced with increasing flexibility and resistance to a wide range of cargoes, although it is unlikely that such an idealized coating will ever materialize since the list of mechanical and chemical resistances is so formidable.

In general, such corrosion is an electrochemical problem. The corroding metal consists of anodic and cathodic areas which behave as short circuit electrolytic cells on the metal surface.

Diagram One depicts the corrosion of iron.

Diagram One

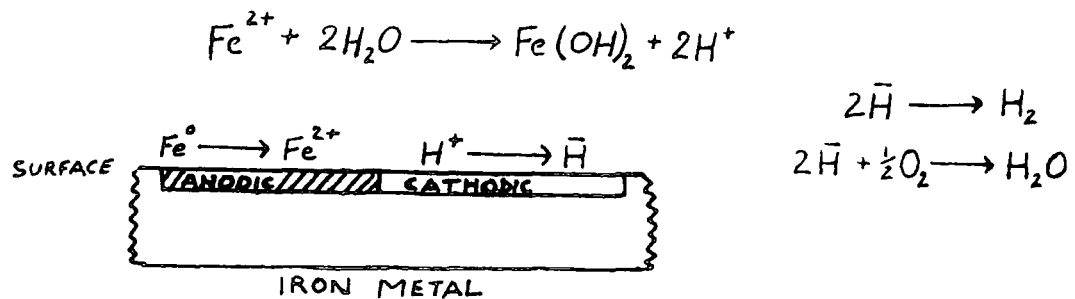

Such areas are created by differential grain size; differential thermal treatment (welding etc.); differential strain; presence of scratches; metal-metal oxide combinations; and differential concentrations of oxygen in moisture. In the case of mill scale on steel, the iron oxide will produce a cathodic area and the iron metal an anodic area. Hence, an electrolytic cell is set up. Once corrosion 'sets in', it has an auto-catalytic effect, creating surface traps for solutions of ferrous ions and dissolved oxygen. The effect described here refers only to surfaces in contact with water. Of course,

the different chemical species and solvents involved in cargoes will complicate the electrochemistry. Although the same principle applies, quantitative effects may be considerably different.

The control of corrosion is clearly a question of preventing the generation of such cells. This may be achieved by inhibiting activity at the anode or cathode, masking the surface, or by electrical methods.

Among anodic inhibitors are red lead (Pb_3O_4), zinc yellow ($K_2O \cdot 4ZnO \cdot 4CrO_3 \cdot 3H_2O$) and potassium barium chromate ($K_2Ba(CrO_4)_2$). On application, such inhibitors form thin films which react with the soluble ferrous salts produced at the anodic areas to deposit a mixture of ferric and chromic oxides. The oxidative properties of red lead are similarly employed.

Cathodic inhibitors, among which are zinc oxide (ZnO) and calcium bicarbonate ($Ca(HCO_3)_2$), react at the cathode with hydrogen ions, etcetera, in a reductive capacity to prevent completion of the cell.

Adsorption inhibitors, such as colloids (albumin and gelatine), mask the metal surface to prevent contact with the corrosive agents.

Introduction of sacrificial electrodes is another method of preventing corrosion but it is unsuitable where contamination of the cargo is undesirable. A deposit of metal which is more easily oxidized (for example, zinc) is introduced to the steel surface and is preferentially eroded, thus protecting the steel.

The use of electric currents is involved in a method known as 'cathodic protection'. The electrode potential of a corroding metal is lowered to the reverse potential of the anodic reaction. Thus, no dissolution of the metal will occur since the back reaction rate induced by the applied potential is equal to the forward reaction rate. Basically, the metal becomes an overall cathode: anodic areas effectively neutralised and cathodic areas enhanced. Hence, no site is available for the anodic reaction (oxidation of metal).

The usual control method employed is to coat the tank with a protective material. Many linings have been developed, including vitreous enamel; glass; metal; glass reinforced polyester; sheet P.V.C. and sheet rubber; synthetic rubbers and painted coatings. The paint coatings used have many

advantages, in that many different properties may be incorporated to varying extents when formulating the paint.

1.3 THE COATINGS IN USE

A paint consists of many ingredients.

- (i) The basic medium which is commonly a polymer resin comprises 50-70% of the mass of the paint when cured. This, of course, gives it the resistive properties required.
- (ii) The extenders which are inert, and are basically padding, allow the paint to be made more economically but do not affect the properties of the paint nor its effectiveness.
- (iii) Pigments are included which serve the dual purpose of giving the paint colour and anti-corrosion properties (examples are zinc phosphate, zinc chromate and calcium phosphate).
- (iv) Surface driers, such as cobalt naphthenate, and through driers, such as lead naphthenate, are included.
- (v) Other additives, such as thixotropes (for example, bentone) for flow control, are important constituents.
- (vi) Solvents which may be aliphatic, aromatic or polar simply to thin the paint for application, comprise about 45% of the 'wet' mass.

The medium may be of four main types: zinc silicate, epoxy, phenolic epoxy or polyurethane.

(a) Zinc Silicates

Zinc dust is combined with inorganic or organic silicates. Hydrolysis of the silicates results in the formation of a zinc cement which, on subsequent reaction with either carbon dioxide, halide, or sulphate, produces a tough coating resistant to organic solvents. Unfortunately, surface preparation, humidity, steel temperature and thickness of film are crucial. If mud cracking, to which zinc silicates are susceptible, occurs, the only remedy is to reblast and recoat. Resistance to solvents is excellent but resistance to other commodities is limited. Acid and alkali resistance outside pH 5-9 range is very low. This results in the use of zinc silicates as specific tank linings.

(b) Epoxy Resins

Epoxy resins are fundamentally aliphatic polyethers but retain their name on the basis of their starting material and the presence of epoxide groups in the polymer before cross-linking.

Historically, epoxy paints are solvent containing two pack paints, normally categorised by the curing agent involved. Typical curing agents are polyamide, polyamine or amine adduct, and isocyanate. The reactions are principally the same, involving nucleophilic attack at the epoxy function.

Polyamine-cured epoxy resins provide good resistance to petroleum products and very good resistance to salt water ballast and caustic soda solutions over 30%. Mechanically, they are hard without being brittle. The rate and degree of cross-linking is dependent on temperature which should be above 20°C (steel temperature) for full cure.

Polyamide-cured epoxy resins have similar mechanical and resistance properties to polyamine-cured epoxy resins. Cure temperatures should again be over 20°C.

Isocyanate cure gives resistance comparable with amine-cured systems but the minimum curing temperature is reduced to 0°C (steel temperature), giving an added advantage in application. However, isocyanates are not environmentally favoured because of the health hazards involved.

(c) Epoxy Phenolic Resins

Epoxy phenolic resins are similar to epoxy resins except that the epoxy functions are in position on side chains, while the polymer back-bone is composed of linked aromatic rings. Cross-linking is achieved with either amine or amine adduct curing agents by virtue of the epoxide groups. Resistance to a wide range of chemicals and solvents is excellent, although lower alcohol homologs receive only weak resistance. Unfortunately, the curing temperature for effective resistance is about 60°C. This may be achieved by carrying a mild hot cargo (for example, lubricating oil) in initial service to mature the coating since the minimum application temperature is 15°C (steel temperature).

(d) Polyurethane Resins

Polyurethane coatings are less commonly used than epoxy paints because of the health hazards associated with them and their isocyanate precursors. They are manufactured by the addition of isocyanates to active hydrogen-containing materials.

They exhibit very good chemical resistance, in many respects superior to epoxy polyamides and comparable to epoxy phenolic polyamines. Good resistance to methanol and animal/vegetable oils is also observed and they have the added advantage of being satisfactorily cured at 0°C (steel temperature).

1.4 GENERAL CONSIDERATIONS IN TANK COATING

Depending on the cargoes that a particular vessel might carry, one must evaluate which coating, or combination of coatings, to apply. Since there is no universal coating, future cargo commitments must be predicted and cargo type limitations must be adhered to. Softening of the coating may occur, as is the case when butan-2-one (MEK) is carried in tanks protected by epoxy paints. However, coatings will recover from such effects if time is allowed for complete evaporation or diffusion of the chemicals involved, and if no product is carried which may take advantage, in terms of chemical attack, of the temporary weakness. The recovery time may vary from 48 hours to several weeks, therefore, even with a limited cargo list, there will be operating restrictions.

Of course, it may not always be possible to apply a first choice coating because the application climate may not be suitable (for example, Norway in autumn or winter). Therefore, all specifications for coating the tank must be considered simultaneously.

1.5 CHOICE OF RESINS

The resin system chosen as a 'medium' for the trial surface coatings must be capable of forming a film on various substrates (for example, glass, metal and primed surfaces) with good adhesion.

There are a number of resins commercially available:

- (i) phenolic resins which have good chemical resistance and

hardness properties but are limited in adhesion and flexibility

- (ii) alkyd resins which have good durability and versatility but limited in alkali resistance and adhesion properties
- (iii) vinyl resins which have good chemical resistance and toughness but are limited due to their softness and insolubility
- (iv) epoxide resins possessing all of the desirable properties mentioned above with a minimum amount of the limiting qualities.

In view of their thermal stability, mechanical strength, chemical resistance and superior adhesion, epoxide resins have been chosen as the monomers for trial systems. In addition, they are well established ingredients in conventionally cured tank coating systems.

1.6 HISTORY OF EPOXIDE RESIN COATINGS

Epoxides first found commercial success in the coatings industry. Hardly known twenty-five years ago, they have established themselves particularly well due to their acid, alkali and organic chemical resistance, hardness, flexibility, weather resistance and outstanding adhesion to metal surfaces. In fact, the chief use of epoxy resins, amounting to over 100 million pounds in 1978, was for coating applications (1).

Although some patents registered in the late 1920s and early 1930s mentioned work on diepoxides, the beginning of today's epoxide resin technology is usually accepted as being December 1934, when I.G. Farben applied for the patent of 'Schlack' (2). This patent describes liquid polyepoxides hardened by a variety of methods.

In 1938 and 1943, P. Castan, a Swiss chemist employed by De Trey Freres of Zurich, filed patents describing the production of diglycidyl ethers and esters and polymerizations of these resins with acid anhydrides, phthalic anhydride, and organic and inorganic bases. Attempts to market these products for dental use failed and the patents were licensed to Ciba A.G. of Basle. Similar work was also carried out by Greenlee for the Devoe and Reynolds paint company in the United States of America. The Shell Chemical Corporation

researchers began investigating a range of possible curing agents and monoepoxide reactive diluents. With licences on the Devoe and Reynolds patents, they marketed a range of liquid and solid epoxide resins under the trade name Epon in the United States, Epikote in all other countries, for the surface coating industry.

When the Dead Sea scrolls were discovered in the 1950s, Professor H. Wright Baker of Manchester University had to solve the problem of how the brittle, badly corroded copper rolls could be unravelled without losing a single letter. Epoxide coatings were the answer. The surface layer was coated with a film of liquid epoxide and an aliphatic amine hardener. After warming and curing for a few hours, the strengthened outer layer was cut through and removed. The process was repeated in successive layers, allowing the scrolls to be both examined and preserved (3).

In the late 1950s, further research provided the coatings industry with a unique new material which has been described as a 'super phenolic' (3) with considerable resistance to chemicals. Also in the late 1950s and early 1960s, Dr D. Swern's work of the 1940s, on the reaction of olefins with oxygen containing compounds such as peroxides and peracids, was expanded by several workers in the United States to produce new and useful epoxide resins (4).

Even with the superior properties of epoxide coatings, their rapid growth has been a remarkable commercial chemical development. There are currently dozens of distinct types of epoxide resins commercially available for a wide variety of applications.

1.7 CHARACTERISTICS AND APPLICATIONS OF EPOXIDE RESINS

Curing temperatures of epoxide resin coatings can be varied from 5-200°C steel temperature by appropriate choice of catalyst or reactive hardener.

With many curing agents, ether linkages, among the most stable known to organic chemists, are the only bonding other than carbon to carbon. Therefore, it follows that these resins are highly resistant to attack from a wide range of solvents, acids, alkalis and other chemicals.

Shrinkage during cure is small because the reaction between monomers is an addition reaction which does not involve the elimination of small molecules such as water. This, of course, is a most advantageous property since it helps minimise stresses in the film. Widely spaced epoxide and hydroxyl groups are the reacting species, giving rise to three dimensional polymers, resulting in toughness and flexibility in the cured film. The polar nature of these functional groups (mainly hydroxyl in the cured polymer) is responsible for the excellent adhesion of epoxide resins. Shrinkage also contributes to adhesion since there is less distortion during cure, hence, surface contacts are not destroyed in the process (5).

The phenolic hydroxyl groups are often a cause for concern in colouring other resins. However, in phenolic epoxides, also called epoxy novolaks, they have been converted to ether linkages, resulting in resins of good colour and colour retention.

There is a considerable list of applications for epoxide resins, including adhesives for aircraft; paint brush bristles; body solders and caulking compounds for the repair of plastic and metal boats, cars, etcetera; casting compounds for the fabrication of short run and prototype molds; and sealant compounds in building applications.

Epoxide based solution coatings are used as maintenance and product finishes in such areas as marine coatings, structural steel coatings, tank coatings, aircraft finishes, primer coatings, furniture finishes, and concrete floor paints and varnishes. Application of these coatings may be carried out at various temperatures by spraying, roller coating, dip coating, or flow coating (3).

CHAPTER TWO

CATIONIC POLYMERIZATION OF EPOXIDES

2.1 TYPES OF INITIATION

There are three general categories of photoinitiation available (6) which are free radical, cationic and anionic. The choice of the most suitable depends in part upon the nature of the groups R_1 and R_2 in the monomer below,

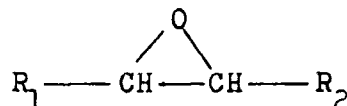

and their effect upon the electron density distribution in the epoxide ring.

In general, electron withdrawing substituents, such as cyanide, ester and amide groups, reduce electron density at the carbon atoms in the ring and favour initiation by anionic species. Electron donating substituents, such as alkyl, alkoxy and phenyl, render the epoxide group more sensitive to cationic initiation via the oxygen atom in the ring. Due to their electrical neutrality, free radicals are less selective and, therefore, have a wider application than anionic or cationic species.

Although photoinitiated radical polymerizations are widely employed, they suffer from many problems, among which are: the short life-times of initiating species; the fact that polymerizations suffer from oxygen inhibition; and the requirement for a minimum threshold viscosity for high polymerization (Tromsdorff-Norrish effect). In order to avoid such problems, one may employ an ionic active centre propagation.

Anionic chain polymerization may be ruled out since it is even more sensitive to oxygen than radical chain polymerization. However, cationic chain polymerizations do not suffer from the same limitations as radical and anionic polymerizations, and also possess some convenient characteristics which lend themselves to UV curing. The advantages are: initiating species have long life-times; propagation continues after removal of the light source; initiation and propagation steps are unaffected by oxygen; it is not necessary to have a high viscosity medium; polymerizations proceed at very low temperatures with high rates, even at -100°C ; and cationic initiation mechanisms are quite well documented.

The Lewis acids may be classified as

- (i) Protonic acids such as perchloric acid, sulphuric acid and certain highly acid surfaces (for example, montmorillonite clay)
- (ii) Friedel-Crafts catalysts such as borontrifluoride, aluminiumtrichloride, etcetera.

Of the two, the Friedel-Crafts halides are the most important. In most cases, Friedel-Crafts halides will only function in the presence of a second component or co-catalyst (SH) such as water or alcohol. The catalyst activation step is

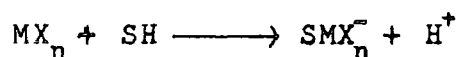

Thus the initiation steps of both protonic acid and Friedel-Crafts catalysts are essentially the same.

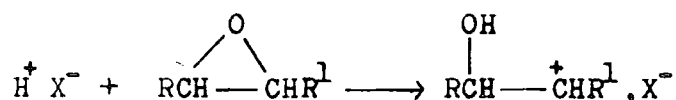

Cationic polymerization normally takes place in a medium of low dielectric constant, such as hydrocarbon solutions, in which charge separation is unlikely so that initiating and propagating species exist as ion pairs. The propagation reaction is a chain process operating via carbonium ions and may be viewed as an insertion of monomer into the partial bond between the propagating species and the counterion.

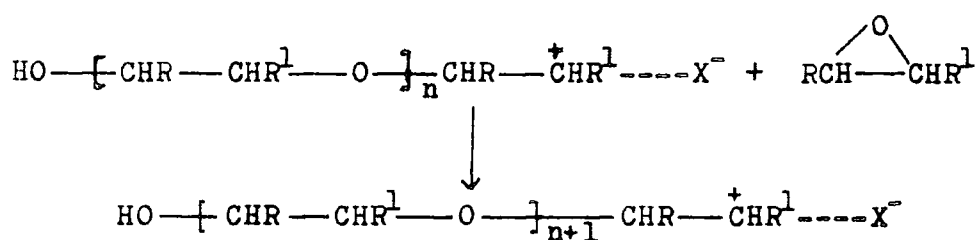

Termination may occur in a variety of ways in cationic polymerizations, such as proton transfer from the propagating species to a monomer; hydride ion abstraction from solvent or monomer; or by carbonium ion rearrangement to produce a more stable species incapable of propagation. However, all of the above can be minimized with an appropriate choice of monomer, solvent and temperature, resulting in a 'living polymer'.

2.2 CATIONIC POLYMERIZATION OF EPOXIDES

Polymerizations proceed by a chain mechanism which may be divided into three general processes: initiation, propagation and termination. Ethylene oxide and other cyclic ethers are readily polymerizable by ring opening mechanisms.

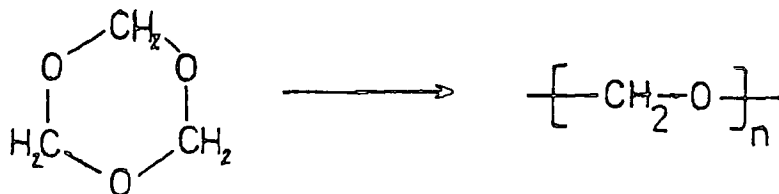
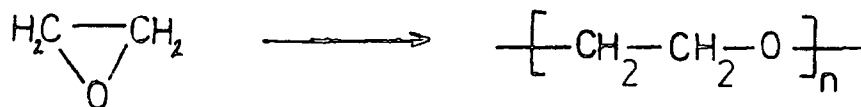

Such mechanisms are polyadditions leading to products which are more conveniently considered condensation polymers. In most cases, a catalyst is required. The most convenient catalysts are cationic species.

Since the propagating species in cationic polymerizations are likely to be carbonium ions, those monomers which have electron donating substituents, capable of stabilizing such ions, are most susceptible to cationic polymerizations.

The generation of a carbonium ion from a monomer may be achieved by addition of a strong Lewis acid (7).

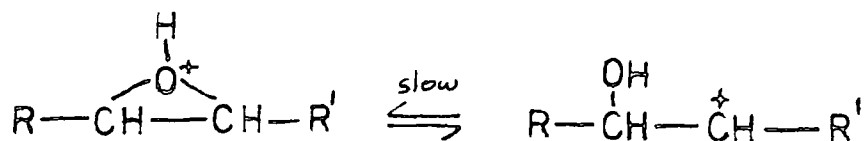
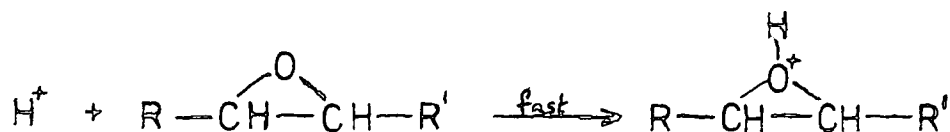

2.3 GENERAL KINETIC SCHEME FOR CATIONIC POLYMERIZATION

As in section 2.2, there are three main stages.

1. Initiation

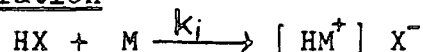

Rate of initiation, $R_i = k_i [\text{M}] [\text{C}]$

where $[\text{C}]$ is the catalyst concentration,

and $[\text{M}]$ is the monomer concentration.

2. Propagation

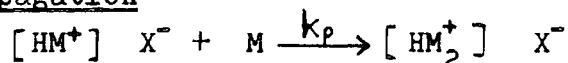

in general $[\text{HM}_n^+] \text{X}^- + \text{M} \xrightarrow{k_p} [\text{HM}_{n+1}^+] \text{X}^-$

Rate of propagation, $R_p = k_p [\text{M}^+] [\text{M}]$

where $[\text{M}^+]$ is the concentration of growing cationic species.

3. Termination

by proton transfer, $[\text{HM}_n^+] \text{X}^- \xrightarrow{k_t^1} \text{M}_n + \text{HX}$

by hydride transfer, $\text{SH} + [\text{HM}_n^+] \text{X}^- \xrightarrow{k_t^2} [\text{H}_2\text{M}] + \text{X}^- + \text{S}^+$

by carbonium ion rearrangement, $[\text{HM}_n^+] \text{X}^- \xrightarrow{k_t^3} [\text{HM}_{n-1} \text{M}_\ddagger^+] \text{X}^-$

where M_\ddagger^+ is the rearranged M^+ species.

Rate of termination, $R_t = k_t^1 [\text{M}^+] + k_t^2 [\text{M}^+] + k_t^3 [\text{M}^+]$

$$R_t = (k_t^1 + k_t^2 + k_t^3) [\text{M}^+]$$

$$R_t = k_t [\text{M}^+]$$

Chain Transfer

The rate of chain transfer does not affect the overall reaction rate since the propagating species is regenerated in chain transfer. $d [\text{M}^+] / dt = 0$

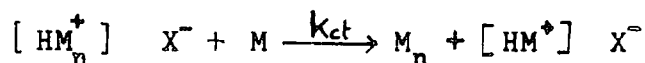

Rate of chain transfer, $R_{ct} = k_{ct} [\text{M}^+] [\text{M}]$

Under steady state conditions, $d [\text{M}^+] / dt = 0$.

$$[\text{M}^+] = k_i / k_t [\text{M}] [\text{C}]$$

$$R_p = k_p [M][M^+]$$

$$R_p = k_i k_p / k_t [C][M]^2$$

The chain length is given by:

$$X_n = R_p / R_t = k_p / k_t [M]$$

However, this equation is not universally applicable when chain transfer is a competing process. When chain transfer is the dominant process, the chain length is given by:

$$X_n = R_p / R_{ct} = k_p / k_{ct}$$

2.4 ENERGETICS OF CATIONIC POLYMERIZATION

One of the important features of cationic polymerization is that the overall rate increases as one decreases the temperature (6). Since the rate is proportional to $k_i k_p / k_t$, the overall activation energy is given by:

$$E_r = E_i + E_p - E_t$$

The activation energies for initiation and propagation are low since the processes involve the approach of positively charged ions to the negative pole of a permanently charged dipole in a relatively non-polar medium. Consequently, E_r normally lies in the range -40 to +60kJ per mole. When the activation energy is negative, an increase in rate is observed as the temperature decreases.

For chain length, the energetic expression is given by:

$$E_x = E_p - E_t$$

E_t is always greater than E_p , thus, the chain length always decreases as the reaction temperature rises.

CHAPTER THREE

THE PHOTOINITIATORS:
PREPARATION AND CHARACTERISATION

3.1 PHOTOINITIATOR SELECTION

The choice of photoinitiator is limited; a substance is required which will release a cationic species on irradiation. Aryldiazonium salts, diaryliodonium salts, triarylsulphonium salts and triarylselenonium salts have been shown to be effective.

(a) Aryldiazonium salts

Although aryldiazonium salts are reported to be highly effective photoinitiators for epoxide ring opening polymerizations (8 & 9), they also have many disadvantages. They are sensitive to visible radiation and low temperature thermolysis; nitrogen gas is liberated during the reaction; and pot-life, even with stabilizers, is reported to be only two weeks.

(b) Diaryliodonium salts

In contrast to their dialkyliodonium counterparts, these are stable, crystalline compounds, insensitive to oxygen and moisture. The excited state from which photolysis occurs is, apparently, not quenched by oxygen nor by singlet and triplet state quenchers (10). Polymerization of epoxide monomers by diaryliodonium salt photoinitiators has been studied by J.V. Crivello and co-workers (11). The overall consequences of photolysis are the generation of an iodoaromatic compound, a radical species and a Bronsted acid. Reaction of the cationic active centre of the growing chain with the acid counterion is very slow, hence, such polymers are termed living in the absence of nucleophilic or basic impurities.

(c) Triarylsulphonium salts

These salts have many photochemical and photosensitivity parallels with the diaryliodonium salts. Initiation, again, is through the Bronsted acid of the counterion. Long storage times have been reported by Crivello and Lam (12), and preparations, identifications and characterisations of such salts are described by the same authors (13 & 14). Photo-initiated polymerization by thiopyrylium salts, which are complex sulphur salts similar to triarylsulphonium salts, has also been investigated (15).

The odour which often accompanies sulphonium salts is disadvantageous, as is the volatile residue which often remains. However, it should be possible to engineer molecules in which these undesirable qualities are minimized. Much attention has recently been given to these salts.

(d) Triarylselenonium salts

Triarylselenonium salts are reported to be slightly less efficient photoinitiators than their sulphur analogues (10). Selenium compounds in general tend to have pungent odours and are unpleasant to work with. There has also been little work on their photoinitiating properties compared with iodonium and sulphonium compounds.

In choosing the class of initiator, diazonium salts were eliminated because of their instability and nitrogen liberation, and selenonium salts are clearly inferior to sulphonium salts, therefore, the final choice was between iodonium and sulphonium species. It was noted that many syntheses of sulphonium salts involve an iodonium salt intermediate (16). Diaryliodonium salts were chosen because they have none of the disadvantages of the triarylsulphonium salts, although their desirable qualities are comparable.

3.2 DIARYLIODONIUM SALT PHOTOINITIATION

Iodonium salts appear at first sight to be quite exotic, in that the central iodine atom displays a coordination number of two in a positive valence state. However, high valence state compounds were described as early as 1885 by the German chemist, C. Willgerodt.

Diaryliodonium salts of the following form have been reported by J.V. Crivello:

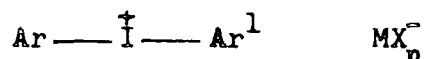

where Ar and Ar¹ represent aryl groups bearing substituents which will not react with epoxide or hydroxyl groups; MX_n⁻ is a complex non-nucleophilic polyhalide counterion such as PF₆⁻, BF₄⁻, SbF₆⁻, etcetera. Iodonium salt photoinitiators require counterions of this type since photolysis of the

corresponding halides does not result in polymerization (17). This is presumably due to reaction of the halide ion with the 'would-be' propagating carbonium ion in the initiation stage.

More complicated aryliodonium salts have been patented as photoinitiators in photopolymerizable compositions by the Minnesota Mining and Manufacturing Company of the United States of America (18). They are described in a patent as aromatic iodonium complex salts of the formula,

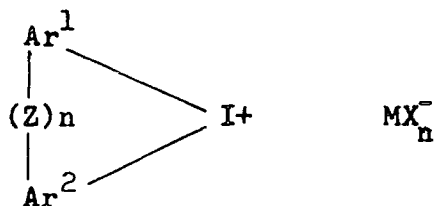

where Ar^1 and Ar^2 independently represent arylene groups having 4 to 20 carbon atoms which may have fused benzene rings or substituents non-reactive with epoxide or hydroxyl groups; Z represents a heteroatom or $>\text{S}=\text{O}$, $>\text{C}=\text{O}$, $\text{O}=\overset{\text{I}}{\text{S}}=\text{O}$, $\text{R}-\text{N}<$ group; n is zero or one with the proviso that when n is zero, there is no bond linking the aromatic groups; MX_n^- is a complex halide of the type already mentioned. This patent includes compounds such as,

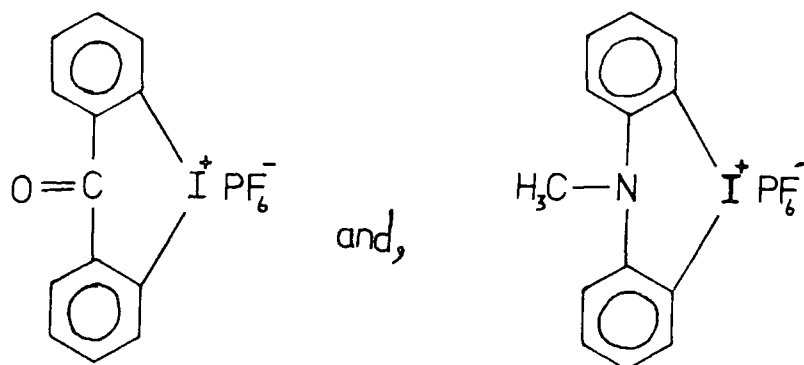

as well as those such as,



described by J.V. Crivello.

The UV spectra of diaryliodonium salts possess strong absorption bands at 230-250nm. The nature of the anion has no observable effect on the position or intensity of these

bands. However, the nature of substituents on the cation does cause shifts in both position and intensity of the bands (19). There is also a very small absorption at wavelengths greater than 300nm. The photolysis of these salts is highly efficient, as was shown by J.V. Crivello and J.H.W. Lam (19) who obtained quantum efficiencies of approximately 0.2 when irradiating these photoinitiators at 313nm (E is approximately 10), which corresponds to the tail of the absorption at 230-250nm.

Predictably, the effects of different anions on photolysis rates is negligible. It appears, therefore, that the anion has no influence on the photosensitivity of diaryliodonium salts. It is important to note that although photolysis is independent of the nature of the anion, the rate of polymerization is not. The anion effect upon polymerization is, apparently, a function of size since the rate and extent of polymerization increases with increasing anion size, $\text{SbF}_6^- > \text{AsF}_6^- > \text{PF}_6^- > \text{BF}_4^-$.

Cation structure, however, does have a slight influence on the rate of photolysis, and although no clear trend is seen in Crivello and Lam's work, there is some scope for a limited degree of control over the photosensitivity of the iodonium salts through careful choice of cation.

3.3 ONIUM SALT SENSITIZERS

Suitable sensitizers for onium salts are anthracene, perylene, acridine orange, and phenothiazines. The mechanism of sensitised photoinitiation using triarylsulphonium salts has been elucidated, and may be summarized as:

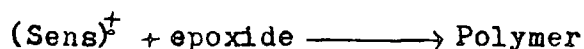
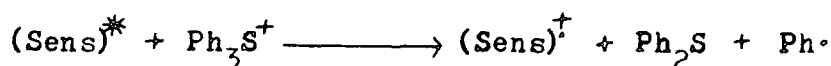
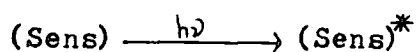

The wavelength of maximum absorption was increased by 100nm to 350nm using *N*-ethylphenothiazone as a sensitizer in the triphenylsulphonium salt polymerization of cyclohexeneoxide (20). Quantum yields for initiator-sensitizer combinations are reported to be high.

3.4 DIARYLIODONIUM SALT PHOTOLYTIC MECHANISMS

A generally accepted scheme (17) for the photolysis of iodonium (and sulphonium) salts is shown below:

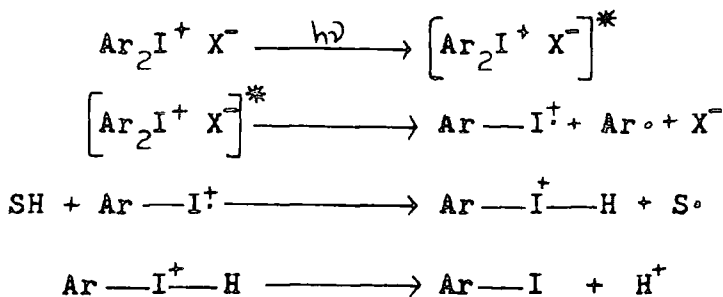

where SH is a solvent molecule and X^- is the counterion; the overall consequence of photolysis being the production of the Bronsted acid of the counterion, an iodoaromatic compound and a radical species whose ultimate end is to produce aryl and biaryl species through hydrogen abstraction or by dimerisation respectively. The protonic acid, HX, may then react with a monomer in an initiation step.

A. Ledwith (20) has proposed an alternative mechanism for the photolysis of diaryliodonium salts in the presence of monomer. This mechanism is as follows:

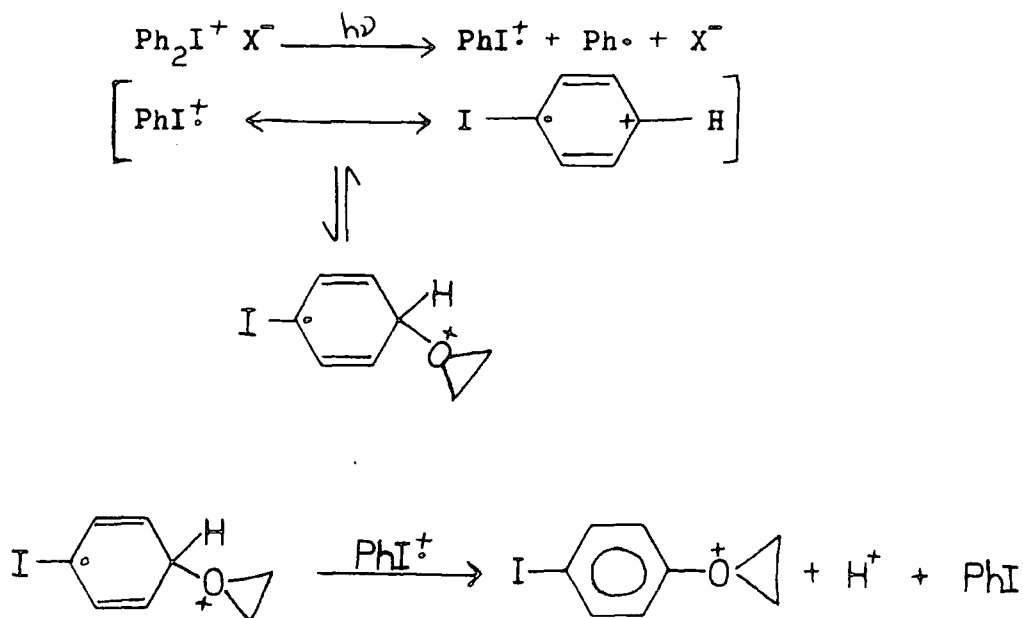

where  is the monomer and X^- is the counterion. In this case, the overall consequence of photolysis is to produce iodobenzene, the Bronsted acid of the counterion and a cationic iodobenzene=monomer adduct. Both the acid and the adduct are capable of initiating polymerization.

Support may be claimed for both schemes from a series of

investigations carried out by A.N. Nesmeyanov and co-workers, in which the cleavage of the carbon-iodine bond in diphenyliodonium halides is found to be homolytic. A. Ledwith has also indicated that ion-pair dissociation constants are important when investigations are not carried out in dilute solution, and that clusters rather than free ions are encountered in coatings.

3.5 COPPER SALT CO-CATALYSTS

There have been several reports on combining onium salt initiators with copper salt co-catalysts. C.D. Dudgeon (22) claimed the use of a triphenylsulphonium hexafluoroantimonate and diphenyliodonium hexafluoroarsenate initiator combination with a copper naphthenate co-catalyst, for the hardening of mineral filler containing solders. The medium is a cycloaliphatic diepoxide and talc mixture. Hardening of a 4.8mm layer after 5 minutes UV irradiation or 1 minute irradiation and 10-15 seconds in a flame is reported. The use of copper salts as co-catalysts for diaryliodonium salts as thermal initiators for cationic polymerization has also been reported (23 & 24). Such salts may prove to be useful co-catalysts in diaryliodonium salt initiated cationic cure of epoxide coatings.

3.6 DIARYLIODONIUM SALT PHOTOINITIATOR PREPARATION

The preparation of diaryliodonium salts was first carried out by C. Hartman and V. Meyer in 1894, by a method involving the condensation of iodosobenzene in the presence of sulphuric acid to produce 4,iododiphenyliodonium bisulphate and water. Since then, many other methods have been devised. J.V. Crivello and J.H.W. Lam (25) have reported methods for the synthesis of symmetrical diaryliodonium salts having electron donating or electron withdrawing substituents and unsymmetrical diaryliodonium salts.

The synthesis of 4,4^o diethyldiphenyliodonium salts (hexafluoroantimonate and hexafluorophosphate) was attempted using Crivello and Lam's method, the process is summarized below:

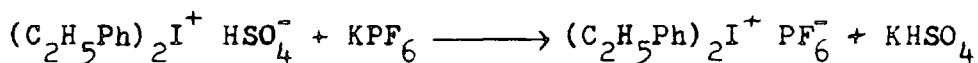
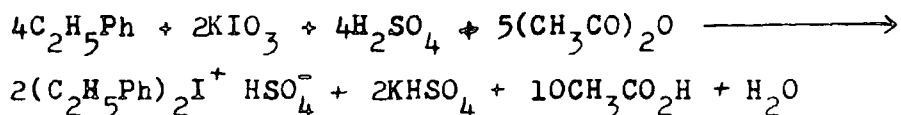

A method adapted from work carried out in the Durham Laboratories by Irvine Masson in the late 1930's (26 & 27) was also examined:

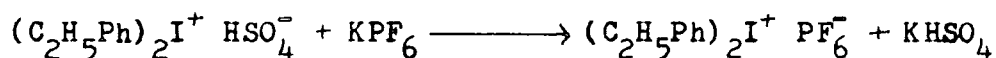
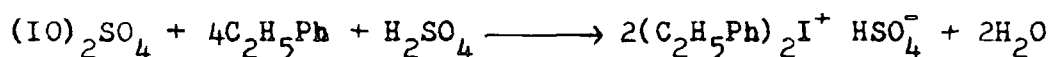

Both of these attempted syntheses were unsuccessful. The author's experience suggests that alkyl substituted diphenyliodonium species cannot be prepared (with the exception of methyl and tertiary butyl substituted derivatives). This view is supported by Berry and co-workers (28) who claim that 'alkyl benzenes without a tertiary carbon atom attached to the benzene ring (except methyl benzenes) cannot be iodylated', although patent claims would contradict this experience.

The simplest diaryliodonium cation is the diphenyliodonium cation. The synthesis of this as the hexafluorophosphate was attempted by a method adapted from that used in 1937 by I. Masson and E. Race (26) according to the scheme given above; diphenyliodonium bisulphate was obtained as an oily precipitate. Unfortunately, metathesis with KPF_6 occurred only with difficulty and in low yield; the overall yield of purified product was only 1%; the analytical data is recorded in Table 3.1.

The preparation of diphenyliodonium hexafluorophosphate by the Crivello and Lam method was found to be more satisfactory. Details of this method are given below.

Synthesis of diphenyliodonium hexafluorophosphate

Potassium iodate (25.0g, 0.115 mole), acetic anhydride (25.0ml) and benzene (22.5ml, 0.250 mole) were placed in a 100ml, round-bottom, 2-neck flask equipped with dropping funnel and thermometer. This mixture was stirred with a magnetic stirrer and cooled to -5°C . A mixture of concentrated sulphuric acid (17.5ml) and acetic anhydride (25.0ml) was

prepared, using an ice-bath to maintain a low temperature; experience established that maintaining a low temperature was a critical factor in the success or failure of this procedure. If the temperature was allowed to rise, a red oil was formed, in which event the reaction failed. After cooling the clear liquid to -5°C , it was added to the reactants in the round-bottomed flask, maintaining a temperature below $+5^{\circ}\text{C}$ at all times. This addition took approximately $1\frac{1}{2}$ hours. On completion of the addition, the reaction mixture and cooling-bath were allowed to reach room temperature. The reaction mixture was then left stirring for 42 hours to complete reaction. It was then cooled to 0°C . On addition of demineralised water (50ml) at approximately 0°C , a colour change from pale yellow to pink was observed. Diethylether (25ml) was added and the mixture filtered to remove potassium bisulphate. The filtrate was then extracted twice with diethylether (25ml) and once with 30/40 petroleum ether (25ml).

Potassium hexafluorophosphate (23.0g) was added to the aqueous layer. The liquid began to thicken rapidly to a paste. It was then diluted by a factor of 4 with demineralised water and left to shake on a flask-shaker for 2 hours. After filtering and washing with water, it was dried in a drying pistol at 56°C under vacuum for 18 hours. A white crystalline product was obtained which needed no further purification. Yield was 46.3%, melting point $138-141^{\circ}\text{C}$.

This method was used in the preparation of 4,4'-dimethyldiphenyliodonium hexafluorophosphate and 3,3',4,4'-tetramethyldiphenyliodonium hexafluorophosphate. Metathesis and purification became increasingly difficult as the number of methyl groups increased. Since these compounds decompose when warmed in propan-2-ol, recrystallisation of the methyl and dimethyl substituted salts had to be carried out by dissolution at room temperature and recrystallisation at temperatures below 0°C using an acetone-dry ice (CO_2) bath.

The results of elemental analysis (Table 3.1) indicated that the diphenyl salt (PI1) $(\text{C}_6\text{H}_5)_2\text{IPF}_6$ was pure, whereas the 4,4'-dimethyl derivative (PI2) $(\text{CH}_3\text{-C}_6\text{H}_4)_2\text{IPF}_6$ was contaminated with 13% KPF_6 and the tetramethyl derivative (PI3) $((\text{CH}_3)_2\text{C}_6\text{H}_3)_2\text{IPF}_6$ was significantly less pure, 33%, with $((\text{CH}_3)_2\text{C}_6\text{H}_3)_2\text{IF}$ as the likely major impurity. Successive

TABLE 3.1

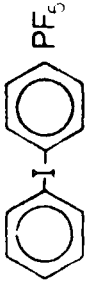
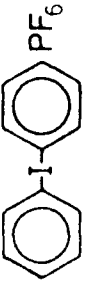
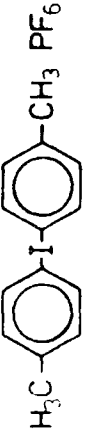
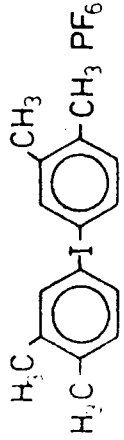
	SALT	YIELD	M. P. °C	%C	%H	%I	%P	%F	EMPIRICAL FORMULA
	 MASSON METHOD	1.0%	LIT. 138-141 FND 134-137	CALC. 33.8 FND. 34.3	2.4 2.5	29.8 30.7	7.3 —	26.8 27.8	$C_{11.8}H_{10.3}I_{1.0}PF_{6.0}$
PI1	 CRIVELLO METHOD	46.3%	LIT. 138-141 FND 138-141	CALC. 33.8 FND. 34.0	2.4 2.4	29.8 29.6	7.3 7.4	26.8 27.5	$C_{12.0}H_{10.0}I_{1.0}P_{1.0}F_{6.1}$
PI2	 CRIVELLO METHOD	25.1%	LIT. 169-173 FND 142	CALC. 37.0 FND. 31.0	3.1 2.5	27.0 27.1	6.8 7.7	25.1 29.1	$C_{14.0}H_{13.6}I_{1.1}P_{1.4}F_{8.3}$
PI3	 CRIVELLO METHOD	11.9%	LIT. FND 151-154	CALC. 39.8 FND. 46.4	3.8 5.1	26.3 30.9	6.4 2.5	23.7 12.8	$C_{15.9}H_{20.9}I_{1.0}P_{0.33}F_{2.8}$

ERRORS INVOLVED IN THE ELEMENTAL ANALYSES CARRIED OUT ARE BETWEEN 0.4 AND 20 PERCENT THUS THESE FIGURES ARE ONLY A GUIDE.

recrystallisations of PI2 and PI3 did not improve the purity of these compounds. The impurity in PI2 is not important with respect to its use as a photoinitiator, whereas the fluoride ion in PI3 would rule it out for such use.

3.7 CHARACTERISATION OF THE PHOTOINITIATORS PREPARED

The three photoinitiators prepared have been assigned the following labels to avoid repetition of their rather lengthy names:

PI1 denotes diphenyliodonium hexafluorophosphate;

PI2 denotes 4,4' dimethyldiphenyliodonium hexafluorophosphate;

PI3 denotes 3,3',4,4' tetramethyldiphenyliodonium hexafluorophosphate.

Their characterisation was carried out using a range of spectroscopic techniques.

(a) Infra-red Spectroscopy

The infra-red spectrum of each photoinitiator was recorded in the form of a hexachlorobutadiene mull, using the Perkin-Elmer 557 Infra-red Spectrophotometer. The spectra are almost identical, as can be seen from Appendix 1.

A summary of the spectra and the band assignments is contained in Table 3.2.

The Carbon-Iodine stretching frequency is not observed in these spectra since it occurs below 400 wavenumbers. The spectra are consistent with the proposed structures, however, they are not informative enough to be positive proof.

(b) Ultra-violet Spectroscopy

The ultra-violet spectra of photoinitiators 1-3 in ethanol were obtained, using a Beckman model 25 Spectrophotometer; the data is recorded in Table 3.3. The wavelength of maximum absorption of each of the initiators is similar to that of iodobenzene ($\lambda_{\text{MAX}}^{\text{EtOH}} = 227\text{nm}$) which is as expected, and can be attributed to the $\pi \longrightarrow \pi^*$ transition.

(c) ¹H Nuclear Magnetic Resonance Spectrometry

The proton NMR spectra of the three photoinitiators in acetone were recorded using the Varian EM 360L Spectrometer

TABLE 3.2

PI1	PI2	PI3	ASSIGNMENT
3080	3080	----	AROMATIC C-H STRETCH
3050	3050	3050	
----	2950	2950	ALIPHATIC C-H STRETCH
----	2920	2920	
1605	1605	1605	AROMATIC BREATHING
1465	1475	1475	SUBSTITUTED AROMATIC C-H BEND
1440	1445	1445	
830	830	830	P-F STRETCH
550	550	550	AROMATIC C-H ROCK
445	470	430	SUBSTITUTED AROMATIC C-C STRETCH
455	485	---	

TABLE 3.3

INITIATOR	DETERMINED		LITERATURE (10)	
	λ_{MAX}^{EtOH}	ϵ_{MAX}	λ_{MAX}^{MeOH}	ϵ_{MAX}
PI1	225nm	14,170	227nm	17,800
PI2 ^(a)	234nm	16,180	237nm	18,200
PI3	237nm	15,270		

(a) adjusted to allow for the 13% KPF_6 impurity

(60 MHz). The results have been tabulated (Table 3.4). The detailed assignment of each proton environment is as follows:

PI1

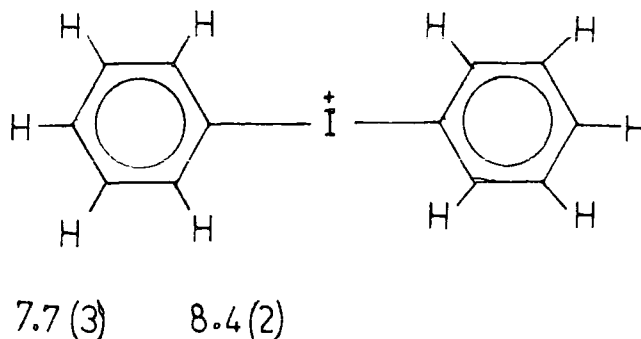

PI2

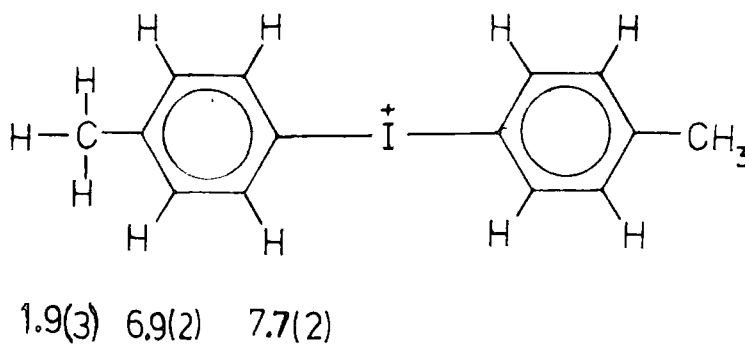

PI3

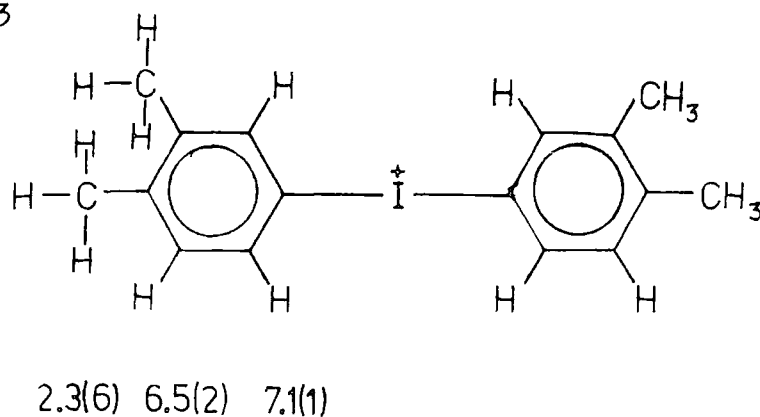

The effect of the iodous moiety is to deshield the nearest aromatic protons resulting in the signal of greatest down-field shift. The progressive increase in methyl groups, from

TABLE 3.4

INITIATOR	SHIFT *	DESCRIPTION	RATIO	ASSIGNMENT
PI1	7.7	DOUBLET	3	AROMATIC
	8.4	DOUBLET OF DOUBLETS	2	AROMATIC
PI2	1.9	SINGLET	3	METHYL
	6.9	DOUBLET	2	AROMATIC
	7.7	DOUBLET	2	AROMATIC
PI3	2.3	SINGLET	6	METHYL
	6.5	BROAD SINGLET	2	AROMATIC
	7.1	BROAD	1	AROMATIC
		SINGLET		

* ppm downfield of TMS.

none in PI1 to two per aromatic ring in PI3, shows a predictable shielding effect which tends to counter the deshielding influence of the iodous moiety. The methyl protons are considerably less deshielded by virtue of their exclusion from the aromatic ring and distance from the iodous species. No splitting is observed in the signals from these protons since they are too far removed from the other environments. The splitting patterns and integration ratios are in agreement with the proposed structures. The environments were easily assigned with the exception of the aromatic proton environments in PI3, where the aromatic portion of the spectrum was not sufficiently well resolved to give a clear splitting pattern. Assignment was based on the shift and integral ratio rather than the splitting pattern. This suggests that the shielding effect of the methyl groups has a greater influence than the deshielding effect of the iodous moiety on these protons.

(d) ^{19}F Nuclear Magnetic Resonance Spectroscopy

The ^{19}F spectra of the three photoinitiators were recorded on the Varian EM 360L Spectrometer. The spectra were identical, which is to be expected since they arise from the PF_6^- counterions. The spectrum of this ion shows a doublet 72.9 ppm upfield of CFCl_3 . Although the fluorine atoms have identical environments the signal is split by the central phosphorous species (both ^{19}F and ^{31}P species have spin quantum numbers of $\frac{1}{2}$). The splitting constant $J_{\text{P-F}}$ is observed to be 12.5 ppm in each case.

(e) Mass Spectrometry

The mass spectrum of each photoinitiator was obtained, using the AEI MS9 Spectrometer. The mass to charge ratio of the main fragments was correlated with the expected fragmentation of the photoinitiators. This information is displayed in the form of a table (Table 3.5).

Each of the parent cations is seen to be present as well as a fragment of the hexafluorophosphate anion. The remainder of the spectrum shown here is consistent with simple break up of the cation. Other peaks were also observed but their assignment was considerably more complicated. However, these peaks alone indicate the existence of the proposed

TABLE 3.5

M/e	PI1	PI2	PI3
336			PARENT ION $C_{16}H_{18}I^+$
308			
307			$C_{14}H_{13}I^+$
292			$C_{13}H_{10}I^+$
281			
232			$C_8H_9I^+$
218		$C_7H_7I^+$	
217			$C_7H_6I^+$
204			
127	$C_6H_5I^+$		I^+
107	I^+	I^+	PF_4^+
105	PF_4^+	PF_4^+	$C_8H_9^+$
91		$C_7H_7^+$	
90			$C_7H_6^+$
77	$C_6H_5^+$	$C_6H_5^+$	
75			$C_6H_3^+$
51	$C_4H_3^+$	$C_4H_3^+$	$C_4H_3^+$
50	$C_4H_2^+$	$C_4H_2^+$	$C_4H_2^+$
39		K^+	

structures of the diaryliodonium compounds prepared. The presence of a peak corresponding to a mass to charge ratio of 39 in the spectrum of PI2 confirms the presence of potassium as an impurity.

From the analysis and characterisation of the photoinitiators, it is seen that purification of these compounds becomes increasingly difficult as the cation structure becomes more complicated. The degree of purity of initiators 2 and 3 is questioned by elemental analysis results, though the only spectroscopic evidence for impurities is the presence of a peak assignable to potassium ions in the mass spectrum of PI2. One would expect any organic impurities to be observed in the nuclear magnetic resonance spectra. Any aromatic species other than the product cations would give observable absorbances in the ultra-violet spectra recorded. There were no unexpected peaks in these spectra. In both cases, (PI2 and PI3) the elemental analysis results add up to approximately 97%, no sulphur was detected, nor were any C-O or I-O stretches observed in the infra-red spectra.

Due to this unlikely disagreement between elemental analysis and spectroscopic characterisation, it was decided to continue with PI1 (diphenyliodonium hexafluorophosphate) as the photoinitiator to be used in ultra-violet curing studies, since its purity was not questioned by any of the techniques employed.

CHAPTER FOUR

THE MONOMERS:
ANALYSIS AND CHARACTERISATION

4.1 INTRODUCTION

This chapter is concerned with the physical and chemical nature of the monomer component or components of the coating systems to be investigated. Rather than prepare monomers in the laboratory, it was decided that the use of commercially available materials would be more compatible with the industrial aspects of this investigation and lead more rapidly to results concerning formation of coatings, the primary objective of the work.

A variety of monomers were generously provided by Ciba Geigy Limited. Unfortunately, they were labelled only with code numbers and a delay of approximately three months was incurred in receiving information on the chemical identity of these resins. During this time work was carried out on the analysis, characterisation and identification of these monomers. Proper definition of these materials is, of course, essential if the consequences of any operations, reactions and treatments are to be adequately investigated and understood at a molecular level. The technical information finally received served only to confirm the conclusions already drawn. It was, however, still valuable because it shows the techniques involved in analysis and characterisation to be appropriate and successful in their own right, since the structures and functionalities of the resins were correctly evaluated without any prior knowledge.

Many of the investigations carried out in this field have used industrial monomers without detailed analysis, quoting simply the technical data available from manufacturers, consequently, there were few useful references available. Chemical and spectral analysis techniques had to be established on known compounds which was also time-consuming.

Much of the technical data, while useful to the coating manufacturer, is not easily transformed into meaningful information for the research chemist without the use of additional data. For example, the Epoxide Equivalent Weight (the weight of resin in grams containing one gram equivalent of epoxide group) does not give a measurement of the epoxide functionality at the molecular level if the molecular weight of the monomer is unknown. Molecular weight determinations are not usually included in technical data sheets. This data

is made less useful by the fact that functionality is seldom an integer and Epoxide Equivalent Weight is usually quoted as being within a quality control range. Since each production batch differs slightly, a proper scientific investigation from the research chemist's point of view must begin with as detailed a definition of the raw materials as possible.

4.2 INFRA-RED ANALYSIS OF THE MONOMERS

After preliminary investigation of the infra-red spectra of the five resins (Appendix 1), the spectra of four standard compounds were recorded (Appendix 1). These compounds were pure samples of cyclohexene oxide, ethyl digol, ethane diol, and epichlorohydrin. These spectra were easy to interpret using standard tables (29) and very useful in the interpretation of the spectra of the resins. Assignments of the bands in these spectra are given in Tables 4.1 and 4.2.

From these spectra it is seen that the resins supplied are all epoxides and fall into two groups: the aromatic resins LY 558 and LY 1805; and the aliphatic resins CY 177, CY 179 and DY 026. It is also noticed that, of the aliphatic resins, two have carbonyl groups somewhere in the molecule and one does not (DY 026). All of the resins have an absorption, due to O-H stretching, in their infra-red spectrum. This indicates one or more of the following: the presence of water; some epoxide ring opening; or some linkage through epoxide functions resulting in the formation of secondary alcohols. In each case, the intensity of the O-H stretching bands is rather low compared to those in the spectra of ethyl digol and ethane diol and, therefore, will correspond to only a minor or trace amount of such impurities.

4.3 CHEMICAL ANALYSIS

Since both epoxide and hydroxyl functionalities are thought to be present in the resins (from infra-red determination), the problem arises of how to evaluate one in the presence of the other.

TABLE 4.1

FREQUENCY/CM ⁻¹	CYCLOHEXENE OXIDE	ETHYL DIGOL	ETHANE DIOL	EPOCHLOROXYDRIN
3400 - 3360		O-H STRETCH	O-H STRETCH	
3060				EPOXIDE C-H STRETCH
2990 - 2860	ALIPHATIC C-H STRETCH	ALIPHATIC C-H STRETCH	ALIPHATIC C-H STRETCH	ALIPHATIC C-H STRETCH
1650		O-H BEND	O-H BEND	
1480 - 1350	C-H BEND	C-H BEND	C-H BEND	C-H BEND
1100		ALIPHATIC ETHER C-O		
1075 - 1030		PRIMARY ALCOHOL C-O	PRIMARY ALCOHOL C-O	
925 - 890	EPOXIDE C-O STRETCH			EPOXIDE C-O STRETCH
850 - 840	EPOXIDE C-O STRETCH			EPOXIDE C-O STRETCH

TABLE 4.2

FREQUENCY/CM ⁻¹	LY 558	LY 1805	CY 177	CY 179	DY 026
3500	O-H STRETCH	O-H STRETCH	O-H STRETCH	O-H STRETCH	O-H STRETCH
3050	EPOXIDE C-H STRETCH	EPOXIDE C-H STRETCH			EPOXIDE C-H STRETCH
3010	AROMATIC C-H STRETCH	AROMATIC C-H STRETCH			
2990 - 2840	ALIPHATIC C-H STRETCH	ALIPHATIC C-H STRETCH	ALIPHATIC C-H STRETCH	ALIPHATIC C-H STRETCH	ALIPHATIC C-H STRETCH
1730			CARBONYL C=O STRETCH	CARBONYL C=O STRETCH	
1610 - 1605	AROMATIC BREATHING	AROMATIC BREATHING			
1505 - 1330	C-H BEND	C-H BEND	C-H BEND	C-H BEND	C-H BEND
1250 - 1240	AROMATIC ETHER C-O	AROMATIC ETHER C-O			
1100					ALIPHATIC ETHER C-O
915 - 900	EPOXIDE C-O STRETCH	EPOXIDE C-O STRETCH	EPOXIDE C-O STRETCH	EPOXIDE C-O STRETCH	EPOXIDE C-O STRETCH
855 - 830	EPOXIDE C-O STRETCH	EPOXIDE C-O STRETCH	EPOXIDE C-O STRETCH	EPOXIDE C-O STRETCH	EPOXIDE C-O STRETCH

(a) Epoxide Determination

There are several methods which may be employed: the alcoholic magnesium chloride-hydrochlorination method; hydrochloric acid cellosolve method; hydrochloric acid-ethyl ether method; hydrochloric acid-dioxane method; pyridinium chloride-pyridine method. All are based upon hydrochlorination of the epoxide group, and are described by S. Siggia (30). The basic chemistry of this method involves the formation of a chlorohydrin and is shown schematically below:



The reaction can be run in various solvents though dioxane, pyridine and pyridine-chloroform are the most suitable for resins. Considering the reaction conditions and the accuracy of determinations on Epon resins (high M.W. polyepoxides) reported by S. Siggia, the pyridinium chloride-pyridine method was selected.

Pyridinium Chloride-Pyridine Method

The hydrochlorination reagent is made by pipetting 4.25ml of analar hydrochloric acid into 250ml of analar pyridine, mixing thoroughly.

To a weighed amount of sample containing 2mM of α -epoxide, in a 250ml conical flask, add 25ml of the pyridinium chloride-pyridine reagent. Dissolve by heating the mixture to 40°C, then reflux on a hot-plate for 20 minutes. Cool the flask and contents, add 6ml of demineralised water together with 5 drops of phenolphthalein solution (neutralised). Titrate with 0.1 Molar methanolic sodium hydroxide solution. Colour change: colourless to pink.

Repeat using 2ml of demineralised water as a blank instead of the resin.

$$\text{CALCULATION: } \frac{A \times N}{W \times 1000} = \begin{array}{l} \text{moles of epoxide functions} \\ \text{per gram} \end{array}$$

A = ml of titrant for blank — ml of titrant for sample

N = normality of sodium hydroxide solution

W = weight of sample in grams

Precision is estimated to be $\pm 0.8\%$

No interference is observed from the following: water, acids, alcohols above C₄, chlorohydrins, saturated ketones, esters, ethers, hydrocarbons, nitriles and alkyl peroxides. Phenols have been observed to give poor end points, though this is not the case for substituted phenols which may be encountered in the aromatic resins.

The method was tested on a solution of epichlorohydrin in ethylacetate. Although the end point was poor and a blank was needed for comparison, the following results were obtained:

RUN	EPOXIDES PER MOLECULE
1	1.01
2	1.00
3	1.02
4	1.03

One may conclude from these results that the error is approximately 3% when the end point is poor, and that this method is satisfactory for epoxide determinations. Analytical results from determinations carried out on resins are included in Table 4.3.

(b) Hydroxyl Determinations

The most widely used method for determining hydroxyl groups is esterification. The reaction is rather fast and claimed to be relatively specific. Carboxylic acid anhydrides are the most commonly used reagents. There are three main reagents: acetic anhydride (AA); phthalic anhydride (PA); and pyromellitic dianhydride (PMDA). The chemistry of the reaction is simple:



Acetic Anhydride Method

The reaction time for this method is reduced by a factor of about five by acid catalysis. This adaptation of the acetic anhydride method was investigated first.

Perchloric Acid Catalysed Acetic Anhydride Method

The reagent was prepared by pipetting 60% perchloric acid (2.8ml) dropwise into reagent grade ethylacetate (150ml) in a 250ml flask. After pipetting acetic anhydride (10ml) into the flask with magnetic stirring, it was allowed to stand for 30 minutes. The contents of the flask were cooled to 5°C and cold acetic acid (40ml) added. After keeping the flask at 40°C for one hour, it was allowed to reach room temperature (this reagent required reparation after two weeks at room temperature).

A sample containing approximately 5mM of hydroxyl was weighed accurately into a 125ml, glass-stoppered flask and exactly 5ml of the above reagent was pipetted into it. After stirring until solids or immiscible liquids had dissolved, the reaction was allowed to proceed for 5 minutes. Demineralised water (1-2ml) was added and the flask shaken. A 3:1 pyridine-water solution (10ml) was added and the flask allowed to stand for 5 minutes. A titration was carried out with 0.55N sodium hydroxide, using neutralised thymol blue-cresol red (3:1) indicator, taking the yellow to violet end point. A blank was also run, using demineralised water instead of the sample.

CALCULATION: As for pyridinium chloride-pyridine method
Precision is estimated to be $\pm 0.5\%$

Several alcohols were used to test this method which is valid only for primary and secondary hydroxyl groups and the results were as tabulated below:

ALCOHOL	OH PER MOLECULE
PROPAN-1-OL	0.999, 0.990, 0.998
PROPAN-2-OL	0.926, 1.056, 1.024
1,9 NONANE-DIOL	2.035

Error, as seen above, was approximately 5%.

Two epoxides were tested. These were known to be pure and should have had no hydroxyl content. This was verified by their IR spectra.

EPOXIDE	OH PER MOLECULE
CYCLOHEXENE OXIDE	NEGATIVE RESULTS
EPICHLOROHYDRIN	0.209, 0.530

Clearly, these results are unsatisfactory. The reaction with epichlorohydrin is probably:

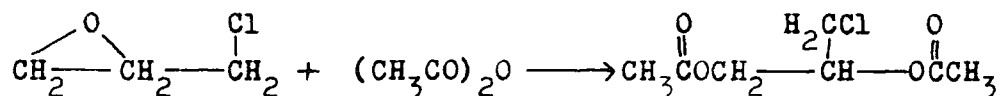

In the cyclohexene oxide case, it is believed that oxidation of the epoxide group by perchloric acid may be the cause of the anomalous results observed. Therefore, it must be concluded that this method is not suitable as an analytical probe for the systems to be investigated. As a result, the uncatalysed acetic anhydride method was investigated.

Uncatalysed Acetic Anhydride Method

The acetic anhydride-pyridine reagent was made by adding 3 volumes of pyridine to 1 volume of acetic anhydride.

A weighed sample containing 10mM of hydroxyl functions was placed in a glass-stoppered iodine flask with 10ml of the above solution. The flask was placed on a steam bath for 45 minutes. Demineralised water (10ml) was added by means of the well on the iodine flask. After two minutes, the flask was cooled under running water. Propan-1-ol (10ml) was added as a rinse for the stopper and sides of the flask. Five drops of thymol blue-cresol red (3:1) indicator were added and the titration carried out with 0.55N methanolic sodium hydroxide.

CALCULATION: As for acid catalysed acetic anhydride method

Using epichlorohydrin as a test material, the solution turned black. The indicator could not be used. Obviously, there was also reaction in this case, although no reaction was anticipated. Using cyclohexene oxide with a phenolphthalein indicator, the end point was almost impossible to detect as a sharp change, however, when the mixed indicator was used, hydroxyl values were obtainable.

DETERMINATION	OH PER MOLECULE
1	0.11
2	0.36
3	0.19
4	0.30
5	0.25

Again, there should not have been any hydroxyl groups present. Since positive results were obtained, there must be a reaction of the acetic anhydride with the epoxide; possibly this reaction is of the form shown below:

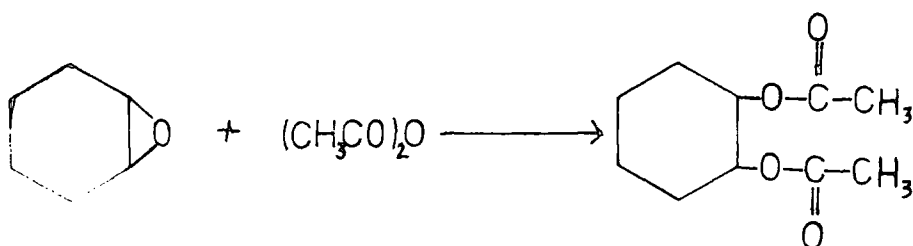

In order to overcome these complications caused by the presence of the epoxide group, a two stage determination was devised. The epoxide content was determined as moles per gram. If the reaction was repeated, omitting the titration, and then followed by the method for hydroxyl determination, a total hydroxyl function figure may be determined. Knowing that one mole of epoxide results in the formation of one mole of chlorohydrin in stage one, then the non-epoxide derived hydroxyl content may be found.

A trial of the above method was carried out, using the pyridinium chloride-pyridine reagent in the first stage and

perchloric acid catalysed acetic anhydride method in the second stage. This gave negative results, presumably due to oxidation of the chlorohydrin by the perchloric acid.

The uncatalysed acetic anhydride method is much longer but involves no perchloric acid oxidizing agent. When this method was employed in the second stage, results were satisfactory. The method was modified slightly to make the weight of resins used suitable for both steps in this analysis.

Modifications

The weight of resin used was approximately 0.2 to 0.3 grams which was expected to contain 2 to 3mM of epoxide (M.W. of the resins had not been determined at this stage). The acetylating reagent in the second stage is 4:1 pyridine-acetic anhydride solution and 5ml aliquots of this reagent were used in the determinations. The reaction was quenched, finally, with demineralised water (16ml).

The reaction scheme in the determination as a whole is as follows:

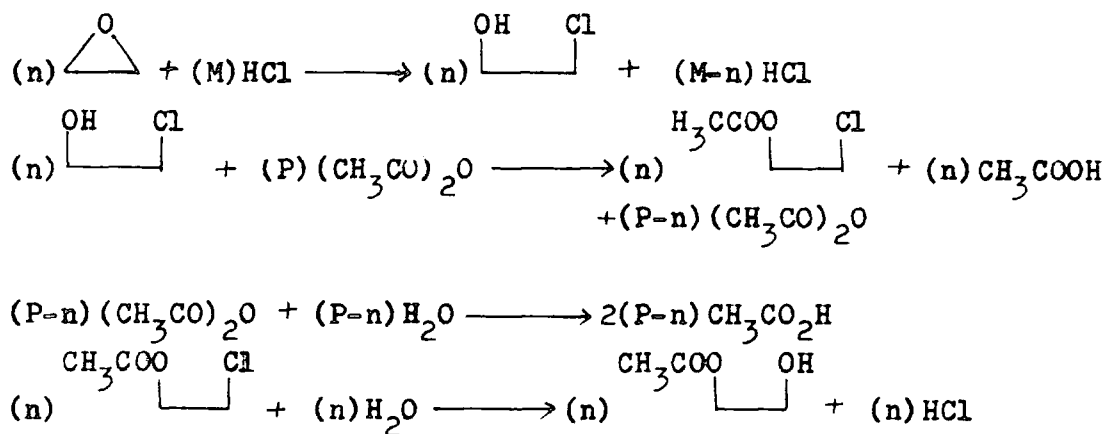

Blank titration ($n = 0$) gives $(2P + M)$ moles of H^+

Determination titration ($n = n$) gives $(M + 2P-n)$ moles of H^+

Blank-Determination gives n moles of H^+

Therefore, n moles of H^+ is equivalent to n moles of hydroxyl groups present. This is total OH, including that derived from the epoxide groups. Therefore, the total hydroxyl group content per gram minus the epoxide group content per gram will give the non-epoxide derived hydroxyl group content per gram of resin.

The results of these determinations are given in Table

4.3, along with results of the molecular weight determination which is described in the next section.

4.4 MOLECULAR WEIGHT DETERMINATION

The molecular weights of the resins were determined by an isopiestic (vapour pressure) method. The apparatus used was the Perkin-Elmer Model 115 Molecular Weight Apparatus. The basic components of this apparatus are shown below:

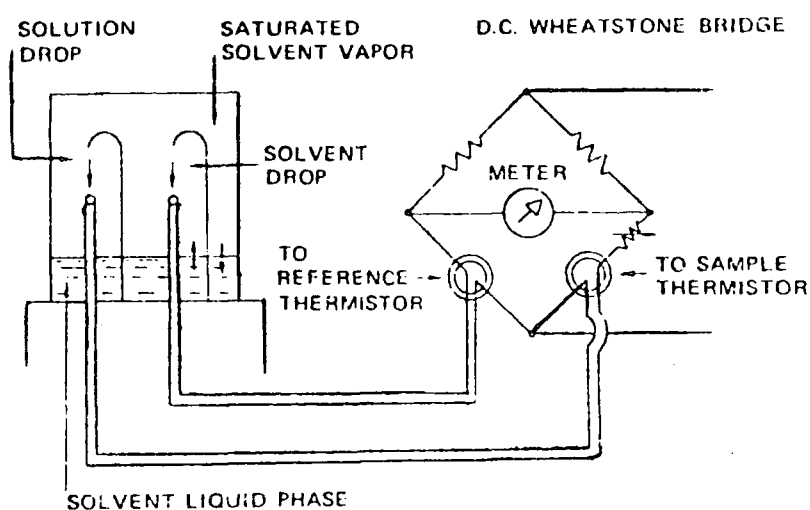

The determination of molecular weight depends on the difference in vapour pressure between a solution and the pure solvent. Two closely matched thermistors, each capable of holding the same size drop of liquid, are contained in a thermostated chamber. In the bottom of the chamber is a reservoir of pure solvent which creates an equilibrated atmosphere of saturated solvent vapour in the chamber. Each thermistor is connected into a Wheatstone bridge to take the place of two resistors, as shown in the diagram above. A drop of pure solvent is placed on one thermistor and a drop of solution on the other. As a result of the unequal vapour pressures, the rate of evaporation/condensation will differ between the two thermistors, thus, giving them a different resistance. This imbalance can be measured with considerable accuracy. When the system is calibrated with material of

TABLE 4.3

RESIN	M _n	EPOXIDE FUNCTION (CHEM. ANALYSIS)	HYDROXYL FUNCTION (CHEM. ANALYSIS)	HYDROXYL FUNCTION (¹⁹ F ADDUCT ANALYSIS)
DY 026	184	1.64	0.14	0.10
CY 177	407	2.01	<0.01	<0.01
CY 179	255	1.80	<0.01	<0.01
LY 558	628	3.36	0.37	0.17
LY 1805	347	1.95	0.25	0.03

FUNCTION - MOLES OF FUNCTIONAL GROUP PER MOLE OF RESIN

known molecular weight, the molality of an unknown solution, under the same conditions, may be found and, hence, the molecular weight of the material.

The instrument was calibrated using benzil as the standard and spectrosol chloroform as the solvent. By plotting a graph of the imbalance in potential (ΔR), measured in arbitrary units against the molal concentration of benzil, an instrument constant (K) may be obtained. K is the gradient of this line and was found to be 43,700 under the conditions of these experiments.

To find the molecular weight of the resins, 4 determinations of ΔR were made for different concentrations of each resin. A graph with $\Delta R/C$ as the ordinate and C as the abscissa was constructed. The best straight line was determined by a least mean squares method and extrapolated to zero concentration; this value is used in the equation (31):

$$M_n = \frac{K}{\lim_{C \rightarrow 0} \Delta R/C}$$

to determine the number average molecular weight. The molecular weights are given in Table 4.3.

4.5 QUALITATIVE AND QUANTITATIVE DETERMINATION OF ALCOHOLIC IMPURITIES IN THE RESINS BY ^{19}F NMR

Hexafluoroacetone (HFA) in ethylacetate solution reacts rapidly with small quantities of organic compounds containing active hydrogen groups, such as alcohols, amines, thiols and oximes, to form adducts.

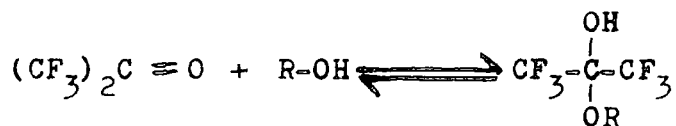

The amount of bound hexafluoroacetone can be determined quantitatively by ^{19}F NMR spectroscopy. Sensitivity over proton NMR is enhanced by virtue of the fact that there are six fluorine atoms for each active hydrogen in the adduct. The reaction is rapid at ambient temperatures and proceeds nearly to completion for primary alcohols and water. However,

it is less complete where there is steric hindrance.

Preparation of Hexafluoroacetone-Ethylacetate Solution

HFA is a toxic gas, attacking liver cells rapidly and must, therefore, be handled with care in a closed system. A solution of 5ml of HFA liquid in 35ml of dry ethylacetate was prepared, using the apparatus in Diagram 4.4. Ethylacetate was dried over molecular sieve for several hours. On addition of 35ml of this solvent to a graduated vessel with a vacuum tap attachment, the solution was frozen using liquid nitrogen. This operation was carried out in a fume-hood. After solidifying the solvent, the system is evacuated to remove any air or residual moisture. Tap A is then closed and the remaining taps opened. By opening Tap B on the HFA cylinder, the bladder is filled with HFA. Taps B and C are closed. The liquid N_2 is removed to allow the solvent to liquify. As the first drops of liquid solvent appear, the bladder reduces, showing that the HFA is dissolving in the ethylacetate. One bladder-full of HFA gave a 5ml increase in solution volume. Tap D is closed and with Tap B also closed, the system is opened to air under the closed fume-hood to allow all of the remaining gas to be expelled.

Qualitative Analysis

Accurate chemical shifts were determined on approximately 20mg of sample, using the Bruker 90 MH_3 Nuclear Magnetic Resonance Spectrometer. The results were interpreted with the aid of papers by G.R. Leader (32 & 33) and K.D. Bartle, R.S. Matthews, and J.W. Stadelhofer (34). The interpretation is given in Table 4.5.

Resins DY 026 and CY 179 show low intensity signals at ~ 0.8 ppm downfield of $HFA.H_2O$. These could not be from alcoholic groups but are found in the region where mercaptan-HFA adducts give signals. The suggestion that these groups are thiols, or some similar sulphur containing groups, is backed up by identification of a trace amount of sulphur in the elemental composition of resins DY 026, CY 177 and CY 179. The amount of sulphur present is so small that it does not merit further investigation at this stage. One possible origin of the sulphur is from sulphuric acid which is commonly

DIAGRAM 4.4

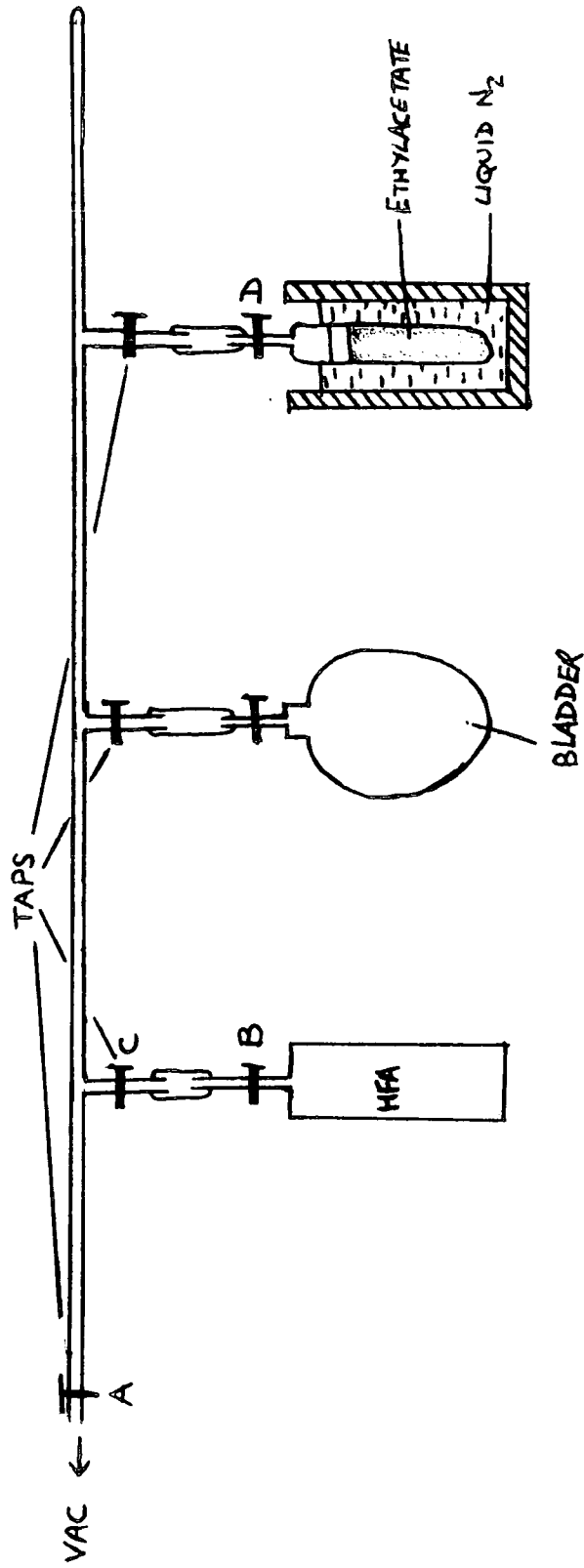

DIAGRAM 4.4

used as a catalyst in the epoxidation of olefins.

Quantitative Analysis

The reaction is reported to be quantitative for primary and secondary alcohols, at room temperature over about twenty minutes, by F.L. Ho (35). The Varian 360L 60 MHz ^{19}F NMR Spectrometer was used to obtain the ^{19}F spectra of weighed amounts of resin in ethylacetate-hexafluoroacetone solution. By using a known amount of propan-1-ol as a standard and assuming complete reaction in all cases, the results recorded in Table 4.3 were obtained. It was found experimentally that the smallest concentration of OH measurable was 3×10^{-5} moles per gram.

When a comparison is made with wet chemical analysis results, it is seen that in each case the ^{19}F NMR results are lower than the chemical analysis results. This is presumably because much of the hydroxyl functionality is derived from epoxide ring opening by water, resulting in 1,2 diol formation. Since this technique is sensitive to steric hindrance, one can envisage incomplete reaction at this point, caused by increased hindrance in the primary 1:1-adduct. In these structural units, five-membered ring formation may occur by interaction of the lone-pair of electrons on the secondary oxygen atom with the central carbon atom of HFA which will be somewhat electron deficient, due to the trifluoromethyl groups.

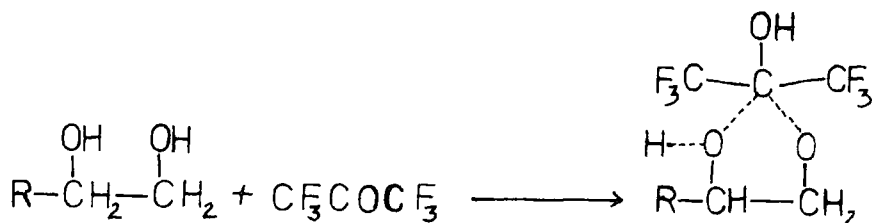

In the extreme case, this may continue to full formation of a cyclic ketal. This could also account for the peaks at 0.8 ppm downfield of HFA.H₂O which have not been properly identified.

From the nature of the technique, it is clear that these results must be regarded as minimum rather than maximum estimates of hydroxyl content. Conveniently, the chemical analysis must be regarded as giving maximum values, since it involves a back titration. From these two techniques, a

TABLE 4.5

RESIN	Δ ppm REL. TO HFA.H ₂ O	ASSIGNMENT
DY 026	0.83 2.66	THIOL ? PRIMARY OH-HFA
CY 177	1.36 2.65	TERTIARY OH-HFA PRIMARY OH-HFA
CY 179	0.87 1.80	THIOL ? SECONDARY OH-HFA
LY 558	1.86 2.08 2.65	SECONDARY OH-HFA SECONDARY OH-HFA PRIMARY OH-HFA
LY 1805	1.76 1.89 2.47 2.58	SECONDARY OH-HFA SECONDARY OH-HFA PRIMARY OH-HFA PRIMARY OH-HFA

qualitative and quantitative inspection of functional groups and functionality has been carried out on the resins.

4.6 STRUCTURAL ANALYSIS BY ^1H AND ^{13}C NMR SPECTROMETRY

The ^1H and ^{13}C NMR spectra of each resin were recorded, using the Bruker 90 MH_3 and the Varian 360L 60 MH_3 spectrometers. The interpretations of both spectra of each resin have been considered together. Using information on the types of epoxide resins commercially available from the 'Handbook of Epoxy Resins' (4), which includes an appendix of infra-red spectra, combined with the guidance of Dr R.S. Matthews, the structures of the resins were elucidated.

(a) LY 558

Although regions for aromatic protons, protons influenced by epoxide groups, and aliphatic protons may be identified in the ^1H NMR spectrum of this resin, it is too complicated to be of analytical use and provides little qualitative information.

The assignment of peaks in the ^{13}C spectrum is given in Table 4.6. The position of the carbon atoms which give rise to these peaks is shown on the proposed structure of the resin. Due to the Nuclear Overhauser Effect, the interpretation of this spectrum was made somewhat easier, although integral values had little meaning in terms of numbers of carbon atoms. The comparison of this spectrum with the spectra of the following cyclophanes (36) was also very useful in assigning observed resonances.

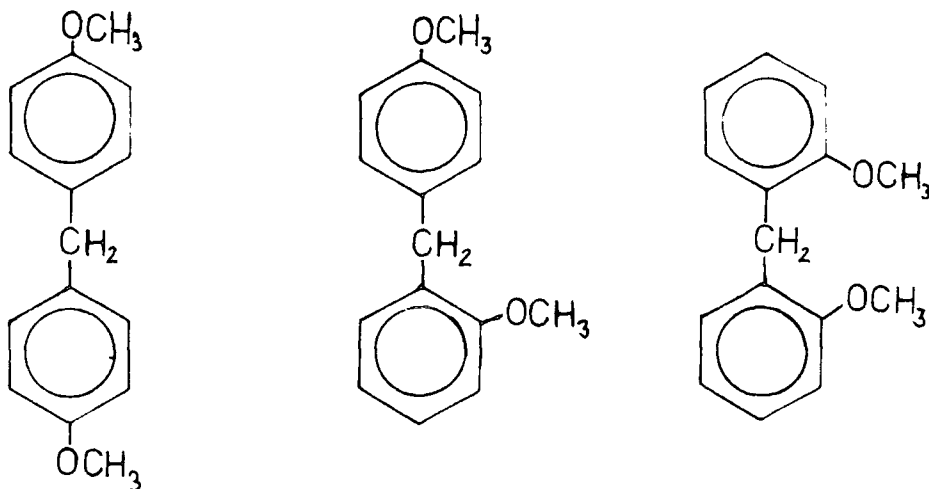
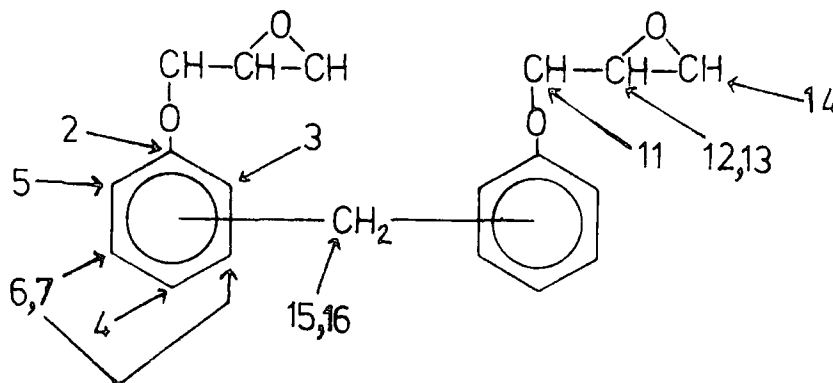

TABLE 4.6

 ^{13}C NMR SPECTRUM OF LY 558

No	ppm DOWNFIELD OF TMS	ASSIGNMENT
2	131.0	AROMATIC C ₁
3	130.1	AROMATIC C ₂
4	129.7	AROMATIC C ₄
5	127.4	AROMATIC C ₆
6	114.6	AROMATIC C ₃₊₅
7	111.7	AROMATIC C ₃₊₅
11	68.9	METHOXY CH ₂
12	50.2	EPOXIDE CH
13	49.8	EPOXIDE CH
14	44.6	EPOXIDE CH ₂
15	40.2	METHYLENE CH ₂
16	35.2	METHYLENE CH ₂

PROPOSED STRUCTURE OF LY 558



The ^{13}C spectra of epoxide groups has been investigated by W. Moniz and C. Poranski Jr. (37), and S. Davies and G. Whitham (38). A paper on the ^{13}C NMR analysis of formaldehyde resins by Jan de Wit and co-workers (39) was also useful here but, unfortunately, did not deal with the epoxy formaldehyde resins.

Since there are two methylene environments, it appears that the aromatic rings may be ortho or para linked.

(b) LY 1805

The ^1H spectrum of this resin was most useful in elucidating its structure. The assignment of the peaks is given in Table 4.7. The aromatic portion of the spectrum shows that the aromatic ring(s) has the substitution pattern:

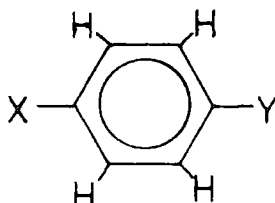

Methyl, methoxy, and epoxide groups are also seen to be present, their relative abundance, as determined by the integration, is also a useful guide in this case, suggesting that the ratio of methyl:methoxy:epoxide:aromatic ring groups is 1:1:1:1.

The ^{13}C NMR spectrum of LY 1805 was interpreted in the same manner as LY 558, using the same references. The assignments are given in Table 4.8 and the environments shown on the proposed structure. Comparisons of the spectra of LY 558 and LY 1805 give good agreement where agreement is expected and deviations in the directions expected in other cases.

(c) DY 026

The ^1H spectrum of this resin was very complex and, although there were regions which indicated the presence of methylene, methoxy and epoxy groups, unambiguous quantitative analysis was found to be impossible.

The ^{13}C spectrum was of much more use, allowing detailed qualitative analysis and giving some indication of ratios. The ratios may be taken only as a rough guide here because of

TABLE 4.7¹H NMR SPECTRUM OF LY 1805

ppm DOWNFIELD OF TMS	SPLITTING	RATIO	ASSIGNMENT
1.75	SINGLET	6	METHYL CH ₃
2.86	SEXTET	4	METHOXY CH ₂
3.42	MULTIPLY	2	EPOXY CH
4.18	SEPTET	4	EPOXY CH ₂
7.13	QUARTET 1:2:2:1	9	AROMATIC CH

TABLE 4.8

 ^{13}C NMR SPECTRUM OF LY1805

No	ppm DOWNFIELD OF TMS	ASSIGNMENT
1	155.8	AROMATIC C_1
2	143.0	AROMATIC C_4
3	127.2	AROMATIC C_{2+6}
4	113.4	AROMATIC C_{3+5}
5	68.2	METHOXY CH_2
6	49.6	EPOXIDE CH
7	44.0	EPOXIDE CH_2
8	42.1	TERTIARY $-\text{C}(\text{CH}_3)_2-$
9	30.5	METHYL CH_3

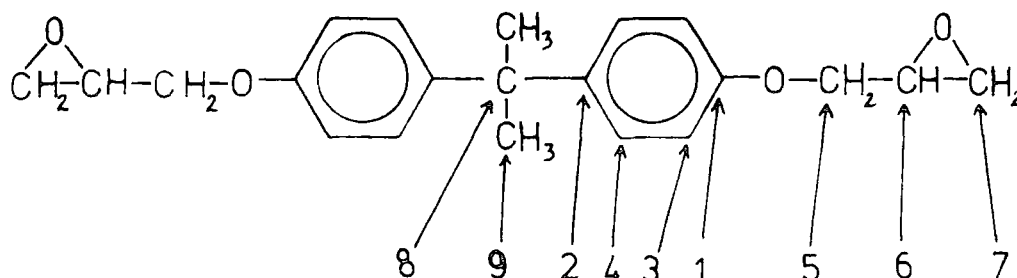
PROPOSED STRUCTURE OF LY 1805

the Nuclear Overhauser Effect. Table 4.9 gives the assignment of the peaks in this spectrum and the proposed structure is numbered to indicate the assignments made.

(d) CY 179

The ^1H spectrum of this compound was rather broad and complicated. However, qualitative identification of cyclic methylene, epoxide, and methoxy groups was possible. Integration of these regions seemed to have little meaning.

The ^{13}C spectrum was also difficult to interpret fully. Cyclohexene oxide was used as a comparison but was of limited value in assignment of particular environments within the aliphatic ring. The carbonyl carbon environment was easily distinguished along with the methoxy and epoxide environments. The Nuclear Overhauser Effect also made any attempt to use the integration ratios valueless.

The decision upon the structure of this resin was made with some difficulty, using all of the analyses and characterisations carried out as well as some intuitive thought. The assignment of peaks has been tabulated (Table 4.10) along with the assignments for CY 177 which has turned out to be a very similar resin. Those specific environments which were identified are shown on the proposed structures. In such cycloaliphatic epoxides, there is further confusion introduced by the possibility of isomerism about the epoxide group.

(e) CY 177

The ^1H NMR spectrum of CY 177 was very similar to that of CY 179, showing epoxide, methoxy and methylene groups to be present but giving no useful information about their relative abundance.

The ^{13}C spectrum was also similar to that of CY 179. However, there was some shift in the peaks, particularly the carbonyl peak which suggests that the main difference between the two is in that area. There are also more methylene-type groups in CY 179 than in CY 177 which is accounted for in the two proposed structures by virtue of the different modes of linking the two rings.

TABLE 4.9

 ^{13}C NMR SPECTRUM OF DY 026

No	ppm DOWNFIELD OF TMS	RATIO	ASSIGNMENT
2	71.7	4.0	METHOXY CH_2O
3	71.1		METHOXY CH_2O
4	50.7	1.0	EPOXY CH
5	43.7	1.7	EPOXY CH_2
6	26.5	2.3	METHYLENE CH_2

PROPOSED STRUCTURE OF DY 026

TABLE 4.10

No	CY 179	CY 177	ASSIGNMENT
	ppm DOWNFIELD OF TMS	ppm DOWNFIELD OF TMS	
1	174.3		CARBONYL C - O
2		172.5	CARBONYL C - O
3	67.6	67.7	METHOXY CH ₂ -O
4	51.3	51.8	EPOXY CH
5	50.5	50.8	EPOXY CH
6	50.0	50.3	EPOXY CH
7	37.2		
8	35.2		
9		33.2	
10	31.7	31.7	METHYLENE GROUPS -CH ₂ -
11	29.0	29.0	
12	27.5	27.7	
13	26.6	26.7	
14	25.7		
15	23.9	23.9	
16	23.1	23.2	
17	22.3	22.4	
18	20.5	20.6	

PROPOSED STRUCTURE OF CY 179PROPOSED STRUCTURE OF CY 177

4.7 MASS SPECTRAL ANALYSIS

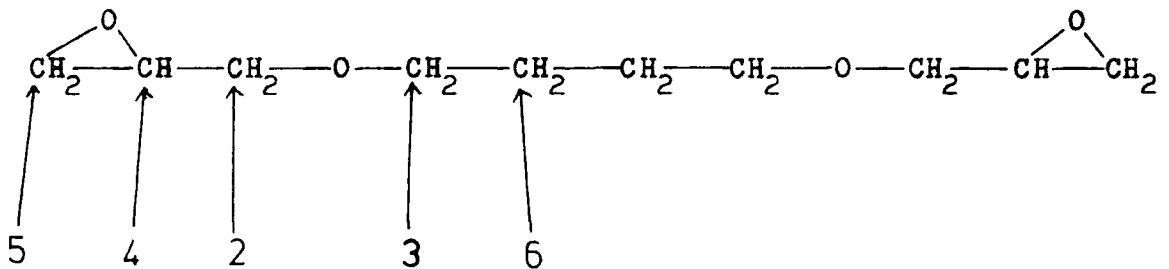
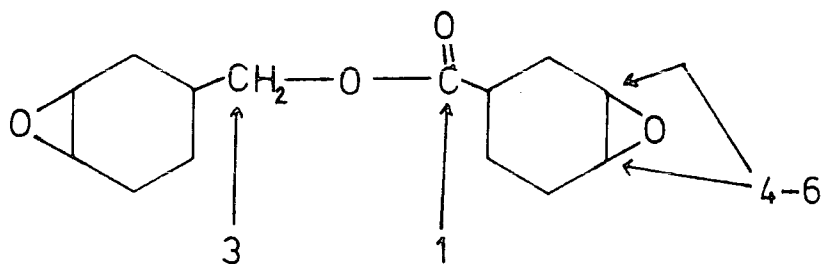
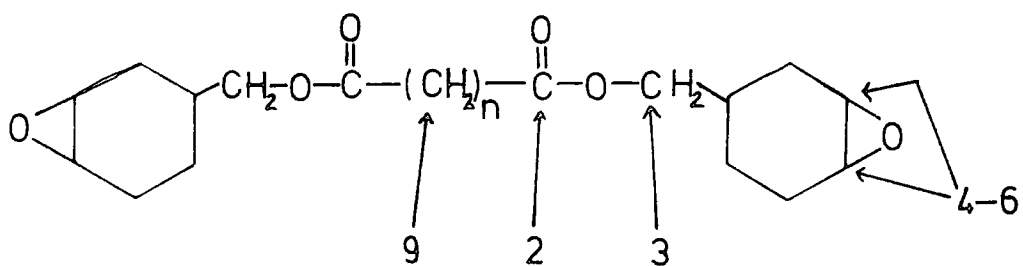

The mass spectra of the resins were obtained, using an AEl MS9 mass spectrometer. Due to the complexity of the monomer structures involved, many intense peaks were observed in each spectrum. In order to avoid lengthy tables of results only the molecular ion peaks and largest fragments detected are included in the Table (Table 4.11). The mass spectra give a good retrospective analysis of the structures of the five monomers. The majority of the major fragments are assignable to parts of the proposed structures of the resins; however, not all of the observed peaks were assigned. The variation in chain length seems to be greatest for the bis-phenol F type resin, LY 558, where pentamers have been detected, towards the higher m/e end of the mass spectrometers range. There is also some telomerisation in the other resins (CY 177 and LY 1805) where mass spectra show mass to charge ratios of $1\frac{1}{2}$ to $2\frac{1}{2}$ times that of the monomer involved.

4.8 CONCLUSIONS

A satisfactory analysis of resins LY 558, LY 1805 and DY 026 has been carried out with no previous knowledge of their nature. The identification of resins CY 177 and CY 179 has been made sufficiently well to propose structures, although it is realised that these two structural assignments were a little tenuous, as complete characterisation was not possible. In each of the five cases the structure arrived at experimentally, was confirmed by the information on the nature of the resins received from Ciba-Geigy at a later date (Appendix 2). These structures were also supported by the results of mass spectral analysis.

Having identified the resins, their infra-red spectra compared favourably with those of the same monomers produced by different companies (4). It was not possible to use this method of identification previously because many of the resins produced commercially have very similar spectra in the $4000-800\text{cm}^{-1}$ part of their spectra, given in the 'Handbook of Epoxy Resins' (4). Without a positive match in the fingerprint region of the spectrum ($800-200\text{cm}^{-1}$), this comparison is only a negative check.

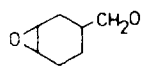
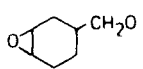
TABLE 4.11

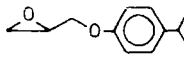
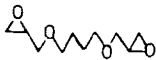
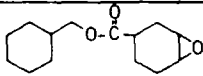
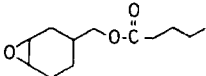
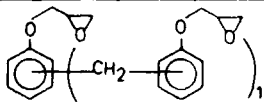
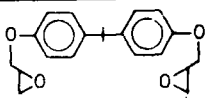
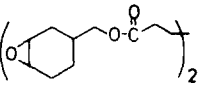
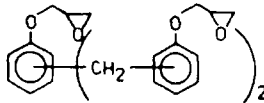
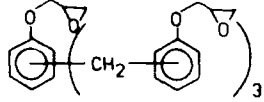
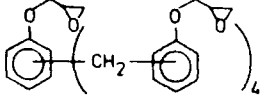
M/e	DY 026	CY177	CY179	LY 558	LY 1805
127					
129					
191					
202					
236					
239					
313					
340					
366					
475					
638					
802					

Analysis of purity with respect to functionality has been carried out by two independent methods based on different principles. Due to the completely different approaches to the analysis, both upper and lower limits of the hydroxyl and epoxide functionality of the resins has been achieved.

However, because of the exact agreement between the analysis carried out here and the data from Ciba-Geigy, together with the absence of any contrary results from mass spectral analysis and infra-red comparisons, the author is satisfied that the techniques employed here are useful and effective in the elucidation of the nature and even the structure of the epoxide resins used as starting materials in this work.

CHAPTER FIVE

THE COATINGS:
PREPARATION AND EXAMINATION

5.1 INTRODUCTION

The identification and characterisation of the materials to be used in the investigation of photoinitiated cure have provided a good platform on which to base preliminary investigations. This chapter deals with the curing of some lacquers prepared from the five resins and the photoinitiator, diphenyliodonium hexafluorophosphate.

5.2 THE CONDITIONS OF IRRADIATION

The radiation source must, of course, provide energy which can be absorbed by the photoinitiator, causing its decomposition. In Chapter Three, it was reported that the maximum absorption occurs at 225nm, however, it has been reported (17) that irradiation at wavelengths between 200 and 360nm produces the desired effect because the absorption has a long tail, extending as far as 365nm.

An Hanovia LL Photochemical Reactor was available which is comprised of: a mercury lamp (approximately 100 watts) in a synthetic, high purity quartz envelope; a clear quartz thimble; and a one litre reaction vessel. This particular arrangement was of little use in the curing of films, and was adapted to suit the needs of the following investigation (Diagram 5.1). The lamp was mounted horizontally rather than vertically, with the thimble in place around the quartz envelope. The whole source was shrouded in an aluminium casing for the protection of the user.

The UV emission from the medium pressure lamp includes wavelengths of 185, 238, 248, 254, 265, 280, 297, 302, 313, and 366nm. Cooling water was pumped through the thimble to avoid heating within the shield affecting the reaction temperature. Nitrogen gas was allowed to flow through the envelope to purge it of oxygen and thus eliminate the formation of ozone.

All irradiations were carried out with substrates deposited on either polyethylene or polytetrafluoroethylene sheet mounted on a laboratory jack. In this way the irradiation conditions for each film could be fairly well defined, the distance from the lamp could be varied as could the time of irradiation, and, if necessary, filters could be circulated around the

FIGURE 5.1

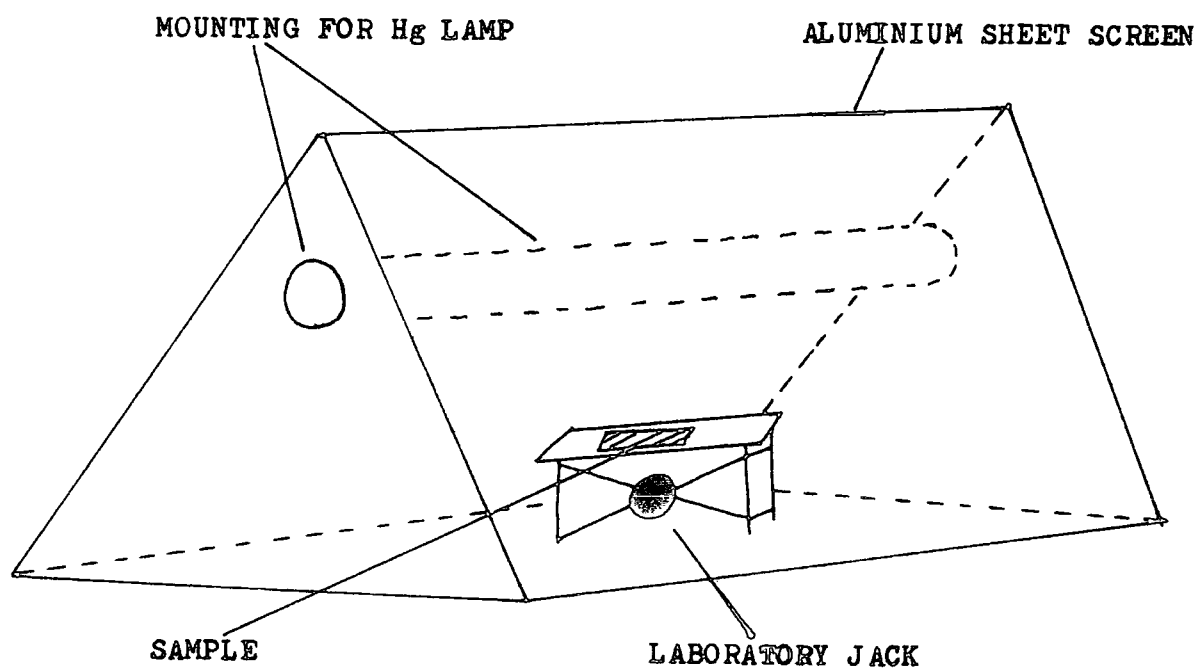
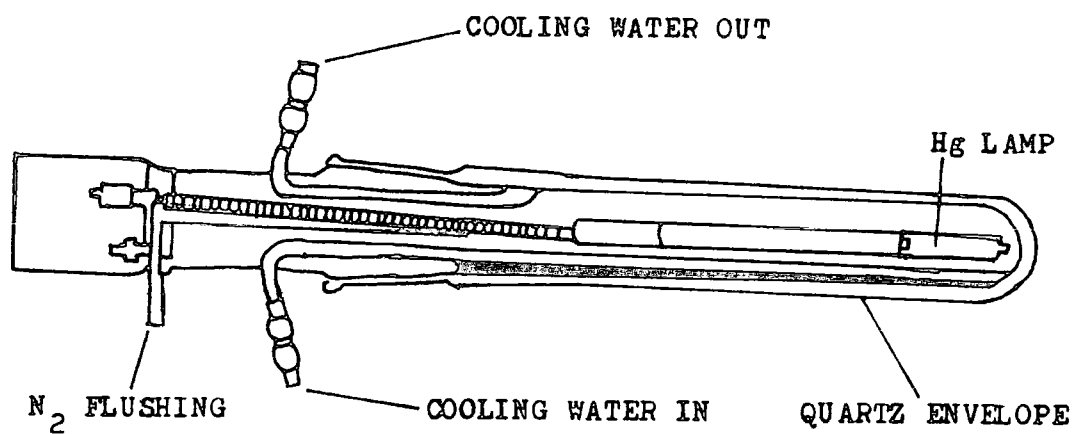

lamp. In the work carried out, the distance was maintained constant at 18cm and the lamp output was unfiltered, the only variables being the time of irradiation and the age of the lamp.

5.3 QUALITATIVE COMPARISON OF CURE RATES

The rate at which coatings cure is frequently based on a subjective judgement of the time required for a film to become non-tacky to the touch. The test is simple and widely used, but it is difficult to quantify. Although an instrument has been developed by W.R. Watt at the Princeton Research Centre, New Jersey, U.S.A., there is no commercially available apparatus for such tests. Consequently, the author has improved the tack-free test to incorporate a pencil hardness test. This also has an element of subjectivity, however, it is hoped that some improvement in reproducibility has been attained. Certainly, this modified procedure proved more useful as a qualitative and comparative measurement of the post irradiation cure observed in the materials investigated in this work.

It is important that the systems under investigation are as simple as possible if useful results are to be obtained at this stage. The systems considered were simple lacquers which have the formulation : 97% resin, 2% photoinitiator (PII) and 1% acetone, for resins LY 1805, DY 026, CY 177 and CY 179. Since resin LY 558 is a solid, with a melting point close to room temperature, an additional component, toluene, was required to produce a mobile lacquer. In this case, the formulation was 83% resin, 14% toluene, 2% photoinitiator (PII) and 1% acetone. The acetone was necessary since the photoinitiator will not dissolve in the resins directly. One would have liked to have avoided the use of acetone and ketones generally as solvents for the photoinitiator to eliminate any confusion when photochemical implications are studied. However, this was not possible because this photoinitiator had a low solubility in a wide range of alternative solvents.

Each lacquer was applied to a piece of polyethylene sheet, using a draw-down block which is simply a steel cube with a

hole drilled through two faces and a channel of a defined depth, between 15 and 300 microns, cut in one face perpendicular to the hole.

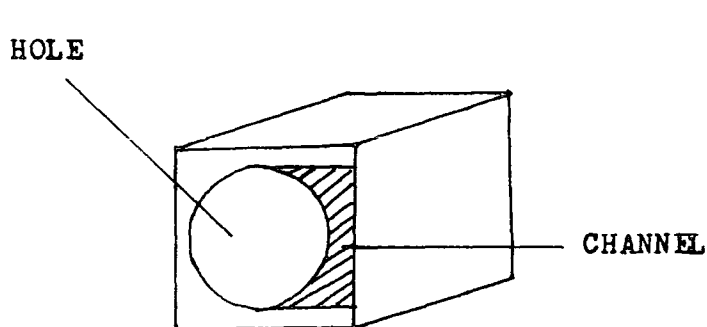

With the block standing on the front face, the hole is filled with lacquer and then drawn down the polyethylene sheet in the opposite direction to the channel, thus, leaving a film of lacquer of given width and depth. By measuring the width after cure, one can assess the spreading of the film (if any) by comparison with the width of the channel and, if necessary, calculate the resulting change in depth.

After attempting to cure the films with the ultra-violet source described in 5.2, the hardness of the film was tested by establishing which of a set of pencils, ranging from 2B to 7H, would mark the surface. This test was repeated at given intervals during the post cure. Rather like the geologists Mohr Scale, this is qualitative and cannot be considered to be even semi-quantitative, since there is no reason to assume that the increase in hardness at each point in the scale is equal to that at the previous point.

This test gave useful results on the cure of the two aromatic resins LY 1805 and LY 558. The results were tabulated and then displayed graphically. Nine different thicknesses of film were cured and a uniform change in cure rate with thickness was observed. Only four results for each resin have been displayed on graphs 5.2 and 5.3 in order to avoid congestion. The expected pattern emerges and is explained by Beer's Law. An increase in film thickness produces an increase in the cure time, as a result of the reduction in light

FIGURE 5.2

CURE OF LY 1805 LACQUER

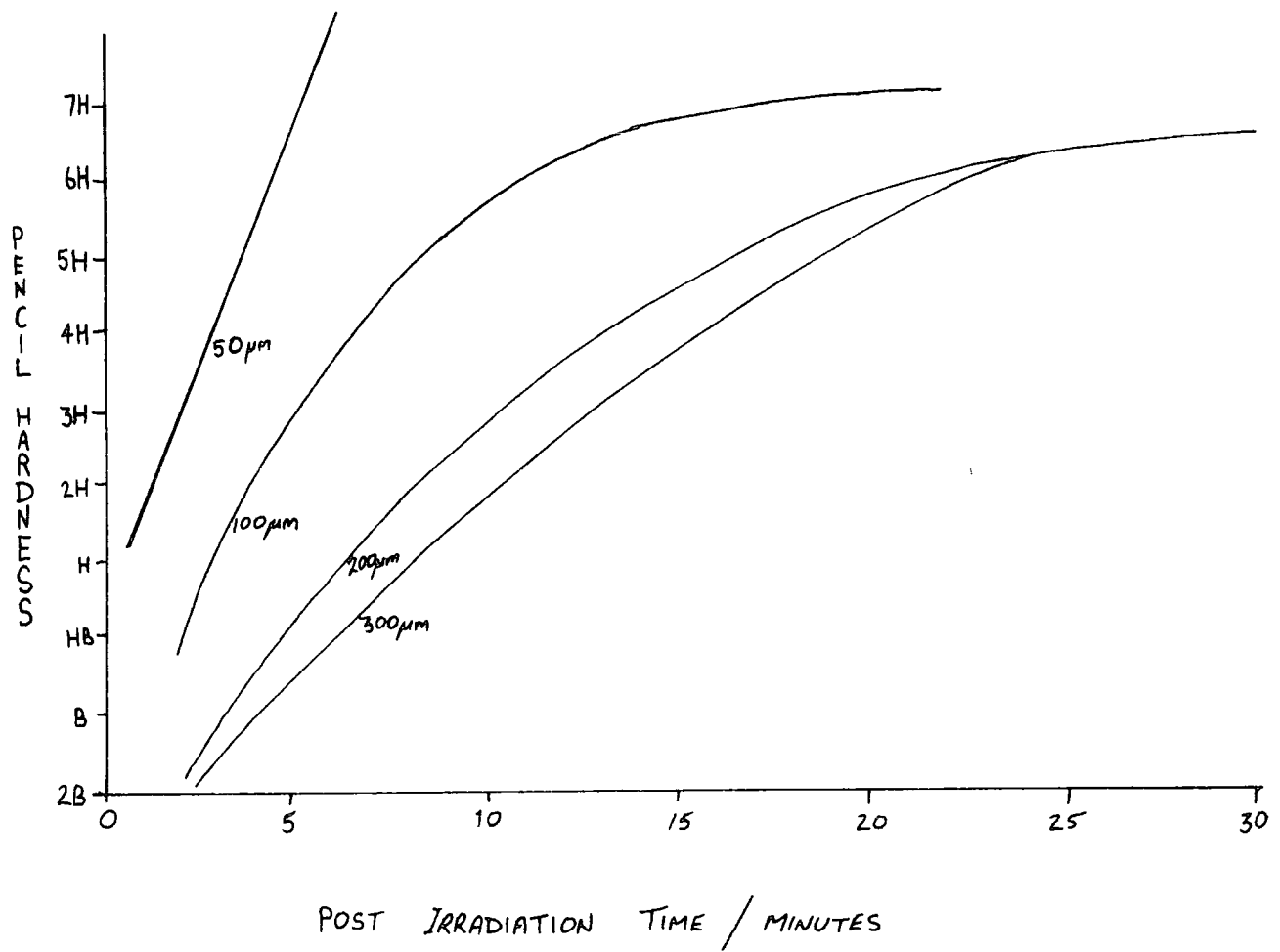
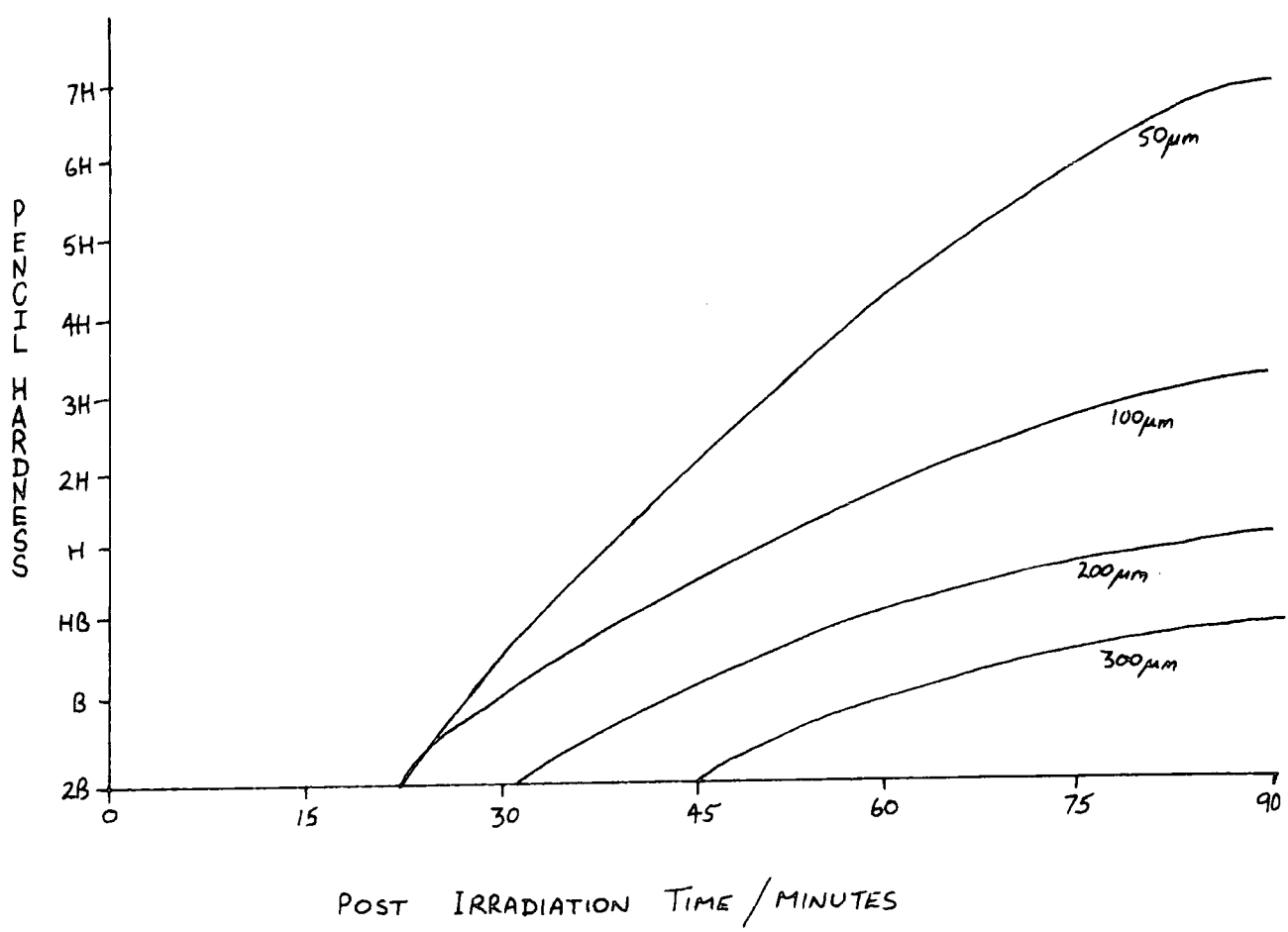

FIGURE 5.3

CURE OF LY 558 LACQUER



penetration into the lower layers of the film.

Attempts to cure DY 026 in this manner were thwarted by the mobility of this resin which is sold as a reactive diluent. The two aliphatic resins CY 177 and CY 179 were applicable only to a thickness of 200 microns because of the spreading resulting from their mobility. In those films which were cured, considerable shrinkage was observed, thus, at thicknesses of 50 microns and below, the 'cured' film had the appearance of Swiss cheese (large areas of voids) and the pencil hardness test was impossible to apply. The remaining films (75-200 microns) were tested, using the pencil hardness test but were found to have cured only on the surface, even after one month. The degree of surface hardness of these films corresponded at a maximum to that of an HB pencil. The results have not been displayed graphically because the tests were considered to be too subjective. This phenomenon will be discussed more fully in Section 5.5.

5.4 QUANTITATIVE COMPARISON OF CURE RATES

The cure kinetics of bisphenol A epoxide resin-anhydride systems have been investigated by infra-red spectroscopy by G.C. Stevens (40 & 41). The use of infra-red absorption as a method of observing cure is also described in the 'Handbook of Epoxy Resins' (4). During cure, two phenomena are involved: the opening of epoxide rings leading to chain extension or crosslinking, depending on the method of cure and resin functionality; crosslinking via condensation reactions, leading to ether links. One may follow cure by observation of either the disappearance of epoxide rings or the appearance of hydroxy and ether groups.

For the two aromatic resins, it was decided to follow the cure by infra-red spectroscopy. It was found from several trials that the optimum film thickness was circa 100 microns. By recording the spectrum of a resin between 1800cm^{-1} and 800cm^{-1} continuously during the post cure period, the disappearance of epoxide groups at 920cm^{-1} (epoxide deformation) may be observed. The height of this peak was normalised by expressing it as a proportion of the height of the aromatic breathing mode at 1605cm^{-1} which, theoretically, should not change in

intensity. This technique proved to be quite successful for the aromatic resins but was of little use for the linear aliphatic resin DY 026 because of its mobility, and resins CY 177 and CY 179 because of the dramatic shrinkage involved with these materials. The work referred to above was carried out on conventionally cured films between sodium chloride plates, unfortunately, this was not practical here from a financial point of view. However, the use of very thin polyethylene sheets, both as a substrate to form films on and also in the reference beam of the Perkin-Elmer 377 infra-red spectrometer, gave satisfactory results.

By recording the infra-red spectrum of the lacquers before irradiation, and assuming that the normalised absorbance at 920cm^{-1} (absorbance at 920cm^{-1} - absorbance at 1605cm^{-1}) to be equal to 100% of the epoxide groups present, then the cure could be recorded as the percentage of epoxide groups remaining after irradiation, and changes in this number could be monitored as a function of time. This procedure was carried out for lacquers of resins LY 1805 and LY 558, receiving irradiation for periods of 5 and 10 minutes. The results are recorded graphically in Figures 5.4 and 5.5.

A comparison of the extent of cure during the irradiation period and the nature of the post irradiation cure process is possible within each system but not between systems, as the LY 558 lacquer has an extra component (toluene) in its formulation. There are some striking differences in the behaviour of the two materials. The results for the novolak epoxide system LY 558, Figure 5.4, show that after 5 minutes irradiation only about 2% of the epoxide functionality has been consumed, and the post irradiation cure is a slow process which continues for the whole period during which measurements were taken (20 minutes), and possibly longer. By contrast, when exactly the same formulation is irradiated for 10 minutes, the extent of cure at the end of the irradiation period is about 50%, and the post irradiation cure process is apparently completed after a further 30 minutes. Figure 5.5 shows that the behaviour of the bisphenol A epoxide system, LY 1805, is similar for both 5 and 10 minute irradiation treatments. In the former case, the extent of cure immediately after

FIGURE S.4 CURE OF LY 558 LACQUER

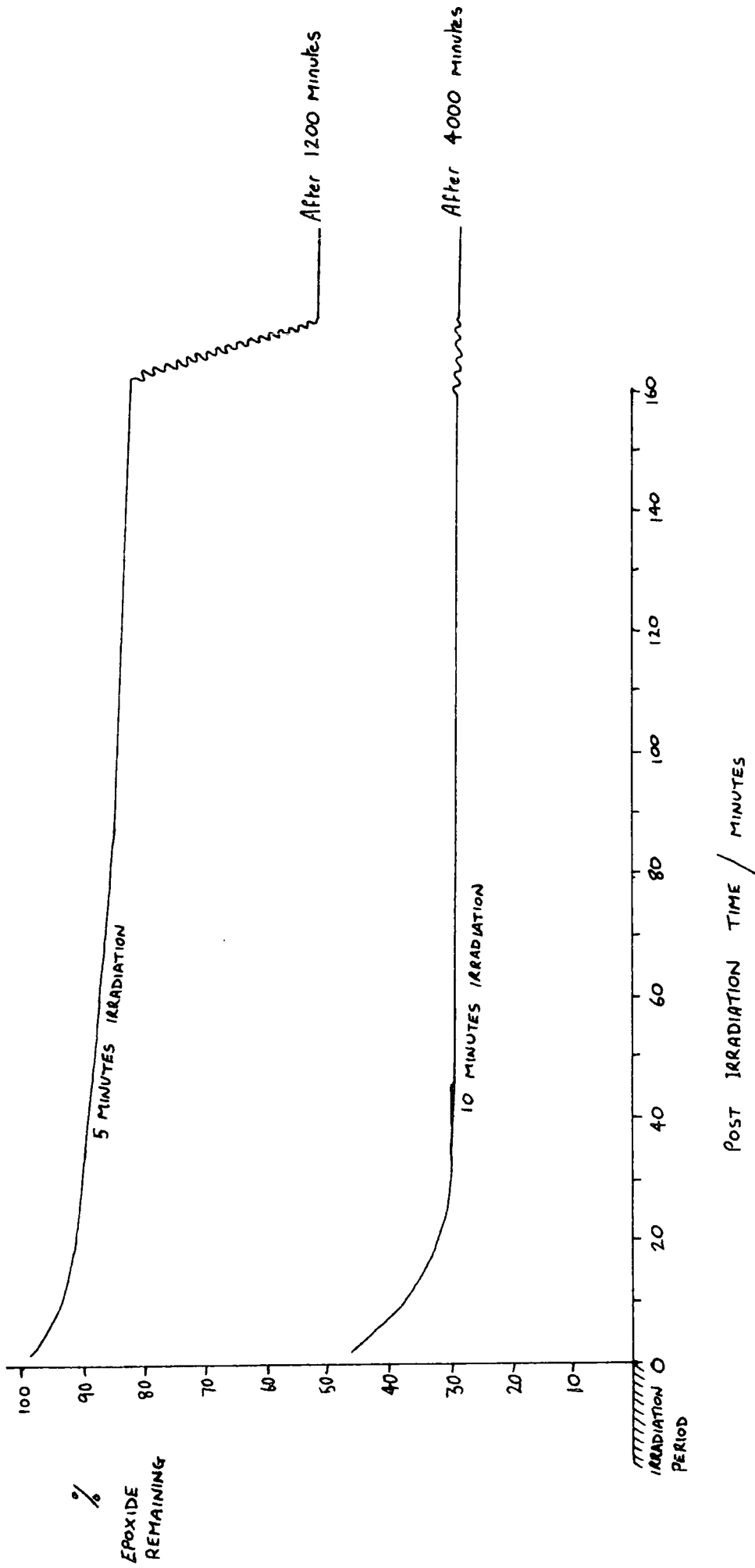

POST IRRADIATION TIME / MINUTES

% EPOXIDE REMAINING

IRRADIATION PERIOD

FIGURE 5.5 CURE OF LY 1805 LACQUER

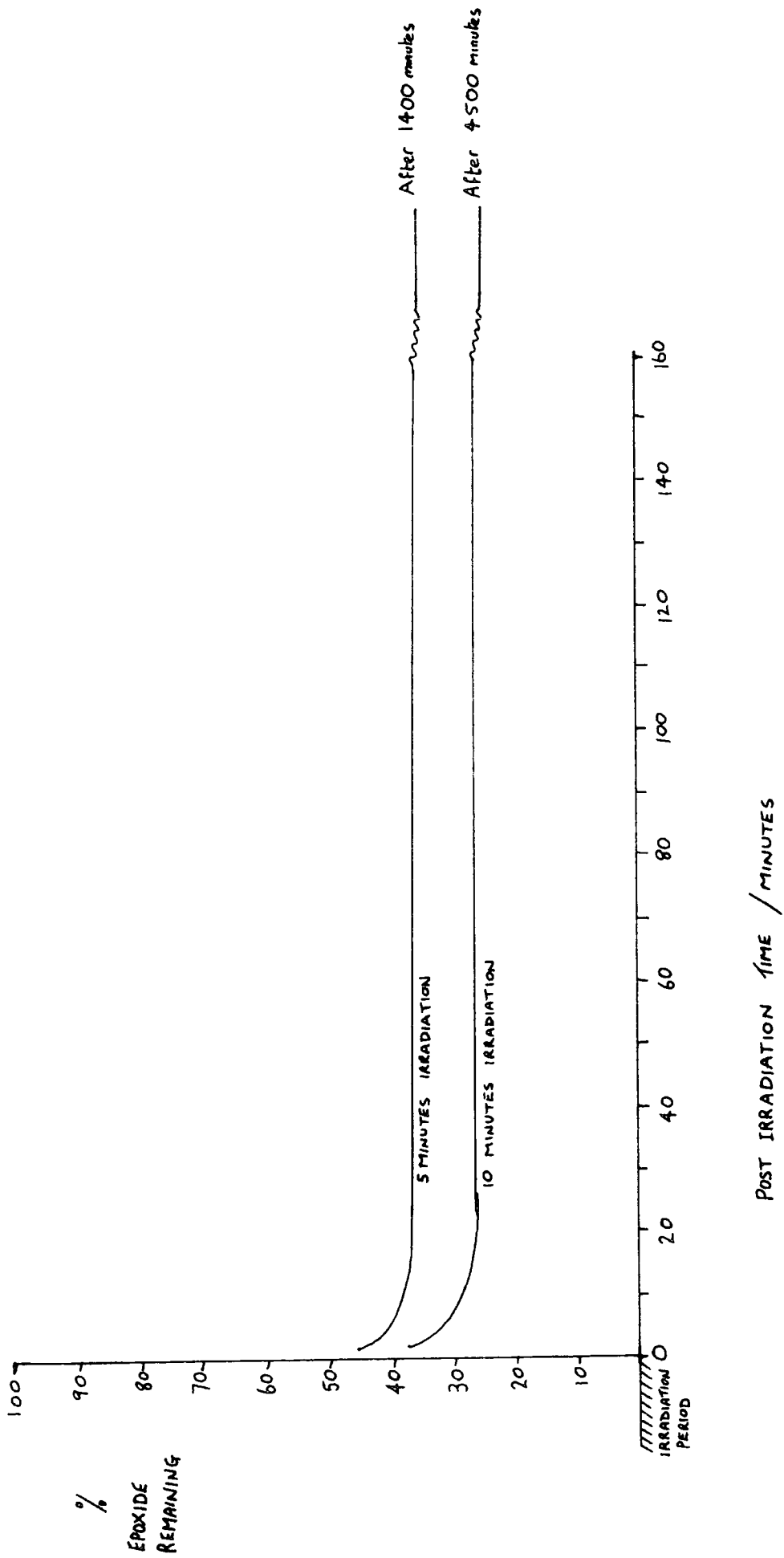

irradiation is about 50% with an additional, relatively small post irradiation cure occurring within 30 minutes, and in the latter case, the cure on irradiation is about 60% with a similar small and rapid post irradiation cure.

This limited set of results with aromatic epoxide systems raises some interesting points. Firstly, as might reasonably be expected, it is clear that the extent of cure depends on the radiation dose received by the system. Secondly, a post irradiation cure process occurs and, in three out of four cases looked at here, the rate of this process decays rapidly and is virtually complete after 30 minutes. Thirdly, even after a fairly lengthy post irradiation period, there is still a significant concentration of epoxide functionality remaining. The spectacular difference between the 5 and 10 minutes irradiation of the novolak formulation is difficult to explain. It seems that there may be an induction period for the photo-chemical cure process in this case. Alternatively, the toluene diluent may be affecting the cure process.

The next stage of this work ought clearly to be the expansion of this initial set of observations. Variation of the irradiation dose, and the rate at which it is provided, would be the first stage in the continuation of the investigation.

5.5 THE SURFACE CURE PHENOMENON

This section deals with the surface cure effect observed for lacquers of resins CY 177 and CY 179. After 10 minutes irradiation of a 200 micron film of the above lacquers, only surface cure is observed. Increasing the irradiation time to 30 minutes fails to achieve through cure.

In order to cure the DY 026 lacquer, the most mobile of the five, a crystallising dish was used to hold the resin during the cure process. Through cure of a film 750 microns thick was achieved after 30 minutes irradiation. Under the same conditions, only surface cure was observed for 750 micron films of resins CY 177 and CY 179. However, in these cases, by contrast to thinner films, no wrinkling nor shrinkage damage of the film surface was observed which is clearly due to the mobile reservoir of liquid below the cured surface

layer. As a comparison, a lacquer of cyclohexene oxide, formulated in the same way, was exposed to 30 minutes irradiation. The lacquer 'set' but remained tacky for several days. One does not expect as complete a cure for this monofunctional epoxide since no crosslinking should occur and the product is expected to be a linear polymer, plasticised with unreacted monomer.

Having cured these lacquers, it was seen that the linear aliphatic epoxide (DY 026) and the cycloaliphatic epoxide (cyclohexene oxide) achieved through cure, whereas the cycloaliphatic epoxide carboxylates (CY 177 and CY 179) did not. It appears that the group responsible for this effect is the carboxylate group.

Since the photoinitiation of cure is being used in this work, it seemed sensible to check if the presence of an ester unit would be likely to affect the photochemistry. Since all of the aliphatic epoxide systems, and the aliphatic ester epoxide systems, absorb below 200nm, it seems most unlikely that they would prevent the diphenyliodonium salt being excited, indeed, the aromatic epoxides might have been more likely to mask the absorption bands of the initiator. However, there is a window in the absorption of the resins where the photoinitiator absorbs. Resins CY 177 and CY 179 also absorb radiation of energies much higher than that of the photoinitiator and, therefore, it is most unlikely that they could act as quenchers. Therefore, we must conclude that the effect is not photochemical. In order to check that the carboxylate group is in fact responsible for this effect, cyclohexylhexanoate was prepared. By adding small quantities of this compound to lacquer DY 026, and to a lacquer of cyclohexene oxide, the effect of the carboxylate group upon their cure may be observed. Cyclohexylhexanoate was prepared as follows below.

Preparation of Cyclohexylhexanoate

Cyclohexanol (25ml) and hexanoic acid (25ml) were placed in a 250ml round-bottomed flask along with benzene (50ml) and a few drops of sulphuric acid as a catalyst. The flask was fitted with a Dean-Stark apparatus and condenser. The mixture was refluxed for 24 hours, collecting water (6mls) in the

trap, indicating that the reaction had gone to completion.

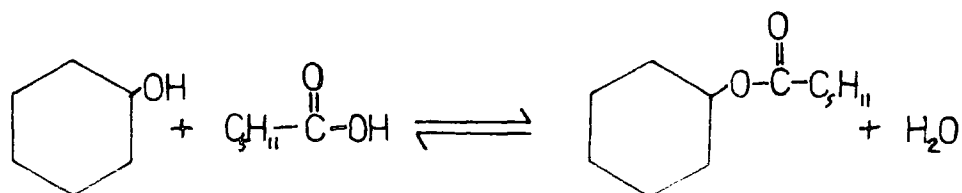

The product was obtained by distillation but during overnight storage in a fridge, the liquid turned pink. Further purification was carried out, using a concentric ring distillation apparatus. With the oil bath at 130°C, the distillate was collected at 65°C and a pressure of 13mm of mercury. Found C, 72.6; H, 11.6%. Calculated for C₁₂H₂₂O₂ C, 72.4; H, 11.6%, with correct infra-red spectrum (Appendix 1).

Increasing amounts of this compound were added to the lacquer of DY 026, the linear aliphatic epoxide, already investigated. The appearance of the resulting lacquers was observed, along with the degree of cure, after 30 minutes irradiation under the conditions already described; the results are tabulated below.

% PHOTO-INITIATOR	% RESIN DY 026	ESTER ‡	APPEARANCE OF LACQUER	CURE*
1.9	96.5	0.8	CLEAR	TACKFREE
1.9	93.4	4.0	CLOUDY	TACKFREE
1.8	89.8	7.7	FINE PPT.	TACKY
1.7	83.3	14.3	PPT.	NO CURE
1.2	71.7	26.6	PPT.	NO CURE

‡ cyclohexylhexanoate

* after 30 minutes irradiation

As the percentage of cyclohexylhexanoate in the lacquer increases, the solubility of the photoinitiator decreases, as is obvious from the appearance of the lacquer. The effect upon cure follows the same pattern, as the ester content

increases, cure decreases. Assuming that the cyclohexylhexanoate acts in the same manner as the cycloaliphatic carboxylates (CY 177 and CY 179), then one may presume that the incomplete cure is caused by the insolubility of diaryliodonium hexafluorophosphates in such systems, although this was not immediately obvious with the other lacquers. The failure to cure in the case of resins CY 177 and CY 179 occurs in the lower layers, and there is a surface skin of cured material, whereas the failure observed in the inhibited DY 026 lacquer was total and there was no cured film at the surface. An explanation of this difference in behaviour may lie in the difference in density between the DY and CY resins. Density measurements carried out in the laboratory yield the following values:

Cyclohexylhexanoate	0.8627g cm ⁻³
DY 026	1.0810g cm ⁻³
CY 177	1.1516g cm ⁻³
CY 179	1.1707g cm ⁻³

Unfortunately, the density of the photoinitiator is not known. There is sufficient difference (accentuated in the lacquers containing inhibitor) between the densities of the two resins for an insoluble compound of intermediate density to float in one medium and sink in the other. If diphenyliodonium hexafluorophosphate is such a compound, then this would explain the surface cure in CY 177 and CY 179 and the surface cure inhibition in DY 026-cyclohexylhexanoate lacquers.

SUMMARY
AND
SUGGESTIONS FOR FURTHER WORK

Three diphenyliodonium hexafluorophosphates were prepared for use as photoinitiators. Increasing difficulty was experienced in purification as substitution of the phenyl groups increased. Elemental analysis and spectroscopic characterisation of these photoinitiators was carried out, using a variety of techniques which allowed the exact nature of these compounds to be determined.

Five industrial resins were obtained from Ciba-Geigy for use as monomers. The identification and analysis of these resins was carried out in the laboratory, using both chemical and spectroscopic techniques. The results obtained were later confirmed by Ciba-Geigy.

Having successfully analysed and characterised the components, a variety of simple lacquer systems were prepared. The photoinitiated cure of these lacquers was carried out using a 100 watt ultra-violet lamp with quite a broad output spectrum.

The extent and rate of cure of these systems was observed through a pencil hardness method which, although still subjective, was found to be superior to the tackfree tests often employed for such qualitative observations. During the course of these determinations, it was found that some cycloaliphatic epoxide carboxylate based lacquers achieved cure only at the surface, whereas aromatic epoxides and other aliphatic epoxides not containing ester groups achieved through cure. Further investigations showed this to be due to the insolubility of the photoinitiator in the ester containing media. The photoinitiator segregates at the surface in the case of these particular resins.

A quantitative investigation of the cure of the aromatic lacquers was carried out using infra-red spectroscopy. This method showed some striking differences in the cure characteristics of the two lacquers studied. Results suggest that there may be an induction period before the initiation step of the polymerization begins. However, further work on these observations is clearly necessary before any definite conclusions can be drawn. The aliphatic lacquers could not be studied by this technique due to their mobility, as it was necessary to mount the samples vertically. However, if this problem were overcome, this technique would be very useful in the

quantitative investigation of the rate and extent of cure for each resin considered here.

In the initial stages of any continuation of this work, a more comprehensive study of the rate and extent of cure of the aromatic epoxide based lacquers by infra-red spectroscopy would seem to be the most profitable starting point. The solution to the problem of mounting mobile lacquers vertically would provide a very powerful tool in expanding the range of monomers investigated. Having overcome this difficulty, the effect of diluting the other four monomers with the reactive diluent, DY 026, could be studied prior to the final expansion to more complicated systems, such as those already employed in the coatings industry. Such an expansion would involve the introduction of pigments, fillers, etcetera, and a study of their influence on the photoinitiated cure.

APPENDIX 1

INDEX TO INFRA-RED SPECTRA

- 1 PI1
- 2 PI2
- 3 PI3
- 4 Hexachlorobuta-1,3,-diene
- 5 Cyclohexene oxide
- 6 Epichlorohydrin
- 7 Ethyl digol
- 8 Ethane diol
- 9 LY 558
- 10 LY 1805
- 11 CY 177
- 12 CY 179
- 13 DY 026
- 14 Cyclohexylhexanoate

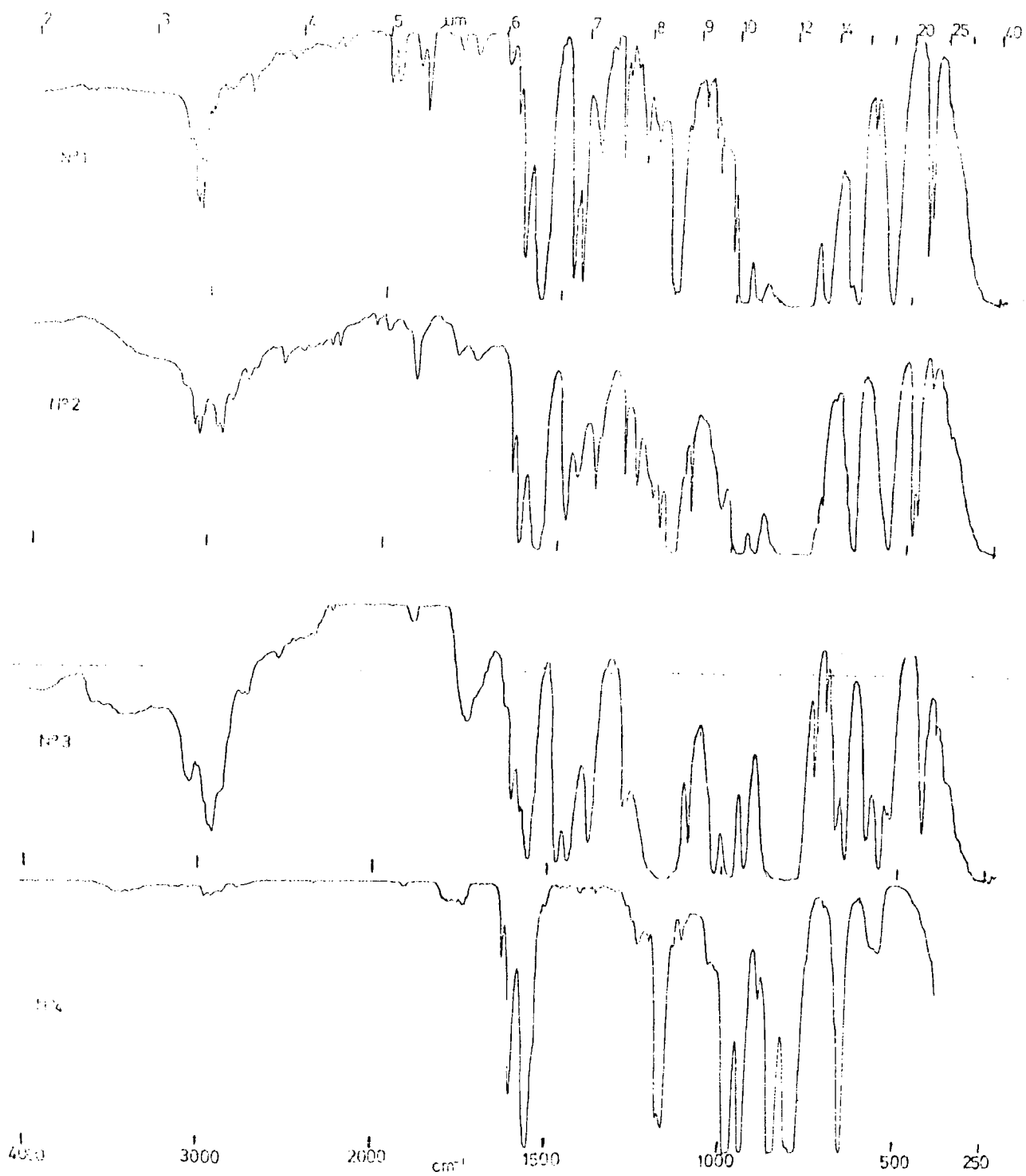

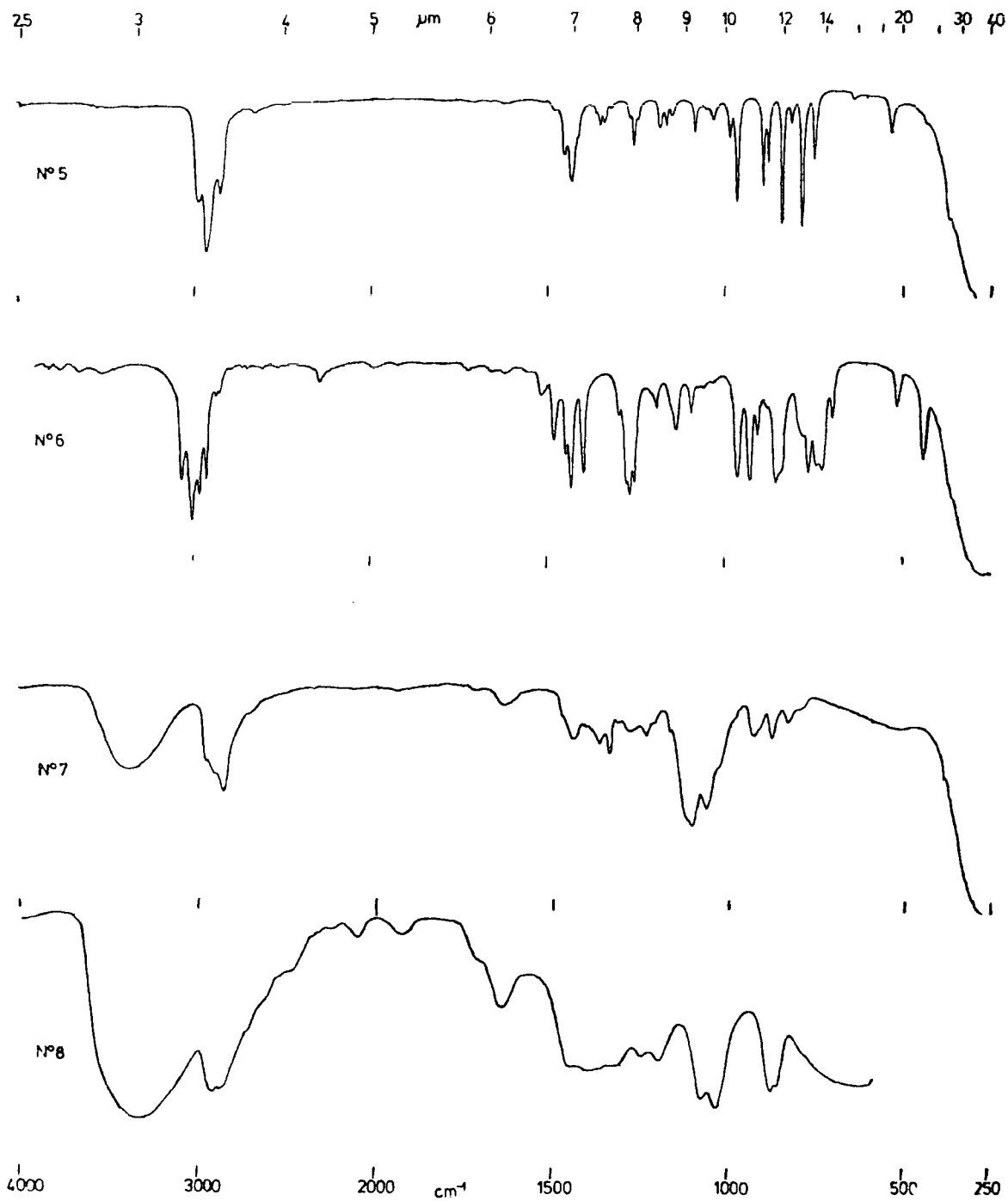

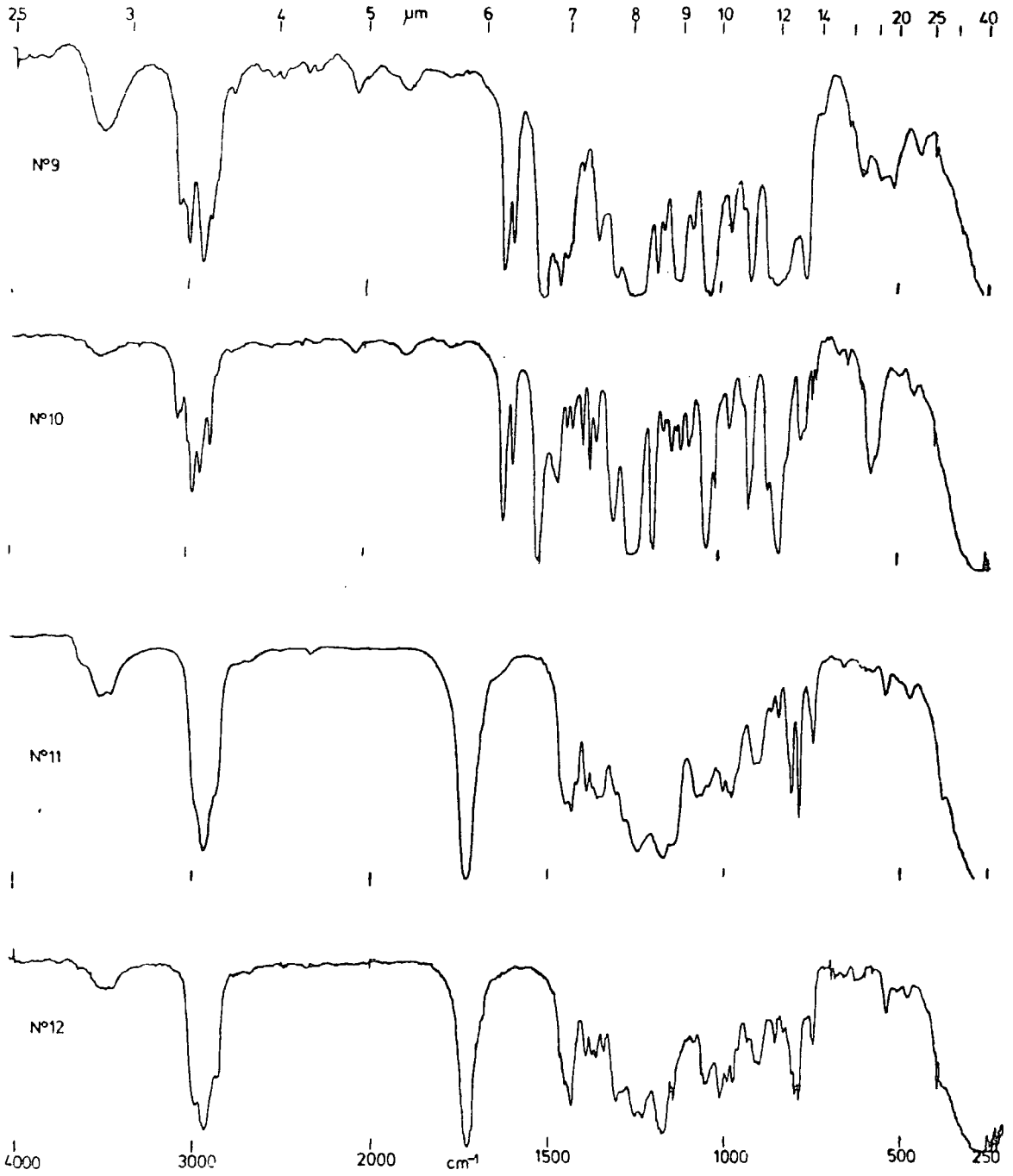

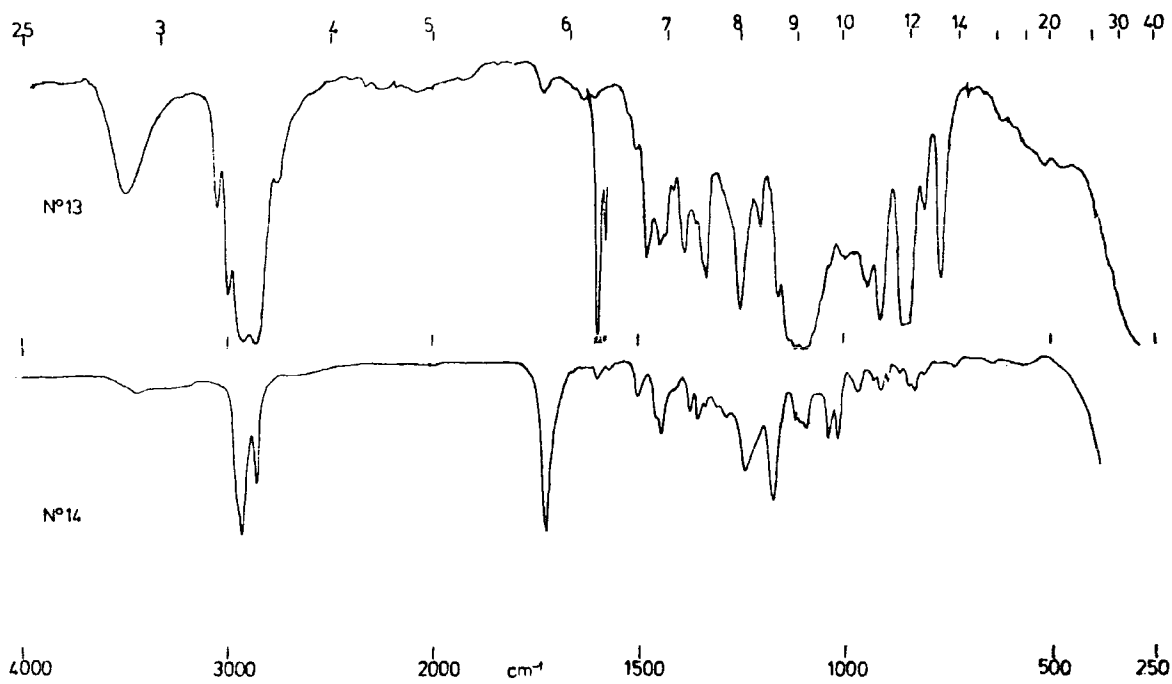

APPENDIX 2

THE IDENTITY AND MODE OF PRODUCTION OF THE RESINS

This appendix deals with the information received from Ciba-Geigy after the work in Chapter Four had been completed. It served to confirm the analysis of the compounds which was carried out with no pre-knowledge of the nature of the resins. The information received has been supplemented from the general literature to give a more complete picture of the production processes. The data for each resin has been divided into two sections, the data from Ciba-Geigy and the supplementary information.

ARALDITE LY 558

This resin is produced by reaction of a phenol novolak with epichlorohydrin.

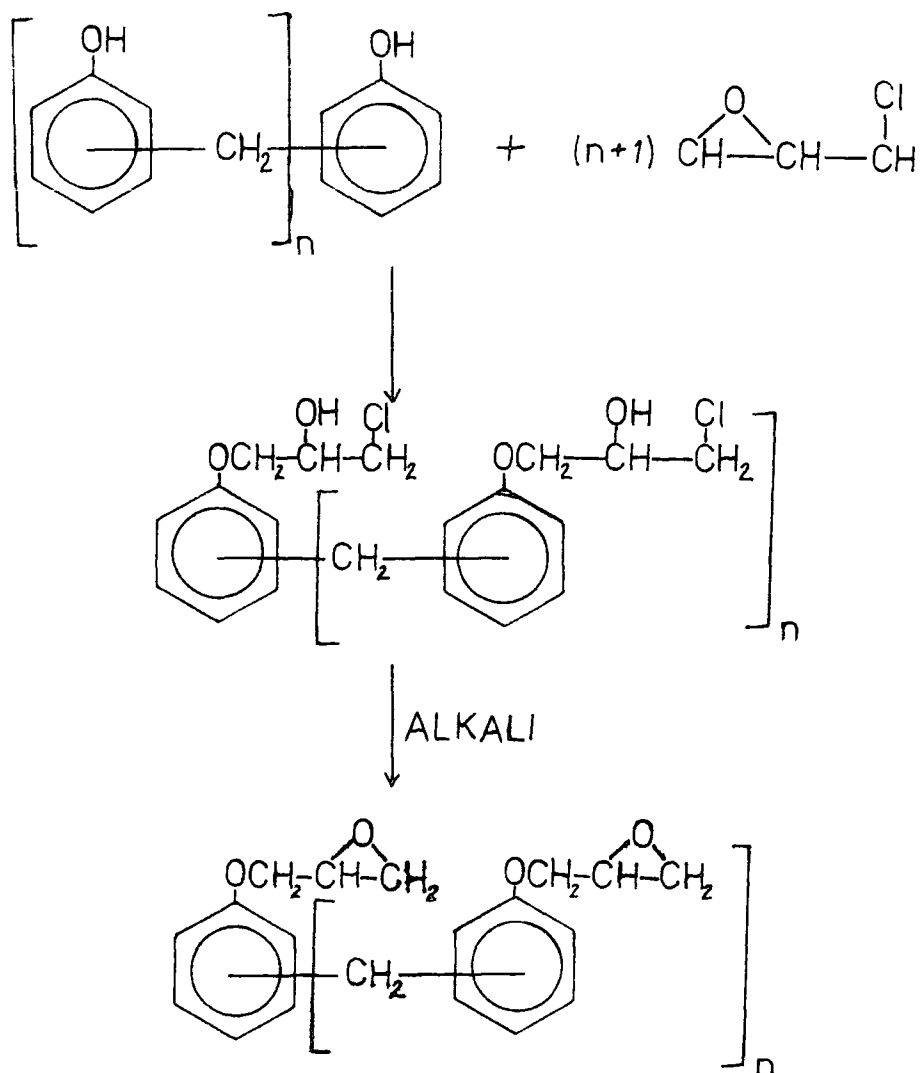

The linkages may be either ortho or para, and the average value of n is a number between 1.5 and 2.0 (in this particular case, it was found to be 1.93). This resin also contains a small amount of glycerol ether linkages, some chlorohydrins and a small number of α -glycols.

Supplement: Ciba-Geigy did not give details of phenol novolak manufacture but it is known that phenol novolaks of this type are usually prepared as the product of formaldehyde and phenol.

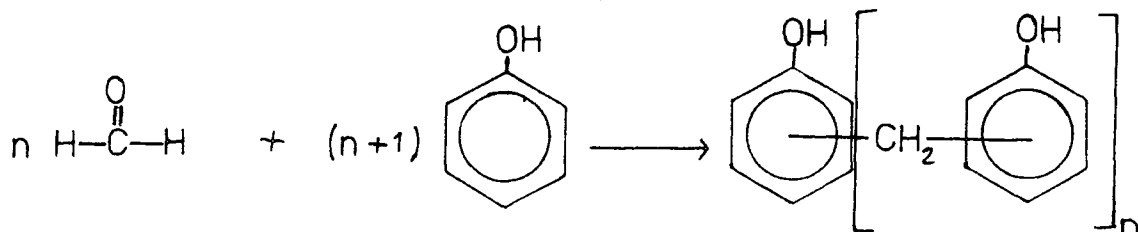

ARALDITE LY 1805

This resin is made from bisphenol A and epichlorohydrin. The first step is the formation of 3-chloro-2-hydroxypropyl ethers, most of the chlorohydrin groups are subsequently converted to epoxy groups by the action of alkali.

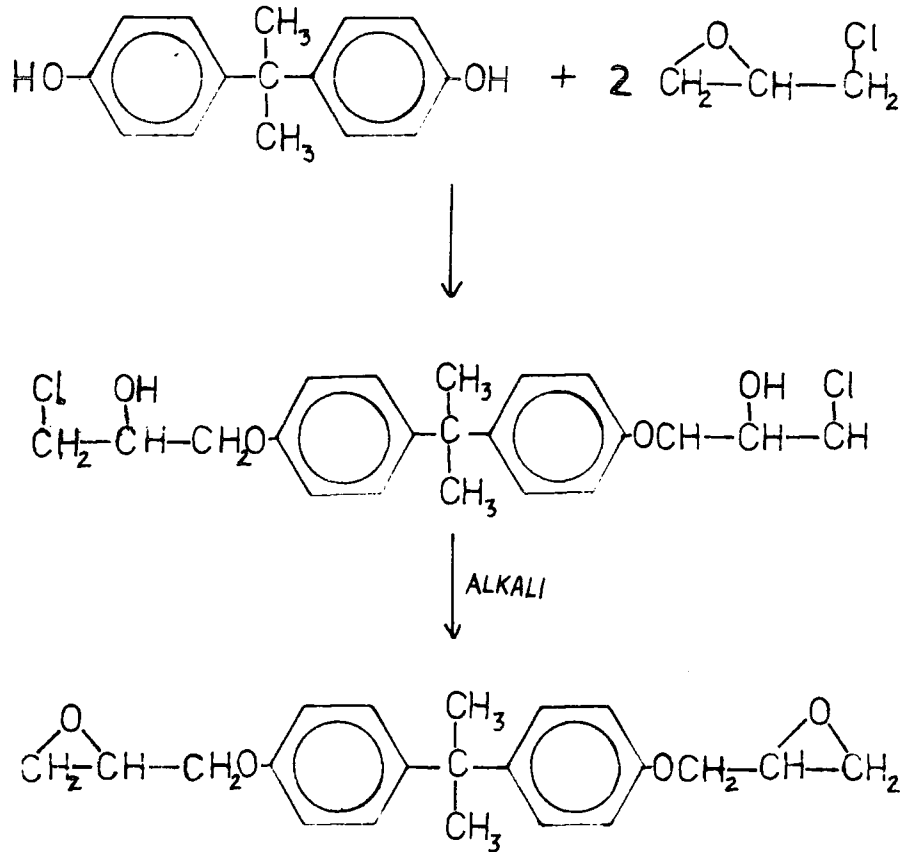

Side reactions produce the following compounds as impurities which can also play a role in curing reactions.

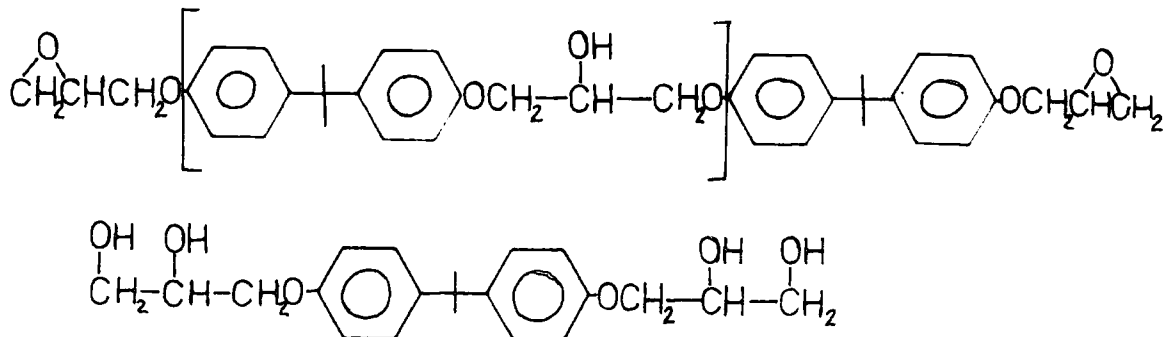

Supplement: Again no information was given on the formation of Ciba-Geigy's starting material but it is known that bisphenol A may be manufactured from the addition of phenol to acetone under acidic conditions.

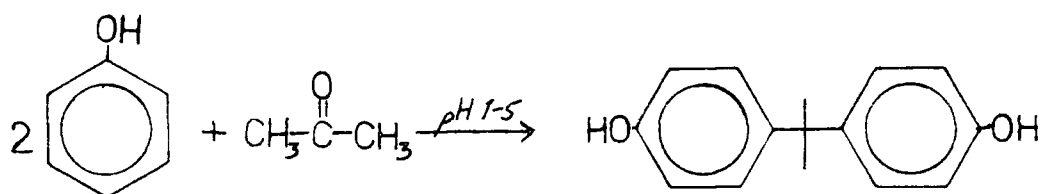

ARALDITE DILUENT DY 026

This diluent is the diglycidyl ether of 1,4-butanediol and contains some of the monoglycidyl ether, together with some chlorohydrin groups.

Supplement: From the above, it is assumed that its method of production is simply the reaction of 1,4-butanediol with epichlorohydrin.

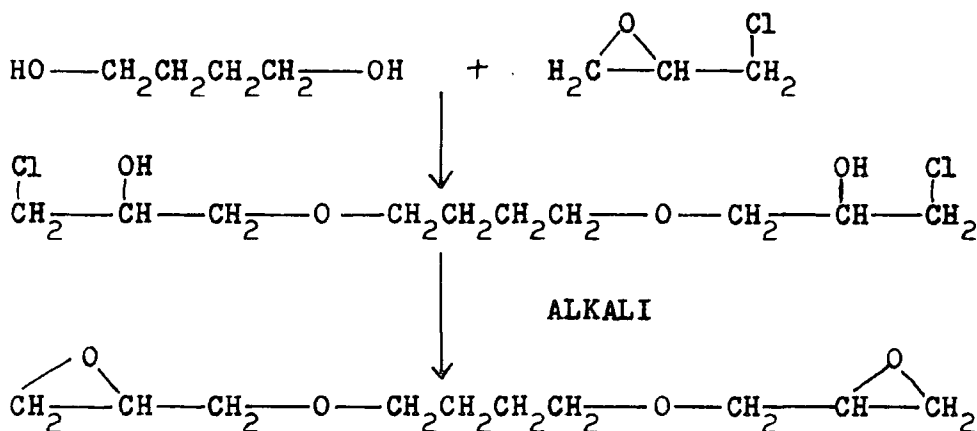

Incomplete reaction will result in the formation of the monoglycidyl ether

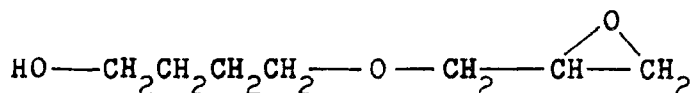

and, of course, residual chlorohydrin groups.

ARALDITE CY 179

This is an epoxy cyclohexane derivative made by peracid epoxidation of the corresponding cyclohexene-type compound.

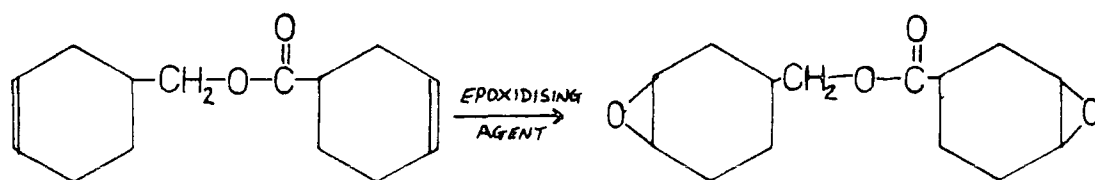

Apart from epoxide groups, the epoxidising agent introduces a small number of hydroxyl groups to the cyclohexane ring(s) of the product.

Supplement: The cyclohexene-type compound is actually cyclohexylmethylcyclohexane carboxylate and is commonly made from the Diels Alder reaction of buta-1,3-diene with propenal (acrylaldehyde), followed by a Tischenko reaction.

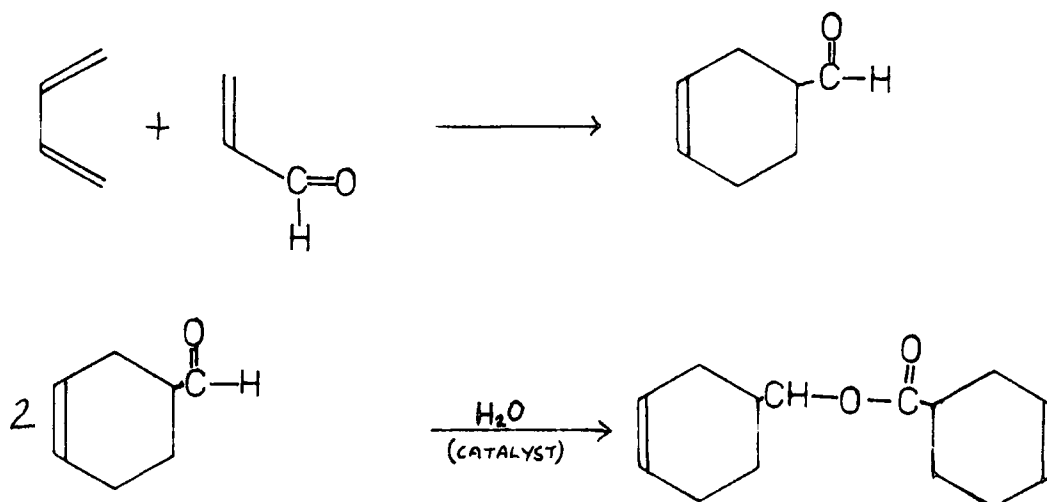

ARALDITE CY 177

At present, there is no data on this product but it is also an epoxycyclohexane derivative, differing from CY 179 essentially in having a different linkage between the epoxy-cyclohexane groups.

Supplement: In the course of this work, the structure has been elucidated as:

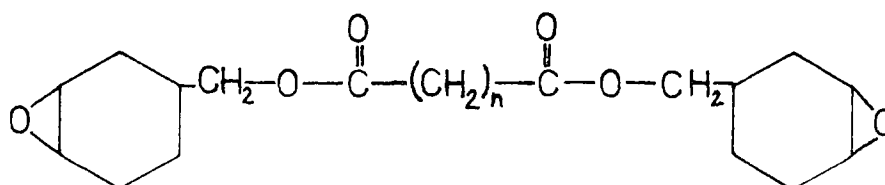

where n is a number, four or greater. Mass spectrometry suggests $n \approx 4$ but average molecular weight (M_n) allows values of n up to eight.

REFERENCES

- (1) R.S. Bauer, Ed., 'Epoxy Resin Chemistry', American Chemical Society, Washington, D.C., 1979
- (2) W.G. Potter, 'Epoxide Resins', Plastics Institute, London, 1970
- (3) I. Skeist, 'Epoxy Resins', Reinhold Book Corporation, 1968
- (4) H. Lee & K. Neville, 'Handbook of Epoxy Resins', McGraw-Hill Inc., 1967
- (5) R.S.R. Parker & P. Taylor, 'Adhesion and Adhesives', First Edition, Pergamon Press, 1966
- (6) J.M.G. Cowie, 'Polymers: Chemistry and Physics of Modern Materials', Intertext Books, 1973
- (7) A.D. Jenkins, 'Polymer Science', North-Holland Publishing Company, 1972
- (8) A.A. Gamble, Journal of Oil and Colour Chemists Association, 1976 (59), p240-244
- (9) S.I. Schlesinger, Photographic Science and Engineering, 1974, 18, (4), p387-393
- (10) S.P. Pappas, 'UV Curing Science and Technology', Technology Marketing Corporation, 1978
- (11) J.V. Crivello, J.H.W. Lam & C.N. Volante, Journal of Radiation Curing, 1977, 4, (3), p2
- (12) J.V. Crivello & J.H.W. Lam, 'Epoxy Resin Chemistry', ACS Symposia Service, 1978, 114, p1-16
- (13) J.V. Crivello & J.H.W. Lam, Journal of Polymer Science: Polymer Chemistry Edition, 1980, 18, p2677-2695
- (14) J.V. Crivello & J.H.W. Lam, Journal of Polymer Science: Polymer Chemistry Edition, 1980, 18, p2697-2714
- (15) A.D. Ketley & Jung-Hsien Tsao, Journal of Radiation Curing, 1979, p22
- (16) J.V. Crivello, (Gen. Elec. Corp.), German Patent 2839586, 22 March 1979
- (17) J.V. Crivello, J.H.W. Lam & C.N. Volante, Journal of Radiation Curing, 1977, 4, (3), p2-16
- (18) Minnesota Mining and Manufacturing Company, British Patent 1565671, 23 April 1980
- (19) J.V. Crivello & J.H.W. Lam, Macromolecules, 1977, 10, p1307-1315
- (20) A. Ledwith, International Symposium on Radiation Curing of Polymers, University of Liverpool, 17 December 1981
- (21) A.N. Nesmeyanov, L.G. Makarova & T.P. Tolstaya, Tetrahedron, 1957, 1, p145-157
- (22) C.D. Dudgeon, (Gen. Elec. Corp.), U.S. Appl 53,259 29 June 1979 (Abs)
- (23) J.V. Crivello (Gen. Elec. Corp.), PCT Int. Appl. 8002,838, 24 December 1980 (Abs)

- (24) J.V. Crivello, (Gen. Elec. Corp.), PCT Int. Appl. 8002,839, 24 December 1980 (Abs)
- (25) J.V. Crivello & J.H.W. Lam, 4th International Symposium on Cationic Polymerisation, Akron, Ohio, 24 June 1976, Journal of Polymer Science Symposia, 1976, 56
- (26) I. Masson & E. Race, Journal of the Chemical Society, 1937, 2, p1718
- (27) I. Masson & C. Argument, Journal of the Chemical Society, 1938, 2, p1702
- (28) D.A. Berry, R.W. Greenlee, W.C. Ellis & M.M. Baldwin, 12th International Congress of Pure and Applied Chemistry, New York N.Y., September 1950, Abstr. p465
- (29) J.R. Dyer, 'Applications of Absorption Spectroscopy of Organic Compounds', Prentice-Hall Inc., 1965
- (30) S.Siggia, 'Quantitative Analysis Via Functional Groups', Third Edition, John Wiley & Sons Inc., 1963
- (31) K. Kamide, T. Terakawa & H. Uchiki, Makromol. Chem., 1976, 177, p1447
- (32) G.R. Leader, Analytical Chemistry, 1970, 42, (1), p16
- (33) G.R. Leader, Analytical Chemistry, 1973, 45, (1), p1700
- (34) K.D. Bartle, R.S. Matthews & J.W. Stadelhofer, Applied Spectroscopy, 1980, 34, (6), p615
- (35) F.L. Ho, Analytical Chemistry, 1973, 45, (3), p603
- (36) Levy, Lichter & Nelson, '¹³C Nuclear Magnetic Resonance Spectroscopy', Second Edition, p109, 1980
- (37) R.S. Bauer, Ed., 'Epoxy Resin Chemistry', Ch 7, ACS Symposium Series 114, American Chemical Society, 1979
- (38) S.G. Davies & G.H. Whitham, Journal of the Chemical Society, Perkin 11, 1975, p861
- (39) A.J.J. de Breet, W. Dankelman, W.G.B. Huysmans & J. de Wit, Die Angewandte Makromolekulare Chemie, 1977, 62, p7-31
- (40) G.C. Stevens, Journal of Applied Polymer Science, 1981, 26, p4259
- (41) G.C. Stevens, Journal of Applied Polymer Science, 1981, 26, p4279